



SPARK PLUGS & COILS & WIRE SETS GLOW PLUGS & CONTROL UNITS

2019
—
2020

CATCM1803

A LEADING QUALITY RANGE



IGNITION

Champion is highly regarded for its top quality spark plugs. Now, we also offer revolutionary glow plug technologies, glow control units, coils and wire sets. This means Champion carries a wide range of high-quality ignition components for diesel and petrol engines alike.



FILTERS

Champion **oil, fuel, air and cabin filters** are designed to meet the stringent OE requirements. For all filter types, we offer you a **comprehensive range**. And each one will provide the quality performance and ease of installation Champion customers are accustomed to.



WIPERS

Champion has 3 brands in its wiper range:

High quality Aerovantage wipers match OE design and technology offering 98%* vehicle parc coverage.

Our compact Easyvision can service 95%* of the vehicle parc, including flat blade equipped cars thanks to the patented Multi Clip system.

The brand new Rainy Day offers 85% parc coverage in an ultra compact range at a great price.



LIGHTING

An outstanding lighting range. A reverse indicator. A cool interior light. Or perfectly processed halogen headlights and Xenon headlights for increased brightness, making you shine like you own the night.



BRAKES

If you get a quick start, you'll want a safe stop. That's why Champion now offers brakes, too. Pads, discs and shoe kits for the front and rear of the car, we've got them. So, Champion provides a matched solution with these simple-to-change brakes who will save you a lot of time.



BATTERIES

Start your engine. Designed to last and deliver optimal power, you can rely on Champion batteries to start your engine time after time. Champion offers a wide range of standard batteries & advanced EFB & AGM batteries for cars equipped with start/stop and brake regeneration systems.

Technical Code → Short Code

| Technical Code | Short Code |
|----------------|------------|
| A6GC | OE112 |
| C11YCC | OE057 |
| C9YC | OE003 |
| CJ6 | CJ6 |
| CJ7Y | CJ7Y |
| CJ8 | CJ8 |
| D16 | D16 |
| DJ8J | DJ8J |
| J17LM | J17LM |
| J19LM | J19LM |
| J8C | J8C |
| KA4ZPYPB4 | OE215 |
| KA6ZPHPB-1 | OE244 |
| KA8ZYCC-1 | OE247 |
| KC10PYPB4 | OE191 |
| KC6PYPB | OE214 |
| KC6PYPBX | OE222 |
| KC6ZWYPB | OE260 |
| KC7PYPBX | OE209 |
| KC7ZPMPBX4 | OE234 |
| KC7ZPYPB4 | OE213 |
| KC7ZTMC4 | OE235 |
| KC8PYP4 | OE228 |
| KC8WYPB4 | OE181 |
| KC8ZMCC | OE177 |
| KC8ZPYPB4 | OE176 |
| KEC4PYPB | OE210 |
| KEC4PYPBF | OE219 |
| KEC4PYPBF-1 | OE220 |
| KEC6WYPB-1 | OE246 |
| KER4PYPB | OE229 |
| L77JC4 | L77JC4 |
| L78C | L78C |
| L82C | L82C |
| L82YC | OE038 |
| L86C | CCH306C |
| L86C | OE037 |
| L87YC | OE007 |
| L92YC | OE059 |
| N11YC | OE065 |
| N12YC | OE015 |
| N3C | OE068 |
| N3G | OE078 |
| N4C | OE079 |
| N5C | OE074 |
| N6YC | OE087 |
| N7BYC | OE012 |
| N7YC | OE010 |
| N9BYC | OE044 |
| N9YC | OE001 |
| P-RA7HC | P-RA7HC |
| P-RG4HCC | P-RG4HCC |
| P-RG6HCC | P-RG6HCC |
| P-RG7C | P-RG7C |
| P-RZ7HC | P-RZ7HC |
| P-RZ9HC | P-RZ9HC |
| QCJ6Y | QCJ6Y |
| QCJ8Y | QCJ8Y |
| QL77JC4 | QL77JC4 |
| RA2PYPB | OE208 |
| RA4HC | OE073 |
| RA4HCX | OE052 |
| RA4YC | OE230 |
| RA6HC | OE083 |
| RA7PYPB4 | OE226 |

| Technical Code | Short Code |
|----------------|------------|
| RA7WHPB | OE187 |
| RA7YC | OE199 |
| RA8MCX4 | OE196 |
| RA8YCX4 | OE186 |
| RC10DMC | OE019 |
| RC10MCC | OE198 |
| RC10WMPB2 | OE184 |
| RC10WYPB4 | OE180 |
| RC10YC4 | OE063 |
| RC10YCC | OE016 |
| RC11LCC4 | OE114 |
| RC11PYPB4 | OE138 |
| RC12LC4 | OE128 |
| RC12LYC | OE041 |
| RC12MCC4 | OE154 |
| RC12WMPB4 | OE194 |
| RC12WYPB4 | OE193 |
| RC12YC | OE013 |
| RC6WYPBX | OE264 |
| RC6YCC | OE094 |
| RC7BMC | OE216 |
| RC7BYC | OE237 |
| RC7BYC | OE254 |
| RC7BYC4 | OE077 |
| RC7DYC | OE217 |
| RC7QMC | OE257 |
| RC7YCC | OE014 |
| RC87YCL | OE033 |
| RC89PYC | OE145 |
| RC89TMC | OE120 |
| RC89WYPB4 | OE182 |
| RC89YCC | OE093 |
| RC8BYC | OE030 |
| RC8DMC | OE026 |
| RC8PMPB | OE227 |
| RC8PYP | OE136 |
| RC8PYPB4 | OE146 |
| RC8QMC | OE218 |
| RC8TYC | OE123 |
| RC8VTYC4 | OE032 |
| RC8WMPB4 | OE188 |
| RC8WYPB4 | OE179 |
| RC8YCL | OE034 |
| RC8ZPYPB4 | OE239 |
| RC9MCC4 | OE089 |
| RC9QMP | OE223 |
| RC9YC | OE005 |
| RC9YC4 | OE039 |
| RC9YCC | OE002 |
| RCJ8 | RCJ8 |
| REA10WYPB | OE261 |
| REA12WMB4 | OE240 |
| REA4PMPB4 | OE233 |
| REA6PYPB | OE225 |
| REA6YC | OE231 |
| REA8MX | OE130 |
| REA8PMPB5 | OE207 |
| REA8WYPB | OE256 |
| REA8WYPB4 | OE253 |
| REC10PYC4 | OE175 |
| REC10WYPB4 | OE190 |
| REC10YC4 | OE148 |
| REC6TMC | OE236 |
| REC7PMPB4 | OE238 |
| REC7QMC | OE262 |

| Technical Code | Short Code |
|----------------|------------|
| REC8PYB | OE206 |
| REC8PYPB | OE224 |
| REC9MCLX | OE178 |
| REC9YCL | OE035 |
| RER12WMPB | OE263 |
| RER2PYPB | OE232 |
| RER3WYPB | OE248 |
| RER6DMC | OE211 |
| RER6YC | OE212 |
| RER8MC | OE201 |
| RER8WMPB | OE249 |
| RER8WYPB | OE250 |
| RER8YC | OE197 |
| RERX4PMPB | OE205 |
| RERX4ZWYPB | OE245 |
| RERX5PMPB | OE242 |
| RERX5ZPYPB | OE243 |
| RERX6PMPB4 | OE204 |
| RERX8PMPBX4 | OE203 |
| RES10TMC4 | OE255 |
| RES9PYP4 | OE029 |
| RES9WYPB5 | OE189 |
| RES9YCC4 | OE031 |
| RET4WYPBX | OE258 |
| RF7YC | OE054 |
| RG4HCX | OE241 |
| RG4PHP | OE122 |
| RG6YC | RG6YC |
| RG6YCA | RG6YCA |
| RJ17LM | RJ17LM |
| RJ19LM | RJ19LM |
| RJ19LMC | RJ19LMC |
| RL78C | RL78C |
| RL82C | OE086 |
| RL82YC | OE064 |
| RN10PYP4 | OE192 |
| RN10VTYC4 | OE027 |
| RN11YC | OE051 |
| RN11YC4 | OE049 |
| RN12YC | OE042 |
| RN14PMP5 | OE105 |
| RN1C | RN1C |
| RN2C | OE091 |
| RN3C | OE108 |
| RN4C | OE098 |
| RN7YC | OE018 |
| RN7YCC | OE008 |
| RN8VTYC4 | OE025 |
| RN8WYPB | OE195 |
| RN9YC | OE006 |
| RN9YC4 | OE048 |
| RN9YCC | OE004 |
| RS8WYPB5 | OE183 |
| RS9PYP4 | OE131 |
| RS9YC | OE011 |
| RV15YC4 | RV15YC4 |
| RV8C | RV8C |
| RX12ZYC | RX12ZYC |
| RY4C | RY4C |
| RZ7C | RZ7C |
| S12YC | OE099 |
| S9YC | OE009 |
| X | CCH425 |
| Z9Y | Z9Y |

TAKE A HEAD START EXPAND YOUR KNOWLEDGE ON CHAMPION PARTS



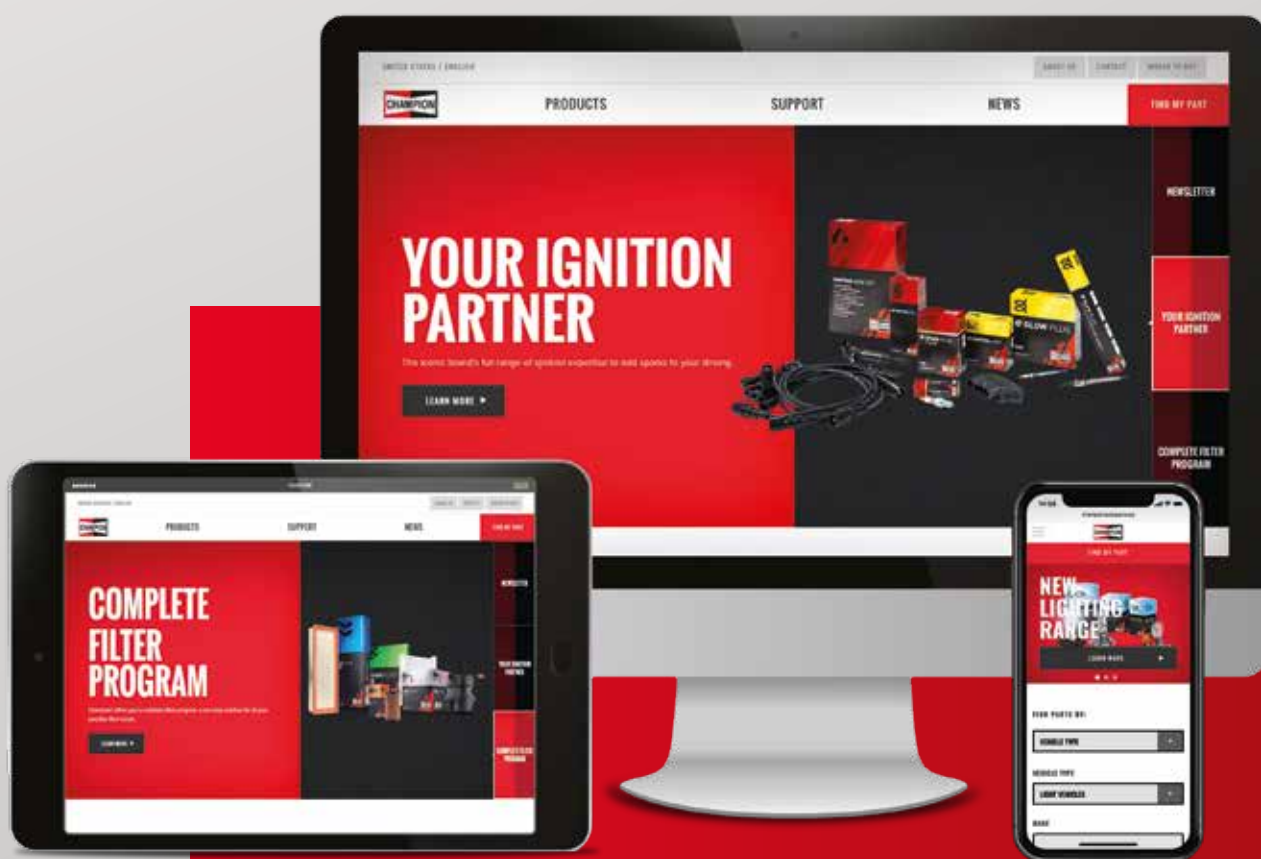







Visit our website and find out everything you need to know about the Champion Range.

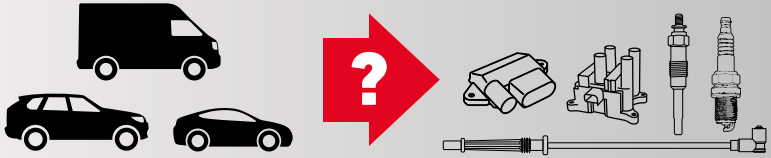

- Stay informed about new Champion Autoparts
- Discover the full Champion range: Ignition, Filters, Wipers, Lighting, Braking and Batteries
- Solve your installation issues with trouble tracers
- Watch our instructional installation videos
- ... and much, much more

www.championautoparts.eu

Table of contents

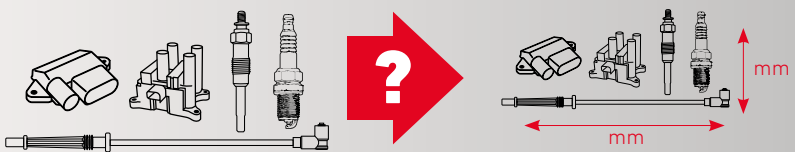
| | | |
|---|--|------------|
|  |  | II |
|  |  HOW TO USE THIS CATALOGUE | XIV |
|  |  | 1 |
|  |  | 338 |
|  |  | 382 |
|  |  | 471 |

CHAMPION IS LEADING IN SPARK PLUGS GLOBALLY, COVERING 95%* OF THE EUROPEAN CAR PARC

Our catalogue includes iridium, platinum and double copper spark plugs, as well as EON TITAN compact plugs featuring Thermal Contour and Poly-V technology. Each of these high-quality spark plugs is designed to optimise engine performance, resist erosion and minimise wear.



The image features a close-up of a Champion Iridium spark plug on the left, with its gold-colored tip and silver body. To its right is a circular logo with 'ORIGINAL QUALITY' around the perimeter and 'OE' in the center. On the far right, a person's hands are shown using a wrench to adjust a spark plug in an engine compartment.

Recent New Product Innovations include:

- Bi-Hex plugs for PSA and BMW/Mini
- 'Sidefire' plugs for VW OEM
- 'Cup Terminal' plugs for VW OEM
- New plugs for small-engine applications

* Source : FMPI/TecDoc : Parc Coverage Summary : of cars equipped with a Glow Plug Control Unit (for more info : www.tecalliance.net/en/company) 2018

EON TITAN: THE RELIABLE TECHNOLOGY FOR A GREAT PERFORMANCE



Formula 1 Ceramic technology for anti-flashover.

EON TITAN brings Champion's ribless F1 technology to the road: physically and dielectrically stronger and it ensures a maximum flashover protection.

FISS suppressor for a smooth balanced idling.

Fired in Suppressor Seal (FISS) construction maintains a consistent spark plug voltage for smoother idling and also contributes to cooling.

Thin walled copper core centre electrode for great heat dissipation.

The thin walls bring the copper nearer to the surface. The firing end retains heat longer under light engine loads to reduce cold fouling, while improving heat dissipation at high rpm to cut wear and extend spark plug life.

Longer core nose/broader seat for wider heat range.

The long core nose -more resistant to fouling- and increased seat diameter contribute to the turbo cooling effect around the core nose.

Gapped for performance.

Eon Titan gives that 'just new' acceleration feel throughout its full life and a superb combustion efficiency that cuts both fuel consumption and emissions.

Copper core.

- Machined thermal contour centre electrode (CET1-9) for precious-metal performance on naturally aspirated engines.
- Platinum fine-wire centre electrode (CET10P-18P) for maximum performance on turbo engines.

Titanium alloy poly-v ground electrode :

Filigree poly-v shape requires lower voltage for greater ignition reliability & better flame front propagation, nickel-titanium alloy provides high erosion resistance



Wired for success

The longevity of a car is determined by the quality of the OE in its engine and even more so, by the quality of the spare parts. Champion Wire Sets offer a price/quality performance of high order. We make sure that clients only pay for the required quality.

Matching the high aftermarket production quality

Champion's product range matches high aftermarket production quality. All three conductive cores are well protected by EPDM or XLPE inner insulation and the silicone outer jacket.

Carbon Core

- Carbon impregnated conductor
- RFI suppression created by resistance in carbon conductor (7 to 30 kOhms/m)

Wire Wound Core

- Wirewound conductor based on ferrite
- RFI suppression created by magnetic field

Copper Core

- Nickel plated copper conductor 1mm² (19 x 0.25mm²)
- RFI suppression created by resistors in the boots



Built for benefits

- **RESISTANT:** Ability to resist high temperatures
- **DURABLE:** Excellent resistance to the effects of salt, water, oil, petrol and acids
- **SAFE:** Secure radio interference suppression



Champion Ignition Coils: The decisive spark for every driving experience

Champion offers a new range of ignition coils, developed to match your vehicle.

- **Pencil Coils** in high-value material, available with electronics module.
- **Plug Top Coils** with electronics module and interference suppressed spark plug connector.
- **Ignition Coil Rails** with double and single spark technology.
- **Block Ignition Coils** for static high voltage distribution. Single and double spark coils available with and without integrated electronics modules for 4, 5 and 6 cylinders.
- **Coils for Ignition Systems with Ignition Distributors** for transistor ignitions, with mounted or integrated electronics module.
- **Canister Type Ignition Coils** for rotating high voltage distribution in older vehicles with contact-controlled battery ignition.

A GLOWING SUCCESS: RELIABLE INNOVATIONS FOR DIESEL ENGINES

Champion's Integrated Pressure Sensor Glow Plug,
Ceramic Glow Plug and Instant Start System

Champion has a long history of introducing new technologies for its range of ignition components. Three of the most groundbreaking ones are for glow plugs. They all ensure an ultra-fast warm-up for fast starting diesel engines, even in cold conditions.

By maintaining high temperatures after the engine has started, Champion's glow plugs keep engines running smoothly from the start as well as help lowering emissions.





Champion Integrated Pressure Sensor Glow Plug

By installing pressure sensor glow plugs higher peak pressures can be implemented in today's smaller engines, standard and future combustion processes can be pushed even further to their limits, and constantly stable emissions control can be obtained throughout the engine's entire service life. In each cylinder, the pressure sensor plug measures the rapidly changing pressure in the combustion chamber during each combustion cycle and transmits this information continuously to the engine control electronics.

The engine can be operated within the optimum window between maximum power and minimum exhaust gases.

- Combustion noise can be reduced.
- Enables constant stability of the combustion process.
- Effective compensation for injector ageing.

Champion Ceramic Glow Plug

The hardness and strength of the materials used for the plugs, withstand temperatures up to 1,100 °C. The short heat-up times, at the tip of the ceramic element, require less energy to generate the proper temperature to start the engine. That also means it needs less fuel.



Instant Start System

Instant reliability at the turn of a key

The Instant Start System for diesel engines with direct injection combines an electronic control unit and optimized glow plugs to reach temperatures up to 1,100 °C in 1 to 2 seconds. Even in temperatures as low as -25 °C. The usual glow plug needs about 5 seconds. Each glow plug can be controlled by a separate power semiconductor within the system. This allows separate monitoring of the current and individual diagnostics.

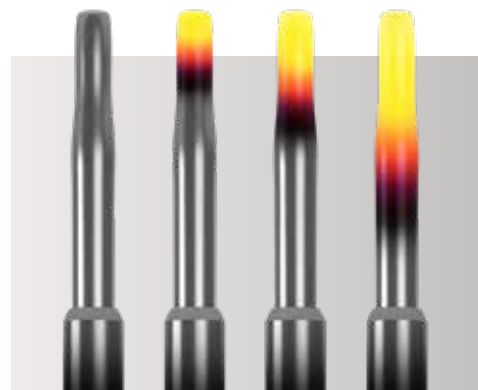

CHAMPION GLOW CONTROL UNITS NEVER MISS A START

Glow Control Units are the latest addition to the ever-expanding range of Champion's ignition technologies. As is the case with most of our ignition components, these units are produced using all proven technologies and industry-first innovations. They require the same quality standards as OE equipment and are tested accordingly.

Furthermore, and more importantly, this is an addition to a range of products made for each other. Champion Glow Control Units secure the optimum support to cold-start operations for every diesel engine.

With Champion's consistently developed range of Glow Control Units, you're guaranteed a long-term collaboration. That's real support.

26 SKUs - 90% European car parc coverage*
Champion Glow Plug Control Units fit 63 Mio cars in Europe, including Russia*



* Source : FMPI/TecDoc : Parc Coverage Summary : of cars equipped with a Glow Plug Control Unit (for more info : www.tecalliance.net/en/company) 2018



SPARK PLUGS: Chazelles*

- A **production facility right around the corner**
- **Quality** swiftly delivered
- **Short lead time**
- **Reduced customs duty** for export customers
- A **perfect location** for customer and Federal-Mogul training sessions or visits



GLOW PLUGS: Ludwigsburg**

- All-wheel **roller test bench**
- **Ceramics Competence Centre**
- Central **vibration test laboratory**
- Laboratories for **ignition system components and sensors**
- **Endurance** test area
- **Electromagnetic compatibility department** to test behavior of various electrical and electronic components
- **Conventional and special engine test benches** for fully automatic endurance and cold-start tests

IS*
NY

Ludwigsburg**
GERMANY

Carpi*
ITALY

Bhiwadi*
INDIA

Qingdao
CHINA

All OE applications manufacturers

AC | ACURA | ALFA ROMEO | ALPINA | ALPINE | AMERICAN MOTORS | ARO | ASIA MOTORS | ASTON MARTIN
| AUDI | AUSTIN | AUSTIN-HEALEY | AUTO UNION | AUTOBIANCHI | AVIA | BAOLONG | BARKAS | BEDFORD |
BENTLEY | BERTONE | BITTER | BMW | BORGWARD | BUGATTI | BUICK | CADILLAC | CARBODIES | CATER-
HAM | CHENGLONG | CHERY | CHEVROLET | CHRYSLER | CITROËN | DACIA | DADI | DAEWOO | DAF |
DAIHATSU | DAIMLER | DALLAS | DE TOMASO | DODGE | EAGLE | EUNOS | FERRARI | FIAT | FORD | FORD
OTOSAN | FOTON | FSO | GAZ | GEELY | GEO | GINETTA | GLAS | GOLDEN DRAGON | GREAT WALL |
HOLDEN | HONDA | HUMMER | HYUNDAI | INFINITI | INNOCENTI | IRMSCHER | ISUZU | IVECO | JAGUAR |
JEEP | KIA | LADA | LAMBORGHINI | LANCIA | LAND ROVER | LANDWIND (JMC) | LDV | LEXUS | LOTUS | LTI |
MAHINDRA | MARUTI | MASERATI | MAZDA | MERCEDES-BENZ | METROCAB | MG | MINI | MITSUBISHI |
MITSUOKA | MORGAN | MORRIS | MOSKVICH | NISSAN | NSU | OLCIT | OPEL | PANTHER | PEUGEOT |
PIAGGIO | PININFARINA | PLYMOUTH | PONTIAC | PORSCHE | PROTON | PUCH | RANGER | RAYTON FISSORE
| RELIANT | RENAULT | ROLLS-ROYCE | ROVER | SAAB | SANTANA | SEAT | SKODA | SMART | SSANGYONG |
SUBARU | SUZUKI | TALBOT | TATA (TELCO) | TOYOTA | TRABANT | TRIUMPH | TVR | UAZ | VAUXHALL |
VOLVO | VW | WARTBURG | WESTFIELD | WIESMANN | WOLSELEY | YUGO | YULON | ZASTAVA | ZAZ

* Marked plants are Federal-Mogul Powertrain plants ** Ludwigsburg is a BorgWarner plant

GB - IMPORTANT

Reproduction of this catalogue or parts thereof is only allowed with our explicit permission in writing. Pictorial representations and design are copyrighted. Claims for damages, of any form whatsoever, resulting from details made in this catalogue or from incorrect use, application, storage or handling, are explicitly excluded. Contractual rights and any resulting or related claims based thereon, irrespective of form, initially come into being on the basis of a separate written agreement, in particular on the basis of our general terms of sale and delivery. All former statements lose their validity with the publication of this catalogue. The catalogue is not an operating manual for the use and installation of the ignition products. It does not contain any advice in a legal sense. The catalogue neither replaces the constantly applicable technical regulations – particularly for tolerances – nor the installation and maintenance stipulations of the individual vehicle manufacturer. Also, it is not possible to forego the expertise of those carrying out the installation and application. The individual references made in this catalogue for the installation and the application of the ignition products are instructions solely for the technically qualified specialist and are to be checked and verified by them for their suitability in each case. Federal-Mogul accepts no responsibility for application decisions. The contents of the catalogue are not intended to create or substitute any contractual agreement which has to be reserved exclusively to a separate agreement between 2 identified parties, whereby seller can be only one of our Federal-Mogul entities as mentioned on the back cover page. The right is retained to correct errors and alterations, particularly with regard to amendments in the vehicle manufacturer's details and stipulations.

DE - WICHTIGE HINWEISE

Nachdruck, auch auszugsweise, ist nur mit unserer ausdrücklichen schriftlichen Zustimmung gestattet. Die bildlichen Darstellungen und Ausstattungen sind geschützt. Ersatzansprüche, gleich welcher Art, aufgrund der Angaben in diesem Katalog oder auf Grund unsachgemäßem Umgang, unsachgemäßer Verwendung, Lagerung oder Handhabung der angebotenen Produkte, sind ausdrücklich ausgeschlossen. Vertragliche Ansprüche und daraus abgeleitete oder darauf beruhende Ansprüche, gleich welcher Art, kommen erst auf Grund einer besonderen schriftlichen Vereinbarung, insbesondere auf der Grundlage unserer allgemeinen Verkaufs- und Lieferbedingungen, zustande. Der Katalog ist keine Einbauanleitung für Zündungsteile. Er enthält keine Beratung im Rechtssinne. Der Katalog ersetzt weder die immer vorrangigen technischen Vorschriften, insbesondere für Toleranzen, sowie die Einbau- und Wartungsvorschriften des jeweiligen Automobilherstellers, noch kann auf das notwendige Fachwissen des die Montage und die Verwendung Durchführenden verzichtet werden. Die in diesem Katalog jeweils gegebenen Hinweise für Einbau und Verwendung der Zündungsteile sind Hinweise ausschließlich für den technisch ausgebildeten und versierten Fachmann, die von ihm im jeweiligen Anwendungsfall auf ihre Eignung geprüft und entschieden werden müssen. Eine Haftung wird von Federal-Mogul für Anwendungsentscheidungen nicht übernommen. Die Inhalte dieses Katalogs sind nicht dazu bestimmt eine vertragliche Verpflichtung zu begründen oder zu ersetzen, was ausschließlich einer gesonderten Vereinbarung zwischen 2 konkret bezeichneten Parteien vorbehalten bleibt, wobei der Verkäufer eine unserer Federal-Mogul Gesellschaften sein wird, wie auf der Rückseite des Kataloges. Die Korrektur von Irrtümern und Änderungen, insbesondere auf Grund von geänderten Angaben und Vorschriften der Automobilhersteller, bleibt vorbehalten.

FR - IMPORTANT

La reproduction de ce catalogue, même partielle, n'est autorisée qu'avec notre accord préalable et par écrit. Les illustrations graphiques et la présentation font l'objet d'un copyright. Nous excluons toutes réclamations ayant pour objet ce catalogue ou pouvant résulter de son incompréhension, portant sur de mauvaises utilisations, manipulations, manutentions ou mauvais stockage. Des droits contractuels et des droits dérivés, de quelque nature qu'ils soient, ne peuvent résulter que d'un accord écrit, particulièrement sur la base de nos conditions générales de ventes et de livraisons. Ce catalogue annule et remplace toute édition antérieure. Le catalogue n'est pas une notice d'utilisation et de montage des produits d'allumage et de préchauffage. Il ne contient pas de directives en tant que telles. Le catalogue ne remplace ni les prescriptions techniques, toujours prioritaires, particulièrement pour les tolérances, ni les prescriptions de montage et d'entretien des constructeurs automobiles. Il ne peut en aucun cas remplacer les connaissances professionnelles nécessaires pour le montage et l'utilisation. Les remarques données pour le montage et l'utilisation des produits d'allumage et de préchauffage sont exclusivement destinées au professionnel averti et de formation technique, à qui il appartiendra de vérifier la conformité des indications pour chaque cas. La responsabilité des décisions d'utilisation ne peut être prise en charge par Federal-Mogul. Le contenu de ce catalogue ne peut constituer ou remplacer un contrat qui doit faire l'objet d'un document séparé établi entre 2 parties, dont l'une doit être une entité légale de Federal-Mogul dont la liste figure sur la couverture arrière. Nous nous réservons le droit d'apporter des corrections d'erreurs et modifications, suite notamment à de nouvelles données fournies par les constructeurs.

ES - IMPORTANTE

Queda totalmente prohibida la reproducción, total o parcial, del contenido de este catálogo, salvo nuestra previa autorización por escrito. Están, asimismo, reservados todos los derechos sobre el diseño y representación pictórica del catálogo. No se aceptará ningún tipo de reclamación fundamentada en la interpretación de los datos contenidos en este catálogo, así como en el incorrecto uso, manipulación o almacenaje de nuestras piezas. Únicamente se aceptarán reclamaciones que estén basadas en derechos contractuales o en los motivos arriba indicados siempre que exista un acuerdo especial y por escrito, con base en nuestras condiciones generales de venta y suministro. Con la edición de este catálogo queda anulada toda la información contenida en publicaciones anteriores. El catálogo no es un manual para el uso e instalación de los productos de encendido, y no representa una asesoría técnica en el sentido legal. Los datos del catálogo no sustituyen, en ningún caso, a las especificaciones técnicas, tanto en lo que se refiere a tolerancias como a las instrucciones de instalación y mantenimiento indicadas por los fabricantes de vehículos, especificaciones que serán siempre prioritarias. Las indicaciones sobre uso y montaje de los productos de encendido contenidas en este catálogo están exclusivamente dirigidas a profesionales con la debida cualificación y formación técnica, que deben decidir en cada caso sobre la exactitud de las mismas. La responsabilidad de estas decisiones no puede ser, en ningún caso, atribuida a Federal-Mogul. La información facilitada en el catálogo no representa o sustituye ningún tipo de acuerdo, quedando a tal efecto el acuerdo por separado entre dos partes identificadas, donde la parte vendedora sólo puede ser una de las entidades de Federal-Mogul mencionadas en la contraportada del catálogo. Los datos e instrucciones contenidos en este catálogo podrán ser corregidos o modificados sin previo aviso.

NL - BELANGRIJK

Reproductie van deze catalogus of gedeelten daarvan is uitsluitend toegestaan met onze uitdrukkelijke schriftelijke toestemming. Er rusten auteursrechten op afbeeldingen en ontwerp. Vorderingen wegens schade, in elke vorm, ten gevolge van informatie in deze catalogus of door verkeerd gebruik, toepassing, opslag of transport, zijn nadrukkelijk uitgesloten. Contractuele rechten en elke resulterende of daaraan gerelateerde aanspraken op basis daarvan, onafhankelijk van de vorm, ontstaan in eerste instantie op basis van een aparte schriftelijke overeenkomst, in het bijzonder op basis van onze algemene verkoop- en leveringsvoorwaarden. Alle eerdere verklaringen verliezen hun geldigheid met de publicatie van deze catalogus. De catalogus is geen bedieningshandleiding voor het gebruik en de montage van de ontstekingsproducten. Hij bevat geen advies in juridische zin. De catalogus vormt geen vervanging van de permanent geldende technische voorschriften – in het bijzonder voor toleranties – of voor de bepalingen voor montage en onderhoud van de individuele autofabrikant. De kennis van degene die de montage en toepassing uitvoert, is ook onontbeerlijk. De individuele verwijzingen in deze catalogus voor de montage en toepassing van de ontstekingsproducten zijn louter instructies voor de daarvoor opgeleide technische specialist en door hen moet voor elk geval worden gecontroleerd en geverifieerd of zij geschikt zijn. Federal-Mogul accepteert geen verantwoordelijkheid voor de keuze van toepassing. De inhoud van de catalogus is niet bedoeld voor het opstellen of vervangen van een contractuele overeenkomst die uitsluitend moet worden gereserveerd tussen 2 geïdentificeerde partijen, waarbij de verkoper uitsluitend een van onze Federal-Mogul entiteiten kan zijn die op de achtercover worden vermeld. Wij behouden ons het recht voor om fouten en wijzigingen te corrigeren, in het bijzonder met betrekking tot wijzigingen in details en bepalingen van de autofabrikant.

IT - IMPORTANTE

La riproduzione di questo catalogo, anche parziale, è permessa soltanto in seguito ad una autorizzazione scritta. I grafici ed i disegni sono marchio depositato. Reclami per difetti, di qualsiasi natura essi siano, relativi al contenuto di questo catalogo, o all'uso improprio di esso, verranno respinti. Le pretese avanzate od i reclami dovranno essere in conformita' con le nostre condizioni generali di vendita. Il presente catalogo annulla e sostituisce tutte le edizioni precedenti. Il catalogo non è un manuale per l'utilizzo ed il montaggio dei prodotti di accensione. Non contiene indicazioni in questo senso. Esso non sostituisce le descrizioni tecniche, sempre prioritarie, in particolare per le tolleranze, né le istruzioni relative al montaggio ed alla manutenzione date dai costruttori. Non può in nessun caso essere paragonato alla conoscenza professionale necessaria per il montaggio e l'utilizzo. Le considerazioni sui prodotti di accensione fatte su questo catalogo, sono destinate esclusivamente a professionisti con formazione tecnica i quali verificheranno l'esattezza della informazioni, in ogni caso. Le responsabilità derivanti dall'utilizzo improprio dello stesso non potranno essere addebitate alla Federal-Mogul. I contenuti del catalogo non sostituiscono in alcun modo gli accordi contrattuali che sono riservati esclusivamente a due contraenti definiti, come venditore si intende una delle società Federal-Mogul menzionate sul retro del catalogo. Ci riserviamo di apportare correzioni e modifiche relative, in particolare a dati o istruzioni ricevute dai costruttori.

© Federal-Mogul Corporation 2015

The contents of this publication are the copyright of Federal-Mogul Corporation.

Unauthorized reproduction in whole or in part is expressly forbidden.

Champion is a trademark of Federal-Mogul Corporation

RU - ВАЖНО

Копирование данного каталога или его частей допускается исключительно при получении нашего разрешения в письменной форме. Иллюстрации и дизайн защищены авторским правом. Требования о возмещении ущерба любой формы, исходя из содержания каталога или из-за неправильного использования, хранения или обращения, абсолютно исключены. Договорные права и любые результирующие или связанные с этим требования, независимо от их формы, должны являться частью отдельного письменного соглашения и основываться на наших общих условиях продаж и поставок. Все прежние утверждения теряют свою юридическую силу с момента публикации данного каталога. Каталог не является руководством пользователя и инструкцией по установке компонентов системы зажигания. Он не содержит советов в юридическом понимании этого слова. Каталог не является заменой для издаваемых автопроизводителями технических инструкций по ремонту, в особенности для допусков технических величин, а также инструкций по монтажу и регламентному обслуживанию. Отдельные ссылки для установки и использования компонентов системы зажигания, приведенные в этом каталоге, являются инструкциями исключительно для технически компетентного специалиста и в каждом случае должны быть проверены им на предмет их пригодности. Federal-Mogul не несет ответственность за ремонтные работы. Содержимое каталога не предназначено для создания или замены любого контрактного соглашения, которое может быть оформлено только в виде отдельного соглашения между двумя установленными сторонами, где продавцом может являться только одно из юридических лиц Federal-Mogul, как упомянуто на внутренней стороне обложки каталога. Federal-Mogul оставляет за собой право вносить исправления и изменения в частности в отношении поправок по деталям изготовителей транспортных средств и их условиям.

PL - WAŻNE

Powielanie tego katalogu lub jakiegokolwiek jego części jest dopuszczalne wyłącznie po uzyskaniu naszej jednoznacznej pisemnej zgody. Prezentacje graficzne i projekt są chronione prawami autorskimi. Jednoznacznie wykluczone są roszczenia odnośnie wszelkiego rodzaju szkód wynikających z informacji zawartych w tym katalogu, a także z nieprawidłowego użycia, zastosowania, magazynowania lub przechowywania. Wszelkie uprawnienia kontraktowe, a także wszelkie inne oparte na nich roszczenia, niezależnie od ich formy, wymagają do swej ważności osobnego pisemnego porozumienia sporządzonego w oparciu o nasze ogólne warunki sprzedaży i dostawy. Wszelkie wcześniejsze oświadczenia tracą ważność wraz z publikacją niniejszego katalogu. Niniejszy katalog nie jest podręcznikiem obsługi, opisującym sposób użytkowania i montażu elementów zapłonu. Nie zawiera on żadnych porad o charakterze prawnym. Niniejszy katalog nie zastępuje także aktualnie obowiązujących norm technologicznych – w szczególności dotyczących tolerancji – ani wskazówek poszczególnych producentów pojazdów odnośnie montażu i konserwacji. Nie może także zastępować specjalistycznego doświadczenia w zakresie montażu i zastosowań. Wszelkie podane w tym katalogu informacje odnośnie montażu i zastosowania elementów zapłonu są przeznaczone wyłącznie dla specjalistów o odpowiednich kwalifikacjach technicznych i muszą być zawsze sprawdzone oraz weryfikowane pod kątem ich odpowiedzialności do konkretnego przypadku. Firma Federal-Mogul nie ponosi odpowiedzialności za decyzje odnośnie konkretnych zastosowań. Treść niniejszego katalogu nie może stanowić ani zastępować porozumienia, które musi przysięgnąć formę osobnej umowy pomiędzy dwoma ściśle określonymi stronami, w której jako Sprzedawca może występować wyłącznie jeden z podmiotów Federal-Mogul (zob. wykaz na tylnej okładce). Zastrzegamy sobie prawo do wprowadzania poprawek i zmian, a w szczególności do modyfikacji danych wprowadzanych przez producentów pojazdów.

GR - ΣΗΜΑΝΤΙΚΟ

Η αναπαραγωγή αυτού του καταλόγου ή τμημάτων του επιτρέπεται μόνο με τη ρητή γραπτή άδεια μας. Οι εικονογραφημένες αναπαραστάσεις και τα σχέδια προστατεύονται με πνευματικά δικαιώματα. Εξαιρούνται ρητώς οι απαιτήσεις αποζημιώσεων, οποιασδήποτε μορφής, που απορρέουν από λεπτομέρειες που παρέχονται στον παρόντα κατάλογο ή από εσφαλμένη χρήση, εφαρμογή, αποθήκευση ή χειρισμό. Τα συμβατικά δικαιώματα και κάθε απορρέουσα ή σχετική αξίωση βάσει αυτών, ανεξαρτήτως μορφής, υφίστανται πρωτίστως βάσει ξεχωριστής γραπτής συμφωνίας και ιδιαίτερα βάσει των γενικών όρων μας αναφορικά με την πώληση και παράδοση. Κάθε προηγούμενη δήλωση χάνει την εγκυρότητά της με την έκδοση του παρόντος καταλόγου. Ο κατάλογος δεν θεωρείται εγχειρίδιο λειτουργίας για τη χρήση και εγκατάσταση των προϊόντων ανάφελης. Δεν περιέχει συμβουλές με τη νομική έννοια του όρου. Ο κατάλογος δεν αντικαθιστά τους πάγια ισχύοντες τεχνικούς κανονισμούς – ιδιαίτερα αναφορικά με τις ανοχές – ούτε τους κανόνες εγκατάστασης και συντήρησης των εκάστοτε κατασκευαστών αυτοκινήτων. Επίσης, πρέπει να λαμβάνεται υπόψη η ειδικότητα των ατόμων που εκτελούν την εγκατάσταση και εφαρμογή. Οι μεμονωμένες αναφορές στον παρόντα κατάλογο για την εγκατάσταση και εφαρμογή των προϊόντων ανάφελης παρέχονται ως οδηγίες αποκλειστικά για τεχνικά ειδικευμένα άτομα και οφείλουν να ελέγχονται και να επαληθεύονται από τα εν λόγω πρόσωπα, ως προς την καταλληλότητά τους, σε κάθε περίπτωση. Η Federal-Mogul δεν αναλαμβάνει καμία ευθύνη για τις αποφάσεις εφαρμογής. Τα περιεχόμενα του καταλόγου δεν προτίθενται να δημιουργήσουν ή υποκαταστήσουν οποιαδήποτε συμβατική συμφωνία, η οποία περιορίζεται ρητώς σε ξεχωριστή συμφωνία μεταξύ 2 κατανομαζόμενων μερών, εκ των οποίων πωλητής μπορεί να είναι μόνο μία από τις εταιρείες της Federal-Mogul που αναφέρονται στο οπισθόφυλλο. Επιφυλάσσεται το δικαίωμα διόρθωσης σφαλμάτων και τροποποιήσεων, ιδιαίτερα αναφορικά με τροποποιήσεις στις λεπτομέρειες και τους ορισμούς του κατασκευαστή του οχήματος.

PT - IMPORTANTE

A reprodução deste catálogo ou parte do mesmo só é permitida mediante a nossa aprovação explícita por escrito. As imagens e o design estão sujeitos a direitos de autor. Reclamações relativas a danos, sob qualquer forma, resultantes de pormenores realizados neste catálogo ou de uso indevido, aplicação, armazenamento ou manuseamento, são explicitamente excluídas. Os direitos contratuais ou quaisquer reclamações resultantes ou relacionadas com os mesmos, independentemente da forma, estão inicialmente na base de um acordo escrito em separado, especialmente no que diz respeito aos nossos termos gerais de venda e entrega. Todas as declarações anteriores perdem a sua validade com a publicação deste catálogo. O catálogo não é um manual de funcionamento para a utilização e instalação dos produtos de ignição. Este não contém nenhum conselho no sentido legal. O catálogo não substitui os regulamentos técnicos constantemente aplicáveis – especialmente no que diz respeito a tolerância – nem as estipulações de instalação e manutenção do fabricante individual do veículo. Para além disso, não é possível ignorar a experiência dos que realizam a instalação e a aplicação. As referências individuais mencionadas neste catálogo para a instalação e aplicação dos produtos de ignição são apenas indicadas para o técnico especialista qualificado e devem ser verificadas pelo mesmo relativamente à sua adequação em cada caso. A Federal-Mogul não aceita quaisquer responsabilidades relativas às decisões de aplicação. Os conteúdos deste catálogo não têm como objetivo criar ou substituir qualquer acordo contratual que está reservado exclusivamente a um acordo separado entre 2 partes identificadas, onde o vendedor só poderá ser uma das entidades da Federal-Mogul conforme mencionado na contracapa. O direito remete-se apenas para a correção de erros e alterações, especialmente no que diz respeito a alterações nas estipulações e pormenores dos fabricantes do veículo.

HU - FONTOS

Ennek a katalógusnak vagy részének a sokszorosítása csak kifejezett írásos engedéllyel megengedett. A képi illusztrációkat és a formai kialakítást szerzői jog védi. Az ebben a katalógusban foglaltakkal kapcsolatban, illetve nem megfelelő használatból, alkalmazásból, tárolásból vagy kezelésből eredően kárigény nem támasztható. A szerződéses jogok, illetve az ezen alapuló vagy ebből eredő követelések jellegüktől függetlenül egy külön írásos szerződés keretén belül lének hatálya, különös tekintettel az általános értékesítési és szolgáltatási feltételeink szerint. Minden korábbi megállapodás elveszíti az érvényességét a katalógus kiadását követően. Ez a katalógus nem egy, gyűjtésalkatrészek használatára és beszerelésére vonatkozó kézikönyv. Jogi értelemben nem tartalmaz semmilyen tanácsot. A katalógus nem helyettesíti a mindenkor érvényben lévő műszaki előírásokat (különösen a tűrésüket nem), illetve az egyes járműgyártók beszerelési és arbantartási utasításait. Ezen felül nem helyettesíti a beszerelést és alkalmazást végzők tapasztalatát. Az ebben a katalógusban lévő, gyűjtésalkatrészek beszerelésére és alkalmazására vonatkozó egyes hivatkozások kizárólag műszakilag képzett szakembereknek szólnak, és megfelelőségüket az egyes esetekben nekik kell ellenőrizniük. A Federal-Mogul nem vállal felelősséget az alkalmazással kapcsolatos döntésekért. Ennek a katalógusnak a tartalma nem hoz létre vagy helyettesít egy olyan szerződéses megállapodást, amelyet kizárólag két fél között kívántak létrehozni, ahol az eladó valamelyik, a belső hátsó borítón említett Federal-Mogul mint jogi személy. Fenntartjuk a jogot a hibák kijavítására és a módosításokra, különös tekintettel a motorgyártó részleteinek és a kikötéseinek részleteivel kapcsolatban.

CZ - DŮLEŽITÉ

Jakákoliv reprodukce tohoto katalogu nebo jeho části je přípustná jen s naším výslovným písemným povolením. Ilustrace a design jsou chráněny autorským právem. Výslovně se vylučují jakékoliv nároky na odškodnění jakéhokoliv druhu v souvislosti s detaily uvedenými v tomto katalogu nebo s nesprávným použitím, aplikací, skladováním nebo manipulací. Smluvní práva a jakékoliv vyplývající nebo související nároky, bez ohledu na jejich formu, primárně vycházejí ze samostatné písemné dohody, zejména z našich všeobecných prodejních a dodacích podmínek. S publikací tohoto katalogu ztrácí platnost veškerá předchozí prohlášení. Katalog není provozním návodem k použití a instalaci dílu zapalování. Neobsahuje žádné rady v zákonném slova smyslu. Katalog ani nenahrazuje trvale platné technické předpisy – zejména tolerance – ani podmínky instalace či údržby stanovené jednotlivými výrobci vozidel. Dále je nutno zajistit kvalifikovanost osob provádějících instalaci a použití výrobku. Jednotlivé odkazy obsažené v tomto katalogu ve vztahu k instalaci a použití dílu zapalování jsou pokyny určené výhradně pro technicky kvalifikované specialisty, kteří jsou v každém případě povinni zkontrolovat a ověřit jejich vhodnost. Společnost Federal-Mogul nepřijímá žádnou odpovědnost za rozhodnutí o aplikaci (použití). Obsah katalogu není určen k vytvoření nebo nahrazení jakékoliv smluvní dohody, které je nutno realizovat výlučně na základě samostatné smlouvy mezi 2 identifikovanými stranami, přičemž prodávající může být pouze jeden z našich subjektů Federal-Mogul uvedených na vnitřní straně obálky katalogu. Ponecháváme si právo na opravu chyb a provádění změn, zvláště ve vztahu ke změnám detailů a podmínek výrobců vozidel.

R

| | |
|---|-------------------------|
| - | Non |
| K | 1-2 |
| Q | 0.1-0.14 |
| R | SAC9 6-15 FISS 3-10 |
| U | Booster Gap : Non |
| X | Dual 6-15 + 0.1-0.13 |

ERX

| | mm | mm | mm | mm | Nm | Cast Iron Head | Alu-minium Head |
|--------|-----------|-------------|-----------|--------|-------|----------------|-----------------|
| A | 16 | M12x1.25 mm | 19 | Gasket | 15-25 | 12-20 | |
| AX | 18 | M12x1.25 mm | 19 | Gasket | 15-25 | 12-20 | |
| C | 16 | M14x1.25 mm | 19 | Gasket | 20-35 | 15-30 | |
| CJ | 19 | M14x1.25 mm | 9.5 | Gasket | 20-35 | 15-30 | |
| D | 23 | M18x1.5 mm | 12.7 | Gasket | 30-45 | 20-35 | |
| DJ | 16 | M14x1.25 mm | 8.3 | Taper | 15-25 | 12-20 | |
| DZ | 16 | M10x1 mm | 12.7 | Taper | 11-12 | 11-12 | |
| EA | 14 | M12x1.25 mm | 26.5 | Gasket | 15-25 | 12-20 | |
| EC | 16 | M14x1.25 mm | 26.5 | Gasket | 20-35 | 15-30 | |
| ER | 16 | M12x1.25 mm | 26.5 | Gasket | 15-25 | 12-20 | |
| ERX | BI-HEX 14 | M12x1.25 mm | 26.5 | Gasket | 15-25 | 12-20 | |
| E / ES | 16 | M14x1.25 mm | 25 | Taper | 15-25 | 12-20 | |
| F | 21 | M18x1.5 mm | 11.7 | Taper | 15-30 | 15-25 | |
| FN | 16 | M14x1.25 mm | 19 | Gasket | 20-35 | 15-30 | |
| G | 16 | M10x1 mm | 19 | Gasket | 10-15 | 10-15 | |
| H | 21 | M14x1.25 mm | 11.1 | Gasket | 20-35 | 15-30 | |
| J | 21 | M14x1.25 mm | 9.5 | Gasket | 20-35 | 15-30 | |
| L | 21 | M14x1.25 mm | 12.7 | Gasket | 20-35 | 15-30 | |
| N | 21 | M14x1.25 mm | 19 | Gasket | 20-35 | 15-30 | |
| P | 18 | M12x1.25 mm | 12.5 | Gasket | 15-25 | 12-20 | |
| S | 16 | M14x1.25 mm | 18 | Taper | 15-25 | 12-20 | |
| V | 16 | M14x1.25 mm | 11.7 | Taper | 15-25 | 12-20 | |
| W | 24 | 7/8"-18 | 16 > 19 | Gasket | 67-74 | - | |
| X | 16 | M14x1.25 mm | 12.7 | Gasket | 20-35 | 15-30 | |
| Y | 16 | M10x1 mm | 6.4 > 9.5 | Gasket | 10-15 | 10-15 | |
| Z | 16 | M10x1 mm | 12.7 | Gasket | 10-15 | 10-15 | |
| ZF | 21 | M18x1.5 mm | 11.1 | Taper | 15-30 | 15-25 | |
| X PLUG | 24 | 1/2"-14 | 25.4 | Taper | | | |
| 7989 | 16 | M16x1.5 mm | 21.6 | Taper | | | |

BI-HEX



7989 FORD HIGH THREAD DESIGN

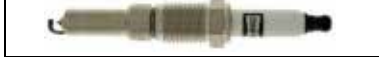

X PLUG FORD MODEL T



8

| | | |
|----|----|----|
| 23 | | |
| 21 | | |
| 20 | | |
| 19 | 95 | |
| 19 | 95 | |
| 18 | 91 | |
| 17 | 90 | |
| 16 | | |
| 15 | | |
| 14 | | |
| 13 | | |
| 12 | 86 | |
| 11 | | |
| 10 | | |
| 9 | | |
| 8 | | |
| 7 | | |
| 6 | 85 | 63 |
| 5 | 82 | 61 |
| 4 | 81 | 59 |
| 3 | 79 | |
| 3 | 77 | 57 |
| 2 | 76 | |
| 1 | 75 | |
| 2 | | 55 |
| 1 | | 54 |
| 1 | | 53 |

PMPBX

| #Z.... | Skirted shell | | Z |
|--------|----------------|-------------------|---------------------|
| - | Nickel | Nickel | 1 non |
| A | Nickel | Nickel | 1 non A |
| B | Nickel | Nickel | 2 non |
| BMC | Copper | Nickel | 2 3.0 |
| BVC | Copper | Nickel | 2-3 1.5 |
| C | Copper | Nickel | 1 non |
| CC | Copper | Copper | 1 non |
| CX | Copper | Nickel | 1 non C |
| D | Nickel | Nickel | 1 8.4 |
| DMC | Copper | Nickel | 2 3.0 |
| DR | Nickel | Nickel | 1 non |
| DYC | Copper | Nickel | 2 1.5 |
| ECC | Copper | Copper | 1 7.4 |
| F | Copper | Nickel | 3 non |
| G | Gold Palladium | Nickel | 1 non |
| GC | Gold Palladium | Copper | 1 non |
| H | Nickel | Nickel | 1 0.8 |
| HC | Copper | Nickel | 1 0.8 |
| HCC | Copper | Copper | 1 0.8 |
| HGX | Copper | Nickel | 1 0.8 C |
| HX | Nickel | Nickel | 1 0.8 C |
| J | Nickel | Nickel | 1 non |
| JC | Copper | Nickel | 1 non |
| LC | Copper | Nickel | 1 2.3 |
| LCC | Copper | Copper | 1 2.3 |
| LM | Nickel | Nickel | 1 non |
| LMC | Steel | Copper | 1 non |
| LY | Nickel | Nickel | 1 5.1 |
| LYC | Copper | Nickel | 1 5.1 |
| MC | Copper | Nickel | 1 3.0 |
| MCC | Copper | Copper | 1 3.0 |
| MCLX | Copper | Copper | 1 3.0 RCN |
| MCX | Copper | 125 Nickel | 1 3.0 |
| MX | Copper | 125 Nickel | 1 3.0 |
| P | Platinum | Nickel / Platinum | 1 > 2 non |
| PEC | Platinum | Copper | 1 7.4 |
| PEP | Platinum | Platinum | 1 7.4 |
| PEPB | Platinum | Platinum | 1 7.4 B |
| PHP | Platinum | Platinum | 1 0.8 |
| PLP | Platinum | Platinum | 1 5.1 |
| PLPB | Platinum | Platinum | 1 5.1 B |
| PNC | Platinum | Copper | 1 3.0 |
| PMCB | Platinum | Copper | 1 3.0 B |
| PMP | Platinum | Platinum | 1 3.0 |
| PMPB | Platinum | Platinum | 1 3.0 B |
| PMPBX | Platinum | Platinum | 1+2 3.0 B & 1+2 |
| PP | Platinum | Platinum | 1 non |
| PYB | Platinum | Nickel | 1 1.5 |
| PYC | Platinum | Copper | 1 1.5 |
| PYCB | Platinum | Copper | 1 1.5 B |
| PYCBX | Platinum | Copper | 1 1.5 B & RCN |
| PYP | Platinum | Platinum | 1 1.5 |
| PYPB | Platinum | Platinum | 1 1.5 B |
| PYPBF | Platinum | Platinum | 1 1.5 F |
| PYPBX | Platinum | Platinum | 1 1.5 B & RCN / 1+2 |
| QMC | Copper | Nickel | 4 3.0 |
| QMP | Platinum | Nickel | 4 3.0 |
| R | Nickel | Nickel | 1 non |
| TMC | Copper | Nickel | 3 3.0 |
| TYC | Copper | Nickel | 3 1.5 |
| V | Nickel | non | non non V |
| VC | Copper | non | non non V |
| VPYC | Platinum | Copper | 1 1.5 |
| VTYC | Copper | Nickel | 3 1.5 |
| WEP | Iridium | Platinum | 1 7.4 B |
| WHPB | Iridium | Platinum | 1 0.8 B |
| WMPB | Iridium | Platinum | 1 3.0 B |
| WP | Iridium | Platinum | 1 non |
| WYCB | Iridium | Copper | 1 1.5 B |
| WYPB | Iridium | Platinum | 1 0.8 B |
| Y | Nickel | Nickel | 1 1.5 |
| YC | Copper | Nickel | 1 1.5 |
| YCC | Copper | Copper | 1 1.5 |
| YCL | Copper | Copper | 1 1.5 |
| YCX | Copper | 125 Nickel | 1 1.5 |
| YDR | Nickel | Nickel | 1 1.5 C |
| YX | Nickel | Nickel | 1 1.5 B |
| X plug | Nickel | Nickel | 1 non |
| 7989 | Platinum | Platinum | 1 1.4 |

4

| | |
|---|--------------|
| - | 0.7 - 0.9 mm |
| 2 | 0.6 mm |
| 3 | 0.9 mm |
| 4 | 1.0 mm |
| 5 | 1.3 mm |
| 6 | 1.5 mm |
| 8 | 2.0 mm |

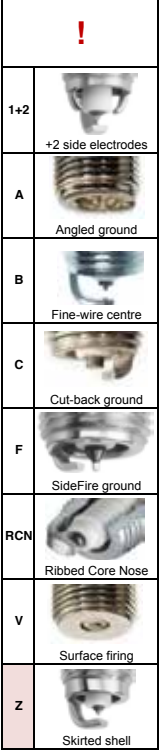

**Verwendungshinweis - Comment utiliser - Cómo usarlo - Hoe te gebruiken - Come si utilizzano -
 Основы использования - Jak korzystać z katalogu - Οδηγίες χρήσης - Como utilizar - Hogyan
 használd - Návod k použití**

| EN | D | F | ES | NL | I | RU | PL | GR | PT | HU | CZ |
|-----------------------------|-----------------------------|----------------------------|----------------------|----------------------|---------------------------------|--|--------------------------------------|------------------------|-----------------------|-----------------------|---------------------------|
| Resistor | Widerstand | Résistance | Resistencia | Weerstand | Resistenza | Резистор | Opornik | Αντίσταση | Resistência | Ellenállás | Odpor |
| Heatrange | Wärme- wert | Dégre thermique | Grado térmico | Warmte- graad | Grado termico | Калильное число | Ciepłota świecy | Θερμική διαβάθμιση | Índice térmico | Hőérték | Tepelná hodnota |
| Centre electrode | Mittel- elektrode | Electrode centrale | Electrodo central | Midden- elektrode | Elettrodo centrale | Цент- ральный электрод | Elektroda centralna | Κεντρικό Ηλεκτρόδιο | Eléctrodo central | Központi elektroda | Střední electroda |
| Ground electrode | Masse- elektrode | Electrode de masse | Electrodo lateral | Massa- elektrode | Elettrodo di masse | Боковой электрод | Elektroda boczna | Ηλεκτρόδιο Γείωσης | Eléctrodo de massa | Test elektroda | Boční electroda |
| Projection | Funken- lage | Projection | Proyec- ción | Projectie | Protezione | Высту- пание центр. электрода | Wysunięcie elektrody środkowej | Προεξοχή | Projeção | Kinyúlás | Vysunutí izolátoru |
| Feature | Bemer- kungen | Caracté- ristique | Caracte- rística | Kenmerk | Carat- terisitica | Описание | Cechy charaktery- styczne | Χαρακτη- ριστικά | Saliência | Tulajdon- ság | Charakte- ristika |
| Terminal | Anschluss | Embouts de connexion | Conexión | Aansluiting | Connettori | Контакт- ный терминал | Element przyłącze- niowy | Τερματική διάταξη | Conexão | Terminál | Konektor |
| Gap | Elek- troden- Abstand | Écarte- ment | Rango | Afstand | Distanza inter- elettrodi | Искровой зазор | Odstęp elektrod | Διάκενο | Folga | Rés | Elektrodová vzdálenost |
| Torque Nm | Anzugs- dreh- moment | Couple de serrage | Par de apriete | Aanhaal- moment | Coppia di serraggio | Момент затяжки | Moment dokręcenia | Ροπή Σύσφιξης | Torque de aperto | Meghúzási nyomaték | Utahovací moment |
| Cylinder head | Zylinder- kopf | Culasse | Culata | Cilinder- kop | Testa cilindro | Головка блока | Głowica cylindra | Κυλινδρο- κεφαλή | Cabeça de cilindro | Hengerfej | Hlava válců |
| Thread | Gewinde | Filetage | Rosca | Spoed | Filettatura | Резьба | Gwint | Σπειρωμα | Rosca | Menet | Závit |
| Iron | Eisen | Fer | Acero | IJzer | Ghisa | Чугун | Żeliwo | Σιδήρου | Ferro | Vas | Litina |
| Aluminium | Aluminium | Aluminium | Aluminio | Aluminium | Alluminio | Алюминий | Aluminium | Αλουμινίου | Alumínio | Alumínium | Lehká slitina |

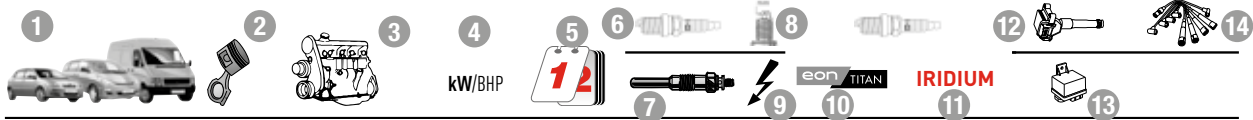

| C3 | | | | | | | | | | |
|-------------|---|------------------------|--------|-------------|--------------------|-----|------|-------|--|--------|
| 1.4 Hybrid | 4 | KFV(TU3JP) | 54/72 | 05/05→ | OE034 | 0,9 | CET2 | OE179 | BAE946A ⁽¹¹⁾ | |
| 1.6 | 4 | NFU(TU5JP4) | 80/107 | 05/03→ | OE035 | 0,9 | CET5 | OE190 | BAEA045E | CLS124 |
| C3 I | | | | | | | | | | |
| 1.1 i | 4 | HFX(TU1A); HFX(TU1JP) | 44/59 | 02/02→ | OE034 | 0,9 | CET2 | OE179 | BAE946A ⁽¹¹⁾ →10/05 BAEA048E ⁽⁷⁾ 11/05→ | CLS124 |
| 1.4 16V | 4 | KFU(ET3J4) | 65/87 | 12/03→ | OE130 | 0,9 | CET4 | | BAEA472 | |
| 1.4 16V HDi | 4 | 8HY(DV4TED4) | 66/89 | 02/02→ | | | | | CCU149 ⁽³⁰¹⁾ | |
| 1.4 Bioflex | 4 | KFV(TU3JP) | 60/80 | 01/09→ | OE034 | 0,9 | CET2 | OE179 | BAE946A ⁽¹¹⁾ →07/12 | |
| 1.4 HDi | 4 | 8HX(DV4TD); 8HZ(DV4TD) | 50/67 | 02/02→ | CH201 RP.10227→ | 11v | | | CCU149 ⁽³⁰¹⁾ | |
| 1.4 HDi | 4 | 8HZ(DV4TD) | 52/70 | 07/03→02/11 | CH201 | 11v | | | | |
| 1.4 HDi | 4 | 8HX(DV4TD) | 55/74 | 05/05→ | CH201 | 11v | | | CCU147 | |

EN

- | | | |
|-------------------------|-----------------|---------------------------|
| 1 Model | 6 Spark plug | 11 Spark plug Iridium |
| 2 Cylinders | 7 Glow plug | 12 Ignition coil |
| 3 Engine code | 8 Electrode Gap | 13 Glow plug control unit |
| 4 KiloWatt / Horsepower | 9 Voltage | 14 Ignition leads |
| 5 Model year | 10 EON Titan | |

DE

- | | | |
|----------------|---------------------|----------------------|
| 1 Modell | 6 Zündkerze | 11 Iridium Zündkerze |
| 2 Zylinder | 7 Glühkerze | 12 Zündspule |
| 3 Motorkennung | 8 Elektrodenabstand | 13 Zündmodul |
| 4 kW / PS | 9 Spannung | 14 Zündkabelsatz |
| 5 Modelljahr | 10 EON Titan | |

FR

- | | | |
|------------------------------|-----------------------------|------------------------------|
| 1 Modèle | 6 Bougie d'allumage | 11 Bougie d'allumage Iridium |
| 2 Cylindres | 7 Bougie de préchauffage | 12 Bobine d'allumage |
| 3 Code moteur | 8 Écartement des électrodes | 13 Module d'allumage |
| 4 Kilowatt/Nombre de chevaux | 9 Tension | 14 Faisceaux |
| 5 Année du modèle | 10 EON Titan | |

NL

- | | | |
|-------------|---------------------|-------------------------|
| 1 Model | 6 Bougies | 11 Iridium bougie |
| 2 Cilinder | 7 Gloeibougies | 12 Bobines |
| 3 Motortype | 8 Elektrodenafstand | 13 Ontstekingsmodule |
| 4 kW/pk | 9 Volt | 14 Ontstekingskabelsets |
| 5 Bouwjaar | 10 EON Titan | |

ES

- | | | |
|----------------------|------------------------------|-------------------------------|
| 1 Modelo | 6 Bujía de encendido | 11 Bujía de encendido Iridium |
| 2 Cilindros | 7 Calentador | 12 Bobina de encendido |
| 3 Código de motor | 8 Distancia entre electrodos | 13 Módulo de encendido |
| 4 Kilovatio/Potencia | 9 Tensión | 14 Juegos de cables |
| 5 Año de modelo | 10 EON Titan | |

IT

- | | | |
|------------------|-------------------------------|---------------------------------|
| 1 Modello | 6 Candele d'accensione | 11 Candele d'accensione Iridium |
| 2 Cilindro | 7 Candele di preriscaldamento | 12 Bobine |
| 3 N. motore | 8 Distanza degli elettrodi | 13 Moduli di accensione |
| 4 kW/CV | 9 Volt | 14 Cavi di accensione |
| 5 Anno di costr. | 10 EON Titan | |

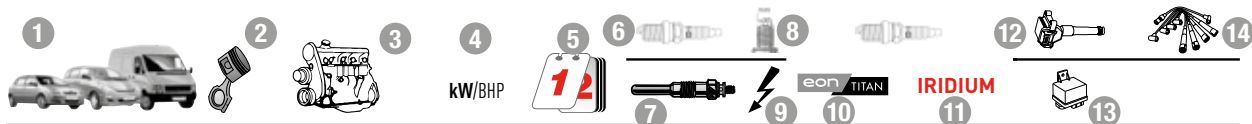

| | 1 | 2 | 3 | 4 | 5 | 6 | 7 | 8 | 9 | 10 | 11 | 12 | 13 | 14 |
|-------------|---|------------------------|--------|-------------|--------------------|-----|------|-------|--|--------|----|----|--------|----|
| C3 | | | | | | | | | | | | | | |
| 1.4 Hybrid | 4 | KFV(TU3JP) | 54/72 | 05/05→ | OE034 | 0,9 | CET2 | OE179 | BAE946A ^[11] | | | | | |
| 1.6 | 4 | NFU(TU5JP4) | 80/107 | 05/03→ | OE035 | 0,9 | CET5 | OE190 | BAEA045E | CLS124 | | | | |
| C3 I | | | | | | | | | | | | | | |
| 1.1 i | 4 | HFX(TU1A); HFX(TU1JP) | 44/59 | 02/02→ | OE034 | 0,9 | CET2 | OE179 | BAE946A ^[11] →10/05 BAEA048E ^[7] 11/05→ | CLS124 | | | | |
| 1.4 16V | 4 | KFU(ET3J4) | 65/87 | 12/03→ | OE130 | 0,9 | CET4 | | BAEA472 | | | | | |
| 1.4 16V HDi | 4 | 8HY(DV4TED4) | 66/89 | 02/02→ | | | | | CCU149 ^[301] | | | | | |
| 1.4 Bioflex | 4 | KFV(TU3JP) | 60/80 | 01/09→ | OE034 | 0,9 | CET2 | OE179 | BAE946A ^[11] →07/12 | | | | | |
| 1.4 HDi | 4 | 8HX(DV4TD); 8HZ(DV4TD) | 50/67 | 02/02→ | CH201 RP.10227→ | 11v | | | CCU149 ^[301] | | | | | |
| 1.4 HDi | 4 | 8HZ(DV4TD) | 52/70 | 07/03→02/11 | CH201 | 11v | | | | | | | | |
| 1.4 HDi | 4 | 8HX(DV4TD) | 55/74 | 05/05→ | CH201 | 11v | | | | | | | CCU147 | |

RU

- | | | |
|----------------------|------------------------|--------------------------------------|
| 1 Модель | 6 Свеча зажигания | 11 Свеча зажигания Iridium |
| 2 Цилиндры | 7 Свеча накаливания | 12 Катушка зажигания |
| 3 Код двигателя | 8 Межэлектродный зазор | 13 Модуль зажигания |
| 4 кВт / л.с. | 9 Вольтаж | 14 Комплекты высоковольтных проводов |
| 5 Год выпуска модели | 10 EON Titan | |

PL

- | | | |
|---------------|---------------------------------|----------------------------------|
| 1 Model | 6 Świeca zapłonowa | 11 Świeca zapłonowa Iridium |
| 2 Cylindry | 7 Świeca żarowa | 12 Cewka zapłonowa |
| 3 Kod silnika | 8 Moduł sterujący świecy żarowe | 13 Moduł zapłonowy |
| 4 kW/KM | 9 Napięcie | 14 Złącza do cewek zapłonowych |
| 5 Rocznik | 10 Odstęp elektrod | 14 Zestawy przewodów zapłonowych |

GR

- | | | |
|-------------------------|-----------------------|---------------------------|
| 1 Μοντέλο | 6 Μπουζί | 11 Μπουζί Iridium |
| 2 Κύλινδροι | 7 Προθερμαντήρας | 12 Πολλαπλασιαστής |
| 3 Κωδικός κινητήρα | 8 Διάκενο Ηλεκτροδίου | 13 Μονάδα ανάφλεξης |
| 4 KiloWatt / Ιπποδύναμη | 9 Τάση | 14 Σετ καλωδίων ανάφλεξης |
| 5 Έτος μοντέλου | 10 EON Titan | |

HU

- | | | |
|------------------|--------------------|--------------------------|
| 1 Típus | 6 Gyújtógyertya | 11 Gyújtógyertya Iridium |
| 2 Hengerek száma | 7 Izzítógyertya | 12 Gyújtótekercs |
| 3 Motorszám | 8 Elektródahézag g | 13 Gyújtómodul |
| 4 kilowatt/lóerő | 9 Feszültség | 14 Gyújtáskábelek |
| 5 Típus évjárata | 10 EON Titan | |

PT

- | | | |
|----------------------------|-------------------------------|----------------------------|
| 1 Modelo | 6 Vela de ignição | 11 Vela de ignição Iridium |
| 2 Cilindros | 7 Vela de incandescência | 12 Bobina de ignição |
| 3 Código do motor | 8 Distância entre elétrodos o | 13 Módulo de ignição |
| 4 Quilowatt/Potência em HP | 9 Tensã | 14 Cabos de ignição |
| 5 Ano modelo | 10 EON Titan | |

CZ

- | | | |
|----------------|-----------------------|------------------------------|
| 1 Model | 6 Zapalovací svíčka | 11 Zapalovací svíčka iridium |
| 2 Válce | 7 Žhavicí svíčka | 12 Zapalovací cívka |
| 3 Kód motoru | 8 Vzdálenost elektrod | 13 Modul zapalování |
| 4 kW / koní | 9 Napětí | 14 Zapalovací kabely |
| 5 Modelový rok | 10 EON Titan | |



**Control Unit,
Glow Plug System**

CCU106

CCU154



Glow Plug

CCGP010

CH302



Spark Plug

OE242

OE243

OE244

OE245

OE246

OE247

OE248

OE249

OE250

OE253

OE254

OE255

OE256

OE258

OE260

OE261

OE263

OE264

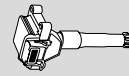

Ignition Coil

BAEA009E

BAEA012E

BAEA013E

BAEA014

BAEA016

BAEA017

BAEA019E

BAEA029E

BAEA030

BAEA031E

BAEA032E

BAEA033E

BAEA037E

BAEA041

BAEA041E

BAEA042E

BAEA043

BAEA043E

BAEA044E

BAEA046E

BAEA048E

BAEA051E

BAEA052E

BAEA055E

BAEA056E

BAEA059E

BAEA061E

BAEA062E

BAEA063E

BAEA065E

BAEA066E

BAEA067E

BAEA068E

BAEA069E

BAEA073E

BAEA077

BAEA084E

BAEA085

BAEA095

BAEA126E

BAEA131E

BAEA132E

BAEA137E

BAEA140E

BAEA143E

BAEA144E

BAEA145E

BAEA146E

BAEA147E

BAEA149E

BAEA150E

BAEA152E

BAEA153E

BAEA154E

BAEA159E

BAEA163E

BAEA169E

BAEA170E

BAEA171E

BAEA173E

BAEA174E

BAEA178E

BAEA180E

BAEA181E

BAEA182E

BAEA183E

BAEA184E

BAEA185E

BAEA186E

BAEA189E

BAEA190E

BAEA191E

BAEA192E

BAEA193E

BAEA194E

BAEA195E

BAEA196E

BAEA198E

BAEA199E

BAEA242

BAEA243

BAEA246

BAEA247

BAEA252

BAEA254

BAEA255

BAEA264

BAEA267

BAEA269

BAEA296

BAEA298

BAEA299

BAEA302

BAEA304

BAEA306

BAEA324

BAEA326

BAEA337

BAEA339

BAEA345

BAEA347

BAEA348

BAEA351

BAEA352

BAEA354

BAEA359

BAEA365

BAEA367

BAEA368

BAEA377

BAEA378

BAEA383

BAEA384

BAEA385

BAEA386

BAEA388

BAEA394

BAEA409

BAEA410

BAEA426

BAEA428

BAEA432

BAEA433

BAEA434

BAEA446

BAEA448

BAEA449

BAEA453

BAEA474

BAEA475

BAEA476

BAEA477

BAEA479

BAEA480

BAEA482

BAEA486

BAEA489

BAEA501

BAEA521

BAEA531

BAEA536

BAEA540

BAEA543

BAEA546

BAEA547

BAEA548

BAEA549

BAEA554

BAEA555

BAEA556

BAEA557

BAEA560

BAEA561



kW/BHP



eon TITAN

IRIDIUM

**ABARTH****500 / 595 / 695**

| | | | | | | | | |
|-----|---|----------------------|---------|--------|---------------------------|-----|--------------------------|-----------------------------|
| 1.4 | 4 | 312A1.000 | 99/133 | 08/08→ | OE208 →Prod.22.01.2013 | 0,8 | CET1 →Prod.22.01.2013 | BAEA095 →Prod.19.11.2014 |
| 1.4 | 4 | 312A3.000 | 103/138 | 05/10→ | OE208 →Prod.22.01.2013 | 0,8 | CET1 →Prod.22.01.2013 | BAEA095 →Prod.19.11.2014 |
| 1.4 | 4 | 312A1.000; 312A3.000 | 118/158 | 08/08→ | OE208 →Prod.22.01.2013 | 0,8 | CET1 →Prod.22.01.2013 | BAEA095 →Prod.19.11.2014 |
| 1.4 | 4 | 312A1.000; 312A3.000 | 119/160 | 01/14→ | | | | BAEA095 →Prod.19.11.2014 |
| 1.4 | 4 | 312A1.000; 312A3.000 | 132/177 | 08/08→ | OE208 →Prod.22.01.2013 | 0,8 | CET1 →Prod.22.01.2013 | BAEA095 →Prod.19.11.2014 |
| 1.4 | 4 | 312A1.000; 312A9.000 | 139/186 | 06/15→ | OE208 →Prod.22.01.2013 | 0,8 | CET1 →Prod.22.01.2013 | BAEA095 →Prod.19.11.2014 |
| 1.4 | 4 | 312A1.000 | 140/188 | 08/08→ | OE208 →Prod.22.01.2013 | 0,8 | CET1 →Prod.22.01.2013 | BAEA095 →Prod.19.11.2014 |

500C / 595C / 695C

| | | | | | | | | |
|-----|---|----------------------|---------|--------|---------------------------|-----|--------------------------|-----------------------------|
| 1.4 | 4 | 312A1.000 | 99/133 | 01/11→ | OE208 →Prod.22.01.2013 | 0,8 | CET1 →Prod.22.01.2013 | BAEA095 →Prod.19.11.2014 |
| 1.4 | 4 | 312A1.000; 312A3.000 | 103/138 | 09/09→ | OE208 →Prod.22.01.2013 | 0,8 | CET1 →Prod.22.01.2013 | BAEA095 →Prod.19.11.2014 |
| 1.4 | 4 | 312A1.000; 312A3.000 | 118/158 | 05/11→ | OE208 →Prod.22.01.2013 | 0,8 | CET1 →Prod.22.01.2013 | BAEA095 →Prod.19.11.2014 |
| 1.4 | 4 | 312A1.000; 312A3.000 | 119/160 | 01/14→ | | | | BAEA095 →Prod.19.11.2014 |
| 1.4 | 4 | 312A3.000 | 132/177 | 06/10→ | OE208 →Prod.22.01.2013 | 0,8 | CET1 →Prod.22.01.2013 | BAEA095 →Prod.19.11.2014 |

GRANDE PUNTO

| | | | | | | | | |
|-----|---|----------------------|---------|-------------|-------|-----|--|---------|
| 1.4 | 4 | 199A8.000 | 114/153 | 12/07→06/10 | OE208 | 0,8 | | BAEA095 |
| 1.4 | 4 | 199A8.000 | 132/177 | 12/07→12/12 | OE208 | 0,8 | | BAEA095 |
| 1.4 | 4 | 955A8.000 | 132/177 | 12/07→12/12 | | | | BAEA095 |
| 1.4 | 4 | 955A8.000 | 120/161 | 03/12→ | OE208 | 0,8 | | |
| 1.4 | 4 | 199A8.000; 955A8.000 | 132/177 | 03/12→ | OE208 | 0,8 | | |

AC**ACE**

| | | | | | | | | |
|-------------------|---|-----|---------|-------------|---------|-----|------|--|
| 4.6 | 8 | | 240/322 | 10/98→ | | | CET9 | |
| 4.9 | 8 | 99E | 179/240 | 10/98→ | RV15YC4 | 1,0 | | |
| 4.9 | 8 | 99E | 191/256 | 01/95→10/98 | RV15YC4 | 1,0 | | |
| 4.9 Super Charger | 8 | 99E | 239/320 | 10/98→ | RV15YC4 | 1,0 | | |

ACECA

| | | | | | | | | |
|-------------------|---|-----|---------|-------------|---------|-----|--|--|
| 4.9 | 8 | 99E | 179/240 | 09/93→12/97 | RV15YC4 | 1,0 | | |
| 4.9 Super Charger | 8 | 99E | 239/320 | 10/98→12/01 | RV15YC4 | 1,0 | | |

COBRA Mk IV

| | | | | | | | | |
|-------------------|---|-----|---------|-------------|---------|-----|--|--|
| 4.9 Roadster | 8 | 99H | 168/225 | 09/97→08/99 | RV15YC4 | 1,0 | | |
| 4.9 Super Charger | 8 | 99F | 239/320 | 10/97→ | RV15YC4 | 1,0 | | |

ACURA**NSX**

| | | | | | | | | |
|-----|---|-------|---------|-------------|-------|-----|--------|-------|
| 3.2 | 6 | C32B2 | 206/276 | 08/97→12/05 | OE146 | 1,0 | CET12P | OE179 |
|-----|---|-------|---------|-------------|-------|-----|--------|-------|

RL

| | | | | | | | | |
|-----|---|-------|---------|-------------|-------|-----|------|-------|
| 3.5 | 6 | C35A2 | 151/202 | 10/95→09/00 | OE154 | 1,0 | CET2 | OE194 |
| 3.5 | 6 | C35A5 | 153/205 | 10/00→09/04 | OE154 | 1,0 | CET2 | OE194 |

RSX

| | | | | | | | | |
|----------------|---|-------|---------|--------|--|--|--|----------|
| 2.0 | 4 | K20A3 | 114/153 | 10/05→ | | | | BAEA169E |
| 2.0 Sport | 4 | K20A3 | 118/158 | 10/01→ | | | | BAEA169E |
| 2.0 Vtec Sport | 4 | K20A | 162/217 | 10/01→ | | | | BAEA169E |

SLX

| | | | | | | | | |
|---------|---|------|---------|-------------|--|--|--------|-------|
| 3.2 4WD | 6 | 6VD1 | 140/188 | 11/95→09/99 | | | CET12P | OE180 |
|---------|---|------|---------|-------------|--|--|--------|-------|

ACURA





kW/BHP



eon TITAN

IRIDIUM

**...ACURA****...SLX**

| | | | | | | | | | | |
|---------|---|-------|---------|-------------|-------|-----|------|-------|--|--|
| 3.5 4WD | 6 | C35A5 | 151/202 | 11/97→09/99 | OE154 | 1,0 | CET2 | OE194 | | |
|---------|---|-------|---------|-------------|-------|-----|------|-------|--|--|

AIXAM**500**

| | | | | | | | | | | |
|-----|---|--------|-------|-------------|-------|-----|------|--|--|--|
| 0.5 | 2 | LGW523 | 15/20 | 09/03→07/05 | OE016 | 0,9 | CET2 | | | |
|-----|---|--------|-------|-------------|-------|-----|------|--|--|--|

A.751

| | | | | | | | | | | |
|-----|---|--------|-------|-------------|-------|-----|------|--|--|--|
| 0.5 | 2 | LGW523 | 15/20 | 07/05→03/10 | OE016 | 0,9 | CET2 | | | |
|-----|---|--------|-------|-------------|-------|-----|------|--|--|--|

CROSSLINE

| | | | | | | | | | | |
|-----|---|--------|-------|--------|-------|-----|------|--|--|--|
| 0.5 | 2 | LGW523 | 15/20 | 02/07→ | OE016 | 0,9 | CET2 | | | |
|-----|---|--------|-------|--------|-------|-----|------|--|--|--|

SCOUTY

| | | | | | | | | | | |
|-----|---|--------|-------|-------------|-------|-----|------|--|--|--|
| 0.5 | 2 | LGW523 | 15/20 | 08/07→07/12 | OE016 | 0,9 | CET2 | | | |
|-----|---|--------|-------|-------------|-------|-----|------|--|--|--|

ALFA ROMEO**4C**

| | | | | | | | | | | |
|-----|---|-----------|---------|--------|--|--|--|-------|--|--|
| 1.8 | 4 | 960A1.000 | 177/237 | 03/13→ | | | | OE256 | | |
|-----|---|-----------|---------|--------|--|--|--|-------|--|--|

4C SPIDER

| | | | | | | | | | | |
|-----|---|-----------|---------|--------|--|--|--|-------|--|--|
| 1.8 | 4 | 960A1.000 | 177/237 | 10/14→ | | | | OE256 | | |
|-----|---|-----------|---------|--------|--|--|--|-------|--|--|

145

| | | | | | | | | | | |
|----------|---|---------|-------|-------------|-------|-----|------|--|---------|--|
| 1.4 i.e. | 4 | AR33501 | 66/89 | 07/94→12/96 | OE087 | 0,9 | CET8 | | BAE800B | |
|----------|---|---------|-------|-------------|-------|-----|------|--|---------|--|

| | | | | | | | | | | |
|-------------------|---|------------------|--------|-------------|------------|-----|--|------------|----------------------------------|--------|
| 1.4 i.e. 16V T.S. | 4 | AR33503; AR38501 | 76/102 | 12/96→01/01 | OE122 [27] | 0,7 | | OE179 [28] | BAEA309 02/99→ Ch.3174688→ | CLS055 |
|-------------------|---|------------------|--------|-------------|------------|-----|--|------------|----------------------------------|--------|

OE223 [28]

1,6

| | | | | | | | | | | |
|--------------|---|---------|--------|-------------|------------|-----|--|------------|-------------------|--|
| 1.6 16V T.S. | 4 | AR32102 | 82/110 | 09/97→12/00 | OE122 [27] | 0,7 | | OE179 [28] | BAEA309 02/99→ | |
|--------------|---|---------|--------|-------------|------------|-----|--|------------|-------------------|--|

OE223 [28]

1,6

| | | | | | | | | | | |
|----------|---|---------|--------|-------------|-------|-----|------|--|---------|--|
| 1.6 i.e. | 4 | AR33201 | 76/102 | 10/94→12/96 | OE087 | 0,9 | CET8 | | BAEA234 | |
|----------|---|---------|--------|-------------|-------|-----|------|--|---------|--|

| | | | | | | | | | | |
|-------------------|---|------------------|--------|-------------|------------|-----|--|------------|----------------------------------|--------|
| 1.6 i.e. 16V T.S. | 4 | AR38201; AR67601 | 88/118 | 12/96→01/01 | OE122 [27] | 0,7 | | OE179 [28] | BAEA309 02/99→ Ch.3174688→ | CLS055 |
|-------------------|---|------------------|--------|-------------|------------|-----|--|------------|----------------------------------|--------|

OE223 [28]

1,6

| | | | | | | | | | | |
|--------------|---|---------|--------|-------------|-------|-----|------|--|---------|--|
| 1.7 i.e. 16V | 4 | AR33401 | 95/127 | 10/94→12/96 | OE094 | 0,9 | CET2 | | BAEA234 | |
|--------------|---|---------|--------|-------------|-------|-----|------|--|---------|--|

| | | | | | | | | | | |
|--------------|---|---------|---------|-------------|------------|-----|--|------------|-------------------|--------|
| 1.8 i.e. 16V | 4 | AR32201 | 106/142 | 03/98→01/01 | OE122 [27] | 0,7 | | OE179 [28] | BAEA309 02/99→ | CLS055 |
|--------------|---|---------|---------|-------------|------------|-----|--|------------|-------------------|--------|

OE223 [28]

1,6

| | | | | | | | | | | |
|-------------------|---|------------------------------|---------|-------------|------------|-----|--|------------|--|--|
| 1.8 i.e. 16V T.S. | 4 | AR38401; AR67106; AR67199 | 103/138 | 12/96→12/98 | OE122 [27] | 0,7 | | OE179 [28] | | |
|-------------------|---|------------------------------|---------|-------------|------------|-----|--|------------|--|--|

OE223 [28]

1,6

| | | | | | | | | | | |
|---------|---|---------|--------|-------------|-----------------------|-----|--|--|--|--|
| 1.9 JTD | 4 | AR32302 | 77/103 | 02/99→01/01 | CH222 Eng.1716459→ | 11v | | | | |
|---------|---|---------|--------|-------------|-----------------------|-----|--|--|--|--|

| | | | | | | | | | | |
|--------|---|------------------|-------|-------------|-------|-----|--|--|--|--|
| 1.9 TD | 4 | AR33601; AR67501 | 66/89 | 10/94→02/99 | CH189 | 11v | | | | |
|--------|---|------------------|-------|-------------|-------|-----|--|--|--|--|

| | | | | | | | | | | |
|---------|---|---------|---------|-------------|------------|-----|--|------------|---------|--------|
| 2.0 16V | 4 | AR32301 | 114/153 | 03/98→01/01 | OE122 [27] | 0,7 | | OE179 [28] | BAEA309 | CLS055 |
|---------|---|---------|---------|-------------|------------|-----|--|------------|---------|--------|

OE223 [28]

1,6

| | | | | | | | | | | |
|--------------|---|---------|---------|-------------|------------|-----|--|------------|--|--------|
| 2.0 16V T.S. | 4 | AR67204 | 110/148 | 10/95→01/01 | OE122 [27] | 0,7 | | OE179 [28] | | CLS055 |
|--------------|---|---------|---------|-------------|------------|-----|--|------------|--|--------|

OE223 [28]

1,6

| | | | | | | | | | | |
|--------------|---|---------|---------|-------------|------------|-----|--|------------|--|--------|
| 2.0 16V T.S. | 4 | AR67204 | 110/148 | 10/95→01/01 | OE122 [27] | 0,7 | | OE179 [28] | | CLS055 |
|--------------|---|---------|---------|-------------|------------|-----|--|------------|--|--------|

OE223 [28]

1,6

| | | | | | | | | | | |
|--------------|---|---------|---------|-------------|------------|-----|--|------------|--|--------|
| 2.0 16V T.S. | 4 | AR67204 | 110/148 | 10/95→01/01 | OE122 [27] | 0,7 | | OE179 [28] | | CLS055 |
|--------------|---|---------|---------|-------------|------------|-----|--|------------|--|--------|

OE223 [28]

1,6

146

| | | | | | | | | | | |
|----------|---|---------|-------|-------------|-------|-----|------|--|---------|--|
| 1.4 i.e. | 4 | AR33501 | 66/89 | 12/94→12/96 | OE087 | 0,9 | CET8 | | BAE800B | |
|----------|---|---------|-------|-------------|-------|-----|------|--|---------|--|

| | | | | | | | | | | |
|-------------------|---|------------------|--------|-------------|------------|-----|--|------------|----------------------------------|------------------|
| 1.4 i.e. 16V T.S. | 4 | AR33503; AR38501 | 76/102 | 11/96→01/01 | OE122 [27] | 0,7 | | OE179 [28] | BAEA309 02/99→ Ch.0165088→ | CLS055 02/99→ |
|-------------------|---|------------------|--------|-------------|------------|-----|--|------------|----------------------------------|------------------|

OE223 [28]

1,6

| | | | | | | | | | | |
|--------------|---|---------|--------|-------------|------------|-----|--|------------|-------------------|--|
| 1.6 16V T.S. | 4 | AR32102 | 82/110 | 09/97→12/00 | OE122 [27] | 0,7 | | OE179 [28] | BAEA309 02/99→ | |
|--------------|---|---------|--------|-------------|------------|-----|--|------------|-------------------|--|

OE223 [28]

1,6

| | | | | | | | | | | |
|--------------|---|---------|--------|-------------|------------|-----|--|------------|-------------------|--|
| 1.6 16V T.S. | 4 | AR32102 | 82/110 | 09/97→12/00 | OE122 [27] | 0,7 | | OE179 [28] | BAEA309 02/99→ | |
|--------------|---|---------|--------|-------------|------------|-----|--|------------|-------------------|--|

OE223 [28]

1,6

| | | | | | | | | | | |
|----------|---|---------|--------|-------------|-------|-----|------|--|---------|--|
| 1.6 i.e. | 4 | AR33201 | 76/102 | 12/94→12/96 | OE087 | 0,9 | CET8 | | BAEA234 | |
|----------|---|---------|--------|-------------|-------|-----|------|--|---------|--|





kW/BHP



eon TITAN

IRIDIUM

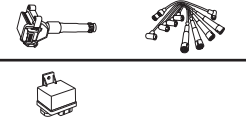

...ALFA ROMEO



...146

| | | | | | | | | | | |
|-------------------|---|------------------|---------|-------------|--|------------|------|-----------------------|----------------------------------|------------------|
| 1.6 i.e. 16V T.S. | 4 | AR38201; AR67601 | 88/118 | 11/96→10/01 | OE122 ^[27] OE223 ^[28] | 0,7 1,6 | | OE179 ^[28] | BAEA309 02/99→ Ch.0165088→ | CLS055 |
| 1.7 i.e. 16V | 4 | AR33401 | 95/127 | 12/94→12/96 | OE094 | 0,9 | CET2 | | BAEA234 | |
| 1.8 i.e. 16V T.S. | 4 | AR38401; AR67106 | 103/138 | 11/96→01/01 | OE122 ^[27] OE223 ^[28] | 0,7 1,6 | | OE179 ^[28] | | |
| 1.8 i.e. 16V T.S. | 4 | AR32201 | 106/142 | 03/98→01/01 | OE122 ^[27] OE223 ^[28] | 0,7 1,6 | | OE179 ^[28] | BAEA309 02/99→ | CLS055 02/99→ |
| 1.9 JTD | 4 | AR32302 | 77/103 | 02/99→01/01 | CH222 Eng.1716459→ | 11v | | | | |
| 1.9 TD | 4 | AR33601; AR67501 | 66/89 | 12/94→02/99 | CH189 | 11v | | | | |
| 2.0 16V | 4 | AR32301 | 114/153 | 03/97→10/01 | OE122 ^[27] OE223 ^[28] | 0,7 1,6 | | OE179 ^[28] | BAEA309 02/99→ | CLS055 02/99→ |
| 2.0 16V T.S. | 4 | AR67204 | 110/148 | 10/95→01/01 | OE122 ^[27] OE223 ^[28] | 0,7 1,6 | | OE179 ^[28] | | CLS055 |

147

| | | | | | | | | | | |
|---------------------|---|----------------------|---------|-------------|--|------------|--------|-----------------------|--------------------------|--------|
| 1.6 16V T.SPARK | 4 | AR32104 | 88/118 | 01/01→03/10 | OE122 ^[27] OE223 ^[28] | 0,7 1,6 | | OE179 ^[28] | | CLS055 |
| 1.6 16V T.SPARK ECO | 4 | AR37203 | 77/103 | 01/01→03/10 | OE077 ^[28] OE122 ^[27] | 1,0 0,7 | | OE179 ^[28] | | CLS055 |
| 1.9 JTD | 4 | 182B9.000 | 74/99 | 06/03→03/10 | CH222 ^[57] CH269 ^[59] | 11v 11v | | | CCU150 | |
| 1.9 JTD, 1.9 JTDM | 4 | 937A2.000; 939A7.000 | 85/114 | 04/01→03/10 | CH222 ^[57] CH269 ^[59] | 11v 11v | | | CCU150 | |
| 1.9 JTD 16V | 4 | 937A4.000 | 93/125 | 09/03→09/04 | CH224 | 11v | | | CCU150 | |
| 1.9 JTD 16V | 4 | 192B1.000 | 100/134 | 10/04→03/10 | CH224 | 11v | | | CCU150 | |
| 1.9 JTD 16V | 4 | 192A5.000 | 103/138 | 11/02→03/10 | CH224 | 11v | | | CCU150 | |
| 1.9 JTDM 8V | 4 | 937A3.000 | 88/118 | 07/05→03/10 | CH222 ^[57] CH269 ^[59] | 11v 11v | | | CCU150 | |
| 1.9 JTDM 16V | 4 | 937A5.000 | 110/148 | 09/04→03/10 | CH224 | 11v | | | CCU150 | |
| 1.9 JTDM 16V | 4 | 937A6.000 | 125/168 | 06/08→03/10 | | | | | CCU150 | |
| 2.0 | 4 | 937A1.000 | 121/162 | 07/02→05/05 | OE122 ^[27] OE123 | 0,7 0,7 | CET2 | OE179 | | |
| 2.0 16V T.SPARK | 4 | AR32310 | 110/148 | 01/01→03/10 | OE122 ^[27] OE223 ^[28] | 0,7 1,6 | | OE179 ^[28] | | CLS055 |
| 3.2 GTA | 6 | 932A.000 | 184/247 | 02/03→03/10 | OE146 | 1,0 | CET12P | OE179 | BAEA428 ^[277] | |

155

| | | | | | | | | | | |
|--------------|---|------------------|---------|-------------|--|------------|--|-----------------------|---------|--|
| 1.6 16V T.S. | 4 | AR67601 | 88/118 | 05/96→12/97 | OE122 ^[27] OE223 ^[28] | 0,7 1,6 | | OE179 ^[28] | | |
| 1.7 T.S. | 4 | AR67103 | 83/111 | 04/93→04/96 | | | | | BAEA234 | |
| 1.7 T.S. | 4 | AR67105 | 85/114 | 04/93→04/96 | | | | | BAEA234 | |
| 1.7 T.S. 16V | 4 | AR67106 | 103/138 | 05/96→12/97 | OE122 ^[27] OE223 ^[28] | 0,7 1,6 | | OE179 ^[28] | | |
| 1.9 TD | 4 | AR67501 | 66/89 | 04/93→12/97 | CH189 | 11v | | | | |
| 2.0 T.S. 16V | 4 | AR67204; AR67299 | 110/148 | 03/95→12/97 | OE122 ^[27] OE223 ^[28] | 0,7 1,6 | | OE179 ^[28] | | |
| 2.5 TD | 4 | VM07B; VM31B | 92/123 | 04/93→12/97 | CH189 →04/95 CH181 05/95→ | 11v 11v | | | | |

ALFA ROMEO





kW/BHP



eon TITAN

IRIDIUM



...ALFA ROMEO



156

| | | | | | | | | | | |
|-----------------------------------|---|---------------------------|---------|-------------|----------------------------|-----|---------|------------|-------------------|--------|
| 1.6 16V T.SPARK | 4 | AR32102 | 82/110 | 09/97→09/05 | OE122 [27] | 0,7 | | OE179 [28] | BAEA309 →09/00 | |
| | | | | | OE223 [28] | 1,6 | | | | |
| 1.6 16V T.SPARK. | 4 | AR32103 | 81/109 | 07/00→07/05 | OE122 [27] | 0,7 | | OE179 [28] | | |
| | | | | | OE223 [28] | 1,6 | | | | |
| 1.6 16V T.SPARK, 1.6 16V T.SPARK. | 4 | AR32103; AR32104; AR67601 | 88/118 | 09/97→05/06 | OE122 [27] | 0,7 | | OE179 [28] | | CLS055 |
| | | | | | OE223 [28] | 1,6 | | | | |
| 1.6 16V T.SPARK, 1.6 16V T.SPARK. | 4 | AR32102 | 88/118 | 09/97→05/06 | OE122 [27] | 0,7 | | OE179 [28] | BAEA309 →09/00 | CLS055 |
| | | | | | OE223 [28] | 1,6 | | | | |
| 1.8 16V T.SPARK | 4 | AR32205 | 103/138 | 02/97→05/06 | OE122 [27] | 0,7 | | OE179 [28] | | CLS055 |
| | | | | | OE223 [28] | 1,6 | | | | |
| 1.8 16V T.SPARK | 4 | AR32201 | 106/142 | 09/97→10/00 | OE122 [27] | 0,7 | | OE179 [28] | | CLS055 |
| | | | | | OE223 [28] | 1,6 | | | | |
| 1.9 JTD | 4 | AR32302 | 77/103 | 09/97→10/00 | CH222 [55] Eng.1716459→ | 11v | | | | |
| 1.9 JTD | 4 | AR37101 | 81/109 | 10/00→05/01 | CH222 [56] Eng.1716459→ | 11v | | | | |
| 1.9 JTD | 4 | 937A2.000 | 85/114 | 05/01→05/06 | CH222 | 11v | | | CCU150 | |
| 1.9 JTD | 4 | 937A4.000 | 93/125 | 11/03→05/06 | CH224 | 11v | | | CCU150 | |
| 1.9 JTD | 4 | 192B1.000 | 100/134 | 11/02→11/04 | CH224 | 11v | | | CCU150 | |
| 1.9 JTD, 1.9 JTD 16V 4WD | 4 | 937A5.000 | 110/148 | 07/04→05/06 | CH224 | 11v | | | CCU150 | |
| 1.9 JTD 16V | 4 | 192A5.000 | 103/138 | 11/02→05/06 | CH224 | 11v | | | CCU150 [57] | |
| 2.0 16V T.SPARK | 4 | AR32310 | 110/148 | 10/00→03/02 | OE122 [27] | 0,7 | | OE179 [28] | | CLS055 |
| | | | | | OE223 [28] | 1,6 | | | | |
| 2.0 16V T.SPARK | 4 | AR32301; AR32310 | 114/153 | 09/97→06/02 | OE122 [27] | 0,7 | | OE179 [28] | BAEA309 | CLS055 |
| | | | | | OE223 [28] | 1,6 | | | | |
| 2.0 JTS | 4 | 932A2.000 | 119/160 | 01/02→05/06 | OE122 [27] | 0,7 | CET2 | OE179 [28] | BAEA309 | |
| | | | | | OE123 | 0,7 | | OE179 | | |
| | | | | | OE223 [28] | 1,6 | | | | |
| 2.0 JTS | 4 | 937A1.000 | 122/164 | 03/02→05/06 | OE123 | 0,7 | CET2 | OE179 | | |
| 2.4 JTD | 5 | AR32501 | 100/134 | 09/97→09/03 | CH222 [56] Eng.1713819→ | 11v | | | | |
| 2.4 JTD | 5 | 839A6.000 | 103/138 | 10/00→05/06 | CH222 [56] Eng.1713819→ | 11v | | | | |
| 2.4 JTD | 5 | 841C000 | 110/148 | 03/02→05/06 | CH222 | 11v | | | CCU150 | |
| 2.4 JTD | 5 | 841M.000; 841N.000 | 120/161 | 06/03→05/06 | CH224 | 11v | | | CCU150 | |
| 2.4 JTD | 5 | 841G.000 | 129/173 | 10/03→05/06 | CH224 | 11v | | | CCU150 [287] | |
| 2.5 V6 24V | 6 | AR32401; AR32402 | 140/188 | 02/97→08/03 | OE136 | 0,8 | CET1 2P | OE179 | BAEA428 [277] | |
| 2.5 V6 24V | 6 | AR32405 | 141/189 | 02/97→05/06 | OE136 | 0,8 | CET1 2P | OE179 | BAEA428 [277] | |
| 3.2 GTA | 6 | 932A.000 | 184/247 | 03/02→05/06 | OE146 | 1,0 | CET1 2P | OE179 | BAEA428 [277] | |
| 159 | | | | | | | | | | |
| 1.8 MPI | 4 | 939A4.000 | 103/138 | 06/05→11/11 | OE089 | 1,0 | CET2 | OE188 | BAEA427 | |
| 1.8 TBi | 4 | 939B1.000 | 147/197 | 05/09→12/12 | | | | OE256 | BAEA427 | |
| 1.9 JTDM 8V | 4 | 937A7.000; 939A7.000 | 85/114 | 09/05→11/11 | CH222 →Eng.5115898 | 11v | | | CCU150 | |
| | | | | | CH269 Eng.5115898→ | 11v | | | | |
| 1.9 JTDM 8V | 4 | 939A1.000 | 88/118 | 09/05→11/11 | CH222 →Eng.5115898 | 11v | | | CCU150 | |
| | | | | | CH269 Eng.5115898→ | 11v | | | | |
| 1.9 JTDM 16V | 4 | 937A8.000; 939A8.000 | 100/134 | 09/05→11/11 | CH224 | 11v | | | CCU150 | |
| 1.9 JTDM 16V | 4 | 939A2.000 | 110/148 | 09/05→11/11 | CH224 | 11v | | | CCU150 | |
| 1.9 JTS | 4 | 939A6.000 | 118/158 | 09/05→11/11 | OE136 | 0,8 | CET1 2P | OE179 | | |
| 2.2 JTS | 4 | 939A5.000 | 136/182 | 09/05→11/11 | OE136 | 0,8 | CET1 2P | OE179 | BAEA149E | |
| 2.4 JTDM | 5 | 939A3.000 | 147/197 | 09/05→11/11 | CH224 | 11v | | | CCU150 | |





kW/BHP



eon TITAN

IRIDIUM



...ALFA ROMEO



...159

| | | | | | | | | | |
|------------------------|---|-----------|---------|-------------|-------|-----|--------|-------|----------|
| 2.4 JTDM, 2.4 JTDM 4WD | 5 | 939A9.000 | 154/207 | 05/07→12/12 | | | | | CCU150 |
| 3.2 JTS, 3.2 JTS 4WD | 6 | 939A.000 | 191/256 | 12/05→11/11 | OE029 | 1,0 | CET17P | OE189 | BAEA174E |

164

| | | | | | | | | | |
|------------------|---|---------------------------|---------|-------------|-------|-----|--------|-------|--------------------------|
| 3.0 | 6 | AR64399 | 145/194 | 10/94→08/97 | OE136 | 0,8 | CET12P | OE179 | BAEA428 ^[277] |
| 3.0 | 6 | AR64304 | 156/209 | 09/93→12/95 | OE136 | 0,8 | CET12P | | BAEA428 ^[277] |
| 3.0 | 6 | AR66306 | 157/211 | 03/95→10/97 | OE136 | 0,8 | CET12P | OE179 | BAEA428 ^[277] |
| 3.0 | 6 | AR64304 | 168/225 | 04/93→02/95 | OE136 | 0,8 | CET12P | OE179 | BAEA428 ^[277] |
| 3.0, 3.0 24V 4WD | 6 | AR64304; AR64307; AR64308 | 170/228 | 02/94→09/98 | OE136 | 0,8 | CET12P | OE179 | BAEA428 ^[277] |
| 3.0 24V | 6 | AR66302 | 154/207 | 03/95→10/97 | OE136 | 0,8 | CET12P | OE179 | BAEA428 ^[277] |

166

| | | | | | | | | | |
|-------------|---|---------|---------|-------------|-----------------------|-----|------|-----------------------|---------|
| 2.0 V6 | 6 | AR34102 | 151/202 | 09/98→10/00 | OE087 | 0,9 | CET8 | | |
| 2.0 T.Spark | 4 | AR36301 | 110/148 | 10/00→06/07 | OE122 ^[27] | 0,7 | | OE179 ^[28] | CLS055 |
| | | | | | OE223 ^[28] | 1,6 | | | |
| 2.0 T.Spark | 4 | AR34103 | 114/153 | 09/98→10/00 | OE122 ^[27] | 0,7 | | OE179 ^[28] | BAEA309 |
| | | | | | OE223 ^[28] | 1,6 | | | CLS055 |

| | | | | | | | | | |
|------------|---|--------------------|---------|-------------|-----------------------|-----|--------|-------|--------------------------|
| 2.4 JTD | 5 | AR34202 | 100/134 | 09/98→10/00 | CH222 ^[56] | 11v | | | |
| | | | | | Eng.1713819→ | | | | |
| 2.4 JTD | 5 | 839A6.000 | 103/138 | 10/00→06/07 | CH222 ^[56] | 11v | | | CCU150 ^[57] |
| | | | | | Eng.1713819→ | | | | |
| 2.4 JTD | 5 | 841C000 | 110/148 | 04/02→06/07 | CH222 | 11v | | | CCU150 |
| 2.4 JTD | 5 | 841M.000; 841N.000 | 120/161 | 10/03→06/07 | CH224 | 11v | | | CCU150 |
| 2.4 JTD | 5 | 841G.000; 841H.000 | 129/173 | 10/03→06/07 | CH224 | 11v | | | CCU150 |
| 2.4 JTD | 5 | 841M.000 | 132/177 | 07/06→06/07 | CH224 | 11v | | | CCU150 |
| 2.4 JTD | 5 | 841M.000 | 136/182 | 07/05→06/07 | CH224 | 11v | | | CCU150 |
| 2.4 JTD | 5 | 936B.000 | 136/182 | 07/05→06/07 | | | | | CCU150 |
| 2.5 V6 24V | 6 | AR36201 | 138/185 | 10/00→06/07 | OE146 | 1,0 | CET12P | OE179 | BAEA428 ^[277] |
| 2.5 V6 24V | 6 | AR34201 | 140/188 | 09/98→12/06 | OE136 | 0,8 | CET12P | OE179 | BAEA428 ^[277] |
| 3.0 V6 24V | 6 | AR36101 | 162/217 | 10/00→06/07 | OE146 | 1,0 | CET12P | OE179 | BAEA428 ^[277] |
| 3.0 V6 24V | 6 | AR34301; AR34302 | 166/223 | 09/98→06/07 | OE136 | 0,8 | CET12P | OE179 | BAEA428 ^[277] |
| 3.2 V6 24V | 6 | 936A.000 | 176/236 | 10/03→06/07 | OE146 | 1,0 | CET12P | OE179 | BAEA428 ^[277] |

BRERA

| | | | | | | | | | |
|----------------------|---|-----------|---------|-------------|-------|-----|--------|-------|----------|
| 1.8 TBi | 4 | 939B1.000 | 147/197 | 05/09→06/10 | | | | OE256 | |
| 2.2 JTS | 4 | 939A5.000 | 136/182 | 01/06→05/11 | OE136 | 0,8 | CET12P | OE179 | BAEA149E |
| 2.4 JTDM 20V | 5 | 939A3.000 | 147/197 | 01/06→06/10 | CH224 | 11v | | | CCU150 |
| 2.4 JTDM 20V | 5 | 939A9.000 | 154/207 | 05/07→06/10 | | | | | CCU150 |
| 3.2 JTS, 3.2 JTS 4WD | 6 | 939A.000 | 191/256 | 01/06→05/11 | OE029 | 1,0 | CET17P | OE189 | BAEA174E |

GIULIETTA

| | | | | | | | | | |
|--------------------|---|----------------------|---------|-------------|-------|-----|--|-------|---------|
| 1.4 BiFuel, 1.4 TB | 4 | 198A4.000; 940B7.000 | 88/118 | 04/10→ | OE208 | 0,8 | | | BAEA095 |
| 1.4 TB | 4 | 940B1.000; 940B8.000 | 77/103 | 04/11→ | OE208 | 0,8 | | | BAEA095 |
| 1.4 TB | 4 | 940A6.000 | 85/114 | 04/10→ | OE208 | 0,8 | | | BAEA095 |
| 1.4 TB | 4 | 940A2.000; 940C2.000 | 110/148 | 09/14→ | | | | | BAEA095 |
| 1.4 TB | 4 | 955A8.000 | 120/161 | 04/10→ | OE208 | 0,8 | | | |
| 1.4 TB | 4 | 940A2.000 | 125/168 | 04/10→ | OE208 | 0,8 | | | |
| 1.8 TBi | 4 | 940A1.000 | 169/227 | 04/10→09/13 | | | | OE256 | |
| 1.8 TBi | 4 | 940A1.000 | 173/232 | 04/10→ | | | | OE256 | |
| 1.8 TBi | 4 | 940B2.000; 960A1.000 | 177/237 | 09/13→ | | | | OE256 | |

GT

| | | | | | | | | | |
|---------|---|----------------------|---------|-------------|-----------------------|-----|------|-----------------------|--------|
| 1.8 TS | 4 | AR32205 | 103/138 | 11/03→09/10 | OE122 ^[27] | 0,7 | | OE179 ^[28] | |
| | | | | | OE223 ^[28] | 1,6 | | | |
| 1.9 JTD | 4 | 937A5.000 | 110/148 | 11/03→09/10 | CH224 | 11v | | | CCU150 |
| 1.9 JTD | 4 | 937A6.000 | 125/168 | 05/08→09/10 | | | | | CCU150 |
| 2.0 JTS | 4 | 932A2.000 | 119/160 | 12/06→09/10 | OE123 | 0,7 | CET2 | OE179 | |
| 2.0 JTS | 4 | 932A2.000; 937A1.000 | 121/162 | 11/03→09/10 | OE123 | 0,7 | CET2 | OE179 | |



kW/BHP



eon TITAN

IRIDIUM



...ALFA ROMEO



| ...GT | | | | | | | | | | |
|----------------------|---|----------------------|---------|-------------|--|------------|--------|-----------------------|--------------------------|------------------|
| 3.2 GTA | 6 | 936A.000 | 176/236 | 11/03→09/10 | OE146 | 1,0 | CET12P | OE179 | BAEA428 ^[277] | |
| GTV | | | | | | | | | | |
| 1.8 16V | 4 | AR32201 | 106/142 | 05/98→10/05 | OE122 ^[27] OE223 ^[28] | 0,7 1,6 | | OE179 ^[28] | BAEA309 | CLS055 |
| 2.0 V6 Turbo | 6 | AR16202 | 148/198 | 06/95→09/98 | OE087 | 0,9 | CET8 | | | CLS235 |
| 2.0 JTS | 4 | 937A1.000 | 121/162 | 04/03→10/05 | OE123 | 0,7 | CET2 | OE179 | | |
| 2.0 T.SPARK 16V | 4 | AR16201; AR32310 | 110/148 | 06/95→10/05 | OE122 ^[27] OE223 ^[28] | 0,7 1,6 | | OE179 ^[28] | | CLS055 |
| 2.0 T.SPARK 16V | 4 | 16201 | 110/148 | 06/95→10/05 | | | | | BAEA309 →04/98 | |
| 2.0 T.SPARK 16V | 4 | AR32301 | 114/153 | 09/97→03/03 | OE122 ^[27] OE223 ^[28] | 0,7 1,6 | | OE179 ^[28] | BAEA309 | CLS055 |
| 3.0 V6 24V | 6 | AR16105 | 160/215 | 10/00→10/05 | OE136 | 0,8 | CET12P | OE179 | BAEA428 ^[277] | |
| 3.0 V6 24V | 6 | AR16102 | 162/217 | 10/96→10/00 | OE136 | 0,8 | CET12P | OE179 | BAEA428 ^[277] | |
| 3.2 V6 24V | 6 | 936A6.000 | 176/236 | 04/03→10/05 | OE146 | 1,0 | CET12P | OE179 | BAEA428 ^[277] | |
| MITO | | | | | | | | | | |
| 0.9 | 2 | 199B6.000 | 74/99 | 12/13→ | OE232 | 0,7 | CET15P | | | |
| 0.9 TwinAir | 2 | 312A2.000 | 63/84 | 07/11→ | OE232 | 0,7 | CET15P | | | |
| 0.9 TwinAir | 2 | 199B6.000 | 77/103 | 04/13→ | OE232 | 0,7 | CET15P | | | |
| 1.3 MultiJet | 4 | 199A3.000; 955B2.000 | 66/89 | 09/08→ | | | | | CCU150 ^[53] | |
| 1.3 MultiJet | 4 | 199B1.000; 330A1.000 | 70/94 | 10/09→ | | | | | CCU150 ^[53] | |
| 1.4 | 4 | 955A9.000 | 51/68 | 05/11→ | OE196 | 1,0 | CET1 | | BAE940A | |
| 1.4 | 4 | 955A1.000 | 57/76 | 03/11→ | OE196 | 1,0 | CET1 | | BAE403C | |
| 1.4 | 4 | 350A1.000 | 57/76 | 03/11→ | OE196 | 1,0 | CET1 | | BAE403C | CLS082 |
| 1.4 | 4 | 955A1.000 | 58/78 | 08/08→ | OE196 | 1,0 | CET1 | | BAE403C | |
| 1.4 | 4 | 199A6.000 | 70/94 | 09/08→ | OE196 | 1,0 | CET1 | | BAE403C | |
| 1.4 Bifuel, 1.4 TJet | 4 | 198A4.000 | 88/118 | 08/08→ | OE208 | 0,8 | | | BAEA095 | |
| 1.4 MultiAir | 4 | 955A6.000 | 77/103 | 09/09→ | OE196 | 1,0 | CET1 | | | |
| 1.4 MultiAir | 4 | 940A2.000 | 125/168 | 09/09→ | OE208 | 0,8 | | | | |
| 1.4 TB | 4 | 955B1.000 | 103/138 | 12/13→ | OE208 | 0,8 | | | | |
| 1.4 TJet | 4 | 198A1.000 | 110/148 | 09/08→ | OE208 | 0,8 | | | BAEA095 | |
| 1.4 TJet | 4 | 199A8.000 | 114/153 | 08/08→ | OE208 | 0,8 | | | BAEA095 | |
| 1.4 Turbo MultiAir | 4 | 955A2.000; 955A7.000 | 99/133 | 10/09→ | OE208 | 0,8 | | | | |
| 1.4 Turbo MultiAir | 4 | 955A8.000 | 120/161 | 10/09→ | OE208 | 0,8 | | | | |
| 1.6 JTDM | 4 | 955A4.000 | 85/114 | 09/08→ | | | | | CCU150 ^[53] | |
| 1.6 JTDM | 4 | 198A2.000; 955A3.000 | 88/118 | 08/08→ | | | | | CCU150 ^[53] | |
| SPIDER | | | | | | | | | | |
| 1.8 16V | 4 | AR32201 | 106/142 | 05/98→04/05 | OE122 ^[27] OE223 ^[28] | 0,7 1,6 | | OE179 ^[28] | BAEA309 | CLS055 |
| 1.8 TBi | 4 | 939B1.000 | 147/197 | 05/09→03/11 | | | | OE256 | | |
| 2.0 V6 Turbo | 6 | AR16202 | 148/198 | 05/98→04/05 | OE006 | 0,9 | CET8 | OE195 | | CLS235 →12/00 |
| 2.0 JTS | 4 | 937A1.000 | 121/162 | 04/03→04/05 | OE123 | 0,7 | CET2 | OE179 | | |
| 2.0 T.SPARK 16V | 4 | AR32310 | 110/148 | 06/95→04/05 | OE122 ^[27] OE223 ^[28] | 0,7 1,6 | | OE179 ^[28] | | CLS055 |
| 2.0 T.SPARK 16V | 4 | AR16201 | 110/148 | 06/95→04/05 | OE122 ^[27] OE223 ^[28] | 0,7 1,6 | | OE179 ^[28] | BAEA309 →04/98 | CLS055 |
| 2.0 T.SPARK 16V | 4 | AR32301 | 114/153 | 05/98→08/00 | OE122 ^[27] OE223 ^[28] | 0,7 1,6 | | OE179 ^[28] | BAEA309 | CLS055 |
| 2.2 JTS | 4 | 939A5.000 | 136/182 | 03/06→03/11 | OE136 | 0,8 | CET12P | OE179 | BAEA149E | |
| 2.4 JTDM | 5 | 939A3.000 | 147/197 | 04/07→06/10 | CH224 | 11v | | | CCU150 | |
| 2.4 JTDM | 5 | 939A3.000 | 154/207 | 03/08→06/10 | CH224 | 11v | | | CCU150 | |

ALFA ROMEO





kW/BHP

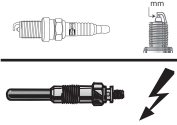

eon TITAN

IRIDIUM

**...ALFA ROMEO****...SPIDER**

| | | | | | | | | | |
|----------------------|---|-----------|---------|-------------|----------------|------------|--------|-------|--------------------------|
| 3.0 V6 | 6 | AR16101 | 141/189 | 04/95→04/05 | OE008 OE018 | 0,9 1,0 | CET8 | OE195 | |
| 3.0 V6 | 6 | AR16105 | 160/215 | 09/94→04/05 | OE146 | 1,0 | CET12P | OE179 | BAEA428 ^[277] |
| 3.0 V6 24V | 6 | AR16102 | 162/217 | 01/99→10/03 | OE136 | 0,8 | CET12P | OE179 | BAEA428 ^[277] |
| 3.2 V6 24V | 6 | 936A6.000 | 176/236 | 04/03→04/05 | OE146 | 1,0 | CET12P | OE179 | BAEA428 ^[277] |
| 3.2 JTS, 3.2 JTS 4WD | 6 | 939A.000 | 191/256 | 03/06→03/11 | OE029 | 1,0 | CET17P | OE189 | BAEA174E |

ALPINA**B3**

| | | | | | | | | | |
|--------------|---|---------------------------------|---------|-------------|-------|-----|--------|-------|--|
| 3.2 | 6 | M60B30(308S); M60B30(308S6K) | 195/261 | 04/96→04/99 | OE026 | 0,9 | CET2 | OE179 | |
| 3.3, 3.3 4WD | 6 | M52B28(286S); M52B28(286S7T) | 206/276 | 03/99→01/05 | OE223 | 1,6 | CET12P | | |
| 3.4 S | 6 | M52B28(286ST5) | 224/300 | 08/02→01/06 | OE223 | 1,6 | CET12P | | |

B5

| | | | | | | | | | |
|-----|---|-----------|---------|-------------|-------|-----|--------|-------|--|
| 4.4 | 8 | N62B44A19 | 368/493 | 03/05→09/10 | OE136 | 0,8 | CET12P | OE179 | |
|-----|---|-----------|---------|-------------|-------|-----|--------|-------|--|

B7

| | | | | | | | | | |
|------------------------------|---|-----------|---------|-------------|--|--|--|--|---------|
| 4.4 | 8 | N62B44A19 | 368/493 | 12/03→06/08 | | | | | BAEA324 |
| 4.4 BITURBO, 4.4 BITURBO 4WD | 8 | N63M10A | 373/500 | 03/09→06/12 | | | | | BAEA143 |

B8

| | | | | | | | | | |
|-----|---|----------------|---------|-------------|-------|-----|------|-------|--|
| 4.6 | 8 | M62B46(468S4K) | 245/329 | 01/95→03/98 | OE026 | 0,9 | CET2 | OE179 | |
|-----|---|----------------|---------|-------------|-------|-----|------|-------|--|

B10

| | | | | | | | | | |
|--------|---|----------------|---------|-------------|-------|-----|--------|-------|--|
| 3.2 | 6 | M60B30(308S6K) | 191/256 | 08/97→12/98 | OE026 | 0,9 | CET2 | OE179 | |
| 3.3 | 6 | M52B28(286S7T) | 206/276 | 01/99→10/03 | OE223 | 1,6 | CET12P | | |
| 4.6 V8 | 8 | M62B46(468S72) | 250/335 | 12/96→10/98 | OE026 | 0,9 | CET2 | OE179 | |
| 4.6 V8 | 8 | M62B46(468S72) | 255/342 | 10/98→09/02 | OE223 | 1,6 | CET12P | | |

B12

| | | | | | | | | | |
|-----|----|----------------|---------|-------------|-------|-----|--------|-------|--|
| 5.7 | 12 | M70B57(5714K2) | 285/382 | 12/95→09/98 | OE026 | 0,9 | CET2 | OE179 | |
| 6.0 | 12 | M73B54(5412AG) | 316/424 | 07/99→07/01 | OE223 | 1,6 | CET12P | | |

D10

| | | | | | | | | | |
|---------------|---|----------------|---------|-------------|-------|-----|--|--|--|
| 3.0 D Biturbo | 6 | M57D30(306DE1) | 180/241 | 04/00→10/03 | CH207 | 11v | | | |
|---------------|---|----------------|---------|-------------|-------|-----|--|--|--|

ROADSTER V8

| | | | | | | | | | |
|--------|---|---------------|---------|-------------|-------|-----|--------|--|---------|
| 4.8 V8 | 8 | M62B48(488S2) | 280/375 | 06/02→10/03 | OE223 | 1,6 | CET12P | | BAEA302 |
|--------|---|---------------|---------|-------------|-------|-----|--------|--|---------|

ROADSTER S

| | | | | | | | | | |
|-----|---|------|---------|-------------|-------|-----|--------|--|--|
| 3.3 | 6 | E5/2 | 221/296 | 07/03→12/05 | OE223 | 1,6 | CET12P | | |
|-----|---|------|---------|-------------|-------|-----|--------|--|--|

ARO**10**

| | | | | | | | | | |
|----------------|---|------|-------|-------------|-------|-----|--|--|--|
| 1.9 1.9 TD 4WD | 4 | F8QT | 69/93 | 06/97→10/06 | CH189 | 11v | | | |
|----------------|---|------|-------|-------------|-------|-----|--|--|--|

SPARTANA

| | | | | | | | | | |
|-----|---|--------|-------|-------------|-------|-----|------|-------|--|
| 1.2 | 4 | C3G702 | 40/54 | 01/99→10/06 | OE001 | 0,9 | CET8 | OE195 | |
|-----|---|--------|-------|-------------|-------|-----|------|-------|--|

ASTON MARTIN**DB7**

| | | | | | | | | | |
|-----|----|-------|---------|-------------|-------|-----|--------|-------|--|
| 3.2 | 6 | AJ6HT | 233/312 | 05/94→06/99 | OE014 | 0,9 | CET2 | OE179 | |
| 3.2 | 6 | AJ6HT | 250/335 | 01/94→10/03 | | | CET2 | OE179 | |
| 5.9 | 12 | AM2 | 298/400 | 07/99→10/03 | OE131 | 1,0 | CET18P | OE183 | |
| 6.0 | 12 | AM2 | 309/414 | 03/99→10/03 | OE131 | 1,0 | CET18P | OE183 | |
| 6.0 | 12 | AM2 | 320/429 | 10/02→10/03 | OE029 | 1,0 | CET17P | OE189 | |

DB9

| | | | | | | | | | |
|--------------|----|-----|---------|-------------|-------|-----|--------|-------|---------|
| 6.0, 6.0 V12 | 12 | AM3 | 331/444 | 01/04→10/16 | OE131 | 1,0 | CET18P | OE183 | BAEA426 |
| 6.0 V12 | 12 | AM3 | 350/469 | 09/05→07/12 | OE131 | 1,0 | CET18P | OE183 | |

ASTON MARTIN



kW/BHP



eon TITAN

IRIDIUM

**...ASTON MARTIN****DBS**

| | | | | | | | | | | |
|---------|----|-------|---------|--------|-------|-----|--------|-------|--|--|
| 6.0 V12 | 12 | AM4R9 | 380/510 | 09/07→ | OE131 | 1,0 | CET18P | OE183 | | |
|---------|----|-------|---------|--------|-------|-----|--------|-------|--|--|

RAPIDE

| | | | | | | | | | | |
|-----|----|-------------|---------|-------------|-------|-----|--------|-------|--|--|
| 6.0 | 12 | AM4R9; AM16 | 350/469 | 03/10→09/13 | OE131 | 1,0 | CET18P | OE183 | | |
|-----|----|-------------|---------|-------------|-------|-----|--------|-------|--|--|

| | | | | | | | | | | |
|-------|----|------|---------|--------|--|--|--|--|----------|--|
| 6.0 S | 12 | AM29 | 412/552 | 08/14→ | | | | | BAEA068E | |
|-------|----|------|---------|--------|--|--|--|--|----------|--|

→06/15

BAEA137E

06/15→

VANQUISH

| | | | | | | | | | | |
|---------|----|-------|---------|-------------|-------|-----|--------|-------|--|--|
| 6.0 V12 | 12 | AM702 | 338/453 | 05/01→08/07 | OE131 | 1,0 | CET18P | OE183 | | |
|---------|----|-------|---------|-------------|-------|-----|--------|-------|--|--|

| | | | | | | | | | | |
|-------|----|-------------|---------|-------------|-------|-----|--------|-------|--|--|
| 6.0 S | 12 | AM4R9; AM06 | 388/520 | 11/04→08/07 | OE131 | 1,0 | CET18P | OE183 | | |
|-------|----|-------------|---------|-------------|-------|-----|--------|-------|--|--|

VANTAGE

| | | | | | | | | | | |
|---------|----|------|---------|-------------|-------|-----|--------|-------|--|--|
| 6.0 V12 | 12 | AM10 | 380/510 | 09/09→12/13 | OE131 | 1,0 | CET18P | OE183 | | |
|---------|----|------|---------|-------------|-------|-----|--------|-------|--|--|

VIRAGE

| | | | | | | | | | | |
|-----|---|-------|---------|-------------|-------|-----|------|-------|--|--|
| 5.3 | 8 | 40HTE | 261/350 | 12/95→12/00 | OE002 | 0,9 | CET2 | OE179 | | |
|-----|---|-------|---------|-------------|-------|-----|------|-------|--|--|

| | | | | | | | | | | |
|-----|----|-------|---------|-------------|-------|-----|--------|-------|--|--|
| 6.0 | 12 | AM4R9 | 365/489 | 06/11→08/12 | OE131 | 1,0 | CET18P | OE183 | | |
|-----|----|-------|---------|-------------|-------|-----|--------|-------|--|--|

AUDI**80**

| | | | | | | | | | | |
|-------|---|-----|-------|-------------|-------|-----|------|-------|----------|--------|
| 1.6 E | 4 | ADA | 74/99 | 06/93→01/96 | OE025 | 1,0 | CET8 | OE195 | BAE851AE | CLS042 |
|-------|---|-----|-------|-------------|-------|-----|------|-------|----------|--------|

[261] [292]

| | | | | | | | | | | |
|---------|---|-----|--------|-------------|-------|-----|------|-------|--|--|
| 2.0 4WD | 4 | ADW | 79/106 | 11/93→01/96 | OE025 | 1,0 | CET8 | OE195 | | |
|---------|---|-----|--------|-------------|-------|-----|------|-------|--|--|

| | | | | | | | | | | |
|-------------|---|-----|---------|-------------|-------|-----|--------|--|--------------------------|--|
| 2.2 RS2 4WD | 5 | ADU | 232/311 | 03/94→05/95 | OE136 | 0,8 | CET11P | | BAEA043 ^[277] | |
|-------------|---|-----|---------|-------------|-------|-----|--------|--|--------------------------|--|

| | | | | | | | | | | |
|------------|---|-----|---------|-------------|-------|-----|--------|--|--------------------------|--|
| 2.2 S2 4WD | 5 | ABY | 169/227 | 02/93→07/95 | OE136 | 0,8 | CET11P | | BAEA043 ^[277] | |
|------------|---|-----|---------|-------------|-------|-----|--------|--|--------------------------|--|

100

| | | | | | | | | | | |
|-----|---|-----|---------|-------------|-------|-----|------|-------|----------|--------|
| 2.6 | 6 | ACZ | 102/137 | 07/93→06/94 | OE032 | 1,0 | CET2 | OE179 | BAEA007E | CLS001 |
|-----|---|-----|---------|-------------|-------|-----|------|-------|----------|--------|

| | | | | | | | | | | |
|-----------|---|-----|---------|-------------|-------|-----|------|-------|----------|--|
| 2.6 E 4WD | 6 | ACZ | 102/137 | 08/93→07/94 | OE032 | 1,0 | CET2 | OE179 | BAEA007E | |
|-----------|---|-----|---------|-------------|-------|-----|------|-------|----------|--|

A1

| | | | | | | | | | | |
|----------|---|------|-------|-------------|--|--|--|-------|---------------------------|--------|
| 1.2 TFSI | 4 | CBZA | 63/84 | 05/10→04/15 | | | | OE260 | BAE907AE ^[262] | CLS090 |
|----------|---|------|-------|-------------|--|--|--|-------|---------------------------|--------|

ModelYear→2014

| | | | | | | | | | | |
|---------|---|------|-------|-------------|---------|------|--|--|--|--|
| 1.4 TDI | 3 | CUSB | 66/89 | 11/14→10/18 | CP5G007 | 4.4v | | | | |
|---------|---|------|-------|-------------|---------|------|--|--|--|--|

| | | | | | | | | | | |
|----------|---|------------|--------|-------------|-------|-----|--|--|----------|--|
| 1.4 TFSI | 4 | CAXA; CNVA | 90/121 | 05/10→04/15 | OE213 | 0,9 | | | BAE408AE | |
|----------|---|------------|--------|-------------|-------|-----|--|--|----------|--|

ModelYear→2014

| | | | | | | | | | | |
|----------|---|------|--------|-------------|-------|-----|--|--|---------------------------|--|
| 1.4 TFSI | 4 | CZCA | 92/123 | 11/14→10/18 | OE244 | 0,8 | | | BAEA067E ^[240] | |
|----------|---|------|--------|-------------|-------|-----|--|--|---------------------------|--|

| | | | | | | | | | | |
|----------|---|------|--------|-------------|-------|-----|--|--|--|--|
| 1.4 TFSI | 4 | CZDD | 92/123 | 11/14→10/18 | OE244 | 0,8 | | | | |
|----------|---|------|--------|-------------|-------|-----|--|--|--|--|

| | | | | | | | | | | |
|----------|---|------|---------|-------------|-------|-----|--|--|---------------------------------|--|
| 1.4 TFSI | 4 | CPTA | 103/138 | 04/12→04/15 | OE244 | 0,8 | | | BAEA067E ^{[240] [275]} | |
|----------|---|------|---------|-------------|-------|-----|--|--|---------------------------------|--|

| | | | | | | | | | | |
|----------|---|------------------|---------|-------------|-------|-----|--|--|----------|--|
| 1.4 TFSI | 4 | CAVG; CTHG; CTJA | 136/182 | 01/11→04/15 | OE213 | 0,9 | | | BAE408AE | |
|----------|---|------------------|---------|-------------|-------|-----|--|--|----------|--|

→Prod.13.02.2011

| | | | | | | | | | | |
|---------|---|------|---------|-------------|-------|-----|--|--|---------------------------|--|
| 1.4 TSI | 4 | CZEA | 110/148 | 11/14→10/18 | OE244 | 0,8 | | | BAEA067E ^[240] | |
|---------|---|------|---------|-------------|-------|-----|--|--|---------------------------|--|

| | | | | | | | | | | |
|---------|---|------|-------|-------------|--|--|--|--|--------|--|
| 1.6 TDI | 4 | CAYB | 66/89 | 03/11→04/15 | | | | | CCU152 | |
|---------|---|------|-------|-------------|--|--|--|--|--------|--|

| | | | | | | | | | | |
|---------|---|------|--------|-------------|--|--|--|--|--------|--|
| 1.6 TDI | 4 | CAYC | 77/103 | 05/10→04/15 | | | | | CCU152 | |
|---------|---|------|--------|-------------|--|--|--|--|--------|--|

| | | | | | | | | | | |
|---------|---|------|--------|-------------|---------|------|--|--|--------|--|
| 1.6 TDI | 4 | CXMA | 85/114 | 11/14→10/18 | CP5G007 | 4.4v | | | CCU152 | |
|---------|---|------|--------|-------------|---------|------|--|--|--------|--|

| | | | | | | | | | | |
|----------|---|------|---------|-------------|--|--|--|-------|----------|--|
| 1.8 TFSI | 4 | DAJB | 141/189 | 02/15→10/18 | | | | OE246 | BAEA068E | |
|----------|---|------|---------|-------------|--|--|--|-------|----------|--|

→02/16

| | | | | | | | | | | |
|------------|---|------|---------|-------------|--|--|--|-------|----------|--|
| 2.0 S1 4WD | 4 | CWZA | 170/228 | 03/14→10/18 | | | | OE246 | BAEA068E | |
|------------|---|------|---------|-------------|--|--|--|-------|----------|--|

| | | | | | | | | | | |
|---------|---|------|---------|-------------|--|--|--|--|--------|--|
| 2.0 TDI | 4 | CFHB | 100/134 | 05/12→04/15 | | | | | CCU152 | |
|---------|---|------|---------|-------------|--|--|--|--|--------|--|

| | | | | | | | | | | |
|---------|---|------|---------|-------------|--|--|--|--|--------|--|
| 2.0 TDI | 4 | CFHD | 105/141 | 09/11→04/15 | | | | | CCU152 | |
|---------|---|------|---------|-------------|--|--|--|--|--------|--|

| | | | | | | | | | | |
|--------------|---|------|---------|-------------|-------|-----|--------|--|-------------------------|--|
| 2.0 TFSI 4WD | 4 | CDLH | 188/252 | 03/12→11/12 | OE214 | 0,7 | CET11P | | BAEA033E ^[7] | |
|--------------|---|------|---------|-------------|-------|-----|--------|--|-------------------------|--|

A2

| | | | | | | | | | | |
|---------|---|-----|-------|-------------|-------|-----|--|--|--|--|
| 1.2 TDI | 3 | ANY | 45/60 | 03/01→08/05 | CH181 | 11v | | | | |
|---------|---|-----|-------|-------------|-------|-----|--|--|--|--|

| | | | | | | | | | | |
|-----|---|-----|-------|-------------|-------|-----|------|-------|---------------------------|--------|
| 1.4 | 4 | AUA | 55/74 | 02/00→08/05 | OE032 | 1,0 | CET2 | OE179 | BAE907AE ^[262] | CLS260 |
|-----|---|-----|-------|-------------|-------|-----|------|-------|---------------------------|--------|

| | | | | | | | | | | |
|-----|---|-----|-------|-------------|-------|-----|------|-------|----------|--|
| 1.4 | 4 | BBY | 55/74 | 02/00→08/05 | OE032 | 1,0 | CET2 | OE179 | BAE408AE | |
|-----|---|-----|-------|-------------|-------|-----|------|-------|----------|--|

| | | | | | | | | | | |
|---------|---|----------|-------|-------------|-------|-----|--|--|--|--|
| 1.4 TDI | 3 | AMF; BHC | 55/74 | 02/00→08/05 | CH181 | 11v | | | | |
|---------|---|----------|-------|-------------|-------|-----|--|--|--|--|

| | | | | | | | | | | |
|---------|---|-----|--------|-------------|--|--|--|--|----------|--|
| 1.6 FSI | 4 | BAD | 81/109 | 05/02→08/05 | | | | | BAE408AE | |
|---------|---|-----|--------|-------------|--|--|--|--|----------|--|



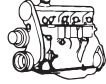

kW/BHP

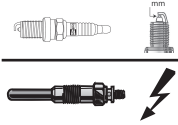

eon TITAN

IRIDIUM



...AUDI



A3

| | | | | | | | | | | |
|--------------------------------|---|------------------|---------|-------------|-------------------------|------|--------|-------|--|--|
| 1.2 TFSI | 4 | CJZA | 77/103 | 03/10→ | OE244 [226] [305] | 0,8 | | | BAEA067E [240] | |
| | | | | | | | | | BAEA126E [249] | |
| 1.2 TFSI | 4 | CYVB | 81/109 | 05/14→ | OE244 [226] [305] | 0,8 | | | BAEA067E [240] | |
| 1.2 TFSI, 1.2 TSI | 4 | CBZB | 77/103 | 03/10→ | | | | OE260 | BAE907AE [262] | CLS090 |
| 1.4 TFSI | 4 | CZCC | 85/114 | 02/16→ | OE244 [221] [303] | 0,8 | | | | |
| 1.4 TFSI | 4 | CMBA | 90/121 | 04/12→ | | | | | BAEA067E [240] | |
| | | | | | | | | | BAEA126E [249] | |
| 1.4 TFSI | 4 | CXSA | 90/121 | 04/12→ | OE244 [222] [304] | 0,8 | | | BAEA067E [240] | |
| | | | | | | | | | BAEA126E [249] | |
| 1.4 TFSI | 4 | CAXC; CMSA | 92/123 | 09/07→ | OE213 | 0,9 | | | BAE408AE | |
| 1.4 TFSI | 4 | CXSB; CZCA | 92/123 | 09/07→ | OE244 [222] [304] | 0,8 | | | BAEA067E [240] | |
| | | | | | OE244 [221] [303] | 0,8 | | | | |
| 1.4 TFSI | 4 | CPTA | 103/138 | 03/13→ | OE244 [222] [304] | 0,8 | | | BAEA067E [240] | |
| | | | | | OE244 [221] [303] | 0,8 | | | BAEA068E | |
| | | | | | | | | | BAEA126E [249] | |
| 1.4 TFSI e-tron | 4 | CUKB | 110/148 | 05/14→ | OE244 [222] [304] | 0,8 | | | BAEA067E [240] | |
| 1.4 TFSI e-tron | 4 | CXUA | 150/201 | 05/14→ | OE244 [222] [304] | 0,8 | | | | |
| 1.4 TFSI e-tron, 1.4 TFSI Flex | 4 | CWLA; CXUA | 110/148 | 05/14→ | OE244 [222] [304] | 0,8 | | | | |
| 1.4 TFSI g-tron | 4 | CPWA | 81/109 | 11/13→ | OE244 [222] [304] | 0,8 | | | BAEA067E [240] | |
| 1.4 TSI | 4 | CZEA | 110/148 | 05/14→ | OE244 [222] [304] | 0,8 | | | BAEA067E [240] | |
| | | | | | OE244 [221] [303] | 0,8 | | | | |
| 1.6 | 4 | AEH; AKL; APF | 74/99 | 09/96→05/03 | OE032 | 1,0 | CET2 | OE179 | BAE907AE [262] | CLS139 |
| 1.6 | 4 | AVU; BFQ | 75/101 | 08/00→03/13 | OE032 | 1,0 | CET2 | OE179 | BAE907AE [262] | CLS048 |
| 1.6 | 4 | BGU; BSE; BSF | 75/101 | 08/00→03/13 | OE032 | 1,0 | CET2 | OE179 | BAE907AE [262] | CLS017 CLS048 |
| 1.6 E-Power | 4 | CCSA; CMXA | 75/101 | 01/11→03/13 | OE032 | 1,0 | CET2 | OE179 | BAE907AE [262] | |
| 1.6 FSI | 4 | BAG; BLF; BLP | 85/114 | 08/03→09/07 | | | | | BAE408AE | |
| 1.6 TDI | 4 | CAYB | 66/89 | 05/09→03/13 | | | | | CCU152 | |
| 1.6 TDI | 4 | CLHA | 77/103 | 05/09→ | | | | | CCU151 | |
| 1.6 TDI | 4 | CAVC | 77/103 | 05/09→ | | | | | CCU152 | |
| 1.6 TDI | 4 | CRKB; CXXB; DBKA | 81/109 | 09/13→ | CPSG007 ^[44] | 4.4v | | | CCU151 | |
| 1.6 TDI | 4 | DDYA | 85/114 | 02/17→ | CPSG007 | 4.4v | | | | |
| 1.6 TDI 4WD | 4 | CXXB | 81/109 | 05/15→ | CPSG007 ^[44] | 4.4v | | | | |
| 1.8 | 4 | AGN | 92/123 | 09/96→05/03 | OE032 | 1,0 | | | BAE907AE [262] | CLS177 →Ch. 8L-V-140000 CLS140 Ch. 8L-V-140001→ |
| 1.8 | 4 | APG | 92/123 | 09/96→05/03 | OE032 | 1,0 | | | BAE907AE [262] | CLS140 Ch. 8L-V-140001→ |
| 1.8 S3 4WD | 4 | AMK; APY; AUL | 154/207 | 03/99→04/02 | OE136 | 0,8 | CET12P | OE179 | BAEA009E ModelYear→2000 BAEA043E ModelYear2001→ | |
| 1.8 S3 4WD | 4 | BAM | 165/221 | 10/01→05/03 | OE136 | 0,8 | CET12P | OE179 | BAEA043E | |
| 1.8 T | 4 | BPU | 110/148 | 12/96→08/12 | OE136 | 0,8 | CET12P | OE179 | | |
| 1.8 T | 4 | AQA; ARZ | 110/148 | 12/96→08/12 | OE136 | 0,8 | CET12P | OE179 | BAEA009E | |
| 1.8 T, 1.8 T 4WD | 4 | AGU | 110/148 | 12/96→08/12 | OE136 | 0,8 | CET12P | OE179 | BAEA043E BAEA016 ModelYear→2000 | |

AUDI





kW/BHP



eon TITAN

IRIDIUM



...AUDI



...A3

| | | | | | | | | | |
|---------------------------------------|---|--------------------|---------|--------------|--|------|---------|-------|--|
| 1.8 T, 1.8 T 4WD | 4 | ARY; AUQ | 132/177 | 10/98 →05/03 | OE136 | 0,8 | CET1 2P | OE179 | BAEA043E |
| 1.8 T, 1.8 T 4WD | 4 | AJQ; APP | 132/177 | 10/98 →05/03 | OE136 | 0,8 | CET1 2P | OE179 | BAEA009E |
| 1.8 T, 1.8 T 4WD | 4 | ARX; AUM | 110/148 | 12/96 →08/12 | OE136 | 0,8 | CET1 2P | OE179 | BAEA043E |
| 1.8 T 4WD | 4 | AQA | 110/148 | 12/96 →05/03 | OE136 | 0,8 | CET1 2P | OE179 | BAEA009E ModelYear →2000 |
| 1.8 TFSI | 4 | CNSB | 125/168 | 11/13 → | | | | OE246 | BAEA068E |
| 1.8 TFSI, 1.8 TFSI 4WD | 4 | BYT; BZB; CDAA | 118/158 | 11/06 →05/13 | OE214 | 0,7 | CET1 1P | | BAEA033E [7] [249] [275] |
| 1.8 TFSI, 1.8 TFSI 4WD | 4 | CJSA; CJSB | 132/177 | 04/12 → | | | | OE246 | BAEA068E |
| 1.9 TDI | 4 | AGR; ALH | 66/89 | 09/96 →07/01 | CH271 | 11v | | | CCU081 |
| 1.9 TDI | 4 | ATD; AXR | 74/99 | 10/00 →05/03 | CH271 | 11v | | | CCU081 |
| 1.9 TDI | 4 | BLS | 77/103 | 05/03 →05/10 | | | | | CCU151 →05/06 →Ch.BP-5A200000 BP-5B050000 |
| 1.9 TDI | 4 | BXE | 77/103 | 05/03 →05/10 | | | | | CCU152 Ch.BP-6A000001 BP-6B000001 → |
| 1.9 TDI | 4 | AHF; ASV | 81/109 | 08/97 →07/01 | CH271 | 11v | | | CCU152 05/08 → |
| 1.9 TDI, 1.9 TDI 4WD | 4 | ASZ | 96/129 | 08/00 →05/03 | CH271 | 11v | | | CCU081 |
| 2.0 FSI | 4 | AXW; BLR; BLX; BVY | 110/148 | 05/03 →06/08 | OE234 | 1,0 | CET3 | | BAEA033E [7] |
| 2.0 FSI | 4 | BLY; BMB | 110/148 | 05/03 →06/08 | | | | | BAEA033E [7] |
| 2.0 FSI | 4 | BVZ | 110/148 | 05/03 →06/08 | | | CET3 | | BAEA033E [7] |
| 2.0 S3 4WD | 4 | BZC; CDLC | 188/252 | 02/07 →03/13 | OE214 | 0,7 | CET1 1P | | BAEA033E [7] [249] [275] |
| 2.0 S3 4WD | 4 | BHZ; CDLA | 195/261 | 11/06 →03/13 | OE214 | 0,7 | CET1 1P | | BAEA033E [7] [249] [275] |
| 2.0 S3 4WD | 4 | CJXB | 206/276 | 02/13 → | | | | OE246 | BAEA068E |
| 2.0 S3 4WD | 4 | CJXF | 210/282 | 03/14 → | | | | OE246 | BAEA068E |
| 2.0 S3 4WD | 4 | CJXC | 221/296 | 11/12 → | | | | OE246 | BAEA068E |
| 2.0 TDI | 4 | CRFA; DEJB | 81/109 | 01/13 → | | | | | CCU151 |
| 2.0 TDI | 4 | CRBD | 100/134 | 05/03 → | | | | | CCU151 |
| 2.0 TDI | 4 | CRLC | 100/134 | 05/03 → | CPSG007 ^[44] | 4.4v | | | CCU151 |
| 2.0 TDI | 4 | CBAA; CFFA | 100/134 | 05/03 → | | | | | CCU152 |
| 2.0 TDI | 4 | CRFC | 105/141 | 09/12 → | | | | | CCU151 |
| 2.0 TDI | 4 | CRUA; DEJA | 110/148 | 04/12 → | CPSG007 | 4.4v | | | CCU151 |
| 2.0 TDI | 4 | DBGA | 110/148 | 04/12 → | CPSG007 ^[44] ModelYear →2016 | 4.4v | | | CCU151 |
| 2.0 TDI | 4 | DCYA | 110/148 | 04/12 → | CPSG007 ^[44] | 4.4v | | | CCU151 |
| 2.0 TDI | 4 | BUY | 120/161 | 06/06 →06/08 | CCGP003 | 7v | | | CCU152 Ch.BP-6A000001 BP-6B000001 → |
| 2.0 TDI, 2.0 TDI 4WD | 4 | BMM | 103/138 | 06/05 →05/13 | CCGP002 →Ch.BP-6A138000 BP-6B019000 | 7v | | | CCU151 →05/06 →Ch.BP-5A200000 BP-5B050000 |
| 2.0 TDI, 2.0 TDI 4WD | 4 | CRBC | 110/148 | 04/12 → | | | | | CCU152 Ch.BP-6A000001 BP-6B000001 → |
| 2.0 TDI, 2.0 TDI 4WD | 4 | CRLB | 110/148 | 04/12 → | CPSG007 ^[44] | 4.4v | | | CCU151 |
| 2.0 TDI, 2.0 TDI 4WD | 4 | BMN | 125/168 | 03/06 →03/13 | CCGP003 | 7v | | | CCU152 |
| 2.0 TDI, 2.0 TDI 4WD | 4 | CBBB | 125/168 | 03/06 →03/13 | | | | | CCU151 |
| 2.0 TDI, 2.0 TDI 4WD | 4 | CUNA; DGCA | 135/181 | 12/12 → | CPSG007 ^[44] | 4.4v | | | CCU151 |
| 2.0 TDI, 2.0 TDI 16V, 2.0 TDI 16V 4WD | 4 | CBAB; CFFB | 103/138 | 05/03 →05/13 | | | | | CCU152 |
| 2.0 TFSI | 4 | CBFA; CCTA | 147/197 | 09/04 →05/13 | | | | | BAEA033E [7] [249] [275] |





kW/BHP

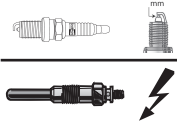

eon TITAN

IRIDIUM

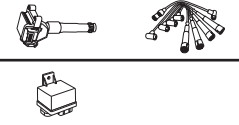

...AUDI



...A3

| | | | | | | | | | |
|------------------------|---|--------------------------------|---------|-------------|-------|-----|--------|-------|-----------------------------|
| 2.0 TFSI, 2.0 TFSI 4WD | 4 | CZPB | 140/188 | 05/16→ | | | | | BAEA137E |
| 2.0 TFSI, 2.0 TFSI 4WD | 4 | AXX; BPY; BWA; CAWB; CCA; CCZA | 147/197 | 09/04→05/13 | OE214 | 0,7 | CET11P | | BAEA033E [7] [249] [275] |
| 2.0 TFSI 4WD | 4 | CNTC | 162/217 | 11/13→ | | | | OE246 | BAEA068E |
| 2.5 RS3 4WD | 5 | CEPA | 250/335 | 01/11→12/12 | OE219 | 0,7 | | | BAEA033E [7] |
| 3.2 V6 4WD | 6 | BDB; BMJ; BUB | 184/247 | 07/03→05/09 | OE215 | 0,9 | | | BAEA044E [356] |

A4

| | | | | | | | | | | |
|------------------------|---|--------------------|---------|-------------|--|------|--------|-------|-----------------------------|--------|
| 1.6 | 4 | AHL; ANA; ARM | 74/99 | 11/94→09/01 | OE032 | 1,0 | CET2 | OE179 | BAE907AE [262] | CLS048 |
| 1.6 | 4 | ADP | 74/99 | 11/94→09/01 | OE032 | 1,0 | CET2 | OE179 | | CLS047 |
| 1.6 | 4 | ALZ | 75/101 | 07/00→06/08 | OE032 | 1,0 | CET2 | OE179 | BAE907AE [262] | CLS048 |
| 1.8 | 4 | ADR; APT; ARG | 92/123 | 11/94→09/01 | OE032 | 1,0 | | | BAEA162E | CLS057 |
| 1.8, 1.8 4WD | 4 | AFY | 85/114 | 04/95→09/01 | OE032 | 1,0 | CET2 | OE179 | BAEA162E | CLS057 |
| 1.8, 1.8 4WD | 4 | ADR; APT; ARG; AVV | 92/123 | 11/94→09/01 | OE032 | 1,0 | | | BAEA162E | CLS057 |
| 1.8 T | 4 | AWT | 110/148 | 01/95→05/10 | OE136 | 0,8 | CET12P | OE179 | BAEA043E | |
| 1.8 T | 4 | BFB | 120/161 | 07/02→03/09 | OE136 | 0,8 | CET12P | OE179 | BAEA043E | |
| 1.8 T, 1.8 T 4WD | 4 | AVJ | 110/148 | 01/95→05/10 | OE136 | 0,8 | CET12P | OE179 | BAEA043E | |
| 1.8 T, 1.8 T 4WD | 4 | AEB; ANB; APU; ARK | 110/148 | 01/95→05/10 | OE136 | 0,8 | CET12P | OE179 | BAEA016 | |
| 1.8 T, 1.8 T 4WD | 4 | AMB | 125/168 | 01/95→10/05 | OE136 | 0,8 | CET12P | OE179 | BAEA043E | |
| 1.8 T, 1.8 T 4WD | 4 | AJL | 132/177 | 12/97→09/01 | OE136 | 0,8 | CET12P | OE179 | BAEA016 | |
| 1.8 T, 1.8 T 4WD | 4 | BEX | 140/188 | 11/02→12/04 | OE136 | 0,8 | CET12P | OE179 | BAEA043E | |
| 1.8 T 4WD | 4 | AWT | 110/148 | 01/95→07/02 | OE136 | 0,8 | CET12P | OE179 | | |
| 1.8 T 4WD | 4 | ARX | 110/148 | 01/95→07/02 | | | | | BAEA016 | |
| 1.8 T 4WD | 4 | BFB | 120/161 | 07/02→03/09 | OE136 | 0,8 | CET12P | OE179 | BAEA043E | |
| | | | | | | | | | BAEA051E | |
| 1.8 TFSI | 4 | CABA; CDHA | 88/118 | 01/08→12/15 | OE214 | 0,7 | CET11P | | BAEA033E [7] [249] [275] | |
| 1.8 TFSI, 1.8 TFSI 4WD | 4 | CABB; CDHB | 118/158 | 11/07→03/12 | OE214 | 0,7 | CET11P | | BAEA033E [7] [249] [275] | |
| 1.8 TFSI, 1.8 TFSI 4WD | 4 | CJEB | 125/168 | 11/11→12/15 | | | | OE246 | BAEA137E | |
| 1.9 DUO, 1.9 TDI | 4 | IZ; AHH; AHU | 66/89 | 01/95→09/01 | CH271 | 11v | | | | |
| 1.9 TDI | 4 | AFF | 55/74 | 12/95→09/01 | CH271 | 11v | | | | |
| 1.9 TDI | 4 | AVB | 74/99 | 05/01→12/04 | CH271 | 11v | | | | |
| 1.9 TDI | 4 | BKE | 85/114 | 03/00→06/08 | | | | | CCU151 →Ch.8E-5-070250 | |
| 1.9 TDI | 4 | BRB | 85/114 | 03/00→06/08 | CCGP002 Ch.8E-5-400001→ | 7v | | | CCU151 Ch.8E-6-132001→ | |
| 1.9 TDI, 1.9 TDI 4WD | 4 | AFN; AVG | 81/109 | 10/95→09/01 | CH271 | 11v | | | | |
| 1.9 TDI, 1.9 TDI 4WD | 4 | AJM; ATJ | 85/114 | 03/00→06/08 | CH271 | 11v | | | | |
| 1.9 TDI, 1.9 TDI 4WD | 4 | AVF; AWX | 96/129 | 11/00→12/04 | CH271 | 11v | | | | |
| 2.0 | 4 | ALT | 96/129 | 11/00→06/08 | | | | | BAEA043E | |
| | | | | | | | | | BAEA051E | |
| 2.0 FSI | 4 | AWA | 110/148 | 07/02→12/04 | OE234 Ch.8E-1-000001→ Ch.8E-5-400000 | 1,0 | CET3 | | BAEA032E [13] | |
| 2.0 TDI | 4 | CAGC; CJCC | 88/118 | 06/08→12/15 | | | | | CCU151 | |
| 2.0 TDI | 4 | BVG | 89/119 | 09/05→09/06 | CCGP003 | 7v | | | CCU151 | |
| 2.0 TDI | 4 | DEUC | 90/121 | 04/16→ | CPSG007 [44] [196] | 4.4v | | | CCU152 | |
| | | | | | CPSG007 [197] | 4.4v | | | | |
| 2.0 TDI | 4 | BVF | 93/125 | 11/05→11/06 | CCGP003 | 7v | | | CCU151 | |
| 2.0 TDI | 4 | BRC | 100/134 | 11/04→ | CCGP002 | 7v | | | CCU151 | |
| 2.0 TDI | 4 | BRF | 100/134 | 11/04→ | CCGP003 Ch.8E-5-400001→ | 7v | | | CCU151 | |
| 2.0 TDI | 4 | CAGB; CJC; CSUB | 100/134 | 11/04→ | | | | | CCU151 | |
| 2.0 TDI | 4 | DEUB | 100/134 | 11/04→ | CPSG007 [44] [196] | 4.4v | | | CCU152 | |
| | | | | | CPSG007 [197] | 4.4v | | | | |

AUDI



kW/BHP

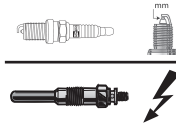

eon TITAN

IRIDIUM

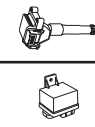

...AUDI



...A4

| | | | | | | | | | | |
|--|---|------------------------|---------|-------------|---|------|---------------|--------------|--|----------------------------------|
| 2.0 TDI | 4 | CZHA; DEUA | 110/148 | 05/13→ | CPSG007 [44][196] | 4.4v | | | | CCU152 |
| | | | | | CPSG007 ^[197] | 4.4v | | | | |
| 2.0 TDI | 4 | CMFB; CSUA | 110/148 | 05/13→ | CPSG007 [44][209] | 4.4v | | | | |
| 2.0 TDI | 4 | CAHB; CGLD; CNHC | 120/161 | 06/06→12/15 | | | | | | CCU151 |
| 2.0 TDI, 2.0 TDI 4WD | 4 | BPW | 103/138 | 11/04→03/09 | CCGP002 | 7v | | | | CCU151 |
| 2.0 TDI, 2.0 TDI 4WD | 4 | CAGA; CJCA; CMEA; CMFA | 105/141 | 11/07→12/15 | | | | | | CCU151 |
| 2.0 TDI, 2.0 TDI 4WD | 4 | CJCD; CSUA | 110/148 | 05/13→ | CPSG007 [44][209] | 4.4v | | | | CCU151 |
| 2.0 TDI, 2.0 TDI 4WD | 4 | BVA | 120/161 | 06/06→ | CCGP003 | 7v | | | | |
| 2.0 TDI, 2.0 TDI 4WD | 4 | BRD | 125/168 | 06/06→03/12 | CCGP003 | 7v | | | | CCU151 |
| 2.0 TDI, 2.0 TDI 4WD | 4 | CAHA | 125/168 | 06/06→03/12 | | | | | | CCU151 |
| 2.0 TDI, 2.0 TDI 4WD | 4 | CGLC; CMGB | 130/174 | 11/11→12/15 | | | | | | CCU151 |
| 2.0 TDI, 2.0 TDI 4WD | 4 | CNHA | 140/188 | 09/13→ | CPSG007 [44][209] | 4.4v | | | | CCU151 |
| 2.0 TDI, 2.0 TDI 4WD | 4 | DESA; DETA; DFVA | 140/188 | 09/13→ | CPSG007 [44][196] | 4.4v | | | | CCU152 |
| | | | | | CPSG007 ^[197] | 4.4v | | | | |
| 2.0 TDI 4WD | 4 | DEUA | 110/148 | 05/13→ | CPSG008 →Prod.17.07.2017 [44][210] | 4.4v | | | | |
| | | | | | CPSG008 ^[197] →Prod.17.07.2017 | 4.4v | | | | |
| 2.0 TDI 4WD | 4 | DETB | 120/161 | 06/06→ | CPSG008 →Prod.17.07.2017 [44][210] | 4.4v | | | | |
| | | | | | CPSG008 ^[197] →Prod.17.07.2017 | 4.4v | | | | |
| 2.0 TDI 16V | 4 | BRE | 103/138 | 11/04→ | CCGP003 Ch.8E-5-400001→ | 7v | | | | CCU151 |
| 2.0 TFSI | 4 | BPJ | 125/168 | 10/06→06/08 | OE214 | 0,7 | CET11P | | | |
| 2.0 TFSI | 4 | CVKB; DBPA; DEMA | 140/188 | 05/15→ | | | | OE246 | | BAEA137E |
| 2.0 TFSI | 4 | CAEB; CDNC | 155/208 | 06/08→05/13 | OE214 | 0,7 | CET11P | | | BAEA033E [7][249][275] |
| 2.0 TFSI | 4 | BUL | 162/217 | 06/05→12/15 | OE214 | 0,7 | CET11P | | | BAEA033E [7][275] |
| 2.0 TFSI, 2.0 TFSI 4WD | 4 | CNCD | 165/221 | 05/13→12/15 | | | | OE246 | | BAEA068E |
| 2.0 TFSI, 2.0 TFSI 4WD | 4 | CYRC | 183/245 | 11/15→ | | | | OE246 | | BAEA068E →02/16 |
| 2.0 TFSI, 2.0 TFSI 4WD | 4 | CYMC; CYRB; DDWA | 185/248 | 05/15→ | | | | OE246 | | BAEA068E →02/16 |
| 2.0 TFSI, 2.0 TFSI 4WD | 4 | BUL; CAED | 162/217 | 06/05→12/15 | OE214 | 0,7 | CET11P | | | BAEA033E ^[7] |
| 2.0 TFSI, 2.0 TFSI 4WD, 2.0 TFSI 4WD, 2.0 TFSI 16V | 4 | BPG; BWT | 147/197 | 11/04→03/09 | | | | | | BAEA033E ^[7] |
| 2.0 TFSI, 2.0 TFSI 4WD, 2.0 TFSI 16V | 4 | BGB; BWE | 147/197 | 11/04→03/09 | OE214 | 0,7 | CET11P | | | BAEA033E ^[7] |
| 2.0 TFSI, 2.0 TFSI flexible fuel, 2.0 TFSI flexible fuel 4WD | 4 | CAEA; CDNB; CFKA | 132/177 | 06/08→12/15 | OE214 | 0,7 | CET11P | | | BAEA033E [7][249][275] |
| 2.0 TFSI 4WD | 4 | CFKA | 132/177 | 11/09→03/12 | OE214 | 0,7 | CET11P | | | BAEA033E [7][249] |
| 2.0 TFSI 4WD | 4 | CPMA | 155/208 | 06/08→12/15 | OE214 | 0,7 | CET11P | | | |
| 2.0 TFSI 4WD | 4 | CAEB; CDNC | 155/208 | 06/08→12/15 | OE214 | 0,7 | CET11P | | | BAEA033E [7][249][275] |
| | | | | | | | | | | BAEA033E ^[7] |
| 2.0 TFSI 4WD | 4 | CAED; CPMB | 162/217 | 06/05→12/15 | OE214 | 0,7 | CET11P | | | BAEA033E [7][249][275] |
| 2.0 TFSI g-tron | 4 | CVLA | 125/168 | 11/16→ | | | | | | BAEA137E |
| 2.4 | 6 | AFM | 110/148 | 07/95→07/97 | OE032 | 1,0 | CET2 | OE179 | | CLS001 |
| 2.4 | 6 | AJG; AMM | 120/161 | 08/97→12/05 | OE237 | 1,6 | CET2 | OE179 | | BAEA154E |
| 2.4 | 6 | BDV | 125/168 | 09/01→12/05 | OE237 | 1,6 | CET2 | OE179 | | BAEA154E CLS046 |
| 2.4, 2.4 4WD | 6 | APZ | 120/161 | 08/97→12/05 | OE237 | 1,6 | CET2 | OE179 | | BAEA154E CLS001 |





kW/BHP



eon TITAN

IRIDIUM



...AUDI



...A4

| | | | | | | | | | | |
|----------------------|---|------------------------------------|---------|---------------|---|------|---------------|--------------|---------------------------------|--|
| 2.4, 2.4 4WD | 6 | AGA; ALF; AML; APS; ARJ | 121/162 | 03/97 → 09/01 | OE237 | 1,6 | CET2 | OE179 | BAEA154E | CLS046 |
| 2.4 4WD | 6 | AJG | 120/161 | 08/97 → 09/01 | OE237 | 1,6 | CET2 | OE179 | | CLS001 |
| 2.4 4WD | 6 | AML | 121/162 | 03/97 → 09/01 | OE237 | 1,6 | CET2 | OE179 | BAEA154E | CLS001 |
| 2.5 TDI | 6 | AYM | 114/153 | 08/01 → 07/02 | CH215 | 12v | | | | |
| 2.5 TDI | 6 | BCZ; BDG; BFC | 120/161 | 07/02 → 05/06 | CH215 | 12v | | | | |
| 2.5 TDI, 2.5 TDI 4WD | 6 | AFB; AKN | 110/148 | 09/97 → 09/01 | CH215 | 12v | | | | |
| 2.5 TDI 4WD | 6 | AKE; BAU; BDH | 132/177 | 11/00 → 12/04 | CH215 | 12v | | | | |
| 2.6 | 6 | ACZ | 102/137 | 01/96 → 07/97 | OE032 | 1,0 | CET2 | OE179 | | |
| 2.6, 2.6 4WD | 6 | ABC | 110/148 | 01/95 → 09/01 | OE032 | 1,0 | | | | CLS001 → 07/97 CLS046 07/97 → |
| 2.7 Bi Turbo 4WD | 6 | APB | 187/251 | 08/98 → 12/98 | | | | | BAEA154E | |
| 2.7 RS4 4WD | 6 | ASJ; AZR | 280/375 | 05/00 → 09/01 | OE136 | 0,8 | CET12P | OE179 | BAEA016 | |
| 2.7 S4 4WD | 6 | AGB; AZB | 195/261 | 09/97 → 09/01 | OE136 | 0,8 | CET12P | OE179 | BAEA016 | |
| 2.7 Turbo 4WD | 6 | AJK | 169/227 | 02/99 → 09/00 | OE136 | 0,8 | CET12P | OE179 | BAEA154E | |
| 2.8 | 6 | AHA | 142/190 | 10/96 → 09/01 | OE237 | 1,6 | CET2 | OE179 | BAEA154E | |
| 2.8, 2.8 4WD | 6 | AAH | 128/172 | 01/95 → 07/97 | OE032 | 1,0 | | | | CLS001 |
| 2.8, 2.8 4WD | 6 | ATX | 140/188 | 03/99 → 10/00 | OE237 | 1,6 | CET2 | OE179 | BAEA154E | |
| 2.8, 2.8 4WD | 6 | ACK; ALG; AMX; APR; AQD | 142/190 | 10/96 → 09/01 | OE237 | 1,6 | CET2 | OE179 | BAEA154E | CLS046 |
| 2.8, 2.8 4WD | 6 | AHA; ATQ | 142/190 | 10/96 → 09/01 | OE237 | 1,6 | CET2 | OE179 | | |
| 2.8 4WD | 6 | ARP | 142/190 | 10/96 → 09/01 | | | | | BAEA154E | |
| 3.0, 3.0 4WD | 6 | BBJ | 160/215 | 04/01 → 07/06 | OE237 | 1,6 | CET2 | OE179 | BAEA051E | |
| 3.0, 3.0 4WD | 6 | ASN | 162/217 | 11/00 → 12/05 | OE237 | 1,6 | CET2 | OE179 | BAEA051E | |
| 3.0, 3.0 4WD | 6 | AVK | 162/217 | 11/00 → 12/05 | | | | | BAEA051E | |
| 3.0 S4 4WD | 6 | CAKA; CCBA; CGWC; CGXC; CREC; CTUB | 245/329 | 11/08 → 12/15 | OE214 | 0,7 | CET11P | | BAEA032E ^[13] | |
| 3.0 S4 4WD | 6 | CWGD | 260/349 | 05/16 → | | | | | BAEA137E | |
| 3.0 TDI 4WD | 6 | CCLA | 176/236 | 11/07 → 03/12 | CPSG007 ^[43] | 4.4v | | | | |
| 3.0 TDI 4WD | 6 | CKVB | 180/241 | 11/11 → 12/15 | CPSG007 ^[38] → Prod. 23.06.2014 | 4.4v | | | | |
| 3.0 TDI 4WD | 6 | CKVC | 180/241 | 11/11 → 12/15 | CPSG007 ^[38] → Prod. 23.06.2014 | 4.4v | | | | |
| 3.0 TDI 4WD | 6 | CRTC | 200/268 | 05/15 → | CPSG008 Prod. 23.06.2014 → | 4.4v | | | | |
| 3.0 TDI 4WD | 6 | CRTC | 200/268 | 05/15 → | CCGP010 ^[71] | 6.2v | | | | |
| 3.0 TFSI 4WD | 6 | CMUA; CRED | 200/268 | 02/12 → 12/15 | | | | | BAEA032E ^[13] | |
| 3.2 FSI, 3.2 FSI 4WD | 6 | AUK; BKH | 188/252 | 01/05 → 03/09 | OE209 | 0,8 | CET11P | | BAEA032E ^[13] | |
| 3.2 FSI, 3.2 FSI 4WD | 6 | CALA | 195/261 | 11/07 → 03/12 | OE146 | 1,0 | CET12P | OE179 | BAEA032E ^[13] | |
| 4.2 RS4 4WD | 8 | BNS | 309/414 | 09/05 → 03/09 | OE214 | 0,7 | CET11P | | | |
| 4.2 RS4 4WD | 8 | CFSA | 331/444 | 05/12 → 08/15 | OE214 | 0,7 | CET11P | | BAEA033E ^[7] | |
| 4.2 S4 4WD | 8 | BBK | 253/339 | 03/03 → 03/09 | | | | | BAEA061E | |
| A4 Allroad | | | | | | | | | | |
| 2.0 TDI 4WD | 4 | CAGB; CJC; CSUB | 100/134 | 09/09 → | | | | | CCU151 | |
| 2.0 TDI 4WD | 4 | DEUB | 100/134 | 09/09 → | CPSG008 → Prod. 17.07.2017 | 4.4v | | | | |
| | | | | | [44] [210] | | | | | |
| | | | | | CPSG008 ^[197] → Prod. 17.07.2017 | 4.4v | | | | |
| 2.0 TDI 4WD | 4 | CAGA; CJCA | 105/141 | 09/09 → 05/16 | | | | | CCU151 | |
| 2.0 TDI 4WD | 4 | CJCD; CSUA | 110/148 | 05/13 → | CPSG007 [44] [209] | 4.4v | | | CCU151 | |
| 2.0 TDI 4WD | 4 | DEUA | 110/148 | 05/13 → | CPSG008 → Prod. 17.07.2017 | 4.4v | | | | |
| | | | | | [44] [210] | | | | | |
| | | | | | CPSG008 ^[197] → Prod. 17.07.2017 | 4.4v | | | | |
| 2.0 TDI 4WD | 4 | CAHB; CGLD; CNHC | 120/161 | 04/09 → | | | | | CCU151 | |

AUDI





kW/BHP



eon TITAN

IRIDIUM



...AUDI



...A4 Allroad

| | | | | | | | | | |
|--------------|---|------------------|---------|-------------|---|--------------|---------------|--------------|------------------------------------|
| 2.0 TDI 4WD | 4 | DETB | 120/161 | 04/09→ | CPSG007 [44] [201] | 4.4v | | | |
| 2.0 TDI 4WD | 4 | CAHA | 125/168 | 04/09→05/16 | | | | | CCU151 |
| 2.0 TDI 4WD | 4 | CGLC | 130/174 | 11/11→05/16 | | | | | CCU151 |
| 2.0 TDI 4WD | 4 | CNHA | 140/188 | 09/13→ | CPSG007 [44] [209] | 4.4v | | | CCU151 |
| 2.0 TDI 4WD | 4 | DESA; DETA; DFVA | 140/188 | 09/13→ | CPSG007 [44] [201] | 4.4v | | | |
| 2.0 TFSI 4WD | 4 | CDNC; CPMA | 155/208 | 04/09→05/16 | OE214 | 0,7 | CET11P | | BAEA033E [7] [249] [275] |
| 2.0 TFSI 4WD | 4 | CPMB | 162/217 | 05/13→05/16 | OE214 | 0,7 | CET11P | | BAEA033E [7] [249] [275] |
| 2.0 TFSI 4WD | 4 | CNCD | 165/221 | 05/13→05/16 | | | | OE246 | BAEA068E |
| 2.0 TFSI 4WD | 4 | CYRC | 183/245 | 05/16→ | | | | OE246 | |
| 2.0 TFSI 4WD | 4 | CYMC; CYRB; DDWA | 185/248 | 01/16→ | | | | OE246 | |
| 3.0 TDI 4WD | 6 | CSWB | 160/215 | 01/16→ | CPSG007 [203] | 4.4v | | | |
| 3.0 TDI 4WD | 6 | CKVB; CKVC | 180/241 | 01/12→05/16 | CPSG007 [215] | 4.4v | | | |
| 3.0 TDI 4WD | 6 | CRTC | 200/268 | 01/16→ | CCGP010 [71] CPSG007 [203] | 6.2v 4.4v | | | |

A5

| | | | | | | | | | |
|------------------------|---|------------------------|---------|-------------|--|------|---------------|--------------|---|
| 1.8 TFSI | 4 | CJED | 106/142 | 09/14→01/17 | | | | OE246 | BAEA137E |
| 1.8 TFSI | 4 | CDHB | 118/158 | 05/09→03/12 | OE214 | 0,7 | CET11P | | BAEA033E [7] [249] [275] |
| 1.8 TFSI | 4 | CABD | 125/168 | 10/07→01/17 | OE214 | 0,7 | CET11P | | BAEA033E [7] [249] [275] |
| 1.8 TFSI | 4 | CJEB | 125/168 | 10/07→01/17 | | | | OE246 | BAEA137E [275] BAEA137E |
| 1.8 TFSI | 4 | CJEE | 130/174 | 05/15→01/17 | | | | OE246 | BAEA137E |
| 2.0 TDI | 4 | CAGB; CJCB; CSUB | 100/134 | 09/09→ | | | | | CCU151 |
| 2.0 TDI | 4 | CAGA; CJCA; CMEA; CMFA | 105/141 | 09/09→01/17 | | | | | CCU151 |
| 2.0 TDI | 4 | CJCD; CSUA | 110/148 | 05/13→ | CPSG007 →Prod.27.04.2014 [44] [209] | 4.4v | | | CCU151 |
| | | | | | CPSG007 →Prod.28.04.2014 [44] [209] | 4.4v | | | |
| 2.0 TDI | 4 | CMFB | 110/148 | 05/13→ | CPSG007 →Prod.27.04.2014 [44] [209] | 4.4v | | | CCU151 |
| 2.0 TDI | 4 | DEUA | 110/148 | 05/13→ | CPSG007 [25] [44] [195] | 4.4v | | | |
| 2.0 TDI | 4 | CAHB; CGLD; CNHC | 120/161 | 08/08→01/17 | | | | | CCU151 |
| 2.0 TDI, 2.0 TDI 4WD | 4 | CAHA | 125/168 | 08/08→03/12 | | | | | CCU151 |
| 2.0 TDI, 2.0 TDI 4WD | 4 | CGLC | 130/174 | 10/11→01/17 | | | | | CCU151 |
| 2.0 TDI, 2.0 TDI 4WD | 4 | CNHA | 140/188 | 09/13→ | CPSG007 →Prod.27.04.2014 [44] [209] | 4.4v | | | CCU151 |
| | | | | | CPSG007 →Prod.28.04.2014 [44] [209] | 4.4v | | | |
| 2.0 TFSI | 4 | CAEA | 132/177 | 11/08→06/14 | OE214 | 0,7 | CET11P | | BAEA033E [7] [249] [275] |
| 2.0 TFSI | 4 | CDNB | 132/177 | 11/08→06/14 | OE214 | 0,7 | CET11P | | BAEA033E [7] [249] [275] BAEA033E [7] |
| 2.0 TFSI | 4 | CVKB; DEMA | 140/188 | 09/16→ | | | | | BAEA137E |
| 2.0 TFSI | 4 | CAEB | 155/208 | 06/08→06/14 | OE214 | 0,7 | CET11P | | BAEA033E [7] [249] [275] |
| 2.0 TFSI | 4 | CAED | 162/217 | 05/13→12/14 | OE214 | 0,7 | CET11P | | BAEA068E |
| 2.0 TFSI, 2.0 TFSI 4WD | 4 | CNCD | 165/221 | 05/13→05/16 | | | CET11P | OE246 | BAEA068E |
| 2.0 TFSI, 2.0 TFSI 4WD | 4 | CNCE | 169/227 | 08/15→01/17 | | | | OE246 | BAEA137E |

AUDI





kW/BHP



eon TITAN

IRIDIUM



...AUDI



...A5

| | | | | | | | | | | |
|------------------------|---|------------------------------|---------|-------------|--------------------------------------|------------|------------------|-------|-----------------------------|--------|
| 2.0 TFSI, 2.0 TFSI 4WD | 4 | CAEB; CDNC | 155/208 | 06/08→01/17 | OE214 | 0,7 | CET11P | | BAEA033E [7] [249] [275] | |
| | | | | | | | | | BAEA033E [7] | |
| 2.0 TFSI 4WD | 4 | CPMA | 155/208 | 06/08→01/17 | OE214 | 0,7 | CET11P | | | |
| 2.0 TFSI 4WD | 4 | CAED | 162/217 | 03/12→01/17 | OE214 | 0,7 | CET11P | | BAEA033E [7] | |
| 2.0 TFSI 4WD | 4 | CPMB | 162/217 | 03/12→01/17 | OE214 | 0,7 | CET11P | | BAEA033E [7] | |
| | | | | | | | | | BAEA033E [7] [249] | |
| 2.0 TFSI g-tron | 4 | CVLA | 125/168 | 02/17→ | | | | | BAEA137E | |
| 3.0 S5 4WD | 6 | CAKA; CCBA | 245/329 | 06/09→01/17 | OE214 | 0,7 | CET11P | | BAEA032E [13] | |
| 3.0 S5 4WD | 6 | CGWC; CGXC; CREC; CTDA; CTUB | 245/329 | 06/09→01/17 | | | CET11P | | BAEA032E [13] | |
| 3.0 S5 4WD | 6 | CWGD | 260/349 | 07/16→ | | | | | BAEA137E | |
| 3.0 TDI 4WD | 6 | CKVD | 160/215 | 05/15→ | CPSEG008 [38] [275] | 4.4v | | | | |
| 3.0 TDI 4WD | 6 | CKVB; CKVC | 180/241 | 10/11→01/17 | CPSEG007 →Prod.23.06.2014 [38] [215] | 4.4v | | | | |
| | | | | | CPSEG008 [215] Prod.23.06.2014→ | 4.4v | | | | |
| 3.0 TDI 4WD | 6 | CRTC | 200/268 | 02/17→ | CCGP010 [71] | 6.2v | | | | |
| 3.0 TDI 4WD | 6 | DCPC | 210/282 | 11/16→ | CCGP010 [71] | 6.2v | | | | |
| 3.0 TFSI 4WD | 6 | CHMB; CMUA; CRED | 200/268 | 11/11→01/17 | OE214 | 0,7 | CET11P | | BAEA032E [13] | |
| 3.2 FSI, 3.2 FSI 4WD | 6 | CALA | 195/261 | 06/07→03/12 | OE146 | 1,0 | CET11P CET12P | OE179 | BAEA032E [13] | |
| 4.2 RS5 4WD | 8 | CFSA | 331/444 | 03/10→08/15 | OE214 | 0,7 | CET11P | | BAEA033E [7] | |
| 4.2 S5 4WD | 8 | CAUA | 260/349 | 06/07→03/12 | OE209 | 0,8 | CET11P | | BAEA033E [7] | |
| A6 | | | | | | | | | | |
| 1.8 | 4 | AFY | 85/114 | 05/97→01/05 | OE032 | 1,0 | CET2 | OE179 | BAEA162E →12/00 | CLS057 |
| 1.8 | 4 | ANQ | 92/123 | 12/95→01/05 | OE032 | 1,0 | CET2 | OE179 | | |
| 1.8 | 4 | AJP | 92/123 | 12/95→01/05 | OE032 | 1,0 | CET2 | OE179 | BAEA009E →07/99 | |
| 1.8 | 4 | AQE; ARH | 92/123 | 12/95→01/05 | OE032 | 1,0 | CET2 | OE179 | BAEA009E 01/99→04/01 | |
| 1.8, 1.8 4WD | 4 | ADR | 92/123 | 12/95→01/05 | OE032 | 1,0 | | | BAEA162E | CLS057 |
| 1.8 T | 4 | AWL | 110/148 | 01/97→01/05 | OE136 | 0,8 | CET12P | OE179 | | |
| 1.8 T | 4 | AEB; ANB; APU; ARK | 110/148 | 01/97→01/05 | OE136 | 0,8 | CET12P | OE179 | BAEA016 | |
| 1.8 T, 1.8 T 4WD | 4 | AWT | 110/148 | 01/97→01/05 | OE136 | 0,8 | CET12P | OE179 | BAEA043E 06/00→ | |
| 1.8 T, 1.8 T 4WD | 4 | AJL | 132/177 | 12/97→01/05 | OE136 | 0,8 | CET12P | OE179 | BAEA016 | |
| 1.8 T 4WD | 4 | AEB; ANB; APU; ARK | 110/148 | 02/97→01/05 | OE136 | 0,8 | CET12P | OE179 | BAEA016 | |
| 1.8 TFSI | 4 | CYGA | 140/188 | 09/14→ | | | | OE246 | BAEA137E [275] | |
| | | | | | | | | | BAEA137E | |
| 1.9 TDI | 4 | 1Z; AHU | 66/89 | 06/94→12/97 | CH271 | 11v | | | | |
| 1.9 TDI | 4 | AFN; AVG | 81/109 | 04/97→04/01 | CH271 | 11v | | | | |
| 1.9 TDI | 4 | AJM | 85/114 | 07/00→01/05 | CH271 | 11v | | | | |
| 1.9 TDI | 4 | AVF; AWX | 96/129 | 08/01→01/05 | CH271 | 11v | | | | |
| 2.0 | 4 | AAE | 74/99 | 06/94→12/97 | OE025 | 1,0 | CET8 | OE195 | | CLS180 |
| 2.0 | 4 | ADW | 79/106 | 06/94→07/96 | OE025 | 1,0 | CET8 | OE195 | | |
| 2.0 | 4 | ABK | 85/114 | 06/94→12/97 | OE025 | 1,0 | CET8 | OE195 | | CLS180 |
| 2.0 | 4 | ALT | 96/129 | 08/01→01/05 | | | | | BAEA043E | |
| 2.0 16V | 4 | ACE | 103/138 | 06/94→12/97 | OE032 | 1,0 | CET2 | OE179 | | |
| 2.0 16V 4WD | 4 | ACE | 103/138 | 06/94→12/97 | OE032 OE136 | 1,0 0,8 | CET12P CET2 | OE179 | | |
| 2.0 TDI | 4 | BVG | 89/119 | 09/05→06/06 | CCGP003 | 7v | | | CCU151 | |
| 2.0 TDI | 4 | BRF | 100/134 | 07/04→ | CCGP003 | 7v | | | CCU151 | |
| 2.0 TDI | 4 | CAGB | 100/134 | 07/04→ | | | | | CCU151 | |

AUDI





kW/BHP



eon TITAN

IRIDIUM

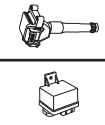

...AUDI



...A6

| | | | | | | | | | | |
|---|---|------------------|---------|-------------|--|------|---------------|--------------|-----------------|--|
| 2.0 TDI | 4 | CGLE | 100/134 | 07/04→ | CPSG007 [44] [209] | 4.4v | | | | CCU151 |
| | | | | | CPSG007 ModelYear→2014 [44] [209] | 4.4v | | | | |
| 2.0 TDI | 4 | CSUE | 100/134 | 07/04→ | CPSG007 [44] [209] | 4.4v | | | | CCU151 |
| | | | | | CPSG007 [44] ModelYear2015→ | 4.4v | | | | |
| 2.0 TDI | 4 | DDCA | 100/134 | 07/04→ | | | | | | CCU151 |
| 2.0 TDI | 4 | BRE | 103/138 | 07/04→10/08 | CCGP003 Ch.4F-5-000001→ | 7v | | | | CCU151 |
| 2.0 TDI | 4 | CSUD; DDCB | 110/148 | 09/14→ | CPSG007 [44] | 4.4v | | | | CCU151 |
| | | | | | CPSG007 ModelYear→2014 [44] [209] | 4.4v | | | | |
| | | | | | CPSG007 [44] ModelYear2015→ | 4.4v | | | | |
| 2.0 TDI | 4 | CAHB | 120/161 | 04/09→ | | | | | | CCU151 |
| 2.0 TDI | 4 | CGLD | 120/161 | 04/09→ | CPSG007 [44] ModelYear2015→ | 4.4v | | | | CCU151 |
| 2.0 TDI | 4 | CAHA | 125/168 | 10/08→08/11 | | | | | | CCU151 |
| 2.0 TDI | 4 | CGLC; CMGB | 130/174 | 03/11→ | CPSG007 [44] ModelYear2015→ | 4.4v | | | | CCU151 |
| 2.0 TDI | 4 | CNHA; CZJA; DDDA | 140/188 | 11/13→ | CPSG007 ModelYear→2014 [44] [209] | 4.4v | | | | CCU151 |
| | | | | | CPSG007 [44] ModelYear2015→ | 4.4v | | | | |
| 2.0 TDI 4WD | 4 | CNHA; DDDA | 140/188 | 04/15→ | CPSG007 ModelYear→2014 [44] [209] | 4.4v | | | | CCU151 |
| | | | | | CPSG007 [44] ModelYear2015→ | 4.4v | | | | |
| 2.0 TFSI | 4 | BPJ | 125/168 | 06/05→08/11 | OE214 | 0,7 | CET11P | | | BAEA033E [7] |
| 2.0 TFSI | 4 | BYK | 125/168 | 06/05→08/11 | | | | | | BAEA033E [7] |
| 2.0 TFSI | 4 | CDNB | 132/177 | 05/11→ | OE214 | 0,7 | CET11P | | | BAEA033E [7] [249] [275] |
| 2.0 TFSI | 4 | CYNB; CYPA | 185/248 | 09/14→ | | | | OE246 | | BAEA068E →06/15 BAEA137E 06/15→ |
| 2.0 TFSI, 2.0 TFSI 4WD | 4 | CAED | 162/217 | 05/13→ | OE214 | 0,7 | CET11P | | | BAEA033E [7] [249] [275] |
| 2.0 TFSI, 2.0 TFSI 4WD, 2.0 TFSI hybrid | 4 | CAEB; CHJA | 155/208 | 03/11→ | OE214 | 0,7 | CET11P | | | BAEA033E [7] [249] [275] |
| 2.0 TFSI 4WD | 4 | CYPB | 183/245 | 05/15→ | | | | OE246 | | BAEA068E →06/15 BAEA137E 06/15→ |
| 2.0 TFSI 4WD | 4 | CYNB | 185/248 | 05/14→ | | | | OE246 | | BAEA068E →06/15 BAEA137E 06/15→ |
| 2.0 TFSI 4WD | 4 | CYPA | 185/248 | 05/14→ | | | | OE246 | | BAEA068E →06/15 BAEA137E |
| 2.2 S6 Turbo 4WD | 5 | AAN | 169/227 | 06/94→12/97 | OE136 | 0,8 | CET11P | | | BAEA043 [277] |
| 2.3, 2.3 4WD | 5 | AAR | 98/131 | 06/94→12/95 | OE027 | 1,0 | CET8 | OE195 | | |
| 2.4 | 6 | ALW | 100/134 | 07/98→01/05 | OE237 | 1,6 | CET2 | OE179 | BAEA154E | CLS046 |
| 2.4 | 6 | ARN | 100/134 | 07/98→01/05 | OE237 | 1,6 | CET2 | OE179 | BAEA154E | CLS001 |
| 2.4 | 6 | ASM | 100/134 | 07/98→01/05 | | | | | BAEA154E | |
| 2.4 | 6 | AFM | 110/148 | 07/95→12/97 | OE032 | 1,0 | CET2 | OE179 | BAEA007E | |
| 2.4 | 6 | APC | 115/154 | 02/97→01/05 | OE237 | 1,6 | CET2 | OE179 | BAEA154E | CLS001 |





kW/BHP



eon TITAN

IRIDIUM



...AUDI



...A6

| | | | | | | | | | | |
|----------------------|---|-------------------------|---------|-------------|---|------|--------|-------|--------------------------|--------|
| 2.4 | 6 | AMM | 120/161 | 02/97→01/05 | | | | | BAEA154E | |
| 2.4, 2.4 4WD | 6 | APZ | 120/161 | 02/97→01/05 | | | | | BAEA154E | CLS001 |
| 2.4, 2.4 4WD | 6 | AJG | 120/161 | 02/97→01/05 | OE237 | 1,6 | CET2 | OE179 | BAEA154E | |
| 2.4, 2.4 4WD | 6 | AGA; ALF | 121/162 | 02/97→01/05 | OE237 | 1,6 | CET2 | OE179 | BAEA154E | CLS046 |
| 2.4, 2.4 4WD | 6 | AML; APS; ARJ | 121/162 | 02/97→01/05 | | | | | BAEA154E | CLS046 |
| 2.4, 2.4 4WD | 6 | BDV | 125/168 | 08/01→01/05 | OE237 | 1,6 | CET2 | OE179 | BAEA154E | CLS046 |
| 2.4, 2.4 4WD | 6 | BDW | 130/174 | 05/04→10/08 | OE146 | 1,0 | CET12P | OE179 | BAEA032E ^[13] | |
| 2.4 4WD | 6 | APC | 115/154 | 08/98→05/01 | OE237 | 1,6 | CET2 | OE179 | BAEA154E | |
| 2.4 4WD | 6 | AML | 121/162 | 02/97→01/05 | | | | | BAEA154E | CLS001 |
| 2.5 TDI | 5 | AAT | 84/113 | 01/95→12/97 | CH271 | 11v | | | | |
| 2.5 TDI | 5 | AAT | 85/114 | 06/94→12/97 | CH271 | 11v | | | | |
| 2.5 TDI | 6 | AYM | 114/153 | 08/01→01/05 | CH215 | 12v | | | | |
| 2.5 TDI | 6 | BCZ; BDG; BFC | 120/161 | 07/02→01/05 | CH215 | 12v | | | | |
| 2.5 TDI, 2.5 TDI 4WD | 5 | AEL | 103/138 | 08/94→12/97 | CH271 | 11v | | | | |
| 2.5 TDI, 2.5 TDI 4WD | 6 | AFB; AKN | 110/148 | 07/97→01/05 | CH215 | 12v | | | | |
| 2.5 TDI, 2.5 TDI 4WD | 6 | AKE; BAU; BDH; BND | 132/177 | 02/00→01/05 | CH215 | 12v | | | | |
| 2.6 | 6 | ACZ | 102/137 | 06/94→10/97 | OE032 | 1,0 | CET2 | OE179 | BAEA007E | CLS001 |
| 2.6, 2.6 4WD | 6 | ABC | 110/148 | 06/94→12/97 | OE032 | 1,0 | CET2 | OE179 | BAEA007E | CLS001 |
| 2.7, 2.7 4WD | 6 | APB; BEL | 187/251 | 05/01→07/04 | OE136 | 0,8 | | | BAEA016 | |
| 2.7 4WD | 6 | BEL | 195/261 | 11/03→07/04 | OE136 | 0,8 | CET12P | OE179 | BAEA043E | |
| 2.7 T, 2.7 T 4WD | 6 | AJK; AZA | 169/227 | 12/97→01/05 | OE136 | 0,8 | CET12P | OE179 | BAEA016 | |
| 2.7 T 4WD | 6 | BES | 184/247 | 08/01→01/05 | OE136 | 0,8 | CET12P | OE179 | BAEA043E | |
| 2.7 T 4WD | 6 | ARE | 184/247 | 08/01→01/05 | OE136 | 0,8 | CET12P | OE179 | BAEA016 | |
| 2.8 | 6 | AEJ | 120/161 | 06/94→07/96 | OE032 | 1,0 | CET2 | OE179 | BAEA007E | |
| 2.8 | 6 | AGE | 132/177 | 10/97→05/00 | OE237 | 1,6 | CET2 | OE179 | BAEA154E | CLS046 |
| 2.8, 2.8 4WD | 6 | AFC | 128/172 | 06/94→12/97 | OE032 | 1,0 | CET2 | OE179 | | |
| 2.8, 2.8 4WD | 6 | AAH | 128/172 | 06/94→12/97 | OE032 | 1,0 | CET2 | OE179 | BAEA007E | CLS001 |
| 2.8, 2.8 4WD | 6 | AEJ | 128/172 | 06/94→12/97 | | | | | BAEA007E | CLS001 |
| 2.8, 2.8 4WD | 6 | ATX | 140/188 | 07/99→01/05 | OE237 | 1,6 | CET2 | OE179 | BAEA154E | |
| 2.8, 2.8 4WD | 6 | AHA | 142/190 | 12/95→01/05 | OE237 | 1,6 | CET2 | OE179 | | CLS046 |
| 2.8, 2.8 4WD | 6 | ACK; ALG; AMX; APR; AQD | 142/190 | 12/95→01/05 | OE237 | 1,6 | CET2 | OE179 | BAEA154E | CLS046 |
| 2.8 4WD | 6 | AGE | 132/177 | 01/98→04/00 | OE237 | 1,6 | CET2 | OE179 | BAEA154E | |
| 2.8 FSI, 2.8 FSI 4WD | 6 | CCDA | 140/188 | 10/08→08/11 | OE146 | 1,0 | CET12P | OE179 | BAEA032E ^[13] | |
| 2.8 FSI, 2.8 FSI 4WD | 6 | CHVA | 150/201 | 11/10→04/15 | | | CET12P | OE181 | BAEA032E ^[13] | |
| 2.8 FSI, 2.8 FSI 4WD | 6 | BDX | 154/207 | 11/06→10/08 | OE146 | 1,0 | CET12P | OE179 | BAEA032E ^[13] | |
| 2.8 FSI, 2.8 FSI 4WD | 6 | CCEA | 162/217 | 10/08→ | OE146 | 1,0 | CET12P | OE179 | BAEA032E ^[13] | |
| 3.0, 3.0 4WD | 6 | BBJ | 160/215 | 06/01→05/06 | OE237 | 1,6 | CET2 | OE179 | BAEA051E | |
| 3.0, 3.0 4WD | 6 | ASN | 162/217 | 08/01→12/05 | OE237 | 1,6 | CET2 | OE179 | BAEA051E | |
| 3.0 TDI 4WD | 6 | CPNB | 176/236 | 10/08→ | CPSG007 ^[38] →Prod.03.03.2014 | 4.4v | | | | |
| | | | | | CPSG008 ^[38] Prod.03.03.2014→ | 4.4v | | | | |
| 3.0 TDI 4WD | 6 | CKVC | 180/241 | 03/11→ | CPSG007 ^[38] →Prod.03.03.2014 | 4.4v | | | | |
| | | | | | CPSG008 ^[38] Prod.03.03.2014→ | 4.4v | | | | |
| 3.0 TDI 4WD | 6 | CKVB | 180/241 | 03/11→ | CPSG007 ^[38] | 4.4v | | | | |
| 3.0 TFSI 4WD | 6 | CAJA | 213/286 | 10/08→08/11 | OE214 | 0,7 | CET11P | | BAEA032E ^[13] | |
| 3.0 TFSI 4WD | 6 | CCAA; CGWB | 220/295 | 10/08→05/12 | OE214 | 0,7 | CET11P | | BAEA032E ^[13] | |
| 3.0 TFSI 4WD | 6 | CGWD; CGXB; CTUA | 228/306 | 03/11→ | | | | | BAEA032E ^[13] | |
| 3.0 TFSI 4WD | 6 | CREC | 245/329 | 09/14→ | | | | | BAEA032E ^[13] | |
| 3.2 FSI | 6 | CALA | 195/261 | 05/09→03/11 | OE146 | 1,0 | CET12P | OE179 | BAEA032E ^[13] | |
| 3.2 FSI, 3.2 FSI 4WD | 6 | AUK | 188/252 | 05/04→05/09 | OE209 | 0,8 | CET11P | | BAEA032E ^[13] | |
| 3.2 FSI, 3.2 FSI 4WD | 6 | BKH | 188/252 | 05/04→05/09 | | | CET11P | | BAEA032E ^[13] | |
| 3.2 FSI 4WD | 6 | BYU | 183/245 | 09/06→10/08 | OE209 | 0,8 | CET11P | | BAEA032E ^[13] | |

AUDI





kW/BHP



eon TITAN

IRIDIUM

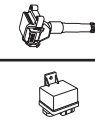

...AUDI



...A6

| | | | | | | | | | |
|----------------------------|----|------------|---------|-------------|---------------------------------|-----|---------------|--------------|---------------------------------|
| 3.7, 3.7 4WD | 8 | AQG | 191/256 | 03/99→01/05 | OE223 | 1,6 | CET12P | OE188 | BAEA009E |
| 4.0 RS6 4WD | 8 | CRDB; CWUB | 412/552 | 01/13→ | OE220 | 0,7 | | | |
| 4.0 S6 4WD | 8 | CEUC | 309/414 | 02/12→ | OE220 Ch.4H-A-000001→ | 0,7 | | | |
| 4.2 4WD | 8 | ASG | 220/295 | 11/98→01/05 | | | | | BAEA009E 06/00→ |
| 4.2 4WD | 8 | ARS | 220/295 | 11/98→01/05 | | | | | BAEA009E 04/99→05/01 |
| 4.2 4WD | 8 | BAT | 246/330 | 05/04→05/06 | | | | | BAEA061E |
| 4.2 FSI 4WD | 8 | BVJ | 257/345 | 06/06→08/11 | OE209 Ch.4F-7-000001→ | 0,8 | CET11P | | BAEA032E ^[13] |
| 4.2 RS6 4WD | 8 | BCY | 331/444 | 07/02→01/05 | OE136 | 0,8 | CET12P | OE179 | BAEA009E |
| 4.2 RS6 plus 4WD | 8 | BRV | 353/473 | 04/04→01/05 | OE136 | 0,8 | CET12P | OE179 | BAEA009E |
| 4.2 S6 4WD | 8 | AQJ | 250/335 | 09/99→01/05 | OE218 | 1,6 | CET2 | OE179 | BAEA009E →05/01 |
| 4.2 S6 4WD | 8 | ANK | 250/335 | 09/99→01/05 | OE218 | 1,6 | CET2 | OE179 | BAEA009E 09/00→ |
| 4.2 S6 4WD, 4.2 S6 4.2 4WD | 8 | AEC | 213/286 | 06/94→12/97 | OE011 | 0,9 | CET9 | OE183 | |
| 4.2 S6 Plus 4WD | 8 | AHK | 240/322 | 04/96→12/97 | OE009 | 0,9 | CET9 | OE183 | BAEA016 |
| 5.0 RS6 4WD | 10 | BUH | 426/571 | 04/08→08/10 | OE136 | 0,8 | CET12P | | BAEA032E ^[13] |
| 5.2 S6 4WD | 10 | BXA | 320/429 | 03/06→08/11 | OE209 | 0,8 | CET11P | | BAEA032E ^[13] |

A6 Allroad

| | | | | | | | | | |
|--------------|---|------|---------|-------------|--------------------------------|------|---------------|--|---------------------------------|
| 3.0 TDI 4WD | 6 | CKVC | 180/241 | 01/12→06/16 | CPSG007 ^[38] | 4.4v | | | |
| 3.0 TFSI 4WD | 6 | CAJA | 213/286 | 10/08→08/11 | OE214 | 0,7 | CET11P | | BAEA032E ^[13] |
| 3.0 TFSI 4WD | 6 | CGWD | 228/306 | 01/12→12/14 | OE214 | 0,7 | CET11P | | BAEA032E ^[13] |
| 3.0 TFSI 4WD | 6 | CREC | 245/329 | 09/14→09/18 | | | | | BAEA032E ^[13] |
| 3.2 FSI 4WD | 6 | AUK | 188/252 | 05/06→10/08 | OE209 | 0,8 | CET11P | | BAEA032E ^[13] |
| 4.2 FSI 4WD | 8 | BVJ | 257/345 | 05/06→12/10 | OE209 | 0,8 | CET11P | | BAEA032E ^[13] |

A7

| | | | | | | | | | |
|----------------------|---|-----------------------|---------|-------------|--|------|---------------|--------------|--|
| 1.8 TFSI | 4 | CYGA | 140/188 | 04/15→05/18 | | | | OE246 | BAEA137E |
| 2.0 TFSI | 4 | CYPA | 185/248 | 09/14→05/18 | | | | OE246 | BAEA068E →04/15 BAEA137E 04/15→ |
| 2.0 TFSI 4WD | 4 | CYPB | 183/245 | 05/15→05/18 | | | | OE246 | |
| 2.0 TFSI 4WD | 4 | CYNB; CYPA | 185/248 | 05/15→05/18 | | | | OE246 | BAEA137E |
| 2.5 FSI | 6 | CLXB | 150/201 | 09/12→03/15 | | | | | BAEA032E ^[13] |
| 2.8 FSI, 2.8 FSI 4WD | 6 | CHVA; CNYA | 150/201 | 10/10→03/15 | | | CET12P | OE181 | BAEA032E ^[13] |
| 3.0 TDI 4WD | 6 | CPNB | 176/236 | 05/13→06/17 | CPSG007 ^[38] →Prod.03.03.2014 | 4.4v | | | |
| | | | | | CPSG008 ^[38] Prod.03.03.2014→ | 4.4v | | | |
| 3.0 TDI 4WD | 6 | CKVC | 180/241 | 10/10→06/16 | CPSG007 ^[38] →Prod.03.03.2014 | 4.4v | | | |
| | | | | | CPSG008 ^[38] Prod.03.03.2014→ | 4.4v | | | |
| 3.0 TDI 4WD | 6 | CKVB | 180/241 | 10/10→06/16 | CPSG007 ^[38] | 4.4v | | | |
| 3.0 TFSI 4WD | 6 | CGWB; CHMA | 220/295 | 10/10→05/12 | OE214 | 0,7 | CET11P | | BAEA032E ^[13] |
| 3.0 TFSI 4WD | 6 | CGWD; CGXB; CTA; CTUA | 228/306 | 01/11→03/15 | OE214 | 0,7 | CET11P | | BAEA032E ^[13] |
| 3.0 TFSI 4WD | 6 | CREC | 245/329 | 05/14→05/18 | | | | | BAEA032E ^[13] |
| 4.0 RS7 4WD | 8 | CRDB; CWUB | 412/552 | 10/13→04/18 | OE220 | 0,7 | | | |
| 4.0 S7 4WD | 8 | CEUC | 309/414 | 02/12→03/15 | OE220 | 0,7 | | | |

A8

| | | | | | | | | | |
|----------------------|---|------------|---------|-------------|--------------|-----|---------------|--|---------------------------------|
| 2.0 TFSI 4WD | 4 | CYPA | 185/248 | 09/16→ | | | | | BAEA137E |
| 2.0 TFSI hybrid | 4 | CHJA | 155/208 | 02/12→ | OE214 | 0,7 | CET11P | | BAEA033E ^[7] |
| 2.5 TDI, 2.5 TDI 4WD | 6 | AFB; AKN | 110/148 | 01/97→04/00 | CH215 | 12v | | | |
| 2.5 TDI, 2.5 TDI 4WD | 6 | AKE | 132/177 | 09/00→09/02 | CH215 | 12v | | | |
| 2.5 TFSI | 6 | CPAA; CVBA | 150/201 | 07/12→ | | | | | BAEA032E ^[13] |





kW/BHP



eon TITAN

IRIDIUM



...AUDI



...A8

| | | | | | | | | | | |
|--|----|-------------------------|---------|-------------|---|------|--------|-------|--|--------|
| 2.8, 2.8 4WD | 6 | AEJ | 120/161 | 07/95→03/96 | OE019 | 0,9 | CET2 | OE184 | | CLS001 |
| 2.8, 2.8 4WD | 6 | AAH | 128/172 | 03/94→03/96 | OE032 | 1,0 | CET2 | OE179 | | CLS001 |
| 2.8, 2.8 4WD | 6 | ACK; ALG; AMX; APR; AQD | 142/190 | 04/96→09/02 | OE237 | 1,6 | CET2 | OE179 | BAEA154E | CLS046 |
| 2.8 4WD | 6 | AMX; APR; AQD | 142/190 | 04/96→09/02 | | | | | BAEA154E | CLS046 |
| 2.8 FSI | 6 | BDX | 154/207 | 08/07→07/10 | OE146 | 1,0 | CET12P | OE179 | BAEA032E ^[13] | |
| 3.0 | 6 | BBJ | 160/215 | 07/03→05/06 | OE237 | 1,6 | CET2 | OE179 | BAEA051E | |
| 3.0 | 6 | ASN | 162/217 | 07/03→05/05 | OE237 | 1,6 | CET2 | OE179 | BAEA051E | |
| 3.0 50 TDI 4WD, 3.0 50 TDI Mild Hybrid 4WD | 6 | ; DDVC | 210/282 | 06/17→ | CGP010 ^[71] ^[207] | 6.2v | | | | |
| 3.0 TDI 4WD | 6 | CPNA | 176/236 | 11/12→ | CPSG007 ^[38] | 4.4v | | | | |
| 3.0 TDI 4WD | 6 | CMHA | 184/247 | 07/10→ | CPSG007 ^[38] | 4.4v | | | | |
| 3.0 TFSI 4WD | 6 | CGXA; CREG | 213/286 | 07/10→ | OE214 | 0,7 | CET11P | | | |
| 3.0 TFSI 4WD | 6 | CGWA | 213/286 | 07/10→ | OE214 | 0,7 | CET11P | | BAEA032E ^[13] | |
| 3.0 TFSI 4WD | 6 | CREA | 228/306 | 11/11→ | OE214 | 0,7 | CET11P | | | |
| 3.0 TFSI 4WD | 6 | CGWD | 228/306 | 11/11→ | OE214 | 0,7 | CET11P | | BAEA032E ^[13] | |
| 3.0 TFSI 4WD | 6 | CREC; CTDA | 245/329 | 06/10→ | OE214 | 0,7 | CET11P | | | |
| 3.0 TFSI 4WD | 6 | CGXC; CMDA; CTUB | 245/329 | 06/10→ | OE214 | 0,7 | CET11P | | BAEA032E ^[13] | |
| 3.2 FSI, 3.2 FSI 4WD | 6 | BPK | 191/256 | 06/05→07/10 | OE209 | 0,8 | CET11P | | BAEA032E ^[13] | |
| 3.3 TDI 4WD | 8 | AKF | 165/221 | 06/00→09/02 | CH215 | 12v | | | | |
| 3.7, 3.7 4WD | 8 | AEW; AKJ | 169/227 | 07/95→12/98 | OE011 | 0,9 | CET9 | OE183 | BAEA016 ^[275] BAEA017 ^[275] | |
| 3.7, 3.7 4WD | 8 | AKC; AQG | 191/256 | 11/98→09/02 | OE223 | 1,6 | CET12P | OE188 | BAEA009E | |
| 3.7 4WD | 8 | BFL | 206/276 | 10/02→05/06 | | | | | BAEA061E | |
| 4.0 S8 4WD | 8 | CGTA; CTFA | 382/512 | 04/12→ | OE220 Ch.4H-A-000001→ | 0,7 | | | | |
| 4.0 TDI 4WD | 8 | ASE | 202/271 | 05/03→07/05 | CH215 | 12v | | | | |
| 4.0 TFSI 4WD | 8 | CEUA | 309/414 | 03/12→ | OE220 | 0,7 | | | | |
| 4.2 4WD | 8 | ARU | 175/235 | 02/99→04/00 | | | | | BAEA009E | |
| 4.2 4WD | 8 | AEM | 180/241 | 03/94→07/96 | OE011 | 0,9 | CET9 | OE183 | BAEA016 Ch.4D-T-000221→ | |
| 4.2 4WD | 8 | AGH | 210/282 | 07/95→09/98 | OE011 | 0,9 | CET9 | OE183 | BAEA016 Ch.4D-T-000221→ | |
| 4.2 4WD | 8 | ABZ; AKG | 220/295 | 03/94→11/98 | OE011 | 0,9 | CET9 | OE183 | BAEA016 ^[275] Ch.4D-T-000221→ BAEA017 ^[275] Ch.4D-T-000221→ | |
| 4.2 4WD | 8 | AQF | 228/306 | 11/98→09/02 | | | | | BAEA009E →02/01 | |
| 4.2 4WD | 8 | BFM | 246/330 | 10/02→07/10 | | | | | BAEA061E | |
| 4.2 FSI 4WD | 8 | BJV | 257/345 | 06/06→07/10 | OE209 | 0,8 | CET11P | | BAEA032E ^[13] | |
| 4.2 FSI 4WD | 8 | CDRA | 273/366 | 11/09→ | OE209 | 0,8 | CET11P | | BAEA032E ^[13] | |
| 4.2 S8 4WD | 8 | AHC; AKH | 250/335 | 07/96→06/99 | OE011 | 0,9 | CET9 | OE183 | BAEA016 Ch.4D-T-000221→ | |
| 4.2 S 8 4WD | 8 | AVP | 265/355 | 06/99→09/02 | OE218 | 1,6 | CET2 | OE188 | BAEA009E 09/00→ | |
| 4.2 S 8 4WD | 8 | AQH | 265/355 | 06/99→09/02 | OE218 | 1,6 | CET2 | OE188 | BAEA009E →02/01 | |
| 4.2 S 8 4WD | 8 | BCS | 265/355 | 06/99→09/02 | OE218 | 1,6 | CET2 | OE188 | | |
| 4.2 TDI 4WD | 8 | BMC | 235/315 | 01/05→06/05 | | | | | CCU151 | |
| 4.2 TDI 4WD | 8 | BVN | 240/322 | 07/05→07/10 | | | | | CCU151 | |
| 4.2 TDI 4WD | 8 | CDSB | 258/346 | 11/09→ | | | | | CCU151 ^[353] | |
| 5.2 S8 4WD | 10 | BSM | 331/444 | 06/06→07/10 | OE209 | 0,8 | CET11P | | BAEA032E ^[13] | |
| 6.0 W12 4WD | 12 | AZC | 309/414 | 01/01→09/02 | OE176 | 1,0 | CET3 | | BAEA031E ^[277] | |
| 6.0 W12 4WD | 12 | BHT; BSB; BTE | 331/444 | 12/03→07/10 | OE176 | 1,0 | CET3 | | BAEA031E ^[277] | |
| ALLROAD | | | | | | | | | | |
| 2.5 TDI 4WD | 6 | BCZ | 120/161 | 05/03→08/05 | CH215 | 12v | | | | |
| 2.5 TDI 4WD | 6 | AKE; BAU | 132/177 | 05/00→08/05 | CH215 | 12v | | | | |

AUDI





kW/BHP



eon TITAN

IRIDIUM



...AUDI



...ALLROAD

| | | | | | | | | | |
|------------|---|-----|---------|---------------|-------|-----|---------|-------|---------------------------|
| 2.7 4WD | 6 | BEL | 187/251 | 09/00 → 08/05 | OE136 | 0,8 | CET1 2P | OE179 | BAEA043E |
| 2.7 4WD | 6 | APB | 187/251 | 09/00 → 08/05 | OE136 | 0,8 | CET1 2P | OE179 | BAEA016 |
| 2.7 T 4WD | 6 | BES | 184/247 | 05/00 → 08/05 | OE136 | 0,8 | CET1 2P | OE179 | |
| 2.7 T 4WD | 6 | ARE | 184/247 | 05/00 → 08/05 | OE136 | 0,8 | CET1 2P | OE179 | BAEA016 |
| 4.2 V8 4WD | 8 | BAS | 220/295 | 07/02 → 08/05 | | | | | BAEA062E ^[277] |

CABRIOLET

| | | | | | | | | | | |
|---------|---|---------|---------|---------------|-------|-----|------|-------|---------------------------------|--------|
| 1.8 | 4 | ADR | 92/123 | 01/97 → 08/00 | OE032 | 1,0 | | | BAEA162E | CLS057 |
| 1.9 TDI | 4 | 1Z; AHU | 66/89 | 06/95 → 08/00 | CH271 | 11v | | | | |
| 2.0 16V | 4 | ACE | 103/138 | 06/95 → 07/96 | OE032 | 1,0 | CET2 | OE179 | BAE851AE ^{[261] [292]} | |
| 2.0 E | 4 | ABK | 85/114 | 01/93 → 07/98 | OE025 | 1,0 | CET8 | OE195 | BAE851AE ^{[261] [292]} | CLS180 |
| 2.6 | 6 | ACZ | 102/137 | 05/95 → 08/00 | OE032 | 1,0 | CET2 | OE188 | | CLS001 |
| 2.6 | 6 | ABC | 110/148 | 06/93 → 08/00 | OE032 | 1,0 | CET2 | OE179 | BAEA007E | CLS001 |

Q2

| | | | | | | | | | | |
|----------------------|---|------------|---------|---------|-------------------------|------|--|--|--|--|
| 1.4 TSI | 4 | CZEA | 110/148 | 06/16 → | OE244 | 0,8 | | | | |
| 1.6 TDI | 4 | DDYA | 85/114 | 06/16 → | CPSG007 ^[44] | 4.4v | | | | |
| 2.0 TDI, 2.0 TDI 4WD | 4 | DCYA; DFGA | 110/148 | 09/16 → | CPSG007 ^[44] | 4.4v | | | | |
| 2.0 TDI 4WD | 4 | DFHA | 140/188 | 07/16 → | CPSG007 ^[44] | 4.4v | | | | |

Q3

| | | | | | | | | | | |
|------------------------|---|------------------|---------|---------|---|------|---------|-------|-------------------------------------|--|
| 1.4 TFSI | 4 | CZDB | 92/123 | 07/16 → | OE244 | 0,8 | | | | |
| 1.4 TSI | 4 | CHPB; CZDA; CZEA | 110/148 | 10/13 → | OE244 | 0,8 | | | BAEA067E ^[240] | |
| 2.0 TDI | 4 | CUVD; DFTC | 88/118 | 03/15 → | CPSG007 ^{[44] [204] [275] [309]} | 4.4v | | | CCU152 | |
| 2.0 TDI | 4 | CFFA; CUVB; DFTB | 100/134 | 09/11 → | CPSG007 ^{ModelYear2015 → [44] [204] [275] [309]} | 4.4v | | | CCU152 | |
| 2.0 TDI, 2.0 TDI 4WD | 4 | CFFB; CLJA | 103/138 | 09/11 → | CPSG007 ^{ModelYear2015 → [44] [204] [275] [309]} | 4.4v | | | CCU152 | |
| 2.0 TDI, 2.0 TDI 4WD | 4 | CUVC; DBBA; DFTA | 110/148 | 11/14 → | CPSG007 ^{[44] [204] [275] [309]} | 4.4v | | | CCU152 | |
| 2.0 TDI, 2.0 TDI 4WD | 4 | CFGC; CLLB | 130/174 | 06/11 → | CPSG007 ^{ModelYear2015 → [44] [204] [275] [309]} | 4.4v | | | CCU152 | |
| 2.0 TDI, 2.0 TDI 4WD | 4 | CUWA; CYLA; DFUA | 135/181 | 11/14 → | CPSG007 ^{[44] [204] [275] [309]} | 4.4v | | | CCU152 | |
| 2.0 TDI 4WD | 4 | CFGD | 120/161 | 06/11 → | CPSG007 ^{ModelYear2015 → [44] [204] [275] [309]} | 4.4v | | | CCU152 | |
| 2.0 TFSI, 2.0 TFSI 4WD | 4 | CULB | 132/177 | 11/14 → | | | | OE246 | BAEA068E ^{→05/16} | |
| 2.0 TFSI 4WD | 4 | CCZC | 125/168 | 06/11 → | OE214 | 0,7 | CET1 1P | | BAEA033E ^{[7] [249] [275]} | |
| 2.0 TFSI 4WD | 4 | CPSA | 155/208 | 06/11 → | OE214 | 0,7 | CET1 1P | | BAEA033E ^{[7] [249] [275]} | |
| 2.5 RS 4WD | 5 | CTSA | 228/306 | 10/13 → | OE219 ^{→12/15} | 0,7 | | | BAEA033E ^{[7] [249] [275]} | |
| 2.5 RS 4WD | 5 | CZGA | 250/335 | 05/13 → | | | | | BAEA033E ^{[7] [249]} | |

Q5

| | | | | | | | | | | |
|---------|---|------------|---------|---------|-------------------------------|------|--|--|--------|--|
| 2.0 TDI | 4 | DEUB | 100/134 | 11/10 → | CPSG007 ^{[44] [211]} | 4.4v | | | | |
| 2.0 TDI | 4 | CJCA | 105/141 | 11/10 → | | | | | CCU151 | |
| 2.0 TDI | 4 | CJCD; CSUA | 110/148 | 05/13 → | CPSG007 ^[44] | 4.4v | | | CCU151 | |

AUDI





kW/BHP



eon TITAN

IRIDIUM

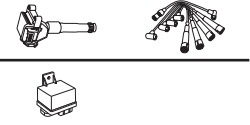

...AUDI



...Q5

| | | | | | | | | | | |
|-----------------------------------|---|------------------------|---------|-------------|---|------|---------------|--------------|--|--|
| 2.0 TDI | 4 | DEUA | 110/148 | 05/13→ | CPSG007 [44] [211] | 4.4v | | | | |
| 2.0 TDI | 4 | CNHA | 140/188 | 09/15→ | CPSG007 [44] | 4.4v | | | | CCU151 |
| 2.0 TDI, 2.0 TDI 4WD | 4 | CAGB; CJCB; CSUB | 100/134 | 08/09→ | | | | | | CCU151 |
| 2.0 TDI 4WD | 4 | CAGA; CJCA | 105/141 | 08/09→ | | | | | | CCU151 |
| 2.0 TDI 4WD | 4 | CJCD; CSUA | 110/148 | 05/13→ | CPSG007 [44] [209] | 4.4v | | | | CCU151 |
| 2.0 TDI 4WD | 4 | CAHB; CGLA; CGLD; CNHC | 120/161 | 11/08→ | | | | | | CCU151 |
| 2.0 TDI 4WD | 4 | DETB | 120/161 | 11/08→ | CPSG007 [44] [211] | 4.4v | | | | |
| 2.0 TDI 4WD | 4 | CAHA; CGLB; CMGA | 125/168 | 11/08→ | | | | | | CCU151 |
| 2.0 TDI 4WD | 4 | CGLC; CMGB | 130/174 | 06/12→ | | | | | | CCU151 |
| 2.0 TDI 4WD | 4 | CNHA | 140/188 | 11/13→ | CPSG007 [44] | 4.4v | | | | CCU151 |
| 2.0 TDI 4WD | 4 | DESA; DETA | 140/188 | 11/13→ | CPSG007 [44] [211] | 4.4v | | | | |
| 2.0 TFSI 4WD | 4 | CDNB | 132/177 | 08/09→ | OE214 | 0,7 | CET11P | | | BAEA033E [7] [249] [275] |
| 2.0 TFSI 4WD | 4 | CNCB | 132/177 | 08/09→ | | | | OE246 | | BAEA033E [7] [249] [275] |
| 2.0 TFSI 4WD | 4 | CPMA | 155/208 | 11/08→ | OE214 | 0,7 | CET11P | | | |
| 2.0 TFSI 4WD | 4 | CPMB | 162/217 | 05/13→ | OE214 | 0,7 | CET11P | | | BAEA033E [7] |
| 2.0 TFSI 4WD | 4 | CNCD | 165/221 | 06/12→ | | | | OE246 | | BAEA068E [253] →06/15 BAEA137E 06/15→ |
| 2.0 TFSI 4WD | 4 | CNCE | 169/227 | 08/15→ | | | | OE246 | | BAEA068E →05/16 BAEA137E 05/16→ |
| 2.0 TFSI 4WD, 2.0 TFSI hybrid 4WD | 4 | CAEB; CDNC; CHJA | 155/208 | 11/08→ | OE214 | 0,7 | CET11P | | | BAEA033E [7] [249] [275] |
| 3.0 SQ5 TFSI 4WD | 6 | CTUD; CTXA | 260/349 | 05/13→ | | | | | | BAEA032E [13] |
| 3.0 SQ5 TFSI 4WD | 6 | CWGD | 260/349 | 05/13→ | | | | | | BAEA137E |
| 3.0 TDI 4WD | 6 | CPNB | 176/236 | 11/08→ | CPSG007 [38] →Prod.03.03.2014 | 4.4v | | | | |
| | | | | | CPSG008 [38] Prod.03.03.2014→ | 4.4v | | | | |
| 3.0 TDI 4WD | 6 | DCPC | 210/282 | 07/17→ | CCGP010 [24] [71] [208] | 6.2v | | | | |
| | | | | | CPSG007 [23] [228] | 4.4v | | | | |
| 3.0 TFSI 4WD | 6 | CTUC; CTVA | 200/268 | 06/12→ | OE214 | 0,7 | CET11P | | | BAEA032E [13] |
| 3.2 FSI 4WD | 6 | CALB | 199/267 | 11/08→ | OE146 | 1,0 | CET12P | OE179 | | BAEA032E [13] |
| Q7 | | | | | | | | | | |
| 2.0 TFSI 4WD | 4 | CYMC; CYRB | 185/248 | 08/15→ | | | | OE246 | | BAEA068E →01/16 BAEA137E 01/16→ |
| 3.0 TDI 4WD | 6 | CZZB | 155/208 | 03/06→ | CCGP010 [71] [190] | 6.2v | | | | |
| | | | | | CPSG007 [23] [189] | 4.4v | | | | |
| 3.0 TDI 4WD | 6 | CRTE; CZZA | 160/215 | 05/15→ | CCGP010 [71] [190] | 6.2v | | | | |
| | | | | | CPSG007 [23] [189] | 4.4v | | | | |
| 3.0 TDI 4WD | 6 | CATA | 165/221 | 06/09→05/12 | CPSG007 [43] [212] | 4.4v | | | | |
| 3.0 TDI 4WD | 6 | CCMA | 176/236 | 11/07→08/15 | CPSG007 [43] [212] | 4.4v | | | | |

AUDI



kW/BHP



eon TITAN

IRIDIUM



...AUDI



...Q7

| | | | | | | | | | |
|---------------------------------|----|-----------------------|---------|-------------|---|------|---------------|--------------|---|
| 3.0 TDI 4WD | 6 | CNRB | 176/236 | 11/07→08/15 | CPSG007 ^[215] →Prod.12.05.2014 | 4.4v | | | |
| | | | | | CPSG007 Prod.12.05.2014→ [26][216] | 4.4v | | | |
| | | | | | CPSG008 Prod.12.05.2014→ [24][217] | 4.4v | | | |
| 3.0 TDI 4WD | 6 | CLZB | 180/241 | 05/11→08/15 | CPSG007 ^[215] →Prod.12.05.2014 | 4.4v | | | |
| | | | | | CPSG007 Prod.12.05.2014→ [26][216] | 4.4v | | | |
| | | | | | CPSG008 Prod.12.05.2014→ [24][217] | 4.4v | | | |
| 3.0 TDI 4WD | 6 | CVMD | 183/245 | 06/15→ | CCGP010 [71][190] | 6.2v | | | |
| | | | | | CPSG007 [23][189] | 4.4v | | | |
| 3.0 TDI 4WD | 6 | CRTC | 200/268 | 06/15→ | CCGP010 [71][190] | 6.2v | | | |
| | | | | | CPSG007 [23][189] | 4.4v | | | |
| 3.0 TDI 4WD, 3.0 TDI e-tron 4WD | 6 | CUEA; CVZA; DDEA | 190/255 | 08/15→ | CCGP010 [71][190] | 6.2v | | | |
| | | | | | CPSG007 [23][189] | 4.4v | | | |
| 3.0 TFSI 4WD | 6 | CJTC; CJWC | 200/268 | 05/10→08/15 | OE214 | 0,7 | CET11P | | BAEA032E ^[13] |
| 3.0 TFSI 4WD | 6 | CJWE; CTWB | 206/276 | 05/11→08/15 | OE214 | 0,7 | CET11P | | BAEA032E ^[13] |
| 3.0 TFSI 4WD | 6 | CREC | 245/329 | 05/10→ | | | | | BAEA032E ^[13] |
| 3.0 TFSI 4WD | 6 | CJTB; CJWB; CNA; CTWA | 245/329 | 05/10→ | OE214 | 0,7 | CET11P | | BAEA032E ^[13] |
| 3.6 FSI 4WD | 6 | BHK | 206/276 | 08/06→05/10 | | | | | BAEA041E [277][324] |
| 4.2 FSI 4WD | 8 | BAR | 257/345 | 03/06→05/10 | OE209 | 0,8 | CET11P | | BAEA032E ^[13] |
| 4.2 TDI 4WD | 8 | BTR | 240/322 | 03/07→06/09 | | | | | CCU151 |
| 4.2 TDI 4WD | 8 | CCFA | 250/335 | 05/09→08/15 | | | | | CCU151 |
| R8 | | | | | | | | | |
| 4.2 FSI 4WD | 8 | BYH | 309/414 | 04/07→09/10 | OE209 | 0,8 | CET11P | | BAEA032E ^[13] |
| 4.2 FSI 4WD | 8 | CNDA | 316/424 | 07/10→07/15 | OE209 | 0,8 | CET11P | | BAEA032E ^[13] |
| 5.2 FSI 4WD | 10 | BUJ; CTYA | 386/518 | 04/09→ | OE214 | 0,7 | CET11P | | BAEA032E ^[13] |
| 5.2 FSI 4WD | 10 | CTPA | 404/542 | 05/12→07/15 | OE214 | 0,7 | CET11P | | BAEA032E ^[13] |
| 5.2 FSI 4WD | 10 | CMPA | 412/552 | 11/10→07/15 | OE214 | 0,7 | CET11P | | BAEA033E ^[7] |
| 5.2 FSI 4WD | 10 | CTPB | 419/562 | 07/14→07/15 | OE214 | 0,7 | | | BAEA032E ^[13] |
| TT | | | | | | | | | |
| 1.8 T | 4 | AUM | 110/148 | 01/01→06/06 | OE136 | 0,8 | CET12P | OE179 | BAEA043E 01/03→ BAEA043E 01/03→ Ch.8N-1-010001→ |
| 1.8 T | 4 | BVP | 120/161 | 09/05→06/06 | OE136 | 0,8 | CET12P | OE179 | BAEA043E |
| 1.8 T | 4 | ATC | 132/177 | 10/98→06/06 | OE136 | 0,8 | CET12P | OE179 | |
| 1.8 T | 4 | AJQ | 132/177 | 10/98→06/06 | OE136 | 0,8 | CET12P | OE179 | BAEA009E |
| 1.8 T | 4 | APP | 132/177 | 10/98→06/06 | OE136 | 0,8 | CET12P | OE179 | BAEA009E →09/00 Ch.8N-1-010001→ |
| | | | | | | | | | BAEA009E |
| 1.8 T | 4 | AUQ | 132/177 | 10/98→06/06 | OE136 | 0,8 | CET12P | OE179 | BAEA009E 09/00→ →Ch.8N-1-010000 |
| | | | | | | | | | BAEA043E 01/03→ |
| 1.8 T, 1.8 T 4WD | 4 | BVR | 140/188 | 09/05→06/06 | OE136 | 0,8 | CET12P | OE179 | BAEA043E |





kW/BHP

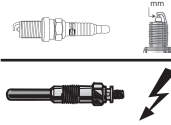

eon TITAN

IRIDIUM

**...AUDI****...TT**

| | | | | | | | | | |
|-------------------------|---|----------------------|---------|-------------|-------------------------|------|--------|-------|--|
| 1.8 T 4WD | 4 | AJQ | 132/177 | 10/98→06/06 | OE136 | 0,8 | CET12P | OE179 | BAEA009E BAEA016 |
| 1.8 T 4WD | 4 | ARY; AUQ | 132/177 | 10/98→06/06 | OE136 | 0,8 | CET12P | OE179 | BAEA043E 01/03→ |
| 1.8 T 4WD | 4 | APX; BAM | 165/221 | 10/98→06/06 | OE136 | 0,8 | CET12P | OE179 | BAEA009E →Ch.8N-1-010000 BAEA043E Ch.8N-1-010001→ |
| 1.8 T 4WD | 4 | BFV | 176/236 | 03/05→06/06 | OE136 | 0,8 | CET12P | OE179 | BAEA043E |
| 1.8 TFSI | 4 | CDA | 118/158 | 06/08→06/14 | OE214 | 0,7 | CET11P | | BAEA033E [7] [249] [275] |
| 1.8 TFSI | 4 | CJSA; CJSB | 132/177 | 08/15→ | | | | OE246 | BAEA068E →06/16 |
| 2.0 TDI | 4 | CUNA | 135/181 | 07/14→ | CP5G007 ^[44] | 4.4v | | | CCU151 |
| 2.0 TDI 4WD | 4 | CBBB; CFGB | 125/168 | 06/08→06/14 | | | | | CCU151 |
| 2.0 TDI 4WD | 4 | CUNA | 135/181 | 01/17→ | CP5G007 ^[44] | 4.4v | | | |
| 2.0 TFSI, 2.0 TFSI 4WD | 4 | BPY; BWA; CCTA; CCZA | 147/197 | 08/06→06/10 | OE214 | 0,7 | CET11P | | BAEA033E [7] [249] [275] BAEA033E ^[7] |
| 2.0 TFSI, 2.0 TFSI 4WD | 4 | CESA; CETA | 155/208 | 05/10→06/14 | OE214 | 0,7 | CET11P | | BAEA033E [7] [249] [275] BAEA033E ^[7] |
| 2.0 TFSI, 2.0 TFSI 4WD | 4 | CHHC | 169/227 | 07/14→ | | | | OE246 | BAEA068E |
| 2.0 TFSI 4WD | 4 | BWA | 147/197 | 06/08→06/10 | OE214 | 0,7 | CET11P | | BAEA033E [7] [249] [275] |
| 2.0 TTS 4WD | 4 | CDLA; CDMA | 195/261 | 05/08→06/14 | OE214 | 0,7 | CET11P | | BAEA033E [7] [249] [275] |
| 2.0 TTS 4WD | 4 | CDLB | 200/268 | 05/08→06/14 | OE214 | 0,7 | CET11P | | BAEA033E [7] [249] [275] BAEA033E ^[7] |
| 2.0 TTS 4WD | 4 | CJXF | 210/282 | 02/15→ | | | | OE246 | BAEA068E →06/16 |
| 2.0 TTS 4WD | 4 | CJXG | 228/306 | 11/14→ | | | | OE246 | BAEA068E |
| 2.5 RS 4WD | 5 | CEPA | 250/335 | 07/09→06/14 | OE219 | 0,7 | | | BAEA033E ^[7] |
| 2.5 RS 4WD | 5 | CEPB | 265/355 | 05/11→06/14 | OE219 | 0,7 | | | BAEA033E ^[7] |
| 2.5 RS 4WD | 5 | DAZA | 294/394 | 10/16→ | | | | | BAEA137E |
| 3.2 V6 4WD, 3.2 VR6 4WD | 6 | BHE; BPF; BUB | 184/247 | 07/03→06/10 | OE215 | 0,9 | | | BAEA044E ^[356] BAEA044E [275] [356] |

V8

| | | | | | | | | | |
|---------|---|----|---------|-------------|-------|-----|------|-------|--|
| 3.6 4WD | 8 | PT | 180/241 | 04/93→02/94 | OE009 | 0,9 | CET9 | OE183 | |
|---------|---|----|---------|-------------|-------|-----|------|-------|--|

AUDI (FAW)**A3**

| | | | | | | | | | |
|-------------|---|----------------|---------|--------|--|-----|--|--|--|
| 1.4 35 TFSI | 4 | CSS; CSSA; DBW | 110/148 | 09/14→ | OE244 Prod.06.07.2015→ [218] [308] | 0,8 | | | |
|-------------|---|----------------|---------|--------|--|-----|--|--|--|

Q3

| | | | | | | | | | |
|-------------|---|-----|---------|--------|-------|-----|--|--|--|
| 1.4 30 TFSI | 4 | CSS | 110/148 | 04/14→ | OE244 | 0,8 | | | |
|-------------|---|-----|---------|--------|-------|-----|--|--|--|

BAOLONG**PEGASUS**

| | | | | | | | | | |
|-----|---|------|--------|-------------|-------|-----|------|-------|--|
| 2.0 | 4 | 4G63 | 84/113 | 12/03→12/06 | OE063 | 1,0 | CET2 | OE180 | |
| 2.4 | 4 | 4G64 | 97/130 | 12/03→12/06 | OE063 | 1,0 | CET2 | OE180 | |

BENTLEY**ARNAGE**

| | | | | | | | | | |
|----------|---|---------|---------|-------------|-------|-----|--------|-------|--|
| 6.7 V8 | 8 | L410IT | 298/400 | 09/99→08/03 | OE002 | 0,9 | CET2 | OE179 | |
| 6.7 V8 T | 8 | L410MT5 | 336/451 | 02/02→10/09 | OE146 | 1,0 | CET12P | OE179 | |

BENTLEY



kW/BHP

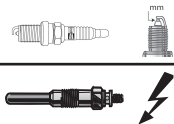

eon TITAN

IRIDIUM



...BENTLEY



AZURE

| | | | | | | | | |
|-----------------|---|----------|---------|-------------|-------|-----|------|--|
| 6.8 V8 | 8 | L410MIT | 286/384 | 09/95→08/99 | OE051 | 0,9 | CET8 | |
| 6.8 V8 | 8 | L410MIT2 | 300/402 | 08/99→06/06 | OE051 | 0,9 | CET8 | |
| 6.8 V8 Mulliner | 8 | L410MIT3 | 313/420 | 08/99→06/06 | OE051 | 0,9 | CET8 | |

CONTINENTAL

| | | | | | | | | |
|-----------------------|----|-------------------|---------|-------------|----------------|------------|----------------|---------------------------|
| 6.0 4WD | 12 | BEB; BWR | 412/552 | 06/03→ | OE051 OE136 | 0,9 0,8 | CET12P CET8 | BAEA031E ^[277] |
| 6.0 4WD | 12 | MTBHT | 412/552 | 06/03→ | OE136 | 0,8 | CET12P | BAEA031E ^[277] |
| 6.0 4WD | 12 | CKHB; CVAB | 423/567 | 11/10→ | | | | BAEA031E ^[277] |
| 6.0 4WD | 12 | BWRA; MTBHT | 449/602 | 08/07→ | | | | BAEA031E ^[277] |
| 6.0 4WD, 6.0 FLEX 4WD | 12 | BWRB; CKHA; MTBHT | 463/621 | 02/08→ | | | | BAEA031E ^[277] |
| 6.0 4WD, 6.0 FLEX 4WD | 12 | CVAC | 467/626 | 05/14→ | | | | BAEA031E ^[277] |
| 6.0 CS ISR 4WD | 12 | CKHE; CVAC | 471/632 | 03/11→ | | | | BAEA031E ^[277] |
| 6.8 V8 R | 8 | L410MIT2 | 300/402 | 08/99→10/02 | OE051 | 0,9 | CET8 | |
| 6.8 V8 S | 8 | L410MIT | 286/384 | 05/94→12/95 | OE051 | 0,9 | CET8 | |
| 6.8 V8 T Mulliner | 8 | L410MIT3 | 313/420 | 08/99→10/02 | OE051 | 0,9 | CET8 | |

CONTINENTAL FLYING SPUR

| | | | | | | | | |
|--------------|----|-----------------|---------|--------|-------|-----|------|---------------------------|
| 6.0 4WD | 12 | BEB; BWR; MTBHT | 412/552 | 03/05→ | OE051 | 0,9 | CET8 | BAEA031E ^[277] |
| 6.0 FLEX 4WD | 12 | BWRA; CKHC | 449/602 | 09/08→ | | | | BAEA031E ^[277] |
| 6.0 4WD | 12 | CVAA; DBDB | 460/617 | 03/13→ | | | | BAEA031E ^[277] |

BMW



1 (E81)

| | | | | | | | | |
|-----------|---|-------------------|---------|-------------|-------|-----|--|--|
| 1.6 116 i | 4 | N45B16A | 85/114 | 04/07→12/11 | OE120 | 0,6 | | BAEA324 →06/09 BAEA143 07/09→ |
| 1.6 116 i | 4 | N43B16A | 85/114 | 04/07→12/11 | | | | BAEA144E |
| 1.6 116 i | 4 | N43B16A; N43B16AA | 89/119 | 08/07→11/11 | | | | BAEA144E |
| 1.6 116 i | 4 | N45B16A | 90/121 | 03/07→11/11 | | | | BAEA324 →06/09 BAEA143 07/09→ |
| 1.6 116 i | 4 | N43B16A | 90/121 | 03/07→11/11 | | | | BAEA144E |
| 2.0 116 d | 4 | N47D20A; N47D20C | 66/89 | 01/11→12/11 | | | | CCU105 |
| 2.0 116 d | 4 | N47D20A; N47D20C | 85/114 | 11/08→12/11 | | | | CCU105 |
| 2.0 116 i | 4 | N43B20A | 90/121 | 11/08→12/11 | | | | BAEA144E 03/09→ |
| 2.0 118 d | 4 | N47D20A; N47D20C | 100/134 | 09/06→12/11 | | | | CCU105 |
| 2.0 118 d | 4 | N47D20A; N47D20C | 105/141 | 09/06→12/11 | | | | CCU105 |
| 2.0 118 i | 4 | N46B20B | 100/134 | 09/06→12/11 | | | | BAEA143 |
| 2.0 118 i | 4 | N43B20A | 105/141 | 09/06→12/11 | | | | BAEA144E 05/07→ |
| 2.0 120 d | 4 | N47D20A; N47D20C | 120/161 | 03/07→12/11 | | | | CCU105 |
| 2.0 120 d | 4 | N47D20A; N47D20C | 130/174 | 03/07→12/11 | | | | CCU105 |
| 2.0 120 i | 4 | N46B20B; N46B20C | 115/154 | 09/06→10/11 | | | | BAEA143 |
| 2.0 120 i | 4 | N43B20A | 120/161 | 09/06→12/11 | | | | BAEA144E 05/07→ |
| 2.0 120 i | 4 | N43B20A | 125/168 | 01/07→09/12 | | | | BAEA144E 05/07→ |
| 2.0 123 d | 4 | N47D20B; N47D20D | 150/201 | 03/07→12/11 | | | | CCU105 |
| 3.0 130 i | 6 | N52B30B; N52B30BF | 190/255 | 09/06→12/11 | OE238 | 1,0 | | |
| 3.0 130 i | 6 | N52B30A | 190/255 | 09/06→12/11 | OE238 | 1,0 | | BAEA143 09/09→ |
| 3.0 130 i | 6 | N52B30B; N52B30BF | 195/261 | 09/06→12/11 | OE238 | 1,0 | | |
| 3.0 130 i | 6 | N52B30A | 195/261 | 09/06→12/11 | OE238 | 1,0 | | BAEA143 11/07→08/09 |



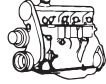

kW/BHP

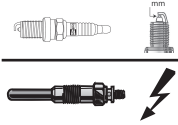

eon TITAN

IRIDIUM



...BMW



1 Coupe (E82)

| | | | | | | | | |
|-----------|---|----------------------------|---------|---------------|-------|-----|-------|--------------------|
| 2.0 118 d | 4 | N47D20C | 100/134 | 09/09 → 10/13 | | | | CCU105 |
| 2.0 118 d | 4 | N47D20C | 105/141 | 09/09 → 10/13 | | | | CCU105 |
| 2.0 120 d | 4 | N47D20A; N47D20C | 120/161 | 09/07 → 10/13 | | | | CCU105 |
| 2.0 120 d | 4 | N47D20A; N47D20C | 130/174 | 09/07 → 10/13 | | | | CCU105 |
| 2.0 120 i | 4 | N46B20B | 115/154 | 09/09 → 10/13 | | | OE188 | BAEA143 |
| 2.0 120 i | 4 | N46B20BD; N46B20C; N46B20E | 115/154 | 09/09 → 10/13 | | | OE188 | |
| 2.0 120 i | 4 | N43B20A | 125/168 | 10/07 → 10/13 | | | | BAEA144E →02/12 |
| 2.0 123 d | 4 | N47D20B; N47D20D | 150/201 | 10/07 → 10/13 | | | | CCU105 |
| 3.0 125 i | 6 | N52B30A | 160/215 | 10/07 → 10/13 | OE238 | 1,0 | | BAEA143 03/08 → |
| 3.0 128 i | 6 | N51B30A; N52B30A | 172/231 | 10/07 → 10/13 | | | | BAEA143 |
| 3.0 135 i | 6 | N55B30A | 225/302 | 10/07 → 10/13 | OE242 | 0,8 | | |
| 3.0 135 i | 6 | N54B30A | 225/302 | 10/07 → 10/13 | | | | BAEA143 |
| 3.0 M | 6 | N54B30A | 250/335 | 04/11 → 06/12 | | | | BAEA143 |

1 (E87)

| | | | | | | | | |
|----------------------|---|--------------------------------------|---------|---------------|-------|-----|-------|--|
| 1.6 116 i | 4 | N45B16A | 85/114 | 11/03 → 06/11 | OE120 | 0,6 | | BAEA324 →06/09 BAEA143 07/09 → |
| 1.6 116 i | 4 | N43B16A | 89/119 | 03/07 → 06/11 | | | | BAEA144E |
| 1.6 116 i | 4 | N43B16A | 90/121 | 03/07 → 06/11 | | | | BAEA144E |
| 2.0 116 d | 4 | N47D20C | 66/89 | 01/11 → 12/11 | | | | CCU105 |
| 2.0 116 d | 4 | N47D20A | 85/114 | 12/08 → 09/12 | | | | CCU105 |
| 2.0 116 i | 4 | N43B20A | 90/121 | 01/09 → 06/11 | | | | BAEA144E |
| 2.0 118 d | 4 | M47D20(204D4) | 90/121 | 11/03 → 02/07 | | | | CCU105 ^[48] |
| 2.0 118 d | 4 | M47 | 90/121 | 11/03 → 02/07 | | | | CCU101 ^[47] |
| 2.0 118 d | 4 | M47D20(204D4) | 100/134 | 09/06 → 06/11 | | | | CCU101 ^[47] |
| 2.0 118 d | 4 | N47D20A; N47D20C | 100/134 | 09/06 → 06/11 | | | | CCU105 ^[48] |
| 2.0 118 d | 4 | M47D20(204D4) | 105/141 | 09/06 → 06/11 | | | | CCU101 ^[47] |
| 2.0 118 d | 4 | N47D20A; N47D20C | 105/141 | 09/06 → 06/11 | | | | CCU105 ^[48] |
| 2.0 118 i | 4 | N46B20B | 95/127 | 07/04 → 02/07 | | | OE188 | BAEA143 |
| 2.0 118 i | 4 | N46B20B | 100/134 | 10/06 → 06/11 | | | OE188 | BAEA143 03/07 → |
| 2.0 118 i | 4 | N43B20A | 105/141 | 09/06 → 06/11 | | | | BAEA144E |
| 2.0 118 i, 2.0 120 i | 4 | N43B20A | 125/168 | 09/06 → 06/11 | | | | BAEA144E |
| 2.0 120 d | 4 | M47D20(204D4) | 120/161 | 03/03 → 06/11 | | | | CCU105 ^[48] |
| 2.0 120 d | 4 | M47 | 120/161 | 03/03 → 06/11 | | | | CCU101 ^[47] |
| 2.0 120 d | 4 | N47D20A; N47D20C | 120/161 | 03/03 → 06/11 | | | | CCU105 ^[48] |
| 2.0 120 d | 4 | M47 | 130/174 | 09/06 → 06/11 | | | | CCU101 ^[47] |
| 2.0 120 d | 4 | N47D20A; N47D20C | 130/174 | 09/06 → 06/11 | | | | CCU105 ^[48] |
| 2.0 120 i | 4 | N46B20B; N46B20BD; N46B20C; N46B20CC | 110/148 | 11/03 → 06/11 | | | | BAEA143 |
| 2.0 120 i | 4 | N46B20B; N46B20BD; N46B20C; N46B20CC | 115/154 | 11/03 → 06/11 | | | OE188 | BAEA143 |
| 2.0 120 i | 4 | N46B20A | 115/154 | 11/03 → 06/11 | | | OE188 | |
| 2.0 120 i | 4 | N46B20CD | 115/154 | 11/03 → 06/11 | | | | BAEA143 |
| 2.0 120 i | 4 | N43B20A | 120/161 | 09/06 → 06/11 | | | | BAEA144E |
| 2.0 123 d | 4 | N47D20B; N47D20C; N47D20D | 150/201 | 03/07 → 09/12 | | | | CCU105 |
| 3.0 130 i | 6 | N52B30A; N52B30AF; N52B30B; N52B30BF | 190/255 | 03/05 → 09/12 | OE238 | 1,0 | | BAEA143 09/09 → 06/11 |
| 3.0 130 i | 6 | N52B30A; N52B30AF; N52B30B; N52B30BF | 195/261 | 03/05 → 09/12 | OE238 | 1,0 | | BAEA145E →04/06 BAEA143 04/06 → 08/09 |

BMW





kW/BHP

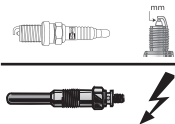

eon TITAN

IRIDIUM



...BMW



1 Convertible (E88)

| | | | | | | | | | |
|-----------|---|------------------------------|---------|---------------|-------|-----|--|-------|--------------------|
| 2.0 118 d | 4 | N47D20A; N47D20C | 100/134 | 09/08 → 12/13 | | | | | CCU105 |
| 2.0 118 d | 4 | N47D20A; N47D20C | 105/141 | 09/08 → 12/13 | | | | | CCU105 |
| 2.0 118 i | 4 | N46B20B | 100/134 | 09/08 → 12/13 | | | | OE188 | BAEA143 |
| 2.0 118 i | 4 | N43B20A | 105/141 | 03/08 → 12/13 | | | | | BAEA144E →02/12 |
| 2.0 120 d | 4 | N47D20A; N47D20C | 120/161 | 03/08 → 12/13 | | | | | CCU105 |
| 2.0 120 d | 4 | N47D20A; N47D20C | 130/174 | 03/08 → 12/13 | | | | | CCU105 |
| 2.0 120 d | 4 | N47D20C | 145/194 | 03/08 → 12/13 | | | | | CCU105 |
| 2.0 120 i | 4 | N46B20B; N46B20C; N46B20E | 115/154 | 03/08 → 12/13 | | | | OE188 | BAEA143 |
| 2.0 120 i | 4 | N43B20A | 120/161 | 03/08 → 12/13 | | | | | BAEA144E →02/12 |
| 2.0 120 i | 4 | N43B20A | 125/168 | 03/08 → 12/13 | | | | | BAEA144E →02/12 |
| 2.0 123 d | 4 | N47D20B; N47D20D | 150/201 | 09/08 → 12/13 | | | | | CCU105 |
| 3.0 125 i | 6 | N52B30A | 160/215 | 03/08 → 12/13 | OE238 | 1,0 | | | BAEA143 |
| 3.0 135 i | 6 | N55B30A | 225/302 | 03/08 → 12/13 | OE242 | 0,8 | | | |
| 3.0 135 i | 6 | N54B30A | 225/302 | 03/08 → 12/13 | | | | | BAEA143 |
| 3.0 135 i | 6 | N55B30A | 240/322 | 03/08 → 12/13 | OE242 | 0,8 | | | BAEA143 |

1 (F20)

| | | | | | | | | | |
|------------------------------|---|---------|---------|---------|-------|-----|--------|-------|------------------------|
| 1.5 114 d | 3 | B37D15A | 70/94 | 06/15 → | | | | | CCU106 |
| 1.5 116 d | 3 | B37D15A | 85/114 | 03/15 → | | | | | CCU106 |
| 1.5 116 i | 3 | B38B15A | 80/107 | 03/15 → | | | | OE245 | BAEA538 |
| 1.5 118 i | 3 | B38B15A | 100/134 | 03/15 → | | | | OE245 | BAEA538 |
| 1.6 114 d | 4 | N47D16A | 70/94 | 10/12 → | | | | | CCU106 |
| 1.6 114 i | 4 | N13B16A | 75/101 | 11/11 → | OE205 | 0,7 | CET16P | | BAEA143 |
| 1.6 116 d | 4 | N47D16A | 85/114 | 11/12 → | | | | | CCU106 ^[47] |
| 1.6 116 i | 4 | N13B16A | 100/134 | 12/10 → | OE205 | 0,7 | CET16P | | BAEA143 |
| 1.6 118 i | 4 | N13B16A | 100/134 | 03/15 → | | | | | BAEA143 |
| 1.6 118 i | 4 | N13B16A | 125/168 | 11/10 → | OE205 | 0,7 | CET16P | | BAEA143 |
| 1.6 120 i | 4 | N13B16A | 130/174 | 03/15 → | OE205 | 0,7 | | | BAEA143 |
| 2.0 116 d | 4 | N47D20C | 85/114 | 12/10 → | | | | | CCU106 |
| 2.0 118 d | 4 | N47D20C | 100/134 | 12/10 → | | | | | CCU106 |
| 2.0 118 d, 2.0 118 d 4WD | 4 | N47D20C | 105/141 | 12/10 → | | | | | CCU106 |
| 2.0 120 d | 4 | N47D20C | 120/161 | 12/10 → | | | | | CCU106 |
| 2.0 120 d, 2.0 120 d 4WD | 4 | N47D20C | 135/181 | 12/10 → | | | | | CCU106 |
| 2.0 120 d, 2.0 120 d 4WD | 4 | N47D20C | 147/197 | 01/11 → | | | | | CCU106 |
| 2.0 120 i | 4 | B48B20A | 135/181 | 09/15 → | | | | OE245 | BAEA538 →06/17 |
| 2.0 125 d | 4 | N47D20D | 155/208 | 08/11 → | | | | | CCU106 ^[47] |
| 2.0 125 d | 4 | N47D20D | 160/215 | 08/11 → | | | | | CCU106 ^[47] |
| 2.0 125 i | 4 | N20B20A | 160/215 | 08/11 → | OE243 | 0,8 | | | BAEA143 |
| 2.0 125 i | 4 | B48B20B | 165/221 | 09/15 → | | | | OE245 | BAEA538 |
| 2.0 125 i | 4 | N20B20A | 175/235 | 03/13 → | OE243 | 0,8 | | | BAEA143 |
| 3.0 M 135 i, 3.0 M 135 i 4WD | 6 | N55B30A | 235/315 | 11/11 → | OE242 | 0,8 | | | BAEA143 |
| 3.0 M 135 i, 3.0 M 135 i 4WD | 6 | N55B30A | 240/322 | 03/15 → | OE242 | 0,8 | | | |
| 3.0 M 140 i, 3.0 M 140 i 4WD | 6 | B58B30A | 250/335 | 09/15 → | | | | OE245 | BAEA538 →06/17 |

1 (F21)

| | | | | | | | | | |
|-----------|---|---------|---------|---------|-------|-----|--------|-------|---------|
| 1.5 114 d | 3 | B37D15A | 70/94 | 06/15 → | | | | | CCU106 |
| 1.5 116 d | 3 | B37D15A | 85/114 | 03/15 → | | | | | CCU106 |
| 1.5 116 i | 3 | B38B15A | 80/107 | 03/15 → | | | | OE245 | BAEA538 |
| 1.5 118 i | 3 | B38B15A | 100/134 | 03/15 → | | | | OE245 | BAEA538 |
| 1.6 114 d | 4 | N47D16A | 70/94 | 07/12 → | | | | | CCU106 |
| 1.6 114 i | 4 | N13B16A | 75/101 | 12/11 → | OE205 | 0,7 | CET16P | | BAEA143 |





kW/BHP



eon TITAN

IRIDIUM

**...BMW****...1 (F21)**

| | | | | | | | | |
|------------------------------|---|---------|---------|--------|-------|-----|--------|------------------------|
| 1.6 116 d | 4 | N47D16A | 85/114 | 12/11→ | | | | CCU106 ^[47] |
| 1.6 116 i | 4 | N13B16A | 100/134 | 12/11→ | OE205 | 0,7 | CET16P | BAEA143 |
| 1.6 118 i | 4 | N13B16A | 100/134 | 03/15→ | | | | BAEA143 |
| 1.6 118 i | 4 | N13B16A | 125/168 | 07/12→ | OE205 | 0,7 | CET16P | BAEA143 |
| 1.6 120 i | 4 | N13B16A | 130/174 | 03/15→ | OE205 | 0,7 | | BAEA143 |
| 2.0 116 d | 4 | N47D20C | 85/114 | 01/12→ | | | | CCU106 |
| 2.0 118 d | 4 | N47D20C | 100/134 | 12/11→ | | | | CCU106 |
| 2.0 118 d, 2.0 118 d 4WD | 4 | N47D20C | 105/141 | 12/11→ | | | | CCU106 |
| 2.0 120 d | 4 | N47D20C | 120/161 | 07/12→ | | | | CCU106 |
| 2.0 120 d, 2.0 120 d 4WD | 4 | N47D20C | 135/181 | 02/12→ | | | | CCU106 |
| 2.0 120 d, 2.0 120 d 4WD | 4 | N47D20C | 147/197 | 01/12→ | | | | CCU106 |
| 2.0 120 i | 4 | B48B20B | 135/181 | 10/15→ | | | OE245 | BAEA538 →06/17 |
| 2.0 125 d | 4 | N47D20D | 155/208 | 12/11→ | | | | CCU106 ^[47] |
| 2.0 125 d | 4 | N47D20D | 160/215 | 12/11→ | | | | CCU106 ^[47] |
| 2.0 125 i | 4 | N20B20A | 160/215 | 12/11→ | OE243 | 0,8 | | BAEA143 |
| 2.0 125 i | 4 | B48B20B | 165/221 | 10/15→ | | | OE245 | BAEA538 →06/17 |
| 2.0 125 i | 4 | N20B20A | 175/235 | 03/13→ | OE243 | 0,8 | | BAEA143 |
| 3.0 M 135 i, 3.0 M 135 i 4WD | 6 | N55B30A | 235/315 | 12/11→ | OE242 | 0,8 | | BAEA143 |
| 3.0 M 135 i, 3.0 M 135 i 4WD | 6 | N55B30A | 240/322 | 03/15→ | OE242 | 0,8 | | BAEA143 |
| 3.0 M 140 i, 3.0 M 140 i 4WD | 6 | B58B30A | 250/335 | 09/15→ | | | OE245 | BAEA538 →06/17 |

2 Active Tourer (F45)

| | | | | | | | | |
|---------------------------|---|---------|---------|-------------|--|--|-------|---------|
| 1.5 216 i | 3 | B38A15A | 75/101 | 02/15→02/18 | | | OE245 | BAEA538 |
| 1.5 218 i, 1.5 225 xe 4WD | 3 | B38A15A | 100/134 | 11/13→ | | | OE245 | BAEA538 |
| 1.5 225 xe 4WD | 3 | B38A15A | 165/221 | 11/14→ | | | OE245 | BAEA538 |
| 2.0 220 i | 4 | B48A20A | 141/189 | 03/14→ | | | OE245 | BAEA538 |
| 2.0 225 i, 2.0 225 i 4WD | 4 | B48A20B | 170/228 | 11/13→ | | | OE245 | BAEA538 |

2 Coupe (F22, F87)

| | | | | | | | | |
|------------------------------|---|------------------|---------|-------------|-------|-----|-------|-------------------|
| 1.5 218 i | 3 | B38B15A | 100/134 | 03/15→ | | | OE245 | BAEA538 |
| 2.0 218 d | 4 | N47D20C | 105/141 | 01/14→ | | | | CCU106 |
| 2.0 220 d | 4 | N47D20C | 135/181 | 10/12→11/14 | | | | CCU106 |
| 2.0 220 d | 4 | N47D20C | 147/197 | 10/12→11/14 | | | | CCU106 |
| 2.0 220 i | 4 | N20B20B | 135/181 | 10/13→ | OE243 | 0,8 | | BAEA143 |
| 2.0 220 i | 4 | B48B20A | 135/181 | 10/13→ | | | OE245 | BAEA538 →06/17 |
| 2.0 225 d | 4 | N47D20D | 160/215 | 01/14→ | | | | CCU106 |
| 2.0 228 i | 4 | N20B20A; N26B20A | 180/241 | 07/14→ | OE243 | 0,8 | | BAEA143 |
| 2.0 230 i | 4 | B48B20B | 185/248 | 09/15→ | | | OE245 | BAEA538 →06/17 |
| 3.0 M 235 i, 3.0 M 235 i 4WD | 6 | N55B30A | 240/322 | 10/13→ | OE242 | 0,8 | | BAEA143 |
| 3.0 M 240 i | 6 | B58B30A | 250/335 | 09/15→ | | | | BAEA538 →06/17 |
| 3.0 M 240 i 4WD | 6 | B58B30A | 250/335 | 09/15→ | | | OE245 | BAEA538 →06/17 |

2 Convertible (F23)

| | | | | | | | | |
|------------------------------|---|---------|---------|--------|-------|-----|-------|-------------------|
| 1.5 218 i | 3 | B38B15A | 100/134 | 03/15→ | | | OE245 | BAEA538 |
| 2.0 220 i | 4 | N20B20B | 135/181 | 04/14→ | OE243 | 0,8 | | |
| 2.0 220 i | 4 | B48B20A | 135/181 | 04/14→ | | | OE245 | BAEA538 →06/17 |
| 2.0 228 i | 4 | N20B20A | 180/241 | 11/14→ | OE243 | 0,8 | | |
| 2.0 230 i | 4 | B48B20B | 185/248 | 09/15→ | | | OE245 | BAEA538 →06/17 |
| 3.0 M 235 i, 3.0 M 235 i 4WD | 6 | N55B30A | 240/322 | 11/14→ | OE242 | 0,8 | | |
| 3.0 M 240 i, 3.0 M 240 i 4WD | 6 | B58B30A | 250/335 | 09/15→ | | | OE245 | BAEA538 →06/17 |

BMW



kW/BHP

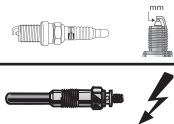

eon TITAN

IRIDIUM



...BMW



2 Gran Tourer (F46)

| | | | | | | | | | |
|-----------|---|---------|---------|-------------|--|--|--|-------|---------|
| 1.5 216 i | 3 | B38A15A | 75/101 | 09/14→02/18 | | | | OE245 | BAEA538 |
| 1.5 218 i | 3 | B38A15A | 100/134 | 07/14→ | | | | OE245 | BAEA538 |
| 2.0 220 i | 4 | B48A20A | 141/189 | 07/14→ | | | | OE245 | BAEA538 |

3 (E36)

| | | | | | | | | | | |
|------------|---|---------------|---------|-------------|-----------------|-----|------|-------|-------------------|--------|
| 1.8 318 is | 4 | M42B18(184S1) | 103/138 | 03/93→02/98 | OE026 | 0,9 | CET2 | OE188 | BAEA014 →09/93 | CLS036 |
| | | | | | OE216 LPG [278] | 0,8 | | | BAEA307 | |

3 /Compact/Convertible/Coupe/Touring (E36)

| | | | | | | | | | |
|-----------------------|---|---------------|---------|-------------|-----------------|-----|------|-------|---------|
| 2.0 320 i | 6 | M52B20(206S3) | 110/148 | 01/95→10/99 | OE026 | 0,9 | CET2 | OE188 | BAEA302 |
| | | | | | OE216 LPG [278] | 0,8 | | | |
| 2.5 323 i, 2.5 323 ti | 6 | M52B25(256S3) | 125/168 | 03/95→08/00 | OE026 | 0,9 | CET2 | OE188 | BAEA302 |
| | | | | | OE216 LPG [278] | 0,8 | | | |
| 2.8 328 i | 6 | M52B28(286S1) | 142/190 | 08/94→12/99 | OE026 | 0,9 | CET2 | OE188 | BAEA302 |
| | | | | | OE216 LPG [278] | 0,8 | | | |

3 /Compact/Coupe (E36)

| | | | | | | | | | | |
|------------------------|---|---------------|---------|-------------|-----------------|-----|------|-------|---------|--------|
| 1.8 318 ti | 4 | M42B18(184S1) | 103/138 | 11/94→08/95 | OE026 | 0,9 | CET2 | OE188 | BAEA307 | CLS036 |
| | | | | | OE216 LPG [278] | 0,8 | | | | |
| 1.9 318 is, 1.9 318 ti | 4 | M44B19(194S1) | 103/138 | 07/95→08/00 | OE026 | 0,9 | CET2 | OE188 | BAEA307 | CLS036 |
| | | | | | OE216 LPG [278] | 0,8 | | | | |

3 /Compact/Touring (E36)

| | | | | | | | | | |
|-------------|---|---------------|---------|-------------|-------|-----|--|--|--|
| 1.7 318 ids | 4 | M41D17(174T1) | 66/89 | 03/94→05/01 | CH189 | 11v | | | |
| 2.5 325 ids | 6 | M51D25(256T1) | 105/141 | 05/93→10/99 | CH189 | 11v | | | |

3 /Convertible/Coupe (E36)

| | | | | | | | | | |
|--------------------|---|---------------|---------|-------------|--|--|--------|-------|---------|
| 3.0 M3 | 6 | S50B30(306S1) | 217/291 | 01/95→10/95 | | | CET10P | OE187 | BAEA014 |
| 3.2 M3, 3.2 M3 3.2 | 6 | S50B32(326S1) | 236/316 | 09/95→04/99 | | | CET10P | OE187 | BAEA302 |

3 /Convertible/Touring (E36)

| | | | | | | | | | | |
|-----------|---|---------------|--------|-------------|-----------------|-----|------|-------|---------|--------|
| 1.8 318 i | 4 | M43B18(184E2) | 85/114 | 10/93→10/99 | OE026 | 0,9 | CET2 | OE188 | BAEA307 | CLS054 |
| | | | | | OE216 LPG [278] | 0,8 | | | | |

3 Compact (E36)

| | | | | | | | | | | |
|-----------|---|---------------|--------|-------------|-------|-----|--------|-------|---------|--------|
| 1.9 316 i | 4 | M43B19(194E1) | 77/103 | 12/98→08/00 | OE223 | 1,6 | CET12P | OE188 | BAEA307 | CLS054 |
|-----------|---|---------------|--------|-------------|-------|-----|--------|-------|---------|--------|

3 Convertible (E36)

| | | | | | | | | | |
|-----------|---|---------------|---------|-------------|-----------------|-----|------|-------|---------|
| 2.5 325 i | 6 | M50B25(256S2) | 141/189 | 03/93→12/95 | OE026 | 0,9 | CET2 | OE188 | BAEA014 |
| | | | | | OE216 LPG [278] | 0,8 | | | |

3 (E46)

| | | | | | | | | | |
|-----------|---|---------------|---------|-------------|------------|-----|--|--|--------------|
| 2.0 318 d | 4 | M47D20(204D1) | 85/114 | 09/01→02/05 | CH203 | 11v | | | |
| 2.0 318 d | 4 | M47N | 85/114 | 09/01→02/05 | | | | | CCU101 |
| 2.0 320 d | 4 | M47D20(204D1) | 95/127 | 02/98→08/01 | CH203 [93] | 11v | | | CCU101 [334] |
| 2.0 320 d | 4 | M47D20(204D1) | 100/134 | 04/98→09/01 | CH203 | 11v | | | |

3 /Compact (E46)

| | | | | | | | | | |
|-----------------------|---|---------|--------|-------------|-------|-----|--------|-------|---------|
| 1.6 316 i, 1.6 316 ti | 4 | N40B16A | 85/114 | 06/02→02/05 | OE223 | 1,6 | CET12P | OE188 | BAEA324 |
| 1.6 316 ti | 4 | N40B16A | 77/103 | 06/02→02/05 | OE223 | 1,6 | CET12P | OE188 | BAEA324 |

3 /Compact/Convertible/Coupe/Touring (E46)

| | | | | | | | | | |
|-------------------------------------|---|------------------|---------|-------------|-------|-----|--------|-------|--|
| 1.6 316 Ci, 1.6 316 i, 1.6 316 4 ti | 4 | N45B16A | 85/114 | 06/02→07/06 | | | CET12P | OE188 | BAEA143 |
| 1.8 316 i, 1.8 316 ti | 4 | N46B18A | 85/114 | 06/01→02/05 | | | CET12P | OE188 | BAEA143 |
| 2.0 318 Ci | 4 | N46B20A; N46B20B | 110/148 | 02/05→12/07 | | | CET12P | OE188 | BAEA143 |
| 2.0 318 Ci, 2.0 318 i, 2.0 318 4 ti | 4 | N42B20A | 105/141 | 12/00→12/07 | OE223 | 1,6 | CET12P | OE188 | BAEA324 →03/03 BAEA143 03/03→ |
| 2.0 318 Ci, 2.0 318 i, 2.0 318 4 ti | 4 | N46B20A; N46B20C | 105/141 | 12/00→12/07 | | | CET12P | OE188 | BAEA143 03/03→ |



kW/BHP



eon TITAN

IRIDIUM

**...BMW****...3 /Compact/Convertible/Coupe/Touring (E46)**

| | | | | | | | | | | |
|---|---|---------------------------------|---------|-------------|-------|-----|--------|-------|---|--------|
| 2.0 318 Ci, 2.0 318 ti | 4 | N42B20A | 100/134 | 12/00→08/06 | OE223 | 1,6 | CET12P | OE188 | BAEA324 →03/03 BAEA143 03/03→ | |
| 2.2 320 Ci, 2.2 320 i | 6 | M54B22(226S1) | 120/161 | 01/00→05/06 | OE223 | 1,6 | CET12P | OE188 | BAEA302 →09/02 BAEA143 09/02→ BAEA324 09/02→ | |
| 2.2 320 Ci, 2.2 320 i | 6 | M54B22(226S1) | 125/168 | 01/00→12/07 | OE223 | 1,6 | CET12P | OE188 | BAEA302 →09/02 BAEA143 09/02→ BAEA324 09/02→ | |
| 2.5 325 Ci, 2.5 325 i, 2.5 325 xi 4WD | 6 | M54B25(256S5) | 137/184 | 09/00→12/06 | OE223 | 1,6 | CET12P | OE188 | BAEA302 →09/02 BAEA143 09/02→ BAEA324 09/02→ | |
| 2.5 325 Ci, 2.5 325 i, 2.5 325 xi 4WD, 2.5 325 ti | 6 | M54B25(256S5) | 141/189 | 09/00→12/07 | OE223 | 1,6 | CET12P | OE188 | BAEA302 →09/02 BAEA143 09/02→ BAEA324 09/02→ | |
| 3.0 330 Ci, 3.0 330 i | 6 | M54B30(306S3) | 168/225 | 06/00→12/06 | OE223 | 1,6 | CET12P | OE188 | BAEA302 →09/02 BAEA143 09/02→ BAEA324 09/02→ | |
| 3.0 330 Ci, 3.0 330 i, 3.0 330 xi 4WD | 6 | M54B30(306S3) | 170/228 | 06/00→12/07 | OE223 | 1,6 | CET12P | OE188 | BAEA302 →09/02 BAEA143 09/02→ BAEA324 09/02→ | |
| 3 /Compact/Coupe (E46) | | | | | | | | | | |
| 2.0 318 td | 4 | M47D20(204D4) | 85/114 | 03/03→02/05 | | | | | CCU101 →09/04 | |
| 2.0 320 Cd, 2.0 320 d | 4 | M47D20(204D4) | 110/148 | 09/01→07/06 | | | | | CCU101 →09/04 | |
| 3 /Compact/Touring (E46) | | | | | | | | | | |
| 1.8 316 i, 1.8 316 ti | 4 | N42B18A | 85/114 | 06/01→02/05 | OE223 | 1,6 | CET12P | OE188 | BAEA143 BAEA324 | |
| 2.0 318 i | 4 | N42B20A | 100/134 | 09/01→02/05 | OE223 | 1,6 | CET12P | OE188 | BAEA143 BAEA324 | |
| 3.0 330 xi 4WD | 6 | M54B30(306S3) | 168/225 | 09/04→04/05 | OE223 | 1,6 | CET12P | OE188 | BAEA143 BAEA324 | |
| 3 /Convertible/Coupe/Touring (E46) | | | | | | | | | | |
| 2.0 320 Ci, 2.0 320 i | 6 | M52B20(206S4) | 110/148 | 03/98→08/01 | OE223 | 1,6 | CET12P | OE188 | BAEA302 | |
| 2.5 323 Ci, 2.5 323 i | 6 | M52B25(256S4) | 120/161 | 03/98→09/00 | OE223 | 1,6 | CET12P | OE188 | BAEA302 | |
| 2.5 323 Ci, 2.5 323 i | 6 | M52B25(256S3); M52B25(256S4) | 125/168 | 03/98→12/00 | OE223 | 1,6 | CET12P | OE188 | BAEA302 | |
| 2.5 323 i | 6 | M52B25(256S4) | 127/170 | 04/99→12/00 | OE223 | 1,6 | CET12P | OE188 | BAEA302 | |
| 2.8 328 Ci, 2.8 328 i | 6 | M52B28(286S2) | 142/190 | 02/98→06/00 | OE223 | 1,6 | CET12P | OE188 | BAEA302 | |
| 2.8 328 i | 6 | M52B28(286S2) | 144/193 | 09/98→12/00 | OE223 | 1,6 | CET12P | OE188 | BAEA302 | |
| 3 /Coupe/Touring (E46) | | | | | | | | | | |
| 1.6 316 Ci, 1.6 316 i | 4 | M43B16(164E3) | 77/103 | 04/00→07/06 | OE223 | 1,6 | CET12P | OE188 | BAEA307 | CLS054 |

BMW



kW/BHP

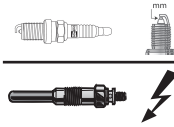

eon TITAN

IRIDIUM

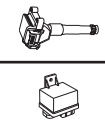

...BMW



...3 /Coupe/Touring (E46)

| | | | | | | | | | | |
|-----------------------|---|---------------|--------|--------------|--------------|-----|---------------|--------------|----------------|---------------|
| 1.9 316 i | 4 | M43B19(194E1) | 77/103 | 09/98 →02/05 | OE223 | 1,6 | CET12P | OE188 | BAEA307 | CLS054 |
| 1.9 318 Ci, 1.9 318 i | 4 | M43B19(194E1) | 85/114 | 10/99 →09/01 | OE223 | 1,6 | CET12P | OE188 | BAEA307 | CLS054 |
| 1.9 318 Ci, 1.9 318 i | 4 | M43B19(194E1) | 87/117 | 02/98 →09/01 | OE223 | 1,6 | CET12P | OE188 | BAEA307 | CLS054 |

3 /Touring (E46)

| | | | | | | | | | | |
|---------------------------|---|---------------|---------|--------------|--------------|-----|--|--|--------------------------------|--|
| 3.0 330 d, 3.0 330 xd 4WD | 6 | M57D30(306D1) | 135/181 | 10/99 →02/05 | CH203 | 11v | | | CCU102 ^[336] | |
| 3.0 330 d, 3.0 330 xd 4WD | 6 | M57D30(306D2) | 150/201 | 08/02 →05/05 | | | | | CCU102 ^[336] | |

3 Compact/Convertible (E46)

| | | | | | | | | | | |
|------------------------|---|---------------|---------|--------------|--|--|--|--|---------------|--|
| 2.0 320 Cd, 2.0 320 td | 4 | M47D20(204D4) | 110/148 | 09/01 →12/07 | | | | | CCU101 | |
|------------------------|---|---------------|---------|--------------|--|--|--|--|---------------|--|

3 Compact/Convertible/Coupe (E46)

| | | | | | | | | | | |
|------------------------|---|---------|---------|--------------|--|--|---------------|--------------|---|--|
| 2.0 318 Ci, 2.0 318 ti | 4 | N46B20A | 100/134 | 12/00 →08/06 | | | CET12P | OE188 | BAEA324 →03/03 BAEA143 03/03 → | |
|------------------------|---|---------|---------|--------------|--|--|---------------|--------------|---|--|

3 Convertible (E46)

| | | | | | | | | | | |
|------------|---|---------------|---------|--------------|--------------|-----|---------------|--------------|----------------|--|
| 2.2 320 Ci | 6 | M54B22(226S1) | 120/161 | 01/06 →12/07 | OE223 | 1,6 | CET12P | OE188 | BAEA143 | |
|------------|---|---------------|---------|--------------|--------------|-----|---------------|--------------|----------------|--|

3 Convertible/Coupe (E46)

| | | | | | | | | | | |
|--------------------|---|---------------|---------|--------------|--|--|---------------|--------------|----------------------------------|--|
| 3.0 330 Cd | 6 | M57D30(306D2) | 150/201 | 03/03 →12/07 | | | | | CCU102 | |
| 3.2 M3 | 6 | S54B32(326S4) | 235/315 | 09/00 →12/06 | | | CET10P | OE187 | BAEA143 BAEA324 | |
| 3.2 M3 | 6 | S54B32(326S4) | 248/333 | 09/00 →12/06 | | | CET10P | OE187 | BAEA143 BAEA324 | |
| 3.2 M3 | 6 | S54B32(326S4) | 265/355 | 06/03 →07/06 | | | CET10P | OE187 | BAEA143 BAEA324 | |
| 3.2 M3, 3.2 M3 3.2 | 6 | S54B32(326S4) | 252/338 | 06/00 →12/07 | | | CET10P | OE187 | BAEA143 BAEA324 | |

3 Touring (E46)

| | | | | | | | | | | |
|-----------|---|---------------|---------|--------------|-------------------------------|-----|--|--|--------------------------------|--|
| 2.0 318 d | 4 | M47D20(204D4) | 85/114 | 10/02 →02/05 | | | | | CCU101 ^[334] | |
| 2.0 318 d | 4 | M47D20(204D1) | 85/114 | 10/02 →02/05 | CH203 ^[333] | 11v | | | CCU101 ^[334] | |
| 2.0 320 d | 4 | M47D20(204D1) | 100/134 | 03/00 →09/01 | CH203 ^[333] | 11v | | | | |
| 2.0 320 d | 4 | M47D20(204D4) | 110/148 | 09/01 →02/05 | | | | | CCU101 ^[334] | |

3 (E90)

| | | | | | | | | | | |
|-----------|---|-------------------|---------|--------------|--|------|---------------|--------------|---------------------------------|--|
| 1.6 316 i | 4 | N45B16A; N45B16AC | 85/114 | 09/05 →10/11 | | | | OE188 | BAEA143 | |
| 1.6 316 i | 4 | N43B16A; N43B16AA | 90/121 | 09/07 →10/11 | | | | | BAEA144E | |
| 2.0 316 d | 4 | N47D20C | 85/114 | 07/09 →12/11 | CCGP001 [92] [240] [344] | 5.4v | | | CCU105 ^[343] | |
| | | | | | | | | | CCU106 [48] [344] | |
| 2.0 318 d | 4 | M47D20(204D4) | 90/121 | 03/05 →08/07 | | | | | CCU101 | |
| 2.0 318 d | 4 | N47D20A | 100/134 | 02/07 →03/10 | CCGP001 [92] [240] [344] | 5.4v | | | CCU105 ^[343] | |
| | | | | | | | | | CCU106 [48] [344] | |
| 2.0 318 d | 4 | N47D20A; N47D20C | 105/141 | 02/07 →10/11 | CCGP001 →02/11 [92] [240] [344] | 5.4v | | | CCU105 ^[343] | |
| | | | | | | | | | CCU106 [48] [344] | |
| 2.0 318 i | 4 | N46B20B | 95/127 | 03/05 →08/07 | OE216 LPG ^[278] | 0,8 | CET12P | OE188 | BAEA143 | |
| 2.0 318 i | 4 | N46B20B | 100/134 | 03/07 →10/11 | | | | | BAEA143 ^[275] | |
| 2.0 318 i | 4 | N43B20A | 105/141 | 02/07 →10/11 | | | | | BAEA144E | |
| 2.0 320 d | 4 | M47D20(204D4) | 110/148 | 12/04 →09/07 | | | | | CCU101 | |
| 2.0 320 d | 4 | M47D20(204D4) | 115/154 | 12/04 →09/07 | | | | | CCU101 | |
| 2.0 320 d | 4 | M47D20(204D4) | 120/161 | 12/04 →12/11 | | | | | CCU101 ^[333] | |
| 2.0 320 d | 4 | N47D20C | 120/161 | 12/04 →12/11 | | | | | CCU105 ^[343] | |
| | | | | | | | | | CCU106 [48] [344] | |

BMW





kW/BHP



eon TITAN

IRIDIUM



...BMW



...3 (E90)

| | | | | | | | | | |
|--|---|---|---------|-------------|----------------------------|-----|--------|-------|--|
| 2.0 320 d, 2.0 320 d 4WD | 4 | N47D20A; N47D20C | 130/174 | 09/07→03/10 | | | | | CCU105 ^[343] CCU106 ^{[48] [344]} |
| 2.0 320 d, 2.0 320 d 4WD | 4 | N47D20C | 135/181 | 03/10→12/11 | | | | | CCU105 ^[343] CCU106 ^{[48] [344]} |
| 2.0 320 d 4WD | 4 | N47D20C | 120/161 | 09/08→10/11 | | | | | CCU105 ^{[48] [343]} CCU106 ^{[48] [344]} |
| 2.0 320 i | 4 | N46B20B; N46B20BD; N46B20C; N46B20CB | 110/148 | 06/04→09/07 | OE216 ^{UPG [278]} | 0,8 | CET12P | OE188 | BAEA143 ^[247] BAEA324 |
| 2.0 320 i | 4 | N46B20B; N46B20C; N46B20CC; N46B20CD; N46B20E | 115/154 | 02/07→12/11 | | | | | BAEA143 ^[247] BAEA324 |
| 2.0 320 i | 4 | N43B20A | 125/168 | 03/07→12/11 | | | | | BAEA144E |
| 2.0 320 si | 4 | N45B20A | 127/170 | 09/05→08/06 | | | | | BAEA143 ^[247] BAEA324 |
| 2.0 320 xd 4WD | 4 | | 130/174 | 09/07→12/11 | | | | | CCU105 ^{[48] [343]} CCU106 ^{[48] [344]} |
| 2.5 323 i | 6 | N52B25A; N52B25B; N52B25BE; N52B25BF | 130/174 | 09/05→02/07 | OE238 | 1,0 | | | BAEA145E →04/06 |
| 2.5 323 i | 6 | N52B25A; N52B25BF | 140/188 | 03/07→12/11 | OE238 | 1,0 | | | BAEA143 |
| 2.5 325 i | 6 | N52B25A | 155/208 | 01/06→12/11 | OE238 | 1,0 | | | BAEA143 05/06→ |
| 2.5 325 i | 6 | N52B25A; N52B25B; N52B25BF | 160/215 | 01/05→10/11 | OE238 | 1,0 | | | BAEA145E →04/06 BAEA143 05/06→ |
| 2.5 325 xi 4WD | 6 | N52B25A | 160/215 | 03/05→10/11 | OE238 | 1,0 | | | BAEA145E 09/05→04/06 BAEA143 04/06→ |
| 3.0 325 d | 6 | M57D30(306D3) | 145/194 | 09/06→02/10 | | | | | CCU102 |
| 3.0 325 d | 6 | N57D30A | 150/201 | 03/10→10/11 | | | | | CCU108 |
| 3.0 325 i, 3.0 325 i 4WD | 6 | N53B30A | 160/215 | 03/07→12/11 | | | | | BAEA144E |
| 3.0 325 xi 4WD | 6 | N53B30A | 160/215 | 03/07→06/08 | | | | | BAEA144E ^[242] |
| 3.0 328 i 4WD | 6 | N51B30A; N52B30A | 172/231 | 09/08→12/10 | | | | | BAEA143 |
| 3.0 330 d | 6 | M57D30(306D3) | 155/208 | 09/05→12/11 | | | | | CCU102 ^[47] |
| 3.0 330 d | 6 | N57D30A | 155/208 | 09/05→12/11 | | | | | CCU108 ^[48] |
| 3.0 330 d | 6 | M57D30(306D3) | 170/228 | 09/05→09/08 | | | | | CCU102 |
| 3.0 330 d, 3.0 330 d 4WD | 6 | N57D30A | 180/241 | 09/08→12/11 | | | | | CCU108 |
| 3.0 330 i, 3.0 330 i 4WD, 3.0 330 xi 4WD | 6 | N53B30A | 200/268 | 09/07→12/11 | | | | | BAEA144E |
| 3.0 330 i, 3.0 330 xi 4WD | 6 | N52B30A; N52B30B; N52B30BF | 190/255 | 12/04→08/07 | OE238 | 1,0 | | | BAEA145E →04/06 BAEA143 05/06→ |
| 3.0 330 xd 4WD | 6 | M57D30(306D3) | 170/228 | 09/05→08/08 | | | | | CCU102 |
| 3.0 335 d | 6 | M57D30(306D5) | 210/282 | 09/06→12/11 | | | | | CCU102 |
| 3.0 335 i | 6 | N55B30A | 220/295 | 03/06→12/11 | OE242 | 0,8 | | | |
| 3.0 335 i | 6 | N54B30A | 220/295 | 03/06→12/11 | OE242 | 0,8 | | | BAEA143 |
| 3.0 335 i | 6 | N54B30A | 224/300 | 03/06→12/11 | OE242 | 0,8 | | | BAEA143 |
| 3.0 335 i, 3.0 335 i 4WD, 3.0 335 xi 4WD | 6 | N55B30A | 225/302 | 03/06→12/11 | OE242 | 0,8 | | | |
| 3.0 335 i, 3.0 335 i 4WD, 3.0 335 xi 4WD | 6 | N54B30A | 225/302 | 03/06→12/11 | | | | | BAEA143 |

BMW



kW/BHP



eon TITAN

IRIDIUM

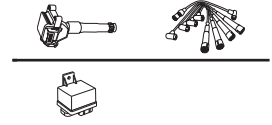

...BMW



...3 (E90)

3.0 335 i 4WD, 3.0 335 xi 4WD 6 N54B30A 224/300 09/06 → 10/11

BAEA143

3 Touring (E91)

1.6 316 i 4 N43B16A 90/121 05/08 → 05/12

BAEA144E
09/08 → 02/12

2.0 316 d 4 N47D20C 85/114 09/09 → 06/12 CCGP001 → 02/11 [92] [240] 5.4v

CCU106 [48]

2.0 318 d 4 M47D20(204D4) 90/121 09/05 → 08/07

CCU101

2.0 318 d 4 N47D20C 100/134 07/07 → 06/12 CCGP001 → 02/11 [92] [240] 5.4v

CCU105 [343]

CCU106
[48] [344]

2.0 318 d 4 N47D20A; N47D20C 105/141 09/07 → 06/12 CCGP001 [92] [240] [344] 5.4v

CCU105 [343]

CCU106
[48] [344]

2.0 318 i 4 N46B20B 95/127 01/06 → 08/07 OE216 LPG [278] 0,8 CET12P OE188

BAEA143 [247]

2.0 318 i 4 N46B20B 100/134 09/07 → 03/12 OE188

BAEA143

2.0 318 i 4 N43B20A 105/141 05/07 → 05/12

BAEA144E
→ 02/12

2.0 320 d 4 M47N204D4 110/148 12/04 → 08/07

CCU101

2.0 320 d 4 M47D20(204D4) 120/161 12/04 → 06/12

CCU101 [333]

2.0 320 d 4 N47D20C 120/161 12/04 → 06/12

CCU105 [343]

2.0 320 d, 2.0 320 d 4WD 4 N47D20A; N47D20C 130/174 02/07 → 12/10

CCU105 [343]

CCU106
[48] [344]

2.0 320 d, 2.0 320 d 4WD 4 N47D20C 135/181 03/10 → 05/12

CCU105 [343]

CCU106
[48] [344]

2.0 320 d, 2.0 320 d 4WD 4 N47D20A; N47D20C 145/194 02/07 → 02/10

CCU106 [48]

2.0 320 d, 2.0 320 d 4WD 4 N47D20C 147/197 03/10 → 05/12

CCU106 [48]

2.0 320 d 4WD 4 N47D20C 120/161 07/09 → 06/12

CCU105 [343]

CCU106
[48] [344]

2.0 320 d ed 4 120/161 10/10 → 05/12

CCU106 [48]

2.0 320 i 4 N46B20B; N46B20C 110/148 09/05 → 06/12 OE216 LPG [278] 0,8 CET12P OE188

BAEA143 [247]

2.0 320 i 4 N46B20B; N46B20BD; N46B20C 115/154 09/05 → 06/12

BAEA144E

2.0 320 i 4 N43B20A 125/168 02/07 → 12/12

BAEA144E

→ 02/12

2.5 323 i 6 N52B25A 130/174 04/06 → 06/07 OE238 1,0

BAEA143

2.5 323 i 6 N52B25A 140/188 09/06 → 07/08 OE238 1,0

BAEA143

2.5 325 i 6 N52B25A 160/215 12/04 → 12/12 OE238 1,0

BAEA145E

→ 04/06
BAEA143

2.5 325 xi 4WD 6 N52B25A 160/215 08/05 → 08/11 OE238 1,0

BAEA145E

→ 06/06
BAEA143

05/06 →

3.0 325 d 6 M57306D3 145/194 09/06 → 06/12

CCU102

3.0 325 d 6 N57D30A 150/201 02/10 → 06/12

CCU108

3.0 325 i 6 N53B30A 155/208 09/07 → 06/12

BAEA144E

3.0 325 i, 3.0 325 i 4WD 6 N53B30A 160/215 09/07 → 06/12

BAEA144E

→ 02/12

3.0 325 xi 4WD 6 N53B30A 160/215 09/07 → 06/12

BAEA144E

→ 08/08

3.0 330 d 6 M57D30(306D3) 155/208 12/04 → 05/12

CCU102 [47]

3.0 330 d 6 N57D30A 155/208 12/04 → 05/12

CCU108 [48]

3.0 330 d 6 M57D30(306D3) 170/228 12/04 → 08/08

CCU102

BMW





kW/BHP



eon TITAN

IRIDIUM



...BMW



...3 Touring (E91)

| | | | | | | | | | | |
|--|---|---------------|---------|---------------|-------|-----|--|--|--|--------------------|
| 3.0 330 d, 3.0 330 d 4WD | 6 | N57D30A | 180/241 | 02/08 → 06/12 | | | | | | CCU108 |
| 3.0 330 i, 3.0 330 i 4WD | 6 | N53B30A | 200/268 | 09/07 → 06/12 | | | | | | BAEA144E →02/12 |
| 3.0 330 i, 3.0 330 xi 4WD | 6 | N52B30A | 190/255 | 08/05 → 08/07 | OE238 | 1,0 | | | | BAEA145E →04/06 |
| 3.0 330 xi 4WD | 6 | N53B30A | 200/268 | 09/07 → 06/12 | | | | | | BAEA144E →08/08 |
| 3.0 330 xd 4WD | 6 | M57D30(306D3) | 170/228 | 09/05 → 06/12 | | | | | | CCU102 |
| 3.0 335 d | 6 | M57D30(306D5) | 210/282 | 09/06 → 06/12 | | | | | | CCU102 |
| 3.0 335 i, 3.0 335 i 4WD, 3.0 335 xi 4WD | 6 | N55B30A | 225/302 | 09/06 → 06/12 | OE242 | 0,8 | | | | |
| 3.0 335 i, 3.0 335 i 4WD, 3.0 335 xi 4WD | 6 | N54B30A | 225/302 | 09/06 → 06/12 | | | | | | BAEA143 |

3 Coupe (E92)

| | | | | | | | | | | |
|--|---|--------------------------------------|---------|---------------|----------------------------|-----|--------|-------|---------|--|
| 1.6 316 i | 4 | N43B16A | 90/121 | 09/07 → 12/13 | | | | | | BAEA144E |
| 2.0 318 i | 4 | N43B20A | 105/141 | 03/10 → 12/13 | | | | | | BAEA144E →02/12 |
| 2.0 320 d | 4 | N47D20A; N47D20C | 120/161 | 03/07 → 06/13 | | | | | | CCU105 ^[47] CCU106 ^[48] |
| 2.0 320 d, 2.0 320 d 4WD | 4 | N47D20C | 135/181 | 03/10 → 06/13 | | | | | | CCU106 ^[48] |
| 2.0 320 d, 2.0 320 d 4WD | 4 | N47D20C | 147/197 | 03/10 → 06/13 | | | | | | CCU106 ^[48] |
| 2.0 320 d, 2.0 320 d 4WD, 2.0 320 xd 4WD | 4 | N47D20A; N47D20C | 130/174 | 09/06 → 02/10 | | | | | | CCU105 ^[47] CCU106 ^[48] |
| 2.0 320 d, 2.0 320 d 4WD, 2.0 320 xd 4WD | 4 | N47D20A; N47D20C | 145/194 | 09/06 → 02/10 | | | | | | CCU106 ^[48] |
| 2.0 320 d 4WD, 2.0 320 xd 4WD | 4 | N47D20A; N47D20C | 120/161 | 03/08 → 06/13 | | | | | | CCU106 ^[48] |
| 2.0 320 i | 4 | | 110/148 | 11/06 → 06/07 | OE216 LPG ^[278] | 0,8 | CET12P | OE188 | BAEA143 | |
| 2.0 320 i | 4 | N46B20B | 115/154 | 06/07 → 12/13 | | | CET12P | OE188 | | |
| 2.0 320 i | 4 | N43B20A | 115/154 | 06/07 → 12/13 | | | | | | BAEA144E |
| 2.0 320 i | 4 | N43B20A | 120/161 | 01/07 → 12/13 | | | | | | BAEA144E |
| 2.0 320 i | 4 | N43B20A | 125/168 | 03/07 → 12/13 | | | | | | BAEA144E →02/12 |
| 2.5 323 i | 6 | N52N825A | 130/174 | 06/06 → 02/12 | | | | | | BAEA143 |
| 2.5 325 i | 6 | N52B25A; N52B25AF; N52B25BF | 155/208 | 03/10 → 06/13 | | | | | | BAEA143 |
| 2.5 325 i | 6 | N52B25AF; N52B25BF | 160/215 | 11/05 → 02/10 | OE238 | 1,0 | | | | |
| 2.5 325 i | 6 | N52B25A | 160/215 | 11/05 → 02/10 | OE238 | 1,0 | | | | BAEA143 11/07 → |
| 2.5 325 xi 4WD | 6 | N52B25A | 160/215 | 09/06 → 02/10 | OE238 | 1,0 | | | | BAEA143 11/07 → 08/08 |
| 3.0 325 d | 6 | M57D30(306D3) | 145/194 | 02/07 → 02/10 | | | | | | CCU102 |
| 3.0 325 d | 6 | N57D30A | 150/201 | 09/09 → 12/13 | | | | | | CCU108 |
| 3.0 325 d | 6 | M57D30(306D3) | 155/208 | 02/07 → 02/10 | | | | | | CCU102 |
| 3.0 325 i | 6 | N53B30A | 155/208 | 03/10 → 06/13 | | | | | | BAEA144E |
| 3.0 325 i, 3.0 325 i 4WD | 6 | N53B30A | 160/215 | 03/07 → 12/13 | | | | | | BAEA144E →02/12 |
| 3.0 325 xi 4WD | 6 | N53B30A | 160/215 | 09/07 → 02/10 | | | | | | BAEA144E →08/08 |
| 3.0 330 d, 3.0 330 d 4WD, 3.0 330 xd 4WD | 6 | N57D30A | 180/241 | 03/08 → 12/13 | | | | | | CCU108 |
| 3.0 330 d, 3.0 330 xd 4WD | 6 | M57D30(306D3) | 170/228 | 03/06 → 08/08 | | | | | | CCU102 |
| 3.0 330 i | 6 | N52B30A | 190/255 | 09/06 → 02/10 | OE238 | 1,0 | | | | BAEA143 11/07 → |
| 3.0 330 i | 6 | N52B30A; N52B30AF; N52B30B; N52B30BF | 200/268 | 09/06 → 06/13 | | | | | | BAEA143 09/07 → |
| 3.0 330 i | 6 | N52B30A; N52B30AF; N52B30B; N52B30BF | 200/268 | 09/06 → 06/13 | | | | | | BAEA144E 09/07 → |
| 3.0 330 i 4WD | 6 | N53B30A | 200/268 | 03/10 → 06/13 | | | | | | BAEA144E →02/12 |

BMW





kW/BHP

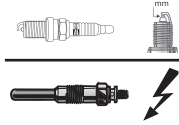

eon TITAN

IRIDIUM

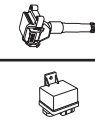

...BMW



...3 Coupe (E92)

| | | | | | | | | | |
|----------------|---|---------------|---------|---------------|--------------|-----|--|--|--------------------------|
| 3.0 330 xi 4WD | 6 | N52B30A | 190/255 | 09/06 → 08/07 | OE238 | 1,0 | | | BAEA143 |
| 3.0 330 xi 4WD | 6 | N52B30A | 200/268 | 09/06 → 02/10 | OE238 | 1,0 | | | BAEA143 |
| 3.0 335 d | 6 | M57D30(306D5) | 210/282 | 03/06 → 03/13 | | | | | CCU102 |
| 3.0 335 i | 6 | N54B30A | 225/302 | 11/05 → 06/13 | | | | | BAEA143 →02/10 |

| | | | | | | | | | |
|--|---|---------|---------|---------------|--------------|-----|--|--|--|
| 3.0 335 i, 3.0 335 i 4WD, 3.0 335 xi 4WD | 6 | N55B30A | 225/302 | 11/05 → 12/13 | OE242 | 0,8 | | | |
|--|---|---------|---------|---------------|--------------|-----|--|--|--|

| | | | | | | | | | |
|-------------------------------|---|---------|---------|---------------|--|--|--|--|----------------|
| 3.0 335 i 4WD, 3.0 335 xi 4WD | 6 | N54B30A | 225/302 | 03/07 → 12/13 | | | | | BAEA143 |
|-------------------------------|---|---------|---------|---------------|--|--|--|--|----------------|

3 Convertible (E93)

| | | | | | | | | | |
|-----------|---|---------|---------|---------------|--|--|--|--|---------------------------|
| 2.0 318 i | 4 | N43B20A | 105/141 | 03/10 → 12/13 | | | | | BAEA144E →02/12 |
|-----------|---|---------|---------|---------------|--|--|--|--|---------------------------|

| | | | | | | | | | |
|-----------|---|---------|---------|---------------|--|--|--|--|--|
| 2.0 320 d | 4 | N47D20C | 120/161 | 01/08 → 12/13 | | | | | CCU105 ^[47] CCU106 ^[48] |
|-----------|---|---------|---------|---------------|--|--|--|--|--|

| | | | | | | | | | |
|-----------|---|------------------|---------|---------------|--|--|--|--|--|
| 2.0 320 d | 4 | N47D20A; N47D20C | 130/174 | 09/07 → 02/10 | | | | | CCU105 ^[47] CCU106 ^[48] |
|-----------|---|------------------|---------|---------------|--|--|--|--|--|

| | | | | | | | | | |
|-----------|---|---------|---------|---------------|--|--|--|--|-------------------------------|
| 2.0 320 d | 4 | N47D20C | 135/181 | 03/10 → 10/13 | | | | | CCU106 ^[48] |
|-----------|---|---------|---------|---------------|--|--|--|--|-------------------------------|

| | | | | | | | | | |
|-----------|---|------------------|---------|---------------|--|--|--|--|-------------------------------|
| 2.0 320 d | 4 | N47D20A; N47D20C | 145/194 | 09/07 → 02/10 | | | | | CCU106 ^[48] |
|-----------|---|------------------|---------|---------------|--|--|--|--|-------------------------------|

| | | | | | | | | | |
|-----------|---|---------|---------|---------------|--|--|--|--|-------------------------------|
| 2.0 320 d | 4 | N47D20C | 147/197 | 03/10 → 10/13 | | | | | CCU106 ^[48] |
|-----------|---|---------|---------|---------------|--|--|--|--|-------------------------------|

| | | | | | | | | | |
|-----------|---|--|---------|---------------|---|------------|-------------|--------------|----------------|
| 2.0 320 i | 4 | | 110/148 | 01/07 → 08/13 | OE120 OE216 LPG ^[278] | 0,6 0,8 | CET2 | OE188 | BAEA143 |
|-----------|---|--|---------|---------------|---|------------|-------------|--------------|----------------|

| | | | | | | | | | |
|-----------|---|---------|---------|---------------|--|--|---------------|--------------|---|
| 2.0 320 i | 4 | N46B20B | 115/154 | 01/07 → 08/13 | | | CET12P | OE188 | BAEA324 →06/09 BAEA143 07/09 → |
|-----------|---|---------|---------|---------------|--|--|---------------|--------------|---|

| | | | | | | | | | |
|-----------|---|---------|---------|---------------|--|--|--|--|-----------------|
| 2.0 320 i | 4 | N43B20A | 115/154 | 01/07 → 08/13 | | | | | BAEA144E |
|-----------|---|---------|---------|---------------|--|--|--|--|-----------------|

| | | | | | | | | | |
|-----------|---|---------|---------|---------------|--|--|--|--|-----------------|
| 2.0 320 i | 4 | N43B20A | 120/161 | 09/06 → 10/13 | | | | | BAEA144E |
|-----------|---|---------|---------|---------------|--|--|--|--|-----------------|

| | | | | | | | | | |
|-----------|---|---------|---------|---------------|--|--|--|--|---------------------------|
| 2.0 320 i | 4 | N43B20A | 125/168 | 09/06 → 10/13 | | | | | BAEA144E →02/12 |
|-----------|---|---------|---------|---------------|--|--|--|--|---------------------------|

| | | | | | | | | | |
|-----------|---|----------|---------|---------------|--|--|--|--|----------------|
| 2.5 323 i | 6 | N52NB25A | 130/174 | 03/07 → 09/11 | | | | | BAEA143 |
|-----------|---|----------|---------|---------------|--|--|--|--|----------------|

| | | | | | | | | | |
|-----------|---|---------|---------|---------------|--------------|-----|--|--|---------------------------|
| 2.5 325 i | 6 | N52B25A | 160/215 | 03/07 → 12/13 | OE238 | 1,0 | | | BAEA143 11/07 → |
|-----------|---|---------|---------|---------------|--------------|-----|--|--|---------------------------|

| | | | | | | | | | |
|-----------|---|---------------|---------|---------------|--|--|--|--|--|
| 3.0 325 d | 6 | M57D30(306D3) | 145/194 | 03/07 → 12/10 | | | | | CCU102 ^[47] CCU108 ^[48] |
|-----------|---|---------------|---------|---------------|--|--|--|--|--|

| | | | | | | | | | |
|-----------|---|---------|---------|---------------|--|--|--|--|---------------|
| 3.0 325 d | 6 | N57D30A | 150/201 | 09/09 → 09/13 | | | | | CCU108 |
|-----------|---|---------|---------|---------------|--|--|--|--|---------------|

| | | | | | | | | | |
|-----------|---|---------------|---------|---------------|--|--|--|--|---------------|
| 3.0 325 d | 6 | M57D30(306D3) | 155/208 | 03/07 → 12/10 | | | | | CCU102 |
|-----------|---|---------------|---------|---------------|--|--|--|--|---------------|

| | | | | | | | | | |
|-----------|---|---------|---------|---------------|--|--|--|--|----------------------------------|
| 3.0 325 i | 6 | N53B30A | 155/208 | 10/06 → 12/13 | | | | | BAEA144E 03/07 → 09/13 |
|-----------|---|---------|---------|---------------|--|--|--|--|----------------------------------|

| | | | | | | | | | |
|-----------|---|---------|---------|---------------|--|--|--|--|---------------------------|
| 3.0 325 i | 6 | N53B30A | 160/215 | 03/07 → 12/13 | | | | | BAEA144E →02/12 |
|-----------|---|---------|---------|---------------|--|--|--|--|---------------------------|

| | | | | | | | | | |
|-----------|---|---------------|---------|---------------|--|--|--|--|--|
| 3.0 330 d | 6 | M57D30(306D3) | 170/228 | 03/07 → 12/13 | | | | | CCU102 ^[47] CCU108 ^[48] |
|-----------|---|---------------|---------|---------------|--|--|--|--|--|

| | | | | | | | | | |
|-----------|---|---------|---------|---------------|--|--|--|--|---------------|
| 3.0 330 d | 6 | N57D30A | 180/241 | 01/09 → 12/13 | | | | | CCU108 |
|-----------|---|---------|---------|---------------|--|--|--|--|---------------|

| | | | | | | | | | |
|-----------|---|---|---------|---------------|--|--|--|--|---------------------------------|
| 3.0 330 i | 6 | N52B30A; N52B30AF; N52B30B; N52B30BF | 190/255 | 03/07 → 12/13 | | | | | BAEA143 11/07 → 01/13 |
|-----------|---|---|---------|---------------|--|--|--|--|---------------------------------|

| | | | | | | | | | |
|-----------|---|---------|---------|---------------|--|--|--|--|---|
| 3.0 330 i | 6 | N53B30A | 200/268 | 03/07 → 12/13 | | | | | BAEA143 →02/12 BAEA144E →02/12 |
|-----------|---|---------|---------|---------------|--|--|--|--|---|

| | | | | | | | | | |
|-----------|---|---------|---------|---------------|--------------|-----|--|--|--|
| 3.0 335 i | 6 | N55B30A | 225/302 | 05/06 → 10/13 | OE242 | 0,8 | | | |
|-----------|---|---------|---------|---------------|--------------|-----|--|--|--|

| | | | | | | | | | |
|-----------|---|------------------|---------|---------------|--|--|--|--|--------------------------|
| 3.0 335 i | 6 | N54B30A; N54B30B | 225/302 | 05/06 → 10/13 | | | | | BAEA143 →02/10 |
|-----------|---|------------------|---------|---------------|--|--|--|--|--------------------------|

3 (F30, F80)

| | | | | | | | | | |
|-----------|---|---------|---------|---------|--|--|--|--------------|----------------|
| 1.5 318 i | 3 | B38B15A | 100/134 | 03/15 → | | | | OE245 | BAEA538 |
|-----------|---|---------|---------|---------|--|--|--|--------------|----------------|

| | | | | | | | | | |
|-----------|---|---------|---------|---------------|--------------|-----|---------------|--|----------------|
| 1.6 316 i | 4 | N13B16A | 100/134 | 10/12 → 08/16 | OE205 | 0,7 | CET16P | | BAEA143 |
|-----------|---|---------|---------|---------------|--------------|-----|---------------|--|----------------|

| | | | | | | | | | |
|-----------|---|---------|---------|---------------|--------------|-----|---------------|--|----------------|
| 1.6 320 i | 4 | N13B16A | 125/168 | 04/12 → 06/16 | OE205 | 0,7 | CET16P | | BAEA143 |
|-----------|---|---------|---------|---------------|--------------|-----|---------------|--|----------------|

| | | | | | | | | | |
|-----------|---|---------|--------|---------|------------------------------|------|--|--|--|
| 2.0 316 d | 4 | B47D20A | 85/114 | 05/11 → | CCGP001 [92] [240] | 5.4v | | | |
|-----------|---|---------|--------|---------|------------------------------|------|--|--|--|

| | | | | | | | | | |
|-----------|---|---------|--------|---------|------------------------------|------|--|--|-----------------------------|
| 2.0 316 d | 4 | N47D20C | 85/114 | 05/11 → | CCGP001 [92] [240] | 5.4v | | | CCU106 [47] [344] |
|-----------|---|---------|--------|---------|------------------------------|------|--|--|-----------------------------|

BMW





kW/BHP



eon TITAN

IRIDIUM



...BMW



...3 (F30, F80)

| | | | | | | | | | |
|-------------------------------------|---|------------------------------|---------|-------------|----------------------------|------|--------|---------------------------------|-------------------------|
| 2.0 318 d | 4 | B47D20A | 100/134 | 05/11→ | CCGP001 [92] [240] | 5.4v | | | |
| 2.0 318 d | 4 | N47D20C | 100/134 | 05/11→ | CCGP001 [92] [240] | 5.4v | | | CCU106 [47] [344] |
| 2.0 318 d, 2.0 318 d 4WD | 4 | N47D20C | 105/141 | 05/11→06/15 | CCGP001 [92] [240] | 5.4v | | | CCU106[47] |
| 2.0 320 d | 4 | B47D20A | 140/188 | 10/14→ | CCGP001 [47] [240] | 5.4v | | | |
| 2.0 320 d | 4 | N47D20C | 147/197 | 03/11→03/16 | CCGP001 [92] [240] | 5.4v | | | CCU106 |
| 2.0 320 d, 2.0 320 d 4WD | 4 | B47D20A | 120/161 | 04/11→ | CCGP001 [92] [240] | 5.4v | | | |
| 2.0 320 d, 2.0 320 d 4WD | 4 | N47D20C | 120/161 | 04/11→ | CCGP001 [92] [240] | 5.4v | | | CCU106[344] |
| 2.0 320 d, 2.0 320 d 4WD | 4 | N47D20C | 135/181 | 03/11→03/16 | CCGP001 [92] [240] | 5.4v | | | CCU106 |
| 2.0 320 d 4WD | 4 | N47D20C | 147/197 | 05/11→06/15 | CCGP001 [47] [240] | 5.4v | | | CCU106 |
| 2.0 320 i | 4 | N20B20D | 135/181 | 04/11→ | | | | | BAEA143 |
| 2.0 320 i, 2.0 320 i 4WD | 4 | N20B20A; N20B20B | 135/181 | 04/11→ | OE243 | 0,8 | | | BAEA143 |
| 2.0 320 i, 2.0 320 i 4WD, 2.0 330 e | 4 | B48B20A | 135/181 | 04/11→ | | | | OE245 ^[48] 07/15→ | BAEA538 →07/15 |
| 2.0 325 d | 4 | N47D20D | 155/208 | 07/12→02/16 | CCGP001 [47] [240] | 5.4v | | | CCU106 |
| 2.0 325 d | 4 | N47D20D | 160/215 | 07/12→02/16 | CCGP001 [92] [240] | 5.4v | | | CCU106 |
| 2.0 328 i, 2.0 328 i 4WD | 4 | N20B20A; N26B20A | 180/241 | 04/11→07/16 | OE243 | 0,8 | | | BAEA143 |
| 2.0 330 e | 4 | B48B20A | 185/248 | 02/15→ | | | | OE245 ^[48] 07/15→ | BAEA538 →07/15 |
| 2.0 330 i | 4 | B46B20B; B48B20A; B48B20B | 185/248 | 09/14→ | | | | OE245 ^[48] 07/15→ | BAEA538 07/15→06/17 |
| 2.0 330 i 4WD | 4 | B48B20A; B48B20B | 185/248 | 10/14→ | | | | OE245 ^[48] 07/15→ | BAEA538 07/15→ |
| 3.0 330 d, 3.0 330 d 4WD | 6 | N57D30A | 190/255 | 01/12→ | CCGP001 [92] [240] | 5.4v | | | |
| 3.0 330 d, 3.0 330 d 4WD | 6 | N57D30A | 210/282 | 01/12→ | CCGP001 ^[240] | 5.4v | | | |
| 3.0 335 d 4WD | 6 | N57D30B | 230/308 | 11/12→ | CCGP001 [47] [92] [240] | 5.4v | | | |
| 3.0 335 i | 6 | N55B30A | 250/335 | 07/13→ | OE242 | 0,8 | | | |
| 3.0 335 i, 3.0 335 i 4WD | 6 | N55B30A | 225/302 | 04/11→07/15 | OE242 | 0,8 | | | |
| 3.0 335 i, 3.0 335 i 4WD | 6 | N55B30A | 225/302 | 04/11→07/15 | | | | | BAEA143 |
| 3.0 335 i, 3.0 335 i 4WD | 6 | N55B30A | 240/322 | 04/11→07/13 | OE242 | 0,8 | | | BAEA143 |
| 3.0 335 i 4WD, 3.0 ActiveHybrid | 6 | N55B30A | 250/335 | 11/11→ | OE242 | 0,8 | | | BAEA143 |
| 3.0 340 i, 3.0 340 i 4WD | 6 | B58B30A | 240/322 | 10/14→ | | | | OE245 ^[48] 07/15→ | BAEA538 07/15→07/16 |
| 3.0 340 i, 3.0 340 i 4WD | 6 | B58B30A | 265/355 | 10/14→ | | | | OE245 ^[48] 07/15→ | BAEA538 07/15→07/16 |
| 3.0 ActiveHybrid | 6 | N55B30A | 225/302 | 11/11→05/15 | OE242 | 0,8 | | | BAEA143 |
| 3.0 M3 | 6 | S55B30A | 317/425 | 04/12→ | | | | | BAEA143 |
| 3 Touring (F31) | | | | | | | | | |
| 1.5 318 i | 3 | B38B15A | 100/134 | 01/15→ | | | | OE245 07/15→ | BAEA538 07/16→ |
| 1.6 316 i | 4 | N13B16A | 100/134 | 03/12→08/16 | OE205 | 0,7 | CET16P | | BAEA143 |
| 2.0 316 d | 4 | N47D20C | 85/114 | 02/12→ | | | | | CCU106 [47] [344] |
| 2.0 318 d | 4 | N47D20C | 100/134 | 07/11→ | | | | | CCU106 [47] [344] |
| 2.0 318 d, 2.0 318 d 4WD | 4 | N47D20C | 105/141 | 07/11→06/15 | | | | | CCU106 ^[47] |
| 2.0 320 d | 4 | B47D20A | 120/161 | 07/11→ | CCGP001 [48] [92] [240] | 5.4v | | | |
| 2.0 320 d | 4 | N47D20C | 120/161 | 07/11→ | CCGP001 [48] [92] [240] | 5.4v | | | CCU106 ^[344] |
| 2.0 320 d | 4 | N47D20C | 135/181 | 07/11→02/16 | CCGP001 [48] [92] [240] | 5.4v | | | CCU106 |

BMW





kW/BHP

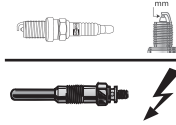

eon TITAN

IRIDIUM

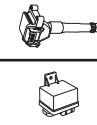
**...BMW****...3 Touring (F31)**

| | | | | | | | | |
|--------------------------|---|------------------|---------|-------------|----------------------------|------|-----------------|-------------------------|
| 2.0 320 d | 4 | N47D20C | 147/197 | 07/11→02/16 | CCGP001 [48] [92] [240] | 5.4v | | CCU106 |
| 2.0 320 d 4WD | 4 | N47D20C | 120/161 | 01/12→ | | | | CCU106 ^[344] |
| 2.0 320 d 4WD | 4 | N47D20C | 135/181 | 01/12→06/15 | | | | CCU106 |
| 2.0 320 d 4WD | 4 | N47D20C | 147/197 | 01/12→06/15 | | | | CCU106 |
| 2.0 320 i, 2.0 320 i 4WD | 4 | N20B20B | 135/181 | 01/12→ | OE243 | 0,8 | | BAEA143 |
| 2.0 320 i, 2.0 320 i 4WD | 4 | B48B20A | 135/181 | 01/12→ | | | OE245 07/15→ | |
| 2.0 325 d | 4 | N47D20D | 155/208 | 09/12→02/16 | CCGP001 [48] [240] | 5.4v | | CCU106 |
| 2.0 325 d | 4 | N47D20D | 160/215 | 09/12→02/16 | CCGP001 [48] [92] [240] | 5.4v | | CCU106 |
| 2.0 328 i, 2.0 328 i 4WD | 4 | N20B20A | 180/241 | 01/12→06/16 | OE243 | 0,8 | | BAEA143 |
| 2.0 330 i, 2.0 330 i 4WD | 4 | B48B20A; B48B20B | 185/248 | 09/14→ | | | OE245 07/15→ | BAEA538 07/16→ |
| 3.0 330 d, 3.0 330 d 4WD | 6 | N57D30A | 190/255 | 01/12→ | CCGP001 [48] [92] [240] | 5.4v | | |
| 3.0 330 d, 3.0 330 d 4WD | 6 | N57D30A | 210/282 | 01/12→ | CCGP001 ^[240] | 5.4v | | |
| 3.0 335 i, 3.0 335 i 4WD | 6 | N55B30A | 225/302 | 07/12→06/15 | OE242 | 0,8 | | BAEA143 |
| 3.0 335 i, 3.0 335 i 4WD | 6 | N55B30A | 240/322 | 07/12→07/13 | OE242 | 0,8 | | BAEA143 |
| 3.0 335 i, 3.0 335 i 4WD | 6 | N55B30A | 250/335 | 07/13→06/15 | OE242 | 0,8 | | BAEA143 |
| 3.0 340 i, 3.0 340 i 4WD | 6 | B58B30A | 240/322 | 10/14→ | | | OE245 07/15→ | BAEA538 →07/16 |
| 3.0 340 i, 3.0 340 i 4WD | 6 | B58B30A | 265/355 | 10/14→ | | | OE245 07/15→ | BAEA538 →07/16 |

3 Gran Turismo (F34)

| | | | | | | | | |
|--------------------------|---|------------------|---------|-------------|-----------------------|------|-----------------|------------------------|
| 2.0 318 d | 4 | N47D20C | 100/134 | 03/13→ | CCGP001 [92] [240] | 5.4v | | CCU106 |
| 2.0 318 d | 4 | N47D20C | 105/141 | 03/13→ | CCGP001 [92] [240] | 5.4v | | CCU106 |
| 2.0 320 d | 4 | N47D20C | 147/197 | 05/13→07/15 | CCGP001 [92] [240] | 5.4v | | CCU106 ^[47] |
| 2.0 320 d, 2.0 320 d 4WD | 4 | B47D20A; N47D20C | 120/161 | 03/13→ | CCGP001 [92] [240] | 5.4v | | CCU106 |
| 2.0 320 d, 2.0 320 d 4WD | 4 | N47D20C | 135/181 | 03/13→07/15 | CCGP001 [92] [240] | 5.4v | | CCU106 |
| 2.0 320 d 4WD | 4 | N47D20C | 147/197 | 05/13→07/15 | CCGP001 [92] [240] | 5.4v | | CCU106 |
| 2.0 320 i, 2.0 320 i 4WD | 4 | B48B20A | 135/181 | 07/12→ | | | OE245 07/16→ | BAEA538 07/16→06/17 |
| 2.0 320 i, 2.0 320 i 4WD | 4 | N20B20A; N20B20B | 135/181 | 07/12→ | | | | BAEA143 |
| 2.0 325 d | 4 | N47D20D | 155/208 | 07/13→ | CCGP001 [92] [240] | 5.4v | | CCU106 |
| 2.0 325 d | 4 | N47D20D | 160/215 | 03/13→ | CCGP001 [92] [240] | 5.4v | | CCU106 ^[47] |
| 2.0 328 i, 2.0 328 i 4WD | 4 | N20B20A; N26B20A | 180/241 | 08/12→07/16 | OE242 | 0,8 | | BAEA143 |
| 2.0 330 i, 2.0 330 i 4WD | 4 | B48B20B | 185/248 | 10/15→ | | | OE245 07/16→ | BAEA538 07/16→06/17 |
| 3.0 335 i, 3.0 335 i 4WD | 6 | N55B30A | 225/302 | 03/13→ | OE242 | 0,8 | | BAEA143 |
| 3.0 335 i, 3.0 335 i 4WD | 6 | N55B30A | 240/322 | 03/13→03/14 | OE242 | 0,8 | | BAEA143 |
| 3.0 335 i, 3.0 335 i 4WD | 6 | N55B30A | 250/335 | 07/13→ | OE242 | 0,8 | | BAEA143 |
| 3.0 340 i, 3.0 340 i 4WD | 6 | B58B30A | 240/322 | 10/15→ | | | OE245 07/16→ | BAEA538 07/16→06/17 |
| 3.0 340 i, 3.0 340 i 4WD | 6 | B58B30A | 265/355 | 09/15→ | | | OE245 07/16→ | BAEA538 07/16→06/17 |

4 Coupe (F32, F82)

| | | | | | | | | |
|--------------------------|---|------------------|---------|-------------|-----------------------|------|-------|-------------------------|
| 1.5 418 i | 3 | B38B15A | 100/134 | 02/16→ | | | OE245 | BAEA538 →06/17 |
| 2.0 420 d, 2.0 420 d 4WD | 4 | N47D20C | 120/161 | 07/13→ | | | | CCU106 ^[344] |
| 2.0 420 d, 2.0 420 d 4WD | 4 | N47D20C | 135/181 | 07/13→03/15 | CCGP001 [92] [240] | 5.4v | | CCU106 |
| 2.0 420 d, 2.0 420 d 4WD | 4 | N47D20C | 147/197 | 07/13→03/15 | CCGP001 [92] [240] | 5.4v | | CCU106 |
| 2.0 420 i, 2.0 420 i 4WD | 4 | N20B20A; N20B20B | 135/181 | 11/13→ | OE243 | 0,8 | | BAEA143 |





kW/BHP



eon TITAN

IRIDIUM



...BMW



...4 Coupe (F32, F82)

| | | | | | | | | | |
|--------------------------|---|------------------|---------|--------|--|------|--|-------|------------------------|
| 2.0 420 i, 2.0 420 i 4WD | 4 | B48B20A | 135/181 | 11/13→ | | | | OE245 | BAEA538 →06/17 |
| 2.0 425 d | 4 | N47D20D | 155/208 | 01/14→ | CCGP001 ^[240] | 5.4v | | | CCU106 |
| 2.0 425 d | 4 | N47D20D | 160/215 | 01/14→ | CCGP001 ^[92] ^[240] | 5.4v | | | CCU106 ^[47] |
| 2.0 428 i, 2.0 428 i 4WD | 4 | N20B20A; N26B20A | 180/241 | 07/13→ | OE243 | 0,8 | | | BAEA143 |
| 2.0 430 i, 2.0 430 i 4WD | 4 | B48B20A; B48B20B | 185/248 | 03/16→ | | | | OE245 | BAEA538 →06/17 |
| 3.0 435 i, 3.0 435 i 4WD | 6 | N55B30A | 225/302 | 07/13→ | OE242 | 0,8 | | | BAEA143 |
| 3.0 435 i, 3.0 435 i 4WD | 6 | N55B30A | 250/335 | 07/13→ | OE242 | 0,8 | | | BAEA143 |
| 3.0 440 i, 3.0 440 i 4WD | 6 | B58B30A | 240/322 | 03/16→ | | | | OE245 | BAEA538 →06/17 |
| 3.0 440 i, 3.0 440 i 4WD | 6 | B58B30A | 265/355 | 03/16→ | | | | OE245 | BAEA538 →06/17 |
| 3.0 M4 | 6 | S55B30A | 317/425 | 01/14→ | | | | | BAEA143 |

4 Convertible (F33, F83)

| | | | | | | | | | |
|--------------------------|---|------------------|---------|-------------|--|------|--|-------|-------------------------|
| 2.0 420 d | 4 | N47D20C | 120/161 | 10/13→ | | | | | CCU106 ^[344] |
| 2.0 420 d | 4 | N47D20C | 135/181 | 10/13→07/15 | CCGP001 ^[92] ^[240] | 5.4v | | | CCU106 |
| 2.0 420 d | 4 | N47D20C | 147/197 | 10/13→07/15 | CCGP001 ^[92] ^[240] | 5.4v | | | CCU106 ^[47] |
| 2.0 420 i | 4 | N20B20B | 135/181 | 07/14→ | OE243 | 0,8 | | | BAEA143 |
| 2.0 420 i | 4 | B48B20A | 135/181 | 07/14→ | | | | OE245 | BAEA538 →06/17 |
| 2.0 425 d | 4 | N47D20D | 155/208 | 07/14→ | CCGP001 ^[240] | 5.4v | | | CCU106 |
| 2.0 425 d | 4 | N47D20D | 160/215 | 07/14→ | CCGP001 ^[92] ^[240] | 5.4v | | | CCU106 ^[47] |
| 2.0 428 i, 2.0 428 i 4WD | 4 | N20B20A; N26B20A | 180/241 | 10/13→ | OE243 | 0,8 | | | BAEA143 |
| 2.0 430 i, 2.0 430 i 4WD | 4 | B48B20B | 185/248 | 03/16→ | | | | OE245 | BAEA538 →06/17 |
| 3.0 435 d 4WD | 6 | N57D30B | 230/308 | 07/14→ | CCGP001 ^[92] ^[240] | 5.4v | | | |
| 3.0 435 i, 3.0 435 i 4WD | 6 | N55B30A | 225/302 | 10/13→ | OE242 | 0,8 | | | BAEA143 |
| 3.0 435 i, 3.0 435 i 4WD | 6 | N55B30A | 250/335 | 10/13→ | OE242 | 0,8 | | | BAEA143 |
| 3.0 440 i, 3.0 440 i 4WD | 6 | B58B30A | 240/322 | 03/16→ | | | | OE245 | BAEA538 →06/17 |
| 3.0 440 i, 3.0 440 i 4WD | 6 | B58B30A | 265/355 | 03/16→ | | | | OE245 | BAEA538 →06/17 |
| 3.0 M4 | 6 | S55B30A | 317/425 | 07/14→ | | | | | BAEA143 |

4 Gran Coupe (F36)

| | | | | | | | | | |
|--------------------------|---|------------------|---------|-------------|--|------|--|-------|-------------------------|
| 1.5 418 i | 3 | B38B15A | 100/134 | 07/15→ | | | | OE245 | BAEA538 →06/17 |
| 2.0 418 d | 4 | N47D20C | 100/134 | 03/14→ | | | | | CCU106 ^[344] |
| 2.0 418 d | 4 | N47D20C | 105/141 | 03/14→ | CCGP001 ^[92] ^[240] | 5.4v | | | CCU106 |
| 2.0 420 d, 2.0 420 d 4WD | 4 | N47D20C | 120/161 | 03/14→ | | | | | CCU106 ^[344] |
| 2.0 420 d, 2.0 420 d 4WD | 4 | N47D20C | 135/181 | 03/14→03/15 | CCGP001 ^[92] ^[240] | 5.4v | | | CCU106 |
| 2.0 420 d, 2.0 420 d 4WD | 4 | N47D20C | 147/197 | 03/14→03/15 | CCGP001 ^[92] ^[240] | 5.4v | | | CCU106 |
| 2.0 420 i, 2.0 420 i 4WD | 4 | N20B20B | 135/181 | 03/14→ | OE243 | 0,8 | | | BAEA143 |
| 2.0 420 i, 2.0 420 i 4WD | 4 | B48B20A | 135/181 | 03/14→ | | | | OE245 | BAEA538 →06/17 |
| 2.0 428 i, 2.0 428 i 4WD | 4 | N20B20A; N26B20A | 180/241 | 03/14→ | OE243 | 0,8 | | | BAEA143 |
| 2.0 430 i, 2.0 430 i 4WD | 4 | B48B20B | 185/248 | 03/16→ | | | | OE245 | BAEA538 →06/17 |
| 3.0 435 d 4WD | 6 | N57D30B | 230/308 | 07/14→ | CCGP001 ^[92] ^[240] | 5.4v | | | |
| 3.0 435 i, 3.0 435 i 4WD | 6 | N55B30A | 225/302 | 03/14→ | OE242 | 0,8 | | | BAEA143 |
| 3.0 435 i, 3.0 435 i 4WD | 6 | N55B30A | 250/335 | 03/14→ | OE242 | 0,8 | | | BAEA143 |
| 3.0 440 i, 3.0 440 i 4WD | 6 | B58B30A | 240/322 | 03/16→ | | | | OE245 | BAEA538 →06/17 |

BMW





kW/BHP



eon TITAN

IRIDIUM



...BMW



...4 Gran Coupe (F36)

3.0 440 i, 3.0 440 i 4WD 6 B58B30A 265/355 03/16→

OE245

BAEA538

→06/17

5 /Touring (E34)

2.5 525 td 6 M51D25(256T1) 85/114 03/93→01/97 CH189 11v

5 Touring (E34)

1.8 518 g 4 M43B18(184E2) 85/114 11/95→06/96 OE026 0,9 CET2 OE188 BAEA307

OE216 LPG [278] 0,8

1.8 518 i 4 M43B18(184E2) 83/111 03/93→09/94 OE026 0,9 CET2 OE188

4.0 540 i 8 M60B40(408S1) 210/282 09/93→01/97 OE026 0,9 CET2 OE188 BAEA014

→12/96

OE216 LPG [278] 0,8

5 (E39)

2.2 520 i 6 M54B22(226S1) 125/168 09/00→06/03 OE223 1,6 CET1 2P OE188 BAEA302

→09/02

BAEA143^[247]

10/02→

BAEA324

10/02→

2.8 528 i 6 M52B28(286S1); M52B28(286S2) 142/190 11/95→09/00 OE026 0,9 CET2 OE188 BAEA302

→09/98

OE216 LPG [278] 0,8

→09/98

OE223 1,6

09/98→

3.0 530 i 6 M54B30(306S3) 170/228 09/00→06/03 OE223 1,6 CET1 2P OE188 BAEA302

→09/02

BAEA143^[247]

10/02→

BAEA324

10/02→

3.5 535 i 8 M62B35(358S1); M62B35(358S2) 173/232 04/96→03/99 OE026 0,9 CET1 2P OE188 BAEA302

→09/98

OE216 LPG [278] 0,8

→09/98

OE223 1,6

09/98→

5 /Touring (E39)

2.0 520 d 4 M47D20(204D1) 100/134 02/00→09/03 CH203 11v

2.0 520 i 6 M52B20(206S3) 100/134 04/99→06/03 OE223 1,6 CET1 2P OE188 BAEA302

2.0 520 i 6 M52B20(206S3); M52B20(206S4) 110/148 01/96→06/03 OE026 0,9 CET1 2P OE188 BAEA302

→09/98

→08/98

OE216 LPG [278] 0,8

→09/98

OE223 1,6

09/98→

2.5 523 i 6 M52B25(256S3) 125/168 11/95→09/00 OE026 0,9 CET1 2P OE188 BAEA302

→09/98

→08/98

OE216 LPG [278] 0,8

→09/98

OE223 1,6

09/98→

2.5 525 d 6 M57D25(256D1) 120/161 02/00→05/04 CH203 11v

2.5 525 i 6 M54B25(256S5) 141/189 09/00→05/04 OE223 1,6 CET1 2P OE188 BAEA302

→09/02

2.5 525 td 6 M51D25(256T1) 85/114 01/97→06/03 CH189 11v

2.5 525 tds 6 M51D25(256T1) 105/141 01/96→05/04 CH189 11v

2.8 528 i 6 M52B28(286S1); M52B28(286S2) 142/190 01/97→09/00 OE223 1,6 CET1 2P OE188 BAEA302

3.0 530 d 6 M57D30(306D1) 135/181 08/98→09/00 CH203 11v

3.0 530 d 6 M57D30(306D1) 142/190 09/98→05/04 CH203 11v

3.5 535 i 8 M62B35(358S2) 180/241 04/99→06/03 OE223 1,6 CET1 2P OE188 BAEA302



kW/BHP

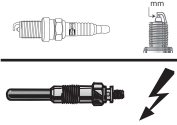

eon TITAN

IRIDIUM

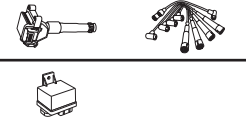

...BMW



...5 /Touring (E39)

| | | | | | | | | | |
|-----------|---|---------------------------------|---------|-------------|--|-------------------|-------------------------|--------------|----------------|
| 4.4 540 i | 8 | M62B44(448S1); M62B44(448S2) | 210/282 | 04/96→05/04 | OE026 →09/98 OE216 LPG [278] →09/98 OE223 09/98→ | 0,9 0,8 1,6 | CET12P →08/98 | OE188 | BAEA302 |
| 4.9 M5 | 8 | S62B50(508S1) | 294/394 | 10/98→06/03 | OE223 | 1,6 | CET12P | OE188 | BAEA302 |

5 Touring (E39)

| | | | | | | | | | |
|-----------|---|---------------------------------|---------|-------------|--|------------|---------------|--------------|--|
| 2.0 520 i | 6 | M52B20(206S3) | 100/134 | 04/99→05/04 | OE223 | 1,6 | CET12P | | BAEA302 |
| 2.2 520 i | 6 | M54B22(226S1) | 125/168 | 09/00→05/04 | OE223 | 1,6 | CET12P | OE188 | BAEA302 →09/02 BAEA324 10/02→ |
| 2.5 523 i | 6 | M52B25(256S3); M52B25(256S4) | 125/168 | 09/96→08/00 | OE026 OE216 LPG [278] | 0,9 0,8 | CET12P | OE188 | BAEA302 |
| 3.0 530 i | 6 | M54B30(306S3) | 170/228 | 09/00→05/04 | OE223 | 1,6 | CET12P | OE188 | BAEA302 →09/02 BAEA324 10/02→ BAEA143 [247] |

5 (E60)

| | | | | | | | | | |
|---|---|-------------------------------|---------|-------------|--------------|-----|---------------|--------------|---|
| 2.0 520 d | 4 | M47D20(204D4) | 110/148 | 02/05→02/08 | | | | | CCU101 |
| 2.0 520 d | 4 | M47D20(204D4) | 120/161 | 02/05→02/08 | | | | | CCU105 [48] [343] |
| 2.0 520 d | 4 | M47 | 120/161 | 02/05→02/08 | | | | | CCU101 |
| 2.0 520 d | 4 | N47D20A; N47D20C | 130/174 | 04/06→12/09 | | | | | CCU105 |
| 2.0 520 i | 4 | N46B20B | 115/154 | 04/06→12/09 | | | | OE188 | BAEA324 →06/09 BAEA143 07/09→ |
| 2.0 520 i | 4 | N43B20A | 120/161 | 12/06→03/10 | | | | | BAEA143 |
| 2.0 520 i | 4 | N43B20A | 125/168 | 09/07→03/10 | | | | | BAEA144E |
| 2.2 520 i | 6 | M54B22(226S1) | 125/168 | 07/03→03/10 | OE223 | 1,6 | CET12P | OE188 | BAEA324 →06/09 BAEA143 [247] |
| 2.5 523 i | 6 | N52B25A; N52B25B; N52B25BE | 130/174 | 10/04→02/07 | OE238 | 1,0 | | | BAEA145E [242] →04/06 BAEA143 [247] |
| 2.5 523 i | 6 | N52B25A | 140/188 | 01/07→03/10 | OE238 | 1,0 | | | BAEA144E |
| 2.5 525 d | 6 | M57D25(256D1) | 120/161 | 12/04→03/10 | | | | | CCU102 |
| 2.5 525 d | 6 | M57D25(256D2) | 130/174 | 06/04→03/10 | | | | | CCU102 |
| 2.5 525 i | 6 | M54B25(256S5) | 141/189 | 09/03→03/10 | OE223 | 1,6 | CET12P | OE188 | BAEA324 →06/09 BAEA143 [247] |
| 2.5 525 i | 6 | N52B25B; N52B25BF | 160/215 | 10/04→12/09 | OE238 | 1,0 | | | BAEA145E →04/06 BAEA143 04/06→ |
| 2.5 525 i | 6 | N52B25A | 160/215 | 10/04→12/09 | OE238 | 1,0 | | | BAEA145E →04/06 [86] [242] BAEA143 04/06→ [87] [242] |
| 2.5 525 xi 4WD | 6 | N52B25A | 160/215 | 07/05→03/10 | OE238 | 1,0 | | | BAEA145E →04/06 [86] [242] BAEA143 04/06→ [87] [242] |
| 3.0 525 d, 3.0 525 d 4WD, 3.0 525 xd 4WD | 6 | M57D30(306D3) | 145/194 | 11/06→03/10 | | | | | CCU102 |
| 3.0 525 i, 3.0 525 i 4WD | 6 | N53B30A | 160/215 | 01/07→03/10 | | | | | BAEA144E |
| 3.0 525 xi 4WD | 6 | N53B30A | 160/215 | 01/07→03/10 | | | | | BAEA144E →12/08 [88] [242] |

BMW





kW/BHP



eon TITAN

IRIDIUM



...BMW



...5 (E60)

| | | | | | | | | | |
|---|---|---------------------------------|---------|-------------|----------------------------|-----|--------|-------|---|
| 3.0 530 d | 6 | M57D30(306D2); M57D30(306D3) | 155/208 | 09/02→12/09 | | | | | CCU102 |
| 3.0 530 d | 6 | M57D30(306D2) | 160/215 | 09/02→09/05 | | | | | CCU102 |
| 3.0 530 d, 3.0 530 d 4WD, 3.0 530 xd 4WD | 6 | M57D30(306D3) | 173/232 | 02/07→12/09 | | | | | CCU102 |
| 3.0 530 d, 3.0 530 xd 4WD | 6 | M57D30(306D3) | 170/228 | 02/05→02/07 | | | | | CCU102 |
| 3.0 530 i | 6 | M54B30(306S3) | 170/228 | 12/01→02/05 | OE223 | 1,6 | CET12P | OE188 | BAEA143 ^[247] BAEA324 |
| 3.0 530 i | 6 | N52B30A | 187/251 | 03/05→03/10 | | | | | BAEA145E →03/06 BAEA143 04/06→ |
| 3.0 530 i | 6 | N52B30A; N52B30B; N52B30BF | 190/255 | 09/04→02/07 | OE238 | 1,0 | | | BAEA145E →04/06 BAEA143 04/06→ [87] [242] |
| 3.0 530 i, 3.0 530 i 4WD, 3.0 530 xi 4WD | 6 | N53B30A | 200/268 | 09/06→12/09 | | | | | BAEA144E |
| 3.0 530 xi 4WD | 6 | N52B30A | 190/255 | 09/04→02/07 | OE238 | 1,0 | | | BAEA145E →04/06 BAEA143 05/06→ |
| 3.0 535 d | 6 | M57D30(306D4) | 200/268 | 09/04→03/10 | | | | | CCU102 |
| 3.0 535 d | 6 | M57D30(306D5) | 210/282 | 01/07→03/10 | | | | | CCU102 |
| 3.0 535 i | 6 | N54B30A | 224/300 | 09/07→03/10 | | | | | BAEA143 |
| 3.0 535 i | 6 | N54B30A | 225/302 | 04/06→12/09 | | | | | BAEA324 →06/09 BAEA143 07/09→ |
| 4.0 540 i | 8 | N62B40A | 225/302 | 07/05→03/10 | OE216 LPG ^[278] | 0,8 | CET12P | OE188 | BAEA143 BAEA324 |
| 4.4 545 i | 8 | N62B44A | 245/329 | 09/03→03/10 | OE223 | 1,6 | CET12P | OE188 | BAEA324 →06/09 BAEA143 ^[87] 07/09→ |
| 4.8 550 i | 8 | N62B48A; N62B48B | 270/362 | 07/05→03/10 | OE216 LPG ^[278] | 0,8 | CET12P | OE188 | BAEA143 |
| 5 Touring (E61) | | | | | | | | | |
| 2.0 520 d | 4 | M47D20(204D4) | 110/148 | 04/05→02/08 | | | | | CCU101 ^[91] CCU105 [48] [343] |
| 2.0 520 d | 4 | M47D20(204D4) | 120/161 | 04/05→02/08 | | | | | CCU101 ^[91] CCU105 [48] [343] |
| 2.0 520 d | 4 | N47D20A; N47D20C | 130/174 | 03/07→05/10 | | | | | CCU105 |
| 2.0 520 i | 4 | N43B20A | 120/161 | 07/07→08/10 | | | | | BAEA144E [88] [242] |
| 2.0 520 i | 4 | N43B20A | 125/168 | 09/07→12/10 | | | | | BAEA144E →08/10 |
| 2.5 523 i | 6 | N52B25A; N52B25B; N52B25BE | 130/174 | 10/04→02/07 | OE238 | 1,0 | | | BAEA145E ^[242] →04/06 BAEA143 ^[247] |
| 2.5 523 i | 6 | N52B25A | 140/188 | 01/07→12/10 | OE238 →12/09 | 1,0 | | | BAEA144E |
| 2.5 525 d | 6 | M57D25(256D2) | 120/161 | 03/04→03/07 | | | | | CCU102 |
| 2.5 525 d | 6 | M57D25(256D2) | 130/174 | 03/04→03/07 | | | | | CCU102 |
| 2.5 525 i | 6 | M54B25(256S5) | 141/189 | 06/04→12/10 | OE223 | 1,6 | CET12P | OE188 | BAEA324 →06/09 BAEA143 ^[247] |
| 2.5 525 i | 6 | N52B25A; N52B25B; N52B25BF | 160/215 | 10/04→03/10 | OE238 | 1,0 | | | BAEA145E ^[242] →04/06 BAEA143 ^[247] |





kW/BHP



eon TITAN

IRIDIUM



...BMW



...5 Touring (E61)

| | | | | | | | | | |
|---|---|---|---------|-------------|---|------|---------------|--------------|---|
| 2.5 525 xi 4WD | 6 | N52B25A | 160/215 | 07/05→12/10 | OE238 | 1,0 | | | BAEA145E →04/06 |
| 3.0 525 d, 3.0 525 d 4WD, 3.0 525 xd 4WD | 6 | M57D30(306D3) | 145/194 | 03/07→05/10 | | | | | CCU102 |
| 3.0 525 i, 3.0 525 i 4WD | 6 | N53B30A | 160/215 | 01/07→12/10 | | | | | BAEA144E →08/10 |
| 3.0 525 xi 4WD | 6 | N53B30A | 160/215 | 01/07→12/10 | | | | | BAEA144E →08/08 |
| 3.0 530 d | 6 | M57D30(306D2); M57D30(306D3) | 155/208 | 03/04→05/10 | | | | | CCU102 |
| 3.0 530 d | 6 | M57D30(306D2) | 160/215 | 03/04→09/05 | | | | | CCU102 |
| 3.0 530 d, 3.0 530 d 4WD, 3.0 530 xd 4WD | 6 | M57D30(306D3) | 173/232 | 01/07→05/10 | | | | | CCU102 |
| 3.0 530 d, 3.0 530 xd 4WD | 6 | M57D30(306D3) | 170/228 | 02/05→02/07 | | | | | CCU102 |
| 3.0 530 i | 6 | N52B30A; N52B30B; N52B30BF | 190/255 | 09/04→02/07 | OE238 | 1,0 | | | BAEA145E ^[242] →04/06 BAEA143 ^[247] |
| 3.0 530 i | 6 | N53B30A | 200/268 | 09/06→12/10 | | | | | BAEA143 →08/10 BAEA144E →08/10 |
| 3.0 530 i 4WD | 6 | N53B30A | 200/268 | 09/08→05/10 | | | | | BAEA144E |
| 3.0 530 xi 4WD | 6 | N52B30A | 190/255 | 04/05→02/07 | OE238 | 1,0 | | | BAEA145E |
| 3.0 530 xi 4WD | 6 | N52B30A | 200/268 | 09/06→05/10 | | | | | BAEA144E →08/08 |
| 3.0 535 d | 6 | M57D30(306D4) | 200/268 | 09/04→12/10 | | | | | CCU102 |
| 3.0 535 d | 6 | M57D30(306D5) | 210/282 | 01/07→12/10 | | | | | CCU102 |
| 4.4 545 i | 8 | N62B44A | 245/329 | 06/04→12/10 | OE223 | 1,6 | CET12P | OE188 | BAEA324 →06/09 |
| 4.8 550 i | 8 | N62B48A; N62B48B | 270/362 | 07/05→12/10 | OE216 ^{UPG [278]} | 0,8 | CET12P | OE188 | BAEA143 |
| 5 (F10) | | | | | | | | | |
| 1.6 520 i | 4 | N20B16A | 125/168 | 07/13→10/16 | OE243 | 0,8 | | | |
| 2.0 518 d | 4 | N47D20C | 100/134 | 02/13→06/14 | | | | | CCU106 ^[48] |
| 2.0 518 d | 4 | N47D20C | 105/141 | 02/13→06/14 | | | | | CCU106 ^[48] |
| 2.0 520 d | 4 | N47D20C | 120/161 | 01/09→10/16 | | | | | CCU106 ^[344] |
| 2.0 520 d, 2.0 520 d 4WD | 4 | N47D20C | 100/134 | 01/13→06/14 | | | | | CCU106 |
| 2.0 520 d, 2.0 520 d 4WD | 4 | N47D20C | 135/181 | 03/10→06/14 | | | | | CCU106 |
| 2.0 520 d, 2.0 520 d 4WD | 4 | N47D20C | 147/197 | 01/13→06/14 | | | | | CCU106 |
| 2.0 520 i | 4 | N20B20A | 120/161 | 10/10→10/16 | OE243 | 0,8 | | | BAEA143 |
| 2.0 520 i | 4 | N20B20B | 120/161 | 10/10→10/16 | | | | | BAEA143 |
| 2.0 520 i | 4 | N20B20A; N20B20B | 135/181 | 10/10→10/16 | OE243 | 0,8 | | | BAEA143 |
| 2.0 525 d, 2.0 525 d 4WD | 4 | N47D20D | 155/208 | 01/11→10/16 | | | | | CCU106 |
| 2.0 525 d, 2.0 525 d 4WD | 4 | N47D20D | 160/215 | 01/11→10/16 | | | | | CCU106 |
| 2.0 528 i, 2.0 528 i 4WD | 4 | N20B20A | 180/241 | 10/10→10/16 | OE243 | 0,8 | | | BAEA143 →05/13 |
| 2.5 523 i | 6 | N52B25A; N52B25AF; N52B25B; N52B25BF | 150/201 | 01/09→08/11 | OE238 | 1,0 | | | BAEA143 |
| 3.0 523 i | 6 | N53B30A | 150/201 | 06/09→08/11 | | | | | BAEA144E |
| 3.0 525 d | 6 | N57D30A | 150/201 | 03/10→08/11 | | | | | CCU108 |
| 3.0 528 i | 6 | N53B30A | 190/255 | 01/09→08/11 | | | | | BAEA143 BAEA144E |
| 3.0 530 d | 6 | N57D30A | 180/241 | 01/09→08/11 | CCGP001 [47] [92] [240] [346] | 5.4v | | | CCU108 ^[357] |
| 3.0 530 d | 6 | N57D30A | 190/255 | 01/11→10/16 | CCGP001 →01/12 [47] [92] [240] [346] | 5.4v | | | CCU108 ^[357] |
| 3.0 530 d | 6 | N57D30A | 210/282 | 09/10→10/16 | CCGP001 →01/12 [47] [92] [240] [346] | 5.4v | | | CCU108 ^[357] |

BMW





kW/BHP



eon TITAN

IRIDIUM

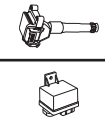

...BMW



...5 (F10)

| | | | | | | | | |
|---------------------------------|---|---------|---------|-------------|---|------|--|-----------------------------|
| 3.0 530 d 4WD | 6 | N57D30A | 190/255 | 03/11→10/16 | CCGP001 →01/12 [47] [92] [240] | 5.4v | | CCU108 [47] [345] |
| 3.0 530 d 4WD | 6 | N57D30A | 210/282 | 09/10→10/16 | CCGP001 →01/12 [47] [92] [240] | 5.4v | | CCU108 [48] |
| 3.0 530 i | 6 | N53B30A | 200/268 | 05/11→06/13 | | | | BAEA144E →02/12 |
| 3.0 535 d | 6 | N57D30B | 220/295 | 03/10→08/11 | CCGP001 [47] [92] [240] [348] | 5.4v | | CCU108 [347] |
| | | | | | CCGP001 [48] [92] [240] | 5.4v | | |
| 3.0 535 d | 6 | N57D30B | 225/302 | 03/10→08/11 | CCGP001 [47] [92] [240] [348] | 5.4v | | CCU108 [347] |
| | | | | | CCGP001 [48] [92] [240] | 5.4v | | |
| 3.0 535 d | 6 | N57D30B | 230/308 | 01/11→10/16 | CCGP001 [47] [92] [240] [348] | 5.4v | | CCU108 [347] |
| | | | | | CCGP001 [48] [92] [240] | 5.4v | | |
| 3.0 535 i | 6 | N55B30A | 225/302 | 01/09→10/16 | OE242 | 0,8 | | BAEA143 →05/13 |
| 3.0 535 i, 3.0 535 i 4WD | 6 | N55B30A | 240/322 | 07/13→10/16 | OE242 | 0,8 | | BAEA143 |
| 3.0 535 i 4WD, 3.0 ActiveHybrid | 6 | N55B30A | 225/302 | 03/10→10/16 | OE242 | 0,8 | | BAEA143 |
| 3.0 ActiveHybrid | 6 | N55B30A | 250/335 | 09/10→08/16 | OE242 | 0,8 | | BAEA143 |
| 3.0 M 550 d 4WD | 6 | N57D30C | 280/375 | 07/11→10/16 | CCGP001 [92] [240] | 5.4v | | |
| 4.4 550 i | 8 | N63B44B | 300/402 | 01/09→06/13 | OE242 | 0,8 | | |
| 4.4 550 i, 4.4 550 i 4WD | 8 | N63B44A | 300/402 | 01/09→06/13 | OE242 | 0,8 | | BAEA143 |
| 4.4 550 i, 4.4 550 i 4WD | 8 | N63B44B | 330/443 | 08/12→10/16 | OE243 | 0,8 | | BAEA143 |
| 4.4 M5 | 8 | S63B44B | 412/552 | 10/10→10/16 | | | | BAEA143 [87] |
| 4.4 M5 Competition | 8 | S63B44B | 423/567 | 02/13→10/16 | | | | BAEA143 |
| 4.4 M5 Edition 30 | 8 | S63B44B | 441/591 | 07/14→10/16 | | | | BAEA143 |

5 Touring (F11)

| | | | | | | | | |
|--------------------------|---|---------|---------|-------------|---|------|--|-----------------------------------|
| 2.0 518 d | 4 | N47D20C | 100/134 | 10/12→ | | | | CCU106 [48] [344] |
| 2.0 518 d | 4 | N47D20C | 105/141 | 10/12→07/14 | | | | CCU106 [48] |
| 2.0 520 d, 2.0 520 d 4WD | 4 | N47D20C | 135/181 | 11/09→10/16 | | | | CCU106 |
| 2.0 520 d, 2.0 520 d 4WD | 4 | N47D20C | 147/197 | 11/09→10/16 | | | | CCU106 |
| 2.0 520 d 4WD | 4 | N47D20C | 100/134 | 07/13→07/14 | | | | CCU106 |
| 2.0 520 i | 4 | N20B20A | 120/161 | 09/11→02/17 | OE243 | 0,8 | | |
| 2.0 520 i | 4 | N20B20A | 135/181 | 10/10→ | OE243 | 0,8 | | BAEA143 |
| 2.0 520 i | 4 | N20B20B | 135/181 | 10/10→ | | | | BAEA143 |
| 2.0 525 d, 2.0 525 d 4WD | 4 | N47D20D | 155/208 | 02/11→ | | | | CCU106 |
| 2.0 525 d, 2.0 525 d 4WD | 4 | N47D20D | 160/215 | 02/11→ | | | | CCU106 |
| 2.0 528 i | 4 | N20B20A | 180/241 | 10/10→ | OE243 | 0,8 | | BAEA143 |
| 2.0 528 i 4WD | 4 | N20B20A | 180/241 | 03/11→ | | | | BAEA143 |
| 2.5 523 i | 6 | N52B25A | 150/201 | 11/09→08/11 | | | | BAEA143 09/10→ |
| 3.0 523 i | 6 | N53B30A | 150/201 | 11/09→08/11 | | | | BAEA144E |
| 3.0 525 d | 6 | N57D30A | 150/201 | 11/09→08/11 | | | | CCU108 |
| 3.0 528 i | 6 | N53B30A | 190/255 | 11/09→08/11 | | | | BAEA143 BAEA144E |
| 3.0 530 d | 6 | N57D30A | 180/241 | 11/09→08/11 | CCGP001 [47] [92] [240] [346] | 5.4v | | CCU108 [357] |
| 3.0 530 d | 6 | N57D30A | 190/255 | 02/11→ | CCGP001 →01/12 [47] [92] [240] [346] | 5.4v | | CCU108 [357] |
| 3.0 530 d | 6 | N57D30A | 210/282 | 09/11→ | CCGP001 →01/12 [47] [92] [240] [346] | 5.4v | | CCU108 [357] |





kW/BHP



eon TITAN

IRIDIUM

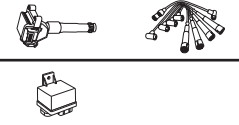

...BMW



...5 Touring (F11)

| | | | | | | | | |
|--------------------------|---|---------|---------|-------------|--------------------------------------|------|--|-------------------------|
| 3.0 530 d 4WD | 6 | N57D30A | 190/255 | 07/10→ | CCGP001 →01/12 [47] [92] [240] | 5.4v | | |
| 3.0 530 d 4WD | 6 | N57D30A | 210/282 | 09/11→ | CCGP001 →01/12 [47] [92] [240] | 5.4v | | CCU108 ^[48] |
| 3.0 530 i | 6 | N53B30A | 200/268 | 07/11→06/13 | | | | BAEA144E →02/12 |
| 3.0 535 d | 6 | N57D30B | 220/295 | 03/10→08/11 | CCGP001 [47] [92] [240] [348] | 5.4v | | CCU108 [47] [347] |
| 3.0 535 d | 6 | N57D30B | 225/302 | 03/10→08/11 | CCGP001 [47] [92] [240] [348] | 5.4v | | CCU108 ^[347] |
| 3.0 535 d | 6 | N57D30B | 230/308 | 03/11→ | CCGP001 [47] [92] [240] [348] | 5.4v | | CCU108 ^[347] |
| 3.0 535 d | 6 | N57D30B | 230/308 | 03/11→ | CCGP001 [48] [92] [240] | 5.4v | | CCU108 ^[347] |
| 3.0 535 i, 3.0 535 i 4WD | 6 | N55B30A | 225/302 | 11/09→ | OE242 | 0,8 | | BAEA143 |
| 3.0 535 i 4WD | 6 | N55B30A | 240/322 | 07/13→ | OE242 | 0,8 | | |
| 3.0 M 550 d 4WD | 6 | N57D30C | 280/375 | 10/10→ | CCGP001 [92] [240] | 5.4v | | |
| 4.4 550 i | 8 | N63B44A | 300/402 | 09/10→06/13 | OE242 | 0,8 | | BAEA143 |
| 4.4 550 i | 8 | N63B44B | 330/443 | 08/12→ | OE243 | 0,8 | | BAEA143 |

5 (G30, F90)

| | | | | | | | | |
|--|---|------------------|---------|--------|--|--|-------|-------------------|
| 2.0 530 e iPerformance | 4 | B48B20B | 135/181 | 03/17→ | | | OE245 | BAEA538 →06/17 |
| 2.0 530 e iPerformance, 2.0 530 i, 2.0 530 i 4WD | 4 | B46B20B; B48B20B | 185/248 | 09/16→ | | | OE245 | BAEA538 →06/17 |
| 3.0 530 d | 6 | B57D30A | 195/261 | 09/16→ | | | | BAEA538 →06/17 |
| 3.0 540 i, 3.0 540 i 4WD | 6 | B58B30A | 250/335 | 09/16→ | | | OE245 | BAEA538 →06/17 |
| 3.0 540 i, 3.0 540 i 4WD | 6 | B58B30A | 265/355 | 09/16→ | | | OE245 | BAEA538 →06/17 |

5 Gran Turismo (F07)

| | | | | | | | | |
|---------------|---|---------|---------|-------------|--|------|--|-------------------------|
| 2.0 520 d | 4 | N47D20C | 100/134 | 10/12→02/17 | | | | CCU106 |
| 2.0 520 d | 4 | N47D20C | 120/161 | 04/11→02/17 | | | | CCU106 |
| 2.0 520 d | 4 | N47D20C | 135/181 | 04/11→02/17 | | | | CCU106 |
| 2.0 528 i | 4 | N20B20A | 180/241 | 07/13→02/17 | OE243 | 0,8 | | BAEA143 |
| 3.0 530 d | 6 | N57D30A | 155/208 | 09/10→06/12 | CCGP001 →01/12 [47] [92] [240] [346] | 5.4v | | CCU108 ^[357] |
| 3.0 530 d | 6 | N57D30A | 180/241 | 08/09→06/12 | CCGP001 →01/12 [47] [92] [240] [346] | 5.4v | | CCU108 ^[357] |
| 3.0 530 d | 6 | N57D30A | 190/255 | 07/12→02/17 | | | | CCU108 ^[357] |
| 3.0 530 d 4WD | 6 | N57D30A | 180/241 | 06/10→06/12 | CCGP001 →01/12 [47] [92] [240] | 5.4v | | CCU108 ^[48] |
| 3.0 530 d 4WD | 6 | N57D30A | 190/255 | 07/12→02/17 | | | | CCU108 ^[48] |
| 3.0 535 d | 6 | N57D30B | 220/295 | 03/10→06/12 | CCGP001 [47] [92] [240] [348] | 5.4v | | CCU108 ^[347] |
| 3.0 535 d | 6 | N57D30B | 220/295 | 03/10→06/12 | CCGP001 [48] [92] [240] | 5.4v | | CCU108 ^[347] |
| 3.0 535 d | 6 | | 225/302 | 05/09→06/12 | CCGP001 [47] [92] [240] [348] | 5.4v | | CCU108 ^[347] |
| 3.0 535 d | 6 | | 225/302 | 05/09→06/12 | CCGP001 [48] [92] [240] | 5.4v | | CCU108 ^[347] |
| 3.0 535 d | 6 | N57D30B | 230/308 | 07/12→02/17 | CCGP001 [47] [92] [240] [348] | 5.4v | | CCU108 ^[347] |
| 3.0 535 d | 6 | N57D30B | 230/308 | 07/12→02/17 | CCGP001 [48] [92] [240] | 5.4v | | CCU108 ^[347] |
| 3.0 535 d 4WD | 6 | N57D30B | 220/295 | 03/10→06/12 | | | | CCU108 ^[347] |
| 3.0 535 d 4WD | 6 | | 225/302 | 05/09→06/12 | | | | CCU108 ^[347] |

BMW





kW/BHP

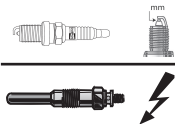

eon TITAN

IRIDIUM



...BMW



...5 Gran Turismo (F07)

| | | | | | | | | | | |
|--------------------------|---|---------|---------|-------------|-------|-----|--|--|--|-------------------------|
| 3.0 535 d 4WD | 6 | N57D30B | 230/308 | 07/12→02/17 | | | | | | CCU108 ^[347] |
| 3.0 535 i, 3.0 535 i 4WD | 6 | N55B30A | 225/302 | 01/09→02/17 | OE242 | 0,8 | | | | BAEA143 |
| 4.4 550 i | 8 | N63B44B | 298/400 | 10/09→06/12 | OE016 | 0,9 | | | | BAEA143 |
| 4.4 550 i 4WD | 8 | N63B44A | 298/400 | 06/10→06/12 | | | | | | BAEA143 |
| 4.4 550 i, 4.4 550 i 4WD | 8 | N63B44A | 300/402 | 08/09→06/12 | OE016 | 0,9 | | | | BAEA143 |
| 4.4 550 i, 4.4 550 i 4WD | 8 | N63B44B | 330/443 | 07/12→02/17 | OE243 | 0,8 | | | | BAEA143 |

6 (E63)

| | | | | | | | | | | |
|------------|---|-------------------|---------|-------------|----------------------------|-----|---------|-------|--|---|
| 3.0 630 i | 6 | N52B30A; N52B30BF | 190/255 | 02/04→07/07 | OE238 | 1,0 | | | | BAEA145E →04/06 BAEA143 04/06→ |
| 3.0 630 i | 6 | N53B30A | 200/268 | 07/07→07/10 | | | | | | BAEA144E |
| 3.0 635 d | 6 | M57D30(306D5) | 210/282 | 07/07→07/10 | | | | | | CCU102 |
| 4.4 645 Ci | 8 | N62B44A | 245/329 | 01/04→08/05 | OE223 | 1,6 | CET1 2P | OE188 | | BAEA324 |
| 4.8 650 i | 8 | N62B48B | 270/362 | 07/05→07/10 | OE216 ^{LPG [278]} | 0,8 | CET1 2P | OE188 | | BAEA143 |

6 Convertible (E64)

| | | | | | | | | | | |
|------------|---|-------------------------------|---------|-------------|----------------------------|-----|---------|-------|--|---|
| 3.0 630 i | 6 | N52B30A; N52B30B; N52B30BF | 190/255 | 03/04→07/07 | OE238 | 1,0 | | | | BAEA145E →04/06 BAEA143 04/06→ |
| 3.0 630 i | 6 | N53B30A | 200/268 | 07/07→07/10 | | | | | | BAEA144E |
| 3.0 635 d | 6 | M57D30(306D5) | 210/282 | 07/07→07/10 | | | | | | CCU102 |
| 4.4 645 Ci | 8 | N62B44A | 245/329 | 04/04→08/05 | OE223 | 1,6 | CET1 2P | OE188 | | BAEA324 |
| 4.8 650 i | 8 | N62B48B | 270/362 | 07/05→07/10 | OE216 ^{LPG [278]} | 0,8 | CET1 2P | OE188 | | BAEA143 |

6 Convertible (F12)

| | | | | | | | | | | |
|--------------------------|---|------------------|---------|-------------|-------------------------------|------|--|--|--|-------------------------|
| 3.0 640 d, 3.0 640 d 4WD | 6 | N57D30B | 230/308 | 09/11→ | CCGP001 ^{[92] [240]} | 5.4v | | | | |
| 3.0 640 i | 6 | N55B30A | 235/315 | 03/11→ | OE242 | 0,8 | | | | BAEA143 →05/13 |
| 3.0 640 i 4WD | 6 | N55B30A | 235/315 | 01/13→ | OE242 | 0,8 | | | | BAEA143 |
| 4.4 650 i | 8 | N63B44A | 298/400 | 09/11→12/12 | OE242 | 0,8 | | | | BAEA143 →06/12 |
| 4.4 650 i | 8 | N63B44A | 300/402 | 03/11→ | OE242 | 0,8 | | | | BAEA143 →06/12 |
| 4.4 650 i 4WD | 8 | N63B44A | 298/400 | 09/11→ | | | | | | BAEA143 |
| 4.4 650 i 4WD | 8 | N63B44A | 300/402 | 06/11→ | OE242 | 0,8 | | | | BAEA143 ^[87] |
| 4.4 650 i, 4.4 650 i 4WD | 8 | N63B44A; N63B44B | 330/443 | 10/11→ | OE243 | 0,8 | | | | |
| 4.4 650 i, 4.4 650 i 4WD | 8 | N63B44A; N63B44B | 330/443 | 10/11→ | OE243 | 0,8 | | | | BAEA143 ^[87] |
| 4.4 M6 | 8 | S63B44B | 412/552 | 01/12→ | | | | | | BAEA143 |
| 4.4 M6 | 8 | S63B44B | 423/567 | 02/14→ | | | | | | BAEA143 |

6 Coupe (F13)

| | | | | | | | | | | |
|--------------------------|---|---------|---------|-------------|-------------------------------|------|--|--|--|-------------------------|
| 3.0 640 d, 3.0 640 d 4WD | 6 | N57D30B | 230/308 | 11/10→ | CCGP001 ^{[92] [240]} | 5.4v | | | | |
| 3.0 640 i, 3.0 640 i 4WD | 6 | N55B30A | 235/315 | 11/10→ | OE242 | 0,8 | | | | BAEA143 |
| 4.4 650 i | 8 | N63B44A | 298/400 | 09/11→12/12 | OE242 | 0,8 | | | | BAEA143 |
| 4.4 650 i | 8 | N63B44A | 300/402 | 11/10→ | OE242 | 0,8 | | | | BAEA143 ^[87] |
| 4.4 650 i 4WD | 8 | N63B44A | 298/400 | 09/11→ | | | | | | BAEA143 |
| 4.4 650 i 4WD | 8 | N63B44A | 300/402 | 06/11→ | OE242 | 0,8 | | | | BAEA143 |
| 4.4 650 i, 4.4 650 i 4WD | 8 | N63B44B | 330/443 | 10/11→ | OE243 | 0,8 | | | | BAEA143 ^[87] |
| 4.4 M6 | 8 | S63B44B | 412/552 | 01/12→ | | | | | | BAEA143 ^[87] |
| 4.4 M6 | 8 | S63B44B | 423/567 | 02/14→ | | | | | | BAEA143 |

6 Gran Coupe (F06)

| | | | | | | | | | | |
|--------------------------|---|---------|---------|--------|-------------------------------|------|--|--|--|-------------------------|
| 3.0 640 d, 3.0 640 d 4WD | 6 | N57D30B | 230/308 | 09/11→ | CCGP001 ^{[92] [240]} | 5.4v | | | | |
| 3.0 640 i, 3.0 640 i 4WD | 6 | N55B30A | 235/315 | 09/11→ | OE242 | 0,8 | | | | BAEA143 |
| 4.4 650 i, 4.4 650 i 4WD | 8 | N63B44B | 330/443 | 11/11→ | OE243 | 0,8 | | | | BAEA143 ^[87] |
| 4.4 M6 | 8 | S63B44B | 412/552 | 12/12→ | | | | | | BAEA143 ^[87] |





kW/BHP



eon TITAN

IRIDIUM

**...BMW****...6 Gran Coupe (F06)**

4.4 M6 8 S63B44B 423/567 02/14 → BAEA143

7 (E38)

2.5 725 tds 6 M51D25(256T1) 105/141 04/96 → 11/01 CH189 11v

2.8 728i 4WD 6 M52B28(286S1) 142/190 11/95 → 09/01 OE223 1,6 CET12P OE188 BAEA302 [83] [242]

2.8 728 i, iL 6 M52B28(286S1); M52B28(286S2) 142/190 08/95 → 11/01 OE026 → 09/98 0,9 CET2 OE188 BAEA302

OE216 LPG [278] → 09/98 0,8

OE223 09/98 → 1,6

3.0 730 d 6 M57D30(306D1) 135/181 08/98 → 04/00 CH203 11v

3.0 730 d 6 M57D30(306D1) 142/190 04/00 → 11/01 CH203 11v

3.0 730 i, iL 8 M60B30(308S1) 155/208 10/94 → 11/01 OE026 → 09/98 0,9 CET12P OE188 BAEA014 → 12/96

OE216 LPG [278] → 09/98 0,8

3.0 730 i, iL 8 M60B30(308S1) 160/215 10/94 → 11/01 OE026 → 09/98 0,9 CET12P OE188 BAEA014 → 12/96

OE216 LPG [278] → 09/98 0,8

3.5 735 i, iL 8 M62B35(358S1) 173/232 01/96 → 12/98 OE026 → 09/98 0,9 CET12P → 05/96 OE188 BAEA302

OE216 LPG [278] → 09/98 0,8

3.9 740 d 8 M67D39(398D1) 180/241 05/99 → 11/01 CH207 11v

4.0 740 i, iL 8 M60B40(408S1) 210/282 10/94 → 11/01 OE026 → 09/98 0,9 CET12P → 08/98 OE188 BAEA014 → 06/96

OE216 LPG [278] → 09/98 0,8

4.4 740 i, iL 8 M62B44(448S1); M62B44(448S2) 210/282 01/96 → 11/01 OE026 → 09/98 0,9 CET12P OE188 BAEA302

OE216 LPG [278] → 09/98 0,8

5.4 750 i, iL 12 M73B54(54121); M73B54(54122) 240/322 09/94 → 11/01 OE223 1,6 CET12P OE184 BAEA302

7 (E65, E66)

3.0 730 i, Li 6 N52B30A 184/247 03/05 → 07/08 OE238 1,0 BAEA145E → 03/06

BAEA143 04/06 →

7 (E65, E66, E67)

3.0 730 d 6 M57D30(306D2); M57D30(306D3) 155/208 10/02 → 07/08 CCU102

3.0 730 d 6 M57D30(306D2) 160/215 06/02 → 02/05 CCU102

3.0 730 i, Li 6 M54B30(306S3) 170/228 03/03 → 07/08 OE223 1,6 CET12P OE188 BAEA143 [247] BAEA324

3.0 730 i, Li 6 N52B30A 190/255 03/05 → 07/08 OE238 1,0 BAEA145E → 04/06

BAEA143 11/07 →

3.0 730 Ld 6 M57D30(306D3) 170/228 07/05 → 08/08 CCU102

3.6 735 i, Li 8 N62B36A 200/268 11/01 → 02/05 OE223 1,6 CET12P OE188 BAEA324

4.0 735 i 8 N62B40A 225/302 03/05 → 12/09 OE120 0,6 CET2 OE188 BAEA143

4.0 740 i, Li 8 N62B40A 225/302 07/05 → 07/08 OE216 LPG [278] 0,8 CET12P OE188 BAEA143 [247]

4.4 745 i, Li 8 N62B44A 245/329 11/01 → 07/08 OE223 1,6 CET12P OE188 BAEA324

4.8 750 i, Li 8 N62B48B 270/362 07/05 → 07/08 OE216 LPG [278] 0,8 CET12P OE188 BAEA143

6.0 760 i, Li 12 N73B60A 327/439 01/03 → 07/08 OE223 1,6 CET12P OE188 BAEA143 [247]

7 (F01, F02, F03, F04)

3.0 730 d 6 N57D30A 180/241 02/08 → 07/12 CCGP001 [48] [92] [240] 5.4v CCU108 [47]

BMW





kW/BHP



eon TITAN

IRIDIUM



...BMW



...7 (F01, F02, F03, F04)

| | | | | | | | | | |
|--|----|-------------------|---------|---------------|----------------------------|------|--|--|-------------------------|
| 3.0 730 d, 3.0 730 d 4WD | 6 | N57D30A | 155/208 | 02/08 → 05/15 | CCGP001 [48] [92] [240] | 5.4v | | | CCU108 ^[47] |
| 3.0 730 d, 3.0 730 d 4WD | 6 | N57D30A | 190/255 | 11/11 → 05/15 | CCGP001 [48] [92] [240] | 5.4v | | | |
| 3.0 730 i, Li | 6 | N52B30A; N52B30BF | 190/255 | 06/08 → 12/15 | OE238 | 1,0 | | | BAEA143 |
| 3.0 740 d, 3.0 740 d 4WD | 6 | N57D30B | 225/302 | 09/09 → 12/15 | CCGP001 [48] [92] [240] | 5.4v | | | CCU108 ^[47] |
| 3.0 740 d, 3.0 740 d 4WD | 6 | N57D30B | 230/308 | 07/12 → 12/15 | CCGP001 [48] [92] [240] | 5.4v | | | |
| 3.0 740 i | 6 | N54B30A | 240/322 | 10/08 → 12/15 | | | | | BAEA143 →06/12 |
| 3.0 740 i, Li, 3.0 740 i, Li 4WD, 3.0 ActiveHybrid | 6 | N55B30A | 235/315 | 05/11 → 12/15 | OE242 | 0,8 | | | BAEA143 |
| 3.0 750 d 4WD | 6 | N57D30C | 280/375 | 07/12 → 12/15 | CCGP001 [92] [240] | 5.4v | | | |
| 3.0 ActiveHybrid | 6 | N55B30A | 260/349 | 05/11 → 05/15 | OE242 | 0,8 | | | BAEA143 |
| 4.4 750 i, 4.4 750 i 4WD | 8 | N63B44A; N63B44B | 300/402 | 10/08 → 12/15 | OE242 | 0,8 | | | BAEA143 →06/12 |
| 4.4 750 i, 4.4 750 i 4WD | 8 | N63B44B | 330/443 | 10/12 → 12/15 | OE243 | 0,8 | | | BAEA143 ^[87] |
| 4.4 ActiveHybrid | 8 | N63B44A | 330/443 | 09/09 → 06/12 | OE242 | 0,8 | | | BAEA143 |
| 4.4 ActiveHybrid | 8 | N63B44B | 339/455 | 09/09 → 06/12 | | | | | BAEA143 |
| 4.4 ActiveHybrid | 8 | N63B44A | 342/459 | 09/09 → 06/12 | OE242 | 0,8 | | | BAEA143 |
| 6.0 760 i | 12 | N74B60A | 400/536 | 09/09 → 12/15 | OE242 | 0,8 | | | BAEA143 |

7 (G11, G12)

| | | | | | | | | | |
|---|---|---------|---------|---------|--|--|-------|--|-------------------|
| 2.0 730 i, Li, 2.0 740 e, Le, 2.0 740 e, Le 4WD | 4 | B48B20B | 190/255 | 02/16 → | | | OE245 | | BAEA538 →06/17 |
| 2.0 740 e, Le, 2.0 740 e, Le 4WD | 4 | B48B20B | 240/322 | 04/16 → | | | OE245 | | BAEA538 →06/17 |
| 3.0 740 i, Li, 3.0 740 i, Li 4WD | 6 | B58B30A | 240/322 | 09/15 → | | | OE245 | | BAEA538 →06/17 |

8 (E31)

| | | | | | | | | | |
|------------|----|---------------|---------|---------------|-------------------------------------|------------|--------|-------|---------|
| 4.0 840 i | 8 | M60B40(408S1) | 210/282 | 02/93 → 02/96 | OE026 OE216 LPG ^[278] | 0,9 0,8 | CET2 | OE188 | BAEA014 |
| 4.4 840 Ci | 8 | M62B44(448S1) | 210/282 | 01/96 → 12/99 | OE026 OE216 LPG ^[278] | 0,9 0,8 | CET2 | OE188 | BAEA302 |
| 5.4 850 Ci | 12 | M73B54(54121) | 240/322 | 09/94 → 12/99 | OE223 | 1,6 | CET12P | OE184 | BAEA302 |

X1 (E84)

| | | | | | | | | | |
|--------------------------------------|---|---------|---------|---------------|---------------------------------------|------|--------|-------|--|
| 1.6 sDrive 16 i | 4 | N20B16A | 105/141 | 03/13 → 06/15 | OE243 | 0,8 | | | BAEA143 |
| 2.0 sDrive 16 d | 4 | N47D20C | 85/114 | 04/12 → 06/15 | | | | | CCU106 ^[344] |
| 2.0 sDrive 18 d, 2.0 xDrive 18 d 4WD | 4 | N47D20C | 100/134 | 03/09 → 06/15 | CCGP001 →02/11 [92] [240] [344] | 5.4v | | | CCU105 ^[343] CCU106 ^[344] |
| 2.0 sDrive 18 d, 2.0 xDrive 18 d 4WD | 4 | N47D20C | 105/141 | 10/09 → 06/15 | CCGP001 →02/11 [92] [240] [344] | 5.4v | | | CCU105 ^[343] CCU106 ^[344] |
| 2.0 sDrive 18 i | 4 | N46B20B | 100/134 | 03/09 → 06/15 | OE216 LPG ^[278] | 0,8 | CET12P | OE188 | BAEA143 |
| 2.0 sDrive 18 i | 4 | N46B20B | 110/148 | 01/10 → 06/15 | OE216 LPG ^[278] | 0,8 | | OE188 | BAEA143 |
| 2.0 sDrive 20 d, 2.0 xDrive 20 d 4WD | 4 | N47D20C | 120/161 | 03/10 → 06/15 | | | | | CCU105 ^[343] CCU106 ^[344] |
| 2.0 sDrive 20 d, 2.0 xDrive 20 d 4WD | 4 | N47D20C | 130/174 | 10/09 → 06/15 | | | | | CCU105 ^[343] CCU106 ^[344] |
| 2.0 sDrive 20 d, 2.0 xDrive 20 d 4WD | 4 | N47D20C | 135/181 | 07/12 → 06/15 | | | | | CCU105 ^[343] CCU106 ^[344] |
| 2.0 sDrive 20 i | 4 | N20B20A | 135/181 | 09/11 → 06/15 | OE243 | 0,8 | | | BAEA143 →05/13 |





kW/BHP



eon TITAN

IRIDIUM



...BMW



...X1 (E84)

| | | | | | | | | |
|---------------------|---|---------|---------|-------------|--------------|-----|--|--------------------------------|
| 2.0 xDrive 20 i 4WD | 4 | N20B20A | 135/181 | 09/11→06/15 | OE243 | 0,8 | | BAEA143 |
| 2.0 xDrive 23 d 4WD | 4 | N47D20D | 150/201 | 10/09→06/15 | | | | CCU105 |
| 2.0 xDrive 25 d 4WD | 4 | N47D20D | 160/215 | 10/09→06/15 | | | | CCU106 ^[344] |
| 2.0 xDrive 28 i 4WD | 4 | N20B20A | 180/241 | 04/11→06/15 | OE243 | 0,8 | | BAEA143 →05/13 |
| 3.0 xDrive 25 i 4WD | 6 | N52B30A | 160/215 | 01/10→06/15 | OE238 | 1,0 | | BAEA143 |
| 3.0 xDrive 28 i 4WD | 6 | N52B30A | 190/255 | 10/09→06/15 | OE238 | 1,0 | | BAEA143 →08/11 |

X1 (F48)

| | | | | | | | | |
|--------------------------------------|---|---------------------------|---------|-------------|--|--|--------------|----------------|
| 1.5 sDrive 18 i | 3 | B38A15A | 100/134 | 11/14→05/17 | | | OE245 | BAEA538 |
| 2.0 sDrive 20 i, 2.0 xDrive 20 i 4WD | 4 | B48A20A; B48A20B | 141/189 | 11/14→ | | | OE245 | BAEA538 |
| 2.0 xDrive 25 i 4WD | 4 | B46A20B; B48A20A; B48A20B | 170/228 | 11/14→ | | | OE245 | BAEA538 |

X2 (F39)

| | | | | | | | | |
|---------------------|---|---------|---------|--------|--|--|--------------|----------------|
| 2.0 sDrive 20 i | 4 | B48A20A | 141/189 | 11/17→ | | | | BAEA538 |
| 2.0 xDrive 28 i 4WD | 4 | B46A20B | 170/228 | 11/17→ | | | OE245 | BAEA538 |

X3 (E83)

| | | | | | | | | |
|--------------------------------|---|------------------|---------|-------------|----------------------------------|-----|---------------|--|
| 2.0 d 4WD | 4 | M47D20(204D4) | 110/148 | 11/03→08/07 | | | | CCU101 |
| 2.0 d 4WD, 2.0 xDrive 20 d 4WD | 4 | N47D20A; N47D20C | 130/174 | 03/07→08/10 | | | | CCU105 |
| 2.0 i 4WD | 4 | N46B20B | 110/148 | 07/05→08/08 | OE216 ^[PG 278] | 0,8 | CET12P | OE188 BAEA143 ^[247] |
| 2.0 xDrive 18 d 4WD | 4 | N47D20C | 100/134 | 04/09→12/11 | | | | CCU105 |
| 2.0 xDrive 18 d 4WD | 4 | N47D20C | 105/141 | 09/08→12/11 | | | | CCU105 |
| 2.0 xDrive 20 d 4WD | 4 | N47D20C | 120/161 | 09/07→08/10 | | | | CCU105 |
| 2.0 xDrive 20 i 4WD | 4 | N46B20B | 110/148 | 09/08→08/11 | | | OE188 | BAEA143 |
| 2.5 i 4WD | 6 | M54B25(256S5) | 141/189 | 01/04→08/06 | OE223 | 1,6 | CET12P | OE188 BAEA143 ^[247] |
| 2.5 i 4WD | 6 | M54256S5; M54B25 | 141/189 | 01/04→08/06 | | | | BAEA324 |
| 2.5 si 4WD | 6 | N52B25A | 155/208 | 07/06→12/08 | OE238 | 1,0 | | BAEA143 09/06→08/08 |
| 2.5 si 4WD | 6 | N52B25A | 160/215 | 09/06→08/08 | OE238 | 1,0 | | BAEA143 |
| 2.5 xDrive 25 i 4WD | 6 | N52B25A | 160/215 | 09/08→12/11 | OE238 | 1,0 | | BAEA143 →08/10 |
| 3.0 d 4WD | 6 | M57D30(306D2) | 150/201 | 01/04→08/05 | | | | CCU102 |
| 3.0 d 4WD, 3.0 xDrive 30 d 4WD | 6 | M57D30(306D3) | 160/215 | 09/05→08/10 | | | | CCU102 |
| 3.0 i 4WD | 6 | M54B30(306S3) | 170/228 | 01/04→08/06 | OE223 | 1,6 | CET12P | OE188 BAEA143 ^[247] |
| 3.0 i 4WD | 6 | M54306S3; M54B30 | 170/228 | 01/04→08/06 | | | | BAEA324 |
| 3.0 sd 4WD | 6 | M57D30(306D5) | 210/282 | 09/06→08/08 | | | | CCU102 |
| 3.0 si 4WD | 6 | N52B30A | 200/268 | 09/06→08/08 | OE238 | 1,0 | | BAEA143 |
| 3.0 xDrive 28 i 4WD | 6 | N52B30A | 171/229 | 09/08→12/10 | | | | BAEA143 |
| 3.0 xDrive 30 d 4WD | 6 | M57D30(306D3) | 155/208 | 09/08→08/10 | | | | CCU102 |
| 3.0 xDrive 30 i 4WD | 6 | N52B30A | 160/215 | 03/06→07/10 | | | | BAEA143 |
| 3.0 xDrive 30 i 4WD | 6 | N52B30A | 200/268 | 09/08→12/11 | OE238 | 1,0 | | BAEA143 →08/10 |

X3 (F25)

| | | | | | | | | |
|--------------------------------------|---|-----------------------------|---------|--------|--------------|-----|--|--------------------------|
| 2.0 sDrive 18 d | 4 | N47D20C | 100/134 | 08/11→ | | | | CCU106 |
| 2.0 sDrive 18 d | 4 | N47D20C | 105/141 | 08/11→ | | | | CCU106 |
| 2.0 sDrive 20 i, 2.0 xDrive 20 i 4WD | 4 | N20B20A | 135/181 | 09/11→ | OE243 | 0,8 | | BAEA143 |
| 2.0 xDrive 20 d 4WD | 4 | N47D20C | 120/161 | 09/10→ | | | | CCU106 |
| 2.0 xDrive 20 d 4WD | 4 | N47D20C | 135/181 | 09/10→ | | | | CCU106 |
| 2.0 xDrive 28 i 4WD | 4 | N20B20A | 180/241 | 08/11→ | OE243 | 0,8 | | BAEA143 →05/13 |
| 3.0 xDrive 28 i 4WD | 6 | N52B30A; N52B30AF; N52B30BF | 190/255 | 04/11→ | OE238 | 1,0 | | BAEA143 →03/12 |

BMW





kW/BHP

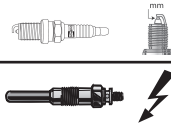

eon TITAN

IRIDIUM



...BMW



...X3 (F25)

| | | | | | | | | | |
|---------------------|---|---------|---------|--------|--------------------------------|------|--|--|-------------------|
| 3.0 xDrive 30 d 4WD | 6 | N57D30A | 190/255 | 05/11→ | CCGP001 →01/12 [92][240] | 5.4v | | | |
| 3.0 xDrive 35 d 4WD | 6 | N57D30B | 230/308 | 09/11→ | CCGP001 [92][240] | 5.4v | | | |
| 3.0 xDrive 35 i 4WD | 6 | N55B30A | 225/302 | 09/10→ | OE242 | 0,8 | | | BAEA143 →05/13 |

X4 (F26)

| | | | | | | | | | |
|---------------------|---|---------|---------|-------------|----------------------|------|--|--|---------|
| 2.0 xDrive 20 i 4WD | 4 | N20B20A | 135/181 | 04/14→03/18 | OE243 | 0,8 | | | BAEA143 |
| 2.0 xDrive 28 i 4WD | 4 | N20B20A | 180/241 | 04/14→03/18 | OE243 | 0,8 | | | BAEA143 |
| 3.0 xDrive 35 d 4WD | 6 | N57D30B | 230/308 | 04/14→03/18 | CCGP001 [92][240] | 5.4v | | | |
| 3.0 xDrive 35 i 4WD | 6 | N55B30A | 225/302 | 04/14→03/18 | | | | | BAEA143 |

X5 (E53)

| | | | | | | | | | |
|------------|---|-----------------|---------|-------------|----------------------------|-----|--------|-------|--|
| 3.0 d 4WD | 6 | M57D30(306D1) | 135/181 | 05/01→12/03 | CH203 | 11v | | | CCU102 ^[336] |
| 3.0 d 4WD | 6 | M57D30(306D2) | 155/208 | 09/03→12/06 | | | | | CCU102 ^[336] |
| 3.0 d 4WD | 6 | M57D30(306D2) | 160/215 | 12/03→12/06 | | | | | CCU102 ^[336] |
| 3.0 i 4WD | 6 | M54B30(306S3) | 170/228 | 05/00→12/06 | OE223 | 1,6 | CET12P | OE188 | BAEA302 →10/02 BAEA143 ^[247] 10/02→ BAEA324 10/02→ |
| 4.4 i 4WD | 8 | M62B44(448S2) | 210/282 | 05/00→12/03 | OE223 | 1,6 | CET12P | OE188 | BAEA302 |
| 4.4 i 4WD | 8 | N62B44; N62B44A | 235/315 | 12/03→09/06 | OE223 | 1,6 | CET12P | OE188 | BAEA324 |
| 4.6 is 4WD | 8 | M62B46(468S1) | 255/342 | 02/02→12/03 | OE223 | 1,6 | CET12P | OE188 | BAEA302 |
| 4.8 is 4WD | 8 | N62B48A | 265/355 | 04/04→09/06 | OE216 ^{LPG [278]} | 0,8 | CET12P | OE188 | BAEA324 |

X5 (E70)

| | | | | | | | | | |
|---------------------|---|---|---------|-------------|----------------------------|------|--------|-------|--|
| 3.0 d 4WD | 6 | M57D30(306D3) | 155/208 | 02/07→09/08 | | | | | CCU102 |
| 3.0 d 4WD | 6 | M57D30(306D3) | 173/232 | 02/07→09/08 | | | | | CCU102 |
| 3.0 M 50 d 4WD | 6 | N57D30C | 280/375 | 08/11→06/13 | CCGP001 [92][240] | 5.4v | | | |
| 3.0 sd 4WD | 6 | M57D30(306D5) | 210/282 | 10/07→03/10 | | | | | CCU102 |
| 3.0 si 4WD | 6 | N52B30A; N52B30AF; N52B30B; N52B30BF | 200/268 | 02/06→09/08 | OE238 | 1,0 | | | BAEA143 11/07→ |
| 3.0 xDrive 30 d 4WD | 6 | M57D30(306D3); N57D30A | 155/208 | 10/08→07/13 | | | | | CCU102 ^[47] CCU108 ^[48] |
| 3.0 xDrive 30 d 4WD | 6 | M57D30(306D3) | 173/232 | 10/08→03/10 | | | | | CCU102 ^[47] CCU108 ^[48] |
| 3.0 xDrive 30 d 4WD | 6 | N57D30A | 180/241 | 04/10→07/13 | | | | | CCU102 ^[47] CCU108 ^[48] |
| 3.0 xDrive 30 i 4WD | 6 | N52B30A | 200/268 | 09/08→03/10 | OE238 | 1,0 | | | BAEA143 |
| 3.0 xDrive 35 d 4WD | 6 | M57D30(306D5) | 210/282 | 09/08→06/13 | | | | | CCU108 |
| 3.0 xDrive 35 i 4WD | 6 | N55B30A | 225/302 | 09/10→06/13 | OE242 | 0,8 | | | BAEA143 →05/13 |
| 3.0 xDrive 35 i 4WD | 6 | N55B30A | 235/315 | 02/12→06/13 | OE242 | 0,8 | | | BAEA143 |
| 3.0 xDrive 40 d 4WD | 6 | N57D30B | 225/302 | 09/10→06/13 | | | | | CCU108 ^[48] |
| 4.4 M 4WD | 8 | S63B44A | 408/547 | 09/09→06/13 | OE242 | 0,8 | | | BAEA143 |
| 4.4 xDrive 50 i 4WD | 8 | N63B44A | 298/400 | 09/09→06/13 | | | | | BAEA143 |
| 4.4 xDrive 50 i 4WD | 8 | N63B44A | 300/402 | 07/09→06/13 | OE242 | 0,8 | | | BAEA143 |
| 4.8 i 4WD | 8 | N62B48B | 261/350 | 02/07→09/08 | OE216 ^{LPG [278]} | 0,8 | CET12P | OE188 | BAEA143 |
| 4.8 xDrive 48 i 4WD | 8 | N62B48B | 261/350 | 09/08→06/13 | OE227 | 0,6 | | | BAEA143 |

X5 (F15, F85)

| | | | | | | | | | |
|--------------------------------------|---|---------|---------|--------|-------|-----|--|--|--------|
| 2.0 sDrive 25 d, 2.0 xDrive 25 d 4WD | 4 | N47D20D | 155/208 | 11/13→ | | | | | CCU106 |
| 2.0 sDrive 25 d, 2.0 xDrive 25 d 4WD | 4 | N47D20D | 160/215 | 11/13→ | | | | | CCU106 |
| 2.0 xDrive 40e 4WD | 4 | N20B20A | 180/241 | 09/15→ | OE243 | 0,8 | | | |

BMW





kW/BHP



eon TITAN

IRIDIUM



...BMW



...X5 (F15, F85)

| | | | | | | | | | |
|---------------------|---|---------|---------|--------|-----------------------|------|--|--|-------------------|
| 3.0 M 50 d 4WD | 6 | N57D30C | 280/375 | 07/13→ | CCGP001 [92] [240] | 5.4v | | | |
| 3.0 xDrive 35 i 4WD | 6 | N55B30A | 225/302 | 11/13→ | OE242 | 0,8 | | | BAEA143 |
| 3.0 xDrive 35 i 4WD | 6 | N55B30A | 240/322 | 11/13→ | OE242 | 0,8 | | | |
| 3.0 xDrive 40 d 4WD | 6 | N57D30B | 230/308 | 12/13→ | CCGP001 [92] [240] | 5.4v | | | |
| 4.4 M 4WD | 8 | S63B44B | 423/567 | 12/14→ | | | | | BAEA143 →01/15 |
| 4.4 xDrive 50 i 4WD | 8 | N63B44B | 330/443 | 07/13→ | OE243 | 0,8 | | | BAEA143 |

X6 (E71, E72)

| | | | | | | | | | |
|---|---|---------------|---------|-------------|-----------------------|------|--|--|------------------------|
| 3.0 M 50 d 4WD | 6 | N57D30C | 280/375 | 08/11→06/14 | CCGP001 [92] [240] | 5.4v | | | |
| 3.0 xDrive 30 d 4WD | 6 | N57D30A | 155/208 | 07/09→06/14 | | | | | CCU108 |
| 3.0 xDrive 30 d 4WD | 6 | M57D30(306D3) | 173/232 | 09/07→06/14 | | | | | CCU108 ^[90] |
| 3.0 xDrive 30 d 4WD | 6 | N57D30A | 180/241 | 04/09→06/14 | | | | | CCU108 |
| 3.0 xDrive 35 d 4WD | 6 | M57D30(306D5) | 210/282 | 06/07→03/10 | | | | | CCU102 |
| 3.0 xDrive 35 i 4WD | 6 | N55B30A | 225/302 | 06/07→06/14 | OE242 | 0,8 | | | |
| 3.0 xDrive 35 i 4WD | 6 | N54B30A | 225/302 | 06/07→06/14 | | | | | BAEA143 |
| 3.0 xDrive 35 i 4WD | 6 | N55B30A | 235/315 | 07/09→06/14 | OE242 | 0,8 | | | BAEA143 |
| 3.0 xDrive 35 i 4WD | 6 | N54B30A | 240/322 | 06/07→03/10 | | | | | BAEA143 |
| 3.0 xDrive 40 d 4WD | 6 | N57D30B | 225/302 | 07/09→06/14 | | | | | CCU108 |
| 4.4 ActiveHybrid 4WD | 8 | N63B44A | 357/479 | 01/09→10/11 | OE242 | 0,8 | | | BAEA143 |
| 4.4 ActiveHybrid 4WD, 4.4 xDrive 50 i 4WD | 8 | N63B44A | 300/402 | 10/07→06/14 | OE242 | 0,8 | | | BAEA143 |
| 4.4 M 4WD | 8 | S63B44A | 408/547 | 07/08→06/14 | OE242 | 0,8 | | | BAEA143 |
| 4.4 xDrive 50 i 4WD | 8 | N63B44A | 298/400 | 10/07→06/14 | | | | | BAEA143 |
| 4.4 xDrive 50 i 4WD | 8 | N63B44A | 330/443 | 10/07→06/14 | OE242 | 0,8 | | | BAEA143 |

X6 (F16, F86)

| | | | | | | | | | |
|---------------------|---|---------|---------|--------|-----------------------|------|--|--|------------------------------------|
| 3.0 M 50 d 4WD | 6 | N57D30C | 280/375 | 08/14→ | CCGP001 [92] [240] | 5.4v | | | |
| 3.0 xDrive 35 i 4WD | 6 | N55B30A | 225/302 | 12/14→ | OE242 | 0,8 | | | BAEA143 |
| 3.0 xDrive 35 i 4WD | 6 | N55B30A | 240/322 | 02/15→ | OE242 | 0,8 | | | BAEA143 |
| 4.4 M 4WD | 8 | S63B44B | 423/567 | 12/14→ | | | | | BAEA143 ^[275] →01/15 |
| 4.4 xDrive 50 i 4WD | 8 | N63B44B | 330/443 | 08/14→ | OE243 | 0,8 | | | BAEA143 11/14→ |

Z3 Coupe (E36)

| | | | | | | | | | |
|-------|---|---------------------------------|---------|-------------|-------|-----|--------|-------|-------------------|
| 2.8 i | 6 | M52B28(286S1) | 142/190 | 07/97→06/00 | OE223 | 1,6 | CET12P | OE188 | BAEA302 |
| 3.0 i | 6 | M54B30(306S3) | 170/228 | 06/00→06/03 | OE223 | 1,6 | CET12P | OE188 | BAEA302 →12/02 |
| 3.2 M | 6 | S50B32(326S1); S50B32(326S3) | 236/316 | 02/98→06/01 | | | CET10P | OE187 | BAEA302 →12/00 |
| 3.2 M | 6 | S54B32(326S4) | 239/320 | 06/01→06/03 | | | CET10P | OE187 | |
| 3.2 M | 6 | S54326S4; S54B32 | 239/320 | 06/01→06/03 | | | | | BAEA324 |

Z3 Roadster (E36)

| | | | | | | | | | | |
|-------|---|---------------|---------|-------------|-------------------------------------|------------|--------|-------|-------------------|--------|
| 1.8 i | 4 | M43B18(184E2) | 85/114 | 10/95→10/98 | OE026 OE216 ^{LPG [278]} | 0,9 0,8 | CET2 | OE188 | BAEA307 | CLS054 |
| 1.9 i | 4 | M43B19(194E1) | 85/114 | 01/99→01/03 | OE223 | 1,6 | CET12P | OE188 | BAEA307 | CLS054 |
| 1.9 i | 4 | M43B19(194E1) | 87/117 | 07/98→01/03 | OE223 09/98→ | 1,6 | CET12P | OE188 | BAEA307 | CLS054 |
| 1.9 i | 4 | M44B19(194S1) | 103/138 | 10/95→03/99 | OE026 OE216 ^{LPG [278]} | 0,9 0,8 | | | BAEA307 | CLS036 |
| 2.0 i | 6 | M52B20(206S4) | 110/148 | 04/99→01/03 | OE223 | 1,6 | CET12P | OE188 | BAEA302 | |
| 2.2 i | 6 | M54B22(226S1) | 125/168 | 08/00→01/03 | OE223 | 1,6 | CET12P | OE188 | BAEA302 →09/02 | |

BMW





kW/BHP

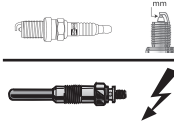

eon TITAN

IRIDIUM

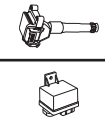

...BMW



...Z3 Roadster (E36)

| | | | | | | | | | |
|-------|---|---------------------------------|---------|-------------|----------------------------------|-----|---------------|--------------|--------------------------|
| 2.8 i | 6 | M52B28(286S1) | 142/190 | 04/97→06/00 | OE026 →09/98 | 0,9 | CET2 | OE188 | BAEA302 |
| | | | | | OE216 LPG [278] →09/98 | 0,8 | | | |
| | | | | | OE223 09/98→ | 1,6 | | | |
| 2.8 i | 6 | M52B28(286S1); M52B28(286S2) | 143/192 | 01/96→07/00 | OE026 | 0,9 | CET2 | | BAEA302 11/96→ |
| 3.0 i | 6 | M54B30(306S3) | 170/228 | 06/00→01/03 | OE223 | 1,6 | CET12P | OE188 | BAEA302 →12/02 |
| 3.2 M | 6 | S50B32(326S1) | 236/316 | 03/97→06/01 | | | CET10P | OE187 | BAEA302 →12/00 |
| 3.2 M | 6 | S54B32(326S4) | 239/320 | 06/01→01/03 | | | CET10P | OE187 | |
| 3.2 M | 6 | S54B32; S54B32(326S4) | 239/320 | 06/01→01/03 | | | | | BAEA324 |

Z4 Coupe (E86)

| | | | | | | | | | |
|--------|---|------------------|---------|-------------|--------------|-----|---------------|--------------|--|
| 3.0 si | 6 | N52B30A | 195/261 | 03/06→01/09 | OE238 | 1,0 | | | BAEA145E →04/06 BAEA143 11/07→08/08 |
| 3.2 M | 6 | S54B32(326S4) | 252/338 | 03/06→01/09 | | | CET10P | OE187 | |
| 3.2 M | 6 | S54326S4; S54B32 | 252/338 | 03/06→01/09 | | | | | BAEA143 [247] BAEA324 |

Z4 Roadster (E85)

| | | | | | | | | | |
|--------|---|-------------------|---------|-------------|------------------------|-----|---------------|--------------|--|
| 2.0 i | 4 | N46B20A | 110/148 | 03/05→02/09 | OE216 LPG [278] | 0,8 | CET12P | OE188 | BAEA143 [247] BAEA324 |
| 2.0 i | 4 | N46B20B | 110/148 | 03/05→02/09 | OE216 LPG [278] | 0,8 | CET12P | OE188 | BAEA143 [247] |
| 2.0 i | 4 | N46B20 | 110/148 | 03/05→02/09 | | | | | BAEA324 |
| 2.2 i | 6 | M54B22(226S1) | 125/168 | 10/03→10/05 | OE223 | 1,6 | CET12P | OE188 | BAEA143 [247] BAEA324 |
| 2.5 i | 6 | N52B25A | 130/174 | 09/05→02/09 | OE238 | 1,0 | | | BAEA145E →04/06 BAEA143 11/07→ |
| 2.5 i | 6 | M54B25(256S5) | 141/189 | 02/03→12/05 | OE223 | 1,6 | CET12P | OE188 | BAEA143 [247] BAEA324 |
| 2.5 si | 6 | N52B25A | 160/215 | 09/05→02/09 | OE238 | 1,0 | | | BAEA145E →04/06 BAEA143 11/07→ |
| 3.0 i | 6 | M54B30(306S3) | 170/228 | 02/03→10/05 | OE223 | 1,6 | CET12P | OE188 | BAEA143 [89] [247] [275] BAEA324 [84] [275] |
| 3.0 si | 6 | N52B30A; N52B30BF | 195/261 | 01/06→12/08 | OE238 | 1,0 | | | BAEA145E →04/06 BAEA143 11/07→08/08 |
| 3.2 M | 6 | S54B32(326S4) | 252/338 | 03/06→02/09 | | | CET10P | OE187 | BAEA143 [247] BAEA324 |

Z4 Roadster (E89)

| | | | | | | | | | |
|------------------|---|---------|---------|--------|--------------|-----|--|--|--------------------------|
| 2.0 sDrive 18 i | 4 | N20B20A | 115/154 | 04/13→ | OE243 | 0,8 | | | BAEA143 →05/13 |
| 2.0 sDrive 20 i | 4 | N20B20A | 135/181 | 09/11→ | OE243 | 0,8 | | | BAEA143 |
| 2.0 sDrive 28 i | 4 | N20B20A | 180/241 | 09/11→ | OE243 | 0,8 | | | BAEA143 →05/13 |
| 2.5 sDrive 23 i | 6 | N52B25A | 150/201 | 05/09→ | OE238 | 1,0 | | | BAEA143 →08/11 |
| 3.0 sDrive 30 i | 6 | N52B30A | 190/255 | 05/09→ | OE238 | 1,0 | | | BAEA143 →08/11 |
| 3.0 sDrive 35 i | 6 | N54B30A | 225/302 | 05/09→ | | | | | BAEA143 |
| 3.0 sDrive 35 is | 6 | N54B30A | 250/335 | 09/10→ | | | | | BAEA143 |



kW/BHP



eon TITAN

IRIDIUM

**...BMW****Z8 Roadster (E52)**

| | | | | | | | | | |
|-----|---|---------------|---------|-------------|-------|-----|--------|-------|---------|
| 4.9 | 8 | S62B50(508S1) | 294/394 | 06/00→06/03 | OE223 | 1,6 | CET12P | OE188 | BAEA302 |
|-----|---|---------------|---------|-------------|-------|-----|--------|-------|---------|

BRISTOL**411**

| | | | | | | | | | |
|--------------|---|-------------|---------|--------|-------|-----|------|--|--|
| 5.9 Series 6 | 8 | LA-360(E59) | 287/385 | 06/10→ | OE042 | 0,9 | CET8 | | |
|--------------|---|-------------|---------|--------|-------|-----|------|--|--|

BYD**F3**

| | | | | | | | | | |
|-----|---|------|-------|-------------|-------|-----|------|-------|--|
| 1.6 | 4 | 4G18 | 74/99 | 09/05→12/10 | OE063 | 1,0 | CET2 | OE180 | |
|-----|---|------|-------|-------------|-------|-----|------|-------|--|

CADILLAC**BLS**

| | | | | | | | | | |
|-----------------|---|--------------------|---------|--------|-------|-----|--------|-------|--|
| 1.9 D | 4 | Z19DTH | 110/148 | 04/06→ | CH224 | 11v | | | |
| 2.0 T | 4 | B207L; LK9; Z20NET | 129/173 | 04/06→ | OE136 | 0,8 | CET12P | OE179 | |
| 2.0 T | 4 | B207R; LK9 | 154/207 | 04/06→ | OE136 | 0,8 | CET12P | OE179 | |
| 2.0 T | 4 | Z20NER | 154/207 | 04/06→ | OE089 | 1,0 | CET2 | OE188 | |
| 2.0 T Flexpower | 4 | Z20LER | 147/197 | 12/07→ | OE089 | 1,0 | CET2 | OE188 | |
| 2.8 T | 6 | B284L; Z28NET | 188/252 | 04/06→ | | | CET14P | OE190 | |

CTS

| | | | | | | | | | |
|-----|---|-----|---------|-------------|--|--|--------|-------|--|
| 2.8 | 6 | LP1 | 155/208 | 01/08→ | | | | | BAEA174E |
| 2.8 | 6 | LP1 | 158/212 | 03/05→09/07 | | | CET14P | OE190 | BAEA174E |
| 3.2 | 6 | LA3 | 160/215 | 03/02→09/07 | | | | | BAEA152E 09/02→08/04 [361] [277] |

| | | | | | | | | | |
|--------------|---|-----|---------|-------------|--|--|--|--|---------------------------------------|
| | | | | | | | | | BAEA153E 09/02→08/04 [42] [277] |
| 3.6 | 6 | LY7 | 189/253 | 03/05→09/07 | | | | | BAEA174E |
| 3.6, 3.6 4WD | 6 | LLT | 199/267 | 01/10→ | | | | | BAEA174E |
| 3.6, 3.6 4WD | 6 | LLT | 229/307 | 01/08→ | | | | | BAEA174E |
| 3.6, 3.6 4WD | 6 | LLT | 237/318 | 09/11→ | | | | | BAEA174E |
| 5.7 V8 | 8 | LS6 | 294/394 | 03/05→09/07 | | | | | BAEA159E |
| 6.2, 6.2 V | 8 | LSA | 415/557 | 01/08→ | | | | | BAEA159E |

ESCALADE

| | | | | | | | | | |
|--|---|---------------|---------|-------------|--|--|--|--|----------|
| 6.0 HYBRID, 6.0 HYBRID 4WD | 8 | LZ1 | 248/333 | 09/10→12/13 | | | | | BAEA159E |
| 6.2, 6.2 4WD, 6.2 Flex, 6.2 Flex 4WD, 6.2 FLEXFUEL, 6.2 FLEXFUEL 4WD | 8 | L9H; L92; L94 | 301/404 | 09/06→ | | | | | BAEA159E |

SRX

| | | | | | | | | | |
|--------------|---|-----|---------|-------------|--|--|--|--|----------|
| 3.6, 3.6 4WD | 6 | LY7 | 190/255 | 01/04→12/08 | | | | | BAEA174E |
|--------------|---|-----|---------|-------------|--|--|--|--|----------|

STS

| | | | | | | | | | |
|--------------|---|-----|---------|-------------|--|--|--|--|----------|
| 3.6 | 6 | LY7 | 189/253 | 05/05→12/07 | | | | | BAEA174E |
| 3.6, 3.6 4WD | 6 | LLT | 229/307 | 10/09→12/12 | | | | | BAEA174E |

CATERHAM**21**

| | | | | | | | | | |
|------------------|---|-------|---------|-------------|-------|-----|------|-------|--|
| 1.6 i Supersport | 4 | 16K4F | 103/138 | 01/96→12/98 | OE005 | 0,9 | CET2 | OE180 | |
|------------------|---|-------|---------|-------------|-------|-----|------|-------|--|

SEVEN

| | | | | | | | | | |
|----------|---|--|---------|--------|--|--|--------|--|--|
| 2.0 R500 | 4 | | 196/263 | 09/04→ | | | CET17P | | |
|----------|---|--|---------|--------|--|--|--------|--|--|

CHENGLONG**FUTURE**

| | | | | | | | | | |
|-----|---|------|--------|--------|-------|-----|------|-------|--|
| 2.0 | 4 | 4G63 | 93/125 | 03/01→ | OE063 | 1,0 | CET2 | OE180 | |
| 2.4 | 4 | 4G64 | 97/130 | 03/01→ | OE063 | 1,0 | CET2 | OE180 | |

CHENGLONG





kW/BHP

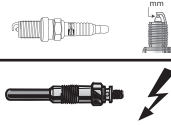

eon TITAN

IRIDIUM

**CHERY****A1**

1.3 4 SQR473F 61/82 04/07→12/14 OE005 0,9 CET2 OE179

A3

1.6 4 SQR481F; SQR481FD 88/118 09/08→12/10 OE005 0,9 CET2 OE179

2.0 4 SQR484F 102/137 04/09→08/10 OE005 0,9 CET2 OE179

A5

1.6 LPG 4 SQR481F 88/118 01/06→01/09 OE005 0,9 CET2 OE179

2.0 4 SQR484F 99/133 01/06→12/12 OE005 0,9 CET2 OE179

COWIN

1.3 4 60/80 09/06→12/10 OE005 0,9 CET2 OE179

1.5 4 SQR477F 80/107 07/08→05/10 OE005 0,9 CET2 OE179

1.6 4 SQR480 65/87 08/03→12/08 OE005 0,9 CET2 OE179

COWIN 2

1.5 4 SQR477F 80/107 05/10→12/14 OE005 0,9 CET2 OE179

COWIN 3

1.5 4 SQR477F 80/107 05/10→12/14 OE005 0,9 CET2 OE179

1.8 4 SQR481FC 97/130 05/10→12/12 OE005 0,9 CET2 OE179

2.0 4 SQR484F 102/137 05/10→12/12 OE005 0,9 CET2 OE179

COWIN 5

1.8 4 SQR481FC 97/130 03/12→12/15 OE005 0,9 CET2 OE179

E5

1.5 4 SQR477F; SQR481G15 80/107 07/11→ OE005 0,9 CET2 OE179

EASTAR CROSS

2.0 4 SQE484F 100/134 06/07→ OE005 0,9 CET2 OE179

FULWIN

1.5 4 SQR477F 80/107 04/06→ OE005 0,9 CET2 OE179

QQ3

0.8 3 SQR372 38/51 03/04→12/12 OE005 0,9 CET2 OE179

1.1 4 F11A; LJ465Q-1ANE1 39/52 06/03→ OE005 0,9 CET2 OE179

1.1 4 SQR472 50/67 06/06→12/10 OE005 0,9 CET2 OE179

QQ6

1.1 4 39/52 09/06→ OE005 0,9 CET2 OE179

TIGGO

1.6 4 SQR481F 80/107 07/06→12/10 OE005 0,9 CET2 OE179

1.6 4 SQR481F 88/118 09/06→12/14 OE005 0,9 CET2 OE179

1.8 4 SQR481FC 97/130 05/07→12/14 OE005 0,9 CET2 OE179

2.0 4 4G63-S4M 92/123 03/05→12/08 OE063 1,0 CET2 OE180

2.0 4 SQR484F 95/127 09/06→12/08 OE005 0,9 CET2 OE179

2.0 4 SQR484F 101/135 01/10→ OE005 0,9 CET2 OE179

2.0, 2.0 4WD 4 SQR484F 102/137 09/06→12/14 OE005 0,9 CET2 OE179

2.4, 2.4 4WD 4 4G64-S4M 95/127 03/05→12/08 OE063 1,0 CET2 OE180

TIGGO 3

1.6 4 SQR481F 80/107 05/07→ OE005 0,9 CET2 OE179

2.0, 2.0 4WD 4 SQR484F 102/137 05/07→12/10 OE005 0,9 CET2 OE179

TIGGO DR

1.8 4 SQR481FC 97/130 12/09→12/13 OE005 0,9 CET2 OE179

V5

2.0 4 SQR484F 99/133 06/06→06/07 OE005 0,9 CET2 OE179

2.4 4 4G64S4M 95/127 06/06→06/07 OE063 1,0 CET2 OE180

X1

1.3 4 SQR473 61/82 01/10→ OE005 0,9 CET2 OE179

CHERY





kW/BHP



eon TITAN

IRIDIUM



CHEVROLET



ALERO

| | | | | | | | | | | |
|-----|---|-----|---------|-------------|-------|-----|------|-------|--|--|
| 2.2 | 4 | L61 | 104/139 | 12/01→09/04 | OE031 | 1,0 | CET7 | OE189 | | |
|-----|---|-----|---------|-------------|-------|-----|------|-------|--|--|

ASTRA

| | | | | | | | | | | |
|----------------------|---|----------|---------|-------------|-------------|-----|------|-------|--|--|
| 2.0, 2.0 GL | 4 | ; C20SEJ | 82/110 | 10/98→07/02 | OE019 | 0,9 | CET2 | OE184 | | |
| 2.0, 2.0 GL | 4 | ; C20NE | 85/114 | 02/96→12/11 | OE019 | 0,9 | CET2 | OE184 | | |
| 2.0, 2.0 GLS | 4 | X20XEV | 94/126 | 03/99→07/02 | OE019 | 0,9 | CET2 | OE184 | | |
| 2.0, 2.0 GLS | 4 | C20SEL | 100/134 | 02/96→12/11 | OE019 | 0,9 | CET2 | OE184 | | |
| 2.0 DTi, 2.0 DTi GLS | 4 | Y20DTH | 74/99 | 08/02→12/11 | CH231 [275] | 11v | | | | |

AVALANCHE

| | | | | | | | | | | |
|-------------------|---|-----|---------|-------------|--|--|--|--|----------|--|
| 5.3 Flex-Fuel | 8 | LY5 | 235/315 | 06/05→07/07 | | | | | BAEA159E | |
| 5.3 Flex-Fuel 4WD | 8 | | 231/310 | 01/07→ | | | | | BAEA159E | |

AVEO

| | | | | | | | | | | |
|-----------|---|-------------------|---------|-------------|-----------------|-----|------|-------|---------------------------|------------------|
| 1.2 | 4 | A12XEL | 51/68 | 03/11→ | OE198 | 0,9 | CET2 | OE184 | BAEA185E | CLS144 |
| 1.2 | 4 | B12S1; F12S3; LY4 | 53/71 | 03/05→ | OE006 | 0,9 | CET8 | OE195 | BAEA447A | CLS085 |
| 1.2 | 4 | B12D1 | 55/74 | 01/08→ | OE199 | 0,9 | CET1 | OE187 | BAEA447A ^[110] | CLS085 |
| | | | | | OE230 LPG [278] | 0,9 | | | BAEA447A | |
| 1.2 | 4 | LMU | 55/74 | 01/08→ | OE199 | 0,9 | CET1 | OE187 | BAEA447A ^[110] | CLS085 |
| | | | | | OE230 LPG [278] | 0,9 | | | | |
| 1.2 | 4 | B12D1; LMU | 62/83 | 01/08→ | OE199 | 0,9 | CET1 | OE187 | BAEA447A ^[110] | CLS085 |
| | | | | | OE230 LPG [278] | 0,9 | | | | |
| 1.2 | 4 | A12XER | 63/84 | 03/11→ | OE198 | 0,9 | CET2 | OE184 | BAEA185E | CLS144 |
| 1.2 LPG | 4 | B12D1; LMU | 62/83 | 04/08→ | OE230 | 0,9 | | | BAEA447A ^[110] | CLS085 |
| 1.2 LPG | 4 | A12XER | 63/84 | 11/12→ | OE198 | 0,9 | CET2 | OE184 | BAEA185E | |
| 1.4 | 4 | F14S3 | 61/82 | 03/05→ | OE006 | 0,9 | CET8 | OE195 | BAEA447A ^[110] | |
| 1.4 | 4 | F14D3; L14 | 69/93 | 03/05→12/07 | OE005 | 0,9 | CET2 | OE179 | BAEA447A ^[110] | CLS086 CLS196 |
| 1.4 | 4 | F14D4 | 74/99 | 04/08→ | OE039 | 1,0 | CET2 | OE179 | BAEA447A | CLS086 |
| | | | | | OE198 | 0,9 | | OE184 | | |
| 1.4 | 4 | LDT | 74/99 | 04/08→ | OE198 | 0,9 | CET2 | OE184 | BAEA447A | CLS086 |
| 1.4 | 4 | A14XER | 74/99 | 04/08→ | OE198 | 0,9 | CET2 | OE184 | BAEA447A | |
| 1.4 Turbo | 4 | LUJ; LUV | 103/138 | 08/13→ | | | | | BAEA185E | |
| 1.5 | 4 | F15S3; LX6 | 62/83 | 05/05→ | OE006 | 0,9 | CET8 | OE195 | BAEA447A | |
| 1.6 | 4 | F16D3; LXV | 76/102 | 05/05→ | OE039 | 1,0 | CET2 | OE179 | | |
| 1.6 | 4 | F16D4 | 85/114 | 03/11→ | OE198 | 0,9 | CET2 | OE184 | BAEA199E | |

AVEO / KALOS

| | | | | | | | | | | |
|---------|---|-------------|--------|-------------|-------|-----|------|-------|---------------------------|--|
| 1.4 | 4 | F14S3 | 61/82 | 03/05→05/08 | OE006 | 0,9 | CET8 | OE195 | BAEA447A ^[110] | CLS020 |
| 1.4 | 4 | F14D3 | 69/93 | 05/03→01/07 | OE005 | 0,9 | CET2 | OE179 | BAEA447A ^[275] | |
| 1.4 16V | 4 | F14D3 | 69/93 | 03/05→05/08 | OE005 | 0,9 | CET2 | OE179 | BAEA447A ^[110] | CLS020 [275] CLS086 [275] CLS196 |
| 1.5 | 4 | F15S3 | 62/83 | 01/05→05/08 | OE006 | 0,9 | CET8 | | BAEA447A | |
| 1.6 | 4 | A16DMS; LXT | 77/103 | 09/03→12/08 | OE039 | 1,0 | CET2 | OE179 | | |

C1500

| | | | | | | | | | | |
|----------|---|-----|---------|-------------|-------------|-----|--|--|--|--|
| 6.5 TDiC | 8 | L56 | 135/181 | 10/96→12/00 | CH189 [275] | 11v | | | | |
|----------|---|-----|---------|-------------|-------------|-----|--|--|--|--|

C3500

| | | | | | | | | | | |
|------------------------|---|-------|---------|-------------|-------------|-----|--|--|--|--|
| 6.5 TDiC, 6.5 TDiC 4WD | 8 | ; L56 | 135/181 | 10/93→09/96 | CH189 [275] | 11v | | | | |
|------------------------|---|-------|---------|-------------|-------------|-----|--|--|--|--|

CAMARO

| | | | | | | | | | | |
|-----|---|-----|---------|--------|--|--|--|--|----------|--|
| 6.2 | 8 | L99 | 298/400 | 09/09→ | | | | | BAEA159E | |
| 6.2 | 8 | LS3 | 318/426 | 09/09→ | | | | | BAEA159E | |

CAPRICE

| | | | | | | | | | | |
|-----|---|-----------|---------|-------------|-------------------|-----|--|--|--|--|
| 5.7 | 8 | LTI(5.7L) | 194/260 | 10/93→09/96 | RV15YC4 →12/93 | 1,0 | | | | |
| 5.7 | 8 | LTI(5.7L) | 207/278 | 10/93→09/96 | RV15YC4 →12/93 | 1,0 | | | | |

CHEVROLET





kW/BHP



eon TITAN

IRIDIUM

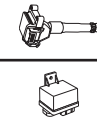
**...CHEVROLET****...CAPRICE**

5.7 LS 8 LT1(5.7L) 183/245 10/93→09/96 RV15YC4 →12/93 1,0

CAPTIVA2.4, 2.4 4WD 4 Z24SED 100/134 06/06→ OE019 0,9 CET2 OE184 BAEA447A^[110]

2.4, 2.4 4WD 4 A24XE; LE5 123/165 03/11→ CET17P OE189

2.4 LPG, 2.4 LPG 4WD 4 Z24SED 100/134 01/07→ BAEA447A^[110]

3.2 4WD 6 10HM 169/227 06/06→ OE029 1,0 CET17P OE189

COBALT

2.2 4 L61 108/145 04/04→ OE031 1,0 CET7 OE189

CORSA

1.4 GLS 4 C14NZ 44/59 08/94→07/97 OE006 0,9 CET8 OE195

CORVETTE

6.0 8 LS2 298/400 09/04→ BAEA159E

6.2 8 LS3 321/430 02/08→ BAEA159E

6.2 ZR1 8 LS9(6, 2L) 476/638 09/08→ BAEA159E

7.0 Z06 8 LS7 371/498 03/06→ BAEA159E

7.0 Z06 8 LS3; LS7 377/506 03/06→ BAEA159E

CRUZE

1.3, 1.3 4WD 4 M13A 61/82 07/00→09/08 OE039 1,0 CET2 OE179

1.4 4 A14XER; LDD 74/99 07/13→ BAEA185E

1.4 4 LUJ 103/138 09/10→ BAEA185E

1.5, 1.5 4WD 4 M15A 73/98 08/03→09/08 CET12P OE179

1.6 4 F16D3; LXV 80/107 05/09→ OE039 1,0 CET2 OE179 BAEA447A^[110] CLS1961.6 4 LXT 80/107 05/09→ OE039 1,0 CET2 OE179 BAEA447A^[110] CLS196
BAEA447A1.6 4 F16D4 83/111 05/09→ OE198 0,9 CET2 OE184 BAEA447A^[110] CLS020

1.6 4 LDE 86/115 12/12→ OE198 0,9 CET2

1.6 4 F16D4; LDE 91/122 05/09→ OE198 0,9 CET2 OE184 BAEA447A

1.8 4 F18D4; LUW; LWE 103/138 11/09→ OE198 0,9 CET2 OE184

1.8 4 2H0; F18D4 104/139 05/09→ OE198 0,9 CET2 OE184 CLS020

1.8 LPG 4 2H0; F18D4 104/139 06/11→ OE198 0,9 CET2 OE184

EPICA2.0 4 C20SED 94/126 01/05→12/06 OE019 0,9 CET2 OE184 BAEA447A^[275]

2.0 4 96/129 08/06→ OE019 0,9 CET2 OE184

2.0 4 T20SED 98/131 01/05→12/06 OE019 0,9 CET2 OE184

2.0 6 X20D1 105/141 06/06→ OE146 1,0 CET12P OE179

2.5 6 LF4 115/154 09/03→ OE146 1,0 CET12P OE179

EVANDA2.0 4 X20SED 96/129 03/05→ OE019 0,9 CET2 OE184 BAEA025E^[275]
BAEA447A**HHR**

2.2 4 L61 108/145 01/06→12/11 OE031 1,0 CET7 OE189

2.4 4 LE5 125/168 10/07→12/11 CET17P OE189

2.4 4 LE5 128/172 01/06→12/11 CET17P OE189

KALOS1.2 4 B12S1 53/71 03/05→ OE049 1,0 CET8 OE195 BAEA447A^[110] CLS085
OE006^{LPG [279]} 0,91.2 4 F12S3 53/71 03/05→ OE006 0,9 CET8 OE195 BAEA447A^[110]1.4 16V 4 F14D3 69/93 03/05→ OE005 0,9 CET2 OE179 BAEA447A^[110] CLS020^[275]
CLS086^[275]
CLS196

1.6 4 L91 77/103 06/06→05/08 OE006 0,9 CET8 OE195

CHEVROLET





kW/BHP

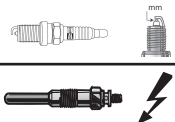

eon TITAN

IRIDIUM



...CHEVROLET



LACETTI

| | | | | | | | | | | |
|---------|---|--------|--------|--------|-------|-----|------|-------|-------------------------------------|--------|
| 1.4 | 4 | F14D3 | 70/94 | 03/05→ | OE005 | 0,9 | CET2 | OE179 | | |
| 1.4 16V | 4 | F14D3 | 70/94 | 03/05→ | OE005 | 0,9 | CET2 | OE179 | BAEA543 | CLS196 |
| 1.6 | 4 | F16D3 | 80/107 | 03/05→ | OE039 | 1,0 | CET2 | OE179 | BAEA543 | CLS196 |
| 1.8 | 4 | F18D3 | 89/119 | 08/05→ | OE026 | 0,9 | CET2 | OE188 | BAEA447A ^[110] | |
| 1.8 | 4 | T18SED | 89/119 | 08/05→ | OE026 | 0,9 | CET2 | | | |
| 1.8 | 4 | T18SED | 90/121 | 05/03→ | OE026 | 0,9 | CET2 | OE188 | BAEA447A ^[110] →02/06 | |
| | | | | | OE077 | 1,0 | | | BAEA508 02/06→ | |

LANOS

| | | | | | | | | | | |
|-----|---|--------|-------|--------|-------|-----|------|-------|----------|--------|
| 1.5 | 4 | A15SMS | 63/84 | 11/05→ | OE006 | 0,9 | CET8 | OE195 | BAEA447A | CLS025 |
|-----|---|--------|-------|--------|-------|-----|------|-------|----------|--------|

LUMINA APV

| | | | | | | | | | | |
|-----|---|-----|---------|-------------|-------|-----|------|-------|--|--|
| 2.3 | 4 | LD2 | 101/135 | 10/93→07/96 | OE039 | 1,0 | CET2 | OE180 | | |
|-----|---|-----|---------|-------------|-------|-----|------|-------|--|--|

MALIBU

| | | | | | | | | | | |
|---------|---|-----|---------|--------|-------|-----|--------|-------|--|--|
| 2.0 | 4 | LTD | 104/139 | 02/12→ | OE019 | 0,9 | CET2 | OE184 | | |
| 2.0 LPG | 4 | LTD | 101/135 | 02/12→ | OE019 | 0,9 | CET2 | OE184 | | |
| 2.4 | 4 | LE9 | 123/165 | 01/12→ | | | CET17P | OE189 | | |
| 2.4 | 4 | LE9 | 125/168 | 01/12→ | | | CET17P | OE189 | | |

MATIZ

| | | | | | | | | | | |
|--------------|---|-------|-------|--------|-----------------|-----|------|-------|---------------------------|--------|
| 0.8, 0.8 LPG | 3 | F8CV | 38/51 | 03/05→ | OE048 | 1,0 | CET8 | OE195 | BAEA539 | |
| 1.0 | 4 | B10S | 47/63 | 03/05→ | OE049 →12/10 | 1,0 | CET8 | OE195 | BAEA447A ^[110] | CLS085 |
| | | | | | OE006 LPG [279] | 0,9 | | | | |
| 1.0 | 4 | LA2 | 48/64 | 01/07→ | OE006 | 0,9 | CET8 | OE195 | | |
| 1.0 | 4 | B10S1 | 49/66 | 03/05→ | OE006 | 0,9 | CET8 | OE195 | BAEA447A ^[110] | CLS085 |
| 1.0 LPG | 4 | B10S1 | 49/66 | 03/05→ | OE230 | 0,9 | | | BAEA447A ^[110] | CLS085 |

NIVA

| | | | | | | | | | | |
|---------|---|-------|--------|-------------|-------|-----|------|-------|---------|--|
| 1.7 4WD | 4 | | 59/79 | 09/02→ | OE006 | 0,9 | CET8 | OE195 | BAEA395 | |
| 1.7 4WD | 4 | | 61/82 | 01/10→ | OE006 | 0,9 | CET8 | OE195 | | |
| 1.8 4WD | 4 | Z18XE | 92/123 | 01/07→12/09 | OE198 | 0,9 | CET2 | OE184 | | |

NUBIRA

| | | | | | | | | | | |
|-----|---|---------|--------|-------------|----------------|------------|------|-------|-------------------------------------|---------|
| 1.4 | 4 | F14D3 | 69/93 | 01/05→12/07 | OE005 OE039 | 0,9 1,0 | CET2 | OE179 | BAEA543 | |
| 1.4 | 4 | F14D3 | 70/94 | 01/06→12/08 | OE005 | 0,9 | CET2 | OE179 | BAEA543 | CLS196 |
| 1.6 | 4 | F16D3 | 80/107 | 03/05→12/11 | OE039 | 1,0 | CET2 | OE179 | BAEA543 | CLS196 |
| 1.8 | 4 | F18D3 | 89/119 | 08/05→12/11 | OE077 OE198 | 1,0 0,9 | CET2 | OE184 | BAEA447A ^[110] | |
| 1.8 | 4 | T18SED | 90/121 | 03/05→12/09 | OE019 OE077 | 0,9 1,0 | CET2 | OE184 | BAEA447A ^[110] →02/06 | BAEA508 |
| 2.0 | 4 | ; F20D2 | 88/118 | 01/05→09/07 | OE019 | 0,9 | CET2 | OE184 | | |

OPTRA

| | | | | | | | | | | |
|--------------|---|--------|--------|-------------|-------|-----|------|-------|---------------------------|--|
| 1.6 | 4 | LXT | 78/105 | 08/03→11/12 | OE039 | 1,0 | CET2 | OE179 | | |
| 1.6 | 4 | F16D3 | 80/107 | 08/03→12/08 | OE039 | 1,0 | CET2 | OE179 | | |
| 1.8, 1.8 SRV | 4 | T18SED | 90/121 | 08/03→ | | | | | BAEA508 | |
| 2.0 | 4 | X20SED | 98/131 | 06/99→07/03 | OE019 | 0,9 | CET2 | OE184 | BAEA447A ^[275] | |

ORLANDO

| | | | | | | | | | | |
|--------------|---|------------|---------|--------|-------|-----|------|-------|----------|--|
| 1.4 | 4 | LUJ | 103/138 | 06/12→ | | | | | BAEA185E | |
| 1.8, 1.8 LPG | 4 | 2HO; F18D4 | 104/139 | 02/11→ | OE198 | 0,9 | CET2 | OE184 | | |
| 2.0 LPG | 4 | LTD | 103/138 | 02/12→ | OE019 | 0,9 | CET2 | OE184 | | |

REZZO

| | | | | | | | | | | |
|-----|---|--------|--------|--------|-------|-----|------|-------|---------------------------|--------|
| 1.6 | 4 | A16DMS | 77/103 | 03/05→ | OE039 | 1,0 | CET2 | OE195 | BAEA447A ^[110] | CLS020 |
| 1.6 | 4 | A16DMS | 79/106 | 08/05→ | | | CET8 | OE195 | BAEA447A ^[110] | CLS020 |



kW/BHP

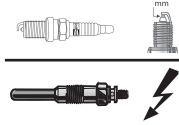

eon TITAN

IRIDIUM

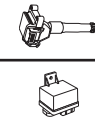

CHEVROLET

| ...CHEVROLET | | | | | | | | | |
|---------------------------|---|------------------|---------|-------------|----------------------------|-----|--------|-------|----------------------------------|
| ...REZZO | | | | | | | | | |
| 2.0 | 4 | T20SED | 89/119 | 03/05→ | OE019 | 0,9 | CET2 | OE184 | BAEA447A ^[110] |
| 2.0 | 4 | T20SED | 90/121 | 08/05→ | OE019 | 0,9 | CET2 | OE184 | BAEA447A ^[110] |
| SILVERADO 1500 | | | | | | | | | |
| 5.3 4WD, 5.3 FlexFuel 4WD | 8 | LH6; LMG | 232/311 | 01/07→ | | | | | BAEA159E |
| SPARK | | | | | | | | | |
| 0.8 | 3 | F8CV | 37/50 | 05/05→ | OE048 | 1,0 | CET8 | OE195 | BAEA539 |
| 0.8 | 3 | F8CV | 38/51 | 09/00→12/04 | OE048 | 1,0 | CET8 | | |
| 1.0 | 4 | B10D1 | 50/67 | 03/10→ | OE199 | 0,9 | CET1 | OE187 | BAEA447A ^[110] CLS144 |
| | | | | | OE230 LPG ^[278] | 0,9 | | | |
| 1.0 LPG | 4 | B10D1 | 50/67 | 03/10→ | OE230 | 0,9 | | | BAEA447A CLS144 |
| 1.0 SX | 4 | LA2 | 44/59 | 06/09→ | OE006 | 0,9 | CET8 | OE195 | |
| 1.0 SX | 4 | B10S; LA2 | 46/62 | 05/05→ | OE006 | 0,9 | CET8 | OE195 | |
| 1.0 SX | 4 | B10S1 | 49/66 | 05/05→ | OE049 | 1,0 | CET8 | OE195 | BAEA447A |
| | | | | | OE006 LPG ^[279] | 0,9 | | | |
| 1.2 | 4 | B12D1; LMU | 60/80 | 03/10→ | OE199 | 0,9 | CET1 | OE187 | BAEA447A ^[110] CLS144 |
| | | | | | OE230 LPG ^[278] | 0,9 | | | |
| 1.2 LPG | 4 | B12D1; LMU | 60/80 | 03/10→ | | | | | BAEA447A CLS144 |
| TAHOE | | | | | | | | | |
| 5.7, 5.7 4WD | 8 | L05 | 147/197 | 10/94→09/95 | RV15YC4 | 1,0 | | | |
| 5.7, 5.7 4WD | 8 | | 184/247 | 10/95→09/96 | RV15YC4 | 1,0 | | | |
| 5.7 V8, 5.7 V8 4WD | 8 | L31 | 190/255 | 10/94→09/96 | RV15YC4 | 1,0 | | | |
| TRAILBLAZER | | | | | | | | | |
| 4.2 4WD | 6 | LL8 | 201/270 | 09/01→09/08 | OE029 | 1,0 | CET17P | OE189 | |
| 6.0 4WD | 8 | LS2 | 295/396 | 08/05→09/08 | | | | | BAEA159E |
| TRAX | | | | | | | | | |
| 1.4, 1.4 4WD | 4 | A14NET; LUJ; LUV | 103/138 | 12/12→ | | | | | BAEA185E |
| 1.6 | 4 | F16D4; LDE | 85/114 | 12/12→ | OE198 | 0,9 | CET2 | OE184 | BAEA198E |
| 1.8, 1.8 4WD | 4 | 2H0; F18D4 | 103/138 | 03/13→ | OE198 | 0,9 | CET2 | | BAEA199E |
| VECTRA | | | | | | | | | |
| 2.0 | 4 | Z0NEJ; C20NE | 81/109 | 03/96→12/05 | OE019 | 0,9 | CET2 | OE184 | |
| 2.0 | 4 | C20SEL | 100/134 | 03/96→04/98 | OE019 | 0,9 | CET2 | OE184 | |
| 2.2 | 4 | Z22SE | 108/145 | 04/02→04/04 | OE255 | 1,0 | CET17P | OE189 | |
| 2.2 | 4 | Z22YH | 114/153 | 01/05→07/06 | OE120 | 0,6 | CET2 | OE188 | |
| 2.8 | 6 | Z28NET | 184/247 | 10/06→ | | | CET14P | OE190 | BAEA174E →08/08 |
| 2.8 | 6 | Z28NET | 188/252 | 11/05→09/06 | | | CET14P | OE190 | BAEA174E |
| VIVA | | | | | | | | | |
| 1.8 | 4 | Z18XE | 90/121 | 09/03→03/08 | OE198 | 0,9 | CET2 | OE184 | |
| VIVANT | | | | | | | | | |
| 1.6 | 4 | A16DMS | 77/103 | 01/05→ | OE039 | 1,0 | CET2 | OE179 | |
| 1.6 | 4 | A16DMS | 78/105 | 08/01→ | OE039 | 1,0 | CET2 | OE179 | |
| 2.0 | 4 | X20SED | 89/119 | 08/00→ | OE019 | 0,9 | CET2 | OE184 | BAEA447A ^[275] |
| 2.0 CX | 4 | T20SED | 89/119 | 01/05→ | OE019 | 0,9 | CET2 | OE184 | |
| VOLT | | | | | | | | | |
| 1.4 EV 150 | 4 | LUU | 111/149 | 11/11→ | | | | | BAEA185E |
| ZAFIRA | | | | | | | | | |
| 2.0 | 4 | C20NE | 85/114 | 04/01→07/04 | OE019 | 0,9 | CET2 | OE184 | |
| 2.0 | 4 | X20XE | 89/119 | 08/04→12/12 | OE019 | 0,9 | CET2 | OE184 | |
| 2.0 | 4 | C20SEL | 100/134 | 04/01→07/12 | OE019 | 0,9 | CET2 | OE184 | |
| 2.2 | 4 | Z22YH | 110/148 | 09/01→ | OE120 | 0,6 | CET2 | OE188 | BAEA149E 09/05→08/06 |





kW/BHP

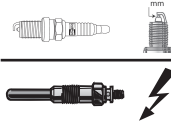

eon TITAN

IRIDIUM



CHEVROLET



ASTRO

4.3 6 LB4 127/170 10/94→09/95 RV15YC4 1,0

EXPRESS

5.3 Flex-Fuel 8 L59 216/290 01/07→ BAEA159E^[96]

G20

5.7 4WD 8 136/182 01/94→09/94 RV15YC4 1,0

CHRYSLER



300 C

2.7 6 EES 130/174 01/07→11/12 BAEA453^[275]

BAEA453^[68]

2.7 6 2.7FX; EER 142/190 09/04→11/12 BAEA453
01/06→

3.5 6 EGG 183/245 09/04→11/12 BAEA453^[275]
08/05→01/08

BAEA432^[277]

3.5, 3.5 4WD 6 EEG; EGG 183/245 09/04→11/12 BAEA453^[275]
01/06→

BAEA432^[277]

300 M

3.5 V6 24V 6 EGG 185/248 08/00→09/04 BAEA432^[277]

3.5 V6 24V 6 EGG 187/251 07/98→08/00 BAEA432^[277]

CIRRUS

2.0 LX 4 ECB 96/129 05/94→09/97 OE005 0,9 CET2 OE180

2.0 LX 4 ECB 98/131 10/97→09/00 OE005 0,9 CET2 OE180

2.5 LX 6 EEB 120/161 10/94→09/00 OE063 1,0 CET2 OE180

CONCORDE

3.5 LX 6 EWZ 174/233 10/97→09/03 BAEA432^[277]

3.5 LX Supercharged 6 EWZ 186/249 10/97→09/03 BAEA432^[277]

CROSSFIRE

3.2 6 EGX 160/215 07/03→12/08 CET12P OE180 BAEA297 CLS064

3.2 SRT-6 6 EGZ 246/330 09/04→12/07 OE191 1,0 CET12P OE180 BAEA297

DELTA

1.4 4 198A4.000 88/118 08/11→ OE208 0,8

1.4 16V 4 198A7.000 103/138 08/11→ OE208 0,8

NEON

1.8 16V 4 EBD 85/114 09/97→08/99 OE002 0,9 CET2 OE180

2.0 16V 4 420H 98/131 05/94→08/99 OE005 0,9 CET2 OE180

2.0 16V 4 ECC 107/143 06/94→08/99 OE005 0,9 CET2 OE180

2.0 16V 4 420T 109/146 04/96→08/99 OE005 0,9 CET2 OE180

NEON II

1.6 4 EJD 85/114 11/01→12/06 OE089 1,0 CET2 OE184

1.8 4 EBD 91/122 01/00→12/01 OE002 0,9 CET2 OE180

2.0 16V 4 ECB 97/130 10/02→12/06 OE005 0,9 CET2 OE180 BAEA380
→12/03

2.0 16V 4 420H; ECB 98/131 08/99→12/06 OE005 0,9 CET2 OE180

2.0 16V R/T 4 ECH 110/148 10/01→12/06 OE005 0,9 CET2 OE180 BAEA380
→12/03

NEW YORKER

3.5 i 24V 6 F01 155/208 04/93→09/98 OE041 0,9 CLS062

PACIFICA

3.5 6 EGN 186/249 08/03→12/06 BAEA432^[277]

3.5 4WD 6 EGN 186/249 08/03→12/06 BAEA432^[275]

BAEA453^[275]

CHRYSLER





kW/BHP



eon TITAN

IRIDIUM



...CHRYSLER



PT CRUISER

| | | | | | | | | | | |
|--------|---|-----|---------|-------------|-------|-----|------|-------|---------|--------|
| 1.6 | 4 | EJD | 85/114 | 11/01→12/10 | OE089 | 1,0 | CET2 | OE184 | | |
| 2.0 | 4 | ECC | 104/139 | 06/00→09/04 | | | | | BAEA380 | CLS241 |
| 2.4 | 4 | EDZ | 105/141 | 03/04→12/10 | | | | | BAEA380 | CLS241 |
| 2.4 | 4 | EDZ | 110/148 | 06/00→12/10 | | | | | BAEA380 | CLS241 |
| 2.4 GT | 4 | EDV | 164/220 | 08/03→12/10 | | | | | BAEA380 | 12/03→ |

SEBRING

| | | | | | | | | | | |
|--------------|---|----------|---------|-------------|-------|-----|------|-------|--------------------------|--------|
| 2.0 | 4 | ECC | 104/139 | 05/95→06/07 | | | | | BAEA380 | CLS241 |
| 2.0 VVT | 4 | ECN | 115/154 | 07/07→12/10 | OE154 | 1,0 | CET2 | OE194 | | |
| 2.4 VVT | 4 | ED3; EDG | 125/168 | 07/07→12/10 | OE154 | 1,0 | CET2 | OE194 | | |
| 2.5 LE | 6 | EEB | 120/161 | 05/95→12/96 | OE063 | 1,0 | CET2 | OE180 | | |
| 2.7, 2.7 VVT | 6 | EER | 137/184 | 07/07→12/10 | | | | | BAEA453 ^[275] | |
| 2.7 VVT | 6 | EER | 141/189 | 09/06→12/10 | | | | | BAEA453 ^[275] | |
| 3.5 4WD | 6 | EGF; EGG | 175/235 | 09/07→12/10 | | | | | BAEA453 ^[275] | |

STRATUS

| | | | | | | | | | | |
|-----------|---|-----------|---------|-------------|-------|-----|--------|-------|---------|--|
| 2.0 16V | 4 | ECB | 98/131 | 12/95→04/01 | OE005 | 0,9 | CET2 | OE180 | | |
| 2.0 LE | 4 | 420X; COO | 96/129 | 12/95→04/01 | OE005 | 0,9 | CET2 | OE180 | BAEA380 | |
| 2.5 V6 | 6 | H00 | 125/168 | 12/95→04/01 | OE063 | 1,0 | CET2 | OE180 | | |
| 2.5 LX | 6 | 625H | 120/161 | 04/96→04/01 | | | CET12P | OE180 | | |
| 2.5 LX V6 | 6 | EEB; H00 | 120/161 | 12/95→04/01 | OE063 | 1,0 | CET2 | OE180 | | |

VIPER

| | | | | | | | | | | |
|-----|----|-----|---------|-------------|-------|-----|--|--|--|--|
| 8.0 | 10 | EPD | 282/378 | 07/98→12/98 | OE041 | 0,9 | | | | |
|-----|----|-----|---------|-------------|-------|-----|--|--|--|--|

VISION

| | | | | | | | | | | |
|---------|---|---------------|---------|-------------|-------|-----|--|--|--|--|
| 3.5 TSi | 6 | EGE; F00; F01 | 155/208 | 09/93→12/97 | OE041 | 0,9 | | | | |
|---------|---|---------------|---------|-------------|-------|-----|--|--|--|--|

VOYAGER / GRAND VOYAGER III

| | | | | | | | | | | |
|--------------|---|-----------------|---------|-------------|-------|-----|------|-------|---------|--------|
| 2.0 i | 4 | COO | 98/131 | 01/95→03/01 | OE002 | 0,9 | CET2 | OE180 | BAEA380 | |
| 2.4 i | 4 | B00 | 111/149 | 01/95→03/01 | | | | | BAEA380 | CLS190 |
| 2.5 TD | 4 | 425CLIRS/X; ENC | 85/114 | 01/95→03/01 | CH181 | 11v | | | | |
| 2.5 TDiC 4WD | 4 | ENC | 85/114 | 10/95→03/01 | CH181 | 11v | | | | |
| 3.0 | 6 | EFA | 112/150 | 01/95→03/01 | OE042 | 0,9 | CET8 | | | |
| 3.3 i | 6 | R00 | 116/156 | 01/95→03/01 | OE105 | 1,3 | | | | CLS062 |
| 3.8 i 4WD | 6 | L00 | 122/164 | 01/95→03/01 | OE105 | 1,3 | | | | CLS062 |
| 3.8 i 4WD | 6 | EGH | 131/176 | 01/95→03/01 | OE105 | 1,3 | | | | CLS062 |

VOYAGER IV

| | | | | | | | | | | |
|--------------|---|----------|---------|-------------|-------|-----|--|--|---------|--------|
| 2.4 | 4 | EDZ | 108/145 | 02/00→12/08 | | | | | BAEA380 | |
| 2.5 CRD | 4 | EDK | 88/118 | 08/05→12/08 | CH180 | 11v | | | | |
| 2.5 CRD | 4 | ENC | 105/141 | 02/00→12/08 | CH180 | 11v | | | | |
| 2.8 CRD | 4 | ENR | 110/148 | 06/04→12/08 | CH180 | 11v | | | | |
| 3.3, 3.3 4WD | 6 | EGA; EGM | 128/172 | 02/00→12/08 | | | | | | CLS193 |
| 3.8, 3.8 4WD | 6 | EGH | 160/215 | 02/00→12/08 | | | | | | CLS193 |

YPSILON

| | | | | | | | | | | |
|-------------|---|-----------|-------|--------|-------|-----|--------|--|--|--|
| 0.9 Twinair | 2 | 312A2.000 | 63/84 | 05/11→ | OE232 | 0,7 | CET15P | | | |
| 1.2 | 4 | 169A4.000 | 51/68 | 05/11→ | OE196 | 1,0 | CET1 | | | |

CITROËN



AX

| | | | | | | | | | | |
|----------|---|----------------------|-------|-------------|-------|-----|--|--|--|--|
| 1.5 15 D | 4 | VJY(TUD5) | 40/54 | 08/94→12/97 | CH185 | 11v | | | | |
| 1.5 15 D | 4 | VJY(TUD5); VJZ(TUD5) | 43/58 | 08/94→12/97 | CH185 | 11v | | | | |

BERLINGO

| | | | | | | | | | | |
|-----|---|--------------|-------|--------|----------------------------|-----|------|-------|----------|--|
| 1.6 | 4 | NFR(TU5JP4B) | 66/89 | 04/08→ | OE035 | 0,9 | CET5 | OE190 | BAEA045E | |
| | | | | | OE224 ^{LPG [279]} | 0,8 | | | | |

CHAMPION

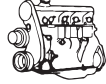

kW/BHP

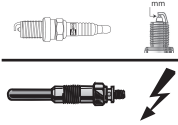

eon TITAN

IRIDIUM



...CITROËN



...BERLINGO

| | | | | | | | | | |
|----------------|---|--------------------------------|--------|-------------|-------------------------------------|------------|--------|-------|----------|
| 1.6 | 4 | NFU(TU5JP4) | 80/107 | 04/08→ | OE035 OE224 ^{IPG [279]} | 0,9 0,8 | CET5 | OE190 | BAEA045E |
| 1.6 HDi 75 16V | 4 | 9HT(DV6BTED4) | 55/74 | 04/08→ | CH201 | 11v | | | |
| 1.6 HDi 90 | 4 | 9HX(DV6ATED4) | 66/89 | 04/08→ | CH201 | 11v | | | |
| 1.6 HDi 90 | 4 | 9HJ(DV6DTEDM); 9HP(DV6DTED) | 68/91 | 07/10→ | CH201 | 11v | | | |
| 1.6 HDi 110 | 4 | 9HZ(DV6TED4) | 80/107 | 04/08→ | CH201 | 11v | | | CCU147 |
| 1.6 VTi 95 | 4 | 5FK(EP6CB) | 72/97 | 07/10→ | OE205 | 0,7 | CET16P | | BAEA143 |
| 1.6 VTi 120 | 4 | 5FS(EP6C) | 88/118 | 11/09→ | OE205 | 0,7 | CET16P | | BAEA143 |
| 1.9 D | 4 | DJY(XUD9A) | 51/68 | 07/96→10/99 | CH189 | 11v | | | |

BERLINGO / BERLINGO FIRST

| | | | | | | | | | | |
|-------------------------|---|-----------------------------|--------|-------------|-------------------------------------|------------|------|-------|--------------------------------------|--------|
| 1.1 i | 4 | HDZ(TU1M) | 44/59 | 07/96→05/08 | OE034 | 0,9 | CET2 | OE179 | | CLS262 |
| 1.1 i | 4 | HFX(TU1JP) | 44/59 | 07/96→05/08 | OE034 | 0,9 | CET2 | OE179 | BAE946A 01/01→08/05 [10] [275] | CLS262 |
| 1.4 | 4 | KFW(TU3JP) | 53/71 | 11/02→10/05 | OE034 | 0,9 | CET2 | OE179 | BAE946A ^[10] | |
| 1.4 bivalent | 4 | KFW(TU3JP) | 48/64 | 11/02→12/11 | OE005 OE034 | 0,9 0,9 | CET2 | OE179 | BAEA048E ^[7] | |
| 1.4 i | 4 | KFW(TU3JP) | 55/74 | 07/96→12/11 | OE034 *to be adjusted | 0,7* | CET2 | OE179 | BAE946A [10] [275] | CLS262 |
| 1.4 i | 4 | KFX(TU3JP) | 55/74 | 07/96→12/11 | OE034 *to be adjusted | 0,7* | CET2 | OE179 | | CLS262 |
| 1.4 i bivalent | 4 | KFW(TU3JP) | 55/74 | 04/03→10/08 | OE034 | 0,9 | CET2 | OE179 | BAE946A ^[10] | |
| 1.6 16V | 4 | NFU(TU5JP4) | 80/107 | 10/00→12/11 | OE035 OE224 ^{IPG [279]} | 0,9 0,8 | CET5 | OE190 | BAEA045E | |
| 1.6 16V | 4 | NFU(TU5JP4) | 81/109 | 11/02→10/08 | OE035 | 0,9 | CET5 | OE190 | BAEA045E | |
| 1.6 HDi 75 | 4 | 9HW(DV6BTED4); DV6B | 55/74 | 07/05→12/11 | CH201 06/06→ | 11v | | | CCU147 | |
| 1.6 HDi 90 | 4 | 9HX(DV6ATED4) | 66/89 | 07/05→05/08 | CH201 03/06→ RP.10689→ | 11v | | | CCU147 | |
| 1.8 D | 4 | A9A(XUD7) | 43/58 | 07/98→10/02 | CH189 | 11v | | | | |
| 1.8 i | 4 | LFX(XU7JB) | 66/89 | 05/97→10/02 | OE034 | 0,9 | CET2 | OE179 | | CLS123 |
| 1.8 i 4WD | 4 | LFX(XU7JB) | 66/89 | 04/97→10/01 | OE034 | 0,9 | CET2 | OE179 | | |
| 1.9 D | 4 | D9B(XUD9A/L); DJY(XUD9A) | 50/67 | 07/96→12/03 | CH189 | 11v | | | | |
| 1.9 D, 1.9 D 4WD | 4 | WJZ(DW8) | 51/68 | 07/98→10/05 | CH185 | 11v | | | | |
| 1.9 D, 1.9 D 4WD | 4 | WJY(DW8B) | 51/68 | 07/98→10/05 | CH185 | 11v | | | CCU149 ^[318] | |
| 2.0 HDi 4WD, 2.0 HDi 90 | 4 | RHY(DW10TD) | 66/89 | 12/99→10/05 | CH170 | 11v | | | CCU149 ^[359] | |

C1

| | | | | | | | | | |
|---------|---|------------|-------|-------------|----------------|------------|------|-------|----------|
| 1.0 | 3 | CFB(1KR) | 50/67 | 06/05→09/14 | OE035 OE178 | 0,9 0,9 | CET5 | OE190 | BAEA164E |
| 1.4 HDi | 4 | 8HT(DV4TD) | 40/54 | 06/05→09/14 | CH201 | 11v | | | CCU147 |

C1 II

| | | | | | | | | | |
|------------|---|----------|-------|--------|--|--|--|--|----------|
| 1.0 VTi 68 | 3 | CFB(1KR) | 51/68 | 04/14→ | | | | | BAEA164E |
|------------|---|----------|-------|--------|--|--|--|--|----------|

C2

| | | | | | | | | | |
|---------|---|------------------------|--------|--------|-------------------------------------|------------|------|-------|-----------------------------------|
| 1.1 | 4 | HFX(TU1JP) | 44/59 | 09/03→ | OE034 | 0,9 | CET2 | OE179 | BAE946A ^[10] |
| 1.4 | 4 | KFV(TU3JP) | 54/72 | 09/03→ | OE034 | 0,9 | CET2 | OE179 | BAE946A ^[10] →02/05 |
| 1.4 | 4 | KFV(TU3JP) | 55/74 | 10/06→ | OE034 | 0,9 | CET2 | OE179 | BAE946A ^[10] |
| 1.4 16V | 4 | KFU(ET3J4) | 65/87 | 06/06→ | OE130 | 0,9 | CET4 | | BAEA472 |
| 1.4 HDi | 4 | 8HX(DV4TD); 8HZ(DV4TD) | 50/67 | 09/03→ | | | | | CCU149 ^[318] |
| 1.6 | 4 | NFU(TU5JP4) | 80/107 | 09/03→ | OE035 OE224 ^{IPG [279]} | 0,9 0,8 | CET5 | OE190 | BAEA045E |
| 1.6 HDi | 4 | 9HZ(DV6TED4) | 80/107 | 09/05→ | CH201 07/07→ | 11v | | | CCU147 |
| 1.6 VTS | 4 | NFS(TU5JP4S) | 90/121 | 01/05→ | OE035 | 0,9 | CET5 | OE190 | BAEA045E |

CITROËN





kW/BHP

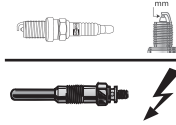

eon TITAN

IRIDIUM



...CITROËN



C3

| | | | | | | | | | | |
|------------|---|-------------|--------|--------|-------------------------------------|------------|------|-------|-----------------------------------|--------|
| 1.4 | 4 | KFV(TU3JP) | 54/72 | 05/03→ | OE034 | 0,9 | CET2 | OE179 | BAE946A ^[10] →10/12 | |
| 1.4 HDi | 4 | 8HX(DV4TD) | 50/67 | 04/04→ | CH201 RP.10221→ | 11v | | | CCU147 | |
| 1.4 Hybrid | 4 | KFV(TU3JP) | 54/72 | 05/05→ | OE034 | 0,9 | CET2 | OE179 | BAE946A ^[10] | |
| 1.6 | 4 | NFU(TU5JP4) | 80/107 | 05/03→ | OE035 OE224 LPG ^[279] | 0,9 0,8 | CET5 | OE190 | BAEA045E | CLS124 |

C3 I

| | | | | | | | | | | |
|----------------|---|------------------------|--------|-------------|-------------------------------------|------------|------|-------|--|--------|
| 1.1 i | 4 | HFX(TU1A); HFX(TU1JP) | 44/59 | 02/02→ | OE034 | 0,9 | CET2 | OE179 | BAE946A ^[10] →10/05 BAEA048E ^[7] 11/05→ | CLS124 |
| 1.4 16V | 4 | KFU(ET3J4) | 65/87 | 12/03→ | OE130 | 0,9 | CET4 | | BAEA472 | |
| 1.4 16V HDi | 4 | 8HY(DV4TED4) | 66/89 | 02/02→ | | | | | CCU149 ^[318] | |
| 1.4 Bioflex | 4 | KFV(TU3JP) | 60/80 | 01/09→ | OE034 | 0,9 | CET2 | OE179 | BAE946A ^[10] →07/12 | |
| 1.4 HDi | 4 | 8HX(DV4TD); 8HZ(DV4TD) | 50/67 | 02/02→ | CH201 RP.10227→ | 11v | | | CCU149 ^[318] | |
| 1.4 HDi | 4 | 8HZ(DV4TD) | 52/70 | 07/03→02/11 | CH201 | 11v | | | | |
| 1.4 HDi | 4 | 8HX(DV4TD) | 55/74 | 05/05→ | CH201 | 11v | | | CCU147 | |
| 1.4 i | 4 | KFV(TU3A); KFV(TU3JP) | 54/72 | 02/02→ | OE034 | 0,9 | CET2 | OE179 | BAE946A ^[10] →10/05 BAEA048E ^[7] 11/05→ | |
| 1.4 i Bivalent | 4 | KFV(TU3JP) | 54/72 | 02/02→ | OE034 | 0,9 | CET2 | OE179 | BAE946A ^[10] | CLS124 |
| 1.6 16V | 4 | NFU(TU5JP4) | 80/107 | 02/02→ | OE035 OE224 LPG ^[279] | 0,9 0,8 | CET5 | OE190 | BAEA045E | CLS124 |
| 1.6 16V | 4 | NFU(TU5JP4) | 81/109 | 05/03→09/05 | OE035 | 0,9 | CET5 | | BAEA045E | |
| 1.6 16V HDi | 4 | 9HX(DV6ATED4) | 66/89 | 10/05→ | CH201 RP.10784→ | 11v | | | | |
| 1.6 16V HDi | 4 | 9HZ(DV6TED4) | 80/107 | 09/05→ | CH201 RP.10784→ | 11v | | | CCU147 | |
| 1.6 Bioflex | 4 | NFU(TU5JP4) | 83/111 | 06/05→ | | | | | BAEA045E | |

C3 II

| | | | | | | | | | | |
|---------------------|---|----------------------|--------|--------|-------|-----|--------|-------|-------------------------|--|
| 1.0 VTi 68 | 3 | ZMZ(EB0) | 50/67 | 08/12→ | | | | OE263 | | |
| 1.1 | 4 | HFX(TU1JP) | 44/59 | 11/09→ | OE034 | 0,9 | CET2 | OE179 | BAEA048E ^[7] | |
| 1.1 BiFuel | 4 | HFX(TU1A) | 44/59 | 11/10→ | OE034 | 0,9 | CET2 | OE179 | | |
| 1.2 THP 110 | 3 | HNZ(EB2DT) | 81/109 | 10/14→ | | | | | BAEA557 | |
| 1.2 VTi 82 | 3 | HMZ(EB2F) | 60/80 | 06/12→ | | | | OE263 | | |
| 1.4 | 4 | KFT(TU3A); KFV(TU3A) | 54/72 | 11/09→ | OE034 | 0,9 | CET2 | OE179 | BAEA048E ^[7] | |
| 1.4 HDi 70 | 4 | 8HR(DV4C) | 50/67 | 11/09→ | CH201 | 11v | | | | |
| 1.4 HDi 70 | 4 | 8HZ(DV4TD) | 50/67 | 11/09→ | CH201 | 11v | | | CCU147 | |
| 1.4 LPG, 1.4 VTi 95 | 4 | 8FN(EP3); 8FP(EP3) | 70/94 | 11/09→ | OE203 | 1,0 | | | BAEA143 | |
| 1.4 VTi | 4 | 8FR(EP3) | 72/97 | 11/09→ | | | | | BAEA143 | |
| 1.6 HDi 90 | 4 | 9HX(DV6ATED4) | 66/89 | 11/09→ | CH201 | 11v | | | | |
| 1.6 VTi 120 | 4 | 5FS(EP6C) | 88/118 | 11/09→ | OE205 | 0,7 | CET16P | | BAEA143 | |

C3 Picasso

| | | | | | | | | | | |
|----------------------------|---|---------------------------------|--------|--------|-------|-----|--------|--|---------|--|
| 1.2 THP 110 | 3 | HNZ(EB2DT) | 81/109 | 01/15→ | | | | | BAEA557 | |
| 1.4 VTi 95, 1.4 VTi 95 LPG | 4 | 8FN(EP3); 8FP(EP3); 8FS(EP3) | 70/94 | 02/09→ | OE203 | 1,0 | | | BAEA143 | |
| 1.6 HDi | 4 | 9HX(DV6ATED4) | 66/89 | 02/09→ | CH201 | 11v | | | | |
| 1.6 HDi | 4 | 9HZ(DV6TED4) | 80/107 | 02/09→ | CH201 | 11v | | | CCU147 | |
| 1.6 VTi 120 | 4 | 5FS(EP6C); 5FW(EP6) | 88/118 | 02/09→ | OE205 | 0,7 | CET16P | | BAEA143 | |

C4

| | | | | | | | | | | |
|---------|---|-------------|--------|-------------|-------------------------------------|------------|------|-------|----------|--|
| 1.4 16V | 4 | KFU(ET3J4) | 65/87 | 11/04→07/11 | OE130 | 0,9 | CET4 | | BAEA472 | |
| 1.6 16V | 4 | NFU(TU5JP4) | 80/107 | 11/04→07/11 | OE035 OE224 LPG ^[279] | 0,9 0,8 | CET5 | OE190 | BAEA045E | |





kW/BHP

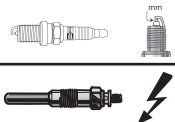

eon TITAN

IRIDIUM

**...CITROËN****...C4**

| | | | | | | | | |
|-------------|---|-------------------------------|---------|-------------|--------------------|-----|--------|-------------------|
| 1.6 HDi | 4 | 9HX(DV6ATED4) | 66/89 | 11/04→07/11 | CH201 RP.10784→ | 11v | | |
| 1.6 HDi | 4 | 9HY(DV6TED4); 9HZ(DV6TED4) | 80/107 | 11/04→07/11 | CH201 →RP.10784 | 11v | | CCU147 |
| | | | | | CH201 RP.10784→ | 11v | | |
| 1.6 THP 150 | 4 | 5FX(EP6DT) | 110/148 | 07/08→07/11 | OE205 | 0,7 | CET16P | BAEA143 |
| 1.6 VTi 120 | 4 | 5FW(EP6) | 88/118 | 07/08→07/11 | OE205 | 0,7 | CET16P | BAEA143 →07/10 |
| 2.0 16V | 4 | RFN(EW10J4) | 100/134 | 11/04→07/07 | OE178 | 0,9 | CET5 | BAEA348 |
| 2.0 16V | 4 | RFJ(EW10A) | 103/138 | 07/06→ | OE178 | 0,9 | CET5 | BAEA352 |
| 2.0 16V | 4 | RFK(EW10J4S) | 130/174 | 11/04→12/10 | OE178 | 0,9 | CET5 | BAEA351 |
| | | | | | OE224 UPG [279] | 0,8 | | |
| 2.0 HDi | 4 | RHR(DW10BTD4) | 100/134 | 11/04→12/10 | CH268 | 11v | | CCU147 |
| 2.0 HDi | 4 | RHF(DW10BTD4) | 103/138 | 06/07→07/11 | CH268 | 11v | | CCU147 |

C4 AIRCROSS

| | | | | | | | | | |
|-----|---|------|--------|--------|--|--|--------|-------|---------|
| 1.6 | 4 | 4A92 | 86/115 | 04/12→ | | | CET14P | OE190 | BAEA547 |
|-----|---|------|--------|--------|--|--|--------|-------|---------|

C4 CACTUS

| | | | | | | | | | |
|-------------|---|------------|--------|--------|--|--|--|--|---------|
| 1.2 THP 110 | 3 | HNZ(EB2DT) | 81/109 | 09/14→ | | | | | BAEA557 |
|-------------|---|------------|--------|--------|--|--|--|--|---------|

C4 Grand Picasso I

| | | | | | | | | |
|-------------|---|-------------------------------|---------|--------|-------|-----|--------|---------|
| 1.6 16V | 4 | 5FT(EP6DT) | 103/138 | 07/08→ | OE205 | 0,7 | CET16P | BAEA143 |
| 1.6 16V | 4 | 5FX(EP6DT) | 110/148 | 10/08→ | OE205 | 0,7 | CET16P | BAEA143 |
| 1.6 HDi | 4 | 9HY(DV6TED4); 9HZ(DV6TED4) | 80/107 | 10/06→ | CH201 | 11v | | CCU147 |
| 1.6 THP 155 | 4 | 5FV(EP6CDT) | 115/154 | 09/10→ | OE205 | 0,7 | CET16P | BAEA143 |
| 1.6 VTi 120 | 4 | 5FW(EP6) | 88/118 | 07/08→ | OE205 | 0,7 | CET16P | BAEA143 |
| 1.8 i 16V | 4 | 6FY(EW7A) | 92/123 | 10/06→ | OE178 | 0,9 | CET5 | BAEA352 |
| 2.0 HDi 138 | 4 | RHR(DW10BTD4) | 100/134 | 10/06→ | CH170 | 11v | | CCU147 |
| 2.0 HDi 138 | 4 | RHJ(DW10BTD4) | 100/134 | 10/06→ | | | | CCU147 |
| 2.0 i 16V | 4 | RFJ(EW10A) | 103/138 | 10/06→ | OE178 | 0,9 | CET5 | BAEA352 |
| 2.0 i 16V | 4 | RFJ(EW10A) | 105/141 | 01/10→ | OE178 | 0,9 | CET5 | |

C4 Grand Picasso II

| | | | | | | | | | |
|-------------|---|-------------|---------|--------|-------|-----|--------|--|---------|
| 1.2 THP 130 | 3 | HNY(EB2DTS) | 96/129 | 04/14→ | | | | | BAEA557 |
| 1.6 THP 155 | 4 | 5FV(EP6CDT) | 115/154 | 09/13→ | OE205 | 0,7 | CET16P | | |
| 1.6 VTi 120 | 4 | 5FS(EP6C) | 88/118 | 09/13→ | OE205 | 0,7 | CET16P | | BAEA143 |

C4 I

| | | | | | | | | | |
|---------------------------|---|-------------------------------|---------|-------------|--------------------|-----|--------|-------|-------------------|
| 1.4 16V | 4 | KFU(ET3J4) | 65/87 | 11/04→07/11 | OE130 | 0,9 | CET4 | | BAEA472 |
| 1.6 16V, 1.6 16V Bio-Flex | 4 | NFU(TU5JP4) | 80/107 | 11/04→07/11 | OE035 | 0,9 | CET5 | OE190 | BAEA045E |
| | | | | | OE224 UPG [279] | 0,8 | | | |
| 1.6 Flex | 4 | | 81/109 | 02/09→07/11 | OE035 | 0,9 | CET5 | | BAEA045E |
| 1.6 HDi | 4 | 9HX(DV6ATED4) | 66/89 | 11/04→07/11 | CH201 RP.10784→ | 11v | | | CCU147 |
| 1.6 HDi | 4 | 9HY(DV6TED4); 9HZ(DV6TED4) | 80/107 | 11/04→07/11 | CH201 RP.10784→ | 11v | | | CCU147 |
| 1.6 THP 140 | 4 | 5FT(EP6DT) | 103/138 | 07/08→07/11 | OE205 | 0,7 | CET16P | | BAEA143 |
| 1.6 THP 150 | 4 | 5FX(EP6DT) | 110/148 | 07/08→07/11 | OE205 | 0,7 | CET16P | | BAEA143 |
| 1.6 VTi 120 | 4 | 5FW(EP6) | 88/118 | 07/08→07/11 | OE205 | 0,7 | CET16P | | BAEA143 →09/10 |
| 2.0 16V | 4 | RFN(EW10J4) | 100/134 | 11/04→07/07 | OE178 | 0,9 | CET5 | | BAEA348 |
| 2.0 16V | 4 | RFJ(EW10A) | 103/138 | 11/04→07/11 | OE178 | 0,9 | CET5 | | BAEA352 |
| 2.0 16V | 4 | RFK(EW10J4S) | 130/174 | 11/04→07/08 | OE178 | 0,9 | CET5 | | BAEA351 |
| | | | | | OE224 UPG [279] | 0,8 | | | |
| 2.0 HDi | 4 | RHR(DW10BTD4) | 100/134 | 11/04→07/11 | CH268 | 11v | | | CCU147 |
| 2.0 HDi | 4 | RHF(DW10BTD4) | 103/138 | 07/08→07/11 | CH268 | 11v | | | CCU147 |

CITROËN





kW/BHP



eon TITAN

IRIDIUM



...CITROËN



C4 II

| | | | | | | | | | |
|-----------------|---|-------------|---------|--------|-------|-----|--------|--|-------------------|
| 1.2 THP 130 | 3 | HNY(EB2DTS) | 96/129 | 04/14→ | | | | | BAEA557 |
| 1.4 VTi 95 | 4 | 8FP(EP3) | 70/94 | 11/09→ | OE203 | 1,0 | | | BAEA143 |
| 1.6 THP 155 | 4 | 5FV(EP6CDT) | 115/154 | 11/09→ | OE205 | 0,7 | CET16P | | BAEA143 |
| 1.6 VTi 120 | 4 | 5FS(EP6C) | 88/118 | 11/09→ | OE205 | 0,7 | CET16P | | BAEA143 09/10→ |
| 1.6 VTi 120 LPG | 4 | 5FS(EP6C) | 88/118 | 09/11→ | OE205 | 0,7 | CET16P | | BAEA143 |

C4 Picasso I

| | | | | | | | | | |
|-------------|---|-----------------------------------|---------|-------------|-------|-----|--------|--|---------|
| 1.6 16V | 4 | 5FX(EP6DT) | 110/148 | 07/08→08/13 | OE205 | 0,7 | CET16P | | BAEA143 |
| 1.6 HDi | 4 | 9HY(DV6TED4); 9HZ(DV6TED4) | 80/107 | 02/07→08/13 | CH201 | 11v | | | CCU147 |
| 1.6 THP 140 | 4 | 5FT(EP6DT) | 103/138 | 07/08→08/13 | OE205 | 0,7 | CET16P | | BAEA143 |
| 1.6 THP 155 | 4 | 5FV(EP6CDT) | 115/154 | 09/10→08/13 | OE205 | 0,7 | CET16P | | BAEA143 |
| 1.6 VTi 120 | 4 | 5FW(EP6) | 88/118 | 07/08→08/13 | OE205 | 0,7 | CET16P | | BAEA143 |
| 1.8 i 16V | 4 | 6FY(EW7A) | 92/123 | 02/07→12/11 | OE178 | 0,9 | CET5 | | BAEA352 |
| 2.0 HDi 138 | 4 | RHJ(DW10BTED4); RHR(DW10BTED4) | 100/134 | 10/06→08/13 | CH268 | 11v | | | CCU147 |
| 2.0 i 16V | 4 | RFJ(EW10A) | 103/138 | 02/07→08/13 | OE178 | 0,9 | CET5 | | BAEA352 |

C4 Picasso II

| | | | | | | | | | |
|-------------|---|-------------|---------|--------|-------|-----|--------|--|---------|
| 1.2 THP 130 | 3 | HNY(EB2DTS) | 96/129 | 04/14→ | | | | | BAEA557 |
| 1.6 THP 155 | 4 | 5FV(EP6CDT) | 115/154 | 02/13→ | OE205 | 0,7 | CET16P | | |
| 1.6 VTi 120 | 4 | 5FS(EP6C) | 88/118 | 02/13→ | OE205 | 0,7 | CET16P | | |
| 1.6 VTi 120 | 4 | 5FS(EP6C) | 88/118 | 02/13→ | | | | | BAEA143 |

C5 I

| | | | | | | | | | |
|--------------|---|---------------------------------|---------|-------------|---|------------|--------|-------|--------------------------------------|
| 1.8 16V | 4 | 6FZ(EW7J4) | 85/114 | 03/01→08/04 | OE178 | 0,9 | CET5 | | BAEA348 |
| 2.0 16V | 4 | RFN(EW10J4) | 100/134 | 03/01→08/04 | OE178 | 0,9 | CET5 | | BAEA348 |
| 2.0 16V HPI | 4 | RLZ(EW10D) | 103/138 | 03/01→08/04 | | | | | BAEA348 |
| 2.0 HDi | 4 | RHY(DW10TD) | 66/89 | 03/01→08/04 | CH170 | 11v | | | CCU149 ^[359] →RP.09701 |
| 2.0 HDi | 4 | RHS(DW10ATED); RHZ(DW10ATED) | 79/106 | 03/01→08/04 | CH170 | 11v | | | CCU149 ^[359] →RP.09820 |
| 2.0 HDi | 4 | RHZ(DW10ATED) | 80/107 | 03/01→08/04 | CH170 | 11v | | | CCU149 ^[359] →RP.09820 |
| 2.2 HDi | 4 | 4HX(DW12TED4/FAP) | 98/131 | 03/01→08/04 | CH170 ^[134] CH268 ^[136] [252] | 11v 11v | | | CCU149 ^[359] |
| 3.0 Carlsson | 6 | XFX(ES9J4S) | 173/232 | 09/03→08/04 | OE175 | 1,0 | CET14P | OE190 | BAEA347 |
| 3.0 V6 | 6 | XFX(ES9J4S) | 152/204 | 03/01→08/04 | OE175 | 1,0 | CET14P | OE190 | BAEA347 |

C5 II

| | | | | | | | | | |
|---------|---|-----------------------------------|---------|--------|--|------------|--------|-------|---------|
| 1.6 HDi | 4 | 9HY(DV6TED4); 9HZ(DV6TED4) | 80/107 | 09/04→ | CH201 RP.10784→ | 11v | | | CCU147 |
| 1.8 16V | 4 | 6FZ(EW7J4) | 85/114 | 09/04→ | OE178 | 0,9 | CET5 | | BAEA348 |
| 1.8 16V | 4 | 6FY(EW7A) | 92/123 | 09/05→ | OE178 | 0,9 | CET5 | | |
| 2.0 16V | 4 | RFJ(EW10A) | 103/138 | 09/04→ | OE178 | 0,9 | CET5 | | BAEA352 |
| 2.0 HDi | 4 | RHR(DW10BTED4) | 100/134 | 09/04→ | CH268 | 11v | | | CCU147 |
| 2.2 HDi | 4 | 4HX(DW12TED4/FAP) | 98/131 | 09/04→ | CH170 ^[134] CH268 ^[136] | 11v 11v | | | CCU147 |
| 2.2 HDi | 4 | 4HP(DW12BTED4); 4HR(DW12BTED4) | 120/161 | 05/06→ | | | | | CCU147 |
| 2.2 HDi | 4 | 4HT(DW12BTED4) | 125/168 | 04/06→ | | | | | CCU147 |
| 3.0 | 6 | XFX(ES9J4S) | 173/232 | 09/04→ | OE175 | 1,0 | CET14P | OE190 | BAEA347 |
| 3.0 V6 | 6 | XFU(ES9A); XFX(ES9J4S) | 152/204 | 09/04→ | OE175 | 1,0 | CET14P | OE190 | BAEA347 |

C5 III

| | | | | | | | | | |
|--------------------------|---|--------------|---------|--------|-------|-----|--------|--|---------|
| 1.6 HDi 110 | 4 | 9HZ(DV6TED4) | 80/107 | 02/08→ | CH201 | 11v | | | CCU147 |
| 1.6 THP 150 | 4 | 5FN(EP6CDT) | 110/148 | 04/09→ | OE205 | 0,7 | CET16P | | |
| 1.6 THP 155 | 4 | 5FV(EP6CDT) | 115/154 | 04/09→ | OE205 | 0,7 | CET16P | | BAEA143 |
| 1.6 VTi 120, 1.6 VTi 120 | 4 | 5FS(EP6C) | 88/118 | 07/10→ | OE205 | 0,7 | CET16P | | BAEA143 |

CHAMPION



kW/BHP



eon TITAN

IRIDIUM

**...CITROËN****...C5 III**

| | | | | | | | | | |
|--------------------------|---|---------------------------------|---------|--------|-------|-----|--------|-------|---------|
| 1.8 16V | 4 | 6FY(EW7A) | 92/123 | 02/08→ | OE178 | 0,9 | CET5 | | |
| 2.0 16V, 2.0 16V BioFlex | 4 | RFJ(EW10A) | 103/138 | 02/08→ | OE178 | 0,9 | CET5 | | BAEA352 |
| 2.0 HDi | 4 | RHF(DW10BTE4); RHR(DW10BTE4) | 100/134 | 02/08→ | CH268 | 11v | | | CCU147 |
| 2.0 HDi 140 | 4 | RHF(DW10BTE4) | 103/138 | 04/09→ | CH268 | 11v | | | CCU147 |
| 2.2 HDi | 4 | 4HT(DW12BTE4) | 125/168 | 02/08→ | | | | | CCU147 |
| 2.2 HDi 165 | 4 | 4HP(DW12BTE4) | 120/161 | 02/08→ | | | | | CCU147 |
| 2.7 HDi | 6 | DT17ED4; UHZ(DT17BTE4) | 150/201 | 02/08→ | CH240 | 11v | | | |
| 3.0 V6 | 6 | XFU(ES9A); XFX(ES9A) | 155/208 | 02/08→ | OE175 | 1,0 | CET14P | OE190 | BAEA347 |

C6

| | | | | | | | | | |
|---------|---|------------------------|---------|--------|-------|-----|--------|-------|-------------------|
| 2.2 HDi | 4 | 4HP(DW12BTE4) | 120/161 | 06/06→ | | | | | CCU147 |
| 2.2 HDi | 4 | 4HT(DW12BTE4) | 125/168 | 06/06→ | | | | | CCU147 |
| 2.7 HDi | 6 | DT17ED4; UHZ(DT17BTE4) | 150/201 | 09/05→ | CH240 | 11v | | | |
| 3.0 V6 | 6 | XFV(ES9A); XFX(ES9J4S) | 155/208 | 09/05→ | OE175 | 1,0 | CET14P | OE190 | BAEA347 12/05→ |

C8

| | | | | | | | | | |
|-------------|---|-----------------------------------|---------|--------|----------------------------------|-----|--------|-------|---------|
| 2.0 | 4 | RFN(EW10J4) | 100/134 | 07/02→ | OE178 | 0,9 | CET5 | | BAEA348 |
| 2.0 16V | 4 | RFJ(EW10A) | 103/138 | 09/05→ | OE178 | 0,9 | CET5 | | BAEA352 |
| 2.0 16V | 4 | RFJ(EW10A) | 104/139 | 09/05→ | OE178 | 0,9 | CET5 | | |
| 2.0 HDi | 4 | RHM(DW10ATED4); RHT(DW10ATED4) | 79/106 | 07/02→ | CH170 ^[134] | 11v | | | CCU149 |
| | | | | | CH268 ^[136] | 11v | | | |
| 2.0 HDi | 4 | RHW(DW10ATED4) | 80/107 | 07/02→ | CH170 →RP.09666 | 11v | | | CCU149 |
| | | | | | CH268 RP.09667→ | 11v | | | |
| 2.0 HDi | 4 | RHK(DW10ATED4) | 88/118 | 07/06→ | CH268 | 11v | | | CCU147 |
| 2.0 HDi 135 | 4 | RHR(DW10ATED4) | 100/134 | 03/06→ | CH268 | 11v | | | |
| 2.0 HDi 135 | 4 | DW10ATED4 | 100/134 | 03/06→ | | | | | CCU147 |
| 2.2 | 4 | 3FZ(EW12J4) | 116/156 | 07/02→ | OE178 | 0,9 | CET5 | | BAEA351 |
| 2.2 HDi | 4 | 4HW(DW12TED4) | 94/126 | 07/02→ | CH170 ^[134] →04/03 | 11v | | | CCU149 |
| | | | | | CH268 ^[136] 05/03→ | 11v | | | |
| 2.2 HDi | 4 | 4HP(DW12BTE4); 4HR(DW12BTE4) | 120/161 | 06/07→ | | | | | CCU147 |
| 2.2 HDi | 4 | 4HT(DW12BTE4) | 125/168 | 06/06→ | | | | | CCU147 |
| 3.0 V6 | 6 | XFX(ES9J4S) | 150/201 | 07/02→ | OE175 | 1,0 | CET14P | OE190 | BAEA347 |

C-CROSSER

| | | | | | | | | | |
|--------------|---|---------------|---------|--------|--|--|--------|-------|--------|
| 2.0, 2.0 4WD | 4 | 4B11 | 108/145 | 11/10→ | | | CET12P | OE182 | |
| 2.2 HDi 4WD | 4 | 4HN(DW12MTE4) | 115/154 | 02/07→ | | | | | CCU147 |
| 2.4 16V 4WD | 4 | SFZ(4B12-MMC) | 125/168 | 08/08→ | | | CET12P | OE180 | |

C-ELYSEE

| | | | | | | | | | |
|-------------|---|----------|--------|--------|-------|-----|------|--|--|
| 1.6 VTi 115 | 4 | NFP(EC5) | 85/114 | 11/12→ | OE035 | 0,9 | CET5 | | |
|-------------|---|----------|--------|--------|-------|-----|------|--|--|

DS3

| | | | | | | | | | |
|----------------------------|---|-------------------------|---------|-------------|-------|-----|--------|--|---------|
| 1.2 THP 110 | 3 | HNZ(EB2DT) | 81/109 | 10/14→07/15 | | | | | BAEA557 |
| 1.4 VTi 95, 1.4 VTi 95 LPG | 4 | 8FN(EP3); 8FP(EP3) | 70/94 | 04/10→07/15 | OE203 | 1,0 | | | BAEA143 |
| 1.4 VTi 98 | 4 | 8FR(EP3) | 72/97 | 11/09→07/15 | OE203 | 1,0 | | | BAEA143 |
| 1.6 THP 150 | 4 | 5FN(EP6CDT); 5FX(EP6DT) | 110/148 | 01/10→07/15 | OE205 | 0,7 | CET16P | | |
| 1.6 THP 155 | 4 | 5FR(EP6DT); 5FV(EP6CDT) | 115/154 | 04/10→07/15 | OE205 | 0,7 | CET16P | | BAEA143 |
| 1.6 VTi 120 | 4 | 5FS(EP6C) | 88/118 | 04/10→07/15 | OE205 | 0,7 | CET16P | | BAEA143 |

DS4

| | | | | | | | | | |
|-------------|---|-------------|---------|-------------|-------|-----|--------|--|---------|
| 1.2 THP 130 | 3 | HNY(EB2DTS) | 96/129 | 07/14→07/15 | | | | | BAEA557 |
| 1.6 THP 155 | 4 | 5FV(EP6CDT) | 115/154 | 04/11→07/15 | OE205 | 0,7 | CET16P | | |
| 1.6 THP 160 | 4 | 5FM(EP6DT) | 120/161 | 04/12→07/15 | OE205 | 0,7 | CET16P | | |

CITROËN



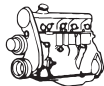

kW/BHP

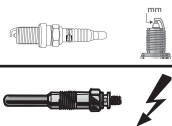

eon TITAN

IRIDIUM



...CITROËN



| ...DS4 | | | | | | | | | | |
|----------------------|---|--|---------|-------------|-----------------|------|--------|-------|-------------------------|--------|
| 1.6 THP 165 | 4 | 5FM(EP6DT); 5GZ(EP6FDT) | 121/162 | 01/12→07/15 | OE205 | 0,7 | CET16P | | | |
| 1.6 THP 200 | 4 | 5FU(EP6DTX) | 147/197 | 04/11→07/15 | OE205 | 0,7 | | | | |
| 1.6 VTi 120 | 4 | 5FS(EP6C) | 88/118 | 04/11→07/15 | OE205 | 0,7 | CET16P | | BAEA143 | |
| ...DS5 | | | | | | | | | | |
| 1.6 THP 155 | 4 | 5FV(EP6CDT) | 115/154 | 11/11→07/15 | OE205 | 0,7 | CET16P | | | |
| 1.6 THP 165 | 4 | 5FM(EP6DT); 5GZ(EP6FDT) | 121/162 | 01/12→07/15 | OE205 | 0,7 | CET16P | | | |
| 1.6 THP 200 | 4 | 5FU(EP6DTX) | 147/197 | 11/11→07/15 | OE205 | 0,7 | | | | |
| ...EVASION | | | | | | | | | | |
| 1.8 | 4 | LFZ(XU7JP) | 73/98 | 05/97→07/02 | OE034 | 0,9 | CET2 | OE179 | | |
| 1.8 | 4 | | 76/102 | 02/96→12/96 | OE034 | 0,9 | CET2 | OE179 | BAEA232 | |
| | | | | | | | | | 09/96→ | |
| 1.9 TD | 4 | D8B(XUD9TF); DHX(XUD9TF/BTF) | 66/89 | 11/94→07/02 | CH189 | 11v | | | CCU149 ^[51] | |
| 1.9 TD | 4 | D8B(XUD9TF) | 68/91 | 10/95→12/98 | CH189 | 11v | | | CCU149 ^[51] | |
| 2.0 | 4 | RFU(XU10J2/C) | 89/119 | 06/94→07/02 | OE034 | 0,9 | CET2 | OE179 | | CLS005 |
| 2.0 16V | 4 | RFV(XU10J4R) | 97/130 | 05/98→04/00 | OE034 | 0,9 | CET2 | OE179 | | |
| 2.0 16V | 4 | RFN(EW10J4) | 100/134 | 05/00→07/02 | OE178 | 0,9 | CET5 | | BAEA348 | |
| 2.0 HDi, 2.0 HDi 16V | 4 | RHW(DW10ATED4); RHZ(DW10ATED) | 80/107 | 08/99→07/02 | CH170 | 11v | | | CCU149 | |
| 2.0 Turbo C.T. | 4 | RGX(XU10J2TE) | 108/145 | 06/94→07/02 | OE034 | 0,9 | CET2 | OE179 | | CLS005 |
| 2.1 TD | 4 | P8C(XUD11BTE) | 80/107 | 05/96→07/02 | CH189 | 11v | | | | |
| ...JUMPY | | | | | | | | | | |
| 1.6 | 4 | 1580SPI | 58/78 | 10/95→08/00 | | | CET2 | OE179 | BAEA234 | CLS123 |
| | | | | | | | →09/99 | | | |
| 1.6 | 4 | 220A2.000 | 58/78 | 10/95→08/00 | | | | | BAEA234 | CLS123 |
| 1.6 HDi 90 16V | 4 | 9HU(DV6UTED4) | 66/89 | 01/07→ | CH201 | 11v | | | CCU147 | |
| 1.9 D | 4 | D9B(XUD9A/U) | 51/68 | 10/95→08/98 | CH189 | 11v | | | | |
| 1.9 D 70 | 4 | WJY(DW8B); WJZ(DW8) | 51/68 | 04/98→11/03 | CH185 | 11v | | | | |
| 1.9 TD | 4 | DHX(XUD9TF/BTF) | 66/89 | 10/95→08/00 | CH189 | 11v | | | CCU149 ^[51] | |
| | | | | | | | | | →Prod.03.05.1998 | |
| | | | | | | | | | →RP.07846 | |
| 1.9 TD | 4 | D8B(XUD9TF) | 68/91 | 04/96→11/03 | CH189 | 11v | | | CCU149 ^[51] | |
| | | | | | | | | | →Prod.03.05.1998 | |
| | | | | | | | | | →RP.07846 | |
| 2.0 | 4 | RFN(EW10J4) | 100/134 | 04/00→12/06 | OE178 | 0,9 | CET5 | | BAEA348 | |
| | | | | | | | | | 09/00→ | |
| 2.0 HDi 95 | 4 | RHX(DW10BTED) | 69/93 | 10/99→10/06 | CH170 | 11v | | | CCU149 | |
| 2.0 HDi 110 | 4 | RHW(DW10ATED4); RHZ(DW10ATED); RHZ(DW10BTED); RHZ(DW10BTED+); RHZ(DW10CTED); RHZ(DW10CTED+) | 80/107 | 03/00→10/06 | CH170 | 11v | | | CCU149 | |
| 2.0 HDi 120 | 4 | RHK(DW10UTED4) | 88/118 | 01/07→ | CH268 | 11v | | | CCU147 | |
| 2.0 HDi 140 | 4 | RHR(DW10BTED4) | 100/134 | 01/07→ | CH268 | 11v | | | CCU149 | |
| 2.0 i | 4 | RFH(EW10A) | 103/138 | 01/07→ | OE178 | 0,9 | CET5 | | BAEA352 | |
| 2.0 i 16V | 4 | RFN(EW10J4) | 102/137 | 03/00→10/06 | OE178 | 0,9 | CET5 | | BAEA348 | |
| | | | | | | | | | 01/04→ | |
| ...NEMO | | | | | | | | | | |
| 1.4 | 4 | KFT(TU3A); KJV(TU3A) | 54/72 | 04/09→ | OE034 | 0,9 | CET2 | OE179 | BAEA048E ^[7] | |
| 1.4 HDi | 4 | 8HS(DV4TED) | 50/67 | 04/09→ | CH201 | 11v | | | CCU147 | |
| ...SAXO | | | | | | | | | | |
| 1.0 X | 4 | CDZ(TU9M) | 33/44 | 05/96→11/98 | OE034 | 0,8* | CET2 | OE179 | | CLS262 |
| | | | | | *to be adjusted | | | | | |
| 1.0 X | 4 | CDZ(TU9M) | 37/50 | 05/98→06/03 | OE034 | 0,9 | CET2 | OE179 | | |
| 1.1 X, SX | 4 | HDZ(TU1M) | 40/54 | 05/96→09/03 | OE034 | 0,9 | CET2 | OE179 | BAE946A ^[10] | CLS262 |
| | | | | | | | | | 06/00→12/02 | |
| 1.1 X, SX | 4 | HDZ(TU1M) | 44/59 | 05/96→09/03 | OE034 | 0,8* | CET2 | OE179 | | CLS262 |
| | | | | | *to be adjusted | | | | | |





kw/BHP



eon TITAN

IRIDIUM



...CITROËN



...SAXO

| | | | | | | | | | | |
|--------------|---|-------------|--------|-------------|-------------------------------------|------------|------|-------|-------------------------------------|--------|
| 1.1 X, SX | 4 | HFX(TU1JP) | 44/59 | 05/96→09/03 | OE034 *to be adjusted | 0,8* | CET2 | OE179 | BAE946A ^[10] 09/00→ | CLS262 |
| 1.4 VTS | 4 | KFX(TU3JP) | 55/74 | 05/96→06/03 | OE034 | 0,9 | CET2 | OE179 | | CLS262 |
| 1.4 VTS | 4 | KFW(TU3JP) | 55/74 | 05/96→06/03 | OE034 | 0,9 | CET2 | OE179 | BAE946A ^[10] 06/00→ | CLS262 |
| 1.5 D | 4 | VJY(TUD5) | 40/54 | 09/96→09/03 | CH185 | 11v | | | | |
| 1.5 D | 4 | VJZ(TUD5) | 42/56 | 09/96→06/01 | CH185 | 11v | | | | |
| 1.5 D | 4 | VJZ(TUD5) | 43/58 | 07/01→04/04 | CH185 | 11v | | | | |
| 1.6 | 4 | NFZ(TU5JP) | 66/89 | 02/96→06/03 | OE034 | 0,9 | CET2 | OE179 | | CLS262 |
| 1.6 | 4 | NFT(TU5JP) | 74/99 | 02/01→04/04 | OE034 | 0,9 | CET2 | OE179 | BAE946A ^[10] | |
| 1.6 | 4 | NFX(TU5JP4) | 88/118 | 02/96→04/04 | OE035 OE218 LPG ^[278] | 0,9 1,6 | CET5 | OE190 | BAEA046E ^[277] | |
| 1.6 VTL, VTR | 4 | NFZ(TU5JP) | 65/87 | 05/96→06/03 | OE034 | 0,9 | CET2 | OE179 | | CLS262 |
| 1.6 VTS | 4 | NFT(TU5JP) | 72/97 | 09/00→09/03 | OE034 | 0,9 | CET2 | OE179 | BAE946A ^[10] | |
| 1.6 VTS | 4 | NFX(TU5JP4) | 87/117 | 06/96→09/03 | OE035 OE218 LPG ^[278] | 0,9 1,6 | CET5 | OE190 | BAEA046E ^[277] 01/01→ | |

XANTIA

| | | | | | | | | | | |
|-------------------|---|---|---------|-------------|-------------------------------------|-------------|------|----------------|-------------------------|--------|
| 1.6 i | 4 | BFX(XU5JP) | 65/87 | 03/93→03/01 | OE034 *to be adjusted | 0,8* | CET2 | OE179 | | CLS123 |
| 1.8 i | 4 | LFX(XU7JB) | 66/89 | 04/97→04/03 | OE034 | 0,9 | CET2 | OE179 | | CLS123 |
| 1.8 i | 4 | LFZ(XU7JP) | 74/99 | 03/93→01/98 | OE034 | 0,9 | CET2 | OE179 | | CLS123 |
| 1.8 i 16V | 4 | LFY(XU7JP4) | 81/109 | 06/95→04/03 | OE034 *to be adjusted OE034 | 0,8* 0,9 | CET2 | OE179 | BAEA256 →RP.7608 | |
| 1.9 D | 4 | DJZ(XUD9Y) | 50/67 | 06/94→01/98 | CH189 | 11v | | | | |
| 1.9 D | 4 | D9B(XUD9A/L) | 51/68 | 06/94→01/98 | CH189 | 11v | | | | |
| 1.9 SD | 4 | DHW(XUD9SD) | 55/74 | 02/96→04/03 | CH189 | 11v | | | | |
| 1.9 Turbo D | 4 | D8B(XUD9TF); DHX(XUD9TF/BTF); DHY(XUD9TE/Y) | 66/89 | 05/93→04/03 | CH189 | 11v | | | CCU149 ^[315] | |
| 2.0 HDI 90 | 4 | RHY(DW10TD) | 66/89 | 03/99→04/03 | CH170 | 11v | | | CCU149 | |
| 2.0 HDI 109 | 4 | RHZ(DW10ATED) | 80/107 | 02/99→04/03 | CH170 | 11v | | | CCU149 | |
| 2.0 i | 4 | RFX(XU10J2C) | 89/119 | 03/93→04/03 | OE005 OE034 | 0,9 0,9 | CET2 | OE179 OE180 | | CLS005 |
| 2.0 i 16V | 4 | RFV(XU10J4R) | 97/130 | 06/95→04/03 | OE034 *to be adjusted OE034 | 0,8* 0,9 | CET2 | OE179 | BAE700AK 03/97→ | CLS005 |
| 2.0 i 16V | 4 | RFT(XU10J4/Z) | 110/148 | 06/94→01/98 | OE014 OE034 | 0,9 0,9 | CET2 | OE179 | BAE700AK 03/97→ | CLS005 |
| 2.0 i 16V | 4 | RFY(XU10J4/Z) | 112/150 | 03/93→01/98 | OE014 OE034 | 0,9 0,9 | CET2 | OE179 | BAE700AK 06/95→ | CLS005 |
| 2.0 Turbo | 4 | RGX(XU10J2TE) | 108/145 | 06/95→04/03 | OE034 | 0,9 | CET2 | OE179 | | CLS005 |
| 2.1 Turbo D 12V | 4 | P8C(XUD11BTE) | 80/107 | 06/95→02/99 | CH189 | 11v | | | | |
| 3.0 i 24V, 3.0 V6 | 6 | XFZ(ES9J4) | 140/188 | 01/97→04/03 | OE026 OE218 LPG ^[278] | 0,9 1,6 | CET2 | OE188 | | |

XM

| | | | | | | | | | | |
|-----------|---|-----------------------------------|---------|-------------|-------|-----|------|-------|-------------------------|--------|
| 2.0 i 16V | 4 | RFV(XU10J4R) | 97/130 | 05/94→10/00 | OE034 | 0,9 | CET2 | OE179 | BAEA256 →08/97 | CLS005 |
| 2.0 Turbo | 4 | RGX(XU10J2TE); RGY(XU10J2TE/Z) | 108/145 | 05/94→10/00 | OE034 | 0,9 | CET2 | OE179 | | CLS005 |
| 2.5 TD | 4 | THY(DKSATE) | 95/127 | 05/94→10/00 | CH189 | 11v | | | CCU149 ^[315] | |
| 3.0 V6 | 6 | XFZ(ES9J4) | 140/188 | 04/97→10/00 | OE026 | 0,9 | CET2 | OE188 | | |

XSARA

| | | | | | | | | | | |
|---------|---|------------|-------|-------------|--|--|--|--|-------------------------|--|
| 1.4 HDi | 4 | 8HX(DV4TD) | 50/67 | 01/03→08/05 | | | | | CCU149 ^[359] | |
|---------|---|------------|-------|-------------|--|--|--|--|-------------------------|--|

CITROËN





kW/BHP

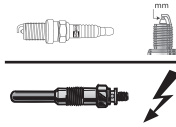

eon TITAN

IRIDIUM



...CITROËN



...XSARA

| | | | | | | | | | | |
|------------------------|---|-----------------------|---------|-------------|-----------------------------------|-----|-------------|--------------|---|---------------|
| 1.4 i | 4 | KFW(TU3JP) | 55/74 | 04/97→08/05 | OE034 | 0,9 | CET2 | OE179 | BAE946A ^[10] 09/00→ | CLS262 |
| | | | | | OE216 LPG ^[278] | 0,8 | | | | |
| 1.4 i | 4 | KFX(TU3JP) | 55/74 | 04/97→08/05 | OE034 | 0,9 | CET2 | OE179 | BAEA232 →06/98 | CLS262 |
| | | | | | OE216 LPG ^[278] | 0,8 | | | | |
| 1.5 D | 4 | VJZ(TUD5) | 42/56 | 04/97→09/00 | CH185 | 11v | | | | |
| 1.6 16V | 4 | NFU(TU5JP4) | 80/107 | 09/00→08/05 | OE035 | 0,9 | CET5 | OE190 | BAEA045E | |
| | | | | | OE224 LPG ^[279] | 0,8 | | | | |
| 1.6 i | 4 | NFZ(TU5JP) | 65/87 | 04/97→09/00 | OE034 | 0,9 | CET2 | OE179 | BAEA232 →06/98 | |
| 1.8 D | 4 | 161A(XUD7); A9A(XUD7) | 43/58 | 04/97→09/00 | CH189 | 11v | | | | |
| 1.8 i | 4 | LFX(XU7JB) | 66/89 | 04/97→09/00 | OE034 | 0,9 | CET2 | OE179 | | CLS123 |
| 1.8 i | 4 | LFZ(XU7JP) | 74/99 | 02/98→09/00 | OE034 | 0,9 | CET2 | OE179 | BAEA232 | |
| 1.8 i 16V, 1.8 LPG | 4 | LFY(XU7JP4) | 81/109 | 04/97→09/00 | OE034 | 0,9 | CET2 | OE179 | | CLS123 |
| 1.8 i Aut. | 4 | LFZ(XU7JP) | 74/99 | 04/97→09/00 | OE034 | 0,9 | CET2 | OE179 | | CLS123 |
| 1.9 D | 4 | DJY(XUD9A) | 50/67 | 04/97→09/00 | CH189 | 11v | | | | |
| 1.9 D | 4 | WJZ(DW8) | 51/68 | 07/98→08/05 | CH185 | 11v | | | | |
| 1.9 D | 4 | WJY(DW8B) | 51/68 | 07/98→08/05 | CH185 | 11v | | | CCU149 ^[314] | |
| 1.9 D, 1.9 SD | 4 | DHV(XUD9BSD) | 55/74 | 01/98→09/00 | CH189 | 11v | | | CCU149 ^[315] | |
| 1.9 TD | 4 | DHY(XUD9TE/Y) | 66/89 | 04/97→09/00 | CH189 | 11v | | | | |
| 2.0 16V | 4 | RFV(XU10J4R) | 97/130 | 07/98→09/00 | OE034 | 0,9 | CET2 | OE179 | | |
| 2.0 16V | 4 | RFN(EW10J4) | 100/134 | 09/00→08/05 | OE178 | 0,9 | CET5 | | BAEA348 | |
| 2.0 16V | 4 | RFS(XU10J4RS) | 120/161 | 04/97→09/00 | OE026 | 0,9 | CET2 | OE179 | | |
| | | | | | OE216 LPG ^[278] | 0,8 | | | | |
| 2.0 HDi 90, 2.0 HDi 90 | 4 | RHY(DW10TD) | 66/89 | 02/99→08/05 | CH170 | 11v | | | CCU149 ^[359] →RP.09701 | |
| 2.0 HDi 109 | 4 | RHZ(DW10ATED) | 80/107 | 05/01→08/05 | CH170 | 11v | | | CCU149 ^[359] →RP.09820 | |
| 2.0 i 16V | 4 | RFS(XU10J4RS) | 120/161 | 02/98→03/05 | OE034 | 0,9 | CET2 | OE179 | | |
| | | | | | OE216 LPG ^[278] | 0,8 | | | | |

XSARA PICASSO

| | | | | | | | | | | |
|------------|---|-------------------------------|---------|-------------|-----------------------------------|-----|-------------|--------------|---|--|
| 1.6 | 4 | NFZ(TU5JP) | 65/87 | 12/99→ | OE034 | 0,9 | CET2 | OE179 | | |
| 1.6 | 4 | NFZ(TU5JP) | 67/90 | 06/02→ | OE005 | 0,9 | CET2 | OE179 | | |
| | | | | | OE034 | 0,9 | | | | |
| 1.6 | 4 | NFV(TU5JP) | 70/94 | 12/99→ | OE034 | 0,9 | CET2 | OE179 | BAE946A 01/00→04/10 ^[10] ^[250] | |
| 1.6 16V | 4 | NFU(TU5JP4) | 80/107 | 09/05→ | OE035 | 0,9 | CET5 | OE190 | BAEA045E | |
| | | | | | OE224 LPG ^[279] | 0,8 | | | | |
| 1.6 16V | 4 | NFU(TU5JP4) | 81/109 | 06/05→09/06 | OE035 | 0,9 | CET5 | | | |
| 1.6 Chrono | 4 | NFV(TU5JP) | 74/99 | 04/01→10/04 | OE034 | 0,9 | CET2 | | BAE946A ^[10] | |
| 1.6 HDi | 4 | 9HX(DV6ATED4) | 66/89 | 09/05→ | CH201 03/06→ | 11v | | | CCU147 | |
| 1.6 HDi | 4 | 9HY(DV6TED4); 9HZ(DV6TED4) | 80/107 | 05/04→ | CH201 03/06→ | 11v | | | CCU147 | |
| 1.8 16V | 4 | 6FZ(EW7J4) | 85/114 | 02/00→ | OE148 | 1,0 | CET5 | | BAEA348 | |
| | | | | | OE178 | 0,9 | | | | |
| 2.0 16V | 4 | RFN(EW10J4) | 100/134 | 01/03→ | OE178 | 0,9 | CET5 | | BAEA348 | |
| 2.0 HDi | 4 | RHY(DW10TD) | 66/89 | 12/99→ | CH170 | 11v | | | CCU149 ^[359] →RP.09820 | |
| 2.0 HDi | 4 | | 80/107 | 12/99→ | CH170 | 11v | | | CCU149 ^[359] →RP.09820 | |

ZX

| | | | | | | | | | | |
|-------|---|-----------------------|--------|-------------|--------------|-------|-------------|--------------|--|---------------|
| 1.4 D | 4 | K9Y(TUD3Y) | 37/50 | 07/94→10/97 | CH147 | 11.5v | | | | |
| 1.6 | 4 | BDY(XU5M); BFZ(XU5JP) | 66/89 | 07/94→10/97 | OE034 | 0,9 | CET2 | | | CLS123 |
| 1.8 | 4 | LFZ(XU7JP) | 76/102 | 07/94→10/97 | OE034 | 0,9 | CET2 | OE179 | | CLS123 |



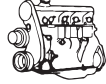

kW/BHP

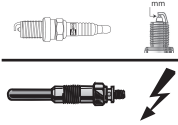

eon TITAN

IRIDIUM



...CITROËN



...ZX

| | | | | | | | | | | |
|-----------|---|-----------------------------|---------|-------------|-----------------|------|------|-------|----------|--------|
| 1.8 | 4 | LFY(XU7JP4) | 82/110 | 04/96→10/97 | OE034 | 0,9 | CET2 | OE179 | BAEA256 | |
| 1.8 D | 4 | 161A(XUD7) | 44/59 | 06/93→10/97 | CH189 | 11v | | | | |
| 1.8 i 16V | 4 | LFY(XU7JP4) | 81/109 | 01/96→02/98 | OE034 | 0,9 | CET2 | OE179 | BAEA256 | |
| | | | | | OE034 | 0,8* | | | | |
| | | | | | *to be adjusted | | | | | |
| 1.9 D | 4 | D9B(XUD9A/U); DJY(XUD9A) | 50/67 | 07/93→10/97 | CH189 | 11v | | | | |
| 1.9 DT | 4 | DHY(XUD9TE/Y) | 65/87 | 07/94→10/97 | CH189 | 11v | | | | |
| 2.0 | 4 | RFX(XU10J2C) | 90/121 | 07/94→10/97 | OE005 | 0,9 | CET2 | | | |
| 2.0 | 4 | RFS(XU10J4RS) | 122/164 | 09/96→10/97 | OE034 | 0,9 | CET2 | | | |
| 2.0 i 16V | 4 | RFT(XU10J4/Z) | 110/148 | 06/94→06/97 | | | CET2 | OE179 | BAE700AK | CLS005 |
| 2.0 i 16V | 4 | RFS(XU10J4RS) | 120/161 | 05/96→06/97 | OE034 | 0,8* | CET2 | OE179 | | |
| | | | | | *to be adjusted | | | | | |

CITROËN



BERLINGO

| | | | | | | | | | | |
|----------------|---|---|--------|-------------|-----------|-----|--------|-------|----------|--|
| 1.4 CNG | 4 | KFW(TU3JP) | 48/64 | 11/02→03/08 | OE034 | 0,9 | CET2 | OE179 | | |
| 1.6 | 4 | NFR(TU5JP4B) | 66/89 | 04/08→ | OE035 | 0,9 | CET5 | OE190 | BAEA045E | |
| | | | | | OE224 | 0,8 | | | | |
| | | | | | UPG [279] | | | | | |
| 1.6 | 4 | NFU(TU5JP4) | 80/107 | 04/08→ | OE035 | 0,9 | CET5 | OE190 | BAEA045E | |
| | | | | | OE224 | 0,8 | | | | |
| | | | | | UPG [279] | | | | | |
| 1.6 HDi 75 | 4 | 9HT(DV6BTED4); 9HT(DV6BUTED4) | 55/74 | 04/08→ | CH201 | 11v | | | CCU147 | |
| 1.6 HDi 90 16V | 4 | 9HS(DV6TED4BU); 9HX(DV6ATED4); 9HX(DV6AUTED4) | 66/89 | 04/08→ | CH201 | 11v | | | | |
| 1.6 HDi 110 | 4 | 9HZ(DV6TED4) | 80/107 | 04/08→ | CH201 | 11v | | | CCU147 | |
| 1.6 VTi 95 | 4 | 5FK(EP6CB) | 72/97 | 07/10→ | OE205 | 0,7 | CET16P | | BAEA143 | |
| 1.6 VTi 120 | 4 | 5FS(EP6C) | 88/118 | 11/09→ | OE205 | 0,7 | CET16P | | BAEA143 | |

BERLINGO / BERLINGO FIRST

| | | | | | | | | | | |
|----------------------------|---|---------------------|--------|-------------|---------------------|------|------|-------|---------------------------|--------|
| 1.1 i | 4 | HDZ(TU1M) | 44/59 | 07/96→03/08 | OE034 | 0,9 | CET2 | OE179 | | CLS262 |
| 1.1 i | 4 | HFX(TU1JP) | 44/59 | 07/96→03/08 | OE034 | 0,9 | CET2 | OE179 | BAE946A | CLS262 |
| | | | | | | | | | 01/01→08/05 [10] [275] | |
| 1.4 bivalent | 4 | KFW(TU3JP) | 48/64 | 11/02→12/11 | OE034 | 0,9 | CET2 | OE179 | BAE946A | |
| | | | | | | | | | →03/10 [10] [275] | |
| 1.4 i | 4 | KFX(TU3JP) | 55/74 | 07/96→12/11 | OE034 | 0,9 | CET2 | OE179 | | CLS262 |
| 1.4 i | 4 | KFW(TU3JP) | 55/74 | 07/96→12/11 | OE034 | 0,9 | CET2 | OE179 | BAE946A | CLS262 |
| | | | | | | | | | →03/10 [10] [275] | |
| 1.4 i bivalent | 4 | KFW(TU3JP) | 55/74 | 04/03→10/05 | OE034 | 0,7* | CET2 | OE179 | BAE946A | [10] |
| | | | | | *to be adjusted | | | | | |
| 1.6 16V | 4 | NFU(TU5JP4) | 80/107 | 10/00→03/08 | OE035 | 0,9 | CET5 | OE190 | BAEA045E | |
| | | | | | OE224 | 0,8 | | | 12/02→ | |
| | | | | | UPG [279] | | | | | |
| 1.6 16V | 4 | NFU(TU5JP4) | 81/109 | 08/05→12/07 | OE035 | 0,9 | CET5 | | | |
| 1.6 HDI 75 | 4 | 9HW(DV6BTED4); DV6B | 55/74 | 07/05→12/11 | CH201 | 11v | | | CCU147 | |
| | | | | | 07/06→ | | | | | |
| 1.6 HDI 90 | 4 | 9HX(DV6ATED4) | 66/89 | 07/05→12/11 | CH201 | 11v | | | CCU147 | |
| | | | | | 03/06→ RP.10689→ | | | | | |
| 1.8 D | 4 | A9A(XUD7) | 43/58 | 07/96→10/02 | CH189 | 11v | | | | |
| 1.8 i | 4 | LFX(XU7JB) | 66/89 | 08/99→10/02 | OE034 | 0,9 | CET2 | OE179 | | CLS123 |
| 1.9 D | 4 | DJY(XUD9A) | 51/68 | 07/96→12/03 | CH189 | 11v | | | | |
| 1.9 D 70, 1.9 D 70 4WD | 4 | WJZ(DW8) | 51/68 | 07/98→12/11 | CH185 | 11v | | | | |
| 1.9 D 70, 1.9 D 70 4WD | 4 | WJY(DW8B) | 51/68 | 07/98→12/11 | CH185 | 11v | | | CCU149 | [318] |
| 2.0 HDI 90, 2.0 HDI 90 4WD | 4 | RHY(DW10TD) | 66/89 | 12/99→12/11 | CH170 | 11v | | | CCU149 | [359] |

CITROËN



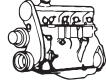

kW/BHP

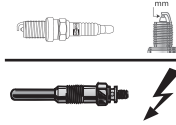

eon TITAN

IRIDIUM

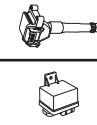

...CITROËN



C2 ENTERPRISE

| | | | | | | | | | | |
|---------|---|------------|-------|--------|--|--|--|--|--|-------------------------|
| 1.4 HDi | 4 | 8HX(DV4TD) | 50/67 | 04/09→ | | | | | | CCU149 ^[318] |
|---------|---|------------|-------|--------|--|--|--|--|--|-------------------------|

C15

| | | | | | | | | | | |
|-------|---|-----------|-------|-------------|-------|--|-----|--|--|--------|
| 1.9 D | 4 | WJX(DW8B) | 44/59 | 12/00→12/05 | CH189 | | 11v | | | CCU149 |
| 1.9 D | 4 | WJY(DW8B) | 51/68 | 10/00→10/02 | CH185 | | 11v | | | CCU149 |

C-CROSSER ENTERPRISE

| | | | | | | | | | | |
|-------------|---|----------------|---------|--------|--|--|--|--------|-------|--------|
| 2.2 HDi 4WD | 4 | 4HN(DW12MTED4) | 115/154 | 01/09→ | | | | | | CCU147 |
| 2.4 16V 4WD | 4 | 4B12 | 125/168 | 01/09→ | | | | CET12P | OE182 | |

JUMPER

| | | | | | | | | | | |
|--------------------------------|---|----------------------------------|---------|-------------|----------------------------------|-------|------|--|-------|--------|
| 1.9 D | 4 | DJY(XUD9A) | 50/67 | 07/99→04/02 | CH189 | | 11v | | | |
| 1.9 D | 4 | D9B(XUD9A/U) | 51/68 | 02/94→04/02 | CH189 | | 11v | | | |
| 1.9 TD | 4 | D8C(XUD9UTF); DHX(XUD9TF/BTF) | 66/89 | 03/94→04/02 | CH189 | | 11v | | | |
| 1.9 TD, 1.9 TD 4WD | 4 | D8C(XUD9UTF) | 68/91 | 02/94→04/02 | CH189 | | 11v | | | |
| 2.0 | 4 | XU10J2 | 81/109 | 04/02→ | OE034 | 0,9 | CET2 | | OE179 | CLS123 |
| 2.0, 2.0 4WD | 4 | RFW(XU10J2U) | 80/107 | 02/94→04/02 | OE034 | 0,9 | CET2 | | OE179 | CLS123 |
| 2.0 bivalent | 4 | XU10J2 | 81/109 | 02/03→ | OE034 | 0,9 | CET2 | | OE179 | |
| 2.0 HDi | 4 | RHV(DW10TD) | 62/83 | 04/02→ | | | | | | CCU149 |
| 2.0 HDi, 2.0 HDi | 4 | RHV(DW10TD); RHV(DW10UTD) | 62/83 | 11/01→ | CH170 | | 11v | | | CCU149 |
| 2.2 HDi | 4 | 4HY(DW12UTED) | 74/99 | 02/02→ | CH170 ^[135] →04/03 | | 11v | | | CCU149 |
| | | | | | CH268 ^[136] 05/03→ | | 11v | | | |
| 2.2 HDi 100 | 4 | 4HV(P22DTE) | 74/99 | 04/06→ | CH229 | 11.5v | | | | |
| 2.2 HDi 120 | 4 | 4HU(P22DTE) | 88/118 | 04/06→ | CH229 | 11.5v | | | | |
| 2.5 D, 2.5 D 4WD | 4 | T9A(DJ5) | 63/84 | 03/94→04/02 | CH189 | | 11v | | | |
| 2.5 DT 4WD, 2.5 TD, 2.5 TD 4WD | 4 | T8A(DJ5T); THZ(DJ5T) | 76/102 | 03/94→04/02 | CH189 | | 11v | | | |
| 2.8 D | 4 | 8140.63(F28D) | 64/86 | 01/99→02/02 | CH216 | | 11v | | | |
| 2.8 HDi | 4 | | 93/125 | 10/00→01/02 | CH216 | | 11v | | | CCU149 |
| 2.8 HDi | 4 | 8140.43N | 107/143 | 05/04→ | CH216 | | 11v | | | CCU149 |
| 2.8 HDi, 2.8 HDi 4WD | 4 | 8140.43S; F28TDCR | 94/126 | 09/00→ | CH216 | | 11v | | | CCU149 |
| 3.0 HDi 145 | 4 | F1CE3481N(F30DTE) | 107/143 | 07/10→ | CH270 | | 11v | | | |
| 3.0 HDi 155 | 4 | F1CE0481D(F30DT) | 115/154 | 07/10→ | CH270 | | 11v | | | |
| 3.0 HDi 160 | 4 | F1CE0481D(F30DT) | 116/156 | 09/06→ | CH270 | | 11v | | | |
| 3.0 HDi 180 | 4 | F1CE3481E(F30DTE) | 130/174 | 07/11→ | CH270 | | 11v | | | |

JUMPY

| | | | | | | | | | | |
|----------------|---|---------------------|---------|-------------|-------|-----|------|----------------|-------|---|
| 1.6 HDi 90 16V | 4 | 9HU(DV6UTED4) | 66/89 | 01/07→ | CH201 | | 11v | | | CCU147 |
| 1.6 i | 4 | 220A2.000 | 58/78 | 10/95→08/00 | | | | CET2 →09/99 | | BAEA234 |
| 1.6 i | 4 | 1580SPI | 58/78 | 10/95→08/00 | | | | CET2 →09/99 | OE179 | BAEA234 |
| 1.9 D | 4 | D9B(XUD9A/U) | 51/68 | 10/95→08/98 | CH189 | | 11v | | | |
| 1.9 D 70 | 4 | WJY(DW8B); WJZ(DW8) | 51/68 | 04/98→10/06 | CH185 | | 11v | | | CCU149 |
| 1.9 DT | 4 | | 65/87 | 10/95→08/00 | CH189 | | 11v | | | CCU149 ^[51] →Prod.03.05.1998 →RP.07846 |
| 1.9 TD | 4 | DHX(XUD9TF/BTF) | 66/89 | 10/95→08/00 | CH189 | | 11v | | | CCU149 ^[51] →Prod.03.05.1998 →RP.07846 |
| 1.9 TD | 4 | D8B(XUD9TF) | 68/91 | 10/99→10/06 | CH189 | | 11v | | | |
| 2.0 | 4 | RFN(EW10J4) | 100/134 | 04/00→10/06 | OE178 | 0,9 | CET5 | | | BAEA348 |
| 2.0 HDi 95 | 4 | RHX(DW10BTED) | 69/93 | 10/99→10/06 | CH170 | | 11v | | | CCU149 |





kW/BHP

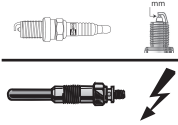

eon TITAN

IRIDIUM



...CITROËN



...JUMPY

| | | | | | | | | | |
|------------------------------|---|--|---------|-------------|-------|-----|------|--|---------|
| 2.0 HDi 110, 2.0 HDi 110 16V | 4 | RHW(DW10ATED4); RHZ(DW10ATED); RHZ(DW10BTED); RHZ(DW10BTED+); RHZ(DW10CTED); RHZ(DW10CTED+) | 80/107 | 10/01→10/06 | CH170 | 11v | | | CCU149 |
| 2.0 HDi 120 | 4 | RHK(DW10ATED4) | 88/118 | 01/07→ | CH268 | 11v | | | CCU147 |
| 2.0 HDi 120 4WD | 4 | RHK(DW10ATED4) | 88/118 | 01/10→ | | | | | CCU147 |
| 2.0 HDi 140 | 4 | RHR(DW10BTED4) | 100/134 | 01/07→ | CH268 | 11v | | | CCU149 |
| 2.0 i | 4 | RFH(EW10A) | 103/138 | 01/07→ | OE178 | 0,9 | CET5 | | BAEA352 |
| 2.0 i 16V | 4 | RFN(EW10J4) | 102/137 | 03/00→10/06 | OE178 | 0,9 | CET5 | | BAEA348 |

NEMO

| | | | | | | | | | |
|---------|---|-------------|-------|--------|-------|-----|------|-------|-------------------------|
| 1.4 | 4 | KFV(TU3A) | 54/72 | 02/08→ | OE034 | 0,9 | CET2 | OE179 | BAEA048E ^[7] |
| 1.4 HDi | 4 | 8HS(DV4TED) | 50/67 | 02/08→ | CH201 | 11v | | | CCU147 |

XSARA

| | | | | | | | | | |
|---------|---|-------------|-------|-------------|-------|-----|--|--|--------------------------------------|
| 2.0 HDi | 4 | RHY(DW10TD) | 66/89 | 09/00→03/05 | CH170 | 11v | | | CCU149 ^[359] →RP.09701 |
|---------|---|-------------|-------|-------------|-------|-----|--|--|--------------------------------------|

DACIA



1309

| | | | | | | | | | |
|-----|---|--|-------|-------------|--|--|--|--|---------|
| 1.6 | 4 | | 53/71 | 12/94→08/01 | | | | | BAEA234 |
|-----|---|--|-------|-------------|--|--|--|--|---------|

1310

| | | | | | | | | | |
|------------------|---|--|-------|-------------|-------|-----|--|--|---------|
| 1.4, 1.4 Classic | 4 | | 46/62 | 01/95→07/04 | OE007 | 0,9 | | | |
| 1.5 | 4 | | 46/62 | 01/95→07/04 | | | | | BAEA354 |

DOKKER

| | | | | | | | | | |
|--------------|---|----------------|--------|--------|-------|-----|------|-------|----------------|
| 1.2 TCe | 4 | H5F402 | 85/114 | 11/12→ | | | | OE261 | BAEA131E |
| 1.6 | 4 | K7M812; K7M828 | 61/82 | 11/12→ | | | CET2 | OE179 | BAEA354 CLS088 |
| 1.6, 1.6 LPG | 4 | | 75/101 | 04/15→ | | | | | BAEA354 |
| 1.6 LPG | 4 | K7M812; K7M828 | 61/82 | 11/13→ | OE033 | 0,9 | CET2 | OE179 | BAEA354 CLS088 |

DUSTER

| | | | | | | | | | |
|--|---|---|--------|--------|----------------------|-----|------|-------|--|
| 1.2 TCe 125, 1.2 TCe 125 4WD | 4 | H5F404; H5F410 | 92/123 | 10/13→ | | | | OE261 | BAEA131E |
| 1.5 dCi | 4 | K9K796; K9K830 | 63/84 | 04/10→ | CH271 | 11v | | | |
| 1.5 dCi | 4 | K9K884; K9K892 | 66/89 | 10/10→ | CH271 ^[9] | 11v | | | |
| 1.5 dCi | 4 | K9K896 | 79/106 | 06/10→ | | | | | CCU147 ^[11] ^[352] |
| 1.5 dCi 4WD | 4 | K9K658; K9K858 | 80/107 | 08/13→ | CH271 ^[9] | 11v | | | |
| 1.5 dCi 4WD | 4 | K9K898 | 81/109 | 10/10→ | | | | | CCU147 ^[11] ^[352] |
| 1.6 16V, 1.6 16V 4WD, 1.6 16V Hi-Flex, 1.6 16V LPG | 4 | K4M606; K4M690; K4M696 | 77/103 | 04/10→ | OE033 | 0,9 | CET2 | OE179 | BAE409A |
| 1.6 SCe 115, 1.6 SCe 115 4WD, 1.6 SCe 115 LPG | 4 | H4M430; H4M438; H4M730; H4M738; H4M740 | 84/113 | 06/15→ | | | | | BAEA131E ^[105] ^[375] |

LOGGY

| | | | | | | | | | |
|-------------|---|----------------|--------|--------|--|------------|------|-------|--|
| 1.2 TCe | 4 | H5F402 | 85/114 | 03/12→ | | | | OE261 | BAEA131E |
| 1.6 | 4 | K7M812; K7M828 | 61/82 | 03/12→ | OE026 OE216 ^{LPG} ^[278] | 0,9 0,8 | CET2 | OE179 | BAEA354 CLS088 |
| 1.6 LPG | 4 | K7M812; K7M828 | 61/82 | 11/13→ | OE033 | 0,9 | CET2 | OE179 | BAEA354 CLS088 |
| 1.6 LPG | 4 | | 75/101 | 04/15→ | | | | | BAEA354 |
| 1.6 SCe 115 | 4 | H4M740 | 75/101 | 06/15→ | | | | | BAEA131E ^[105] ^[375] |

LOGAN

| | | | | | | | | | |
|-------------|---|--------|-------|--------|-------|-----|------|--|--------------------|
| 1.2 16V | 4 | D4F732 | 55/74 | 02/06→ | OE130 | 0,9 | CET4 | | BAE947A BAEA325 |
| 1.2 16V LPG | 4 | D4F734 | 55/74 | 02/06→ | OE130 | 0,9 | CET4 | | |

DACIA



kW/BHP



eon TITAN

IRIDIUM

**...DACIA****...LOGAN**

| | | | | | | | | | | |
|----------------------------|---|---|--------|--------|--|-------------------|-------------|--------------|-----------------------------|--|
| 1.4 | 4 | K7J710 | 55/74 | 09/04→ | OE026 OE216 LPG [278] | 0,9 0,8 | CET2 | OE179 | BAEA354 | CLS076 |
| 1.4 MPI LPG | 4 | K7J710; K7J714 | 55/74 | 02/06→ | OE026 OE216 LPG [278] | 0,9 0,8 | CET2 | OE179 | BAEA354 | CLS076 |
| 1.5 dCi | 4 | K9K790 | 48/64 | 09/05→ | CH271 | 11v | | | CCU147 [11] [352] | |
| 1.5 dCi | 4 | K9K792 | 50/67 | 01/06→ | CH271 | 11v | | | | |
| 1.5 dCi | 4 | K9K892 | 55/74 | 05/10→ | CH271 [9] | 11v | | | | |
| 1.5 dCi | 4 | K9K796 | 63/84 | 09/07→ | CH271 | 11v | | | | |
| 1.5 dCi | 4 | K9K892 | 65/87 | 05/10→ | CH271 [9] | 11v | | | | |
| 1.6 | 4 | K7M710 | 64/86 | 09/04→ | OE026 OE033 OE216 LPG [278] | 0,9 0,9 0,8 | CET2 | OE179 | BAEA354 | CLS019 →Eng.050317 CLS076 Eng.050318→ Eng.090920 CLS088 Eng.090921→ |
| 1.6 16V, 1.6 16V Flexifuel | 4 | K4M690; K4M694; K4M696; K4M697; K4M698 | 77/103 | 02/06→ | OE033 | 0,9 | CET2 | OE179 | BAE409A | |
| 1.6 Bifuel, 1.6 MPI 85 | 4 | K7M718; K7M800 | 62/83 | 05/10→ | OE026 OE216 LPG [278] | 0,9 0,8 | CET2 | OE179 | BAEA354 | CLS019 →Eng.050317 CLS076 Eng.050318→ Eng.090920 CLS088 Eng.090921→ |

LOGAN II

| | | | | | | | | | | |
|----------------|---|----------------|-------|--------|--------------|-----|-------------|--------------|----------------------------------|--|
| 0.9 TCe 90 | 3 | H4B400; H4B408 | 66/89 | 10/12→ | | | | OE261 | BAEA131E | |
| 0.9 TCe 90 LPG | 3 | H4B405; H4B410 | 66/89 | 09/15→ | | | | | BAEA131E | |
| 1.2, 1.2 LPG | 4 | D4F732; D4F734 | 55/74 | 10/12→ | OE130 | 0,9 | CET4 | | BAE947A BAEA325 | |

LOGAN MCV

| | | | | | | | | | | |
|--------------------------|---|----------------|--------|--------|--|------------|-------------|--------------|----------------|--|
| 1.4 | 4 | K7J710 | 55/74 | 02/07→ | OE026 OE216 LPG [278] | 0,9 0,8 | CET2 | OE179 | BAEA354 | CLS076 |
| 1.5 dCi | 4 | K9K792 | 50/67 | 02/07→ | CH271 | 11v | | | | |
| 1.5 dCi | 4 | K9K796 | 63/84 | 09/07→ | CH271 | 11v | | | | |
| 1.5 dCi | 4 | K9K892 | 65/87 | 05/10→ | CH271 [9] | 11v | | | | |
| 1.6, 1.6 Bifuel | 4 | K7M710 | 64/86 | 02/07→ | OE026 OE216 LPG [278] | 0,9 0,8 | CET2 | OE179 | BAEA354 | CLS019 →Eng.050317 CLS076 Eng.050318→ Eng.090920 CLS088 Eng.090921→ |
| 1.6 16V | 4 | K4M697 | 77/103 | 02/07→ | OE033 | 0,9 | CET2 | OE179 | | |
| 1.6 16V, 1.6 16V Hi-Flex | 4 | K4M690; K4M696 | 77/103 | 02/07→ | OE033 | 0,9 | CET2 | OE179 | BAE409A | |
| 1.6 MPI 85 | 4 | K7M800 | 62/83 | 05/10→ | OE026 OE216 LPG [278] | 0,9 0,8 | CET2 | OE179 | BAEA354 | CLS019 →Eng.050317 CLS076 Eng.050318→ Eng.090920 CLS088 Eng.090921→ |

LOGAN MCV II

| | | | | | | | | | | |
|----------------------------|---|-----------------------------------|-------|--------|--------------|-----|-------------|--------------|-----------------|-----------------------------------|
| 0.9 TCe 90, 0.9 TCe 90 LPG | 3 | H4B400; H4B405; H4B408; H4B410 | 66/89 | 02/13→ | | | | OE261 | BAEA131E | |
| 1.2 | 4 | D4F732 | 54/72 | 05/15→ | | | | | | CLS084 [296] Eng.15622→ |
| 1.2 | 4 | D4F732 | 55/74 | 02/13→ | OE130 | 0,9 | CET4 | | BAEA325 | CLS084 [296] Eng.15622→ |

CHAMPION



kW/BHP



eon TITAN

IRIDIUM



...DACIA



...LOGAN MCV II

| | | | | | | | | | | |
|---------|---|--------|-------|--------|-------|-----|------|--|--|----------------------------|
| 1.2 LPG | 4 | D4F734 | 55/74 | 02/13→ | OE130 | 0,9 | CET4 | | | CLS084 [296] Eng.15622→ |
|---------|---|--------|-------|--------|-------|-----|------|--|--|----------------------------|

NOVA

| | | | | | | | | | | |
|-----|---|-----|-------|-------------|----------------|------------|--|--|---------|--|
| 1.4 | 4 | C2J | 48/64 | 04/96→03/01 | OE007 OE064 | 0,9 0,9 | | | | |
| 1.6 | 4 | | 53/71 | 04/96→03/03 | OE051 | 0,9 | | | BAEA234 | |

PICK UP

| | | | | | | | | | | |
|-----|---|--|-------|-------------|--|--|--|--|-------------------|--|
| 1.6 | 4 | | 53/71 | 04/96→08/01 | | | | | BAEA234 02/97→ | |
|-----|---|--|-------|-------------|--|--|--|--|-------------------|--|

SANDERO

| | | | | | | | | | | |
|-------------|---|--------|-------|--------|--------------------------|------------|------|-------|--------------------------|---|
| 1.2 16V | 4 | D4F732 | 55/74 | 11/08→ | OE130 | 0,9 | CET4 | | BAE947A BAEA325 | CLS084 [296] |
| 1.2 16V LPG | 4 | D4F732 | 55/74 | 11/08→ | OE130 | 0,9 | CET4 | | BAE947A BAEA325 [323] | |
| 1.4 | 4 | K7J710 | 55/74 | 06/08→ | OE026 OE216 LPG [278] | 0,9 0,8 | CET2 | OE179 | BAEA354 | CLS076 |
| 1.4 MPI LPG | 4 | K7J714 | 53/71 | 01/09→ | OE026 OE216 LPG [278] | 0,9 0,8 | CET2 | OE179 | BAEA354 | CLS076 |
| 1.5 dCi | 4 | K9K792 | 50/67 | 11/08→ | CH271 | 11v | | | | |
| 1.5 dCi | 4 | K9K796 | 63/84 | 11/08→ | CH271 | 11v | | | | |
| 1.6 | 4 | K7M710 | 64/86 | 06/08→ | OE026 OE216 LPG [278] | 0,9 0,8 | CET2 | OE179 | BAEA354 | CLS019 →Eng.050317 CLS076 Eng.050318→ Eng.090920 CLS088 Eng.090921→ |

| | | | | | | | | | | |
|-------------------------|---|----------------|--------|--------|--------------------------|------------|------|-------|---------|---|
| 1.6 16V, 1.6 16V Bifuel | 4 | K4M690; K4M696 | 77/103 | 01/11→ | OE033 | 0,9 | CET2 | OE179 | BAE409A | |
| 1.6 16V Bifuel | 4 | K4M690; K4M694 | 77/103 | 01/11→ | OE033 | 0,9 | CET2 | OE179 | | |
| 1.6 MPI 85 | 4 | K7M800 | 62/83 | 05/10→ | OE026 OE216 LPG [278] | 0,9 0,8 | CET2 | OE179 | BAEA354 | CLS019 →Eng.050317 CLS076 Eng.050318→ Eng.090920 CLS088 Eng.090921→ |

SANDERO II

| | | | | | | | | | | |
|----------------|---|--------|-------|--------|-------|-----|------|------------------------------------|--------------------------|--|
| 0.9 TCe 90 | 3 | H4B400 | 66/89 | 10/12→ | | | | OE261 Eng.130429→ Eng.140609 | BAEA131E | |
| 0.9 TCe 90 LPG | 3 | | 66/89 | 09/15→ | | | | | BAEA131E | |
| 1.2, 1.2 LPG | 4 | D4F732 | 55/74 | 10/12→ | OE130 | 0,9 | CET4 | | BAE947A BAEA325 [323] | |

SOLENZA

| | | | | | | | | | | |
|-------|---|--------|-------|--------|--------------------------|------------|------|-------|--------------|--|
| 1.4 | 4 | E7J262 | 55/74 | 02/03→ | OE026 OE216 LPG [278] | 0,9 0,8 | CET2 | OE179 | BAEA354 | |
| 1.9 D | 4 | F8Q636 | 46/62 | 02/03→ | CH217 CH233 | 11v 11v | | | CCU129 [338] | |

SUPERNOVA

| | | | | | | | | | | |
|-----|---|--------|-------|-------------|-------|-----|------|-------|---------|--|
| 1.4 | 4 | E7J262 | 55/74 | 04/00→03/03 | OE005 | 0,9 | CET2 | OE179 | BAEA354 | |
|-----|---|--------|-------|-------------|-------|-----|------|-------|---------|--|

DACIA



DOKKER Express

| | | | | | | | | | | |
|--------------|---|----------------|--------|--------|-------|-----|------|-------|----------|--------|
| 1.2 TCe 115 | 4 | H5F402 | 84/113 | 12/12→ | | | | | BAEA131E | |
| 1.2 TCe 115 | 4 | | 85/114 | 07/15→ | | | | OE261 | BAEA131E | |
| 1.6, 1.6 LPG | 4 | K7M812; K7M828 | 61/82 | 12/12→ | OE033 | 0,9 | CET2 | OE179 | BAEA354 | CLS088 |
| 1.6, 1.6 LPG | 4 | | 75/101 | 04/15→ | | | | | BAEA354 | |

DACIA





kW/BHP

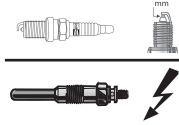

eon TITAN

IRIDIUM



...DACIA



DUSTER

| | | | | | | | | | |
|------------------------------|---|----------------|--------|---------|--------------------|-----|--|-------|----------|
| 1.2 TCe 125 4WD | 4 | H5F404 | 92/123 | 10/13 → | | | | OE261 | BAEA131E |
| 1.5 dCi 4WD | 4 | K9K658; K9K858 | 80/107 | 04/13 → | CH271 [9] [337] | 11v | | | |
| 1.6 SCe 115, 1.6 SCe 115 4WD | 4 | | 84/113 | 06/15 → | | | | | BAE409A |

LOGAN

| | | | | | | | | | |
|------------|---|--------|-------|---------|--------------------------|------------|------|-------|--|
| 1.4 | 4 | K7J710 | 55/74 | 03/09 → | OE026 OE216 LPG [278] | 0,9 0,8 | CET2 | OE179 | BAEA354 |
| 1.5 dCi | 4 | K9K792 | 50/67 | 03/09 → | CH271 [9] | 11v | | | |
| 1.5 dCi | 4 | K9K796 | 63/84 | 03/09 → | CH271 | 11v | | | |
| 1.6 | 4 | K7M710 | 64/86 | 03/09 → | OE026 OE216 LPG [278] | 0,9 0,8 | CET2 | OE179 | BAEA354 CLS019 →Eng.050317 CLS076 Eng.050318 → Eng.090920 CLS088 Eng.090921 → |
| 1.6 MPI 85 | 4 | K7M800 | 62/83 | 05/10 → | OE026 OE216 LPG [278] | 0,9 0,8 | CET2 | OE179 | BAEA354 CLS019 →Eng.050317 CLS076 Eng.050318 → Eng.090920 CLS088 Eng.090921 → |

DADI



CITY COURSER

| | | | | | | | | |
|--------------|---|---------|--------|---------------|-------------|-----|------|-------|
| 2.2, 2.2 4WD | 4 | 491QE | 76/102 | 09/01 → | OE006 | 0,9 | CET8 | OE195 |
| 2.4 4WD | 4 | 4G64S4M | 97/130 | 09/04 → 12/12 | OE063 | 1,0 | CET2 | OE180 |
| 2.8 TD | 4 | 4JB1T | 74/99 | 09/04 → | CH306 [275] | 11v | | |

ELEGANTEST

| | | | | | | | | |
|---------|---|---------|--------|---------|-------|-----|------|-------|
| 2.3 4WD | 4 | 4G64S4M | 97/130 | 05/03 → | OE063 | 1,0 | CET2 | OE180 |
|---------|---|---------|--------|---------|-------|-----|------|-------|

DADI



PICK UP

| | | | | | | | | |
|--------|---|-------|-------|---------|-------------|-----|--|--|
| 2.8 TD | 4 | 4JB1T | 74/99 | 02/01 → | CH306 [275] | 11v | | |
|--------|---|-------|-------|---------|-------------|-----|--|--|

DAEWOO



ARANOS

| | | | | | | | | |
|-----|---|-------|--------|---------------|-------|-----|------|-------|
| 2.0 | 4 | C20LE | 77/103 | 01/95 → 11/97 | OE006 | 0,9 | CET8 | OE195 |
|-----|---|-------|--------|---------------|-------|-----|------|-------|

BROUGHAM

| | | | | | | | | |
|-----|---|-------|---------|---------------|-------|-----|------|-------|
| 2.0 | 4 | | 81/109 | 08/94 → 12/97 | OE019 | 0,9 | CET2 | OE184 |
| 2.0 | 4 | X20XE | 100/134 | 08/94 → 12/97 | OE019 | 0,9 | CET2 | OE184 |

CIELO

| | | | | | | | | |
|-----|---|------|-------|---------------|-------|-----|------|------------------|
| 1.5 | 4 | Y15L | 55/74 | 04/95 → 07/97 | OE006 | 0,9 | CET8 | OE195 |
| 1.5 | 4 | V15L | 66/89 | 06/94 → 07/98 | OE006 | 0,9 | CET8 | OE195 BAEA554 |

ESPERO

| | | | | | | | | |
|---------|---|-------|--------|---------------|-------|-----|------|------------------|
| 1.5 16V | 4 | A15MF | 65/87 | 10/93 → 09/94 | OE039 | 1,0 | CET2 | OE180 |
| 1.5 16V | 4 | A15MF | 66/89 | 02/95 → 06/99 | OE039 | 1,0 | CET2 | OE180 BAEA554 |
| 1.8 | 4 | C18LE | 66/89 | 02/95 → 09/99 | OE006 | 0,9 | CET8 | OE195 BAEA554 |
| 1.8 | 4 | C18LE | 70/94 | 02/95 → 06/99 | OE006 | 0,9 | CET8 | OE195 BAEA554 |
| 2.0 | 4 | C20LE | 77/103 | 02/95 → 06/99 | | | CET8 | OE195 BAEA554 |
| 2.0 | 4 | C20LE | 81/109 | 10/93 → 09/94 | | | CET8 | OE195 |

EVANDA

| | | | | | | | | |
|-----|---|--------|--------|---------|-------|-----|------|-------------------|
| 2.0 | 4 | L88 | 96/129 | 08/02 → | OE019 | 0,9 | CET2 | OE184 |
| 2.0 | 4 | X20SED | 96/129 | 08/02 → | OE019 | 0,9 | CET2 | OE184 BAEA447A |





kW/BHP

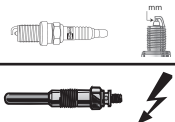

eon TITAN

IRIDIUM



...DAEWOO

**GENTRA**

| | | | | | | | | | | |
|--------------|---|-------|--------|--------|-------|-----|------|-------|--|--|
| 1.6 E-Tec LS | 4 | F16D3 | 77/103 | 05/05→ | OE039 | 1,0 | CET2 | OE179 | | |
|--------------|---|-------|--------|--------|-------|-----|------|-------|--|--|

KALOS

| | | | | | | | | | | |
|-----|---|--------------|-------|--------|-------|-----|------|-------|----------|--------|
| 1.2 | 4 | B12S1; F12S3 | 53/71 | 04/03→ | OE049 | 1,0 | CET8 | OE195 | BAEA447A | CLS085 |
|-----|---|--------------|-------|--------|-------|-----|------|-------|----------|--------|

| | | | | | | | | | | |
|-----|---|-------|-------|--------|-------|-----|------|-------|----------|--------|
| 1.4 | 4 | F14S3 | 61/82 | 09/02→ | OE006 | 0,9 | CET8 | OE195 | BAEA447A | CLS025 |
|-----|---|-------|-------|--------|-------|-----|------|-------|----------|--------|

| | | | | | | | | | | |
|-----|---|-------|-------|-------------|-------|-----|------|-------|----------|------------------|
| 1.4 | 4 | F14D3 | 69/93 | 05/03→12/04 | OE005 | 0,9 | CET2 | OE179 | BAEA447A | CLS020 CLS196 |
|-----|---|-------|-------|-------------|-------|-----|------|-------|----------|------------------|

| | | | | | | | | | | |
|---------|---|-------|-------|--------|-------|-----|------|-------|----------|--|
| 1.4 16V | 4 | F14D3 | 69/93 | 04/03→ | OE005 | 0,9 | CET2 | OE179 | BAEA447A | CLS020 [275] CLS086 [275] CLS196 |
|---------|---|-------|-------|--------|-------|-----|------|-------|----------|--|

| | | | | | | | | | | |
|-----|---|------|-------|-------------|-------|-----|------|-------|----------|--|
| 1.5 | 4 | F15S | 62/83 | 11/02→12/04 | OE006 | 0,9 | CET8 | OE195 | BAEA447A | |
|-----|---|------|-------|-------------|-------|-----|------|-------|----------|--|

KORANDO

| | | | | | | | | | | |
|-------------|---|----------|--------|--------|-------|-----|------|-------|---------|--|
| 2.0 16V 4WD | 4 | M161.950 | 94/126 | 02/99→ | OE019 | 0,9 | CET2 | OE184 | BAEA340 | |
|-------------|---|----------|--------|--------|-------|-----|------|-------|---------|--|

| | | | | | | | | | | |
|---------|---|----------|---------|--------|-------|-----|------|-------|---------|--|
| 2.3 4WD | 4 | M161.970 | 105/141 | 01/99→ | OE005 | 0,9 | CET2 | OE180 | BAEA340 | |
|---------|---|----------|---------|--------|-------|-----|------|-------|---------|--|

| | | | | | | | | | | |
|-----------|---|----------|-------|--------|-------|-------|--|--|--|--|
| 2.9 D 4WD | 5 | MB-OM662 | 72/97 | 01/99→ | CH176 | 11.5v | | | | |
|-----------|---|----------|-------|--------|-------|-------|--|--|--|--|

| | | | | | | | | | | |
|------------|---|--------------|--------|--------|-------|-------|--|--|--|--|
| 2.9 TD 4WD | 5 | MB-OM60129TD | 88/118 | 01/99→ | CH176 | 11.5v | | | | |
|------------|---|--------------|--------|--------|-------|-------|--|--|--|--|

| | | | | | | | | | | |
|---------|---|----------|---------|--------|-------|-----|------|-------|---------|--|
| 3.2 4WD | 6 | M104.995 | 156/209 | 01/99→ | OE005 | 0,9 | CET2 | OE180 | BAEA340 | |
|---------|---|----------|---------|--------|-------|-----|------|-------|---------|--|

LACETTI

| | | | | | | | | | | |
|-----|---|-------|-------|--------|-------|-----|------|-------|---------|------------------|
| 1.4 | 4 | F14D3 | 70/94 | 02/04→ | OE005 | 0,9 | CET2 | OE179 | BAEA543 | CLS020 CLS196 |
|-----|---|-------|-------|--------|-------|-----|------|-------|---------|------------------|

| | | | | | | | | | | |
|-----|---|-------|--------|--------|-------|-----|------|-------|---------|--------|
| 1.6 | 4 | F16D3 | 80/107 | 02/04→ | OE039 | 1,0 | CET2 | OE179 | BAEA543 | CLS196 |
|-----|---|-------|--------|--------|-------|-----|------|-------|---------|--------|

| | | | | | | | | | | |
|-----|---|--------|--------|--------|-------|-----|------|-------|---|--------|
| 1.8 | 4 | T18SED | 90/121 | 02/04→ | OE019 | 0,9 | CET2 | OE188 | BAEA447A →02/06 BAEA508 02/06→ | CLS107 |
|-----|---|--------|--------|--------|-------|-----|------|-------|---|--------|

| | | | | | | | | | | |
|---------|---|-------|-------|-------------|--|--|--|--|---------|--|
| 1.8 CDX | 4 | F18D2 | 67/90 | 08/03→12/04 | | | | | BAEA508 | |
|---------|---|-------|-------|-------------|--|--|--|--|---------|--|

| | | | | | | | | | | |
|---------|---|--------|--------|-------------|--|--|--------|-------|---------|--|
| 1.8 CDX | 4 | T18SED | 90/121 | 08/03→12/04 | | | CET12P | OE184 | BAEA508 | |
|---------|---|--------|--------|-------------|--|--|--------|-------|---------|--|

| | | | | | | | | | | |
|-----|---|--------|--------|-------------|-------|-----|------|-------|--|--|
| 2.0 | 4 | C20SED | 81/109 | 06/99→07/03 | OE019 | 0,9 | CET2 | OE184 | | |
|-----|---|--------|--------|-------------|-------|-----|------|-------|--|--|

| | | | | | | | | | | |
|-----|---|--------|--------|-------------|-------|-----|------|-------|----------------------------------|--|
| 2.0 | 4 | X20SED | 98/131 | 06/99→07/03 | OE019 | 0,9 | CET2 | OE184 | BAEA025E [275] BAEA447A [275] | |
|-----|---|--------|--------|-------------|-------|-----|------|-------|----------------------------------|--|

LANOS

| | | | | | | | | | | |
|-----|---|----------------|-------|--------|-------|-----|------|-------|------------------------|--------|
| 1.3 | 4 | A13SMS; A14SMS | 55/74 | 05/97→ | OE006 | 0,9 | CET8 | OE195 | BAEA447A Ch.590906→ | CLS025 |
|-----|---|----------------|-------|--------|-------|-----|------|-------|------------------------|--------|

| | | | | | | | | | | |
|-----|---|--------|-------|--------|-------|-----|------|-------|------------------------------------|--------|
| 1.5 | 4 | A15SMS | 63/84 | 05/97→ | OE006 | 0,9 | CET8 | OE195 | BAEA025E BAEA447A Ch.590906→ | CLS025 |
|-----|---|--------|-------|--------|-------|-----|------|-------|------------------------------------|--------|

| | | | | | | | | | | |
|-----|---|--------|-------|-------------|-------|-----|------|-------|----------|--|
| 1.5 | 4 | A15DMS | 73/98 | 10/97→06/99 | OE006 | 0,9 | CET8 | OE195 | BAEA447A | |
|-----|---|--------|-------|-------------|-------|-----|------|-------|----------|--|

| | | | | | | | | | | |
|---------|---|--------|--------|--------|-------|-----|------|-------|----------------------------------|--------|
| 1.6 16V | 4 | A16DMS | 78/105 | 02/97→ | OE039 | 1,0 | CET2 | OE179 | BAEA025E [275] BAEA447A [275] | CLS020 |
|---------|---|--------|--------|--------|-------|-----|------|-------|----------------------------------|--------|

LEGANZA

| | | | | | | | | | | |
|--------|---|-------|-------|-------------|-------|-----|------|-------|--|--|
| 1.8 CD | 4 | C18LE | 70/94 | 06/97→07/03 | OE006 | 0,9 | CET8 | OE195 | | |
|--------|---|-------|-------|-------------|-------|-----|------|-------|--|--|

| | | | | | | | | | | |
|---------|---|--------|--------|-------------|-------|-----|------|-------|----------------------------------|--|
| 2.0 16V | 4 | T20SED | 93/125 | 07/00→04/04 | OE019 | 0,9 | CET2 | OE184 | BAEA025E [275] BAEA447A [275] | |
|---------|---|--------|--------|-------------|-------|-----|------|-------|----------------------------------|--|

| | | | | | | | | | | |
|---------|---|--------|--------|-------------|-------|-----|------|-------|----------------------------------|--|
| 2.0 16V | 4 | X20SED | 98/131 | 06/97→12/02 | OE019 | 0,9 | CET2 | OE184 | BAEA025E [275] BAEA447A [275] | |
|---------|---|--------|--------|-------------|-------|-----|------|-------|----------------------------------|--|

| | | | | | | | | | | |
|---------|---|--------|---------|-------------|-------|-----|------|-------|----------------------------------|--|
| 2.2 16V | 4 | T22SED | 100/134 | 04/99→12/02 | OE026 | 0,9 | CET2 | OE188 | BAEA025E [275] BAEA447A [275] | |
|---------|---|--------|---------|-------------|-------|-----|------|-------|----------------------------------|--|

MAGNUS

| | | | | | | | | | | |
|-----|---|--------|--------|--------|-------|-----|------|-------|----------------------------------|--|
| 2.0 | 4 | X20SED | 96/129 | 07/99→ | OE019 | 0,9 | CET2 | OE184 | BAEA025E [275] BAEA447A [275] | |
|-----|---|--------|--------|--------|-------|-----|------|-------|----------------------------------|--|

| | | | | | | | | | | |
|-----|---|-------|---------|-------------|-------|-----|--------|-------|--|--|
| 2.5 | 6 | X25D1 | 115/154 | 08/03→12/04 | OE146 | 1,0 | CET12P | OE179 | | |
|-----|---|-------|---------|-------------|-------|-----|--------|-------|--|--|

DAEWOO





kW/BHP

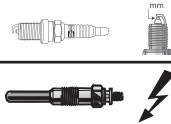

eon TITAN

IRIDIUM



...DAEWOO



MATIZ

| | | | | | | | | | | |
|-----|---|------|-------|---------|-------|-----|------|-------|---|------------------------|
| 0.8 | 3 | F8CV | 38/51 | 09/98 → | OE048 | 1,0 | CET8 | OE195 | BAEA540 →09/00 →Ch.577030 BAEA539 10/00 → | CLS013 [292] →12/01 |
| 1.0 | 4 | B10S | 47/63 | 01/03 → | OE006 | 0,9 | CET8 | OE195 | BAEA447A | CLS085 |

MUSSO

| | | | | | | | | | | |
|------------|---|--------------|---------|--------------|-------|-------|------|-------|---------|------------------|
| 2.2 TD 4WD | 4 | MBOM601 | 74/99 | 09/99 → | CH176 | 11.5v | | | | |
| 2.3 4WD | 4 | M111.970 | 103/138 | 01/99 → | OE003 | 0,9 | CET2 | OE180 | BAEA340 | CLS063 CLS071 |
| 2.9 D 4WD | 5 | MB-OM662 | 73/98 | 01/99 →09/99 | CH176 | 11.5v | | | | |
| 2.9 TD 4WD | 5 | MB-OM60129TD | 88/118 | 01/99 → | CH176 | 11.5v | | | | |
| 3.2 4WD | 6 | M104.992 | 162/217 | 01/99 → | OE005 | 0,9 | CET2 | OE180 | BAEA340 | |

NEXIA

| | | | | | | | | | | |
|---------|---|-------|--------|--------------|--------------------------|------|------|-------|--------------------|--|
| 1.5 | 4 | G15MF | 44/59 | 08/96 →08/97 | OE006 *to be adjusted | 0,7* | CET8 | OE195 | BAEA554 | |
| 1.5 | 4 | G15MF | 52/70 | 02/95 →08/97 | | | CET8 | OE195 | BAEA554 | |
| 1.5 | 4 | G15MF | 55/74 | 02/95 →08/97 | OE006 | 0,9 | CET8 | OE195 | BAEA554 | |
| 1.5 | 4 | Y15L | 59/79 | 08/97 → | OE006 | 0,9 | CET8 | OE195 | BAEA554 | |
| 1.5 16V | 4 | A15MF | 66/89 | 02/95 →08/97 | OE039 | 1,0 | CET2 | OE180 | BAEA554 | |
| 1.6 | 4 | F16D3 | 80/107 | 08/97 → | OE039 | 1,0 | CET2 | OE179 | BAEA543 BAEA554 | |

NUBIRA

| | | | | | | | | | | |
|---------|---|--------------|--------|--------------|----------------|------------|------|----------------|--------------------------------|--------|
| 1.4 | 4 | F14D3 | 69/93 | 10/03 →12/04 | OE005 | 0,9 | CET2 | OE179 | BAEA543 | CLS020 |
| 1.5 SE | 4 | A15DMS | 81/109 | 06/99 →07/03 | OE039 | 1,0 | CET2 | OE179 | | |
| 1.6 | 4 | A16DMS | 76/102 | 08/02 →07/03 | OE019 | 0,9 | CET2 | OE184 | BAEA447A | |
| 1.6 | 4 | F16D3 | 80/107 | 07/03 → | OE039 | 1,0 | CET2 | OE179 | BAEA543 | CLS196 |
| 1.6 16V | 4 | A16SMS | 66/89 | 06/97 → | OE039 | 1,0 | CET2 | | BAEA025E[275] BAEA447A[275] | |
| 1.6 16V | 4 | A16DMS | 76/102 | 07/00 → | OE019 OE039 | 0,9 1,0 | CET2 | OE179 OE184 | BAEA447A | CLS020 |
| 1.6 16V | 4 | A16DMS | 78/105 | 05/97 → | OE019 | 0,9 | CET2 | OE184 | BAEA025E[275] BAEA447A[275] | CLS020 |
| 1.8 | 4 | C18LE | 70/94 | 06/04 → | OE006 | 0,9 | CET8 | OE195 | | |
| 1.8 | 4 | T18SED | 90/121 | 07/03 → | OE019 | 0,9 | CET2 | OE184 | BAEA447A →02/06 BAEA508 | |
| 2.0 | 4 | C20SED | 81/109 | 06/99 →07/03 | OE019 | 0,9 | CET2 | OE184 | BAEA025E[275] BAEA447A[275] | |
| 2.0 16V | 4 | T20SED | 93/125 | 12/00 → | OE019 | 0,9 | CET2 | OE184 | BAEA447A | |
| 2.0 16V | 4 | X20SED; Z20L | 98/131 | 05/97 → | OE019 | 0,9 | CET2 | OE184 | BAEA025E[275] BAEA447A[275] | |

PRINCE

| | | | | | | | | | | |
|-----|---|---------------|---------|--------------|-------|-----|------|-------|--|--|
| 2.0 | 4 | C20LE; C20NED | 85/114 | 08/94 →12/98 | OE006 | 0,9 | CET8 | OE195 | | |
| 3.0 | 6 | C30NE | 130/174 | 08/94 →07/97 | OE064 | 0,9 | | | | |

REXTON

| | | | | | | | | | | |
|------------|---|-----------|---------|---------|-------|-------|------|-------|---------|--|
| 2.9 TD 4WD | 5 | OM662.983 | 88/118 | 04/02 → | CH176 | 11.5v | | | | |
| 3.2 V6 4WD | 6 | M162.992 | 162/217 | 04/02 → | OE005 | 0,9 | CET2 | OE180 | BAEA340 | |

REZZO

| | | | | | | | | | | |
|--------|---|--------|--------|--------------|-------|-----|------|-------|----------|--------|
| 1.6 | 4 | A16DMS | 77/103 | 09/00 → | OE039 | 1,0 | CET2 | OE195 | BAEA447A | CLS020 |
| 1.6 SX | 4 | A16SMS | 66/89 | 08/01 →12/04 | OE039 | 1,0 | CET2 | | BAEA447A | CLS020 |
| 1.8 | 4 | F18D2 | 67/90 | 09/00 → | OE006 | 0,9 | CET8 | OE195 | BAEA447A | |
| 1.8 | 4 | A18DMS | 72/97 | 09/00 → | OE006 | 0,9 | CET8 | OE195 | BAEA447A | |
| 1.8 | 4 | F18S2 | 74/99 | 09/00 → | OE006 | 0,9 | CET8 | OE195 | BAEA447A | |



kW/BHP



eon TITAN

IRIDIUM

**...DAEWOO****...REZZO**

| | | | | | | | | | |
|-----|---|--------|--------|-------------|-------|-----|------|-------|----------|
| 2.0 | 4 | X20SED | 89/119 | 09/01→12/04 | OE019 | 0,9 | CET2 | OE184 | BAEA447A |
| 2.0 | 4 | T20SED | 94/126 | 09/00→ | OE019 | 0,9 | CET2 | OE184 | BAEA447A |

SUPER SALOON

| | | | | | | | | | |
|------------|---|-------|---------|-------------|-------|-----|--|--|--|
| 3.0 Luxury | 6 | C30NE | 130/174 | 08/94→08/95 | OE064 | 0,9 | | | |
|------------|---|-------|---------|-------------|-------|-----|--|--|--|

TICO

| | | | | | | | | | |
|-----|---|------|-------|-------------|-------|-----|------|-------|---------|
| 0.8 | 3 | F8C | 35/47 | 02/95→12/00 | OE049 | 1,0 | CET8 | | BAEA539 |
| 0.8 | 3 | F8CV | 38/51 | 01/96→12/00 | OE048 | 1,0 | CET8 | OE195 | BAEA540 |

TOSCA

| | | | | | | | | | |
|---------------|---|-------|---------|--------|-------|-----|--------|-------|--|
| 2.0 XT | 6 | X20D1 | 105/141 | 02/06→ | OE146 | 1,0 | CET12P | OE179 | |
| 2.5 Executive | 6 | X25D1 | 115/154 | 02/06→ | OE146 | 1,0 | CET12P | OE179 | |

WINSTORM

| | | | | | | | | | |
|--------------------|---|--------|---------|--------|-------|-----|------|-------|--|
| 2.4, 2.4 4WD | 4 | Z24XED | 104/139 | 12/06→ | OE019 | 0,9 | CET2 | OE184 | |
| 2.4 LS, 2.4 LT 4WD | 4 | Z24XED | 103/138 | 12/06→ | OE019 | 0,9 | CET2 | OE184 | |

DAEWOO**MATIZ**

| | | | | | | | | | |
|-----|---|------|-------|-------------|--|--|--|--|--|
| 0.8 | 3 | F8CV | 38/51 | 08/98→08/02 | | | | | BAEA540 →Ch.577030 BAEA539 Ch.577031→ |
|-----|---|------|-------|-------------|--|--|--|--|--|

DAIHATSU**ALTIS**

| | | | | | | | | | |
|------------------------------|---|--------|---------|-------------|-------|-----|--------|-------|--|
| 2.2 4WD, 2.2 SL, 2.2 SL 4WD | 4 | 5S-FE | 103/138 | 10/96→07/01 | OE039 | 1,0 | CET2 | OE179 | |
| 2.4, 2.4 4WD | 4 | 2AZ-FE | 112/150 | 08/01→12/05 | | | CET12P | OE182 | |
| 2.4 VVTi SX, 2.4 VVTi SX 4WD | 4 | 2AZ-FE | 116/156 | 01/06→12/10 | | | CET12P | OE182 | |

APPLAUSE II

| | | | | | | | | | |
|---------|---|------|-------|-------------|-------|-----|------|-------|--|
| 1.6 16V | 4 | HD-E | 73/98 | 07/97→05/00 | OE039 | 1,0 | CET2 | OE180 | |
|---------|---|------|-------|-------------|-------|-----|------|-------|--|

BOON

| | | | | | | | | | |
|--------------|---|--------|-------|--------|--|--|--------|-------|--|
| 1.0, 1.0 4WD | 3 | 1KR-FE | 51/68 | 01/10→ | | | CET14P | OE190 | |
|--------------|---|--------|-------|--------|--|--|--------|-------|--|

CHARADE

| | | | | | | | | | |
|---------|---|--------|-------|--------|--|--|--|--|----------|
| 1.3 16V | 4 | 1NR-FE | 73/98 | 05/11→ | | | | | BAEA172E |
|---------|---|--------|-------|--------|--|--|--|--|----------|

CHARADE IV

| | | | | | | | | | |
|-----------|---|---------|--------|-------------|-------|-----|--------|-------|--|
| 1.0 | 3 | CB22 | 38/51 | 09/94→03/96 | OE048 | 1,0 | CET8 | OE195 | |
| 1.3 | 4 | HC | 44/59 | 09/96→11/99 | OE039 | 1,0 | CET2 | OE180 | |
| 1.3 16V | 4 | HCE | 55/74 | 05/96→11/99 | | | CET2 | OE179 | |
| 1.3 i 16V | 4 | HC; HCE | 62/83 | 01/93→09/00 | OE039 | 1,0 | CET2 | OE180 | |
| 1.5 16V | 4 | HEE | 55/74 | 10/94→01/01 | OE039 | 1,0 | CET2 | OE180 | |
| 1.5 i 16V | 4 | HEEG | 66/89 | 06/94→11/99 | | | CET2 | OE179 | |
| 1.5 i 16V | 4 | HEE | 66/89 | 06/94→11/99 | OE030 | 0,9 | CET2 | OE179 | |
| 1.6 GTi | 4 | HD-E | 77/103 | 03/93→11/99 | | | CET12P | OE179 | |

COO

| | | | | | | | | | |
|-----|---|-------|-------|--------|-------|-----|------|-------|--|
| 1.0 | 3 | EJ-VE | 43/58 | 10/06→ | OE019 | 0,9 | CET2 | OE184 | |
|-----|---|-------|-------|--------|-------|-----|------|-------|--|

COPEN

| | | | | | | | | | |
|-----|---|------------|-------|-------------|--|--|--------|-------|----------|
| 0.7 | 4 | JB; JB-DET | 50/67 | 09/03→12/07 | | | CET12P | OE179 | |
| 1.3 | 4 | K3-VE | 64/86 | 03/06→09/12 | | | CET12P | OE179 | BAEA194E |

CUORE IV

| | | | | | | | | | |
|-----|---|------|-------|-------------|-------|-----|------|-------|--|
| 0.8 | 3 | ED20 | 31/42 | 11/96→10/98 | OE006 | 0,9 | CET8 | OE195 | |
| 0.8 | 3 | ED20 | 32/43 | 01/95→08/98 | OE006 | 0,9 | CET8 | OE195 | |

CUORE V

| | | | | | | | | | |
|----------|---|--------------|-------|-------------|-------|-----|------|-------|----------|
| 1.0 DVVT | 3 | EJ-VE | 43/58 | 10/00→02/03 | OE019 | 0,9 | CET2 | OE184 | |
| 1.0 i | 3 | EJ-DE; EJ-VE | 41/55 | 10/98→05/03 | OE026 | 0,9 | CET2 | OE188 | BAEA180E |

DAIHATSU



kW/BHP

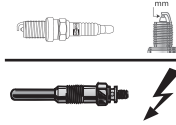

eon TITAN

IRIDIUM

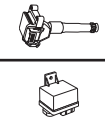
**...DAIHATSU****CUORE VI**

| | | | | | | | | | | |
|-----|---|-------|-------|--------|----------------|------------|------|----------------|--|--|
| 1.0 | 3 | EJ-VE | 43/58 | 03/03→ | OE019 OE026 | 0,9 0,9 | CET2 | OE184 OE188 | | |
|-----|---|-------|-------|--------|----------------|------------|------|----------------|--|--|

CUORE VII

| | | | | | | | | | | |
|-----|---|--------|-------|--------|--|--|--------|-------|----------|--|
| 1.0 | 3 | 1KR-FE | 51/68 | 04/07→ | | | CET14P | OE190 | BAEA164E | |
|-----|---|--------|-------|--------|--|--|--------|-------|----------|--|

GRAN MOVE

| | | | | | | | | | | |
|---------|---|------|-------|-------------|--|--|--------|-------|--|--|
| 1.5 16V | 4 | HEEG | 66/89 | 10/96→07/98 | | | CET12P | OE179 | | |
| 1.6 16V | 4 | HDEP | 67/90 | 05/98→ | | | CET12P | OE179 | | |

HIJET

| | | | | | | | | | | |
|-------|---|------|-------|-------------|-------|-----|------|-------|--|--|
| 1.0 | 3 | CB42 | 35/47 | 10/94→05/98 | OE006 | 0,9 | CET8 | OE195 | | |
| 1.2 D | 4 | | 27/36 | 01/96→03/98 | CH189 | 11v | | | | |

MATERIA

| | | | | | | | | | | |
|------------------|---|--------|--------|--------|-------|-----|--------|-------|----------|--|
| 1.0 DVVT | 3 | EJ-VE | 43/58 | 10/06→ | OE019 | 0,9 | CET2 | OE184 | | |
| 1.3 | 4 | K3-VE | 67/90 | 10/06→ | | | CET10P | OE187 | BAEA194E | |
| 1.5, 1.5 ECO 4WD | 4 | 3SZ-VE | 76/102 | 10/06→ | | | CET10P | OE187 | BAEA194E | |

MOVE

| | | | | | | | | | | |
|-------|---|-------|-------|-------------|-------|-----|------|-------|----------|--|
| 0.8 | 3 | ED20 | 31/42 | 01/97→11/99 | OE048 | 1,0 | CET8 | OE195 | | |
| 1.0 i | 3 | EJ-DE | 41/55 | 10/98→09/02 | OE026 | 0,9 | CET2 | OE188 | BAEA180E | |

SIRION

| | | | | | | | | | | |
|------------------|---|--------|--------|-------------|-------|-----|--------|-------|----------|--|
| 1.0 | 3 | 1KR-FE | 51/68 | 01/05→ | | | CET14P | OE190 | BAEA164E | |
| 1.0 DVVT 4WD | 3 | 1KR-FE | 51/68 | 04/05→ | | | CET14P | OE190 | | |
| 1.0 i | 3 | EJ-VE | 43/58 | 09/00→01/05 | OE026 | 0,9 | CET2 | OE188 | BAEA180E | |
| 1.0 i, 1.0 i 4WD | 3 | EJ-DE | 41/55 | 04/98→09/00 | OE026 | 0,9 | CET2 | OE188 | BAEA180E | |
| 1.0 i 4WD | 3 | EJ-VE | 43/58 | 09/00→01/05 | OE026 | 0,9 | CET2 | OE188 | | |
| 1.3 | 4 | K3-VE | 64/86 | 01/05→ | | | CET12P | OE179 | BAEA194E | |
| 1.3, 1.3 4WD | 4 | K3-VE | 67/90 | 03/08→ | OE199 | 0,9 | CET1 | | BAEA194E | |
| 1.3 4WD | 4 | K3-VE | 64/86 | 04/05→ | OE089 | 1,0 | CET2 | OE188 | BAEA194E | |
| 1.3 Sport | 4 | K3-VE2 | 75/101 | 08/00→01/05 | | | CET2 | OE182 | BAEA194E | |
| 1.3 Sport 4WD | 4 | K3-VE2 | 75/101 | 08/00→03/05 | | | CET2 | OE182 | | |
| 1.5 | 4 | 3SZ-VE | 76/102 | 03/08→ | OE199 | 0,9 | CET1 | | BAEA194E | |

TERIOS

| | | | | | | | | | | |
|---------------|---|--------|--------|-------------|--------------------------|------------|--------|-------|----------|--------|
| 1.3, 1.3 4WD | 4 | K3-VE | 63/84 | 10/00→10/05 | | | | OE188 | | |
| 1.3 4WD | 4 | HC-EJ | 61/82 | 10/97→10/00 | OE026 OE216 LPG (278) | 0,9 0,8 | CET2 | OE188 | | CLS163 |
| 1.3 VVT-i 4WD | 4 | K3-VE | 63/84 | 11/05→ | OE089 | 1,0 | CET2 | OE188 | BAEA194E | |
| 1.5 4WD | 4 | 3SZ-VE | 77/103 | 05/06→ | | | CET10P | OE187 | BAEA194E | |
| 1.5 VVT-i 4WD | 4 | 3SZ-VE | 75/101 | 09/10→ | OE199 | 0,9 | CET1 | | | |

TREVIS

| | | | | | | | | | | |
|-----|---|-------|-------|--------|-------|-----|------|-------|--|--|
| 1.0 | 3 | EJ-VE | 43/58 | 06/06→ | OE026 | 0,9 | CET2 | OE188 | | |
|-----|---|-------|-------|--------|-------|-----|------|-------|--|--|

YRV

| | | | | | | | | | | |
|--------------|---|--------|--------|--------|-------|-----|--------|-------|--|--|
| 1.0 | 3 | EJ-VE | 43/58 | 02/01→ | OE026 | 0,9 | CET2 | OE188 | | |
| 1.3, 1.3 4WD | 4 | K3-VE | 64/86 | 02/01→ | | | | OE188 | | |
| 1.3 GTi | 4 | K3-VET | 95/127 | 07/02→ | OE136 | 0,8 | CET12P | OE179 | | |

DAIHATSU**EXTOL**

| | | | | | | | | | | |
|-----|---|-------|-------|-------------|--|--|--|-------|--|--|
| 1.3 | 4 | K3-VE | 63/84 | 07/00→11/11 | | | | OE188 | | |
|-----|---|-------|-------|-------------|--|--|--|-------|--|--|

HIJET

| | | | | | | | | | | |
|-----------|---|-------|-------|-------------|-------|-----|------|-------|--|--|
| 0.5 | 2 | AB30 | 20/27 | 10/94→12/95 | OE006 | 0,9 | CET8 | OE195 | | |
| 1.0 i | 3 | CB42 | 35/47 | 07/94→05/98 | OE006 | 0,9 | CET8 | OE195 | | |
| 1.2 D | 4 | LDW12 | 26/35 | 05/95→03/98 | CH189 | 11v | | | | |
| 1.3 i 16V | 4 | HCE | 48/64 | 05/98→ | OE039 | 1,0 | CET2 | OE180 | | |





kW/BHP



eon TITAN

IRIDIUM

**DAIMLER****DAIMLER XJ**

| | | | | | | | | | |
|------------------|----|--------|---------|-------------|-------|-----|--------|-------|--------------------------|
| 4.0 V8 Super 4.0 | 8 | DC | 267/358 | 07/97→06/03 | OE146 | 1,0 | CET12P | OE179 | BAEA368 ^[277] |
| 4.0 Long | 8 | AJ-V8 | 216/290 | 10/97→06/03 | OE002 | 0,9 | CET2 | | |
| 4.0 Six | 6 | 9JPF8B | 177/237 | 10/94→06/03 | OE002 | 0,9 | CET2 | OE179 | |
| 4.0 Six | 8 | BC | 209/280 | 07/97→12/02 | OE136 | 0,8 | CET12P | OE179 | BAEA368 ^[277] |
| 6.0 Double Six | 12 | 8E | 229/307 | 10/94→06/03 | OE011 | 0,9 | CET9 | OE183 | |

XJ 40, 81

| | | | | | | | | | |
|----------------|----|----|---------|-------------|-------|-----|------|-------|--|
| 6.0 Double Six | 12 | 8C | 229/307 | 02/93→09/94 | OE011 | 0,9 | CET9 | OE183 | |
|----------------|----|----|---------|-------------|-------|-----|------|-------|--|

DALLAS**FUN**

| | | | | | | | | | |
|-------|---|-----------|-------|-------------|-------|-----|--|--|--|
| 1.8 D | 4 | 161(XUD7) | 43/58 | 01/94→12/98 | CH189 | 11v | | | |
|-------|---|-----------|-------|-------------|-------|-----|--|--|--|

DE TOMASO**BIGUA**

| | | | | | | | | | |
|-----|---|--|---------|-------------|--|--|------|--|--|
| 4.6 | 8 | | 237/318 | 01/96→12/02 | | | CET9 | | |
|-----|---|--|---------|-------------|--|--|------|--|--|

GUARA

| | | | | | | | | | |
|-----|---|--|---------|-------------|-------|-----|------|-------|--|
| 4.0 | 8 | | 208/279 | 01/93→12/04 | OE030 | 0,9 | CET2 | OE179 | |
|-----|---|--|---------|-------------|-------|-----|------|-------|--|

DODGE**AVENGER**

| | | | | | | | | | |
|-----|---|----------|---------|--------|-------|-----|------|-------|-------------------------|
| 2.0 | 4 | ECN | 115/154 | 06/07→ | OE154 | 1,0 | CET2 | OE194 | |
| 2.4 | 4 | EDG | 125/168 | 06/07→ | OE154 | 1,0 | CET2 | OE194 | |
| 2.4 | 4 | ED3; EDG | 129/173 | 06/07→ | OE154 | 1,0 | CET2 | OE194 | |
| 2.7 | 6 | EER | 137/184 | 06/07→ | | | | | BAEA453 ^[68] |

CALIBER

| | | | | | | | | | |
|--------------|---|-----|---------|-------------|-------|-----|------|-------|--|
| 1.8 | 4 | EBA | 110/148 | 06/06→12/09 | OE154 | 1,0 | CET2 | OE194 | |
| 2.0 | 4 | ECN | 115/154 | 06/06→ | OE154 | 1,0 | CET2 | OE194 | |
| 2.4 | 4 | ED3 | 125/168 | 10/06→ | OE154 | 1,0 | CET2 | OE194 | |
| 2.4 | 4 | ED3 | 126/169 | 10/06→ | OE154 | 1,0 | CET2 | | |
| 2.4 4WD | 4 | ED3 | 125/168 | 10/06→ | OE154 | 1,0 | CET2 | | |
| 2.4 SRT4 4WD | 4 | ED4 | 223/299 | 10/06→ | OE154 | 1,0 | CET2 | OE194 | |
| 2.4 Turbo | 4 | ED4 | 217/291 | 12/07→ | OE154 | 1,0 | CET2 | OE194 | |

CARAVAN

| | | | | | | | | | |
|------------------|---|-----|---------|-------------|-------|-----|------|-------|--|
| 2.0 i | 4 | | 98/131 | 01/95→03/01 | OE002 | 0,9 | CET2 | OE180 | |
| 2.5 TD | 4 | ENC | 85/114 | 01/95→03/01 | CH189 | 11v | | | |
| 3.0 | 6 | EFA | 112/150 | 01/95→03/01 | OE042 | 0,9 | CET8 | | |
| 3.3 i | 6 | EGP | 116/156 | 01/95→03/01 | OE105 | 1,3 | | | |
| 3.8 i, 3.8 i 4WD | 6 | EGH | 122/164 | 01/95→03/01 | OE105 | 1,3 | | | |
| 3.8 i, 3.8 i 4WD | 6 | EGH | 131/176 | 01/95→03/01 | OE105 | 1,3 | | | |

CHALLENGER

| | | | | | | | | | |
|----------|---|-----|---------|--------|--|--|--------|-------|--|
| 6.4 SRT8 | 8 | ESH | 346/464 | 08/11→ | | | CET17P | OE189 | |
| 6.4 SRT8 | 8 | ESG | 351/471 | 01/11→ | | | CET17P | OE189 | |

CHARGER

| | | | | | | | | | |
|----------|---|-----|---------|-------------|--|--|--------|-------|--------------------------|
| 2.7 | 6 | EER | 141/189 | 04/06→12/10 | | | | | BAEA453 |
| 3.5 | 6 | EGG | 186/249 | 06/05→12/10 | | | | | BAEA432 ^[277] |
| 6.4 SRT8 | 8 | ESG | 351/471 | 09/11→ | | | CET17P | OE189 | |

DAKOTA

| | | | | | | | | | |
|------------------|---|-----|---------|-------------|-------|-----|------|-------|--|
| 2.5 | 4 | EDM | 88/118 | 10/95→09/03 | OE013 | 0,8 | CET2 | | |
| 3.9 4WD, 3.9 SLT | 6 | EHC | 128/172 | 10/95→09/03 | OE128 | 1,0 | | | |
| 4.7, 4.7 4WD | 8 | EVA | 172/231 | 09/99→ | OE154 | 1,0 | CET2 | OE194 | |
| 5.9 | 8 | EML | 184/247 | 10/00→09/03 | OE128 | 1,0 | | | |

DODGE



kW/BHP



eon TITAN

IRIDIUM

**...DODGE****DART**

| | | | | | | | | | | |
|-------|---|-----|---------|--------|-------|-----|------|-------|--|---------|
| 1.4 T | 4 | EAF | 119/160 | 04/12→ | | | | | | BAE403C |
| 2.4 | 4 | ED6 | 137/184 | 04/12→ | OE154 | 1,0 | CET2 | OE194 | | |

DURANGO

| | | | | | | | | | | |
|--------------|---|-----|---------|-------------|-------|-----|------|-------|--|--|
| 3.7, 3.7 4WD | 6 | EKG | 157/211 | 11/03→12/10 | OE089 | 1,0 | CET2 | | | |
| 4.7 4WD | 8 | EVA | 172/231 | 11/03→12/09 | OE154 | 1,0 | CET2 | OE194 | | |

INTREPID

| | | | | | | | | | | |
|--------|---|----------|---------|-------------|-------|-----|--|--|--|--------------------------|
| 3.2 | 6 | EGW; EKK | 168/225 | 04/98→09/04 | | | | | | BAEA432 ^[277] |
| 3.3 | 6 | EGD | 120/161 | 01/95→12/98 | OE105 | 1,3 | | | | |
| 3.5 ES | 6 | EGG | 187/251 | 04/98→09/04 | | | | | | BAEA432 ^[277] |

JOURNEY

| | | | | | | | | | | |
|---------------|---|----------|---------|--------|-------|-----|--------|-------|--|-------------------------|
| 2.4 | 4 | ED3; EDG | 129/173 | 09/08→ | OE154 | 1,0 | CET2 | OE194 | | |
| 2.4, 2.4 ECO+ | 4 | ED3; EDG | 125/168 | 01/09→ | OE154 | 1,0 | CET2 | OE194 | | |
| 3.5, 3.5 4WD | 6 | EGF | 173/232 | 06/08→ | | | CET17P | OE189 | | BAEA453 ^[68] |

NEON

| | | | | | | | | | | |
|-----------------------|---|-----|---------|-------------|-------|-----|------|-------|--|-------------------|
| 2.0 16V | 4 | ECC | 107/143 | 06/94→08/99 | OE005 | 0,9 | CET2 | OE180 | | BAEA380 |
| 2.0 16V | 4 | ECC | 109/146 | 04/96→08/99 | OE005 | 0,9 | CET2 | OE180 | | BAEA380 |
| 2.0 16V | 4 | ECC | 112/150 | 04/96→08/99 | OE005 | 0,9 | CET2 | OE180 | | BAEA380 |
| 2.0 16V, 2.0 Highline | 4 | ECB | 98/131 | 01/94→09/99 | OE005 | 0,9 | CET2 | OE180 | | BAEA380 →06/97 |

NEON II

| | | | | | | | | | | |
|---------|---|-----|---------|--------|-------|-----|------|-------|--|--|
| 2.0 16V | 4 | ECB | 98/131 | 08/99→ | OE005 | 0,9 | CET2 | OE180 | | |
| 2.0 16V | 4 | ECH | 112/150 | 08/99→ | OE005 | 0,9 | CET2 | OE180 | | |

NITRO

| | | | | | | | | | | |
|--------------|---|-----|---------|-------------|-------|-----|------|-------|--|-------------------------|
| 3.7, 3.7 4WD | 6 | EKG | 157/211 | 09/06→12/12 | OE089 | 1,0 | CET2 | | | |
| 3.7 V6 | 6 | | 154/207 | 06/07→12/12 | OE089 | 1,0 | CET2 | | | |
| 3.7 V6 4WD | 6 | EKG | 151/202 | 06/07→12/12 | OE089 | 1,0 | CET2 | OE184 | | |
| 4.0 4WD | 6 | EGS | 191/256 | 09/06→12/07 | | | | | | BAEA453 ^[68] |

RAM 1500

| | | | | | | | | | | |
|--------------|----|-----|---------|-------------|-------|-----|------|--|--|--|
| 3.7 | 6 | EKG | 157/211 | 06/01→09/08 | OE089 | 1,0 | CET2 | | | |
| 3.9 | 6 | EHC | 128/172 | 01/93→05/01 | OE128 | 1,0 | | | | |
| 3.9 | 6 | EHC | 130/174 | 01/93→08/02 | OE128 | 1,0 | | | | |
| 4.7, 4.7 4WD | 8 | EVA | 172/231 | 06/01→09/08 | OE154 | 1,0 | CET2 | | | |
| 4.7, 4.7 4WD | 8 | EVC | 175/235 | 08/01→09/08 | OE154 | 1,0 | CET2 | | | |
| 5.2 | 8 | ELF | 172/231 | 01/93→09/01 | OE128 | 1,0 | | | | |
| 5.9, 5.9 4WD | 8 | EML | 180/241 | 06/01→09/08 | OE128 | 1,0 | | | | |
| 5.9, 5.9 4WD | 8 | EML | 184/247 | 01/93→09/01 | OE128 | 1,0 | | | | |
| 8.3 SRT-10 | 10 | EWC | 373/500 | 09/03→12/06 | OE041 | 0,9 | | | | |

RAM 2500

| | | | | | | | | | | |
|--------------|----|-----|---------|-------------|-------|-----|------|--|--|--|
| 5.9, 5.9 4WD | 8 | EML | 184/247 | 01/93→09/01 | OE128 | 1,0 | | | | |
| 8.0 4WD | 10 | EWA | 228/306 | 01/02→12/09 | | | CET2 | | | |
| 8.0, 8.0 4WD | 10 | EWA | 221/296 | 01/93→05/01 | | | CET2 | | | |

RAMCHARGER II

| | | | | | | | | | | |
|---------|---|-----|---------|-------------|-------|-----|--|--|--|--|
| 5.2 4WD | 8 | ELN | 164/220 | 01/99→12/01 | OE128 | 1,0 | | | | |
| 5.9 4WD | 8 | EML | 183/245 | 01/99→12/01 | OE128 | 1,0 | | | | |

STRATUS

| | | | | | | | | | | |
|---------|---|-----|---------|-------------|-------|-----|--------|-------|--|--|
| 2.0 16V | 4 | ECB | 98/131 | 12/95→04/01 | OE005 | 0,9 | CET2 | OE180 | | |
| 2.5 V6 | 6 | EEB | 125/168 | 12/95→04/01 | | | CET12P | OE180 | | |

VIPER

| | | | | | | | | | | |
|--------------|----|-------|---------|-------------|-------|-----|--|--|--|--|
| 8.0 RT10 ACR | 10 | EWB | 335/449 | 10/97→09/02 | OE041 | 0,9 | | | | |
| 8.3 SRT-10 | 10 | ; EWC | 372/499 | 09/02→ | OE041 | 0,9 | | | | |

DODGE





kW/BHP



eon TITAN

IRIDIUM

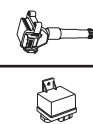

DODGE



RAM

| | | | | | | | | |
|---------|---|-----|---------|-------------|-------|-----|--|--|
| 3.9 | 6 | EHC | 128/172 | 08/93→09/03 | OE128 | 1,0 | | |
| 5.2 | 8 | ELF | 172/231 | 08/93→09/03 | OE128 | 1,0 | | |
| 5.2 CNG | 8 | | 165/221 | 08/99→09/03 | OE128 | 1,0 | | |
| 5.9 | 8 | EML | 184/247 | 01/93→09/03 | OE128 | 1,0 | | |

EMGRAND (GEELY)



EC 7

| | | | | | | | | |
|-----|---|--------------------|---------|-------------|-------|-----|------|-------|
| 1.8 | 4 | JL4G18 | 94/126 | 07/09→ | OE034 | 0,9 | CET2 | OE179 |
| 1.8 | 4 | JLC-4G18; JLY-4G18 | 98/131 | 07/09→12/15 | OE034 | 0,9 | CET2 | OE179 |
| 1.8 | 4 | JL4G18 | 102/137 | 07/09→12/14 | OE034 | 0,9 | CET2 | OE179 |

EC 7 RV

| | | | | | | | | |
|-----|---|--------|---------|-------------|-------|-----|------|-------|
| 1.8 | 4 | JL4G18 | 102/137 | 07/09→12/14 | OE034 | 0,9 | CET2 | OE179 |
|-----|---|--------|---------|-------------|-------|-----|------|-------|

EUNOS



500

| | | | | | | | | |
|-----|---|------|--------|-------------|-------|-----|------|-------|
| 1.6 | 4 | B6EW | 79/106 | 04/94→10/99 | OE063 | 1,0 | CET2 | OE180 |
|-----|---|------|--------|-------------|-------|-----|------|-------|

FERRARI



348

| | | | | | | | | |
|-----|---|------|---------|-------------|-------|-----|--|-------------------|
| 3.4 | 8 | | 221/296 | 03/93→12/95 | | | | BAEA234 →04/94 |
| 3.4 | 8 | V834 | 235/315 | 03/93→12/95 | OE073 | 0,8 | | BAEA234 →04/94 |

348 tb/GTB

| | | | | | | | | |
|-----|---|----------|---------|-------------|-------|-----|--|---------|
| 3.4 | 8 | F119D040 | 235/315 | 10/93→04/94 | OE073 | 0,8 | | BAEA234 |
|-----|---|----------|---------|-------------|-------|-----|--|---------|

348 ts/GTS

| | | | | | | | | |
|-----|---|----------|---------|-------------|-------|-----|--|---------|
| 3.4 | 8 | F119D040 | 235/315 | 10/93→12/95 | OE073 | 0,8 | | BAEA234 |
|-----|---|----------|---------|-------------|-------|-----|--|---------|

360

| | | | | | | | | |
|------------------------|---|---------|---------|-------------|-------|-----|--|--|
| 3.6, 3.6 Modena | 8 | F131B40 | 294/394 | 03/99→03/05 | OE122 | 0,7 | | |
| 3.6 Challenge | 8 | F131B44 | 305/409 | 05/01→03/05 | OE122 | 0,7 | | |
| 3.6 Challenge Stradale | 8 | | 313/420 | 05/03→03/05 | OE122 | 0,7 | | |
| 3.6 Modena | 8 | F131B44 | 316/424 | 01/02→03/05 | OE122 | 0,7 | | |

612 SCAGLIETTI

| | | | | | | | | |
|-----|----|---------|---------|-------------|-------|-----|--|--|
| 5.7 | 12 | F118B42 | 397/532 | 04/04→06/11 | OE073 | 0,8 | | |
|-----|----|---------|---------|-------------|-------|-----|--|--|

ENZO FERRARI

| | | | | | | | | |
|-----|----|---------|---------|-------------|-------|-----|--|--|
| 6.0 | 12 | F140B49 | 485/650 | 10/02→12/03 | OE122 | 0,7 | | |
|-----|----|---------|---------|-------------|-------|-----|--|--|

F355

| | | | | | | | | |
|-----|---|----------|---------|-------------|--------------------------|------|--|---------|
| 3.5 | 8 | F129B/40 | 280/375 | 07/95→12/00 | OE122 *to be adjusted | 0,6* | | BAEA234 |
|-----|---|----------|---------|-------------|--------------------------|------|--|---------|

F355 Berlinetta

| | | | | | | | | |
|-----|---|----------|---------|-------------|--------------------------|------|--|---------|
| 3.5 | 8 | F129B/40 | 280/375 | 05/94→03/99 | OE122 *to be adjusted | 0,6* | | BAEA234 |
|-----|---|----------|---------|-------------|--------------------------|------|--|---------|

F430

| | | | | | | | | |
|-----|---|---------|---------|-------------|-------|-----|--|--|
| 4.3 | 8 | F131B43 | 360/483 | 03/05→12/09 | OE122 | 0,7 | | |
|-----|---|---------|---------|-------------|-------|-----|--|--|

FIAT



500

| | | | | | | | | |
|----------------|---|----------------------|--------|--------|-------|-----|--------|----------------|
| 0.9 | 2 | 312A4.000; 312A6.000 | 44/59 | 12/13→ | OE232 | 0,7 | CET15P | BAE403C |
| 0.9 | 2 | 312A4.000 | 48/64 | 09/12→ | OE232 | 0,7 | CET15P | BAE403C |
| 0.9 | 2 | 312A5.000 | 59/79 | 12/13→ | OE232 | 0,7 | CET15P | BAE403C |
| 0.9 | 2 | 312A2.000 | 63/84 | 07/10→ | OE232 | 0,7 | CET15P | BAEA090 |
| 0.9 | 2 | 199B6.000 | 77/103 | 10/13→ | OE232 | 0,7 | CET15P | |
| 1.2, 1.2 LPG | 4 | 169A4.000 | 51/68 | 10/07→ | OE196 | 1,0 | CET1 | BAE940A CLS082 |
| 1.3 D Multijet | 4 | 169A1.000 | 55/74 | 10/07→ | | | | CCU150 |

FIAT





kW/BHP

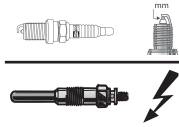

eon TITAN

IRIDIUM



...FIAT



...500

| | | | | | | | | | |
|---------------|---|-----------|---------|--------|--|------------|--|--|----------------|
| 1.4 | 4 | 169A3.000 | 74/99 | 10/07→ | OE196 OE230 LPG [278] | 1,0 0,9 | | | BAE403C |
| 1.4 | 4 | 169A3.000 | 75/101 | 09/08→ | OE196 OE230 LPG [278] | 1,0 0,9 | | | BAE403C |
| 1.4, 1.4 Flex | 4 | 169A3.000 | 77/103 | 02/09→ | OE196 OE230 LPG [278] | 1,0 0,9 | | | BAE403C |
| 1.4 Flex | 4 | 169A3.000 | 79/106 | 07/13→ | OE196 OE230 LPG [278] | 1,0 0,9 | | | BAE403C |
| 1.4 Turbo | 4 | EAF | 101/135 | 09/13→ | OE196 OE230 LPG [278] | 1,0 0,9 | | | BAE403C |

500 C

| | | | | | | | | | |
|----------------|---|----------------|--------|--------|--|------------|----------------|--|------------------------------|
| 0.9 | 2 | 312A4.000 | 48/64 | 09/12→ | OE232 | 0,7 | CET1 5P | | BAE403C |
| 0.9 | 2 | 312A2.000 | 63/84 | 09/09→ | OE232 | 0,7 | CET1 5P | | BAEA090 |
| 0.9 | 2 | 199B6.000 | 77/103 | 12/13→ | OE232 | 0,7 | CET1 5P | | |
| 1.2 | 4 | 169A4.000 | 51/68 | 09/09→ | OE196 | 1,0 | CET1 | | BAE940A CLS082 |
| 1.3 D Multijet | 4 | 169A1.000 | 55/74 | 09/09→ | | | | | CCU150 |
| 1.4 | 4 | 169A3.000 | 74/99 | 09/09→ | OE196 OE230 LPG [278] | 1,0 0,9 | | | BAE403C |
| 1.4 | 4 | 169A3.000; EAB | 75/101 | 09/11→ | OE196 OE230 LPG [278] | 1,0 0,9 | | | BAE403C |
| 1.4 | 4 | 169A3.000 | 77/103 | 08/11→ | OE196 OE230 LPG [278] | 1,0 0,9 | | | BAE403C |
| 1.4 Flex | 4 | 169A3.000 | 79/106 | 08/11→ | OE196 OE230 LPG [278] | 1,0 0,9 | | | BAE403C |

500X

| | | | | | | | | | |
|-----|---|----------|---------|--------|--------------|-----|--|--|--|
| 1.4 | 4 | 55263624 | 103/138 | 09/14→ | OE208 | 0,8 | | | |
|-----|---|----------|---------|--------|--------------|-----|--|--|--|

500L

| | | | | | | | | | |
|-------------------|---|-----------|---------|--------|--|------------|----------------|--|------------------------------------|
| 0.9 | 2 | 199B6.000 | 77/103 | 09/12→ | OE232 | 0,7 | CET1 5P | | BAEA090 |
| 0.9 Natural Power | 2 | 312A2.000 | 63/84 | 03/13→ | OE232 | 0,7 | CET1 5P | | BAEA090 |
| 1.4 | 4 | 843A1.000 | 70/94 | 09/12→ | OE196 OE230 LPG [278] | 1,0 0,9 | | | BAE403C |
| 1.4 | 4 | | 93/125 | 05/14→ | | | | | BAEA095 →Prod.19.11.2014 |
| 1.4 | 4 | 312A1.000 | 118/158 | 09/13→ | | | | | BAEA095 →Prod.19.11.2014 |
| 1.4 | 4 | EAM | 119/160 | 09/13→ | | | | | BAEA095 →Prod.19.11.2014 |
| 1.4, 1.4 LPG | 4 | 940B7.000 | 88/118 | 10/13→ | | | | | BAEA095 →Prod.19.11.2014 |
| 1.4 Flex | 4 | 843A1.000 | 65/87 | 11/14→ | OE196 OE230 LPG [278] | 1,0 0,9 | | | BAE403C |

BARCETTA

| | | | | | | | | | |
|---------|---|-----------|--------|-------------|------------------------|-----|-------------|--------------|--------------------------|
| 1.8 16V | 4 | 188A6.000 | 96/129 | 04/95→05/05 | OE016 | 0,9 | CET2 | OE180 | |
| 1.8 16V | 4 | 183A1.000 | 96/129 | 04/95→05/05 | OE016 | 0,9 | CET2 | OE180 | BAEA549 →05/98 |
| 1.8 16V | 4 | 183A1000 | 96/129 | 04/95→05/05 | OE216 LPG [278] | 0,8 | | | |

BRAVA

| | | | | | | | | | |
|------------|---|-----------|-------|-------------|--|------------|-------------|--------------|------------------------------|
| 1.2 16V | 4 | 182B2.000 | 64/86 | 12/98→12/02 | OE186 | 1,0 | CET1 | | BAEA234 CLS044 |
| 1.2 16V 80 | 4 | 188A5.000 | 59/79 | 10/00→10/01 | OE196 | 1,0 | CET1 | | BAEA234 CLS044 |
| 1.2 16V 80 | 4 | 182B2.000 | 60/80 | 12/98→12/02 | OE186 OE230 LPG [278] Eng.1945438→ | 1,0 0,9 | CET1 | | BAEA234 CLS044 |
| 1.4 | 4 | 182A5.000 | 55/74 | 10/95→10/01 | OE216 LPG [278] →10/98 | 0,8 | CET2 | OE179 | BAEA234 CLS136 |
| 1.4 12 V | 4 | 182A3.000 | 59/79 | 10/95→08/98 | OE216 LPG [278] | 0,8 | CET2 | OE179 | BAEA234 CLS136 |

FIAT





kW/BHP



eon TITAN

IRIDIUM



...FIAT



...BRAVA

| | | | | | | | | | | |
|--------------|---|-----------|---------|-------------|---|-----|------|-------|------------------------|--------|
| 1.6 16V | 4 | 182A6.000 | 66/89 | 10/95→10/01 | OE216 LPG [278] →10/98 | 0,8 | CET2 | OE179 | BAE920AX | CLS137 |
| 1.6 16V | 4 | 182A4.000 | 76/102 | 02/96→12/02 | OE216 LPG [278] →10/98 | 0,8 | CET2 | OE179 | BAE920AX | CLS137 |
| 1.6 16V | 4 | 182B6.000 | 76/102 | 02/96→12/02 | OE030 | 0,9 | CET2 | OE179 | BAE920AX | CLS137 |
| 1.8 GT 16V | 4 | 182A2.000 | 83/111 | 10/95→08/01 | | | CET2 | OE188 | BAEA549 →07/99 | |
| 1.9 D | 4 | 160A7.000 | 48/64 | 10/95→10/01 | CH189 | 11v | | | | |
| 1.9 JTD | 4 | 182B9.000 | 74/99 | 09/00→10/01 | CH222 | 11v | | | CCU150 ^[57] | |
| 1.9 JTD | 4 | 182B4.000 | 79/106 | 01/01→12/02 | CH222 | 11v | | | CCU150 ^[57] | |
| 1.9 JTD 105 | 4 | 182B4.000 | 77/103 | 12/98→10/01 | CH222 Eng.1716459→ Prod.15.11.1999→ | 11v | | | CCU150 ^[57] | |
| 1.9 TD 75 S | 4 | 182A8.000 | 55/74 | 03/96→10/01 | CH167 | 11v | | | CCU153 | |
| 1.9 TD 100 S | 4 | 182A7.000 | 74/99 | 03/96→10/01 | CH167 | 11v | | | | |
| 2.0 | 5 | 182B7.000 | 113/152 | 09/98→08/00 | OE216 LPG [278] | 0,8 | CET2 | OE179 | | |

BRAVO I

| | | | | | | | | | | |
|--------------|---|-----------|---------|-------------|---|-----|------|-------|------------------------|--------|
| 1.2 16V 80 | 4 | 188A5.000 | 59/79 | 10/00→10/01 | OE196 | 1,0 | CET1 | | BAEA234 | CLS044 |
| 1.2 16V 80 | 4 | 182B2.000 | 60/80 | 12/98→10/00 | OE186 | 1,0 | CET1 | | BAEA234 | CLS044 |
| 1.2 16V 80 | 4 | 182B2.000 | 64/86 | 12/98→10/01 | OE230 LPG [278] Eng.1945438→ | 0,9 | | | | |
| 1.2 16V 80 | 4 | 182B2.000 | 64/86 | 12/98→10/01 | OE186 →07/99 | 1,0 | CET1 | | BAEA234 | CLS044 |
| 1.4 | 4 | 182A5.000 | 55/74 | 10/95→10/01 | OE216 LPG [278] →10/98 | 0,8 | CET2 | OE179 | BAEA234 | CLS136 |
| 1.4 | 4 | 182A3.000 | 59/79 | 10/95→10/01 | OE216 LPG [278] →10/98 | 0,8 | CET2 | OE179 | BAEA234 | CLS136 |
| 1.6 | 4 | 182B6.000 | 76/102 | 09/00→10/01 | OE030 | 0,9 | CET2 | OE179 | BAE920AX | CLS137 |
| 1.6 16V | 4 | 182A6.000 | 66/89 | 10/95→10/01 | OE216 LPG [278] | 0,8 | CET2 | OE179 | BAE920AX | CLS137 |
| 1.6 16V | 4 | 182A4.000 | 76/102 | 03/96→10/01 | OE216 LPG [278] →10/98 | 0,8 | CET2 | OE179 | BAE920AX | CLS137 |
| 1.8 GT | 4 | 182A2.000 | 83/111 | 10/95→10/01 | OE216 LPG [278] →07/99 →Eng.1945438 | 0,8 | CET2 | OE188 | BAEA549 →07/99 | |
| 1.9 D | 4 | 160A7.000 | 48/64 | 10/95→10/01 | CH189 | 11v | | | | |
| 1.9 JTD | 4 | 182B9.000 | 74/99 | 09/00→10/01 | CH222 | 11v | | | CCU150 ^[57] | |
| 1.9 JTD 105 | 4 | 182B4.000 | 77/103 | 12/98→10/01 | CH222 Eng.1716459→ Prod.15.11.1999→ | 11v | | | CCU150 ^[57] | |
| 1.9 TD 75 S | 4 | 182A8.000 | 55/74 | 03/96→10/01 | CH167 | 11v | | | CCU153 | |
| 1.9 TD 100 S | 4 | 182A7.000 | 74/99 | 03/96→10/01 | CH167 | 11v | | | | |
| 2.0 HGT 20V | 5 | 182A1.000 | 108/145 | 10/95→07/98 | OE216 LPG [278] | 0,8 | CET2 | OE179 | | |
| 2.0 HGT 20V | 5 | 182B7.000 | 113/152 | 07/98→10/01 | OE216 LPG [278] | 0,8 | CET2 | OE179 | | |

BRAVO II

| | | | | | | | | | | |
|----------------|---|----------------------|---------|-------------|-----------------|-----|------|--|------------------------|--|
| 1.4 | 4 | 192B2.000 | 66/89 | 04/07→12/14 | OE196 | 1,0 | CET1 | | BAE403C | |
| 1.4 | 4 | 198A7.000 | 103/138 | 03/08→ | OE230 LPG [278] | 0,9 | | | | |
| 1.4 16V | 4 | 198A7.000 | 103/138 | 03/08→ | OE208 | 0,8 | | | BAE403C [131] [275] | |
| 1.4 LPG | 4 | 192B2.000 | 66/89 | 12/08→12/14 | OE196 | 1,0 | CET1 | | BAE403C | |
| 1.4 T-Jet | 4 | 198A4.000 | 88/118 | 09/07→ | OE208 | 0,8 | | | BAEA095 | |
| 1.4 T-Jet | 4 | 198A1.000 | 110/148 | 09/07→12/14 | OE208 | 0,8 | | | BAEA095 | |
| 1.9 D Multijet | 4 | 192B5.000 | 66/89 | 04/07→12/08 | CH269 | 11v | | | CCU150 | |
| 1.9 D Multijet | 4 | 192A1.000; 192B4.000 | 85/114 | 11/06→ | CH269 →12/09 | 11v | | | CCU150 | |
| 1.9 D Multijet | 4 | 192A8.000 | 88/118 | 04/07→ | CH269 | 11v | | | CCU150 | |
| 1.9 D Multijet | 4 | 937A5.000 | 110/148 | 04/07→ | CH224 | 11v | | | CCU150 | |

CINQUECENTO

| | | | | | | | | | | |
|--------------|---|-----------|-------|-------------|-------|-----|------|-------|---------|--------|
| 0.7 i | 2 | 170A.046 | 22/30 | 07/94→01/98 | OE004 | 0,9 | CET8 | OE195 | BAE800B | |
| 1.1 Sporting | 4 | 176B2.000 | 40/54 | 10/94→01/98 | OE002 | 0,9 | CET2 | OE180 | BAE800B | CLS261 |

FIAT





kW/BHP

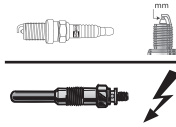

eon TITAN

IRIDIUM

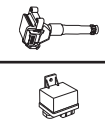

...FIAT



COUPE

| | | | | | | | | | |
|---------------|---|-----------|---------|---------------|-----------------|------------|--------|-------|-------------------|
| 1.8 16V | 4 | 183A1.000 | 96/129 | 03/96 → 08/00 | OE216 LPG [278] | 0,8 | CET2 | OE179 | BAEA549 →05/98 |
| 2.0 16V | 4 | 836A3.000 | 102/137 | 11/93 → 08/96 | OE008 OE018 | 0,9 1,0 | CET8 | OE195 | |
| 2.0 16V Turbo | 4 | 175A1.000 | 140/188 | 11/93 → 08/96 | OE012 | 0,8 | CET8 | OE195 | BAE800B |
| 2.0 20V | 5 | 182A1.000 | 108/145 | 08/96 → 09/98 | OE216 LPG [278] | 0,8 | CET2 | OE179 | |
| 2.0 20V | 5 | 182B3.000 | 113/152 | 04/98 → 08/00 | OE216 LPG [278] | 0,8 | CET2 | OE179 | |
| 2.0 20V Turbo | 5 | 175A3.000 | 162/217 | 08/96 → 08/00 | OE136 | 0,8 | CET12P | OE179 | |

CROMA

| | | | | | | | | | |
|----------------|---|-----------|---------|---------------|------------------------|-----|--------|-------|---------|
| 1.8 16V | 4 | 939A4.000 | 103/138 | 12/05 → | OE089 | 1,0 | CET2 | OE188 | BAEA427 |
| 1.9 D Multijet | 4 | 939A7.000 | 85/114 | 06/05 → | CH222 →Eng.5115898 | 11v | | | CCU150 |
| 1.9 D Multijet | 4 | 939A1.000 | 88/118 | 06/05 → 12/11 | CH269 Eng.5115898 → | 11v | | | |
| 1.9 D Multijet | 4 | 939A1.000 | 88/118 | 06/05 → 12/11 | CH222 →Eng.5115898 | 11v | | | CCU150 |
| 1.9 D Multijet | 4 | 939A8.000 | 100/134 | 12/05 → | CH269 Eng.5115898 → | 11v | | | CCU150 |
| 1.9 D Multijet | 4 | 939A2.000 | 110/148 | 06/05 → 12/11 | CH224 | 11v | | | CCU150 |
| 2.2 16V | 4 | 194A1.000 | 108/145 | 06/05 → | OE255 | 1,0 | CET17P | OE189 | |
| 2.4 D Multijet | 5 | 939A3.000 | 147/197 | 06/05 → | CH224 | 11v | | | CCU150 |
| 2.5 2500 V6 | 6 | 834G.000 | 119/160 | 06/93 → 08/96 | OE018 | 1,0 | CET8 | OE195 | |

DOBLO

| | | | | | | | | | | |
|------------------------|---|----------------------|--------|---------------|--------------------------|------------|------|-------|----------------------|--------|
| 1.2 | 4 | 223A5.000 | 48/64 | 03/01 → | OE016 | 0,9 | CET2 | OE180 | BAE800B | CLS067 |
| 1.3 D Multijet | 4 | 223A9.000 | 62/83 | 10/05 → | | | | | CCU150 | |
| 1.3 D Multijet | 4 | 199A3.000; 263A2.000 | 66/89 | 02/10 → | | | | | CCU150 [22] [298] | |
| 1.3 JTD | 4 | 199A2.000 | 55/74 | 05/05 → | | | | | CCU150 | |
| 1.3 JTD 16V | 4 | 188A9.000 | 51/68 | 12/04 → 05/05 | | | | | CCU150 | |
| 1.4 | 4 | 350A1.000 | 57/76 | 10/05 → | OE196 | 1,0 | CET1 | | BAE940A | CLS082 |
| 1.4 | 4 | 843A1.000 | 70/94 | 02/10 → | OE196 OE230 LPG [278] | 1,0 0,9 | CET1 | | BAE403C | |
| 1.4, 1.4 Natural Power | 4 | 198A4.000 | 88/118 | 02/10 → | OE208 | 0,8 | | | BAEA095 | |
| 1.6 | 4 | 182B6.000 | 68/91 | 09/02 → | OE030 | 0,9 | CET2 | OE179 | BAE920AX | |
| 1.6 16V | 4 | 182B6.000 | 76/102 | 10/01 → | OE016 | 0,9 | CET2 | OE180 | BAE403B | |
| 1.6 Natural Power | 4 | 182B6.000 | 76/102 | 09/02 → | OE030 | 0,9 | CET2 | OE179 | BAE920AX | |
| 1.9 D | 4 | 223A6.000 | 46/62 | 03/01 → | CH209 | 11v | | | | |
| 1.9 D Multijet | 4 | 186A9.000 | 88/118 | 10/05 → | CH269 | 11v | | | CCU150 | |
| 1.9 JTD | 4 | 182B9.000; 223B2.000 | 74/99 | 10/01 → | CH222 | 11v | | | CCU150 | |
| 1.9 JTD | 4 | 223A7.000; 223B1.000 | 77/103 | 07/03 → | CH222 | 11v | | | CCU150 | |

ELBA

| | | | | | | | | | |
|-----|---|----------------------|-------|---------------|-------|-----|------|-------|--|
| 1.6 | 4 | 146C6.000; 146D6.000 | 69/93 | 01/94 → 12/96 | OE018 | 1,0 | CET8 | OE195 | |
|-----|---|----------------------|-------|---------------|-------|-----|------|-------|--|

FIORINO Pick up

| | | | | | | | | | |
|--------|---|-----------|-------|---------------|-------|-----|------|-------|--------------------|
| 1.4 | 4 | 146D5.000 | 49/66 | 05/94 → 05/01 | | | CET8 | OE195 | BAE504D BAEA234 |
| 1.6 | 4 | 146C6.000 | 55/74 | 01/94 → 05/01 | OE018 | 1,0 | CET8 | OE195 | BAE504D |
| 1.6 | 4 | 146D6.000 | 55/74 | 01/94 → 05/01 | OE018 | 1,0 | CET8 | OE195 | BAEA234 |
| 1.7 D | 4 | 146B2.000 | 42/56 | 10/93 → 10/99 | CH189 | 11v | | | |
| 1.7 TD | 4 | 146D7.000 | 46/62 | 01/97 → 05/01 | CH189 | 11v | | | CCU153 |

FREEMONT

| | | | | | | | | | |
|--------------|---|----------|---------|---------|-------|-----|------|-------|-------------------------|
| 2.4 | 4 | ED3; EDG | 125/168 | 08/11 → | OE154 | 1,0 | CET2 | OE194 | |
| 3.6, 3.6 4WD | 6 | ERB | 206/276 | 08/11 → | | | | | BAEA453 ^[68] |

GRANDE PUNTO

| | | | | | | | | | | |
|-----|---|-----------|-------|---------|-------|-----|------|--|---------|--------|
| 1.2 | 4 | 199A4.000 | 48/64 | 10/05 → | OE196 | 1,0 | CET1 | | BAE940A | CLS082 |
|-----|---|-----------|-------|---------|-------|-----|------|--|---------|--------|

FIAT





kW/BHP



eon TITAN

IRIDIUM

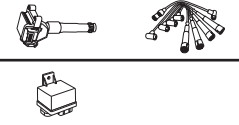

...FIAT



...GRANDE PUNTO

| | | | | | | | | | | |
|---------------------------------|---|-----------|---------|-------------|-------|-----|------|--|---|--------|
| 1.2 | 4 | 169A4.000 | 51/68 | 09/10→ | OE196 | 1,0 | CET1 | | BAE940A | CLS082 |
| 1.2 LPG | 4 | 199A4.000 | 51/68 | 07/08→ | OE196 | 1,0 | CET1 | | | |
| 1.3 D Multijet | 4 | 199B2.000 | 51/68 | 07/08→ | | | | | CCU150 ^[53] | |
| 1.3 D Multijet | 4 | 199A2.000 | 55/74 | 10/05→ | | | | | CCU150 Ch.0456091→ Prod.15.10.2008→ | |
| 1.3 D Multijet | 4 | 199A2.000 | 56/75 | 06/09→ | | | | | CCU150 | |
| 1.3 D Multijet | 4 | 199B4.000 | 62/83 | 04/10→ | | | | | CCU150 | |
| 1.3 D Multijet | 4 | 223A9.000 | 62/83 | 04/10→ | | | | | CCU150 | |
| 1.3 D Multijet | 4 | 199A3.000 | 66/89 | 10/05→ | | | | | CCU150 Ch.0456091→ Prod.15.10.2008→ | |
| 1.4 | 4 | 199A7.000 | 55/74 | 10/05→07/07 | OE196 | 1,0 | CET1 | | BAE940A | |
| 1.4, 1.4 LPG, 1.4 Natural Power | 4 | 350A1.000 | 57/76 | 06/05→ | OE196 | 1,0 | CET1 | | BAE940A | CLS082 |
| 1.4 16V | 4 | 199A6.000 | 70/94 | 10/05→ | OE196 | 1,0 | CET1 | | BAE403C | |
| 1.4 16V | 4 | 198A1.000 | 112/150 | 09/07→07/12 | OE208 | 0,8 | | | BAEA095 | |
| 1.4 T-Jet | 4 | 198A4.000 | 88/118 | 09/07→ | OE208 | 0,8 | | | BAEA095 | |
| 1.6 D Multijet | 4 | 955A3.000 | 88/118 | 07/08→ | | | | | CCU150 ^[53] | |
| 1.9 D Multijet | 4 | 939A7.000 | 85/114 | 06/06→12/09 | CH269 | 11v | | | CCU150 | |
| 1.9 D Multijet | 4 | 939A1.000 | 88/118 | 10/05→ | CH269 | 11v | | | CCU150 | |
| 1.9 D Multijet | 4 | 199A5.000 | 96/129 | 10/05→ | CH269 | 11v | | | CCU150 | |

IDEA

| | | | | | | | | | | |
|----------------|---|-------------|--------|-------------|-------------------------------------|------------|------|--|---------|--------|
| 1.2 16V | 4 | 188A5.000 | 59/79 | 01/04→ | OE196 OE230 LPG ^[278] | 1,0 0,9 | CET1 | | BAE403C | |
| 1.3 D Multijet | 4 | 188A9.000 | 51/68 | 01/04→ | | | | | CCU150 | |
| 1.3 D Multijet | 4 | 199A3.000 | 66/89 | 10/05→ | | | | | CCU150 | |
| 1.3 D Multijet | 4 | 199B1.000 | 70/94 | 05/08→12/12 | | | | | CCU150 | |
| 1.4 | 4 | 192B2.000 | 66/89 | 12/03→ | OE196 OE230 LPG ^[278] | 1,0 0,9 | CET1 | | BAE403C | |
| 1.4, 1.4 LPG | 4 | 350A1.000 | 57/76 | 10/05→ | OE196 | 1,0 | CET1 | | BAE940A | CLS082 |
| 1.4 16V | 4 | 843A1.000 | 70/94 | 01/04→ | OE196 OE230 LPG ^[278] | 1,0 0,9 | CET1 | | BAE403C | |
| 1.8 | 4 | 93313090-7U | 81/109 | 01/08→07/10 | OE089 | 1,0 | CET2 | | | |
| 1.9 JTD | 4 | 188B2.000 | 74/99 | 01/04→ | CH222 | 11v | | | CCU150 | |

LINEA

| | | | | | | | | | | |
|----------------|---|-----------|--------|--------|-------|-----|------|--|---------|--------|
| 1.3 D Multijet | 4 | 199A3.000 | 66/89 | 06/07→ | | | | | CCU150 | |
| 1.4 | 4 | 350A1.000 | 57/76 | 06/07→ | OE196 | 1,0 | CET1 | | BAE940A | CLS082 |
| 1.4 T-Jet | 4 | 198A4.000 | 88/118 | 09/07→ | OE208 | 0,8 | | | BAEA095 | |
| 1.9 16V | 4 | | 94/126 | 07/08→ | OE002 | 0,9 | CET2 | | | |

MAREA

| | | | | | | | | | | |
|---------------------|---|----------------------|--------|-------------|--|-----|------|-------|-------------------|--------|
| 1.2 16V | 4 | 182B2.000 | 60/80 | 10/98→05/02 | OE186 | 1,0 | CET1 | | BAEA234 | CLS044 |
| 1.4 80 12V | 4 | 182A3.000 | 59/79 | 09/96→05/02 | OE216 LPG ^[278] | 0,8 | CET2 | OE179 | BAEA234 | CLS136 |
| 1.6 | 4 | 185A3.000 | 68/91 | 03/99→08/00 | OE016 | 0,9 | CET2 | OE180 | BAE920AX | |
| 1.6 | 4 | 182B6.000 | 76/102 | 09/00→08/02 | OE030 | 0,9 | CET2 | OE179 | BAE920AX | CLS137 |
| 1.6 16V | 4 | 185A3.000 | 75/101 | 04/97→02/99 | OE026 | 0,9 | CET2 | OE179 | BAE920AX | CLS137 |
| 1.6 100 16V | 4 | 182A4.000 | 76/102 | 09/96→05/02 | OE216 LPG ^[278] →03/99 | 0,8 | CET2 | OE179 | BAE920AX | CLS137 |
| 1.6 100 16V Bipower | 4 | 185A3.000; 186A4.000 | 76/102 | 04/99→05/02 | OE016 | 0,9 | CET2 | OE180 | BAE920AX | CLS137 |
| 1.6 SX | 4 | 182B5.098 | 72/97 | 09/00→08/02 | OE016 | 0,9 | CET2 | | BAE920AX | |
| 1.8 115 16V | 4 | 182A2.000 | 83/111 | 09/96→05/02 | OE216 LPG ^[278] →07/99 →Eng.1945438 | 0,8 | CET2 | OE188 | BAEA549 →01/99 | |
| 1.9 JTD | 4 | 182B4.000; 182B9.000 | 79/106 | 01/01→12/07 | CH222 | 11v | | | | |

FIAT





kW/BHP



eon TITAN

IRIDIUM



...FIAT



...MAREA

| | | | | | | | | | |
|-------------|---|----------------------|---------|---------------|---|-----|------|------------------------|--|
| 1.9 JTD 105 | 4 | 182B4.000 | 77/103 | 12/98 → 12/02 | CH222 Eng.1713819 → Prod.15.11.1999 → | 11v | | | |
| 1.9 JTD 110 | 4 | 186A6.000 | 81/109 | 09/00 → 08/02 | CH222 | 11v | | CCU150 ^[57] | |
| 1.9 TD 75 | 4 | 182A8.000 | 55/74 | 09/96 → 05/02 | CH167 | 11v | | CCU153 | |
| 1.9 TD 100 | 4 | 182A7.000; 182B9.000 | 74/99 | 05/96 → 06/03 | CH167 | 11v | | | |
| 2.0 150 20V | 5 | 182A1.000 | 108/145 | 09/96 → 04/99 | OE216 LPG [278] | 0,8 | CET2 | OE179 | |
| 2.0 150 20V | 5 | 185A8.000 | 110/148 | 01/01 → 05/02 | OE216 LPG [278] | 0,8 | CET2 | OE179 | |
| 2.0 155 20V | 5 | 182B7.000 | 113/152 | 04/99 → 02/03 | OE216 LPG [278] | 0,8 | CET2 | OE188 | |
| 2.4 JTD 130 | 5 | 185A6.000; 839A5.000 | 96/129 | 04/99 → 05/02 | CH222 Eng.1713819 → Prod.15.11.1999 → | 11v | | | |
| 2.4 TD 125 | 5 | 185A2.000 | 91/122 | 09/96 → 04/99 | CH167 | 11v | | | |

MULTIPLA

| | | | | | | | | | |
|---------------------------|---|----------------------|--------|---------------|---|-----|------|-------|------------------------|
| 1.6 | 4 | 182B6.000 | 68/91 | 05/04 → 08/05 | OE030 | 0,9 | CET2 | OE179 | BAE920AX |
| 1.6 | 4 | 182B6.000 | 74/99 | 03/01 → 08/05 | OE030 | 0,9 | CET2 | OE179 | BAE920AX |
| 1.6, 1.6 100 16V | 4 | 182A4.000; 182B6.000 | 76/102 | 04/99 → 06/10 | OE030 | 0,9 | CET2 | OE179 | BAE920AX CLS137 |
| 1.6 16V, 1.6 16V Blupower | 4 | 182B6.000; 186A3.000 | 70/94 | 04/99 → 06/10 | OE016 | 0,9 | CET2 | OE180 | BAE920AX CLS137 |
| 1.6 16V Bipower | 4 | 182B6.000; 186A4.000 | 76/102 | 04/99 → 06/10 | OE016 | 0,9 | CET2 | OE180 | BAE920AX CLS137 |
| 1.6 16V GPL | 4 | 182B6.000 | 76/102 | 10/01 → 06/10 | | | | | BAE920AX |
| 1.9 JTD | 4 | 186A9.000 | 88/118 | 04/02 → 06/10 | CH269 10/05 → | 11v | | | CCU150 ^[59] |
| 1.9 JTD 105 | 4 | 182B4.000 | 77/103 | 04/99 → 06/10 | CH222 Eng.1692991 → Prod.15.11.1999 → | 11v | | | |
| 1.9 JTD 110 | 4 | 186A6.000 | 81/109 | 03/01 → 07/02 | CH222 | 11v | | | CCU150 ^[57] |
| 1.9 JTD 115 | 4 | 186A8.000 | 85/114 | 07/02 → 06/10 | CH222 | 11v | | | CCU150 ^[58] |

PALIO

| | | | | | | | | | |
|-------------------|---|------------------------------------|-------|---------------|-----------------------------------|-------------------|--------------|-------|---------------------------------|
| 1.0 | 4 | 178A1.000 | 45/60 | 04/96 → 10/03 | OE018 | 1,0 | CET8 | OE195 | BAE800B |
| 1.0 | 4 | 178A1.000 | 56/75 | 04/96 → 10/03 | OE018 | 1,0 | CET8 | OE195 | BAE800B |
| 1.2 | 4 | 178B7.045 | 44/59 | 07/97 → 10/04 | OE196 | 1,0 | CET1 | | BAE800B CLS067 |
| 1.2 | 4 | 178C4.066 | 44/59 | 07/97 → 10/04 | OE016 OE196 | 0,9 1,0 | CET1 CET2 | OE180 | BAE800B CLS067 |
| 1.2 | 4 | 188A4.000 | 44/59 | 07/97 → 10/04 | OE016 OE196 OE230 LPG [278] | 0,9 1,0 0,9 | CET1 CET2 | OE180 | BAE800B CLS067 |
| 1.2 | 4 | 178E2.000 | 50/67 | 06/99 → 10/02 | OE063 OE216 LPG [278] | 1,0 0,8 | CET2 | OE180 | BAE800B CLS067 CLS261 |
| 1.2 | 4 | 178B5.000 | 53/71 | 07/01 → 06/05 | | | | | BAE800B |
| 1.2 | 4 | 176A8.000; 178B5.000; 178E2.000 | 54/72 | 04/96 → | OE063 OE216 LPG [278] | 1,0 0,8 | CET2 | OE180 | BAE800B CLS007 → Eng.7672018 |
| 1.2 | 4 | 188A5.000 | 59/79 | 09/01 → | OE196 OE230 LPG [278] | 1,0 0,9 | CET1 | | BAEA234 |
| 1.2 Biopower | 4 | 178E9.011 | 52/70 | 01/04 → 12/05 | OE196 | 1,0 | CET1 | | BAE800B |
| 1.2 Flex, 1.2 LPG | 4 | 188A4.000 | 44/59 | 07/97 → 08/02 | OE196 | 1,0 | CET1 | | BAE800B |
| 1.4 | 4 | 178B2.000 | 51/68 | 04/96 → 10/02 | OE019 | 0,9 | CET2 | OE179 | BAE800B |
| 1.4 | 4 | 199A1.000 | 57/76 | 10/05 → | OE196 | 1,0 | CET1 | | |
| 1.4 | 4 | 834A1.000 | 70/94 | 06/03 → | OE196 | 1,0 | CET1 | | |
| 1.4 Biopower | 4 | 310A2.011 | 63/84 | 02/05 → | OE196 | 1,0 | CET1 | | |
| 1.4 Cat | 4 | 178B2.016 | 51/68 | 04/96 → 08/01 | | | CET2 | OE179 | BAE800B |
| 1.5 | 4 | | 57/76 | 04/96 → 12/00 | OE014 | 0,9 | CET2 | OE179 | BAE920AX |
| 1.5 | 4 | 178E5.022 | 62/83 | 02/02 → | OE005 | 0,9 | CET2 | OE179 | BAE800B |
| 1.6 | 4 | 178D2.011 | 70/94 | 07/97 → | | | | | BAE920AX 03/00 → 09/01 |
| 1.6 16V | 4 | 178C7.098; 178D2.011 | 68/91 | 07/97 → 10/03 | OE016 | 0,9 | CET2 | | BAE920AX |





kW/BHP



eon TITAN

IRIDIUM

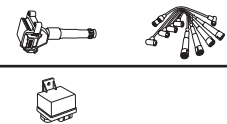

...FIAT



...PALIO

| | | | | | | | | | | |
|---------|---|-----------|--------|-------------|-------|-----|------|-------|----------|--------|
| 1.6 16V | 4 | 178B3.000 | 74/99 | 04/96→12/05 | OE016 | 0,9 | CET2 | OE180 | BAE920AX | CLS137 |
| 1.6 16V | 4 | 182B6.000 | 76/102 | 02/01→ | OE016 | 0,9 | CET2 | OE180 | BAE920AX | CLS137 |
| 1.7 TD | 4 | 176A3.000 | 51/68 | 04/96→01/12 | CH189 | 11v | | | CCU153 | |
| 1.9 D | 4 | 223A6.000 | 46/62 | 09/00→ | CH209 | 11v | | | | |
| 1.9 JTD | 4 | 188A2.000 | 59/79 | 09/01→ | CH222 | 11v | | | CCU150 | |

PANDA

| | | | | | | | | | | |
|------------------------------------|---|----------------------|-------|-------------|------------------------------------|------------|----------------------------------|-----------------|--------------------|------------------------|
| 0.9 | 2 | 312A4.000; 312A6.000 | 44/59 | 12/13→ | OE232 | 0,7 | CET15P | | BAEA090 | |
| 0.9 | 2 | 312A4.000 | 48/64 | 02/12→ | OE232 | 0,7 | CET15P | | BAEA090 | |
| 0.9 | 2 | 312A2.000; 312A7.000 | 57/76 | 02/12→ | OE232 | 0,7 | CET15P | | BAEA090 | |
| 0.9, 0.9 4WD, 0.9 Natural Power | 2 | 312A2.000 | 63/84 | 02/12→ | OE232 | 0,7 | CET15P | | BAEA090 | |
| 0.9, 0.9 Natural Power | 2 | 312A2.000; 312A5.000 | 59/79 | 12/13→ | OE232 | 0,7 | CET15P | | BAEA090 | |
| 0.9 4WD | 2 | 312A2.000; 312A7.000 | 66/89 | 06/14→ | OE232 | 0,7 | CET15P | | BAEA090 | |
| 1.1 | 4 | 187A1.000 | 40/54 | 09/03→ | OE016 →12/04 OE196 01/05→ | 0,9 1,0 | CET2 →12/04 CET1 01/05→ | OE180 →12/04 | BAE800B | CLS261 |
| 1.1 1100, 1.1 1100 4WD | 4 | 176B2.000; 187A1.000 | 40/54 | 02/95→07/04 | OE016 | 0,9 | CET2 | OE180 | BAE800B | CLS067 |
| 1.2 | 4 | 188A4.000 | 44/59 | 09/03→ | OE016 →09/04 OE196 10/04→ | 0,9 1,0 | CET2 →09/04 CET1 10/04→ | OE180 →09/04 | BAE800B | CLS261 |
| 1.2 | 4 | 169A4.000 | 51/68 | 03/10→ | OE196 | 1,0 | CET1 | | BAE403C BAE940A | CLS082 |
| 1.2 4WD | 4 | 188A4.000 | 44/59 | 10/04→ | OE196 | 1,0 | CET1 | | BAE800B | CLS261 |
| 1.2 4WD | 4 | 169A4.000 | 51/68 | 11/09→ | OE196 | 1,0 | CET1 | | BAE940A | CLS082 |
| 1.2 LPG | 4 | 169A4.000 | 51/68 | 11/10→ | OE196 | 1,0 | CET1 | | BAE403C BAE800B | |
| 1.2 LPG, 1.2 Natural Power | 4 | 188A4.000 | 44/59 | 01/07→ | OE196 | 1,0 | CET1 | | BAE800B | CLS067 →Eng.2888158 |
| 1.3 D Multijet | 4 | 169A1.000; 169A5.000 | 55/74 | 06/06→ | | | | | CCU150 | |
| 1.3 D Multijet, 1.3 D Multijet 4WD | 4 | 188A8.000 | 51/68 | 09/03→ | | | | | CCU150 | |
| 1.3 D Multijet 4WD | 4 | 169A1.000 | 55/74 | 09/10→ | | | | | CCU150 | |
| 1.3 D Multijet 4WD | 4 | 169A5.000 | 55/74 | 09/10→ | | | | | CCU150 | |
| 1.4 | 4 | 169A3.000 | 74/99 | 10/06→ | OE196 OE230 LPG [278] | 1,0 0,9 | CET1 | | BAE403C | |
| 1.4 Natural Power | 4 | 350A1.000 | 51/68 | 01/10→ | OE196 | 1,0 | CET1 | | | |
| 1.4 Natural Power | 4 | 350A1.000 | 57/76 | 09/10→ | OE196 | 1,0 | CET1 | | BAE940A | |

PREMIO

| | | | | | | | | | | |
|----------|---|----------------------|-------|-------------|-------|-----|------|-------|---------|--|
| 1.6 i.e. | 4 | 146B7.011; 160A2.011 | 60/80 | 08/93→12/96 | OE018 | 1,0 | CET8 | OE195 | BAE800B | |
|----------|---|----------------------|-------|-------------|-------|-----|------|-------|---------|--|

PUNTO

| | | | | | | | | | | |
|-------------------------------|---|----------------------|--------|-------------|--------------------------|------------|--------|-------|---------|--------|
| 0.9 | 2 | 199B6.000; 199B7.000 | 74/99 | 12/13→ | OE232 | 0,7 | CET15P | | BAEA090 | |
| 0.9 | 2 | 199B6.000 | 77/103 | 07/13→ | OE232 | 0,7 | CET15P | | BAEA090 | |
| 0.9 Bifuel, 0.9 Twinair Turbo | 2 | 312A2.000 | 63/84 | 03/12→ | OE232 | 0,7 | CET15P | | BAEA090 | |
| 1.1 55 | 4 | 176A6.000; 176B2.000 | 40/54 | 09/93→09/99 | OE002 | 0,9 | CET2 | OE180 | BAE800B | CLS261 |
| 1.2 | 4 | 199B9.000 | 49/66 | 02/14→ | OE196 | 1,0 | CET1 | | BAE940A | |
| 1.2 | 4 | 169A4.000 | 51/68 | 03/12→ | OE196 | 1,0 | CET1 | | BAE940A | CLS082 |
| 1.2 16V, 1.2 85 16V | 4 | 176B9.000 | 63/84 | 04/97→06/00 | OE186 | 1,0 | CET1 | | BAE800B | CLS035 |
| 1.2 16V 80 | 4 | 188A5.000 | 59/79 | 09/99→12/06 | OE196 OE230 LPG [278] | 1,0 0,9 | CET1 | | BAEA234 | CLS044 |
| 1.2 60 | 4 | 176A7.000 | 43/58 | 01/94→06/00 | OE002 | 0,9 | CET2 | OE180 | BAE800B | CLS261 |
| 1.2 60 | 4 | 176B1.000; 176B4.000 | 44/59 | 09/93→12/10 | OE002 | 0,9 | CET2 | OE180 | BAE800B | CLS261 |

FIAT





kW/BHP

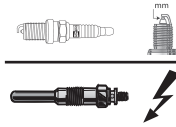

eon TITAN

IRIDIUM

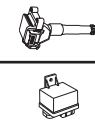

...FIAT



...PUNTO

| | | | | | | | | | | |
|------------------------------------|---|----------------------|--------|-------------|--|------------|----------------------------------|-----------------|------------------------|--|
| 1.2 60 | 4 | 188A4.000 | 44/59 | 09/93→12/10 | OE016 →09/04 OE196 10/04→ | 0,9 1,0 | CET2 →09/04 CET1 10/04→ | OE180 →09/04 | BAE800B | CLS261 →01/03 CLS067 02/03→ →Eng.2935743 |
| 1.2 75 | 4 | 176A8.000 | 54/72 | 10/93→09/99 | OE002 | 0,9 | CET2 | OE180 | BAE800B | CLS261 |
| 1.2 Bifuel | 4 | 188A4.000 | 44/59 | 08/07→03/12 | OE196 | 1,0 | CET1 | | BAE800B | CLS082 CLS067 Eng.C10491→ →Eng.2935743 |
| 1.2 Natural Power | 4 | 188A4.000 | 44/59 | 09/03→03/12 | OE016 →09/04 OE196 10/04→ | 0,9 1,0 | CET2 →09/04 CET1 10/04→ | OE180 →09/04 | BAE800B | CLS067 →Eng.2935743 |
| 1.3 D Multijet | 4 | 199A2.000; 199A9.000 | 55/74 | 03/12→ | | | | | CCU150 ^[21] | |
| 1.3 D Multijet | 4 | 199B8.000 | 59/79 | 12/13→ | | | | | CCU150 ^[53] | |
| 1.3 D Multijet | 4 | 199B4.000 | 62/83 | 03/12→ | | | | | CCU150 ^[21] | |
| 1.3 D Multijet | 4 | 199B1.000; 330A1.000 | 70/94 | 03/12→ | | | | | CCU150 ^[21] | |
| 1.3 JTD 16V | 4 | 188A9.000 | 51/68 | 06/03→03/12 | | | | | CCU150 | |
| 1.4 | 4 | 199A7.000 | 55/74 | 03/12→ | | | | | BAE940A | |
| 1.4 | 4 | 843A1.000 | 70/94 | 09/03→03/12 | OE196 OE230 LPG ^[278] | 1,0 0,9 | CET1 | | BAE403C | |
| 1.4 | 4 | 199A6.000 | 71/95 | 11/05→03/12 | OE196 | 1,0 | CET1 | | BAE403C | |
| 1.4, 1.4 Bifuel, 1.4 Natural Power | 4 | 350A1.000 | 57/76 | 03/12→ | OE196 | 1,0 | CET1 | | BAE940A | |
| 1.4 GT Turbo | 4 | 176B6.000 | 96/129 | 09/96→07/99 | OE077 | 1,0 | CET2 | OE179 | BAEA234 | |
| 1.4 GT Turbo | 4 | 176A4.000 | 98/131 | 10/93→03/97 | OE077 | 1,0 | CET2 | OE179 | BAEA234 | |
| 1.4 Multi Air | 4 | 955A6.000 | 77/103 | 03/12→ | OE196 | 1,0 | CET1 | | | |
| 1.4 Turbo Multi Air | 4 | 955A2.000 | 99/133 | 03/12→ | OE208 | 0,8 | | | | |
| 1.6 | 4 | 176A9.000 | 65/87 | 01/94→04/97 | | | CET2 | OE179 | BAEA234 | |
| 1.6 90 | 4 | 176A9.000 | 65/87 | 04/94→04/97 | | | CET2 | OE179 | | |
| 1.7 D | 4 | 176B3.000 | 42/56 | 04/94→09/97 | CH189 | 11v | | | | |
| 1.7 TD | 4 | 176B7.000 | 46/62 | 09/96→09/99 | CH189 | 11v | | | CCU153 | |
| 1.7 TD | 4 | 176A3.000 | 51/68 | 01/94→09/99 | CH189 →09/96 | 11v | | | CCU153 | |
| 1.7 TD | 4 | 176A5.000 | 52/70 | 01/94→09/99 | CH189 | 11v | | | CCU153 | |
| 1.8 130 HGT | 4 | 183A1.000; 188A6.000 | 96/129 | 09/99→03/12 | OE016 | 0,9 | CET2 | OE180 | | |
| 1.9 DS 60 | 4 | 188A3.000 | 44/59 | 09/99→03/12 | CH209 | 11v | | | | |
| 1.9 JTD | 4 | 188A7.000 | 63/84 | 10/01→03/12 | CH222 [47] ^[310] CH269 [48] ^[311] | 11v 11v | | | CCU150 | |
| 1.9 JTD | 4 | 188B2.000 | 74/99 | 06/03→03/12 | CH222 | 11v | | | | |
| 1.9 JTD 80 | 4 | 188A2.000 | 59/79 | 09/99→03/12 | CH222 | 11v | | | CCU150 | |
| PUNTO EVO | | | | | | | | | | |
| 1.2 | 4 | 199A4.000 | 48/64 | 10/09→02/12 | OE196 | 1,0 | CET1 | | BAE940A | CLS082 |
| 1.2 | 4 | 169A4.000 | 51/68 | 10/09→02/12 | OE196 | 1,0 | CET1 | | BAE940A | CLS082 |
| 1.3 D Multijet | 4 | 199B2.000 | 51/68 | 07/08→02/12 | | | | | CCU150 ^[53] | |
| 1.3 D Multijet | 4 | 199A2.000; 199A9.000 | 55/74 | 10/09→02/12 | | | | | CCU150 ^[53] | |
| 1.3 D Multijet | 4 | 199B4.000; 223A9.000 | 62/83 | 10/09→02/12 | | | | | CCU150 ^[53] | |
| 1.3 D Multijet | 4 | 199A3.000 | 66/89 | 10/09→ | | | | | CCU150 ^[53] | |
| 1.3 D Multijet | 4 | 199B1.000 | 70/94 | 10/09→02/12 | | | | | CCU150 ^[53] | |
| 1.4 | 4 | 199A7.000 | 55/74 | 07/09→02/12 | OE196 | 1,0 | CET1 | | BAE940A | |
| 1.4 | 4 | 350A1.000 | 57/76 | 10/09→02/12 | OE196 | 1,0 | CET1 | | BAE940A | CLS082 |
| 1.4 16V | 4 | 955A6.000 | 77/103 | 10/09→02/12 | OE196 | 1,0 | CET1 | | | |
| 1.4 16V | 4 | 955A2.000 | 99/133 | 10/09→02/12 | OE208 | 0,8 | | | | |
| 1.4 LPG, 1.4 Natural Power | 4 | 350A1.000 | 57/76 | 06/09→02/12 | OE196 | 1,0 | CET1 | | BAE940A | |

FIAT





kW/BHP



eon TITAN

IRIDIUM



...FIAT



QUBO

| | | | | | | | | | |
|-------------------|---|----------------------|-------|--------|-------|-----|------|-------|-------------------------|
| 1.3 D Multijet | 4 | 199A2.000; 199A9.000 | 55/74 | 02/08→ | | | | | CCU150 ^[267] |
| 1.3 D Multijet | 4 | 199B1.000 | 70/94 | 07/10→ | | | | | CCU150 ^[267] |
| 1.4 | 4 | KFT; KFV | 54/72 | 02/08→ | OE034 | 0,9 | CET2 | OE179 | BAEA048E ^[7] |
| 1.4 Natural Power | 4 | 350A1.000 | 57/76 | 10/09→ | OE196 | 1,0 | CET1 | | BAE940A |

SCUDO

| | | | | | | | | | | |
|------------------------------------|---|---------------------|---------|-------------|------------------------|-----|------|-------|------------------------|-------------------------------------|
| 1.6 | 4 | 220A2.000 | 58/78 | 02/96→12/06 | | | CET2 | OE179 | BAEA234 | CLS135 |
| 1.6 D Multijet | 4 | 9HU | 66/89 | 01/07→ | CH201 | 11v | | | CCU147 ^[21] | |
| 1.9 D | 4 | WJZ(DW8) | 51/68 | 02/96→12/06 | CH185 | 11v | | | | |
| 1.9 D | 4 | D9B | 51/68 | 02/96→12/06 | CH189 | 11v | | | | |
| 1.9 TD | 4 | D8B | 68/91 | 02/96→12/06 | CH189 | 11v | | | CCU149 | 12/99→ Ch.0008420→ [52] [319] |
| 1.9 TD Eco | 4 | DHX(XUD9TF/L) | 66/89 | 02/96→12/06 | CH189 | 11v | | | CCU149 | 12/99→ Ch.0008420→ [52] [319] |
| 2.0 16V | 4 | RFN(EW10J4) | 100/134 | 06/00→12/06 | OE178 | 0,9 | CET5 | | BAEA348 | |
| 2.0 D Multijet | 4 | RHR | 100/134 | 01/07→ | CH268 | 11v | | | CCU147 | |
| 2.0 D Multijet | 4 | RH02; RHH | 120/161 | 07/10→ | CH268 | 11v | | | CCU147 | |
| 2.0 D Multijet, 2.0 D Multijet 4WD | 4 | RHK | 88/118 | 01/07→ | CH268 | 11v | | | CCU147 | |
| 2.0 D Multijet, 2.0 D Multijet 4WD | 4 | RH02 | 94/126 | 04/11→ | CH268 | 11v | | | CCU147 | |
| 2.0 JTD | 4 | RHX | 69/93 | 01/04→12/06 | CH170 | 11v | | | | |
| 2.0 JTD, 2.0 JTD 16V | 4 | RHW(DW10ATED4); RHZ | 80/107 | 05/99→12/06 | CH170 ^[172] | 11v | | | | |
| | | | | | CH268 ^[173] | 11v | | | | |

SEDICI

| | | | | | | | | | | |
|------------------------------------|---|-------|--------|-------------|-------|-----|------|-------|----------|--------|
| 1.6 16V | 4 | M16A | 79/106 | 06/06→10/14 | OE016 | 0,9 | | | BAEA181E | CLS167 |
| | | | | | | | | | →06/09 | →06/09 |
| 1.6 16V | 4 | M16A | 88/118 | 06/06→10/14 | OE016 | 0,9 | CET2 | | BAEA181E | CLS167 |
| | | | | | | | | | →06/09 | →06/09 |
| 1.6 16V 4WD | 4 | M16A | 79/106 | 06/06→10/14 | OE016 | 0,9 | CET2 | OE180 | BAEA181E | CLS167 |
| | | | | | | | | | →06/09 | →06/09 |
| 1.6 16V 4WD | 4 | M16A | 88/118 | 06/06→10/14 | OE016 | 0,9 | CET2 | OE180 | BAEA181E | CLS167 |
| | | | | | | | | | →06/09 | →06/09 |
| 1.9 D Multijet, 1.9 D Multijet 4WD | 4 | D19AA | 88/118 | 06/06→10/11 | CH222 | 11v | | | | |

SEICENTO / 600

| | | | | | | | | | | |
|-----|---|----------------------|-------|-------------|--------|-----|--------|--------|---------|--------|
| 0.9 | 4 | 1170A1.046 | 29/39 | 11/97→12/08 | OE004 | 0,9 | CET8 | OE195 | BAE800B | CLS003 |
| 1.1 | 4 | 176B2.000; 187A1.000 | 40/54 | 01/98→01/10 | OE002 | 0,9 | CET2 | OE180 | BAE800B | CLS261 |
| | | | | | →10/04 | | →10/04 | →10/04 | | |
| | | | | | OE196 | 1,0 | CET1 | | | |
| | | | | | 11/04→ | | 11/04→ | | | |

SIENA

| | | | | | | | | | | |
|-------------|---|-----------|-------|-------------|----------------------------|-----|------|-------|---------|-------------|
| 1.2 | 4 | 178C4.066 | 44/59 | 09/01→12/12 | OE016 | 0,9 | CET2 | OE180 | BAE800B | CLS067 |
| 1.2 | 4 | 188A4.000 | 44/59 | 09/01→12/12 | OE016 | 0,9 | CET2 | OE180 | BAE800B | CLS067 |
| | | | | | OE230 LPG ^[278] | 0,9 | | | | |
| 1.2 | 4 | 178E9.011 | 52/70 | 06/04→12/09 | | | | | BAE800B | |
| 1.2 | 4 | 178B5.000 | 54/72 | 09/98→12/09 | OE016 | 0,9 | CET2 | OE180 | BAE800B | |
| 1.2 | 4 | 188A5.000 | 59/79 | 09/01→12/09 | OE196 | 1,0 | CET1 | | BAEA234 | CLS044 |
| 1.2 Flex | 4 | 178E9.011 | 52/70 | 03/04→05/05 | OE196 | 1,0 | CET1 | | | |
| 1.3 JTD | 4 | 188A9.000 | 51/68 | 09/03→ | | | | | CCU150 | |
| 1.4 | 4 | 178B2.000 | 51/68 | 04/96→12/09 | OE002 | 0,9 | CET2 | OE180 | BAE800B | 03/00→06/01 |
| | | | | | | | | | BAE940A | |
| 1.4 | 4 | 350A1.000 | 57/76 | 01/07→ | OE196 | 1,0 | CET1 | | BAE940A | |
| 1.4 | 4 | 178F3.011 | 57/76 | 01/07→ | OE196 | 1,0 | CET1 | | BAE940A | |
| 1.4 Bipower | 4 | 178F3.011 | 60/80 | 06/04→10/07 | OE196 | 1,0 | CET1 | | | |

FIAT





kW/BHP



eon TITAN

IRIDIUM



...FIAT



...SIENA

| | | | | | | | | | | |
|-------------|---|-------------|--------|-------------|-------|-----|------|-------|------------------------|--------|
| 1.4 Cat | 4 | 178B2.016 | 51/68 | 04/96→12/09 | OE019 | 0,9 | CET2 | OE184 | BAE800B 05/98→06/01 | |
| 1.6 | 4 | 182B6.000 | 76/102 | 11/00→12/09 | OE030 | 0,9 | CET2 | OE179 | BAE920AX | CLS137 |
| 1.6 16V | 4 | 178B3.000 | 78/105 | 10/97→12/09 | OE016 | 0,9 | CET2 | OE180 | BAE920AX | |
| 1.7 TD | 4 | 176A3.000 | 51/68 | 02/06→12/09 | CH189 | 11v | | | CCU153 | |
| 1.8 Bipower | 4 | 93313090-7U | 81/109 | 06/04→12/09 | OE089 | 1,0 | CET2 | | | |

STILO

| | | | | | | | | | | |
|----------------|---|----------------------|---------|-------------|--------------------------|------------|------|-------|-------------------|--|
| 1.2 16V | 4 | 188A5.000 | 59/79 | 02/02→11/06 | OE196 OE230 LPG [278] | 1,0 0,9 | CET1 | | BAE403C | |
| 1.4 16V | 4 | 192B2.000 | 66/89 | 03/05→08/08 | OE196 OE230 LPG [278] | 1,0 0,9 | CET1 | | BAE403C | |
| 1.4 16V | 4 | 843A1.000 | 70/94 | 01/04→08/08 | OE196 OE230 LPG [278] | 1,0 0,9 | CET1 | | BAE403C | |
| 1.6 16V | 4 | 182B6.000 | 76/102 | 10/01→08/08 | OE016 | 0,9 | CET2 | OE180 | BAE403B | |
| 1.6 16V | 4 | 192B3.000 | 77/103 | 03/05→12/07 | OE089 | 1,0 | CET2 | OE188 | BAEA427 | |
| 1.8 16V | 4 | 192A4.000 | 98/131 | 10/01→08/08 | OE016 | 0,9 | CET2 | OE180 | | |
| 1.9 D, 1.9 JTD | 4 | 192B5.000 | 66/89 | 09/04→08/08 | CH269 | 11v | | | CCU150 | |
| 1.9 D Multijet | 4 | 192A9.000 | 74/99 | 09/05→08/08 | CH222 | 11v | | | CCU150 | |
| 1.9 D Multijet | 4 | 192A8.000 | 88/118 | 09/05→08/08 | CH269 | 11v | | | | |
| 1.9 D Multijet | 4 | 937A5.000 | 110/148 | 09/05→08/08 | CH224 | 11v | | | CCU150 | |
| 1.9 JTD | 4 | 192A3.000 | 59/79 | 02/02→08/08 | CH222 | 11v | | | CCU150 | |
| 1.9 JTD | 4 | 192A1.000; 937A7.000 | 85/114 | 10/01→08/08 | CH222 | 11v | | | CCU150 | |
| 1.9 JTD | 4 | 937A4.000 | 93/125 | 09/03→08/08 | CH224 | 11v | | | CCU150 | |
| 1.9 JTD | 4 | 192B1.000 | 100/134 | 04/04→08/08 | CH224 | 11v | | | | |
| 1.9 JTD | 4 | 192A5.000 | 103/138 | 01/04→08/08 | CH224 | 11v | | | CCU150 | |
| 2.4 20V | 5 | 192A2.000 | 125/168 | 10/01→04/07 | OE216 LPG [278] | 0,8 | CET2 | OE179 | BAE403D →12/03 | |

STRADA

| | | | | | | | | | | |
|----------------|---|-----------|-------|-------------|---|-------------------|----------------------------------|-----------------|----------------------|--------|
| 1.2 | 4 | 188A4.000 | 44/59 | 04/03→ | OE016 →09/04 OE196 10/04→ OE230 LPG [278] | 0,9 1,0 0,9 | CET2 →09/04 CET1 10/04→ | OE180 →09/04 | BAE800B | CLS067 |
| 1.2 | 4 | 178B5.000 | 54/72 | 06/99→12/06 | OE063 | 1,0 | CET2 | OE180 | BAE800B | CLS261 |
| 1.3 D Multijet | 4 | 223A9.000 | 62/83 | 05/06→ | | | | | CCU150 [59] [295] | |
| 1.7 TD | 4 | 176A3.000 | 51/68 | 06/99→12/06 | CH189 | 11v | | | CCU153 | |
| 1.9 D | 4 | 223A6.000 | 46/62 | 12/00→ | CH209 | 11v | | | | |
| 1.9 JTD | 4 | 188A2.000 | 59/79 | 04/03→ | CH222 | 11v | | | | |

TEMPRA

| | | | | | | | | | | |
|----------|---|-----------|--------|-------------|-------|-----|------|-------|---------|--------|
| 1.6 i.e. | 4 | 159B9.000 | 63/84 | 06/94→08/96 | | | CET2 | OE179 | | CLS135 |
| 1.6 i.e. | 4 | 159B9.000 | 66/89 | 06/94→08/96 | | | CET2 | OE179 | BAEA234 | CLS135 |
| 1.8 i.e. | 4 | 835C4.000 | 66/89 | 09/93→08/96 | OE018 | 1,0 | CET8 | OE195 | BAE800B | |
| 1.8 i.e. | 4 | 836A5.000 | 74/99 | 10/94→08/96 | OE018 | 1,0 | CET8 | OE195 | BAE800B | |
| 1.8 i.e. | 4 | 835C2.000 | 76/102 | 09/93→08/96 | OE018 | 1,0 | CET8 | OE195 | BAE800B | |
| 2.0 | 4 | 159A6.046 | 81/109 | 05/94→12/98 | | | | | BAE800B | |

TIPO

| | | | | | | | | | | |
|--------------------|---|------------------------------------|---------|-------------|-------|-----|------|-------|--------------|--------|
| 1.6 | 4 | 159A3.046; 159A3.048; 835C1.000 | 56/75 | 03/93→10/95 | OE005 | 0,9 | CET2 | | BAEA234[139] | |
| 1.8 i.e | 4 | 836A5.000 | 71/95 | 03/93→04/95 | OE018 | 1,0 | CET8 | OE195 | BAE800B | |
| 1.8 i.e. | 4 | 835C4.000 | 66/89 | 09/93→04/95 | OE018 | 1,0 | CET8 | OE195 | BAE800B | CLS002 |
| 1.8 i.e. | 4 | 159A4.000; 836A5.000 | 74/99 | 10/94→10/95 | OE018 | 1,0 | CET8 | OE195 | BAE800B | |
| 1.8 i.e. | 4 | 835C2.000 | 76/102 | 04/93→04/95 | OE018 | 1,0 | CET8 | OE195 | BAE800B | |
| 2.0 | 4 | 836A3.011 | 104/139 | 03/93→04/95 | OE018 | 1,0 | CET8 | | | |
| 2.0 i.e. 16V Sport | 4 | 836A3.000 | 102/137 | 03/93→04/95 | OE018 | 1,0 | CET8 | OE195 | | |





kW/BHP



eon TITAN

IRIDIUM

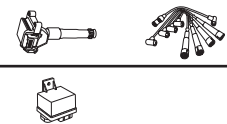

...FIAT



ULYSSE

| | | | | | | | | | |
|----------------------|---|---------------------|---------|-------------|-----------------|-----|--------|-------|-------------------------|
| 1.8 | 4 | LFW | 73/98 | 05/97→08/02 | OE019 | 0,9 | CET2 | OE184 | CLS005 |
| 1.9 TD | 4 | DHX(XUD9TF/L) | 66/89 | 02/95→08/02 | CH189 | 11v | | | |
| 2.0 | 4 | RFU(XU10J2C) | 89/119 | 06/94→08/02 | OE014 | 0,9 | CET2 | OE179 | CLS005 |
| 2.0, 2.0 16V | 4 | RFN(EW10J4) | 100/134 | 09/00→06/11 | OE178 | 0,9 | CET5 | | BAEA348 |
| 2.0 16V | 4 | RFV | 97/130 | 05/98→09/00 | OE014 | 0,9 | CET2 | OE179 | |
| 2.0 D Multijet | 4 | RHK | 88/118 | 05/06→06/11 | CH268 [173] | 11v | | | |
| 2.0 D Multijet | 4 | RHR | 100/134 | 05/06→06/11 | CH268 | 11v | | | |
| 2.0 JTD | 4 | RHM(DW10ATED4) | 79/106 | 05/03→08/06 | CH170 [172] | 11v | | | |
| | | | | | CH268 [173] | 11v | | | |
| 2.0 JTD | 4 | RHZ | 80/107 | 10/99→08/06 | CH170 | 11v | | | |
| 2.0 JTD, 2.0 JTD 16V | 4 | RHW(DW10ATED4) | 80/107 | 05/99→08/06 | CH170 [172] | 11v | | | |
| | | | | | CH268 [173] | 11v | | | |
| 2.0 Turbo | 4 | RGX(XU10J2CTE) | 108/145 | 06/94→08/02 | OE034 →05/00 | 0,9 | CET2 | OE188 | CLS005 |
| 2.1 TD | 4 | P8C | 80/107 | 03/96→10/99 | CH189 | 11v | | | |
| 2.2 D Multijet | 4 | 4HS; 4HT(DW12BTED4) | 125/168 | 03/08→06/11 | | | | | CCU147 ^[285] |
| 2.2 JTD | 4 | 4HW(DW12ATED4) | 94/126 | 08/02→08/06 | CH170 [172] | 11v | | | CCU147 ^[285] |
| | | | | | CH268 [173] | 11v | | | |
| 2.2 JTD | 4 | 4HP; 4HR | 120/161 | 03/08→06/11 | | | | | CCU147 ^[285] |
| 3.0 | 6 | XFW | 150/201 | 08/02→06/11 | OE175 | 1,0 | CET14P | OE190 | BAEA347 |

UNO

| | | | | | | | | | |
|--------|---|-----------|-------|-------------|-------|-----|------|-------|--------------------------|
| 1.0 iE | 4 | 156A2.246 | 34/46 | 05/98→08/00 | OE005 | 0,9 | CET2 | OE180 | BAE506D ^[292] |
| 1.7 D | 4 | 146B2.000 | 43/58 | 11/94→08/00 | CH189 | 11v | | | |

FIAT



DOBLO

| | | | | | | | | | | |
|----------------------|---|----------------------|--------|-------------|----------------------------|-----|------|---------|----------------------|--------|
| 1.2 | 4 | 223A5.000 | 48/64 | 03/01→ | OE016 | 0,9 | CET2 | OE180 | BAE800B | CLS067 |
| 1.3 D Multijet | 4 | 263A6.000 | 55/74 | 10/05→ | | | | | CCU150 [22] [298] | |
| 1.3 D Multijet | 4 | 199A2.000 | 55/74 | 10/05→ | | | | | CCU150 | |
| 1.3 D Multijet | 4 | 199A3.000; 263A2.000 | 66/89 | 02/10→ | | | | | CCU150 [22] [298] | |
| 1.3 JTD 16V | 4 | 188A8.000; 188A9.000 | 51/68 | 05/04→12/06 | | | | | CCU150 | |
| 1.3 JTD 16V Multijet | 4 | 223A9.000 | 62/83 | 08/06→ | | | | | CCU150 | |
| 1.4 | 4 | 350A1.000 | 57/76 | 10/05→ | OE196 | 1,0 | CET1 | BAE940A | CLS082 | |
| 1.4 | 4 | 843A1.000 | 70/94 | 02/10→ | OE196 | 1,0 | CET1 | BAE403C | | |
| | | | | | OE230 LPG ^[278] | 0,9 | | | | |
| 1.4 | 4 | 198A4.000 | 88/118 | 10/11→ | OE208 | 0,8 | | BAE403C | | |
| 1.4 Natural Power | 4 | 198A4.000 | 88/118 | 06/10→ | OE208 | 0,8 | | BAEA095 | | |
| 1.6 16V | 4 | 182B6.000 | 76/102 | 10/01→ | OE016 | 0,9 | CET2 | OE180 | BAE403B | |
| 1.6 Natural Power | 4 | 182B6.000 | 76/102 | 09/02→ | OE016 | 0,9 | CET2 | OE180 | BAE920AX | |
| 1.9 D | 4 | 223A6.000 | 46/62 | 03/01→ | CH209 | 11v | | | | |
| 1.9 JTD | 4 | 182B9.000 | 74/99 | 10/01→ | CH222 | 11v | | | CCU150 | |
| 1.9 JTD | 4 | 223A7.000; 223B1.000 | 77/103 | 07/03→ | CH222 | 11v | | | CCU150 | |
| 1.9 JTD Multijet | 4 | 186A9.000 | 88/118 | 12/06→ | CH269 →12/10 | 11v | | | CCU150 | |

DUCATO

| | | | | | | | | | | |
|------------------------------|---|----------------------|--------|-------------|-------|-----|------|-------|---------|--------|
| 1.9 D | 4 | D9B; D9B(XUD9A); DJY | 50/67 | 04/98→04/02 | CH185 | 11v | | | | |
| 1.9 TD | 4 | DHX(XUD9TF/L) | 66/89 | 04/98→04/02 | CH189 | 11v | | | | |
| 1.9 TD CAT, 1.9 TD Combinato | 4 | 230A4.000 | 59/79 | 08/94→04/02 | CH189 | 11v | | | | |
| 2.0, 2.0 Bipower | 4 | RFL(XU10J2U) | 81/109 | 04/02→ | OE002 | 0,9 | CET2 | OE180 | BAEA232 | CLS123 |
| 2.0, 2.0 Panorama/Combinato | 4 | RFW | 80/107 | 03/94→04/02 | OE002 | 0,9 | CET2 | OE180 | CLS123 | |
| 2.0 4WD | 4 | RFW | 80/107 | 11/94→04/02 | OE002 | 0,9 | CET2 | OE179 | BAEA232 | CLS123 |
| 2.0 4WD | 4 | RFL(XU10J2U) | 81/109 | 05/02→07/06 | OE002 | 0,9 | CET2 | OE179 | BAEA232 | |
| | | | | | | | | OE180 | | |

FIAT





kW/BHP

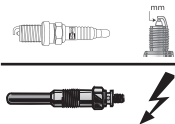

eon TITAN

IRIDIUM



...FIAT



...DUCATO

| | | | | | | | | | |
|--|---|--|---------|-------------|-------|-------|------|-------|---------|
| 2.0 JTD | 4 | RHV(DW10) | 62/83 | 07/01→ | CH170 | 11v | | | |
| 2.2 100 Multijet 2, 2 D | 4 | 4HV(P22DTE) | 74/99 | 07/06→ | CH229 | 11.5v | | | |
| 2.3 110 Multijet 2, 3 D | 4 | F1AE3481G | 83/111 | 10/11→ | CH270 | 11v | | | |
| 2.3 120 Multijet 2, 3 D, 2.3 120 Multijet 2, 3 D 4WD | 4 | F1AE0481D; FPT | 88/118 | 07/06→ | CH270 | 11v | | | |
| 2.3 130 Multijet 2, 3 D | 4 | F1AE0481T | 93/125 | 08/06→ | CH270 | 11v | | | |
| 2.3 130 Multijet 2, 3 D | 4 | F1AE0481N; F1AE3481D; F1AGL411D; F1AGL411M | 96/129 | 07/06→ | CH270 | 11v | | | |
| 2.3 150 Multijet 2, 3 D | 4 | F1AE3481E | 109/146 | 06/11→ | CH270 | 11v | | | |
| 2.3 JTD | 4 | F1AE0481C | 81/109 | 04/02→ | CH270 | 11v | | | CCU150 |
| 2.5 D, 2.5 D 4WD, 2.5 D Combinato | 4 | 8140.67 | 62/83 | 03/94→04/02 | CH147 | 11.5v | | | |
| 2.8 D, 2.8 D 4WD, 2.8 TD 4WD | 4 | 8140.63 | 64/86 | 02/98→04/02 | CH216 | 11v | | | |
| 2.8 iDTD 4WD, 2.8 TD 4WD, 2.8 TDI, 2.8 TDI 4WD | 4 | 8140.43 | 90/121 | 10/97→07/06 | CH216 | 11v | | | |
| 2.8 JTD, 2.8 JTD 4WD | 4 | 8140.43S | 94/126 | 11/00→ | CH216 | 11v | | | |
| 2.8 JTD, 2.8 JTD Power | 4 | 8140.43N | 107/143 | 04/04→ | CH216 | 11v | | | |
| 3.0 140 Natural Power | 4 | F1CE0441A; F1CFA401A | 100/134 | 04/09→ | OE077 | 1,0 | CET2 | OE179 | BAE403C |
| 3.0 150 Multijet 3, 0 D | 4 | F1CE3481N | 107/143 | 04/10→ | CH270 | 11v | | | |
| 3.0 160 Multijet 3, 0 D | 4 | F1CE0481D; F1CE3481M | 115/154 | 07/06→ | CH270 | 11v | | | |
| 3.0 160 Multijet 3, 0 D | 4 | F1CE0481D | 116/156 | 07/06→ | CH270 | 11v | | | |
| 3.0 180 Multijet 3, 0 D | 4 | F1CE3481E | 130/174 | 06/11→ | CH270 | 11v | | | |

FIORINO

| | | | | | | | | | |
|-----------------------|---|----------------------|-------|-------------|-------|-----|------|-------|---|
| 1.3 D Multijet | 4 | 199A2.000; 199A9.000 | 55/74 | 11/07→ | | | | | CCU150 ^[267] |
| 1.3 D Multijet | 4 | 199B1.000; 330A1.000 | 70/94 | 07/09→ | | | | | CCU150 ^[267] |
| 1.4 | 4 | KFT; KFV | 54/72 | 11/07→ | OE034 | 0,9 | CET2 | OE179 | BAEA048E ^[7] |
| 1.4 70 i.e. | 4 | 146C5.000; 146D5.000 | 49/66 | 05/94→05/01 | OE006 | 0,9 | CET8 | OE195 | BAE506F ^[292] →05/95 BAE234 06/95→ BAE504D |
| 1.4 Natural Power | 4 | 350A1.000 | 57/76 | 06/08→ | OE196 | 1,0 | CET1 | | BAE940A |
| 1.6 75 i.e. | 4 | 146C6.000; 146D6.000 | 55/74 | 10/93→05/01 | OE008 | 0,9 | CET8 | OE195 | BAE234 06/95→ BAE504D |
| | | | | | OE018 | 1,0 | | | |
| 1.7 65 1.7 TD, 1.7 TD | 4 | 146D7.000 | 46/62 | 11/96→05/01 | CH189 | 11v | | | CCU153 |

PANDA

| | | | | | | | | | |
|----------------------------|---|-----------|-------|-------------|-------------------------------------|------------|--------------|-------|----------------|
| 1.1 | 4 | 187A1.000 | 40/54 | 09/00→ | OE016 OE196 | 0,9 1,0 | CET1 CET2 | OE180 | BAE800B |
| 1.1 4WD | 4 | 187A1.000 | 40/54 | 09/00→02/04 | | | | | BAE800B |
| 1.2, 1.2 4WD | 4 | 188A4.000 | 44/59 | 09/04→ | OE196 | 1,0 | CET1 | | BAE800B CLS261 |
| 1.2, 1.2 4WD | 4 | 169A4.000 | 51/68 | 09/10→ | OE196 | 1,0 | CET1 | | CLS082 |
| 1.2 LPG | 4 | 169A4.000 | 51/68 | 09/10→ | OE196 | 1,0 | CET1 | | |
| 1.2 LPG, 1.2 Natural Power | 4 | 188A4.000 | 44/59 | 01/07→ | OE196 | 1,0 | CET1 | | BAE800B |
| 1.3 D Multijet | 4 | 188A8.000 | 51/68 | 03/04→ | | | | | CCU150 |
| 1.3 D Multijet | 4 | 169A1.000 | 55/74 | 01/06→ | | | | | CCU150 |
| 1.3 D Multijet 4WD | 4 | 169A1.000 | 55/74 | 01/06→ | | | | | CCU150 |
| 1.4 Natural Power | 4 | 350A1.000 | 57/76 | 10/09→ | OE196 OE230 ^{LPG [278]} | 1,0 0,9 | CET1 | | BAE403C |

PANDA VAN

| | | | | | | | | | |
|---------------------------------|---|----------------------|-------|--------|-------|-----|--------|--|---------|
| 0.9 | 2 | 312A4.000 | 48/64 | 02/12→ | OE232 | 0,7 | CET15P | | BAEA090 |
| 0.9, 0.9 4WD, 0.9 Natural Power | 2 | 312A2.000 | 63/84 | 02/12→ | OE232 | 0,7 | CET15P | | BAEA090 |
| 0.9, 0.9 Natural Power | 2 | 312A2.000; 312A5.000 | 59/79 | 12/13→ | OE232 | 0,7 | CET15P | | BAEA090 |
| 1.2, 1.2 LPG | 4 | 169A4.000 | 51/68 | 02/12→ | OE196 | 1,0 | CET1 | | BAE403C |





kW/BHP



eon TITAN

IRIDIUM



...FIAT



PUNTO

| | | | | | | | | | | |
|----------------------------|---|-----------|-------|-------------|--|----------------|--------|-------|------------------------|--|
| 0.9 Twinair Turbo | 2 | 312A2.000 | 63/84 | 03/12→ | OE232 | 0,7 | CET15P | | | |
| 1.1 | 4 | 176B2.000 | 40/54 | 04/96→02/00 | OE002 | 0,9 | CET2 | OE180 | BAE800B | CLS261 |
| 1.2 60 | 4 | 188A4.000 | 44/59 | 02/00→10/09 | OE016 | 0,9 | CET2 | OE180 | BAE800B | CLS261 →01/03 CLS067 02/03→ →Eng.2935743 |
| 1.3 D Multijet | 4 | 199B4.000 | 62/83 | 03/12→ | | | | | CCU150 ^[21] | |
| 1.3 D Multijet | 4 | 199B1.000 | 70/94 | 03/09→ | | | | | CCU150 ^[53] | |
| 1.4 | 4 | 350A1.000 | 57/76 | 02/06→ | OE196 | 1,0 | CET1 | | BAE940A | CLS082 |
| 1.4 LPG, 1.4 Natural Power | 4 | 350A1.000 | 57/76 | 03/09→ | OE196 | 1,0 | CET1 | | BAE940A | |
| 1.7 D | 4 | 176B3.000 | 42/56 | 04/96→02/00 | CH189 | 11v | | | CCU153 | |
| 1.7 TD | 4 | 176B7.000 | 46/62 | 09/96→09/99 | CH189 | 11v | | | | |
| 1.7 TD | 4 | 176A5.000 | 52/70 | 04/96→02/00 | CH189 | 11v | | | CCU153 | |
| 1.9 D 60 | 4 | 188A3.000 | 44/59 | 02/00→10/09 | CH209 | 11v | | | | |
| 1.9 JTD | 4 | 188A7.000 | 63/84 | 02/00→10/09 | CH222 [47] [310] CH269 [48] [311] | 11v 11v | | | CCU150 | |

SCUDO

| | | | | | | | | | | |
|------------------------------------|---|--|---------|-------------|------------------------|-----|------|-------|---|--------|
| 1.6 | 4 | 220A2.000 | 58/78 | 02/96→12/06 | | | CET2 | OE179 | BAEA234 | CLS135 |
| 1.6 D Multijet | 4 | 9HU | 66/89 | 01/07→ | CH201 | 11v | | | CCU147 ^[21] | |
| 1.9 D | 4 | WJY(DW8B); WJZ(DW8) | 51/68 | 02/96→12/06 | CH185 | 11v | | | | |
| 1.9 D | 4 | D9B | 51/68 | 02/96→12/06 | CH189 | 11v | | | | |
| 1.9 TD | 4 | DHX(XUD9TF/L) | 66/89 | 02/96→12/06 | CH189 | 11v | | | CCU149 12/99→ Ch.0008420→ [52] [319] | |
| 1.9 TD | 4 | D8B | 68/91 | 09/96→12/06 | CH189 | 11v | | | CCU149 12/99→ Ch.0008420→ [52] [319] | |
| 2.0 | 4 | RFN(EW10J4) | 100/134 | 05/00→12/06 | OE178 | 0,9 | CET5 | | BAEA348 | |
| 2.0 D Multijet | 4 | RH02 | 94/126 | 05/11→ | CH268 | 11v | | | CCU147 | |
| 2.0 D Multijet | 4 | DW10BTED4; RHR | 100/134 | 01/07→ | CH268 | 11v | | | CCU147 | |
| 2.0 D Multijet | 4 | RH02; RHH | 120/161 | 07/10→ | CH268 | 11v | | | CCU147 | |
| 2.0 D Multijet, 2.0 D Multijet 4WD | 4 | RHK | 88/118 | 01/07→ | CH268 | 11v | | | CCU147 | |
| 2.0 JTD | 4 | RHX | 69/93 | 10/99→12/06 | CH170 | 11v | | | | |
| 2.0 JTD | 4 | RHZ | 80/107 | 12/02→12/06 | CH170 | 11v | | | | |
| 2.0 JTD 16V | 4 | RHK(DW10UTED4); RHM(DW10ATED4); RHW(DW10ATED4) | 80/107 | 05/99→12/06 | CH170 ^[172] | 11v | | | | |
| | | | | | CH268 ^[173] | 11v | | | | |

SEICENTO / 600

| | | | | | | | | | | |
|-----|---|------------|-------|-------------|-------|-----|------|-------|---------|--------|
| 0.9 | 4 | 1170A1.046 | 29/39 | 01/98→01/10 | OE004 | 0,9 | CET8 | OE195 | BAE800B | CLS003 |
| 1.1 | 4 | 176B2.000 | 40/54 | 01/98→01/10 | OE002 | 0,9 | CET2 | OE180 | BAE800B | CLS067 |

FORD



BANTAM

| | | | | | | | | | | |
|-----|---|------|-------|-------------|-------|-----|--------|--|---------|--|
| 1.3 | 4 | A9JD | 55/74 | 11/94→ | | | | | BAEA422 | |
| 1.6 | 4 | | 70/94 | 09/06→ | | | | | BAEA422 | |
| 1.6 | 4 | | 74/99 | 09/01→08/06 | OE029 | 1,0 | CET17P | | | |

B-MAX

| | | | | | | | | | | |
|---------|---|------------|--------|--------|-------|-----|--------|-------|---------|--|
| 1.4 | 4 | SPJD; SPJE | 66/89 | 10/12→ | OE131 | 1,0 | CET18P | OE183 | BAEA387 | |
| 1.4 LPG | 4 | RTJC | 64/86 | 08/13→ | OE031 | 1,0 | CET7 | | | |
| 1.4 LPG | 4 | RTJC | 66/89 | 08/13→ | OE031 | 1,0 | CET7 | | | |
| 1.6 Ti | 4 | IQJA | 77/103 | 10/12→ | OE131 | 1,0 | CET18P | OE183 | BAEA387 | |

FORD





kW/BHP

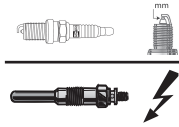

eon TITAN

IRIDIUM

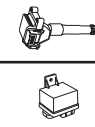

FORD

| ...FORD | | | | | | | | | | |
|-----------------------|---|------------------------------|---------|-------------|--------------------------|------------|--------|-------|--|--|
| C-MAX | | | | | | | | | | |
| 1.6 | 4 | HWDA; HWDB; SHDA; SHDB; SHDC | 74/99 | 02/07→09/10 | OE031 | 1,0 | CET7 | OE189 | BAEA387 →07/10 | CLS077 →Prod.26.03.2007 CLS089 Prod.26.03.2007→ |
| 1.6 | 4 | HXDA; HXDB; SIDA | 85/114 | 04/07→09/10 | | | | | BAEA387 | CLS089 |
| 1.6 TDCi | 4 | HHDA; HHDB | 66/89 | 02/07→09/10 | CH201 | 11v | | | | |
| 1.6 TDCi | 4 | G8DC; MTDA | 74/99 | 02/07→09/10 | CH201 →07/10 | 11v | | | | |
| 1.6 TDCi | 4 | G8DA; G8DB; G8DD | 80/107 | 02/07→09/10 | CH201 | 11v | | | | |
| 1.8 | 4 | QQDC | 90/121 | 02/07→09/10 | | | CET18P | OE183 | BAEA408 | |
| 1.8, 1.8 Flexifuel | 4 | Q7DA; QQDA; QQDB | 92/123 | 02/07→09/10 | OE131 | 1,0 | CET18P | OE183 | BAEA408 | |
| 1.8 TDCi | 4 | KKDA | 85/114 | 02/07→09/10 | CH196 | 10v | | | | |
| 2.0, 2.0 CNG, 2.0 LPG | 4 | AODA; AODB; AODE; SYDA | 107/143 | 02/07→09/10 | OE131 | 1,0 | CET18P | OE183 | BAEA408 | |
| 2.0 TDCi | 4 | IXDA | 81/109 | 02/08→09/10 | CH268 | 11v | | | | |
| 2.0 TDCi | 4 | G6DC; G6DE; G6DF | 98/131 | 02/07→09/10 | CH268 | 11v | | | | |
| 2.0 TDCi | 4 | G6DA; G6DB; G6DD; G6DG | 100/134 | 02/07→09/10 | CH268 | 11v | | | | |
| C-MAX II | | | | | | | | | | |
| 1.6 EcoBoost | 4 | JQDA; JQDB | 110/148 | 12/10→ | | | | | BAEA387 | |
| 1.6 EcoBoost | 4 | JTDA; JTDB | 134/180 | 12/10→ | | | | | BAEA387 | |
| 1.6 Flexifuel | 4 | MUDA | 88/118 | 02/11→ | | | | | BAEA387 | |
| 1.6 Ti | 4 | XTDA | 63/84 | 12/10→ | OE131 | 1,0 | CET18P | OE183 | | |
| 1.6 Ti | 4 | IQDA; IQDB | 77/103 | 12/10→ | OE031 | 1,0 | CET7 | OE189 | BAEA387 →05/11 | CLS089 |
| 1.6 Ti | 4 | PNDA | 92/123 | 12/10→ | OE031 | 1,0 | CET7 | OE189 | BAEA387 →05/11 | CLS089 |
| COUGAR | | | | | | | | | | |
| 2.0 16V | 4 | EDBA; EDBB; EDBC; EDBD | 96/129 | 08/98→12/01 | OE029 OE031 | 1,0 1,0 | CET17P | OE189 | BAEA350 | CLS016 [275] |
| 2.5 V6 24V | 6 | LCBB; LCBC; LCBE | 125/168 | 08/98→12/01 | OE131 | 1,0 | CET18P | OE183 | | CLS156 09/00→ |
| 2.5 V6 24V | 6 | LCBA | 125/168 | 08/98→12/01 | OE131 | 1,0 | CET18P | OE183 | BAEA372 10/00→ | CLS156 09/00→ |
| 2.5 ST 200 | 6 | SGA | 151/202 | 01/00→12/01 | OE131 | 1,0 | CET18P | OE183 | | CLS156 09/00→ |
| ECOSPORT | | | | | | | | | | |
| 2.0 4WD | 4 | | 105/141 | 04/04→ | | | | | BAEA422 | |
| ESCORT CLASSIC | | | | | | | | | | |
| 1.6 16V | 4 | L1E | 66/89 | 10/98→07/00 | OE029 | 1,0 | CET17P | OE189 | BAEA281 | CLS111 |
| 1.8 TD | 4 | RFD; RFK | 66/89 | 10/98→07/00 | CH147 | 11.5v | | | | |
| ESCORT VI | | | | | | | | | | |
| 1.4 | 4 | F4B; FUH | 55/74 | 08/93→01/95 | | | CET2 | OE179 | BAEA281 [275] BAEA281 | CLS122 |
| 1.4 i | 4 | F4B | 55/74 | 07/93→01/95 | | | CET2 | OE179 | BAEA281 01/94→ | CLS122 |
| 1.6 i 16V | 4 | L1H | 65/87 | 01/94→01/95 | OE029 | 1,0 | CET17P | OE189 | BAEA281 | CLS111 |
| 1.8 TD | 4 | RFD; RFK | 66/89 | 02/93→01/95 | CH147 | 11.5v | | | | |
| 1.8 TD | 4 | RFS | 66/89 | 02/93→01/95 | CH205 | 10v | | | | |
| ESCORT VII | | | | | | | | | | |
| 1.3 | 4 | J4B | 44/59 | 01/95→02/99 | OE131 | 1,0 | CET18P | OE183 | BAEA281 →08/98 BAEA350 09/98→ | CLS121 |
| 1.3 | 4 | J6A | 44/59 | 01/95→02/99 | OE011 *to be adjusted | 0,7* | CET9 | OE183 | BAEA281 →08/98 BAEA350 09/98→ | CLS121 |
| 1.4 | 4 | F4B; FUH | 55/74 | 01/95→02/99 | | | CET2 | OE179 | BAEA281 | CLS122 |
| 1.6 | 4 | | 70/94 | 01/01→08/02 | | | | | BAEA422 | |





kW/BHP

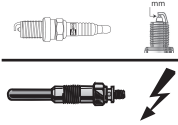

eon TITAN

IRIDIUM



...FORD



...ESCORT VII

| | | | | | | | | | | |
|---|---|---------------|---------|-------------|-------|-------|--------|-------|-------------------|--------|
| 1.6 16V, 1.6 16V 4WD, 1.6 16V XR3i, 1.6 i 16V | 4 | L1E; L1K | 66/89 | 01/95→09/99 | OE029 | 1,0 | CET17P | OE189 | BAEA281 | CLS111 |
| 1.6 16V XR3i, 1.6 i 16V | 4 | L1H | 65/87 | 01/95→12/96 | OE029 | 1,0 | CET17P | OE189 | BAEA281 | CLS111 |
| 1.8 16V, 1.8 16V XR3i | 4 | RDA | 77/103 | 01/95→08/98 | OE029 | 1,0 | CET17P | OE189 | BAEA281 | CLS111 |
| 1.8 16V, 1.8 16V XR3i | 4 | RKC | 85/114 | 01/95→02/99 | OE029 | 1,0 | CET17P | OE189 | BAEA281 | CLS111 |
| 1.8 16V XR3i | 4 | RQB | 96/129 | 02/95→08/00 | OE029 | 1,0 | CET17P | OE189 | BAEA281 | CLS111 |
| 1.8 D | 4 | RTE; RTF; RTH | 44/59 | 01/95→02/99 | CH147 | 11.5v | | | | |
| 1.8 TD | 4 | RFD; RFK | 66/89 | 01/95→02/99 | CH147 | 11.5v | | | | |
| 1.8 Turbo D | 4 | RVA | 51/68 | 12/95→08/99 | CH205 | 10v | | | | |
| 2.0 RS 2000, 2.0 RS 2000 4WD | 4 | N7A | 110/148 | 02/95→10/98 | OE039 | 1,0 | CET2 | OE180 | BAEA308 →08/96 | |

FIESTA

| | | | | | | | | | | |
|------------|---|--|-------|-------------|--|--|--|--|---------|--|
| 1.0 | 4 | | 49/66 | 05/02→03/08 | | | | | BAEA422 | |
| 1.0 | 4 | | 70/94 | 09/04→12/06 | | | | | BAEA422 | |
| 1.0 Street | 4 | | 48/64 | 10/01→08/04 | | | | | BAEA422 | |
| 1.6 Street | 4 | | 70/94 | 03/02→03/10 | | | | | BAEA422 | |

FIESTA III

| | | | | | | | | | | |
|-----------|---|-----|-------|-------------|-------|-------|------|-------|---------|--------|
| 1.6 i 16V | 4 | L1G | 65/87 | 01/94→12/95 | OE031 | 1,0 | CET7 | OE189 | BAEA281 | CLS111 |
| 1.8 TD | 4 | RFL | 55/74 | 03/93→12/95 | CH147 | 11.5v | | | | |

FIESTA IV

| | | | | | | | | | | |
|----------------|---|-----------------------------------|--------|-------------|-------|-----|--------|-------|--|--|
| 1.0 i | 4 | ZH10JRB | 38/51 | 02/97→09/99 | OE011 | 0,9 | CET9 | OE183 | | |
| 1.0 i | 4 | | 48/64 | 09/99→01/02 | OE011 | 0,9 | CET9 | OE183 | BAEA422 | |
| 1.3 | 4 | | 42/56 | 04/96→08/99 | OE131 | 1,0 | CET18P | OE183 | | |
| 1.3 1.25 i 16V | 4 | DHA; DHB; DHC; DHD; DHE; DHF; DHG | 55/74 | 08/95→01/02 | OE031 | 1,0 | CET7 | OE189 | BAEA281 →04/98 BAEA350 05/98→ | CLS032 →04/98 CLS077 05/98→ CLS015 |
| 1.3 i | 4 | JJA; JJC; JJE; JJJ; JJK; JJM | 37/50 | 08/95→01/02 | OE131 | 1,0 | CET18P | OE183 | BAEA281 →08/98 | CLS033 [275] →08/98 CLS066 [275] 09/98→ |
| 1.3 i | 4 | JBC | 44/59 | 08/95→01/02 | OE131 | 1,0 | CET18P | OE183 | BAEA281 →08/98 | CLS033 [275] →08/98 CLS066 [275] 09/98→ |
| 1.3 i | 4 | J4C; J4J; J4L; J4Q; J4R; J4T | 44/59 | 08/95→01/02 | OE011 | 0,9 | CET18P | OE183 | BAEA281 | CLS033 [275] →08/98 |
| | | | | | OE131 | 1,0 | CET9 | | BAEA422 | CLS066 [275] 09/98→ |
| 1.4 i 16V | 4 | FHA; FHE | 66/89 | 04/96→01/02 | OE031 | 1,0 | CET7 | OE189 | BAEA281 →04/98 BAEA350 05/98→ | CLS111 →05/98 CLS015 |
| 1.6 16V Sport | 4 | L1V; L1T | 76/102 | 02/00→01/02 | OE031 | 1,0 | CET7 | OE189 | BAEA281 | CLS111 |
| 1.8 D | 4 | RTJ; RTK | 44/59 | 08/95→04/00 | CH205 | 10v | | | | |
| 1.8 DI | 4 | RTN; RTP; RTQ | 55/74 | 04/00→01/02 | CH196 | 10v | | | | |

FIESTA V

| | | | | | | | | | | |
|------------------|---|------------|-------|-------------|-------|-----|--------|-------|--|--------|
| 1.0 | 4 | | 49/66 | 05/02→03/08 | OE031 | 1,0 | CET7 | | BAEA422 →08/06 | |
| 1.0 Supercharger | 4 | | 70/94 | 05/02→12/06 | | | | | BAEA422 | |
| 1.3 | 4 | BAJA | 44/59 | 11/01→06/08 | OE031 | 1,0 | CET7 | OE189 | BAEA350 [274] | CLS092 |
| 1.3 | 4 | A9JA; A9JB | 51/68 | 11/01→06/08 | OE031 | 1,0 | CET7 | OE189 | BAEA350 [274] →08/07 BAEA387 09/07→ | CLS092 |
| 1.3 16V | 4 | M7JA; M7JB | 51/68 | 03/03→06/08 | OE029 | 1,0 | CET17P | OE189 | BAEA387 03/05→ | CLS077 |

FORD





kW/BHP



eon TITAN

IRIDIUM



FORD

| ...FORD | | | | | | | | | | |
|------------------------------------|---|------------------------------|---------|-------------|-----------------------|-----|--------|-------|--|--|
| ...FIESTA V | | | | | | | | | | |
| 1.3 16V | 4 | FUJA; FUJB | 55/74 | 05/02→06/08 | OE029 | 1,0 | CET17P | OE189 | BAEA422 →02/05 BAEA387 03/05→ | CLS077 |
| 1.4 16V | 4 | FXJA; FXJB | 59/79 | 11/01→06/08 | OE029 | 1,0 | CET17P | OE189 | BAEA350 →02/05 BAEA387 03/05→ | CLS077 |
| 1.4 TDCi | 4 | F6JA; F6JB | 50/67 | 11/01→06/08 | CH201 [124] 08/04→ | 11v | | | CCU147 | |
| 1.6 | 4 | | 70/94 | 11/01→12/04 | | | | | BAEA422 | |
| 1.6 | 4 | | 72/97 | 05/02→06/08 | | | | | BAEA422 | |
| 1.6 16V | 4 | FYJA; FYJB | 74/99 | 11/01→06/08 | OE031 | 1,0 | CET7 | OE189 | BAEA350 →02/05 BAEA387 03/05→ | CLS077 |
| 1.6 TDCi | 4 | HHJA; HHJB | 66/89 | 11/04→06/08 | CH201 06/06→ | 11v | | | CCU147 →Prod.30.01.2006 | |
| 2.0 ST150 | 4 | N4JB | 110/148 | 03/05→06/08 | OE131 | 1,0 | CET18P | OE183 | BAEA448 [275] | CLS074 |
| FIESTA VI | | | | | | | | | | |
| 1.3 | 4 | STJA; STJB; STJC | 44/59 | 06/08→ | OE031 | 1,0 | CET7 | OE189 | BAEA387 | CLS089 |
| 1.3 | 4 | SNJA; SNJB; SNJC; SNJD | 60/80 | 06/08→ | OE031 | 1,0 | CET7 | OE189 | BAEA387 | CLS089 |
| 1.4 | 4 | SPJA; SPJC | 71/95 | 06/08→ | OE031 | 1,0 | CET7 | OE189 | BAEA387 | CLS077 |
| 1.4 LPG | 4 | RTJA; RTJB | 68/91 | 01/09→ | OE131 | 1,0 | CET18P | OE183 | BAEA387 | |
| 1.4 LPG | 4 | RTJA; RTJB | 71/95 | 01/09→ | OE131 | 1,0 | CET18P | OE183 | BAEA387 | |
| 1.4 TDCi | 4 | F6JB; F6JD | 50/67 | 01/09→ | CH201 | 11v | | | | |
| 1.4 TDCi | 4 | F6JD | 51/68 | 07/10→ | CH201 | 11v | | | | |
| 1.6 ST | 4 | JTJA; JTJB | 134/180 | 03/13→ | | | CET17P | OE189 | | |
| 1.6 TDCi | 4 | HHJF; UBJA | 55/74 | 06/08→ | CH201 | 11v | | | | |
| 1.6 TDCi | 4 | HHJC; HHJD; HHJE | 66/89 | 06/08→ | CH201 | 11v | | | | |
| 1.6 Ti | 4 | IQJA; IQJC | 77/103 | 09/12→ | OE131 | 1,0 | CET18P | OE183 | BAEA387 | |
| 1.6 Ti | 4 | HXJA; HXJB | 88/118 | 06/08→ | OE031 | 1,0 | CET7 | OE189 | BAEA387 | CLS089 |
| 1.6 Ti | 4 | U5JA | 99/133 | 12/10→ | | | CET17P | OE189 | BAEA387 | CLS089 |
| FOCUS | | | | | | | | | | |
| 1.4 16V | 4 | FXDA; FXDB; FXDC; FXDD | 55/74 | 10/98→11/04 | OE031 | 1,0 | CET7 | OE189 | BAEA350 | CLS077 |
| 1.6 16V | 4 | FYDA; FYDB; FYDC; FYDD; FYDH | 74/99 | 10/98→11/04 | OE031 | 1,0 | CET7 | OE189 | BAEA350 | CLS077 |
| 1.6 16V Flexifuel | 4 | FYDH | 75/101 | 01/02→11/04 | OE031 | 1,0 | CET7 | OE189 | BAEA350 | CLS077 |
| 1.8 16V | 4 | EYDB; EYDC; EYDD; EYDE; EYDF | 85/114 | 10/98→11/04 | OE029 | 1,0 | CET17P | OE189 | BAEA350 →07/04 | CLS016 [275] |
| 1.8 16V | 4 | EYDG; EYDI; EYDJ; EYDL | 85/114 | 10/98→11/04 | OE029 | 1,0 | CET17P | OE189 | BAEA350 →07/04 | |
| 1.8 BiFuel | 4 | EYDL | 82/110 | 02/03→01/05 | | | | | BAEA350 | |
| 1.8 DI / TDDi, 1.8 Turbo DI / TDDi | 4 | BHDA; BHDB | 55/74 | 08/99→03/05 | CH196 | 10v | | | | |
| 1.8 TDCi | 4 | FFDA | 74/99 | 08/02→11/04 | CH196 | 10v | | | | |
| 1.8 TDCi | 4 | F9DA; F9DB | 85/114 | 03/01→11/04 | CH196 | 10v | | | | |
| 1.8 Turbo DI / TDDi | 4 | C9DA; C9DB; C9DC | 66/89 | 10/98→11/04 | CH196 | 10v | | | | |
| 2.0 16V | 4 | EDDB; EDCC; EDDD; EDDF | 96/129 | 10/98→11/04 | OE029 | 1,0 | CET17P | OE189 | BAEA350 →07/04 | CLS016 [275] |
| 2.0 RS | 4 | HMDA | 158/212 | 10/02→11/04 | OE029 | 1,0 | CET17P | OE189 | BAEA350 | CLS016 [275] |
| 2.0 ST170 | 4 | ALDA | 127/170 | 03/02→11/04 | OE029 | 1,0 | CET17P | OE189 | BAEA350 | CLS016 [275] |
| FOCUS C-MAX | | | | | | | | | | |
| 1.6 | 4 | HWDA; HWDB; SHDA; SHDB; SHDC | 74/99 | 10/03→03/07 | OE031 | 1,0 | CET7 | OE189 | BAEA422 →02/05 BAEA387 03/05→ | CLS077 →Prod.26.03.2007 CLS089 Prod.26.03.2007→ |
| 1.6 TDCi | 4 | HHDA; HHDB | 66/89 | 02/05→03/07 | CH201 [124] | 11v | | | CCU147 | |
| 1.6 TDCi | 4 | G8DA; G8DB | 80/107 | 10/03→03/07 | CH201 [124] | 11v | | | CCU147 | |





kW/BHP



eon TITAN

IRIDIUM



...FORD



...FOCUS C-MAX

| | | | | | | | | | | |
|---------------|---|------------------------|---------|-------------|------------------------|-----|---------------|------------------------|--|---------------|
| 1.6 Ti | 4 | HXDA; SIDA | 85/114 | 08/04→03/07 | OE031 | 1,0 | | | BAEA422 →02/05 BAEA387 03/05→ | CLS077 |
| 1.8 | 4 | CSDA; CSDB | 88/118 | 10/03→03/07 | OE131 →08/05 | 1,0 | CET18P | OE183 | BAEA408 | |
| 1.8 | 4 | QQDC | 90/121 | 09/05→03/07 | | | | OE183 | BAEA408 | |
| 1.8 | 4 | QQDB | 92/123 | 04/04→03/07 | OE131 →08/05 | 1,0 | CET18P | OE183 09/05→ | BAEA408 | |
| 1.8 | 4 | QQDA | 92/123 | 04/04→03/07 | OE131 →08/05 | 1,0 | | OE183 09/05→ | BAEA408 | |
| 1.8 | 4 | Q7DA | 92/123 | 04/04→03/07 | | | | | BAEA408 | |
| 1.8 Flexifuel | 4 | Q7DA | 92/123 | 01/06→03/07 | | | CET18P | OE183 | BAEA408 | |
| 1.8 TDCi | 4 | KKDA; KKDB | 85/114 | 01/05→03/07 | CH196 | 10v | | | | |
| 2.0 | 4 | AODA; AODB | 107/143 | 03/04→03/07 | OE131 →01/05 | 1,0 | CET18P | OE183 02/05→ | BAEA408 | |
| 2.0 | 4 | AODE; SYDA | 107/143 | 03/04→03/07 | | | CET18P | | BAEA408 | |
| 2.0 TDCi | 4 | G6DC; G6DE; G6DF | 98/131 | 10/03→03/07 | CH268 | 11v | | | | |
| 2.0 TDCi | 4 | G6DA; G6DB; G6DD; G6DG | 100/134 | 10/03→03/07 | CH268 | 11v | | | CCU147 | |

FOCUS II

| | | | | | | | | | | |
|-----------------------|---|------------------------------|---------|-------------|--------------------|-----|------------------------------|--------------|--|---|
| 1.4 | 4 | ASDA; ASDB | 59/79 | 07/04→09/12 | OE031 | 1,0 | CET7 | OE189 | BAEA422 →02/05 BAEA387 | CLS016 [275] |
| 1.6 | 4 | HWDA; HWDB | 74/99 | 07/04→09/12 | OE031 | 1,0 | CET7 | OE189 | BAEA422 →02/05 BAEA387 | CLS077 →Prod.26.03.2007 CLS089 Prod.26.03.2007→ |
| 1.6 | 4 | SHDA; SHDB; SHDC | 74/99 | 07/04→09/12 | OE031 | 1,0 | CET7 | OE189 | BAEA387 | CLS077 →Prod.26.03.2007 CLS089 Prod.26.03.2007→ |
| 1.6 LPG | 4 | SIDA | 85/114 | 10/09→09/12 | OE031 | 1,0 | CET18P CET7 | OE183 | BAEA387 | |
| 1.6 TDCi | 4 | GPDA; GPDB; GPDC; HHDA; HHDB | 66/89 | 07/04→09/12 | CH201 [124] | 11v | | | CCU147 | |
| 1.6 TDCi | 4 | G8DC; MTD A | 74/99 | 07/04→09/12 | CH201 [124] | 11v | | | CCU147 | |
| 1.6 TDCi | 4 | G8DA; G8DB; G8DD; G8DE; G8DF | 80/107 | 07/04→09/12 | CH201 [124] | 11v | | | CCU147 | |
| 1.6 TDCi | 4 | G8DA | 81/109 | 12/07→09/12 | CH201 [124] | 11v | | | CCU147 | |
| 1.6 Ti | 4 | HXDA; HXDB | 85/114 | 07/04→09/12 | OE031 | 1,0 | CET7 | OE189 | BAEA422 →02/05 BAEA387 | CLS077 →03/07 CLS089 03/07→ CLS016 [275] |
| 1.6 Ti | 4 | SIDA | 85/114 | 07/04→09/12 | OE031 | 1,0 | CET7 | OE189 | BAEA422 →02/05 BAEA387 03/05→ | CLS077 →03/07 CLS089 03/07→ |
| 1.8, 1.8 Flexifuel | 4 | Q7DA; QQDA; QQDB | 92/123 | 01/06→09/12 | OE131 | 1,0 | CET18P | OE183 | BAEA408 | |
| 1.8 Flexifuel | 4 | ; QQDD | 96/129 | 12/05→01/08 | OE131 | 1,0 | CET18P | OE183 | | |
| 1.8 TDCi | 4 | KKDA | 85/114 | 07/04→09/12 | CH196 | 10v | | | CCU147 →Prod.15.01.2008 | |
| 2.0 | 4 | | 104/139 | 06/05→ | OE131 | 1,0 | CET18P | | BAEA422 | |
| 2.0, 2.0 CNG, 2.0 LPG | 4 | AODA; AODB; AODE; SYDA | 107/143 | 07/04→09/12 | OE131 | 1,0 | CET18P | OE183 | BAEA408 | |
| 2.0 Flex | 4 | SYDA | 107/143 | 10/08→03/10 | | | | | BAEA422 | |
| 2.0 TDCi | 4 | IXDA | 81/109 | 02/08→07/11 | CH268 | 11v | | | | |
| 2.0 TDCi | 4 | G6DE; G6DF | 98/131 | 07/04→01/08 | CH268 | 11v | | | | |
| 2.0 TDCi | 4 | G6DA; G6DB; G6DD; G6DG | 100/134 | 07/04→09/12 | CH268 | 11v | | | CCU147 | |
| 2.5 RS | 5 | JZDA | 224/300 | 01/09→07/11 | | | CET14P | OE190 | BAEA055E | |
| 2.5 RS 500 | 5 | JZDA | 257/345 | 05/10→07/11 | | | CET14P | OE190 | BAEA055E | |

FORD





kW/BHP

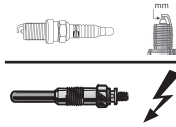

eon TITAN

IRIDIUM



...FORD



...FOCUS II

| | | | | | | | | | | |
|--------|---|------|---------|-------------|--------------------------|------------|--------|-------|----------|--|
| 2.5 ST | 5 | HYDA | 166/223 | 10/05→09/12 | OE206 OE224 LPG [279] | 0,7 0,8 | CET14P | OE190 | BAEA055E | |
|--------|---|------|---------|-------------|--------------------------|------------|--------|-------|----------|--|

FOCUS III

| | | | | | | | | | | |
|---------------|---|------------------------|---------|--------|-------|-----|--------|-------|---------|--------|
| 1.6 EcoBoost | 4 | JQDA; JQDB; YUDA | 110/148 | 07/10→ | | | | | BAEA387 | |
| 1.6 Flexifuel | 4 | MUDA | 88/118 | 07/10→ | OE031 | 1,0 | CET7 | OE189 | BAEA387 | CLS089 |
| 1.6 LPG | 4 | MUDA | 88/118 | 02/12→ | OE031 | 1,0 | CET7 | | | |
| 1.6 Ti | 4 | XTDA | 63/84 | 08/11→ | OE031 | 1,0 | CET7 | OE189 | BAEA387 | |
| 1.6 Ti | 4 | IQDB | 77/103 | 07/10→ | OE031 | 1,0 | CET7 | OE189 | BAEA387 | CLS089 |
| 1.6 Ti | 4 | PNDA | 92/123 | 07/10→ | OE031 | 1,0 | CET7 | OE189 | BAEA387 | CLS089 |
| 1.6 Ti | 4 | PNDD | 92/123 | 07/10→ | OE031 | 1,0 | CET7 | OE189 | BAEA387 | |
| 2.0 ST | 4 | R9DA; R9DB; R9DC; R9DD | 184/247 | 07/12→ | | | CET17P | | | |

FUSION

| | | | | | | | | | | |
|----------|---|------------|-------|-------------|---------------------------------|-----|------|-------|--|------------------|
| 1.3 | 4 | FUJA; FUJB | 55/74 | 08/04→12/12 | OE031 | 1,0 | CET7 | OE189 | BAEA350 →02/05 BAEA387 03/05→ | CLS077 |
| 1.4 | 4 | FXJA; FXJB | 59/79 | 08/02→12/12 | OE031 | 1,0 | CET7 | OE189 | BAEA350 →02/05 BAEA387 03/05→ | CLS077 |
| 1.4 | 4 | FXJC | 59/79 | 08/02→12/12 | OE031 | 1,0 | CET7 | OE189 | BAEA350 →02/05 BAEA387 03/05→ | |
| 1.4 LPG | 4 | UTJA | 59/79 | 01/10→12/12 | OE031 | 1,0 | CET7 | OE189 | BAEA387 →06/12 | CLS089 →06/12 |
| 1.4 TDCi | 4 | F6JA; F6JB | 50/67 | 08/02→12/12 | CH201 [124] Prod.08.01.2004→ | 11v | | | CCU147 | |
| 1.6 | 4 | FYJA; FYJB | 74/99 | 08/02→11/08 | OE031 | 1,0 | CET7 | OE189 | BAEA350 →02/05 BAEA387 03/05→ | CLS077 |
| 1.6 | 4 | FYJC | 74/99 | 08/02→11/08 | OE031 | 1,0 | CET7 | OE189 | BAEA350 →02/05 BAEA387 03/05→ | |

GALAXY

| | | | | | | | | | | |
|---------------|---|--------------|---------|-------------|--|------------|--------|-------|-------------------|--------------|
| 1.8 TDCi | 4 | FFWA | 74/99 | 05/06→06/15 | CH196 | 10v | | | | |
| 1.8 TDCi | 4 | QYWA | 92/123 | 05/06→06/15 | CH196 | 10v | | | | |
| 1.9 TDI | 4 | IZ; AHU; ANU | 66/89 | 03/95→05/06 | CH271 →Prod.31.10.2001 CH181 Prod.01.11.2001→ | 11v 11v | | | | |
| 1.9 TDI | 4 | AFN; AVG | 81/109 | 08/97→04/00 | CH271 | 11v | | | | |
| 1.9 TDI | 4 | AUY | 85/114 | 04/00→05/06 | CH271 →Prod.31.10.2001 CH181 Prod.01.11.2001→ | 11v 11v | | | | |
| 1.9 TDI | 4 | ASZ | 96/129 | 02/03→05/06 | CH181 | 11v | | | | |
| 1.9 TDI | 4 | BTB | 110/148 | 05/05→05/06 | CH181 | 11v | | | | |
| 2.0 | 4 | AOWA; AOWB | 107/143 | 05/06→06/15 | | | CET18P | OE183 | BAEA408 | |
| 2.0 EcoBoost | 4 | TNWB | 146/196 | 07/10→06/15 | | | CET17P | | | |
| 2.0 EcoBoost | 4 | TNWA | 149/200 | 03/10→06/15 | | | CET17P | | | |
| 2.0 Flexifuel | 4 | TBWA; TBWB | 107/143 | 05/06→06/15 | | | | | BAEA408 | |
| 2.0 i | 4 | NSE | 85/114 | 11/95→05/06 | OE136 | 0,8 | CET12P | OE179 | BAEA422 01/01→ | CLS049 |
| 2.0 i | 4 | ZVSA | 85/114 | 11/95→05/06 | OE136 | 0,8 | CET12P | OE179 | BAEA422 01/01→ | CLS243 [275] |
| 2.0 TDCi | 4 | KLWA | 85/114 | 11/07→06/15 | CH268 →02/10 | 11v | | | | |
| 2.0 TDCi | 4 | AZWA | 96/129 | 05/06→06/15 | CH268 | 11v | | | | |





kW/BHP



eon TITAN

IRIDIUM



...FORD



...GALAXY

| | | | | | | | | | | |
|------------------------|---|------------------|---------|-------------|-------|-------|--------|-------|--|--------|
| 2.0 TDCi | 4 | AZWC | 100/134 | 05/06→06/15 | CH268 | 11v | | | | |
| 2.0 TDCi | 4 | QXWA; QXWB; QXWC | 103/138 | 05/06→06/15 | CH229 | 11.5v | | | | |
| 2.3 | 4 | SEWA | 118/158 | 09/07→06/15 | | | CET18P | OE183 | | |
| 2.3 4WD, 2.3 16V | 4 | YSB | 107/143 | 09/96→05/06 | OE146 | 1,0 | CET12P | OE179 | BAEA308 ^[41] →Prod.30.03.2000 | |
| 2.3 16V | 4 | E5SB | 103/138 | 09/01→05/06 | OE146 | 1,0 | CET12P | OE179 | BAEA365 BAEA422 | |
| 2.3 16V | 4 | E5SA | 107/143 | 01/97→05/06 | OE146 | 1,0 | CET12P | OE179 | BAEA365 Prod.01.04.2000→ BAEA422 Prod.01.04.2000→ | |
| 2.8 i V6, 2.8 i V6 4WD | 6 | AAA; AMY | 128/172 | 11/95→04/00 | | | CET12P | OE180 | BAEA004E | CLS240 |
| 2.8 V6 | 6 | AYL | 150/201 | 04/00→05/06 | OE176 | 1,0 | CET3 | | BAEA063E | |

GRAND C-MAX

| | | | | | | | | | | |
|--------------|---|------------|---------|--------|-------|-----|------|-------|-------------------|--------|
| 1.6 EcoBoost | 4 | JQDA; JQDB | 110/148 | 12/10→ | | | | | BAEA387 | |
| 1.6 EcoBoost | 4 | JTDA; JTDB | 134/180 | 12/10→ | | | | | BAEA387 | |
| 1.6 Ti | 4 | IQDA; IQDB | 77/103 | 12/10→ | OE031 | 1,0 | CET7 | OE189 | BAEA387 →05/11 | CLS089 |
| 1.6 Ti | 4 | PNDA | 92/123 | 12/10→ | OE031 | 1,0 | CET7 | OE189 | BAEA387 →05/11 | CLS089 |

KA

| | | | | | | | | | | |
|-------|---|---------------------------------|-------|-------------|-------------------------------------|------------|--------|-------|---|--|
| 1.0 i | 4 | ZHTOJRB | 38/51 | 07/97→09/99 | OE011 | 0,9 | CET9 | OE183 | | |
| 1.0 i | 4 | | 48/64 | 09/99→11/08 | OE011 | 0,9 | CET9 | OE183 | BAEA422 | |
| 1.2 | 4 | 169A4000; AAAA; FP4 | 51/68 | 10/08→ | OE196 OE230 LPG ^[278] | 1,0 0,9 | CET1 | | BAE940A | |
| 1.3 i | 4 | JJD; JJF; JJG; JJH; JJJ | 36/48 | 06/98→11/08 | OE131 | 1,0 | CET18P | OE183 | BAEA350 10/02→07/07 | CLS033 ^[275] →09/98 CLS066 ^[275] 09/98→ |
| 1.3 i | 4 | JJB | 37/50 | 09/96→10/02 | OE131 | 1,0 | CET18P | OE183 | BAEA350 ^[274] 09/98→ | CLS033 ^[275] →08/98 CLS066 ^[275] 09/98→ |
| 1.3 i | 4 | J4D; J4K; J4M; J4N; J4P; J4S | 44/59 | 09/96→11/08 | OE131 | 1,0 | CET18P | OE183 | BAEA281 →08/98 BAEA350 ^[274] 09/98→ | CLS033 ^[275] →08/98 CLS066 ^[275] 09/98→ |
| 1.3 i | 4 | BAA | 44/59 | 09/96→11/08 | OE031 | 1,0 | CET7 | OE189 | BAEA281 →08/98 BAEA350 ^[274] 09/98→ | CLS033 ^[275] →08/98 CLS066 ^[275] 09/98→ CLS091 10/02→ |
| 1.3 i | 4 | A9A; A9B | 51/68 | 08/02→11/08 | OE031 | 1,0 | CET7 | OE189 | BAEA350 →02/07 | CLS091 |
| 1.6 | 4 | CDB; CDC | 70/94 | 09/00→ | OE031 | 1,0 | CET7 | | | |
| 1.6 i | 4 | CDB; CDC | 70/94 | 02/01→11/08 | OE029 | 1,0 | CET17P | OE189 | BAEA350 →07/07 BAEA387 08/07→ | CLS091 |

KUGA I

| | | | | | | | | | | |
|------------------------|---|-----------------|---------|-------------|-------|-----|--------|-------|----------|--|
| 2.0 TDCi, 2.0 TDCi 4WD | 4 | G6DG | 100/134 | 03/08→11/12 | CH268 | 11v | | | | |
| 2.5, 2.5 4WD | 5 | HYDB; HYDC | 147/197 | 03/09→ | | | CET14P | OE190 | | |
| 2.5 4WD | 5 | DuratecST-Motor | 147/197 | 03/09→ | | | | | BAEA055E | |

KUGA II

| | | | | | | | | | | |
|----------|---|------------|--------|--------|--|--|--|--|---------|--|
| 2.0 TDCi | 4 | XRMA; XRMB | 88/118 | 09/14→ | | | | | BAEA143 | |
|----------|---|------------|--------|--------|--|--|--|--|---------|--|

MAVERICK

| | | | | | | | | | | |
|-------------|---|------|---------|-------------|-------|-----|--------|-------|---------|-------------------------|
| 2.0 16V 4WD | 4 | YF | 91/122 | 02/01→ | OE029 | 1,0 | CET17P | OE189 | BAEA350 | CLS016 ^[275] |
| 2.3 16V 4WD | 4 | GZ | 110/148 | 03/04→ | | | CET18P | OE183 | BAEA408 | |
| 2.4 i 4WD | 4 | KA24 | 85/114 | 09/96→04/98 | OE089 | 1,0 | CET2 | OE184 | | |

FORD





kW/BHP



eon TITAN

IRIDIUM

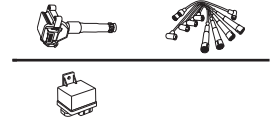

FORD

| ...FORD | | | | | | | | | | |
|--------------------------|---|-------------------------|---------|---------------|-------|-------|--------|-------|-------------------------------------|------------------------------------|
| ...MAVERICK | | | | | | | | | | |
| 2.4 i 4WD | 4 | KA24 | 87/117 | 09/96 → 04/98 | OE089 | 1,0 | CET2 | OE184 | | |
| 2.4 i 4WD | 4 | KA24E | 91/122 | 02/93 → 08/96 | OE089 | 1,0 | CET2 | OE184 | | |
| 2.7 TD 4WD | 4 | TD27 | 74/99 | 02/93 → 08/96 | CH186 | 11v | | | | |
| 3.0 V6 24V 4WD | 6 | AJ | 145/194 | 02/01 → | | | CET18P | OE183 | BAEA410 ^[277] | |
| 3.0 V6 24V 4WD | 6 | AJ | 149/200 | 03/04 → | | | CET18P | OE183 | | |
| MONDEO I | | | | | | | | | | |
| 1.6 i 16V | 4 | L1J | 65/87 | 07/94 → 08/96 | OE029 | 1,0 | CET17P | OE189 | BAEA281 | CLS111 |
| 1.6 i 16V | 4 | L1F | 66/89 | 02/93 → 08/96 | OE029 | 1,0 | CET17P | OE189 | BAEA281 | CLS111 |
| 1.8 i 16V | 4 | RKB | 82/110 | 01/94 → 08/96 | OE029 | 1,0 | CET17P | OE189 | BAEA281 | CLS111 |
| 1.8 i 16V, 1.8 i 16V 4WD | 4 | RKA | 85/114 | 02/93 → 08/96 | OE029 | 1,0 | CET17P | OE189 | BAEA281 | CLS111 |
| 1.8 TD | 4 | RFM; RFN | 65/87 | 06/93 → 08/96 | CH147 | 11.5v | | | | |
| 1.8 TD | 4 | RFM; RFN | 66/89 | 10/95 → 08/96 | CH147 | 11.5v | | | | |
| 2.0 i 16V | 4 | NGA | 97/130 | 01/93 → 08/96 | OE029 | 1,0 | CET17P | OE189 | | CLS111 |
| 2.0 i 16V, 2.0 i 16V 4WD | 4 | NGA | 100/134 | 02/93 → 08/96 | OE029 | 1,0 | CET17P | OE189 | BAEA281 | CLS111 |
| 2.0 i 16V 4WD | 4 | NGA | 97/130 | 12/94 → 08/96 | OE029 | 1,0 | CET17P | OE189 | BAEA281 | CLS111 |
| 2.5 i 24V | 6 | SEA | 125/168 | 07/94 → 08/96 | OE131 | 1,0 | CET18P | OE183 | | |
| MONDEO II | | | | | | | | | | |
| 1.6 i | 4 | L1J | 66/89 | 08/96 → 09/00 | OE029 | 1,0 | CET17P | OE189 | BAEA281 → 08/98 | CLS111 → 08/98 |
| | | | | | | | | | BAEA350 09/98 → | CLS016 ^[275] 09/98 → |
| 1.6 i 16V | 4 | L1L; L1N; L1Q | 70/94 | 05/98 → 09/00 | OE029 | 1,0 | CET17P | OE189 | BAEA281 → 08/98 | CLS111 → 08/98 |
| | | | | | | | | | BAEA350 09/98 → | CLS016 ^[275] 09/98 → |
| 1.8 i | 4 | RKB; RKF; RKH; RKJ; RKK | 85/114 | 08/96 → 09/00 | OE029 | 1,0 | CET17P | OE189 | BAEA281 → 08/98 | CLS111 → 08/98 |
| | | | | | | | | | BAEA350 09/98 → | CLS016 ^[275] 09/98 → |
| 1.8 TD | 4 | RFN | 66/89 | 08/96 → 09/00 | CH205 | 10v | | | | |
| 2.0 i | 4 | NGA; NGB; NGC; NGD | 96/129 | 08/96 → 09/00 | OE029 | 1,0 | CET17P | OE189 | BAEA281 → 08/98 | CLS111 → 08/98 |
| | | | | | | | | | BAEA350 09/98 → | CLS016 ^[275] 09/98 → |
| 2.5 2.5 ST 200 | 6 | SGA | 151/202 | 05/99 → 09/00 | OE131 | 1,0 | CET18P | OE183 | | |
| 2.5 24V | 6 | LCBD; SEA; SEB; SEC | 125/168 | 08/96 → 09/00 | OE131 | 1,0 | CET18P | OE183 | | |
| MONDEO III | | | | | | | | | | |
| 1.8 16V | 4 | CGBA; CGBB | 81/109 | 10/00 → 03/07 | OE131 | 1,0 | CET18P | OE183 | BAEA365 → 02/05 | CLS074 |
| | | | | | | | | | BAEA448 ^[275] 03/05 → | |
| 1.8 16V | 4 | CHBA; CHBB | 92/123 | 10/00 → 03/07 | OE131 | 1,0 | CET18P | OE183 | BAEA365 → 02/05 | CLS074 |
| | | | | | | | | | BAEA448 ^[275] 03/05 → | |
| 1.8 SGi | 4 | CFBA | 96/129 | 06/03 → 03/07 | | | CET18P | OE183 | BAEA422 → 02/05 | CLS074 |
| 2.0 16V | 4 | CJBA; CJBB | 107/143 | 10/00 → 03/07 | OE131 | 1,0 | CET18P | OE183 | BAEA365 → 02/05 | CLS074 |
| | | | | | | | | | BAEA448 ^[275] 03/05 → | |
| 2.0 16V DI / TDDi / TDGi | 4 | D5BA | 66/89 | 10/00 → 03/07 | CH229 | 11.5v | | | | |
| 2.0 16V TDDi / TDGi | 4 | D6BA; HJBA; HJBB; HJBC | 85/114 | 10/00 → 03/07 | CH229 | 11.5v | | | | |
| 2.0 TDGi | 4 | FMBA; N7BA | 96/129 | 10/01 → 03/07 | CH229 | 11.5v | | | | |
| 2.2 TDGi | 4 | QJBC; QJBD | 110/148 | 09/04 → 03/07 | CH229 | 11.5v | | | | |
| 2.2 TDGi | 4 | QJBA; QJBB | 114/153 | 09/04 → 03/07 | CH229 | 11.5v | | | | |
| 2.5 V6 24V | 6 | LCBD | 125/168 | 10/00 → 03/07 | OE131 | 1,0 | CET18P | OE183 | BAEA372 | CLS156 |
| 3.0 V6 24V | 6 | REBA | 150/201 | 09/04 → 03/07 | OE131 | 1,0 | CET18P | OE183 | BAEA372 | |
| 3.0 ST220 | 6 | MEBA | 166/223 | 04/02 → 03/07 | OE131 | 1,0 | CET18P | OE183 | BAEA372 | |





kW/BHP



eon TITAN

IRIDIUM

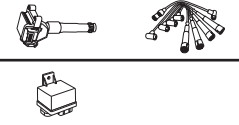

...FORD



MONDEO IV

| | | | | | | | | | | |
|--------------------|---|------------------------|---------|-------------|--------------------------|------------|--------|-------|-------------------|--------|
| 1.6 Ti | 4 | RHBA | 81/109 | 03/07→01/15 | OE031 | 1,0 | CET7 | OE189 | BAEA387 →08/10 | |
| 1.6 Ti | 4 | KGBA | 88/118 | 03/10→01/15 | OE031 | 1,0 | CET7 | OE189 | BAEA387 | |
| 1.6 Ti | 4 | PNBA | 92/123 | 03/07→01/15 | OE031 | 1,0 | CET7 | OE189 | BAEA387 →08/10 | CLS077 |
| 1.8 TDCi | 4 | FFBA | 74/99 | 03/07→01/15 | CH196 | 10v | | | | |
| 1.8 TDCi | 4 | KHBA; QYBA | 92/123 | 06/07→01/15 | CH196 | 10v | | | | |
| 2.0, 2.0 Flexifuel | 4 | AOBA; AOBC; TBBA; TBBB | 107/143 | 03/07→01/15 | | | CET18P | OE183 | BAEA408 | |
| 2.0 EcoBoost | 4 | TPBA | 176/236 | 03/10→01/15 | | | CET17P | | | |
| 2.0 LPG | 4 | TBBA | 107/143 | 07/09→01/15 | | | | | BAEA408 | |
| 2.0 SCTi | 4 | TNBA | 149/200 | 03/10→01/15 | | | CET17P | | | |
| 2.0 TDCi | 4 | KLBA; LPBA | 85/114 | 11/07→01/15 | CH268 | 11v | | | | |
| 2.0 TDCi | 4 | AZBA | 96/129 | 03/07→01/15 | CH268 | 11v | | | | |
| 2.0 TDCi | 4 | AZBC | 100/134 | 03/07→01/15 | CH268 →02/10 | 11v | | | | |
| 2.3 | 4 | SEBA | 118/158 | 07/07→01/15 | | | CET18P | OE183 | | |
| 2.5 | 5 | HUBA | 162/217 | 03/07→01/15 | OE206 OE224 LPG [279] | 0,7 0,8 | CET14P | | BAEA055E | |

PUMA

| | | | | | | | | | | |
|-------------------|---|----------|---------|-------------|-------|-----|--------|-------|--|--------------------------------------|
| 1.4 16V | 4 | FHD; FHF | 66/89 | 11/97→10/00 | OE031 | 1,0 | CET7 | OE189 | BAEA281 →05/98 BAEA350 05/98→ | CLS032 →05/98 CLS077 05/98→ |
| 1.6 16V | 4 | L1W | 76/102 | 08/00→06/02 | OE031 | 1,0 | CET7 | OE189 | BAEA350 | CLS077 |
| 1.7 16V | 4 | MHA; MHB | 92/123 | 03/97→06/02 | OE029 | 1,0 | CET17P | OE189 | BAEA281 →04/00 BAEA350 05/00→ | CLS032 →04/00 CLS077 05/00→ |
| 1.7 Racing ST 160 | 4 | MHA | 114/153 | 06/99→06/02 | OE029 | 1,0 | CET17P | OE189 | | |

RANGER

| | | | | | | | | | | |
|------------------------|---|---------------------|---------|-------------|-----------------|-----|--------|-------|--|--|
| 2.2 | 4 | | 78/105 | 03/02→09/05 | OE039 | 1,0 | CET2 | | | |
| 2.5 D, 2.5 D 4WD | 4 | WL | 57/76 | 10/99→04/02 | CH242 →09/01 | 11v | | | | |
| 2.5 i 4WD | 4 | GBVAF; GBVAK; GBVAL | 122/164 | 11/11→ | | | CET17P | OE189 | | |
| 2.5 TD | 4 | MD25TI | 80/107 | 06/05→05/07 | CH242 | 11v | | | | |
| 2.5 TD, 2.5 TD 4WD | 4 | WL-T | 62/83 | 04/02→06/06 | CH242 | 11v | | | | |
| 2.5 TD 4WD | 4 | WL-T | 80/107 | 10/99→06/06 | CH242 →09/01 | 11v | | | | |
| 2.5 TDCi 4WD, 2.5 TDdi | 4 | WLAA | 105/141 | 05/06→07/12 | CH242 | 11v | | | | |
| 2.5 TDdi, 2.5 TDdi 4WD | 4 | | 86/115 | 04/02→09/05 | CH242 | 11v | | | | |
| 2.9 D | 4 | D29UYT | 70/94 | 06/99→02/02 | CH242 [187] | 11v | | | | |

SCORPIO I

| | | | | | | | | | | |
|--------|---|-----|--------|-------------|-------|-----|--|--|--|--|
| 2.5 TD | 4 | SCB | 85/114 | 08/93→09/94 | CH189 | 11v | | | | |
|--------|---|-----|--------|-------------|-------|-----|--|--|--|--|

SCORPIO II

| | | | | | | | | | | |
|-----------|---|-----|---------|-------------|--------------------------|------|--------|-------|-------------------|------------------------|
| 2.0 i | 4 | NSD | 85/114 | 10/94→08/98 | OE136 | 0,8 | CET12P | OE179 | | CLS022 |
| 2.0 i 16V | 4 | N3A | 100/134 | 10/94→08/98 | OE136 | 0,8 | CET12P | OE179 | BAEA308 →04/96 | CLS022 |
| 2.3 i 16V | 4 | Y5A | 108/145 | 06/96→08/98 | | | CET12P | OE182 | BAEA308 | CLS022 [292] CLS187 |
| 2.5 TD | 4 | SCC | 85/114 | 10/94→08/98 | CH181 | 11v | | | | |
| 2.5 TD | 4 | VM | 92/123 | 09/96→08/98 | CH181 | 11v | | | | |
| 2.9 i | 6 | BRG | 110/148 | 02/95→08/98 | OE011 *to be adjusted | 1,0* | CET9 | OE183 | | |
| 2.9 i 24V | 6 | BOB | 152/204 | 10/94→08/98 | | | CET12P | OE180 | | |

S-MAX

| | | | | | | | | | | |
|----------|---|------|--------|-------------|-------------|-----|--|--|--|--|
| 1.8 TDCi | 4 | FFWA | 74/99 | 01/07→12/10 | CH196 | 10v | | | | |
| 1.8 TDCi | 4 | QYWA | 92/123 | 05/06→12/14 | CH196 [322] | 10v | | | | |

FORD





kW/BHP

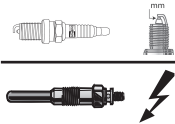

eon TITAN

IRIDIUM

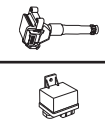

...FORD



...S-MAX

| | | | | | | | | | | |
|--------------------|---|------------------------|---------|---------------|-----------------|-----|--------|-------|----------|--|
| 2.0, 2.0 Flexifuel | 4 | AOWA; AOWB; TBWA; TBWB | 107/143 | 05/06 → 12/14 | | | CET18P | OE183 | BAEA408 | |
| 2.0 EcoBoost | 4 | TNWB | 146/196 | 07/10 → 12/14 | | | CET17P | | | |
| 2.0 EcoBoost | 4 | TNWA | 149/200 | 03/10 → 12/14 | | | CET17P | | BAEA408 | |
| 2.0 EcoBoost | 4 | TPWA | 176/236 | 07/10 → | | | CET17P | | | |
| 2.0 TDCi | 4 | KLWA | 85/114 | 11/07 → 12/14 | CH268 | 11v | | | | |
| 2.0 TDCi | 4 | AZWA | 96/129 | 05/06 → 12/14 | CH268 | 11v | | | | |
| 2.0 TDCi | 4 | AZWC | 100/134 | 05/06 → 12/14 | CH268 →02/10 | 11v | | | | |
| 2.3 | 4 | SEWA | 118/158 | 07/07 → 12/14 | | | CET18P | OE183 | | |
| 2.5 ST | 5 | HUWA | 162/217 | 05/06 → 12/14 | OE206 | 0,7 | CET14P | | BAEA055E | |
| | | | | | OE224 LPG [279] | 0,8 | | | | |

STREET KA

| | | | | | | | | | | |
|-----|---|------------|-------|---------------|-------|-----|------|-------|--------------------------|--------|
| 1.6 | 4 | CDRA; CDRB | 70/94 | 05/03 → 07/05 | OE031 | 1,0 | CET7 | OE189 | BAEA350 ^[274] | CLS092 |
|-----|---|------------|-------|---------------|-------|-----|------|-------|--------------------------|--------|

TOURNEO CONNECT

| | | | | | | | | | | |
|----------------------|---|--|--------|---------------|-------|-----|--------|-------|---------|--|
| 1.8 16V | 4 | EYPA; EYPC; EYPD | 85/114 | 06/02 → 12/13 | OE029 | 1,0 | CET17P | OE189 | BAEA350 | |
| 1.8 TDCi | 4 | HCPA; HCPB; P9PA; P9PB; P9PC; P9PD; R3PA; RWPE; RWPF | 66/89 | 06/02 → 12/13 | CH196 | 10v | | | | |
| 1.8 TDCi | 4 | RWPA; RWPC; RWPD | 81/109 | 08/06 → 12/13 | CH196 | 10v | | | | |
| 1.8 TDCi / TDDi / DI | 4 | BHPA; P7PA; P7PB; R2PA | 55/74 | 06/02 → 12/13 | CH196 | 10v | | | | |

FORD



B-MAX

| | | | | | | | | | | |
|--------|---|------|--------|---------|-------|-----|------|--|--|--|
| 1.4 | 4 | SPJD | 66/89 | 10/12 → | OE031 | 1,0 | CET7 | | | |
| 1.6 Ti | 4 | IQJA | 77/103 | 10/12 → | OE031 | 1,0 | CET7 | | | |

ESCORT '95

| | | | | | | | | | | |
|-------------|---|----------|-------|---------------|-------|-------|------|-------|---------|--------|
| 1.4 | 4 | F4B | 54/72 | 01/95 → 08/00 | | | CET2 | OE179 | BAEA281 | CLS122 |
| 1.8 D | 4 | RTF; RTH | 44/59 | 01/95 → 08/00 | CH147 | 11.5v | | | | |
| 1.8 TD | 4 | RFD; RFK | 66/89 | 01/95 → 08/00 | CH147 | 11.5v | | | | |
| 1.8 TD | 4 | RFS | 66/89 | 01/95 → 08/00 | CH205 | 10v | | | | |
| 1.8 Turbo D | 4 | RVA | 51/68 | 12/95 → 06/01 | CH205 | 10v | | | | |

FIESTA

| | | | | | | | | | | |
|----------------|---|---------------|-------|---------------|-----------------|-----|--------|-------|---------|--------|
| 1.4 i | 4 | FHA | 66/89 | 04/96 → 10/99 | OE131 | 1,0 | CET18P | OE183 | BAEA281 | CLS015 |
| 1.8 DI, 1.8 TD | 4 | RTN; RTP; RTQ | 55/74 | 07/93 → 08/03 | CH196 →12/02 | 10v | | | | |

FIESTA V

| | | | | | | | | | | |
|----------|---|------------|-------|---------------|-----------------------------------|-----|------|-------|--------------------------|--------|
| 1.3 | 4 | A9JA; A9JB | 51/68 | 10/03 → 07/05 | OE031 | 1,0 | CET7 | OE189 | BAEA350 ^[274] | CLS092 |
| 1.4 TDCi | 4 | F6JA; F6JB | 50/67 | 10/03 → 12/10 | CH201 ^[124] 08/04 → | 11v | | | CCU147 | |

FIESTA VI

| | | | | | | | | | | |
|----------|---|------------------|-------|---------|-------|-----|------|-------|---------|--------|
| 1.3 | 4 | SNJA; SNJB | 60/80 | 01/09 → | OE031 | 1,0 | CET7 | OE189 | BAEA387 | CLS089 |
| 1.4 TDCi | 4 | F6JB; F6JD | 50/67 | 01/09 → | CH201 | 11v | | | | |
| 1.4 TDCi | 4 | F6JD | 51/68 | 07/10 → | CH201 | 11v | | | | |
| 1.6 TDCi | 4 | HHJC; HHJD; HHJE | 66/89 | 01/09 → | CH201 | 11v | | | | |

KA Van

| | | | | | | | | | | |
|-------|---|---------------------------------|-------|---------------|--|--|--------|-------|--|--|
| 1.3 i | 4 | BAA | 44/59 | 05/02 → 05/05 | | | CET17P | OE189 | BAEA422 10/02 → | |
| 1.3 i | 4 | J4D; J4K; J4M; J4N; J4P; J4S | 44/59 | 05/02 → 05/05 | | | CET17P | OE189 | BAEA281 ^[275] →10/02 BAEA422 ^[275] →10/02 | |

TRANSIT

| | | | | | | | | | | |
|---------|---|----------|--------|---------------|-------|-------|------|-------|--|--------|
| 2.0 | 4 | NSF; NSG | 84/113 | 06/94 → 03/06 | OE014 | 0,9 | CET2 | OE179 | | CLS022 |
| 2.0 CNG | 4 | NSH | 84/113 | 06/94 → 03/00 | | | CET2 | OE179 | | |
| 2.0 DI | 4 | D3FA | 55/74 | 08/00 → 05/06 | CH229 | 11.5v | | | | |

FORD





kW/BHP



eon TITAN

IRIDIUM

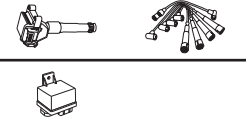
**...FORD****...TRANSIT**

| | | | | | | | | | |
|------------------------|---|--|---------|-------------|--|----------------|--------|-------|--------------------|
| 2.0 DI | 4 | F3FA | 63/84 | 08/00→05/06 | CH229 | 11.5v | | | |
| 2.0 DI | 4 | ABFA | 74/99 | 08/00→05/06 | CH229 | 11.5v | | | |
| 2.0 TDCi | 4 | F1FA | 92/123 | 08/02→05/06 | CH229 | 11.5v | | | |
| 2.2 TDCi | 4 | P8FA; P8FB | 63/84 | 04/06→08/14 | CH229 [362] | 11.5v | | | |
| 2.2 TDCi | 4 | DRF5; DRFF; DRFG; DRR5 | 74/99 | 10/11→ | CH229 [362] →Prod.30.12.2014 | 11.5v | | | |
| 2.2 TDCi | 4 | DRFA; DRFB; DRFC; DRFD; DRFE; DRR4; DRRB; DRRC | 74/99 | 10/11→ | CH229 [362] | 11.5v | | | |
| 2.2 TDCi | 4 | QVFA | 81/109 | 04/06→08/14 | CH229 [362] | 11.5v | | | |
| 2.2 TDCi | 4 | SRFA; SRFB; SRFC; SRFD; SRFE | 85/114 | 10/08→08/14 | CH229 [362] | 11.5v | | | |
| 2.2 TDCi | 4 | QWFA | 96/129 | 04/06→08/14 | CH229 [362] | 11.5v | | | |
| 2.2 TDCi | 4 | UHR5 | 99/133 | 08/13→ | CH229 [362] →Prod.30.12.2014 | 11.5v | | | |
| 2.2 TDCi | 4 | USRA; USRB | 100/134 | 09/11→08/14 | CH229 [362] | 11.5v | | | |
| 2.2 TDCi | 4 | PGFA; PGFB; UHFA; UHFB; UHFC | 103/138 | 10/07→08/14 | CH229 [362] | 11.5v | | | |
| 2.2 TDCi | 4 | CVRA; CVRB; CVRC | 114/153 | 10/11→ | CH229 [362] CH229 [362] →Prod.30.12.2014 | 11.5v 11.5v | | | |
| 2.2 TDCi, 2.2 TDCi 4WD | 4 | CY14; CY24; CYF5; CYFG; CYR5; USF6; USR6 | 92/123 | 10/11→ | CH229 [362] →Prod.30.12.2014 | 11.5v | | | |
| 2.2 TDCi, 2.2 TDCi 4WD | 4 | CYFA; CYFB; CYFC; CYFD; CYRA; CYRB; CYRC | 92/123 | 10/11→ | CH229 [362] | 11.5v | | | |
| 2.2 TDCi, 2.2 TDCi 4WD | 4 | CV24; CVF5; CVR5; UYR6 | 114/153 | 10/11→ | CH229 [362] →Prod.30.12.2014 | 11.5v | | | |
| 2.3 | 4 | E5FC | 105/141 | 03/01→03/06 | | | | | BAEA308 |
| 2.3 | 4 | E5FA | 107/143 | 08/00→03/06 | | | | | BAEA308 |
| 2.3 16V | 4 | GZFA; GZFB; GZFC | 107/143 | 08/00→08/14 | | | CET18P | | BAEA408 |
| 2.3 16V | 4 | E5FA; E5FC | 107/143 | 08/00→08/14 | OE136 | 0,8 | CET12P | OE179 | BAEA308 |
| 2.4 DI | 4 | D4FA | 88/118 | 01/00→05/06 | CH229 | 11.5v | | | |
| 2.4 DI, 2.4 TD | 4 | F4FA | 55/74 | 01/00→05/06 | CH229 | 11.5v | | | |
| 2.4 DI, 2.4 TDdi | 4 | D2FA; D2FB; D2FE | 66/89 | 01/00→05/06 | CH229 | 11.5v | | | |
| 2.4 TDCi | 4 | PHFA; PHFC | 74/99 | 04/06→08/14 | CH229 | 11.5v | | | |
| 2.4 TDCi | 4 | H9FA | 101/135 | 03/04→05/06 | CH229 | 11.5v | | | |
| 2.4 TDCi, 2.4 TDCi 4WD | 4 | H9FB; H9FD | 103/138 | 04/06→ | CH229 | 11.5v | | | |
| 2.4 TDCi, 2.4 TDE | 4 | FXFA; JXFA; JXFC | 85/114 | 03/04→08/14 | CH229 | 11.5v | | | |
| 2.4 TDE | 4 | DOFA | 92/123 | 07/01→05/06 | CH229 | 11.5v | | | |
| 3.2 TDCi | 5 | SAFA; SAFB | 147/197 | 09/07→08/14 | CH229 | 11.5v | | | |
| TRANSIT CONNECT | | | | | | | | | |
| 1.8 16V | 4 | EYPA; EYPC; EYPD | 85/114 | 06/02→12/13 | OE029 | 1,0 | CET17P | OE189 | BAEA350 BAEA365 |
| 1.8 16V LPG | 4 | EYPC | 85/114 | 06/02→12/13 | OE029 | 1,0 | CET17P | OE189 | BAEA281 |
| 1.8 Di | 4 | BHPA; P7PA; P7PB; R2PA | 55/74 | 06/02→12/13 | CH196 | 10v | | | |
| 1.8 TDCi | 4 | HCPA; HCPB; P9PA; P9PB; P9PC; P9PD; R3PA; RWPE; RWPF | 66/89 | 06/02→12/13 | CH196 | 10v | | | |
| 1.8 TDCi | 4 | RWPA; RWPC; RWPD | 81/109 | 08/06→12/13 | CH196 | 10v | | | |
| TRANSIT CUSTOM | | | | | | | | | |
| 2.2 TDCi | 4 | DRF4; DRFF; DRFG | 74/99 | 04/12→ | CH229 [362] →Prod.30.12.2014 | 11.5v | | | |
| 2.2 TDCi | 4 | CYF4; CYFF | 92/123 | 04/12→ | CH229 [362] →Prod.30.12.2014 | 11.5v | | | |
| 2.2 TDCi | 4 | CVFF | 114/153 | 04/12→ | CH229 [362] →Prod.30.12.2014 | 11.5v | | | |
| TRANSIT TOURNEO | | | | | | | | | |
| 2.0 | 4 | NSF; NSG; NSH | 84/113 | 11/94→12/00 | OE014 | 0,9 | CET2 | OE179 | |
| 2.2 TDCi | 4 | QVFA | 81/109 | 07/06→08/14 | CH229 [362] | 11.5v | | | |

FORD





kW/BHP

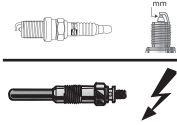

eon TITAN

IRIDIUM



...FORD



...TRANSIT TOURNEO

| | | | | | | | | |
|----------|---|---------------------------------|---------|-------------|-------------|-------|--|--|
| 2.2 TDCi | 4 | SRFA; SRFB; SRFC; SRFD; SRFE | 85/114 | 10/08→08/14 | CH229 [362] | 11.5v | | |
| 2.2 TDCi | 4 | QWFA | 96/129 | 07/06→08/14 | CH229 [362] | 11.5v | | |
| 2.2 TDCi | 4 | PGFA; PGFB; UHFA; UHFB; UHFC | 103/138 | 10/07→08/14 | CH229 [362] | 11.5v | | |

FORD ASIA / OCEANIA



FALCON

| | | | | | | | | |
|---------------|---|----------|---------|--------|-------|-----|--------|-------|
| 4.0, 4.0 Ghia | 6 | BARRA182 | 182/244 | 09/02→ | OE191 | 1,0 | CET12P | OE180 |
|---------------|---|----------|---------|--------|-------|-----|--------|-------|

IKON

| | | | | | | | | |
|-----|---|--|-------|--------|--|--|--|---------|
| 1.6 | 4 | | 67/90 | 06/99→ | | | | BAEA422 |
|-----|---|--|-------|--------|--|--|--|---------|

LASER / LASER LIDEA

| | | | | | | | | |
|-----|---|------|-------|-------------|-------|-----|------|-------|
| 1.6 | 4 | B6GP | 66/89 | 06/94→05/99 | OE039 | 1,0 | CET2 | OE179 |
|-----|---|------|-------|-------------|-------|-----|------|-------|

FORD ASIA / OZEAANIA



FESTIVA

| | | | | | | | | |
|---------|---|------------|--------|-------------|-------|-----|------|-------|
| 1.8 GLX | 4 | BPE4; BPE5 | 85/114 | 05/94→08/98 | OE034 | 0,9 | CET2 | OE179 |
|---------|---|------------|--------|-------------|-------|-----|------|-------|

LIATA

| | | | | | | | | |
|---------|---|------------|--------|-------------|-------|-----|------|-------|
| 1.8 GLX | 4 | BPE3; BPE5 | 85/114 | 05/94→06/97 | OE034 | 0,9 | CET2 | OE179 |
|---------|---|------------|--------|-------------|-------|-----|------|-------|

TELSTAR

| | | | | | | | | |
|-----|---|------|--------|-------------|-------|-----|------|-------|
| 1.8 | 4 | BPE5 | 85/114 | 05/94→10/00 | OE034 | 0,9 | CET2 | OE179 |
|-----|---|------|--------|-------------|-------|-----|------|-------|

TIERRA

| | | | | | | | | |
|-----|---|------|--------|-------------|-------|-----|------|-------|
| 1.6 | 4 | B6EW | 79/106 | 05/98→09/03 | OE063 | 1,0 | CET2 | OE180 |
|-----|---|------|--------|-------------|-------|-----|------|-------|

FORD ASIA / OZEAANIA



FREDA

| | | | | | | | | |
|-----|---|--------|-------|-------------|-------|-----|------|-------|
| 2.0 | 4 | HCL580 | 59/79 | 10/94→10/01 | OE063 | 1,0 | CET2 | OE180 |
| 2.5 | 4 | HCR589 | 62/83 | 10/94→10/01 | OE063 | 1,0 | CET2 | OE180 |

FORD AUSTRALIA



COUGAR

| | | | | | | | | |
|-----|---|------|---------|-------------|-------|-----|--------|--|
| 2.5 | 6 | LCBC | 125/168 | 10/99→03/03 | OE131 | 1,0 | CET18P | |
|-----|---|------|---------|-------------|-------|-----|--------|--|

COURIER

| | | | | | | | | |
|------------------|---|----|-------|-------------|-------|-----|--|--|
| 2.5 D, 2.5 D 4WD | 4 | WL | 63/84 | 05/96→02/99 | CH242 | 11v | | |
|------------------|---|----|-------|-------------|-------|-----|--|--|

ESCAPE

| | | | | | | | | |
|---------|---|----|---------|-------------|--|--|--------|--|
| 3.0 4WD | 6 | AJ | 149/200 | 03/01→03/04 | | | CET18P | |
|---------|---|----|---------|-------------|--|--|--------|--|

EXPLORER

| | | | | | | | | |
|---------|---|--|---------|-------------|--|--|------|--|
| 4.6 4WD | 8 | | 178/239 | 11/01→01/08 | | | CET9 | |
|---------|---|--|---------|-------------|--|--|------|--|

F150

| | | | | | | | | |
|--------------------|---|-------|---------|-------------|--|--|--------|--|
| 4.6 V8 | 8 | | 154/207 | 05/97→08/98 | | | CET9 | |
| 4.6 V8 | 8 | | 164/220 | 09/98→10/01 | | | CET9 | |
| 4.6 V8 4WD | 8 | | 248/333 | 10/03→09/07 | | | CET9 | |
| 4.6 V8, 4.6 V8 4WD | 8 | | 162/217 | 10/96→09/98 | | | CET9 | |
| 4.6 V8, 4.6 V8 4WD | 8 | ; 99W | 170/228 | 10/98→09/07 | | | CET9 | |
| 5.4 V8 | 8 | | 280/375 | 05/01→11/03 | | | CET18P | |

F250

| | | | | | | | | |
|--------------------|---|--|---------|-------------|--|--|------|--|
| 4.6 V8, 4.6 V8 4WD | 8 | | 162/217 | 10/96→09/98 | | | CET9 | |
| 4.6 V8, 4.6 V8 4WD | 8 | | 170/228 | 10/98→11/03 | | | CET9 | |

F350

| | | | | | | | | |
|--------------------|---|--|---------|-------------|--|--|--------|--|
| 5.4 V8, 5.4 V8 4WD | 8 | | 191/256 | 10/96→11/03 | | | CET18P | |
|--------------------|---|--|---------|-------------|--|--|--------|--|

FALCON

| | | | | | | | | |
|--------------|---|---------|---------|-------------|-------|-----|--------|--|
| 5.4 i V8 XR8 | 8 | Boss260 | 260/349 | 01/03→04/08 | OE131 | 1,0 | CET18P | |
|--------------|---|---------|---------|-------------|-------|-----|--------|--|

FORD



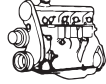

kW/BHP

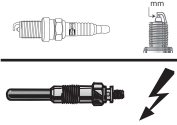

eon TITAN

IRIDIUM

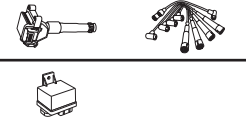

...FORD AUSTRALIA



...FALCON

| | | | | | | | | | |
|--------------|---|---------|---------|-------------|-------|-----|--------|--|--|
| 5.4 i V8 XR8 | 8 | Boss290 | 290/389 | 02/08→12/14 | OE131 | 1,0 | CET18P | | |
|--------------|---|---------|---------|-------------|-------|-----|--------|--|--|

FIESTA

| | | | | | | | | | |
|----------|---|------|-------|-------------|-------|-----|--------|-------|--|
| 1.4 i | 4 | SPJA | 71/95 | 10/09→12/10 | OE029 | 1,0 | CET17P | OE189 | |
| 1.6 TDCi | 4 | HHJD | 66/89 | 01/09→12/10 | CH201 | 11v | | | |

FOCUS

| | | | | | | | | | |
|-------------|---|------|---------|-------------|-------|-----|--|--|---------|
| 1.8 i | 4 | EYDE | 85/114 | 09/02→04/05 | | | | | BAEA422 |
| 2.0 i | 4 | EDDB | 96/129 | 09/02→04/05 | | | | | BAEA422 |
| 2.0 i ST170 | 4 | ALDA | 127/170 | 04/03→04/05 | | | | | BAEA422 |
| 2.0 TDCi | 4 | G6DA | 100/134 | 04/07→08/11 | CH268 | 11v | | | |

KA

| | | | | | | | | | |
|-----|---|----------|-------|-------------|-------|-----|--------|-------|--|
| 1.3 | 4 | J4D; J4F | 44/59 | 11/99→12/03 | OE131 | 1,0 | CET18P | OE183 | |
|-----|---|----------|-------|-------------|-------|-----|--------|-------|--|

MONDEO

| | | | | | | | | | |
|----------|---|------|---------|-------------|-------|-----|--------|-------|---------|
| 2.0 | 4 | | 94/126 | 12/96→04/01 | | | | | BAEA422 |
| 2.0 | 4 | NGA | 96/129 | 07/95→02/00 | OE029 | 1,0 | CET17P | OE189 | |
| 2.0 i | 4 | NGA | 97/130 | 07/95→12/99 | OE029 | 1,0 | CET17P | OE189 | |
| 2.0 TDCi | 4 | AZBA | 103/138 | 03/07→01/15 | CH201 | 11v | | | |

MUSTANG

| | | | | | | | | | |
|--------|---|--|---------|-------------|--|--|--------|--|--|
| 4.6 V8 | 8 | | 160/215 | 11/95→05/99 | | | CET9 | | |
| 4.6 V8 | 8 | | 165/221 | 11/95→05/99 | | | CET9 | | |
| 4.6 V8 | 8 | | 192/257 | 06/99→10/00 | | | CET9 | | |
| 4.6 V8 | 8 | | 224/300 | 12/04→ | | | CET9 | | |
| 4.6 V8 | 8 | | 225/302 | 11/95→05/99 | | | CET9 | | |
| 4.6 V8 | 8 | | 236/316 | 06/99→09/03 | | | CET9 | | |
| 5.4 V8 | 8 | | 355/476 | 01/06→ | | | CET18P | | |

RANGER

| | | | | | | | | | |
|----------|---|-----------|---------|-------------|-------|-----|--|--|--|
| 2.5 TDDi | 4 | WLAT(16V) | 105/141 | 11/06→11/11 | CH242 | 11v | | | |
|----------|---|-----------|---------|-------------|-------|-----|--|--|--|

TAURUS

| | | | | | | | | | |
|-------|---|--|---------|-------------|--|--|--------|--|--|
| 3.0 i | 6 | | 149/200 | 03/96→09/98 | | | CET18P | | |
|-------|---|--|---------|-------------|--|--|--------|--|--|

FORD AUSTRALIA



COURIER

| | | | | | | | | | |
|------------------|---|----|-------|-------------|-------|-----|--|--|--|
| 2.5 D, 2.5 D 4WD | 4 | WL | 64/86 | 05/96→02/99 | CH242 | 11v | | | |
|------------------|---|----|-------|-------------|-------|-----|--|--|--|

TRANSIT

| | | | | | | | | | |
|----------|---|------------------------------|---------|-------------|------------------------|-------|--|--|--|
| 2.2 TD | 4 | QVFA | 81/109 | 09/06→12/14 | CH229 ^[362] | 11.5v | | | |
| 2.2 TD | 4 | CYFA; CYFB; CYFC | 92/123 | 01/12→12/14 | CH229 ^[362] | 11.5v | | | |
| 2.2 TDCi | 4 | SRFA; SRFB; SRFC; SRFD; SRFE | 85/114 | 01/10→12/14 | CH229 ^[362] | 11.5v | | | |
| 2.2 TDCi | 4 | CVRA; CVRB; CVRC | 114/153 | 10/11→ | CH229 ^[362] | 11.5v | | | |
| 2.4 D | 4 | D2FA | 66/89 | 01/00→09/06 | CH229 | 11.5v | | | |
| 2.4 D | 4 | FXFA | 85/114 | 03/04→ | CH229 | 11.5v | | | |
| 2.4 D | 4 | D4FA | 88/118 | 01/00→09/06 | CH229 | 11.5v | | | |
| 2.4 D | 4 | DOFA | 92/123 | 07/01→09/06 | CH229 | 11.5v | | | |
| 2.4 D | 4 | H9FA | 101/135 | 03/04→09/06 | CH229 | 11.5v | | | |
| 2.4 TD | 4 | H9FB | 103/138 | 07/06→ | CH229 | 11.5v | | | |

TRANSIT CUSTOM

| | | | | | | | | | |
|----------|---|------------|--------|--------|--|-------|--|--|--|
| 2.2 TDCi | 4 | CYF4; CYFF | 92/123 | 09/13→ | CH229 ^[362] →Prod.30.12.2014 | 11.5v | | | |
|----------|---|------------|--------|--------|--|-------|--|--|--|

FORD USA



CROWN VICTORIA

| | | | | | | | | | |
|-----|---|-----|---------|-------------|--|--|------|--|--|
| 4.6 | 8 | 99W | 167/224 | 09/02→12/07 | | | CET9 | | |
|-----|---|-----|---------|-------------|--|--|------|--|--|

FORD USA





kW/BHP

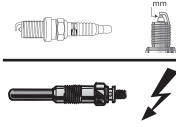

eon TITAN

IRIDIUM

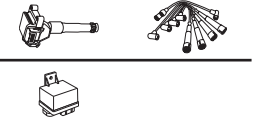

FORD USA

| ...FORD USA  | | | | | | | | | | |
|---|---|-------|---------|-------------|----------------------------|-----|--------|-------|-------|--------------------------|
| ECOSPORT | | | | | | | | | | |
| 1.0 XL Supercharged | 4 | | 70/94 | 06/02→ | | | | | | BAEA422 |
| 1.6 | 4 | | 72/97 | 10/07→ | | | | | | BAEA422 |
| 2.0 XLT 4WD | 4 | | 105/141 | 06/02→ | | | | | | BAEA422 |
| ESCAPE | | | | | | | | | | |
| 3.0 4WD | 6 | | 145/194 | 01/01→04/04 | | | CET18P | | | BAEA410 ^[277] |
| EXPEDITION | | | | | | | | | | |
| 4.6 4WD | 8 | 99W | 158/212 | 08/96→09/02 | | | CET9 | | | |
| 4.6, 4.6 4WD | 8 | 99W | 173/232 | 09/01→02/06 | | | CET9 | | | |
| 5.4 4WD, 5.4 XLT | 8 | | 194/260 | 08/96→02/06 | | | CET18P | | | |
| EXPLORER | | | | | | | | | | |
| 4.0, 4.0 4WD | 6 | 99X | 150/201 | 10/99→12/01 | | | CET9 | | | |
| 4.0 V6 4WD | 6 | | 115/154 | 03/95→12/01 | | | CET18P | OE183 | | |
| 4.0 V6 4WD | 6 | | 121/162 | 01/93→12/94 | | | CET18P | OE183 | | |
| 4.0 V6 4WD | 6 | | 150/201 | 10/98→12/01 | | | CET9 | OE183 | | |
| 4.0 V6 4WD | 6 | | 152/204 | 10/96→12/01 | | | CET18P | OE183 | | |
| 4.6, 4.6 4WD | 8 | | 178/239 | 09/01→12/05 | | | CET9 | | | |
| 5.0 4WD | 8 | | 157/211 | 01/96→12/01 | | | CET18P | OE183 | | |
| F150 | | | | | | | | | | |
| 4.6 | 8 | | 164/220 | 09/98→10/01 | | | CET9 | | | |
| 4.6 Lariat Supercab 4WD | 8 | | 248/333 | 10/03→09/07 | | | CET9 | | | |
| 4.6 XL Styleside | 8 | 99W | 170/228 | 10/03→09/07 | | | CET9 | | | |
| F-150 | | | | | | | | | | |
| 4.6 | 8 | | 154/207 | 05/97→08/98 | | | CET9 | | | |
| 4.6, 4.6 4WD | 8 | | 162/217 | 10/96→09/98 | | | CET9 | | | |
| 4.6, 4.6 4WD | 8 | ; 99W | 170/228 | 10/98→09/07 | | | CET9 | | | |
| 5.4 | 8 | | 280/375 | 05/01→11/03 | | | CET18P | | | |
| F250 | | | | | | | | | | |
| 4.6, 4.6 4WD | 8 | | 162/217 | 10/96→09/98 | | | CET9 | | | |
| 4.6, 4.6 4WD | 8 | | 170/228 | 10/98→11/03 | | | CET9 | | | |
| FIVE HUNDRED | | | | | | | | | | |
| 3.0 | 6 | | 151/202 | 08/04→ | | | CET18P | | | BAEA410 ^[277] |
| MUSTANG | | | | | | | | | | |
| 4.6 | 8 | | 160/215 | 11/95→05/99 | | | CET9 | | | |
| 4.6 | 8 | 99W | 165/221 | 11/95→05/99 | | | CET9 | | | |
| 4.6 | 8 | | 192/257 | 09/98→12/04 | | | CET9 | | | |
| 4.6 | 8 | | 225/302 | 11/95→05/99 | | | CET9 | | | |
| 4.6 | 8 | | 228/306 | 11/95→05/99 | | | CET9 | | | |
| 4.6 | 8 | | 236/316 | 06/99→09/03 | | | CET9 | | | |
| 5.4 V8 | 8 | | 355/476 | 01/06→ | | | CET18P | OE183 | | |
| PROBE II | | | | | | | | | | |
| 2.0 16V | 4 | FS | 85/114 | 10/93→03/98 | OE089 | 1,0 | CET2 | | OE184 | |
| 2.5 V6 24V | 6 | KL | 119/160 | 10/93→03/98 | OE089 | 1,0 | CET2 | | OE184 | |
| | | | | | OE216 ^{LPG [278]} | 0,8 | | | | |
| 2.5 V6 24V | 6 | KL | 120/161 | 12/94→03/98 | OE089 | 1,0 | CET2 | | OE184 | |
| | | | | | OE216 ^{LPG [278]} | 0,8 | | | | |
| TAURUS | | | | | | | | | | |
| 3.0 | 6 | | 95/127 | 11/98→12/99 | | | CET18P | | | |
| 3.0, 3.0 Flex-Fuel | 6 | | 108/145 | 09/95→12/99 | | | CET18P | | | |
| 3.0 24V | 6 | | 130/174 | 09/95→12/99 | | | CET18P | | | |
| 3.0 24V | 6 | | 149/200 | 06/95→12/03 | | | CET18P | | | |
| 3.0 V6 | 6 | | 115/154 | 01/96→12/99 | | | CET18P | | | |





kW/BHP

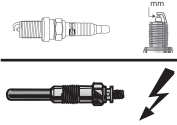

eon TITAN

IRIDIUM

**...FORD USA****THUNDERBIRD**

4.6 8 99W 151/202 01/93→12/97 CET9

WINDSTAR

3.0 V6 6 108/145 01/95→12/00 CET18P

3.0 V6 6 109/146 03/95→02/99 CET18P

FORD USA**E SERIES**

4.6 8 99W 167/224 10/01→09/07 CET9

FOTON**SURF**

2.2 4 4YME 76/102 06/99→08/03 OE048 1,0 CET8 OE195

2.8 TD 4 4JB1T 74/99 02/00→08/03 CH306 (275) 11v

SURFING

2.2 4 491EQ1 76/102 09/03→ OE006 0,9 CET8 OE195

FOTON**ALPHA**

2.2, 2.2 DLX 4 4YME 76/102 08/02→ OE048 1,0 CET8 OE195

2.2 DX 4 4YE 68/91 08/02→ OE048 1,0 CET8 OE195

SEA LION

2.2 DLX 4 4YE 68/91 08/98→03/02 OE048 1,0 CET8 OE195

2.2 DLX 4 4YME 76/102 06/01→ OE048 1,0 CET8 OE195

SUP

2.2 4 BJ491EQ1 76/102 08/03→ OE006 0,9 CET8 OE195

VIEW

2.2 4 BJ491EQ1 76/102 08/02→08/14 OE006 0,9 CET8 OE195

FSO**LANOS**

1.4 4 A13SM 55/74 05/04→10/08 OE006 0,9 CET8 OE195 BAEA447A

1.5 4 A15SM 63/84 05/04→10/08 OE006 0,9 CET8 OE195

1.6 16V 4 A16DMS 78/105 05/04→10/08 OE039 1,0 CET2 OE179 BAEA025E

GAZ**VOLGA**

2.3 4 ZMZ-4062.10 96/129 02/93→12/10 OE051 0,9 CET8

2.3 4 ZMZ-4062.10 107/143 01/07→12/10 OE051 0,9 CET8

2.4 4 ZMZ-4021.10 59/79 02/93→12/10 OE059 0,8

2.4 4 ZMZ-4021.10 66/89 01/97→12/10 OE059 0,8

2.4 4 ZMZ-4021.10 74/99 01/97→12/10 OE059 0,8

GAZ**GAZELLE**

2.3 4 ZMZ-4063.10 72/97 09/01→12/02 OE051 0,9

2.3 4 ZMZ-4062.10 96/129 10/93→08/01 OE051 0,9 CET8

2.3, 2.3 4WD 4 ZMZ-4063.10 104/139 01/03→01/10 OE051 0,9

2.3 4WD 4 ZMZ-4063.10 112/150 01/08→01/10 OE051 0,9

2.4 4 ZMZ-4027.10 63/84 01/03→03/13 OE059 0,8

2.4, 2.4 4WD 4 ; ZMZ-402.10; ZMZ-4025.10 66/89 10/93→03/13 OE059 0,8

2.9 4 UMZ-4215.10 75/101 01/03→01/10 OE006 0,9 CET8 OE195

2.9, 2.9 4WD 4 UMZ4216 78/105 01/05→03/13 OE006 0,9 CET8 OE195

2.9, 2.9 4WD 4 UMZ4216 79/106 01/07→03/13 OE006 0,9 CET8 OE195

GAZ





kW/BHP



eon TITAN

IRIDIUM

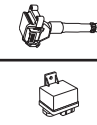
**...GAZ****SOBOL (2217)**

2.3 4 ZMZ-4063.10 72/97 09/97→04/13 OE051 0,9

2.4 4 ZMZ-402.10 66/89 01/97→ OE059 0,8

SOBOL (2310)

2.4 4 ZMZ-402.10 66/89 09/97→04/13 OE059 0,8

SOBOL (2752)

2.3 4 ZMZ-4063.10 72/97 09/97→04/13 OE051 0,9

2.4 4 ZMZ-402.10 66/89 01/97→ OE059 0,8

GEELY**BL**

1.3 4 MR479Q 63/84 09/05→ OE034 0,9 CET2 OE179

1.5 4 MR479QA 69/93 09/05→ OE034 0,9 CET2 OE179

CK

1.3 4 8A-FE; MR479Q 63/84 04/05→ OE034 0,9 CET2 OE179

1.5 4 5A-FE; MR479QA 69/93 09/05→ OE034 0,9 CET2 OE179

1.6 4 MR481QA 79/106 09/05→ OE034 0,9 CET2 OE179

GC2

1.3 4 MR479Q 63/84 12/14→ OE034 0,9 CET2 OE179

HAOQING

1.0 3 JL376QE; TJ376Q 37/50 05/98→08/01 OE006 0,9 CET8 OE195

HISOON

1.3 4 MR479Q 63/84 07/04→ OE034 0,9 CET2 OE179

1.5 4 MR479QA 69/93 07/04→12/09 OE034 0,9 CET2 OE179

HQ

1.0 3 JL376QE 38/51 09/05→ OE006 0,9 CET8 OE195

1.1 3 JL378QE 40/54 09/05→ OE006 0,9 CET8 OE195

1.3 4 MR479Q 63/84 09/05→ OE034 0,9 CET2 OE179

MARINDO

1.5 4 MR479QA 69/93 03/05→ OE034 0,9 CET2 OE179

MEIRI

1.3 4 8A-FE 63/84 06/99→08/04 OE034 0,9 CET2 OE179

MK

1.5 4 MR479QA 69/93 06/05→ OE034 0,9 CET2 OE179

MR

1.0 3 JL376QE 38/51 09/05→ OE006 0,9 CET8 OE195

1.1 3 JL378QE 40/54 09/05→ OE006 0,9 CET8 OE195

1.3 4 MR479Q 63/84 09/05→ OE034 0,9 CET2 OE179

1.5 4 MR479QA 69/93 09/05→ OE034 0,9 CET2 OE179

PU

1.0 3 JL376QE 38/51 09/05→ OE006 0,9 CET8 OE195

1.1 3 JL378QE 40/54 09/05→ OE006 0,9 CET8 OE195

1.3 4 MR479Q 63/84 09/05→ OE034 0,9 CET2 OE179

SL

1.8 4 JL4G18 93/125 09/11→ OE034 0,9 CET2 OE179

URBAN NANNY

1.0 3 JL376QE 38/51 05/04→ OE006 0,9 CET8 OE195

1.1 3 JL378QE; JT378QE 40/54 05/04→ OE006 0,9 CET8 OE195

1.3 4 MR479Q 63/84 05/04→ OE034 0,9 CET2 OE179

VISION

1.5 4 JL4G15D 78/105 05/09→ OE034 0,9 CET2 OE179

GAZ





kW/BHP

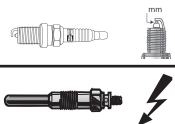

eon TITAN

IRIDIUM

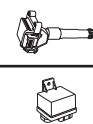
**...GEELY****...VISION**

1.8 4 JL4G18 103/138 08/06→12/12 OE034 0,9 CET2 OE179

GINETTA**G34**

2.0 4 B204FT 140/188 01/95→12/98 OE018 1,0 CET8 OE195

GMC**SAVANA 2500**

5.3 4WD 8 LM7 220/295 09/04→12/05 BAE538

GOLDEN DRAGON**XML**

2.2 4 491Q 68/91 06/99→08/02 OE006 0,9 CET8 OE195

2.2 4 491QME 76/102 08/01→ OE006 0,9 CET8 OE195

GREAT WALL**FENGJUN 5**

2.4 4 4G69S4N 93/125 01/13→ OE063 1,0 CET2 OE180

HOVER H3

2.0 4 4G63S4M 85/114 05/09→ OE063 1,0 CET2 OE180

2.0 4 4G63S4M 90/121 05/09→ OE063 1,0 CET2 OE180

PEGASUS

2.2 RHG Royale, 2.2 RHN Royale 4WD 4 491QE 74/99 02/04→12/08 OE006 0,9 CET8 OE195

STEED

2.2 4 GW491Q-E 78/105 01/12→ OE006 0,9 CET8 OE195

GREAT WALL**DEER**

2.2 4 GA491QE 76/102 02/00→08/03 OE006 0,9 CET8 OE195

SAILING

2.2 4 491Q 74/99 06/01→08/02 OE006 0,9 CET8 OE195

2.2 4WD 4 4YME 76/102 09/02→08/03 OE048 1,0 CET8 OE195

HOLDEN**ADVENTRA**

3.6 i V6 4WD 6 H7 195/261 05/06→07/09 BAE174E

APOLLO

3.0 i 6 3VZ-FE 136/182 03/93→05/97 OE191 1,0 CET12P OE180

ASTRA

1.6 CD 4 X16XEL; Z16XE 74/99 08/95→09/98 OE198 0,9 CET2 OE184

1.8 i 4 X18XE1 85/114 09/96→08/00 BAE342

1.8 i 4 Z18XE 92/123 09/00→03/08 OE198 0,9 CET2 OE184 BAE342

1.8 i 4 Z18XER 103/138 04/07→03/10 OE198 0,9 CET2 OE184

1.9 CDTI 4 Z19DTH 110/148 06/06→03/10 CH224 11v

2.0 i Turbo 4 Z20LER; Z20LET 147/197 06/02→03/10 OE019 0,9 CET2 OE184

2.0 VXR 4 A20NFT 206/276 12/14→ CET17P OE189
*to be adjusted

2.2 4 Z22YH 110/148 12/06→03/08 OE120 0,6 CET2 OE188

2.2 i 4 Z22SE 108/145 09/00→12/06 OE029 1,0 CET17P OE184
OE198 0,9 CET2 OE189**BARINA**

1.4 Efi 4 Z14XEP 66/89 01/04→02/05 OE198 0,9 CET2 OE184

1.8 SRi 4 Z18XE 92/123 09/00→02/05 OE198 0,9 CET2 OE184 BAE342

HOLDEN



kW/BHP

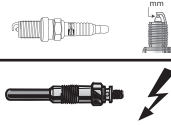

eon TITAN

IRIDIUM

**...HOLDEN****CAPRICE**

3.6 i V6 6 H7 190/255 08/04 → 07/06

BAEA174E

CAPTIVA

2.4 i, 2.4 i 4WD 4 Z24XED 103/138 12/09 → 12/11

OE019

0,9

CET2

OE184

COMMODORE

3.6 i V6 6 HN 180/241 09/04 →

BAEA174E

3.6 i V6 6 HV 210/282 09/07 → 10/13

BAEA174E

3.6 i V6, 3.6 i V6 6 H7; HV; LY7 195/261 07/06 → 10/13

BAEA174E

3.6 i V6, 3.6 i V6 4WD 6 H7; HV 190/255 09/04 → 05/13

BAEA174E

3.6 i V6, 3.6 i V6 Dual Fuel LPG 6 HB 175/235 09/04 → 10/13

BAEA174E

CREWMAN

3.6 i V6 6 HN 180/241 09/06 → 12/07

BAEA174E

3.6 i V6 4WD 6 HB 175/235 11/05 → 12/07

BAEA174E

INSIGNIA

2.8 VXR 4WD 6 A28NER 239/320 01/15 →

OE238

1,0

RODEO

3.0 TD 4 4JH1-TC 96/129 12/01 → 01/07

CH306

11v

STATESMAN

3.6 i V6 6 LY7 195/261 07/06 → 12/10

BAEA174E

3.6 VVT 6 H7 190/255 08/04 → 07/06

BAEA174E

TIGRA

1.8 4 Z18XE 92/123 09/05 → 12/07

OE198

0,9

CET2

OE184

TRAX

1.8 4 2H0; F18D4 103/138 10/13 →

OE198

0,9

CET2

BAEA199E

VECTRA

2.2 i 4 Z22SE 108/145 04/02 → 12/06

OE029

1,0

CET17P

OE189

VIVA

1.8 i 4 F18D3 89/119 03/05 → 12/09

OE198

0,9

CET2

OE184

BAEA342

ZAFIRA

2.2 i 4 Z22SE 108/145 06/01 → 02/06

OE029

1,0

CET17P

OE189

HOLDEN**COMBO**

1.4 i 4 Z14XEP 66/89 04/05 → 12/12

OE198

0,9

CET2

OE184

BAEA338

ONE TONNER

3.6 i V6, 3.6 i V6 4WD 6 HB 175/235 08/03 → 12/05

BAEA174E

HONDA**ACCORD V**

1.9 i 4 F18A3 85/114 02/96 → 10/98

OE089

1,0

CET2

OE184

OE216 LPG [278]

0,8

2.0, 2.0 i LS 16V 4 F20B3 100/134 09/93 → 02/98

OE089

1,0

CET2

OE184

BAEA275^[292]

OE216 LPG [278]

0,8

2.0 i 4 F20Z2 85/114 03/93 → 01/96

OE089

1,0

CET2

OE184

BAEA275^[292]

OE216 LPG [278]

0,8

2.0 i LS 4 F20Z1 96/129 02/96 → 10/98

OE089

1,0

CET2

OE184

OE216 LPG [278]

0,8

2.0 i S 4 F20Z1 96/129 03/93 → 01/96

OE089

1,0

CET2

OE184

BAEA275^[292]

OE216 LPG [278]

0,8

2.0 TDi 4 20T2N 77/103 04/96 → 10/98

CH169

11v

2.2 4 F22B1 107/143 10/93 → 12/97

BAEA275^[292]



kW/BHP



eon TITAN

IRIDIUM

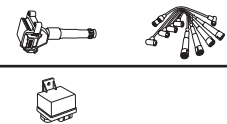

...HONDA



...ACCORD V

| | | | | | | | | | |
|------------|---|-------|---------|-------------|--|------------|-------------|--------------|---------------------------------|
| 2.2 i ES | 4 | F22B5 | 110/148 | 09/93→02/98 | OE089 OE216 LPG [278] | 1,0 0,8 | CET2 | OE184 | BAEA275 ^[292] |
| 2.2 i VTEC | 4 | F22Z2 | 110/148 | 02/96→10/98 | OE089 OE216 LPG [278] | 1,0 0,8 | CET2 | OE184 | |
| 2.3 i SR | 4 | H23A3 | 116/156 | 03/93→01/96 | OE089 OE216 LPG [278] | 1,0 0,8 | CET2 | OE184 | BAEA275 ^[292] |

ACCORD VI

| | | | | | | | | | |
|-----------------------|---|-------|---------|-------------|---|-------------|---------------|--------------|---------------------------------|
| 1.6 | 4 | A16A5 | 65/87 | 10/98→12/02 | OE039 | 1,0 | CET2 | OE179 | |
| 1.6 i | 4 | D16B6 | 85/114 | 10/98→12/02 | OE089 OE216 LPG [278] | 1,0 0,8 | CET2 | OE184 | |
| 1.8 i | 4 | F18B2 | 100/134 | 10/98→12/02 | OE089 OE216 LPG [278] | 1,0 0,8 | CET2 | OE184 | |
| 2.0 | 4 | F20B6 | 108/145 | 12/99→12/02 | OE089 | 1,0 | CET2 | OE184 | |
| 2.0 i | 4 | F20B6 | 108/145 | 10/98→01/01 | OE089 OE216 LPG [278] | 1,0 0,8 | CET2 | OE184 | |
| 2.0 i 16V | 4 | F20B7 | 108/145 | 02/98→06/03 | OE089 | 1,0 | CET2 | OE184 | BAEA275 ^[292] |
| 2.0 i 16V | 4 | F20B5 | 108/145 | 02/98→06/03 | OE089 OE216 LPG [278] | 1,0 0,8 | CET2 | OE184 | BAEA275 ^[292] |
| 2.0 TDi, 2.0 Turbo DI | 4 | 20T2N | 77/103 | 02/99→12/02 | CH169 | 11v | | | |
| 2.2 Type-R | 4 | H22A7 | 156/209 | 02/99→12/02 | | | CET12P | OE179 | BAEA275 ^[292] |
| 2.3 | 4 | F23A1 | 113/152 | 11/00→06/03 | | | CET2 | OE184 | |
| 2.3 | 4 | F23Z5 | 113/152 | 11/00→06/03 | OE089 *to be adjusted OE216 LPG [278] | 0,9* 0,8 | CET2 | OE184 | |
| 2.3 16 V | 4 | F23A7 | 118/158 | 02/98→12/02 | OE089 | 1,0 | CET2 | OE184 | |
| 3.0 V6 24V | 6 | J30A1 | 147/197 | 02/98→06/03 | OE089 OE216 LPG [278] | 1,0 0,8 | CET2 | OE184 | |

ACCORD VII

| | | | | | | | | | |
|---------|---|-------------|---------|-------------|--|------------|-------------|--------------|----------------------------------|
| 2.0 | 4 | K20A6 | 114/153 | 02/03→05/08 | OE089 OE216 LPG [278] | 1,0 0,8 | CET2 | OE184 | BAEA169E ^[125] |
| 2.0 4WD | 4 | K20A6 | 114/153 | 02/03→05/08 | OE089 OE216 LPG [278] | 1,0 0,8 | CET2 | OE184 | BAEA169E |
| 2.4 | 4 | K24A; K24A3 | 140/188 | 02/03→05/08 | OE239 | 1,1 | CET3 | | BAEA169E ^[125] |

ACCORD VIII

| | | | | | | | | | |
|-------|---|-------|---------|--------|--------------|-----|-------------|--|-----------------|
| 2.0 i | 4 | R20A4 | 110/148 | 07/08→ | OE239 | 1,1 | CET3 | | |
| 2.0 i | 4 | R20A3 | 115/154 | 06/08→ | OE239 | 1,1 | CET3 | | BAEA182E |

CAPA

| | | | | | | | | | |
|----------|---|------|---------|-------------|--------------|-----|-------------|--------------|--|
| 1.5 16V | 4 | D15B | 72/97 | 04/98→09/02 | OE089 | 1,0 | CET2 | OE184 | |
| 1.6 Vtec | 4 | B16A | 125/168 | 01/98→09/02 | OE014 | 0,9 | CET2 | OE179 | |

CITY

| | | | | | | | | | |
|------------------------|---|-------|-------|-------------|--------------|-----|-------------|--------------|---|
| 1.3 i-DSI 4WD, 1.3 SES | 4 | L13A1 | 63/84 | 09/01→09/05 | OE039 | 1,0 | CET2 | OE179 | BAEA175E ^{[12] [28]} BAEA176E ^{[7] [27]} |
|------------------------|---|-------|-------|-------------|--------------|-----|-------------|--------------|---|

CIVIC V

| | | | | | | | | | |
|------------|---|---------------------|--------|-------------|--|------------|-------------|--------------|---|
| 1.5 | 4 | D15B2 | 66/89 | 10/93→12/95 | OE039 | 1,0 | CET2 | OE180 | BAEA275 ^[292] CLS128 ^[292] CLS129 |
| 1.5 | 4 | D15B7 | 67/90 | 10/93→12/95 | | | | | BAEA275 ^[292] |
| 1.5 | 4 | D15B2; D15B7; D15Z1 | 74/99 | 10/93→12/95 | OE039 | 1,0 | CET2 | OE180 | |
| 1.5 iLSi | 4 | D15B7 | 74/99 | 08/93→11/95 | OE089 OE216 LPG [278] | 1,0 0,8 | CET2 | OE184 | BAEA275 ^[292] CLS128 ^[292] |
| 1.6 i | 4 | D16Y7 | 77/103 | 01/94→11/95 | OE039 | 1,0 | CET2 | OE180 | BAEA275 ^[292] CLS129 |
| 1.6 i Vtec | 4 | D16Y6; D16Z9 | 92/123 | 01/94→03/96 | OE039 | 1,0 | CET2 | OE180 | CLS012 |

HONDA





kW/BHP

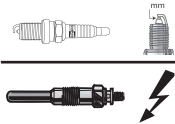

eon TITAN

IRIDIUM



...HONDA



...CIVIC V

| | | | | | | | | | | |
|------------|---|-------|---------|-------------|-------|-----|------|-------|--------------------------|--|
| 1.6 i Vtec | 4 | B16A2 | 118/158 | 01/94→11/95 | OE005 | 0,9 | CET2 | OE180 | BAEA275 ^[292] | |
|------------|---|-------|---------|-------------|-------|-----|------|-------|--------------------------|--|

CIVIC VI

| | | | | | | | | | | |
|-----|---|-------|-------|-------------|--|--|--|--|--------------------------|--|
| 1.4 | 4 | D14A4 | 55/74 | 11/95→10/98 | | | | | BAEA275 ^[292] | |
|-----|---|-------|-------|-------------|--|--|--|--|--------------------------|--|

| | | | | | | | | | | |
|---------|---|-------|-------|-------------|-------|-----|------|-------|--|--------|
| 1.4 16V | 4 | D14A7 | 55/74 | 04/98→02/01 | OE089 | 1,0 | CET2 | OE184 | | CLS012 |
|---------|---|-------|-------|-------------|-------|-----|------|-------|--|--------|

| | | | | | | | | | | |
|--|--|--|--|--|----------------------------|-----|--|--|--|--|
| | | | | | OE216 LPG ^[278] | 0,8 | | | | |
|--|--|--|--|--|----------------------------|-----|--|--|--|--|

| | | | | | | | | | | |
|---------|---|-------|-------|-------------|-------|-----|------|-------|--------------------------|--------|
| 1.4 16V | 4 | D14A8 | 66/89 | 04/98→02/01 | OE089 | 1,0 | CET2 | OE180 | BAEA275 ^[292] | CLS012 |
|---------|---|-------|-------|-------------|-------|-----|------|-------|--------------------------|--------|

| | | | | | | | | | | |
|--|--|--|--|--|----------------------------|-----|--|--|--|--|
| | | | | | OE216 LPG ^[278] | 0,8 | | | | |
|--|--|--|--|--|----------------------------|-----|--|--|--|--|

| | | | | | | | | | | |
|-------|---|---------------------|-------|-------------|-------|-----|------|-------|--|-------------------------|
| 1.4 i | 4 | D14A5; D14A7; D14Z3 | 55/74 | 09/95→02/01 | OE016 | 0,9 | CET2 | OE180 | | CLS128 ^[292] |
|-------|---|---------------------|-------|-------------|-------|-----|------|-------|--|-------------------------|

| | | | | | | | | | | |
|-------|---|--------------|-------|-------------|-------|-----|------|-------|--------------------------|--------|
| 1.4 i | 4 | D14A3; D14Z1 | 55/74 | 09/95→02/01 | OE016 | 0,9 | CET2 | OE180 | BAEA275 ^[292] | CLS129 |
|-------|---|--------------|-------|-------------|-------|-----|------|-------|--------------------------|--------|

| | | | | | | | | | | |
|--|--|--|--|--|-------|-----|--|-------|--|--|
| | | | | | OE089 | 1,0 | | OE184 | | |
|--|--|--|--|--|-------|-----|--|-------|--|--|

| | | | | | | | | | | |
|-------|---|---------------------|-------|-------------|-------|-----|------|-------|--|-------------------------|
| 1.4 i | 4 | D14A2; D14A6; D14A8 | 66/89 | 06/95→02/01 | OE016 | 0,9 | CET2 | OE180 | | CLS128 ^[292] |
|-------|---|---------------------|-------|-------------|-------|-----|------|-------|--|-------------------------|

| | | | | | | | | | | |
|-------|---|-------|-------|-------------|-------|-----|------|-------|--|-------------------------|
| 1.4 i | 4 | D14Z4 | 66/89 | 06/95→02/01 | OE016 | 0,9 | CET2 | OE180 | | CLS128 ^[292] |
|-------|---|-------|-------|-------------|-------|-----|------|-------|--|-------------------------|

| | | | | | | | | | | |
|--|--|--|--|--|-------|-----|--|-------|--|--------|
| | | | | | OE089 | 1,0 | | OE184 | | CLS129 |
|--|--|--|--|--|-------|-----|--|-------|--|--------|

| | | | | | | | | | | |
|-------|---|-------|-------|-------------|-------|-----|------|-------|--|--------|
| 1.4 i | 4 | D14A4 | 66/89 | 06/95→02/01 | OE016 | 0,9 | CET2 | OE180 | | CLS129 |
|-------|---|-------|-------|-------------|-------|-----|------|-------|--|--------|

| | | | | | | | | | | |
|--|--|--|--|--|-------|-----|--|-------|--|--|
| | | | | | OE089 | 1,0 | | OE184 | | |
|--|--|--|--|--|-------|-----|--|-------|--|--|

| | | | | | | | | | | |
|-------|---|-------|-------|-------------|-------|-----|------|-------|--------------------------|--------|
| 1.4 i | 4 | D14Z2 | 66/89 | 06/95→02/01 | OE016 | 0,9 | CET2 | OE180 | BAEA275 ^[292] | CLS129 |
|-------|---|-------|-------|-------------|-------|-----|------|-------|--------------------------|--------|

| | | | | | | | | | | |
|--|--|--|--|--|-------|-----|--|-------|--------|--|
| | | | | | OE089 | 1,0 | | OE184 | 12/98→ | |
|--|--|--|--|--|-------|-----|--|-------|--------|--|

| | | | | | | | | | | |
|---------|---|---------------------|-------|-------------|-------|-----|------|-------|--------------------------|--------|
| 1.4 i S | 4 | D14A4; D14Z2; D14Z4 | 66/89 | 11/95→02/01 | OE016 | 0,9 | CET2 | OE180 | BAEA275 ^[292] | CLS129 |
|---------|---|---------------------|-------|-------------|-------|-----|------|-------|--------------------------|--------|

| | | | | | | | | | | |
|--|--|--|--|--|-------|-----|--|-------|--|--|
| | | | | | OE089 | 1,0 | | OE184 | | |
|--|--|--|--|--|-------|-----|--|-------|--|--|

| | | | | | | | | | | |
|-----|---|-------|-------|-------------|-------|-----|------|-------|--------------------------|--|
| 1.5 | 4 | D15Z3 | 66/89 | 11/95→12/96 | OE089 | 1,0 | CET2 | OE184 | BAEA275 ^[292] | |
|-----|---|-------|-------|-------------|-------|-----|------|-------|--------------------------|--|

| | | | | | | | | | | |
|--|--|--|--|--|-------|-----|--|--|--|--|
| | | | | | OE216 | 0,8 | | | | |
|--|--|--|--|--|-------|-----|--|--|--|--|

| | | | | | | | | | | |
|---------|---|-------|--------|-------------|-------|-----|------|-------|--|--------|
| 1.5 16V | 4 | D15Z8 | 84/113 | 01/97→02/01 | OE089 | 1,0 | CET2 | OE184 | | CLS012 |
|---------|---|-------|--------|-------------|-------|-----|------|-------|--|--------|

| | | | | | | | | | | |
|--|--|--|--|--|----------------------------|-----|--|--|--|--|
| | | | | | OE216 LPG ^[278] | 0,8 | | | | |
|--|--|--|--|--|----------------------------|-----|--|--|--|--|

| | | | | | | | | | | |
|-------|---|-------|--------|-------------|-------|-----|------|-------|--------------------------|--------|
| 1.5 i | 4 | D15Z6 | 84/113 | 11/95→02/01 | OE089 | 1,0 | CET2 | OE184 | BAEA275 ^[292] | CLS129 |
|-------|---|-------|--------|-------------|-------|-----|------|-------|--------------------------|--------|

| | | | | | | | | | | |
|--|--|--|--|--|----------------------------|-----|--|--|--|--|
| | | | | | OE216 LPG ^[278] | 0,8 | | | | |
|--|--|--|--|--|----------------------------|-----|--|--|--|--|

| | | | | | | | | | | |
|--------------|---|-------|-------|-------------|-------|-----|------|-------|--------------------------|--------|
| 1.5 i Vtec-E | 4 | D15Z3 | 66/89 | 09/94→01/97 | OE089 | 1,0 | CET2 | OE184 | BAEA275 ^[292] | CLS129 |
|--------------|---|-------|-------|-------------|-------|-----|------|-------|--------------------------|--------|

| | | | | | | | | | | |
|--|--|--|--|--|----------------------------|-----|--|--|--|--|
| | | | | | OE216 LPG ^[278] | 0,8 | | | | |
|--|--|--|--|--|----------------------------|-----|--|--|--|--|

| | | | | | | | | | | |
|-----|---|-------|--------|-------------|--|--|--|--|--------------------------|--|
| 1.6 | 4 | D16Y7 | 79/106 | 09/95→12/00 | | | | | BAEA275 ^[292] | |
|-----|---|-------|--------|-------------|--|--|--|--|--------------------------|--|

| | | | | | | | | | | |
|-----|---|-------|--------|-------------|--|--|--|--|--------------------------|--|
| 1.6 | 4 | D16Y2 | 93/125 | 10/95→12/00 | | | | | BAEA275 ^[292] | |
|-----|---|-------|--------|-------------|--|--|--|--|--------------------------|--|

| | | | | | | | | | | |
|---------|---|-------|--------|-------------|-------|-----|------|-------|--------------------------|--------|
| 1.6 16V | 4 | D16B2 | 85/114 | 01/97→02/01 | OE089 | 1,0 | CET2 | OE180 | BAEA275 ^[292] | CLS012 |
|---------|---|-------|--------|-------------|-------|-----|------|-------|--------------------------|--------|

| | | | | | | | | | | |
|--|--|--|--|--|----------------------------|-----|--|--|--|--------|
| | | | | | OE216 LPG ^[278] | 0,8 | | | | CLS129 |
|--|--|--|--|--|----------------------------|-----|--|--|--|--------|

| | | | | | | | | | | |
|-------|---|-------|--------|-------------|-------|-----|------|-------|--------------------------|--------|
| 1.6 i | 4 | D16Y7 | 77/103 | 03/96→03/00 | OE039 | 1,0 | CET2 | OE180 | BAEA275 ^[292] | CLS129 |
|-------|---|-------|--------|-------------|-------|-----|------|-------|--------------------------|--------|

| | | | | | | | | | | |
|--|--|--|--|--|--------|--|--|--|--|--|
| | | | | | →12/98 | | | | | |
|--|--|--|--|--|--------|--|--|--|--|--|

| | | | | | | | | | | |
|--|--|--|--|--|-------|-----|--|--|--|--|
| | | | | | OE089 | 1,0 | | | | |
|--|--|--|--|--|-------|-----|--|--|--|--|

| | | | | | | | | | | |
|--|--|--|--|--|--------|--|--|--|--|--|
| | | | | | 01/99→ | | | | | |
|--|--|--|--|--|--------|--|--|--|--|--|

| | | | | | | | | | | |
|--|--|--|--|--|----------------------------|-----|--|--|--|--|
| | | | | | OE216 LPG ^[278] | 0,8 | | | | |
|--|--|--|--|--|----------------------------|-----|--|--|--|--|

| | | | | | | | | | | |
|-------|---|-------|--------|-------------|-------|-----|------|-------|--|-------------------------|
| 1.6 i | 4 | D16Y3 | 83/111 | 09/94→01/97 | OE002 | 0,9 | CET2 | OE180 | | CLS128 ^[292] |
|-------|---|-------|--------|-------------|-------|-----|------|-------|--|-------------------------|

| | | | | | | | | | | |
|-------|---|-------|--------|-------------|-------|-----|------|-------|--|--|
| 1.6 i | 4 | D16Y5 | 84/113 | 11/95→02/01 | OE089 | 1,0 | CET2 | OE184 | | |
|-------|---|-------|--------|-------------|-------|-----|------|-------|--|--|

| | | | | | | | | | | |
|--|--|--|--|--|----------------------------|-----|--|--|--|--|
| | | | | | OE216 LPG ^[278] | 0,8 | | | | |
|--|--|--|--|--|----------------------------|-----|--|--|--|--|

| | | | | | | | | | | |
|------------|---|-------|--------|-------------|----------------------------|-----|------|-------|--------------------------|--------|
| 1.6 i Vtec | 4 | D16Y8 | 92/123 | 11/95→02/01 | OE216 LPG ^[278] | 0,8 | CET2 | OE180 | BAEA275 ^[292] | CLS012 |
|------------|---|-------|--------|-------------|----------------------------|-----|------|-------|--------------------------|--------|

| | | | | | | | | | | |
|--|--|--|--|--|--------|--|--|--|--|--|
| | | | | | 01/98→ | | | | | |
|--|--|--|--|--|--------|--|--|--|--|--|

| | | | | | | | | | | |
|--|--|--|--|--|-------|-----|--|--|--|--|
| | | | | | OE089 | 1,0 | | | | |
|--|--|--|--|--|-------|-----|--|--|--|--|

| | | | | | | | | | | |
|--|--|--|--|--|--------|--|--|--|--|--|
| | | | | | 01/99→ | | | | | |
|--|--|--|--|--|--------|--|--|--|--|--|

| | | | | | | | | | | |
|--|--|--|--|--|-------|-----|--|--|--|--|
| | | | | | OE039 | 1,0 | | | | |
|--|--|--|--|--|-------|-----|--|--|--|--|

| | | | | | | | | | | |
|------------|---|-------|--------|-------------|-------|-----|------|-------|--------------------------|--------|
| 1.6 i Vtec | 4 | D16Y6 | 92/123 | 11/95→02/01 | OE039 | 1,0 | CET2 | OE180 | BAEA275 ^[292] | CLS012 |
|------------|---|-------|--------|-------------|-------|-----|------|-------|--------------------------|--------|

| | | | | | | | | | | |
|------------|---|-------|--------|-------------|-------|-----|------|-------|--------------------------|--------|
| 1.6 i Vtec | 4 | D16Y2 | 93/125 | 09/94→01/97 | OE002 | 0,9 | CET2 | OE180 | BAEA275 ^[292] | CLS129 |
|------------|---|-------|--------|-------------|-------|-----|------|-------|--------------------------|--------|

| | | | | | | | | | | |
|------------|---|-------|---------|-------------|-------|-----|------|-------|--------------------------|--|
| 1.6 i Vtec | 4 | B16A2 | 118/158 | 04/99→12/00 | OE034 | 0,9 | CET2 | OE179 | BAEA275 ^[292] | |
|------------|---|-------|---------|-------------|-------|-----|------|-------|--------------------------|--|

| | | | | | | | | | | |
|---------|---|-------|---------|-------------|--|--|------|-------|--------------------------|--|
| 1.6 VTi | 4 | B16A2 | 118/158 | 11/95→02/01 | | | CET2 | OE179 | BAEA275 ^[292] | |
|---------|---|-------|---------|-------------|--|--|------|-------|--------------------------|--|

| | | | | | | | | | | |
|---------|---|-------|---------|-------------|--|--|------|-------|--------------------------|--|
| 1.8 16V | 4 | B18C4 | 124/166 | 01/97→02/01 | | | CET2 | OE179 | BAEA275 ^[292] | |
|---------|---|-------|---------|-------------|--|--|------|-------|--------------------------|--|

| | | | | | | | | | | |
|-------------------|---|-------|-------|-------------|-------|-----|--|--|--|--|
| 2.0 i D, 2.0 TDiC | 4 | 20T2N | 74/99 | 04/98→02/01 | CH169 | 11v | | | | |
|-------------------|---|-------|-------|-------------|-------|-----|--|--|--|--|

| | | | | | | | | | | |
|-------------------|---|-------|--------|-------------|-------|-----|--|--|--|--|
| 2.0 i D, 2.0 TDiC | 4 | 20T2N | 77/103 | 04/98→02/01 | CH169 | 11v | | | | |
|-------------------|---|-------|--------|-------------|-------|-----|--|--|--|--|

| | | | | | | | | | | |
|----------|---|-------|-------|-------------|-------|-----|--|--|--|--|
| 2.0 i TD | 4 | 20T2R | 63/84 | 01/97→02/01 | CH169 | 11v | | | | |
|----------|---|-------|-------|-------------|-------|-----|--|--|--|--|

HONDA





kW/BHP

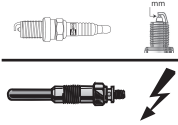

eon TITAN

IRIDIUM



...HONDA



| CIVIC VII | | | | | | | | | | |
|-------------------|---|--------------|---------|-------------|-----------------|-----|--------|-------|--|---|
| 1.2 i-DSI | 4 | L12A1 | 58/78 | 04/01→10/04 | | | | | | BAEA175E [12] [28] BAEA176E [7] [27] |
| 1.3 Hybrid | 4 | LDA1 | 69/93 | 09/02→12/05 | | | CET12P | OE180 | | BAEA175E [12] [28] BAEA176E [7] [27] |
| 1.3 IMA | 4 | LDA1 | 61/82 | 10/03→09/05 | | | CET12P | OE180 | | BAEA175E [12] [28] BAEA176E [7] [27] |
| 1.4, 1.4 iS | 4 | D14Z5; D14Z6 | 66/89 | 12/00→09/05 | OE089 | 1,0 | CET2 | OE184 | | BAEA170E |
| | | | | | OE216 LPG [278] | 0,8 | | | | |
| 1.4 i | 4 | D14Z6 | 55/74 | 02/01→09/05 | OE089 | 1,0 | CET2 | OE184 | | BAEA170E |
| | | | | | OE216 LPG [278] | 0,8 | | | | |
| 1.6 | 4 | R16A1 | 84/113 | 02/01→09/05 | | | | | | BAEA182E |
| 1.6, 1.6 i | 4 | D16V1; D16W7 | 81/109 | 02/01→12/05 | OE089 | 1,0 | CET2 | OE180 | | BAEA170E |
| | | | | | OE216 LPG [278] | 0,8 | | | | |
| 1.7 | 4 | D17A6 | 85/114 | 02/01→09/05 | OE089 | 1,0 | CET2 | OE184 | | BAEA170E |
| 1.7 | 4 | D17A6 | 92/123 | 01/00→08/05 | | | | | | BAEA170E [275] |
| 1.7 i | 4 | D17A8 | 88/118 | 05/01→12/05 | OE089 | 1,0 | CET2 | OE184 | | BAEA170E |
| | | | | | OE216 LPG [278] | 0,8 | | | | |
| 1.7 i VTEC | 4 | D17A9 | 92/123 | 05/01→12/05 | OE089 | 1,0 | CET2 | OE184 | | BAEA170E |
| | | | | | OE216 LPG [278] | 0,8 | | | | |
| 1.7 i VTEC | 4 | D17A5 | 92/123 | 05/01→12/05 | OE089 | 1,0 | CET2 | OE184 | | BAEA170E |
| 2.0 | 4 | K20A3 | 118/158 | 10/03→09/05 | OE146 | 1,0 | CET12P | OE179 | | BAEA169E |
| | | | | | OE216 LPG [278] | 0,8 | | | | |
| 2.0 i Sport | 4 | K20A3 | 118/158 | 09/01→09/05 | OE089 | 1,0 | CET2 | OE184 | | BAEA169E [125] |
| | | | | | OE216 LPG [278] | 0,8 | | | | |
| 2.0 Type-R | 4 | K20A2 | 147/197 | 09/01→09/05 | | | CET12P | OE179 | | BAEA169E [125] |
| CIVIC VIII | | | | | | | | | | |
| 1.3 Hybrid | 4 | LDA2 | 70/94 | 01/06→ | | | CET14P | OE190 | | BAEA176E [7] |
| 1.3 Hybrid | 4 | LDA2 | 85/114 | 01/10→02/12 | | | CET14P | OE190 | | BAEA176E [7] |
| 1.4 | 4 | L13A7 | 61/82 | 09/05→ | | | CET12P | OE179 | | BAEA175E [12] [28] BAEA176E [7] [27] |
| 1.6 | 4 | R16A1 | 84/113 | 09/05→ | OE239 | 1,1 | CET3 | | | BAEA182E |
| 1.6 | 4 | R16A1 | 92/123 | 09/05→ | | | | | | BAEA182E 06/06→03/12 |
| 1.8 | 4 | R18A1; R18A2 | 103/138 | 09/05→ | OE239 | 1,1 | CET3 | | | BAEA182E |
| 2.0 | 4 | K20A3 | 114/153 | 02/06→02/12 | OE146 | 1,0 | CET12P | OE179 | | BAEA169E |
| | | | | | OE216 LPG [278] | 0,8 | | | | |
| 2.0 Type R | 4 | K20Z4 | 148/198 | 09/06→ | | | CET12P | OE179 | | BAEA169E [125] |
| CIVIC IX | | | | | | | | | | |
| 1.4 i-VTEC | 4 | L13Z4 | 73/98 | 02/12→ | OE239 | 1,1 | CET3 | | | |
| CR-V I | | | | | | | | | | |
| 2.0 4WD | 4 | B20Z1 | 98/131 | 04/99→02/02 | OE089 | 1,0 | CET2 | OE188 | | BAEA275 [292] |
| 2.0 16V 4WD | 4 | B20B | 94/126 | 10/95→12/01 | OE089 | 1,0 | CET2 | OE184 | | BAEA275 [292] |
| | | | | | OE216 LPG [278] | 0,8 | | | | |
| 2.0 16V 4WD | 4 | B20Z1 | 108/145 | 01/99→02/02 | OE089 | 1,0 | CET2 | OE184 | | BAEA275 [292] |
| | | | | | OE216 LPG [278] | 0,8 | | | | |
| CR-V II | | | | | | | | | | |
| 2.0 4WD | 4 | K20A | 110/148 | 09/01→03/07 | OE089 | 1,0 | CET2 | OE184 | | |
| 2.0 4WD | 4 | K20A4 | 110/148 | 09/01→03/07 | OE216 LPG [278] | 0,8 | | | | BAEA169E [125] |

HONDA





kW/BHP

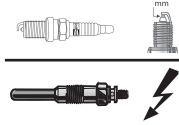

eon TITAN

IRIDIUM



HONDA

...HONDA



...CR-V II

| | | | | | | | | | |
|--------------|---|-------|---------|-------------|-------|-----|------|-------|--|
| 2.0 4WD | 4 | K20A5 | 112/150 | 03/02→09/06 | OE089 | 1,0 | | | |
| 2.4 Vtec 4WD | 4 | K24A | 118/158 | 09/01→09/06 | OE089 | 1,0 | CET2 | OE184 | |

CR-V III

| | | | | | | | | | |
|----------------|---|--------------|---------|--------|-------|-----|------|-------|----------|
| 2.0 i 4WD | 4 | R20A2 | 110/148 | 01/07→ | OE239 | 1,1 | CET3 | | BAEA182E |
| 2.4 | 4 | K24A1 | 125/168 | 04/07→ | OE089 | 1,0 | CET2 | OE184 | BAEA169E |
| 2.4 4WD | 4 | K24A; K24Z1 | 124/166 | 09/06→ | OE089 | 1,0 | CET2 | OE184 | |
| 2.4 i-VTEC 4WD | 4 | K24Z1 | 118/158 | 10/06→ | OE239 | 1,1 | CET3 | | BAEA169E |
| 2.4 i-VTEC 4WD | 4 | K24Z1; K24Z4 | 122/164 | 09/09→ | OE239 | 1,1 | CET3 | | BAEA169E |
| 2.4 i-Vtec 4WD | 4 | K24Z1 | 125/168 | 04/07→ | OE239 | 1,1 | CET3 | | |

CR-V IV

| | | | | | | | | | |
|--------------|---|-------|---------|--------|-------|-----|------|--|--|
| 2.0, 2.0 4WD | 4 | R20A9 | 114/153 | 10/12→ | OE239 | 1,1 | CET3 | | |
| 2.4 4WD | 4 | K24Z9 | 140/188 | 01/12→ | OE239 | 1,1 | CET3 | | |

CR-Z

| | | | | | | | | | |
|------------|---|------|--------|--------|-------|-----|------|--|--|
| 1.5 Hybrid | 4 | LEA1 | 84/113 | 06/10→ | OE239 | 1,1 | CET3 | | |
|------------|---|------|--------|--------|-------|-----|------|--|--|

DOMANI

| | | | | | | | | | |
|-----|---|-------|---------|-------------|-------|-----|------|-------|--|
| 1.4 | 4 | B13B | 67/90 | 11/94→12/97 | OE014 | 0,9 | CET2 | OE179 | |
| 1.8 | 4 | B18B6 | 103/138 | 10/94→09/00 | OE089 | 1,0 | CET2 | OE188 | |

ELEMENT

| | | | | | | | | | |
|------------------------|---|-------|---------|-------------|--|--|--------|-------|--|
| 2.4 Vtec, 2.4 Vtec 4WD | 4 | K24A6 | 118/158 | 07/02→12/11 | | | CET12P | OE194 | |
|------------------------|---|-------|---------|-------------|--|--|--------|-------|--|

ELYSION

| | | | | | | | | | |
|------------|---|-------|---------|--------|-------|-----|------|--|--|
| 3.0 i-VTEC | 6 | J30A4 | 184/247 | 05/04→ | OE239 | 1,1 | CET3 | | |
| 3.5 i-VTEC | 6 | | 221/296 | 05/04→ | OE239 | 1,1 | CET3 | | |

FR-V

| | | | | | | | | | |
|---------|---|-------|---------|-------------|-----------------|-----|------|-------|---------------------------|
| 1.7 | 4 | D17A2 | 92/123 | 08/04→ | OE089 | 1,0 | CET2 | OE184 | BAEA170E |
| | | | | | OE216 LPG [278] | 0,8 | | | |
| 1.8 | 4 | R18A1 | 103/138 | 01/07→ | OE239 | 1,1 | CET3 | | BAEA182E |
| 2.0 | 4 | K20A9 | 110/148 | 02/05→ | OE089 | 1,0 | CET2 | OE184 | BAEA169E ^[125] |
| | | | | | OE216 LPG [278] | 0,8 | | | |
| 2.0 | 4 | K20A9 | 114/153 | 08/04→09/06 | OE089 | 1,0 | CET2 | OE184 | BAEA169E |
| | | | | | OE216 LPG [278] | 0,8 | | | |
| 2.0 4WD | 4 | K20A9 | 114/153 | 08/04→09/06 | OE089 | 1,0 | CET2 | OE184 | |
| | | | | | OE216 LPG [278] | 0,8 | | | |

HR-V

| | | | | | | | | | |
|----------------------|---|-------|--------|--------|-----------------|-----|------|-------|---------------------------------|
| 1.6 16V, 1.6 16V 4WD | 4 | D16W1 | 77/103 | 03/99→ | OE089 | 1,0 | CET2 | OE184 | BAEA275 ^[292] CLS129 |
| | | | | | OE216 LPG [278] | 0,8 | | | |
| 1.6 16V 4WD | 4 | D16W5 | 91/122 | 10/99→ | OE089 | 1,0 | CET2 | OE184 | BAEA275 ^[292] CLS129 |
| | | | | | OE216 LPG [278] | 0,8 | | | →12/05 |

INSIGHT

| | | | | | | | | | |
|------------|---|------|-------|-------------|--|--|--------|-------|--|
| 1.0 Hybrid | 3 | ECA1 | 56/75 | 04/00→12/06 | | | CET14P | OE190 | |
| 1.3 Hybrid | 4 | LDA3 | 65/87 | 04/09→ | | | CET14P | OE190 | |
| 1.3 Hybrid | 4 | LDA3 | 73/98 | 04/09→ | | | CET14P | OE190 | |

INSPIRE

| | | | | | | | | | |
|--------|---|------|---------|-------------|-------|-----|--------|-------|--|
| 3.2 GX | 6 | C32A | 155/208 | 06/95→08/98 | OE136 | 0,8 | CET12P | OE179 | |
|--------|---|------|---------|-------------|-------|-----|--------|-------|--|

INTEGRA

| | | | | | | | | | |
|----------------|---|-------|---------|-------------|-----------------|-----|--------|-------|--------------------------|
| 1.8 SiR | 4 | B18C | 132/177 | 09/93→08/01 | | | | | BAEA275 ^[292] |
| 1.8 Type-R | 4 | B18C6 | 140/188 | 11/97→10/01 | | | CET12P | OE180 | BAEA275 ^[292] |
| 1.8 VtiR | 4 | B18C1 | 127/170 | 07/93→11/99 | | | | | BAEA275 ^[292] |
| 2.0 | 4 | K20A3 | 118/158 | 02/02→ | OE089 | 1,0 | CET12P | OE179 | BAEA169E |
| | | | | | →07/06 | | | | |
| | | | | | OE216 LPG [278] | 0,8 | | | |
| 2.0 16V Type-R | 4 | K20Z1 | 162/217 | 02/02→ | | | CET12P | OE179 | |

CHAMPION



kW/BHP



eon TITAN

IRIDIUM

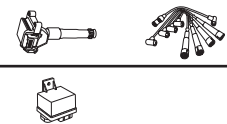

...HONDA



JAZZ

| | | | | | | | | | |
|-----------|---|-------|--------|-------------|-------|-----|------|-------|---|
| 1.3 | 4 | L13A1 | 63/84 | 05/03→07/08 | OE039 | 1,0 | CET2 | OE179 | BAEA175E [12] [28] BAEA176E [7] [27] |
| 1.5 i-DSI | 4 | L15A2 | 66/89 | 12/02→07/08 | OE039 | 1,0 | CET2 | OE179 | |
| 1.5 i-DSI | 4 | L15A2 | 81/109 | 10/04→07/08 | OE039 | 1,0 | CET2 | OE179 | |

JAZZ II

| | | | | | | | | | |
|-----------|---|--------------|--------|-------------|-------|-----|------|-------|---|
| 1.2 i-DSI | 4 | L12A1; L12A4 | 57/76 | 03/02→07/08 | OE039 | 1,0 | CET2 | OE179 | BAEA175E [12] [28] BAEA176E [7] [27] |
| 1.3 | 4 | L13A1 | 61/82 | 03/02→07/08 | OE039 | 1,0 | CET2 | OE179 | BAEA175E [12] [28] BAEA176E [7] [27] |
| 1.3 iDSi | 4 | L13A1 | 63/84 | 03/02→09/07 | OE039 | 1,0 | CET2 | OE179 | BAEA175E [12] [28] BAEA176E [7] [27] |
| 1.4 | 4 | L13A1 | 59/79 | 12/06→10/08 | OE039 | 1,0 | CET2 | OE179 | BAEA175E [12] [28] BAEA176E [7] [27] |
| 1.5 | 4 | L15A | 81/109 | 04/02→07/08 | OE039 | 1,0 | | | |

JAZZ III

| | | | | | | | | | |
|------------|---|--------------|--------|--------|-------|-----|--------|-------|---|
| 1.2 | 4 | L12B1 | 66/89 | 07/08→ | OE239 | 1,1 | CET3 | | BAEA175E [12] [28] BAEA176E [7] [27] |
| 1.3 HYBRID | 4 | LDA3 | 65/87 | 04/11→ | | | CET14P | OE190 | |
| 1.5 i-VTEC | 4 | L15A3; L15A7 | 88/118 | 07/08→ | OE239 | 1,1 | CET3 | | |

LAGREAT

| | | | | | | | | | |
|--------------|---|-------|---------|-------------|-------|-----|--------|-------|--|
| 3.5 EX | 6 | J35A | 151/202 | 11/98→06/02 | OE239 | 1,1 | CET3 | | |
| 3.5 EXi Vtec | 6 | J35A8 | 182/244 | 09/05→ | | | CET12P | OE194 | |

LEGEND III

| | | | | | | | | | |
|-------------|---|-------|---------|-------------|-------|-----|--------|-------|--|
| 3.5 i 24V | 6 | C35A2 | 151/202 | 02/96→10/97 | | | CET12P | OE180 | |
| 3.5 VTEC V6 | 6 | C35A8 | 221/296 | 10/04→06/09 | OE154 | 1,0 | CET2 | OE194 | |

LEGEND IV

| | | | | | | | | | |
|------------|---|--------------|---------|-------------|-------|-----|------|--|--|
| 3.5 V6 4WD | 6 | C35A8; J35A8 | 217/291 | 05/06→12/12 | OE239 | 1,1 | CET3 | | |
|------------|---|--------------|---------|-------------|-------|-----|------|--|--|

LOGO

| | | | | | | | | | |
|-----|---|-------|-------|-------------|--------------------------|------------|------|-------|------------------------------------|
| 1.3 | 4 | D13B7 | 48/64 | 03/99→03/02 | OE089 OE216 LPG [278] | 1,0 0,8 | CET2 | OE184 | BAEA275 ^[292] CLS129 |
|-----|---|-------|-------|-------------|--------------------------|------------|------|-------|------------------------------------|

NSX I

| | | | | | | | | | |
|--------------|---|-------|---------|-------------|-------|-----|--------|-------|--|
| 3.2 24V Vtec | 6 | C32B2 | 206/276 | 01/97→09/05 | OE146 | 1,0 | CET12P | OE179 | |
|--------------|---|-------|---------|-------------|-------|-----|--------|-------|--|

ODYSSEY

| | | | | | | | | | |
|-----|---|-------|---------|-------------|-------|-----|------|--|--|
| 3.5 | 6 | J35A | 171/229 | 07/02→08/04 | OE239 | 1,1 | CET3 | | |
| 3.5 | 6 | J35A8 | 182/244 | 09/04→ | OE239 | 1,1 | CET3 | | |

PRELUDE IV

| | | | | | | | | | |
|----------------|---|-------|---------|-------------|--------------------------|------------|--------|-------|--------------------------|
| 2.2 i 16V Vtec | 4 | H22A2 | 136/182 | 02/93→09/96 | OE089 OE216 LPG [278] | 1,0 0,8 | CET12P | OE179 | BAEA275 ^[292] |
|----------------|---|-------|---------|-------------|--------------------------|------------|--------|-------|--------------------------|

PRELUDE V

| | | | | | | | | | |
|---------|---|--------------|---------|-------------|--------------------------|------------|--------|-------|--------------------------|
| 2.0 16V | 4 | F20A4 | 98/131 | 10/96→10/00 | OE089 OE216 LPG [278] | 1,0 0,8 | CET2 | OE184 | BAEA275 ^[292] |
| 2.2 16V | 4 | H22A2; H22A5 | 136/182 | 10/96→10/00 | | | CET12P | OE179 | BAEA275 ^[292] |
| 2.2 16V | 4 | H22A5 | 147/197 | 10/96→10/00 | | | CET12P | OE179 | BAEA275 ^[292] |

HONDA





kW/BHP

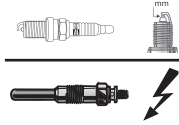



eon TITAN

IRIDIUM



HONDA

| ...HONDA  | | | | | | | | | |
|--|---|----------|---------|-------------|----------------------------|-----|--------|-------|---------------------------------|
| RIDGELINE | | | | | | | | | |
| 3.5 4WD | 6 | J35A9 | 188/252 | 03/05→12/14 | OE239 | 1,1 | CET3 | | |
| S2000 | | | | | | | | | |
| 2.0 | 4 | F20CVTEC | 177/237 | 06/99→ | OE136 | 0,8 | CET12P | OE179 | BAEA169E |
| 2.2 Vtec | 4 | F22C1 | 176/236 | 10/03→ | | | | | BAEA169E |
| SHUTTLE | | | | | | | | | |
| 2.2 16V | 4 | F22B8 | 110/148 | 10/94→02/98 | OE089 | 1,0 | CET2 | OE184 | BAEA275 ^[292] |
| | | | | | OE216 ^{LPG [278]} | 0,8 | | | |
| 2.3 16V | 4 | F23A7 | 110/148 | 10/97→06/04 | OE089 | 1,0 | CET2 | OE184 | BAEA275 ^[292] |
| | | | | | OE216 ^{LPG [278]} | 0,8 | | | |
| SMX | | | | | | | | | |
| 2.0 Lowdown | 4 | B20B1 | 103/138 | 10/99→09/02 | OE089 | 1,0 | CET2 | OE188 | |
| STEPWGN | | | | | | | | | |
| 2.0, 2.0 4WD | 4 | K20A9 | 118/158 | 10/00→09/05 | OE089 | 1,0 | CET2 | OE184 | |
| | | | | | OE216 ^{LPG [278]} | 0,8 | | | |
| STREAM | | | | | | | | | |
| 1.7 16V | 4 | D17A2 | 92/123 | 05/01→ | OE089 | 1,0 | CET2 | OE184 | BAEA170E |
| | | | | | OE216 ^{LPG [278]} | 0,8 | | | |
| 2.0 16V | 4 | K20A1 | 115/154 | 05/01→ | OE089 | 1,0 | CET2 | OE184 | BAEA169E ^[125] |
| | | | | | OE216 ^{LPG [278]} | 0,8 | | | |
| HUMMER  | | | | | | | | | |
| HUMMER H3 | | | | | | | | | |
| 3.5 4WD | 5 | L52 | 162/217 | 04/05→ | | | CET17P | OE189 | |
| HYUNDAI  | | | | | | | | | |
| ACCENT | | | | | | | | | |
| 1.3 | 4 | G4EH | 44/59 | 10/94→01/00 | OE063 | 1,0 | CET2 | OE180 | BAEA264 CLS023 |
| 1.3 | 4 | G4EH | 55/74 | 10/94→01/00 | OE063 | 1,0 | CET2 | OE180 | BAEA264 CLS023 |
| 1.3 i 12V | 4 | G4EH | 62/83 | 10/94→01/00 | OE063 | 1,0 | CET2 | OE180 | BAEA264 CLS023 |
| | | | | | | | | | →07/99 |
| 1.5 | 4 | G4EK | 63/84 | 10/94→07/99 | | | | | BAEA264 |
| 1.5 i 12V | 4 | G4EK | 65/87 | 10/94→01/00 | OE063 | 1,0 | CET2 | OE180 | BAEA264 CLS024 |
| 1.5 i 16V | 4 | G4ER | 73/98 | 10/95→01/00 | OE063 | 1,0 | CET2 | OE180 | BAEA264 CLS023 |
| ACCENT I | | | | | | | | | |
| 1.3 | 4 | G4EH | 44/59 | 10/94→01/00 | OE063 | 1,0 | CET2 | OE180 | BAEA264 CLS023 |
| 1.3 | 4 | G4EH | 55/74 | 10/94→01/00 | OE063 | 1,0 | CET2 | OE180 | BAEA264 CLS023 |
| 1.3 i 12V | 4 | G4EH | 62/83 | 10/94→01/00 | OE063 | 1,0 | CET2 | OE180 | BAEA264 CLS023 |
| 1.5 i 12V | 4 | G4EK | 65/87 | 10/94→01/00 | OE063 | 1,0 | CET2 | OE180 | BAEA264 CLS023 ^[367] |
| | | | | | | | | | CLS024 ^[320] |
| 1.5 i 16V | 4 | G4ER | 73/98 | 12/95→01/00 | OE063 | 1,0 | CET2 | OE180 | BAEA264 CLS023 ^[367] |
| | | | | | | | | | CLS024 ^[320] |
| ACCENT II | | | | | | | | | |
| 1.3 | 4 | G4EA | 55/74 | 01/00→11/05 | OE063 | 1,0 | CET2 | OE180 | BAEA479 CLS023 |
| | | | | | | | | | →07/00 |
| | | | | | | | | | CLS072 |
| | | | | | | | | | 07/00→ |
| 1.3 | 4 | G4EA | 61/82 | 01/00→11/05 | OE063 | 1,0 | CET2 | OE180 | BAEA479 CLS023 |
| | | | | | | | | | →07/00 |
| | | | | | | | | | CLS072 |
| | | | | | | | | | 07/00→ |
| 1.3 | 4 | G4EH | 62/83 | 08/02→11/05 | OE063 | 1,0 | CET2 | OE180 | BAEA479 CLS072 |
| 1.3 | 4 | G4EA | 63/84 | 01/00→11/05 | OE063 | 1,0 | CET2 | OE180 | BAEA479 ^[117] CLS023 |
| | | | | | | | | | →07/00 |
| | | | | | | | | | BAEA479 CLS072 |
| | | | | | | | | | 07/00→ |





kW/BHP

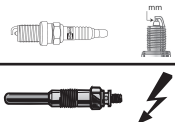

eon TITAN

IRIDIUM

**...HYUNDAI****...ACCENT II**

| | | | | | | | | | | |
|----------|---|--------|--------|-------------|-------|-----|------|-------|---------|--------|
| 1.5 | 4 | G4EB | 66/89 | 01/00→11/05 | OE063 | 1,0 | CET2 | OE180 | BAEA479 | CLS072 |
| 1.5 | 4 | G4FK | 73/98 | 09/99→10/02 | OE063 | 1,0 | | | BAEA479 | |
| 1.5 | 4 | G4EC-G | 75/101 | 09/99→11/05 | OE063 | 1,0 | CET2 | OE180 | BAEA479 | CLS024 |
| 1.5 | 4 | G4FK | 75/101 | 09/99→11/05 | OE063 | 1,0 | CET2 | OE180 | BAEA483 | |
| 1.5 CRDi | 3 | D3EA | 60/80 | 01/02→11/05 | CH226 | 11v | | | | |
| 1.6 | 4 | G4ED-G | 77/103 | 12/02→11/05 | OE063 | 1,0 | CET2 | OE180 | BAEA483 | |

ACCENT III

| | | | | | | | | | | |
|---------|---|------|--------|-------------|-------|-----|------|-------|--|--------|
| 1.4 GL | 4 | G4EE | 71/95 | 11/05→11/10 | | | CET2 | OE179 | | CLS024 |
| 1.6 GLS | 4 | G4ED | 82/110 | 11/05→11/10 | OE063 | 1,0 | CET2 | OE180 | | |

ACCENT IV

| | | | | | | | | | | |
|-----|---|------|--------|-------------|-------|-----|------|-------|---|--|
| 1.4 | 4 | G4LC | 74/99 | 11/10→ | | | | OE248 | | |
| 1.4 | 4 | G4FA | 79/106 | 11/10→ | OE201 | 0,9 | CET6 | | BAEA475 ^[275] | |
| 1.4 | 4 | G4FA | 80/107 | 11/10→12/14 | OE201 | 0,9 | CET6 | | BAEA475 ^[326] Prod.20.01.2011→ Prod.25.10.2013 | |
| 1.6 | 4 | G4FC | 90/121 | 11/10→ | OE201 | 0,9 | CET6 | | BAEA475 ^[275] | |
| 1.6 | 4 | G4FC | 91/122 | 11/10→ | OE201 | 0,9 | CET6 | | BAEA475 ^[275] | |

ASLAN

| | | | | | | | | | | |
|---------|---|------|---------|-------------|--|--|--------|-------|--|--|
| 3.3 GDi | 6 | G6DH | 216/290 | 06/14→08/16 | | | CET14P | OE190 | | |
|---------|---|------|---------|-------------|--|--|--------|-------|--|--|

ATOS

| | | | | | | | | | | |
|-------|---|--------|-------|-------------|-------|-----|------|-------|-----------------------------------|--------------------------------------|
| 1.0 i | 4 | G4HC | 40/54 | 02/98→12/00 | OE063 | 1,0 | CET2 | OE180 | BAEA266 ^[17] 08/00→ | CLS021 |
| 1.0 i | 4 | G4HC | 41/55 | 02/98→03/02 | OE063 | 1,0 | CET2 | | BAEA266 08/00→ | |
| 1.0 i | 4 | G4HC-E | 43/58 | 03/01→07/03 | OE063 | 1,0 | CET2 | OE180 | BAEA266 ^[18] | CLS093 →04/03 CLS023 05/03→ |
| 1.1 | 4 | G4HD | 43/58 | 08/03→12/08 | OE063 | 1,0 | CET2 | OE180 | BAEA266 [112] [275] | |
| 1.1 | 4 | G4HG | 45/60 | 06/03→12/10 | OE063 | 1,0 | CET2 | OE180 | | |
| 1.1 | 4 | G4HG | 46/62 | 08/03→12/08 | OE063 | 1,0 | CET2 | OE180 | | CLS073 |

ATOS PRIME

| | | | | | | | | | | |
|-------|---|------|-------|--------|-------|-----|------|-------|-----------------------------------|------------------|
| 1.0 i | 4 | G4HC | 40/54 | 08/99→ | OE063 | 1,0 | CET2 | OE180 | BAEA266 ^[17] 08/00→ | CLS093 08/00→ |
|-------|---|------|-------|--------|-------|-----|------|-------|-----------------------------------|------------------|

COUPE

| | | | | | | | | | | |
|------------------|---|--------|---------|-------------|-------|-----|--------|-------|--|--------------------------------------|
| 1.6 16V | 4 | G4ED-G | 77/103 | 03/02→08/09 | OE063 | 1,0 | CET2 | OE180 | BAEA483 | CLS024 |
| 1.6 16V | 4 | G4ED-G | 79/106 | 03/02→08/09 | OE063 | 1,0 | CET2 | OE180 | BAEA483 | CLS024 |
| 1.6 16V | 4 | G4GR | 85/114 | 03/98→04/02 | OE063 | 1,0 | CET2 | OE180 | BAEA267 →05/00 BAEA483 09/01→ | CLS130 →05/00 CLS024 05/00→ |
| 1.6 i 16V | 4 | G4GR | 84/113 | 12/96→04/02 | OE063 | 1,0 | CET2 | OE180 | BAEA267 →12/00 | CLS130 |
| 1.8 SX | 4 | G4GM | 94/126 | 07/96→04/02 | OE063 | 1,0 | CET2 | OE180 | | |
| 2.0 | 4 | G4GC-G | 100/134 | 08/01→08/09 | | | CET12P | OE180 | BAEA482 08/02→12/06 | CLS094 |
| 2.0 | 4 | G4DF | 101/135 | 08/99→01/02 | OE063 | 1,0 | CET2 | OE180 | BAEA267 →08/01 | CLS130 |
| 2.0 | 4 | G4GC-G | 102/137 | 03/02→08/09 | | | CET12P | OE180 | BAEA482 08/02→12/06 | |
| 2.0 16V | 4 | G4DF | 99/133 | 03/01→04/02 | OE063 | 1,0 | CET2 | OE180 | BAEA267 →08/01 | CLS094 |
| 2.0 16V | 4 | G4GF | 102/137 | 08/96→04/02 | OE063 | 1,0 | CET2 | OE180 | BAEA267 →12/00 | CLS130 |
| 2.0 F2 Evolution | 4 | G4GF | 115/154 | 01/99→12/01 | OE063 | 1,0 | CET2 | OE180 | BAEA267 | |
| 2.0 GLS | 4 | G4GC-G | 105/141 | 02/03→08/09 | | | CET12P | OE180 | BAEA482 | CLS094 |
| 2.7 V6 | 6 | G6BA-G | 121/162 | 01/01→08/09 | OE191 | 1,0 | CET12P | OE180 | | |

HYUNDAI





kW/BHP



eon TITAN

IRIDIUM



...HYUNDAI



...COUPE

| | | | | | | | | | | |
|--------|---|--------|---------|-------------|--|--|--------|-------|--|--------|
| 2.7 V6 | 6 | G6BA-G | 123/165 | 03/02→08/09 | | | CET12P | OE180 | | CLS189 |
|--------|---|--------|---------|-------------|--|--|--------|-------|--|--------|

ELANTRA

| | | | | | | | | | | |
|----------|---|------------|---------|-------------|-----------------|-----|----------------|-----------------|-------------------|--------|
| 1.5 D | 4 | D4FA | 82/110 | 06/00→07/06 | CH226 | 11v | | | | |
| 1.6 | 4 | G4GR | 66/89 | 06/00→07/06 | OE063 | 1,0 | CET2 | OE180 | BAEA483 | CLS024 |
| 1.6 | 4 | G4ED-G | 77/103 | 05/03→07/06 | OE063 | 1,0 | CET2 | OE180 | BAEA483 | CLS024 |
| 1.6 | 4 | G4ED-G | 79/106 | 06/00→07/06 | OE063 | 1,0 | CET2 | OE180 | BAEA483 | CLS024 |
| 1.6 | 4 | G4GA | 82/110 | 09/03→07/06 | OE063 | 1,0 | CET2 | OE180 | | |
| 1.6 | 4 | G4FG | 94/126 | 06/11→ | OE201 | 0,9 | CET6 | | | |
| 1.6 | 4 | G4FG | 97/130 | 06/11→ | OE201 | 0,9 | | | BAEA475 | |
| 1.6 CVT | 4 | G4FC | 90/121 | 06/06→06/11 | OE063 →12/08 | 1,0 | CET2 | OE180 →12/08 | BAEA474 | |
| | | | | | OE201 01/09→ | 0,9 | CET6 | | | |
| 1.8 | 4 | G4BB | 79/106 | 06/00→07/03 | OE063 | 1,0 | CET2 | OE180 | BAEA482 09/02→ | |
| 1.8 | 4 | G4BB; G4GB | 97/130 | 03/98→07/06 | OE063 | 1,0 | CET2 | OE180 | BAEA482 09/02→ | CLS094 |
| 1.8 | 4 | G4GB | 98/131 | 11/02→07/06 | OE063 | 1,0 | CET2 | OE180 | BAEA482 | |
| 1.8 | 4 | G4NB | 110/148 | 09/10→ | OE201 | 0,9 | | OE249 | | |
| 2.0 | 4 | G4GC-G | 102/137 | 06/00→07/06 | OE063 | 1,0 | CET2 | OE180 | BAEA482 09/02→ | CLS094 |
| 2.0 | 4 | G4GC | 104/139 | 06/00→07/06 | OE063 | 1,0 | CET2 | OE180 | BAEA482 09/02→ | CLS094 |
| 2.0 | 4 | G4GC | 105/141 | 10/03→07/06 | OE063 | 1,0 | CET12P CET2 | OE180 | BAEA482 | CLS094 |
| 2.0 CRDi | 4 | D4EA | 83/111 | 04/01→07/06 | CH226 | 11v | | | | |
| 2.0 CVT | 4 | G4GC | 103/138 | 06/06→05/10 | OE063 | 1,0 | CET2 | | BAEA482 | |
| 2.0 CVT | 4 | G4GC | 105/141 | 06/06→06/11 | OE063 | 1,0 | CET2 | OE180 | | CLS130 |

EQUUS / CENTENNIAL

| | | | | | | | | | | |
|---------|---|------|---------|-------------|-------|-----|--------|-------|---------|--|
| 3.5 | 6 | G6CU | 155/208 | 10/99→03/09 | | | CET12P | OE188 | | |
| 4.5 | 8 | 8A80 | 195/261 | 10/99→09/03 | OE146 | 1,0 | CET12P | OE179 | BAEA548 | |
| 4.6 V8 | 8 | G8BA | 269/361 | 03/09→ | | | | | BAEA548 | |
| 5.0 GDi | 8 | G8BE | 316/424 | 03/09→ | | | | | BAEA548 | |

GALLOPER II

| | | | | | | | | | | |
|------------------------|---|------------|---------|-------------|-------|-----|--------|-------|--|--|
| 2.5 TGi D 4WD | 4 | D4BH | 77/103 | 08/98→12/03 | CH256 | 11v | | | | |
| 2.5 TD 4WD | 4 | D4BA; D4BF | 65/87 | 08/98→12/03 | CH256 | 11v | | | | |
| 2.5 TD intercooler 4WD | 4 | D4BH | 73/98 | 08/98→12/03 | CH256 | 11v | | | | |
| 2.6 TD 4WD | 4 | D4BB | 63/84 | 08/98→06/03 | CH256 | 11v | | | | |
| 3.0 V6 4WD | 6 | G6AT | 104/139 | 08/98→12/03 | | | CET12P | OE180 | | |

GENESIS

| | | | | | | | | | | |
|----------------------|---|------|---------|-------------|--|--|--------|-------|---------|--|
| 2.0 T | 4 | G4KF | 157/211 | 01/08→12/12 | | | | | BAEA548 | |
| 2.0 T | 4 | G4KF | 204/274 | 04/12→02/14 | | | | | BAEA548 | |
| 3.3 24V | 6 | G6DB | 171/229 | 06/08→12/14 | | | CET12P | OE180 | | |
| 3.3 24V | 6 | G6DH | 221/296 | 01/08→12/14 | | | CET14P | OE190 | | |
| 3.3 GDI, 3.3 GDI 4WD | 6 | G6DH | 207/278 | 08/14→ | | | CET14P | OE190 | | |
| 3.8 V6 | 6 | G6DA | 223/299 | 01/08→02/14 | | | | | BAEA531 | |

GETZ

| | | | | | | | | | | |
|-------|---|------|-------|-------------|-------|-----|------|-------|--------------------------|--------------------------------------|
| 1.1 | 4 | G4HD | 46/62 | 09/02→09/05 | OE063 | 1,0 | CET2 | OE180 | BAEA480 ^[111] | CLS023 →04/03 CLS073 04/03→ |
| 1.1 | 4 | G4HD | 49/66 | 09/05→06/09 | OE063 | 1,0 | CET2 | OE180 | BAEA480 | CLS093 |
| 1.3 | 4 | G4EA | 61/82 | 09/04→06/09 | OE063 | 1,0 | CET2 | OE180 | BAEA479 | CLS072 |
| 1.3 | 4 | G4EA | 63/84 | 09/03→09/05 | OE063 | 1,0 | CET2 | OE180 | BAEA479 | CLS072 |
| 1.3 i | 4 | G4EA | 60/80 | 09/02→03/04 | OE063 | 1,0 | CET2 | OE180 | BAEA479 ^[117] | CLS072 |

HYUNDAI





kW/BHP



eon TITAN

IRIDIUM



...HYUNDAI



...GETZ

| | | | | | | | | | | |
|----------|---|--------|--------|-------------|-------|-----|------|-------|-------------------|--------|
| 1.4 i | 4 | G4EE | 71/95 | 08/05→12/10 | OE063 | 1,0 | CET2 | OE180 | BAEA483 11/06→ | CLS024 |
| 1.5 CRDi | 3 | D3EA | 60/80 | 03/03→09/05 | CH226 | 11v | | | | |
| 1.5 i | 4 | G4ER | 73/98 | 03/03→09/05 | OE063 | 1,0 | CET2 | OE180 | | |
| 1.6 | 4 | G4ED-G | 77/103 | 09/02→09/05 | OE063 | 1,0 | CET2 | OE180 | BAEA483 | CLS024 |
| 1.6 | 4 | G4ED-G | 78/105 | 06/05→12/06 | OE063 | 1,0 | CET2 | OE180 | BAEA483 | |

GRANDEUR

| | | | | | | | | | | |
|----------|---|------|---------|-------------|-------|-----|--------|-------|---------|--|
| 2.2 CRDi | 4 | D4EB | 110/148 | 06/06→12/11 | CH226 | 11v | | | | |
| 2.2 CRDi | 4 | D4EB | 114/153 | 06/06→10/10 | CH226 | 11v | | | | |
| 2.7 | 6 | G6BA | 141/189 | 05/06→ | | | CET14P | OE190 | | |
| 3.3 | 6 | G6DB | 173/232 | 04/05→12/10 | | | CET12P | OE180 | BAEA531 | |
| 3.3 | 6 | G6DB | 191/256 | 11/10→12/11 | | | CET12P | OE180 | | |
| 3.3 | 6 | G6DB | 194/260 | 09/10→12/11 | | | CET12P | OE180 | | |
| 3.3 | 6 | G6DB | 196/263 | 09/09→12/10 | | | CET12P | OE180 | | |
| 3.3 | 6 | G6DB | 198/266 | 02/07→ | | | CET12P | OE180 | | |
| 3.3 | 6 | G6DH | 218/292 | 09/11→ | | | CET14P | OE190 | | |
| 3.3 Flex | 6 | G6DB | 177/237 | 01/07→11/11 | | | CET12P | OE180 | | |
| 3.8 | 6 | G6DA | 195/261 | 06/05→12/11 | | | CET14P | OE190 | | |

GRAND SANTA FÉ

| | | | | | | | | | | |
|----------------------|---|------|---------|--------|--|--|--------|-------|--|--|
| 3.3 GDi, 3.3 GDi 4WD | 6 | G6DH | 216/290 | 07/13→ | | | CET14P | OE190 | | |
| 3.3 GDi 4WD | 6 | G6DH | 210/282 | 07/13→ | | | CET14P | OE190 | | |

H-1 / STAREX

| | | | | | | | | | | |
|------------------------|---|------|---------|-------------|------------------------|-----|------|-------|--------------------------|--|
| 2.4 | 4 | G4JS | 101/135 | 02/03→04/04 | OE048 | 1,0 | CET8 | OE195 | BAEA502E ^[13] | |
| 2.4 | 4 | G4JS | 107/143 | 11/01→04/04 | OE048 | 1,0 | CET8 | OE195 | BAEA502E ^[13] | |
| 2.4, 2.4 4WD | 4 | G4CS | 82/110 | 06/97→04/04 | OE048 | 1,0 | CET8 | OE195 | | |
| 2.4 4WD | 4 | G4JS | 99/133 | 06/01→04/04 | OE048 | 1,0 | CET8 | OE195 | BAEA502E ^[13] | |
| 2.5 CRDi | 4 | D4CB | 81/109 | 06/06→12/07 | CH234 | 11v | | | | |
| 2.5 CRDi | 4 | D4CB | 85/114 | 06/97→04/04 | CH234 | 11v | | | | |
| 2.5 CRDi | 4 | D4CB | 120/161 | 12/02→04/04 | CH234 | 11v | | | | |
| 2.5 CRDi, 2.5 CRDi 4WD | 4 | D4CB | 103/138 | 12/02→ | CH234 | 11v | | | | |
| 2.5 D | 4 | D4BF | 57/76 | 10/97→04/04 | CH225 ^[275] | 11v | | | | |
| | | | | | CH256 ^[275] | 11v | | | | |
| 2.5 D | 4 | D4BF | 62/83 | 10/97→04/04 | CH225 ^[275] | 11v | | | | |
| | | | | | CH256 ^[275] | 11v | | | | |
| 2.5 TGi, 2.5 TD 4WD | 4 | D4BH | 73/98 | 10/97→12/07 | CH225 ^[275] | 11v | | | | |
| | | | | | CH256 ^[275] | 11v | | | | |
| 2.5 TGi, 2.5 TD 4WD | 4 | D4BH | 74/99 | 11/01→12/07 | CH225 ^[275] | 11v | | | | |
| | | | | | CH256 ^[275] | 11v | | | | |
| 2.5 TD, 2.5 TD 4WD | 4 | D4BF | 59/79 | 06/97→04/04 | CH225 ^[275] | 11v | | | | |
| | | | | | CH256 ^[275] | 11v | | | | |
| 2.6 TDiC | 4 | D4BB | 63/84 | 10/97→04/04 | CH234 | 11v | | | | |

H100

| | | | | | | | | | | |
|-------|---|------|-------|-------------|-------|-----|--|--|--|--|
| 2.5 D | 4 | D4BA | 57/76 | 05/96→10/01 | CH225 | 11v | | | | |
|-------|---|------|-------|-------------|-------|-----|--|--|--|--|

i10

| | | | | | | | | | | |
|-----|---|------|-------|-------------|-------|-----|------|-------|-----------------------------|--------|
| 1.0 | 3 | G3LA | 49/66 | 08/13→ | | | | | BAEA476 →Prod.17.09.2016 | |
| 1.0 | 3 | G3LA | 51/68 | 01/11→12/17 | OE197 | 0,9 | CET6 | | | |
| 1.1 | 4 | G4HG | 48/64 | 12/07→12/13 | OE063 | 1,0 | CET2 | OE180 | | CLS093 |
| 1.1 | 4 | G4HG | 49/66 | 01/08→12/13 | OE063 | 1,0 | CET2 | OE180 | BAEA477 | CLS093 |
| 1.1 | 4 | G4HG | 51/68 | 04/11→12/13 | OE063 | 1,0 | CET2 | OE180 | BAEA477 | CLS093 |
| 1.2 | 4 | G4LA | 57/76 | 11/08→12/11 | OE197 | 0,9 | CET6 | | BAEA536 ^[114] | |
| 1.2 | 4 | G4LA | 63/84 | 04/11→12/13 | OE197 | 0,9 | CET6 | | BAEA536 | |
| 1.2 | 4 | G4LA | 64/86 | 12/13→ | | | | | BAEA536 | |

HYUNDAI





kW/BHP

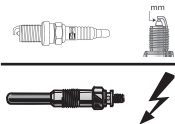

eon TITAN

IRIDIUM



...HYUNDAI



i20

| | | | | | | | | | |
|-----------|---|------|--------|---------------|------------------------|-----|------|------------------|--------------------------|
| 1.0 T-GDI | 3 | G3LC | 74/99 | 01/16 → | | | | OE248 | |
| 1.0 T-GDI | 3 | G3LC | 88/118 | 01/16 → | | | | OE248 | |
| 1.2 | 4 | G4LA | 57/76 | 09/08 → 12/12 | OE197 | 0,9 | CET6 | | BAEA536 |
| 1.2 | 4 | G4LA | 62/83 | 01/13 → | OE197 | 0,9 | CET6 | | |
| 1.2 | 4 | G4LA | 63/84 | 03/12 → 12/15 | OE197 | 0,9 | CET6 | | BAEA536 |
| 1.4 | 4 | G4FA | 74/99 | 09/08 → | OE201 | 0,9 | CET6 | | BAEA475 ^[275] |
| 1.4 | 4 | G4LC | 74/99 | 09/08 → | | | | OE248 | |
| 1.6 | 4 | G4FC | 91/122 | 12/08 → | OE201 07/09 → 03/12 | 0,9 | | | BAEA475 |
| 1.6 | 4 | G4FC | 93/125 | 09/08 → 12/12 | OE063 → 12/08 | 1,0 | CET2 | OE180 → 12/08 | BAEA475 ^[275] |
| | | | | | OE201 01/09 → | 0,9 | CET6 | | |

i30

| | | | | | | | | | |
|----------|---|--------------|---------|---------------|------------------|-----|--------|------------------|--|
| 1.4 | 4 | G4FA | 73/98 | 12/11 → | OE201 | 0,9 | CET6 | | BAEA475 ^[275] BAEA475 |
| 1.4 | 4 | G4LC | 74/99 | 12/14 → | | | | OE248 | BAEA475 |
| 1.4 | 4 | G4FA | 77/103 | 10/07 → 06/12 | OE063 → 12/08 | 1,0 | CET2 | OE180 → 12/08 | BAEA474 |
| | | | | | OE201 | 0,9 | CET6 | | |
| 1.4 | 4 | G4FA | 80/107 | 10/07 → 06/12 | OE063 → 12/08 | 1,0 | CET2 | OE180 → 12/08 | BAEA474 ^[120] BAEA475 ^[275] |
| | | | | | OE201 | 0,9 | CET6 | | |
| 1.6 | 4 | G4FC | 85/114 | 10/07 → 06/12 | OE063 → 12/08 | 1,0 | CET2 | OE180 → 12/08 | BAEA475 ^[121] |
| | | | | | OE201 01/09 → | 0,9 | CET6 | | |
| 1.6 | 4 | G4FC | 88/118 | 01/12 → | OE201 | 0,9 | CET6 | | BAEA475 |
| 1.6 | 4 | G4FG | 88/118 | 01/12 → | OE201 | 0,9 | | | BAEA475 |
| 1.6 | 4 | G4FC | 90/121 | 10/07 → 06/12 | OE063 → 12/08 | 1,0 | CET2 | OE180 → 12/08 | BAEA475 ^[121] |
| | | | | | OE201 01/09 → | 0,9 | CET6 | | |
| 1.6 | 4 | G4FC | 93/125 | 02/08 → 06/12 | OE063 → 12/08 | 1,0 | CET2 | OE180 → 12/08 | BAEA475 ^[121] |
| | | | | | OE201 01/09 → | 0,9 | CET6 | | |
| 1.6 | 4 | G4FG | 95/127 | 12/11 → 12/15 | OE201 | 0,9 | | | BAEA475 |
| 2.0 | 4 | G4GC; G4GC-G | 105/141 | 10/07 → 06/12 | | | CET12P | OE180 | CLS094 |
| 2.0 CRDi | 4 | D4EA-F | 100/134 | 10/07 → 06/12 | CH226 | 11v | | | |
| 2.0 CRDi | 4 | D4EA-F | 103/138 | 10/07 → 06/12 | CH226 | 11v | | | |

i40

| | | | | | | | | | |
|---------|---|------|---------|---------|--|--|--|-------|--|
| 2.0 GDi | 4 | G4NC | 121/162 | 12/14 → | | | | OE249 | |
| 2.0 GDI | 4 | G4NC | 130/174 | 07/11 → | | | | OE249 | |
| 2.0 GDI | 4 | G4NC | 131/176 | 03/12 → | | | | OE249 | |

ix20

| | | | | | | | | | |
|-----|---|------|--------|---------|-------|-----|------|--|--------------------------|
| 1.4 | 4 | G4FA | 66/89 | 11/10 → | OE201 | 0,9 | CET6 | | BAEA475 ^[275] |
| 1.4 | 4 | G4FA | 74/99 | 11/10 → | OE201 | 0,9 | | | |
| 1.6 | 4 | G4FC | 92/123 | 11/10 → | OE201 | 0,9 | CET6 | | BAEA475 ^[275] |

ix35

| | | | | | | | | | |
|-----------------------------------|---|------------|---------|---------------|-------|-----|------|-------|---------|
| 2.0 | 4 | G4KD | 122/164 | 01/10 → | OE148 | 1,0 | CET5 | OE190 | BAEA548 |
| 2.0, 2.0 4WD | 4 | G4KD | 120/161 | 01/10 → | OE148 | 1,0 | CET5 | OE190 | BAEA548 |
| 2.0 CVT 4WD, 2.0 GDi, 2.0 GDi 4WD | 4 | G4KD; G4NC | 122/164 | 08/09 → | | | | OE249 | |
| 2.4 4WD | 4 | G4KE | 130/174 | 01/10 → | OE148 | 1,0 | CET5 | OE190 | |
| 2.4 DCVVT-I 4WD | 4 | G4KE | 128/172 | 07/10 → 12/13 | OE148 | 1,0 | CET5 | OE190 | |

HYUNDAI





kW/BHP



eon TITAN

IRIDIUM

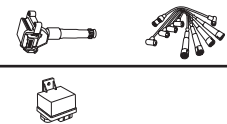

...HYUNDAI



LANTRA II

| | | | | | | | | | | |
|---------|---|------|---------|-------------|-------|------|------|-------|---------|--------|
| 1.5 12V | 4 | G4EK | 65/87 | 12/96→10/00 | OE063 | 1,0 | CET2 | OE180 | BAEA264 | |
| 1.6 16V | 4 | G4GR | 84/113 | 11/95→10/00 | OE063 | 1,0 | CET2 | OE180 | BAEA267 | CLS130 |
| 1.6 i | 4 | G4GR | 66/89 | 11/95→10/00 | OE063 | 1,0 | CET2 | OE180 | BAEA267 | CLS130 |
| 1.8 16V | 4 | G4GM | 94/126 | 11/95→10/00 | OE063 | 1,0 | CET2 | OE180 | BAEA267 | CLS130 |
| 1.9 D | 4 | DJY | 50/67 | 03/98→10/00 | CH189 | 11v | | | | |
| 2.0 | 4 | G4JP | 100/134 | 04/97→05/00 | | | | | BAEA483 | |
| 2.0 16V | 4 | G4GF | 102/137 | 11/95→10/00 | OE063 | 0,7* | CET2 | OE180 | BAEA267 | CLS130 |

*to be adjusted

MATRIX

| | | | | | | | | | | |
|----------|---|--------|--------|-------------|-------|-----|------|-------|--------------------------|--------|
| 1.5 CRDi | 3 | D3EA | 60/80 | 10/01→08/10 | CH226 | 11v | | | | |
| 1.6 | 4 | G4ED-L | 66/89 | 01/02→12/05 | OE063 | 1,0 | CET2 | OE180 | BAEA483 | |
| 1.6 | 4 | G4ED-G | 76/102 | 06/01→08/10 | OE063 | 1,0 | CET2 | OE180 | BAEA483 | CLS024 |
| 1.8 | 4 | G4GB-G | 90/121 | 06/01→08/10 | OE063 | 1,0 | CET2 | OE180 | BAEA482 ^[118] | |

PORTER

| | | | | | | | | | | |
|----------|---|------|---------|-------------|-------|-----|------|--|--|--|
| 2.4 | 4 | G4CS | 82/110 | 03/96→04/04 | OE049 | 1,0 | CET8 | | | |
| 2.5 CRDi | 4 | D4CB | 103/138 | 02/03→04/04 | CH234 | 11v | | | | |
| 2.5 TD | 4 | D4BA | 57/76 | 07/94→04/04 | CH225 | 11v | | | | |
| 2.5 TD | 4 | D4BH | 73/98 | 07/94→04/04 | CH221 | 11v | | | | |
| 2.6 TD | 4 | D4BB | 63/84 | 07/94→04/04 | CH256 | 11v | | | | |

SANTA FÉ I

| | | | | | | | | | | |
|------------------------|---|--------|---------|-------------|--------|-----|--------|-------|--------------------------|--------|
| 2.0 | 4 | G4JP | 99/133 | 08/01→03/06 | | | CET12P | OE180 | BAEA502E ^[13] | |
| 2.0 CRDi, 2.0 CRDi 4WD | 4 | D4EA | 83/111 | 04/01→03/06 | CH226 | 11v | | | | |
| 2.0 CRDi 4WD | 4 | D4EA-V | 92/123 | 08/03→03/06 | CH226 | 11v | | | | |
| 2.0 CRDi 4WD | 4 | D4EA-F | 107/143 | 11/03→02/06 | CH226 | 11v | | | | |
| | | | | | →12/05 | | | | | |
| 2.4 16V, 2.4 16V 4WD | 4 | G4JS-G | 100/134 | 02/01→03/06 | OE192 | 1,0 | CET8 | OE195 | BAEA502E ^[13] | |
| 2.4 16V, 2.4 16V 4WD | 4 | G4JS-G | 107/143 | 02/01→03/06 | OE192 | 1,0 | CET8 | OE195 | BAEA502E ^[13] | |
| 2.7 | 6 | G6EA | 129/173 | 08/04→03/06 | | | CET14P | OE190 | | |
| 2.7 4WD | 6 | G6EA | 132/177 | 11/00→03/06 | | | CET14P | OE190 | | |
| 2.7 V6 4WD | 6 | G6BA-G | 127/170 | 02/01→03/06 | | | CET12P | OE180 | | CLS189 |

SANTA FÉ II

| | | | | | | | | | | |
|--------------------------------|---|------|---------|-------------|------------------|-----|--------|-------|--------------------------|--------------------------|
| 2.2 CRDi, 2.2 CRDi 4WD | 4 | D4EB | 102/137 | 03/06→12/12 | CH226 | 11v | | | | |
| | | | | | →Prod.23.09.2009 | | | | | |
| 2.2 CRDi, 2.2 CRDi 4WD | 4 | D4EB | 114/153 | 03/06→12/09 | CH226 | 11v | | | | |
| | | | | | →Prod.23.09.2009 | | | | | |
| 2.2 CRDi, 2.2 CRDi 4WD | 4 | D4HB | 145/194 | 01/09→12/12 | CH226 | 11v | | | | |
| | | | | | →Prod.23.09.2009 | | | | | |
| 2.2 CRDi GLS, 2.2 CRDi GLS 4WD | 4 | D4EB | 110/148 | 03/06→12/09 | CH226 | 11v | | | | |
| | | | | | →Prod.23.09.2009 | | | | | |
| 2.4, 2.4 4WD | 4 | G4KE | 128/172 | 07/10→12/12 | OE148 | 1,0 | CET5 | OE190 | BAEA531 ^[275] | BAEA548 ^[275] |
| 2.7, 2.7 4WD | 6 | G6BA | 125/168 | 03/06→12/12 | | | CET12P | OE180 | | |
| 2.7 V6 GLS, 2.7 V6 GLS 4WD | 6 | G6EA | 139/186 | 03/06→12/09 | | | CET14P | OE190 | | |
| 3.3, 3.3 4WD | 6 | G6DB | 180/241 | 03/06→12/09 | | | CET12P | OE180 | | |
| 3.3 Dynamic 4WD | 6 | G6DB | 173/232 | 03/06→12/12 | | | CET12P | OE180 | | |

SANTA FÉ III

| | | | | | | | | | | |
|--------------|---|------|---------|-------------|--|--|--------|-------|---------|--|
| 2.4, 2.4 4WD | 4 | G4KJ | 141/189 | 09/12→12/15 | | | | | BAEA548 | |
| 3.3, 3.3 4WD | 6 | G6DH | 216/290 | 09/12→ | | | CET14P | OE190 | | |

SANTAMO

| | | | | | | | | | | |
|----------------------|---|--------------|---------|-------------|--|--|------|-------|--------------------------|--|
| 2.0 16V, 2.0 16V 4WD | 4 | G4CP-D, G4JP | 102/137 | 05/99→12/02 | | | CET8 | OE195 | BAEA521 ^[275] | |
|----------------------|---|--------------|---------|-------------|--|--|------|-------|--------------------------|--|

SONATA III

| | | | | | | | | | | |
|---------|---|------|-------|-------------|-------|-----|------|-------|--|--|
| 1.8 GLS | 4 | G4DM | 63/84 | 07/96→05/98 | OE048 | 1,0 | CET8 | | | |
| 1.8 i | 4 | G4CM | 72/97 | 05/93→06/98 | OE048 | 1,0 | CET8 | OE195 | | |
| 2.0 i | 4 | G4EP | 70/94 | 08/96→06/98 | OE006 | 0,9 | CET8 | OE195 | | |

HYUNDAI





kW/BHP



eon TITAN

IRIDIUM

**...HYUNDAI****...SONATA III**

| | | | | | | | | | |
|-----------|---|---------|---------|-------------|-------|-----|------|-------|--|
| 2.0 i | 4 | G4CP | 77/103 | 06/94→08/96 | | | CET8 | OE195 | |
| 2.0 i 16V | 4 | G4CP-DM | 92/123 | 06/96→06/98 | OE048 | 1,0 | CET8 | OE195 | |
| 2.0 i 16V | 4 | G4CP-D | 102/137 | 05/93→06/98 | OE048 | 1,0 | CET8 | OE195 | |
| 3.0 i V6 | 6 | G6AT | 107/143 | 05/93→06/98 | OE192 | 1,0 | CET8 | OE195 | |

SONATA IV

| | | | | | | | | | |
|------------------|---|---------|---------|-------------|-------|-----|--------|-------|------------------------------------|
| 2.0 16V | 4 | G4JP-EG | 96/129 | 10/01→11/04 | OE191 | 1,0 | CET12P | OE180 | BAEA502E ^[13] |
| 2.0 16V | 4 | G4JP-G | 100/134 | 06/98→10/01 | OE048 | 1,0 | CET8 | OE195 | BAEA502E ^[13] |
| 2.0 16V | 4 | | 106/142 | 10/01→11/04 | OE048 | 1,0 | CET8 | | BAEA502E ^[13] |
| 2.0 CRDi Dynamic | 4 | D4EA | 103/138 | 10/01→11/04 | CH226 | 11v | | | |
| 2.0 Flex | 4 | G4JP | 98/131 | 04/01→11/04 | | | | | BAEA502E ^[13] |
| 2.2 CRDi | 4 | D4EB | 110/148 | 06/02→11/04 | CH226 | 11v | | | |
| 2.4 16V | 4 | G4BS | 105/141 | 03/98→10/01 | OE192 | 1,0 | CET8 | OE195 | BAEA502E ^[13] →03/01 |
| 2.5 V6 24V | 6 | G6BV-G | 118/158 | 06/98→10/01 | | | CET12P | OE180 | BAEA269 |
| 2.7 i V6 | 6 | G6BA-Y | 132/177 | 10/01→05/05 | | | CET14P | OE190 | |
| 2.7 V6 | 6 | G6BA-G | 127/170 | 10/01→11/04 | | | CET12P | OE180 | BAEA269 ^[361] CLS189 |
| 2.7 V6 | 6 | G6BA | 129/173 | 11/02→11/04 | | | CET12P | OE188 | |

SONATA V

| | | | | | | | | | |
|--------------|---|--------|---------|-------------|-------|-----|--------|-------|--|
| 2.0 CRDi | 4 | D4EA-F | 100/134 | 02/06→12/10 | CH226 | 11v | | | |
| 2.0 CRDi | 4 | D4EA-F | 103/138 | 02/06→12/10 | CH226 | 11v | | | |
| 2.0 CRDi | 4 | D4EA-F | 110/148 | 03/09→12/10 | CH226 | 11v | | | |
| 2.0 VVTi GLS | 4 | G4KA | 106/142 | 05/05→12/10 | OE063 | 1,0 | CET2 | OE180 | BAEA531 |
| 2.0 VVTi GLS | 4 | G4KD | 121/162 | 01/08→12/10 | OE148 | 1,0 | CET5 | OE190 | BAEA548 |
| 2.4 | 4 | G4KC | 119/160 | 01/05→12/10 | OE063 | 1,0 | CET2 | OE180 | BAEA531 ^[275] →11/07 BAEA548 ^[275] 12/07→ |
| 2.4 | 4 | G4KC | 125/168 | 06/08→12/09 | | | | | BAEA502E ^[13] |
| 2.4 | 4 | G4KE | 128/172 | 06/08→12/10 | OE148 | 1,0 | CET5 | OE190 | BAEA531 BAEA548 |
| 3.3 | 6 | G6DB | 171/229 | 01/05→12/10 | | | CET12P | OE180 | BAEA531 |
| 3.3 | 6 | G6DB | 173/232 | 06/05→12/10 | | | CET12P | OE180 | BAEA531 |
| 3.3 | 6 | G6DB | 175/235 | 09/05→12/06 | | | CET12P | OE180 | |
| 3.3 | 6 | G6DB | 184/247 | 01/08→12/10 | | | CET12P | OE180 | BAEA531 |
| 3.3 | 6 | G6DB | 186/249 | 09/07→12/08 | | | CET12P | OE180 | |

SONATA VI

| | | | | | | | | | |
|-------|---|------|---------|-------------|-------|-----|------|-------|---------|
| 2.0 | 4 | G4KD | 110/148 | 01/09→06/14 | OE148 | 1,0 | CET5 | OE190 | BAEA548 |
| 2.0 i | 4 | G4KD | 121/162 | 01/11→06/14 | OE148 | 1,0 | CET5 | OE190 | |
| 2.4 | 4 | G4KC | 128/172 | 01/09→11/10 | OE148 | 1,0 | CET5 | OE190 | BAEA548 |
| 2.4 | 4 | G4KC | 131/176 | 01/09→12/15 | OE148 | 1,0 | CET5 | OE190 | BAEA548 |

TERRACAN

| | | | | | | | | | |
|------------------------|---|------|---------|-------------|-------|-----|--------|-------|--|
| 2.5 D | 4 | D4BH | 59/79 | 06/01→10/03 | CH225 | 11v | | | |
| 2.5 D, 2.5 TD 4WD | 4 | D4BH | 74/99 | 06/01→12/06 | CH225 | 11v | | | |
| 2.9 CRDi, 2.9 CRDi 4WD | 4 | J3 | 110/148 | 11/01→12/06 | CH256 | 11v | | | |
| 2.9 CRDi 4WD | 4 | J3 | 120/161 | 11/03→12/06 | CH256 | 11v | | | |
| 3.5 i V6 4WD | 6 | G6CU | 143/192 | 12/01→12/06 | | | CET12P | OE180 | |
| 3.5 i V6 4WD | 6 | G6CU | 147/197 | 12/01→12/06 | | | CET12P | OE180 | |

TIBURON

| | | | | | | | | | |
|---------|---|--------|---------|-------------|-------|-----|------|-------|--------------------------|
| 1.6 CVT | 4 | G4ED-G | 78/105 | 10/06→12/08 | OE063 | 1,0 | CET2 | OE180 | |
| 2.0 CVT | 4 | G4GC | 105/141 | 10/06→12/08 | OE039 | 1,0 | CET2 | OE179 | BAEA502E ^[13] |

HYUNDAI





kW/BHP



eon TITAN

IRIDIUM

**...HYUNDAI****TRAJET**

| | | | | | | | | | | |
|----------|---|--------|---------|-------------|-------|-----|--------|-------|--|------------------|
| 2.0 | 4 | G4JP-G | 100/134 | 03/00→07/08 | OE191 | 1,0 | CET12P | OE180 | BAEA502E ^[13] →02/04 BAEA482 ^[118] 02/04→ | CLS094 02/04→ |
| 2.0 | 4 | G4GC-G | 103/138 | 03/01→07/08 | | | CET12P | OE180 | BAEA502E ^[13] →02/04 BAEA482 ^[118] 02/04→ | CLS094 02/04→ |
| 2.0 | 4 | G4CP-D | 103/138 | 03/01→07/08 | | | | | BAEA502E ^[13] | |
| 2.0 | 4 | G4GC | 104/139 | 11/03→07/08 | OE063 | 1,0 | CET2 | OE180 | BAEA502E ^[13] →02/04 BAEA482 ^[118] 02/04→ | CLS094 02/04→ |
| 2.0 CRDi | 4 | D4EA | 83/111 | 04/01→07/08 | CH226 | 11v | | | | |
| 2.0 CRDi | 4 | D4EA | 92/123 | 08/05→07/08 | CH226 | 11v | | | | |
| 2.7 V6 | 6 | G6BA-G | 127/170 | 09/00→07/08 | | | CET12P | OE180 | | |

TUCSON

| | | | | | | | | | | |
|------------------------|---|--------|---------|-------------|-------|-----|--------|-------|--------------------------|--------|
| 2.0, 2.0 4WD | 4 | G4GC | 104/139 | 08/04→ | | | CET12P | OE180 | BAEA482 ^[122] | CLS094 |
| 2.0, 2.0 4WD | 4 | G4GC | 105/141 | 07/05→01/12 | | | | | BAEA482 | |
| 2.0 CRDi, 2.0 CRDi 4WD | 4 | D4EA | 83/111 | 08/04→03/10 | CH226 | 11v | | | | |
| 2.0 CRDi, 2.0 CRDi 4WD | 4 | D4EA-F | 88/118 | 01/07→03/10 | CH226 | 11v | | | | |
| 2.0 CRDi, 2.0 CRDi 4WD | 4 | D4EA-F | 100/134 | 01/06→ | CH226 | 11v | | | | |
| 2.0 CRDi, 2.0 CRDi 4WD | 4 | D4EA-F | 103/138 | 01/06→03/10 | CH226 | 11v | | | | |
| 2.0 CRDi, 2.0 CRDi 4WD | 4 | D4EA-F | 110/148 | 01/09→03/10 | CH226 | 11v | | | | |
| 2.7 4WD | 6 | G6BA-G | 129/173 | 08/04→ | | | CET12P | OE180 | BAEA555 | |

VELOSTER

| | | | | | | | | | | |
|-----------|---|------|---------|--------|-------|-----|--|-------|---------|--|
| 1.6 | 4 | G4FG | 94/126 | 06/11→ | OE201 | 0,9 | | | | |
| 1.6 MPI | 4 | G4FG | 97/130 | 04/11→ | OE201 | 0,9 | | | BAEA475 | |
| 1.6 T-GDI | 4 | G4FJ | 137/184 | 10/12→ | | | | OE250 | | |

XG

| | | | | | | | | | | |
|---------|---|--------|---------|-------------|--|--|--------|-------|--|--|
| 2.5 250 | 6 | G6BV | 120/161 | 12/98→12/05 | | | CET12P | OE180 | | |
| 3.0 30 | 6 | G6CT-G | 138/185 | 12/98→12/05 | | | CET12P | OE180 | | |
| 3.5 350 | 6 | G6CU | 145/194 | 10/02→12/05 | | | CET12P | OE180 | | |

HYUNDAI**GRACE**

| | | | | | | | | | | |
|--------|---|------|-------|-------------|-------|-----|--|--|--|--|
| 2.5 D | 4 | D4BA | 55/74 | 07/93→06/94 | CH221 | 11v | | | | |
| 2.5 TD | 4 | D4BF | 59/79 | 06/98→10/01 | CH221 | 11v | | | | |

H-1

| | | | | | | | | | | |
|--------------------|---|--------------|---------|-------------|--|-----|------|-------|---------|--|
| 2.4 | 4 | G4CS | 82/110 | 03/00→04/04 | OE048 ^[2] | 1,0 | CET8 | OE195 | | |
| 2.4 i | 4 | G4KC | 126/169 | 02/08→ | | | | | BAEA548 | |
| 2.4 i | 4 | G4KC | 129/173 | 02/08→ | | | | | BAEA548 | |
| 2.5 CRDi | 4 | D4CB | 81/109 | 07/01→ | CH234 ^[130] →04/11 CH234 | 11v | | | | |
| 2.5 CRDi | 4 | D4CB | 85/114 | 01/09→ | CH234 | 11v | | | | |
| 2.5 CRDi | 4 | D4CB | 103/138 | 12/02→ | CH234 | 11v | | | | |
| 2.5 CRDi | 4 | D4CB; D4CB-L | 120/161 | 02/08→ | CH234 | 11v | | | | |
| 2.5 CRDi | 4 | D4CB | 125/168 | 02/08→ | CH234 | 11v | | | | |
| 2.5 CRDi, 2.5 CRDi | 4 | D4CB; D4CB-W | 100/134 | 07/08→ | CH234 | 11v | | | | |
| 2.5 D, 2.5 TD | 4 | D4BH | 73/98 | 03/00→10/05 | CH225 ^[275] CH256 ^[275] | 11v | | | | |
| 2.5 TD | 4 | D4BF | 59/79 | 03/00→09/00 | CH225 ^[275] CH256 ^[275] | 11v | | | | |
| 2.5 TD | 4 | D4BH | 74/99 | 10/01→08/07 | CH225 ^[275] CH256 ^[275] | 11v | | | | |

HYUNDAI



kW/BHP



eon TITAN

IRIDIUM



...HYUNDAI



H100

| | | | | | | | | | |
|-------------------------|---|------------|--------|-------------|-------|-----|------|-------|--|
| 2.4 | 4 | G4CS | 82/110 | 10/97→12/04 | OE049 | 1,0 | CET8 | | |
| 2.4 | 4 | G4CS | 84/113 | 05/96→10/03 | OE048 | 1,0 | CET8 | OE195 | |
| 2.4 | 4 | G4CS | 90/121 | 07/93→03/00 | OE048 | 1,0 | CET8 | OE195 | |
| 2.5 D | 4 | D4BA; D4BX | 55/74 | 07/93→12/94 | CH225 | 11v | | | |
| 2.5 D | 4 | D4BA | 57/76 | 07/93→03/00 | CH225 | 11v | | | |
| 2.5 D, 2.5 TD, 2.5 TDiC | 4 | D4BF | 59/79 | 07/93→10/03 | CH225 | 11v | | | |

HIGHWAY VAN

| | | | | | | | | | |
|------------|---|------|---------|-------------|--|--|--------|-------|--------------------------|
| 2.0 16V | 4 | G4JP | 100/134 | 03/00→03/04 | | | CET12P | OE180 | BAEA502E ^[13] |
| 2.7 V6 24V | 6 | G6BA | 125/168 | 03/00→03/04 | | | CET12P | OE180 | |

PORTER

| | | | | | | | | | |
|----------|---|------|---------|-------------|----------------|------------|------|-------|--|
| 2.4 | 4 | G4CS | 82/110 | 03/96→04/04 | OE006 OE049 | 0,9 1,0 | CET8 | OE195 | |
| 2.5 CRDi | 4 | D4CB | 103/138 | 02/03→ | CH234 | 11v | | | |
| 2.5 TGi | 4 | D4BH | 74/99 | 05/04→ | CH221 | 11v | | | |
| 2.5 TD | 4 | D4BA | 57/76 | 07/94→04/04 | CH225 | 11v | | | |
| 2.5 TD | 4 | D4BH | 73/98 | 07/94→04/04 | CH221 | 11v | | | |
| 2.6 TD | 4 | D4BB | 63/84 | 07/94→04/04 | CH256 | 11v | | | |

INFINITI



EX

| | | | | | | | | | |
|-------------|---|--------|---------|--------|---------|----|--|--|----------|
| 3.0 30d 4WD | 6 | V9X | 175/235 | 04/10→ | CCGP007 | 7v | | | |
| 3.5 35 4WD | 6 | VQ35HR | 221/296 | 10/08→ | | | | | BAEA158E |

FX

| | | | | | | | | | |
|--------------------|---|--------|---------|-------------|---------|----|--------|-------|---------------------------|
| 3.0 30d 4WD | 6 | V9X | 175/235 | 04/10→ | CCGP007 | 7v | | | |
| 3.5 35, 3.5 35 4WD | 6 | VQ35DE | 206/276 | 01/03→12/08 | | | CET14P | OE190 | BAEA132E ^[277] |
| 4.5 45, 4.5 45 4WD | 8 | VK45DE | 232/311 | 01/03→12/08 | | | CET14P | OE190 | |
| 5.0 50 4WD | 8 | VK50VE | 287/385 | 10/08→ | | | | | BAEA088E |
| 5.0 50 4WD | 8 | VK50VE | 309/414 | 06/13→ | | | | | BAEA088E |

G

| | | | | | | | | | |
|--------|---|--------|---------|--------|--|--|--------|-------|---------------------------|
| 2.5 25 | 6 | VQ25HR | 163/219 | 01/11→ | | | | | BAEA158E |
| 3.5 35 | 6 | VQ35DE | 191/256 | 10/02→ | | | CET14P | OE190 | BAEA132E ^[277] |

I30

| | | | | | | | | | |
|-----|---|--------|---------|--------|-------|-----|------|-------|----------------------------------|
| 3.0 | 6 | VQ30DE | 142/190 | 01/97→ | OE063 | 1,0 | CET2 | OE180 | BAEA073E →12/99 [32] [277] |
|-----|---|--------|---------|--------|-------|-----|------|-------|----------------------------------|

M

| | | | | | | | | | |
|---------|---|--------|---------|--------|---------|----|--|--|----------|
| 3.0 30d | 6 | V9X | 175/235 | 03/10→ | CCGP007 | 7v | | | |
| 3.5 35h | 6 | VQ35HR | 225/302 | 04/11→ | | | | | BAEA158E |

M35

| | | | | | | | | | |
|----------------------------|---|--------|---------|--------|--|--|--------|-------|---------------------------|
| 3.5 Luxury, 3.5 Luxury 4WD | 6 | VQ35DE | 206/276 | 01/05→ | | | CET14P | OE190 | BAEA132E ^[277] |
| 3.5 Luxury Hybrid | 6 | VQ35HR | 268/359 | 01/10→ | | | | | BAEA158E |

M45

| | | | | | | | | | |
|------------|---|--------|---------|--------|--|--|--------|-------|--|
| 4.5 Luxury | 8 | VK45DE | 250/335 | 01/05→ | | | CET14P | OE190 | |
|------------|---|--------|---------|--------|--|--|--------|-------|--|

Q45 I

| | | | | | | | | | |
|-----|---|--------|---------|-------------|--|--|--------|-------|--|
| 4.1 | 8 | VH41DE | 205/275 | 01/93→12/96 | | | CET12P | OE180 | |
|-----|---|--------|---------|-------------|--|--|--------|-------|--|

Q45 II

| | | | | | | | | | |
|-----|---|--------|---------|-------------|-------|-----|--------|--|--|
| 4.1 | 8 | VH41DE | 205/275 | 01/97→01/01 | OE138 | 1,0 | CET12P | | |
|-----|---|--------|---------|-------------|-------|-----|--------|--|--|

Q45 III

| | | | | | | | | | |
|-----|---|--------|---------|--------|--|--|--------|-------|--|
| 4.5 | 8 | VK45DE | 250/335 | 02/01→ | | | CET14P | OE190 | |
|-----|---|--------|---------|--------|--|--|--------|-------|--|

Q50

| | | | | | | | | | |
|----------------------------------|---|--------|---------|--------|--|--|--|--|----------|
| 3.5 50 Hybrid, 3.5 50 Hybrid 4WD | 6 | VQ35HR | 268/359 | 04/13→ | | | | | BAEA158E |
|----------------------------------|---|--------|---------|--------|--|--|--|--|----------|

HYUNDAI





kW/BHP



eon TITAN

IRIDIUM



...INFINITI



Q70

| | | | | | | | | |
|-----|---|-----|---------|--------|---------|----|--|--|
| 3.0 | 6 | V9X | 175/235 | 03/13→ | CCGP007 | 7v | | |
|-----|---|-----|---------|--------|---------|----|--|--|

QX4

| | | | | | | | | |
|---------|---|-------|---------|--------|-------|-----|------|-------|
| 3.3 4WD | 6 | VG33E | 125/168 | 01/97→ | OE063 | 1,0 | CET2 | OE180 |
|---------|---|-------|---------|--------|-------|-----|------|-------|

QX50

| | | | | | | | | |
|-------------|---|-----|---------|--------|---------|----|--|--|
| 3.0 30d 4WD | 6 | V9X | 175/235 | 08/13→ | CCGP007 | 7v | | |
|-------------|---|-----|---------|--------|---------|----|--|--|

QX70

| | | | | | | | | |
|-------------|---|-----|---------|--------|---------|----|--|--|
| 3.0 30d 4WD | 6 | V9X | 175/235 | 08/13→ | CCGP007 | 7v | | |
|-------------|---|-----|---------|--------|---------|----|--|--|

| | | | | | | | | |
|------------|---|--------|---------|--------|--|--|--|----------|
| 5.0 50 4WD | 8 | VK50VE | 287/385 | 08/13→ | | | | BAEA088E |
|------------|---|--------|---------|--------|--|--|--|----------|

INNOCENTI



ELBA

| | | | | | | | | |
|----------|---|----------------------|-------|-------------|-------|-----|------|-------|
| 1.4 i.e. | 4 | 146C5.000; 146D5.000 | 49/66 | 09/94→12/96 | OE018 | 1,0 | CET8 | OE195 |
|----------|---|----------------------|-------|-------------|-------|-----|------|-------|

| | | | | | | | | |
|----------|---|----------------------|-------|-------------|-------|-----|------|-------|
| 1.6 i.e. | 4 | 146C6.000; 146D6.000 | 55/74 | 09/94→12/96 | OE018 | 1,0 | CET8 | OE195 |
|----------|---|----------------------|-------|-------------|-------|-----|------|-------|

ISUZU



ASCENDER

| | | | | | | | | |
|---------|---|-----|---------|--------|--|--|--------|-------|
| 4.2 4WD | 6 | LL8 | 217/291 | 03/03→ | | | CET17P | OE189 |
|---------|---|-----|---------|--------|--|--|--------|-------|

ASKA III

| | | | | | | | | |
|-----|---|------|-------|-------------|-------|-----|------|-------|
| 2.3 | 4 | 4ZD1 | 71/95 | 10/97→09/01 | OE006 | 0,9 | CET8 | OE195 |
|-----|---|------|-------|-------------|-------|-----|------|-------|

D-MAX I

| | | | | | | | | |
|-------|---|--|---------|-------------|----------------------|-----|--|--|
| 3.0 D | 4 | | 107/143 | 01/04→06/12 | CH306 [158] [275] | 11v | | |
|-------|---|--|---------|-------------|----------------------|-----|--|--|

| | | | | | | | | |
|------------------|---|-----------|--------|-------------|----------------------|-----|--|--|
| 3.0 D, 3.0 D 4WD | 4 | ; 4JH1-TC | 88/118 | 06/03→10/04 | CH306 [158] [275] | 11v | | |
|------------------|---|-----------|--------|-------------|----------------------|-----|--|--|

| | | | | | | | | |
|------------------------|---|---------|---------|-------------|----------------------|-----|--|--|
| 3.0 DiTD, 3.0 DiTD 4WD | 4 | 4JJ1-TC | 120/161 | 01/07→06/12 | CH306 [158] [275] | 11v | | |
|------------------------|---|---------|---------|-------------|----------------------|-----|--|--|

| | | | | | | | | |
|--------------|---|---------|--------|-------------|----------------------|-----|--|--|
| 3.0 DiTD 4WD | 4 | 4JH1-TC | 96/129 | 05/02→06/12 | CH306 [158] [275] | 11v | | |
|--------------|---|---------|--------|-------------|----------------------|-----|--|--|

| | | | | | | | | |
|--------------|---|--|---------|-------------|----------------------|-----|--|--|
| 3.0 DiTD 4WD | 4 | | 100/134 | 06/03→06/12 | CH306 [158] [275] | 11v | | |
|--------------|---|--|---------|-------------|----------------------|-----|--|--|

| | | | | | | | | |
|--------------|---|---------|---------|-------------|----------------------|-----|--|--|
| 3.0 DiTD 4WD | 4 | 4JH1-TC | 114/153 | 06/05→06/07 | CH306 [158] [275] | 11v | | |
|--------------|---|---------|---------|-------------|----------------------|-----|--|--|

| | | | | | | | | |
|--------------|---|---------|---------|-------------|----------------------|-----|--|--|
| 3.0 DiTD 4WD | 4 | 4JH1-TC | 114/153 | 06/05→06/07 | CH306 [158] [275] | 11v | | |
|--------------|---|---------|---------|-------------|----------------------|-----|--|--|

| | | | | | | | | |
|--------------|---|---------|---------|-------------|----------------------|-----|--|--|
| 3.0 DiTD 4WD | 4 | 4JH1-TC | 114/153 | 06/05→06/07 | CH306 [158] [275] | 11v | | |
|--------------|---|---------|---------|-------------|----------------------|-----|--|--|

KB

| | | | | | | | | |
|------------------------|---|------|-------|-------------|-------|-----|--|--|
| 2.5 DiTD, 2.5 DiTD 4WD | 4 | 4JA1 | 56/75 | 07/02→06/04 | CH306 | 11v | | |
|------------------------|---|------|-------|-------------|-------|-----|--|--|

| | | | | | | | | |
|--------------------------|---|---------|--------|--------|-------|-----|--|--|
| 2.5 D-TEQ, 2.5 D-TEQ 4WD | 4 | 4JK1-TC | 85/114 | 10/08→ | CH306 | 11v | | |
|--------------------------|---|---------|--------|--------|-------|-----|--|--|

| | | | | | | | | |
|--------------------------|---|---------|---------|--------|-------|-----|--|--|
| 3.0 D-TEQ, 3.0 D-TEQ 4WD | 4 | 4JJ1-TC | 120/161 | 08/10→ | CH306 | 11v | | |
|--------------------------|---|---------|---------|--------|-------|-----|--|--|

TROOPER III

| | | | | | | | | |
|----------------|---|------|---------|-------------|--|--|--------|-------|
| 3.5 V6 24V 4WD | 6 | 6VE1 | 158/212 | 04/00→08/04 | | | CET12P | OE180 |
|----------------|---|------|---------|-------------|--|--|--------|-------|

VEHICROSS

| | | | | | | | | |
|---------|---|------|---------|-------------|-------|-----|------|-------|
| 3.2 4WD | 6 | 6VD1 | 158/212 | 04/97→12/00 | OE063 | 1,0 | CET2 | OE179 |
|---------|---|------|---------|-------------|-------|-----|------|-------|

WIZARD

| | | | | | | | | |
|---------|---|------|---------|-------------|-------|-----|------|-------|
| 3.2 4WD | 6 | 6VD1 | 158/212 | 06/98→08/02 | OE063 | 1,0 | CET2 | OE179 |
|---------|---|------|---------|-------------|-------|-----|------|-------|

ISUZU



D-MAX I

| | | | | | | | | |
|-------|---|---------|---------|-------------|----------------------|-----|--|--|
| 3.0 D | 4 | 4JJ1-TC | 120/161 | 01/07→06/12 | CH306 [158] [275] | 11v | | |
|-------|---|---------|---------|-------------|----------------------|-----|--|--|

| | | | | | | | | |
|-----------|---|---------|---------|-------------|----------------------|-----|--|--|
| 3.0 D 4WD | 4 | 4JJ1-TC | 120/161 | 01/07→06/12 | CH306 [158] [275] | 11v | | |
|-----------|---|---------|---------|-------------|----------------------|-----|--|--|

| | | | | | | | | |
|-----------|---|---------|---------|-------------|----------------------|-----|--|--|
| 3.0 D 4WD | 4 | 4JJ1-TC | 120/161 | 01/07→06/12 | CH306 [158] [275] | 11v | | |
|-----------|---|---------|---------|-------------|----------------------|-----|--|--|

IVECO



MASSIF

| | | | | | | | | |
|-------------|---|------------|---------|-------------|-------|-----|--|--|
| 3.0 HPI 4WD | 4 | F1CE0481FA | 107/143 | 10/08→02/11 | CH270 | 11v | | |
|-------------|---|------------|---------|-------------|-------|-----|--|--|

| | | | | | | | | |
|-------------|---|------------|---------|-------------|-------|-----|--|--|
| 3.0 HPT 4WD | 4 | F1CE0481HA | 130/174 | 10/08→02/11 | CH270 | 11v | | |
|-------------|---|------------|---------|-------------|-------|-----|--|--|

IVECO

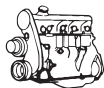

kW/BHP



eon TITAN

IRIDIUM

**IVECO****DAILY C14G**3.0 50C14G Natural Power 4 100/134 10/15→10/16 **OE254** 0,5**DAILY II**2.8 30-8, 2.8 30-8 V, 2.8 35-8, 2.8 35-8 K 4 8140.63 62/83 09/98→05/99 **CH216** 11v**DAILY III**2.3 29 L 10, 2.3 29 L 10 V, 2.3 35 C 10 V, 35 S 10 V, 2.3 35 S 10 4 F1AE0481A 70/94 09/02→07/07 **CH270** 11v2.3 29 L 12, 2.3 29 L 12 V, 2.3 35 C 12, 35 S 12, 2.3 35 C 12 V, 35 S 12 V 4 F1AE0481B 85/114 09/02→07/07 **CH270** 11v2.3 29 L 14, 2.3 35 C 14, 35 S 14, 2.3 40 C 14 4 F1AE0481M 100/134 01/05→04/06 **CH270** 11v2.8 29 L 9, 2.8 29 L 9 V, 2.8 35 S 9, 35 C 9, 2.8 35 S 9 V, 35 C 9 V 4 8140.63 62/83 05/99→07/07 **CH216** 11v2.8 29 L 13, 2.8 35 S 13, 35 C 13, 2.8 35 S 13 V, 35 C 13 V, 2.8 40 C 13, 2.8 50 C 13 4 8140.43S 92/123 05/99→07/07 **CH216** 11v2.8 35 C 15, 2.8 35 S 15 V, 35 C 15 V, 2.8 40 C 15, 2.8 50 C 15, 2.8 65 C 15 4 8140.43N 107/143 01/01→07/07 **CH216** 11v2.8 50 C 11 Natural Power (CNG), 2.8 CNG 4 8149.03 78/105 05/99→07/07 **OE254** 0,53.0 35 C 14, 3.0 40 C 14, 3.0 45 C 14, 3.0 50 C 14, 3.0 65 C 14 4 F1CE0481A 100/134 07/99→04/06 **CH270** 11v3.0 35 C 17, 35 S 17, 3.0 40 C 17, 40 S 17, 3.0 50 C 17, 3.0 65 C 17 4 F1CE0481B 122/164 09/04→04/06 **CH270** 11v**DAILY IV**2.3 29L10, 2.3 29L10 V, 2.3 35C10, 35S10, 2.3 35C10 K, 2.3 40C10, 2.3 40C10 V 4 F1AE0481FA 70/94 05/06→08/11 **CH270** 11v2.3 29L12, 2.3 29L12 V, 29L12 V/P, 2.3 35C12, 2.3 35C12, 35S12, 2.3 35C12 V, 35C12 V/P, 35S12 V, 35S12 V/P, 2.3 40C12, 2.3 40C12 V, 40C14 V/P 4 F1AE0481GA 85/114 05/06→08/11 **CH270** 11v2.3 29L14, 2.3 29L14 C, 29L14 C/P, 29L14 V, 29L14 V/P, 2.3 35C14, 35S14, 35S14 /P, 2.3 35S14, 35S14 /P, 2.3 35S14 C, 35S14 C/P, 35S14 V, 35S14 V/P, 35C14 V, 35C14 V/P, 2.3 35S14 K, 35S14 DK 4 F1AE0481HA 100/134 05/06→08/11 **CH270** 11v2.3 35C11, 35S11, 35S11 D, 35S11 /P, 2.3 35C11 V, 35S11 V, 2.3 35C11 K, 35C11 DK, 35S11 K, 35S11 DK, 2.3 40C11, 40C11 D, 2.3 40C11 V 4 F1AE0481FA 78/105 07/07→08/11 **CH270** 11v2.3 35C13, 35C13 /P, 35S13 D, 35S13, 35S13 /P, 2.3 35C13 V, 35C13 V/P, 35S13 V, 35S13 V/P, 2.3 35C13 K, 35C13 DK, 35S13 K, 35S13 DK, 2.3 40C13, 40C13 /P, 2.3 40C13 V, 40C13 V/P 4 F1AE0481GA 93/125 07/07→08/11 **CH270** 11v

IVECO





kW/BHP

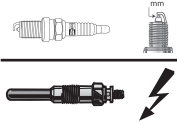

eon TITAN

IRIDIUM

**...IVECO****...DAILY IV**

| | | | | | | |
|---|---|------------------------|---------|-------------|--------------|-----|
| 3.0 35C14, 35C14 /P, 35S14, 35S14 /P, 35S14 D, 35S14 D/P, 3.0 35C14 V, 35C14 V/P, 35S14 V, 35S14 V/P, 3.0 35C14 K, 35C14 DK, 35S14 K, 35S14 DK, 3.0 40C14, 40C14 /P, 3.0 40C14 V, 40C14 V/P, 3.0 40C14 K, 40C14 DK, 3.0 45C14, 45C14 /P, 3.0 50C... | 4 | FICE3481LC | 103/138 | 07/07→08/11 | CH270 | 11v |
| 3.0 35C14 G, 35C14 G/P, 35S14 G, 35S14 G/P, 35C14 GD, 35S14 GD, 3.0 35C14 GV, 35C14 GV/P, 35S14 GV, 35S14 GV/P, 3.0 35S14 G, 3.0 40C14 G, 40C14 G/P, 3.0 40C14 GV, 40C14 GV/P, 3.0 50C14 G, 50C14 G/P, 50C14 GD, 50C14 GD/P, 3.0 50C14 GV, 50C14... | 4 | FICE0441A | 100/134 | 07/07→08/11 | OE254 | 0,5 |
| 3.0 35C15, 3.0 35C15 V, 35C15 V/P, 3.0 40C15, 3.0 40C15 V, 40C15 V/P, 3.0 45C15, 3.0 45C15 V, 3.0 50C15, 3.0 50C15 V, 50C15 V/P, 3.0 60C15, 3.0 60C15, 60C15 /P, 60C15 D, 60C15 D/P, 3.0 60C15 V, 3.0 65C15, 3.0 65C15, 65C15 /P, 65C15 D, 65C15... | 4 | FICE0481FA | 107/143 | 05/06→08/11 | CH270 | 11v |
| 3.0 35C17, 35C17 /P, 35S17, 35S17 /P, 35S17 D, 3.0 35C17 V, 35C17 V/P, 35S17 V, 35S17 V/P, 3.0 35C17 K, 35C17 DK, 35S17 K, 35S17 DK, 3.0 35S17 W, 35S17 WD 4WD, 3.0 40C17, 40C17 /P, 3.0 40C17 V, 40C17 V/P, 3.0 40C17 K, 40C17 DK, 3.0 45C17, 4... | 4 | FICE0481HA | 125/168 | 07/07→08/11 | CH270 | 11v |
| 3.0 35C18, 3.0 35C18, 35S18, 3.0 35C18 V, 35C18 V/P, 35S18 V, 35S18 V/P, 3.0 40C18, 3.0 40C18 V, 40C18 V/P, 3.0 45C18, 3.0 45C18, 45C18 /P, 45C18 D, 45C18 D/P, 3.0 50C18, 3.0 50C18 V, 50C18 V/P, 3.0 60C18, 3.0 65C18 | 4 | FICE0481HA; FICE0481HC | 130/174 | 05/06→08/11 | CH270 | 11v |
| 3.0 35S15 | 4 | FICE0481L | 110/148 | 06/06→08/11 | CH270 | 11v |
| DAILY V | | | | | | |
| 2.3 26L11, 26L11D, 35C11D, 35S11, 40C11, 2.3 29L11 V, 35C11 V, 35S11 V, 40C11 V, 2.3 35C11K, 35S11DKP | 4 | FIAE3481A | 78/105 | 09/11→02/14 | CH270 | 11v |
| 2.3 29L13, 29L13D, 35C13D, 40C13, 2.3 29L13 V, 35C13 V, 35S13 V, 40C13 V, 40S13 V, 2.3 35C13K, 35C13DKP | 4 | FIAE3481B | 93/125 | 09/11→02/14 | CH270 | 11v |
| 2.3 29L15 V, 35C15L V, 40C15L V, 50C15L V | 4 | FIAE3481C | 107/143 | 09/11→02/14 | CH270 | 11v |
| 3.0 35C15, 35C15D, 35S15, 40C15, 45C15, 50C15, 60C15, 70C15, 3.0 35C15 V, 40C15 V, 3.0 35C15K, 35S15DKP, 50C15K, 60C15K, 65C15DK, 70C15K | 4 | FICE3481J; FICE3481L | 107/143 | 09/11→02/14 | CH270 | 11v |

IVECO



kW/BHP

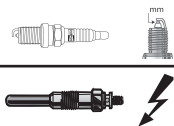

eon TITAN

IRIDIUM



...IVECO



...DAILY V

| | | | | | | | | | |
|--|---|----------------------|---------|-------------|-------|-----|--|--|--|
| 3.0 35C17, 35C17D, 35S17, 40C17, 45C17, 50C17, 60C17, 70C17, 3.0 35C17 V, 35S17 V, 40C17 V, 45C17 V, 50C17 V, 60C17 V, 3.0 35C17K, 35S17DKP, 50C17K, 65C17DK, 70C17K | 4 | F1CE3481C; F1CE3481K | 125/168 | 09/11→02/14 | CH270 | 11v | | | |
| 3.0 35C21, 35S21, 40C21, 45C21, 50C21, 60C21, 70C21, 3.0 35C21 V, 35S21 V, 40C21 V, 45C21 V, 50C21 V, 3.0 35S21DKP | 4 | F1CE3481D | 150/201 | 09/11→02/14 | CH270 | 11v | | | |
| 3.0 35 S 14 | 4 | F1CE3481L | 110/148 | 04/12→02/14 | CH270 | 11v | | | |

DAILY VI

| | | | | | | | | | |
|---|---|------------------------|---------|--------|-----------------|-----|--|--|--|
| 3.0 Natural Power 35S14, 35C14, 40C14, 50C14, 3.0 Natural Power 35S14, 35C14, 40C14, 50C14, 65C14, 70C14, 3.0 NaturalPower 35S14, 35C14, 40C14, 50C14, 65C14, 70C14, 72C1 | 4 | ; F1CFA401A; F1CFA401B | 100/134 | 03/14→ | OE254 →12/16 | 0,5 | | | |
|---|---|------------------------|---------|--------|-----------------|-----|--|--|--|

DAILY LINE

| | | | | | | | | | |
|-------------------------|---|-----------|---------|--------|-----------------|-----|--|--|--|
| 3.0 50C14 Natural Power | 4 | F1CFA401A | 100/134 | 06/14→ | OE254 →12/16 | 0,5 | | | |
|-------------------------|---|-----------|---------|--------|-----------------|-----|--|--|--|

MASSIF

| | | | | | | | | | |
|-------------|---|------------|---------|-------------|-------|-----|--|--|--|
| 3.0 HPI 4WD | 4 | F1CE0481FA | 107/143 | 10/08→02/11 | CH270 | 11v | | | |
| 3.0 HPT 4WD | 4 | F1CE0481HA | 130/174 | 10/08→02/11 | CH270 | 11v | | | |

JAGUAR



S-TYPE

| | | | | | | | | | |
|------------------|---|-----------------|---------|-------------|-------|-----|--------|-------|---|
| 2.5 V6 | 6 | AJ25; JB(AJ-V6) | 147/197 | 04/02→10/07 | OE131 | 1,0 | CET18P | OE183 | |
| 2.7 D | 6 | AJD | 152/204 | 06/04→10/07 | CH240 | 11v | | | |
| 3.0 V6 | 6 | AJ-V6; FB | 175/235 | 01/99→10/07 | OE131 | 1,0 | CET18P | OE183 | BAEA367 |
| 4.0 V8 | 8 | AJ-V8 | 203/272 | 01/99→04/02 | OE146 | 1,0 | CET12P | OE179 | BAEA368 ^[277] →Ch.M45254 BAEA196E ^[275] Ch.M45255→ |
| 4.0 V8 | 8 | AJ-V8 | 209/280 | 09/99→12/02 | OE146 | 1,0 | CET12P | | |
| 4.2 V8 | 8 | AJ8FT | 219/294 | 04/02→10/07 | | | CET12P | OE180 | BAEA196E ^[275] BAEA368 ^[275] |
| 4.2 R 4, 2 V8 | 8 | AJ8FT | 291/390 | 04/02→10/07 | | | CET12P | OE180 | BAEA368 ^[277] →Ch.M45254 BAEA196E ^[275] Ch.M45255→ |
| 4.2 Supercharged | 8 | AJ8FT | 298/400 | 11/01→12/08 | | | CET12P | OE180 | |

XF

| | | | | | | | | | |
|----------------|---|-------|---------|-------------|-----------------|-----|--------|-------|---------------------------|
| 2.0 | 4 | 204PT | 177/237 | 06/12→ | | | CET17P | | |
| 2.7 D | 6 | AJD | 152/204 | 03/08→04/15 | CH240 →02/09 | 11v | | | |
| 3.0 | 6 | AJ6WG | 175/235 | 03/08→04/15 | OE131 | 1,0 | CET18P | OE183 | |
| 3.0, 3.0 4WD | 6 | 306PS | 250/335 | 03/12→ | | | | | BAEA196E ^[275] |
| 4.2 | 8 | SV82G | 219/294 | 03/08→04/15 | | | CET12P | OE180 | BAEA196E ^[275] |
| 4.2 Kompressor | 8 | SV8TS | 306/410 | 03/08→04/15 | | | CET12P | OE180 | BAEA196E ^[275] |

XJ

| | | | | | | | | | |
|-------|---|-------|---------|-------------|-------|-----|--------|-------|---------------------------|
| 2.0 | 4 | 204PT | 177/237 | 05/12→ | | | CET17P | | |
| 2.7 D | 6 | AJD | 152/204 | 10/05→03/09 | CH240 | 11v | | | |
| 3.0 | 6 | AJ-V6 | 175/235 | 05/03→ | OE131 | 1,0 | CET18P | OE183 | |
| 3.0 | 6 | AJ-V6 | 179/240 | 04/04→01/07 | OE131 | 1,0 | CET18P | OE183 | |
| 3.0 | 6 | 306PS | 250/335 | 03/12→ | | | | | BAEA196E ^[275] |

CHAMPION



kW/BHP

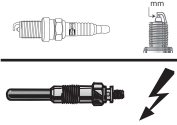

eon TITAN

IRIDIUM

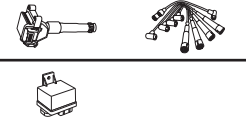
**...JAGUAR****...XJ**

| | | | | | | | | | |
|---------------------|----|---------------|---------|-------------|------------------------------------|------------|--------|-------|---------------------------|
| 3.2 | 8 | | 174/233 | 07/97→05/03 | OE136 →09/98 OE146 10/98→ | 0,8 1,0 | CET12P | OE179 | BAEA368 ^[277] |
| 3.2 6 | 6 | 9JPCRB | 155/208 | 11/94→07/97 | OE005 | 0,9 | CET2 | OE180 | |
| 3.6 | 8 | RG(AJ-V8) | 190/255 | 05/03→03/09 | | | CET12P | OE180 | BAEA196E ^[275] |
| 4.0 | 6 | 9LPFRB | 171/229 | 07/94→03/96 | OE013 | 0,8 | CET2 | OE193 | |
| 4.0 | 8 | BC | 209/280 | 07/97→05/03 | OE136 →09/98 OE146 10/98→ | 0,8 1,0 | CET12P | OE179 | BAEA368 ^[277] |
| 4.0 | 8 | AJ-V8 | 216/290 | 10/97→04/03 | OE146 | 1,0 | CET12P | | |
| 4.0 | 8 | DC | 267/358 | 07/97→05/03 | OE146 | 1,0 | CET12P | OE179 | BAEA368 ^[277] |
| 4.0 6 Sovereign | 6 | 9JPFRB | 177/237 | 09/94→07/97 | OE002 | 0,9 | CET2 | OE180 | |
| 4.0 R Super Charged | 6 | 9KPDRB | 235/315 | 11/94→07/97 | OE014 | 0,9 | CET2 | OE179 | |
| 4.2 | 8 | AJ8FT | 219/294 | 05/03→03/09 | | | CET12P | OE180 | BAEA196E ^[275] |
| 4.2 R | 8 | AJ8FT | 291/390 | 03/03→03/09 | | | CET12P | OE180 | BAEA196E ^[275] |
| 6.0 | 12 | 8D | 222/298 | 05/93→03/96 | OE011 | 0,9 | CET9 | OE183 | |
| 6.0 12, 6.0 V12 | 12 | 8C(92-94); 8E | 229/307 | 03/93→09/97 | OE011 | 0,9 | CET9 | OE183 | |

XJSC

| | | | | | | | | | |
|-----|----|--------|---------|-------------|-------|-----|------|-------|--|
| 4.0 | 6 | 9LPFRB | 171/229 | 07/94→03/96 | OE013 | 0,8 | CET2 | OE193 | |
| 6.0 | 12 | 8D | 222/298 | 05/93→03/96 | OE011 | 0,9 | CET9 | OE183 | |

XK

| | | | | | | | | | |
|---------|---|-----------|---------|-------------|--|--|--------|-------|---------------------------|
| 3.6 | 8 | RG(AJ-V8) | 190/255 | 07/07→07/14 | | | CET12P | OE180 | BAEA196E ^[275] |
| 4.2 XK8 | 8 | AJ8FT | 219/294 | 03/06→07/14 | | | CET12P | OE180 | BAEA196E ^[275] |
| 4.2 XKR | 8 | AJ8FT | 291/390 | 03/06→07/14 | | | CET12P | OE180 | BAEA196E |
| 4.2 XKR | 8 | SV8TS | 306/410 | 03/06→07/14 | | | CET12P | OE180 | BAEA196E ^[275] |
| 4.2 XKR | 8 | SV8TS | 313/420 | 08/06→07/14 | | | CET12P | OE180 | |

XK 8

| | | | | | | | | | |
|------------|---|--------------------|---------|-------------|-------|-----|--------|-------|---------------------------|
| 4.0 | 8 | AJ26; AJ27; CC; CE | 209/280 | 03/96→07/05 | OE136 | 0,8 | CET12P | OE179 | |
| 4.0 | 8 | AJ26; AJ-V8 | 216/290 | 05/96→07/05 | OE136 | 0,8 | CET12P | OE179 | |
| 4.0 | 8 | EC | 267/358 | 02/98→07/05 | OE136 | 0,8 | CET12P | | |
| 4.0 XKR | 8 | AJ27S | 276/370 | 05/98→07/05 | OE136 | 0,8 | CET12P | OE180 | |
| 4.2 | 8 | AJ8FT | 219/294 | 08/02→12/06 | | | CET12P | OE180 | BAEA196E ^[275] |
| 4.2 R 4, 2 | 8 | AJ8FT | 291/390 | 08/02→12/06 | | | CET12P | OE180 | BAEA196E ^[275] |

X-TYPE

| | | | | | | | | | |
|---------------------|---|---------------------|---------|-------------|-------|-------|--------|-------|--|
| 2.0 D | 4 | FMBA; FMBB; R4-X404 | 96/129 | 07/03→12/09 | CH229 | 11.5v | | | |
| 2.1 V6 | 6 | YB(AJ-V6) | 115/154 | 03/02→11/09 | OE131 | 1,0 | CET18P | OE183 | |
| 2.2 D | 4 | LJ46G | 107/143 | 01/07→12/09 | CH229 | 11.5v | | | |
| 2.2 D | 4 | LJ46G | 110/148 | 10/05→12/09 | CH229 | 11.5v | | | |
| 2.2 D | 4 | LJ46G | 114/153 | 10/05→12/09 | CH229 | 11.5v | | | |
| 2.5 4WD, 2.5 V6 4WD | 6 | XB(AJ-V6) | 144/193 | 06/01→12/09 | OE131 | 1,0 | CET18P | OE183 | |
| 3.0 4WD, 3.0 V6 4WD | 6 | AJ-V6 | 169/227 | 06/01→12/09 | OE131 | 1,0 | CET18P | OE183 | |

JEEP**CHEROKEE**

| | | | | | | | | | |
|---------------------|---|----------|---------|-------------|----------------------------|-----|------|-------|-------------------|
| 2.4 4WD, 2.4 Laredo | 4 | ED1 | 108/145 | 09/01→01/08 | | | | | BAEA380 →12/03 |
| 2.5 CRD 4WD | 4 | R425DOHC | 105/141 | 09/01→01/08 | CH180 | 11v | | | |
| 2.8 CRD 4WD | 4 | ENR | 110/148 | 11/02→01/08 | CH180 | 11v | | | |
| 2.8 CRD 4WD | 4 | ENR | 120/161 | 11/04→01/08 | CH180 | 11v | | | |
| 3.7 4WD | 6 | EKG | 155/208 | 09/01→01/08 | OE089 | 1,0 | CET2 | OE184 | |
| | | | | | OE216 ^{UPG [278]} | 0,8 | | | |
| 3.7 4WD, 3.7 Laredo | 6 | EKG | 150/201 | 10/01→01/08 | OE089 | 1,0 | CET2 | OE184 | |
| | | | | | OE216 ^{UPG [278]} | 0,8 | | | |





kW/BHP



eon TITAN

IRIDIUM

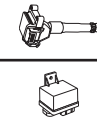

...JEEP



...CHEROKEE

| | | | | | | | | | |
|--------------------|---|-----|---------|--------------|--|------------|-------------|--------------|--------------------------------|
| 3.7 V6, 3.7 V6 4WD | 6 | EKG | 157/211 | 01/08 → | OE089 OE216 LPG [278] | 1,0 0,8 | CET2 | OE184 | |
| 3.7 V6 4WD | 6 | EKG | 151/202 | 01/08 → | OE089 OE216 LPG [278] | 1,0 0,8 | CET2 | OE184 | |
| 4.0 i 4WD | 6 | ERH | 127/170 | 07/98 →09/01 | OE041 | 0,9 | | | |
| 4.0 i 4WD | 6 | ERH | 131/176 | 01/95 →09/01 | OE041 | 0,9 | | | BAEA394 [292] →09/98 |

COMMANDER

| | | | | | | | | | |
|------------|---|-----|---------|--------------|--|------------|-------------|--------------|--|
| 3.7 V6 4WD | 6 | EKG | 157/211 | 09/05 →12/10 | OE089 OE216 LPG [278] | 1,0 0,8 | CET2 | OE184 | |
| 4.7 V8 4WD | 8 | EVA | 170/228 | 09/05 →12/10 | OE154 | 1,0 | CET2 | OE194 | |

COMPASS

| | | | | | | | | | |
|--------------|---|-----|---------|---------|--------------|-----|-------------|--------------|--|
| 2.4, 2.4 4WD | 4 | ED3 | 125/168 | 08/06 → | OE154 | 1,0 | CET2 | OE194 | |
|--------------|---|-----|---------|---------|--------------|-----|-------------|--------------|--|

GRAND CHEROKEE I

| | | | | | | | | | |
|-----------------|---|----------|---------|--------------|--------------|-----|-------------|--------------|--------------------------------|
| 2.5 TD 4WD | 4 | M51; M52 | 85/114 | 10/95 →04/99 | CH181 | 11v | | | |
| 4.0 i 4WD | 6 | S01 | 130/174 | 10/95 →04/99 | OE041 | 0,9 | | | BAEA394 [292] →12/97 |
| 4.0 Laredo | 6 | ERH | 131/176 | 10/96 →09/98 | OE041 | 0,9 | | | BAEA394 [275] [292] |
| 5.2 4WD | 8 | Y01 | 156/209 | 10/95 →04/99 | OE013 | 0,8 | CET2 | OE193 | |
| 5.2, 5.2 4WD | 8 | ELF | 164/220 | 10/96 →09/98 | OE128 | 1,0 | | | BAEA394 [292] →12/97 |
| 5.2 Limited 4WD | 8 | ELF | 136/182 | 10/96 →09/98 | OE128 | 1,0 | | | BAEA394 [292] →12/97 |
| 5.9 i 4WD | 8 | | 177/237 | 08/97 →04/99 | OE128 | 1,0 | | | |

GRAND CHEROKEE II

| | | | | | | | | | |
|--------------|---|-----|---------|--------------|--------------|-----|-------------|--------------|--|
| 3.1 TD 4WD | 5 | EXA | 103/138 | 04/99 →12/01 | CH181 | 11v | | | |
| 4.0, 4.0 4WD | 6 | ERH | 140/188 | 10/98 →09/05 | OE041 | 0,9 | | | |
| 4.7 V8 4WD | 8 | EVA | 162/217 | 04/99 →08/00 | OE154 | 1,0 | CET2 | OE194 | |
| 4.7 V8 4WD | 8 | EVA | 164/220 | 04/99 →09/05 | OE154 | 1,0 | CET2 | OE194 | |
| 4.7 V8 4WD | 8 | EVA | 167/224 | 06/03 →09/05 | OE154 | 1,0 | CET2 | OE194 | |
| 4.7 V8 4WD | 8 | EVC | 190/255 | 10/01 →09/05 | OE154 | 1,0 | CET2 | OE194 | |

GRAND CHEROKEE III

| | | | | | | | | | |
|----------------------|---|-----|---------|--------------|--|------------|-------------|--------------|---------------------|
| 3.0 CRD, 3.0 CRD 4WD | 6 | EXL | 160/215 | 06/05 →12/10 | | | | | CCU114 [275] |
| 3.0 CRD 4WD | 6 | EXL | 155/208 | 05/06 →12/10 | | | | | CCU114 [275] |
| 3.7 V6 4WD | 6 | EKG | 148/198 | 01/08 →12/10 | OE089 OE216 LPG [278] | 1,0 0,8 | CET2 | OE184 | |
| 3.7 V6 4WD | 6 | EKG | 157/211 | 10/04 →12/10 | OE089 OE216 LPG [278] | 1,0 0,8 | CET2 | OE184 | |
| 4.7 V8 4WD | 8 | EVA | 170/228 | 06/05 →12/10 | OE154 | 1,0 | CET2 | OE194 | |

GRAND CHEROKEE IV

| | | | | | | | | | |
|--------------|---|-----|---------|---------|--|--|---------------|--------------|--|
| 6.4 SRT8 4WD | 8 | ESG | 344/461 | 03/11 → | | | CET17P | OE189 | |
|--------------|---|-----|---------|---------|--|--|---------------|--------------|--|

PATRIOT

| | | | | | | | | | |
|-----------------------------|---|-----|---------|---------|--------------|-----|-------------|--------------|--|
| 2.4, 2.4 4WD, 2.4 Eco + 4WD | 4 | ED3 | 125/168 | 01/08 → | OE154 | 1,0 | CET2 | OE194 | |
|-----------------------------|---|-----|---------|---------|--------------|-----|-------------|--------------|--|

RENEGADE

| | | | | | | | | | |
|-----|---|---------------|---------|---------|--------------|-----|--|--|--|
| 1.4 | 4 | 55263624; EAM | 103/138 | 07/14 → | OE208 | 0,8 | | | |
|-----|---|---------------|---------|---------|--------------|-----|--|--|--|

WRANGLER II

| | | | | | | | | | |
|-----------------|---|-----|---------|--------------|--------------|-----|--|--|----------------|
| 2.4 4WD | 4 | ED1 | 105/141 | 11/02 →04/07 | | | | | BAEA380 |
| 2.5 4WD | 4 | P00 | 87/117 | 08/96 →04/07 | OE041 | 0,9 | | | |
| 4.0 4WD | 6 | | 124/166 | 06/98 →04/07 | OE041 | 0,9 | | | |
| 4.0 4WD | 6 | S01 | 130/174 | 08/96 →04/07 | OE041 | 0,9 | | | |
| 4.0 Rubicon 4WD | 6 | ERH | 128/172 | 08/03 →04/07 | OE041 | 0,9 | | | |





kW/BHP

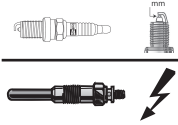

eon TITAN

IRIDIUM



JENSEN



S-V8

4.6 8 243/326 10/98→05/07 CET9

KIA



AVELLA

1.3 4 B3 55/74 11/95→12/01 OE048 1,0 CET8

1.5 4 55/74 02/97→12/01 OE048 1,0 CET8 OE195

CADENZA I

3.3 GDI 6 G6DH 216/290 01/10→ CET14P OE190

3.3 GDI 6 G6DH 218/292 09/13→ CET14P OE190

3.5 CVT 6 G6DC 213/286 01/10→ OE191 1,0 CET12P

CARENS I

1.8 i 4 T8 81/109 11/00→07/02 OE063 1,0 CET2 OE180 BAEA433 CLS173

CARENS II

1.6 4 GA6D 77/103 07/02→ OE063 1,0 CET2 OE180 BAEA486^[275] CLS256

1.8 4 TB 93/125 07/02→ OE063 1,0 CET2 OE180 BAEA433 CLS173

2.0 CRDi 4 D4EA 83/111 07/02→ CH226 11v

2.0 CRDi 4 D4EA-F 103/138 11/05→ CH226 11v

2.0 CVT 4 G4GC 102/137 08/04→ CET12P OE180 BAEA482 CLS094

CARENS III

1.6 CVT 4 G4FC 93/125 10/10→ OE201 0,9 CET6 BAEA475

1.6 CVT 4 G4FC 97/130 08/09→ OE201 0,9 CET6 BAEA475

2.0 CRDi 115 4 D4EA 85/114 05/07→ CH226 11v

2.0 CRDi 135 4 D4EA 100/134 08/09→ CH226 11v

2.0 CRDi 140 4 D4EA-F 103/138 09/06→ CH226 11v

2.0 CVT 4 G4KA 106/142 09/06→ OE063 1,0 CET2 OE180 BAEA531

CARENS IV

2.0 GDi 4 G4NC 122/164 03/13→ OE249

2.0 GDi 4 G4NC 130/174 03/13→ OE249

CARNIVAL / GRAND CARNIVAL III

2.7 V6 6 G6EA 139/186 06/06→ CET14P OE190

3.8 6 G6DA 182/244 01/10→ CET14P OE190

2.5 V6 6 KRV6 121/162 08/99→10/01 OE136 0,8 CET12P OE179

OE216^{UPG [278]} 0,8

2.9 TD 4 J3 93/125 08/99→10/01 CH226 11v

CARNIVAL II

2.4 4 109/146 12/01→10/06 OE048 1,0 CET8 OE195

2.5 V6 6 K5 110/148 10/01→06/06 OE136 0,8 CET12P OE179

OE216^{UPG [278]} 0,8

2.9 CRDi 4 J3 106/142 10/01→06/06 CH226 11v

2.9 TD 4 J3 93/125 01/99→09/07 CH226 11v

3.5 6 G6CU 143/192 07/02→04/06 CET12P OE180

CEE'D

1.0 T-GDI 3 G3LC 74/99 07/15→ OE248

1.0 T-GDI 3 G3LC 88/118 07/15→ OE248

1.4 4 G4FA 77/103 12/06→12/12 OE201 0,9 CET6 BAEA475

1.4 4 G4FA 80/107 12/06→12/12 OE063 1,0 CET2 OE180 BAEA475

→12/08

OE201 0,9 CET6 BAEA474

01/09→

1.4 CVT 4 G4FA 66/89 07/09→ OE201 0,9 CET6 BAEA475

1.4 CVT 4 G4FA 73/98 05/12→ OE201 0,9 CET6 BAEA475



KIA



kW/BHP



eon TITAN

IRIDIUM



...KIA



...CEE'D

| | | | | | | | | | | |
|--------------|---|--------|---------|-------------|------------------------------------|------------|--------------|-----------------|--|--------|
| 1.6 | 4 | G4FC | 85/114 | 09/07→12/12 | OE063 →12/08 OE201 01/09→ | 1,0 0,9 | CET2 CET6 | OE180 →12/08 | BAEA474 →04/09 BAEA475 04/09→ | |
| 1.6 | 4 | G4FC | 90/121 | 12/06→12/12 | OE063 →12/08 OE201 01/09→ | 1,0 0,9 | CET2 CET6 | OE180 →12/08 | BAEA474 →03/09 BAEA475 04/09→ | |
| 1.6 | 4 | G4FC | 93/125 | 09/07→12/12 | OE063 →12/08 OE201 01/09→ | 1,0 0,9 | CET2 CET6 | OE180 →12/08 | BAEA474 →03/09 BAEA475 04/09→ | |
| 1.6 CVT | 4 | G4FC | 92/123 | 06/09→ | OE201 | 0,9 | CET6 | | BAEA475 BAEA475 [275] [342] | |
| 1.6 CVT | 4 | G4FC | 95/127 | 01/13→ | | | | | BAEA475 [275] [342] | |
| 1.6 CVT | 4 | G4FC | 96/129 | 11/14→ | | | | | BAEA475 [275] [342] | |
| 2.0 | 4 | G4GC | 105/141 | 12/06→12/12 | | | CET12P | OE180 | | CLS094 |
| 2.0 CRDi | 4 | D4EA | 100/134 | 06/07→12/12 | CH226 | 11v | | | | |
| 2.0 CRDi 140 | 4 | D4EA-F | 103/138 | 09/07→12/12 | CH226 | 11v | | | | |

CERATO

| | | | | | | | | | | |
|----------|---|------|---------|-------------|------------------------------------|------------|--------------|-----------------|--|--------|
| 1.5 CRDi | 4 | D4FA | 75/101 | 07/05→ | CH226 | 11v | | | | |
| 1.6 | 4 | | 75/101 | 04/04→12/09 | | | | | BAEA483 →Prod.19.10.2006 BAEA474 Prod.04.09.2006→ Prod.25.01.2008 BAEA475 Prod.10.06.2008→ | |
| 1.6 | 4 | G4ED | 77/103 | 04/04→ | OE063 | 1,0 | CET2 | OE180 | BAEA483 ^[119] →10/06 BAEA474 ^[120] 11/06→ | CLS024 |
| 1.6 | 4 | G4FC | 90/121 | 04/04→ | OE063 →12/08 OE201 01/09→ | 1,0 0,9 | CET2 CET6 | OE180 →12/08 | BAEA474 →01/08 BAEA475 02/08→ | |
| 1.6 MPi | 4 | G4FC | 96/129 | 06/13→ | OE201 | 0,9 | | | BAEA475 | |
| 1.8 | 4 | T8 | 85/114 | 10/01→07/04 | OE063 | 1,0 | CET2 | | BAEA433 | |
| 1.8 | 4 | G4GB | 93/125 | 09/01→ | OE063 | 1,0 | CET2 | OE180 | | |
| 2.0 | 4 | G4GC | 105/141 | 04/04→ | OE063 | 1,0 | CET2 | OE180 | BAEA482 ^[118] | CLS094 |
| 2.0 CRDi | 4 | D4EA | 83/111 | 04/04→ | CH226 | 11v | | | | |

CERATO II

| | | | | | | | | | | |
|---------|---|------|---------|--------|-------|-----|------|-------|--------------------------|--|
| 1.6 | 4 | G4FC | 90/121 | 01/10→ | OE201 | 0,9 | CET6 | | BAEA475 | |
| 1.6 | 4 | G4FC | 91/122 | 02/09→ | OE201 | 0,9 | | | | |
| 1.6 | 4 | G4FC | 93/125 | 01/10→ | OE201 | 0,9 | CET6 | | BAEA475 | |
| 1.6 CVT | 4 | G4FC | 91/122 | 02/09→ | OE201 | 0,9 | CET6 | | BAEA475 | |
| 2.0 | 4 | G4KD | 115/154 | 01/09→ | OE148 | 1,0 | CET5 | OE190 | BAEA548 ^[275] | |

CERATO KOUP

| | | | | | | | | | | |
|---------|---|------|---------|--------|-------|-----|------|-------|--------------------------|--|
| 1.6 CVT | 4 | G4FC | 91/122 | 10/09→ | OE201 | 0,9 | CET6 | | BAEA475 | |
| 2.0 | 4 | G4KD | 115/154 | 01/09→ | OE148 | 1,0 | CET5 | OE190 | BAEA548 ^[275] | |

CLARUS

| | | | | | | | | | | |
|-----------|---|---------|--------|--------|-------|-----|------|-------|---------|--------|
| 1.8 i 16V | 4 | T8 | 85/114 | 07/96→ | OE063 | 1,0 | CET2 | OE180 | BAEA433 | CLS173 |
| 2.0 i 16V | 4 | FE(16V) | 98/131 | 07/96→ | OE039 | 1,0 | CET2 | OE180 | | |

JOICE

| | | | | | | | | | | |
|-----|---|------|---------|--------|-------|-----|------|-------|------------------------------------|--|
| 2.0 | 4 | G4CP | 88/118 | 09/01→ | OE006 | 0,9 | CET8 | OE195 | BAEA521 ^[277] →02/03 | |
| 2.0 | 4 | G4CP | 102/137 | 02/00→ | OE006 | 0,9 | CET8 | OE195 | BAEA521 ^[277] | |





kW/BHP

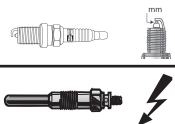

eon TITAN

IRIDIUM

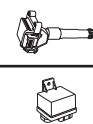

...KIA



MAGENTIS

| | | | | | | | | | | |
|----------|---|--------|---------|-------------|-------|-----|--------|-------|--------------------------|--------|
| 2.0 | 4 | G4JP | 100/134 | 05/01→09/05 | OE048 | 1,0 | CET8 | OE195 | BAEA502E ^[13] | |
| 2.0 | 4 | G4KA | 106/142 | 11/05→ | | | CET12P | OE180 | BAEA531 | |
| | | | | | | | | | BAEA548 ^[275] | |
| 2.0 | 4 | G4KD | 121/162 | 07/09→ | OE148 | 1,0 | CET5 | OE190 | BAEA548 | |
| 2.0 CRDi | 4 | D4EA | 100/134 | 11/05→12/08 | CH226 | 11v | | | | |
| 2.0 CRDi | 4 | D4EA-F | 103/138 | 04/06→ | CH226 | 11v | | | | |
| 2.0 CRDi | 4 | D4EA-F | 110/148 | 04/06→ | CH226 | 11v | | | | |
| 2.5 V6 | 6 | G6BV | 124/166 | 05/01→ | | | CET12P | OE180 | BAEA269 | CLS189 |
| 2.7 | 6 | G6EA | 138/185 | 11/05→ | | | CET14P | OE190 | | |
| 2.7 V6 | 6 | G6EA | 142/190 | 07/09→ | | | CET14P | OE190 | | |

OPIRUS

| | | | | | | | | | | |
|--------|---|------|---------|--------|--|--|--------|-------|---------|--|
| 2.7 | 6 | G6EA | 139/186 | 10/06→ | | | CET14P | OE190 | | |
| 3.3 | 6 | | 173/232 | 10/06→ | | | CET12P | OE180 | | |
| 3.5 | 6 | G6CU | 149/200 | 09/03→ | | | CET12P | OE180 | | |
| 3.8 V6 | 6 | G6DA | 196/263 | 10/06→ | | | CET12P | OE180 | BAEA531 | |

OPTIMA

| | | | | | | | | | | |
|----------------|---|------|---------|--------|-------|-----|--|-------|--------------------------|--|
| 2.0 | 4 | G4KD | 125/168 | 03/12→ | | | | OE249 | BAEA548 | |
| 2.0 | 4 | G4KH | 204/274 | 03/12→ | | | | | BAEA548 ^[275] | |
| 2.0 CVL | 4 | G4KD | 121/162 | 03/12→ | | | | OE249 | BAEA548 | |
| 2.0 CVT Hybrid | 4 | G4NE | 110/148 | 03/12→ | | | | | BAEA548 | |
| 2.4 | 4 | G4KJ | 132/177 | 03/12→ | OE148 | 1,0 | | | BAEA548 | |

PICANTO

| | | | | | | | | | | |
|--------------|---|--------|-------|-------------|-------|-----|------|-------|--|--------|
| 1.0 | 3 | G3LA | 51/68 | 05/11→ | OE197 | 0,9 | CET6 | | BAEA476 ^[116] | |
| 1.0 | 4 | G4HE | 45/60 | 04/04→ | OE063 | 1,0 | CET2 | OE180 | BAEA477 ^[113] →Prod.31.10.2007 | CLS093 |
| 1.0 | 4 | G4HE | 46/62 | 09/07→ | OE063 | 1,0 | CET2 | OE180 | BAEA477 ^[113] →Prod.31.10.2007 | CLS093 |
| 1.0, 1.0 LPG | 4 | ; G4HC | 53/71 | 04/04→04/11 | | | | | BAEA477 ^[113] →Prod.31.10.2007 | |
| 1.0 Bi-Fuel | 3 | B3LA | 60/80 | 05/11→ | | | | | BAEA476 ^[116] | |
| 1.1 | 4 | G4HG | 48/64 | 04/04→ | OE063 | 1,0 | CET2 | OE180 | BAEA477 ^[113] →Prod.31.10.2007 | CLS093 |
| 1.2 | 4 | G4LA | 63/84 | 09/11→ | OE197 | 0,9 | CET6 | | | |

PRIDE

| | | | | | | | | | | |
|------------|---|------|--------|-------------|-------|-----|------|-------|--|--------|
| 1.3 | 4 | B3A5 | 47/63 | 08/99→05/01 | OE006 | 0,9 | CET8 | OE195 | | |
| 1.3 | 4 | | 54/72 | 05/94→05/97 | OE006 | 0,9 | CET8 | | | CLS258 |
| 1.3 16V | 4 | B3 | 47/63 | 10/96→05/01 | OE006 | 0,9 | CET8 | OE195 | | CLS258 |
| 1.4 LX | 4 | G4EE | 71/95 | 03/05→12/11 | | | CET2 | OE179 | | CLS197 |
| 1.6 CVT LX | 4 | G4ED | 82/110 | 03/05→12/11 | OE063 | 1,0 | CET2 | OE180 | | |

PRO CEE'D

| | | | | | | | | | | |
|-----------|---|------|--------|-------------|-----------------|-----|------|-----------------|--------------------------|--|
| 1.0 T-GDI | 3 | G3LC | 74/99 | 07/15→ | | | | OE248 | | |
| 1.0 T-GDI | 3 | G3LC | 88/118 | 07/15→ | | | | OE248 | | |
| 1.4 | 4 | G4FA | 77/103 | 02/08→09/12 | OE201 | 0,9 | CET6 | | BAEA475 ^[275] | |
| 1.4 | 4 | G4FA | 80/107 | 02/08→09/12 | OE063 →12/08 | 1,0 | CET2 | OE180 →12/08 | BAEA474 | |
| | | | | | OE201 01/09→ | 0,9 | CET6 | | | |
| 1.4 CVT | 4 | G4FA | 66/89 | 06/10→09/12 | OE201 | 0,9 | CET6 | | BAEA475 | |
| 1.4 CVT | 4 | G4FA | 73/98 | 03/13→ | OE201 | 0,9 | CET6 | | BAEA475 | |
| 1.6 | 4 | G4FC | 90/121 | 02/08→09/12 | OE063 →12/08 | 1,0 | CET2 | OE180 →12/08 | BAEA474 →03/09 | |
| | | | | | OE201 01/09→ | 0,9 | CET6 | | BAEA475 ^[275] | |
| 1.6 | 4 | G4FC | 93/125 | 02/08→09/12 | OE063 →12/08 | 1,0 | CET2 | OE180 →12/08 | BAEA474 →03/09 | |
| | | | | | OE201 01/09→ | 0,9 | CET6 | | BAEA475 ^[275] | |

KIA





kW/BHP

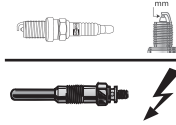

eon TITAN

IRIDIUM

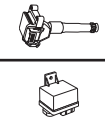

...KIA



...PRO CEE'D

| | | | | | | | | | | |
|--------------|---|--------|---------|---------------|-------|-----|--------|-------|--------------------------|--------|
| 1.6 CVT | 4 | G4FC | 92/123 | 10/10 → 02/13 | OE201 | 0,9 | CET6 | | BAEA475 ^[275] | |
| 1.6 GDI | 4 | G4FD | 99/133 | 03/13 → | | | | | BAEA475 | |
| 1.6 GT | 4 | G4FJ | 150/201 | 06/13 → | | | | | BAEA475 | |
| 2.0 | 4 | G4GC | 105/141 | 02/08 → 09/12 | OE063 | 1,0 | CET2 | OE180 | | CLS094 |
| 2.0 CRDi 140 | 4 | D4EA-F | 103/138 | 02/08 → 09/12 | CH226 | 11v | | | | |
| 2.0 LPG | 4 | G4GC | 105/141 | 01/09 → 12/09 | OE191 | 1,0 | CET12P | | | CLS094 |

QUORIS

| | | | | | | | | | | |
|-----|---|--|---------|---------|--|--|--------|-------|--|--|
| 3.3 | 6 | | 221/296 | 11/12 → | | | CET14P | OE190 | | |
|-----|---|--|---------|---------|--|--|--------|-------|--|--|

RETONA

| | | | | | | | | | | |
|-------------|---|---------|--------|---------|-------|-----|------|-------|--------------------------|--|
| 2.0 16V 4WD | 4 | FE(16V) | 94/126 | 05/00 → | OE039 | 1,0 | CET2 | OE180 | BAEA434 ^[277] | |
| 2.0 TD 4WD | 4 | RF | 61/82 | 06/99 → | CH242 | 11v | | | | |

RIO

| | | | | | | | | | | |
|---------|---|-----|-------|---------------|-----------------|------|------|-------|---------|--------|
| 1.3 | 4 | A3E | 55/74 | 08/00 → 02/05 | OE089 | 1,0 | CET2 | OE184 | BAEA561 | CLS009 |
| 1.3 | 4 | A3E | 60/80 | 08/00 → 02/05 | OE006 | 0,9 | CET8 | OE195 | BAEA561 | |
| | | | | | OE049 | 1,0 | | | | |
| | | | | | OE006 | 0,9 | | | | |
| | | | | | LPG [266] [279] | | | | | |
| 1.5 | 4 | A5D | 70/94 | 09/02 → 02/05 | OE039 | 1,0 | CET2 | | BAEA486 | CLS256 |
| 1.5 16V | 4 | A5D | 71/95 | 09/02 → 02/05 | | | CET2 | OE179 | BAEA486 | CLS256 |
| 1.5 16V | 4 | A5D | 72/97 | 08/00 → 02/05 | OE034 | 0,8* | CET2 | OE179 | BAEA486 | CLS256 |
| | | | | | *to be adjusted | | | | | |

RIO II

| | | | | | | | | | | |
|------------------|---|------|--------|---------|-------|-----|------|-------|---------------|--------|
| 1.4 16V | 4 | G4EE | 71/95 | 03/05 → | | | CET2 | OE179 | BAEA483 | CLS197 |
| | | | | | | | | | 04/05 → 12/06 | |
| 1.6 16V, 1.6 CVT | 4 | G4ED | 82/110 | 03/05 → | OE063 | 1,0 | CET2 | OE180 | BAEA483 | CLS256 |
| | | | | | | | | | 04/05 → 12/06 | |

RIO III

| | | | | | | | | | | |
|------------------|---|------|--------|---------|------------------|-----|------------------|--|--------------------------|--|
| 1.2 CVT | 4 | G4LA | 62/83 | 11/14 → | | | | | BAEA536 ^[115] | |
| 1.3 CVT | 4 | G4LA | 65/87 | 06/11 → | OE197 | 0,9 | CET6 | | | |
| | | | | | →Prod.20.05.2012 | | →Prod.20.05.2012 | | | |
| 1.3 CVT, 1.3 LPG | 4 | G4LA | 63/84 | 09/11 → | OE197 | 0,9 | CET6 | | | |
| | | | | | →Prod.20.05.2012 | | →Prod.20.05.2012 | | | |
| 1.4 CVT | 4 | G4FA | 79/106 | 06/11 → | OE201 | 0,9 | CET6 | | BAEA475 ^[275] | |
| | | | | | | | | | BAEA475 | |
| 1.4 CVT | 4 | G4FA | 80/107 | 09/11 → | OE201 | 0,9 | CET6 | | BAEA475 ^[275] | |
| 1.6 CVT | 4 | G4FC | 90/121 | 06/12 → | OE201 | 0,9 | | | BAEA475 ^[366] | |
| | | | | | | | | | BAEA475 | |

ROADSTER

| | | | | | | | | | | |
|-----|---|--|---------|---------|-------|-----|------|-------|--|--|
| 1.8 | 4 | | 100/134 | 08/99 → | OE048 | 1,0 | CET8 | OE195 | | |
|-----|---|--|---------|---------|-------|-----|------|-------|--|--|

SEDONA

| | | | | | | | | | | |
|---------|---|------|---------|---------|--|--|--------|-------|--|--|
| 3.3 | 6 | G6DF | 196/263 | 01/15 → | | | CET14P | OE190 | | |
| 3.3 GDI | 6 | G6DH | 206/276 | 09/14 → | | | CET14P | OE190 | | |

SEPHIA

| | | | | | | | | | | |
|-----------|---|--------------|--------|---------------|-------|-----|------|-------|---------|--------|
| 1.5 i | 4 | B5 | 59/79 | 02/96 → 10/97 | OE006 | 0,9 | CET8 | OE195 | | CLS131 |
| 1.6 i | 4 | B6 | 59/79 | 09/93 → 10/97 | OE048 | 1,0 | CET8 | OE195 | | CLS131 |
| 1.8 i 16V | 4 | OK24N; OK26Y | 82/110 | 01/95 → 10/97 | OE005 | 0,9 | CET2 | OE179 | BAEA433 | CLS173 |

SHUMA

| | | | | | | | | | | |
|-----------|---|------------|--------|---------------|-------|-----|------|-------|---------|--------|
| 1.5 | 4 | OK280 | 59/79 | 03/96 → 12/98 | OE005 | 0,9 | CET2 | OE180 | | CLS131 |
| | | | | | OE039 | 1,0 | | | | |
| 1.5 i 16V | 4 | BFD; ZY-VE | 65/87 | 10/97 → 10/01 | | | CET8 | OE195 | | CLS157 |
| 1.6 | 4 | GA6D | 75/101 | 01/01 → 12/01 | OE005 | 0,9 | CET2 | OE180 | BAEA486 | |
| | | | | | OE063 | 1,0 | | | | |
| 1.8 GX | 4 | | 85/114 | 05/99 → 10/01 | OE063 | 1,0 | CET2 | OE180 | | |
| 1.8 i 16V | 4 | T8 | 81/109 | 10/97 → 03/01 | | | CET8 | OE195 | BAEA433 | CLS173 |





kW/BHP



eon TITAN

IRIDIUM

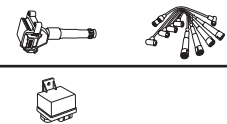

...KIA



SHUMA II

| | | | | | | | | | | |
|-----|---|------|--------|-------------|---|------------|------|-------|---------|--------|
| 1.6 | 4 | GA6D | 75/101 | 05/01→08/04 | OE063 <small>*to be adjusted</small> | 0,7* | CET2 | OE180 | BAEA486 | CLS256 |
| 1.8 | 4 | T8 | 81/109 | 05/01→06/04 | OE063 | 1,0 | CET2 | | | |
| 1.8 | 4 | T8 | 84/113 | 04/03→08/04 | OE005 OE063 | 0,9 1,0 | CET2 | OE180 | BAEA433 | CLS173 |

SORENTO I

| | | | | | | | | | | |
|--------------|---|------|---------|-------------|-------|-----|--------|-------|--------------------------|--|
| 2.4 4WD | 4 | G4JS | 102/137 | 08/02→ | OE192 | 1,0 | CET8 | OE195 | BAEA502E ^[13] | |
| 2.5 CRDi | 4 | D4CB | 131/176 | 09/06→ | CH234 | 11v | | | | |
| 2.5 CRDi 4WD | 4 | D4CB | 103/138 | 08/02→ | CH234 | 11v | | | | |
| 2.5 CRDi 4WD | 4 | D4CB | 120/161 | 05/06→ | CH234 | 11v | | | | |
| 2.5 CRDi 4WD | 4 | D4CB | 125/168 | 12/06→ | CH234 | 11v | | | | |
| 3.3 | 6 | G6DB | 182/244 | 09/08→12/09 | | | CET12P | OE180 | | |
| 3.3, 3.3 4WD | 6 | G6DB | 180/241 | 09/07→12/09 | | | CET12P | OE180 | | |
| 3.3 V6 4WD | 6 | | 177/237 | 12/06→ | | | CET12P | OE180 | | |
| 3.3 V6 4WD | 6 | G6DB | 182/244 | 02/07→ | | | CET12P | OE180 | BAEA531 | |
| 3.5 V6 4WD | 6 | G6CU | 143/192 | 08/02→ | | | CET12P | OE180 | | |

SORENTO II

| | | | | | | | | | | |
|----------------------|---|------|---------|--------|-------|-----|--------|-------|--------------------------|--|
| 2.4 CVT, 2.4 CVT 4WD | 4 | G4KE | 128/172 | 11/09→ | OE148 | 1,0 | CET5 | OE190 | BAEA548 | |
| 2.4 CVT, 2.4 CVT 4WD | 4 | | 141/189 | 10/12→ | | | | | BAEA548 | |
| 2.4 GDI, 2.4 GDI 4WD | 4 | G4KJ | 141/189 | 10/12→ | | | | | BAEA548 ^[275] | |
| 3.3 GDI, 3.3 GDI 4WD | 6 | G6DH | 216/290 | 09/13→ | | | CET14P | OE190 | | |

SORENTO III

| | | | | | | | | | | |
|---------|---|--|---------|--------|--|--|--------|-------|--|--|
| 3.3 4WD | 6 | | 196/263 | 01/15→ | | | CET14P | OE190 | | |
|---------|---|--|---------|--------|--|--|--------|-------|--|--|

SOUL

| | | | | | | | | | | |
|---------|---|------|--------|-------------|-------|-----|------|--|--------------------------|--|
| 1.6 | 4 | G4FG | 91/122 | 09/09→12/10 | | | | | BAEA475 | |
| 1.6 CVT | 4 | G4FC | 77/103 | 02/09→ | OE201 | 0,9 | CET6 | | BAEA475 ^[275] | |
| 1.6 CVT | 4 | G4FC | 93/125 | 02/09→ | OE201 | 0,9 | CET6 | | BAEA475 ^[121] | |
| 1.6 CVT | 4 | G4FC | 95/127 | 03/12→ | OE201 | 0,9 | CET6 | | BAEA475 | |

SOUL II

| | | | | | | | | | | |
|---------|---|------|---------|--------|--|--|--|-------|--|--|
| 1.6 GDI | 4 | G4FD | 97/130 | 02/14→ | | | | OE250 | | |
| 2.0 CVT | 4 | G4NA | 113/152 | 02/14→ | | | | OE249 | | |

SPORTAGE

| | | | | | | | | | | |
|------------------------|---|---------|---------|-------------|---|------|--------|-------|---|--------|
| 2.0, 2.0 4WD | 4 | FE(16V) | 87/117 | 10/00→08/03 | | | CET2 | OE179 | BAEA434 ^[277] | |
| 2.0 16V 4WD, 2.0 i 16V | 4 | G4GC | 104/139 | 09/04→ | | | CET12P | OE180 | | CLS094 |
| 2.0 CRDi, 2.0 CRDi 4WD | 4 | D4EA | 83/111 | 09/04→ | CH226 | 11v | | | | |
| 2.0 CRDi, 2.0 CRDi 4WD | 4 | D4EA | 100/134 | 01/06→ | CH226 | 11v | | | | |
| 2.0 CRDi, 2.0 CRDi 4WD | 4 | D4EA-F | 103/138 | 01/06→ | CH226 | 11v | | | | |
| 2.0 CRDi, 2.0 CRDi 4WD | 4 | D4EA-F | 110/148 | 09/07→ | CH226 | 11v | | | | |
| 2.0 CVT | 4 | G4KD | 122/164 | 07/10→ | OE148 | 1,0 | CET5 | OE190 | BAEA548 | |
| 2.0 CVT, 2.0 CVT 4WD | 4 | G4KD | 120/161 | 07/10→ | OE148 | 1,0 | CET5 | OE190 | BAEA548 | |
| 2.0 CVT 4WD | 4 | G4KD | 110/148 | 06/10→12/13 | | | | | BAEA548 | |
| 2.0 CVT 4WD | 4 | G4KD | 122/164 | 07/10→ | OE148 | 1,0 | | | BAEA548 ^[275] | |
| 2.0 i 4WD | 4 | FE(8V) | 70/94 | 04/94→08/99 | OE005 <small>*to be adjusted</small> | 0,7* | CET2 | OE180 | BAEA234 | |
| 2.0 i 16V | 4 | FE(16V) | 94/126 | 10/99→08/03 | | | CET2 | OE179 | BAEA434 ^[277] | |
| 2.0 i 16V 4WD | 4 | FE(16V) | 94/126 | 04/94→08/03 | | | CET2 | OE179 | BAEA234 →11/98 BAEA434 ^[277] 12/98→ | |
| 2.0 TD 4WD | 4 | RF | 61/82 | 10/97→08/03 | CH242 →10/98 | 11v | | | | |
| 2.2 D 4WD | 4 | | 52/70 | 08/94→04/99 | CH242 →10/98 | 11v | | | | |
| 2.4 i 4WD | 4 | G4KE | 130/174 | 08/10→ | OE148 | 1,0 | CET5 | OE190 | | |
| 2.7 V6 4WD | 6 | G6BA | 129/173 | 09/04→ | | | CET12P | OE180 | BAEA555 | |

KIA





kW/BHP





eon TITAN

IRIDIUM



KIA

| ...KIA  | | | | | | | | | |
|--|---|-----------|---------|-------------|------------------------------------|------|------|-------|--------------------------|
| VENGA | | | | | | | | | |
| 1.4 CVT | 4 | G4FA | 66/89 | 02/10→ | OE201 | 0,9 | CET6 | | BAEA475 ^[275] |
| 1.6 CVT | 4 | G4FC | 92/123 | 02/10→ | OE201 | 0,9 | CET6 | | BAEA475 ^[275] |
| KIA  | | | | | | | | | |
| K2500 | | | | | | | | | |
| 2.5 D | 4 | D4BH | 69/93 | 01/03→ | CH256 →08/03 | 11v | | | |
| | | | | | CH225 09/03→ | 11v | | | |
| K2700 | | | | | | | | | |
| 2.7 D | 4 | J2 | 59/79 | 10/99→ | CH242 | 11v | | | |
| 2.7 D | 4 | J2 | 61/82 | 03/97→ | CH242 | 11v | | | |
| PREGIO | | | | | | | | | |
| 2.5 D | 4 | D4BH | 69/93 | 08/95→09/04 | CH256 →11/03 | 11v | | | |
| 2.5 TGi D | 4 | D4BH | 69/93 | 09/02→ | CH256 →08/03 | 11v | | | |
| | | | | | CH225 08/03→ | 11v | | | |
| 2.7 D | 4 | J2 | 60/80 | 10/97→ | CH242 | 11v | | | |
| PRIDE Van | | | | | | | | | |
| 1.3 16V | 4 | B3 | 47/63 | 10/96→06/99 | OE006 | 0,9 | CET8 | | |
| LADA  | | | | | | | | | |
| 110 | | | | | | | | | |
| 1.5 | 4 | BA32111 | 52/70 | 06/96→09/04 | OE006 | 0,9 | CET8 | OE195 | |
| 1.5 | 4 | ; BA32111 | 54/72 | 01/95→12/12 | OE006 | 0,9 | CET8 | OE195 | |
| 1.5 | 4 | VAZ-2111 | 56/75 | 10/00→12/05 | OE006 | 0,9 | CET8 | OE195 | |
| 1.5 | 4 | VAZ-2111 | 57/76 | 01/95→12/05 | OE048 | 1,0 | CET8 | OE195 | |
| 1.5 16V | 4 | VAZ-2112 | 67/90 | 10/00→12/10 | OE039 | 1,0 | CET2 | OE180 | |
| 1.5 16V | 4 | VAZ-2112 | 70/94 | 01/95→12/05 | OE006 →09/00 *to be adjusted | 0,7* | CET2 | OE180 | |
| | | | | | OE039 | 1,0 | | | |
| 1.6 | 4 | VAZ-21114 | 60/80 | 01/00→12/12 | OE048 | 1,0 | CET8 | OE195 | BAEA395 01/05→ |
| 1.6 | 4 | VAZ-21124 | 66/89 | 01/00→04/07 | OE039 | 1,0 | CET2 | OE179 | |
| 2.0 i | 4 | C20XE | 110/148 | 08/96→07/00 | OE019 | 0,9 | CET2 | OE184 | |
| 2.6 Wankel | 2 | VAZ-415 | 88/118 | 06/97→09/04 | OE091 | 0,7 | | | |
| 111 | | | | | | | | | |
| 1.5 | 4 | BA32111 | 52/70 | 01/97→12/03 | OE048 ^[313] | 1,0 | | | |
| 1.5 | 4 | VAZ-2111 | 56/75 | 10/00→12/05 | OE006 | 0,9 | CET8 | OE195 | |
| 1.5 | 4 | VAZ-2111 | 57/76 | 01/96→12/05 | OE048 | 1,0 | CET8 | OE195 | |
| 1.5 | 4 | VAZ-2111 | 58/78 | 10/00→09/04 | OE048 | 1,0 | CET8 | OE195 | |
| 1.5 16V | 4 | VAZ-2112 | 67/90 | 10/00→12/05 | OE006 | 0,9 | CET8 | OE195 | |
| 1.5 16V | 4 | VAZ-2112 | 70/94 | 01/95→08/02 | OE006 →09/00 *to be adjusted | 0,7* | CET2 | OE180 | |
| | | | | | OE039 | 1,0 | | | |
| 1.6 | 4 | VAZ-21114 | 60/80 | 09/04→12/13 | OE039 | 1,0 | CET2 | OE179 | BAEA395 |
| 1.6 | 4 | VAZ-21124 | 66/89 | 09/04→ | OE039 | 1,0 | CET2 | OE179 | BAEA395 |
| 112 | | | | | | | | | |
| 1.5 | 4 | VAZ-2111 | 54/72 | 01/95→10/00 | OE006 | 0,9 | CET8 | OE195 | |
| 1.5 | 4 | VAZ-2111 | 56/75 | 10/00→12/05 | OE006 | 0,9 | CET8 | OE195 | |
| 1.5 | 4 | VAZ-2111 | 57/76 | 01/95→09/04 | OE048 | 1,0 | CET8 | OE195 | |
| 1.5 16V | 4 | VAZ-2112 | 67/90 | 10/00→12/05 | OE006 | 0,9 | CET8 | OE195 | |





kW/BHP



eon TITAN

IRIDIUM

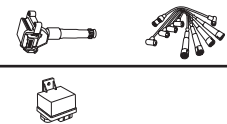
**...LADA****...112**

| | | | | | | | | | |
|---------|---|-----------|-------|-------------|----------------|------------|------|-------|--|
| 1.5 16V | 4 | VAZ-2112 | 70/94 | 01/95→09/00 | OE006 OE039 | 0,9 1,0 | CET2 | OE180 | |
| 1.6 | 4 | VAZ-21114 | 60/80 | 01/05→12/11 | OE039 | 1,0 | CET2 | OE179 | |
| 1.6 | 4 | VAZ-21124 | 66/89 | 03/06→12/08 | OE039 | 1,0 | CET2 | OE179 | |

GRANTA

| | | | | | | | | | |
|-----|---|-----------|-------|--------|----------------|------------|------|-------|--------------------------|
| 1.6 | 4 | VAZ-11183 | 60/80 | 10/11→ | OE039 | 1,0 | CET2 | OE179 | BAEA395 ^[275] |
| 1.6 | 4 | VAZ-11186 | 64/86 | 10/11→ | OE039 OE048 | 1,0 1,0 | CET2 | OE179 | BAEA395 ^[275] |
| 1.6 | 4 | VAZ-21126 | 72/97 | 10/11→ | OE039 | 1,0 | CET2 | OE179 | |

GRANTA (2349)

| | | | | | | | | | |
|-----|---|-----------|-------|--------|-------|-----|------|--|--|
| 1.6 | 4 | VAZ-11186 | 64/86 | 10/11→ | OE039 | 1,0 | CET2 | | |
|-----|---|-----------|-------|--------|-------|-----|------|--|--|

KALINA

| | | | | | | | | | |
|-------------|---|-----------|-------|-------------|----------------|------------|--------------|----------------|--------------------------|
| 1.4 16V | 4 | VAZ-11194 | 66/89 | 11/08→12/13 | OE039 | 1,0 | CET2 | OE179 | |
| 1.4 16V LPG | 4 | VAZ-11194 | 65/87 | 11/08→ | OE039 | 1,0 | CET2 | OE179 | |
| 1.6 | 4 | VAZ-21124 | 60/80 | 10/04→ | OE039 | 1,0 | CET2 | OE179 | |
| 1.6 | 4 | VAZ-21114 | 60/80 | 10/04→ | OE039 OE048 | 1,0 1,0 | CET2 CET8 | OE179 OE195 | BAEA395 |
| 1.6 | 4 | VAZ1110 | 62/83 | 01/10→ | OE039 | 1,0 | CET2 | OE179 | BAEA395 ^[275] |
| 1.6 | 4 | VAZ-11186 | 64/86 | 06/13→ | OE039 | 1,0 | CET2 | OE179 | |
| 1.6 | 4 | VAZ-11186 | 66/89 | 10/04→ | OE039 OE048 | 1,0 1,0 | CET2 CET8 | OE179 OE195 | BAEA395 |
| 1.6 | 4 | VAZ-21126 | 72/97 | 10/04→ | OE039 | 1,0 | CET2 | OE179 | |

LARGUS

| | | | | | | | | | |
|-----|---|---------|--------|--------|----------------|------------|------|-------|---------|
| 1.6 | 4 | VAZ-K7M | 62/83 | 03/12→ | OE048 | 1,0 | CET8 | OE195 | BAEA354 |
| 1.6 | 4 | VAZ-K4M | 77/103 | 03/12→ | OE033 OE034 | 0,9 0,9 | CET2 | OE179 | |

NADESHDA

| | | | | | | | | | |
|-----------|---|------------|-------|-------------|-------|-----|------|-------|--------|
| 1.7 4WD | 4 | VAZ-2121.3 | 60/80 | 12/97→12/06 | OE048 | 1,0 | CET8 | OE195 | CLS147 |
| 1.7 i 4WD | 4 | BA321214 | 59/79 | 12/97→12/06 | OE048 | 1,0 | CET8 | OE195 | |
| 1.8 4WD | 4 | VAZ-2130 | 60/80 | 12/97→12/06 | OE048 | 1,0 | CET8 | OE195 | CLS147 |
| 1.8 i 4WD | 4 | VAZ-2130.1 | 67/90 | 12/97→12/06 | OE048 | 1,0 | CET8 | OE195 | |

NIVA

| | | | | | | | | | | |
|---------------------|---|----------------------|-------|-------------|-------|-----|------|-------|---------|--------|
| 1.7 1700 i 4WD | 4 | BA321214; VAZ-2121.3 | 59/79 | 06/96→12/06 | OE048 | 1,0 | CET8 | OE195 | BAEA395 | CLS147 |
| 1.7 1700 i 4WD | 4 | BA321214 | 60/80 | 10/00→12/10 | OE006 | 0,9 | CET8 | OE195 | BAEA395 | CLS147 |
| 1.7 1700 i 4WD | 4 | BA321214 | 61/82 | 09/10→ | OE006 | 0,9 | CET8 | OE195 | BAEA395 | CLS147 |
| 1.9 1900 Diesel 4WD | 4 | XUD9A | 48/64 | 01/93→08/99 | CH189 | 11v | | | | |
| 1.9 1900 Diesel 4WD | 4 | XUD9SD | 55/74 | 01/99→12/06 | CH189 | 11v | | | | |

NIVA II

| | | | | | | | | | | |
|-------------|---|----------|-------|--------|-------|-----|------|-------|---------|--------|
| 1.7 4WD | 4 | BA321214 | 59/79 | 09/02→ | OE006 | 0,9 | CET8 | OE195 | BAEA395 | |
| 1.7 4WD | 4 | BA321214 | 61/82 | 08/04→ | OE006 | 0,9 | CET8 | OE195 | BAEA395 | CLS147 |
| 1.7 LPG 4WD | 4 | BA321214 | 57/76 | 09/02→ | OE006 | 0,9 | CET8 | OE195 | BAEA395 | |

NOVA

| | | | | | | | | | | |
|------------------------------|---|---------|-------|-------------|-------|-----|------|-------|---------|-----------|
| 1.5 1500 | 4 | BA32103 | 49/66 | 05/93→04/12 | OE001 | 0,9 | CET8 | OE195 | BAEA115 | [8] [275] |
| 1.7 1700, 1.7 1700 i Classic | 4 | B032123 | 62/83 | 08/94→04/12 | OE001 | 0,9 | CET8 | OE195 | BAEA234 | |

OKA

| | | | | | | | | | | |
|-----|---|--|-------|-------------|-------|-----|--|--|--|--|
| 0.8 | 2 | | 24/32 | 08/96→09/07 | OE003 | 0,9 | | | | |
|-----|---|--|-------|-------------|-------|-----|--|--|--|--|

PRIORA

| | | | | | | | | | | |
|-----|---|-----------|-------|-------------|-------|-----|------|-------|--------------------------|--|
| 1.6 | 4 | | 60/80 | 12/08→12/13 | OE048 | 1,0 | CET8 | OE195 | BAEA395 | |
| 1.6 | 4 | VAZ-21116 | 66/89 | 01/11→12/13 | | | | | BAEA395 ^[275] | |
| 1.6 | 4 | VAZ-21126 | 72/97 | 04/07→ | OE039 | 1,0 | CET2 | OE179 | | |

LADA





kW/BHP



eon TITAN

IRIDIUM



LADA

...LADA**...PRIORA**

| | | | | | | | | | |
|---------|---|-----------|-------|---------|-------|-----|------|-------|--|
| 1.6 LPG | 4 | VAZ-21126 | 71/95 | 12/08 → | OE048 | 1,0 | CET8 | OE195 | |
|---------|---|-----------|-------|---------|-------|-----|------|-------|--|

SAMARA

| | | | | | | | | | |
|----------|---|----------|-------|---------------|--------------------------|------|------|-------|--|
| 1.1 1100 | 4 | BA321081 | 43/58 | 02/96 → 08/99 | OE006 *to be adjusted | 0,7* | CET8 | OE195 | |
|----------|---|----------|-------|---------------|--------------------------|------|------|-------|--|

| | | | | | | | | | |
|----------|---|----------|-------|---------------|-----------------------------------|-------------|------|-------|---|
| 1.3 1300 | 4 | BA321115 | 50/67 | 02/96 → 12/06 | OE001 OE006 *to be adjusted | 0,9 0,7* | CET8 | OE195 | BAEA115 ^[8] BAEA115 ^[8] [275] |
|----------|---|----------|-------|---------------|-----------------------------------|-------------|------|-------|---|

| | | | | | | | | | |
|-----|---|----------|-------|---------------|-------|-----|------|-------|--|
| 1.5 | 4 | BA321083 | 53/71 | 08/03 → 12/13 | OE006 | 0,9 | CET8 | OE195 | |
|-----|---|----------|-------|---------------|-------|-----|------|-------|--|

| | | | | | | | | | |
|-----|---|----------|-------|---------------|-------|-----|------|-------|--|
| 1.5 | 4 | VAZ-2111 | 56/75 | 04/96 → 12/13 | OE006 | 0,9 | CET8 | OE195 | |
|-----|---|----------|-------|---------------|-------|-----|------|-------|--|

| | | | | | | | | | |
|-----|---|----------|-------|---------------|-------|-----|------|-------|--|
| 1.5 | 4 | VAZ-2111 | 57/76 | 01/00 → 12/06 | OE006 | 0,9 | CET8 | OE195 | |
|-----|---|----------|-------|---------------|-------|-----|------|-------|--|

| | | | | | | | | | |
|-----|---|------------|-------|---------------|-------|-----|------|-------|--|
| 1.5 | 4 | ; VAZ-2111 | 59/79 | 08/03 → 12/06 | OE006 | 0,9 | CET8 | OE195 | |
|-----|---|------------|-------|---------------|-------|-----|------|-------|--|

| | | | | | | | | | |
|----------|---|----------|-------|---------------|----------------|------------|------|-------|--|
| 1.5 1500 | 4 | BA321111 | 52/70 | 11/94 → 12/06 | OE001 OE048 | 0,9 1,0 | CET8 | OE195 | |
|----------|---|----------|-------|---------------|----------------|------------|------|-------|--|

| | | | | | | | | | |
|-----|---|----------|-------|---------------|-------|-----|--|--|--|
| 1.6 | 4 | BA311183 | 60/80 | 02/09 → 12/13 | OE048 | 1,0 | | | |
|-----|---|----------|-------|---------------|-------|-----|--|--|--|

| | | | | | | | | | |
|-----|---|--|-------|---------------|--|--|--|--|--------------------------|
| 1.6 | 4 | | 60/80 | 02/09 → 12/13 | | | | | BAEA395 ^[275] |
|-----|---|--|-------|---------------|--|--|--|--|--------------------------|

XRAY

| | | | | | | | | | |
|-----|---|-----------|--------|---------|--|--|--|--|----------|
| 1.6 | 4 | VAZ-21129 | 78/105 | 02/16 → | | | | | BAEA131E |
|-----|---|-----------|--------|---------|--|--|--|--|----------|

| | | | | | | | | | |
|-----|---|-------------|--------|---------|--|--|--|--|----------|
| 1.6 | 4 | H4M; HR16DE | 81/109 | 02/16 → | | | | | BAEA131E |
|-----|---|-------------|--------|---------|--|--|--|--|----------|

| | | | | | | | | | |
|-----|---|-----------|--------|---------|--|--|--|--|----------|
| 1.8 | 4 | VAZ-21179 | 90/121 | 02/16 → | | | | | BAEA131E |
|-----|---|-----------|--------|---------|--|--|--|--|----------|

LADA**LARGUS**

| | | | | | | | | | |
|-----|---|---------|-------|---------|-------|-----|------|-------|--------------------------|
| 1.6 | 4 | VAZ-K7M | 62/83 | 03/12 → | OE048 | 1,0 | CET8 | OE195 | BAEA354 ^[275] |
|-----|---|---------|-------|---------|-------|-----|------|-------|--------------------------|

| | | | | | | | | | |
|-----|---|---------|--------|---------|----------------|------------|------|-------|---------|
| 1.6 | 4 | VAZ-K4M | 77/103 | 03/12 → | OE033 OE034 | 0,9 0,9 | CET2 | OE179 | BAE409A |
|-----|---|---------|--------|---------|----------------|------------|------|-------|---------|

LAMBORGHINI**DIABLO**

| | | | | | | | | | |
|--------|----|--|---------|---------------|--|--|--|--|---------|
| 5.7 SE | 12 | | 386/518 | 01/94 → 12/96 | | | | | BAE800B |
|--------|----|--|---------|---------------|--|--|--|--|---------|

GALLARDO

| | | | | | | | | | |
|---------|----|------|---------|---------|-------|-----|--------|-------|-----------------------------------|
| 5.0 4WD | 10 | L510 | 368/493 | 08/03 → | OE136 | 0,8 | CET12P | OE179 | BAEA032E ^[13] [275] |
|---------|----|------|---------|---------|-------|-----|--------|-------|-----------------------------------|

| | | | | | | | | | |
|---------|----|--|---------|---------|-------|-----|--------|-------|-----------------------------------|
| 5.0 4WD | 10 | | 382/512 | 07/05 → | OE136 | 0,8 | CET12P | OE179 | BAEA032E ^[13] [275] |
|---------|----|--|---------|---------|-------|-----|--------|-------|-----------------------------------|

| | | | | | | | | | |
|-----------------|----|------|---------|---------|--|--|--|--|----------------------------------|
| 5.2 LP560-4 4WD | 10 | CMPA | 412/552 | 06/08 → | | | | | BAEA033E ^[7] [275] |
|-----------------|----|------|---------|---------|--|--|--|--|----------------------------------|

GALLARDO SPYDER

| | | | | | | | | | |
|---------|----|--|---------|---------|-------|-----|--------|-------|-----------------------------------|
| 5.0 4WD | 10 | | 382/512 | 08/05 → | OE136 | 0,8 | CET12P | OE179 | BAEA032E ^[13] [275] |
|---------|----|--|---------|---------|-------|-----|--------|-------|-----------------------------------|

| | | | | | | | | | |
|-----------------|----|------|---------|---------|--|--|--|--|----------------------------------|
| 5.2 LP560-4 4WD | 10 | CMPA | 412/552 | 11/08 → | | | | | BAEA033E ^[7] [275] |
|-----------------|----|------|---------|---------|--|--|--|--|----------------------------------|

LANCIA**DEDRA**

| | | | | | | | | | |
|-----|---|-----------|-------|---------------|-------|-----|------|-------|--|
| 1.6 | 4 | 159B9.000 | 66/89 | 10/94 → 07/99 | OE014 | 0,9 | CET2 | OE179 | |
|-----|---|-----------|-------|---------------|-------|-----|------|-------|--|

| | | | | | | | | | |
|---------|---|-----------|--------|---------------|----------------------------|-----|------|-------|--------------------|
| 1.6 16V | 4 | 182A4.000 | 76/102 | 01/96 → 07/99 | OE216 ^{LPG [278]} | 0,8 | CET2 | OE179 | BAE920AX CLS137 |
|---------|---|-----------|--------|---------------|----------------------------|-----|------|-------|--------------------|

| | | | | | | | | | |
|----------|---|-----------|-------|---------------|-------|-----|------|-------|-------------------|
| 1.6 i.e. | 4 | 835C1.000 | 55/74 | 04/93 → 07/99 | OE014 | 0,9 | CET2 | OE179 | BAEA234 →10/94 |
|----------|---|-----------|-------|---------------|-------|-----|------|-------|-------------------|

| | | | | | | | | | |
|------------|---|-----------|-------|---------------|-------|-----|------|-------|---------|
| 1.6 LE Cat | 4 | 159B9.000 | 66/89 | 07/94 → 07/99 | OE014 | 0,9 | CET2 | OE179 | BAEA234 |
|------------|---|-----------|-------|---------------|-------|-----|------|-------|---------|

| | | | | | | | | | |
|------------|---|-----------|--------|---------------|----------------------------|-----|------|-------|---------|
| 1.8 16V LE | 4 | 182A2.000 | 83/111 | 03/96 → 07/99 | OE216 ^{LPG [278]} | 0,8 | CET2 | OE188 | BAEA549 |
|------------|---|-----------|--------|---------------|----------------------------|-----|------|-------|---------|

| | | | | | | | | | |
|------------|---|-----------|--------|---------------|-------------------------------------|------------|------|-------|---------|
| 1.8 GT 16V | 4 | 183A1.000 | 96/129 | 03/96 → 07/99 | OE016 OE216 ^{LPG [278]} | 0,9 0,8 | CET2 | OE180 | BAEA549 |
|------------|---|-----------|--------|---------------|-------------------------------------|------------|------|-------|---------|

| | | | | | | | | | |
|----------|---|-----------|-------|---------------|----------------|------------|------|-------|--|
| 1.8 i.e. | 4 | 835C5.000 | 66/89 | 08/93 → 07/99 | OE008 OE018 | 0,9 1,0 | CET8 | OE195 | |
|----------|---|-----------|-------|---------------|----------------|------------|------|-------|--|

| | | | | | | | | | |
|----------|---|-----------|-------|---------------|--|--|------|-------|---------|
| 1.8 i.e. | 4 | 836A5.000 | 74/99 | 07/94 → 07/99 | | | CET2 | OE179 | BAE800B |
|----------|---|-----------|-------|---------------|--|--|------|-------|---------|





kW/BHP



eon TITAN

IRIDIUM

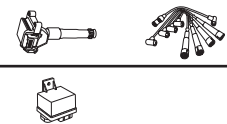

...LANCIA



...DEDRA

| | | | | | | | | | | |
|------------------|---|-----------|---------|-------------|------------------------------|------------|-------------|--------------|--|--|
| 2.0 4WD, 2.0 16V | 4 | 836A3.000 | 102/137 | 07/94→07/99 | OE008 OE018 | 0,9 1,0 | CET8 | OE195 | | |
|------------------|---|-----------|---------|-------------|------------------------------|------------|-------------|--------------|--|--|

DELTA I

| | | | | | | | | | | |
|--------------------|---|----------------------|---------|-------------|--------------|-----|-------------|--------------|----------------|--|
| 2.0 16V HF Evo 4WD | 4 | 831E5.000; 831E5.046 | 155/208 | 06/93→01/94 | OE012 | 0,8 | CET8 | OE195 | BAE800B | |
|--------------------|---|----------------------|---------|-------------|--------------|-----|-------------|--------------|----------------|--|

DELTA II

| | | | | | | | | | | |
|----------|---|-----------|-------|-------------|--|------|-------------|--------------|----------------|---------------------|
| 1.4 i.e. | 4 | 160A1.046 | 51/68 | 10/94→08/99 | OE002 <small>*to be adjusted</small> | 0,8* | CET2 | OE180 | BAE504D | CLS002 [341] |
|----------|---|-----------|-------|-------------|--|------|-------------|--------------|----------------|---------------------|

| | | | | | | | | | | |
|--|--|--|--|--|--|--|--|--|--|---------------------|
| | | | | | | | | | | CLS135 [340] |
|--|--|--|--|--|--|--|--|--|--|---------------------|

| | | | | | | | | | | |
|----------|---|-----------|-------|-------------|--|------|-------------|--------------|----------------|---------------------|
| 1.4 i.e. | 4 | 836A4.000 | 51/68 | 10/94→08/99 | OE002 <small>*to be adjusted</small> | 0,8* | CET2 | OE180 | BAE504D | CLS002 [341] |
|----------|---|-----------|-------|-------------|--|------|-------------|--------------|----------------|---------------------|

| | | | | | | | | | | |
|--|--|--|--|--|--|--|--|--|----------------|---------------------|
| | | | | | | | | | BAEA234 | CLS135 [340] |
|--|--|--|--|--|--|--|--|--|----------------|---------------------|

| | | | | | | | | | | |
|----------|---|-----------|-------|-------------|--------------|-----|-------------|--------------|----------------|---------------|
| 1.6 i.e. | 4 | 835C1.000 | 55/74 | 06/93→08/99 | OE014 | 0,9 | CET2 | OE179 | BAEA234 | CLS135 |
|----------|---|-----------|-------|-------------|--------------|-----|-------------|--------------|----------------|---------------|

| | | | | | | | | | | |
|----------|---|-----------|-------|-------------|------------------------|-----|-------------|--------------|-----------------|---------------|
| 1.6 i.e. | 4 | 182A6.000 | 66/89 | 03/96→08/99 | OE216 LPG [278] | 0,8 | CET2 | OE179 | BAE920AX | CLS137 |
|----------|---|-----------|-------|-------------|------------------------|-----|-------------|--------------|-----------------|---------------|

| | | | | | | | | | | |
|--------------|---|-----------|--------|-------------|------------------------|-----|-------------|--------------|-----------------|---------------|
| 1.6 i.e. 16V | 4 | 182A4.000 | 76/102 | 01/96→08/99 | OE216 LPG [278] | 0,8 | CET2 | OE179 | BAE920AX | CLS137 |
|--------------|---|-----------|--------|-------------|------------------------|-----|-------------|--------------|-----------------|---------------|

| | | | | | | | | | | |
|----------|---|---------------------------------|-------|-------------|--------------|-----|-------------|--------------|----------------|--|
| 1.8 i.e. | 4 | 835C4.000; 836A6.000; 836C4.000 | 66/89 | 07/94→08/99 | OE018 | 1,0 | CET8 | OE195 | BAE800B | |
|----------|---|---------------------------------|-------|-------------|--------------|-----|-------------|--------------|----------------|--|

| | | | | | | | | | | |
|----------|---|-----------|--------|-------------|------------------------------|------------|-------------|--------------|----------------|---------------|
| 1.8 i.e. | 4 | 835C2.000 | 76/102 | 06/93→08/99 | OE008 OE018 | 0,9 1,0 | CET8 | OE195 | BAE800B | CLS005 |
|----------|---|-----------|--------|-------------|------------------------------|------------|-------------|--------------|----------------|---------------|

| | | | | | | | | | | |
|--------------|---|-----------|--------|-------------|------------------------|-----|-------------|--------------|----------------|--|
| 1.8 i.e. 16V | 4 | 182A2.000 | 83/111 | 03/96→08/99 | OE216 LPG [278] | 0,8 | CET2 | OE188 | BAEA549 | |
|--------------|---|-----------|--------|-------------|------------------------|-----|-------------|--------------|----------------|--|

| | | | | | | | | | | |
|-----------------|---|-----------|--------|-------------|--|------------|-------------|--------------|--------------------------|--|
| 1.8 i.e. 16V GT | 4 | 183A1.000 | 96/129 | 03/96→08/99 | OE016 OE216 LPG [278] | 0,9 0,8 | CET2 | OE180 | BAEA549 →07/99 | |
|-----------------|---|-----------|--------|-------------|--|------------|-------------|--------------|--------------------------|--|

| | | | | | | | | | | |
|--|--|--|--|--|--|--|--|--|---------------|--|
| | | | | | | | | | CCU153 | |
|--|--|--|--|--|--|--|--|--|---------------|--|

| | | | | | | | | | | |
|--------|---|----------------------|-------|-------------|--|--|--|--|--|--|
| 1.9 TD | 4 | 160D1.000; 835A4.000 | 66/89 | 10/94→08/99 | | | | | | |
|--------|---|----------------------|-------|-------------|--|--|--|--|--|--|

| | | | | | | | | | | |
|---------|---|-----------|---------|-------------|--------------|-----|-------------|--------------|--|--|
| 2.0 16V | 4 | 836A3.000 | 102/137 | 06/93→08/99 | OE018 | 1,0 | CET8 | OE195 | | |
|---------|---|-----------|---------|-------------|--------------|-----|-------------|--------------|--|--|

| | | | | | | | | | | |
|---------------|---|-----------|---------|-------------|--------------|-----|-------------|--------------|----------------|--|
| 2.0 16V Turbo | 4 | 836A2.000 | 137/184 | 06/93→08/99 | OE012 | 0,8 | CET8 | OE195 | BAE800B | |
|---------------|---|-----------|---------|-------------|--------------|-----|-------------|--------------|----------------|--|

| | | | | | | | | | | |
|---------------|---|-----------|---------|-------------|--------------|-----|-------------|--------------|----------------|--|
| 2.0 16V Turbo | 4 | 175A4.000 | 142/190 | 07/96→08/99 | OE012 | 0,8 | CET8 | OE195 | BAE800B | |
|---------------|---|-----------|---------|-------------|--------------|-----|-------------|--------------|----------------|--|

| | | | | | | | | | | |
|--|--|--|--|--|--|--|--|--|--|--|
| | | | | | | | | | | |
|--|--|--|--|--|--|--|--|--|--|--|

DELTA III

| | | | | | | | | | | |
|-----|---|-----------|---------|-------------|--------------|-----|--|--|----------------|--|
| 1.4 | 4 | 198A1.000 | 110/148 | 09/08→08/14 | OE208 | 0,8 | | | BAEA095 | |
|-----|---|-----------|---------|-------------|--------------|-----|--|--|----------------|--|

| | | | | | | | | | | |
|-----------------|---|-----------|--------|-------------|--------------|-----|--|--|----------------|--|
| 1.4, 1.4 Bifuel | 4 | 198A4.000 | 88/118 | 09/08→08/14 | OE208 | 0,8 | | | BAEA095 | |
|-----------------|---|-----------|--------|-------------|--------------|-----|--|--|----------------|--|

| | | | | | | | | | | |
|---------|---|-----------|---------|-------------|--------------|-----|--|--|--|--|
| 1.4 16V | 4 | 198A7.000 | 103/138 | 07/10→08/14 | OE208 | 0,8 | | | | |
|---------|---|-----------|---------|-------------|--------------|-----|--|--|--|--|

FLAVIA

| | | | | | | | | | | |
|-----|---|-----|---------|-------------|--------------|-----|-------------|--------------|--|--|
| 2.4 | 4 | EDG | 125/168 | 03/12→12/14 | OE154 | 1,0 | CET2 | OE194 | | |
|-----|---|-----|---------|-------------|--------------|-----|-------------|--------------|--|--|

| | | | | | | | | | | |
|-----|---|-----|---------|-------------|--------------|-----|-------------|--------------|--|--|
| 2.4 | 4 | EDG | 129/173 | 03/12→12/14 | OE154 | 1,0 | CET2 | OE194 | | |
|-----|---|-----|---------|-------------|--------------|-----|-------------|--------------|--|--|

KAPPA

| | | | | | | | | | | |
|---------------|---|-----------|---------|-------------|--------------|-----|-------------|--------------|----------------|--|
| 2.0 16V Turbo | 4 | 838A4.000 | 151/202 | 02/95→10/01 | OE012 | 0,8 | CET8 | OE195 | BAEA234 | |
|---------------|---|-----------|---------|-------------|--------------|-----|-------------|--------------|----------------|--|

| | | | | | | | | | | |
|---------|---|-----------|---------|-------------|--------------|-----|-------------|--------------|--|--|
| 2.0 20V | 5 | 838A1.000 | 107/143 | 10/94→10/01 | OE030 | 0,9 | CET2 | OE179 | | |
|---------|---|-----------|---------|-------------|--------------|-----|-------------|--------------|--|--|

| | | | | | | | | | | |
|---------|---|-----------|---------|-------------|--------------|-----|-------------|--------------|--|--|
| 2.0 20V | 5 | 838A6.000 | 114/153 | 07/96→10/01 | OE030 | 0,9 | CET2 | OE179 | | |
|---------|---|-----------|---------|-------------|--------------|-----|-------------|--------------|--|--|

| | | | | | | | | | | |
|---------------|---|-----------|---------|-------------|--------------|-----|---------------|--------------|--|--|
| 2.0 20V Turbo | 5 | 175A3.000 | 162/217 | 06/98→10/01 | OE136 | 0,8 | CET12P | OE179 | | |
|---------------|---|-----------|---------|-------------|--------------|-----|---------------|--------------|--|--|

| | | | | | | | | | | |
|---------|---|----------------------|---------|-------------|--|------------|-------------|--------------|--|--|
| 2.4 20V | 5 | 838A2.000; 838A2.027 | 129/173 | 08/94→10/01 | OE030 OE216 LPG [278] | 0,9 0,8 | CET2 | OE179 | | |
|---------|---|----------------------|---------|-------------|--|------------|-------------|--------------|--|--|

| | | | | | | | | | | |
|---------|---|-----------|---------|-------------|--|-----|--|--|--|--|
| 2.4 JTD | 5 | 838A8.000 | 100/134 | 06/98→10/01 | CH222 Eng.1713819→ Prod.15.11.1999→ | 11v | | | | |
|---------|---|-----------|---------|-------------|--|-----|--|--|--|--|

| | | | | | | | | | | |
|----------|---|----------------------|--------|-------------|--------------|-----|--|--|--|--|
| 2.4 T.DS | 5 | 838A3.000; 838A7.000 | 91/122 | 08/94→10/01 | CH167 | 11v | | | | |
|----------|---|----------------------|--------|-------------|--------------|-----|--|--|--|--|

| | | | | | | | | | | |
|---------|---|----------|---------|-------------|--------------|-----|-------------|--|----------------------|--|
| 3.0 24V | 6 | 838B.000 | 150/201 | 08/94→10/01 | OE094 | 0,9 | CET2 | | BAEA428 [277] | |
|---------|---|----------|---------|-------------|--------------|-----|-------------|--|----------------------|--|

| | | | | | | | | | | |
|--|--|--|--|--|--|--|--|--|--|--|
| | | | | | | | | | | |
|--|--|--|--|--|--|--|--|--|--|--|

LYBRA

| | | | | | | | | | | |
|-----|---|-----------|--------|-------------|--------------|-----|-------------|--------------|-----------------|--|
| 1.6 | 4 | 182B6.000 | 76/102 | 10/00→10/05 | OE030 | 0,9 | CET2 | OE179 | BAE920AX | |
|-----|---|-----------|--------|-------------|--------------|-----|-------------|--------------|-----------------|--|

| | | | | | | | | | | |
|---------|---|-----------|--------|-------------|--|------------|-------------|--------------|-----------------|---------------|
| 1.6 16V | 4 | 182A4.000 | 76/102 | 07/99→10/05 | OE030 OE216 LPG [278] | 0,9 0,8 | CET2 | OE179 | BAE920AX | CLS137 |
|---------|---|-----------|--------|-------------|--|------------|-------------|--------------|-----------------|---------------|

| | | | | | | | | | | |
|--|--|--|--|--|--|--|--|--|--|--|
| | | | | | | | | | | |
|--|--|--|--|--|--|--|--|--|--|--|

| | | | | | | | | | | |
|---------|---|---------------------------------|--------|-------------|--|------------|-------------|--------------|--|--|
| 1.8 16V | 4 | 839A4.000; 839A7.000; 839A9.000 | 96/129 | 07/99→10/05 | OE016 OE216 LPG [278] | 0,9 0,8 | CET2 | OE180 | | |
|---------|---|---------------------------------|--------|-------------|--|------------|-------------|--------------|--|--|

| | | | | | | | | | | |
|--|--|--|--|--|--|--|--|--|--|--|
| | | | | | | | | | | |
|--|--|--|--|--|--|--|--|--|--|--|

| | | | | | | | | | | |
|---------|---|---------|--------|-------------|---|-----|--|--|--|--|
| 1.9 JTD | 4 | AR32302 | 77/103 | 07/99→09/01 | CH222 [55] Eng.1713819→ Prod.15.11.1999→ | 11v | | | | |
|---------|---|---------|--------|-------------|---|-----|--|--|--|--|

| | | | | | | | | | | |
|--|--|--|--|--|--|--|--|--|--|--|
| | | | | | | | | | | |
|--|--|--|--|--|--|--|--|--|--|--|

LANCIA





kW/BHP

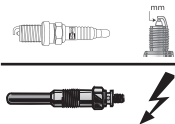

eon TITAN

IRIDIUM

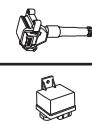

...LANCIA



...LYBRA

| | | | | | | | | | |
|---------|---|--------------------|---------|-------------|----------------------------------|-----|------|-------|------------------------|
| 1.9 JTD | 4 | AR37101 | 81/109 | 09/00→05/01 | CH222 | 11v | | | CCU150 ^[57] |
| 1.9 JTD | 4 | 937A2.000 | 85/114 | 05/01→10/05 | CH222 | 11v | | | CCU150 ^[57] |
| 2.0 20V | 5 | 185A8.000 | 110/148 | 09/00→10/05 | OE030 | 0,9 | CET2 | OE179 | |
| | | | | | OE216 LPG ^[278] | 0,8 | | | |
| 2.0 20V | 5 | 182B7.000 | 113/152 | 07/99→09/00 | OE030 | 0,9 | CET2 | OE179 | |
| | | | | | OE216 LPG ^[278] | 0,8 | | | |
| 2.4 20V | 5 | 192A2.000 | 125/168 | 10/01→10/05 | OE030 | 0,9 | CET2 | | |
| 2.4 JTD | 5 | 839A5.000; AR32501 | 99/133 | 07/99→02/01 | CH222 | 11v | | | |
| | | | | | Eng.1713819→ Prod.15.11.1999→ | | | | |
| 2.4 JTD | 5 | 839A6.000 | 103/138 | 09/00→10/05 | CH222 | 11v | | | CCU150 ^[57] |
| 2.4 JTD | 5 | 841C.000 | 110/148 | 05/02→10/05 | CH222 | 11v | | | CCU150 ^[57] |

MUSA

| | | | | | | | | | |
|----------------|---|-----------|-------|-------------|----------------------------|-----|------|--|------------------------|
| 1.3 D Multijet | 4 | 188A9.000 | 51/68 | 10/04→09/12 | | | | | CCU150 |
| 1.3 D Multijet | 4 | 199A3.000 | 66/89 | 09/06→09/12 | | | | | CCU150 |
| 1.3 D Multijet | 4 | 199B1.000 | 70/94 | 03/09→09/12 | | | | | CCU150 ^[53] |
| 1.4 | 4 | 192B2.000 | 66/89 | 10/07→09/12 | OE196 | 1,0 | CET1 | | BAE403C |
| | | | | | OE230 LPG ^[278] | 0,9 | | | |
| 1.4 | 4 | 843A1.000 | 70/94 | 10/04→09/12 | OE196 | 1,0 | CET1 | | BAE403C |
| 1.4, 1.4 LPG | 4 | 350A1.000 | 57/76 | 09/05→09/12 | OE196 | 1,0 | CET1 | | BAE940A CLS082 |
| 1.9 D Multijet | 4 | 188B2.000 | 74/99 | 10/04→09/12 | CH222 | 11v | | | CCU150 |

PHEDRA

| | | | | | | | | | |
|----------------|---|----------------|---------|-------------|------------------------|-----|--------|-------|------------------------------|
| 2.0 | 4 | RFN(EW10J4) | 100/134 | 09/02→11/10 | OE178 | 0,9 | CET5 | | |
| 2.0 D Multijet | 4 | RHR(DW10BTED4) | 100/134 | 07/06→11/10 | CH268 | 11v | | | |
| 2.0 JTD | 4 | RHM(DW10ATED4) | 79/106 | 07/03→11/10 | CH170 ^[172] | 11v | | | |
| | | | | | CH268 ^[173] | 11v | | | |
| 2.0 JTD | 4 | RHW(DW10ATED4) | 80/107 | 09/02→11/10 | CH170 ^[172] | 11v | | | |
| | | | | | CH268 ^[173] | 11v | | | |
| 2.0 JTD | 4 | RHK(DW10UTED4) | 88/118 | 06/06→11/10 | CH170 ^[172] | 11v | | | |
| | | | | | CH268 ^[173] | 11v | | | |
| 2.2 D Multijet | 4 | 4HS; 4HT | 125/168 | 03/08→11/10 | | | | | CCU147 ^{[21] [285]} |
| 2.2 JTD | 4 | 4HW(DW12ATED4) | 94/126 | 09/02→11/10 | CH170 ^[172] | 11v | | | CCU147 ^{[21] [285]} |
| | | | | | CH268 ^[173] | 11v | | | |
| 2.2 JTD | 4 | 4HP; 4HR | 120/161 | 04/06→11/10 | | | | | CCU147 ^{[21] [285]} |
| 3.0 V6 | 6 | ES9J4S | 150/201 | 09/02→11/10 | OE175 | 1,0 | CET14P | OE190 | BAEA347 |

THEISIS

| | | | | | | | | | |
|----------------|---|--------------------|---------|-------------|-------|-----|--------|-------|--------------------------|
| 2.4 | 5 | 841D.000 | 125/168 | 07/02→07/09 | OE005 | 0,9 | CET2 | OE180 | |
| 2.4 D Multijet | 5 | 841P.000 | 136/182 | 04/06→07/09 | CH224 | 11v | | | CCU150 |
| 2.4 JTD | 5 | 841C.000 | 110/148 | 07/02→07/09 | CH222 | 11v | | | CCU150 |
| 2.4 JTD | 5 | 841M.000; 841N.000 | 120/161 | 09/03→07/09 | CH224 | 11v | | | CCU150 |
| 2.4 JTD | 5 | 841G.000 | 129/173 | 05/03→07/09 | CH224 | 11v | | | CCU150 |
| 3.0 V6 | 6 | 841A.000 | 158/212 | 07/02→07/09 | OE136 | 0,8 | CET12P | OE179 | BAEA428 ^[277] |
| 3.2 V6 | 6 | 841L.000 | 169/227 | 05/03→07/09 | OE136 | 0,8 | CET11P | | BAEA428 ^[277] |

Y

| | | | | | | | | | |
|---------|---|-----------|-------|-------------|-------|-----|------|-------|----------------|
| 1.1 | 4 | 176B2.000 | 40/54 | 11/95→09/03 | OE002 | 0,9 | CET2 | OE180 | BAE800B CLS261 |
| 1.2 | 4 | 840A3.000 | 44/59 | 03/96→09/03 | OE002 | 0,9 | CET2 | OE180 | BAE800B CLS261 |
| 1.2 | 4 | 188A4.000 | 44/59 | 03/96→09/03 | OE002 | 0,9 | CET2 | OE180 | BAE800B CLS067 |
| 1.2 16V | 4 | 188A5.000 | 59/79 | 10/00→09/03 | OE186 | 1,0 | CET1 | | BAEA234 CLS044 |
| 1.2 16V | 4 | 176B9.000 | 63/84 | 04/97→09/03 | OE186 | 1,0 | CET1 | | BAE800B CLS035 |
| 1.4 12V | 4 | 840A4.000 | 55/74 | 03/96→09/03 | OE030 | 0,9 | CET2 | OE179 | BAEA234 CLS136 |
| 1.4 12V | 4 | 840A2.000 | 59/79 | 10/96→09/03 | OE030 | 0,9 | CET2 | OE179 | BAEA234 CLS136 |





kW/BHP

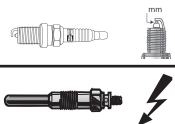

eon TITAN

IRIDIUM

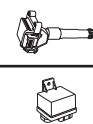
**...LANCIA****Y10**

| | | | | | | | | | | |
|------------------------|---|-----------|-------|-------------|-------|-----|------|-------|---------|--------|
| 1.1 Fire, 1.1 Fire 4WD | 4 | 176B2.000 | 40/54 | 01/95→12/95 | OE002 | 0,9 | CET2 | OE180 | BAEA234 | CLS112 |
|------------------------|---|-----------|-------|-------------|-------|-----|------|-------|---------|--------|

YPSILON

| | | | | | | | | | | |
|----------------------|---|-----------|-------|--------|-------|-----|--------|--|---------|--|
| 0.9 CNG, 0.9 TwinAir | 2 | 312A2.000 | 63/84 | 05/11→ | OE232 | 0,7 | CET15P | | BAEA090 | |
|----------------------|---|-----------|-------|--------|-------|-----|--------|--|---------|--|

| | | | | | | | | | | |
|-------------|---|----------------------|-------|--------|-------|-----|--------|--|--|--|
| 0.9 TwinAir | 2 | 312A2.000; 312A5.000 | 59/79 | 12/13→ | OE232 | 0,7 | CET15P | | | |
|-------------|---|----------------------|-------|--------|-------|-----|--------|--|--|--|

| | | | | | | | | | | |
|-----|---|-----------|-------|-------------|-------|-----|------|--|---------|--------|
| 1.2 | 4 | 188A4.000 | 44/59 | 10/03→12/11 | OE196 | 1,0 | CET1 | | BAE800B | CLS067 |
|-----|---|-----------|-------|-------------|-------|-----|------|--|---------|--------|

| | | | | | | | | | | |
|-----|---|-----------|-------|--------|-------|-----|------|--|-------------------------|--------|
| 1.2 | 4 | 169A4.000 | 51/68 | 08/10→ | OE196 | 1,0 | CET1 | | BAE800B ^[21] | CLS082 |
|-----|---|-----------|-------|--------|-------|-----|------|--|-------------------------|--------|

| | | | | | | | | | | |
|--|--|--|--|--|--|--|--|--|-------------------------|--|
| | | | | | | | | | BAE940A ^[22] | |
|--|--|--|--|--|--|--|--|--|-------------------------|--|

| | | | | | | | | | | |
|-----|---|-----------|-------|-------------|-------|-----|------|--|---------|--|
| 1.2 | 4 | 188A5.000 | 59/79 | 10/03→12/11 | OE196 | 1,0 | CET1 | | BAE403C | |
|-----|---|-----------|-------|-------------|-------|-----|------|--|---------|--|

| | | | | | | | | | | |
|------------|---|-----------|-------|--------|-------|-----|------|--|-------------------------|--------|
| 1.2 Bifuel | 4 | 169A4.000 | 49/66 | 05/11→ | OE196 | 1,0 | CET1 | | BAE800B ^[21] | CLS082 |
|------------|---|-----------|-------|--------|-------|-----|------|--|-------------------------|--------|

| | | | | | | | | | | |
|--|--|--|--|--|--|--|--|--|-------------------------|--|
| | | | | | | | | | BAE940A ^[22] | |
|--|--|--|--|--|--|--|--|--|-------------------------|--|

| | | | | | | | | | | |
|----------------|---|-----------|-------|-------------|--|--|--|--|--------|--|
| 1.3 D Multijet | 4 | 199A2.000 | 55/74 | 09/06→12/11 | | | | | CCU150 | |
|----------------|---|-----------|-------|-------------|--|--|--|--|--------|--|

| | | | | | | | | | | |
|----------------|---|-----------|-------|-------------|--|--|--|--|--------|--|
| 1.3 D Multijet | 4 | 199A3.000 | 66/89 | 09/06→12/11 | | | | | CCU150 | |
|----------------|---|-----------|-------|-------------|--|--|--|--|--------|--|

| | | | | | | | | | | |
|----------------|---|-----------|--------|-------------|--|--|--|--|--------|--|
| 1.3 D Multijet | 4 | 199A3.000 | 77/103 | 05/07→12/11 | | | | | CCU150 | |
|----------------|---|-----------|--------|-------------|--|--|--|--|--------|--|

| | | | | | | | | | | |
|---------|---|-----------|-------|-------------|--|--|--|--|--------|--|
| 1.3 JTD | 4 | 188A9.000 | 51/68 | 10/03→12/11 | | | | | CCU150 | |
|---------|---|-----------|-------|-------------|--|--|--|--|--------|--|

| | | | | | | | | | | |
|--------------|---|-----------|-------|-------------|-------|-----|------|--|---------|--------|
| 1.4, 1.4 LPG | 4 | 350A1.000 | 57/76 | 02/06→12/11 | OE196 | 1,0 | CET1 | | BAE940A | CLS082 |
|--------------|---|-----------|-------|-------------|-------|-----|------|--|---------|--------|

| | | | | | | | | | | |
|---------|---|-----------|-------|-------------|-------|-----|------|--|---------|--|
| 1.4 16V | 4 | 843A1.000 | 70/94 | 10/03→12/11 | OE196 | 1,0 | CET1 | | BAE403C | |
|---------|---|-----------|-------|-------------|-------|-----|------|--|---------|--|

ZETA

| | | | | | | | | | | |
|---------|---|--------------|--------|-------------|-------|-----|------|-------|--|--|
| 2.0 16V | 4 | RFV(XU10J4R) | 97/130 | 05/98→07/00 | OE019 | 0,9 | CET2 | OE184 | | |
|---------|---|--------------|--------|-------------|-------|-----|------|-------|--|--|

| | | | | | | | | | | |
|---------|---|-----|---------|-------------|-------|-----|------|--|--|--|
| 2.0 16V | 4 | RFN | 100/134 | 07/00→09/02 | OE178 | 0,9 | CET5 | | | |
|---------|---|-----|---------|-------------|-------|-----|------|--|--|--|

| | | | | | | | | | | |
|----------------------|---|-------------------------------|--------|-------------|-------|-----|--|--|--|--|
| 2.0 JTD, 2.0 JTD 16V | 4 | RHW(DW10ATED4); RHZ(DW10ATED) | 80/107 | 09/99→09/02 | CH170 | 11v | | | | |
|----------------------|---|-------------------------------|--------|-------------|-------|-----|--|--|--|--|

| | | | | | | | | | | |
|-----------|---|---------------|---------|-------------|-------|-----|------|-------|--|--------|
| 2.0 Turbo | 4 | RGX(XU10J2TE) | 108/145 | 05/95→09/02 | OE034 | 0,9 | CET2 | OE188 | | CLS005 |
|-----------|---|---------------|---------|-------------|-------|-----|------|-------|--|--------|

| | | | | | | | | | | |
|--------|---|-----|--------|-------------|-------|-----|--|--|--|--|
| 2.1 TD | 4 | P8C | 80/107 | 05/96→09/99 | CH189 | 11v | | | | |
|--------|---|-----|--------|-------------|-------|-----|--|--|--|--|

LAND ROVER**DEFENDER**

| | | | | | | | | | | |
|-------------|---|-------|--------|-------------|-------|-------|--|--|--|--|
| 2.4 Td4 4WD | 4 | DT244 | 90/121 | 05/07→02/16 | CH229 | 11.5v | | | | |
|-------------|---|-------|--------|-------------|-------|-------|--|--|--|--|

| | | | | | | | | | | |
|-------------|---|---------------|--------|-------------|-----------------|-------|--|--|--|--|
| 2.5 Td5 4WD | 5 | 10P; 14P; 15P | 90/121 | 06/98→02/16 | CH178 →12/98 | 11.5v | | | | |
|-------------|---|---------------|--------|-------------|-----------------|-------|--|--|--|--|

| | | | | | | | | | | |
|--|--|--|--|--|-----------------|-----|--|--|--|--|
| | | | | | CH272 01/99→ | 11v | | | | |
|--|--|--|--|--|-----------------|-----|--|--|--|--|

| | | | | | | | | | | |
|---------|---|--------|---------|-------------|-------|-----|------|-------|--|--|
| 2.8 4WD | 6 | M52B28 | 140/188 | 11/98→09/03 | OE026 | 0,9 | CET2 | OE188 | | |
|---------|---|--------|---------|-------------|-------|-----|------|-------|--|--|

| | | | | | | | | | | |
|---------|---|-----|---------|-------------|-------|-----|------|--|--|--|
| 3.9 4WD | 8 | 37L | 134/180 | 04/98→09/00 | OE051 | 0,9 | CET8 | | | |
|---------|---|-----|---------|-------------|-------|-----|------|--|--|--|

| | | | | | | | | | | |
|------------|---|-----|---------|-------------|-------|-----|------|--|--|--|
| 3.9 V8 4WD | 8 | 37L | 136/182 | 11/98→02/16 | OE051 | 0,9 | CET8 | | | |
|------------|---|-----|---------|-------------|-------|-----|------|--|--|--|

DISCOVERY I

| | | | | | | | | | | |
|-----------|---|---------------|--------|-------------|-------|-------|--|--|--|--|
| 2.5 D 4WD | 4 | 17L; 19L; 22L | 90/121 | 06/93→10/98 | CH178 | 11.5v | | | | |
|-----------|---|---------------|--------|-------------|-------|-------|--|--|--|--|

| | | | | | | | | | | |
|---------|---|----------|---------|-------------|-------|-----|------|--|----------------------|--|
| 4.0 4WD | 8 | 35D; 36D | 134/180 | 09/93→10/98 | OE051 | 0,9 | CET8 | | BAEA115 [8] [275] | |
|---------|---|----------|---------|-------------|-------|-----|------|--|----------------------|--|

DISCOVERY II

| | | | | | | | | | | |
|-------------|---|----------|---------|-------------|-------|-----|--|--|--|--|
| 2.5 Td5 4WD | 5 | 10P; 15P | 102/137 | 11/98→06/04 | CH272 | 11v | | | | |
|-------------|---|----------|---------|-------------|-------|-----|--|--|--|--|

| | | | | | | | | | | |
|------------|---|---------------|---------|-------------|-------|-----|--------|-------|---------|--|
| 4.0 V8 4WD | 8 | 35D; 56D; 94D | 136/182 | 11/98→06/04 | OE138 | 1,0 | CET12P | OE180 | BAEA234 | |
|------------|---|---------------|---------|-------------|-------|-----|--------|-------|---------|--|

DISCOVERY III

| | | | | | | | | | | |
|------------|---|-------|---------|-------------|-------|-----|--|--|--|--|
| 2.7 TD 4WD | 6 | 276DT | 140/188 | 07/04→09/09 | CH240 | 11v | | | | |
|------------|---|-------|---------|-------------|-------|-----|--|--|--|--|

| | | | | | | | | | | |
|---------|---|-------|---------|-------------|--|--|--------|-------|---------------------------|--|
| 4.4 4WD | 8 | 448PN | 220/295 | 07/04→09/09 | | | CET12P | OE180 | BAEA196E ^[275] | |
|---------|---|-------|---------|-------------|--|--|--------|-------|---------------------------|--|

DISCOVERY IV

| | | | | | | | | | | |
|------------|---|-------|---------|--------|-------|-----|--|--|--|--|
| 2.7 TD 4WD | 6 | 276DT | 140/188 | 09/09→ | CH240 | 11v | | | | |
|------------|---|-------|---------|--------|-------|-----|--|--|--|--|

DISCOVERY SPORT

| | | | | | | | | | | |
|---------|---|-------|---------|--------|--|--|--------|--|--|--|
| 2.0 4WD | 4 | 204PT | 177/237 | 11/14→ | | | CET17P | | | |
|---------|---|-------|---------|--------|--|--|--------|--|--|--|

FREELANDER

| | | | | | | | | | | |
|---------|---|-------|--------|-------------|--|--|--|--|---------|--|
| 1.8 4WD | 4 | 18K4F | 86/115 | 10/00→10/06 | | | | | BAEA501 | |
|---------|---|-------|--------|-------------|--|--|--|--|---------|--|

| | | | | | | | | | | |
|-------------|---|-------|--------|-------------|-------|-----|--------|-------|--|--------|
| 1.8 16V 4WD | 4 | 18K4F | 86/115 | 11/00→10/06 | OE146 | 1,0 | CET12P | OE179 | BAEA501 →Ch.5A000001 BAEA469 Ch.1A000001→ | CLS045 |
|-------------|---|-------|--------|-------------|-------|-----|--------|-------|--|--------|

LAND ROVER





kW/BHP

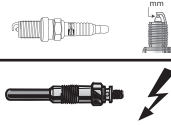

eon TITAN

IRIDIUM

**...LAND ROVER****...FREELANDER**

| | | | | | | | | | | |
|---------------|---|-------|--------|---------------|----------------|------------|--------|-------|--|--------|
| 1.8 i 16V 4WD | 4 | 18K4F | 88/118 | 02/98 → 10/06 | OE136 OE146 | 0,8 1,0 | CET12P | OE179 | BAEA469 [185] [275] BAEA501 [275] BAEA469 [185] Ch.1A000001 → BAEA501 Ch.5A000001 → | CLS155 |
|---------------|---|-------|--------|---------------|----------------|------------|--------|-------|--|--------|

| | | | | | | | | | | |
|-------------|---|------------|---------|---------------|-------|-----|--------|-------|--|--|
| 2.0 DI 4WD | 4 | 20T2N | 72/97 | 02/98 → 10/06 | CH169 | 11v | | | | |
| 2.0 Td4 4WD | 4 | 204D3 | 80/107 | 03/01 → 10/06 | CH203 | 11v | | | | |
| 2.0 Td4 4WD | 4 | 204D3; M47 | 82/110 | 11/00 → 10/06 | CH203 | 11v | | | | |
| 2.5 V6 4WD | 6 | 25K4F | 130/174 | 11/00 → 10/06 | OE146 | 1,0 | CET12P | OE179 | | |

FREELANDER 2

| | | | | | | | | | | |
|-------------|---|--------|---------|---------------|--|--|--------|-------|--|--|
| 2.0 Si4 4WD | 4 | 204PT | 177/237 | 10/11 → 10/14 | | | CET17P | | | |
| 3.2 4WD | 6 | B6324S | 171/229 | 10/06 → 10/14 | | | CET14P | OE190 | | |

RANGE ROVER EVOQUE

| | | | | | | | | | | |
|---------|---|-------|---------|---------|--|--|--------|--|--|--|
| 2.0 4WD | 4 | 204PT | 177/237 | 06/11 → | | | CET17P | | | |
|---------|---|-------|---------|---------|--|--|--------|--|--|--|

RANGE ROVER II

| | | | | | | | | | | |
|-----------|---|-----------|---------|---------------|------------------|-----|--------|------------------|---------|--|
| 2.5 D 4WD | 4 | 19L; 22L | 83/111 | 08/94 → 03/02 | CH189 | 11v | | | | |
| 2.5 D 4WD | 6 | 256T(BMW) | 100/134 | 07/94 → 03/02 | CH189 | 11v | | | | |
| 3.9 4WD | 8 | 42D | 140/188 | 07/94 → 03/02 | OE051 | 0,9 | CET8 | | BAEA234 | |
| 4.0 4WD | 8 | 42D | 136/182 | 01/95 → 03/02 | OE138 | 1,0 | CET12P | OE180 | BAEA234 | |
| 4.6 4WD | 8 | 60D | 160/215 | 06/98 → 03/02 | OE138 | 1,0 | CET12P | OE180 | BAEA234 | |
| 4.6 4WD | 8 | 46D | 165/221 | 07/94 → 03/02 | OE138 01/99 → | 1,0 | CET12P | OE180 01/99 → | BAEA234 | |
| 4.6 4WD | 8 | 46D | 168/225 | 09/95 → 03/02 | OE138 | 1,0 | CET12P | | BAEA234 | |

RANGE ROVER III

| | | | | | | | | | | |
|-----------|---|--------|---------|---------------|-------|-----|--------|-------|----------------|--|
| 3.0 D 4WD | 6 | 306D1 | 130/174 | 03/02 → 08/12 | CH203 | 11v | | | | |
| 3.6 D 4WD | 8 | 368DT | 200/268 | 04/06 → 08/12 | CH240 | 11v | | | | |
| 4.2 4WD | 8 | 428PS | 291/390 | 05/05 → 08/12 | | | CET12P | OE180 | BAEA196E [275] | |
| 4.4 4WD | 8 | M62B44 | 210/282 | 03/02 → 08/05 | OE223 | 1,6 | | | BAEA302 | |
| 4.4 4WD | 8 | 448PN | 220/295 | 08/04 → 08/12 | | | CET12P | OE180 | | |
| 4.4 4WD | 8 | 448PN | 225/302 | 05/05 → 08/12 | | | CET12P | | BAEA196E [275] | |
| 4.4 4WD | 8 | AJ | 225/302 | 05/05 → 08/12 | | | | OE180 | | |

RANGE ROVER SPORT

| | | | | | | | | | | |
|-----------|---|-------|---------|---------------|-------|-----|--------|-------|----------------|--|
| 2.7 D 4WD | 6 | 276DT | 140/188 | 02/05 → 03/13 | CH240 | 11v | | | | |
| 3.6 D 4WD | 8 | 368DT | 200/268 | 04/06 → 03/13 | CH240 | 11v | | | | |
| 4.2 4WD | 8 | 428PS | 287/385 | 02/05 → 03/13 | | | CET12P | OE180 | BAEA196E [275] | |
| 4.4 4WD | 8 | 448PN | 220/295 | 02/05 → 03/13 | | | CET12P | OE180 | BAEA196E [275] | |

LANDWIND (JMC)**LANDWIND**

| | | | | | | | | | | |
|------------|---|----------|--------|---------|-------|-----|------|-------|--|--|
| 2.0 4WD | 4 | 4G63-S4M | 84/113 | 09/05 → | OE063 | 1,0 | CET2 | OE180 | | |
| 2.4 4WD | 4 | 4G64-S4M | 92/123 | 09/05 → | OE063 | 1,0 | CET2 | OE180 | | |
| 2.8 TD 4WD | 4 | JX493ZQ | 68/91 | 09/05 → | CH306 | 11v | | | | |

LDV**CONVOY**

| | | | | | | | | | | |
|----------------|---|-----------|-------|---------------|-------|-------|--|--|--|--|
| 2.4 D | 4 | D2FA | 66/89 | 03/02 → 04/09 | CH229 | 11.5v | | | | |
| 2.5 D | 4 | EN55 | 53/71 | 04/96 → 02/02 | CH189 | 11v | | | | |
| 2.5 D | 4 | 4HB | 55/74 | 10/97 → 04/09 | CH189 | 11v | | | | |
| 2.5 D | 4 | ET70 | 71/95 | 04/96 → 06/06 | CH189 | 11v | | | | |
| 2.5 D, 2.5 TDI | 4 | 4EB; ET70 | 74/99 | 10/97 → 04/09 | CH189 | 11v | | | | |
| 2.5 DI | 4 | EN55 | 56/75 | 10/98 → 04/09 | CH189 | 11v | | | | |





kW/BHP



eon TITAN

IRIDIUM

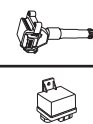

...LDV



CUB

| | | | | | | | | | |
|-------|---|------|-------|---------------|-------|-----|--|--|--|
| 2.3 D | 4 | LD23 | 53/71 | 08/98 → 09/01 | CH186 | 11v | | | |
|-------|---|------|-------|---------------|-------|-----|--|--|--|

MAXUS

| | | | | | | | | | |
|-------|---|------------------------|--------|---------------|------------------------|-----|--|--|--|
| 2.5 D | 4 | VM39C; VM40C; VMR425 | 70/94 | 02/05 → 12/08 | CH180 ^[275] | 11v | | | |
| 2.5 D | 4 | | 78/105 | 04/07 → 12/09 | CH180 ^[275] | 11v | | | |
| 2.5 D | 4 | BS580VM; VM39C; VMR425 | 88/118 | 02/05 → 12/09 | CH180 ^[275] | 11v | | | |
| 2.5 D | 4 | BS582VM | 99/133 | 02/06 → 12/09 | CH180 ^[275] | 11v | | | |

PILOT

| | | | | | | | | | |
|-------|---|------|-------|---------------|-------|-----|--|--|--|
| 1.9 D | 4 | XUD9 | 52/70 | 04/96 → 10/05 | CH189 | 11v | | | |
|-------|---|------|-------|---------------|-------|-----|--|--|--|

LEXUS



CT

| | | | | | | | | | |
|----------|---|------------------|-------|---------|--|--|--|--|----------|
| 1.8 200h | 4 | 2ZR-FXE; 5ZR-FXE | 73/98 | 12/10 → | | | | | BAEA184E |
|----------|---|------------------|-------|---------|--|--|--|--|----------|

ES

| | | | | | | | | | |
|--------------|---|---------|---------|---------------|-------|-----|--------|-------|----------|
| 2.5 250 | 4 | 2AR-FE | 135/181 | 06/12 → | | | CET14P | OE190 | BAEA192E |
| 2.5 300h | 4 | 2AR-FXE | 118/158 | 06/12 → | | | | | BAEA192E |
| 3.0 | 6 | 1MZ-FE | 140/188 | 10/96 → 07/01 | | | CET12P | OE182 | |
| 3.0 | 6 | 1MZ-FE | 157/211 | 08/01 → 10/06 | OE136 | 0,8 | CET12P | OE179 | |
| 3.0 | 6 | 1MZ-FE | 158/212 | 10/01 → 06/08 | OE136 | 0,8 | CET12P | OE179 | |
| 3.3 | 6 | 3MZ-FE | 168/225 | 06/03 → 10/06 | | | CET12P | OE182 | |
| 3.5, 3.5 350 | 6 | 2GR-FE | 204/274 | 05/06 → | | | CET14P | OE190 | |

GS

| | | | | | | | | | |
|-------------------------|---|---------|---------|---------------|-------|-----|--------|-------|---------------------------|
| 2.5 250 | 6 | 4GR-FSE | 154/207 | 01/12 → | | | CET14P | OE190 | BAEA192E |
| 2.5 300h | 4 | 2AR-FSE | 133/178 | 10/13 → | | | | | BAEA192E |
| 2.5 GS 250 | 6 | 4GR-FSE | 158/212 | 01/12 → | | | CET14P | OE190 | |
| 3.0 300 | 6 | 2JZ-GE | 156/209 | 01/93 → 08/97 | OE026 | 0,9 | CET2 | OE188 | BAEA445 ^[275] |
| 3.0 300 | 6 | 2JZ-GE | 161/216 | 10/00 → 12/04 | OE026 | 0,9 | CET2 | OE188 | |
| 3.0 300 | 6 | 2JZ-GE | 163/219 | 08/97 → 10/00 | OE026 | 0,9 | CET2 | OE188 | |
| 3.0 300 | 6 | 3GR-FE | 170/228 | 04/05 → 11/11 | | | CET14P | OE190 | BAEA192E |
| 3.0 300 | 6 | 3GR-FSE | 183/245 | 04/05 → 11/11 | | | CET14P | OE190 | BAEA192E |
| 3.5 350 | 6 | 2GR-FSE | 232/311 | 05/08 → | | | CET14P | OE190 | |
| 3.5 350, 3.5 350 4WD | 6 | 2GR-FSE | 226/303 | 04/08 → 11/11 | | | CET14P | OE190 | |
| 3.5 350 4WD | 6 | 2GR-FSE | 232/311 | 05/08 → | | | CET14P | OE190 | BAEA192E |
| 3.5 350 4WD, 3.5 GS 350 | 6 | 2GR-FSE | 234/314 | 12/11 → | | | CET14P | OE190 | BAEA192E |
| 3.5 450h | 6 | 2GR-FXE | 215/288 | 01/12 → | | | | | BAEA192E |
| 3.5 450h | 6 | 2GR-FSE | 218/292 | 02/06 → 11/11 | | | CET14P | OE190 | BAEA192E |
| 3.5 450h | 6 | 2GR-FSE | 254/341 | 02/06 → 11/11 | | | CET14P | OE190 | BAEA192E |
| 4.0 400 | 8 | 1UZ-FE | 216/290 | 12/97 → 11/00 | OE136 | 0,8 | CET12P | OE179 | |
| 4.3 430 | 8 | 3UZ-FE | 208/279 | 11/00 → 11/11 | | | CET12P | OE182 | BAEA172E ^[161] |
| 4.3 VVTi | 8 | 3UZ-FE | 221/296 | 04/05 → 11/11 | | | CET12P | OE182 | |
| 4.6 460 | 8 | 1UR-FSE | 255/342 | 09/07 → 11/11 | | | CET14P | OE190 | |

GX

| | | | | | | | | | |
|-------------|---|--------|---------|---------------|--|--|--------|-------|----------|
| 4.6 470 4WD | 8 | 1UR-FE | 218/292 | 11/09 → | | | CET14P | OE190 | BAEA192E |
| 4.6 470 4WD | 8 | 1UR-FE | 225/302 | 01/10 → | | | CET14P | OE190 | |
| 4.7 470 4WD | 8 | 2UZ-FE | 175/235 | 11/01 → 11/09 | | | CET12P | OE182 | |
| 4.7 470 4WD | 8 | 2UZ-FE | 199/267 | 11/01 → 11/09 | | | CET12P | OE182 | |

HS

| | | | | | | | | | |
|----------|---|---------|---------|---------|--|--|--------|-------|--|
| 2.4 250h | 4 | 2AZ-FXE | 110/148 | 07/09 → | | | CET12P | OE182 | |
|----------|---|---------|---------|---------|--|--|--------|-------|--|

IS

| | | | | | | | | | |
|---------|---|--------|---------|---------------|-------|-----|--------|-------|---------------------------|
| 2.0 200 | 6 | 1G-FE | 114/153 | 10/02 → 10/05 | | | CET12P | OE182 | BAEA172E ^[161] |
| 3.0 300 | 6 | 2JZ-GE | 157/211 | 10/01 → 10/05 | OE136 | 0,8 | CET12P | OE179 | |

IS C

| | | | | | | | | | |
|---------|---|---------|---------|---------|--|--|--------|-------|----------|
| 2.5 250 | 6 | 4GR-FSE | 153/205 | 04/09 → | | | CET14P | OE190 | BAEA192E |
|---------|---|---------|---------|---------|--|--|--------|-------|----------|

LEXUS



kW/BHP



eon TITAN

IRIDIUM



...LEXUS



IS I

| | | | | | | | | | |
|---------|---|--------|---------|-------------|-------|-----|--------|-------|---------------------------|
| 2.0 200 | 6 | 1G-FE | 114/153 | 04/99→07/05 | | | CET12P | OE182 | BAEA172E ^[161] |
| 3.0 300 | 6 | 2JZ-GE | 157/211 | 09/01→07/05 | OE136 | 0,8 | CET12P | OE179 | |

IS II

| | | | | | | | | | |
|----------------------|---|---------|---------|-------------|--|--|--------|-------|---------------------------|
| 2.5 250, 2.5 250 4WD | 6 | 4GR-FSE | 153/205 | 08/05→03/13 | | | CET14P | OE190 | BAEA192E |
| 2.5 250, 2.5 250 4WD | 6 | 4GR-FSE | 158/212 | 11/10→03/13 | | | CET14P | OE190 | |
| 3.5 350 | 6 | 2GR-FSE | 234/314 | 01/08→03/13 | | | CET14P | OE190 | |
| 3.5 350, 3.5 350 4WD | 6 | 2GR-FSE | 228/306 | 10/05→03/13 | | | CET14P | OE190 | |
| 5.0 IS F | 8 | 2UR-GSE | 311/417 | 11/07→03/13 | | | CET14P | OE190 | BAEA167E ^[166] |

IS III

| | | | | | | | | | |
|----------|---|---------|---------|--------|--|--|--------|-------|----------|
| 2.5 250 | 6 | 4GR-FSE | 153/205 | 04/13→ | | | CET14P | OE190 | |
| 2.5 300h | 4 | 2AR-FSE | 133/178 | 04/13→ | | | | | BAEA192E |

LS

| | | | | | | | | | |
|----------------------|---|---------|---------|-------------|----------------------------|-----|--------|-------|---------------------------|
| 4.0 400 | 8 | 1UZ-FE | 194/260 | 12/94→08/97 | OE136 | 0,8 | CET12P | OE179 | BAEA445 |
| | | | | | OE218 ^{LPG [278]} | 1,6 | | | |
| 4.0 400 | 8 | 1UZ-FE | 203/272 | 09/98→10/00 | OE136 | 0,8 | CET12P | OE179 | BAEA445 |
| 4.0 400 | 8 | 1UZ-FE | 209/280 | 09/97→10/00 | OE136 | 0,8 | CET12P | OE179 | BAEA445 |
| 4.0 400 | 8 | 1UZ-FE | 216/290 | 10/97→07/00 | OE136 | 0,8 | CET12P | | |
| 4.3 430 | 8 | 3UZ-FE | 207/278 | 10/00→08/06 | | | CET12P | OE182 | BAEA172E ^[161] |
| 4.3 430 | 8 | 3UZ-FE | 208/279 | 10/00→08/06 | | | CET12P | OE182 | |
| 4.6 460 | 8 | 1UR-FE | 255/342 | 05/08→ | | | CET14P | OE190 | BAEA192E |
| 4.6 460 | 8 | 1UR-FSE | 270/362 | 10/09→ | | | CET14P | OE190 | |
| 4.6 460 | 8 | 1UR-FSE | 280/375 | 04/06→ | | | CET14P | OE190 | BAEA192E |
| 4.6 460 | 8 | 1UR-FSE | 285/382 | 09/12→ | | | CET14P | OE190 | BAEA192E |
| 4.6 460 4WD | 8 | 1UR-FSE | 270/362 | 12/08→ | | | CET14P | OE190 | BAEA192E |
| 4.6 460 4WD | 8 | 1UR-FSE | 272/365 | 09/12→ | | | CET14P | OE190 | BAEA192E |
| 4.6 460, 4.6 460 4WD | 8 | 1UR-FSE | 283/380 | 12/08→ | | | CET14P | OE190 | |
| 5.0 600h 4WD | 8 | 2UR-FSE | 290/389 | 08/07→ | | | CET14P | OE190 | BAEA192E |

LX

| | | | | | | | | | |
|-------------|---|--------|---------|-------------|--|--|--------|-------|----------|
| 4.7 470 4WD | 8 | 2UZ-FE | 170/228 | 05/98→03/08 | | | CET12P | OE182 | BAEA172E |
| 4.7 470 4WD | 8 | 2UZ-FE | 173/232 | 05/98→03/08 | | | CET12P | OE182 | |
| 4.7 470 4WD | 8 | 2UZ-FE | 197/264 | 05/98→10/02 | | | CET12P | OE182 | |
| 4.7 470 4WD | 8 | 2UZ-FE | 202/271 | 08/02→03/08 | | | CET12P | OE182 | |
| 5.7 570 4WD | 8 | 3UR-FE | 270/362 | 11/07→ | | | CET14P | OE190 | BAEA192E |
| 5.7 570 4WD | 8 | 3UR-FE | 282/378 | 11/07→ | | | CET14P | OE190 | |

RX

| | | | | | | | | | |
|------------------------|---|-----------------|---------|-------------|--|--|--------|-------|---------------------------|
| 2.7 270 | 4 | 1AR-FE | 138/185 | 12/08→10/15 | | | CET14P | OE190 | BAEA192E |
| 3.0 300 | 6 | 1MZ-FE | 148/198 | 01/98→02/03 | | | CET12P | OE182 | BAEA173E |
| 3.0 300 4WD | 6 | 1MZ-FE | 148/198 | 10/00→05/03 | | | CET12P | OE182 | BAEA173E ^[162] |
| 3.0 300 4WD | 6 | 1MZ-FE | 150/201 | 05/03→12/08 | | | CET12P | OE182 | BAEA173E ^[162] |
| 3.0 300 4WD | 6 | 1MZ-FE | 164/220 | 01/98→02/03 | | | CET12P | OE182 | BAEA173E |
| 3.3 330, 3.3 330 4WD | 6 | 3MZ-FE | 171/229 | 04/03→12/08 | | | CET12P | OE182 | |
| 3.3 400h, 3.3 400h 4WD | 6 | 3MZ-FE | 155/208 | 09/04→12/08 | | | CET12P | OE182 | |
| 3.5 350, 3.5 350 4WD | 6 | 2GR-FE | 203/272 | 01/06→12/08 | | | CET14P | OE190 | |
| 3.5 350, 3.5 350 4WD | 6 | 2GR-FE | 206/276 | 12/08→10/15 | | | CET14P | OE190 | |
| 3.5 350 4WD | 6 | 2GR-FE; 2GR-FXE | 204/274 | 12/08→08/15 | | | CET14P | OE190 | |
| 3.5 450h, 3.5 450h 4WD | 6 | 2GR-FXE | 183/245 | 12/08→10/15 | | | CET14P | OE190 | |
| 3.5 450h, 3.5 450h 4WD | 6 | | 220/295 | 12/08→10/15 | | | CET14P | OE190 | |

SC

| | | | | | | | | | |
|---------|---|--------|---------|-------------|--|--|--------|-------|-------------------------------------|
| 4.3 430 | 8 | 3UZ-FE | 210/282 | 05/01→07/10 | | | CET12P | OE182 | BAEA172E ^[161] →07/03 |
| 4.3 430 | 8 | 3UZ-FE | 215/288 | 01/01→07/10 | | | CET12P | OE188 | |
| 4.3 430 | 8 | 3UZ-FE | 244/327 | 05/01→07/10 | | | CET12P | OE188 | |



kW/BHP



eon TITAN

IRIDIUM

**LIFAN****320**

| | | | | | | | | |
|-----|---|---------|-------|--------|-------|-----|------|-------|
| 1.3 | 4 | LF479Q3 | 65/87 | 07/06→ | OE005 | 0,9 | CET2 | OE179 |
|-----|---|---------|-------|--------|-------|-----|------|-------|

520

| | | | | | | | | |
|-----|---|---------------------------|-------|-------------|-------|-----|------|-------|
| 1.3 | 4 | LF479Q1; LF479Q3; LF479Q4 | 65/87 | 07/06→12/15 | OE005 | 0,9 | CET2 | OE179 |
|-----|---|---------------------------|-------|-------------|-------|-----|------|-------|

| | | | | | | | | |
|-----|---|---------|--------|-------------|-------|-----|------|-------|
| 1.6 | 4 | LF481Q3 | 78/105 | 04/06→12/12 | OE005 | 0,9 | CET2 | OE179 |
|-----|---|---------|--------|-------------|-------|-----|------|-------|

| | | | | | | | | |
|-----|---|-------|--------|--------|-------|-----|------|-------|
| 1.6 | 4 | T16b3 | 85/114 | 04/06→ | OE005 | 0,9 | CET2 | OE179 |
|-----|---|-------|--------|--------|-------|-----|------|-------|

620

| | | | | | | | | |
|-----|---|---------|--------|--------|-------|-----|------|-------|
| 1.6 | 4 | LF481Q3 | 78/105 | 06/08→ | OE005 | 0,9 | CET2 | OE179 |
|-----|---|---------|--------|--------|-------|-----|------|-------|

X60

| | | | | | | | | |
|-----------|---|---------|--------|--------|-------|-----|------|-------|
| 1.8 i 4WD | 4 | LFB479Q | 98/131 | 01/11→ | OE005 | 0,9 | CET2 | OE179 |
|-----------|---|---------|--------|--------|-------|-----|------|-------|

LIGIER**AMBRA**

| | | | | | | | |
|-----|---|--------|-------|-------------|-------|-----|------|
| 0.5 | 2 | LGW523 | 14/19 | 12/96→12/06 | OE016 | 0,9 | CET2 |
|-----|---|--------|-------|-------------|-------|-----|------|

BE UP

| | | | | | | | |
|-----|---|--------|-------|-------------|-------|-----|------|
| 0.5 | 2 | LGW523 | 14/19 | 08/02→12/06 | OE016 | 0,9 | CET2 |
|-----|---|--------|-------|-------------|-------|-----|------|

NOVA

| | | | | | | | |
|---------|---|--|-----|--------|-------|-----|------|
| 0.1 400 | 1 | | 5/7 | 08/02→ | OE016 | 0,9 | CET2 |
|---------|---|--|-----|--------|-------|-----|------|

| | | | | | | | |
|---------|---|--------|-------|--------|-------|-----|------|
| 0.5 650 | 2 | LGW523 | 14/19 | 08/02→ | OE016 | 0,9 | CET2 |
|---------|---|--------|-------|--------|-------|-----|------|

LINCOLN**CONTINENTAL TOWN CAR**

| | | | | | | | |
|-----|---|------|---------|-------------|--|--|------|
| 4.6 | 8 | V99V | 209/280 | 01/94→12/02 | | | CET9 |
|-----|---|------|---------|-------------|--|--|------|

| | | | | | | | |
|---------------|---|--|---------|-------------|--|--|------|
| 4.6 Signature | 8 | | 157/211 | 01/94→10/99 | | | CET9 |
|---------------|---|--|---------|-------------|--|--|------|

LS

| | | | | | | | | | |
|------------|---|--|---------|--------|-------|-----|--------|-------|---------|
| 3.0 V6 24V | 6 | | 140/188 | 05/98→ | OE131 | 1,0 | CET18P | OE183 | BAEA367 |
|------------|---|--|---------|--------|-------|-----|--------|-------|---------|

| | | | | | | | | | |
|------------|---|--|---------|--------|--|--|--|--|--------------------------|
| 3.9 V8 32V | 8 | | 180/241 | 05/98→ | | | | | BAEA368 ^[277] |
|------------|---|--|---------|--------|--|--|--|--|--------------------------|

TOWN CAR III

| | | | | | | | |
|-----|---|--|---------|-------------|--|--|------|
| 4.6 | 8 | | 160/215 | 10/97→12/03 | | | CET9 |
|-----|---|--|---------|-------------|--|--|------|

LOTUS**ELISE**

| | | | | | | | | | |
|-----|---|-------|--------|-------------|-------|-----|--------|-------|-------------------------|
| 1.8 | 4 | 18K4F | 88/118 | 08/95→11/00 | OE146 | 1,0 | CET12P | OE179 | CLS061 ^[292] |
|-----|---|-------|--------|-------------|-------|-----|--------|-------|-------------------------|

| | | | | | | | | | |
|--|--|--|--|--|----------------------------|-----|--|--|--|
| | | | | | OE218 ^{UPG [278]} | 1,6 | | | |
|--|--|--|--|--|----------------------------|-----|--|--|--|

| | | | | | | | | | |
|-----|---|-------|--------|-------------|-------|-----|--------|-------|-------------------------|
| 1.8 | 4 | 18K4F | 90/121 | 11/00→08/05 | OE146 | 1,0 | CET12P | OE179 | CLS061 ^[292] |
|-----|---|-------|--------|-------------|-------|-----|--------|-------|-------------------------|

| | | | | | | | | | |
|-----|---|--------|--------|--------|-------|-----|------|--|--|
| 1.8 | 4 | 1ZZ-FE | 99/133 | 10/03→ | OE089 | 1,0 | CET2 | | |
|-----|---|--------|--------|--------|-------|-----|------|--|--|

| | | | | | | | | | |
|-----|---|-------|---------|-------------|-------|-----|--------|--|--|
| 1.8 | 4 | 18K4G | 101/135 | 11/98→12/03 | OE146 | 1,0 | CET12P | | |
|-----|---|-------|---------|-------------|-------|-----|--------|--|--|

| | | | | | | | | | |
|-----|---|-------|---------|--------|-------|-----|--------|--|--|
| 1.8 | 4 | 18K4K | 118/158 | 11/98→ | OE146 | 1,0 | CET12P | | |
|-----|---|-------|---------|--------|-------|-----|--------|--|--|

| | | | | | | | | | |
|-----|---|--------|---------|--------|-------|-----|--------|-------|-------------------------|
| 1.8 | 4 | 2ZZ-GE | 118/158 | 11/98→ | OE146 | 1,0 | CET12P | OE179 | CLS061 ^[292] |
|-----|---|--------|---------|--------|-------|-----|--------|-------|-------------------------|

| | | | | | | | | | |
|-----|---|--------|---------|--------|--|--|--------|-------|--|
| 1.8 | 4 | 2ZZ-GE | 140/188 | 11/02→ | | | CET12P | OE182 | |
|-----|---|--------|---------|--------|--|--|--------|-------|--|

| | | | | | | | | | |
|-----|---|--------|---------|--------|--|--|--------|-------|--|
| 1.8 | 4 | 2ZZ-GE | 141/189 | 01/04→ | | | CET12P | OE182 | |
|-----|---|--------|---------|--------|--|--|--------|-------|--|

| | | | | | | | | | |
|-----------|---|-------|---------|-------------|-------|-----|--------|-------|--|
| 1.8 111 S | 4 | 18K4K | 107/143 | 03/99→11/00 | OE146 | 1,0 | CET12P | OE179 | |
|-----------|---|-------|---------|-------------|-------|-----|--------|-------|--|

ELISE 340 R

| | | | | | | | | |
|-----|---|--|---------|-------------|-------|-----|--------|-------|
| 1.8 | 4 | | 132/177 | 03/00→02/01 | OE146 | 1,0 | CET12P | OE179 |
|-----|---|--|---------|-------------|-------|-----|--------|-------|

ESPRIT S4

| | | | | | | | | |
|-----|---|--|---------|-------------|-------|-----|------|--|
| 2.2 | 4 | | 221/296 | 05/93→07/96 | OE018 | 1,0 | CET8 | |
|-----|---|--|---------|-------------|-------|-----|------|--|

| | | | | | | | | |
|-----|---|--|---------|-------------|-------|-----|------|--|
| 2.2 | 4 | | 222/298 | 11/94→07/96 | OE018 | 1,0 | CET8 | |
|-----|---|--|---------|-------------|-------|-----|------|--|

| | | | | | | | | |
|------------------|---|-----|---------|-------------|-------|-----|------|-------|
| 3.5 V8 32V Turbo | 8 | 618 | 260/349 | 02/96→06/03 | OE030 | 0,9 | CET2 | OE179 |
|------------------|---|-----|---------|-------------|-------|-----|------|-------|

| | | | | | | | | |
|--|--|--|--|--|----------------------------|-----|--|--|
| | | | | | OE216 ^{UPG [278]} | 0,8 | | |
|--|--|--|--|--|----------------------------|-----|--|--|

EUROPA S

| | | | | | | | | |
|-----------|---|--------|---------|--------|-------|-----|------|-------|
| 2.0 Turbo | 4 | Z20LER | 147/197 | 07/06→ | OE019 | 0,9 | CET2 | OE184 |
|-----------|---|--------|---------|--------|-------|-----|------|-------|

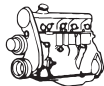

kW/BHP

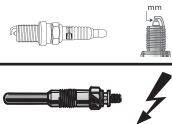

eon TITAN

IRIDIUM

**...LOTUS****EXIGE**

| | | | | | | | | |
|-----------|---|--------|---------|-------------|-------|-----|---------|-------|
| 1.8 16V | 4 | 2ZZ-GE | 132/177 | 05/00→07/08 | OE014 | 0,9 | CET2 | OE179 |
| 1.8 16V | 4 | 2ZZ-GE | 141/189 | 09/01→07/08 | | | CET1 2P | OE182 |
| 1.8 16V | 4 | 2ZZ-GE | 163/219 | 04/06→06/12 | | | CET1 2P | OE182 |
| 1.8 265 E | 4 | 2ZZ-GE | 197/264 | 08/06→06/12 | | | CET1 2P | OE182 |

LTI**TX**

| | | | | | | | | |
|---------|---|----------|--------|--------|-------------|-------|--|--|
| 2.4 TDi | 4 | D2FA | 66/89 | 10/02→ | CH229 | 11.5v | | |
| 2.5 TD | 4 | R425DOHC | 75/101 | 01/06→ | CH180 [275] | 11v | | |
| 2.7 TD | 4 | TD27 | 60/80 | 01/97→ | CH221 | 11v | | |

MARCOS**MANTA RAY**

| | | | | | | | | |
|-----|---|--|---------|-------------|--|--|------|--|
| 4.6 | 8 | | 261/350 | 08/97→09/02 | | | CET9 | |
|-----|---|--|---------|-------------|--|--|------|--|

MANTIS

| | | | | | | | | |
|-----|---|--|---------|--------|--|--|------|--|
| 4.6 | 8 | | 261/350 | 01/97→ | | | CET9 | |
|-----|---|--|---------|--------|--|--|------|--|

MASERATI**3200 GT**

| | | | | | | | | |
|--------------------|---|-------|---------|-------------|-------|------|--|--|
| 3.2 Biturbo V8 32V | 8 | AM585 | 271/363 | 10/98→03/02 | OE122 | 0,6* | | |
|--------------------|---|-------|---------|-------------|-------|------|--|--|

*to be adjusted

4200 GT

| | | | | | | | | |
|-----|---|------|---------|-------------|-------|-----|--|--|
| 4.2 | 8 | M138 | 287/385 | 03/02→11/07 | OE122 | 0,7 | | |
|-----|---|------|---------|-------------|-------|-----|--|--|

4200 GT SPYDER

| | | | | | | | | |
|-----|---|------|---------|--------|-------|-----|--|--|
| 4.2 | 8 | M138 | 287/385 | 10/01→ | OE122 | 0,7 | | |
|-----|---|------|---------|--------|-------|-----|--|--|

QUATTROPORTE IV

| | | | | | | | | |
|-------------|---|---------------|---------|-------------|-------|-----|------|----------|
| 2.0 Biturbo | 6 | 24VDOHC | 211/283 | 03/94→09/98 | | | | BAE700AK |
| 2.8 Biturbo | 6 | AM574; AM574A | 209/280 | 03/94→09/98 | OE087 | 0,9 | CET8 | BAE700AK |
| 3.2 V8 32V | 8 | AM578 | 247/331 | 12/95→05/01 | OE122 | 0,7 | | |

QUATTROPORTE V

| | | | | | | | | |
|-----|---|-------|---------|--------|-------------|-----|--|--|
| 4.2 | 8 | M139A | 295/396 | 03/04→ | OE122 [290] | 0,7 | | |
|-----|---|-------|---------|--------|-------------|-----|--|--|

MAYBACH**57**

| | | | | | | | | |
|--------------|----|----------|---------|-------------|--|--|---------|-------|
| 5.5, 5.5 V12 | 12 | M285.950 | 405/543 | 09/02→12/12 | | | CET1 2P | OE188 |
| 6.0 | 12 | M285.980 | 463/621 | 01/11→12/12 | | | CET1 2P | OE188 |
| 6.0 | 12 | M285.980 | 471/632 | 06/09→12/12 | | | CET1 2P | OE188 |
| 6.0 S | 12 | M285.980 | 450/603 | 09/05→12/12 | | | CET1 2P | OE188 |

MAZDA**2 Saloon (DE_)**

| | | | | | | | | |
|-------|---|-------|--------|-------------|--|--|--|---------|
| 1.5 i | 4 | ZY-DE | 76/102 | 05/10→06/15 | | | | BAEA489 |
|-------|---|-------|--------|-------------|--|--|--|---------|

2 (DE_, DH_3)

| | | | | | | | | |
|------------|---|--------------|--------|-------------|-------|-----|---------|-------|
| 1.3 | 4 | ZJ-VE | 55/74 | 10/07→06/15 | | | CET1 2P | OE180 |
| 1.3 | 4 | ZJ-VE | 63/84 | 10/07→06/15 | | | CET1 2P | OE180 |
| 1.3 MZR | 4 | ZJ-VE | 62/83 | 01/10→06/15 | | | CET1 2P | OE180 |
| 1.4 MZR-CD | 4 | Y404 | 50/67 | 01/08→06/15 | CH201 | 11v | | |
| 1.5 | 4 | ZY-DE; ZY-VE | 76/102 | 10/07→06/15 | | | CET1 2P | OE180 |
| 1.5 MZR | 4 | ZY05; ZY66 | 75/101 | 06/11→06/15 | | | CET1 2P | OE180 |
| 1.6 MZ-CD | 4 | Y406; Y646 | 66/89 | 10/08→06/15 | CH201 | 11v | | |

2 (DL, DJ)

| | | | | | | | | |
|-----|---|--|-------|--------|--|--|--|-------------|
| 1.5 | 4 | P5X0; P5X2; P5Y5; P5Y8; P5Z7; P5Z8; P5Z9 | 55/74 | 08/14→ | | | | OE253 [294] |
|-----|---|--|-------|--------|--|--|--|-------------|





kW/BHP

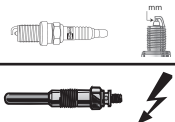

eon TITAN

IRIDIUM

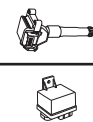

...MAZDA



...2 (DL, DJ)

| | | | | | | | | | | |
|-----|---|--|--------|--------|--|--|--|------------------------|--|--|
| 1.5 | 4 | P5X0; P5X2; P5Y5; P5Y6; P5Y8; P5Z2; P5Z3; P5Z7; P5Z8; P5Z9 | 66/89 | 08/14→ | | | | OE253 ^[294] | | |
| 1.5 | 4 | P5X0; P5X2; P5Y5; P5Z3; P5Z7; P5Z8; P5Z9 | 85/114 | 08/14→ | | | | OE253 ^[294] | | |

2 (DY)

| | | | | | | | | | | |
|--------|---|------------|--------|-------------|-------|-----|------|-------|---|--------|
| 1.2 | 4 | FUJA | 55/74 | 02/03→06/07 | OE031 | 1,0 | CET7 | OE189 | BAEA350 | |
| 1.3 | 4 | FUJA | 55/74 | 04/03→06/07 | OE031 | 1,0 | CET7 | OE189 | BAEA350 →02/05 | CLS077 |
| 1.4 | 4 | FXJA | 59/79 | 02/03→06/07 | OE031 | 1,0 | CET7 | OE189 | BAEA350 →02/05 BAEA422 →02/05 BAEA387 02/05→ | CLS077 |
| 1.4 CD | 4 | F6JA; F6JB | 50/67 | 04/03→06/07 | | | | | CCU147 | |
| 1.5 | 4 | ZY-VE | 82/110 | 04/03→06/07 | OE063 | 1,0 | CET2 | OE180 | BAEA489 | |
| 1.6 | 4 | FYJA | 74/99 | 02/03→06/07 | OE031 | 1,0 | CET7 | OE189 | BAEA350 | CLS077 |

3 (BK)

| | | | | | | | | | | |
|--------------------|---|--------------------------------------|---------|-------------|-------|-----|--------|-------|-------------------|--|
| 1.4 | 4 | FXJA | 59/79 | 02/04→06/09 | | | CET12P | OE180 | BAEA489 | |
| 1.4 | 4 | ZJ-VE | 62/83 | 10/03→06/09 | | | CET12P | OE180 | BAEA489 | |
| 1.6 MZ-CD | 4 | Y406 | 66/89 | 06/06→12/09 | CH201 | 11v | | | | |
| 2.0 | 4 | LF50; LF72; LF-DE; LFN7; LFN8; LF-VE | 110/148 | 10/03→12/09 | | | CET18P | OE183 | BAEA422 →02/06 | |
| 2.3 DiSi Turbo MPS | 4 | L3YH | 184/247 | 06/06→06/09 | | | CET17P | | | |
| 2.3 MPS Turbo | 4 | L3N9; L3-VDT | 191/256 | 12/06→06/09 | | | CET17P | | | |
| 2.3 MZR | 4 | L3-VE | 115/154 | 03/04→03/09 | | | CET18P | OE183 | | |
| 2.3 MZR Sport | 4 | L3YS; L3YT | 126/169 | 10/03→06/09 | | | CET18P | OE183 | | |

3 /Saloon (BK)

| | | | | | | | | | | |
|-----|---|----------|--------|-------------|--|--|--------|-------|-------------------|--|
| 1.6 | 4 | B6ZE; Z6 | 77/103 | 10/03→06/09 | | | CET12P | OE180 | BAEA489 03/06→ | |
|-----|---|----------|--------|-------------|--|--|--------|-------|-------------------|--|

3 Saloon (BK)

| | | | | | | | | | | |
|-----|---|--------------------------------------|---------|-------------|--|--|--------|-------|--|--|
| 2.0 | 4 | LF17 | 104/139 | 04/04→06/06 | | | CET18P | OE183 | BAEA408 | |
| 2.0 | 4 | LF50; LF72; LF-DE; LFN7; LFN8; LF-VE | 110/148 | 10/03→12/09 | | | CET18P | OE183 | BAEA422 →02/06 BAEA489 03/06→ | |

3 (BL)

| | | | | | | | | | | |
|---------------|---|--------------|---------|-------------|--|--|--------|--|---------|--|
| 1.6 MZR | 4 | Z6 | 79/106 | 01/10→12/13 | | | | | BAEA489 | |
| 2.3 MPS Turbo | 4 | L3KG; L3-VDT | 191/256 | 06/09→09/14 | | | CET17P | | | |

3 /Saloon (BL)

| | | | | | | | | | | |
|--------------|---|-------------|---------|-------------|------------------------|-----|--------|-------|---------|--|
| 1.6 MZR | 4 | Z6 | 77/103 | 12/08→09/14 | | | CET12P | OE180 | BAEA489 | |
| 1.6 MZR CD | 4 | Y601; Y642 | 80/107 | 12/08→05/13 | CH201 ^[288] | 11v | | | | |
| 1.6 MZR CD | 4 | Y650; Y655 | 85/114 | 09/10→05/13 | CH201 ^[288] | 11v | | | | |
| 2.0 MZR | 4 | LF17; LF-DE | 110/148 | 01/09→09/14 | | | CET17P | OE189 | | |
| 2.0 MZR DISI | 4 | LF-Z2 | 111/149 | 12/08→05/13 | | | CET17P | OE189 | | |
| 2.5 | 4 | L5-VE | 122/164 | 03/09→09/14 | | | CET17P | OE189 | | |

3 /Saloon (BM, BN)

| | | | | | | | | | | |
|-----|---|------------|---------|--------|--|--|--|-------|---------|--|
| 1.5 | 4 | P5Y1 | 74/99 | 09/13→ | | | | OE253 | | |
| 1.5 | 4 | P5Y1 | 88/118 | 10/13→ | | | | OE253 | | |
| 1.6 | 4 | Z6Y1; Z6Y3 | 77/103 | 09/13→ | | | | | BAEA489 | |
| 2.0 | 4 | PEY7 | 88/118 | 09/13→ | | | | OE253 | | |
| 2.0 | 4 | PEY7 | 110/148 | 11/13→ | | | | OE253 | | |
| 2.0 | 4 | PEX2; PEY7 | 121/162 | 09/13→ | | | | OE253 | | |

5 (CR19)

| | | | | | | | | | | |
|-----|---|------|--------|-------------|--|--|--------|-------|--|--|
| 1.8 | 4 | L823 | 85/114 | 02/05→05/10 | | | CET18P | OE183 | | |
|-----|---|------|--------|-------------|--|--|--------|-------|--|--|

MAZDA





kW/BHP

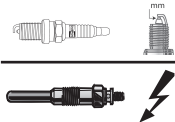

eon TITAN

IRIDIUM



...MAZDA



...5 (CR19)

2.0 4 LFF7 107/143 02/05→05/10

CET17P
CET18P
OE183
OE189

5 (CW)

1.8 MZR 4 L850 85/114 09/10→

CET18P
OE183

2.0 4 LF-ZB 110/148 09/10→

CET17P
OE189

6 Hatchback (GG)

3.0 6 AJ 162/217 01/04→12/07

OE131 1,0

CET18P
OE183

3.0 6 AJ 164/220 01/05→12/07

OE131 1,0

CET18P
OE183

6 Hatchback/Saloon (GG)

1.8 4 L813; L823; L828 88/118 08/02→08/07

CET18P
OE183
BAEA556
CLS075

2.0 4 LF17; LF18 104/139 06/02→08/07

CET18P
OE183
BAEA556
CLS075

2.0 4 LFF7 108/145 03/05→08/07

CET17P
CET18P
OE183
OE189
CLS075

2.3 4 L3C1 122/164 06/02→08/07

CET18P
OE183
CLS075

BAEA422
→02/05
BAEA556^[275]
03/05→

6 Saloon (GG)

2.3 MPS Turbo 4WD 4 L3KG 191/256 12/05→08/07

CET17P

6 Estate (GH)

1.8 MZR 4 L813 88/118 02/08→07/13

CET18P
OE183

6 Estate/Hatchback (GH)

2.0 MZR 4 LF17 108/145 08/07→07/13

OE031
→12/12

1,0
CET17P
OE189

2.0 MZR 4 LF-DE 114/153 01/10→07/13

OE031
→12/12

1,0
CET17P
OE189

6 Estate/Hatchback/Saloon (GH)

2.0 MZR 4 LF-DE 114/153 01/10→12/12

CET17P
OE189

2.5 MZR 4 L5-VE 125/168 08/07→07/13

CET17P
OE189

6 Hatchback/Saloon (GH)

1.8 MZR 4 L813 88/118 08/07→07/13

CET18P
OE183
BAEA556

6 Saloon (GH)

2.0 MZR 4 LF17 108/145 08/07→12/12

OE031 1,0

CET17P
OE189

6 Estate/Saloon (GJ, GL)

2.0 4 PEXB; PEXL; PEY5; PEY7 107/143 01/13→

OE253

2.0 4 PEXB; PEXL; PEY5; PEY7 121/162 01/13→

OE253

2.5 4 PYY1; PY-Y8; PY-ZA 141/189 12/12→

OE253

6 Station Wagon (GY)

1.8 4 L813 88/118 08/02→08/07

CET18P
OE183
BAEA556
CLS075

2.0 4 LF17; LF18 104/139 08/02→08/07

CET18P
OE183
BAEA556
CLS075

2.0 4 LFF7 108/145 03/05→08/07

CET17P
CET18P
OE183
OE189
CLS075

2.3 4 L3C1 122/164 01/02→02/08

CET18P
OE183
CLS075

BAEA422
→02/05
BAEA556^[275]
03/05→

2.3 4WD 4 L3C1 119/160 11/02→08/07

CET18P
OE183
BAEA556
→02/05

121 II (DB)

1.5 i 4 B5C4 62/83 01/94→05/97

OE063 1,0

CET2
OE180

121 III (JASM, JBSM)

1.3 4 JJK; JJM 37/50 03/96→04/03

OE131 1,0

CET18P
OE183
BAEA350
CLS033^[275]

CLS066^[275]

MAZDA





kW/BHP

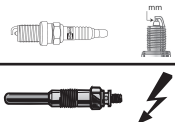

eon TITAN

IRIDIUM

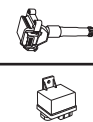

...MAZDA



...121 III (JASM, JBSM)

| | | | | | | | | | | |
|----------------------|---|----------------|---------|-------------|-----------------|-----|--------|-------|---------------|--|
| 1.3 | 4 | J4R; J4T | 44/59 | 03/96→04/03 | OE039 | 1,0 | CET2 | OE180 | BAEA350 | CLS033 [275] CLS066 [275] |
| 1.3 | 4 | DHF; DHG | 55/74 | 03/96→04/03 | OE029 | 1,0 | CET17P | OE189 | BAEA350 | CLS032 →04/98 CLS016 [275] 05/98→ |
| 1.8 D | 4 | RTJ; RTK | 44/59 | 03/96→04/03 | CH205 | 10v | | | | |
| 323 C IV (BG) | | | | | | | | | | |
| 1.6 | 4 | B67K | 66/89 | 09/93→09/00 | OE005 | 0,9 | CET2 | OE179 | | |
| 1.8 16V Turbo 4WD | 4 | BPTurbo | 136/182 | 01/93→07/94 | OE005 | 0,9 | CET2 | OE180 | | |
| 323 C V (BA) | | | | | | | | | | |
| 1.3 16V | 4 | B3(16V) | 54/72 | 08/94→09/98 | OE039 | 1,0 | CET2 | OE180 | BAEA560 [275] | CLS131 |
| 1.5 16V | 4 | Z5-DE | 65/87 | 08/94→09/98 | OE039 | 1,0 | CET2 | OE180 | | CLS031 |
| 1.8 16V | 4 | BP-ZE | 84/113 | 08/94→09/98 | | | CET12P | OE179 | | |
| 323 F V (BA) | | | | | | | | | | |
| 1.5 16V | 4 | Z5-DE | 65/87 | 07/94→09/98 | OE063 | 1,0 | CET2 | OE180 | | CLS031 |
| 1.8 16V | 4 | BP-ZE | 84/113 | 08/94→09/98 | OE039 | 1,0 | CET2 | OE179 | | |
| 2.0 24V | 6 | KF | 106/142 | 08/94→09/98 | | | CET12P | OE179 | | |
| 323 F VI (BJ) | | | | | | | | | | |
| 1.4 | 4 | B3(16V) | 53/71 | 01/01→05/04 | OE063 | 1,0 | CET2 | OE180 | BAEA560 | |
| 1.4 16V | 4 | B3ME | 54/72 | 09/98→01/01 | OE063 | 1,0 | CET2 | OE180 | | |
| 1.5 16V | 4 | ZL05 | 65/87 | 09/98→01/01 | OE005 | 0,9 | CET2 | OE180 | BAEA190E | CLS183 |
| 1.5 16V | 4 | ZL06 | 65/87 | 09/98→01/01 | OE005 | 0,9 | CET2 | OE180 | BAEA190E | CLS257 |
| 1.6 | 4 | ZM | 70/94 | 01/01→05/04 | OE089 | 1,0 | CET2 | OE184 | BAEA190E | CLS257 |
| | | | | | OE216 LPG [278] | 0,8 | | | | |
| 1.6 | 4 | ZM | 72/97 | 01/01→05/04 | OE089 | 1,0 | CET2 | OE184 | BAEA190E | CLS257 |
| | | | | | OE216 LPG [278] | 0,8 | | | | |
| 1.8 Astina | 4 | BP(DOHC) | 92/123 | 09/98→05/04 | | | | | BAEA083E | CLS198 10/00→ |
| 1.9 16V | 4 | FP; FP55 | 84/113 | 09/98→01/01 | OE063 | 1,0 | CET2 | OE180 | BAEA083E | CLS198 10/00→ |
| 2.0 | 4 | FS7E; FS7G | 96/129 | 01/01→05/04 | OE089 | 1,0 | CET2 | OE184 | BAEA083E | CLS198 |
| 323 P V (BA) | | | | | | | | | | |
| 1.3 16V | 4 | B3(16V) | 54/72 | 10/96→09/98 | OE005 | 0,9 | CET2 | OE180 | BAEA560 [275] | CLS131 |
| 1.5 16V | 4 | Z5-DE | 65/87 | 10/96→09/98 | OE063 | 1,0 | CET2 | OE180 | | CLS031 |
| 2.0 D | 4 | RF1G | 52/70 | 10/96→09/98 | CH242 [186] | 11v | | | | |
| 323 S V (BA) | | | | | | | | | | |
| 1.3 16V | 4 | B3(16V) | 54/72 | 08/94→09/98 | OE039 | 1,0 | CET2 | OE180 | BAEA560 [275] | CLS131 |
| 1.5 16V | 4 | Z5-DE | 65/87 | 08/94→09/98 | OE063 | 1,0 | CET2 | OE180 | | CLS031 |
| 1.6 TD | 4 | 4EE1-T | 60/80 | 05/94→09/98 | CH242 [186] | 11v | | | | |
| 1.8 16V | 4 | BP-ZE | 84/113 | 08/94→09/98 | | | CET12P | OE179 | | |
| 2.0 D | 4 | RF1G | 52/70 | 10/96→09/98 | CH242 [186] | 11v | | | | |
| 323 S VI (BJ) | | | | | | | | | | |
| 1.4 | 4 | B3(16V) | 53/71 | 01/01→05/04 | OE039 | 1,0 | CET2 | OE180 | | |
| 1.4 16V | 4 | B3ME | 54/72 | 09/98→01/01 | OE063 | 1,0 | CET2 | OE180 | | |
| 1.5 | 4 | | 80/107 | 05/98→05/04 | OE063 | 1,0 | CET2 | OE180 | | |
| 1.5 16V | 4 | ZL05 | 65/87 | 09/98→01/01 | OE063 | 1,0 | CET2 | OE180 | BAEA190E | CLS183 |
| 1.5 16V | 4 | ZL06 | 65/87 | 09/98→01/01 | OE063 | 1,0 | CET2 | OE180 | BAEA190E | CLS257 |
| 1.6 | 4 | ZM | 70/94 | 01/01→05/04 | OE089 | 1,0 | CET2 | OE184 | BAEA190E | CLS257 |
| | | | | | OE216 LPG [278] | 0,8 | | | | |
| 1.6 | 4 | ZM | 72/97 | 01/01→05/04 | OE089 | 1,0 | CET2 | OE184 | BAEA190E | CLS257 |
| | | | | | OE216 LPG [278] | 0,8 | | | | |
| 1.8 Protege | 4 | BP(DOHC); FP55 | 92/123 | 05/98→05/04 | | | | | BAEA083E | CLS198 10/00→ |

MAZDA



kW/BHP

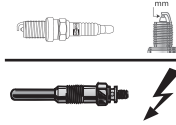

eon TITAN

IRIDIUM

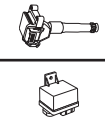

...MAZDA



...323 S VI (BJ)

| | | | | | | | | | | |
|---------|---|------------|--------|-------------|--------------|-----|-------------|--------------|---------------------------|-------------------------|
| 1.9 16V | 4 | FP; FP55 | 84/113 | 09/98→05/04 | OE063 | 1,0 | CET2 | OE180 | BAEA083E 10/00→ | CLS198 10/00→ |
| 2.0 | 4 | FS7E; FS7G | 96/129 | 01/01→05/04 | OE005 | 0,9 | CET2 | OE179 | BAEA083E | CLS198 |

626 III Station Wagon (GV)

| | | | | | | | | | | |
|---------------|---|-------|-------|-------------|--------------|-----|--|--|--|--|
| 2.0 D | 4 | RF65 | 60/80 | 11/94→09/97 | CH242 | 11v | | | | |
| 2.0 D Complex | 4 | RF-CX | 55/74 | 05/93→11/96 | CH242 | 11v | | | | |

626 IV (GE)

| | | | | | | | | | | |
|-------|---|------|--------|-------------|--------------|-----|-------------|--|--|--|
| 1.8 i | 4 | FP | 78/105 | 05/94→06/97 | OE005 | 0,9 | CET2 | | | |
| 2.0 D | 4 | RF55 | 56/75 | 05/94→06/97 | CH242 | 11v | | | | |

626 IV /Hatchback (GE)

| | | | | | | | | | | |
|------------|---|----------|-------|-------------|--------------|-----|-------------|--------------|--|---------------|
| 1.8, 1.8 i | 4 | ; FP01LP | 66/89 | 08/94→04/97 | OE005 | 0,9 | CET2 | OE180 | | CLS229 |
|------------|---|----------|-------|-------------|--------------|-----|-------------|--------------|--|---------------|

626 IV Hatchback (GE)

| | | | | | | | | | | |
|-------------------|---|------|---------|-------------|--|------------|-------------|--------------|--|--|
| 2.0 D GLX Complex | 4 | RF55 | 55/74 | 01/93→04/97 | CH242 →12/95 | 11v | | | | |
| 2.5 24V | 6 | KL | 120/161 | 08/94→04/97 | OE089 OE216 LPG [278] | 1,0 0,8 | CET2 | OE184 | | |

626 V (GF)

| | | | | | | | | | | |
|-----|---|------|---------|-------------|--------------|-----|-------------|--------------|----------------|---------------|
| 2.0 | 4 | FS | 85/114 | 05/97→10/02 | OE005 | 0,9 | CET2 | OE180 | | CLS239 |
| 2.0 | 4 | FS2C | 100/134 | 04/98→10/02 | OE005 | 0,9 | CET2 | OE180 | BAEA281 | |

626 V /Hatchback (GF)

| | | | | | | | | | | |
|-----|---|----------|-------|-------------|--------------|-----|-------------|--------------|----------------------|---------------|
| 1.8 | 4 | FPY3 | 66/89 | 05/97→12/99 | OE039 | 1,0 | CET2 | OE180 | BAEA281 [275] | CLS239 |
| 1.8 | 4 | FP; FP9A | 74/99 | 12/99→10/02 | OE005 | 0,9 | CET2 | OE180 | BAEA281 [275] | CLS239 |

626 V Hatchback (GF)

| | | | | | | | | | | |
|----------|---|------|---------|-------------|--------------|-----|-------------|--------------|----------------|---------------|
| 2.0 | 4 | FS | 85/114 | 05/97→10/02 | OE005 | 0,9 | CET2 | OE180 | BAEA281 | CLS239 |
| 2.0 H.P. | 4 | FS2C | 100/134 | 02/98→10/02 | OE005 | 0,9 | CET2 | OE180 | BAEA354 | CLS239 |

626 V Station Wagon (GW)

| | | | | | | | | | | |
|----------|---|------|---------|-------------|--------------|-----|-------------|--------------|----------------------|---------------|
| 1.8 | 4 | FPY3 | 66/89 | 02/98→01/00 | OE039 | 1,0 | CET2 | OE180 | BAEA281 [275] | CLS239 |
| 1.8 | 4 | FP9A | 74/99 | 01/00→10/02 | OE005 | 0,9 | CET2 | OE180 | BAEA281 [275] | CLS239 |
| 2.0 | 4 | FS | 85/114 | 02/98→10/02 | OE005 | 0,9 | CET2 | OE180 | BAEA281 | CLS239 |
| 2.0 H.P. | 4 | FS2C | 100/134 | 02/98→10/02 | OE005 | 0,9 | CET2 | OE180 | BAEA281 [275] | |

B-SERIE (UF)

| | | | | | | | | | | |
|---------|---|--|-------|-------------|--------------|-----|-------------|--|--|--|
| 2.2 12V | 4 | | 68/91 | 04/96→01/99 | OE039 | 1,0 | CET2 | | | |
|---------|---|--|-------|-------------|--------------|-----|-------------|--|--|--|

B-SERIE /Platform/Chassis (UF)

| | | | | | | | | | | |
|-------------------|---|------|-------|-------------|--------------|-----|--|--|--|--|
| 2.5 D, 2.5 D 4WD | 4 | | 63/84 | 02/96→06/99 | CH242 | 11v | | | | |
| 2.5 D 4WD, 2.5 TD | 4 | WL-T | 64/86 | 04/96→02/99 | CH242 | 11v | | | | |

B-SERIE (UN)

| | | | | | | | | | | |
|-------------|---|------|--------|-------------|--|------------|-------------|--------------|--|--|
| 2.2 | 4 | F2R4 | 68/91 | 11/99→08/02 | OE039 | 1,0 | CET2 | | | |
| 2.2 4WD | 4 | R5A2 | 60/80 | 02/99→11/06 | OE039 | 1,0 | CET2 | | | |
| 2.2 8V 4WD | 4 | JL22 | 68/91 | 06/99→11/06 | OE051 | 0,9 | CET8 | | | |
| 2.6 12V 4WD | 4 | JK26 | 90/121 | 06/99→11/06 | | | CET2 | OE188 | | |
| 2.6 12V 4WD | 4 | G6 | 90/121 | 06/99→11/06 | OE089 OE216 LPG [278] | 1,0 0,8 | | | | |

B-SERIE /Platform/Chassis (UN)

| | | | | | | | | | | |
|-------------------|---|------------|--------|-------------|--------------|-----|--|--|--|--|
| 2.5 D, 2.5 D 4WD | 4 | MD25NA | 57/76 | 06/99→11/06 | CH242 | 11v | | | | |
| 2.5 D, 2.5 D 4WD | 4 | WLE7 | 61/82 | 11/99→12/01 | CH242 | 11v | | | | |
| 2.5 D, 2.5 D 4WD | 4 | WLE7 | 62/83 | 12/02→11/06 | CH242 | 11v | | | | |
| 2.5 D 4WD | 4 | WLE9 | 65/87 | 11/99→07/02 | CH242 | 11v | | | | |
| 2.5 D 4WD, 2.5 TD | 4 | WLF5; WL-T | 86/115 | 02/99→03/05 | CH242 | 11v | | | | |
| 2.5 TD 4WD | 4 | MD25TI | 80/107 | 06/99→07/06 | CH242 | 11v | | | | |

CX-3 (DK)

| | | | | | | | | | | |
|-----|---|------------|--------|--------|--|--|--|--------------|--|--|
| 2.0 | 4 | PEX3; PEXB | 88/118 | 05/15→ | | | | OE253 | | |
|-----|---|------------|--------|--------|--|--|--|--------------|--|--|

MAZDA





kW/BHP



eon TITAN

IRIDIUM

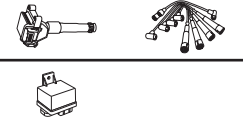

...MAZDA



...CX-3 (DK)

| | | | | | | | | | |
|---------|---|------------|---------|--------|--|--|--|--------------|--|
| 2.0 4WD | 4 | PEX3; PEXB | 110/148 | 05/15→ | | | | OE253 | |
|---------|---|------------|---------|--------|--|--|--|--------------|--|

CX-5 (KE, GH)

| | | | | | | | | | |
|-----|---|------------|---------|-------------|--|--|--|--------------|--|
| 2.0 | 4 | PEY4; PEY5 | 114/153 | 07/12→12/18 | | | | OE253 | |
|-----|---|------------|---------|-------------|--|--|--|--------------|--|

| | | | | | | | | | |
|-----|---|------------|---------|-------------|--|--|--|--------------|--|
| 2.0 | 4 | PEY6; PEY7 | 121/162 | 11/11→02/17 | | | | OE253 | |
|-----|---|------------|---------|-------------|--|--|--|--------------|--|

| | | | | | | | | | |
|--|--|--|--|--|--|--|--|--------|--|
| | | | | | | | | 02/12→ | |
|--|--|--|--|--|--|--|--|--------|--|

| | | | | | | | | | |
|--|--|--|--|--|--|--|--|---------------|--|
| | | | | | | | | Ch.KE9132624→ | |
|--|--|--|--|--|--|--|--|---------------|--|

| | | | | | | | | | |
|---------|---|------------|---------|-------------|--|--|--|--------------|--|
| 2.0 4WD | 4 | PEY6; PEY7 | 118/158 | 11/11→02/17 | | | | OE253 | |
|---------|---|------------|---------|-------------|--|--|--|--------------|--|

| | | | | | | | | | |
|--|--|--|--|--|--|--|--|--------|--|
| | | | | | | | | 08/12→ | |
|--|--|--|--|--|--|--|--|--------|--|

| | | | | | | | | | |
|--|--|--|--|--|--|--|--|--------------|--|
| | | | | | | | | Ch.KE132624→ | |
|--|--|--|--|--|--|--|--|--------------|--|

| | | | | | | | | | |
|---------|---|------|---------|-------------|--|--|--|--------------|--|
| 2.5 4WD | 4 | PYY1 | 141/189 | 02/15→02/17 | | | | OE253 | |
|---------|---|------|---------|-------------|--|--|--|--------------|--|

CX-7 (ER)

| | | | | | | | | | |
|------------------------|---|--------|---------|-------------|--|--|---------------|--|--|
| 2.3 MZR DISI Turbo 4WD | 4 | L3-VDT | 175/235 | 06/06→12/14 | | | CET17P | | |
|------------------------|---|--------|---------|-------------|--|--|---------------|--|--|

| | | | | | | | | | |
|------------------------|---|--------|---------|-------------|--|--|---------------|--|--|
| 2.3 MZR DISI Turbo 4WD | 4 | L3-VDT | 190/255 | 10/07→08/09 | | | CET17P | | |
|------------------------|---|--------|---------|-------------|--|--|---------------|--|--|

| | | | | | | | | | |
|------------------------|---|--------|---------|-------------|--|--|---------------|--|--|
| 2.3 MZR DISI Turbo 4WD | 4 | L3-VDT | 191/256 | 06/09→03/13 | | | CET17P | | |
|------------------------|---|--------|---------|-------------|--|--|---------------|--|--|

| | | | | | | | | | |
|---------|---|-------|---------|-------------|--|--|---------------|--------------|--|
| 2.5 MZR | 4 | L5-VE | 120/161 | 07/09→03/13 | | | CET17P | OE189 | |
|---------|---|-------|---------|-------------|--|--|---------------|--------------|--|

CX-9 (TB)

| | | | | | | | | | |
|--------------|---|------|---------|--------|--|--|---------------|--------------|--|
| 3.5, 3.5 4WD | 6 | CYC4 | 193/259 | 09/06→ | | | CET17P | OE189 | |
|--------------|---|------|---------|--------|--|--|---------------|--------------|--|

| | | | | | | | | | |
|--------------|---|----------------------|---------|--------|--|--|---------------|--|--|
| 3.7, 3.7 4WD | 6 | CA; CAY1; CAY5; CAY6 | 204/274 | 01/07→ | | | CET17P | | |
|--------------|---|----------------------|---------|--------|--|--|---------------|--|--|

DEMIO (DW)

| | | | | | | | | | |
|---------|---|------|-------|-------------|--------------|-----|-------------|--------------|---------------|
| 1.3 16V | 4 | B3ME | 46/62 | 08/98→07/03 | OE063 | 1,0 | CET2 | OE180 | CLS168 |
|---------|---|------|-------|-------------|--------------|-----|-------------|--------------|---------------|

| | | | | | | | | | |
|-----------|---|---------|-------|-------------|--------------|-----|-------------|--------------|---------------|
| 1.3 i 16V | 4 | B3(16V) | 53/71 | 08/98→04/00 | OE063 | 1,0 | CET2 | OE180 | CLS168 |
|-----------|---|---------|-------|-------------|--------------|-----|-------------|--------------|---------------|

| | | | | | | | | | |
|---------|---|-----|-------|-------------|--------------|-----|-------------|--------------|--|
| 1.5 16V | 4 | B5E | 55/74 | 04/00→07/03 | OE063 | 1,0 | CET2 | OE180 | |
|---------|---|-----|-------|-------------|--------------|-----|-------------|--------------|--|

E-SERIE MPV (SG)

| | | | | | | | | | |
|-------|---|---------|-------|-------------|--------------|-----|-------------|--|--|
| 2.0 i | 4 | FE(12V) | 74/99 | 06/95→10/01 | OE063 | 1,0 | CET2 | | |
|-------|---|---------|-------|-------------|--------------|-----|-------------|--|--|

| | | | | | | | | | |
|-------|---|--|--------|-------------|--------------|-----|-------------|--|--|
| 2.5 i | 4 | | 96/129 | 08/99→10/01 | OE063 | 1,0 | CET2 | | |
|-------|---|--|--------|-------------|--------------|-----|-------------|--|--|

| | | | | | | | | | |
|--------------------|---|------|--------|-------------|--------------|-----|--|--|--|
| 2.5 TD, 2.5 TD 4WD | 4 | WL-T | 92/123 | 06/95→10/01 | CH242 | 11v | | | |
|--------------------|---|------|--------|-------------|--------------|-----|--|--|--|

MPV I (LV)

| | | | | | | | | | |
|--------|---|------|--------|-------------|--------------|-----|--|--|--|
| 2.5 TD | 4 | WL-T | 85/114 | 05/96→09/99 | CH242 | 11v | | | |
|--------|---|------|--------|-------------|--------------|-----|--|--|--|

| | | | | | | | | | |
|----------|---|------|---------|-------------|--------------|-----|-------------|--------------|--|
| 3.0 i V6 | 6 | JE94 | 113/152 | 03/95→09/99 | OE089 | 1,0 | CET2 | OE184 | |
|----------|---|------|---------|-------------|--------------|-----|-------------|--------------|--|

| | | | | | | | | | |
|--|--|--|--|--|------------------------|-----|--|--|--|
| | | | | | OE216 LPG [278] | 0,8 | | | |
|--|--|--|--|--|------------------------|-----|--|--|--|

MPV II (LW)

| | | | | | | | | | |
|-----|---|----|--------|-------------|--------------|-----|-------------|--------------|----------------------|
| 2.0 | 4 | FS | 88/118 | 08/00→07/02 | OE089 | 1,0 | CET2 | OE184 | BAEA281 [275] |
|-----|---|----|--------|-------------|--------------|-----|-------------|--------------|----------------------|

| | | | | | | | | | |
|-----|---|-------|--------|-------------|--------------|-----|-------------|--------------|---------------|
| 2.0 | 4 | FS-DS | 90/121 | 09/99→08/00 | OE089 | 1,0 | CET2 | OE184 | CLS198 |
|-----|---|-------|--------|-------------|--------------|-----|-------------|--------------|---------------|

| | | | | | | | | | |
|--|--|--|--|--|------------------------|-----|--|--|--|
| | | | | | OE216 LPG [278] | 0,8 | | | |
|--|--|--|--|--|------------------------|-----|--|--|--|

| | | | | | | | | | |
|-----|---|----|---------|-------------|--|--|---------------|--------------|----------------|
| 2.3 | 4 | L3 | 104/139 | 07/02→02/06 | | | CET18P | OE183 | BAEA556 |
|-----|---|----|---------|-------------|--|--|---------------|--------------|----------------|

MPV III (LY)

| | | | | | | | | | |
|--------------|---|-------|---------|--------|--|--|---------------|--------------|--|
| 2.3, 2.3 4WD | 4 | L3-VE | 120/161 | 02/06→ | | | CET18P | OE183 | |
|--------------|---|-------|---------|--------|--|--|---------------|--------------|--|

MX-3 (EC)

| | | | | | | | | | |
|-------|---|-----|--------|-------------|--|--|---------------|--------------|---------------------|
| 1.6 i | 4 | B6D | 79/106 | 01/94→10/97 | | | CET12P | OE179 | CLS031 [275] |
|-------|---|-----|--------|-------------|--|--|---------------|--------------|---------------------|

| | | | | | | | | | |
|----------|---|------|--------|-------------|--------------|-----|-------------|--------------|--|
| 1.8 i V6 | 6 | K838 | 95/127 | 01/94→10/97 | OE063 | 1,0 | CET2 | OE180 | |
|----------|---|------|--------|-------------|--------------|-----|-------------|--------------|--|

MX-5 I (NA)

| | | | | | | | | | |
|-----|---|------|-------|-------------|--------------|-----|-------------|--------------|---------------------|
| 1.6 | 4 | 8AN1 | 66/89 | 01/95→04/98 | OE039 | 1,0 | CET2 | OE180 | CLS056 [275] |
|-----|---|------|-------|-------------|--------------|-----|-------------|--------------|---------------------|

| | | | | | | | | | |
|-----|---|----------|--------|-------------|--|--|-------------|--------------|-------------------------------------|
| 1.8 | 4 | BP(DOHC) | 96/129 | 01/93→04/98 | | | CET2 | OE179 | BAEA195E CLS056 [275] |
|-----|---|----------|--------|-------------|--|--|-------------|--------------|-------------------------------------|

| | | | | | | | | | |
|-----|---|------|--------|-------------|--------------|-----|-------------|--------------|-------------------------------------|
| 1.8 | 4 | BPF1 | 96/129 | 01/93→04/98 | OE039 | 1,0 | CET2 | OE179 | BAEA195E CLS056 [275] |
|-----|---|------|--------|-------------|--------------|-----|-------------|--------------|-------------------------------------|

MX-5 II (NB)

| | | | | | | | | | |
|---------|---|-----|--------|-------------|--------------|-----|-------------|--------------|---------------|
| 1.6 16V | 4 | B6D | 81/109 | 05/98→10/05 | OE063 | 1,0 | CET2 | OE180 | CLS056 |
|---------|---|-----|--------|-------------|--------------|-----|-------------|--------------|---------------|

| | | | | | | | | | |
|-----|---|-----|---------|-------------|--------------|-----|-------------|--------------|-------------------------------------|
| 1.8 | 4 | BPD | 103/138 | 01/98→07/02 | OE039 | 1,0 | CET2 | OE179 | BAEA084E [277] CLS056 |
|-----|---|-----|---------|-------------|--------------|-----|-------------|--------------|-------------------------------------|

| | | | | | | | | | |
|--|--|--|--|--|--|--|--|--------|--------|
| | | | | | | | | 08/00→ | →07/00 |
|--|--|--|--|--|--|--|--|--------|--------|

| | | | | | | | | | |
|--|--|--|--|--|--|--|--|--|---------------|
| | | | | | | | | | CLS159 |
|--|--|--|--|--|--|--|--|--|---------------|

| | | | | | | | | | |
|--|--|--|--|--|--|--|--|--|--------|
| | | | | | | | | | 08/00→ |
|--|--|--|--|--|--|--|--|--|--------|

| | | | | | | | | | |
|-----|---|------|---------|-------------|--------------|-----|-------------|--|-------------------------------------|
| 1.8 | 4 | BP6J | 107/143 | 08/02→10/05 | OE063 | 1,0 | CET2 | | BAEA084E [277] CLS159 |
|-----|---|------|---------|-------------|--------------|-----|-------------|--|-------------------------------------|

| | | | | | | | | | |
|---------|---|-----|---------|-------------|--------------|-----|-------------|--------------|-------------------------------------|
| 1.8 16V | 4 | BPD | 102/137 | 11/00→10/05 | OE063 | 1,0 | CET2 | OE180 | BAEA084E [277] CLS159 |
|---------|---|-----|---------|-------------|--------------|-----|-------------|--------------|-------------------------------------|

MAZDA





kW/BHP

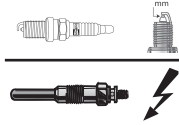

eon TITAN

IRIDIUM

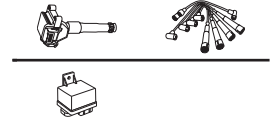
**...MAZDA****...MX-5 II (NB)**

| | | | | | | | | | | |
|-------------|---|------------|---------|-------------|--------------|-----|---------------|--------------|--|---|
| 1.8 16V | 4 | BP-ZE | 103/138 | 05/98→10/05 | OE063 | 1,0 | CET2 | OE180 | BAEA084E ^[277] 08/00→ | CLS056 →07/00 CLS159 ^[275] 08/00→ |
| 1.8 16V | 4 | BPD; BP-ZE | 107/143 | 11/00→10/05 | OE063 | 1,0 | CET2 | OE180 | BAEA084E ^[277] | CLS159 |
| 1.8 i Turbo | 4 | BPTurbo | 136/182 | 04/02→10/05 | | | CET12P | OE180 | BAEA084E ^[277] | CLS159 |

MX-5 III (NC)

| | | | | | | | | | | |
|-----|---|------------------------------|---------|-------------|--|--|---------------|--------------|-----------------|--|
| 1.8 | 4 | L8-DE; L828 | 93/125 | 03/05→12/14 | | | CET18P | OE183 | BAEA195E | |
| 2.0 | 4 | LFG7; LFG8; LFY7; LFYK; LFZ8 | 118/158 | 07/05→12/14 | | | CET17P | OE189 | | |

MX-5 IV (ND)

| | | | | | | | | | | |
|-----|---|--------|--------|--------|--|--|--|--------------|--|--|
| 1.5 | 4 | P5-VPR | 96/129 | 06/15→ | | | | OE253 | | |
|-----|---|--------|--------|--------|--|--|--|--------------|--|--|

MX-6 (GE)

| | | | | | | | | | | |
|-----------|---|----|---------|-------------|---|------------|-------------|--------------|--|--|
| 2.5 i 24V | 6 | KL | 120/161 | 08/94→02/97 | OE089 OE216 LPG ^[278] | 1,0 0,8 | CET2 | OE184 | | |
|-----------|---|----|---------|-------------|---|------------|-------------|--------------|--|--|

PREMACY (CP)

| | | | | | | | | | | |
|-----|---|------------|---------|-------------|---|--------------------------|--------------------------------|------------------------------|-----------------|---------------|
| 1.9 | 4 | FP | 74/99 | 07/99→03/05 | OE039 Ch.100001→ Ch.151176 OE063 Ch.100001→ Ch.151176 OE089 Ch.151177→ OE216 LPG ^[278] Ch.151177→ | 1,0 1,0 1,0 0,8 | CET2 | OE180 | BAEA083E | CLS198 |
| 1.9 | 4 | FP | 84/113 | 07/99→03/05 | OE039 Ch.100001→ Ch.151176 OE063 Ch.10001→ Ch.151176 OE089 Ch.151177→ OE216 LPG ^[278] Ch.151177→ | 1,0 1,0 1,0 0,8 | CET2 | OE180 | BAEA083E | CLS198 |
| 2.0 | 4 | FS7E; FS7G | 96/129 | 11/01→03/05 | OE039 Ch.300001→ | 1,0 | CET2 | OE180 | BAEA083E | CLS198 |
| 2.0 | 4 | LFF7 | 107/143 | 02/05→03/05 | | | CET17P CET18P | OE183 OE189 | | |

TRIBUTE (EP)

| | | | | | | | | | | |
|----------------|---|-------|---------|-------------|--------------|-----|---------------|--------------|---------------------------------|--------------------------------|
| 2.0 | 4 | YF | 91/122 | 03/00→05/08 | OE029 | 1,0 | CET17P | OE189 | BAEA350 →12/05 | CLS016 ^[275] |
| 2.0 4WD | 4 | YF | 91/122 | 03/00→05/08 | OE029 | 1,0 | CET17P | OE189 | BAEA350 →12/03 | CLS016 ^[275] |
| 2.3 4WD | 4 | L3-VE | 110/148 | 04/04→05/08 | | | CET18P | OE183 | BAEA408 | |
| 3.0 V6 4WD | 6 | AJ | 149/200 | 04/04→05/08 | | | CET18P | OE183 | BAEA410 ^[277] | |
| 3.0 V6 24V 4WD | 6 | AJ | 145/194 | 03/00→05/08 | | | CET18P | OE183 | BAEA410 ^[277] | |

XEDOS 6 (CA)

| | | | | | | | | | | |
|---------|---|----------|---------|-------------|--------------|-----|---------------|--------------|--|--|
| 1.6 16V | 4 | B6(DOHC) | 79/106 | 06/94→10/99 | OE063 | 1,0 | CET2 | OE180 | | |
| 2.0 V6 | 6 | KF1 | 103/138 | 06/94→10/99 | | | CET12P | OE179 | | |

XEDOS 9 (TA)

| | | | | | | | | | | |
|---------|---|--------|---------|-------------|---|------------|---------------|--------------|--|--|
| 2.0 24V | 6 | KF | 105/141 | 08/93→01/00 | | | CET12P | OE179 | | |
| 2.3 24V | 6 | KJ-ZEM | 155/208 | 02/95→01/00 | OE089 | 1,0 | CET2 | OE184 | | |
| 2.5 24V | 6 | KL | 123/165 | 07/93→07/00 | OE089 OE216 LPG ^[278] | 1,0 0,8 | CET2 | OE184 | | |
| 2.5 V6 | 6 | KL | 120/161 | 07/00→09/02 | OE005 | 0,9 | CET2 | OE180 | | |

MAZDA





kW/BHP



eon TITAN

IRIDIUM

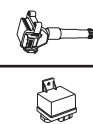

MAZDA



B-SERIE /Platform/Chassis (UN)

| | | | | | | | | | |
|--------|---|------|--------|-------------|-------|-----|--|--|--|
| 2.5 TD | 4 | WL-T | 86/115 | 02/99→03/05 | CH242 | 11v | | | |
|--------|---|------|--------|-------------|-------|-----|--|--|--|

E-SERIE Platform/Chassis (SD1)

| | | | | | | | | | |
|-------------|---|----|-------|-------------|-------|-----|--|--|--|
| 2.2 E2200 D | 4 | R2 | 52/70 | 04/97→07/99 | CH242 | 11v | | | |
|-------------|---|----|-------|-------------|-------|-----|--|--|--|

E-SERIE Box (SR2)

| | | | | | | | | | |
|-----------|---|--------|-------|-------------|-------|-----|------|-------|--|
| 2.0 E2000 | 4 | FE(8V) | 70/94 | 06/94→05/03 | OE039 | 1,0 | CET2 | OE180 | |
|-----------|---|--------|-------|-------------|-------|-----|------|-------|--|

| | | | | | | | | | |
|------------------------------|---|----|-------|-------------|-------|-----|--|--|--|
| 2.2 E2200 D, 2.2 E2200 D 4WD | 4 | R2 | 52/70 | 02/97→05/03 | CH242 | 11v | | | |
|------------------------------|---|----|-------|-------------|-------|-----|--|--|--|

| | | | | | | | | | |
|-------------|---|------|-------|-------------|-------|-----|--|--|--|
| 2.5 E2500 D | 4 | WLE2 | 61/82 | 08/97→05/03 | CH242 | 11v | | | |
|-------------|---|------|-------|-------------|-------|-----|--|--|--|

| | | | | | | | | | |
|--------------|---|--|--------|-------------|-------|-----|--|--|--|
| 2.5 E2500 TD | 4 | | 84/113 | 09/99→07/04 | CH242 | 11v | | | |
|--------------|---|--|--------|-------------|-------|-----|--|--|--|

MEGA



CLUB II

| | | | | | | | | | |
|-------|---|---------|-------|--------|-------|-----|------|--|--|
| 1.4 i | 4 | TU3FMC2 | 55/74 | 06/99→ | OE034 | 0,9 | CET2 | | |
|-------|---|---------|-------|--------|-------|-----|------|--|--|

MONTE CARLO

| | | | | | | | | | |
|---------|----|--|---------|--------|-------|-----|------|--|--|
| 6.0 V12 | 12 | | 290/389 | 01/98→ | OE057 | 0,9 | CET2 | | |
|---------|----|--|---------|--------|-------|-----|------|--|--|

MERCEDES-BENZ



A-CLASS (W168)

| | | | | | | | | | |
|-----------|---|----------|-------|-------------|-------|-----|------|-------|----------|
| 1.4 A 140 | 4 | M166.940 | 60/80 | 07/97→08/04 | OE032 | 1,0 | CET2 | OE179 | BAEA146E |
|-----------|---|----------|-------|-------------|-------|-----|------|-------|----------|

| | | | | | | | | | |
|-----------|---|----------|-------|-------------|--|--|--|--|----------|
| 1.6 A 140 | 4 | M166.960 | 60/80 | 01/01→08/04 | | | | | BAEA146E |
|-----------|---|----------|-------|-------------|--|--|--|--|----------|

| | | | | | | | | | |
|-----------|---|----------|--------|-------------|-------|-----|------|-------|----------|
| 1.6 A 160 | 4 | M166.960 | 75/101 | 07/97→08/04 | OE032 | 1,0 | CET2 | OE179 | BAEA146E |
|-----------|---|----------|--------|-------------|-------|-----|------|-------|----------|

| | | | | | | | | | |
|---------------|---|-----------|-------|-------------|-------|-----|--|--|--------|
| 1.7 A 160 CDI | 4 | OM668.941 | 44/59 | 07/98→02/01 | CH219 | 11v | | | CCU140 |
|---------------|---|-----------|-------|-------------|-------|-----|--|--|--------|

| | | | | | | | | | |
|---------------|---|-----------|-------|-------------|-------|-----|--|--|--------|
| 1.7 A 160 CDI | 4 | OM668.940 | 55/74 | 02/01→08/04 | CH219 | 11v | | | CCU140 |
|---------------|---|-----------|-------|-------------|-------|-----|--|--|--------|

| | | | | | | | | | |
|---------------|---|-----------|-------|-------------|-------|-----|--|--|--------|
| 1.7 A 170 CDI | 4 | OM668.940 | 66/89 | 07/98→02/01 | CH219 | 11v | | | CCU140 |
|---------------|---|-----------|-------|-------------|-------|-----|--|--|--------|

| | | | | | | | | | |
|---------------|---|-----------|-------|-------------|-------|-----|--|--|--------|
| 1.7 A 170 CDI | 4 | OM668.942 | 70/94 | 02/01→08/04 | CH219 | 11v | | | CCU140 |
|---------------|---|-----------|-------|-------------|-------|-----|--|--|--------|

| | | | | | | | | | |
|-----------|---|----------|--------|-------------|--|--|--|--|----------|
| 1.9 A 190 | 4 | M166.990 | 92/123 | 03/99→08/04 | | | | | BAEA146E |
|-----------|---|----------|--------|-------------|--|--|--|--|----------|

| | | | | | | | | | |
|-----------------------|---|--|---------|-------------|-------|-----|------|--|--|
| 1.9 A 190 Twin Engine | 4 | | 184/247 | 04/99→02/01 | OE120 | 0,6 | CET2 | | |
|-----------------------|---|--|---------|-------------|-------|-----|------|--|--|

| | | | | | | | | | |
|-----------|---|----------|---------|-------------|--|--|--|--|----------|
| 2.1 A 210 | 4 | M166.995 | 103/138 | 12/01→08/04 | | | | | BAEA146E |
|-----------|---|----------|---------|-------------|--|--|--|--|----------|

A-CLASS (W169)

| | | | | | | | | | | |
|----------------------|---|----------|-------|-------------|--|--|--------|-------|---------|--------|
| 1.5 A 150, 1.5 A 160 | 4 | M266.920 | 70/94 | 09/04→06/12 | | | CET12P | OE180 | BAEA297 | CLS078 |
|----------------------|---|----------|-------|-------------|--|--|--------|-------|---------|--------|

| | | | | | | | | | | |
|----------------------|---|----------|--------|-------------|--|--|--------|-------|---------|--------|
| 1.7 A 170, 1.7 A 180 | 4 | M266.940 | 85/114 | 09/04→06/12 | | | CET12P | OE180 | BAEA297 | CLS078 |
|----------------------|---|----------|--------|-------------|--|--|--------|-------|---------|--------|

| | | | | | | | | | | |
|---------------|---|-----------|-------|-------------|--|--|--|--|--------|--|
| 2.0 A 160 CDI | 4 | OM640.942 | 60/80 | 09/04→06/12 | | | | | CCU156 | |
|---------------|---|-----------|-------|-------------|--|--|--|--|--------|--|

| | | | | | | | | | | |
|---------------|---|-----------|--------|-------------|--|--|--|--|--------|--|
| 2.0 A 180 CDI | 4 | OM640.940 | 80/107 | 09/04→06/12 | | | | | CCU156 | |
|---------------|---|-----------|--------|-------------|--|--|--|--|--------|--|

| | | | | | | | | | | |
|-----------|---|----------|---------|-------------|--|--|--------|-------|---------|--------|
| 2.0 A 200 | 4 | M266.960 | 100/134 | 09/04→06/12 | | | CET12P | OE180 | BAEA297 | CLS078 |
|-----------|---|----------|---------|-------------|--|--|--------|-------|---------|--------|

| | | | | | | | | | | |
|---------------|---|-----------|---------|-------------|--|--|--|--|--------|--|
| 2.0 A 200 CDI | 4 | OM640.941 | 100/134 | 09/04→06/12 | | | | | CCU156 | |
|---------------|---|-----------|---------|-------------|--|--|--|--|--------|--|

| | | | | | | | | | | |
|---------------|---|-----------|---------|-------------|--|--|--|--|--------|--|
| 2.0 A 200 CDI | 4 | OM640.941 | 103/138 | 09/04→06/12 | | | | | CCU156 | |
|---------------|---|-----------|---------|-------------|--|--|--|--|--------|--|

| | | | | | | | | | | |
|-----------------|---|----------|---------|-------------|--|--|--------|-------|---------|--|
| 2.0 A 200 TURBO | 4 | M266.980 | 142/190 | 09/05→06/12 | | | CET12P | OE181 | BAEA297 | |
|-----------------|---|----------|---------|-------------|--|--|--------|-------|---------|--|

B-CLASS (W245)

| | | | | | | | | | | |
|----------------------|---|----------|-------|-------------|--|--|--------|-------|---------|--------|
| 1.5 B 150, 1.5 B 160 | 4 | M266.920 | 70/94 | 03/05→11/11 | | | CET12P | OE180 | BAEA297 | CLS078 |
|----------------------|---|----------|-------|-------------|--|--|--------|-------|---------|--------|

| | | | | | | | | | | |
|----------------------|---|----------|--------|-------------|--|--|--------|-------|---------|--------|
| 1.7 B 170, 1.7 B 180 | 4 | M266.940 | 85/114 | 03/05→11/11 | | | CET12P | OE180 | BAEA297 | CLS078 |
|----------------------|---|----------|--------|-------------|--|--|--------|-------|---------|--------|

| | | | | | | | | | | |
|---------------|---|----------|--------|-------------|-------|-----|------|-------|--------------------------|--|
| 2.0 B 170 NGT | 4 | M266.960 | 85/114 | 04/08→11/11 | OE005 | 0,9 | CET2 | OE179 | BAEA297 ^[174] | |
|---------------|---|----------|--------|-------------|-------|-----|------|-------|--------------------------|--|

| | | | | | | | | | | |
|---------------|---|-----------|--------|-------------|--|--|--|--|--------|--|
| 2.0 B 180 CDI | 4 | OM640.940 | 80/107 | 03/05→11/11 | | | | | CCU156 | |
|---------------|---|-----------|--------|-------------|--|--|--|--|--------|--|

| | | | | | | | | | | |
|---------------|---|----------|--------|-------------|-------|-----|------|-------|---------|--|
| 2.0 B 180 NGT | 4 | M266.960 | 85/114 | 04/08→11/11 | OE005 | 0,9 | CET2 | OE179 | BAEA297 | |
|---------------|---|----------|--------|-------------|-------|-----|------|-------|---------|--|

| | | | | | | | | | | |
|-----------|---|----------|---------|-------------|--|--|--------|-------|---------|--------|
| 2.0 B 200 | 4 | M266.960 | 100/134 | 03/05→11/11 | | | CET12P | OE180 | BAEA297 | CLS078 |
|-----------|---|----------|---------|-------------|--|--|--------|-------|---------|--------|

| | | | | | | | | | | |
|---------------|---|-----------|---------|-------------|--|--|--|--|--------|--|
| 2.0 B 200 CDI | 4 | OM640.941 | 100/134 | 03/05→11/11 | | | | | CCU156 | |
|---------------|---|-----------|---------|-------------|--|--|--|--|--------|--|

| | | | | | | | | | | |
|---------------|---|-----------|---------|-------------|--|--|--|--|--------|--|
| 2.0 B 200 CDI | 4 | OM640.941 | 103/138 | 03/05→11/11 | | | | | CCU156 | |
|---------------|---|-----------|---------|-------------|--|--|--|--|--------|--|

| | | | | | | | | | | |
|-----------------|---|----------|---------|-------------|--|--|--------|-------|---------|--|
| 2.0 B 200 TURBO | 4 | M266.980 | 142/190 | 03/05→11/11 | | | CET12P | OE181 | BAEA297 | |
|-----------------|---|----------|---------|-------------|--|--|--------|-------|---------|--|

C-CLASS Coupe (C204)

| | | | | | | | | | | |
|-----------|---|----------|---------|--------|-------|-----|--------|--|---------|--|
| 1.8 C 180 | 4 | M271.820 | 115/154 | 06/11→ | OE229 | 0,8 | CET15P | | BAEA077 | |
|-----------|---|----------|---------|--------|-------|-----|--------|--|---------|--|

MERCEDDES-BENZ





kW/BHP



eon TITAN

IRIDIUM

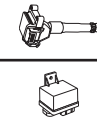

...MERCEDES-BENZ



...C-CLASS Coupe (C204)

| | | | | | | | | | |
|--------------------------|---|----------|---------|--------|--------------|-----|----------------|--|-----------------|
| 1.8 C 200 CGI | 4 | M271.860 | 135/181 | 06/11→ | OE229 | 0,8 | CET1 5P | | |
| 1.8 C 250 | 4 | M271.860 | 150/201 | 06/11→ | OE229 | 0,8 | CET1 5P | | BAEA077 |
| 3.5 C 350, 3.5 C 350 4WD | 6 | M276.957 | 225/302 | 06/11→ | | | | | BAEA093E |
| 6.2 C 63 AMG | 8 | M156.985 | 336/451 | 06/11→ | OE233 | 1,0 | | | |
| 6.2 C 63 AMG | 8 | M156.985 | 358/480 | 01/12→ | OE233 | 1,0 | | | |
| 6.2 C 63 AMG | 8 | M156.985 | 373/500 | 11/12→ | OE233 | 1,0 | | | |
| 6.2 C 63 AMG | 8 | M156.985 | 380/510 | 01/12→ | OE233 | 1,0 | | | |

C-CLASS Coupe (CL203)

| | | | | | | | | | |
|---------------------------------|---|-----------|---------|-------------|---|-----|---|--------------|--|
| 1.8 C 160 Kompressor | 4 | M271.921 | 90/121 | 05/02→05/08 | OE224 →11/06 →Eng.30853899 | 0,8 | CET1 4P | | BAEA053 →11/06 →Eng.30853899 |
| | | | | | OE229 12/06→ Eng.30853900→ | 0,8 | CET1 5P | | BAEA077 11/06→ Eng.30853900→ BAEA077 08/07→ Eng.30099999→ |
| 1.8 C 180 Kompressor | 4 | M271.946 | 105/141 | 05/02→05/08 | OE229 [232] | 0,8 | CET1 5P [232] | | BAEA053 →Eng.30853899 →Prod.30.11.2006 |
| | | | | | OE224 →Eng.30853899 →Prod.30.11.2006 | 0,8 | CET1 4P →Eng.30853899 →Prod.30.11.2006 | | BAEA077 Eng.30853900→ Prod.30.11.2006→ |
| | | | | | OE229 Eng.30853900→ Prod.30.11.2006→ | 0,8 | CET1 5P Eng.30853900→ Prod.30.11.2006→ | | |
| 1.8 C 200 CGI Kompressor | 4 | M271.942 | 125/168 | 03/03→05/08 | OE229 [232] | 0,8 | CET1 5P [232] | | BAEA053 →Eng.30853899 →Prod.30.11.2006 |
| | | | | | OE224 →Eng.30853899 →Prod.30.11.2006 | 0,8 | CET1 4P →Eng.30853899 →Prod.30.11.2006 | | BAEA077 Eng.30853900→ Prod.30.11.2006→ |
| | | | | | OE229 Eng.30853900→ Prod.30.11.2006→ | 0,8 | CET1 5P Eng.30853900→ Prod.30.11.2006→ | | |
| 1.8 C 200 Kompressor, 1.8 C 220 | 4 | M271.940 | 120/161 | 05/02→05/08 | OE229 [232] | 0,8 | CET1 5P [232] | | BAEA053 →Eng.30853899 →Prod.30.11.2006 |
| | | | | | OE224 →Eng.30853899 →Prod.30.11.2006 | 0,8 | CET1 4P →Eng.30853899 →Prod.30.11.2006 | | BAEA077 Eng.30853900→ Prod.30.11.2006→ |
| | | | | | OE229 Eng.30853900→ Prod.30.11.2006→ | 0,8 | CET1 5P Eng.30853900→ Prod.30.11.2006→ | | |
| 1.8 C 230 Kompressor | 4 | M271.948 | 141/189 | 05/02→05/08 | OE229 [232] | 0,8 | CET1 5P [232] | | BAEA053 →Eng.30853899 →Prod.30.11.2006 |
| | | | | | OE224 →Eng.30853899 →Prod.30.11.2006 | 0,8 | CET1 4P →Eng.30853899 →Prod.30.11.2006 | | BAEA077 Eng.30853900→ Prod.30.11.2006→ |
| | | | | | OE229 Eng.30853900→ Prod.30.11.2006→ | 0,8 | CET1 5P Eng.30853900→ Prod.30.11.2006→ | | |
| 2.0 C 180 | 4 | M111.951 | 95/127 | 03/01→05/02 | | | CET1 2P | OE181 | BAEA041 |
| 2.0 C 200 Kompressor | 4 | M111.955 | 120/161 | 03/01→05/02 | OE146 | 1,0 | CET1 2P | OE181 | BAEA041 |
| 2.2 C 200 CDI | 4 | OM646.962 | 90/121 | 03/03→05/08 | | | | | CCU140 |
| 2.2 C 220 CDI | 4 | OM611.962 | 100/134 | 03/01→01/04 | | | | | CCU140 |
| 2.2 C 220 CDI | 4 | OM611.962 | 105/141 | 03/01→01/04 | | | | | CCU140 |
| 2.2 C 220 CDI | 4 | OM646.963 | 110/148 | 02/04→05/08 | | | | | CCU140 |
| 2.3 C 230 Kompressor | 4 | M111.981 | 145/194 | 03/01→05/02 | | | CET1 2P | OE181 | BAEA041 |
| 2.5 C 230 | 6 | M272.920 | 150/201 | 01/05→05/08 | OE229 | 0,8 | CET1 5P | | BAEA077 08/07→ Eng.30099999→ BAEA140E |

MERCEDES-BENZ



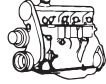

kW/BHP



eon TITAN

IRIDIUM



...MERCEDES-BENZ



...C-CLASS Coupe (CL203)

| | | | | | | | | | | |
|-------------------------|---|-----------|---------|-------------|-------------|-----|--------|-------|------------------------------------|--------|
| 3.0 C 30 CDI AMG | 5 | OM612.990 | 170/228 | 09/02→05/08 | CH704 [275] | 5v | | | CCU104 | |
| 3.2 C 32 AMG Kompressor | 6 | M112.961 | 260/349 | 05/02→05/08 | | | CET12P | OE180 | BAEA077 08/07→ Eng.30099999→ | |
| | | | | | | | | | BAEA297 | |
| 3.2 C 320 | 6 | M112.946 | 160/215 | 09/02→05/08 | OE191 | 1,0 | CET12P | OE180 | BAEA077 08/07→ Eng.30099999→ | CLS064 |
| | | | | | | | | | BAEA297 | |
| 3.5 C 350 | 6 | M272.960 | 200/268 | 01/05→05/08 | OE229 | 0,8 | CET15P | | BAEA077 08/07→ Eng.30099999→ | |
| | | | | | | | | | BAEA140E | |

C-CLASS T-Model (S202)

| | | | | | | | | | | |
|------------------------|---|-----------|---------|-------------|--|-------|--------|-----------------|-------------|---------------------------------------|
| 1.8 C 180 T | 4 | M111.920 | 90/121 | 06/96→09/00 | OE057 →06/97 | 0,9 | CET2 | OE180 →06/97 | BAEA313 | CLS106 [229] →Eng.045966 017110 |
| | | | | | OE032 07/97→ | 1,0 | | OE179 07/97→ | | CLS065 [230] Eng.045967 017111→ |
| 1.8 C 180 T | 4 | M111.921 | 90/121 | 06/96→09/00 | OE057 →06/97 | 0,9 | CET2 | OE180 →06/97 | BAEA340 | CLS138 [35] |
| | | | | | OE032 07/97→ | 1,0 | | OE179 07/97→ | | |
| 2.0 C 180 T | 4 | M111.952 | 95/127 | 09/00→03/01 | | | CET12P | OE181 | BAEA041 | |
| 2.0 C 200 T | 4 | M111.945 | 100/134 | 06/96→03/01 | OE057 →06/97 | 0,9 | CET2 | OE180 →06/97 | BAEA340[41] | CLS138 [35] |
| | | | | | OE032 07/97→ | 1,0 | | OE179 07/97→ | | |
| 2.0 C 200 T | 4 | M111.941 | 100/134 | 06/96→03/01 | OE057 →06/97 | 0,9 | CET2 | OE180 →06/97 | BAEA313 | CLS106 [229] →Eng.000765 000704 |
| | | | | | OE032 07/97→ | 1,0 | | OE179 07/97→ | | CLS065 [230] Eng.000766 000705→ |
| 2.0 C 200 T D | 4 | OM604.915 | 65/87 | 10/96→03/01 | CH177 [293] | 11.5v | | | CCU140 | |
| 2.0 C 200 T Kompressor | 4 | M111.956 | 120/161 | 09/00→03/01 | | | CET12P | OE181 | BAEA041 | |
| 2.0 C 200 T Kompressor | 4 | M111.944 | 141/189 | 11/96→03/01 | OE032 | 1,0 | CET2 | OE179 | BAEA340[41] | CLS138 [35] |
| 2.2 C 200 T CDI | 4 | OM611.960 | 75/101 | 03/98→03/01 | | | | | CCU140 | |
| 2.2 C 220 T CDI | 4 | OM611.960 | 92/123 | 09/97→03/01 | | | | | CCU140 | |
| 2.2 C 220 T D | 4 | OM604.910 | 55/74 | 06/96→03/01 | CH177 [293] | 11.5v | | | CCU140 | |
| 2.2 C 220 T D | 4 | OM604.910 | 70/94 | 06/96→09/98 | CH175 [175] [275] [297] CH177 [176] [275] [293] | 11.5v | | | CCU140 | |
| 2.3 C 230 T | 4 | M111.974 | 110/148 | 06/96→06/98 | OE057 | 0,9 | CET2 | OE180 | BAEA340[41] | CLS138 [35] |
| 2.3 C 230 T Kompressor | 4 | M111.975 | 142/190 | 06/97→09/00 | OE136 | 0,8 | CET12P | OE179 | BAEA340[41] | CLS138 [35] |
| 2.4 C 240 T | 6 | M112.910 | 125/168 | 06/97→09/00 | OE191 | 1,0 | CET12P | OE180 | BAEA297 | CLS064 |
| 2.5 C 250 T Turbo-D | 5 | OM605.960 | 110/148 | 06/96→03/01 | CH177 [293] | 11.5v | | | CCU141 | |
| 2.6 C 240 T | 6 | M112.915 | 125/168 | 09/00→03/01 | OE191 | 1,0 | CET12P | OE180 | BAEA297 | CLS064 |
| 2.8 C 280 T | 6 | M112.920 | 145/194 | 06/97→03/01 | OE191 | 1,0 | CET12P | OE180 | BAEA297 | CLS064 |
| 4.3 C 43 AMG | 8 | M113.944 | 225/302 | 08/97→03/01 | OE191 | 1,0 | CET12P | OE180 | BAEA297 | |

C-CLASS T-Model (S203)

| | | | | | | | | | | |
|----------------------|---|----------|---------|-------------|--|-----|---|--|--|--|
| 1.8 C 180 Kompressor | 4 | M271.946 | 105/141 | 05/02→08/07 | OE229 [232] | 0,8 | CET15P [232] | | BAEA053 →Eng.30853899 →Prod.30.11.2006 | |
| | | | | | OE224 →Eng.30853899 →Prod.30.11.2006 | 0,8 | CET14P →Eng.30853899 →Prod.30.11.2006 | | BAEA077 Eng.30853900→ Prod.30.11.2006→ | |
| | | | | | OE229 Eng.30853900→ Prod.30.11.2006→ | 0,8 | CET15P Eng.30853900→ Prod.30.11.2006→ | | | |

MERCEDES-BENZ





kW/BHP

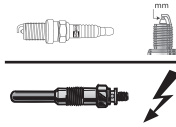

eon TITAN

IRIDIUM

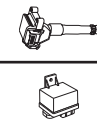
**...MERCEDES-BENZ****...C-CLASS T-Model (S203)**

| | | | | | | | | | |
|-------------------------------|---|----------------------|---------|-------------|---|-----|--|--------------|---|
| 1.8 C 200 CGI Kompressor | 4 | M271.942 | 125/168 | 07/03→08/07 | OE229 [232] | 0,8 | CET15P [232] | | BAEA053 →Eng.30853899 →Prod.30.11.2006 |
| | | | | | OE224 →Eng.30853899 →Prod.30.11.2006 | 0,8 | CET14P →Eng.30853899 →Prod.30.11.2006 | | BAEA077 Eng.30853900→ Prod.30.11.2006→ |
| | | | | | OE229 Eng.30853900→ Prod.30.11.2006→ | 0,8 | CET15P Eng.30853900→ Prod.30.11.2006→ | | |
| 1.8 C 200 Kompressor | 4 | M271.940 | 120/161 | 05/02→08/07 | OE229 [232] | 0,8 | CET15P [232] | | BAEA053 →Eng.30853899 →Prod.30.11.2006 |
| | | | | | OE224 →Eng.30853899 →Prod.30.11.2006 | 0,8 | CET14P →Eng.30853899 →Prod.30.11.2006 | | BAEA077 Eng.30853900→ Prod.30.11.2006→ |
| | | | | | OE229 Eng.30853900→ Prod.30.11.2006→ | 0,8 | CET15P Eng.30853900→ Prod.30.11.2006→ | | |
| 1.8 C 230 Kompressor | 4 | M271.948 | 141/189 | 02/04→08/07 | OE229 [232] | 0,8 | CET15P [232] | | BAEA053 →Eng.30853899 →Prod.30.11.2006 |
| | | | | | OE224 →Eng.30853899 →Prod.30.11.2006 | 0,8 | CET14P →Eng.30853899 →Prod.30.11.2006 | | BAEA077 Eng.30853900→ Prod.30.11.2006→ |
| | | | | | OE229 Eng.30853900→ Prod.30.11.2006→ | 0,8 | CET15P Eng.30853900→ Prod.30.11.2006→ | | |
| 2.0 C 180 | 4 | M111.951 | 95/127 | 03/01→05/02 | | | CET12P | OE181 | BAEA041 |
| 2.0 C 200 Kompressor | 4 | M111.955 | 120/161 | 03/01→05/02 | | | CET12P | OE181 | BAEA041 |
| 2.2 C 200 CDI | 4 | OM611.962; OM646.962 | 75/101 | 03/01→08/07 | | | | | CCU140 |
| 2.2 C 200 CDI | 4 | OM611.962 | 85/114 | 03/01→08/07 | | | | | CCU140 |
| 2.2 C 200 CDI | 4 | OM646.962; OM646.963 | 90/121 | 04/03→08/07 | | | | | CCU140 |
| 2.2 C 220 CDI | 4 | OM646.963 | 100/134 | 08/06→08/07 | | | | | CCU140 |
| 2.2 C 220 CDI | 4 | OM611.962 | 105/141 | 03/01→08/07 | | | | | CCU140 |
| 2.2 C 220 CDI | 4 | OM646.963 | 110/148 | 02/04→08/07 | | | | | CCU140 |
| 2.5 C 230 | 6 | M272.920 | 150/201 | 01/05→08/07 | OE229 | 0,8 | CET15P | | BAEA140E |
| 2.6 C 240 | 6 | M112.912 | 125/168 | 03/01→08/07 | OE191 | 1,0 | CET12P | OE180 | BAEA297 CLS064 |
| 2.6 C 240 4WD | 6 | M112.916 | 125/168 | 07/02→08/07 | OE191 | 1,0 | CET12P | OE180 | BAEA297 CLS064 →01/04 |
| 2.7 C 270 CDI | 5 | OM612.962 | 125/168 | 03/01→08/07 | | | | | CCU141 |
| 3.0 C 30 CDI AMG | 5 | OM612.990 | 170/228 | 01/03→08/07 | CH704 [275] | 5v | | | CCU104 |
| 3.0 C 280, 3.0 C 280 4WD | 6 | M272.940; M272.941 | 170/228 | 01/05→08/07 | OE229 | 0,8 | CET15P | | BAEA140E |
| 3.0 C 320 CDI | 6 | OM642.910 | 165/221 | 06/05→08/07 | | | | | CCU114 [180] [275] |
| 3.2 C 32 AMG Kompressor | 6 | M112.961 | 260/349 | 03/01→08/07 | | | CET12P | OE180 | BAEA297 CLS064 →01/04 |
| 3.2 C 320, 3.2 C 320 4WD | 6 | M112.946; M112.953 | 160/215 | 03/01→08/07 | OE191 | 1,0 | CET12P | OE180 | BAEA297 CLS064 |
| 3.5 C 350, 3.5 C 350 4WD | 6 | M272.960; M272.970 | 200/268 | 01/05→08/07 | OE229 | 0,8 | CET15P | | BAEA140E |
| 5.4 C 55 AMG | 8 | M113.988 | 270/362 | 02/04→08/07 | | | CET12P | OE180 | BAEA297 CLS064 |
| C-CLASS T-Model (S204) | | | | | | | | | |
| 1.6 C 180 Kompressor | 4 | M271.910 | 115/154 | 01/08→08/14 | OE229 | 0,8 | CET15P | | BAEA077 |
| 1.8 C 180 CGI | 4 | M271.820 | 115/154 | 11/09→08/14 | OE229 | 0,8 | CET15P | | BAEA077 |
| 1.8 C 180 Kompressor | 4 | M271.952 | 115/154 | 08/07→08/14 | OE229 | 0,8 | CET15P | | BAEA077 Eng.30853900→ |
| 1.8 C 200 CGI | 4 | M271.820; M271.860 | 135/181 | 08/07→08/14 | OE229 | 0,8 | CET15P | | BAEA077 |
| 1.8 C 200 Kompressor | 4 | M271.950 | 135/181 | 08/07→08/14 | OE229 | 0,8 | CET15P | | BAEA077 Eng.30853900→ |
| 1.8 C 250 CGI | 4 | M271.860 | 150/201 | 07/09→08/14 | OE229 | 0,8 | CET15P | | BAEA077 |
| 2.1 C 200 CDI | 4 | OM646.811 | 100/134 | 08/07→08/14 | | | | | CCU110 |
| 2.1 C 220 CDI | 4 | OM646.811 | 120/161 | 08/07→08/14 | | | | | CCU110 |
| 2.1 C 220 CDI | 4 | OM646.811 | 125/168 | 08/07→08/14 | | | | | CCU110 |
| 2.5 C 230 | 6 | M272.921 | 150/201 | 08/07→08/14 | OE229 | 0,8 | CET15P | | BAEA140E |

MERCEDES-BENZ





kW/BHP

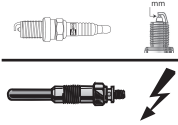

eon TITAN

IRIDIUM

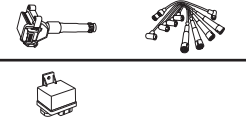

...MERCEDES-BENZ



...C-CLASS T-Model (S204)

| | | | | | | | | | | |
|----------------------------------|---|----------------------|---------|-------------|-------|-----|--------|--|-------------------------|--|
| 3.0 C 280 | 6 | M272.947 | 170/228 | 08/07→08/14 | OE229 | 0,8 | CET15P | | BAEA140E | |
| 3.0 C 300 | 6 | M272.947 | 170/228 | 08/07→08/14 | OE229 | 0,8 | CET15P | | | |
| 3.0 C 320 CDI, 3.0 C 320 CDI 4WD | 6 | OM642.960; OM642.961 | 165/221 | 08/07→08/14 | | | | | CCU114 [180] [275] | |
| 3.0 C 350 CDI | 6 | OM642.830 | 165/221 | 08/07→08/14 | | | | | CCU116 ^[275] | |
| 3.0 C 350 CDI | 6 | OM642.834 | 195/261 | 06/11→08/14 | | | | | CCU116 ^[275] | |
| 3.0 C 350 CDI, 3.0 C 350 CDI 4WD | 6 | OM642.830; OM642.832 | 170/228 | 10/09→08/14 | | | | | CCU116 ^[275] | |
| 3.5 C 350 | 6 | M272.961 | 200/268 | 08/07→08/14 | OE229 | 0,8 | CET15P | | BAEA140E | |
| 3.5 C 350 CGI | 6 | M276.957 | 225/302 | 06/11→08/14 | | | | | BAEA093E | |
| 6.2 C 63 AMG | 8 | M156.985 | 336/451 | 02/08→08/14 | OE233 | 1,0 | | | | |
| 6.2 C 63 AMG | 8 | M156.985 | 358/480 | 01/12→08/14 | OE233 | 1,0 | | | | |
| 6.2 C 63 AMG | 8 | M156.985 | 373/500 | 06/13→08/14 | OE233 | 1,0 | | | | |

C-CLASS (W202)

| | | | | | | | | | | |
|----------------------|---|-----------|---------|-------------|---------------------------------------|-------|--------|-----------------|-------------------------|--|
| 1.8 C 180 | 4 | M111.921 | 89/119 | 11/94→05/00 | OE057 →06/97 | 0,9 | CET2 | OE180 →06/97 | BAEA340 ^[41] | CLS138 ^[35] |
| | | | | | OE032 07/97→ | 1,0 | | OE179 07/97→ | | |
| 1.8 C 180 | 4 | M111.921 | 90/121 | 03/93→05/00 | OE057 →06/97 | 0,9 | CET2 | OE180 →06/97 | BAEA340 ^[41] | CLS138 ^[35] |
| | | | | | OE032 07/97→ | 1,0 | | OE179 07/97→ | | |
| 1.8 C 180 | 4 | M111.920 | 90/121 | 03/93→05/00 | OE057 →06/97 | 0,9 | CET2 | OE180 →06/97 | BAEA313 | CLS106 ^[229] →Eng.045966 017110 |
| | | | | | OE032 07/97→ | 1,0 | | OE179 07/97→ | | CLS065 ^[230] Eng.045967 017111→ |
| 2.0 C 200 | 4 | M111.945 | 100/134 | 01/94→05/00 | OE057 →06/97 | 0,9 | CET2 | OE180 →06/97 | BAEA340 ^[41] | CLS138 ^[35] |
| | | | | | OE032 07/97→ | 1,0 | | OE179 07/97→ | | |
| 2.0 C 200 | 4 | M111.941 | 100/134 | 01/94→05/00 | OE057 →06/97 | 0,9 | CET2 | OE180 →06/97 | BAEA313 | CLS106 ^[229] →Eng.000765 000704 |
| | | | | | OE032 07/97→ | 1,0 | | OE179 07/97→ | | CLS065 ^[230] Eng.000766 000705→ |
| 2.0 C 200 D | 4 | OM601.913 | 55/74 | 03/93→05/00 | CH176 | 11.5v | | | | |
| 2.0 C 200 D | 4 | OM604.915 | 65/87 | 10/96→05/00 | CH177 ^[293] | 11.5v | | | CCU140 | |
| 2.0 C 200 Kompressor | 4 | M111.944 | 132/177 | 10/95→05/00 | OE032 | 1,0 | CET2 | OE179 | BAEA340 ^[41] | CLS138 ^[35] |
| 2.0 C 200 Kompressor | 4 | M111.944 | 141/189 | 11/96→05/00 | OE032 | 1,0 | CET2 | OE179 | BAEA340 ^[41] | CLS138 ^[35] |
| 2.2 C 200 CDI | 4 | OM611.960 | 75/101 | 03/98→05/00 | | | | | CCU140 | |
| 2.2 C 220 | 4 | M111.961 | 110/148 | 03/93→05/00 | OE057 | 0,9 | CET2 | OE180 | BAEA313 | |
| 2.2 C 220 CDI | 4 | OM611.960 | 92/123 | 09/97→05/00 | | | | | CCU140 | |
| 2.2 C 220 D | 4 | OM604.910 | 55/74 | 07/96→05/00 | CH175 ^{[175] [275] [297]} | 11.5v | | | CCU140 | |
| | | | | | CH177 ^{[176] [275] [293]} | 11.5v | | | | |
| 2.2 C 220 D | 4 | OM604.910 | 70/94 | 08/93→05/00 | CH175 ^{[175] [275] [297]} | 11.5v | | | CCU140 | |
| | | | | | CH177 ^{[176] [275] [293]} | 11.5v | | | | |
| 2.3 C 230 | 4 | M111.974 | 110/148 | 06/96→06/97 | OE057 | 0,9 | CET2 | OE180 | BAEA340 ^[41] | CLS138 ^[35] |
| 2.3 C 230 Kompressor | 4 | M111.975 | 142/190 | 10/95→05/00 | OE136 | 0,8 | CET12P | OE179 | BAEA340 ^[41] | CLS138 ^[35] |
| 2.4 C 240 | 6 | M112.910 | 125/168 | 06/97→05/00 | OE191 | 1,0 | CET12P | OE180 | BAEA297 | CLS064 |
| 2.5 C 250 D | 5 | OM605.910 | 83/111 | 05/93→05/00 | CH175 ^{[175] [275] [297]} | 11.5v | | | | |
| | | | | | CH177 ^{[176] [275] [293]} | 11.5v | | | | |
| 2.5 C 250 Turbo-D | 5 | OM605.960 | 110/148 | 10/95→05/00 | CH177 ^[293] | 11.5v | | | CCU141 | |

MERCEDES-BENZ





kW/BHP

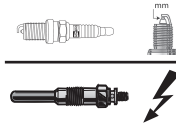

eon TITAN

IRIDIUM

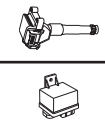
**...MERCEDES-BENZ****...C-CLASS (W202)**

| | | | | | | | | | | |
|--------------|---|-------------------|---------|-------------|--------------|-----|---------------|--------------|----------------|--|
| 2.8 C 280 | 6 | M104.941 | 142/190 | 05/93→05/00 | OE057 | 0,9 | CET2 | OE180 | BAEA340 | CLS252 →08/95 CLS254 09/95→ |
| 2.8 C 280 | 6 | M112.920 | 145/194 | 06/97→05/00 | OE191 | 1,0 | CET12P | OE180 | BAEA297 | CLS064 |
| 3.6 C 36 AMG | 6 | M104.941 (AMG3.6) | 206/276 | 05/94→05/00 | OE057 | 0,9 | CET2 | OE180 | BAEA340 | |
| 4.3 C 43 AMG | 8 | M113.944 | 205/275 | 09/97→12/98 | OE191 | 1,0 | CET12P | OE180 | | |
| 4.3 C 43 AMG | 8 | M113.944 | 225/302 | 08/97→05/00 | OE191 | 1,0 | CET12P | OE180 | BAEA297 | |

C-CLASS (W203)

| | | | | | | | | | | |
|--------------------------|---|----------------------|---------|-------------|---|-----|--|---|---|------------------------------|
| 1.8 C 180 Kompressor | 4 | M271.946 | 105/141 | 05/02→02/07 | OE229 [232] | 0,8 | CET15P [232] | | BAEA053 →Eng.30853899 →Prod.30.11.2006 | |
| | | | | | OE224 →Eng.30853899 →Prod.30.11.2006 | 0,8 | CET14P →Eng.30853899 →Prod.30.11.2006 | BAEA077 Eng.30853900→ Prod.30.11.2006→ | | |
| | | | | | OE229 Eng.30853900→ Prod.30.11.2006→ | 0,8 | CET15P Eng.30853900→ Prod.30.11.2006→ | | | |
| 1.8 C 200 CGI Kompressor | 4 | M271.942 | 125/168 | 07/03→02/07 | OE229 [232] | 0,8 | CET15P [232] | | BAEA053 →Eng.30853899 →Prod.30.11.2006 | |
| | | | | | OE224 →Eng.30853899 →Prod.30.11.2006 | 0,8 | CET14P →Eng.30853899 →Prod.30.11.2006 | BAEA077 Eng.30853900→ Prod.30.11.2006→ | | |
| | | | | | OE229 Eng.30853900→ Prod.30.11.2006→ | 0,8 | CET15P Eng.30853900→ Prod.30.11.2006→ | | | |
| 1.8 C 200 Kompressor | 4 | M271.940 | 120/161 | 05/02→02/07 | OE229 [232] | 0,8 | CET15P [232] | | BAEA053 →Eng.30853899 →Prod.30.11.2006 | |
| | | | | | OE224 →Eng.30853899 →Prod.30.11.2006 | 0,8 | CET14P →Eng.30853899 →Prod.30.11.2006 | BAEA077 Eng.30853900→ Prod.30.11.2006→ | | |
| | | | | | OE229 Eng.30853900→ Prod.30.11.2006→ | 0,8 | CET15P Eng.30853900→ Prod.30.11.2006→ | | | |
| 1.8 C 230 Kompressor | 4 | M271.948 | 141/189 | 02/04→02/07 | OE229 [232] | 0,8 | CET15P [232] | | BAEA053 →Eng.30853899 →Prod.30.11.2006 | |
| | | | | | OE224 →Eng.30853899 →Prod.30.11.2006 | 0,8 | CET14P →Eng.30853899 →Prod.30.11.2006 | BAEA077 Eng.30853900→ Prod.30.11.2006→ | | |
| | | | | | OE229 Eng.30853900→ Prod.30.11.2006→ | 0,8 | CET15P Eng.30853900→ Prod.30.11.2006→ | | | |
| 2.0 C 180 | 4 | M111.951 | 95/127 | 10/00→05/02 | | | CET12P | OE181 | BAEA041 | |
| 2.0 C 200 Kompressor | 4 | M111.955 | 120/161 | 05/00→06/02 | | | CET12P | OE181 | BAEA041 | |
| 2.2 C 200 CDI | 4 | OM611.962 | 75/101 | 02/01→02/07 | | | | | | CCU140 |
| 2.2 C 200 CDI | 4 | OM611.962 | 85/114 | 09/00→02/07 | | | | | | CCU140 |
| 2.2 C 200 CDI | 4 | OM646.962; OM646.963 | 90/121 | 04/03→02/07 | | | | | | CCU140 |
| 2.2 C 220 CDI | 4 | OM611.962 | 100/134 | 05/00→02/07 | | | | | | CCU140 |
| 2.2 C 220 CDI | 4 | OM611.962; OM646.963 | 105/141 | 05/00→02/07 | | | | | | CCU140 |
| 2.2 C 220 CDI | 4 | OM646.963 | 110/148 | 02/03→02/07 | | | | | | CCU140 |
| 2.5 C 230 | 6 | M272.920 | 150/201 | 01/05→02/07 | OE229 | 0,8 | CET15P | | | BAEA140E |
| 2.6 C 240, 2.6 C 240 4WD | 6 | M112.912; M112.916 | 125/168 | 05/00→02/07 | OE191 | 1,0 | CET12P | OE180 | BAEA297 | CLS064 |
| 2.7 C 270 CDI | 5 | OM612.962 | 125/168 | 12/00→02/07 | | | | | | CCU141 |
| 3.0 C 30 CDI AMG | 5 | OM612.990 | 170/228 | 01/03→02/07 | CH704 [275] | 5v | | | | CCU104 |
| 3.0 C 280, 3.0 C 280 4WD | 6 | M272.940; M272.941 | 170/228 | 01/05→02/07 | OE229 | 0,8 | CET15P | | | BAEA140E |
| 3.0 C 320 CDI | 6 | OM642.910 | 165/221 | 01/05→02/07 | | | | | | CCU114 [180] [275] |
| 3.2 C 32 AMG Kompressor | 6 | M112.961 | 260/349 | 02/01→02/07 | | | CET12P | OE180 | BAEA297 09/02→ | CLS064 |
| 3.2 C 320, 3.2 C 320 4WD | 6 | M112.946; M112.953 | 160/215 | 05/00→02/07 | OE191 | 1,0 | CET12P | OE180 | BAEA297 | CLS064 |

MERCEDES-BENZ





kW/BHP



eon TITAN

IRIDIUM



...MERCEDES-BENZ



...C-CLASS (W203)

| | | | | | | | | | | |
|--------------------------|---|--------------------|---------|---------------|--------------|-----|---------------|------------------------------|-----------------|---------------|
| 3.5 C 350, 3.5 C 350 4WD | 6 | M272.960; M272.970 | 200/268 | 01/05 → 02/07 | OE229 | 0,8 | CET15P | | BAEA140E | |
| 5.4 C 55 AMG | 8 | M113.988 | 270/362 | 02/04 → 02/07 | | | CET12P | OE180 OE181 | BAEA297 | CLS242 |

C-CLASS (W204)

| | | | | | | | | | | |
|--|---|----------------------|---------|---------------|--------------|-----|---------------|--|----------------------------------|--|
| 1.6 C 180 Kompressor | 4 | M271.910 | 115/154 | 01/08 → 01/14 | | | | | BAEA077 | |
| 1.8 C 180 CGI | 4 | M271.820 | 115/154 | 01/07 → 01/14 | OE229 | 0,8 | CET15P | | BAEA077 | |
| 1.8 C 180 Kompressor | 4 | M271.952 | 115/154 | 01/07 → 01/14 | OE229 | 0,8 | CET15P | | BAEA077 Eng.30853900 → | |
| 1.8 C 200 | 4 | M271.820 | 137/184 | 05/11 → 01/14 | OE229 | 0,8 | CET15P | | BAEA077 | |
| 1.8 C 200 CGI | 4 | M271.820; M271.860 | 135/181 | 01/07 → 01/14 | OE229 | 0,8 | CET15P | | BAEA077 | |
| 1.8 C 200 Kompressor | 4 | M271.950 | 135/181 | 01/07 → 01/14 | OE229 | 0,8 | CET15P | | BAEA077 Eng.30853900 → | |
| 1.8 C 250 CGI | 4 | M271.860 | 150/201 | 07/09 → 01/14 | OE229 | 0,8 | CET15P | | BAEA077 | |
| 2.1 C 200 CDI | 4 | OM646.811; OM646.812 | 100/134 | 01/07 → 01/14 | | | | | CCU110 | |
| 2.1 C 220 CDI | 4 | OM646.811 | 120/161 | 01/07 → 01/14 | | | | | CCU110 | |
| 2.1 C 220 CDI | 4 | OM646.811 | 125/168 | 01/07 → 01/14 | | | | | CCU110 | |
| 2.5 C 230, 2.5 C 230 4WD | 6 | M272.911; M272.921 | 150/201 | 01/07 → 01/14 | OE229 | 0,8 | CET15P | | BAEA140E | |
| 3.0 C 280, 3.0 C 280 4WD, 3.0 C 300, 3.0 C 300 4WD | 6 | M272.947; M272.948 | 170/228 | 01/07 → 01/14 | OE229 | 0,8 | CET15P | | BAEA140E | |
| 3.0 C 300 CDI 4WD, 3.0 C 350 CDI, 3.0 C 350 CDI 4WD | 6 | OM642.830; OM642.832 | 170/228 | 10/09 → 01/14 | | | | | CCU116 ^[275] | |
| 3.0 C 320 CDI, 3.0 C 320 CDI 4WD, 3.0 C 350 CDI, 3.0 C 350 CDI 4WD | 6 | OM642.960; OM642.961 | 165/221 | 01/07 → 01/14 | | | | | CCU114 [180] [275] | |
| 3.0 C 350 CDI | 6 | OM642.834 | 195/261 | 06/11 → 01/14 | | | | | CCU116 ^[275] | |
| 3.5 C 300, 3.5 C 300 4WD | 6 | M276.957 | 185/248 | 02/11 → 01/14 | | | | | BAEA093E | |
| 3.5 C 350, 3.5 C 350 4WD | 6 | M272.961; M272.971 | 200/268 | 01/07 → 01/14 | OE229 | 0,8 | CET15P | | BAEA140E | |
| 3.5 C 350, 3.5 C 350 4WD | 6 | M276.957 | 225/302 | 01/11 → 01/14 | | | | | BAEA093E | |
| 3.5 C 350 CGI | 6 | M272.982 | 215/288 | 09/08 → 01/14 | | | | | BAEA140E | |
| 6.2 C 63 AMG | 8 | M156.985 | 336/451 | 02/08 → 01/14 | OE233 | 1,0 | | | | |
| 6.2 C 63 AMG | 8 | M156.985 | 358/480 | 02/08 → 01/14 | OE233 | 1,0 | | | | |
| 6.2 C 63 AMG | 8 | M156.985 | 373/500 | 02/08 → 01/14 | OE233 | 1,0 | | | | |

CITAN Combi (415)

| | | | | | | | | | | |
|---------|---|----------|--------|---------|--|--|--|--------------|-----------------|--|
| 1.2 112 | 4 | M200.711 | 84/113 | 06/13 → | | | | OE261 | BAEA131E | |
|---------|---|----------|--------|---------|--|--|--|--------------|-----------------|--|

CLC-CLASS (CL203)

| | | | | | | | | | | |
|------------------------|---|-----------|---------|---------------|---|-----|--|--|---|--|
| 1.6 CLC 160 | 4 | M271.911 | 95/127 | 02/09 → 06/11 | OE229 | 0,8 | CET15P | | BAEA077 | |
| 1.8 CLC 180 Kompressor | 4 | M271.946 | 105/141 | 05/08 → 06/11 | OE229 ^[232] | 0,8 | CET15P ^[232] | | BAEA053 → Eng.30853899 → Prod.30.11.2006 | |
| | | | | | OE224 → Eng.30853899 → Prod.30.11.2006 | 0,8 | CET14P → Eng.30853899 → Prod.30.11.2006 | | BAEA077 Eng.30853900 → Prod.30.11.2006 → | |
| | | | | | OE229 Eng.30853900 → Prod.30.11.2006 → | 0,8 | CET15P Eng.30853900 → Prod.30.11.2006 → | | | |
| 1.8 CLC 200 Kompressor | 4 | M271.957 | 135/181 | 05/08 → 06/11 | OE229 | 0,8 | CET15P | | BAEA077 | |
| 2.1 CLC 200 CDI | 4 | OM646.962 | 90/121 | 05/08 → 06/11 | | | | | CCU140 | |
| 2.1 CLC 220 CDI | 4 | OM646.963 | 110/148 | 05/08 → 06/11 | | | | | CCU140 | |
| 2.5 CLC 230 | 6 | M272.920 | 150/201 | 05/08 → 06/11 | OE229 | 0,8 | CET15P | | BAEA140E | |
| 3.5 CLC 350 | 6 | M272.960 | 200/268 | 05/08 → 06/11 | OE229 | 0,8 | CET15P | | BAEA140E | |

CLK Convertible (A208)

| | | | | | | | | | | |
|--------------------|---|----------|---------|---------------|------------------------------|-----|---------------|------------------------------|--------------------------------|-------------------------------|
| 2.0 200 | 4 | M111.941 | 100/134 | 03/98 → 03/02 | | | | OE179 | | |
| 2.0 200 | 4 | M111.945 | 100/134 | 03/98 → 03/02 | OE057 → Eng.052061 | 0,9 | | OE179 | BAEA340 ^[41] | CLS138 ^[35] |
| | | | | | | | | OE179 → Eng.052061 | | |
| 2.0 200 Kompressor | 4 | M111.956 | 120/161 | 06/00 → 03/02 | | | CET12P | OE181 | BAEA041 | |
| 2.0 200 Kompressor | 4 | M111.944 | 141/189 | 03/98 → 06/00 | OE032 | 1,0 | CET2 | OE179 | BAEA340 ^[41] | CLS138 ^[35] |

MERCEDES-BENZ





kW/BHP



eon TITAN

IRIDIUM



...MERCEDES-BENZ



...CLK Convertible (A208)

| | | | | | | | | | | |
|--------------------|---|--------------------|---------|---------------|--------------|-----|----------------|--------------|--------------------------------|-------------------------------|
| 2.3 230 Kompressor | 4 | M111.975 | 142/190 | 03/98 → 06/00 | OE032 | 1,0 | CET2 | OE179 | BAEA340 ^[41] | CLS138 ^[35] |
| 2.3 230 Kompressor | 4 | M111.973 | 142/190 | 03/98 → 06/00 | | | CET2 | | BAEA340 ^[41] | |
| 2.3 230 Kompressor | 4 | M111.982 | 145/194 | 06/00 → 03/02 | | | CET1 2P | OE181 | BAEA041 | |
| 3.2 320 | 6 | M112.940 | 160/215 | 03/98 → 03/02 | OE191 | 1,0 | CET1 2P | OE180 | BAEA297 | CLS064 |
| 4.3 430 | 8 | M113.943 | 205/275 | 09/98 → 03/02 | OE191 | 1,0 | CET1 2P | OE180 | BAEA297 | CLS242 |
| 5.4 55 AMG | 8 | M113.981; M113.984 | 255/342 | 01/00 → 03/02 | OE191 | 1,0 | CET1 2P | OE180 | BAEA297 | CLS242 |

CLK Convertible (A209)

| | | | | | | | | | | |
|-----------------|---|----------|---------|---------------|---|-----|---|--|---|--|
| 1.8 CLK 200 CGI | 4 | M271.942 | 125/168 | 07/03 → 03/10 | OE229 ^[232] | 0,8 | CET1 5P ^[232] | | BAEA053 → Eng.30853899 → Prod.30.11.2006 | |
| | | | | | OE224 → Eng.30853899 → Prod.30.11.2006 | 0,8 | CET1 4P → Eng.30853899 → Prod.30.11.2006 | | BAEA077 Eng.30853900 → Prod.30.11.2006 → | |
| | | | | | OE229 Eng.30853900 → Prod.30.11.2006 → | 0,8 | CET1 5P Eng.30853900 → Prod.30.11.2006 → | | | |

| | | | | | | | | | | |
|------------------------|---|----------|---------|---------------|---|-----|---|--|---|--|
| 1.8 CLK 200 Kompressor | 4 | M271.940 | 120/161 | 02/03 → 03/10 | OE229 ^[232] | 0,8 | CET1 5P ^[232] | | BAEA053 → Eng.30853899 → Prod.30.11.2006 | |
| | | | | | OE224 → Eng.30853899 → Prod.30.11.2006 | 0,8 | CET1 4P → Eng.30853899 → Prod.30.11.2006 | | BAEA077 Eng.30853900 → Prod.30.11.2006 → | |
| | | | | | OE229 Eng.30853900 → Prod.30.11.2006 → | 0,8 | CET1 5P Eng.30853900 → Prod.30.11.2006 → | | | |

| | | | | | | | | | | |
|------------------------|---|----------|---------|---------------|---|-----|----------------|--|----------------------------------|--|
| 1.8 CLK 200 Kompressor | 4 | M271.955 | 135/181 | 10/06 → 03/10 | OE224 → 08/07 → Eng.30099998 | 0,8 | CET1 5P | | BAEA053 → Eng.30853899 | |
| | | | | | OE229 08/07 → Eng.30099999 → | 0,8 | | | BAEA077 Eng.30853900 → | |

| | | | | | | | | | | |
|-------------|---|----------|---------|---------------|--------------|-----|----------------|--------------|----------------|---------------|
| 2.6 CLK 240 | 6 | M112.912 | 125/168 | 02/03 → 03/10 | OE191 | 1,0 | CET1 2P | OE180 | BAEA297 | CLS064 |
|-------------|---|----------|---------|---------------|--------------|-----|----------------|--------------|----------------|---------------|

| | | | | | | | | | | |
|-------------|---|----------|---------|---------------|--------------|-----|----------------|--|-----------------|--|
| 3.0 CLK 280 | 6 | M272.940 | 170/228 | 01/05 → 03/10 | OE229 | 0,8 | CET1 5P | | BAEA140E | |
|-------------|---|----------|---------|---------------|--------------|-----|----------------|--|-----------------|--|

| | | | | | | | | | | |
|-----------------|---|-----------|---------|---------------|--|--|--|--|---|--|
| 3.0 CLK 320 CDI | 6 | OM642.910 | 165/221 | 03/05 → 03/10 | | | | | CCU114 ^{[180] [275]} | |
|-----------------|---|-----------|---------|---------------|--|--|--|--|---|--|

| | | | | | | | | | | |
|-------------|---|----------|---------|---------------|--------------|-----|----------------|--------------|----------------|---------------|
| 3.2 CLK 320 | 6 | M112.955 | 160/215 | 02/03 → 03/10 | OE191 | 1,0 | CET1 2P | OE180 | BAEA297 | CLS064 |
|-------------|---|----------|---------|---------------|--------------|-----|----------------|--------------|----------------|---------------|

| | | | | | | | | | | |
|-------------|---|----------|---------|---------------|--------------|-----|----------------|--|-----------------|--|
| 3.5 CLK 350 | 6 | M272.960 | 200/268 | 01/05 → 03/10 | OE229 | 0,8 | CET1 5P | | BAEA140E | |
|-------------|---|----------|---------|---------------|--------------|-----|----------------|--|-----------------|--|

| | | | | | | | | | | |
|-------------|---|----------|---------|---------------|--------------|-----|----------------|--------------|--|--|
| 5.0 CLK 500 | 8 | M113.968 | 215/288 | 09/03 → 12/05 | OE191 | 1,0 | CET1 2P | OE180 | | |
|-------------|---|----------|---------|---------------|--------------|-----|----------------|--------------|--|--|

| | | | | | | | | | | |
|-------------|---|----------|---------|---------------|--------------|-----|----------------|--------------|----------------|---------------|
| 5.0 CLK 500 | 8 | M113.968 | 225/302 | 02/03 → 03/10 | OE191 | 1,0 | CET1 2P | OE180 | BAEA297 | CLS242 |
|-------------|---|----------|---------|---------------|--------------|-----|----------------|--------------|----------------|---------------|

| | | | | | | | | | | |
|-----------------|---|----------|---------|---------------|--|--|----------------|--------------|----------------|--|
| 5.4 CLK AMG DTM | 8 | M113.994 | 428/574 | 06/04 → 03/10 | | | CET1 4P | OE190 | BAEA297 | |
|-----------------|---|----------|---------|---------------|--|--|----------------|--------------|----------------|--|

| | | | | | | | | | | |
|----------------|---|----------|---------|---------------|--|--|----------------|--------------|----------------|---------------|
| 5.5 CLK 55 AMG | 8 | M113.987 | 270/362 | 02/03 → 03/10 | | | CET1 2P | OE180 | BAEA297 | CLS242 |
|----------------|---|----------|---------|---------------|--|--|----------------|--------------|----------------|---------------|

| | | | | | | | | | | |
|-------------|---|----------|---------|---------------|--------------|-----|----------------|--|-----------------|--|
| 5.5 CLK 500 | 8 | M273.967 | 285/382 | 06/06 → 03/10 | OE229 | 0,8 | CET1 5P | | BAEA140E | |
|-------------|---|----------|---------|---------------|--------------|-----|----------------|--|-----------------|--|

| | | | | | | | | | | |
|----------------|---|----------|---------|---------------|--------------|-----|--|--|--|--|
| 6.2 CLK 63 AMG | 8 | M156.982 | 354/475 | 04/06 → 03/10 | OE233 | 1,0 | | | | |
|----------------|---|----------|---------|---------------|--------------|-----|--|--|--|--|

CLK (C208)

| | | | | | | | | | | |
|---------|---|----------|---------|---------------|------------------------------|-----|--|--------------|--------------------------------|-------------------------------|
| 2.0 200 | 4 | M111.945 | 100/134 | 06/97 → 06/02 | OE057 → Eng.052061 | 0,9 | | OE179 | BAEA340 ^[41] | CLS138 ^[35] |
|---------|---|----------|---------|---------------|------------------------------|-----|--|--------------|--------------------------------|-------------------------------|

| | | | | | | | | | | |
|--------------------|---|----------|---------|---------------|--|--|----------------|--------------|----------------|--|
| 2.0 200 Kompressor | 4 | M111.956 | 120/161 | 06/00 → 06/02 | | | CET1 2P | OE181 | BAEA041 | |
|--------------------|---|----------|---------|---------------|--|--|----------------|--------------|----------------|--|

| | | | | | | | | | | |
|--------------------|---|----------|---------|---------------|--------------|-----|-------------|--------------|--------------------------------|-------------------------------|
| 2.0 200 Kompressor | 4 | M111.944 | 141/189 | 06/97 → 06/00 | OE032 | 1,0 | CET2 | OE179 | BAEA340 ^[41] | CLS138 ^[35] |
|--------------------|---|----------|---------|---------------|--------------|-----|-------------|--------------|--------------------------------|-------------------------------|

| | | | | | | | | | | |
|--------------------|---|----------|---------|---------------|--------------|-----|-------------|--------------|--------------------------------|-------------------------------|
| 2.3 230 Kompressor | 4 | M111.975 | 142/190 | 06/97 → 06/00 | OE032 | 1,0 | CET2 | OE179 | BAEA340 ^[41] | CLS138 ^[35] |
|--------------------|---|----------|---------|---------------|--------------|-----|-------------|--------------|--------------------------------|-------------------------------|

| | | | | | | | | | | |
|--------------------|---|----------|---------|---------------|--|--|-------------|--|--------------------------------|--|
| 2.3 230 Kompressor | 4 | M111.973 | 142/190 | 06/97 → 06/00 | | | CET2 | | BAEA340 ^[41] | |
|--------------------|---|----------|---------|---------------|--|--|-------------|--|--------------------------------|--|

| | | | | | | | | | | |
|--------------------|---|----------|---------|---------------|--|--|----------------|--------------|----------------|--|
| 2.3 230 Kompressor | 4 | M111.982 | 145/194 | 06/00 → 06/02 | | | CET1 2P | OE181 | BAEA041 | |
|--------------------|---|----------|---------|---------------|--|--|----------------|--------------|----------------|--|

| | | | | | | | | | | |
|---------|---|----------|---------|---------------|--------------|-----|----------------|--------------|----------------|---------------|
| 3.2 320 | 6 | M112.940 | 160/215 | 06/97 → 06/02 | OE191 | 1,0 | CET1 2P | OE180 | BAEA297 | CLS064 |
|---------|---|----------|---------|---------------|--------------|-----|----------------|--------------|----------------|---------------|

| | | | | | | | | | | |
|---------|---|----------|---------|---------------|--------------|-----|----------------|--------------|----------------|---------------|
| 4.3 430 | 8 | M113.943 | 205/275 | 07/98 → 06/02 | OE191 | 1,0 | CET1 2P | OE180 | BAEA297 | CLS242 |
|---------|---|----------|---------|---------------|--------------|-----|----------------|--------------|----------------|---------------|

| | | | | | | | | | | |
|-----|---|----------|---------|---------------|--------------|-----|----------------|--------------|--|--|
| 5.4 | 8 | M113.984 | 260/349 | 10/98 → 07/02 | OE191 | 1,0 | CET1 2P | OE180 | | |
|-----|---|----------|---------|---------------|--------------|-----|----------------|--------------|--|--|

| | | | | | | | | | | |
|------------|---|--------------------|---------|---------------|--------------|-----|----------------|--------------|----------------|---------------|
| 5.4 55 AMG | 8 | M113.981; M113.984 | 255/342 | 08/99 → 06/02 | OE191 | 1,0 | CET1 2P | OE180 | BAEA297 | CLS242 |
|------------|---|--------------------|---------|---------------|--------------|-----|----------------|--------------|----------------|---------------|





kW/BHP



eon TITAN

IRIDIUM



...MERCEDES-BENZ



CLK (C209)

| | | | | | | | | | | |
|--|---|--|---------|-------------|---|-----|--|--------------|--|---------------|
| 1.8 200 CGI | 4 | M271.942 | 125/168 | 07/03→05/09 | OE229 [232] | 0,8 | CET15P [232] | | BAEA053 →Eng.30853899 →Prod.30.11.2006 | |
| | | | | | OE224 →Eng.30853899 →Prod.30.11.2006 | 0,8 | CET14P →Eng.30853899 →Prod.30.11.2006 | | BAEA077 Eng.30853900→ Prod.30.11.2006→ | |
| | | | | | OE229 Eng.30853900→ Prod.30.11.2006→ | 0,8 | CET15P Eng.30853900→ Prod.30.11.2006→ | | | |
| 1.8 200 Kompressor | 4 | M271.940 | 120/161 | 09/02→05/09 | OE229 [232] | 0,8 | CET15P [232] | | BAEA053 →Eng.30853899 →Prod.30.11.2006 | |
| | | | | | OE224 →Eng.30853899 →Prod.30.11.2006 | 0,8 | CET14P →Eng.30853899 →Prod.30.11.2006 | | BAEA077 Eng.30853900→ Prod.30.11.2006→ | |
| | | | | | OE229 Eng.30853900→ Prod.30.11.2006→ | 0,8 | CET15P Eng.30853900→ Prod.30.11.2006→ | | | |
| 1.8 200 Kompressor | 4 | M271.955 | 135/181 | 10/06→05/09 | OE229 | 0,8 | CET15P | | BAEA053 →Eng.30853899 BAEA077 Eng.30853900→ | |
| 2.2 220 CDI | 4 | OM646.966 | 100/134 | 01/05→05/09 | | | | | CCU140 | |
| 2.2 220 CDI | 4 | OM646.966 | 110/148 | 01/05→05/09 | | | | | CCU140 | |
| 2.6 240 | 6 | M112.912 | 120/161 | 06/02→05/09 | OE191 | 1,0 | CET12P | OE180 | BAEA297 | |
| 2.6 240 | 6 | M112.912 | 125/168 | 06/02→05/09 | OE191 | 1,0 | CET12P | OE180 | BAEA297 | CLS064 |
| 2.7 270 CDI | 5 | OM612.967 | 120/161 | 02/03→06/05 | | | | | CCU141 | |
| 2.7 270 CDI | 5 | OM612.962; OM612.967 | 125/168 | 10/02→05/09 | | | | | CCU141 | |
| 3.0 280 | 6 | M272.940 | 170/228 | 01/05→05/09 | OE229 | 0,8 | CET15P | | BAEA140E | |
| 3.0 320 CDI | 6 | OM642.910 | 165/221 | 01/05→05/09 | | | | | CCU114 [180] [275] | |
| 3.2 320 | 6 | M112.955 | 160/215 | 06/02→05/09 | OE191 | 1,0 | CET12P | OE180 | BAEA297 | CLS064 |
| 3.5 350 | 6 | M272.960 | 200/268 | 01/05→05/09 | OE229 | 0,8 | CET15P | | BAEA140E | |
| 5.0 500 | 8 | M113.968 | 215/288 | 09/02→12/05 | OE191 | 1,0 | CET12P | OE180 | | |
| 5.0 500 | 8 | M113.968 | 225/302 | 06/02→05/09 | OE191 | 1,0 | CET12P | OE180 | BAEA297 | CLS242 |
| 5.4 55 AMG | 8 | M113.987 | 270/362 | 09/02→05/09 | | | CET12P | OE180 | BAEA297 | CLS242 |
| 5.4 DTM AMG | 8 | M113.994 | 428/574 | 06/04→05/09 | | | CET14P | OE190 | BAEA297 | |
| 5.5 500 | 8 | M273.965 | 285/382 | 06/06→05/09 | OE229 | 0,8 | CET15P | | BAEA140E | |
| 6.2 63 AMG | 8 | M156.982 | 354/475 | 04/06→05/09 | OE233 | 1,0 | | | | |
| 6.2 63 AMG | 8 | M156.982 | 373/500 | 05/07→05/09 | OE233 | 1,0 | | | | |
| CLS (C218) | | | | | | | | | | |
| 3.0 CLS 350 BlueTEC / d, 3.0 CLS 350 BlueTEC / d 4WD | 6 | OM642.852; OM642.853; OM642.854; OM642.858 | 185/248 | 11/12→ | | | | | CCU116 [275] | |
| 3.0 CLS 350 CDI / d, 3.0 CLS 350 CDI / d 4WD | 6 | OM642.852; OM642.853; OM642.854; OM642.858 | 195/261 | 01/11→ | | | | | CCU116 [275] | |
| 3.5 CLS 350 | 6 | M276.952 | 225/302 | 01/11→ | | | | | BAEA093E | |
| 4.7 CLS 500, 4.7 CLS 500 4WD | 8 | M278.922 | 300/402 | 02/11→ | | | | | BAEA093E | |
| 5.5 CLS 63 AMG | 8 | M157.980; M157.981 | 386/518 | 02/11→ | | | | | BAEA093E | |
| 5.5 CLS 63 AMG, 5.5 CLS 63 AMG 4WD | 8 | M157.980; M157.981 | 410/550 | 01/11→ | | | | | BAEA093E | |
| 5.5 CLS 63 AMG, 5.5 CLS 63 AMG 4WD | 8 | M157.981 | 430/577 | 02/13→ | | | | | BAEA093E | |
| CLS (C219) | | | | | | | | | | |
| 3.0 CLS 280, 3.0 CLS 300 | 6 | M272.943 | 170/228 | 07/08→12/10 | OE229 | 0,8 | CET15P | | BAEA140E | |
| 3.0 CLS 320 CDI | 6 | OM642.920 | 155/208 | 01/05→12/10 | | | | | CCU114 [180] [273] [275] [281] | |
| | | | | | | | | | CCU116 [239] [275] [284] | |

MERCEDES-BENZ



kW/BHP



eon TITAN

IRIDIUM

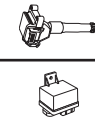

...MERCEDES-BENZ



...CLS (C219)

| | | | | | | | | | | |
|----------------------------------|---|-----------|---------|-------------|-------|-----|--------|-------|----------|---|
| 3.0 CLS 320 CDI, 3.0 CLS 350 CDI | 6 | OM642.920 | 165/221 | 01/05→12/10 | | | | | | CCU114 [180] [273] [275] [281] |
| | | | | | | | | | | CCU116 [239] [275] [284] |
| 3.0 CLS 350 CDI | 6 | OM642.920 | 200/268 | 04/09→12/10 | | | | | | CCU114 [180] [273] [275] [281] |
| | | | | | | | | | | CCU116 [239] [275] [284] |
| 3.5 CLS 350 | 6 | M272.964 | 200/268 | 10/04→12/10 | OE229 | 0,8 | CET15P | | | BAEA140E |
| 3.5 CLS 350 | 6 | M272.985 | 215/288 | 04/06→12/10 | | | | | | BAEA140E [275] →10/06 →Eng.30417696 |
| 3.5 CLS 350 CGI | 6 | M272.985 | 215/288 | 04/09→12/10 | | | | | | BAEA140E [275] |
| 5.0 CLS 500 | 8 | M113.967 | 218/292 | 09/05→12/06 | OE191 | 1,0 | CET12P | OE180 | | |
| 5.0 CLS 500 | 8 | M113.967 | 225/302 | 10/04→12/10 | OE191 | 1,0 | CET12P | OE180 | BAEA297 | CLS064 |
| 5.4 CLS 55 AMG | 8 | M113.990 | 350/469 | 01/05→12/10 | | | CET14P | OE190 | BAEA297 | |
| 5.5 CLS 500 | 8 | M273.960 | 285/382 | 04/06→12/10 | OE229 | 0,8 | CET15P | | BAEA140E | |
| 6.2 CLS 63 AMG | 8 | M156.983 | 378/507 | 04/06→12/10 | OE233 | 1,0 | | | | |

CLS Shooting Brake (X218)

| | | | | | | | | | | |
|--|---|---------------------------------|---------|--------|--|--|--|--|--|--------------|
| 3.0 CLS 350 CDI / d, 3.0 CLS 350 CDI / d 4WD | 6 | OM642.852; OM642.853; OM642.854 | 195/261 | 10/12→ | | | | | | CCU116 [275] |
| 3.5 CLS 350 | 6 | M276.952 | 225/302 | 10/12→ | | | | | | BAEA093E |
| 4.7 CLS 500, 4.7 CLS 500 4WD | 8 | M278.922 | 300/402 | 10/12→ | | | | | | BAEA093E |
| 5.5 CLS 63 AMG | 8 | M157.981 | 386/518 | 10/12→ | | | | | | BAEA093E |
| 5.5 CLS 63 AMG, 5.5 CLS 63 AMG 4WD | 8 | M157.981 | 410/550 | 05/13→ | | | | | | BAEA093E |
| 5.5 CLS 63 AMG, 5.5 CLS 63 AMG 4WD | 8 | M157.981 | 430/577 | 02/13→ | | | | | | BAEA093E |

E-CLASS Convertible (A124)

| | | | | | | | | | | |
|--------------|---|------------------|---------|-------------|-------|-----|------|-------|---------|--|
| 2.0 E 200 | 4 | M111.940 | 100/134 | 06/93→03/98 | OE057 | 0,9 | CET2 | OE180 | BAEA313 | CLS106 [229] →Eng.040193 017707 CLS065 [230] Eng.040194 017708→ |
| 2.2 E 220 | 4 | M111.960 | 110/148 | 06/93→03/98 | OE057 | 0,9 | CET2 | OE180 | BAEA313 | CLS106 [229] →Eng.024563 049833 CLS065 [230] Eng.024564 049834→ |
| 3.2 E 320 | 6 | M104.992 | 162/217 | 06/93→03/98 | OE057 | 0,9 | CET2 | OE180 | BAEA340 | CLS252 →08/95 CLS254 09/95→ |
| 3.6 E 36 AMG | 6 | M104.992(AMG3.6) | 200/268 | 05/94→03/98 | OE057 | 0,9 | CET2 | OE180 | BAEA340 | CLS252 →08/95 CLS254 09/95→ |

E-CLASS Convertible (A207)

| | | | | | | | | | | |
|-------------------|---|--------------------|---------|--------|-------|-----|--------|--|----------|--------------|
| 1.8 E 200 CGI | 4 | M271.820; M271.860 | 135/181 | 01/10→ | OE229 | 0,8 | CET15P | | BAEA077 | |
| 1.8 E 250 CGI | 4 | M271.860 | 150/201 | 01/10→ | OE229 | 0,8 | CET15P | | BAEA077 | |
| 3.0 E 350 BlueTEC | 6 | OM642.838 | 185/248 | 06/13→ | | | | | | CCU116 [275] |
| 3.0 E 350 CDI | 6 | OM642.836 | 170/228 | 01/10→ | | | | | | CCU116 [275] |
| 3.0 E 350 CDI | 6 | OM642.838 | 195/261 | 04/11→ | | | | | | CCU116 [275] |
| 3.5 E 300 | 6 | M276.957 | 185/248 | 04/11→ | | | | | | BAEA093E |
| 3.5 E 350 | 6 | M276.957 | 225/302 | 04/11→ | | | | | | BAEA093E |
| 4.7 E 500 | 8 | M278.922 | 300/402 | 09/11→ | | | | | | BAEA093E |
| 5.5 E 500 | 8 | M273.966 | 285/382 | 01/10→ | OE229 | 0,8 | CET15P | | BAEA140E | |



kW/BHP

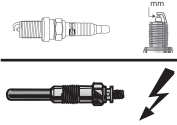

eon TITAN

IRIDIUM

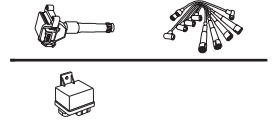
**...MERCEDES-BENZ****E-CLASS Coupe (C124)**

| | | | | | | | | | | |
|--------------|---|------------------|---------|-------------|--------------|-----|-------------|--------------|----------------|--|
| 2.0 E 200 | 4 | M111.940 | 100/134 | 06/93→06/97 | OE057 | 0,9 | CET2 | OE180 | BAEA313 | CLS106 [229] →Eng.040193 017707 CLS065 [230] Eng.040194 017708→ |
| 2.2 E 220 | 4 | M111.960 | 110/148 | 06/93→06/97 | OE057 | 0,9 | CET2 | OE180 | BAEA313 | CLS106 [229] →Eng.024563 049833 CLS065 [230] Eng.024564 049834→ |
| 3.2 E 320 | 6 | M104.992 | 162/217 | 06/93→06/97 | OE057 | 0,9 | CET2 | OE180 | BAEA340 | CLS252 →08/95 CLS254 09/95→ |
| 3.6 E 36 AMG | 6 | M104.992(AMG3.6) | 195/261 | 06/93→04/95 | OE057 | 0,9 | CET2 | OE180 | BAEA340 | CLS254 |
| 3.6 E 36 AMG | 6 | M104.992(AMG3.6) | 200/268 | 05/94→06/97 | OE057 | 0,9 | CET2 | OE180 | BAEA340 | CLS252 →08/95 CLS254 09/95→ |

E-CLASS Coupe (C207)

| | | | | | | | | | | |
|--------------------------|---|--------------------|---------|--------|--------------|-----|---------------|--|---------------------|--|
| 1.8 E 200 CGI | 4 | M271.820; M271.860 | 135/181 | 01/10→ | OE229 | 0,8 | CET15P | | BAEA077 | |
| 1.8 E 250 CGI | 4 | M271.860 | 150/201 | 01/09→ | OE229 | 0,8 | CET15P | | BAEA077 | |
| 3.0 E 350 BlueTEC | 6 | OM642.838 | 185/248 | 03/13→ | | | | | CCU116 [275] | |
| 3.0 E 350 CDI | 6 | OM642.836 | 170/228 | 01/09→ | | | | | CCU116 [275] | |
| 3.0 E 350 CDI | 6 | OM642.838 | 195/261 | 04/11→ | | | | | CCU116 [275] | |
| 3.5 E 300 | 6 | M276.957 | 185/248 | 04/11→ | | | | | BAEA093E | |
| 3.5 E 350 | 6 | M272.961; M272.988 | 200/268 | 05/11→ | OE229 | 0,8 | CET15P | | BAEA140E | |
| 3.5 E 350, 3.5 E 350 4WD | 6 | M276.957 | 225/302 | 04/11→ | | | | | BAEA093E | |
| 4.7 E 500 | 8 | M278.922 | 300/402 | 09/11→ | | | | | BAEA093E | |
| 5.5 E 500 | 8 | M273.966 | 285/382 | 01/09→ | OE229 | 0,8 | CET15P | | BAEA140E | |

E-CLASS T-Model (S124)

| | | | | | | | | | | |
|---------------------|---|-----------|---------|-------------|--|--------------------|-------------|--------------|----------------------|--|
| 2.0 E 200 T | 4 | M111.940 | 100/134 | 06/93→06/96 | OE057 | 0,9 | CET2 | OE180 | BAEA313 | CLS106 [229] →Eng.040193 017707 CLS065 [230] Eng.040194 017708→ |
| 2.2 E 220 T | 4 | M111.960 | 110/148 | 06/93→06/96 | OE057 | 0,9 | CET2 | OE180 | BAEA313 | CLS106 [229] →Eng.024563 049833 CLS065 [230] Eng.024564 049834→ |
| 2.5 E 250 TD | 5 | OM605.911 | 83/111 | 06/93→06/96 | CH175 [297] | 11.5v | | | | |
| 2.5 E 250 Turbo D | 5 | OM602.962 | 93/125 | 06/93→06/96 | CH176 | 11.5v | | | | |
| 2.8 E 280 T | 6 | M104.942 | 142/190 | 06/93→06/96 | OE057 | 0,9 | CET2 | OE180 | BAEA340 | CLS252 →08/95 CLS254 09/95→ |
| 2.8 E 280 T | 6 | M104.942 | 145/194 | 06/93→06/96 | OE057 | 0,9 | CET2 | OE180 | BAEA340 | CLS252 →08/95 CLS254 09/95→ |
| 3.0 E 300 T 4WD | 6 | M103.985 | 132/177 | 06/93→06/96 | OE011 | 0,9 | CET9 | OE183 | BAEA296 [292] | CLS250 →08/95 CLS254 09/95→ |
| 3.0 E 300 TD | 6 | OM606.910 | 100/134 | 06/93→06/96 | CH175 [297] →05/95 CH177 [293] 06/95→ | 11.5v 11.5v | | | | |
| 3.0 E 300 TE-24 AMG | 6 | M104.980 | 162/217 | 06/93→06/96 | OE057 | 0,9 | CET2 | OE180 | | |

MERCEDES-BENZ





kW/BHP



eon TITAN

IRIDIUM



...MERCEDES-BENZ



...E-CLASS T-Model (S124)

| | | | | | | | | | | |
|--|---|----------------------|---------|-------------|-------|-------|------|-------|---------|--------------------------------------|
| 3.0 E 300 T Turbo-D, 3.0 E 300 T Turbo-D 4WD | 6 | OM603.960; OM603.963 | 108/145 | 06/93→06/96 | CH176 | 11.5v | | | | |
| 3.2 E 320 T | 6 | M104.992 | 162/217 | 06/93→06/96 | OE057 | 0,9 | CET2 | OE180 | BAEA340 | CLS252 →08/95 CLS254 09/95→ |
| 3.6 E 36 T AMG | 6 | M104.992(AMG3.6) | 200/268 | 05/94→06/96 | OE057 | 0,9 | CET2 | OE180 | BAEA340 | CLS252 →08/95 CLS254 09/95→ |

E-CLASS T-Model (S210)

| | | | | | | | | | | |
|------------------------------|---|-----------|---------|-------------|------------------------|-------|--------|-------|-------------------------|--|
| 2.0 E 200 T | 4 | M111.942 | 100/134 | 06/96→08/00 | OE032 | 1,0 | CET2 | OE179 | BAEA340 ^[41] | CLS138 ^[35] |
| 2.0 E 200 T Kompressor | 4 | M111.957 | 120/161 | 08/00→03/03 | | | CET12P | OE181 | BAEA041 | |
| 2.0 E 200 T Kompressor | 4 | M111.947 | 137/184 | 06/97→03/03 | OE032 | 1,0 | CET2 | OE179 | BAEA340 ^[41] | CLS063 ^[35] CLS071 ^[35] |
| 2.1 E 220 T CDI | 4 | OM611.961 | 100/134 | 05/99→03/03 | | | | | CCU140 | |
| 2.2 E 220 T CDI | 4 | OM611.961 | 92/123 | 06/98→07/99 | | | | | CCU140 | |
| 2.2 E 220 T CDI | 4 | OM611.961 | 105/141 | 07/99→03/03 | | | | | CCU140 | |
| 2.3 E 230 T | 4 | M111.970 | 110/148 | 06/96→06/97 | OE057 | 0,9 | CET2 | OE180 | BAEA340 ^[41] | |
| 2.4 E 240 T | 6 | M112.911 | 125/168 | 06/97→03/03 | OE191 | 1,0 | CET12P | OE180 | BAEA297 | CLS064 |
| 2.5 E 250 T D | 5 | OM605.912 | 83/111 | 06/96→07/99 | CH177 ^[293] | 11.5v | | | CCU141 | |
| 2.5 E 250 T Turbo-D | 5 | OM605.962 | 110/148 | 06/97→07/99 | CH177 ^[293] | 11.5v | | | CCU141 | |
| 2.6 E 240 T | 6 | M112.914 | 125/168 | 08/00→03/03 | OE191 | 1,0 | CET12P | OE180 | BAEA297 | CLS064 |
| 2.7 E 270 T CDI | 5 | OM612.961 | 120/161 | 02/00→03/03 | | | | | CCU141 | |
| 2.7 E 270 T CDI | 5 | OM612.961 | 125/168 | 07/99→03/03 | | | | | CCU141 | |
| 2.8 E 280 T, 2.8 E 280 T 4WD | 6 | M112.921 | 150/201 | 12/96→03/03 | OE191 | 1,0 | CET12P | OE180 | BAEA297 | CLS064 |
| 2.9 E 290 T Turbo-D | 5 | OM602.982 | 95/127 | 06/96→07/99 | CH204 | 11.5v | | | CCU141 | |
| 3.0 E 300 T Turbo-D | 6 | OM606.962 | 130/174 | 12/96→07/99 | CH177 ^[293] | 11.5v | | | CCU141 | |
| 3.2 E 320 | 6 | M112.941 | 160/215 | 09/97→12/98 | OE191 | 1,0 | CET12P | OE180 | | |
| 3.2 E 320 T, 3.2 E 320 T 4WD | 6 | M112.941 | 165/221 | 12/96→03/03 | OE191 | 1,0 | CET12P | OE180 | BAEA297 | CLS064 |
| 3.2 E 320 T CDI | 6 | OM613.961 | 145/194 | 07/99→03/03 | | | | | CCU141 | |
| 4.2 E 420 T | 8 | M119.985 | 205/275 | 06/96→06/97 | | | CET12P | OE179 | | CLS219 |
| 4.3 E 430 T, 4.3 E 430 T 4WD | 8 | M113.940 | 205/275 | 06/97→03/03 | OE191 | 1,0 | CET12P | OE180 | BAEA297 | CLS242 |
| 5.4 E 55 T AMG | 8 | M113.980 | 260/349 | 08/97→03/03 | OE191 | 1,0 | CET12P | OE180 | BAEA297 | CLS242 |
| 5.4 E 55 T AMG 4WD | 8 | M113.980 | 260/349 | 03/01→03/03 | OE191 | 1,0 | CET12P | OE180 | BAEA297 | |

E-CLASS T-Model (S211)

| | | | | | | | | | | |
|------------------------|---|-----------|---------|-------------|--|-----|---|--|--|--|
| 1.8 E 200 Kompressor | 4 | M271.956 | 135/181 | 04/06→07/09 | OE224 →11/06 →Eng.30853899 | 0,8 | CET14P | | BAEA053 →11/06 →Eng.30853899 | |
| | | | | | OE229 12/06→ Eng.30853900→ | 0,8 | CET15P | | BAEA077 11/06→ Eng.30853900→ | |
| 1.8 E 200 T Kompressor | 4 | M271.941 | 120/161 | 03/03→07/09 | OE229 ^[232] | 0,8 | CET15P ^[232] | | BAEA053 →Eng.30853899 →Prod.30.11.2006 | |
| | | | | | OE224 →Eng.30853899 →Prod.30.11.2006 | 0,8 | CET14P →Eng.30853899 →Prod.30.11.2006 | | BAEA077 Eng.30853900→ Prod.30.11.2006→ | |
| | | | | | OE229 Eng.30853900→ Prod.30.11.2006→ | 0,8 | CET15P Eng.30853900→ Prod.30.11.2006→ | | | |
| 2.1 E 200 CDI | 4 | OM646.821 | 100/134 | 04/06→07/09 | | | | | CCU110 | |
| 2.1 E 220 CDI | 4 | OM646.961 | 100/134 | 03/03→07/09 | | | | | CCU140 ^[233] | |
| 2.1 E 220 T CDI | 4 | OM646.961 | 110/148 | 03/03→07/09 | | | | | CCU140 ^[233] | |
| 2.1 E 220 T CDI | 4 | OM646.821 | 120/161 | 03/03→07/09 | | | | | CCU110 ^[269] CCU140 ^[233] | |
| 2.1 E 220 T CDI | 4 | OM646.821 | 125/168 | 04/06→07/09 | | | | | CCU110 ^[269] CCU140 ^[233] | |

MERCEDES-BENZ





kW/BHP



eon TITAN

IRIDIUM

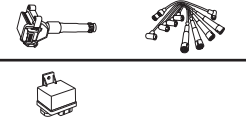

...MERCEDES-BENZ



...E-CLASS T-Model (S211)

| | | | | | | | | | | |
|--------------------------------------|---|----------------------|---------|-------------|-------|-----|--------|-------|---|--------|
| 2.5 E 230 T | 6 | M272.922 | 150/201 | 05/07→07/09 | OE229 | 0,8 | CET15P | | BAEA140E | |
| 2.6 E 240 T | 6 | M112.913 | 130/174 | 03/03→07/09 | OE191 | 1,0 | CET12P | OE180 | BAEA297 | CLS064 |
| 2.6 E 240 T 4WD | 6 | M112.917 | 130/174 | 07/03→07/09 | OE191 | 1,0 | CET12P | OE180 | BAEA297 | |
| 2.7 E 270 T CDI | 5 | OM647.961 | 120/161 | 03/03→07/09 | | | | | CCU141 | |
| 2.7 E 270 T CDI | 5 | OM647.961 | 130/174 | 03/03→07/09 | | | | | CCU141 | |
| 3.0 E 280 T, 3.0 E 280 T 4WD | 6 | M272.943; M272.944 | 170/228 | 03/05→07/09 | OE229 | 0,8 | CET15P | | BAEA140E | |
| 3.0 E 280 T CDI, 3.0 E 280 T CDI 4WD | 6 | OM642.920; OM642.921 | 140/188 | 03/05→07/09 | | | | | CCU114 [180] [273] [275] [281] CCU116 [239] [275] [284] | |
| 3.0 E 320 T CDI, 3.0 E 320 T CDI 4WD | 6 | OM642.920; OM642.921 | 165/221 | 03/05→07/09 | | | | | CCU114 [180] [273] [275] [281] CCU116 [239] [275] [284] | |
| 3.2 E 280 T CDI | 6 | OM648.961 | 130/174 | 05/04→07/09 | | | | | CCU113 [231] [283] CCU141 [268] [280] | |
| 3.2 E 320 T, 3.2 E 320 T 4WD | 6 | M112.949; M112.954 | 165/221 | 03/03→07/09 | OE191 | 1,0 | CET12P | OE180 | BAEA297 | CLS064 |
| 3.2 E 320 T CDI | 6 | OM648.961 | 150/201 | 03/03→07/09 | | | | | CCU113 [231] [283] CCU141 [268] [280] | |
| 3.5 E 350 T, 3.5 E 350 T 4WD | 6 | M272.964; M272.972 | 200/268 | 03/05→07/09 | OE229 | 0,8 | CET15P | | BAEA140E | |
| 5.0 E 500 T | 8 | M113.967 | 225/302 | 10/03→07/09 | OE191 | 1,0 | CET12P | OE180 | BAEA297 | CLS242 |
| 5.0 E 500 T 4WD | 8 | M113.969 | 225/302 | 10/03→07/09 | OE191 | 1,0 | CET12P | OE180 | BAEA297 | |
| 5.4 E 55 T AMG Kompressor | 8 | M113.990 | 350/469 | 07/03→07/09 | OE224 | 0,8 | CET14P | | BAEA297 | CLS242 |
| 5.5 E 500 T, 5.5 E 500 T 4WD | 8 | M273.960; M273.962 | 285/382 | 04/06→07/09 | OE229 | 0,8 | CET15P | | BAEA140E | |
| 6.2 E 63 AMG | 8 | M156.983 | 378/507 | 03/06→07/09 | OE233 | 1,0 | | | | |

E-CLASS T-Model (S212)

| | | | | | | | | | | |
|---|---|---------------------------------|---------|-------------|-------|-----|--------|--|-------------------------|--|
| 1.8 E 200 CGI | 4 | M271.860 | 135/181 | 11/09→ | OE229 | 0,8 | CET15P | | BAEA077 | |
| 1.8 E 250 CGI | 4 | M271.860 | 150/201 | 11/09→ | OE229 | 0,8 | CET15P | | BAEA077 | |
| 3.0 E 300 | 6 | M272.952 | 170/228 | 11/09→ | OE229 | 0,8 | CET15P | | | |
| 3.0 E 300 CDI | 6 | OM642.850 | 150/201 | 12/09→12/10 | | | | | CCU116 ^[275] | |
| 3.0 E 300 CDI / BlueTEC, 3.0 E 350 CDI, 3.0 E 350 CDI 4WD | 6 | OM642.850; OM642.852; OM642.856 | 170/228 | 11/09→ | | | | | CCU116 ^[275] | |
| 3.0 E 350 BlueTEC | 6 | OM642.850 | 155/208 | 11/09→ | | | | | CCU116 ^[275] | |
| 3.0 E 350 BlueTEC, 3.0 E 350 BlueTEC 4WD | 6 | OM642.852; OM642.858 | 185/248 | 11/12→ | | | | | CCU116 ^[275] | |
| 3.0 E 350 CDI, 3.0 E 350 CDI 4WD | 6 | OM642.852; OM642.858 | 195/261 | 07/11→ | | | | | CCU116 ^[275] | |
| 3.5 E 300, 3.5 E 300 4WD | 6 | M276.952 | 185/248 | 07/11→ | | | | | BAEA093E | |
| 3.5 E 350, 3.5 E 350 4WD | 6 | M276.952 | 225/302 | 09/11→ | | | | | BAEA093E | |
| 3.5 E 350, 3.5 E 350 4WD | 6 | M272.977; M272.980 | 200/268 | 08/09→ | OE229 | 0,8 | CET15P | | BAEA140E | |
| 4.7 E 500 4WD | 8 | M278.922 | 300/402 | 09/11→ | | | | | BAEA093E | |
| 5.5 E 63 AMG | 8 | M157.981 | 386/518 | 02/11→ | | | | | BAEA093E | |
| 5.5 E 63 AMG | 8 | M157.981 | 410/550 | 02/11→ | | | | | BAEA093E | |
| 5.5 E 63 AMG 4WD | 8 | M157.981 | 410/550 | 02/11→ | | | | | BAEA093E 08/12→ | |
| 5.5 E 63 AMG, 5.5 E 63 AMG 4WD | 8 | M157.981 | 430/577 | 02/13→ | | | | | BAEA093E | |
| 5.5 E 500 | 8 | M273.971 | 285/382 | 11/09→ | OE229 | 0,8 | CET15P | | BAEA140E | |
| 6.2 E 63 AMG | 8 | M156.985 | 386/518 | 08/09→ | OE233 | 1,0 | | | | |

MERCEDES-BENZ





kW/BHP

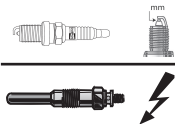

eon TITAN

IRIDIUM



...MERCEDES-BENZ



E-CLASS (W124)

| | | | | | | | | | | |
|--|---|----------------------|---------|-------------|--------------------|-------|-------------|--------------|--|--|
| 2.0 E 200 | 4 | M111.940 | 100/134 | 06/93→06/95 | OE057 | 0,9 | CET2 | OE180 | BAEA313 | CLS106 [229] →Eng.040193 017707 CLS065 [230] Eng.040194 017708→ |
| 2.0 E 200 D | 4 | OM601.912 | 55/74 | 06/93→06/95 | CH176 | 11.5v | | | | |
| 2.2 E 220 | 4 | M111.960 | 110/148 | 06/93→06/95 | OE057 | 0,9 | CET2 | OE180 | BAEA313 | CLS106 [229] →Eng.024563 049833 CLS065 [230] Eng.024564 049834→ |
| 2.5 E 250 D | 5 | OM605.911 | 83/111 | 07/93→06/95 | CH175 [297] | 11.5v | | | | |
| 2.5 E 250 Turbo-D | 5 | OM602.962 | 93/125 | 06/93→06/95 | CH176 | 11.5v | | | | |
| 2.8 E 280 | 6 | M104.942 | 142/190 | 06/93→06/95 | OE057 | 0,9 | CET2 | OE180 | BAEA340 | CLS252 |
| 2.8 E 280 | 6 | M104.942 | 145/194 | 06/93→06/95 | OE003 | 0,9 | CET2 | OE180 | BAEA340 | CLS252 |
| 3.0 E 300 4WD | 6 | M103.985 | 132/177 | 06/93→06/95 | OE011 | 0,9 | CET9 | OE183 | BAEA296 [292] | CLS250 |
| 3.0 E 300 D | 6 | OM606.910 | 100/134 | 07/93→06/95 | CH175 [297] | 11.5v | | | | |
| 3.0 E 300 Turbo-D, 3.0 E 300 Turbo-D 4WD | 6 | OM603.960; OM603.963 | 108/145 | 06/93→06/95 | CH176 | 11.5v | | | | |
| 3.2 E 320 | 6 | M104.992 | 162/217 | 06/93→06/95 | OE057 | 0,9 | CET2 | OE180 | BAEA340 | CLS252 |
| 3.6 E 36 AMG | 6 | M104.992(AMG3.6) | 200/268 | 07/94→01/95 | OE057 | 0,9 | CET2 | OE180 | BAEA340 | |
| 4.2 E 420 | 8 | M119.975 | 205/275 | 06/93→06/95 | OE057 | 0,9 | CET2 | OE180 | BAEA298 [29] [292] BAEA299 [46] [292] | CLS219 |
| 5.0 E 500 | 8 | M119.974 | 235/315 | 06/93→06/95 | OE057 | 0,9 | CET2 | OE180 | BAEA296 [292] | CLS219 |
| 6.0 E 60 AMG | 8 | M119.974(AMG6.0) | 280/375 | 05/94→06/95 | OE057 | 0,9 | CET2 | OE180 | BAEA296 [292] | |

E-CLASS (W210)

| | | | | | | | | | | |
|----------------------|---|-----------|---------|-------------|--|------------|---------------|--------------|--------------------------|--|
| 2.0 E 200 | 4 | M111.942 | 100/134 | 06/95→08/00 | OE032 | 1,0 | CET2 | OE179 | BAEA340 [41] | CLS138 [35] |
| 2.0 E 200 D | 4 | OM604.917 | 65/87 | 01/96→03/02 | CH177 [293] | 11.5v | | | CCU140 | |
| 2.0 E 200 Kompressor | 4 | M111.957 | 120/161 | 08/00→03/02 | | | CET12P | OE181 | BAEA041 | |
| 2.0 E 200 Kompressor | 4 | M111.947 | 137/184 | 06/97→03/02 | OE032 | 1,0 | CET2 | OE179 | BAEA340 [41] | CLS063 [35] CLS071 [35] |
| 2.2 E 200 CDI | 4 | OM611.961 | 75/101 | 06/98→03/02 | | | | | CCU140 | |
| 2.2 E 200 CDI | 4 | OM611.961 | 85/114 | 07/99→03/02 | | | | | CCU140 | |
| 2.2 E 220 CDI | 4 | OM611.961 | 92/123 | 06/98→07/99 | | | | | CCU140 | |
| 2.2 E 220 CDI | 4 | OM611.961 | 100/134 | 07/99→03/02 | | | | | CCU140 | |
| 2.2 E 220 CDI | 4 | OM611.961 | 105/141 | 07/99→03/02 | | | | | CCU140 | |
| 2.2 E 220 D | 4 | OM604.912 | 55/74 | 05/96→03/02 | CH177 [293] | 11.5v | | | CCU140 | |
| 2.2 E 220 D | 4 | OM604.912 | 70/94 | 06/95→07/99 | CH177 [293] | 11.5v | | | CCU140 | |
| 2.3 E 230 | 4 | M111.970 | 110/148 | 06/95→06/97 | OE057 →Eng.052061 OE032 Eng.052062→ | 0,9 1,0 | CET2 | OE179 | BAEA340 [41] | CLS063 [35] CLS071 [35] |
| 2.4 E 240 | 6 | M112.911 | 125/168 | 06/97→08/00 | OE191 | 1,0 | CET12P | OE180 | BAEA297 →06/99 | CLS064 |
| 2.5 E 250 D | 5 | OM605.912 | 83/111 | 06/95→07/99 | CH177 [293] | 11.5v | | | CCU141 | |
| 2.5 E 250 Turbo-D | 5 | OM605.962 | 110/148 | 06/97→07/99 | CH177 [293] | 11.5v | | | CCU141 | |
| 2.6 E 240 | 6 | M112.914 | 125/168 | 08/00→03/02 | OE191 | 1,0 | CET12P | OE180 | BAEA297 | CLS064 |
| 2.7 E 270 CDI | 5 | OM612.961 | 120/161 | 07/99→03/02 | | | | | CCU141 | |
| 2.7 E 270 CDI | 5 | OM612.961 | 125/168 | 07/99→03/02 | | | | | CCU141 | |
| 2.8 E 280 | 6 | M104.945 | 142/190 | 01/96→06/97 | OE057 | 0,9 | CET2 | OE180 | BAEA340 | CLS252 |
| 2.8 E 280 | 6 | M112.921 | 150/201 | 12/96→03/02 | OE191 | 1,0 | CET12P | OE180 | BAEA297 | CLS064 |
| 2.8 E 280 4WD | 6 | M112.921 | 150/201 | 12/96→03/02 | OE191 | 1,0 | CET12P | OE180 | BAEA297 →06/99 | CLS064 |
| 2.9 E 290 Turbo-D | 5 | OM602.982 | 95/127 | 03/96→07/99 | CH204 | 11.5v | | | CCU141 | |
| 3.0 E 300 D | 6 | OM606.912 | 100/134 | 06/95→06/97 | CH177 [293] | 11.5v | | | | |

MERCEDES-BENZ





kW/BHP



eon TITAN

IRIDIUM



...MERCEDES-BENZ



...E-CLASS (W210)

| | | | | | | | | | | |
|--------------------------|---|------------------|---------|-------------|-------------|-------|--------|-------|---------|--------------------------------------|
| 3.0 E 300 Turbo-D | 6 | OM606.962 | 130/174 | 12/96→07/99 | CH177 [293] | 11.5v | | | CCU141 | |
| 3.2 E 320 | 6 | M104.995 | 162/217 | 06/95→06/97 | OE057 | 0,9 | CET2 | OE180 | BAEA340 | CLS252 →08/95 CLS254 09/95→ |
| 3.2 E 320, 3.2 E 320 4WD | 6 | M112.941 | 160/215 | 09/97→12/98 | OE191 | 1,0 | CET12P | OE180 | | |
| 3.2 E 320, 3.2 E 320 4WD | 6 | M112.941 | 165/221 | 06/97→03/02 | OE191 | 1,0 | CET12P | OE180 | BAEA297 | CLS064 |
| 3.2 E 320 CDI | 6 | OM613.961 | 145/194 | 07/99→03/02 | | | | | CCU141 | |
| 3.6 E 36 AMG | 6 | | 200/268 | 04/96→01/98 | OE057 | 0,9 | CET2 | OE180 | | |
| 4.2 E 420 | 8 | M119.985 | 205/275 | 01/96→06/97 | OE057 | 0,9 | CET2 | OE180 | | CLS219 |
| 4.3 E 430, 4.3 E 430 4WD | 8 | M113.940 | 205/275 | 06/97→03/02 | OE191 | 1,0 | CET12P | OE180 | BAEA297 | CLS242 |
| 5.0 E 50 AMG | 8 | M119.985(AMG5.0) | 255/342 | 02/96→08/97 | OE057 | 0,9 | CET2 | OE180 | | |
| 5.4 E 55 AMG | 8 | M113.980 | 255/342 | 09/97→02/02 | OE191 | 1,0 | CET12P | OE180 | | |
| 5.4 E 55 AMG | 8 | M113.980 | 260/349 | 08/97→03/02 | OE191 | 1,0 | CET12P | OE180 | BAEA297 | CLS242 |
| 5.4 E 55 AMG 4WD | 8 | M113.980 | 260/349 | 03/01→03/02 | OE191 | 1,0 | CET12P | OE180 | BAEA297 | |

E-CLASS (W211)

| | | | | | | | | | | |
|-------------------------------------|---|------------------------------------|---------|-------------|--|-----|---|-------|--|--------|
| 1.8 E 200 Kompressor | 4 | M271.956 | 135/181 | 04/06→12/08 | OE224 →11/06 →Eng.30853899 | 0,8 | CET14P | | BAEA053 →11/06 →Eng.30853899 | |
| | | | | | OE229 12/06→ Eng.30853900→ | 0,8 | CET15P | | BAEA077 11/06→ Eng.30853900→ | |
| 1.8 E 200 Kompressor, 1.8 E 200 NGT | 4 | M271.941 | 120/161 | 11/02→12/08 | OE229 [232] | 0,8 | CET15P [232] | | BAEA053 →Eng.30853899 →Prod.30.11.2006 | |
| | | | | | OE224 →Eng.30853899 →Prod.30.11.2006 | 0,8 | CET14P →Eng.30853899 →Prod.30.11.2006 | | BAEA077 Eng.30853900→ Prod.30.11.2006→ | |
| | | | | | OE229 Eng.30853900→ Prod.30.11.2006→ | 0,8 | CET15P Eng.30853900→ Prod.30.11.2006→ | | | |
| 2.1 E 200 CDI | 4 | OM646.820 | 100/134 | 04/06→12/08 | | | | | CCU110[269] CCU140[233] | |
| 2.1 E 220 CDI | 4 | OM646.961 | 100/134 | 03/02→12/08 | | | | | CCU140[233] | |
| 2.1 E 220 CDI | 4 | OM646.961 | 110/148 | 03/02→12/08 | | | | | CCU140[233] | |
| 2.1 E 220 CDI | 4 | OM646.821 | 120/161 | 03/03→12/08 | | | | | CCU110[269] CCU140[233] | |
| 2.1 E 220 CDI | 4 | OM646.821 | 125/168 | 04/06→12/08 | | | | | CCU110[269] CCU140[233] | |
| 2.2 E 200 CDI | 4 | OM646.951 | 75/101 | 07/02→12/08 | | | | | CCU140 | |
| 2.2 E 200 CDI | 4 | OM646.951 | 90/121 | 07/02→12/08 | | | | | CCU140 | |
| 2.5 E 230 | 6 | M272.922 | 150/201 | 09/07→12/08 | OE229 | 0,8 | CET15P | | BAEA140E | |
| 2.6 E 240, 2.6 E 240 4WD | 6 | M112.913; M112.917 | 130/174 | 03/02→12/08 | OE191 | 1,0 | CET12P | OE180 | BAEA297 | CLS064 |
| 2.7 E 270 CDI | 5 | OM647.961 | 120/161 | 03/02→12/08 | | | | | CCU141 | |
| 2.7 E 270 CDI | 5 | OM647.961 | 130/174 | 03/02→12/08 | | | | | CCU141 | |
| 3.0 E 280, 3.0 E 280 4WD | 6 | M272.943; M272.944 | 170/228 | 03/05→12/08 | OE229 | 0,8 | CET15P | | BAEA140E | |
| 3.0 E 280 CDI, 3.0 E 280 CDI 4WD | 6 | OM642.920; OM642.921 | 140/188 | 03/05→12/08 | | | | | CCU114 [180] [273] [275] [281] | |
| | | | | | | | | | CCU116 [239] [275] [284] | |
| 3.0 E 300 BlueTEC | 6 | OM642.920 | 155/208 | 09/07→12/08 | | | | | CCU114 [180] [273] [275] [281] | |
| | | | | | | | | | CCU116 [239] [275] [284] | |
| 3.0 E 320 CDI, 3.0 E 320 CDI 4WD | 6 | OM642.910; OM642.920; OM642.921 | 165/221 | 03/05→12/08 | | | | | CCU114 [180] [273] [275] [281] | |
| | | | | | | | | | CCU116 [239] [275] [284] | |

MERCEDES-BENZ





kW/BHP



eon TITAN

IRIDIUM

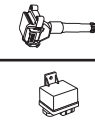

...MERCEDES-BENZ



...E-CLASS (W211)

| | | | | | | | | | | |
|--------------------------|---|--------------------|---------|-------------|-------|-----|--------|-------|----------|--|
| 3.2 E 280 CDI | 6 | OM648.961 | 130/174 | 05/04→12/08 | | | | | | CCU113 [231] [283] CCU141 [268] [280] |
| 3.2 E 320 | 6 | M112.949 | 165/221 | 03/02→12/08 | OE191 | 1,0 | CET12P | OE180 | BAEA297 | CLS064 |
| 3.2 E 320 4WD | 6 | M112.954 | 165/221 | 03/03→12/08 | OE191 | 1,0 | CET12P | OE180 | BAEA297 | |
| 3.2 E 320 CDI | 6 | OM648.961 | 150/201 | 11/02→12/08 | | | | | | CCU113 [231] [283] CCU141 [268] [280] |
| 3.5 E 350, 3.5 E 350 4WD | 6 | M272.964; M272.972 | 200/268 | 03/05→12/08 | OE229 | 0,8 | CET15P | | BAEA140E | |
| 4.0 E 420 CDI | 8 | OM629.910 | 231/310 | 01/06→12/08 | | | | | CCU118 | |
| 5.0 E 500 | 8 | M113.967 | 215/288 | 09/02→12/05 | OE191 | 1,0 | CET12P | OE180 | | |
| 5.0 E 500 | 8 | M113.967 | 225/302 | 03/02→12/08 | OE191 | 1,0 | CET12P | OE180 | BAEA297 | CLS242 |
| 5.0 E 500 4WD | 8 | M113.969 | 225/302 | 10/03→12/08 | OE191 | 1,0 | CET12P | OE180 | BAEA297 | |
| 5.5 E 55 AMG Kompressor | 8 | M113.990 | 350/469 | 10/02→12/08 | OE224 | 0,8 | CET14P | | BAEA297 | CLS242 |
| 5.5 E 500, 5.5 E 500 4WD | 8 | M273.960; M273.962 | 285/382 | 04/06→12/08 | OE229 | 0,8 | CET15P | | BAEA140E | |
| 6.2 E 63 AMG | 8 | M156.983 | 378/507 | 03/06→12/08 | OE233 | 1,0 | | | | |

E-CLASS (W212)

| | | | | | | | | | | |
|---|---|---------------------------------|---------|-------------|-------|-----|--------|--|--------------------|--|
| 1.8 E 200 CGI | 4 | M271.820; M271.860 | 135/181 | 08/09→ | OE229 | 0,8 | CET15P | | BAEA077 | |
| 1.8 E 200 NGT | 4 | M271.958 | 120/161 | 03/11→ | OE229 | 0,8 | CET15P | | BAEA077 | |
| 1.8 E 250 CGI | 4 | M271.860 | 150/201 | 01/09→ | OE229 | 0,8 | CET15P | | BAEA077 | |
| 3.0 E 300 | 6 | M272.952 | 170/228 | 01/09→ | OE229 | 0,8 | CET15P | | BAEA140E | |
| 3.0 E 300 CDI | 6 | OM642.850 | 150/201 | 12/09→12/10 | | | | | CCU116 [275] | |
| 3.0 E 300 CDI / BlueTEC, 3.0 E 350 CDI, 3.0 E 350 CDI 4WD | 6 | OM642.850; OM642.852; OM642.856 | 170/228 | 01/09→ | | | | | CCU116 [275] | |
| 3.0 E 350 BlueTEC | 6 | OM642.850 | 155/208 | 01/09→ | | | | | CCU116 [275] | |
| 3.0 E 350 BlueTEC, 3.0 E 350 BlueTEC 4WD | 6 | OM642.852; OM642.858 | 185/248 | 11/12→ | | | | | CCU116 [275] | |
| 3.0 E 350 CDI, 3.0 E 350 CDI 4WD | 6 | OM642.852; OM642.858 | 195/261 | 03/11→ | | | | | CCU116 [275] | |
| 3.5 E 300, 3.5 E 300 4WD | 6 | M276.952 | 185/248 | 07/11→ | | | | | BAEA093E | |
| 3.5 E 350, 3.5 E 350 4WD | 6 | M276.952 | 225/302 | 09/11→ | | | | | BAEA093E | |
| 3.5 E 350, 3.5 E 350 4WD | 6 | M272.977; M272.980 | 200/268 | 01/09→ | OE229 | 0,8 | CET15P | | BAEA140E | |
| 4.7 E 500, 4.7 E 500 4WD | 8 | M278.922 | 300/402 | 09/11→ | | | | | BAEA093E | |
| 5.5 E 63 AMG | 8 | M157.980; M157.981 | 386/518 | 02/11→ | | | | | BAEA093E | |
| 5.5 E 63 AMG | 8 | M157.981 | 410/550 | 02/11→ | | | | | BAEA093E 04/11→ | |
| 5.5 E 63 AMG 4WD | 8 | M157.981 | 410/550 | 02/11→ | | | | | BAEA093E 08/12→ | |
| 5.5 E 63 AMG, 5.5 E 63 AMG 4WD | 8 | M157.981 | 430/577 | 02/13→ | | | | | BAEA093E | |
| 5.5 E 500, 5.5 E 500 4WD | 8 | M273.970; M273.971 | 285/382 | 01/09→ | OE229 | 0,8 | CET15P | | BAEA140E | |
| 6.2 E 63 AMG | 8 | M156.985 | 386/518 | 12/09→ | OE233 | 1,0 | | | | |

G-CLASS (W461)

| | | | | | | | | | | |
|--------------------------------------|---|----------------------|---------|-------------|----------------------|-------|------|-------|-----------------------|--------|
| 2.3 230 GE 4WD | 4 | M102.996; M102.997 | 92/123 | 06/93→07/00 | OE009 | 0,9 | CET9 | OE183 | | CLS098 |
| 2.7 G 270 CDI 4WD | 5 | OM612.966 | 115/154 | 01/03→ | | | | | CCU141 | |
| 2.9 290 GD/G 290 D 4WD | 5 | OM602.942 | 70/94 | 06/93→07/00 | CH176 | 11.5v | | | | |
| 2.9 G 290 TD 4WD | 5 | OM602.983 | 88/118 | 07/97→ | CH204 [177] [275] | 11.5v | | | CCU141 | |
| 3.0 G 280 CDI 4WD, 3.0 G 300 CDI 4WD | 6 | OM642.884; OM642.975 | 135/181 | 04/09→ | | | | | CCU114 [180] [275] | |

G-CLASS (W463)

| | | | | | | | | | | |
|-------------------|---|------------------|---------|-------------|-------|-----|--------|-------|---------------|--|
| 2.7 G 270 CDI 4WD | 5 | OM612.965 | 115/154 | 10/01→ | | | | | CCU141 | |
| 3.6 G 36 AMG 4WD | 6 | M104.996(AMG3.6) | 200/268 | 01/95→07/98 | OE057 | 0,9 | CET2 | OE180 | BAEA340 [41] | |
| 5.0 500 GE 4WD | 8 | M117.965 | 177/237 | 09/93→12/94 | OE001 | 0,9 | CET8 | OE195 | BAEA298 [292] | |
| 5.0 G 500 4WD | 8 | M113.962 | 215/288 | 09/04→12/05 | OE191 | 1,0 | CET12P | OE180 | | |

MERCEDES-BENZ



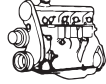

kW/BHP

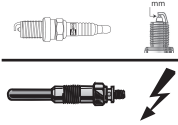

eon TITAN

IRIDIUM

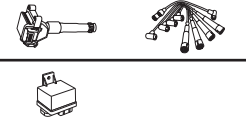

...MERCEDES-BENZ



...G-CLASS (W463)

| | | | | | | | | | | |
|------------------|----|--------------------|---------|--------|-------|-----|--------|-------|----------|--------|
| 5.0 G 500 4WD | 8 | M113.962 | 218/292 | 04/98→ | OE191 | 1,0 | CET12P | OE180 | BAEA297 | CLS242 |
| 5.4 G 55 AMG 4WD | 8 | M113.993 | 350/469 | 06/04→ | | | CET14P | OE190 | BAEA297 | |
| 5.4 G 55 AMG 4WD | 8 | M113.993 | 368/493 | 08/06→ | OE224 | 0,8 | CET14P | | BAEA297 | CLS242 |
| 5.5 G 55 AMG 4WD | 8 | M113.982 | 260/349 | 04/99→ | OE191 | 1,0 | CET12P | OE180 | BAEA297 | |
| 5.5 G 55 AMG 4WD | 8 | M113.993 | 373/500 | 08/08→ | OE224 | 0,8 | CET14P | | BAEA297 | CLS242 |
| 5.5 G 63 AMG 4WD | 8 | M157.984 | 400/536 | 05/12→ | | | | | BAEA093E | |
| 5.5 G 500 4WD | 8 | M273.963; M273.969 | 285/382 | 05/08→ | OE229 | 0,8 | CET15P | | | |
| 6.0 G 65 AMG 4WD | 12 | M279.982 | 450/603 | 05/12→ | | | CET12P | OE180 | | |

G-CLASS /Cabrio (W463)

| | | | | | | | | | | |
|-------------------------------|---|-----------|---------|-------------|------------------------|-------|--------|-------|-------------------------|--------------------------------------|
| 3.0 G 300 TD 4WD | 6 | OM606.964 | 130/174 | 08/96→07/00 | CH177 ^[293] | 11.5v | | | CCU141 | |
| 3.0 G 320 CDI 4WD | 6 | OM642.970 | 165/221 | 09/06→ | | | | | CCU116 ^[275] | |
| 3.0 G 350 CDI 4WD | 6 | OM642.886 | 155/208 | 07/11→ | | | | | CCU116 ^[275] | |
| 3.2 320 GE 4WD, 3.2 G 320 4WD | 6 | M104.996 | 155/208 | 09/94→12/97 | OE057 | 0,9 | CET2 | OE180 | BAEA340 ^[41] | CLS252 →08/95 CLS254 09/95→ |
| 3.2 G 320 4WD | 6 | M112.945 | 158/212 | 07/97→ | OE191 | 1,0 | CET12P | OE180 | BAEA297 | CLS064 |

G-CLASS Cabrio (W463)

| | | | | | | | | | | |
|---------------|---|--------------------|---------|--------|-------|-----|--------|-------|-------------------|--------|
| 5.0 G 500 4WD | 8 | M113.962 | 218/292 | 04/98→ | OE191 | 1,0 | CET12P | OE180 | BAEA297 →09/05 | CLS242 |
| 5.5 G 500 4WD | 8 | M273.963; M273.969 | 285/382 | 12/09→ | OE229 | 0,8 | CET15P | | BAEA140E | |

GL-CLASS (X164)

| | | | | | | | | | | |
|--|---|-----------|---------|-------------|-------|-----|--------|--|--|--|
| 3.0 GL 320 CDI / 350 BlueTEC 4WD | 6 | OM642.820 | 155/208 | 12/09→ | | | | | CCU116 ^[275] | |
| 3.0 GL 320 CDI 4WD | 6 | OM642.940 | 165/221 | 09/06→05/09 | | | | | CCU114 [180] [275] [280] CCU116 [275] [283] | |
| 3.0 GL 350 CDI 4WD | 6 | OM642.940 | 165/221 | 05/09→ | | | | | CCU114 [180] [275] [280] CCU116 [275] [283] | |
| 3.0 GL 350 CDI 4WD | 6 | OM642.822 | 195/261 | 10/10→ | | | | | CCU116 ^[275] | |
| 4.0 GL 420 CDI 4WD, 4.0 GL 450 CDI 4WD | 8 | OM629.912 | 225/302 | 09/06→ | | | | | CCU118 | |
| 4.7 GL 450 4WD | 8 | M273.923 | 250/335 | 09/06→ | OE229 | 0,8 | CET15P | | BAEA140E | |
| 5.5 GL 500 4WD | 8 | M273.963 | 285/382 | 09/06→ | OE229 | 0,8 | CET15P | | BAEA140E | |

GL-CLASS (X166)

| | | | | | | | | | | |
|------------------------------|---|-----------|---------|--------|--|--|--|--|-------------------------|--|
| 3.0 GL 350 CDI / BlueTec 4WD | 6 | OM642.826 | 190/255 | 07/12→ | | | | | CCU116 ^[275] | |
| 4.7 GL 500 4WD | 8 | M278.928 | 320/429 | 07/12→ | | | | | BAEA093E | |
| 5.5 GL 63 AMG 4WD | 8 | M157.982 | 410/550 | 07/12→ | | | | | BAEA093E | |

GLK-CLASS (X204)

| | | | | | | | | | | |
|----------------------|---|--------------------|---------|-------------|-------|-----|--------|--|---------------------------|--|
| 3.0 280 4WD | 6 | M272.948 | 170/228 | 06/08→06/09 | OE229 | 0,8 | CET15P | | BAEA140E ^[179] | |
| 3.0 300 4WD | 6 | M272.948 | 170/228 | 07/09→04/11 | OE229 | 0,8 | CET15P | | BAEA140E | |
| 3.0 320 CDI 4WD | 6 | OM642.961 | 165/221 | 06/08→06/15 | | | | | CCU114 [180] [275] | |
| 3.0 350 CDI 4WD | 6 | OM642.832 | 165/221 | 07/09→01/10 | | | | | CCU116 ^[275] | |
| 3.0 350 CDI 4WD | 6 | OM642.832 | 170/228 | 02/10→05/10 | | | | | CCU116 ^[275] | |
| 3.0 350 CDI 4WD | 6 | OM642.835 | 195/261 | 07/12→06/15 | | | | | CCU116 ^[275] | |
| 3.5 350, 3.5 350 4WD | 6 | M272.971; M272.991 | 200/268 | 06/08→06/15 | OE229 | 0,8 | CET15P | | BAEA140E | |
| 3.5 350 4WD | 6 | M276.957 | 225/302 | 06/08→06/15 | | | | | BAEA093E 06/11→ | |

M-CLASS (W163)

| | | | | | | | | | | |
|--------------------|---|-----------|---------|-------------|-------|-----|------|-------|-------------------------|--|
| 2.3 ML 230 4WD | 4 | M111.977 | 110/148 | 02/98→06/05 | OE032 | 1,0 | CET2 | OE179 | BAEA340 ^[41] | CLS063 ^[35] CLS071 ^[35] |
| 2.7 ML 270 CDI 4WD | 5 | OM612.963 | 120/161 | 12/99→06/05 | | | | | CCU141 | |

MERCEDES-BENZ





kW/BHP

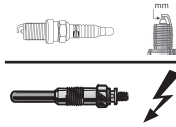

eon TITAN

IRIDIUM

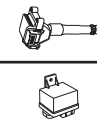
**...MERCEDES-BENZ****...M-CLASS (W163)**

| | | | | | | | | | | |
|-------------------|---|--------------------|---------|---------------|-------|-----|--------|-------|---------|--------|
| 3.2 ML 320 4WD | 6 | M112.942 | 160/215 | 02/98 → 08/02 | OE191 | 1,0 | CET12P | OE180 | BAEA297 | CLS064 |
| 3.7 ML 350 4WD | 6 | M112.970 | 173/232 | 02/03 → 06/05 | OE191 | 1,0 | CET12P | OE180 | BAEA297 | CLS064 |
| 3.7 ML 350 4WD | 6 | M112.970 | 180/241 | 08/02 → 06/05 | OE191 | 1,0 | CET12P | OE180 | BAEA297 | CLS064 |
| 4.3 ML 430 4WD | 8 | M113.942 | 200/268 | 02/98 → 06/05 | OE191 | 1,0 | CET12P | OE180 | BAEA297 | CLS242 |
| 5.0 ML 500 4WD | 8 | M113.964; M113.965 | 215/288 | 09/01 → 06/05 | OE191 | 1,0 | CET12P | OE180 | BAEA297 | CLS242 |
| 5.4 ML 55 AMG 4WD | 8 | M113.981 | 255/342 | 02/00 → 06/05 | OE191 | 1,0 | CET12P | OE180 | BAEA297 | CLS242 |

M-CLASS (W164)

| | | | | | | | | | | |
|--|---|-----------|---------|---------------|-------|-----|--------|-------|-----------------------------|--|
| 3.0 ML 280 CDI 4WD, 3.0 ML 300 CDI 4WD | 6 | OM642.940 | 140/188 | 07/05 → 12/11 | | | | | CCU114 [180] [275] [280] | |
| | | | | | | | | | CCU116 [275] [283] | |
| 3.0 ML 300 CDI 4WD | 6 | OM642.820 | 150/201 | 02/10 → 12/11 | | | | | CCU116 [275] [283] | |
| 3.0 ML 320 CDI 4WD, 3.0 ML 350 CDI 4WD | 6 | OM642.940 | 165/221 | 07/05 → 12/11 | | | | | CCU114 [180] [275] [280] | |
| | | | | | | | | | CCU116 [275] [283] | |
| 3.0 ML 350 CDI 4WD | 6 | OM642.820 | 155/208 | 09/09 → 12/11 | | | | | CCU116 [275] [283] | |
| 3.0 ML 350 CDI 4WD | 6 | OM642.820 | 170/228 | 02/10 → 12/11 | | | | | CCU116 [275] [283] | |
| 3.5 ML 350 4WD | 6 | M272.967 | 200/268 | 02/05 → 12/11 | OE229 | 0,8 | CET15P | | BAEA140E | |
| 4.0 ML 420 CDI 4WD, 4.0 ML 450 CDI 4WD | 8 | OM629.912 | 225/302 | 02/06 → 12/11 | | | | | CCU118 | |
| 5.0 ML 500 4WD | 8 | M113.964 | 218/292 | 09/05 → 12/06 | OE191 | 1,0 | CET12P | OE180 | | |
| 5.0 ML 500 4WD | 8 | M113.964 | 225/302 | 07/05 → 12/11 | OE191 | 1,0 | CET12P | OE180 | BAEA297 | |
| 5.5 ML 500 4WD | 8 | M273.963 | 285/382 | 12/07 → 12/11 | OE229 | 0,8 | CET15P | | BAEA140E | |
| 6.2 ML 63 AMG 4WD | 8 | M156.980 | 375/503 | 01/06 → 12/11 | OE233 | 1,0 | | | | |

M-CLASS (W166)

| | | | | | | | | | | |
|------------------------|---|----------------------|---------|---------------|--|--|--|--|--------------|--|
| 3.0 ML 350 BlueTEC 4WD | 6 | OM642.826; OM642.864 | 190/255 | 06/11 → 02/15 | | | | | CCU116 [275] | |
| 3.5 ML 300 4WD | 6 | M276.955 | 185/248 | 08/12 → 02/15 | | | | | BAEA093E | |
| 3.5 ML 350 4WD | 6 | M276.955 | 225/302 | 06/11 → 12/15 | | | | | BAEA093E | |
| 4.7 ML 500 4WD | 8 | M278.928 | 300/402 | 02/12 → 02/15 | | | | | BAEA093E | |
| 5.5 ML 63 AMG 4WD | 8 | M157.982 | 386/518 | 11/11 → 02/15 | | | | | BAEA093E | |
| 5.5 ML 63 AMG 4WD | 8 | M157.982 | 410/550 | 11/11 → 02/15 | | | | | BAEA093E | |

R-CLASS (W251, V251)

| | | | | | | | | | | |
|--|---|----------------------|---------|---------------|-------|-----|--------|-------|-----------------------------|--------|
| 3.0 R 280, 3.0 R 300 | 6 | M272.945 | 170/228 | 01/07 → | OE229 | 0,8 | CET15P | | BAEA140E | |
| 3.0 R 280 4WD | 6 | M272.945 | 170/228 | 05/07 → | OE229 | 0,8 | CET15P | | BAEA140E Eng.30417697 → | |
| 3.0 R 280 CDI, 3.0 R 280 CDI 4WD, 3.0 R 300 CDI, 3.0 R 300 CDI 4WD | 6 | OM642.950 | 140/188 | 05/06 → | | | | | CCU114 [180] [275] [280] | |
| | | | | | | | | | CCU116 [275] [283] | |
| 3.0 R 280 CDI, 3.0 R 300 CDI | 6 | OM642.870; OM642.872 | 140/188 | 05/06 → | | | | | CCU116 [275] [283] | |
| 3.0 R 320 CDI 4WD, 3.0 R 350 CDI 4WD | 6 | OM642.870; OM642.950 | 155/208 | 01/06 → | | | | | CCU116 [275] [283] | |
| 3.0 R 320 CDI 4WD, 3.0 R 350 CDI 4WD | 6 | OM642.950 | 165/221 | 01/06 → | | | | | CCU114 [180] [275] [280] | |
| | | | | | | | | | CCU116 [275] [283] | |
| 3.0 R 350 CDI 4WD | 6 | OM642.872 | 195/261 | 08/10 → | | | | | CCU116 [275] | |
| 3.5 R 350, 3.5 R 350 4WD | 6 | M272.967 | 200/268 | 01/06 → | OE229 | 0,8 | CET15P | | BAEA140E | |
| 3.5 R 350 CGI 4WD | 6 | M276.958 | 225/302 | 01/06 → | | | | | BAEA093E 06/11 → | |
| 5.0 R 500 4WD | 8 | M113.971 | 218/292 | 01/06 → 12/06 | OE191 | 1,0 | CET12P | OE180 | | |
| 5.0 R 500 4WD | 8 | M113.960; M113.971 | 225/302 | 01/06 → | OE191 | 1,0 | CET12P | OE180 | BAEA297 | CLS242 |
| 5.5 R 500 4WD | 8 | M273.963 | 285/382 | 01/07 → | OE229 | 0,8 | CET15P | | BAEA140E | |

MERCEDES-BENZ





kW/BHP



eon TITAN

IRIDIUM



...MERCEDES-BENZ



...R-CLASS (W251, V251)

| | | | | | | | | | | |
|------------------|---|----------|---------|--------|--------------|-----|--|--|--|--|
| 6.2 R 63 AMG 4WD | 8 | M156.980 | 375/503 | 02/06→ | OE233 | 1,0 | | | | |
|------------------|---|----------|---------|--------|--------------|-----|--|--|--|--|

S-CLASS Coupe (C140)

| | | | | | | | | | | |
|----------------|---|----------|---------|-------------|---|-----|--|---|----------------------|---------------|
| 4.2 SEC/CL 420 | 8 | M119.981 | 205/275 | 10/94→02/99 | OE057 [270] →Eng.12/52, 22/62011673 | 0,9 | CET2 [270] →Eng.12/52, 22/62011673 | OE180 [270] →Eng.12/52, 22/62011673 | BAEA299 [292] | CLS219 |
| | | | | | OE228 Eng.12/52, 22/62011674→ | 1,0 | CET12P Eng.12/52, 22/62011674→ | OE181 Eng.12/52, 22/62011674→ | | |

| | | | | | | | | | | |
|----------------|---|----------|---------|-------------|--------------|-----|-------------|--------------|----------------------|---------------|
| 4.2 SEC/CL 420 | 8 | M119.971 | 205/275 | 10/94→02/99 | OE057 | 0,9 | CET2 | OE180 | BAEA299 [292] | CLS219 |
|----------------|---|----------|---------|-------------|--------------|-----|-------------|--------------|----------------------|---------------|

S-CLASS Coupe (C215)

| | | | | | | | | | | |
|--------------------------|----|----------|---------|-------------|--------------|-----|---------------|--------------|----------------|---------------|
| 5.0 CL 500 | 8 | M113.960 | 225/302 | 03/99→03/06 | OE191 | 1,0 | CET12P | OE180 | BAEA297 | CLS242 |
| 5.4 CL 55 AMG | 8 | M113.986 | 265/355 | 10/99→03/06 | OE191 | 1,0 | CET12P | OE180 | BAEA297 | CLS242 |
| 5.5 CL 55 AMG Kompressor | 8 | M113.991 | 368/493 | 06/02→03/06 | OE224 | 0,8 | CET14P | | BAEA297 | |
| 5.5 CL 600 | 12 | M275.950 | 368/493 | 09/02→03/06 | | | CET12P | OE188 | | |
| 5.8 CL 600 | 12 | M137.970 | 270/362 | 03/99→03/06 | | | CET12P | OE181 | | |
| 6.0 CL 65 AMG | 12 | M275.980 | 450/603 | 09/03→03/06 | | | CET12P | OE188 | | |

S-CLASS Coupe (C216)

| | | | | | | | | | | |
|----------------------------|----|--------------------|---------|-------------|--------------|-----|---------------|--------------|---------------------------|--|
| 4.7 CL 500, 4.7 CL 500 4WD | 8 | M278.920 | 320/429 | 02/11→12/13 | | | | | BAEA093E | |
| 5.5 CL 63 AMG | 8 | M157.980 | 400/536 | 02/11→12/13 | | | | | BAEA093E | |
| 5.5 CL 63 AMG | 8 | M157.980 | 420/563 | 01/10→12/13 | | | | | BAEA093E 09/11→ | |
| 5.5 CL 500, 5.5 CL 500 4WD | 8 | M273.961; M273.968 | 285/382 | 06/06→12/13 | OE229 | 0,8 | CET15P | | BAEA140E | |
| 5.5 CL 600 | 12 | M275.953 | 380/510 | 05/06→12/13 | | | CET12P | OE188 | | |
| 6.0 CL 65 AMG | 12 | M275.982 | 450/603 | 10/06→12/10 | | | CET12P | OE188 | | |
| 6.0 CL 65 AMG | 12 | M275.982 | 463/621 | 02/11→12/13 | | | CET12P | OE188 | | |
| 6.2 CL 63 AMG | 8 | M156.984 | 386/518 | 10/06→12/13 | OE233 | 1,0 | | | | |

S-CLASS Coupe (C217)

| | | | | | | | | | | |
|--------------|----|----------|---------|--------|--|--|---------------|--------------|--|--|
| 6.0 S 65 AMG | 12 | M279.980 | 463/621 | 07/14→ | | | CET12P | OE188 | | |
|--------------|----|----------|---------|--------|--|--|---------------|--------------|--|--|

S-CLASS (W140)

| | | | | | | | | | | |
|------------|---|----------|---------|-------------|--------------|-----|-------------|--------------|---------------------|--|
| 2.8 300 SE | 6 | M104.944 | 145/194 | 01/93→10/98 | OE057 | 0,9 | CET2 | OE180 | BAEA340 [41] | CLS252 →08/95 CLS254 09/95→ |
| 2.8 S 280 | 6 | M104.944 | 142/190 | 02/93→10/98 | OE057 | 0,9 | CET2 | OE180 | BAEA340 [41] | CLS252 →08/95 CLS254 09/95→ |

| | | | | | | | | | | |
|-------------------|---|-----------|---------|-------------|--------------------|-------|--|--|---------------|--|
| 3.0 S 300 Turbo-D | 6 | OM606.961 | 130/174 | 05/96→10/98 | CH177 [293] | 11.5v | | | CCU141 | |
|-------------------|---|-----------|---------|-------------|--------------------|-------|--|--|---------------|--|

| | | | | | | | | | | |
|-------------------|---|-----------|---------|-------------|--------------|-------|--|--|--|--|
| 3.4 S 350 Turbo-D | 6 | OM603.971 | 110/148 | 01/93→10/98 | CH176 | 11.5v | | | | |
|-------------------|---|-----------|---------|-------------|--------------|-------|--|--|--|--|

| | | | | | | | | | | |
|-----------|---|----------|---------|-------------|--------------|-----|-------------|--|--|---------------|
| 4.2 S 420 | 8 | M119.971 | 205/275 | 01/93→10/98 | OE057 | 0,9 | CET2 | | BAEA296 [30] [292] BAEA339 [31] [292] | CLS219 |
|-----------|---|----------|---------|-------------|--------------|-----|-------------|--|--|---------------|

| | | | | | | | | | | |
|-----------|---|----------|---------|-------------|--------------|-----|-------------|--------------|--|--|
| 5.0 S 500 | 8 | M119.970 | 235/315 | 01/93→10/98 | OE057 | 0,9 | CET2 | OE180 | | |
|-----------|---|----------|---------|-------------|--------------|-----|-------------|--------------|--|--|

| | | | | | | | | | | |
|-----------|---|----------|---------|-------------|---|-----|--|---|----------------|---------------|
| 5.0 S 500 | 8 | M119.980 | 235/315 | 01/93→10/98 | OE057 [270] →Eng.12/52, 22/62021034 | 0,9 | CET2 [270] →Eng.12/52, 22/62021034 | OE180 [270] →Eng.12/52, 22/62021034 | BAEA296 | CLS219 |
| | | | | | OE228 Eng.12/52, 22/62021035→ | 1,0 | CET12P Eng.12/52, 22/62021035→ | OE181 Eng.12/52, 22/62021035→ | BAEA339 | |

| | | | | | | | | | | |
|-----------|---|----------|---------|-------------|--|--|--|--|--|---------------|
| 5.0 S 500 | 8 | M119.970 | 235/315 | 01/93→10/98 | | | | | BAEA296 [30] [292] BAEA339 [31] [292] | CLS219 |
|-----------|---|----------|---------|-------------|--|--|--|--|--|---------------|

| | | | | | | | | | | |
|-----------|----|----------|---------|-------------|-----------------------------------|-----|----------------------------------|-----------------------------------|------------------------------|--|
| 6.0 S 600 | 12 | M120.982 | 290/389 | 01/93→10/98 | OE057 [270] →Eng.008359 | 0,9 | CET2 [270] →Eng.008359 | OE180 [270] →Eng.008359 | BAEA298 [31] [292] | |
| | | | | | OE228 Eng.008360→ | 1,0 | CET12P Eng.008360→ | OE181 Eng.008360→ | BAEA299 [30] [292] | |

| | | | | | | | | | | |
|-----------|----|----------|---------|-------------|--------------|-----|-------------|--------------|--|--|
| 6.0 S 600 | 12 | M120.980 | 290/389 | 01/93→10/98 | OE057 | 0,9 | CET2 | OE180 | BAEA298 [31] [292] BAEA299 [30] [292] | |
|-----------|----|----------|---------|-------------|--------------|-----|-------------|--------------|--|--|

S-CLASS (W220)

| | | | | | | | | | | |
|-----------|---|----------|---------|-------------|--------------|-----|---------------|--------------|----------------|---------------|
| 2.8 S 280 | 6 | M112.922 | 150/201 | 10/98→08/05 | OE191 | 1,0 | CET12P | OE180 | BAEA297 | CLS064 |
|-----------|---|----------|---------|-------------|--------------|-----|---------------|--------------|----------------|---------------|

MERCEDES-BENZ





kW/BHP

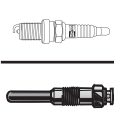

eon TITAN

IRIDIUM



...MERCEDES-BENZ



...S-CLASS (W220)

| | | | | | | | | | | |
|--------------------------|----|--------------------|---------|---------------|-------|-----|--------|-------|---------|--------|
| 3.2 S 320 | 6 | M112.944 | 165/221 | 10/98 → 08/05 | OE191 | 1,0 | CET12P | OE180 | BAEA297 | CLS064 |
| 3.2 S 320 CDI | 6 | OM613.960 | 145/194 | 08/99 → 09/02 | | | | | CCU141 | |
| 3.2 S 320 CDI | 6 | OM648.960 | 150/201 | 09/02 → 08/05 | | | | | CCU141 | |
| 3.7 S 350, 3.7 S 350 4WD | 6 | M112.972; M112.975 | 180/241 | 09/02 → 08/05 | OE191 | 1,0 | CET12P | OE180 | BAEA297 | CLS064 |
| 4.3 S 430, 4.3 S 430 4WD | 8 | M113.941; M113.948 | 205/275 | 10/98 → 08/05 | OE191 | 1,0 | CET12P | OE180 | BAEA297 | CLS242 |
| 5.0 S 500 | 8 | M113.960 | 220/295 | 10/98 → 12/03 | OE191 | 1,0 | CET12P | OE180 | | |
| 5.0 S 500, 5.0 S 500 4WD | 8 | M113.960; M113.966 | 225/302 | 10/98 → 08/05 | OE191 | 1,0 | CET12P | OE180 | BAEA297 | CLS242 |
| 5.5 S 55 AMG | 8 | M113.986 | 265/355 | 04/99 → 08/05 | OE191 | 1,0 | CET12P | OE180 | BAEA297 | CLS242 |
| 5.5 S 55 AMG Kompressor | 8 | M113.991 | 368/493 | 06/02 → 08/05 | OE224 | 0,8 | CET14P | | BAEA297 | CLS242 |
| 5.5 S 600 | 12 | M275.950 | 368/493 | 09/02 → 12/06 | | | CET12P | OE188 | | |
| 5.8 S 600 | 12 | M137.970 | 270/362 | 01/00 → 08/05 | | | CET12P | OE181 | | |
| 6.0 S 65 AMG | 12 | M275.980 | 450/603 | 03/04 → 08/05 | | | CET12P | OE188 | | |

S-CLASS (W221)

| | | | | | | | | | | |
|---|----|----------------------|---------|---------------|-------|-----|--------|-------|-------------------------|--|
| 3.0 S 280, 3.0 S 300 | 6 | M272.946 | 170/228 | 08/06 → 12/13 | OE229 | 0,8 | CET15P | | BAEA140E | |
| 3.0 S 320 CDI | 6 | OM642.930 | 173/232 | 12/05 → 06/09 | | | | | CCU114 ^[275] | |
| 3.0 S 320 CDI, 3.0 S 320 CDI 4WD, 3.0 S 350 CDI | 6 | OM642.930; OM642.932 | 155/208 | 10/05 → 12/13 | | | | | CCU114 ^[275] | |
| 3.0 S 320 CDI 4WD, 3.0 S 350 CDI | 6 | OM642.930; OM642.932 | 173/232 | 10/06 → 12/13 | | | | | CCU114 ^[275] | |
| 3.0 S 350 BlueTec, 3.0 S 350 BlueTEC 4WD | 6 | OM642.862; OM642.868 | 190/255 | 04/11 → 12/13 | | | | | CCU116 ^[275] | |
| 3.5 S 350, 3.5 S 350 4WD | 6 | M272.965; M272.975 | 200/268 | 10/05 → 12/13 | OE229 | 0,8 | CET15P | | BAEA140E | |
| 3.5 S 350 CGI, 3.5 S 350 CGI 4WD | 6 | M276.950 | 225/302 | 04/11 → 12/13 | | | | | BAEA093E | |
| 3.5 S 400 Hybrid | 6 | M272.974 | 205/275 | 01/09 → 12/13 | OE229 | 0,8 | CET15P | | BAEA140E | |
| 4.0 S 420 CDI | 8 | OM629.911 | 235/315 | 10/06 → 12/09 | | | | | CCU118 | |
| 4.7 S 450, 4.7 S 450 4WD | 8 | M273.922; M273.924 | 250/335 | 12/05 → 12/13 | OE229 | 0,8 | CET15P | | BAEA140E | |
| 4.7 S 500 CGI, 4.7 S 500 CGI 4WD | 8 | M278.932 | 320/429 | 03/11 → 12/13 | | | | | BAEA093E | |
| 5.5 S 63 AMG | 8 | M157.980 | 400/536 | 03/11 → 12/13 | | | | | BAEA093E | |
| 5.5 S 63 AMG | 8 | M157.980 | 420/563 | 02/12 → 12/13 | | | | | BAEA093E | |
| 5.5 S 500, 5.5 S 500 4WD | 8 | M273.961; M273.968 | 285/382 | 10/05 → 12/13 | OE229 | 0,8 | CET15P | | BAEA140E | |
| 5.5 S 600 | 12 | M275.953 | 380/510 | 12/05 → 12/13 | | | CET12P | OE188 | | |
| 6.0 S 65 AMG | 12 | M275.982 | 450/603 | 12/05 → 12/13 | | | CET12P | OE188 | | |
| 6.0 S 65 AMG | 12 | M275.982 | 463/621 | 04/11 → 12/13 | | | CET12P | OE188 | | |
| 6.2 S 63 AMG | 8 | M156.984 | 386/518 | 10/06 → 12/13 | OE233 | 1,0 | | | | |

S-CLASS (W222, V222, X222)

| | | | | | | | | | | |
|--|----|----------------------|---------|---------|--|--|--------|-------|-------------------------|--|
| 3.0 S 350 BlueTEC / d, 3.0 S 350 BlueTEC / d 4WD | 6 | OM642.861; OM642.867 | 190/255 | 05/13 → | | | | | CCU116 ^[275] | |
| 3.0 S 350 BlueTEC 4WD | 6 | OM642.867 | 185/248 | 02/14 → | | | | | CCU116 ^[275] | |
| 3.5 S 400 Hybrid / h | 6 | M276.960 | 225/302 | 05/13 → | | | | | BAEA093E | |
| 4.7 S 500, 4.7 S 500 4WD | 8 | M278.929 | 335/449 | 05/13 → | | | | | BAEA093E | |
| 5.5 S 63 AMG, 5.5 S 63 AMG 4WD | 8 | M157.985 | 430/577 | 05/13 → | | | | | BAEA093E | |
| 6.0 S 65 AMG | 12 | M279.980 | 463/621 | 02/14 → | | | CET12P | OE188 | | |
| 6.0 S 600, 6.0 S 600 Maybach | 12 | M277.980 | 390/523 | 02/14 → | | | CET12P | OE188 | | |

SL (R129)

| | | | | | | | | | | |
|---------|---|----------|---------|---------------|------------------|-----|--------|------------------|-------------------------|-------------------|
| 2.8 280 | 6 | M104.943 | 142/190 | 08/93 → 10/01 | OE057 →05/97 | 0,9 | CET2 | OE180 →05/97 | BAEA340 ^[41] | CLS252 →08/95 |
| | | | | | OE032 06/97 → | 1,0 | | OE179 06/97 → | | CLS254 09/95 → |
| 2.8 280 | 6 | M112.923 | 150/201 | 05/98 → 10/01 | OE191 | 1,0 | CET12P | OE180 | BAEA297 | CLS064 |
| 3.2 320 | 6 | M112.943 | 165/221 | 05/98 → 10/01 | OE191 | 1,0 | CET12P | OE180 | BAEA297 | CLS064 |
| 3.2 320 | 6 | M104.991 | 170/228 | 09/93 → 10/01 | OE057 →06/97 | 0,9 | CET2 | OE180 →06/97 | BAEA340 ^[41] | CLS252 →08/95 |
| | | | | | OE032 07/97 → | 1,0 | | OE179 07/97 → | | CLS254 09/95 → |





kW/BHP



eon TITAN

IRIDIUM

**...MERCEDES-BENZ****...SL (R129)**

| | | | | | | | | | | |
|---------------|----|---------------------------------------|---------|-------------|---|-----|--|---|----------------|---------------|
| 5.0 500 | 8 | M113.961 | 225/302 | 05/98→10/01 | OE191 | 1,0 | CET12P | OE180 | BAEA297 | CLS242 |
| 5.5 55 AMG | 8 | M113.985 | 260/349 | 03/00→10/01 | OE191 | 1,0 | CET12P | OE180 | | |
| 6.0 60 AMG | 8 | M119.982 | 280/375 | 05/97→10/01 | OE057 [270] →Eng.12/52, 22/62012118 | 0,9 | CET2 [270] →Eng.12/52, 22/62012118 | OE180 [270] →Eng.12/52, 22/62012118 | | |
| 6.0 60 AMG | 8 | M119.972(AMG6.0); M119.982(AMG6.0) | 280/375 | 05/97→10/01 | OE228 Eng.12/52, 22/62012119→ | 1,0 | CET12P Eng.12/52, 22/62012119→ | OE181 Eng.12/52, 22/62012119→ | | |
| 6.0 SL 60AMG | 8 | M119.982(AMG6.0) | 284/381 | 09/96→12/99 | OE057 →Eng.12/52, 22/62012118 | 0,9 | CET2 →Eng.12/52, 22/62012118 | OE180 →Eng.12/52, 22/62012118 | | |
| | | | | | OE228 Eng.12/52, 22/62012119→ | 1,0 | CET12P Eng.12/52, 22/62012119→ | OE181 Eng.12/52, 22/62012119→ | | |
| 7.3 SL 73 AMG | 12 | M120.981 | 386/518 | 01/99→12/01 | OE057 | 0,9 | CET2 | OE180 | | |
| 7.3 SL 73 AMG | 12 | M120.983 | 386/518 | 01/99→12/01 | OE057 [270] →Eng.002262 | 0,9 | CET2 [270] →Eng.002262 | OE180 [270] →Eng.002262 | | |
| | | | | | OE228 Eng.002263→ | 1,0 | CET12P Eng.002263→ | OE181 Eng.002263→ | | |

SL (R230)

| | | | | | | | | | | |
|-----------------------|----|----------|---------|-------------|--------------|-----|---------------|--------------|-----------------|---------------|
| 3.0 280, 3.0 300 | 6 | M272.949 | 170/228 | 03/08→01/12 | OE229 | 0,8 | CET15P | | BAEA140E | |
| 3.5 350 | 6 | M272.966 | 200/268 | 03/06→01/12 | OE229 | 0,8 | CET15P | | BAEA140E | |
| 3.5 350 | 6 | M272.968 | 232/311 | 04/08→01/12 | OE229 | 0,8 | CET15P | | BAEA140E | |
| 3.7 350 | 6 | M112.973 | 180/241 | 03/03→01/12 | OE191 | 1,0 | CET12P | OE180 | BAEA297 | CLS064 |
| 5.0 500 | 8 | M113.963 | 215/288 | 09/02→12/05 | OE191 | 1,0 | CET12P | OE180 | | |
| 5.0 500 | 8 | M113.963 | 225/302 | 10/01→01/12 | OE191 | 1,0 | CET12P | OE180 | BAEA297 | CLS242 |
| 5.4 55 AMG | 8 | M113.992 | 350/469 | 10/01→06/02 | OE224 | 0,8 | CET14P | | BAEA297 | CLS242 |
| 5.4 55 AMG | 8 | M113.995 | 380/510 | 03/06→01/12 | OE224 | 0,8 | CET14P | | BAEA297 | |
| 5.5 55 AMG Kompressor | 8 | M113.992 | 368/493 | 06/02→01/12 | OE224 | 0,8 | CET14P | | BAEA297 | CLS242 |
| 5.5 500 | 8 | M273.965 | 285/382 | 03/06→01/12 | OE229 | 0,8 | CET15P | | BAEA140E | |
| 5.5 600 | 12 | M275.951 | 368/493 | 04/03→01/12 | | | CET12P | OE188 | | |
| 5.5 600 | 12 | M275.954 | 380/510 | 03/06→01/12 | | | CET12P | OE188 | | |
| 6.0 65 AMG | 12 | M275.981 | 450/603 | 03/04→01/12 | | | CET12P | OE188 | | |
| 6.2 63 AMG | 8 | M156.981 | 386/518 | 03/08→01/12 | OE233 | 1,0 | | | | |

SL (R231)

| | | | | | | | | | | |
|------------|----|----------|---------|--------|--|--|---------------|--------------|---------------------------|--|
| 3.5 350 | 6 | M276.954 | 225/302 | 02/12→ | | | | | BAEA093E | |
| 4.7 500 | 8 | M278.927 | 320/429 | 01/12→ | | | | | BAEA093E | |
| 5.5 63 AMG | 8 | M157.983 | 395/530 | 01/12→ | | | | | BAEA093E | |
| 5.5 63 AMG | 8 | M157.983 | 415/557 | 01/12→ | | | | | BAEA093E 02/12→ | |
| 6.0 65 AMG | 12 | M279.981 | 463/621 | 05/12→ | | | CET12P | OE180 | | |

SLK (R170)

| | | | | | | | | | | |
|-----------------------|---|----------|---------|-------------|------------------------|-----|---------------|--------------|---------------------|--|
| 2.0 200 | 4 | M111.946 | 100/134 | 09/96→03/00 | OE057 →06/97 | 0,9 | CET2 | OE180 | BAEA340 [41] | CLS138 [35] |
| 2.0 200 Kompressor | 4 | M111.958 | 120/161 | 03/00→04/04 | | | CET12P | OE181 | BAEA041 | CLS063 [35] CLS071 [35] |
| 2.0 200 Kompressor | 4 | M111.943 | 141/189 | 10/96→03/00 | OE032 | 1,0 | CET2 | OE179 | BAEA340 [41] | CLS138 [35] |
| 2.3 230 Kompressor | 4 | M111.973 | 142/190 | 09/96→03/00 | OE032 | 1,0 | CET2 | OE179 | BAEA340 [41] | CLS138 [35] |
| 2.3 230 Kompressor | 4 | M111.983 | 145/194 | 03/00→04/04 | | | CET12P | OE181 | BAEA041 | |
| 3.2 32 AMG Kompressor | 6 | M112.960 | 260/349 | 03/01→04/04 | | | CET12P | OE180 | BAEA297 | CLS064 |
| 3.2 320 | 6 | M112.947 | 160/215 | 03/00→04/04 | OE191 | 1,0 | CET12P | OE180 | BAEA297 | CLS064 |

SLK (R171)

| | | | | | | | | | | |
|--------------------|---|----------|---------|-------------|---|-----|--|--|---|--|
| 1.8 200 Kompressor | 4 | M271.944 | 120/161 | 03/04→02/11 | OE229 [232] | 0,8 | CET15P [232] | | BAEA053 →Eng.30853899 →Prod.30.11.2006 | |
| | | | | | OE224 →Eng.30853899 →Prod.30.11.2006 | 0,8 | CET14P →Eng.30853899 →Prod.30.11.2006 | | BAEA077 Eng.30853900→ Prod.30.11.2006→ | |
| | | | | | OE229 Eng.30853900→ Prod.30.11.2006→ | 0,8 | CET15P Eng.30853900→ Prod.30.11.2006→ | | | |
| 1.8 200 Kompressor | 4 | M271.954 | 135/181 | 01/08→02/11 | OE229 | 0,8 | CET15P | | BAEA077 Eng.30853900→ | |

MERCEDES-BENZ





kW/BHP



eon TITAN

IRIDIUM

**...MERCEDES-BENZ****...SLK (R171)**

| | | | | | | | | | | |
|------------------|---|----------|---------|---------------|-------|-----|---------|-------|----------|--------|
| 3.0 280, 3.0 300 | 6 | M272.942 | 170/228 | 01/05 → 02/11 | OE229 | 0,8 | CET1 5P | | BAEA140E | |
| 3.5 350 | 6 | M272.963 | 200/268 | 06/04 → 02/11 | OE229 | 0,8 | CET1 5P | | BAEA140E | |
| 3.5 350 | 6 | M272.969 | 224/300 | 01/08 → 02/11 | OE229 | 0,8 | CET1 5P | | BAEA140E | |
| 5.5 55 AMG | 8 | M113.989 | 265/355 | 06/04 → 02/11 | | | CET1 2P | OE180 | BAEA297 | CLS242 |
| 5.5 55 AMG | 8 | M113.989 | 294/394 | 06/06 → 02/11 | OE191 | 1,0 | CET1 2P | | BAEA297 | |

SLK (R172)

| | | | | | | | | | | |
|------------|---|--------------------|---------|---------|-------|-----|---------|--|----------|--|
| 1.8 200 | 4 | M271.860 | 135/181 | 02/11 → | OE229 | 0,8 | CET1 5P | | | |
| 1.8 200 | 4 | M271.861 | 135/181 | 02/11 → | OE229 | 0,8 | CET1 5P | | BAEA077 | |
| 1.8 250 | 4 | M271.860; M271.861 | 150/201 | 02/11 → | OE229 | 0,8 | CET1 5P | | BAEA077 | |
| 3.5 350 | 6 | M276.956 | 225/302 | 02/11 → | | | | | BAEA093E | |
| 5.5 55 AMG | 8 | M152.980 | 310/416 | 01/12 → | | | | | BAEA093E | |

SLR (R199)

| | | | | | | | | | | |
|-----------------|---|----------|---------|---------|-------|-----|---------|--|---------|--|
| 5.4 | 8 | M155.980 | 460/617 | 04/04 → | OE224 | 0,8 | CET1 4P | | BAEA297 | |
| 5.4 722 Edition | 8 | M155.980 | 478/641 | 10/06 → | OE224 | 0,8 | CET1 4P | | BAEA297 | |

SLR Roadster (R199)

| | | | | | | | | | | |
|-----|---|----------|---------|---------|-------|-----|---------|--|---------|--|
| 5.4 | 8 | M155.980 | 460/617 | 04/07 → | OE224 | 0,8 | CET1 4P | | BAEA297 | |
| 5.4 | 8 | M155.980 | 478/641 | 10/06 → | OE224 | 0,8 | CET1 4P | | BAEA297 | |

VANEO (414)

| | | | | | | | | | | |
|---------|---|-----------|--------|---------------|-------|-----|--|--|----------|--|
| 1.6 | 4 | M166.961 | 60/80 | 02/02 → 07/05 | | | | | BAEA146E | |
| 1.6 | 4 | M166.961 | 75/101 | 02/02 → 07/05 | | | | | BAEA146E | |
| 1.7 CDI | 4 | OM668.914 | 55/74 | 02/02 → 07/05 | CH219 | 11v | | | CCU140 | |
| 1.7 CDI | 4 | OM668.914 | 67/90 | 02/02 → 07/05 | CH219 | 11v | | | CCU140 | |
| 1.9 | 4 | M166.991 | 92/123 | 02/02 → 07/05 | | | | | BAEA146E | |

V-CLASS (638/2)

| | | | | | | | | | | |
|---------------|---|--------------------|---------|---------------|-------|-------|------|-------|-------------------------|------------------------|
| 2.0 V 200 | 4 | M111.948; M111.950 | 95/127 | 02/97 → 07/03 | | | | | BAEA340 ^[41] | CLS138 ^[35] |
| 2.2 V 200 CDI | 4 | OM611.980 | 75/101 | 03/99 → 07/03 | | | | | CCU140 | |
| 2.2 V 220 CDI | 4 | OM611.980 | 90/121 | 03/99 → 07/03 | | | | | CCU140 | |
| 2.3 V 230 | 4 | M111.978; M111.980 | 105/141 | 10/96 → 07/03 | OE019 | 0,9 | CET2 | OE184 | BAEA340 ^[41] | CLS138 ^[35] |
| 2.3 V 230 TD | 4 | OM601.970 | 72/97 | 09/96 → 07/03 | CH176 | 11.5v | | | | |
| 2.8 V 280 | 6 | M104.900 | 128/172 | 08/97 → 07/03 | | | | | BAEA004E | |

VIANO (W639)

| | | | | | | | | | | |
|----------------------|---|----------------------|---------|---------------|-------|-----|---------|-------|--|--------|
| 2.0 CDI | 4 | OM646.982 | 85/114 | 08/05 → | | | | | CCU140 | |
| 2.0 CDI, 2.0 CDI 4WD | 4 | OM646.982 | 80/107 | 09/03 → | | | | | CCU140 | |
| 2.0 CDI 4WD | 4 | OM646.982 | 85/114 | 03/06 → | | | | | CCU140 ^[235] | |
| 2.2 CDI, 2.2 CDI 4WD | 4 | OM646.980; OM646.982 | 110/148 | 09/03 → | | | | | CCU140 | |
| 3.0 CDI | 6 | OM642.990 | 150/201 | 03/06 → | | | | | CCU114 ^[180] ^[275] | |
| 3.0 CDI | 6 | OM642.890 | 165/221 | 07/10 → | | | | | CCU114 ^[180] ^[275] | |
| 3.2 | 6 | M112.951 | 160/215 | 09/03 → | OE191 | 1,0 | CET1 2P | OE180 | BAEA297 | CLS064 |
| 3.2 3,0 | 6 | M112.951 | 140/188 | 09/03 → | OE191 | 1,0 | CET1 2P | OE180 | BAEA297 | CLS064 |
| 3.5 | 6 | M272.978 | 190/255 | 09/07 → | OE229 | 0,8 | CET1 5P | | BAEA140E | |
| 3.7 | 6 | M112.976 | 165/221 | 06/04 → 07/07 | OE191 | 1,0 | CET1 2P | OE180 | BAEA297 | |
| 3.7 | 6 | M112.976 | 170/228 | 06/04 → | OE191 | 1,0 | CET1 2P | OE180 | BAEA297 | |

MERCEDES-BENZ**100 Box/Bus/Platform/Chassis (631)**

| | | | | | | | | | | |
|-------|---|-----------|-------|---------------|-------|-------|--|--|--|--|
| 2.0 D | 4 | OM615.970 | 45/60 | 09/93 → 04/96 | CH176 | 11.5v | | | | |
|-------|---|-----------|-------|---------------|-------|-------|--|--|--|--|

CITAN Box (415)

| | | | | | | | | | | |
|---------|---|----------|--------|---------|--|--|--|-------|----------|--|
| 1.2 112 | 4 | M200.711 | 84/113 | 06/13 → | | | | OE261 | BAEA131E | |
|---------|---|----------|--------|---------|--|--|--|-------|----------|--|

SPRINTER 2-t Box (901, 902)

| | | | | | | | | | | |
|---------|---|----------|---------|---------------|-------|-----|------|-------|-------------------------|------------------------|
| 2.3 214 | 4 | M111.979 | 105/141 | 02/95 → 05/06 | OE057 | 0,9 | CET2 | OE180 | BAEA340 ^[41] | CLS138 ^[35] |
|---------|---|----------|---------|---------------|-------|-----|------|-------|-------------------------|------------------------|



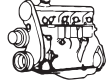

kW/BHP

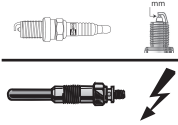

eon TITAN

IRIDIUM



...MERCEDES-BENZ



...SPRINTER 2-t Box (901, 902)

| | | | | | | | | | | |
|---------|---|----------|---------|-------------|--------------|-----|-------------|--------------|--------------------------------|--|
| 2.3 214 | 4 | M111.984 | 105/141 | 02/95→05/06 | OE032 | 1,0 | CET2 | OE179 | BAEA340 ^[41] | CLS063 ^[35] CLS071 ^[35] |
|---------|---|----------|---------|-------------|--------------|-----|-------------|--------------|--------------------------------|--|

SPRINTER 2-t Box/Bus/Platform/Chassis (901, 902)

| | | | | | | | | | | |
|-------------|---|--------------------|---------|-------------|--|-----------------------|---------------|--------------|--------------------------------|--|
| 2.1 208 CDI | 4 | OM611.987 | 60/80 | 04/00→05/06 | | | | | CCU140 | |
| 2.1 211 CDI | 4 | OM611.981 | 80/107 | 04/00→05/06 | | | | | CCU140 | |
| 2.1 213 CDI | 4 | OM611.981 | 95/127 | 04/00→05/06 | | | | | CCU140 | |
| 2.3 208 D | 4 | OM601.943 | 58/78 | 01/95→04/00 | CH176 | 11.5v | | | | |
| 2.3 208 D | 4 | OM601.943 | 60/80 | 09/96→04/00 | CH176 | 11.5v | | | | |
| 2.3 214 NGT | 4 | M111.979; M111.984 | 95/127 | 02/95→05/06 | OE146 | 1,0 | CET12P | OE179 | BAEA340 ^[41] | CLS063 ^[35] CLS071 ^[35] |
| 2.7 216 CDI | 5 | OM612.981 | 115/154 | 04/00→05/06 | | | | | CCU141 | |
| 2.9 210 D | 5 | OM602.980 | 75/101 | 01/97→04/00 | CH204 | 11.5v | | | CCU141 | |
| 2.9 212 D | 5 | OM602.980 | 90/121 | 02/95→04/00 | CH189 →Eng.9849 CH204 ^[285] Eng.137→ CH204 ^[287] Eng.9850→ | 11v 11.5v 11.5v | | | CCU141 | |

SPRINTER 2-t Bus/Platform/Chassis (901, 902)

| | | | | | | | | | | |
|---------|---|----------|---------|-------------|--|--|--|--------------|--------------------------------|-------------------------------|
| 2.3 214 | 4 | M111.979 | 105/141 | 02/95→05/06 | | | | OE180 | BAEA340 ^[41] | CLS138 ^[35] |
| 2.3 214 | 4 | M111.984 | 105/141 | 02/95→05/06 | | | | | BAEA340 ^[41] | CLS138 ^[35] |

SPRINTER 3,5-t Box (906)

| | | | | | | | | | | |
|---------|---|----------|---------|-------------|--------------|-----|---------------|--|--|--|
| 3.5 324 | 6 | M272.979 | 190/255 | 06/06→12/13 | OE229 | 0,8 | CET15P | | BAEA140E BAEA077 Eng.30099999→ | |
|---------|---|----------|---------|-------------|--------------|-----|---------------|--|--|--|

SPRINTER 3,5-t Box/Bus/Platform/Chassis (906)

| | | | | | | | | | | |
|--|---|---------------------------------|---------|-------------|--------------|-----|---------------|--|--|--|
| 1.8 316, 1.8 316 NGT | 4 | M271.951 | 115/154 | 09/08→ | OE229 | 0,8 | CET15P | | BAEA053 →10/10 →Eng.30853899 BAEA077 11/10→ Eng.30853900→ | |
| 1.8 316 LGT | 4 | M271.951 | 115/154 | 09/08→ | OE229 | 0,8 | CET15P | | BAEA077 Eng.30099999→ | |
| 2.1 309 CDI | 4 | OM646.984 | 65/87 | 06/06→12/09 | | | | | CCU140 | |
| 2.1 311 CDI, 2.1 311 CDI 4WD | 4 | OM646.985 | 80/107 | 06/06→12/09 | | | | | CCU140 | |
| 2.1 313 CDI | 4 | OM646.986 | 95/127 | 06/06→ | | | | | CCU140 | |
| 2.1 315 CDI, 2.1 315 CDI 4WD | 4 | OM646.986; OM646.989; OM646.990 | 110/148 | 06/06→ | | | | | CCU140 | |
| 3.0 318 CDI, 3.0 318 CDI 4WD | 6 | OM642.993 | 135/181 | 06/06→12/09 | | | | | CCU114 ^[275] | |
| 3.0 318 CDI, 3.0 318 CDI 4WD | 6 | OM642.992 | 135/181 | 06/06→12/09 | | | | | CCU114 ^[275] →Eng.41694476 | |
| 3.0 318 CDI, 3.0 318 CDI 4WD | 6 | OM642.896 | 135/181 | 06/06→12/09 | | | | | CCU116 [272] [275] CCU114 →Eng.41330713 [272] [275] CCU116 →Eng.41689183 [234] [275] | |
| 3.0 319 CDI / BlueTEC, 3.0 319 CDI / BlueTEC 4WD | 6 | OM642.992 | 140/188 | 03/09→ | | | | | CCU114 ^[275] →Eng.41694476 →Prod.03.03.2015 | |

MERCEDES-BENZ





kW/BHP

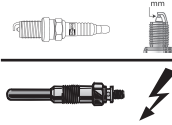

eon TITAN

IRIDIUM

**...MERCEDES-BENZ****...SPRINTER 3,5-t Box/Bus/Platform/Chassis (906)**

3.0 319 CDI / BlueTEC, 3.0 319 CDI / BlueTEC 4WD 6 OM642.896; OM642.898 140/188 03/09→

CCU116 [272] [275]

CCU114

→Eng.41330713
→Prod.15.06.2012
[272] [275]

CCU116

→Eng.41689183
→Prod.17.02.2015
[234] [275]**SPRINTER 3,5-t Bus/Platform/Chassis (906)**

3.5 324 6 M272.979 190/255 06/06→12/13 OE229 0,8 CET15P BAEA140E

SPRINTER 3-t Box (903)

2.3 314 4 M111.979 105/141 02/95→05/06 OE057 0,9 CET2 OE180 BAEA340 [41] CLS138 [35]

2.9 310 D 5 OM602.980 75/101 02/95→04/00 CH204 11.5v CCU141
01/97→**SPRINTER 3-t Box/Bus/Platform/Chassis (903)**

2.1 308 CDI 4 OM611.987 60/80 04/00→05/06 CCU140

2.1 311 CDI, 2.1 311 CDI 4 OM611.981 80/107 04/00→05/06 CCU140
4WD2.1 313 CDI, 2.1 313 CDI 4 OM611.981 95/127 04/00→05/06 CCU140
4WD

2.3 308 D 4 OM601.943 58/78 02/95→04/00 CH176 11.5v

2.3 308 D 4 OM601.943 60/80 02/95→04/00 CH176 11.5v

2.3 314, 2.3 314 4WD 4 M111.984 105/141 02/95→05/06 OE032 1,0 CET2 OE179 BAEA340 [41] CLS063 [35]
CLS071 [35]

2.3 314 4WD 4 M111.979 105/141 08/02→05/06 OE057 0,9 OE180

2.3 314 NGT 4 M111.979; M111.984 95/127 02/95→05/06 OE146 1,0 CET12P OE179 BAEA340 [41] CLS063 [35]
CLS071 [35]2.7 316 CDI, 2.7 316 CDI 5 OM612.981 115/154 04/00→05/06 CCU141
4WD2.9 312 D, 2.9 312 D 2.9 5 OM602.980 90/121 02/95→08/02 CH189 11v CCU141
4WD
→Eng.9849CH204 [285] 11.5v
Eng.137→CH204 [287] 11.5v
Eng.9850→2.9 310 D 5 OM602.980 75/101 01/97→12/99 CH204 [177] 11.5v
Eng.9850
137→2.9 310 D 4WD 5 OM602.980 75/101 05/97→08/02 CH204 11.5v CCU141
→03/002.3 314 4 M111.979 105/141 02/95→05/06 OE057 0,9 CET2 OE180 BAEA340 [41] CLS063 [35]
CLS071 [35]

2.9 310 D 5 OM602.980 75/101 01/97→04/00 CH204 11.5v CCU141

2.9 312 D 5 OM602.980 85/114 12/98→09/01 CH204 [177] 11.5v CCU141
Eng.9850
137→1.8 216 4 M271.951 115/154 09/08→ OE229 0,8 CET15P BAEA077
Eng.030099999→

2.1 209 CDI 4 OM646.984 65/87 06/06→12/09 CCU140

2.1 211 CDI 4 OM646.985 80/107 06/06→12/09 CCU140

2.1 213 CDI 4 OM646.986 95/127 06/06→ CCU140

MERCEDES-BENZ





kW/BHP



eon TITAN

IRIDIUM

**...MERCEDES-BENZ****...SPRINTER 3-t Box/Bus/Platform/Chassis (906)**

2.1 215 CDI 4 OM646.986; OM646.989; OM646.990 110/148 06/06→12/09

CCU140

3.5 224 6 M272.979 190/255 06/06→

OE229

0,8

CET15P**BAEA140E****SPRINTER 3-t Box/Platform/Chassis (906)**

3.0 218 CDI 6 OM642.992 135/181 06/06→12/09

CCU114^[275]
→Eng.41694476

3.0 218 CDI 6 OM642.896 135/181 06/06→12/09

CCU116
[272] [275]**CCU114**
→Eng.41330713
[272] [275]**CCU116**
→Eng.41689183
[234] [275]

3.0 219 CDI / BlueTEC 6 OM642.992 140/188 03/09→

CCU114^[275]
→Eng.41694476
→Prod.03.03.2015

3.0 219 CDI / BlueTEC 6 OM642.896 140/188 03/09→

CCU116
[272] [275]**CCU114**
→Eng.41330713
→Prod.15.06.2012
[272] [275]**CCU116**
→Eng.41689183
→Prod.17.02.2015
[234] [275]**SPRINTER 3-t Bus (906)**

1.8 216 4 M271.951 115/154 09/08→

OE229

0,8

CET15P**BAEA077**
Eng.30099999→**SPRINTER 3-t Platform/Chassis (906)**

1.8 216 4 M271.951 115/154 09/08→05/16

OE229

0,8

CET15P**BAEA077**

3.0 218 CDI 6 OM642.993 135/181 06/06→12/09

CCU114^[275]**SPRINTER 4,6-t Box/Platform/Chassis (906)**

2.1 411 CDI 4 OM646.985 80/107 06/09→12/09

CCU140

2.1 413 CDI 4 OM646.986 95/127 06/06→

CCU140

2.1 415 CDI 4 OM646.986; OM646.989; OM646.990 110/148 06/06→

CCU140

3.0 418 CDI 6 OM642.992 135/181 06/09→05/16

CCU114^[275]
→Eng.41694476
→Prod.03.03.2015

3.0 418 CDI 6 OM642.896 135/181 06/09→05/16

CCU116
[272] [275]**CCU114**
→Eng.41330713
→Prod.15.06.2012
[272] [275]**CCU116**
→Eng.41689183
→Prod.17.02.2015
[234] [275]

3.0 419 CDI 6 OM642.992 140/188 03/09→

CCU114^[275]
→Eng.41694476
→Prod.03.03.2015

3.0 419 CDI 6 OM642.896; OM642.898 140/188 03/09→

CCU116
[272] [275]**CCU114**
→Eng.41330713
→Prod.15.06.2012
[272] [275]**CCU116**
→Eng.41689183
→Prod.17.02.2015
[234] [275]

3.5 424 6 M272.979 190/255 06/06→12/13

OE229

0,8

CET15P**BAEA140E**

MERCEDES-BENZ





kW/BHP



eon TITAN

IRIDIUM

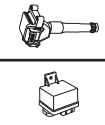
**...MERCEDES-BENZ****SPRINTER 4,6-t Platform/Chassis (906)**

| | | | | | | | | | | |
|-------------|---|----------------------|---------|--------------|--|--|--|--|--|--|
| 2.1 415 CDI | 4 | OM646.986; OM646.989 | 110/148 | 06/06 → | | | | | | CCU140 |
| 3.0 418 CDI | 6 | OM642.993 | 135/181 | 06/06 →12/09 | | | | | | CCU114 [275] |
| 3.0 418 CDI | 6 | OM642.992 | 135/181 | 06/06 →12/09 | | | | | | CCU114 [275] →Eng.41694476 |
| 3.0 418 CDI | 6 | OM642.896 | 135/181 | 06/06 →12/09 | | | | | | CCU116 [272] [275] CCU114 →Eng.41330713 [272] [275] CCU116 →Eng.41689183 [234] [275] |

SPRINTER 4-t Box (904)

| | | | | | | | | | | |
|---------------|---|-----------|--------|--------------|--|--|--|--|--|------------------------------|
| 2.9 414 D 4WD | 5 | OM602.980 | 90/121 | 05/97 →05/06 | | | | | | CCU140 [237] CCU141 [238] |
|---------------|---|-----------|--------|--------------|--|--|--|--|--|------------------------------|

SPRINTER 4-t Box/Bus/Platform/Chassis (904)

| | | | | | | | | | | |
|------------------------------|---|-----------|---------|--------------|--|--|-------|--|--|--------------------------|
| 2.1 408 CDI | 4 | OM611.987 | 60/80 | 04/00 →05/06 | | | | | | CCU140 |
| 2.1 411 CDI, 2.1 411 CDI 4WD | 4 | OM611.981 | 80/107 | 04/00 →05/06 | | | | | | CCU140 |
| 2.1 413 CDI, 2.1 413 CDI 4WD | 4 | OM611.981 | 95/127 | 04/00 →05/06 | | | | | | CCU140 |
| 2.3 414, 2.3 414 4WD | 4 | M111.979 | 105/141 | 02/95 →05/06 | | | OE180 | | | BAEA340 [41] CLS138 [35] |
| 2.3 414, 2.3 414 4WD | 4 | M111.984 | 105/141 | 02/96 →05/06 | | | | | | BAEA340 [41] CLS138 [35] |
| 2.7 416 CDI, 2.7 416 CDI 4WD | 5 | OM612.981 | 115/154 | 04/00 →05/06 | | | | | | CCU141 |

SPRINTER 4-t Box/Platform/Chassis (904)

| | | | | | | | | | | |
|--------------------------|---|-----------|--------|--------------|------------------------------------|-------|--|--|--|--------|
| 2.3 408 D | 4 | OM601.943 | 58/78 | 02/96 →05/06 | CH176 | 11.5v | | | | |
| 2.9 410 D, 2.9 410 D 4WD | 5 | OM602.980 | 75/101 | 02/96 →05/06 | CH204 [285] →03/00 Eng.000137 → | 11.5v | | | | CCU141 |
| | | | | | CH204 [287] →03/00 Eng.009850 → | 11.5v | | | | |
| 2.9 412 D, 2.9 412 D 4WD | 5 | OM602.980 | 85/114 | 02/96 →05/06 | CH204 [285] →03/00 Eng.000137 → | 11.5v | | | | CCU141 |
| | | | | | CH204 [287] →03/00 Eng.009850 → | 11.5v | | | | |
| 2.9 412 D, 2.9 412 D 4WD | 5 | OM602.980 | 90/121 | 02/96 →05/06 | CH204 [285] →03/00 Eng.000137 → | 11.5v | | | | CCU141 |
| | | | | | CH204 [287] →03/00 Eng.009850 → | 11.5v | | | | |
| | | | | | CH189 →Eng.009850 000137 | 11v | | | | |

SPRINTER 4-t Platform/Chassis (904)

| | | | | | | | | | | |
|-----------|---|-----------|---------|--------------|------------------------------------|-------|--|--|--|---|
| 2.3 414 | 4 | M111.984 | 105/141 | 02/95 →05/06 | | | | | | BAEA340 [41] CLS063 [35] CLS071 [35] |
| 2.9 412 D | 5 | OM602.980 | 85/114 | 02/96 →05/06 | CH204 [285] →03/00 Eng.000137 → | 11.5v | | | | CCU141 |
| | | | | | CH204 [287] →03/00 Eng.009850 → | 11.5v | | | | |

SPRINTER 5-t Bus

| | | | | | | | | | | |
|-----------------------|---|-----------|---------|---------|--|--|--|--|--|---|
| 3.0 519 CDI / BlueTEC | 6 | OM642.992 | 140/188 | 03/09 → | | | | | | CCU114 [275] →Eng.41694476 →Prod.03.03.2015 |
|-----------------------|---|-----------|---------|---------|--|--|--|--|--|---|

MERCEDES-BENZ





kW/BHP

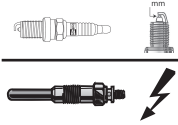

eon TITAN

IRIDIUM

**...MERCEDES-BENZ****...SPRINTER 5-t Bus**

3.0 519 CDI / BlueTEC 6 OM642.896; OM642.898 140/188 03/09→

CCU116→Eng.41689183
→Prod.17.02.2015
[234] [275]**SPRINTER 5-t Platform/Chassis (905)**

2.7 616 CDI 5 OM612.981 115/154 04/01→05/06

CCU141**SPRINTER 5-t Box/Platform/Chassis (906)**

2.1 509 CDI 4 OM646.984 65/87 06/06→12/09

CCU140

2.1 511 CDI, 2.1 511 CDI 4WD 4 OM646.985 80/107 06/06→12/09

CCU140

2.1 513 CDI 4 OM646.986 95/127 06/06→

CCU140

2.1 515 CDI, 2.1 515 CDI 4WD 4 OM646.986; OM646.989; OM646.990 110/148 06/06→

CCU140

3.0 518 CDI, 3.0 518 CDI 4WD 6 OM642.993 135/181 06/06→12/09

CCU114^[275]

3.0 518 CDI, 3.0 518 CDI 4WD 6 OM642.992 135/181 06/06→12/09

CCU114^[275]
→Eng.41694476

3.0 518 CDI, 3.0 518 CDI 4WD 6 OM642.896 135/181 06/06→12/09

CCU116
[272] [275]**CCU114**
→Eng.41330713
[272] [275]**CCU116**
→Eng.41689183
[234] [275]

3.0 519 CDI / BlueTEC, 3.0 519 CDI / BlueTEC 4WD 6 OM642.992 140/188 03/09→

CCU114^[275]
→Eng.41694476
→Prod.03.03.2015

3.0 519 CDI / BlueTEC, 3.0 519 CDI / BlueTEC 4WD 6 OM642.896; OM642.898 140/188 03/09→

CCU116
[272] [275]**CCU114**
→Eng.41330713
→Prod.15.06.2012
[272] [275]**CCU116**
→Eng.41689183
→Prod.17.02.2015
[234] [275]3.5 524 6 M272.979 190/255 06/06→12/13 **OE229** 0,8 **CET15P****BAEA140E****SPRINTER 5-t Platform/Chassis (906)**

1.8 516 4 M271.951 115/154 09/08→

OE229 0,8 **CET15P****BAEA053**→10/10
→Eng.30853899**BAEA077**11/10→
Eng.30853900→

1.8 516 NGT 4 M271.951 115/154 09/08→

OE229 0,8 **CET15P****BAEA053**

→Eng.30853899

BAEA077

Eng.30853900→

SPRINTER Dumptruck (905)

2.7 616 CDI 5 OM612.981 115/154 04/01→

CCU141**SPRINTER CLASSIC 3,5-t Box (909)**

2.1 311 CDI 4 OM646.701 80/107 09/13→

CCU141^[236]**SPRINTER CLASSIC 4,6-t Bus (909)**

2.1 411 CDI 4 OM646.701 80/107 09/13→

CCU141^[236]**VARIO Box Body / Estate/Bus/Dumptruck/Platform/Chassis**2.9 512 D, 2.9 612 D, 2.9 812 D, 2.9 O 812 5 OM602.984; OM602.985 90/121 09/96→12/10 **CH204** 11.5v**VITO / MIXTO Box (W639)**

2.2 109 CDI 4 OM646.983 65/87 09/03→

CCU140

MERCEDES-BENZ



kW/BHP



eon TITAN

IRIDIUM

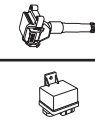

...MERCEDES-BENZ



...VITO / MIXTO Box (W639)

| | | | | | | | | | | |
|------------------------------|---|----------------------|---------|---------------|-------|-----|--------|-------|-----------------------|--------|
| 2.2 109 CDI | 4 | OM646.980; OM646.981 | 70/94 | 08/06 → | | | | | CCU140 | |
| 2.2 111 CDI | 4 | OM646.980; OM646.982 | 85/114 | 09/07 → | | | | | CCU140 | |
| 2.2 111 CDI, 2.2 111 CDI 4WD | 4 | OM646.982 | 80/107 | 09/03 → | | | | | CCU140 | |
| 2.2 115 CDI, 2.2 115 CDI 4WD | 4 | OM646.980; OM646.982 | 110/148 | 09/03 → | | | | | CCU140 | |
| 3.0 120 CDI | 6 | OM642.990 | 150/201 | 07/06 → | | | | | CCU114 [180] [275] | |
| 3.0 122 CDI | 6 | OM642.890 | 165/221 | 09/10 → | | | | | CCU116 [275] | |
| 3.2 119 | 6 | M112.951 | 140/188 | 09/03 → | OE191 | 1,0 | CET12P | OE180 | BAEA297 | CLS064 |
| 3.2 122 | 6 | M112.951 | 160/215 | 09/03 → | OE191 | 1,0 | CET12P | OE180 | BAEA297 | CLS064 |
| 3.5 126 | 6 | M272.978 | 190/255 | 09/07 → | OE229 | 0,8 | CET15P | | BAEA140E | |
| 3.7 123 | 6 | M112.976 | 165/221 | 06/04 → 07/08 | OE191 | 1,0 | CET12P | OE180 | BAEA297 | |
| 3.7 123 | 6 | M112.976 | 170/228 | 06/04 → 07/08 | OE191 | 1,0 | CET12P | OE180 | BAEA297 | |

VITO Box/Bus (638)

| | | | | | | | | | | |
|-----------------------|---|--------------------|---------|---------------|-------|-------|------|-------|--------------|-------------|
| 2.0 113 | 4 | M111.948; M111.950 | 95/127 | 02/96 → 07/03 | OE019 | 0,9 | CET2 | OE184 | BAEA340 [41] | CLS138 [35] |
| 2.2 108 CDI | 4 | OM611A(60KWCDI) | 60/80 | 03/99 → 07/03 | | | | | CCU140 | |
| 2.2 110 CDI | 4 | OM611LA(75KWCDI) | 75/101 | 03/99 → 07/03 | | | | | CCU140 | |
| 2.2 112 CDI | 4 | OM611.980 | 90/121 | 03/99 → 07/03 | | | | | CCU140 | |
| 2.3 108 D | 4 | OM601.942 | 58/78 | 02/96 → 07/03 | CH176 | 11.5v | | | | |
| 2.3 110 D, 2.3 110 TD | 4 | OM601.970 | 72/97 | 02/96 → 07/03 | CH176 | 11.5v | | | | |
| 2.3 114 | 4 | M111.978 | 105/141 | 12/96 → 07/03 | OE019 | 0,9 | CET2 | OE184 | BAEA340 [41] | CLS138 [35] |

VITO Bus (W639)

| | | | | | | | | | | |
|------------------------------|---|----------------------|---------|---------------|-------|-----|--------|-------|-----------------------|--|
| 2.2 109 CDI | 4 | OM646.983 | 65/87 | 09/03 → | | | | | CCU140 | |
| 2.2 109 CDI, 2.2 109 CDI 4WD | 4 | OM646.980; OM646.981 | 70/94 | 09/06 → | | | | | CCU140 | |
| 2.2 111 CDI | 4 | OM646.980 | 85/114 | 09/07 → | | | | | CCU140 | |
| 2.2 111 CDI, 2.2 111 CDI 4WD | 4 | OM646.982 | 80/107 | 09/03 → | | | | | CCU140 | |
| 2.2 115 CDI, 2.2 115 CDI 4WD | 4 | OM646.980; OM646.982 | 110/148 | 09/03 → | | | | | CCU140 | |
| 3.0 120 CDI | 6 | OM642.990 | 150/201 | 07/06 → | | | | | CCU114 [180] [275] | |
| 3.0 122 CDI | 6 | OM642.890 | 165/221 | 09/10 → | | | | | CCU116 [275] | |
| 3.2 119 | 6 | M112.951 | 140/188 | 09/03 → | OE191 | 1,0 | CET12P | OE180 | BAEA297 | |
| 3.2 122 | 6 | M112.951 | 160/215 | 09/03 → | OE191 | 1,0 | CET12P | OE180 | BAEA297 | |
| 3.5 126 | 6 | M272.978 | 190/255 | 09/07 → | OE229 | 0,8 | CET15P | | BAEA140E | |
| 3.7 123 | 6 | M112.976 | 165/221 | 06/04 → 07/08 | OE191 | 1,0 | CET12P | OE180 | BAEA297 | |
| 3.7 123 | 6 | M112.976 | 170/228 | 06/04 → | OE191 | 1,0 | CET12P | OE180 | BAEA297 | |

MERCEDES-BENZ (BBDC)



E-CLASS

| | | | | | | | | | | |
|-----------|---|----------|---------|---------------|--|-----|---|--|--|--|
| 1.8 E 200 | 4 | M271.941 | 120/161 | 11/05 → 12/06 | OE229 [232] | 0,8 | CET15P [232] | | BAEA053 → Eng.30853899 → Prod.30.11.2006 | |
| | | | | | OE224 → Eng.30853899 → Prod.30.11.2006 | 0,8 | CET14P → Eng.30853899 → Prod.30.11.2006 | | BAEA077 Eng.30853900 → Prod.30.11.2006 → | |
| | | | | | OE229 Eng.30853900 → Prod.30.11.2006 → | 0,8 | CET15P Eng.30853900 → Prod.30.11.2006 → | | | |

MERCURY



MOUNTAINEER

| | | | | | | | | | | |
|--------------|---|--|---------|---------------|--|--|------|--|--|--|
| 4.0, 4.0 4WD | 6 | | 152/204 | 10/00 → 12/05 | | | CET9 | | | |
|--------------|---|--|---------|---------------|--|--|------|--|--|--|





kW/BHP

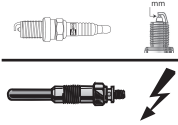

eon TITAN

IRIDIUM



METROCAB



TAXI

2.4 TD 4 2L-T 66/89 01/01→05/06 CH154 11v

MG



MG 6

1.8 T 4 18N4TI 118/158 11/10→ OE146 1,0 CET12P

MGF

1.6 4 16K4F 82/110 02/00→03/02 OE146 1,0 CET12P OE179 BAEA469
→Ch.YD522572
[185] [260] CLS061 [292]
→Ch.YD522572
BAEA501
Ch.YD522573→

1.8 i, 8 i VVC 4 18K4K 118/158 10/01→03/02 OE146 1,0 CET12P OE179 CLS095
→Ch.YD522572

1.8 i 16V 4 18K4F 88/118 03/95→03/02 OE146 1,0 CET12P OE179 BAEA469
→Ch.YD522572
[185] [260] CLS061 [292]
→Ch.YD522572
BAEA501 [286]
Ch.YD522573→

1.8 i VVC 4 18K4K 107/143 03/95→03/02 OE146 1,0 CET12P OE179 CLS095
→Ch.YD522572

MG TF

1.6 115 4 16K4F 85/114 03/02→12/09 OE146 1,0 CET12P OE179 BAEA469
→Ch.YD522572
[185] [260] CLS061 [292]
→Ch.YD522572

1.8 120 4 18K4F 88/118 03/02→12/09 OE146 1,0 CET12P OE179 BAEA469
→Ch.YD522572
[185] [260] CLS061 [292]
→Ch.YD522572
BAEA501
Ch.YD522573→

1.8 135 4 18K4F 100/134 03/02→12/09 OE146 1,0 CET12P OE179 BAEA469
→Ch.YD522572
[185] [260] CLS061 [292]
→Ch.YD522572

1.8 160 4 18K4K 118/158 03/02→12/09 OE146 1,0 CET12P OE179 CLS095
→Ch.YD522572

MG X-POWER

4.6 SV 8 46K4F 230/308 01/03→04/08 CET9

MG ZR

1.4 105 4 14K4F 76/102 06/01→04/05 OE146 1,0 CET12P OE179 BAEA469
→Ch.YD471564
[185] [260] CLS061 [292]
→Ch.YD471564
BAEA501
Ch.YD471565→

1.8 120 4 18K4F 86/115 06/01→04/05 OE146 1,0 CET12P OE179 BAEA469
→Ch.YD471564
[185] [260] CLS061 [292]
→Ch.YD471564
BAEA501
Ch.YD471565→

1.8 160 4 18K4K 118/158 06/01→04/05 OE146 1,0 CET12P OE179 CLS095
→Ch.YD471564

2.0 TD 4 20T2N 74/99 06/01→04/05 CH169 11v

2.0 TD 4 20T2N 83/111 12/02→04/05 CH169 11v

MG ZS

1.6 4 16K4F 79/106 11/01→04/05 OE146 1,0 CET12P OE179 BAEA501

1.6 4 16K4F 82/110 11/01→10/05 OE146 1,0 CET12P OE179

1.8 120 4 18K4F 86/115 07/01→10/05 OE146 1,0 CET12P OE179 BAEA501

2.0 TD 4 20T2N 74/99 01/04→10/05 CH169 11v

2.0 TD 4 20T2N 83/111 01/04→10/05 CH169 11v

2.5 180 6 25K4F 130/174 07/01→10/05 OE146 1,0 CET12P OE179 BAEA302
[245] [275]

MG ZT

1.8 16V 4 18K4F 88/118 01/03→07/05 OE146 1,0 CET12P OE179 BAEA501

MG





kW/BHP



eon TITAN

IRIDIUM



...MG



...MG ZT

| | | | | | | | | | |
|-----------------|---|-------|---------|-------------|-------|-----|--------|-------|---------|
| 1.8 T 16V | 4 | 18K4G | 118/158 | 01/03→07/05 | OE146 | 1,0 | CET12P | OE179 | BAEA501 |
| 2.0 CDTi | 4 | 204D2 | 85/114 | 06/02→09/03 | CH203 | 11v | | | |
| 2.0 CDTi | 4 | 204D2 | 96/129 | 11/02→07/05 | CH203 | 11v | | | |
| 2.5 160 | 6 | 25K4F | 118/158 | 06/01→07/05 | OE146 | 1,0 | CET12P | OE179 | |
| 2.5 180 | 6 | 25K4F | 130/174 | 02/04→10/05 | OE146 | 1,0 | CET12P | OE179 | |
| 2.5 190 | 6 | 25K4F | 140/188 | 06/01→07/05 | OE146 | 1,0 | CET12P | OE179 | |
| 4.6 260 | 8 | 99W | 191/256 | 10/03→07/05 | OE146 | 1,0 | CET12P | OE179 | |
| 4.6 X Power 385 | 8 | | 283/380 | 06/02→07/05 | | | CET9 | | |
| 4.6 X Power 500 | 8 | | 368/493 | 06/01→07/05 | | | CET9 | | |

MG ZT-

| | | | | | | | | | |
|-----------------|---|------------|---------|-------------|-------|-----|--------|-------|---------|
| 1.8 16V | 4 | 18K4F | 88/118 | 01/03→07/05 | OE146 | 1,0 | CET12P | OE179 | BAEA501 |
| 1.8 T 16V | 4 | 18K4G | 118/158 | 01/03→07/05 | OE146 | 1,0 | CET12P | OE179 | BAEA501 |
| 2.0 CDTi | 4 | 204D2 | 85/114 | 06/02→07/05 | CH203 | 11v | | | |
| 2.0 CDTi | 4 | 204D2 | 96/129 | 11/02→07/05 | CH203 | 11v | | | |
| 2.5 160 | 6 | 25K4F | 118/158 | 10/01→07/05 | OE146 | 1,0 | CET12P | OE179 | |
| 2.5 180 | 6 | 25K4F | 130/174 | 02/04→10/05 | OE146 | 1,0 | CET12P | OE179 | |
| 2.5 190 | 6 | 25K4F | 140/188 | 10/01→07/05 | OE146 | 1,0 | CET12P | OE179 | |
| 4.6 260 | 8 | 46F2F; 99W | 191/256 | 10/03→07/05 | OE146 | 1,0 | CET12P | OE179 | |
| 4.6 X Power 385 | 8 | | 283/380 | 06/02→07/05 | | | CET9 | | |

MG



EXPRESS

| | | | | | | | | | |
|---------|---|-------|---------|-------------|-------|-----|--------|-------|---|
| 1.4 | 4 | 14K4F | 76/102 | 03/03→05/05 | OE006 | 0,9 | CET8 | | BAEA469 [260] [275] BAEA501 [275] |
| 1.8 | 4 | 18K4F | 86/115 | 03/03→05/05 | OE146 | 1,0 | CET12P | OE179 | BAEA501 |
| 1.8 160 | 4 | 18K4K | 118/158 | 03/03→05/05 | OE146 | 1,0 | CET12P | | |
| 2.0 TD | 4 | 20T2N | 74/99 | 03/03→05/05 | CH169 | 11v | | | |

MINI



MINI

| | | | | | | | | | | |
|---------------|---|----------------------|---------|-------------|-------|-----|--------|-----------------|------------------------|--------|
| 1.2 One | 3 | B38A12A | 75/101 | 04/14→ | | | | OE245 | BAEA538 →06/17 | |
| 1.2 One First | 3 | B38A12A | 55/74 | 06/14→10/17 | | | | OE245 →10/15 | BAEA538 →06/17 | |
| 1.4 One | 4 | W10B14A | 55/74 | 04/03→03/10 | OE223 | 1,6 | CET12P | | BAEA382 | |
| 1.4 One | 4 | N12B14A | 55/74 | 04/03→03/10 | OE204 | 1,0 | CET16P | | BAEA143 →02/10 | |
| 1.4 One | 4 | N12B14A | 70/94 | 11/06→03/10 | OE204 | 1,0 | CET16P | | BAEA143 →02/10 | |
| 1.5 Cooper | 3 | B36A15A; B38A15A | 100/134 | 09/13→ | | | | OE245 | BAEA538 →06/17 | |
| 1.6 Cooper | 4 | W10B16A | 85/114 | 06/01→04/15 | OE223 | 1,6 | CET12P | OE188 | BAEA382 BAEA382[85] | CLS069 |
| 1.6 Cooper | 4 | N12B16A | 85/114 | 06/01→04/15 | OE204 | 1,0 | CET16P | | BAEA143 | |
| 1.6 Cooper | 4 | N16B16A | 85/114 | 06/01→04/15 | OE204 | 1,0 | CET16P | | BAEA143 | |
| 1.6 Cooper | 4 | N12B16A | 88/118 | 10/06→06/15 | OE204 | 1,0 | CET16P | | BAEA143 →08/10 | |
| 1.6 Cooper | 4 | N12B16A; N16B16A | 90/121 | 09/09→06/15 | OE204 | 1,0 | CET16P | | BAEA143 | |
| 1.6 Cooper D | 4 | 9HZ(DV6TED4); W16D16 | 80/107 | 11/06→09/10 | CH201 | 11v | | | | |
| 1.6 Cooper S | 4 | N18B16A | 120/161 | 03/02→06/15 | OE205 | 0,7 | CET16P | | | |
| 1.6 Cooper S | 4 | W11B16A | 120/161 | 03/02→06/15 | OE223 | 1,6 | CET12P | OE188 | BAEA382 | CLS069 |
| 1.6 Cooper S | 4 | W11B16A | 125/168 | 07/04→12/08 | OE223 | 1,6 | CET12P | OE188 | BAEA382 | CLS069 |
| 1.6 Cooper S | 4 | N14B16A; N14B16AB | 128/172 | 10/06→12/14 | OE205 | 0,7 | CET16P | | BAEA143 | |
| 1.6 Cooper S | 4 | N18B16A | 135/181 | 02/10→06/15 | OE205 | 0,7 | CET16P | | BAEA143 | |
| 1.6 Cooper S | 4 | N14B16A | 135/181 | 02/10→06/15 | OE205 | 0,7 | CET16P | | | |

CHAMPION



kW/BHP

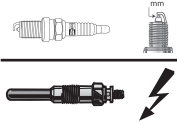

eon TITAN

IRIDIUM

**...MINI****...MINI**

| | | | | | | | | | | |
|---|---|------------------|---------|-------------|-------|-----|--------|-------|---------|--------|
| 1.6 Cooper S, 1.6 Cooper S JCW | 4 | N18B16A | 147/197 | 02/10→06/15 | OE205 | 0,7 | CET16P | | | |
| 1.6 John Cooper Works | 4 | N14B16C | 155/208 | 07/04→05/15 | OE205 | 0,7 | | | BAEA143 | |
| 1.6 John Cooper Works | 4 | N18B16C | 155/208 | 07/04→05/15 | | | | | BAEA143 | |
| 1.6 John Cooper Works, 1.6 John Cooper Works GP | 4 | N18B16C; W11B16A | 160/215 | 03/06→11/13 | OE205 | 0,7 | | | | |
| 1.6 John Cooper Works, 1.6 Works | 4 | W11B16A | 155/208 | 11/03→05/15 | OE223 | 1,6 | CET2 | OE188 | BAEA382 | |
| 1.6 One | 4 | N16B16A | 55/74 | 03/10→11/13 | OE204 | 1,0 | CET16P | | BAEA143 | |
| 1.6 One | 4 | W10B16A | 66/89 | 06/01→11/07 | OE223 | 1,6 | CET12P | OE188 | BAEA382 | CLS069 |
| 1.6 One | 4 | N16B16A | 72/97 | 09/09→06/15 | OE204 | 1,0 | CET16P | | BAEA143 | |
| 1.6 One D | 4 | 9HZ(DV6TED4) | 66/89 | 06/09→11/13 | CH201 | 11v | | | | |
| 1.6 S Works | 4 | W11B16A | 149/200 | 11/03→06/05 | OE223 | 1,6 | CET2 | OE188 | BAEA382 | |
| 2.0 Cooper S | 4 | B48A20A | 120/161 | 09/13→ | | | | OE245 | BAEA538 | |
| | | | | | | | | | →06/17 | |
| 2.0 Cooper S | 4 | B46A20A | 120/161 | 09/13→ | | | | OE245 | BAEA538 | |
| | | | | | | | | | →06/17 | |
| 2.0 Cooper S | 4 | B48A20A | 141/189 | 09/13→ | | | | OE245 | BAEA538 | |
| | | | | | | | | | →06/17 | |
| 2.0 Cooper S | 4 | B46A20A | 141/189 | 09/13→ | | | | OE245 | BAEA538 | |
| | | | | | | | | | →06/17 | |
| 2.0 John Cooper Works | 4 | B48A20B | 170/228 | 03/15→ | | | | OE245 | BAEA538 | |
| | | | | | | | | | →06/17 | |

MINI CLUBMAN

| | | | | | | | | | | |
|--------------------------------|---|------------------|---------|-------------|--------|-----|--------|--------|---------|--|
| 1.4 One | 4 | N12B14A | 70/94 | 03/09→02/10 | OE204 | 1,0 | CET16P | | BAEA143 | |
| 1.5 Cooper | 3 | B36A15A; B38A15A | 100/134 | 12/14→ | | | | OE245 | BAEA538 | |
| | | | | | | | | →10/15 | →06/17 | |
| 1.5 One | 3 | B38A15A | 75/101 | 02/15→ | | | | OE245 | BAEA538 | |
| | | | | | | | | | →06/17 | |
| 1.6 Cooper | 4 | N16B16A | 85/114 | 03/10→06/14 | OE204 | 1,0 | CET16P | | BAEA143 | |
| 1.6 Cooper | 4 | N12B16A; N16B16A | 88/118 | 10/07→12/13 | OE204 | 1,0 | CET16P | | BAEA143 | |
| | | | | | | | | | →07/10 | |
| 1.6 Cooper | 4 | N16B16A | 90/121 | 03/10→06/14 | OE204 | 1,0 | CET16P | | BAEA143 | |
| 1.6 Cooper D | 4 | 9HZ(DV6TED4) | 80/107 | 10/07→02/10 | CH201 | 11v | | | | |
| 1.6 Cooper S | 4 | N14B16A | 120/161 | 10/07→02/10 | OE205 | 0,7 | CET16P | | BAEA143 | |
| 1.6 Cooper S | 4 | N14B16AB | 128/172 | 10/07→02/10 | OE205 | 0,7 | CET16P | | BAEA143 | |
| 1.6 Cooper S | 4 | N18B16A | 135/181 | 03/10→06/14 | OE205 | 0,7 | CET16P | | | |
| 1.6 Cooper S | 4 | N18B16A | 147/197 | 03/10→06/14 | OE205 | 0,7 | CET16P | | | |
| 1.6 John Cooper Works | 4 | N14B16C | 155/208 | 11/07→06/14 | OE205 | 0,7 | | | BAEA143 | |
| | | | | | 05/08→ | | | | | |
| 1.6 John Cooper Works | 4 | N18B16C | 155/208 | 11/07→06/14 | | | | | BAEA143 | |
| 1.6 One | 4 | N16B16A | 72/97 | 03/10→06/14 | OE204 | 1,0 | CET16P | | BAEA143 | |
| 2.0 Cooper S | 4 | B46A20A; B48A20A | 141/189 | 11/14→ | | | | OE245 | BAEA538 | |
| | | | | | | | | | →06/17 | |
| 2.0 Cooper S, 2.0 Cooper S 4WD | 4 | B48A20A | 120/161 | 11/14→ | | | | OE245 | BAEA538 | |
| | | | | | | | | →10/15 | →06/17 | |
| 2.0 Cooper S 4WD | 4 | B48A20A | 141/189 | 04/15→ | | | | OE245 | BAEA538 | |
| | | | | | | | | →10/15 | →06/17 | |
| 2.0 John Cooper Works 4WD | 4 | B48A20B | 170/228 | 11/15→ | | | | OE245 | BAEA538 | |
| | | | | | | | | | →06/17 | |

MINI COUNTRYMAN

| | | | | | | | | | | |
|----------------------------|---|------------------|---------|-------------|-------|-----|--------|-------|---------|--|
| 1.5 Cooper, 1.5 Cooper 4WD | 3 | B36A15A; B38A15A | 100/134 | 10/16→ | | | | OE245 | | |
| 1.5 Cooper SE 4WD | 3 | B38A15A | 165/221 | 01/17→ | | | | OE245 | | |
| 1.6 Cooper | 4 | N16B16A | 85/114 | 01/10→10/16 | OE204 | 1,0 | CET16P | | BAEA143 | |
| 1.6 Cooper | 4 | N16B16A | 88/118 | 01/10→10/16 | | | | | BAEA143 | |
| 1.6 Cooper | 4 | N16B16A | 90/121 | 01/10→10/16 | OE204 | 1,0 | CET16P | | BAEA143 | |
| | | | | | | | | | 09/10→ | |
| 1.6 Cooper 4WD | 4 | N16B16A | 90/121 | 11/12→10/16 | | | | | BAEA143 | |
| 1.6 Cooper S | 4 | N18B16A | 147/197 | 01/10→10/16 | OE205 | 0,7 | CET16P | | | |





kW/BHP



eon TITAN

IRIDIUM



...MINI



...MINI COUNTRYMAN

| | | | | | | | | | |
|--------------------------------|---|------------------|---------|-------------|-------|-----|--------|-------|-------------------|
| 1.6 Cooper S, 1.6 Cooper S 4WD | 4 | N14B16A; N18B16A | 135/181 | 01/10→10/16 | OE205 | 0,7 | CET16P | | BAEA143 |
| 1.6 Cooper S 4WD | 4 | N18B16A | 120/161 | 01/10→10/16 | OE205 | 0,7 | CET16P | | |
| 1.6 John Cooper Works 4WD | 4 | N18B16A | 160/215 | 04/11→10/16 | OE205 | 0,7 | | | |
| 1.6 One | 4 | N16B16A | 72/97 | 01/10→09/16 | OE204 | 1,0 | CET16P | | BAEA143 |
| 2.0 Cooper S, 2.0 Cooper S 4WD | 4 | B46A20A; B48A20A | 120/161 | 10/16→ | | | | OE245 | BAEA538 →06/17 |
| 2.0 Cooper S, 2.0 Cooper S 4WD | 4 | B46A20A; B48A20A | 141/189 | 10/16→ | | | | OE245 | BAEA538 →06/17 |
| 2.0 John Cooper Works 4WD | 4 | B48A20B | 170/228 | 01/17→ | | | | OE245 | |

MINI PACEMAN

| | | | | | | | | | |
|--------------------------------|---|---------|---------|-------------|-------|-----|--------|--|---------|
| 1.6 Cooper | 4 | N16B16A | 88/118 | 04/12→09/16 | | | | | BAEA143 |
| 1.6 Cooper | 4 | N16B16A | 90/121 | 04/12→09/16 | OE204 | 1,0 | CET16P | | BAEA143 |
| 1.6 Cooper 4WD | 4 | N16B16A | 90/121 | 11/12→09/16 | | | | | BAEA143 |
| 1.6 Cooper S, 1.6 Cooper S 4WD | 4 | N18B16A | 135/181 | 03/12→09/16 | OE205 | 0,7 | CET16P | | |

MINI



MINI CLUBVAN

| | | | | | | | | | |
|------------|---|---------|--------|-------------|-------|-----|--------|--|---------|
| 1.6 Cooper | 4 | N16B16A | 90/121 | 12/12→06/14 | OE204 | 1,0 | CET16P | | BAEA143 |
| 1.6 One | 4 | N16B16A | 72/97 | 12/12→06/14 | OE204 | 1,0 | CET16P | | BAEA143 |

MITSUBISHI



380

| | | | | | | | | | |
|-------|---|------|---------|-------------|--|--|--------|-------|--|
| 3.8 i | 6 | 6G75 | 175/235 | 04/05→04/08 | | | CET12P | OE179 | |
|-------|---|------|---------|-------------|--|--|--------|-------|--|

ASX

| | | | | | | | | | |
|------------------|---|------|---------|--------|--|--|--------|-------|---------|
| 1.6 MIVEC | 4 | 4A92 | 85/114 | 05/10→ | | | CET14P | OE190 | BAEA547 |
| 1.6 MIVEC | 4 | 4A92 | 86/115 | 06/10→ | | | CET14P | OE190 | BAEA547 |
| 1.8, 1.8 4WD | 4 | 4B10 | 102/137 | 02/10→ | | | CET12P | OE179 | |
| 2.0 i, 2.0 i 4WD | 4 | 4B11 | 110/148 | 06/10→ | | | CET12P | OE182 | |
| 2.0 i, 2.0 i 4WD | 4 | 4B11 | 118/158 | 06/10→ | | | CET12P | OE182 | |

CARISMA

| | | | | | | | | | |
|---------------------------|---|---------------|---------|-------------|-----------------|-----|--------|-------|--------------------|
| 1.6 | 4 | 4G92(SOHC16V) | 66/89 | 07/95→06/06 | OE039 | 1,0 | CET2 | OE179 | BAEA179E 05/97→ |
| 1.6 | 4 | 4G92(SOHC16V) | 70/94 | 12/98→06/06 | OE039 | 1,0 | CET2 | OE179 | BAEA179E |
| 1.6 | 4 | 4G92(SOHC16V) | 73/98 | 05/97→06/06 | OE039 | 1,0 | CET2 | OE179 | BAEA179E |
| 1.6 | 4 | 4G92(SOHC16V) | 76/102 | 09/00→06/06 | OE039 | 1,0 | CET2 | OE179 | BAEA179E |
| 1.8 | 4 | 4G93(SOHC16V) | 85/114 | 07/95→09/97 | OE039 | 1,0 | CET2 | OE179 | BAEA179E 05/97→ |
| 1.8 16V GDI | 4 | 4G93(GDI) | 92/123 | 09/97→06/06 | OE227 | 0,6 | CET12P | OE188 | BAEA179E |
| | | | | | OE216 LPG [278] | 0,8 | | | |
| 1.8 GDI | 4 | 4G93(GDI) | 90/121 | 10/00→06/06 | OE227 | 0,6 | CET12P | OE188 | |
| | | | | | OE216 LPG [278] | 0,8 | | | |
| 1.8 MSX - 16V | 4 | 4G93(DOHC16V) | 103/138 | 07/95→07/97 | OE039 | 1,0 | CET2 | OE179 | |
| 1.9 DI-D | 4 | F9Q1 | 75/101 | 09/00→06/06 | CH271 | 11v | | | |
| 1.9 DI-D | 4 | F9Q2 | 85/114 | 09/00→06/06 | CH271 | 11v | | | |
| 1.9 TD | 4 | F8QT | 66/89 | 10/96→09/00 | CH260 | 11v | | | |
| 2.0 16V GT EVO VI/VII 4WD | 4 | 4G63Turbo | 206/276 | 11/99→06/06 | OE006 | 0,9 | CET8 | OE195 | |

COLT CZC

| | | | | | | | | | |
|-----------|---|-------|---------|-------------|-------|-----|------|-------|--|
| 1.5 | 4 | 4A91 | 80/107 | 05/06→07/09 | OE035 | 0,9 | CET5 | OE190 | |
| 1.5 Turbo | 4 | 4G15T | 110/148 | 05/06→07/09 | OE035 | 0,9 | CET5 | OE190 | |

COLT IV

| | | | | | | | | | |
|---------|---|---------------|--------|-------------|-------|-----|------|-------|--|
| 1.6 | 4 | 4G92(SOHC16V) | 66/89 | 02/94→04/96 | OE039 | 1,0 | CET2 | OE179 | |
| 1.6 4WD | 4 | 4G92(SOHC16V) | 84/113 | 08/93→08/95 | OE039 | 1,0 | CET2 | OE179 | |





kW/BHP



eon TITAN

IRIDIUM

**...MITSUBISHI****COLT V**

| | | | | | | | | | | |
|------------------|---|---------------|---------|-------------|-------|-----|------|-------|----------|--------|
| 1.3 | 4 | 4G19 | 66/89 | 08/02→09/03 | OE063 | 1,0 | CET2 | OE180 | | |
| 1.3 1300 | 4 | 4G13(16V) | 60/80 | 06/00→09/03 | OE039 | 1,0 | CET2 | OE179 | BAEA178E | CLS010 |
| 1.3 1300 GL, GLX | 4 | 4G13(12V) | 55/74 | 05/96→06/00 | OE048 | 1,0 | CET8 | OE195 | BAEA264 | CLS169 |
| 1.5 | 4 | 4G15(16V) | 81/109 | 09/95→09/03 | OE006 | 0,9 | CET8 | OE195 | | |
| 1.5 16V | 4 | 4G15(16V) | 69/93 | 10/99→09/03 | OE048 | 1,0 | CET8 | OE195 | | |
| 1.6 1600 | 4 | 4G92(SOHC16V) | 76/102 | 09/00→09/03 | OE039 | 1,0 | CET2 | OE179 | BAEA179E | |
| 1.6 1600 GLX | 4 | 4G92(SOHC16V) | 66/89 | 05/96→09/00 | OE039 | 1,0 | CET2 | OE179 | BAEA179E | |
| 1.8 | 4 | 4G93 | 109/146 | 11/97→07/01 | OE039 | 1,0 | CET2 | OE179 | | |

COLT VI

| | | | | | | | | | | |
|--------------|---|------------|---------|-------------|-----------------|-----|------|-------|-----------------------------|--|
| 1.1 | 3 | 3A91 | 55/74 | 10/04→06/12 | OE238 →06/10 | 1,0 | CET5 | OE190 | BAEA547 Prod.01.07.2010→ | |
| | | | | | OE035 | 0,9 | | | | |
| 1.1 LPG | 3 | 3A91 | 55/74 | 10/04→06/12 | OE034 | 0,9 | CET2 | OE179 | | |
| 1.3 | 4 | 4A90 | 70/94 | 06/04→06/12 | OE238 →06/10 | 1,0 | CET5 | OE190 | BAEA547 Prod.01.07.2010→ | |
| | | | | | OE035 | 0,9 | | | | |
| 1.3 LPG | 4 | 4A90 | 70/94 | 06/04→06/12 | OE238 | 1,0 | | | | |
| 1.5 | 4 | 4G15(16V) | 72/97 | 09/04→02/06 | OE048 | 1,0 | CET8 | OE195 | | |
| 1.5 | 4 | 4A91 | 80/107 | 06/04→06/12 | OE238 →06/10 | 1,0 | CET5 | OE190 | | |
| | | | | | OE035 | 0,9 | | | | |
| 1.5, 1.5 4WD | 4 | 4A91; 4G91 | 77/103 | 07/06→06/12 | OE035 | 0,9 | CET5 | OE190 | | |
| 1.5 CZT | 4 | 4G15T | 110/148 | 03/05→06/12 | OE035 | 0,9 | CET5 | OE190 | | |

COLT PLUS VII

| | | | | | | | | | | |
|---------|---|------|--------|--------|-------|-----|------|-------|--|--|
| 1.5 | 4 | 4A91 | 77/103 | 08/04→ | OE035 | 0,9 | CET5 | OE190 | | |
| 1.5 4WD | 4 | 4A91 | 75/101 | 08/04→ | OE035 | 0,9 | CET5 | OE190 | | |

DIAMANTE II

| | | | | | | | | | | |
|-----|---|---------------|---------|-------------|-------|-----|--------|-------|--|--|
| 2.5 | 6 | 6G73 | 147/197 | 09/99→08/04 | OE136 | 0,8 | CET12P | OE179 | | |
| 3.0 | 6 | 6G72(DOHC24V) | 140/188 | 06/99→09/02 | OE146 | 1,0 | CET12P | OE179 | | |
| 3.5 | 6 | 6G74(SOHC24V) | 157/211 | 10/02→11/05 | OE146 | 1,0 | CET12P | OE184 | | |

DION

| | | | | | | | | | | |
|-------------|---|------------|---------|-------------|-----------------|-----|--------|-------|--|--|
| 1.8 16V 4WD | 4 | 4G93T(GDI) | 121/162 | 12/99→12/05 | OE227 | 0,6 | CET12P | OE188 | | |
| | | | | | OE216 LPG [278] | 0,8 | | | | |

ECLIPSE

| | | | | | | | | | | |
|-----|---|---------------|---------|-------------|-------|-----|------|-------|--|--|
| 1.8 | 4 | 4G93(SOHC16V) | 102/137 | 04/94→04/99 | OE039 | 1,0 | CET2 | OE179 | | |
| 1.8 | 4 | 4G93 | 103/138 | 05/99→03/05 | OE039 | 1,0 | CET2 | OE179 | | |

ECLIPSE II

| | | | | | | | | | | |
|-----------------|---|-----------------|---------|-------------|-------|-----|------|-------|--|--|
| 2.0 2000 GS 16V | 4 | 4G63(DOHC16V) | 107/143 | 12/95→04/99 | OE006 | 0,9 | CET8 | OE195 | | |
| 2.0 2000 GT 16V | 4 | 4G63-T(DOHC16V) | 157/211 | 12/95→04/99 | OE006 | 0,9 | CET8 | OE195 | | |
| 2.4 2400 GS 16V | 4 | 4G64(16V) | 105/141 | 09/98→04/99 | OE039 | 1,0 | CET2 | OE180 | | |

ECLIPSE III

| | | | | | | | | | | |
|-----|---|---------------|---------|-------------|-------|-----|--------|-------|--|--|
| 3.0 | 6 | 6G72(DOHC24V) | 149/200 | 05/99→03/05 | OE146 | 1,0 | CET12P | OE179 | | |
|-----|---|---------------|---------|-------------|-------|-----|--------|-------|--|--|

ECLIPSE IV

| | | | | | | | | | | |
|--------|---|------|---------|-------------|--|--|--------|-------|--|--|
| 2.4 GS | 4 | 4G69 | 120/161 | 04/05→12/11 | | | CET14P | OE190 | | |
|--------|---|------|---------|-------------|--|--|--------|-------|--|--|

FTO

| | | | | | | | | | | |
|-----|---|---------------|--------|-------------|-------|-----|------|-------|--|--|
| 1.8 | 4 | 4G93(SOHC16V) | 92/123 | 09/94→07/01 | OE039 | 1,0 | CET2 | OE179 | | |
|-----|---|---------------|--------|-------------|-------|-----|------|-------|--|--|

GALANT

| | | | | | | | | | | |
|----------------------------------|---|-----------|---------|--------|--|--|--------|-------|--|--|
| 2.0 GDi G, 2.0 GDi V 4WD | 4 | 4G94(GDI) | 107/143 | 10/03→ | | | CET12P | OE184 | | |
| 2.4 GDi Sport, 2.4 GDi Sport 4WD | 4 | 4G69 | 121/162 | 10/03→ | | | CET14P | OE190 | | |
| 3.8 GDi, 3.8 GDi 4WD | 6 | 6G75 | 171/229 | 10/03→ | | | CET12P | OE179 | | |

GALANT V

| | | | | | | | | | | |
|-----|---|---------------|--------|-------------|-------|-----|------|-------|--|--|
| 1.8 | 4 | 4G93(SOHC16V) | 85/114 | 02/94→08/96 | OE039 | 1,0 | CET2 | OE179 | | |
|-----|---|---------------|--------|-------------|-------|-----|------|-------|--|--|

MITSUBISHI





kW/BHP



eon TITAN

IRIDIUM



...MITSUBISHI



GALANT VI

| | | | | | | | | | |
|------------|---|---------------|---------|-------------|--------------------------|------------|---------|-------|--------------------------|
| 1.8 GDi | 4 | 4G93(GDI) | 103/138 | 11/97→10/01 | OE227 OE216 LPG [278] | 0,6 0,8 | CET1 2P | OE188 | |
| 2.0 | 4 | 4G63(SOHC16V) | 98/131 | 09/00→10/04 | OE136 | 0,8 | CET1 2P | OE179 | BAEA179E ^[41] |
| 2.0 | 4 | 4G63(SOHC16V) | 100/134 | 09/96→09/00 | OE005 | 0,9 | CET2 | OE180 | BAEA179E ^[41] |
| 2.0 GDI | 4 | 4G94(GDI) | 107/143 | 01/97→10/04 | | | CET1 2P | OE184 | |
| 2.0 TDI | 4 | 4D68T | 66/89 | 09/96→10/04 | CH256 →02/00 | 11v | | | |
| 2.4 | 4 | 4G69 | 121/162 | 10/03→10/04 | | | CET1 4P | OE190 | |
| 2.4 GDI | 4 | 4G64(GDI) | 106/142 | 09/00→10/04 | | | CET1 2P | OE184 | |
| 2.4 GDI | 4 | 4G64(GDI) | 110/148 | 02/99→10/03 | | | CET1 2P | OE184 | CLS010 |
| 2.5 V6 24V | 6 | 6A13 | 118/158 | 09/00→10/04 | OE136 | 0,8 | CET1 2P | OE179 | |
| 2.5 V6 24V | 6 | 6A13 | 120/161 | 09/96→09/00 | OE136 | 0,8 | CET1 2P | OE179 | BAEA179E |

GALLOPER

| | | | | | | | | | |
|------------------------|---|------|---------|-------------|-----------------|-----|------|-------|--|
| 2.5 TD 4WD | 4 | D4BF | 65/87 | 09/98→12/03 | CH256 | 11v | | | |
| 2.5 TD intercooler 4WD | 4 | D4BH | 73/98 | 09/98→12/03 | CH256 →12/01 | 11v | | | |
| 3.0 V6 4WD | 6 | G6AT | 104/139 | 09/98→12/03 | OE039 | 1,0 | CET2 | OE180 | |

GRANDIS

| | | | | | | | | | |
|-----------|---|------|---------|-------------|--|--|---------|-------|--|
| 2.4 MIVEC | 4 | 4G69 | 121/162 | 04/04→12/11 | | | CET1 4P | OE190 | |
| 2.4 MIVEC | 4 | 4G69 | 130/174 | 04/04→12/11 | | | CET1 4P | OE190 | |

i

| | | | | | | | | | |
|---------|---|-------|-------|--------|-------|-----|---------|--|--|
| 0.7 | 3 | 3B20 | 38/51 | 01/10→ | OE229 | 0,8 | CET1 5P | | |
| 0.7 | 3 | 3B20T | 42/56 | 01/06→ | OE229 | 0,8 | CET1 5P | | |
| 0.7 4WD | 3 | 3B20T | 47/63 | 08/10→ | OE229 | 0,8 | CET1 5P | | |

KUDA

| | | | | | | | | | |
|-----|---|------|-------|-------------|-------|-----|------|-------|--|
| 1.8 | 4 | 4G37 | 66/89 | 06/98→04/03 | OE006 | 0,9 | CET8 | OE195 | |
|-----|---|------|-------|-------------|-------|-----|------|-------|--|

L 200

| | | | | | | | | | |
|------------|---|---------------|--------|-------------|----------------|------------|------|-------|--|
| 2.0 | 4 | 4G63(SOHC16V) | 90/121 | 06/96→12/07 | OE018 | 1,0 | CET8 | OE195 | |
| 2.4 4WD | 4 | 4G64(16V) | 97/130 | 06/96→12/07 | OE048 | 1,0 | CET8 | OE195 | |
| 2.5 TD | 4 | 4D56T | 66/89 | 08/01→11/05 | CH221 CH256 | 11v 11v | | | |
| 2.5 TD 4WD | 4 | 4D56TD | 73/98 | 06/96→12/07 | CH256 | 11v | | | |
| 2.5 TD 4WD | 4 | 4D56T | 85/114 | 09/01→12/07 | CH256 | 11v | | | |
| 2.5 TD 4WD | 4 | 4D56T | 98/131 | 08/01→12/07 | CH256 | 11v | | | |

LANCER V

| | | | | | | | | | |
|-----------------|---|---------------|---------|-------------|-----------------|-----|------|-------|--|
| 1.3 16V | 4 | 4G13(12V) | 55/74 | 09/97→10/99 | OE006 | 0,9 | CET8 | OE195 | |
| 1.6 | 4 | 4G92(SOHC16V) | 66/89 | 02/94→12/96 | OE039 | 1,0 | CET2 | OE179 | |
| 1.8 4WD, 1.8 i | 4 | 4G93 | 88/118 | 03/95→10/03 | OE039 | 1,0 | CET2 | OE179 | |
| 2.0 D | 4 | 4D68T | 65/87 | 03/95→10/03 | CH256 →05/96 | 11v | | | |
| 2.0 EVO II 4WD | 4 | 4G63Turbo | 192/257 | 01/94→07/95 | | | CET8 | OE195 | |
| 2.0 EVO III 4WD | 4 | 4G63Turbo | 198/266 | 08/95→07/96 | | | CET8 | OE195 | |

LANCER VI

| | | | | | | | | | |
|-------------|---|---------------|---------|-------------|--------------------------|------------|---------|-------|------------------|
| 1.3 12V | 4 | 4G13(12V) | 55/74 | 12/95→08/03 | OE048 | 1,0 | CET8 | OE195 | |
| 1.3 12V | 4 | 4G13 | 55/74 | 12/95→08/03 | | | | | CLS169 04/98→ |
| 1.5 16V | 4 | 4G15(12V) | 81/109 | 09/95→08/99 | OE048 | 1,0 | CET8 | OE195 | |
| 1.6 16V | 4 | 4G92(SOHC16V) | 66/89 | 12/95→08/03 | OE039 | 1,0 | CET2 | OE179 | |
| 1.8 | 4 | 4G93 | 91/122 | 09/95→08/03 | OE039 | 1,0 | CET2 | OE179 | |
| 1.8 16V | 4 | 4G93T | 151/202 | 09/95→08/03 | OE039 | 1,0 | CET2 | OE179 | |
| 1.8 GDI | 4 | 4G93(GDI) | 96/129 | 06/00→08/03 | OE227 OE216 LPG [278] | 0,6 0,8 | CET1 2P | OE188 | |
| 1.8 GDI 4WD | 4 | 4G93T(GDI) | 121/162 | 06/00→08/03 | OE227 OE216 LPG [278] | 0,6 0,8 | CET1 2P | OE188 | |

MITSUBISHI





kW/BHP



eon TITAN

IRIDIUM

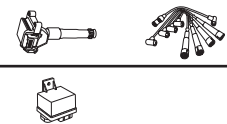

...MITSUBISHI



...LANCER VI

| | | | | | | | | | | |
|----------------|---|-----------|---------|-------------|-------|-----|--------|-------|--|--|
| 2.0 | 4 | 4G94(GDI) | 92/123 | 09/95→08/03 | | | CET12P | OE184 | | |
| 2.0 D | 4 | 4D68 | 50/67 | 09/95→08/03 | CH256 | 11v | | | | |
| 2.0 EVO V 4WD | 4 | 4G63Turbo | 206/276 | 01/98→12/98 | | | CET8 | OE195 | | |
| 2.0 EVO VI 4WD | 4 | 4G63Turbo | 207/278 | 01/99→02/01 | | | CET8 | OE195 | | |

LANCER VII

| | | | | | | | | | | |
|------------------------|---|---------------|---------|-------------|--------------------------|------------|--------|-------|--------------------|--------|
| 1.3 | 4 | 4G13(16V) | 60/80 | 09/03→ | | | CET2 | OE179 | BAEA178E →04/10 | CLS010 |
| 1.6 | 4 | 4G18 | 72/97 | 09/03→ | | | CET2 | OE179 | BAEA178E | CLS010 |
| 1.8 GDi T | 4 | 4G93T(GDI) | 121/162 | 09/03→10/08 | OE227 OE216 LPG [278] | 0,6 0,8 | CET12P | OE188 | | |
| 1.8 SEi Limited | 4 | 4G93 | 91/122 | 09/03→03/07 | OE039 | 1,0 | CET2 | OE179 | | |
| 2.0 | 4 | 4G63(DOHC16V) | 85/114 | 08/03→ | | | | | BAEA193E | |
| 2.0 | 4 | 4G63(DOHC16V) | 99/133 | 09/03→ | | | CET8 | OE195 | BAEA193E | |
| 2.0 EVO VIII - 260 4WD | 4 | 4G63Turbo | 195/261 | 03/04→07/05 | | | CET8 | OE195 | BAEA193E | |
| 2.0 EVO IX 4WD | 4 | 4G63Turbo | 206/276 | 01/05→09/07 | | | CET8 | OE195 | | |
| 2.0 EVO IX 4WD | 4 | 4G63Turbo | 213/286 | 08/05→09/06 | | | CET8 | OE195 | | |
| 2.0 GDi | 4 | 4G94(GDI) | 92/123 | 09/03→ | | | CET12P | OE184 | | |

LANCER VIII

| | | | | | | | | | | |
|--|---|------|---------|--------|-------|-----|--------|-------|---------|--|
| 1.5 | 4 | 4A91 | 80/107 | 06/08→ | OE035 | 0,9 | CET5 | OE190 | BAEA547 | |
| 1.5 Bifuel | 4 | 4A91 | 80/107 | 02/10→ | OE035 | 0,9 | CET5 | OE190 | | |
| 1.6 MIVEC | 4 | 4A92 | 86/115 | 05/10→ | | | CET14P | OE190 | BAEA547 | |
| 1.8, 1.8 Bifuel | 4 | 4B10 | 105/141 | 02/08→ | | | CET12P | OE179 | | |
| 1.8, 1.8 Flex, 1.8 Flexfuel, 1.8 MIVEC | 4 | 4B10 | 103/138 | 03/09→ | | | CET12P | OE179 | | |
| 2.0 | 4 | 4B11 | 108/145 | 01/09→ | | | CET12P | OE182 | | |
| 2.0 | 4 | 4B11 | 115/154 | 04/08→ | | | CET12P | OE182 | | |
| 2.0 i | 4 | 4B11 | 113/152 | 10/07→ | | | CET12P | OE182 | | |

MAGNA

| | | | | | | | | | | |
|--|---|---------------|---------|-------------|-------|-----|--------|-------|--|--|
| 3.0 | 6 | 6G72(SOHC24V) | 150/201 | 08/00→07/02 | OE146 | 1,0 | CET12P | OE179 | | |
| 3.0 i | 6 | 6G72(SOHC24V) | 140/188 | 04/96→05/03 | OE146 | 1,0 | CET12P | OE179 | | |
| 3.5 | 6 | 6G74(SOHC24V) | 143/192 | 06/03→09/04 | OE146 | 1,0 | CET12P | OE184 | | |
| 3.5, 3.5 i | 6 | 6G74(SOHC24V) | 147/197 | 03/99→05/03 | OE146 | 1,0 | CET12P | OE184 | | |
| 3.5 i | 6 | 6G74(SOHC24V) | 155/208 | 08/00→07/05 | OE146 | 1,0 | CET12P | OE184 | | |
| 3.5 i | 6 | 6G74(SOHC24V) | 157/211 | 10/04→05/05 | OE146 | 1,0 | CET12P | OE184 | | |
| 3.5 i 4WD | 6 | 6G74(SOHC24V) | 159/213 | 06/03→05/05 | OE146 | 1,0 | CET12P | OE184 | | |
| 3.5 i Series II Raliant | 6 | 6G74(DOHC24V) | 180/241 | 08/02→05/05 | OE146 | 1,0 | CET12P | OE184 | | |
| 3.5 i Sport, 3.5 Series II Sports VR-X | 6 | 6G74(SOHC24V) | 163/219 | 08/00→05/05 | OE146 | 1,0 | CET12P | OE184 | | |

MIRAGE

| | | | | | | | | | | |
|---------|---|-----------|---------|-------------|-------|-----|------|-------|--|--|
| 1.5 | 4 | 4G15(12V) | 66/89 | 09/95→08/99 | OE048 | 1,0 | CET8 | OE195 | | |
| 1.5 | 4 | 4G15(16V) | 81/109 | 09/95→12/00 | OE048 | 1,0 | CET8 | OE195 | | |
| 1.8 4WD | 4 | 4G93T | 152/204 | 09/95→08/99 | OE039 | 1,0 | CET2 | OE179 | | |

MIRAGE V

| | | | | | | | | | | |
|-----|---|-----------|--------|-------------|-------|-----|------|-------|--|--|
| 1.5 | 4 | 4G15(12V) | 81/109 | 09/95→08/99 | OE048 | 1,0 | CET8 | OE195 | | |
|-----|---|-----------|--------|-------------|-------|-----|------|-------|--|--|

OUTLANDER I

| | | | | | | | | | | |
|------------------------|---|-----------------|---------|-------------|--|--|--------|-------|----------|--|
| 2.0, 2.0 4WD | 4 | 4G63(DOHC16V) | 100/134 | 05/03→10/06 | | | CET8 | OE195 | BAEA193E | |
| 2.0 4WD | 4 | 4G63(DOHC16V) | 93/125 | 05/03→10/06 | | | CET8 | OE195 | | |
| 2.0 Turbo 4WD | 4 | 4G63-T(DOHC16V) | 148/198 | 04/04→10/06 | | | CET8 | OE195 | BAEA193E | |
| 2.0 Turbo-R 4WD | 4 | 4G63Turbo | 177/237 | 01/02→10/06 | | | CET8 | OE195 | BAEA193E | |
| 2.4 4WD | 4 | 4G64(16V) | 102/137 | 05/03→10/06 | | | CET12P | OE180 | | |
| 2.4 4WD | 4 | 4G69 | 119/160 | 05/03→10/06 | | | CET14P | OE190 | | |
| 2.4 4WD, 2.4 HDD Mivec | 4 | 4G69 | 118/158 | 03/01→12/06 | | | CET14P | OE190 | | |

MITSUBISHI





kW/BHP



eon TITAN

IRIDIUM



...MITSUBISHI



OUTLANDER II

| | | | | | | | | | |
|----------------------------|---|----------|---------|---------------|-------|-----|---------|-------|--------|
| 2.0, 2.0 4WD | 4 | 4B11 | 108/145 | 11/06 → 11/12 | | | CET1 2P | OE182 | |
| 2.2 DI-D, 2.2 DI-D 4WD | 4 | 4N14 | 130/174 | 11/06 → 11/12 | | | | | CCU147 |
| 2.2 DI-D 4WD | 4 | 4N14 | 103/138 | 09/10 → 11/12 | | | | | CCU147 |
| 2.2 DI-D 4WD | 4 | 4HK; 4HN | 115/154 | 08/07 → 11/12 | | | | | CCU147 |
| 2.4, 2.4 4WD, 2.4 Flex 4WD | 4 | 4B12 | 125/168 | 11/06 → 11/12 | | | CET1 2P | OE180 | |
| 3.0, 3.0 4WD | 6 | 6B31 | 162/217 | 11/06 → 11/12 | OE229 | 0,8 | CET1 5P | | |
| 3.0 4WD | 6 | 6B31 | 177/237 | 10/09 → 11/12 | OE229 | 0,8 | CET1 5P | | |

OUTLANDER III

| | | | | | | | | | |
|----------------|---|----------------|---------|---------|--|--|---------|-------|--|
| 2.0, 2.0 4WD | 4 | 4J11 | 110/148 | 08/12 → | | | CET1 2P | OE179 | |
| 2.0, 2.0 4WD | 4 | 4B11; 4J11 | 107/143 | 10/12 → | | | CET1 2P | OE179 | |
| 2.0 Hybrid 4WD | 4 | 4B11; S61; Y61 | 89/119 | 12/12 → | | | CET1 2P | OE182 | |

PAJERO CLASSIC

| | | | | | | | | | |
|----------------------|---|-------|---------|---------|-------|-----|---------|-------|--|
| 2.5 TD 4WD | 4 | 4D56T | 85/114 | 07/01 → | CH256 | 11v | | | |
| 3.8 GDi, 3.8 GDi 4WD | 6 | 6G75 | 160/215 | 06/02 → | | | CET1 2P | OE179 | |

PAJERO II

| | | | | | | | | | |
|-----------------|---|---------------------------------|---------|---------------|--------------------------|------------|---------|-------|--|
| 1.8 1.8 GDI 4WD | 4 | 4G93(GDI) | 96/129 | 06/98 → 04/00 | OE227 OE216 LPG [278] | 0,6 0,8 | CET1 2P | OE188 | |
| 3.0 V6 24V 4WD | 6 | 6G72(SOHC24V) | 130/174 | 06/94 → 04/00 | OE039 | 1,0 | CET2 | OE180 | |
| 3.0 V6 24V 4WD | 6 | 6G72(SOHC24V) | 133/178 | 06/94 → 04/00 | OE039 | 1,0 | CET2 | OE180 | |
| 3.5 V6 24V 4WD | 6 | 6G74(DOHC24V); 6G74(SOHC24V) | 143/192 | 07/97 → 10/99 | OE146 | 1,0 | CET1 2P | OE184 | |
| 3.5 V6 24V 4WD | 6 | 6G74(DOHC24V); 6G74(SOHC24V) | 153/205 | 06/94 → 10/99 | OE146 | 1,0 | CET1 2P | OE184 | |

PAJERO III

| | | | | | | | | | |
|----------------------------|---|-----------------------------|---------|---------------|-------|-----|---------|-------|--|
| 2.5 TDi 4WD | 4 | 4D56T | 73/98 | 04/00 → 12/06 | CH256 | 11v | | | |
| 2.5 TDi 4WD | 4 | 4D56T | 85/114 | 09/01 → 12/06 | CH256 | 11v | | | |
| 3.0 4WD | 6 | 6G72(SOHC24V) | 125/168 | 10/01 → 12/06 | OE146 | 1,0 | CET1 2P | OE179 | |
| 3.2 Di-D 4WD | 4 | 4M41 | 129/173 | 04/00 → 01/07 | CH263 | 11v | | | |
| 3.2 Di-D 4WD, 3.2 DI-D 4WD | 4 | 4M41 | 118/158 | 04/00 → 12/06 | CH263 | 11v | | | |
| 3.2 Di-D 4WD, 3.2 DI-D 4WD | 4 | 4M41 | 121/162 | 04/00 → 12/06 | CH263 | 11v | | | |
| 3.5 4WD, 3.5 V6 GDI 4WD | 6 | 6G74(DOHC24V); 6G74(GDI) | 149/200 | 04/00 → 01/07 | OE146 | 1,0 | CET1 2P | OE184 | |

PAJERO IV

| | | | | | | | | | |
|------------|---|---------------|---------|---------|-------|-----|---------|-------|--|
| 3.0 4WD | 6 | 6G72(SOHC24V) | 131/176 | 02/07 → | OE146 | 1,0 | CET1 2P | OE179 | |
| 3.8 V6 4WD | 6 | 6G75 | 184/247 | 02/07 → | | | CET1 2P | OE179 | |

PAJERO PININ

| | | | | | | | | | |
|-------------|---|---------------|--------|---------------|-------------------------------------|------------|---------|-------|--------|
| 1.8 4WD | 4 | 4G93(SOHC16V) | 84/113 | 11/01 → 06/07 | OE039 | 1,0 | CET2 | OE179 | CLS010 |
| 1.8 GDI 4WD | 4 | 4G93(GDI) | 88/118 | 10/99 → 10/01 | OE227 → 06/00 OE216 LPG [278] | 0,6 0,8 | CET1 2P | OE188 | CLS010 |
| 2.0 GDI 4WD | 4 | 4G94(GDI) | 95/127 | 10/00 → 06/07 | | | CET1 2P | OE184 | |

PAJERO SPORT I

| | | | | | | | | | |
|-------------|---|---------------|---------|---------------|--------------------------|------------|---------|-------|--|
| 1.8 4WD | 4 | 4G93(SOHC16V) | 84/113 | 03/01 → 02/05 | OE039 | 1,0 | CET2 | OE179 | |
| 1.8 GDi 4WD | 4 | 4G93(GDI) | 88/118 | 05/99 → 02/01 | OE227 OE216 LPG [278] | 0,6 0,8 | CET1 2P | OE188 | |
| 2.0 GDi 4WD | 4 | 4G94(GDI) | 95/127 | 10/01 → 02/05 | | | CET1 2P | OE184 | |
| 2.5 TD 4WD | 4 | 4D56T | 73/98 | 11/98 → | CH256 | 11v | | | |
| 2.5 TD 4WD | 4 | 4D56T | 83/111 | 11/97 → 10/98 | CH256 08/98 → | 11v | | | |
| 2.5 TD 4WD | 4 | 4D56T | 85/114 | 07/02 → | CH256 | 11v | | | |
| 2.5 TD 4WD | 4 | 4D56T | 98/131 | 08/03 → | CH256 | 11v | | | |
| 3.0 V6 4WD | 6 | 6G72(DOHC24V) | 123/165 | 03/03 → | OE039 | 1,0 | CET2 | OE180 | |
| 3.0 V6 4WD | 6 | 6G72(SOHC24V) | 125/168 | 06/00 → | OE039 | 1,0 | CET2 | OE180 | |
| 3.0 V6 4WD | 6 | 6G72(SOHC24V) | 130/174 | 11/98 → | OE039 | 1,0 | CET2 | OE180 | |

MITSUBISHI



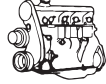

kW/BHP

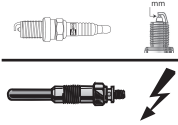

eon TITAN

IRIDIUM

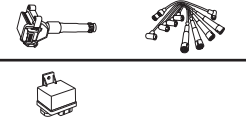

...MITSUBISHI



...PAJERO SPORT I

| | | | | | | | | | |
|-------------|---|------|---------|--------|-------|-----|--|--|--|
| 3.2 TDi 4WD | 4 | 4M41 | 121/162 | 11/98→ | CH263 | 11v | | | |
|-------------|---|------|---------|--------|-------|-----|--|--|--|

PAJERO SPORT II

| | | | | | | | | | |
|---------|---|------|---------|--------|-------|-----|--------|--|--|
| 3.0 4WD | 6 | 6B31 | 162/217 | 09/08→ | OE229 | 0,8 | CET15P | | |
|---------|---|------|---------|--------|-------|-----|--------|--|--|

| | | | | | | | | | |
|----------------|---|---------------|---------|--------|-------|-----|--------|-------|--|
| 3.5 V6 24V 4WD | 6 | 6G74(SOHC24V) | 153/205 | 09/08→ | OE146 | 1,0 | CET12P | OE184 | |
|----------------|---|---------------|---------|--------|-------|-----|--------|-------|--|

PROUDIA/DIGNITY

| | | | | | | | | | |
|-----|---|------|---------|-------------|-------|-----|--------|-------|--|
| 4.5 | 8 | 8A80 | 206/276 | 10/99→05/01 | OE146 | 1,0 | CET12P | OE179 | |
|-----|---|------|---------|-------------|-------|-----|--------|-------|--|

SANTAMO

| | | | | | | | | | |
|----------------------|---|---------------|---------|-------------|-------|-----|------|-------|--------------------------|
| 2.0 16V, 2.0 16V 4WD | 4 | 4G63(DOHC16V) | 102/137 | 05/99→12/04 | OE039 | 1,0 | CET2 | OE180 | BAEA521 ^[277] |
|----------------------|---|---------------|---------|-------------|-------|-----|------|-------|--------------------------|

SPACE RUNNER

| | | | | | | | | | |
|--------------|---|---------------|--------|-------------|-------|-----|------|-------|--|
| 1.8, 1.8 4WD | 4 | 4G93(SOHC16V) | 85/114 | 06/96→08/99 | OE039 | 1,0 | CET2 | OE179 | |
|--------------|---|---------------|--------|-------------|-------|-----|------|-------|--|

| | | | | | | | | | |
|-----|---|---------------|--------|-------------|-------|-----|------|--|--|
| 2.0 | 4 | 4G63(SOHC16V) | 98/131 | 05/00→08/02 | OE063 | 1,0 | CET2 | | |
|-----|---|---------------|--------|-------------|-------|-----|------|--|--|

| | | | | | | | | | |
|-----|---|---------------|---------|-------------|-------|-----|------|-------|--------------------------|
| 2.0 | 4 | 4G63(SOHC16V) | 100/134 | 08/99→08/02 | OE063 | 1,0 | CET2 | OE180 | BAEA179E ^[41] |
|-----|---|---------------|---------|-------------|-------|-----|------|-------|--------------------------|

| | | | | | | | | | |
|---------|---|---------------|--------|-------------|-------|-----|------|-------|--|
| 2.0 16V | 4 | 4G63(DOHC16V) | 98/131 | 06/97→08/99 | OE063 | 1,0 | CET2 | OE180 | |
|---------|---|---------------|--------|-------------|-------|-----|------|-------|--|

| | | | | | | | | | |
|---------|---|-----------|---------|-------------|--|--|--------|-------|--------|
| 2.4 GDI | 4 | 4G64(GDI) | 110/148 | 08/99→01/03 | | | CET12P | OE184 | CLS010 |
|---------|---|-----------|---------|-------------|--|--|--------|-------|--------|

SPACE STAR

| | | | | | | | | | | |
|---------|---|-----------|-------|-------------|-------|-----|------|-------|----------|--------|
| 1.3 16V | 4 | 4G13(16V) | 60/80 | 09/00→12/04 | OE063 | 1,0 | CET2 | OE180 | BAEA178E | CLS010 |
|---------|---|-----------|-------|-------------|-------|-----|------|-------|----------|--------|

| | | | | | | | | | | |
|---------|---|-----------|-------|-------------|-------|-----|------|-------|----------|--------|
| 1.3 16V | 4 | 4G13(16V) | 61/82 | 12/98→12/04 | OE063 | 1,0 | CET2 | OE180 | BAEA178E | CLS010 |
|---------|---|-----------|-------|-------------|-------|-----|------|-------|----------|--------|

| | | | | | | | | | | |
|---------|---|-----------|-------|-------------|-------|-----|------|-------|----------|--------|
| 1.3 16V | 4 | 4G13(16V) | 63/84 | 06/98→12/04 | OE063 | 1,0 | CET2 | OE180 | BAEA178E | CLS010 |
|---------|---|-----------|-------|-------------|-------|-----|------|-------|----------|--------|

| | | | | | | | | | |
|-----|---|---------------|-------|-------------|-------|-----|------|-------|--|
| 1.6 | 4 | 4G92(SOHC16V) | 72/97 | 04/01→12/04 | OE039 | 1,0 | CET2 | OE179 | |
|-----|---|---------------|-------|-------------|-------|-----|------|-------|--|

| | | | | | | | | | | |
|---------|---|------|-------|-------------|-------|-----|------|-------|----------|--------|
| 1.6 16V | 4 | 4G18 | 72/97 | 01/01→12/04 | OE063 | 1,0 | CET2 | OE180 | BAEA178E | CLS010 |
|---------|---|------|-------|-------------|-------|-----|------|-------|----------|--------|

| | | | | | | | | | |
|---------|---|-----------|--------|-------------|-------|-----|--------|-------|--|
| 1.8 GDI | 4 | 4G93(GDI) | 87/117 | 06/98→12/04 | OE227 | 0,6 | CET12P | OE188 | |
|---------|---|-----------|--------|-------------|-------|-----|--------|-------|--|

| | | | | | | | | | |
|---------|---|-----------|--------|-------------|----------------------------|-----|--|--|--|
| 1.8 GDI | 4 | 4G93(GDI) | 90/121 | 06/98→12/04 | OE216 ^{LPG [278]} | 0,8 | | | |
|---------|---|-----------|--------|-------------|----------------------------|-----|--|--|--|

| | | | | | | | | | |
|---------|---|-----------|--------|-------------|-------|-----|--------|-------|--|
| 1.8 GDI | 4 | 4G93(GDI) | 90/121 | 06/98→12/04 | OE227 | 0,6 | CET12P | OE188 | |
|---------|---|-----------|--------|-------------|-------|-----|--------|-------|--|

| | | | | | | | | | |
|---------|---|-----------|--------|-------------|----------------------------|-----|--|--|--|
| 1.8 GDI | 4 | 4G93(GDI) | 90/121 | 06/98→12/04 | OE216 ^{LPG [278]} | 0,8 | | | |
|---------|---|-----------|--------|-------------|----------------------------|-----|--|--|--|

| | | | | | | | | | |
|---------|---|---------------|--------|-------------|-------|-----|------|-------|--|
| 1.8 MPI | 4 | 4G93(DOHC16V) | 82/110 | 10/02→12/04 | OE227 | 0,6 | CET2 | OE179 | |
|---------|---|---------------|--------|-------------|-------|-----|------|-------|--|

| | | | | | | | | | |
|---------|---|---------------|--------|-------------|----------------------------|-----|--|--|--|
| 1.8 MPI | 4 | 4G93(DOHC16V) | 82/110 | 10/02→12/04 | OE216 ^{LPG [278]} | 0,8 | | | |
|---------|---|---------------|--------|-------------|----------------------------|-----|--|--|--|

| | | | | | | | | | |
|----------|---|------|--------|-------------|-------|-----|--|--|--|
| 1.9 DI-D | 4 | F9Q1 | 75/101 | 02/01→12/04 | CH271 | 11v | | | |
|----------|---|------|--------|-------------|-------|-----|--|--|--|

| | | | | | | | | | |
|----------|---|------|--------|-------------|-------|-----|--|--|--|
| 1.9 DI-D | 4 | F9Q2 | 85/114 | 10/02→12/04 | CH271 | 11v | | | |
|----------|---|------|--------|-------------|-------|-----|--|--|--|

SPACE WAGON

| | | | | | | | | | |
|-----|---|------|--------|-------------|-------|-----|------|-------|--|
| 1.8 | 4 | 4G93 | 93/125 | 05/02→08/04 | OE039 | 1,0 | CET2 | OE179 | |
|-----|---|------|--------|-------------|-------|-----|------|-------|--|

| | | | | | | | | | |
|---------|---|-----------|---------|-------------|--|--|--------|-------|--------|
| 2.4 GDI | 4 | 4G64(GDI) | 108/145 | 09/00→12/04 | | | CET12P | OE184 | CLS010 |
|---------|---|-----------|---------|-------------|--|--|--------|-------|--------|

| | | | | | | | | | |
|----------------------|---|-----------|---------|-------------|--|--|--------|-------|--------|
| 2.4 GDI, 2.4 GDI 4WD | 4 | 4G64(GDI) | 110/148 | 10/98→12/04 | | | CET12P | OE184 | CLS010 |
|----------------------|---|-----------|---------|-------------|--|--|--------|-------|--------|

| | | | | | | | | | |
|-------------|---|-----------|---------|-------------|--|--|--------|-------|--|
| 2.4 GDI 4WD | 4 | 4G64(GDI) | 108/145 | 09/00→12/04 | | | CET12P | OE184 | |
|-------------|---|-----------|---------|-------------|--|--|--------|-------|--|

VERADA

| | | | | | | | | | |
|---------------------|---|---------------|---------|-------------|-------|-----|--------|-------|--|
| 3.5 i Series II 4WD | 6 | 6G74(SOHC24V) | 155/208 | 08/02→05/05 | OE146 | 1,0 | CET12P | OE184 | |
|---------------------|---|---------------|---------|-------------|-------|-----|--------|-------|--|

MITSUBISHI



L 300 III

| | | | | | | | | | |
|-----|---|---------------|--------|-------------|-------|-----|------|-------|--|
| 2.0 | 4 | 4G63(SOHC16V) | 85/114 | 07/94→04/00 | OE063 | 1,0 | CET2 | OE180 | |
|-----|---|---------------|--------|-------------|-------|-----|------|-------|--|

| | | | | | | | | | |
|--------------|---|---------------|--------|-------------|-------|-----|------|-------|--|
| 2.0, 2.0 4WD | 4 | 4G63(SOHC16V) | 82/110 | 06/94→05/03 | OE063 | 1,0 | CET2 | OE180 | |
|--------------|---|---------------|--------|-------------|-------|-----|------|-------|--|

| | | | | | | | | | |
|-------|---|---------------|--------|-------------|-------|-----|------|-------|--|
| 2.0 i | 4 | 4G63(SOHC16V) | 83/111 | 06/94→10/98 | OE063 | 1,0 | CET2 | OE180 | |
|-------|---|---------------|--------|-------------|-------|-----|------|-------|--|

| | | | | | | | | | |
|-----|---|---------------|--------|-------------|-------|-----|------|-------|--|
| 2.4 | 4 | 4G64(SOHC16V) | 94/126 | 09/97→05/03 | OE048 | 1,0 | CET8 | OE195 | |
|-----|---|---------------|--------|-------------|-------|-----|------|-------|--|

| | | | | | | | | | |
|---------|---|---------------|---------|-------------|-------|-----|--------|-------|--|
| 3.0 4WD | 6 | 6G72(DOHC24V) | 136/182 | 10/00→05/03 | OE146 | 1,0 | CET12P | OE179 | |
|---------|---|---------------|---------|-------------|-------|-----|--------|-------|--|

L 400

| | | | | | | | | | |
|-----|---|------|-------|-------------|-------|-----|------|--|--|
| 1.6 | 4 | 4G32 | 51/68 | 06/96→10/02 | OE051 | 0,9 | CET8 | | |
|-----|---|------|-------|-------------|-------|-----|------|--|--|

| | | | | | | | | | |
|-----|---|---------------|--------|-------------|-------|-----|------|--|--|
| 2.0 | 4 | 4G63(SOHC16V) | 83/111 | 12/94→10/02 | OE063 | 1,0 | CET2 | | |
|-----|---|---------------|--------|-------------|-------|-----|------|--|--|

| | | | | | | | | | |
|--------------|---|---------------|--------|-------------|-------|-----|------|-------|--|
| 2.0, 2.0 16V | 4 | 4G63(SOHC16V) | 85/114 | 05/95→03/01 | OE063 | 1,0 | CET2 | OE180 | |
|--------------|---|---------------|--------|-------------|-------|-----|------|-------|--|

| | | | | | | | | | |
|-----------|---|-----------|--------|-------------|-------|-----|------|-------|--|
| 2.4 i 4WD | 4 | 4G64(16V) | 97/130 | 05/95→05/00 | OE063 | 1,0 | CET2 | OE180 | |
|-----------|---|-----------|--------|-------------|-------|-----|------|-------|--|

| | | | | | | | | | |
|------------------------------|---|-------|-------|-------------|-------|-----|--|--|--|
| 2.5 2500 TD, 2.5 2500 TD 4WD | 4 | 4D56T | 64/86 | 05/95→06/05 | CH256 | 11v | | | |
|------------------------------|---|-------|-------|-------------|-------|-----|--|--|--|

| | | | | | | | | | |
|--------------------|---|--------|-------|-------------|-------|-----|--|--|--|
| 2.5 TD, 2.5 TD 4WD | 4 | 4D56TD | 73/98 | 05/95→05/00 | CH256 | 11v | | | |
|--------------------|---|--------|-------|-------------|-------|-----|--|--|--|

MITSUBISHI





kW/BHP

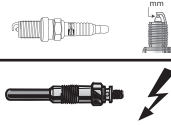

eon TITAN

IRIDIUM

**...MITSUBISHI****PAJERO SPORT VAN I**

2.5 TD 4WD 4 4D56T 85/114 12/99→01/08 CH256 11v

MITSUOKA**VIEWT**

1.2 Royal 4 CR12DE 66/89 02/05→ OE175 1,0 CET14P OE190

1.3, 1.3 G 4 CG13DE 55/74 05/96→08/01 OE063 1,0 CET2 OE180

1.4 Royal 4WD 4 CR14DE 71/95 02/05→ OE175 1,0 CET14P OE190

YUGA

1.3 Royal, 1.3 Royal 4WD 4 CGA3DE 63/84 06/99→ OE063 1,0 CET2 OE180

ZERO I

1.8 Turbo 4 BP28 120/161 06/96→08/00 OE005 0,9 CET2 OE179

MORGAN**AERO 8**

4.4 8 M62448S2 210/282 10/00→ OE223 1,6 CET12P OE188

FOUR FOUR

1.8 i 4 ZH18P 92/123 01/93→01/05 OE029 1,0 CET17P OE189

PLUS EIGHT

4.6 8 46D 164/220 01/96→10/01 OE146 1,0 CET12P OE179

PLUS FOUR

1.8 i 4 RQB 96/129 01/93→06/99 OE029 1,0 CET17P OE189

2.0 i 4 AODA 106/142 01/04→06/14 OE131 1,0 CET18P OE183

ROADSTER

2.0 Plus4 4 AODA 106/142 01/04→ OE131 1,0 CET18P OE183

3.0 V6 6 MEBA 165/221 01/04→ OE131 1,0 CET18P OE183

MOSKVICH**2141**

1.6 4 56/75 11/97→12/01 OE006 0,9 CET8 OE195

1.6 4 59/79 05/94→10/97 OE006 0,9 CET8 OE195

1.7 4 63/84 03/95→12/01 OE006 0,9 CET8 OE195

2335

1.7 4 Y3AM3317 63/84 01/95→12/01 OE068 0,7

NISSAN**100 NX**

1.6 SR 4 GA16DE 75/101 09/93→10/94 OE005 0,9 CET2 OE180

200 SX

2.0 i 16V 4 SR20DE 118/158 10/93→12/99 OE089 1,0 CET2 OE184

2.0 i 16V Turbo 4 SR20DET 147/197 10/93→12/99 OE136 0,8 CET12P OE179

2.0 Turbo 4 SR20DET 162/217 04/94→09/99 OE136 0,8 CET12P OE179

240 SX

2.4 4 KA24DE 112/150 05/94→08/97 OE063 1,0 CET2

350 Z3.5 6 VQ35DE 206/276 10/03→12/07 OE175 1,0 CET14P OE190 BAEA158E
01/07→
BAEA132E^[277]

3.5 6 VQ35DE 214/287 10/03→01/07 OE175 1,0 CET14P OE190

3.5 6 VQ35DE 221/296 09/02→12/08 OE175 1,0 CET14P OE190 BAEA158E
01/07→
BAEA132E^[277]3.5 6 VQ35HR 230/308 09/05→12/09 BAEA158E
01/07→



kW/BHP



eon TITAN

IRIDIUM

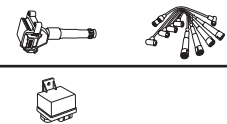

...NISSAN



| AD Van | |
|---------------------------|---|
| 2.0 | 4 SR20DE 92/123 10/94→04/99 OE063 1,0 CET2 OE180 |
| 2.0 D | 4 CD20 55/74 10/94→04/99 CH600 11v |
| AD Wagon | |
| 1.5 | 4 QG15DE 66/89 05/99→08/04 OE063 1,0 CET2 OE180 |
| 2.0 | 4 SR20DE 92/123 05/99→08/01 OE063 1,0 CET2 OE180 |
| ALMERA Classic | |
| 1.6 16V | 4 QG16DE 79/106 03/06→ OE148 1,0 CET5 OE190 BAEA081E |
| ALMERA I | |
| 1.4 | 4 GA14DE 64/86 09/95→07/00 OE063 1,0 CET2 OE180 |
| 1.4 GX, LX, 1.4 S, GX, LX | 4 GA14DE 55/74 09/95→07/00 OE063 1,0 CET2 OE180 |
| 1.6 | 4 GA16DE 73/98 09/95→07/00 OE063 1,0 CET2 OE180 |
| 1.6 | 4 GA16DE 75/101 07/95→03/00 OE063 1,0 CET2 OE180 |
| 1.6 SLX, 1.6 SR, SLX | 4 GA16DE 66/89 09/95→07/00 OE063 1,0 CET2 OE180 |
| 2.0 D | 4 CD20 55/74 11/95→07/00 CH600 11v |
| 2.0 GTi | 4 SR20DE 105/141 07/96→03/00 OE063 1,0 CET2 OE180 CLS132 |
| ALMERA II | |
| 1.5 | 4 QG15DE 66/89 03/00→11/06 OE063 1,0 CET2 OE180 BAEA081E [371] →08/02 BAEA021E →12/04 [7] [264] [328] |
| 1.5 | 4 QG15DE 72/97 10/02→09/06 OE224 LPG [279] 0,8 CET5 OE190 BAEA021E →12/04 [7] [264] [328] BAEA081E [371] |
| 1.5 | 4 QC15DE 72/97 10/02→09/06 OE190 |
| 1.5 | 4 GA15DE; QG15DE 77/103 03/01→ CET14P CET5 OE190 |
| 1.5 dCi | 4 K9K722 60/80 01/03→09/06 CH271 11v CCU154 [82] |
| 1.5 XL | 4 QG15DE 77/103 03/01→ OE148 1,0 CET14P CET5 OE190 |
| 1.6 | 4 GA16DE; QG16DE 83/111 07/00→02/03 OE063 1,0 CET2 OE180 |
| 1.8 | 4 QG18DE 84/113 01/00→11/02 OE224 LPG [279] 10/02→ 0,8 CET2 OE180 BAEA021E →12/04 [7] [264] [328] BAEA081E [371] 10/00→ |
| 1.8 | 4 QG18DE 85/114 10/02→09/06 OE224 LPG [279] 0,8 CET5 OE190 BAEA021E →12/04 [7] [264] [328] BAEA081E [371] |
| 2.0 | 4 SR20DE 107/143 08/02→ OE063 1,0 CET2 OE180 |
| 2.2 dCi | 4 YD22DDT 82/110 09/03→09/06 CH230 11v |
| 2.2 dCi | 4 YD22DDTi 100/134 09/03→09/06 CH230 11v |
| 2.2 Di | 4 YD22DDT 81/109 03/00→04/03 CH230 11v |
| ALMERA TINO | |
| 1.8 | 4 QG18DE 84/113 08/00→02/06 OE063 →11/02 1,0 CET2 OE180 →11/02 BAEA021E →11/00 [7] [264] BAEA081E 11/00→ |
| 1.8 | 4 QC18DE 85/114 12/02→02/06 OE224 LPG [279] 12/02→ 0,8 CET5 OE190 BAEA081E |
| 1.8 | 4 QG18DE 85/114 12/02→02/06 OE224 LPG [279] 0,8 CET5 OE190 BAEA081E |
| 2.0 | 4 SR20DE 100/134 08/00→01/03 OE063 1,0 CET2 OE180 |
| 2.2 dCi | 4 YD22DDT 82/110 09/03→02/06 CH230 11v |
| 2.2 dCi | 4 YD22DDTi 84/113 08/00→02/06 CH230 11v |

NISSAN





kW/BHP



eon TITAN

IRIDIUM



...NISSAN



...ALMERA TINO

2.2 dCi 4 YD22DDTi 100/134 09/03→02/06 CH230 11v

ALTIMA

2.5 4 QR25DE 121/162 08/01→09/06 OE148 1,0 CET5 OE190

2.5 4 QR25DE 128/172 10/06→07/13 OE207 1,1

3.5 6 VQ35DE 180/241 08/01→09/06 OE175 1,0 CET14P OE190

3.5 6 VQ35DE 201/270 10/06→ OE175 1,0 CET14P OE190 BAEA158E
→12/09

AVENIR

1.6 4 QG16DE 80/107 11/97→12/05 OE063 1,0 CET2 OE180

1.8 4 QG18DE 92/123 11/97→12/05 OE148 1,0 CET5 OE190

2.0, 2.0 4WD 4 SR20DE 107/143 11/97→12/05 OE063 1,0 CET2

2.0, 2.0 4WD 4 QR20DE 110/148 09/01→12/05 OE148 1,0 CET5 OE190

OE224 LPG [279] 0,8

BASSARA

2.4 4 KA24DE 110/148 11/99→08/02 OE063 1,0 CET2

2.5 4 QR25DE 121/162 06/02→08/03 OE148 1,0 CET5 OE190

BLUEBIRD SYLPHY / SYLPHY III

1.6 4 HR16DE 86/115 05/13→ OE240
08/14→

BLUEBIRD SYLPHY I

1.5 4 QG15DE 77/103 08/00→08/05 OE063 1,0 CET2 OE180

2.0 4 SR20DE 107/143 08/00→08/02 OE063 1,0 CET2

BLUEBIRD SYLPHY II

1.5, 1.5 4WD 4 HR15DE 80/107 09/05→08/12 OE240 BAEA088E

2.0 4 MR20DE 98/131 09/05→08/12 OE207 1,1

CEDRIC

2.5 6 VQ25DE 140/188 06/96→04/99 OE191 1,0 CET12P OE180

CEFIRO I

2.5 6 VQ25DE 154/207 01/00→09/03 OE191 1,0 CET12P OE180

3.5 6 VQ35DE 221/296 01/00→09/03 OE175 1,0 CET14P OE190

CEFIRO II

2.0 6 VQ20DE 103/138 10/94→12/99 OE005 0,9 CET2 OE180 BAEA073E
[31] [277]

2.5 6 VQ25DE 140/188 10/94→12/99 OE191 1,0 CET12P OE180

3.0 6 VQ30DE 142/190 10/94→12/99 OE063 1,0 CET2 OE180 BAEA073E
[31] [275]

CEFIRO III

2.0 6 VQ20DE 103/138 01/00→09/03 OE005 0,9 CET2 OE180

3.0 6 VQ30DE 147/197 01/00→09/03 OE063 1,0 CET2 OE180

CUBE

1.3 4 CG13DE 55/74 03/98→08/00 OE063 1,0 CET2 OE180

1.3, 1.3 4WD 4 CGA3DE 63/84 09/00→12/02 OE063 1,0 CET2 OE180

1.3, 1.3 4WD 4 CGA3DE 74/99 09/00→12/02 OE063 1,0 CET2 OE180

1.4, 1.4 4WD 4 CR14DE 72/97 01/03→09/05 OE175 1,0 CET14P OE190 BAEA188E

1.5, 1.5 4WD 4 HR15DE; QG15DE 80/107 01/03→09/05 CET14P OE190

CET5

1.6 16V 4 HR16DE 81/109 03/10→ OE240 BAEA056E

ELGRAND

2.5, 2.5 4WD 4 QR25DE 125/168 11/10→ OE207 1,1

3.5, 3.5 4WD 6 VQ35DE 177/237 08/00→12/10 OE175 1,0 CET14P OE190

GLORIA

2.5 6 VQ25DE 140/188 06/96→04/99 OE191 1,0 CET12P OE180



kW/BHP



eon TITAN

IRIDIUM



...NISSAN



| | | | | | | | | |
|------------------------------|---|----------------|---------|-------------|--------------------------------|-----|--------|--|
| GLORIA XI | | | | | | | | |
| 2.4 | 4 | KA24DE | 112/150 | 05/99→08/04 | OE063 | 1,0 | CET2 | |
| JUKE | | | | | | | | |
| 1.2 DIG-T | 4 | HRA2DDT | 85/114 | 05/14→ | | | | OE261 ^[103] BAEA131E |
| 1.6 | 4 | HR16DE | 69/93 | 01/13→ | | | | BAEA088E |
| 1.6 | 4 | HR16DE | 86/115 | 06/10→ | | | | BAEA088E |
| KUBISTAR | | | | | | | | |
| 1.2 | 4 | D7F764 | 44/59 | 08/03→10/09 | OE026 | 0,9 | CET2 | OE188 BAE409A BAEA354 |
| 1.2 16V | 4 | D4F712 | 55/74 | 04/06→10/09 | OE130 | 0,9 | CET4 | BAEA354 |
| 1.4 | 4 | K7J700 | 55/74 | 08/03→10/09 | | | | BAE409A |
| 1.5 dCi | 4 | K9K710; K9K714 | 42/56 | 08/03→10/09 | CH271 | 11v | | |
| 1.5 dCi | 4 | K9K710; K9K714 | 45/60 | 08/05→10/09 | CH271 | 11v | | CCU154 |
| 1.5 dCi | 4 | K9K704 | 48/64 | 08/03→10/09 | CH271 | 11v | | CCU154 |
| 1.5 dCi | 4 | K9K722 | 60/80 | 08/03→10/09 | CH271 | 11v | | CCU154 |
| 1.5 dCi 70 | 4 | K9K700; K9K716 | 50/67 | 04/06→10/09 | CH271 | 11v | | CCU154 |
| 1.5 dCi 85 | 4 | K9K276 | 62/83 | 04/06→10/09 | CH271 | 11v | | CCU154 |
| 1.6 16V | 4 | K4M752 | 70/94 | 08/03→10/09 | OE019 | 0,9 | CET2 | OE184 BAE409A |
| LAFESTA | | | | | | | | |
| 2.0 CVTC | 4 | MR20DE | 101/135 | 07/05→ | OE207 | 1,1 | | |
| LEOPARD | | | | | | | | |
| 2.4 | 4 | KA24DE | 112/150 | 10/95→08/01 | OE063 | 1,0 | CET2 | |
| LIVINA / GRAND LIVINA | | | | | | | | |
| 1.6 | 4 | HR16DE | 80/107 | 02/07→ | OE207 | 1,1 | | |
| LUCINO | | | | | | | | |
| 1.6 | 4 | GA16DE | 73/98 | 11/95→01/00 | OE063 | 1,0 | CET2 | OE180 |
| 2.0 D | 4 | CD20 | 55/74 | 11/97→01/00 | CH600 | 11v | | |
| MAXIMA / MAXIMA QX IV | | | | | | | | |
| 2.0, 2.0 QX | 6 | VQ20DE | 103/138 | 02/95→12/00 | OE005 | 0,9 | CET2 | OE180 BAEA073E ^[31] ^[277] |
| 2.5 V6 24V | 6 | VQ25DE | 140/188 | 02/95→12/00 | | | CET12P | OE180 |
| 3.0, 3.0 QX | 6 | VQ30DE | 142/190 | 03/94→12/00 | OE063 | 1,0 | CET2 | OE180 BAEA073E ^[31] ^[277] |
| MAXIMA / MAXIMA QX V | | | | | | | | |
| 2.0 V6 24V | 6 | VQ20DE | 103/138 | 03/00→11/03 | OE063 | 1,0 | CET2 | OE180 |
| 2.5 V6 24V | 6 | VQ25DE | 154/207 | 03/00→11/03 | OE191 | 1,0 | CET12P | OE180 |
| 3.0 V6 24V | 6 | VQ30DE | 147/197 | 03/00→11/03 | OE063 | 1,0 | CET2 | OE180 |
| 3.5 | 6 | VQ35DE | 188/252 | 08/01→02/03 | OE175 | 1,0 | CET14P | OE190 BAEA079E |
| 3.5 | 6 | VQ35DE | 190/255 | 03/03→11/03 | OE175 | 1,0 | CET14P | OE190 BAEA079E |
| 3.5 | 6 | VQ35DE | 170/228 | 10/03→11/03 | OE175 | 1,0 | CET14P | OE190 BAEA079E |
| MICRA C+C III | | | | | | | | |
| 1.4 16V | 4 | CR14DE | 65/87 | 08/05→ | OE175 | 1,0 | CET14P | OE190 BAEA188E |
| 1.6 160 SR | 4 | HR16DE | 81/109 | 08/05→ | OE207 ^[6] 01/07→ | 1,1 | | BAEA056E |
| MICRA II | | | | | | | | |
| 1.0 i 16V | 4 | CG10DE | 44/59 | 09/00→02/03 | OE063 | 1,0 | CET2 | OE180 BAEA337 →10/02 |
| 1.4 i 16V | 4 | CGA3DE | 60/80 | 09/00→02/03 | OE063 | 1,0 | CET2 | OE180 BAEA337 →10/02 |
| 1.5 D | 4 | TD15 | 42/56 | 02/98→02/03 | CH185 | 11v | | |
| MICRA III | | | | | | | | |
| 1.0 16V | 4 | CG10DE | 48/64 | 01/03→06/10 | OE175 | 1,0 | CET14P | OE190 BAEA188E |
| 1.2 16V | 4 | CG12DE; CR12DE | 48/64 | 01/03→06/10 | OE175 | 1,0 | CET14P | OE190 BAEA188E |
| 1.2 16V | 4 | CG12DE; CR12DE | 59/79 | 01/03→06/10 | OE175 | 1,0 | CET14P | OE190 BAEA188E |

NISSAN



kW/BHP



eon TITAN

IRIDIUM



...NISSAN



...MICRA III

| | | | | | | | | | |
|------------|---|--------|--------|---------------|---------------------------------|-----|--------|-------|---|
| 1.4 16V | 4 | CR14DE | 65/87 | 01/03 → 06/10 | OE175 | 1,0 | CET14P | OE190 | BAEA188E |
| 1.5 dCi | 4 | K9K704 | 48/64 | 01/03 → 06/10 | CH271 | 11v | | | CCU154 ^[82] 03/03 → 05/05 |
| 1.5 dCi | 4 | K9K708 | 50/67 | 06/05 → 06/10 | CH271 | 11v | | | |
| 1.5 dCi | 4 | K9K722 | 60/80 | 09/03 → 06/10 | CH271 | 11v | | | CCU154 ^[82] → 05/05 |
| 1.5 dCi | 4 | K9K276 | 63/84 | 06/05 → 06/10 | CH271 | 11v | | | |
| 1.6 160 SR | 4 | HR16DE | 81/109 | 05/05 → 06/10 | OE207 ^[6] 01/07 → | 1,1 | | | BAEA056E |

MICRA IV

| | | | | | | | | | |
|-----------|---|---------|--------|---------|--|--|--|-------|----------|
| 1.2 | 3 | HR12DE | 56/75 | 05/10 → | | | | OE240 | BAEA088E |
| 1.2 | 3 | HR12DE | 59/79 | 05/10 → | | | | OE240 | BAEA088E |
| 1.2 DIG-S | 3 | HR12DDR | 72/97 | 04/11 → | | | | OE240 | BAEA088E |
| 1.5 | 4 | HR15DE | 75/101 | 11/10 → | | | | OE240 | |

MICRA V

| | | | | | | | | | |
|----------|---|-----------------|-------|---------|--|--|--|-------|--|
| 0.9 IG-T | 3 | H4B408; HR09DET | 66/89 | 12/16 → | | | | OE261 | |
|----------|---|-----------------|-------|---------|--|--|--|-------|--|

MURANO I

| | | | | | | | | | |
|---------|---|--------|---------|---------------|-------|-----|--------|-------|----------|
| 3.5 4WD | 6 | VQ35DE | 172/231 | 08/03 → 09/08 | OE175 | 1,0 | CET14P | OE190 | BAEA079E |
|---------|---|--------|---------|---------------|-------|-----|--------|-------|----------|

MURANO II

| | | | | | | | | | |
|--------------|---|----------|---------|---------------|---------|----|--|--|----------|
| 2.5 dCi 4WD | 4 | YD25DDTi | 140/188 | 01/10 → 09/14 | CCGP007 | 7v | | | |
| 3.5, 3.5 4WD | 6 | VQ35DE | 195/261 | 11/07 → 09/14 | | | | | BAEA158E |
| 3.5 4WD | 6 | VQ35DE | 188/252 | 10/08 → 09/14 | | | | | BAEA158E |

NOTE

| | | | | | | | | | |
|-----------|---|---------|--------|---------------|------------------------|-----|--------|------------------|--|
| 1.2 | 3 | HR12DE | 59/79 | 06/13 → | | | | OE240 | BAEA088E |
| 1.2 DIG-S | 3 | HR12DDR | 72/97 | 06/13 → | | | | OE240 | |
| 1.4 | 4 | CR14DE | 65/87 | 03/06 → 06/12 | OE175 | 1,0 | CET14P | OE190 | BAEA188E |
| 1.5 dCi | 4 | K9K700 | 50/67 | 03/06 → 06/12 | CH271 → 10/10 | 11v | | | |
| 1.5 dCi | 4 | K9K276 | 63/84 | 03/06 → 06/12 | CH271 → 10/10 | 11v | | | |
| 1.5 dCi | 4 | K9K292 | 76/102 | 07/08 → 06/12 | CH271 → 10/10 | 11v | | | |
| 1.6 | 4 | HR16DE | 81/109 | 03/06 → | OE207 ^[358] | 1,1 | | OE240 08/10 → | BAEA056E → 12/08 BAEA088E 08/10 → |

NP300 NAVARA

| | | | | | | | | | |
|----------------------|---|----------|---------|---------|--|-----|--|--|--|
| 2.5 dCi | 4 | YD25DDTi | 120/161 | 10/06 → | CH230 → 01/10 | 11v | | | |
| | | | | | CCGP007 ^[81] 01/10 → 11/13 | 7v | | | |
| 2.5 dCi, 2.5 dCi 4WD | 4 | YD25DDTi | 106/142 | 07/05 → | CH230 → 01/10 | 11v | | | |
| | | | | | CCGP007 ^[81] 01/10 → 11/13 | 7v | | | |
| 2.5 dCi, 2.5 dCi 4WD | 4 | YD25DDTi | 128/172 | 07/05 → | CH230 → 01/10 | 11v | | | |
| | | | | | CCGP007 ^[81] 01/10 → 11/13 | 7v | | | |
| 2.5 dCi 4WD | 4 | YD25DDTi | 126/169 | 10/06 → | CH230 → 01/10 | 11v | | | |
| | | | | | CCGP007 ^[81] 01/10 → 11/13 | 7v | | | |
| 2.5 dCi 4WD | 4 | YD25DDTi | 140/188 | 12/09 → | CH230 → 01/10 | 11v | | | |
| | | | | | CCGP007 ^[81] 01/10 → 11/13 | 7v | | | |
| 3.0 dCi 4WD | 6 | V9X | 170/228 | 02/10 → | CCGP007 | 7v | | | |

NP300 PICKUP

| | | | | | | | | | |
|----------------------|---|----------|--------|---------|-------|-----|--|--|--|
| 2.5 dCi, 2.5 dCi 4WD | 4 | YD25DDTi | 98/131 | 04/08 → | CH230 | 11v | | | |
|----------------------|---|----------|--------|---------|-------|-----|--|--|--|

NISSAN





kW/BHP



eon TITAN

IRIDIUM

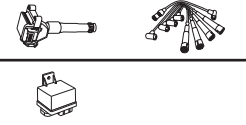

...NISSAN



PATHFINDER II

| | | | | | | | | | |
|------------|---|---------|---------|-------------|-------|-----|------|-------|--------------------|
| 2.7 TD 4WD | 4 | TD27ETi | 96/129 | 09/97→12/04 | CH221 | 11v | | | |
| 3.3 V6 4WD | 6 | VG33E | 110/148 | 03/98→10/00 | OE013 | 0,8 | CET2 | OE193 | |
| 3.3 V6 4WD | 6 | VG33E | 125/168 | 09/97→12/04 | OE013 | 0,8 | CET2 | OE193 | |
| 3.5 V6 4WD | 6 | VQ35 | 162/217 | 11/00→12/04 | | | CET5 | OE190 | BAEA079E 01/03→ |

PATHFINDER III

| | | | | | | | | | |
|----------------------|---|----------|---------|--------|--|-----|------|-------|--|
| 2.5 dCi, 2.5 dCi 4WD | 4 | YD25DDTi | 128/172 | 01/05→ | CH230 →01/10 | 11v | | | |
| | | | | | CCGP007 ^[81] 01/10→11/13 | 7v | | | |
| 2.5 dCi 4WD | 4 | YD25DDTi | 120/161 | 01/05→ | CH230 →01/10 | 11v | | | |
| | | | | | CCGP007 ^[81] 01/10→11/13 | 7v | | | |
| 2.5 dCi 4WD | 4 | YD25DDTi | 126/169 | 10/06→ | CH230 →01/10 | 11v | | | |
| | | | | | CCGP007 ^[81] 01/10→11/13 | 7v | | | |
| 2.5 dCi 4WD | 4 | YD25DDTi | 140/188 | 08/10→ | CCGP007 ^[81] →11/13 | 7v | | | |
| 3.0 dCi 4WD | 6 | V9X | 170/228 | 08/10→ | CCGP007 | 7v | | | |
| 4.0 4WD | 6 | VQ40DE | 198/266 | 09/05→ | OE148 | 1,0 | CET5 | OE190 | |

PATROL GR V

| | | | | | | | | | |
|-----------|---|-------|---------|--------|-------|-----|------|-------|--|
| 4.5 i 4WD | 6 | TB45E | 147/197 | 06/97→ | OE048 | 1,0 | CET8 | OE195 | |
|-----------|---|-------|---------|--------|-------|-----|------|-------|--|

PATROL III

| | | | | | | | | | |
|---------|---|--------|---------|--------|-------|-----|--|--|--|
| 5.6 4WD | 8 | VK56VD | 298/400 | 04/10→ | OE233 | 1,0 | | | |
|---------|---|--------|---------|--------|-------|-----|--|--|--|

PICK UP

| | | | | | | | | | |
|------------------|---|----------|---------|-------------|--------------------------|------|------|-------|--|
| 2.4 | 4 | KA24DE | 110/148 | 01/03→04/05 | OE063 | 1,0 | CET2 | | |
| 2.4, 2.4 i 4WD | 4 | KA24DE | 98/131 | 11/01→04/05 | OE063 | 1,0 | CET2 | | |
| 2.4 i, 2.4 i 4WD | 4 | KA24E | 88/118 | 02/98→04/05 | OE089 *to be adjusted | 0,8* | CET2 | OE184 | |
| 2.5 D 4WD | 4 | | 96/129 | 01/97→04/05 | CH230 | 11v | | | |
| 2.5 Di | 4 | YD25DDTi | 98/131 | 03/02→12/10 | CH230 | 11v | | | |

PIXO

| | | | | | | | | | |
|-----|---|------|-------|--------|-----------------|-----|--------|--|--|
| 1.0 | 3 | K10B | 50/67 | 06/09→ | OE226 | 1,1 | CET10P | | |
| | | | | | OE230 LPG [278] | 0,9 | | | |

PRIMERA

| | | | | | | | | | |
|----------------|---|--------|---------|-------------|-----------------|-----|------|-------|---|
| 1.6 | 4 | QG16DE | 78/105 | 03/02→08/08 | OE148 | 1,0 | CET5 | OE190 | BAEA081E →06/10 |
| 1.6, 1.6 Visia | 4 | QG16DE | 80/107 | 01/02→04/06 | OE148 | 1,0 | CET5 | OE190 | BAEA081E →06/10 |
| 1.6 16V | 4 | GA16DE | 66/89 | 09/96→07/02 | OE033 | 0,9 | CET2 | OE179 | CLS059 [292] |
| 1.6 16V | 4 | GA16DE | 73/98 | 09/96→07/02 | OE033 | 0,9 | CET2 | OE179 | CLS059 [292] |
| 1.6 16V | 4 | QG16DE | 78/105 | 06/96→07/02 | OE063 | 1,0 | CET2 | OE180 | BAEA081E CLS059 [292] |
| 1.6 16V | 4 | QG16DE | 80/107 | 04/98→12/01 | OE063 | 1,0 | CET2 | OE180 | |
| 1.8 | 4 | QG18DE | 85/114 | 03/02→10/08 | OE224 LPG [279] | 0,8 | CET5 | OE190 | BAEA081E |
| 1.8 16V | 4 | QG18DE | 84/113 | 08/99→07/02 | OE063 | 1,0 | CET2 | OE180 | BAEA021E →09/00 [7] [264] BAEA081E 09/00→ |
| 1.9 dCi | 4 | F9Q | 85/114 | 08/02→10/07 | CH271 | 11v | | | CCU154 |
| 1.9 dCi | 4 | F9Q | 88/118 | 04/03→ | CH271 | 11v | | | CCU154 |
| 2.0 | 4 | QR20DE | 103/138 | 03/02→ | OE224 LPG [279] | 0,8 | CET5 | OE190 | BAEA080E |
| 2.0 16V | 4 | SR20DE | 96/129 | 09/96→07/02 | OE089 | 1,0 | CET2 | OE184 | CLS132 |
| 2.0 16V | 4 | SR20DE | 103/138 | 08/99→07/02 | OE089 | 1,0 | CET2 | OE184 | CLS132 |
| 2.0 16V | 4 | SR20DE | 110/148 | 09/96→07/02 | OE089 | 1,0 | CET2 | OE184 | CLS132 |
| 2.0 16V | 4 | SR20VE | 140/188 | 06/96→05/99 | OE002 | 0,9 | CET2 | | |

NISSAN





kW/BHP



eon TITAN

IRIDIUM



...NISSAN



...PRIMERA

| | | | | | | | | |
|---------|---|---------|---------|--------------|----------------|------------|------|-------|
| 2.0 i | 4 | SR20DE | 92/123 | 01/95 →06/96 | OE005 | 0,9 | CET2 | OE180 |
| 2.0 TD | 4 | CD20T | 66/89 | 09/96 →07/02 | CH600 | 11v | | |
| 2.2 dCi | 4 | YD22DDT | 102/137 | 04/03 → | CH230 | 11v | | |
| 2.2 Di | 4 | YD22DDT | 93/125 | 03/02 →05/07 | CH230 | 11v | | |
| 2.5 | 4 | QG25DD | 125/168 | 01/02 → | OE207 | 1,1 | | |
| 2.5 | 4 | QR25DE | 125/168 | 01/02 → | OE148 OE207 | 1,0 1,1 | CET5 | OE190 |

PULSAR

| | | | | | | | | |
|-----------|---|---------|--------|---------|--|--|--|----------|
| 1.2 DIG-T | 4 | HR12DDT | 85/114 | 10/14 → | | | | OE261 |
| 1.2 DIG-T | 4 | HRA2DDT | 85/114 | 10/14 → | | | | BAEA131E |

QASHQAI / QASHQAI +2 I

| | | | | | | | | |
|----------------------|---|----------------|---------|--------------|----------------------|-----|--|--|
| 1.5 dCi | 4 | K9K282; K9K292 | 76/102 | 07/08 →12/13 | CH271 | 11v | | |
| 1.5 dCi | 4 | K9K282; K9K292 | 78/105 | 02/07 →12/13 | CH271 | 11v | | |
| 1.6 | 4 | HR16DE | 81/109 | 02/07 →12/13 | OE207 [104] [358] | 1,1 | | OE240 BAEA056E |
| 1.6 | 4 | HR16DE | 84/113 | 02/07 →12/13 | OE207 [104] [358] | 1,1 | | OE240 BAEA056E →01/10 BAEA088E 09/10 → |
| 1.6 | 4 | HR16DE | 86/115 | 11/10 →12/13 | OE207 [104] [358] | 1,1 | | OE240 BAEA056E [20] [109] [298] BAEA088E [22] [106] [294] |
| 2.0, 2.0 4WD | 4 | MR20DE | 104/139 | 02/07 →12/13 | OE207 | 1,1 | | BAEA088E |
| 2.0 dCi, 2.0 dCi 4WD | 4 | MTD; M9R | 110/148 | 02/07 →12/13 | CCGP007 | 7v | | |

QASHQAI II

| | | | | | | | | |
|-----------|---|---------|--------|---------|--|--|--|----------------------|
| 1.2 DIG-T | 4 | HR12DDT | 85/114 | 11/13 → | | | | OE261 [102] |
| 1.2 DIG-T | 4 | HRA2DDT | 85/114 | 11/13 → | | | | OE261 [102] BAEA131E |

QUEST

| | | | | | | | | |
|-----|---|--------|---------|---------|-------|-----|--------|-------|
| 3.5 | 6 | VQ35DE | 176/236 | 05/03 → | OE175 | 1,0 | CET14P | OE190 |
|-----|---|--------|---------|---------|-------|-----|--------|-------|

SENTRA V

| | | | | | | | | |
|-----|---|--------|---------|--------------|-------|-----|------|-------|
| 2.5 | 4 | QR25DE | 129/173 | 06/02 →08/06 | OE148 | 1,0 | CET5 | OE190 |
|-----|---|--------|---------|--------------|-------|-----|------|-------|

SENTRA VII

| | | | | | | | | |
|-----|---|--------|--------|---------|--|--|--|-------|
| 1.6 | 4 | HR16DE | 83/111 | 05/13 → | | | | OE240 |
| 1.6 | 4 | HR16DE | 85/114 | 05/13 → | | | | OE240 |
| 1.6 | 4 | HR16DE | 86/115 | 08/14 → | | | | OE240 |

SERENA

| | | | | | | | | |
|----------------------|---|--------|---------|--------------|-------|-----|------|-------|
| 1.6 | 4 | GA16DE | 71/95 | 02/93 →09/01 | OE033 | 0,9 | CET2 | OE179 |
| 1.6 | 4 | GA16DE | 75/101 | 10/94 →08/00 | OE063 | 1,0 | CET2 | |
| 2.0, 2.0 4WD | 4 | MR20DE | 108/145 | 04/05 →07/16 | OE207 | 1,1 | | |
| 2.0 SGX, 2.0 SGX 4WD | 4 | SR20DE | 107/143 | 09/00 →09/05 | OE063 | 1,0 | CET2 | |
| 2.3 D | 4 | LD23 | 55/74 | 01/95 →09/01 | CH186 | 11v | | |

SKYLINE

| | | | | | | | | |
|---------|---|--------|---------|--------------|-------|-----|--------|-------|
| 3.5 4WD | 6 | VQ35DE | 206/276 | 08/03 →08/07 | OE175 | 1,0 | CET14P | OE190 |
|---------|---|--------|---------|--------------|-------|-----|--------|-------|

STAGEA

| | | | | | | | | |
|---------------|---|---------|---------|--------------|-------|-----|--------|-------|
| 2.5, 2.5 4WD | 6 | RB25DE | 140/188 | 09/96 →10/01 | | | CET12P | OE188 |
| 2.5 Turbo 4WD | 6 | RB25DET | 173/232 | 09/96 →10/01 | | | CET12P | OE188 |
| 2.5 Turbo 4WD | 6 | VQ25DET | 206/276 | 10/01 →06/03 | OE191 | 1,0 | CET12P | OE180 |
| 3.5, 3.5 4WD | 6 | VQ35DE | 200/268 | 04/06 →12/07 | OE175 | 1,0 | CET14P | OE190 |

SUNNY III

| | | | | | | | | |
|-----|---|--------|--------|--------------|-------|-----|------|--|
| 1.6 | 4 | GA16DE | 75/101 | 07/95 →03/00 | OE063 | 1,0 | CET2 | |
|-----|---|--------|--------|--------------|-------|-----|------|--|

SUNNY IV

| | | | | | | | | |
|-----|---|--------|-------|--------------|-------|-----|------|-------|
| 1.3 | 4 | QG13DE | 64/86 | 09/97 →03/00 | OE063 | 1,0 | CET2 | OE180 |
|-----|---|--------|-------|--------------|-------|-----|------|-------|



kW/BHP

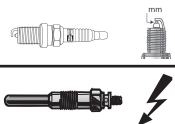

eon TITAN

IRIDIUM

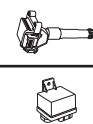

...NISSAN



...SUNNY IV

| | | | | | | | | | |
|-----|---|--------|---------|-------------|-------|-----|------|-------|--|
| 1.5 | 4 | QG15DE | 77/103 | 09/97→08/03 | OE063 | 1,0 | CET2 | OE180 | |
| 2.0 | 4 | SR20DE | 110/148 | 01/00→05/02 | OE063 | 1,0 | CET2 | | |

SYLPHY III

| | | | | | | | | | |
|-----|---|--------|--------|--------|--|--|--|-------|--|
| 1.6 | 4 | HR16DE | 85/114 | 08/12→ | | | | OE240 | |
|-----|---|--------|--------|--------|--|--|--|-------|--|

TEANA I

| | | | | | | | | | |
|-----|---|--------|---------|-------------|-------|-----|--------|-------|--------------------------|
| 2.0 | 4 | QR20DE | 103/138 | 10/03→06/08 | | | CET5 | OE190 | BAEA080E |
| 2.3 | 6 | VQ23DE | 127/170 | 10/03→06/08 | OE175 | 1,0 | CET14P | OE190 | BAEA079E [108] 03/07→ |
| 3.5 | 6 | VQ35DE | 170/228 | 10/03→06/08 | OE175 | 1,0 | CET14P | OE190 | BAE940A |

TEANA II

| | | | | | | | | | |
|-----|---|--------|---------|-------------|-------|-----|--|--|----------|
| 2.5 | 6 | VQ25DE | 134/180 | 07/08→09/13 | OE207 | 1,1 | | | BAEA158E |
| 3.5 | 6 | VQ35DE | 183/245 | 07/08→09/13 | | | | | BAEA158E |

TERRANO II

| | | | | | | | | | |
|---------------|---|--------|---------|-------------|-------|-----|--------|-------|--|
| 2.4 4WD | 4 | KA24E | 85/114 | 05/96→01/02 | OE089 | 1,0 | CET2 | OE184 | |
| 2.4 4WD | 4 | KA24E | 87/117 | 05/96→09/07 | OE089 | 1,0 | CET2 | OE184 | |
| 2.4 i 12V 4WD | 4 | KA24E | 91/122 | 02/93→12/97 | OE089 | 1,0 | CET2 | OE184 | |
| 3.5 4WD | 6 | VQ35DE | 177/237 | 10/94→06/03 | OE175 | 1,0 | CET14P | OE190 | |

TIIDA

| | | | | | | | | | |
|--------------|---|-------------|--------|-------------|-------------|-----|--|-------|----------|
| 1.5, 1.5 4WD | 4 | HR15DE | 80/107 | 05/04→06/13 | | | | OE240 | BAEA088E |
| 1.5 dCi | 4 | K9K; K9K278 | 76/102 | 01/07→12/12 | CH271 | 11v | | | |
| 1.5 dCi | 4 | K9K; K9K278 | 78/105 | 09/07→12/12 | CH271 | 11v | | | |
| 1.6 | 4 | HR16DE | 78/105 | 09/12→09/16 | | | | OE240 | |
| 1.6 | 4 | HR16DE | 79/106 | 09/16→ | | | | OE240 | |
| 1.6 | 4 | HR16DE | 80/107 | 05/06→06/13 | OE207 [358] | 1,1 | | OE240 | |
| 1.6 | 4 | HR16DE | 81/109 | 09/07→12/12 | OE207 [358] | 1,1 | | OE240 | BAEA056E |
| 1.6 | 4 | HR16DE | 87/117 | 08/05→06/13 | OE207 [358] | 1,1 | | OE240 | |
| 1.8 | 4 | MR18DE | 78/105 | 01/07→06/11 | OE207 | 1,1 | | | BAEA056E |
| 1.8 | 4 | MR18DE | 93/125 | 09/07→ | OE207 | 1,1 | | | BAEA056E |
| 1.8 | 4 | MR18DE | 95/127 | 08/06→12/12 | | | | | BAEA056E |
| 1.8, 1.8 4WD | 4 | HR18DE | 81/109 | 05/04→02/07 | OE207 | 1,1 | | | |

XTERRA

| | | | | | | | | | |
|---------|---|--------|---------|--------|-------|-----|--|--|--|
| 4.0 4WD | 6 | VQ40DE | 198/266 | 01/05→ | OE175 | 1,0 | | | |
|---------|---|--------|---------|--------|-------|-----|--|--|--|

X-TRAIL

| | | | | | | | | | |
|----------------------|---|-------------------|---------|-------------|-----------------|-----|----------------|-------|--------------------|
| 2.0 | 4 | MR20DE | 103/138 | 07/01→11/13 | OE207 →07/10 | 1,1 | | | BAEA056E |
| 2.0 | 4 | MR20DE | 104/139 | 03/07→ | OE207 →07/10 | 1,1 | | | BAEA056E |
| 2.0, 2.0 4WD | 4 | QR20DE | 103/138 | 07/01→11/13 | OE224 [PG 279] | 0,8 | CET5 | OE190 | BAEA080E |
| 2.0, 2.0 4WD | 4 | QR20DE | 110/148 | 09/01→01/13 | OE224 [PG 279] | 0,8 | CET5 | OE190 | BAEA080E →01/07 |
| 2.0 4WD | 4 | MR20DE | 101/135 | 06/07→11/13 | OE207 | 1,1 | | | BAEA056E |
| 2.0 4WD | 4 | MR20DE | 103/138 | 07/01→11/13 | OE207 | 1,1 | | | BAEA056E |
| 2.0 4WD | 4 | MR20DE | 104/139 | 06/07→11/13 | OE207 | 1,1 | | | BAEA056E |
| 2.0 4WD | 4 | SR20VET | 206/276 | 06/01→01/13 | OE148 | 1,0 | CET14P CET5 | OE190 | |
| 2.0 4WD | 4 | QR20DE | 206/276 | 06/01→01/13 | | | | | BAEA080E →01/07 |
| 2.0 dCi, 2.0 dCi 4WD | 4 | M9R | 110/148 | 06/07→11/13 | CCGP007 | 7v | | | |
| 2.0 dCi 4WD | 4 | M9R760 | 127/170 | 06/07→11/13 | CCGP007 | 7v | | | |
| 2.2 dCi, 2.2 dCi 4WD | 4 | YD22DDTi | 100/134 | 12/03→01/13 | CH230 | 11v | | | |
| 2.2 dCi, 2.2 Di 4WD | 4 | YD22DDTi; YD22ETi | 84/113 | 06/01→01/13 | CH230 | 11v | | | |
| 2.5 4WD | 4 | QR25DE | 121/162 | 09/02→01/13 | OE224 [PG 279] | 0,8 | CET5 | OE190 | BAEA080E |
| 2.5 4WD | 4 | QR25DE | 124/166 | 09/04→ | | | | | BAEA056E |

NISSAN





kW/BHP



eon TITAN

IRIDIUM



...NISSAN



...X-TRAIL

| | | | | | | | | | |
|---------|---|--------|---------|--------|---------------------------------|-----|-------------|--------------|--|
| 2.5 4WD | 4 | QR25DE | 132/177 | 11/02→ | OE224 LPG [266] [279] | 0,8 | CET5 | OE190 | BAEA080E ^[107] →01/07 |
|---------|---|--------|---------|--------|---------------------------------|-----|-------------|--------------|--|

NISSAN



CABSTAR

| | | | | | | | | | |
|-------------------------------------|---|----------|--------|-------------|--------------------------|-----|--|--|--|
| 2.5 28.11 DCI, 32.11 DCI, 35.11 DCI | 4 | YD25DDTi | 81/109 | 09/06→12/13 | CH230 →10/11 | 11v | | | |
| | | | | | CCGP007 10/11→ | 7v | | | |
| 2.5 35.13 DCI, 45.13 DCI | 4 | YD25DDTi | 96/129 | 09/06→12/12 | CH230 →10/11 | 11v | | | |
| | | | | | CCGP007 10/11→ | 7v | | | |

CARAVAN

| | | | | | | | | | |
|-----|---|--------|--------|-------------|--------------|-----|-------------|--------------|--|
| 2.0 | 4 | KA20DE | 88/118 | 10/00→09/02 | OE063 | 1,0 | CET2 | OE180 | |
|-----|---|--------|--------|-------------|--------------|-----|-------------|--------------|--|

INTERSTAR

| | | | | | | | | | |
|-------------|---|------------------------|---------|-------------|--------------|-----|--|--|--|
| 1.9 dCi 80 | 4 | F9Q772; F9Q774 | 60/80 | 04/02→08/06 | CH271 | 11v | | | |
| 2.2 dCi 90 | 4 | G9T722 | 66/89 | 07/02→ | CH232 | 11v | | | |
| 2.5 dCi 100 | 4 | G9U720; G9U754 | 73/98 | 11/03→ | CH232 | 11v | | | |
| 2.5 dCi 100 | 4 | G9U650; G9U720; G9U754 | 74/99 | 04/06→ | CH232 | 11v | | | |
| 2.5 dCi 120 | 4 | G9U720; G9U724; G9U750 | 84/113 | 04/02→ | CH232 | 11v | | | |
| 2.5 dCi 120 | 4 | G9U650 | 88/118 | 08/06→ | CH232 | 11v | | | |
| 2.5 dCi 150 | 4 | G9U632 | 107/143 | 08/06→ | CH232 | 11v | | | |

KUBISTAR

| | | | | | | | | | |
|---------|---|----------------|-------|--------|--------------|-----|-------------|--------------|----------------------------------|
| 1.2 | 4 | D7F764 | 44/59 | 08/03→ | OE026 | 0,9 | CET2 | OE188 | BAE409A |
| 1.2 16V | 4 | D4F712 | 55/74 | 04/06→ | OE130 | 0,9 | CET4 | | BAE947A BAEA325 |
| 1.5 dCi | 4 | K9K710; K9K714 | 45/60 | 08/05→ | CH271 | 11v | | | |
| 1.5 dCi | 4 | K9K704 | 48/64 | 08/03→ | CH271 | 11v | | | |
| 1.5 dCi | 4 | K9K722 | 60/80 | 08/03→ | CH271 | 11v | | | |
| 1.6 16V | 4 | K4M752 | 70/94 | 08/03→ | OE033 | 0,9 | CET2 | OE179 | BAE409A |

NP300 NAVARA

| | | | | | | | | | |
|-------------|---|----------|---------|--------|---|-----|--|--|--|
| 2.5 dCi 4WD | 4 | YD25DDTi | 106/142 | 08/08→ | CH230 →01/10 | 11v | | | |
| | | | | | CCGP007 ^[81] 01/10→11/13 | 7v | | | |
| 2.5 dCi 4WD | 4 | YD25DDTi | 126/169 | 08/08→ | CH230 →01/10 | 11v | | | |
| | | | | | CCGP007 ^[81] 01/10→11/13 | 7v | | | |
| 2.5 dCi 4WD | 4 | YD25DDTi | 140/188 | 03/10→ | CCGP007 ^[81] →11/13 | 7v | | | |
| 3.0 dCi 4WD | 6 | V9X | 170/228 | 03/10→ | CCGP007 | 7v | | | |

NV200

| | | | | | | | | | |
|---------|---|------------------------|--------|--------|------------------------------|-----|--|--|-----------------|
| 1.5 dci | 4 | K9K400; K9K608; K9K628 | 63/84 | 02/10→ | CH271 ^[21] | 11v | | | |
| 1.5 dci | 4 | K9K892 | 66/89 | 04/11→ | CH271 ^[21] | 11v | | | |
| 1.6 16V | 4 | HR16DE | 81/109 | 02/10→ | OE207 | 1,1 | | | BAEA056E |

NV200 / EVALIA

| | | | | | | | | | |
|---------|---|------------------------|--------|--------|------------------------------|-----|--|--|-----------------|
| 1.5 dci | 4 | K9K400; K9K608; K9K628 | 63/84 | 07/10→ | CH271 ^[21] | 11v | | | |
| 1.5 dci | 4 | K9K892 | 66/89 | 04/11→ | CH271 ^[21] | 11v | | | |
| 1.6 16V | 4 | HR16DE | 81/109 | 07/10→ | OE207 | 1,1 | | | BAEA056E |

NV400

| | | | | | | | | | |
|-------------|---|---|--------|-------------|----------------|----|--|--|--|
| 2.3 dCi 100 | 4 | M9T670; M9T672; M9T676 | 74/99 | 11/11→06/14 | CCGP007 | 7v | | | |
| 2.3 dCi 125 | 4 | M9T670; M9T672; M9T676; M9T686; M9T690; M9T692; M9T696; M9T698; M9T870; M9T896 | 92/123 | 11/11→09/16 | CCGP007 | 7v | | | |

NISSAN





kW/BHP



eon TITAN

IRIDIUM



...NISSAN



...NV400

| | | | | | | | | | |
|--------------------------|---|--|---------|-------------|---------|----|--|--|--|
| 2.3 dCi 145 | 4 | M9T678; M9T680; M9T694; M9T696; M9T698; M9T706 | 107/143 | 11/11→06/16 | CCGP007 | 7v | | | |
| 2.3 dCi 160, 2.3 dCi 165 | 4 | M9T | 120/161 | 06/14→ | CCGP007 | 7v | | | |

PRIMASTAR

| | | | | | | | | | |
|--------------------------|---|----------------|---------|--------|---------|-----|------|-------|---------|
| 1.9 dCi 80 | 4 | F9Q762 | 60/80 | 03/01→ | CH271 | 11v | | | CCU154 |
| 1.9 dCi 100 | 4 | F9Q760 | 74/99 | 03/01→ | CH271 | 11v | | | CCU154 |
| 2.0 | 4 | F4R720; F4R722 | 88/118 | 03/01→ | | | CET2 | OE179 | BAE409A |
| 2.0 dCi 90 | 4 | M9R782 | 66/89 | 09/06→ | CCGP007 | 7v | | | |
| 2.0 dCi 115, 2.0 dCi 120 | 4 | M9R630; M9R780 | 84/113 | 09/06→ | CCGP007 | 7v | | | |
| 2.5 dCi 140 | 4 | G9U730 | 99/133 | 07/02→ | CH232 | 11v | | | CCU154 |
| 2.5 dCi 150 | 4 | G9U632 | 107/143 | 04/06→ | CH232 | 11v | | | CCU154 |

TRADE

| | | | | | | | | | |
|----------|---|---------|--------|-------------|-------|-----|--|--|--|
| 2.3 75 | 4 | LD23 | 55/74 | 05/97→12/00 | CH186 | 11v | | | |
| 3.0 D | 4 | BD30II | 63/84 | 04/93→12/98 | CH271 | 11v | | | |
| 3.0 TD | 4 | BD-30Ti | 81/109 | 11/98→09/04 | CH271 | 11v | | | |
| 3.0 TDiC | 4 | BD-30Ti | 78/105 | 06/96→10/01 | CH271 | 11v | | | |

URVAN

| | | | | | | | | | |
|-----|---|--------|---------|-------------|-------|-----|------|--|--|
| 2.4 | 4 | KA24DE | 103/138 | 05/01→11/10 | OE063 | 1,0 | CET2 | | |
|-----|---|--------|---------|-------------|-------|-----|------|--|--|

VANETTE CARGO

| | | | | | | | | | |
|-------|---|--------|-------|-------------|-------|-----|------|-------|--------|
| 1.6 i | 4 | GA16DE | 71/95 | 09/94→05/01 | OE089 | 1,0 | CET2 | OE184 | CLS153 |
| 1.6 i | 4 | GA16DE | 72/97 | 01/96→05/01 | OE089 | 1,0 | CET2 | OE184 | CLS153 |
| 2.3 D | 4 | LD23 | 55/74 | 09/94→05/02 | CH186 | 11v | | | |

OPEL



ADAM

| | | | | | | | | | |
|---------|---|----------------|--------|--------|-------|-----|------|-------|----------|
| 1.0 | 3 | B10XFL; F10XFL | 66/89 | 07/14→ | | | | OE258 | |
| 1.0 | 3 | B10XFT; F10XFT | 85/114 | 07/14→ | | | | OE258 | |
| 1.2 | 4 | A12XEL; B12XEL | 51/68 | 10/12→ | | | CET2 | OE184 | BAEA185E |
| 1.2 | 4 | | 69/93 | 07/13→ | | | | | BAEA185E |
| 1.4 | 4 | A14XEL; B14XEL | 64/86 | 10/12→ | OE198 | 0,9 | CET2 | OE184 | BAEA185E |
| 1.4 | 4 | A14XER; B14XER | 74/99 | 10/12→ | OE198 | 0,9 | CET2 | OE184 | BAEA185E |
| 1.4 LPG | 4 | A14XEL; B14XEL | 64/86 | 07/13→ | | | | | BAEA185E |

AGILA (A)

| | | | | | | | | | |
|------------------|---|--------|-------|-------------|-------|-----|------|-------|---------------------------------------|
| 1.0 | 3 | Z10XEP | 44/59 | 08/03→12/07 | OE198 | 0,9 | CET2 | OE184 | BAEA359 |
| 1.0 12V | 3 | Z10XE | 43/58 | 09/00→12/07 | OE198 | 0,9 | CET2 | OE184 | BAEA358 |
| 1.2 16V | 4 | Z12XE | 55/74 | 09/00→12/07 | OE019 | 0,9 | CET2 | OE184 | BAEA147E |
| 1.2 16V Twinport | 4 | Z12XEP | 59/79 | 07/04→12/07 | OE198 | 0,9 | CET2 | OE184 | BAEA338 |
| 1.3 CDTI | 4 | Z13DT | 51/68 | 08/03→12/07 | | | | | CCU142 ^[8] →Ch.4G999999 |

AGILA (B)

| | | | | | | | | | |
|--------------|---|--------------|-------|-------------|----------------------------|-----|--------|--|-----------------------|
| 1.0 | 3 | K10B | 50/67 | 07/11→07/14 | OE226 | 1,1 | CET10P | | BAEA189E |
| | | | | | OE230 ^{LPG [278]} | 0,9 | | | |
| 1.0, 1.0 LPG | 3 | K10B | 48/64 | 04/08→06/11 | OE226 | 1,1 | CET10P | | BAEA189E |
| | | | | | OE230 ^{LPG [278]} | 0,9 | | | |
| 1.2 | 4 | K12B | 69/93 | 04/10→10/14 | OE226 | 1,1 | CET10P | | BAEA189E |
| 1.2, 1.2 LPG | 4 | K12B | 63/84 | 04/08→10/12 | OE226 | 1,1 | CET10P | | BAEA189E |
| | | | | | OE230 ^{LPG [278]} | 0,9 | | | |
| 1.3 CDTI | 4 | D13A; Z13DTJ | 55/74 | 04/08→04/10 | | | | | CCU142 ^[8] |

AMPERA

| | | | | | | | | | |
|------------|---|--------|---------|-------------|--|--|--|--|----------|
| 1.4 EV 150 | 4 | A14XFL | 111/149 | 11/11→03/15 | | | | | BAEA185E |
|------------|---|--------|---------|-------------|--|--|--|--|----------|

ANTARA

| | | | | | | | | | |
|------------------------|---|-------|---------|-------------|--|--|--------|-------|--------|
| 2.2 CDTi, 2.2 CDTi 4WD | 4 | A22DM | 120/161 | 12/10→12/15 | | | | | CCU138 |
| 2.4, 2.4 4WD | 4 | A24XE | 123/165 | 12/10→ | | | CET17P | OE189 | |

OPEL





kW/BHP



eon TITAN

IRIDIUM



...OPEL



...ANTARA

| | | | | | | | | | | |
|------------------------------------|---|---------------|---------|---------------|-------|-----|--------|-------|----------|--|
| 2.4, 2.4 4WD, 2.4 LPG, 2.4 LPG 4WD | 4 | Z24XE | 103/138 | 08/06 → | OE019 | 0,9 | CET2 | OE184 | BAEA447A | |
| 2.4 4WD | 4 | Z24XE; Z24XED | 104/139 | 07/06 → 12/11 | OE019 | 0,9 | CET2 | OE184 | BAEA447A | |
| 3.0 4WD | 6 | A30XH | 190/255 | 11/10 → 12/15 | | | CET17P | OE189 | | |
| 3.2 V6 4WD | 6 | 10HM; Z32SEE | 167/224 | 07/06 → 12/11 | OE029 | 1,0 | CET17P | OE189 | | |

ASTRA F

| | | | | | | | | | | |
|-----------|---|---------------|---------|---------------|-------|-----|------|-------|------------------------|-------------------------------------|
| 1.4 i 16V | 4 | X14XE | 66/89 | 01/96 → 03/01 | OE019 | 0,9 | CET2 | OE184 | BAEA026E | CLS030 |
| 1.6 | 4 | 16LZ2 | 55/74 | 09/95 → 09/98 | OE019 | 0,9 | CET2 | OE184 | BAEA252 [275] [292] | |
| 1.6 | 4 | 16NZR | 55/74 | 09/95 → 09/98 | OE019 | 0,9 | CET2 | OE184 | BAEA026E [275] | |
| 1.6 | 4 | 16LZ2 | 55/74 | 09/95 → 09/98 | OE019 | 0,9 | CET2 | OE184 | BAEA252 [275] [292] | |
| 1.6 i | 4 | X16SZ | 52/70 | 03/93 → 08/96 | OE019 | 0,9 | CET2 | OE184 | BAEA026E | CLS114 08/95 → Eng.028E6167 → |
| 1.6 i 16V | 4 | X16XEL | 74/99 | 08/94 → 09/98 | OE019 | 0,9 | CET2 | OE184 | BAEA026E | CLS029 |
| 1.7 TD | 4 | X17DTL | 50/67 | 11/94 → 09/98 | CH189 | 11v | | | | |
| 1.8 i 16V | 4 | 18SE | 82/110 | 09/95 → 09/96 | OE019 | 0,9 | CET2 | OE184 | | |
| 1.8 i 16V | 4 | C18SEL | 85/114 | 07/94 → 03/01 | OE019 | 0,9 | CET2 | OE184 | | |
| 1.8 i 16V | 4 | C18XEL; X18XE | 85/114 | 07/94 → 03/01 | OE019 | 0,9 | CET2 | OE184 | BAEA344 | CLS107 |
| 1.8 i 16V | 4 | C18XE | 92/123 | 06/93 → 01/98 | OE019 | 0,9 | CET2 | OE184 | BAEA344 | CLS107 |
| 2.0 i 16V | 4 | X20XEV | 100/134 | 02/95 → 09/98 | OE019 | 0,9 | CET2 | OE184 | BAEA344 | CLS107 |
| 2.0 i 16V | 4 | C20XE | 110/148 | 03/93 → 01/98 | OE019 | 0,9 | CET2 | OE184 | | |

ASTRA F CLASSIC

| | | | | | | | | | | |
|-----------|---|--------|-------|---------------|-------|-----|------|-------|---------------|--|
| 1.4 i | 4 | X14NZ | 44/59 | 01/98 → 01/05 | OE019 | 0,9 | CET2 | OE184 | BAEA253 [292] | CLS018 → Eng.028F1476 19241623 CLS141 Eng.028F1477 19241624 → |
| 1.6 i | 4 | X16SZR | 55/74 | 01/98 → 01/05 | OE019 | 0,9 | CET2 | OE184 | BAEA026E | CLS114 |
| 1.6 i 16V | 4 | X16XEL | 74/99 | 01/98 → 01/05 | OE019 | 0,9 | CET2 | OE184 | BAEA026E | CLS030 |

ASTRA G

| | | | | | | | | | | |
|--------------|---|----------------|---------|---------------|----------------|------------|--------|-------|---------------------------|--------|
| 1.2 16V | 4 | X12XE | 48/64 | 02/98 → 09/00 | OE019 | 0,9 | CET2 | OE184 | BAEA147E | |
| 1.2 16V | 4 | Z12XE | 55/74 | 09/00 → 01/05 | OE019 | 0,9 | CET2 | OE184 | BAEA147E → 09/03 | |
| 1.4 | 4 | Z14XEP | 66/89 | 10/04 → 12/09 | OE198 OE089 | 0,9 1,0 | CET2 | OE184 | BAEA338 | |
| 1.4 16V | 4 | X14XE; Z14XE | 66/89 | 02/98 → 01/05 | OE019 | 0,9 | CET2 | OE184 | BAE965A | CLS030 |
| 1.6 | 4 | X16SZR | 55/74 | 02/98 → 09/00 | OE019 | 0,9 | CET2 | OE184 | BAEA026E | CLS176 |
| 1.6 | 4 | Z16SE | 62/83 | 09/00 → 01/05 | OE019 | 0,9 | CET2 | OE184 | | CLS114 |
| 1.6, 1.6 16V | 4 | Z16XEP | 76/102 | 03/00 → 12/09 | OE198 | 0,9 | CET2 | OE184 | BAEA427 | |
| 1.6 16V | 4 | C16SEL | 74/99 | 02/98 → 10/05 | OE198 | 0,9 | CET2 | OE184 | | |
| 1.6 16V | 4 | Z16XE | 74/99 | 02/98 → 10/05 | OE019 | 0,9 | CET2 | OE184 | BAE965A → Eng.41000000 | |
| 1.6 16V | 4 | X16XEL | 74/99 | 02/98 → 10/05 | OE198 OE019 | 0,9 0,9 | CET2 | OE184 | BAE965A | |
| 1.6 CNG | 4 | Z16YNG | 71/95 | 03/03 → 07/04 | OE136 | 0,8 | CET12P | OE179 | BAE965A | |
| 1.7 CDTI | 4 | Z17DTL | 59/79 | 04/03 → 12/09 | | | | | CCU143 [7] | |
| 1.7 DTI 16V | 4 | Y17DT | 55/74 | 02/00 → 01/05 | | | | | CCU143 [7] | |
| 1.7 TD | 4 | X17DTL | 50/67 | 02/98 → 08/00 | CH189 | 11v | | | CCU143 [7] | |
| 1.8 16V | 4 | X18XE1 | 85/114 | 02/98 → 10/00 | OE019 | 0,9 | CET2 | OE184 | BAEA342 | |
| 1.8 16V | 4 | Z18XE | 92/123 | 06/00 → 10/05 | OE198 | 0,9 | CET2 | OE184 | BAEA342 | |
| 2.0 16V | 4 | C20SEL; X20XEV | 100/134 | 02/98 → 01/05 | OE019 | 0,9 | CET2 | OE184 | BAEA344 | |

OPEL





kW/BHP



eon TITAN

IRIDIUM



...OPEL



...ASTRA G

| | | | | | | | | | | |
|------------------------|---|----------------|---------|-------------|--|-----|---------------|--------------|------------------------------|---------------|
| 2.0 16V OPC | 4 | X20XER | 118/158 | 11/99→09/02 | OE019 | 0,9 | CET2 | OE184 | BAEA344 | CLS107 |
| 2.0 16V Turbo | 4 | Z20LET | 140/188 | 09/00→08/01 | OE019 | 0,9 | CET2 | OE184 | | |
| 2.0 16V Turbo, 2.0 OPC | 4 | Z20LET | 141/189 | 08/01→10/05 | OE019 | 0,9 | CET2 | OE184 | | |
| 2.0 16V Turbo, 2.0 OPC | 4 | Z20LET | 147/197 | 11/02→10/05 | OE019 | 0,9 | CET2 | OE184 | | |
| 2.0 DI | 4 | X20DTL; Y20DTL | 60/80 | 02/98→01/05 | CH207 | 11v | | | CCU143 ^[7] | |
| 2.0 DTI 16V | 4 | Y20DTH | 74/99 | 08/99→01/05 | CH231 09/02→ Ch.32000001 35000001 36000001 38000001 38000001 3H000001 46000001→ | 11v | | | CCU142 ^[8] | |
| 2.2 16V | 4 | Z22SE | 108/145 | 06/00→10/05 | OE255 | 1,0 | CET17P | OE189 | | |
| 2.2 DTI | 4 | Y22DTR | 86/115 | 09/02→01/05 | CH231 | 11v | | | CCU142 ^[8] | |
| 2.2 DTI | 4 | Y22DTR | 92/123 | 09/02→10/05 | CH231 | 11v | | | CCU142 ^[8] | |

ASTRA H

| | | | | | | | | | | |
|----------------------------|---|----------------|---------|-------------|--|-----|---------------|--------------|------------------------------|--|
| 1.2 | 4 | Z12XEP | 59/79 | 08/05→10/10 | OE198 | 0,9 | CET2 | OE184 | BAEA338 | |
| 1.3 CDTi, 1.3 CDTi | 4 | Z13DTH | 66/89 | 04/05→10/10 | | | | | CCU142 ^[8] | |
| 1.4 | 4 | Z14XEL | 55/74 | 04/04→10/10 | OE198 | 0,9 | CET2 | OE184 | | |
| 1.4 | 4 | Z14XEL | 59/79 | 04/04→10/04 | OE198 | 0,9 | CET2 | OE184 | | |
| 1.4, 1.4 LPG | 4 | Z14XEP | 66/89 | 03/04→10/10 | OE198 | 0,9 | CET2 | OE184 | BAEA338 | |
| 1.6 | 4 | Z16XE1; Z16XEP | 77/103 | 03/04→10/10 | OE198 | 0,9 | CET2 | OE184 | BAEA427 | |
| 1.6, 1.6 LPG | 4 | A16XER; Z16XER | 85/114 | 12/06→05/14 | OE198 | 0,9 | CET2 | OE184 | BAEA427 | |
| 1.6 Turbo | 4 | Z16LET | 132/177 | 02/07→10/10 | | | CET12P | OE188 | BAEA427 | |
| 1.7 CDTi | 4 | Z17DTL | 59/79 | 03/04→10/10 | | | | | CCU143 ^[7] | |
| 1.7 CDTi | 4 | A17DTR; Z17DTR | 92/123 | 02/07→05/14 | | | | | CCU143 ^[7] | |
| 1.7 CDTi, 1.7 CDTi | 4 | Z17DTH | 74/99 | 03/04→10/10 | | | | | CCU143 ^[7] | |
| 1.7 CDTi, 1.7 CDTi | 4 | A17DTJ; Z17DTJ | 81/109 | 02/07→05/14 | | | | | CCU143 ^[7] | |
| 1.8 | 4 | Z18XE | 92/123 | 01/04→10/10 | OE198 | 0,9 | CET2 | OE184 | BAEA342 | |
| 1.8 | 4 | A18XER; Z18XER | 103/138 | 08/05→10/10 | OE198 | 0,9 | CET2 | OE184 | BAEA427 | |
| 1.9 CDTi | 4 | Z19DTL | 74/99 | 09/05→10/10 | CH222 →Ch.72045139 75030986 78007391 76 CH269 Ch.72045140 75030987 78007392 88000001 76→ | 11v | | | CCU142 ^[8] | |
| | | | | | | 11v | | | CCU143 ^[7] | |
| 1.9 CDTi | 4 | Z19DT | 88/118 | 06/04→10/10 | CH222 →Ch.72045139 75030986 78007391 76 CH269 Ch.72045140 75030987 78007392 88000001 76→ | 11v | | | CCU142 ^[8] | |
| | | | | | | 11v | | | CCU143 ^[7] | |
| 1.9 CDTi, 1.9 CDTi | 4 | Z19DTH | 110/148 | 09/04→10/10 | CH224 | 11v | | | CCU142 ^[8] | |
| | | | | | | | | | CCU143 ^[7] | |
| 1.9 CDTi 16V, 1.9 CDTi 16V | 4 | Z19DTJ | 88/118 | 04/04→10/10 | CH224 | 11v | | | CCU142 ^[8] | |
| 2.0 Turbo | 4 | Z20LEL | 125/168 | 03/04→10/10 | OE136 | 0,8 | CET12P | OE179 | | |
| 2.0 Turbo | 4 | Z20LER | 147/197 | 09/04→10/10 | OE089 | 1,0 | CET2 | OE179 | | |
| 2.0 Turbo | 4 | Z20LEH | 177/237 | 03/05→10/10 | OE136 | 0,8 | CET12P | OE179 | | |

OPEL





kW/BHP



eon TITAN

IRIDIUM



...OPEL



ASTRA J

| | | | | | | | | | | |
|-------------------------------|---|----------------|---------|-------------|--|------|--------|------------------------|--------------------------|--------|
| 1.3 CDTI | 4 | A13DTE | 70/94 | 12/09→10/15 | CP5G003 ^[37] →Ch. B3999999 B8999999 BG999999 | 4.4v | | | | CCU138 |
| 1.4 | 4 | A14XEL | 64/86 | 12/09→10/15 | | | CET2 | OE184 | BAEA185E | |
| 1.4 | 4 | A14XER; B14XER | 74/99 | 12/09→10/15 | | | CET2 | OE184 | BAEA185E | |
| 1.4, 1.4 LPG | 4 | A14NET; B14NET | 103/138 | 10/11→ | | | | | BAEA185E | |
| 1.4, 1.4 Turbo | 4 | A14NEL; B14NEL | 88/118 | 10/10→ | | | | | BAEA185E | |
| 1.4 Turbo | 4 | A14NET; B14NET | 103/138 | 12/09→ | | | | OE264 | BAEA185E | |
| 1.6 | 4 | A16XER; B16XER | 85/114 | 12/09→ | OE198 | 0,9 | CET2 | OE184 | BAEA198E Ch.205D0232→ | |
| 1.6, 1.6 Turbo, 1.6 Turbo 4WD | 4 | A16LET | 132/177 | 12/09→ | OE216 ^{LPG [278]} | 0,8 | CET12P | OE179 | BAEA199E | |
| 1.6 LPG | 4 | A16XER | 84/113 | 10/12→10/15 | | | | | BAEA198E Ch.205D0232→ | |
| 1.7 CDTI | 4 | A17DTL; A17DTN | 74/99 | 10/10→10/15 | | | | | CCU145 | |
| 1.7 CDTI | 4 | A17DTJ | 81/109 | 09/09→10/15 | | | | | CCU145 | |
| 1.7 CDTI | 4 | A17DTE | 81/109 | 09/09→10/15 | CP5G004 | 4.4v | | | | |
| 1.7 CDTI | 4 | A17DTR | 92/123 | 12/09→10/15 | | | | | CCU145 | |
| 1.7 CDTI | 4 | A17DTF | 96/129 | 10/10→10/15 | CP5G004 | 4.4v | | | CCU145 | |
| 1.7 CDTI | 4 | A17DTS | 96/129 | 10/10→10/15 | | | | | CCU145 | |
| 1.8 | 4 | A18XER | 103/138 | 10/11→10/15 | OE198 | 0,9 | CET2 | OE184 | BAEA199E | |
| 2.0 | 4 | A20NFT; B20NFT | 206/276 | 04/12→ | | | CET17P | OE189 *tobeadjusted | | |
| 2.0 BiTurbo CDTI | 4 | A20DTR | 143/192 | 09/12→10/15 | CP5G006 | 4.4v | | | CCU138 | |
| 2.0 CDTI | 4 | A20DTH | 118/158 | 09/09→10/15 | CP5G006 | 4.4v | | | CCU138 | |
| 2.0 CDTI | 4 | A20DTH | 121/162 | 06/11→10/15 | CP5G006 | 4.4v | | | CCU138 | |

ASTRA K

| | | | | | | | | | | |
|-----------|---|----------------|---------|--------|--|--|--|-------|--|--|
| 1.0 Turbo | 3 | B10XFL; D10XFL | 77/103 | 06/15→ | | | | OE258 | | |
| 1.4 Turbo | 4 | B14XFL | 92/123 | 06/15→ | | | | OE258 | | |
| 1.4 Turbo | 4 | B14XFT | 103/138 | 07/17→ | | | | OE258 | | |
| 1.4 Turbo | 4 | B14XFT | 110/148 | 06/15→ | | | | OE258 | | |

CALIBRA A

| | | | | | | | | | | |
|--------------------------|---|--------------|---------|-------------|-------|-----|------|-------|---------|--------|
| 2.0 i 16V, 2.0 i 16V 4WD | 4 | X20XE | 100/134 | 02/94→07/97 | OE019 | 0,9 | CET2 | OE184 | BAEA344 | CLS107 |
| 2.5 i V6 | 6 | C25XE; X25XE | 125/168 | 04/93→07/97 | OE019 | 0,9 | CET2 | OE184 | | |

CAMPO

| | | | | | | | | | | |
|----------------------|---|-----------|-------|-------------|-------|-----|------|-------|--|--|
| 2.3, 2.3 4WD | 4 | 4ZD1; 23P | 72/97 | 08/94→09/96 | OE006 | 0,9 | CET8 | OE195 | | |
| 2.5 DTI, 2.5 DTI 4WD | 4 | 4JA1 | 74/99 | 07/01→12/01 | CH306 | 11v | | | | |

CASCADA

| | | | | | | | | | | |
|-----------|---|--------|---------|--------|---------|------|--|--|----------|--|
| 1.4 | 4 | A14NEL | 88/118 | 03/13→ | | | | | BAEA185E | |
| 1.4 Turbo | 4 | A14NET | 103/138 | 03/13→ | | | | | BAEA185E | |
| 2.0 CDTI | 4 | A20DTH | 121/162 | 03/13→ | CP5G006 | 4.4v | | | CCU138 | |
| 2.0 CDTI | 4 | A20DTR | 143/192 | 03/13→ | CP5G006 | 4.4v | | | CCU138 | |

COMBO

| | | | | | | | | | | |
|--------------|---|--------|--------|-------------|-------|-----|--------|-------|---------|--|
| 1.4 | 4 | Z14XEP | 66/89 | 10/04→12/11 | OE198 | 0,9 | CET2 | OE184 | BAEA338 | |
| 1.4 | 4 | A14FP | 70/94 | 02/12→ | OE199 | 0,9 | | | | |
| 1.4, 1.4 CNG | 4 | A14FC | 88/118 | 02/12→ | | | | | BAEA095 | |
| 1.6 | 4 | Z16SE | 64/86 | 10/01→09/06 | | | CET2 | OE188 | | |
| 1.6 CNG | 4 | Z16YNG | 69/93 | 06/06→12/11 | OE136 | 0,8 | CET12P | OE179 | BAE965A | |
| 1.6 CNG | 4 | Z16YNG | 71/95 | 04/05→01/11 | OE136 | 0,8 | CET12P | OE179 | BAE965A | |
| 1.7 DI 16V | 4 | Y17DTL | 48/64 | 10/01→06/04 | CH189 | 11v | | | | |

CORSA B

| | | | | | | | | | | |
|-----------|---|-------|-------|-------------|-------|-----|------|-------|---------|--|
| 1.0 i 12V | 3 | X10XE | 40/54 | 11/96→09/00 | OE019 | 0,9 | CET2 | OE184 | BAEA358 | |
|-----------|---|-------|-------|-------------|-------|-----|------|-------|---------|--|

OPEL





kW/BHP



eon TITAN

IRIDIUM



...OPEL



...CORSA B

| | | | | | | | | | | |
|----------------------|---|--------------|--------|-------------|-----------------|------|------|-----------------|---|-----------------------------------|
| 1.2 i | 4 | C12NZ | 33/44 | 03/93→09/00 | OE019 08/95→ | 0,9 | CET2 | OE195 →07/95 | BAEA253 [275] [292] | CLS115 08/95→ Eng.19334657→ |
| | | | | | | | CET8 | OE184 08/95→ | | |
| 1.2 i | 4 | X12SZ | 33/44 | 03/93→09/00 | OE019 08/95→ | 0,9 | CET2 | OE195 →07/95 | BAEA026E [275] | CLS114 08/95→ Eng.028D0922→ |
| | | | | | | | CET8 | OE184 08/95→ | | |
| 1.2 i | 4 | 12NZ | 33/44 | 03/93→09/00 | OE019 08/95→ | 0,9 | CET2 | OE195 →07/95 | BAEA253 [292] | |
| | | | | | | | CET8 | OE184 08/95→ | | |
| 1.2 i 16V | 4 | X12XE | 48/64 | 03/98→09/00 | OE019 | 0,9 | CET2 | OE184 | BAEA147E | |
| 1.4 | 4 | C14SE | 54/72 | 04/93→08/94 | OE019 | 0,9 | CET2 | | BAEA026E | |
| 1.4 i | 4 | C14NZ; X14SZ | 40/54 | 03/93→09/00 | OE019 | 0,9 | CET2 | OE184 | | |
| 1.4 i | 4 | C14NZ | 44/59 | 03/93→09/00 | OE019 | 0,9 | CET2 | OE184 | BAEA253 [275] [292] | CLS115 08/95→ |
| 1.4 i | 4 | X14SZ | 44/59 | 03/93→09/00 | OE019 | 0,9 | CET2 | OE184 | BAEA026E [275] | CLS114 |
| 1.4 i 16V | 4 | C14SEL | 63/84 | 08/97→09/00 | OE019 | 0,9 | CET8 | | BAEA026E | CLS030 |
| 1.4 i 16V | 4 | X14XE | 66/89 | 09/94→12/02 | OE019 | 0,9 | CET2 | OE184 | BAEA026E | CLS030 |
| 1.4 i 16V | 4 | X14XE | 67/90 | 09/94→09/00 | OE019 | 0,9 | CET2 | OE184 | BAEA026E | CLS030 |
| 1.4 Si | 4 | C14SE | 60/80 | 03/93→09/00 | OE019 08/95→ | 0,9 | CET2 | OE195 →07/95 | BAEA026E [275] | CLS114 08/95→ Eng.028D0922→ |
| | | | | | | | CET8 | OE184 08/95→ | BAEA253 [275] [292] | |
| 1.6 GSI 16V | 4 | C16XE | 80/107 | 03/93→09/00 | OE019 | 0,9 | CET2 | OE184 | BAEA026E | CLS030 →Eng.20C71331 |
| 1.6 i 16V | 4 | C16SEL | 74/99 | 08/97→09/00 | OE019 | 0,9 | CET8 | | BAEA026E | CLS030 |
| 1.6 i 16V | 4 | X16XE | 78/105 | 09/94→09/00 | OE019 | 0,9 | CET2 | OE184 | BAEA026E | CLS030 |
| CORSA C | | | | | | | | | | |
| 1.0 | 3 | Z10XE | 43/58 | 09/00→06/03 | OE198 | 0,9 | CET2 | OE184 | BAEA358 | |
| 1.0 | 3 | Z10XEP | 44/59 | 06/03→12/09 | OE198 | 0,9 | CET2 | OE184 | BAEA359 | |
| 1.2 | 4 | Z12XE | 55/74 | 09/00→12/09 | OE019 | 0,9 | CET2 | OE184 | BAEA147E →Ch.36999999 BAEA338 Ch.37000000→ | |
| 1.2 Twinport | 4 | Z12XEP | 59/79 | 07/04→12/09 | OE198 | 0,9 | CET2 | OE184 | BAEA338 | |
| 1.3 CDTI | 4 | Z13DT | 51/68 | 06/03→12/09 | | | | | CCU142 [8] | |
| 1.4 | 4 | Z14XE | 66/89 | 09/00→12/09 | OE019 | 0,9 | CET2 | OE184 | BAE965A | |
| 1.4 Twinport | 4 | Z14XEP | 66/89 | 06/03→12/09 | OE198 | 0,9 | CET2 | OE184 | BAEA338 | |
| 1.7 CDTI | 4 | Z17DTH | 74/99 | 06/03→12/09 | | | | | CCU143 [7] | |
| 1.7 DI | 4 | Y17DTL | 48/64 | 09/00→12/09 | | | | | CCU143 [7] | |
| 1.7 DTI | 4 | Y17DT | 55/74 | 09/00→12/09 | | | | | CCU143 [7] | |
| 1.8 | 4 | Z18XE | 92/123 | 09/00→12/09 | OE198 | 0,9 | CET2 | OE184 | BAEA342 | |
| CORSA CLASSIC | | | | | | | | | | |
| 1.4 | 4 | Z14XE | 66/89 | 07/00→12/03 | OE019 | 0,9 | | | | |
| CORSA D | | | | | | | | | | |
| 1.0 | 3 | Z10XEP | 44/59 | 07/06→12/10 | OE198 | 0,9 | CET2 | OE184 | BAEA359 | |
| 1.0 | 3 | A10XEP | 48/64 | 12/09→08/14 | OE198 | 0,9 | CET2 | OE184 | | |
| 1.2 | 4 | A12XEL | 51/68 | 12/09→08/14 | | | CET2 | OE184 | BAEA185E | |
| 1.2 | 4 | Z12XEP | 59/79 | 07/06→08/14 | OE198 | 0,9 | CET2 | OE184 | BAEA338 | |
| 1.2, 1.2 LPG | 4 | A12XER | 63/84 | 12/09→08/14 | | | CET2 | OE184 | BAEA185E | |
| 1.2 LPG | 4 | Z12XEP | 59/79 | 08/06→08/14 | | | CET2 | OE184 | BAEA338 | |
| 1.2 LPG | 4 | A12XER | 61/82 | 06/11→08/14 | | | CET2 | OE184 | BAEA185E | |
| 1.3 CDTI | 4 | A13DTC | 55/74 | 07/06→08/14 | CPSG003 | 4.4v | | | CCU138 | |
| 1.3 CDTI | 4 | Z13DTJ | 55/74 | 07/06→08/14 | | | | | CCU144 | |

OPEL





kW/BHP

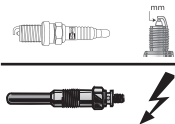

eon TITAN

IRIDIUM



...OPEL



...CORSA D

| | | | | | | | | | |
|--------------|---|------------------------|---------|---------------|-----------------|-----|--------|-------|----------|
| 1.3 CDTI | 4 | Z13DTH | 66/89 | 07/06 → 06/11 | | | | | CCU144 |
| 1.3 CDTI | 4 | A13DTE; A13DTR; Z13DTE | 70/94 | 06/09 → 08/14 | | | | | CCU138 |
| 1.4 | 4 | Z14XEP | 66/89 | 07/06 → 08/14 | OE198 | 0,9 | CET2 | OE184 | BAEA338 |
| 1.4 | 4 | A14XER | 74/99 | 12/09 → 08/14 | | | CET2 | OE184 | BAEA185E |
| 1.4 | 4 | A14NEL | 88/118 | 07/12 → 08/14 | | | | | BAEA185E |
| 1.4, 1.4 LPG | 4 | A14XEL | 64/86 | 09/09 → 08/14 | | | CET2 | OE184 | BAEA185E |
| 1.4 LPG | 4 | Z14XEP | 66/89 | 08/06 → 12/11 | | | CET2 | OE184 | BAEA338 |
| 1.6 Turbo | 4 | A16LEL; Z16LEL | 110/148 | 05/07 → 08/14 | OE216 LPG [278] | 0,8 | CET12P | OE179 | BAEA427 |
| 1.6 Turbo | 4 | B16LER | 141/189 | 11/06 → 08/14 | OE216 LPG [278] | 0,8 | CET12P | OE179 | |
| 1.6 Turbo | 4 | A16LER; Z16LER | 141/189 | 11/06 → 08/14 | OE216 LPG [278] | 0,8 | CET12P | OE179 | BAEA427 |
| 1.6 Turbo | 4 | A16LES | 155/208 | 06/11 → 08/14 | | | | OE188 | |
| 1.6 Turbo | 4 | A16LER; Z16LER | 155/208 | 06/11 → 08/14 | | | | | BAEA427 |
| 1.7 CDTI | 4 | Z17DTR | 92/123 | 08/06 → 12/11 | | | | | CCU145 |
| 1.7 CDTI | 4 | A17DTS | 96/129 | 12/09 → 08/14 | | | | | CCU145 |

CORSA E

| | | | | | | | | | |
|-----------|---|----------------|---------|---------|--|--|--|-------|----------|
| 1.0 | 3 | B10XFL; F10XFL | 66/89 | 09/14 → | | | | OE258 | |
| 1.0 | 3 | B10XFT; F10XFT | 85/114 | 09/14 → | | | | OE258 | |
| 1.2 | 4 | B12XEL; B12XER | 51/68 | 09/14 → | | | | | BAEA185E |
| 1.4 | 4 | B14XEL | 66/89 | 09/14 → | | | | | BAEA185E |
| 1.6 Turbo | 4 | B16LES | 152/204 | 03/15 → | | | | | BAEA199E |

CORSA Utility

| | | | | | | | | | |
|-----|---|-------|-------|---------------|-------|-----|--|--|---------|
| 1.4 | 4 | Z14XE | 66/89 | 07/00 → 12/10 | OE019 | 0,9 | | | BAE965A |
|-----|---|-------|-------|---------------|-------|-----|--|--|---------|

FRONTERA A

| | | | | | | | | | |
|-------------|---|---------------|---------|---------------|-------|-----|------|-------|--|
| 2.2 i 4WD | 4 | X22XE | 100/134 | 03/95 → 10/98 | OE019 | 0,9 | CET2 | OE184 | |
| 2.5 TDS 4WD | 4 | 25TDS(VM41B) | 85/114 | 09/96 → 10/98 | CH181 | 11v | | | |
| 2.8 TD 4WD | 4 | 28TDI(4JB1-T) | 83/111 | 03/95 → 10/98 | CH306 | 11v | | | |

FRONTERA B

| | | | | | | | | | |
|-------------|---|-------------|---------|---------------|-----------------------------------|-----|--------|-------|-----------|
| 2.2 DTI 4WD | 4 | X22DTH | 85/114 | 10/98 → 09/02 | CH207 → 07/00 | 11v | | | CCU143[7] |
| 2.2 DTI 4WD | 4 | Y22DTH | 85/114 | 10/98 → 09/02 | CH231 09/00 → Ch.1V500001 → | 11v | | | CCU143[7] |
| 2.2 DTI 4WD | 4 | Y22DTH | 88/118 | 09/02 → | CH231 | 11v | | | CCU143[7] |
| 2.2 i 4WD | 4 | Y22SE | 100/134 | 10/98 → | OE191 | 1,0 | CET12P | OE180 | BAEA025E |
| 2.2 i 4WD | 4 | X22SE | 100/134 | 10/98 → | OE019 | 0,9 | CET2 | OE184 | BAEA025E |
| 3.2 i 4WD | 6 | 6VD1; Y32NE | 151/202 | 10/98 → | OE191 | 1,0 | CET12P | OE180 | |

GT

| | | | | | | | | | |
|-----|---|-------------|---------|---------------|--|--|--------|-------|--|
| 2.0 | 4 | LNF; Z20NHH | 194/260 | 06/07 → 12/11 | | | CET17P | OE189 | |
|-----|---|-------------|---------|---------------|--|--|--------|-------|--|

INSIGNIA A

| | | | | | | | | | |
|--|---|----------------|---------|---------------|------------------------|------|--------|------------------------|--------------------------|
| 1.4, 1.4 LPG | 4 | A14NET; B14NET | 103/138 | 04/11 → 03/17 | | | | OE264 | BAEA185E |
| 1.6 | 4 | A16XER | 85/114 | 07/08 → 03/17 | OE089 → Ch.91999999 | 1,0 | CET2 | OE188 → Ch.91999999 | BAEA199E |
| | | | | | OE198 Ch.A1000001 → | 0,9 | | OE184 Ch.A1000001 → | |
| 1.6 SIDI | 4 | A16XHT; B16SHL | 125/168 | 03/13 → 03/17 | | | | OE258 | |
| 1.6 Turbo | 4 | A16LET | 132/177 | 07/08 → 03/17 | OE216 LPG [278] | 0,8 | CET12P | OE188 | BAEA427 → Ch.B1999999 |
| 1.8 | 4 | A18XER; B18XER | 103/138 | 07/08 → 03/17 | OE089 → Ch.91999999 | 1,0 | CET2 | OE188 → Ch.91999999 | BAEA199E |
| | | | | | OE198 Ch.A1000001 → | 0,9 | | OE184 Ch.A1000001 → | |
| 2.0 Biturbo CDTI, 2.0 Biturbo CDTI 4WD | 4 | A20DTR | 140/188 | 07/08 → 03/17 | CPSG006 | 4.4v | | | CCU138 |
| 2.0 Biturbo CDTI, 2.0 Biturbo CDTI 4WD | 4 | A20DTR | 143/192 | 01/12 → 03/17 | CPSG006 | 4.4v | | | CCU138 |
| 2.0 CDTI | 4 | A20DTC; A20DTL | 81/109 | 07/08 → 03/17 | CPSG006 | 4.4v | | | CCU138 |

OPEL





kW/BHP



eon TITAN

IRIDIUM

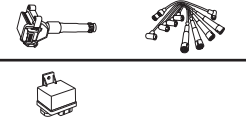

...OPEL



...INSIGNIA A

| | | | | | | | | | |
|--|---|----------------|---------|-------------|----------------|------|---------------------|-------------------------------------|---------------|
| 2.0 CDTI | 4 | A20DTE | 88/118 | 03/12→03/17 | CPSG006 | 4.4v | | | CCU138 |
| 2.0 CDTI | 4 | A20DT; A20DTJ | 96/129 | 07/08→03/17 | CPSG006 | 4.4v | | | CCU138 |
| 2.0 CDTI | 4 | A20DTE | 103/138 | 06/13→03/17 | CPSG006 | 4.4v | | | CCU138 |
| 2.0 CDTI, 2.0 CDTi, 2.0 CDTI 4WD, 2.0 CDTi 4WD | 4 | A20DTH | 120/161 | 07/13→03/17 | CPSG006 | 4.4v | | | CCU138 |
| 2.0 CDTI, 2.0 CDTI 4WD | 4 | A20DTH | 118/158 | 07/08→03/17 | CPSG006 | 4.4v | | | CCU138 |
| 2.0 E85 Turbo | 4 | A20NFT | 162/217 | 09/10→03/17 | | | CET17P [331] | OE189 *tobeadjusted | |
| | | | | | | | CET17P | OE189 [331] *tobeadjusted | |
| 2.0 E85 Turbo, 2.0 Turbo, 2.0 Turbo 4WD | 4 | A20NHT | 162/217 | 07/08→03/17 | | | CET17P [331] | OE189 [331] *tobeadjusted | |
| 2.0 Turbo | 4 | A20NHT; B20NHT | 184/247 | 04/14→03/17 | | | CET17P [331] | OE189 [331] *tobeadjusted | |
| 2.0 Turbo 4WD | 4 | B20NHT | 184/247 | 07/11→03/17 | | | CET17P | OE189 *tobeadjusted | |
| 2.0 Turbo 4WD | 4 | A20NFT | 184/247 | 07/11→03/17 | | | CET17P [332] | OE189 [332] *tobeadjusted | |
| | | | | | | | CET17P | OE189 *tobeadjusted | |
| 2.0 Turbo 4WD | 4 | A20NHT | 184/247 | 07/11→03/17 | | | CET17P [332] | OE189 [332] *tobeadjusted | |
| | | | | | | | CET17P [331] | OE189 *tobeadjusted | |
| | | | | | | | CET17P | OE189 [331] *tobeadjusted | |
| 2.0 Turbo E85 | 4 | A20NFT | 162/217 | 07/08→03/17 | | | CET17P | OE189 *tobeadjusted | |
| 2.8 V6 Turbo 4WD | 6 | A28NET | 191/256 | 07/08→03/17 | OE238 | 1,0 | | | |
| 2.8 V6 Turbo OPC 4WD | 6 | A28NER; B28NER | 239/320 | 07/09→03/17 | OE238 | 1,0 | | | |

INSIGNIA B

| | | | | | | | | | |
|-----|---|----------------|---------|--------|--|--|--|--|--------------|
| 1.5 | 4 | B15SFL; D15SFL | 103/138 | 03/17→ | | | | | OE258 |
| 1.5 | 4 | B15SFT; D15SFT | 121/162 | 03/17→ | | | | | OE258 |

MERIVA A

| | | | | | | | | | |
|--|---|---------------|---------|-------------|--------------|-----|---------------|--------------|-------------------|
| 1.3 CDTI | 4 | Y13DT; Z13DT | 51/68 | 04/05→05/10 | | | | | CCU142 [8] |
| 1.3 CDTI | 4 | Z13DTJ | 55/74 | 09/03→05/10 | | | | | CCU142 [8] |
| 1.4 16V Twinport, 1.4 16V Twinport LPG | 4 | Z14XEP | 66/89 | 07/04→05/10 | OE198 | 0,9 | CET2 | OE184 | BAEA338 |
| 1.6 | 4 | Z16SE | 64/86 | 05/03→05/10 | OE019 | 0,9 | CET2 | OE184 | |
| 1.6 | 4 | Z16XEP | 77/103 | 01/06→05/10 | OE198 | 0,9 | CET2 | OE184 | BAEA427 |
| 1.6 16V | 4 | Z16XE | 74/99 | 05/03→01/06 | OE198 | 0,9 | CET2 | OE184 | BAE965A |
| 1.6 Turbo | 4 | Z16LET | 132/177 | 09/05→05/10 | | | CET12P | OE188 | BAEA427 |
| 1.7 CDTI | 4 | Z17DT; Z17DTH | 74/99 | 09/03→05/10 | | | | | CCU143 [7] |
| 1.7 CDTI | 4 | Z17DTR | 92/123 | 09/06→05/10 | | | | | CCU143 [7] |
| 1.7 DTI | 4 | Y17DT | 55/74 | 09/03→05/10 | | | | | CCU143 [7] |
| 1.8 | 4 | Z18XE | 92/123 | 05/03→05/10 | OE019 | 0,9 | CET2 | OE184 | BAEA342 |

MERIVA B

| | | | | | | | | | |
|----------|---|----------------|---------|-------------|----------------|------|-------------|--------------|-----------------|
| 1.3 CDTI | 4 | A13DTC | 55/74 | 06/10→10/13 | CPSG003 | 4.4v | | | CCU138 |
| 1.3 CDTI | 4 | A13DTE | 70/94 | 06/10→11/14 | CPSG003 | 4.4v | | | CCU138 |
| 1.4 | 4 | A14XER; B14XER | 74/99 | 06/10→03/17 | OE198 | 0,9 | CET2 | OE184 | BAEA185E |
| 1.4 | 4 | A14NEL; B14NEL | 88/118 | 06/10→03/17 | | | | OE264 | BAEA185E |
| 1.4 | 4 | A14NET; B14NET | 103/138 | 06/10→03/17 | | | | | BAEA185E |
| 1.4 LPG | 4 | A14NEL; B14NEL | 88/118 | 06/11→03/17 | | | | | BAEA185E |
| 1.7 CDTI | 4 | A17DT | 74/99 | 06/10→01/17 | | | | | CCU145 |
| 1.7 CDTI | 4 | A17DTJ | 81/109 | 06/10→06/15 | | | | | CCU145 |
| 1.7 CDTI | 4 | A17DTS | 96/129 | 06/10→10/13 | | | | | CCU145 |

MOKKA

| | | | | | | | | | |
|--------------|---|--------|---------|--------|--------------|-----|-------------|--------------|-----------------|
| 1.8, 1.8 4WD | 4 | A18XER | 103/138 | 01/13→ | OE198 | 0,9 | CET2 | OE184 | BAEA199E |
|--------------|---|--------|---------|--------|--------------|-----|-------------|--------------|-----------------|

OPEL





kW/BHP

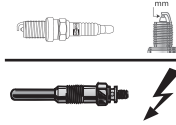

eon TITAN

IRIDIUM

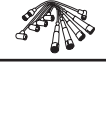
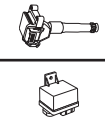

...OPEL



MOKKA / MOKKA X

| | | | | | | | | | | |
|------------------------|---|------------------------|---------|--------|-------------------|------|------|-------|----------|--|
| 1.4 | 4 | A14NET; B14NET; D14NET | 103/138 | 04/13→ | | | | OE264 | BAEA185E | |
| 1.4 4WD | 4 | B14XFT | 112/150 | 06/16→ | | | | OE258 | | |
| 1.4 4WD, 1.4 LPG | 4 | A14NET; B14NET; D14NET | 103/138 | 06/12→ | | | | | BAEA185E | |
| 1.6 | 4 | A16XER; B16XER | 85/114 | 06/12→ | OE198 | 0,9 | CET2 | OE184 | BAEA198E | |
| 1.7 CDTI, 1.7 CDTI 4WD | 4 | A17DTS | 96/129 | 06/12→ | CP5G004 →11/12 | 4.4v | | | CCU145 | |

MONTEREY B

| | | | | | | | | | | |
|----------------|---|------|---------|-------------|-------|-----|--------|-------|--|--|
| 3.5 V6 24V 4WD | 6 | 6VE1 | 158/212 | 07/98→08/99 | OE191 | 1,0 | CET12P | OE180 | | |
|----------------|---|------|---------|-------------|-------|-----|--------|-------|--|--|

OMEGA B

| | | | | | | | | | | |
|---------------|---|----------------------------|---------|-------------|-------|-----|------|-------|--|------------------------|
| 2.0 | 4 | 20SE; X20SE | 85/114 | 03/94→12/00 | OE019 | 0,9 | CET2 | OE184 | | |
| 2.0 | 4 | XF20E | 90/121 | 05/94→05/99 | OE019 | 0,9 | CET2 | OE184 | | |
| 2.0 16V | 4 | X20XEV | 100/134 | 03/94→09/99 | OE019 | 0,9 | CET2 | OE184 | BAEA344 | CLS107 |
| 2.0 DTI 16V | 4 | X20DTH | 74/99 | 09/97→09/00 | | | | | CCU143 ^[7] | |
| 2.2 16V | 4 | Y22XE; Z22XE | 106/142 | 09/99→07/03 | OE019 | 0,9 | CET2 | OE184 | BAEA150E ^[277] | |
| 2.2 DTI 16V | 4 | Y22DTH | 81/109 | 09/00→07/03 | CH231 | 11v | | | CCU143 ^[7] | |
| 2.2 DTI 16V | 4 | Y22DTR | 86/115 | 01/01→07/03 | CH231 | 11v | | | | |
| 2.2 DTI 16V | 4 | Y22DTH | 88/118 | 09/00→07/03 | CH231 | 11v | | | CCU143 ^[7] | |
| 2.5 D, 2.5 TD | 6 | U25DT; U25TD; X25DT; X25TD | 96/129 | 04/94→07/03 | CH189 | 11v | | | | |
| 2.5 DTI | 6 | Y25DT; Y25TD | 110/148 | 09/01→07/03 | CH203 | 11v | | | | |
| 2.5 V6 | 6 | X25XE | 125/168 | 03/94→09/00 | OE019 | 0,9 | CET2 | OE184 | BAEA306 | CLS175 →Ch.08145499 |
| | | | | | | | | | | CLS175 →Ch.8145499 |
| 2.6 V6 | 6 | Y26SE | 132/177 | 09/00→07/03 | | | CET2 | OE188 | BAEA152E ^[36] ^[277] | |
| | | | | | | | | | BAEA153E ^[42] ^[277] | |
| 3.0 V6 | 6 | X30XE | 155/208 | 04/94→02/01 | OE019 | 0,9 | CET2 | OE184 | BAEA306 | CLS175 →Ch.08145499 |
| 3.2 V6 | 6 | Y32SE | 160/215 | 02/01→07/03 | | | CET2 | OE188 | BAEA152E ^[36] ^[277] | |
| | | | | | | | | | BAEA153E ^[42] ^[277] | |

SIGNUM

| | | | | | | | | | | |
|--------------|---|--------|---------|-------------|-----------------------|-----|--------|-------|--|--|
| 1.8 | 4 | Z18XE | 90/121 | 05/03→07/05 | OE198 | 0,9 | CET2 | OE188 | BAEA342 | |
| 1.8 | 4 | Z18XER | 103/138 | 09/05→12/08 | OE198 | 0,9 | CET2 | OE188 | BAEA427 | |
| 1.9 CDTI | 4 | Z19DTL | 74/99 | 08/05→02/08 | CH222 →Ch.71021891 | 11v | | | CCU143 ^[7] →Ch.61010105 | |
| | | | | | CH269 Ch.71021892→ | 11v | | | CCU142 ^[8] Ch.61010106→ | |
| 1.9 CDTI | 4 | Z19DT | 88/118 | 04/04→02/08 | CH222 →Ch.71021891 | 11v | | | CCU143 ^[7] →Ch.61010105 | |
| | | | | | CH269 Ch.71021892→ | 11v | | | CCU142 ^[8] Ch.61010106→ | |
| 1.9 CDTI | 4 | Z19DTH | 110/148 | 04/04→02/08 | CH224 | 11v | | | CCU143 ^[7] →Ch.61010105 | |
| | | | | | | | | | CCU142 ^[8] Ch.61010106→ | |
| 2.0 DTI | 4 | Y20DTH | 74/99 | 05/03→04/04 | CH231 | 11v | | | CCU143 ^[7] | |
| 2.0 Turbo | 4 | Z20NET | 129/173 | 05/03→12/08 | OE136 | 0,8 | CET12P | OE179 | | |
| 2.2 direct | 4 | Z22YH | 114/153 | 05/03→09/08 | | | CET2 | OE188 | BAEA149E | |
| 2.2 DTI | 4 | Y22DTR | 92/123 | 05/03→04/04 | CH231 | 11v | | | CCU143 ^[7] | |
| 2.2 DTI 16V | 4 | Y22DTR | 86/115 | 05/03→06/08 | CH231 | 11v | | | CCU143 ^[7] | |
| 2.8 V6 Turbo | 6 | Z28NEL | 169/227 | 09/05→12/08 | OE238 | 1,0 | | | BAEA174E | |
| 2.8 V6 Turbo | 6 | Z28NET | 184/247 | 01/06→12/08 | OE238 | 1,0 | | | BAEA174E | |
| 3.2 V6 | 6 | Z32SE | 155/208 | 05/03→07/05 | | | CET2 | OE188 | BAEA152E ^[36] ^[277] | |
| | | | | | | | | | BAEA153E ^[42] ^[277] | |

OPEL





kW/BHP



eon TITAN

IRIDIUM



...OPEL



SINTRA

| | | | | | | | | | | |
|-----------|---|--------|---------|-------------|-------|-----|------|-------|-----------------------|------------------------|
| 2.2 DTI | 4 | X22DTH | 85/114 | 07/97→04/99 | CH207 | 11v | | | CCU143 ^[7] | |
| 2.2 i 16V | 4 | X22XE | 104/139 | 11/96→04/99 | OE019 | 0,9 | CET2 | OE184 | | CLS107 |
| 3.0 i 24V | 6 | X30XE | 148/198 | 11/96→04/99 | OE019 | 0,9 | CET2 | OE184 | | CLS175 →Ch.08145499 |

SPEEDSTER

| | | | | | | | | | | |
|-----------|---|--------|---------|-------------|-------|-----|--------|-------|--|--|
| 2.0 Turbo | 4 | Z20LET | 147/197 | 08/02→08/06 | OE019 | 0,9 | CET2 | OE184 | | |
| 2.2 | 4 | Z22SE | 108/145 | 06/00→08/05 | OE255 | 1,0 | CET17P | OE189 | | |

TIGRA

| | | | | | | | | | | |
|----------|---|--------|--------|-------------|-------|-----|------|-------|-----------------------|--------|
| 1.3 CDTI | 4 | Z13DT | 51/68 | 06/04→12/10 | | | | | CCU142 ^[8] | |
| 1.4 | 4 | Z14XEP | 66/89 | 06/04→12/10 | OE198 | 0,9 | CET2 | OE184 | BAEA338 | |
| 1.4 16V | 4 | X14XE | 63/84 | 08/97→12/00 | | | CET2 | OE188 | BAEA026E | CLS030 |
| 1.4 16V | 4 | X14XE | 66/89 | 07/94→12/00 | | | CET2 | OE188 | BAEA026E | CLS030 |
| 1.6 16V | 4 | C16SEL | 74/99 | 08/97→08/98 | OE019 | 0,9 | CET8 | | BAEA026E | CLS030 |
| 1.6 16V | 4 | X16XE | 78/105 | 07/94→08/98 | OE019 | 0,9 | CET2 | OE184 | BAEA026E | CLS030 |
| 1.8 | 4 | Z18XE | 92/123 | 06/04→12/10 | OE198 | 0,9 | CET2 | OE184 | BAEA342 | |

VECTRA A

| | | | | | | | | | | |
|-----------------|---|--------|---------|-------------|----------------------------|-----|------|-------|----------|-------------------------|
| 1.6 i | 4 | X16SZ | 52/70 | 09/93→11/95 | OE019 | 0,9 | CET2 | OE184 | BAEA026E | CLS114 ^[275] |
| 2.0 i Turbo 4WD | 4 | C20LET | 150/201 | 06/94→11/95 | OE089 | 1,0 | CET2 | OE188 | | |
| | | | | | OE216 ^{LPG [278]} | 0,8 | | | | |
| 2.5 V6 | 6 | C25XE | 125/168 | 02/93→11/95 | OE089 | 1,0 | CET2 | OE184 | | |

VECTRA B

| | | | | | | | | | | |
|-------------|---|----------------|---------|-------------|-------------|-----|------|-------|--|--------|
| 1.6 GL | 4 | 16SV | 60/80 | 09/95→08/96 | OE006 | 0,9 | CET8 | OE195 | | |
| 1.6 i | 4 | X16SZR | 55/74 | 10/95→07/03 | OE019 | 0,9 | CET2 | OE184 | BAEA026E | CLS114 |
| 1.6 i | 4 | 16LZ2 | 55/74 | 10/95→07/03 | OE019 | 0,9 | CET2 | OE184 | BAEA253 ^[292] | |
| 1.6 i 16V | 4 | X16XEL | 74/99 | 10/95→07/02 | OE019 | 0,9 | CET2 | OE184 | BAE965A | CLS030 |
| | | | | | OE198 | 0,9 | | | BAE965A Ch.W1285447 W71544259→ | |
| 1.6 i 16V | 4 | Y16XE; Z16XE | 74/99 | 10/95→07/02 | OE019 | 0,9 | CET2 | OE184 | BAE965A | |
| | | | | | OE198 | 0,9 | | | BAE965A Ch.W1285447 W71544259→ | |
| 1.8 i 16V | 4 | X18XE | 85/114 | 10/95→09/00 | OE019 | 0,9 | CET2 | OE184 | BAEA344 | CLS107 |
| 1.8 i 16V | 4 | X18XE1 | 85/114 | 10/95→09/00 | OE019 | 0,9 | CET2 | OE184 | BAEA342 | CLS107 |
| | | | | | | | | OE188 | | |
| 1.8 i 16V | 4 | Z18XEL | 85/114 | 10/95→09/00 | OE019 | 0,9 | CET2 | OE184 | BAEA342 | CLS107 |
| 1.8 i 16V | 4 | Z18XE | 92/123 | 09/00→07/03 | OE198 | 0,9 | CET2 | OE184 | BAEA342 | |
| 2.0 DI 16V | 4 | X20DTL | 60/80 | 11/96→04/02 | CH207 | 11v | | | | |
| 2.0 DTI 16V | 4 | X20DTH | 74/99 | 06/97→07/03 | CH207 | 11v | | | CCU143 ^[7] | |
| | | | | | 03/98→06/00 | | | | Ch.W1000001 W5000001 W7000001 X1000001 WS WP→ | |
| 2.0 DTI 16V | 4 | Y20DTH | 74/99 | 06/97→07/03 | CH231 | 11v | | | CCU143 ^[7] | |
| | | | | | | | | | Ch.W1000001 W5000001 W7000001 X1000001 WS WP→ | |
| 2.0 i | 4 | Z0NEJ | 82/110 | 10/95→04/02 | OE026 | 0,9 | CET2 | OE188 | | |
| 2.0 i 16V | 4 | C20SEL; X20XEV | 100/134 | 10/95→09/00 | OE019 | 0,9 | CET2 | OE184 | BAEA344 | CLS107 |

OPEL





kW/BHP



eon TITAN

IRIDIUM



...OPEL



...VECTRA B

| | | | | | | | | | |
|-------------|---|--------|---------|-------------|---|------|--------|-------|---|
| 2.2 DTI 16V | 4 | Y22DTR | 88/118 | 09/00→04/02 | CH231 | 11v | | | CCU143 ^[7] Ch.W1000001 W5000001 W7000001 XL000001 WS WP→ |
| 2.2 DTI 16V | 4 | Y22DTR | 92/123 | 09/00→07/03 | CH231 | 11v | | | CCU143 ^[7] Ch.W1000001 W5000001 W7000001 XL000001 WS WP→ |
| 2.2 i 16V | 4 | Z22SE | 108/145 | 09/00→07/03 | OE255 | 1,0 | CET17P | OE189 | |
| 2.5 | 6 | X25XE | 144/193 | 10/99→06/00 | OE019 | 0,9 | CET2 | OE184 | |
| 2.5 i 500 | 6 | X25XE | 143/192 | 05/98→09/00 | OE089 <small>*to be adjusted</small> | 0,8* | CET2 | OE184 | |
| 2.5 i V6 | 6 | X25XE | 125/168 | 10/95→09/00 | OE019 | 0,9 | CET2 | OE184 | |
| 2.6 i V6 | 6 | Y26SE | 125/168 | 09/00→07/03 | | | CET2 | OE188 | BAEA152E [36] [277] BAEA153E [42] [277] |

VECTRA C

| | | | | | | | | | |
|--------------------------------|---|--------|---------|-------------|--|-----|--------|----------------|--|
| 1.6 | 4 | Z16XEP | 77/103 | 08/05→08/08 | OE198 | 0,9 | CET2 | OE184 OE188 | BAEA427 |
| 1.6, 1.6 16V | 4 | Z16XE | 74/99 | 06/04→09/08 | OE198 | 0,9 | CET2 | OE188 | BAE965A |
| 1.8 | 4 | Z18XEL | 81/109 | 04/02→07/08 | OE198 | 0,9 | CET2 | OE184 | BAEA342 |
| 1.8 | 4 | Z18XER | 103/138 | 08/05→08/08 | OE198 | 0,9 | CET2 | OE188 | BAEA427 |
| 1.8, 1.8 16V | 4 | Z18XE | 90/121 | 04/02→09/08 | OE198 | 0,9 | CET2 | OE188 | BAEA342 |
| 1.8 16V | 4 | Z18XEL | 81/109 | 08/02→12/06 | OE019 | 0,9 | CET2 | OE184 | |
| 1.9 CDTI | 4 | Z19DTL | 74/99 | 06/05→08/08 | CH222 →Ch.71021891 48999999 CH269 Ch.71021892 78→ | 11v | | | CCU143 ^[7] →Ch.61010105 48999999 CCU142 ^[8] Ch.61010106 68→ |
| 1.9 CDTI | 4 | Z19DT | 88/118 | 04/04→01/09 | CH222 →Ch.71021891 48999999 CH269 Ch.71021892 78→ | 11v | | | CCU143 ^[7] →Ch.61010105 48999999 CCU142 ^[8] Ch.61010106 68→ |
| 1.9 CDTI | 4 | Z19DTH | 110/148 | 04/04→08/08 | CH224 →03/07 | 11v | | | CCU143 ^[7] →Ch.61010105 48999999 CCU142 ^[8] Ch.61010106 68→ |
| 2.0 16V Turbo, 2.0 Turbo | 4 | Z20NET | 129/173 | 03/03→08/08 | OE136 | 0,8 | CET12P | OE179 | |
| 2.0 DTI, 2.0 DTI 16V | 4 | Y20DTH | 74/99 | 04/02→08/06 | CH231 | 11v | | | CCU143 ^[7] |
| 2.2 16V | 4 | Z22SE | 108/145 | 04/02→12/08 | OE255 | 1,0 | CET17P | OE188 OE189 | |
| 2.2 DGi, 2.2 direct | 4 | Z22YH | 114/153 | 10/03→08/08 | | | CET2 | OE188 | BAEA149E →10/08 |
| 2.2 DTI, 2.2 DTI 16V | 4 | Y22DTR | 86/115 | 04/02→06/08 | CH231 | 11v | | | CCU143 ^[7] |
| 2.2 DTI, 2.2 DTI 16V | 4 | Y22DTR | 92/123 | 04/02→07/06 | CH231 | 11v | | | CCU143 ^[7] |
| 2.8 V6 Turbo | 6 | Z28NEL | 169/227 | 08/05→10/08 | OE238 | 1,0 | | | BAEA174E |
| 2.8 V6 Turbo | 6 | Z28NET | 184/247 | 08/05→08/08 | OE238 | 1,0 | | | BAEA174E |
| 2.8 V6 Turbo | 6 | Z28NET | 188/252 | 08/05→09/08 | OE238 | 1,0 | | | BAEA174E |
| 2.8 V6 Turbo, 2.8 V6 Turbo OPC | 6 | Z28NET | 206/276 | 07/06→08/08 | OE238 | 1,0 | | | BAEA174E |

OPEL





kW/BHP



eon TITAN

IRIDIUM



...OPEL



...VECTRA C

| | | | | | | | | | |
|--------|---|-------|---------|-------------|-------|-----|------|-------|--|
| 3.2 V6 | 6 | Z32SE | 155/208 | 08/02→07/06 | OE120 | 0,6 | CET2 | OE188 | BAEA152E [36] [277] BAEA153E [42] [277] |
|--------|---|-------|---------|-------------|-------|-----|------|-------|--|

ZAFIRA A

| | | | | | | | | | |
|-----|---|--------|--------|-------------|--|--|--|--|---------|
| 1.6 | 4 | Z16XEP | 76/102 | 10/03→06/05 | | | | | BAEA427 |
|-----|---|--------|--------|-------------|--|--|--|--|---------|

| | | | | | | | | | |
|---------|---|--------|-------|-------------|----------------|------------|------|-------|---------|
| 1.6 16V | 4 | X16XEL | 74/99 | 04/99→06/05 | OE019 OE198 | 0,9 0,9 | CET2 | OE184 | BAE965A |
|---------|---|--------|-------|-------------|----------------|------------|------|-------|---------|

| | | | | | | | | | |
|---------|---|-------|-------|-------------|----------------|------------|------|-------|--|
| 1.6 16V | 4 | Z16XE | 74/99 | 04/99→06/05 | OE019 OE198 | 0,9 0,9 | CET2 | OE184 | |
|---------|---|-------|-------|-------------|----------------|------------|------|-------|--|

| | | | | | | | | | |
|---------|---|--------|-------|-------------|--|--|--------|-------|-------------------|
| 1.6 CNG | 4 | Z16YNG | 71/95 | 09/01→06/05 | | | CET12P | OE179 | BAE965A CLS114 |
|---------|---|--------|-------|-------------|--|--|--------|-------|-------------------|

| | | | | | | | | | |
|---------|---|--------|--------|-------------|-------|-----|------|-------|---------|
| 1.8 16V | 4 | X18XE1 | 85/114 | 04/99→09/00 | OE019 | 0,9 | CET2 | OE184 | BAEA342 |
|---------|---|--------|--------|-------------|-------|-----|------|-------|---------|

| | | | | | | | | | |
|---------|---|-------|--------|-------------|-------|-----|------|-------|---------|
| 1.8 16V | 4 | Z18XE | 92/123 | 09/00→06/05 | OE198 | 0,9 | CET2 | OE184 | BAEA342 |
|---------|---|-------|--------|-------------|-------|-----|------|-------|---------|

| | | | | | | | | | |
|--------|---|--------|-------|-------------|---|-----|--|--|-----------------------|
| 2.0 DI | 4 | X20DTL | 63/84 | 07/99→06/00 | CH207 →Ch.22999999 25999999 26999999 28999999 28999999 2H999999 2G | 11v | | | CCU143 ^[7] |
|--------|---|--------|-------|-------------|---|-----|--|--|-----------------------|

| | | | | | | | | | |
|------------|---|--------|-------|-------------|---|-----|--|--|-----------------------|
| 2.0 DI 16V | 4 | X20DTL | 60/80 | 07/99→06/05 | CH207 →Ch.22999999 25999999 26999999 28999999 28999999 2H999999 2G | 11v | | | CCU143 ^[7] |
|------------|---|--------|-------|-------------|---|-----|--|--|-----------------------|

| | | | | | | | | | |
|-------------|---|--------|-------|-------------|---|-----|--|--|-----------------------|
| 2.0 DTI 16V | 4 | Y20DTH | 74/99 | 09/00→06/05 | CH207 →Ch.22999999 25999999 26999999 28999999 28999999 2H999999 2G | 11v | | | CCU142 ^[8] |
|-------------|---|--------|-------|-------------|---|-----|--|--|-----------------------|

| | | | | | | | | | |
|--|--|--|--|--|---|-----|--|--|--|
| | | | | | CH231 Ch.32000001 35000001 36000001 38000001 38000001 3H000001 4G000001→ | 11v | | | |
|--|--|--|--|--|---|-----|--|--|--|

| | | | | | | | | | |
|---------|---|--------|---------|-------------|-------|-----|------|-------|--|
| 2.0 OPC | 4 | Z20LET | 141/189 | 09/01→06/05 | OE019 | 0,9 | CET2 | OE184 | |
|---------|---|--------|---------|-------------|-------|-----|------|-------|--|

| | | | | | | | | | |
|---------|---|----------------|---------|-------------|-------|-----|------|-------|--|
| 2.0 OPC | 4 | Z20LER; Z20LET | 147/197 | 11/02→06/05 | OE019 | 0,9 | CET2 | OE184 | |
|---------|---|----------------|---------|-------------|-------|-----|------|-------|--|

| | | | | | | | | | |
|---------|---|-------|---------|-------------|-------|-----|--------|-------|--|
| 2.2 16V | 4 | Z22SE | 108/145 | 09/00→06/05 | OE255 | 1,0 | CET17P | OE189 | |
|---------|---|-------|---------|-------------|-------|-----|--------|-------|--|

| | | | | | | | | | |
|-------------|---|--------|--------|-------------|---|-----|--|--|-----------------------|
| 2.2 DTI 16V | 4 | Y22DTR | 86/115 | 01/02→06/05 | CH231 Ch.32000001 35000001 36000001 38000001 38000001 3H000001 4G000001→ | 11v | | | CCU142 ^[8] |
|-------------|---|--------|--------|-------------|---|-----|--|--|-----------------------|

| | | | | | | | | | |
|-------------|---|--------|--------|-------------|---|-----|--|--|-----------------------|
| 2.2 DTI 16V | 4 | Y22DTR | 92/123 | 01/02→06/05 | CH231 Ch.32000001 35000001 36000001 38000001 38000001 3H000001 4G000001→ | 11v | | | CCU142 ^[8] |
|-------------|---|--------|--------|-------------|---|-----|--|--|-----------------------|

ZAFIRA B

| | | | | | | | | | |
|-----|---|----------------|--------|-------------|-------|-----|------|-------|---------|
| 1.6 | 4 | Z16XE1; Z16XEP | 77/103 | 07/05→09/12 | OE198 | 0,9 | CET2 | OE184 | BAEA427 |
|-----|---|----------------|--------|-------------|-------|-----|------|-------|---------|

OPEL





kW/BHP



eon TITAN

IRIDIUM

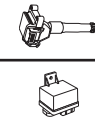

OPEL

| ...OPEL | | | | | | | | | |
|------------------------|---|----------------------------|---------|---------------|---|-------|--------|-------|---|
| ...ZAFIRA B | | | | | | | | | |
| 1.6 | 4 | A16XER | 85/114 | 01/08 → 04/15 | OE198 | 0,9 | CET2 | OE184 | |
| 1.6 | 4 | Z16XER | 85/114 | 01/08 → 04/15 | OE198 | 0,9 | CET2 | OE184 | BAEA427 |
| 1.6 CNG | 4 | Z16YNG | 69/93 | 07/05 → 04/15 | OE136 | 0,8 | CET12P | OE179 | BAE965A |
| 1.6 CNG Turbo | 4 | A16XNT; Z16XNT | 110/148 | 02/09 → 04/15 | | | | | BAEA427 |
| 1.7 CDTi | 4 | A17DTJ; Z17DTJ | 81/109 | 01/08 → 04/15 | | | | | CCU143 ^[7] |
| 1.7 CDTi | 4 | A17DTR | 92/123 | 01/08 → 04/15 | | | | | CCU143 ^[7] |
| 1.8 | 4 | A18XER; Z18XER | 103/138 | 07/05 → 04/15 | OE198 | 0,9 | CET2 | OE184 | BAEA427 |
| 1.9 CDTi | 4 | Z19DTL | 74/99 | 07/05 → 12/10 | CH222 → Ch.62999999 6G999999 | 11v | | | CCU142 ^[8] |
| | | | | | CH269 Ch.72000001 7G000001 → | 11v | | | CCU143 ^[7] |
| 1.9 CDTi | 4 | Z19DT | 88/118 | 07/05 → 04/15 | CH222 → Ch.62999999 6G999999 | 11v | | | CCU142 ^[8] |
| | | | | | CH269 Ch.72000001 7G000001 → | 11v | | | CCU143 ^[7] |
| 1.9 CDTi | 4 | Z19DTH | 110/148 | 07/05 → 04/15 | CH224 | 11v | | | CCU142 ^[8] CCU143 ^[7] |
| 2.0 | 4 | Z20LER | 147/197 | 07/05 → 12/10 | OE089 | 1,0 | CET2 | OE184 | |
| 2.0 | 4 | Z20LEH | 177/237 | 01/06 → 12/10 | OE136 | 0,8 | CET12P | OE179 | |
| 2.2 | 4 | Z22YH | 110/148 | 07/05 → 12/12 | | | CET2 | OE188 | BAEA149E |
| ZAFIRA TOURER C | | | | | | | | | |
| 1.4 | 4 | A14NEL; B14NEL | 88/118 | 10/11 → | | | | | BAEA185E |
| 1.4, 1.4 LPG | 4 | A14NET; B14NET | 103/138 | 10/11 → | | | | | BAEA185E |
| 1.6 CNG | 4 | A16XNT; B16XNT | 110/148 | 10/11 → | | | | | BAEA427 |
| 1.8 | 4 | A18XEL | 85/114 | 10/11 → | OE198 | 0,9 | CET2 | OE184 | BAEA199E |
| 1.8 | 4 | A18XER | 103/138 | 10/11 → | OE198 | 0,9 | CET2 | OE184 | BAEA199E |
| 1.8 LPG | 4 | A18XER | 101/135 | 10/11 → | OE198 | 0,9 | CET2 | OE184 | BAEA199E |
| 2.0 BiTurbo CDTi | 4 | A20DTR | 143/192 | 01/13 → | CPSG006 ^[287] | 4.4v | | | CCU138 |
| 2.0 CDTi | 4 | A20DTL | 81/109 | 10/11 → | CPSG006 ^[287] | 4.4v | | | CCU138 |
| 2.0 CDTi | 4 | A20DT | 96/129 | 10/11 → | CPSG006 ^[287] ^[298] | 4.4v | | | CCU138 |
| | | | | | CPSG006 ^[287] ^[294] | 4.4v | | | |
| 2.0 CDTi | 4 | Y20DTJ | 96/129 | 10/11 → | CPSG006 | 4.4v | | | CCU138 |
| 2.0 CDTi | 4 | Z20DTY | 96/129 | 10/11 → | CPSG006 | 4.4v | | | |
| 2.0 CDTi | 4 | Z20DTJ | 96/129 | 10/11 → | | | | | CCU138 |
| 2.0 CDTi | 4 | A20DTH | 118/158 | 10/11 → | CPSG006 | 4.4v | | | CCU138 |
| 2.0 CDTi | 4 | A20DTH | 121/162 | 10/11 → | CPSG006 | 4.4v | | | CCU138 |
| OPEL | | | | | | | | | |
| ARENA | | | | | | | | | |
| 1.9 D | 4 | 19DJ; 19DL; F8Q600; F8Q606 | 44/59 | 01/97 → 12/01 | CH217 | 11v | | | |
| 2.5 D | 4 | 25DG; 25DM | 55/74 | 01/97 → 12/01 | CH147 | 11.5v | | | |
| 2.5 D | 4 | S8U758; S8U780; S8U782 | 55/74 | 01/97 → 12/01 | CH189 | 11v | | | |
| ASTRA F | | | | | | | | | |
| 1.6 i | 4 | X16SZ | 52/70 | 02/93 → 07/96 | OE019 | 0,9 | CET2 | OE184 | BAEA026E CLS114 08/95 → Eng.028E6167 → |
| 1.6 i 16V | 4 | X16XEL | 74/99 | 08/94 → 03/98 | OE019 | 0,9 | CET2 | OE184 | |
| 1.7 TD | 4 | X17DTL | 50/67 | 08/94 → 01/99 | CH189 | 11v | | | |
| 1.7 TD | 4 | X17DT(TC4EE1) | 60/80 | 03/95 → 02/98 | CH158 | 11v | | | |
| ASTRA G | | | | | | | | | |
| 1.6 | 4 | X16SZR | 55/74 | 01/99 → 09/00 | OE019 | 0,9 | CET2 | OE184 | BAEA026E CLS176 |





kW/BHP



eon TITAN

IRIDIUM



...OPEL



...ASTRA G

| | | | | | | | | | | |
|-------------|---|--------|--------|-------------|-------|-----|------|-------|-----------------------|--------|
| 1.6 | 4 | Z16SE | 62/83 | 09/00→04/05 | OE019 | 0,9 | CET2 | OE184 | | CLS114 |
| 1.6 | 4 | Z16XEP | 76/102 | 10/04→04/05 | | | | | BAEA427 | |
| 1.7 DTI 16V | 4 | Y17DT | 55/74 | 02/00→04/05 | | | | | CCU143 ^[7] | |
| 1.7 TD | 4 | X17DTL | 50/67 | 01/99→04/05 | CH189 | 11v | | | CCU143 ^[7] | |
| 2.0 DI | 4 | X20DTL | 60/80 | 01/99→04/05 | CH207 | 11v | | | CCU143 ^[7] | |

ASTRA H

| | | | | | | | | | | |
|--------------|---|----------------|---------|-------------|---|-----|------|--|--|--|
| 1.3 CDTI | 4 | Z13DTH | 66/89 | 08/05→10/10 | | | | | CCU142 ^[8] | |
| 1.6 | 4 | Z16XEP | 76/102 | 02/04→11/04 | OE198 | 0,9 | CET2 | | BAEA427 | |
| 1.7 CDTI | 4 | Z17DTH | 74/99 | 03/04→10/10 | | | | | CCU143 ^[7] | |
| 1.7 CDTI | 4 | A17DTJ; Z17DTJ | 81/109 | 02/07→10/10 | | | | | CCU143 ^[7] | |
| 1.7 CDTI | 4 | A17DTR; Z17DTR | 92/123 | 02/07→10/10 | | | | | CCU143 ^[7] | |
| 1.9 CDTI | 4 | Z19DT | 88/118 | 09/05→10/10 | CH222 →Ch.72045139 75030986 78007391 7G | 11v | | | CCU142 ^[8] | |
| | | | | | CH269 Ch.72045140 75030987 78007392 88000001 7G→ | 11v | | | CCU143 ^[7] | |
| 1.9 CDTI | 4 | Z19DTH | 110/148 | 09/04→10/10 | CH224 | 11v | | | CCU142 ^[8] CCU143 ^[7] | |
| 1.9 CDTI 16V | 4 | Z19DTJ | 88/118 | 08/04→10/10 | CH224 | 11v | | | CCU142 ^[8] | |

COMBO

| | | | | | | | | | | |
|--------------|---|--------|--------|-------------|-------|-----|--------|-------|----------------------------------|-------------------------|
| 1.2 | 4 | C12NZ | 33/44 | 07/94→10/01 | | | CET8 | OE195 | BAEA026E | |
| 1.2 | 4 | X12SZ | 33/44 | 07/94→10/01 | | | CET8 | OE195 | | CLS114 Eng.028D0922→ |
| 1.4 | 4 | C14NZ | 44/59 | 07/94→10/01 | | | CET8 | | BAEA253 →08/00 [275] [292] | CLS114 |
| 1.4 | 4 | X14SZ | 44/59 | 07/94→10/01 | | | CET8 | OE195 | BAEA026E ^[275] | CLS114 |
| 1.4 | 4 | C14SE | 60/80 | 07/94→10/01 | OE019 | 0,9 | CET2 | OE184 | BAEA026E | |
| 1.4, 1.4 CNG | 4 | A14FC | 88/118 | 02/12→ | | | | | BAEA095 | |
| 1.4 16V | 4 | Z14XEP | 66/89 | 08/99→ | OE198 | 0,9 | CET2 | OE184 | BAEA338 | |
| 1.4 16V | 4 | X14XE | 66/89 | 08/99→ | OE089 | 1,0 | CET2 | OE184 | BAEA026E | CLS030 |
| 1.6 | 4 | Z16SE | 64/86 | 10/01→ | OE019 | 0,9 | CET2 | OE188 | | |
| 1.6 CNG 16V | 4 | Z16YNG | 69/93 | 06/06→ | OE136 | 0,8 | CET12P | OE179 | BAE965A | |
| 1.6 CNG 16V | 4 | Z16YNG | 71/95 | 04/05→ | OE136 | 0,8 | CET12P | OE179 | BAE965A | |
| 1.7 DI 16V | 4 | Y17DTL | 48/64 | 10/01→ | CH189 | 11v | | | | |

CORSA B

| | | | | | | | | | | |
|-------|---|--------------|-------|-------------|-------|-----|------|-------|----------|--------|
| 1.4 i | 4 | C14NZ; X14SZ | 44/59 | 08/99→09/00 | OE019 | 0,9 | CET2 | OE184 | BAEA026E | CLS114 |
|-------|---|--------------|-------|-------------|-------|-----|------|-------|----------|--------|

CORSA C

| | | | | | | | | | | |
|--------------|---|--------|-------|--------|-------|-----|------|-------|---|--|
| 1.2 | 4 | Z12XEP | 59/79 | 07/05→ | OE198 | 0,9 | CET2 | OE184 | BAEA338 | |
| 1.2 16V | 4 | Z12XE | 55/74 | 09/00→ | OE019 | 0,9 | CET2 | OE184 | BAEA147E →Ch.36999999 BAEA338 Ch.37000000→ | |
| 1.3 CDTI 16V | 4 | Z13DT | 51/68 | 08/05→ | | | | | CCU142 ^[8] | |
| 1.4 | 4 | Z14XEP | 66/89 | 08/03→ | OE198 | 0,9 | CET2 | OE184 | BAEA338 | |
| 1.7 CDTi | 4 | Z17DTH | 74/99 | 08/03→ | | | | | CCU143 ^[7] | |
| 1.7 DI 16V | 4 | Y17DTL | 48/64 | 09/00→ | | | | | CCU143 ^[7] | |
| 1.7 DTI 16V | 4 | Y17DT | 55/74 | 09/00→ | | | | | CCU143 ^[7] | |

CORSA D

| | | | | | | | | | | |
|-----|---|--------|-------|--------|--|--|------|-------|--|--|
| 1.0 | 3 | A10XEP | 44/59 | 07/06→ | | | CET2 | OE184 | | |
| 1.0 | 3 | A10XEP | 48/64 | 01/10→ | | | CET2 | OE184 | | |

OPEL



kW/BHP



eon TITAN

IRIDIUM



...OPEL



...CORSA D

| | | | | | | | | | |
|----------|---|------------------------|-------|--------|---------|------|------|-------|----------|
| 1.2 | 4 | A12XEL | 51/68 | 06/10→ | | | CET2 | OE184 | BAEA185E |
| 1.2 | 4 | Z12XEP | 59/79 | 07/09→ | OE198 | 0,9 | CET2 | OE184 | BAEA338 |
| 1.2 | 4 | A12XER | 63/84 | 06/10→ | | | CET2 | OE184 | BAEA185E |
| 1.3 CDTI | 4 | A13DTC | 55/74 | 07/06→ | CPSG003 | 4.4v | | | CCU138 |
| 1.3 CDTI | 4 | Z13DTJ | 55/74 | 07/06→ | | | | | CCU144 |
| 1.3 CDTI | 4 | Z13DTH | 66/89 | 07/06→ | | | | | CCU144 |
| 1.3 CDTI | 4 | A13DTE; A13DTR; Z13DTE | 70/94 | 06/10→ | | | | | CCU138 |

MOVANO

| | | | | | | | | | |
|------------------|---|--------------------------------|---------|-------------|-------|-------|--|--|-------------------------|
| 1.9 DTI | 4 | F9Q770 | 59/79 | 09/00→10/01 | CH271 | 11v | | | CCU129 ^[338] |
| 1.9 DTI | 4 | F9Q774 | 60/80 | 10/01→ | CH271 | 11v | | | |
| 1.9 DTI | 4 | F9Q772 | 60/80 | 10/01→ | CH271 | 11v | | | CCU154 |
| 2.2 DTI | 4 | G9T750 | 66/89 | 09/00→ | CH232 | 11v | | | |
| 2.2 DTI | 4 | G9T720; G9T722 | 66/89 | 09/00→ | CH232 | 11v | | | CCU154 |
| 2.5 CDTI | 4 | G9U754 | 73/98 | 10/03→12/06 | CH232 | 11v | | | |
| 2.5 CDTI | 4 | G9U650 | 74/99 | 10/03→ | CH232 | 11v | | | |
| 2.5 CDTI | 4 | G9U632; G9U650 | 88/118 | 10/03→ | CH232 | 11v | | | |
| 2.5 CDTI | 4 | G9U632; G9U650 | 107/143 | 10/03→ | CH232 | 11v | | | |
| 2.5 D | 4 | S8U770; S8U772 | 59/79 | 07/98→09/00 | CH147 | 11.5v | | | |
| 2.5 DTI | 4 | G9U720; G9U724; G9U750; G9U754 | 84/113 | 10/01→ | CH232 | 11v | | | CCU154 |
| 2.5 DTI, 2.5 DTi | 4 | G9U754 | 73/98 | 10/03→ | CH232 | 11v | | | CCU154 |
| 3.0 DTI, 3.0 DTi | 4 | ZD3200; ZD3202 | 100/134 | 10/03→ | | | | | CCU154 |

MOVANO B

| | | | | | | | | | |
|----------|---|--|---------|--------|---------------------------------|----|--|--|--|
| 2.3 CDTI | 4 | M9T670; M9T672; M9T676; M9T690; M9T692 | 74/99 | 05/10→ | CCGP007 | 7v | | | |
| 2.3 CDTI | 4 | M9T670; M9T672; M9T676; M9T680; M9T686; M9T690; M9T692; M9T696; M9T698; M9T876 | 92/123 | 05/10→ | CCGP007 | 7v | | | |
| 2.3 CDTI | 4 | M9T678; M9T680; M9T694; M9T696; M9T698 | 107/143 | 05/10→ | CCGP007 | 7v | | | |
| 2.3 CDTI | 4 | M9T694; M9T696; M9T698 | 110/148 | 01/13→ | CCGP007 | 7v | | | |
| 2.3 CDTI | 4 | M9T880 | 110/148 | 01/13→ | CCGP007 →06/13 [14] [171] | 7v | | | |

VIVARO A

| | | | | | | | | | |
|----------------|---|--------------------------------|---------|--------|---|-----|------|----------------|------------------------------|
| 1.9 DI, 1.9 Di | 4 | F9Q762 | 60/80 | 08/01→ | CH271 | 11v | | | CCU154 →Ch.6V699999 6Y |
| 1.9 DTI | 4 | F9Q760 | 74/99 | 08/01→ | CH271 | 11v | | | CCU154 →Ch.6V699999 6Y |
| 2.0 16V | 4 | F4R720 | 88/118 | 08/01→ | | | CET2 | OE179 | BAE409A |
| 2.0 CDTI | 4 | M9R630 | 66/89 | 01/06→ | CCGP007 ^[14] →12/11 | 7v | | | |
| 2.0 CDTI | 4 | M9R780; M9R782; M9R786 | 66/89 | 01/06→ | CCGP007 ^[14] Ch.C056227→ | 7v | | | |
| 2.0 CDTI | 4 | M9R630 | 84/113 | 08/06→ | CCGP007 ^[14] →Prod.12.12.2011 | 7v | | | |
| 2.0 CDTI | 4 | M9R780; M9R784; M9R786; M9R788 | 84/113 | 08/06→ | CCGP007 ^[14] Ch.C056227→ | 7v | | | |
| 2.0 ECOTEC | 4 | F4R820 | 86/115 | 08/06→ | OE019 | 0,9 | CET2 | OE179 OE184 | BAE409A |
| 2.5 CDTI | 4 | G9U630 | 84/113 | 08/06→ | CH232 | 11v | | | |
| 2.5 CDTI | 4 | G9MB6; G9U630 | 107/143 | 08/06→ | CH232 | 11v | | | |

OPEL





kW/BHP

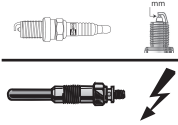

eon TITAN

IRIDIUM

**...OPEL****...VIVARO A**

| | | | | | | | | | |
|------------------|---|--------|--------|--------|-------|-----|--|--|------------------------------|
| 2.5 DTi, 2.5 DTi | 4 | G9U730 | 99/133 | 05/03→ | CH232 | 11v | | | CCU154 →Ch.6V699999 6Y |
|------------------|---|--------|--------|--------|-------|-----|--|--|------------------------------|

ZAFIRA B

| | | | | | | | | | |
|---------------|---|----------------|---------|-------------|-------|-----|------|-------|-----------------------|
| 1.6 CNG Turbo | 4 | A16XNT; Z16XNT | 110/148 | 02/09→04/15 | | | | | BAEA427 |
| 1.7 CDTi | 4 | A17DTJ; Z17DTJ | 81/109 | 01/08→04/15 | | | | | CCU143 ^[7] |
| 1.7 CDTi | 4 | A17DTR | 92/123 | 01/08→04/15 | | | | | CCU143 ^[7] |
| 1.8 | 4 | A18XER; Z18XER | 103/138 | 07/05→04/15 | OE198 | 0,9 | CET2 | OE184 | BAEA427 |

PANOZ**ROADSTER**

| | | | | | | | | | |
|-----|---|--|---------|-------------|--|--|------|--|--|
| 4.6 | 8 | | 227/304 | 06/96→12/00 | | | CET9 | | |
|-----|---|--|---------|-------------|--|--|------|--|--|

PEUGEOT**106 I**

| | | | | | | | | | | |
|-------|---|----------------------|--------|-------------|-------|-----|------|-------|---------------------|--------|
| 1.3 | 4 | TU2J2 | 72/97 | 10/93→04/96 | OE005 | 0,9 | CET2 | OE180 | BAEA231 | CLS262 |
| 1.5 D | 4 | VJY(TUD5) | 40/54 | 06/94→04/96 | CH185 | 11v | | | | |
| 1.5 D | 4 | VJY(TUD5); VJZ(TUD5) | 43/58 | 06/94→04/96 | CH185 | 11v | | | | |
| 1.6 | 4 | NFZ(TU5JP) | 65/87 | 06/93→04/96 | OE034 | 0,9 | CET2 | OE179 | BAEA231 →Ch.3200 | CLS262 |
| 1.6 | 4 | NFY(TU5J2) | 76/102 | 01/94→04/96 | OE034 | 0,9 | CET2 | OE179 | BAEA231 | CLS262 |

106 II

| | | | | | | | | | | |
|---------|---|---------------------------------|--------|-------------|-----------------|-----|------|-----------------|--|--------|
| 1.0 i | 4 | CDY(TU9M) | 33/44 | 05/96→10/99 | OE034 | 0,9 | CET2 | OE179 | BAEA232 | CLS262 |
| 1.0 i | 4 | CDZ(TU9M) | 37/50 | 01/97→03/01 | OE034 | 0,9 | CET2 | OE179 | BAEA232 | CLS262 |
| 1.1 i | 4 | HDY(TU1M) | 40/54 | 01/97→03/01 | OE034 | 0,9 | CET2 | OE179 | BAEA232 | CLS262 |
| 1.1 i | 4 | HDZ(TU1M) | 44/59 | 05/96→07/04 | OE034 | 0,9 | CET2 | OE179 | BAEA232 | CLS262 |
| 1.1 i | 4 | HFX(TU1JP) | 44/59 | 05/96→07/04 | OE034 | 0,9 | CET2 | OE179 | BAE946A ^[10] | CLS262 |
| 1.4 i | 4 | KFW(TU3JP); KFX(TU3JP) | 55/74 | 05/96→07/04 | OE034 | 0,9 | CET2 | OE179 | BAEA232 →02/98 BAE946A [10][19] | CLS262 |
| 1.5 D | 4 | VJY(TUD5) | 40/54 | 05/96→03/01 | CH185 | 11v | | | | |
| 1.5 D | 4 | VJX(TUD5); VJY(TUD5); VJZ(TUD5) | 42/56 | 04/98→07/04 | CH185 | 11v | | | | |
| 1.6 i | 4 | NFZ(TU5JP) | 65/87 | 05/96→10/99 | OE034 | 0,9 | CET2 | OE179 | BAEA232 →Ch.3200 | CLS262 |
| 1.6 i | 4 | NFW(TU5J2); NFY(TU5J2) | 74/99 | 05/96→01/01 | OE034 10/99→ | 0,9 | CET2 | OE179 10/99→ | BAEA231 | CLS262 |
| 1.6 S16 | 4 | NFX(TU5J4) | 87/117 | 05/96→07/04 | OE034 10/99→ | 0,9 | CET2 | OE179 10/99→ | BAEA046E ^[277] | |

107

| | | | | | | | | | |
|---------|---|---------------------|-------|-------------|-------|-----|------|-------|----------|
| 1.0 | 3 | CFA(384F); CFB(1KR) | 50/67 | 06/05→ | OE035 | 0,9 | CET5 | OE190 | BAEA164E |
| 1.4 HDi | 4 | 8HT(DV4TD) | 40/54 | 06/05→05/14 | CH201 | 11v | | | |

108

| | | | | | | | | | |
|---------|---|----------|-------|--------|--|--|--|--|----------|
| 1.0 VTi | 3 | CFB(1KR) | 51/68 | 05/14→ | | | | | BAEA164E |
|---------|---|----------|-------|--------|--|--|--|--|----------|

206

| | | | | | | | | | |
|-------------------------|---|------------------------|-------|-------------|--------------------|-----|------|-------|--|
| 1.1 | 4 | HFY(TU1JP) | 40/54 | 08/98→07/00 | OE034 | 0,9 | CET2 | OE179 | |
| 1.1, 1.1 i | 4 | HFX(TU1JP); HFZ(TU1JP) | 44/59 | 09/98→ | OE034 | 0,9 | CET2 | OE179 | BAE946A ^[10] |
| 1.4 | 4 | KFV(TU3A); KFW(TU3JP) | 55/74 | 07/02→ | OE034 | 0,9 | CET2 | OE179 | BAE946A ^[10] BAEA048E ^[7] |
| 1.4 16V | 4 | KFU(ET3J4) | 65/87 | 10/03→ | OE130 | 0,9 | CET4 | | BAEA472 |
| 1.4 HDi | 4 | 8HX(DV4TD) | 51/68 | 09/02→02/07 | CH201 Ch.10444→ | 11v | | | CCU149 ^[359] |
| 1.4 HDi, 1.4 HDi eco 70 | 4 | 8HX(DV4TD); 8HZ(DV4TD) | 50/67 | 09/01→ | CH201 RP.10444→ | 11v | | | CCU149 ^[359] |
| 1.4 i | 4 | KFW(TU3A); KFX(TU3JP) | 55/74 | 09/98→ | OE034 | 0,9 | CET2 | OE179 | |
| 1.4 i | 4 | KFW(TU3JP) | 55/74 | 09/98→ | OE034 | 0,9 | CET2 | OE179 | BAE946A ^[10] 06/00→ |

PEUGEOT



kW/BHP



eon TITAN

IRIDIUM



...PEUGEOT



...206

| | | | | | | | | | |
|---------------------|---|-------------------------------|---------|-------------|----------------------------|-----|----------------|-------|-------------------------|
| 1.4 LPG | 4 | KFV(TU3JP) | 55/74 | 07/02→ | OE034 | 0,9 | CET2 | OE179 | BAE946A ^[10] |
| 1.6 | 4 | NFU(TU5JP4) | 81/109 | 09/01→12/08 | OE035 | 0,9 | CET14P CET5 | OE190 | |
| 1.6 16V | 4 | NFU(TU5JP4) | 79/106 | 06/01→04/09 | OE148 | 1,0 | | | BAEA045E |
| 1.6 16V | 4 | NFU(TU5JP4) | 80/107 | 09/00→ | OE035 | 0,9 | CET5 | OE190 | BAEA045E |
| | | | | | OE224 ^{LPG [279]} | 0,8 | | | |
| 1.6 HDi 110 | 4 | 9HY(DV6TED4); 9HZ(DV6TED4) | 80/107 | 05/04→ | CH201 RP.10784→ | 11v | | | CCU147 |
| 1.6 i | 4 | NFZ(TU5JP) | 65/87 | 09/98→12/00 | OE034 | 0,9 | CET2 | OE179 | |
| 1.9 D | 4 | WJY(DW8B); WJZ(DW8) | 51/68 | 09/98→11/01 | CH185 | 11v | | | CCU149 ^[315] |
| 2.0 16V, 2.0 S16 | 4 | RFN(EW10J4) | 100/134 | 06/99→ | OE178 | 0,9 | CET5 | | BAEA348 |
| 2.0 HDi, 2.0 HDi 90 | 4 | RHY(DW10TD) | 66/89 | 12/99→ | CH170 | 11v | | | CCU149 ^[359] |
| 2.0 RC | 4 | RFK(EW10J4S) | 130/174 | 07/03→ | OE178 | 0,9 | CET5 | | BAEA351 |
| | | | | | OE224 ^{LPG [279]} | 0,8 | | | |
| 2.0 S16 | 4 | RFR(EW10J4) | 99/133 | 04/99→10/00 | OE178 | 0,9 | CET5 | | BAEA348 |

206+

| | | | | | | | | | |
|----------------|---|--------------------------------------|-------|--------|--------------------|------------|------|-------|-------------------------|
| 1.1 | 4 | HFX(TU1A); TU1AE5 | 44/59 | 01/09→ | OE005 OE034 | 0,9 0,9 | CET2 | OE179 | BAEA048E ^[7] |
| 1.1 | 4 | HFX(TU1JP) | 44/59 | 01/09→ | OE034 | 0,9 | CET2 | OE179 | BAEA048E ^[7] |
| 1.4 HDi eco 70 | 4 | 8HR(DV4C); 8HX(DV4TD); 8HZ(DV4TD) | 50/67 | 01/09→ | CH201 RP.10444→ | 11v | | | CCU147 |
| 1.4 i | 4 | KFT(TU3A) | 54/72 | 09/10→ | OE034 | 0,9 | CET2 | OE179 | BAEA048E ^[7] |
| 1.4 i | 4 | KFV(TU3A); KFW(TU3A) | 55/74 | 01/09→ | OE034 | 0,9 | CET2 | OE179 | BAEA048E ^[7] |

207

| | | | | | | | | | |
|---------------|---|--|---------|-------------|----------------------------|-----|--------|-------|-------------------------|
| 1.4 | 4 | KFV(TU3A) | 53/71 | 02/06→ | OE034 | 0,9 | CET2 | OE179 | BAEA048E ^[7] |
| 1.4 | 4 | KFT(TU3A); KFV(TU3A) | 54/72 | 12/07→ | OE034 | 0,9 | CET2 | OE179 | BAEA048E ^[7] |
| 1.4 | 4 | KFV(TU3A); KFW(TU3A) | 55/74 | 08/08→ | OE034 | 0,9 | CET2 | OE179 | BAEA048E ^[7] |
| 1.4 16V | 4 | KFU(ET3J4) | 65/87 | 02/06→ | OE130 | 0,9 | CET4 | | BAEA472 |
| 1.4 16V | 4 | 8FS(EP3); EP3; EP3C | 70/94 | 06/07→ | OE203 | 1,0 | | | BAEA143 |
| 1.4 16V | 4 | 8FR(EP3) | 72/97 | 10/09→ | OE203 | 1,0 | | | BAEA143 |
| 1.4 Bioflex | 4 | KFW(TU3JP) | 60/80 | 08/08→ | OE034 | 0,9 | CET2 | OE179 | |
| 1.4 Bioflex | 4 | KFW(TU3A) | 60/80 | 08/08→ | OE034 | 0,9 | CET2 | OE179 | BAEA048E ^[7] |
| 1.4 HDi | 4 | 8HR(DV4C) | 50/67 | 02/06→ | CH201 | 11v | | | |
| 1.4 HDi | 4 | 8HZ(DV4TD) | 50/67 | 02/06→ | CH201 | 11v | | | CCU147 |
| 1.6 | 4 | | 90/121 | 09/07→12/13 | | | | | BAEA143 |
| 1.6 16V | 4 | NFU(TU5JP4) | 80/107 | 02/06→ | OE035 | 0,9 | CET5 | OE190 | BAEA045E |
| | | | | | OE224 ^{LPG [279]} | 0,8 | | | |
| 1.6 16V RC | 4 | 5FY(EP6DTS) | 128/172 | 02/07→ | OE205 | 0,7 | CET16P | | BAEA143 |
| 1.6 16V Turbo | 4 | 5FX(EP6DT) | 110/148 | 02/06→ | OE205 | 0,7 | CET16P | | BAEA143 |
| 1.6 16V Turbo | 4 | 5FR(EP6DT) | 115/154 | 10/09→ | OE205 | 0,7 | CET16P | | BAEA143 |
| 1.6 16V VTi | 4 | 5FS(EP6C); 5FW(EP6); EP6 | 88/118 | 02/07→ | OE205 | 0,7 | CET16P | | BAEA143 03/07→ |
| 1.6 Bioflex | 4 | N6A(TU5JP4) | 83/111 | 01/08→ | OE035 | 0,9 | CET5 | | BAEA045E |
| 1.6 HDi | 4 | 9HV(DV6TED4B); 9HV(DV6TED4BU); 9HX(DV6ATED4) | 66/89 | 02/06→10/13 | CH201 | 11v | | | CCU147 |
| 1.6 HDi | 4 | 9HY(DV6TED4); 9HZ(DV6TED4) | 80/107 | 02/06→ | CH201 | 11v | | | CCU147 |

207 CC

| | | | | | | | | | |
|---------------|---|--------------------------|---------|-------------|-------|-----|--------|--|---------|
| 1.6 | 4 | | 90/121 | 09/10→12/11 | | | | | BAEA143 |
| 1.6 16V | 4 | 5FS(EP6C); 5FW(EP6); EP6 | 88/118 | 02/07→ | OE205 | 0,7 | CET16P | | BAEA143 |
| 1.6 16V Turbo | 4 | 5FX(EP6DT) | 110/148 | 02/07→ | OE205 | 0,7 | CET16P | | BAEA143 |
| 1.6 16V Turbo | 4 | 5FR(EP6DT); 5FV(EP6CDT) | 115/154 | 10/09→ | OE205 | 0,7 | CET16P | | BAEA143 |
| 1.6 HDi | 4 | 9HZ(DV6TED4) | 80/107 | 02/07→ | CH201 | 11v | | | CCU147 |

CHAMPION



kW/BHP



eon TITAN

IRIDIUM



...PEUGEOT



207 SW

| | | | | | | | | | |
|------------|---|-------------------------------|---------|-------------|-------|-----|--------|-------|-------------------------|
| 1.4 | 4 | KFT(TU3A); KfV(TU3A) | 54/72 | 06/07→ | OE034 | 0,9 | CET2 | OE179 | BAEA048E ^[7] |
| 1.4 16V | 4 | 8FS(EP3); EP3; EP3C | 70/94 | 06/07→ | OE203 | 1,0 | | | BAEA143 |
| 1.4 16V | 4 | 8FR(EP3) | 72/97 | 11/09→ | OE203 | 1,0 | | | BAEA143 |
| 1.6 16V | 4 | 5FS(EP6C); 5FW(EP6); EP6 | 88/118 | 06/07→ | OE205 | 0,7 | CET16P | | BAEA143 |
| 1.6 16V RC | 4 | 5FY(EP6DTS) | 128/172 | 02/07→ | OE205 | 0,7 | CET16P | | BAEA143 |
| 1.6 HDi | 4 | 9HV(DV6TED4B); 9HV(DV6TED4BU) | 66/89 | 06/07→12/12 | CH201 | 11v | | | |
| 1.6 HDi | 4 | 9HZ(DV6TED4) | 80/107 | 06/07→12/12 | CH201 | 11v | | | CCU147 |

208

| | | | | | | | | | |
|------------------|---|----------------|---------|--------|-------|-----|--------|-------|---------|
| 1.0 | 3 | ZMZ(EBO) | 50/67 | 03/12→ | | | | OE263 | |
| 1.2 | 3 | HMZ(EB2F) | 60/80 | 03/12→ | | | | OE263 | |
| 1.2 THP | 3 | HNZ(EB2DT) | 81/109 | 01/13→ | | | | | BAEA557 |
| 1.4 GPL, 1.4 VTi | 4 | 8FS(EP3); EP3C | 70/94 | 03/12→ | | | | | BAEA143 |
| 1.6 | 4 | 5FS(EP6C) | 88/118 | 03/12→ | OE205 | 0,7 | CET16P | | BAEA143 |
| 1.6 | 4 | 5FV(EP6CDT) | 115/154 | 03/12→ | OE205 | 0,7 | CET16P | | |

301

| | | | | | | | | | |
|-------------|---|----------|--------|--------|-------|-----|------|--|--|
| 1.6 VTi 115 | 4 | NFP(EC5) | 85/114 | 11/12→ | OE035 | 0,9 | CET5 | | |
|-------------|---|----------|--------|--------|-------|-----|------|--|--|

306

| | | | | | | | | | | |
|----------------|---|------------------------------|--------|-------------|--------------------------|------------|------|-------|--|------------------|
| 1.1 | 4 | HDZ(TU1M) | 44/59 | 05/93→05/01 | OE034 | 0,9 | CET2 | OE179 | BAEA231 ^[275] BAEA232 ^[275] | CLS124 CLS262 |
| 1.4 | 4 | KDX(TU3MC) | 55/74 | 04/93→04/02 | OE034 | 0,9 | CET2 | OE179 | BAEA231 | |
| 1.4 | 4 | KFW(TU3JP); KFX(TU3JP) | 55/74 | 04/93→04/02 | OE034 | 0,9 | CET2 | OE179 | BAEA232 →RP.7874 | CLS005 |
| 1.4 | 4 | TU3MC | 55/74 | 04/93→04/02 | | | | | | CLS124 |
| 1.4 SL | 4 | KDX(TU3MC) | 55/74 | 06/94→05/01 | OE034 *to be adjusted | 0,8* | CET2 | OE179 | BAEA231 | CLS262 |
| 1.4 SL | 4 | KFW(TU3JP); KFX(TU3JP) | 55/74 | 06/94→05/01 | OE034 *to be adjusted | 0,8* | CET2 | OE179 | BAEA232 →RP.7874 | CLS262 |
| 1.6 | 4 | NFZ(TU5JP) | 65/87 | 05/93→10/00 | OE034 | 0,9 | CET2 | OE179 | BAEA231 ^[47] BAEA232 ^[48] →Prod.31.05.1998 →RP.07874 | CLS262 |
| 1.6 | 4 | | 66/89 | 07/00→05/01 | OE034 | 0,9 | CET2 | OE179 | | |
| 1.6 | 4 | NFZ(TU5JP) | 66/89 | 07/00→05/01 | OE005 OE034 | 0,9 0,9 | CET2 | OE179 | | |
| 1.6 | 4 | NFT(TU5JP) | 72/97 | 10/00→04/02 | OE034 | 0,9 | CET2 | OE179 | BAE946A ^[10] | |
| 1.6 SR | 4 | NFZ(TU5JP) | 65/87 | 06/94→10/00 | OE034 07/95→ | 0,9 | CET2 | OE179 | BAEA231 ^[47] BAEA232 ^[48] →Prod.31.05.1998 →RP.07874 | CLS262 |
| 1.8 | 4 | LFZ(XU7JP) | 74/99 | 05/93→04/02 | OE005 OE034 | 0,9 0,9 | CET2 | OE179 | BAEA232 | CLS123 |
| 1.8, 1.8 ST | 4 | L6A(XU7JP); LFZ(XU7JP) | 74/99 | 05/93→04/02 | OE034 | 0,9 | CET2 | OE179 | BAEA232 | CLS123 |
| 1.8 16V | 4 | LFY(XU7JP4) | 81/109 | 03/97→04/02 | OE034 | 0,9 | CET2 | OE179 | BAEA256 →RP.7608 | |
| 1.8 D | 4 | A9A(XUD7) | 43/58 | 05/93→05/01 | CH189 | 11v | | | | |
| 1.9 D | 4 | DJZ(XUD9Y) | 47/63 | 05/93→05/01 | CH189 | 11v | | | | |
| 1.9 D | 4 | DJY(XUD9A) | 50/67 | 06/94→04/02 | CH189 | 11v | | | | |
| 1.9 D | 4 | WJZ(DW8) | 51/68 | 04/93→04/02 | CH185 | 11v | | | | |
| 1.9 D | 4 | WJY(DW8B) | 51/68 | 04/93→04/02 | CH185 | 11v | | | CCU149 ^[314] | |
| 1.9 D | 4 | DHV(XUD9BSD) | 55/74 | 03/98→04/02 | CH189 | 11v | | | | |
| 1.9 D | 4 | D8A(XUD9TE) | 68/91 | 01/93→12/97 | CH189 | 11v | | | CCU148 ^[61] →Prod.01.06.1994 CCU148 ^[49] →Prod.01.06.1995 | |
| 1.9 D, 1.9 STD | 4 | D9B(XUD9A); DJY(XUD9A); XUD9 | 51/68 | 04/93→04/02 | CH189 | 11v | | | | |

PEUGEOT





kW/BHP



eon TITAN

IRIDIUM

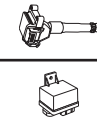

...PEUGEOT



...306

| | | | | | | | | | | |
|--------------------------|---|------------------------------|---------|-------------|------------------------------------|------|------|-----------------|--|--------|
| 1.9 DT, 1.9 SRDT, 1.9 TD | 4 | D8A(XUD9TE); DHY(XUD9TE) | 66/89 | 05/93→04/02 | CH189 | 11v | | | | |
| 1.9 SLD | 4 | DJZ(XUD9Y) | 47/63 | 06/94→05/01 | CH189 | 11v | | | | |
| 1.9 SLD | 4 | DJY(XUD9A) | 50/67 | 06/94→05/01 | CH189 | 11v | | | | |
| 2.0 | 4 | RFV(XU10J4R) | 97/130 | 03/97→04/02 | OE034 *to be adjusted | 0,8* | CET2 | OE179 | BAEA256 →Prod.07.09.1997 →RP.07608 | CLS005 |
| 2.0 | 4 | RFV(XU10J4R) | 99/133 | 05/97→06/00 | | | | | BAEA256 →Prod.07.09.1997 →RP.07608 | |
| 2.0, 2.0 ST, 2.0 XSi | 4 | RFX(XU10J2) | 89/119 | 05/93→04/02 | OE034 | 0,9 | CET2 | OE179 | BAEA232 | CLS005 |
| 2.0 16V | 4 | RFV(XU10J4R) | 97/130 | 03/97→04/02 | OE034 →03/01 *to be adjusted | 0,8* | CET2 | OE179 →03/01 | BAEA256 →Prod.07.09.1997 →RP.07608 | CLS005 |
| 2.0 16V | 4 | RFV(XU10J4R) | 99/133 | 03/97→04/02 | OE034 | 0,9 | CET2 | | BAEA256 →Prod.07.09.1997 →RP.07608 | |
| 2.0 HDI 90 | 4 | RHY(DW10TD) | 66/89 | 06/99→12/02 | CH170 | 11v | | | CCU149 | |
| 2.0 S16 | 4 | RFT(XU10J4); RFY(XU10J4Z) | 110/148 | 06/94→05/01 | OE034 *to be adjusted | 0,8* | CET2 | OE179 | BAE700AK | |
| 2.0 S16 | 4 | XU10J4TEZ | 110/148 | 06/94→05/01 | | | | | BAE700AK | |
| 2.0 S16 | 4 | RFY(XU10J4Z) | 112/150 | 05/93→05/01 | OE034 →09/99 | 0,9 | CET2 | OE179 | BAEA232 | |
| 2.0 S16 | 4 | RFS(XU10J4RS) | 120/161 | 07/96→05/01 | OE034 →09/99 *to be adjusted | 0,8* | CET2 | OE179 →09/99 | | |

307

| | | | | | | | | | | |
|--------------------------|---|---|---------|-------------|-------------------------------------|------------|------|-------|-------------------------|--|
| 1.4 | 4 | KFU(TU3JP) | 55/74 | 08/00→ | OE034 | 0,9 | CET2 | OE179 | BAE946A ^[10] | |
| 1.4 16V | 4 | KFU(ET3J4) | 65/87 | 11/03→ | OE130 | 0,9 | CET4 | | BAEA472 | |
| 1.4 HDi | 4 | 8HX(DV4TD); 8HZ(DV4TD) | 50/67 | 10/01→ | CH201 RP.10221→ | 11v | | | CCU149 ^[359] | |
| 1.4 HDi 70 | 4 | 8HZ(DV4TD) | 50/67 | 03/02→06/05 | | | | | CCU149 ^[359] | |
| 1.6 | 4 | NFU(TU5JP4) | 81/109 | 07/06→ | OE035 | 0,9 | CET5 | | | |
| 1.6 16V | 4 | NFU(TU5JP4) | 80/107 | 08/00→ | OE035 OE224 ^{LPG [279]} | 0,9 0,8 | CET5 | OE190 | BAEA045E | |
| 1.6 BioFlex | 4 | NFU(TU5JP4) | 80/107 | 09/07→ | OE035 | 0,9 | CET5 | OE190 | BAEA045E | |
| 1.6 HDi, 1.6 HDI 90 | 4 | 9HV(DV6TED4B); 9HV(DV6TED4BU); 9HX(DV6ATED4); 9HX(DV6AUTED4) | 66/89 | 04/05→ | CH201 RP.10784→ | 11v | | | | |
| 1.6 HDi 110, 1.6 HDI 110 | 4 | 9HY(DV6TED4); 9HZ(DV6TED4) | 80/107 | 02/04→ | CH201 RP.10784→ | 11v | | | CCU147 | |
| 2.0 | 4 | RFN(EW10J4) | 100/134 | 03/02→06/05 | OE178 | 0,9 | CET5 | | BAEA348 | |
| 2.0 16V | 4 | RFN(EW10J4) | 100/134 | 08/00→ | OE035 OE178 | 0,9 0,9 | CET5 | | BAEA348 | |
| 2.0 16V | 4 | RFJ(EW10A) | 103/138 | 12/04→ | OE178 | 0,9 | CET5 | | BAEA352 | |
| 2.0 16V | 4 | RFK(EW10J4S) | 130/174 | 10/03→ | OE178 OE224 ^{LPG [279]} | 0,9 0,8 | CET5 | | BAEA351 | |
| 2.0 HDi 90, 2.0 HDI 90 | 4 | RHY(DW10TD) | 66/89 | 08/00→ | CH170 | 11v | | | CCU149 ^[359] | |
| 2.0 HDi 110, 2.0 HDI 110 | 4 | RHS(DW10ATED) | 79/106 | 08/00→ | CH170 | 11v | | | CCU149 ^[359] | |
| 2.0 HDi 135 | 4 | RHR(DW10BTED4) | 100/134 | 10/03→ | CH268 | 11v | | | | |

308

| | | | | | | | | | | |
|---------|---|---------------|---------|--------|-------|-----|--------|--|---------|--|
| 1.4 16V | 4 | 8FS(EP3); EP3 | 70/94 | 09/07→ | OE203 | 1,0 | | | BAEA143 | |
| 1.4 16V | 4 | 8FR(EP3) | 72/97 | 12/09→ | OE203 | 1,0 | | | BAEA143 | |
| 1.6 | 4 | | 120/161 | 01/12→ | OE205 | 0,7 | CET16P | | | |
| 1.6 16V | 4 | 5FW(EP6); EP6 | 88/118 | 09/07→ | OE205 | 0,7 | CET16P | | BAEA143 | |
| 1.6 16V | 4 | 5FT(EP6DT) | 103/138 | 09/07→ | OE205 | 0,7 | CET16P | | BAEA143 | |
| 1.6 16V | 4 | 5FX(EP6DT) | 110/148 | 09/07→ | OE205 | 0,7 | CET16P | | BAEA143 | |





kW/BHP



eon TITAN

IRIDIUM



...PEUGEOT



...308

| | | | | | | | | | |
|-------------|---|--|---------|--------|-------|-----|--------|-------|---------|
| 1.6 16V | 4 | 5FV(EP6CDT) | 115/154 | 10/09→ | OE205 | 0,7 | CET16P | | BAEA143 |
| 1.6 16V | 4 | 5FY(EP6DTS) | 128/172 | 03/08→ | OE205 | 0,7 | CET16P | | BAEA143 |
| 1.6 BioFlex | 4 | NFU(TU5JP4) | 80/107 | 04/08→ | OE035 | 0,9 | CET5 | OE190 | |
| 1.6 GTi | 4 | EP6CDTX | 147/197 | 07/10→ | OE205 | 0,7 | | | BAEA143 |
| 1.6 HDi | 4 | 9HV(DV6TED4B); 9HV(DV6TED4BU); 9HX(DV6ATED4) | 66/89 | 09/07→ | CH201 | 11v | | | CCU147 |
| 1.6 HDi | 4 | 9HZ(DV6TED4) | 80/107 | 09/07→ | CH201 | 11v | | | CCU147 |
| 2.0 HDi | 4 | RHR(DW10BTED4); RHR(DW10CB) | 100/134 | 09/07→ | CH268 | 11v | | | |
| 2.0 HDi | 4 | RHR(DW10BTED4) | 103/138 | 07/10→ | CH268 | 11v | | | |

308 CC

| | | | | | | | | | |
|---------|---|----------------|---------|--------|-------|-----|--------|--|---------|
| 1.6 16V | 4 | EP6 | 88/118 | 06/09→ | OE205 | 0,7 | CET16P | | BAEA143 |
| 1.6 16V | 4 | 5FT(EP6DT) | 103/138 | 06/09→ | OE205 | 0,7 | CET16P | | BAEA143 |
| 1.6 16V | 4 | 5FX(EP6DT) | 110/148 | 06/09→ | OE205 | 0,7 | CET16P | | BAEA143 |
| 1.6 16V | 4 | 5FV(EP6CDT) | 115/154 | 06/09→ | OE205 | 0,7 | CET16P | | BAEA143 |
| 1.6 THP | 4 | EP6CDTX | 147/197 | 10/10→ | OE205 | 0,7 | | | |
| 2.0 HDi | 4 | RHR(DW10BTED4) | 100/134 | 04/09→ | CH268 | 11v | | | |
| 2.0 HDi | 4 | RHF(DW10BTED4) | 103/138 | 04/09→ | CH268 | 11v | | | |

308 II

| | | | | | | | | | |
|-------------|---|-------------|---------|--------|-------|-----|--------|--|---------|
| 1.2 THP 110 | 3 | HNZ(EB2DT) | 81/109 | 11/13→ | | | | | BAEA557 |
| 1.2 THP 130 | 3 | HNY(EB2DTS) | 96/129 | 11/13→ | | | | | BAEA557 |
| 1.6 | 4 | 5FV(EP6CDT) | 115/154 | 09/13→ | OE205 | 0,7 | CET16P | | |
| 1.6 THP 125 | 4 | 5FA(EP6CDT) | 92/123 | 09/13→ | OE205 | 0,7 | CET16P | | |

308 SW

| | | | | | | | | | |
|-------------|---|--|---------|--------|-------|-----|--------|-------|-------------------|
| 1.4 16V | 4 | 8FS(EP3) | 70/94 | 09/07→ | OE203 | 1,0 | | | BAEA143 |
| 1.4 16V | 4 | 8FR(EP3) | 72/97 | 12/09→ | OE203 | 1,0 | | | BAEA143 |
| 1.6 16V | 4 | 5FW(EP6); EP6 | 88/118 | 09/07→ | OE205 | 0,7 | CET16P | | BAEA143 05/08→ |
| 1.6 16V | 4 | 5FT(EP6DT) | 103/138 | 09/07→ | OE205 | 0,7 | CET16P | | BAEA143 |
| 1.6 16V | 4 | 5FX(EP6DT) | 110/148 | 09/07→ | OE205 | 0,7 | CET16P | | BAEA143 |
| 1.6 16V | 4 | 5FV(EP6CDT) | 115/154 | 10/09→ | OE205 | 0,7 | CET16P | | BAEA143 |
| 1.6 16V | 4 | 5FY(EP6DTS) | 128/172 | 03/08→ | OE205 | 0,7 | CET16P | | BAEA143 |
| 1.6 Bioflex | 4 | NFU(TU5JP4) | 82/110 | 03/09→ | OE035 | 0,9 | CET5 | OE190 | BAEA045E |
| 1.6 HDi | 4 | 9HV(DV6TED4B); 9HV(DV6TED4BU); 9HX(DV6ATED4) | 66/89 | 09/07→ | CH201 | 11v | | | |
| 1.6 HDi | 4 | 9HZ(DV6TED4) | 80/107 | 09/07→ | CH201 | 11v | | | CCU147 |
| 2.0 Bioflex | 4 | RFJ(EW10A) | 103/138 | 01/08→ | OE178 | 0,9 | CET5 | | |
| 2.0 HDi | 4 | RHR(DW10BTED4) | 100/134 | 09/07→ | CH268 | 11v | | | |
| 2.0 HDi | 4 | RHR(DW10BTED4) | 103/138 | 09/07→ | CH268 | 11v | | | |

308 SW II

| | | | | | | | | | |
|-------------|---|-------------|---------|--------|-------|-----|--------|--|---------|
| 1.2 THP 110 | 3 | HNZ(EB2DT) | 81/109 | 03/14→ | | | | | BAEA557 |
| 1.2 THP 130 | 3 | HNY(EB2DTS) | 96/129 | 03/14→ | | | | | BAEA557 |
| 1.6 THP 155 | 4 | 5FV(EP6CDT) | 115/154 | 03/14→ | OE205 | 0,7 | CET16P | | |

405 II

| | | | | | | | | | |
|---------|---|-------------|---------|-------------|-------|-----|------|-------|----------|
| 1.8 | 4 | LFZ(XU7JP) | 76/102 | 08/96→11/99 | OE034 | 0,9 | CET2 | OE179 | |
| 1.9 D | 4 | DJY(XUD9A) | 50/67 | 06/94→10/96 | CH189 | 11v | | | |
| 2.0 16V | 4 | RFT(XU10J4) | 110/148 | 06/94→10/95 | OE034 | 0,9 | CET2 | OE188 | BAE700AK |

406

| | | | | | | | | | |
|-----|---|------------------------|-------|-------------|-------|-----|------|-------|-------------------|
| 1.6 | 4 | BFZ(XU5JP) | 65/87 | 11/95→05/04 | OE034 | 0,9 | CET2 | OE179 | BAEA232 CLS123 |
| 1.8 | 4 | LFX(XU7JB) | 66/89 | 05/97→10/04 | OE034 | 0,9 | CET2 | OE179 | BAEA232 CLS123 |
| 1.8 | 4 | L6A(XU7JP); LFZ(XU7JP) | 74/99 | 10/96→03/99 | | | | | BAEA232 |

PEUGEOT



kW/BHP

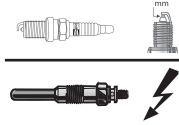

eon TITAN

IRIDIUM



...PEUGEOT



...406

| | | | | | | | | | | |
|---------------------|---|-----------------------------------|---------|-------------|--|------------|---------------|--------------|---|---------------|
| 1.8 16V | 4 | LFY(XU7JP4) | 81/109 | 11/95→10/00 | OE034 | 0,9 | CET2 | OE179 | BAEA256 →RP.7608 | |
| 1.8 16V | 4 | 6FZ(EW7J4) | 85/114 | 10/00→10/04 | OE178 | 0,9 | CET5 | | BAEA348 | |
| 1.9 D | 4 | DHW(XUD9SD) | 55/74 | 10/96→10/04 | CH189 | 11v | | | | |
| 1.9 TD | 4 | DHX(XUD9TE) | 66/89 | 01/96→10/04 | CH189 | 11v | | | CCU149 [315] | |
| 1.9 TD | 4 | DHY(XUD9TE) | 68/91 | 01/96→05/04 | CH189 | 11v | | | CCU149 [315] | |
| 1.9 TD | 4 | D8B(XUD9TE) | 69/93 | 10/95→10/97 | | | | | CCU149 [51] | |
| 2.0 | 4 | RGY(XU10J2TE) | 104/139 | 11/96→03/99 | OE034 | 0,9 | CET2 | OE179 | | |
| 2.0 16V | 4 | RFV(XU10J4R) | 97/130 | 11/95→12/04 | OE019 | 0,9 | CET2 | OE184 | BAEA256 →Prod.05.10.1997 →RP.07636 | CLS005 |
| 2.0 16V | 4 | RFR(EW10J4) | 99/133 | 01/99→09/04 | OE178 | 0,9 | CET5 | | BAEA348 | |
| 2.0 16V | 4 | RFV(XU10J4R) | 99/133 | 01/99→09/04 | | | | | BAEA256 →Prod.05.10.1997 →RP.07636 | |
| 2.0 16V | 4 | RFN(EW10J4) | 100/134 | 08/00→12/04 | OE178 | 0,9 | CET5 | | BAEA348 BAEA256 →Prod.05.10.1997 →RP.07636 | |
| 2.0 16V | 4 | RFV(XU10J4R) | 100/134 | 08/00→12/04 | OE178 | 0,9 | CET5 | | BAEA256 →Prod.05.10.1997 →RP.07636 | |
| 2.0 HDI 90 | 4 | RHY(DW10TD) | 66/89 | 02/99→10/04 | CH170 | 11v | | | CCU149 [359] →RP.09741 | |
| 2.0 HDi 110 | 4 | RHS(DW10ATED); RHZ(DW10ATED) | 79/106 | 08/01→10/04 | CH170 | 11v | | | CCU149 [359] →RP.09820 | |
| 2.0 HDI 110 | 4 | RHZ(DW10ATED) | 80/107 | 06/98→04/04 | CH170 | 11v | | | CCU149 [359] →RP.09820 | |
| 2.0 Turbo | 4 | RGX(XU10J2TE) | 108/145 | 04/96→10/04 | OE034 | 0,9 | CET2 | OE179 | BAEA232 | CLS005 |
| 2.1 TD 12V | 4 | P8C(XUD11BTE) | 80/107 | 01/96→10/04 | CH189 | 11v | | | | |
| 2.2 | 4 | 3FZ(EW12J4) | 116/156 | 07/00→12/04 | OE178 | 0,9 | CET5 | | BAEA351 | |
| 2.2 HDi, 2.2 HDI | 4 | 4HX(DW12TED4/FAP) | 98/131 | 03/00→12/04 | CH170 →RP.09666 CH268 RP.09667→ | 11v 11v | | | CCU149 [359] | |
| 3.0 24V, 3.0 V6 24V | 6 | XFZ(ES9J4) | 140/188 | 10/96→12/04 | OE026 | 0,9 | CET2 | OE188 | | |
| 3.0 V6 | 6 | AFX(ES9J4S) | 152/204 | 03/00→12/04 | OE175 | 1,0 | CET14P | OE190 | BAEA347 | |
| 407 | | | | | | | | | | |
| 1.6 HDi 110 | 4 | 9HZ(DV6TED4) | 80/107 | 05/04→ | CH201 RP.10784→ | 11v | | | CCU147 | |
| 1.8 | 4 | 6FZ(EW7J4) | 85/114 | 05/04→ | OE178 | 0,9 | CET5 | | BAEA348 BAEA351 | |
| 1.8 16V | 4 | 6FY(EW7A) | 92/123 | 09/05→ | OE178 | 0,9 | CET5 | | BAEA352 | |
| 2.0 | 4 | RFN(EW10J4) | 100/134 | 05/04→ | OE178 | 0,9 | CET5 | | BAEA348 | |
| 2.0 16V | 4 | RFJ(EW10A) | 103/138 | 09/05→ | OE178 | 0,9 | CET5 | | BAEA352 01/06→ | |
| 2.0 Bioflex | 4 | RFJ(EW10A) | 103/138 | 09/07→ | OE178 | 0,9 | CET5 | | | |
| 2.0 HDi | 4 | RHR(DW10BTED4) | 100/134 | 10/05→ | CH268 | 11v | | | | |
| 2.0 HDi | 4 | RHF(DW10BTED4); RHR(DW10BTED4) | 103/138 | 08/08→ | CH268 | 11v | | | | |
| 2.0 HDi 135 | 4 | RHR(DW10BTED4) | 100/134 | 05/04→ | CH268 | 11v | | | CCU147 | |
| 2.2 | 4 | 3FZ(EW12J4) | 116/156 | 05/04→ | OE178 | 0,9 | CET5 | | BAEA351 | |
| 2.2 16V | 4 | 3FY(EW12J4) | 120/161 | 09/05→ | OE178 | 0,9 | CET5 | | BAEA351 | |
| 2.7 HDi | 6 | UHZ(DT17) | 150/201 | 10/05→ | CH240 | 11v | | | | |
| 3.0, 3.0 V6 | 6 | XFV(ES9A) | 155/208 | 05/04→ | OE175 | 1,0 | CET14P | OE190 | BAEA347 | |
| 408 | | | | | | | | | | |
| 1.6 16V | 4 | | 80/107 | 02/10→ | OE205 | 0,7 | CET16P | | | |
| 1.6 Vti | 4 | 5FS(EP6C) | 88/118 | 01/12→ | OE205 | 0,7 | CET16P | | BAEA143 | |

PEUGEOT



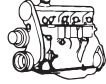

kW/BHP



eon TITAN

IRIDIUM



...PEUGEOT



508 I

| | | | | | | | | | |
|---------|---|----------------------------------|---------|--------|-------|-----|--------|--|---------|
| 1.6 | 4 | 5GZ(EP6FDT) | 120/161 | 01/12→ | OE205 | 0,7 | CET16P | | |
| 1.6 THP | 4 | 5FN(EP6CDT) | 110/148 | 11/10→ | OE205 | 0,7 | CET16P | | |
| 1.6 THP | 4 | 5FV(EP6CDT) | 115/154 | 11/10→ | OE205 | 0,7 | CET16P | | BAEA143 |
| 1.6 VTi | 4 | 5FH(EP6C) | 85/114 | 11/10→ | OE205 | 0,7 | CET16P | | BAEA143 |
| 1.6 VTi | 4 | 5FS(EP6C) | 88/118 | 11/10→ | OE205 | 0,7 | CET16P | | BAEA143 |
| 2.0 HDi | 4 | RHR(DW10BTD4) | 100/134 | 11/10→ | CH268 | 11v | | | |
| 2.0 HDi | 4 | RHA(DW10CTED4); RHF(DW10BTD4) | 103/138 | 11/10→ | CH268 | 11v | | | |

508 SW I

| | | | | | | | | | |
|---------|---|----------------------------------|---------|--------|-------|-----|--------|--|---------|
| 1.6 THP | 4 | 5FX(EP6DT) | 110/148 | 11/10→ | OE205 | 0,7 | CET16P | | |
| 1.6 THP | 4 | 5FV(EP6CDT) | 115/154 | 11/10→ | OE205 | 0,7 | CET16P | | BAEA143 |
| 1.6 VTi | 4 | 5FH(EP6C) | 85/114 | 11/10→ | OE205 | 0,7 | CET16P | | BAEA143 |
| 1.6 VTi | 4 | 5FS(EP6C) | 88/118 | 11/10→ | OE205 | 0,7 | CET16P | | BAEA143 |
| 2.0 HDi | 4 | RHR(DW10BTD4) | 100/134 | 11/10→ | CH268 | 11v | | | |
| 2.0 HDi | 4 | RHA(DW10CTED4); RHF(DW10BTD4) | 103/138 | 11/10→ | CH268 | 11v | | | |

605

| | | | | | | | | | |
|------------------|---|---------------------------------|---------|-------------|--------------------------|------|------|-------|--|
| 2.0 16V | 4 | RFV(XU10J4R) | 97/130 | 07/94→09/99 | OE034 *to be adjusted | 0,8* | CET2 | OE179 | BAEA256 →Prod.07.09.1997 →RP.07608 |
| 2.1 TD 12V | 4 | P8C(XUD11BTE); PHZ(XUD11ATE) | 80/107 | 08/94→09/99 | CH189 | 11v | | | CCU148 |
| 2.5 Turbo Diesel | 4 | THY(DKSATE) | 95/127 | 07/94→09/99 | CH189 | 11v | | | CCU149 ^[315] |
| 3.0 V6 | 6 | XFZ(ES9J4) | 140/188 | 04/97→09/99 | OE026 | 0,9 | CET2 | OE188 | |

607

| | | | | | | | | | |
|-------------|---|------------------------|---------|-------------|--|-----|--------|-------|--------------------------------------|
| 2.0 | 4 | RFN(EW10J4) | 100/134 | 02/00→08/05 | OE178 | 0,9 | CET5 | | BAEA348 05/00→ |
| 2.0 HDi | 4 | RHS(DW10ATED) | 79/106 | 03/01→09/04 | CH170 | 11v | | | CCU149 ^[359] →RP.09820 |
| 2.0 HDI | 4 | RHZ(DW10ATED) | 80/107 | 05/00→09/05 | CH170 | 11v | | | CCU149 ^[359] →RP.09820 |
| 2.0 HDI | 4 | RHR(DW10BTD4) | 100/134 | 09/05→07/11 | CH268 | 11v | | | |
| 2.2 16V | 4 | 3FZ(EW12J4) | 116/156 | 02/00→08/05 | OE178 | 0,9 | CET5 | | BAEA351 05/00→ |
| 2.2 16V | 4 | 3FY(EW12J4) | 120/161 | 09/05→06/10 | OE178 | 0,9 | CET5 | | BAEA351 |
| 2.2 HDi | 4 | 4HX(DW12TED4/FAP) | 98/131 | 02/00→02/06 | CH170 →RP.09666 CH268 RP.09667→ | 11v | | | CCU149 ^[359] |
| 2.7 HDi 24V | 6 | DT17TED4 | 150/201 | 12/04→07/11 | CH240 | 11v | | | |
| 3.0 V6 24V | 6 | XFX(ES9J4S) | 152/204 | 02/00→07/04 | OE175 | 1,0 | CET14P | OE190 | BAEA347 |
| 3.0 V6 24V | 6 | XFV(ES9A); XFX(ES9J4S) | 155/208 | 03/04→07/11 | OE175 | 1,0 | CET14P | OE190 | BAEA347 10/04→ |

806

| | | | | | | | | | |
|----------------------|---|----------------------------------|---------|-------------|-------|-----|------|-------|-------------------------|
| 1.8 | 4 | LFW(XU7JP) | 73/98 | 07/95→08/02 | OE034 | 0,9 | CET2 | OE179 | BAEA232 |
| 1.9 TD | 4 | DHX(XUD9TE) | 66/89 | 07/95→08/02 | CH189 | 11v | | | CCU149 ^[315] |
| 1.9 TD | 4 | DHY(XUD9TE) | 68/91 | 05/97→08/02 | CH189 | 11v | | | CCU149 ^[315] |
| 2.0 | 4 | RFU(XU10J2) | 89/119 | 06/94→08/02 | OE034 | 0,9 | CET2 | OE179 | BAEA232 |
| 2.0 16V | 4 | RFV(XU10J4R) | 97/130 | 05/98→09/00 | OE034 | 0,9 | CET2 | OE179 | BAEA232 |
| 2.0 16V | 4 | RFN(EW10J4) | 100/134 | 09/00→08/02 | OE178 | 0,9 | CET5 | | BAEA348 →05/02 |
| 2.0 HDI, 2.0 HDI 16V | 4 | RHW(DW10ATED4); RHZ(DW10ATED) | 80/107 | 08/99→08/02 | CH170 | 11v | | | CCU149 |
| 2.0 Turbo | 4 | RGX(XU10J2TE) | 108/145 | 06/94→08/02 | OE034 | 0,9 | CET2 | OE179 | BAEA232 |
| 2.1 td 12V | 4 | P8C(XUD11BTE) | 80/107 | 06/96→08/99 | CH189 | 11v | | | CLS005 |

807

| | | | | | | | | | |
|-----|---|-------------|---------|--------|-------|-----|------|--|---------|
| 2.0 | 4 | RFN(EW10J4) | 100/134 | 06/02→ | OE178 | 0,9 | CET5 | | BAEA348 |
|-----|---|-------------|---------|--------|-------|-----|------|--|---------|

PEUGEOT





kW/BHP



eon TITAN

IRIDIUM

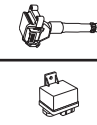

PEUGEOT

...PEUGEOT



| ...807 | | | | | | | | | |
|---------------------|---|--|---------|-------------|-----------------------------------|-----|---------------|--------------|--|
| 2.0 16V | 4 | RFJ(EW10A) | 103/138 | 09/05→ | OE178 | 0,9 | CET5 | | BAEA352 02/06→ |
| 2.0 HDi | 4 | RHM(DW10ATED4); RHT(DW10ATED4); RHW(DW10ATED4) | 79/106 | 06/02→ | CH170 →RP.09666 | 11v | | | CCU149 |
| | | | | | CH268 RP.09667→ | 11v | | | |
| 2.0 HDi | 4 | RHW(DW10ATED4) | 80/107 | 04/04→ | CH170 →RP.09666 | 11v | | | CCU149 |
| | | | | | CH268 RP.09667→ | 11v | | | |
| 2.0 HDi | 4 | RHK(DW10ATED4) | 88/118 | 02/06→ | CH268 | 11v | | | |
| 2.0 HDI | 4 | RHD(DW10ATED4); RHR(DW10ATED4) | 100/134 | 06/06→ | CH268 | 11v | | | |
| 2.2 | 4 | 3FZ(EW12J4) | 116/156 | 06/02→ | OE178 | 0,9 | CET5 | | BAEA351 |
| 2.2 HDi | 4 | 4HW(DW12ATED4); 4HW(DW12ATED4) | 94/126 | 06/02→ | CH170 →RP.09666 | 11v | | | CCU149 |
| | | | | | CH268 RP.09667→ | 11v | | | |
| 3.0 V6 | 6 | XFX(ES9J4S) | 150/201 | 06/02→ | OE175 | 1,0 | CET14P | OE190 | BAEA347 |
| 1007 | | | | | | | | | |
| 1.4 | 4 | KFV(TU3A); KFV(TU3JP) | 54/72 | 04/05→ | OE034 | 0,9 | CET2 | OE179 | BAEA048E ^[7] 09/05→ BAE946A ^[10] |
| 1.4 16V | 4 | KFU(ET3J4) | 65/87 | 10/05→ | OE130 | 0,9 | CET4 | | BAEA472 |
| 1.4 HDi | 4 | 8HX(DV4TD); 8HZ(DV4TD) | 50/67 | 04/05→ | CH201 | 11v | | | CCU149 ^[318] |
| 1.6 16V | 4 | NFU(TU5JP4) | 80/107 | 04/05→ | OE035 | 0,9 | CET5 | OE190 | BAEA045E |
| | | | | | OE224 LPG ^[279] | 0,8 | | | |
| 1.6 HDi | 4 | 9HZ(DV6TED4) | 80/107 | 06/07→ | CH201 | 11v | | | CCU147 |
| 2008 | | | | | | | | | |
| 1.2 THP 110 | 3 | HNZ(EB2DT) | 81/109 | 01/15→ | | | | | BAEA557 |
| 1.2 THP 130 | 3 | HNY(EB2DTS) | 96/129 | 01/15→ | | | | | BAEA557 |
| 1.2 VTi | 3 | HMZ(EB2F) | 60/80 | 03/13→ | | | | OE263 | |
| 1.6 VTi | 4 | 5FS(EP6C) | 88/118 | 03/13→ | OE205 | 0,7 | CET16P | | BAEA143 |
| 3008 | | | | | | | | | |
| 1.2 | 3 | HNY(EB2DTS) | 96/129 | 01/15→ | | | | | BAEA557 |
| 1.6 HDi | 4 | 9HZ(DV6TED4) | 80/107 | 06/09→ | CH201 | 11v | | | CCU147 |
| 1.6 THP | 4 | 5FE(EP6CDTM); 5FE(EP6CDTMD); 5FX(EP6DT) | 110/148 | 06/09→ | OE205 | 0,7 | CET16P | | BAEA143 |
| 1.6 THP | 4 | 5FV(EP6CDT) | 115/154 | 06/09→ | OE205 | 0,7 | CET16P | | BAEA143 |
| 1.6 VTi | 4 | 5FS(EP6C); 5FW(EP6); EP6 | 88/118 | 06/09→ | OE205 | 0,7 | CET16P | | BAEA143 |
| 4007 | | | | | | | | | |
| 2.0, 2.0 4WD | 4 | 4B11 | 108/145 | 11/10→ | | | CET12P | OE182 | |
| 2.4 16V 4WD | 4 | SFY(4B12-MMC); SFZ(4B12-MMC) | 125/168 | 01/08→ | | | CET12P | OE180 | |
| 5008 | | | | | | | | | |
| 1.2 | 3 | HNY(EB2DTS) | 96/129 | 01/15→ | | | | | BAEA557 |
| 1.6 16V | 4 | 5FS(EP6C); 5FW(EP6); EP6 | 88/118 | 09/09→ | OE205 | 0,7 | CET16P | | BAEA143 |
| 1.6 16V | 4 | 5FV(EP6CDT) | 115/154 | 09/09→ | OE205 | 0,7 | CET16P | | BAEA143 |
| 1.6 HDi | 4 | 9HZ(DV6TED4) | 80/107 | 09/09→ | CH201 | 11v | | | CCU147 |
| BIPPER Tepee | | | | | | | | | |
| 1.4 | 4 | KFV(TU3A) | 54/72 | 04/08→ | OE034 | 0,9 | CET2 | OE179 | BAEA048E ^[7] |
| 1.4 HDi | 4 | 8HS(DV4TED) | 50/67 | 04/08→ | CH201 | 11v | | | |
| EXPERT | | | | | | | | | |
| 1.6 | 4 | 222A2(1580SPI) | 58/78 | 02/96→09/00 | OE014 | 0,9 | CET2 | OE179 | BAEA234 |
| 1.8 | 4 | LFZ(XU7JP) | 74/99 | 10/96→09/00 | OE034 | 0,9 | CET2 | OE179 | BAEA232 |





kW/BHP



eon TITAN

IRIDIUM

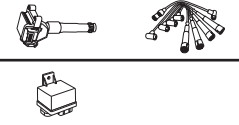

...PEUGEOT



...EXPERT

| | | | | | | | | | |
|----------------------|---|---|---------|-------------|--------------------|-----|------|--------------------------------------|---------|
| 1.9 D | 4 | WJZ(DW8) | 51/68 | 02/96→12/06 | CH185 | 11v | | | |
| 1.9 D | 4 | WJY(DW8B) | 51/68 | 02/96→12/06 | CH185 | 11v | | CCU149 | |
| 1.9 D | 4 | D9B(XUD9AU) | 51/68 | 02/96→12/06 | CH189 | 11v | | | |
| 1.9 TD | 4 | DHX(XUD9TE) | 66/89 | 02/96→09/00 | CH189 | 11v | | CCU149 ^[315] →RP.07846 | |
| 1.9 TD | 4 | D8B(XUD9TE) | 68/91 | 02/96→05/98 | CH189 | 11v | | CCU149 ^[315] →RP.07846 | |
| 2.0 | 4 | RFN(EW10J4) | 100/134 | 07/00→12/06 | OE178 | 0,9 | CET5 | | BAEA348 |
| 2.0 HDi | 4 | RHX(DW10BTD) | 69/93 | 10/00→10/06 | CH170 | 11v | | CCU149 | |
| 2.0 HDi, 2.0 HDi 16V | 4 | RHW(DW10ATED4); RHZ(DW10ATED); RHZ(DW10BTD); RHZ(DW10BTD+); RHZ(DW10CTED) | 80/107 | 07/00→12/06 | CH170 →RP.09666 | 11v | | CCU149 | |
| | | | | | CH268 RP.09667→ | 11v | | | |

EXPERT Tepee

| | | | | | | | | | |
|------------------------------|---|------------------------|---------|--------|-------|-----|------|--------|---------|
| 1.6 HDi 90 16V | 4 | 9HU(DV6UTED4) | 66/89 | 01/07→ | CH201 | 11v | | | |
| 2.0 16V | 4 | RFH(EW10A); RFJ(EW10A) | 103/138 | 01/07→ | OE178 | 0,9 | CET5 | | BAEA352 |
| 2.0 HDi 120, 2.0 HDi 120 4WD | 4 | RHK(DW10UTED4) | 88/118 | 01/07→ | CH268 | 11v | | | |
| 2.0 HDi 140 | 4 | RHR(DW10BTD4) | 100/134 | 01/07→ | CH268 | 11v | | CCU149 | |

PARTNER

| | | | | | | | | | | |
|----------------------|---|-----------------------------|--------|-------------|-------------------------------------|------------|------|-------|-----------------------------------|--------|
| 1.1 | 4 | HDZ(TU1M); HFX(TU1JP) | 44/59 | 06/96→10/02 | OE034 | 0,9 | CET2 | OE179 | BAEA232 | CLS262 |
| 1.4 | 4 | KFW(TU3JP) | 54/72 | 11/02→10/06 | OE034 | 0,9 | CET2 | OE179 | BAE946A ^[10] | |
| 1.4 | 4 | KFW(TU3A); KFX(TU3JP); TU32 | 55/74 | 06/96→12/15 | OE034 | 0,9 | CET2 | OE179 | BAEA048E ^[7] 09/05→ | CLS262 |
| 1.4 | 4 | KFW(TU3JP) | 55/74 | 06/96→12/15 | OE034 | 0,9 | CET2 | OE179 | BAEA048E ^[7] 09/05→ | CLS262 |
| | | | | | | | | | BAE946A ^[10] | |
| 1.6 16V | 4 | NFU(TU5JP4) | 80/107 | 07/01→03/08 | OE035 OE224 ^{LPG [279]} | 0,9 0,8 | CET5 | OE190 | BAEA045E | |
| 1.6 HDi 75 | 4 | 9HW(DV6BTED4) | 55/74 | 02/06→12/13 | CH201 | 11v | | | | |
| 1.6 HDi 90 | 4 | 9HX(DV6ATED4) | 66/89 | 10/05→12/15 | CH201 RP.10784→ | 11v | | | | |
| 1.8 | 4 | LFX(XU7JB) | 66/89 | 05/97→12/03 | OE034 | 0,9 | CET2 | OE179 | BAEA232 | CLS123 |
| 1.9 D | 4 | DJY(XUD9A) | 50/67 | 06/96→12/02 | CH189 | 11v | | | | |
| 1.9 D | 4 | WJZ(DW8) | 51/68 | 05/96→07/08 | CH185 | 11v | | | | |
| 1.9 D | 4 | XUD9 | 51/68 | 05/96→07/08 | CH189 | 11v | | | | |
| 1.9 D, 1.9 D 4WD | 4 | WJY(DW8B) | 51/68 | 05/96→07/08 | CH185 | 11v | | | CCU149 ^[318] | |
| 2.0 HDi, 2.0 HDi 4WD | 4 | RHY(DW10TD) | 66/89 | 02/00→07/08 | CH170 | 11v | | | CCU149 ^[359] | |

PARTNER Tepee

| | | | | | | | | | | |
|-------------|---|----------------------------------|--------|--------|--------------------|-----|--------|-------|----------|--|
| 1.6 | 4 | NFR(TU5JP4B) | 66/89 | 04/08→ | OE035 | 0,9 | CET5 | OE190 | BAEA045E | |
| 1.6 | 4 | 5FK(EP6CB) | 72/97 | 08/10→ | OE205 | 0,7 | CET16P | | BAEA143 | |
| 1.6 | 4 | NFU(TU5JP4) | 80/107 | 04/08→ | OE035 | 0,9 | CET5 | OE190 | BAEA045E | |
| 1.6 | 4 | NFU(TU5JP4) | 81/109 | 09/08→ | OE035 | 0,9 | CET5 | | BAEA045E | |
| 1.6 | 4 | 5FS(EP6C) | 88/118 | 04/10→ | OE205 | 0,7 | CET16P | | BAEA143 | |
| 1.6 HDi | 4 | | 55/74 | 04/08→ | CH201 RP.10784→ | 11v | | | | |
| 1.6 HDi | 4 | 9HZ(DV6TED4) | 80/107 | 04/08→ | CH201 | 11v | | | CCU147 | |
| 1.6 HDi 16V | 4 | 9HV(DV6TED4B); 9HV(DV6TED4BU) | 66/89 | 04/08→ | CH201 | 11v | | | | |

RCZ

| | | | | | | | | | | |
|---------|---|-------------|---------|--------|-------|-----|--------|--|---------|--|
| 1.6 16V | 4 | 5FV(EP6CDT) | 115/154 | 03/10→ | OE205 | 0,7 | CET16P | | BAEA143 | |
| 1.6 16V | 4 | EP6CDTX | 147/197 | 06/10→ | OE205 | 0,7 | | | BAEA143 | |

PEUGEOT





kW/BHP

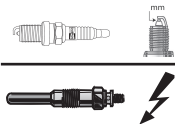

eon TITAN

IRIDIUM



PEUGEOT



106 Van

| | | | | | | | | | |
|-------|---|-----------|-------|---------------|-------|-----|--|--|--|
| 1.5 D | 4 | VJY(TUD5) | 40/54 | 05/96 → 03/01 | CH185 | 11v | | | |
| 1.5 D | 4 | VJX(TUD5) | 42/56 | 10/00 → 03/01 | CH185 | 11v | | | |

205

| | | | | | | | | | |
|------------|---|------------|-------|---------------|-------|-----|--|--|--|
| 1.7 Diesel | 4 | 161A(XUD7) | 44/59 | 03/94 → 05/97 | CH189 | 11v | | | |
|------------|---|------------|-------|---------------|-------|-----|--|--|--|

206 Van

| | | | | | | | | | |
|---------|---|------------------------|-------|---------------|---------------------|-----|--|--|-------------------------|
| 1.4 HDi | 4 | 8HX(DV4TD); 8HZ(DV4TD) | 50/67 | 09/01 → 03/09 | CH201 RP.10444 → | 11v | | | CCU149 ^[359] |
| 1.9 D | 4 | WJY(DW8B); WJZ(DW8) | 51/68 | 04/99 → 05/07 | CH185 | 11v | | | CCU149 ^[315] |

207

| | | | | | | | | | |
|---------|---|-----------------------------|-------|---------------|-------|-----|--|--|--------|
| 1.4 HDi | 4 | 8HZ(DV4TD) | 50/67 | 04/07 → | CH201 | 11v | | | CCU147 |
| 1.6 HDi | 4 | 9HV(DV6TED4); 9HX(DV6ATED4) | 66/89 | 04/07 → 10/12 | CH201 | 11v | | | |

306

| | | | | | | | | | |
|---------|---|------------|-------|---------------|-------|-----|--|--|--|
| 1.4 | 4 | KFW(TU3JP) | 55/74 | 03/96 → 07/01 | | | | | BAEA232 ^[275] → 06/98 |
| 1.9 D | 4 | XUD9TE | 69/93 | 02/94 → 04/99 | CH189 | 11v | | | CCU148 ^[61] → Prod.01.06.1994 CCU148 ^[49] → Prod.01.06.1995 |
| 1.9 STD | 4 | XUD9 | 51/68 | 02/94 → 05/99 | CH189 | 11v | | | |

BIPPER

| | | | | | | | | | |
|---------|---|-------------|-------|---------|-------|-----|------|-------|-------------------------|
| 1.4 | 4 | KFV(TU3A) | 54/72 | 02/08 → | OE034 | 0,9 | CET2 | OE179 | BAEA048E ^[7] |
| 1.4 HDi | 4 | 8HS(DV4TED) | 50/67 | 02/08 → | CH201 | 11v | | | |

BOXER

| | | | | | | | | | |
|-------------------------------|---|----------------------|---------|---------------|--|-------|------|-------|----------------|
| 1.9 D | 4 | DJY(XUD9A) | 50/67 | 07/99 → 04/02 | CH189 | 11v | | | |
| 1.9 D | 4 | D9B(XUD9AU) | 51/68 | 03/94 → 04/02 | CH189 | 11v | | | |
| 1.9 DT 4WD, 1.9 TD | 4 | XUD9TE | 66/89 | 06/94 → 04/02 | CH189 | 11v | | | |
| 1.9 TD | 4 | DHY(XUD9TE) | 66/89 | 06/94 → 04/02 | CH189 | 11v | | | |
| 1.9 TD, 1.9 TD 4WD | 4 | D8C(XUD9UTF); XUD9TE | 68/91 | 03/94 → 04/02 | CH189 | 11v | | | |
| 2.0 | 4 | RFL(XU10J2U) | 81/109 | 12/01 → | OE034 | 0,9 | CET2 | OE179 | BAEA232 CLS123 |
| 2.0 4WD | 4 | RFW(XU10J2) | 80/107 | 03/96 → 09/98 | OE034 | 0,9 | CET2 | | CLS123 |
| 2.0 HDi | 4 | RHV(DW10TD) | 62/83 | 04/02 → | CH170 | 11v | | | CCU149 |
| 2.0 HDi, 2.0 HDi | 4 | RHV(DW10UTD) | 62/83 | 08/01 → | CH170 | 11v | | | |
| 2.0 i, 2.0 i 4WD | 4 | RFW(XU10J2) | 80/107 | 03/94 → 04/02 | OE034 | 0,9 | CET2 | OE179 | BAEA232 CLS123 |
| 2.2 HDi | 4 | 4HY(DW12UTED) | 74/99 | 04/02 → | CH170 ^[134] → 04/03 CH268 ^[136] 05/03 → | 11v | | | CCU149 |
| 2.2 HDi 100 | 4 | 4HV(P22DTE) | 74/99 | 04/06 → | CH229 | 11.5v | | | |
| 2.2 HDi 120 | 4 | 4HU(P22DTE) | 88/118 | 04/06 → | CH229 | 11.5v | | | |
| 2.5 D, 2.5 D 4WD | 4 | T9A(DJ5) | 63/84 | 03/94 → 04/02 | CH189 | 11v | | | |
| 2.5 TD, 2.5 TD 4WD | 4 | T8A(DJ5T) | 76/102 | 03/94 → 04/02 | CH189 | 11v | | | |
| 2.8 D | 4 | 8140.63(F28D) | 64/86 | 01/99 → 02/02 | CH216 | 11v | | | |
| 2.8 HDi | 4 | 8140.43N | 107/143 | 04/04 → | CH216 | 11v | | | CCU149 |
| 2.8 HDi, 2.8 HDi, 2.8 HDi 4WD | 4 | 8140.43S(F28DTCR) | 94/126 | 10/00 → | CH216 | 11v | | | CCU149 |
| 2.8 HDi, 2.8 HDi 4WD | 4 | 8140.43S(F28DTCR) | 93/125 | 10/00 → 09/09 | CH216 | 11v | | | CCU149 |
| 3.0 HDi | 4 | F1CE0481D(F30DT) | 115/154 | 07/06 → | CH270 | 11v | | | |
| 3.0 HDi 145 | 4 | F1CE3481N(F30DTE) | 107/143 | 04/10 → | CH270 | 11v | | | |
| 3.0 HDi 160 | 4 | F1CE0481D(F30DT) | 116/156 | 04/06 → | CH270 | 11v | | | |
| 3.0 HDi 175 | 4 | F1CE3481E(F30DTE) | 130/174 | 03/11 → | CH270 | 11v | | | |

EXPERT

| | | | | | | | | | |
|----------------|---|----------------|-------|---------------|-------|-----|------|-------|---------|
| 1.6 | 4 | 222A2(1580SPI) | 58/78 | 02/96 → 09/00 | OE014 | 0,9 | CET2 | OE179 | BAEA234 |
| 1.6 HDi 90 16V | 4 | 9HU(DV6UTED4) | 66/89 | 01/07 → | CH201 | 11v | | | |
| 1.8 | 4 | LFZ(XU7JP) | 74/99 | 10/96 → 09/00 | OE034 | 0,9 | CET2 | OE179 | BAEA232 |

PEUGEOT





kW/BHP



eon TITAN

IRIDIUM



...PEUGEOT



...EXPERT

| | | | | | | | | | |
|------------------------------|---|---|---------|-------------|--------------------|-----|------|--|--------------------------------------|
| 1.9 D | 4 | D9B(XUD9AU) | 51/68 | 02/96→09/01 | CH189 | 11v | | | |
| 1.9 D, 1.9 D 70 | 4 | WJZ(DW8) | 51/68 | 02/96→12/06 | CH185 | 11v | | | |
| 1.9 D, 1.9 D 70 | 4 | WJY(DW8B) | 51/68 | 02/96→12/06 | CH185 | 11v | | | CCU149 |
| 1.9 TD | 4 | DHX(XUD9TE) | 66/89 | 02/96→09/00 | CH189 | 11v | | | CCU149 ^[315] →RP.07846 |
| 1.9 TD | 4 | D8B(XUD9TE) | 68/91 | 02/96→05/98 | CH189 | 11v | | | CCU149 ^[315] →RP.07846 |
| 2.0 | 4 | RFN(EW10J4) | 100/134 | 09/02→12/06 | OE178 | 0,9 | CET5 | | BAEA348 |
| 2.0 16V | 4 | RFH(EW10A); RFJ(EW10A) | 103/138 | 01/07→ | OE178 | 0,9 | CET5 | | BAEA352 |
| 2.0 HDI | 4 | RHX(DW10BTD) | 69/93 | 07/00→12/06 | CH170 | 11v | | | CCU149 |
| 2.0 HDI, 2.0 HDi | 4 | RHW(DW10ATED4); RHZ(DW10ATED); RHZ(DW10BTD); RHZ(DW10BTD+); RHZ(DW10CTED) | 80/107 | 07/00→12/06 | CH170 →RP.09666 | 11v | | | CCU149 |
| | | | | | CH268 RP.09667→ | 11v | | | |
| 2.0 HDi 120, 2.0 HDi 120 4WD | 4 | RHK(DW10UTED4) | 88/118 | 01/07→ | CH268 | 11v | | | |
| 2.0 HDi 140 | 4 | RHR(DW10BTD4) | 100/134 | 01/07→ | CH268 | 11v | | | CCU149 |

PARTNER

| | | | | | | | | | | |
|--|---|-----------------------------------|--------|-------------|--------------------|-----|--------|-------|------------------------------------|--------|
| 1.1 | 4 | HDZ(TU1M) | 44/59 | 06/96→09/05 | OE034 | 0,9 | CET2 | OE179 | BAE946A ^[10] BAEA232 | CLS262 |
| 1.4 | 4 | KFV(TU3A) | 54/72 | 11/02→10/06 | OE034 | 0,9 | CET2 | OE179 | BAEA048E ^[7] | |
| 1.4 | 4 | KFX(TU3JP); TU32 | 55/74 | 06/96→12/15 | OE034 | 0,9 | CET2 | OE179 | | CLS262 |
| 1.4 BiFuel | 4 | KFW(TU3JP) | 55/74 | 04/03→10/06 | OE034 | 0,9 | CET2 | OE179 | BAE946A ^[10] | |
| 1.6 | 4 | NFR(TU5JP4B) | 66/89 | 04/08→ | OE035 | 0,9 | CET5 | OE190 | BAEA045E | |
| 1.6 | 4 | 5FK(EP6CB) | 72/97 | 11/10→ | OE205 | 0,7 | CET16P | | BAEA143 | |
| 1.6 | 4 | NFU(TU5JP4) | 80/107 | 09/00→ | OE035 | 0,9 | CET5 | | BAEA045E | |
| 1.6 | 4 | 5FS(EP6C) | 88/118 | 04/10→ | OE205 | 0,7 | CET16P | | BAEA143 | |
| 1.6 HDi | 4 | 9HT(DV6BTD4); 9HW(DV6BTD4) | 55/74 | 04/08→ | CH201 RP.10784→ | 11v | | | | |
| 1.6 HDi | 4 | 9HZ(DV6TED4) | 80/107 | 04/08→ | CH201 | 11v | | | CCU147 | |
| 1.6 HDi 16V | 4 | 9HS(DV6TED4BU); 9HX(DV6AUTED4) | 66/89 | 04/08→ | CH201 RP.10784→ | 11v | | | CCU147 | |
| 1.6 HDi 16V, 1.6 HDi 16V 4WD, 1.6 HDi 90 | 4 | 9HS(DV6TED4BU); 9HX(DV6ATED4) | 66/89 | 02/06→ | CH201 RP.10784→ | 11v | | | | |
| 1.6 HDi 75 | 4 | 9HW(DV6BTD4) | 55/74 | 08/05→07/08 | CH201 | 11v | | | | |
| 1.8 | 4 | LFX(XU7JB) | 66/89 | 03/97→08/00 | OE034 | 0,9 | CET2 | OE179 | | |
| 1.8 D | 4 | A9A(XUD7) | 43/58 | 06/96→12/02 | CH189 | 11v | | | | |
| 1.8 D | 4 | A9A(XUD7) | 44/59 | 11/96→02/98 | CH189 | 11v | | | | |
| 1.9 D | 4 | DJY(XUD9A) | 50/67 | 05/96→12/98 | CH189 | 11v | | | | |
| 1.9 D | 4 | WJZ(DW8) | 51/68 | 06/96→12/15 | CH185 | 11v | | | | |
| 1.9 D | 4 | DJY(XUD9A) | 51/68 | 06/96→12/15 | CH189 | 11v | | | | |
| 1.9 D, 1.9 D 4WD | 4 | WJY(DW8B) | 51/68 | 06/96→12/15 | CH185 | 11v | | | CCU149 ^[318] | |
| 2.0 HDi, 2.0 HDi 4WD | 4 | RHY(DW10TD) | 66/89 | 04/00→07/08 | CH170 | 11v | | | CCU149 ^[359] | |

PIAGGIO



PORTER

| | | | | | | | | | | |
|-------|---|----------|-------|-------------|----------------|------------|------|-------|--|--|
| 1.0 | 3 | CB41 | 33/44 | 02/93→06/04 | OE004 | 0,9 | CET8 | OE195 | | |
| 1.0 | 3 | CB42 | 35/47 | 07/94→ | OE004 OE006 | 0,9 0,9 | CET8 | OE195 | | |
| 1.2 D | 2 | | 47/63 | 01/11→ | CH229 | 11.5v | | | | |
| 1.2 D | 4 | LDW1204 | 26/35 | 05/95→ | CH189 | 11v | | | | |
| 1.3 | 4 | DA471QLR | 52/70 | 01/11→ | OE199 | 0,9 | | | | |
| 1.3 | 4 | DA471QLR | 53/71 | 01/11→ | OE199 | 0,9 | | | | |

PIAGGIO





kW/BHP

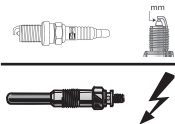

eon TITAN

IRIDIUM

**...PIAGGIO****...PORTER**

| | | | | | | | | | |
|---------------------------------|---|--------|-------|--------|-------|-----|------|-------|--|
| 1.3 16V, 1.3 16V 4WD, 1.3 i 16V | 4 | ; HCEL | 48/64 | 05/98→ | | | CET2 | OE188 | |
| 1.3 i 16V 4WD | 4 | | 48/64 | 05/98→ | OE120 | 0,6 | CET2 | OE188 | |

PLYMOUTH**BREEZE**

| | | | | | | | | | |
|---------|---|-----|--------|-------------|-------|-----|------|-------|--|
| 2.0 16V | 4 | ECB | 98/131 | 12/95→04/01 | OE002 | 0,9 | CET2 | OE179 | |
|---------|---|-----|--------|-------------|-------|-----|------|-------|--|

VOYAGER / GRAND VOYAGER

| | | | | | | | | | |
|----------------------|---|-----|---------|-------------|-----------------|-----|--|--|--|
| 2.5 TD | 4 | ENC | 85/114 | 01/95→03/01 | CH181 05/95→ | 11v | | | |
| 3.3 Flex-Fuel, 3.3 i | 6 | EGM | 116/156 | 01/95→03/01 | OE105 | 1,3 | | | |
| 3.8 i, 3.8 i 4WD | 6 | EGH | 122/164 | 01/95→03/01 | OE105 | 1,3 | | | |
| 3.8 i, 3.8 i 4WD | 6 | EGH | 131/176 | 01/95→03/01 | OE105 | 1,3 | | | |

PONTIAC**TRANS SPORT**

| | | | | | | | | | |
|-----|---|-----|---------|-------------|-------|-----|------|-------|--|
| 2.3 | 4 | LGO | 101/135 | 01/93→03/97 | OE005 | 0,9 | CET2 | OE180 | |
| 2.3 | 4 | LGO | 108/145 | 01/93→03/97 | OE005 | 0,9 | CET2 | OE180 | |

PORSCHE**911 (964)**

| | | | | | | | | | |
|-----------|---|--------|---------|-------------|-------|-----|------|-------|--|
| 3.6 Turbo | 6 | M64.50 | 265/355 | 01/93→09/93 | OE216 | 0,8 | CET2 | OE188 | |
|-----------|---|--------|---------|-------------|-------|-----|------|-------|--|

911 /Convertible (991)

| | | | | | | | | | |
|-----------------------------------|---|----------------|---------|--------|-------|-----|--|--|---------------------------|
| 3.8 Carrera 4S 4WD, 3.8 Carrera S | 6 | MA1.03; MAB.03 | 294/394 | 12/11→ | | | | | BAEA052E ^[277] |
| 3.8 Turbo 4WD | 6 | MA1.71 | 383/514 | 09/13→ | OE210 | 0,8 | | | |
| 3.8 Turbo S 4WD | 6 | MA1.71 | 412/552 | 09/13→ | OE210 | 0,8 | | | |

911 (993)

| | | | | | | | | | |
|----------------------------------|---|------------------|---------|-------------|-------|-----|------|-------|--------|
| 3.6 Carrera | 6 | M64.21; M64.22 | 210/282 | 08/95→09/97 | OE216 | 0,8 | CET2 | OE188 | CLS251 |
| 3.6 Carrera | 6 | M64.23; M64.24 | 210/282 | 08/95→09/97 | | | CET2 | OE188 | CLS251 |
| 3.6 Turbo 4WD | 6 | M64.60 | 300/402 | 03/95→09/97 | OE216 | 0,8 | CET2 | OE188 | CLS251 |
| 3.6 Turbo GT2, 3.6 Turbo GT2 4WD | 6 | M64.60R | 316/424 | 03/95→09/97 | OE216 | 0,8 | CET2 | OE188 | |
| 3.6 Turbo GT2 4WD | 6 | M64.60RS | 331/444 | 06/97→09/97 | OE026 | 0,9 | CET2 | OE188 | |
| 3.8 Carrera, 3.8 Carrera 4WD | 6 | M64.05S; M64.06S | 210/282 | 06/95→09/97 | OE216 | 0,8 | CET2 | | |
| 3.8 Carrera RS | 6 | M64.20 | 221/296 | 06/95→09/97 | OE094 | 0,9 | CET2 | | CLS251 |

911 /Convertible (993)

| | | | | | | | | | |
|------------------------------|---|------------------|---------|-------------|-------|-----|------|--|--|
| 3.8 Carrera, 3.8 Carrera 4WD | 6 | M64.05S; M64.06S | 210/282 | 06/95→09/97 | OE094 | 0,9 | CET2 | | |
| 3.8 Carrera, 3.8 Carrera 4WD | 6 | M64.21S | 221/296 | 08/95→09/97 | OE094 | 0,9 | CET2 | | |

911 /Convertible/Targa (993)

| | | | | | | | | | |
|------------------------------|---|--------------------------------|---------|-------------|-------|-----|------|-------|--------|
| 3.6 Carrera, 3.6 Carrera 4WD | 6 | M64.05; M64.06; M64.07; M64.08 | 200/268 | 10/93→08/95 | OE026 | 0,9 | CET2 | OE188 | CLS251 |
| 3.6 Carrera, 3.6 Carrera 4WD | 6 | M64.21; M64.22; M64.23; M64.24 | 210/282 | 08/95→09/97 | OE026 | 0,9 | CET2 | OE188 | CLS251 |

911 Targa (993)

| | | | | | | | | | |
|-------------|---|---------|---------|-------------|--|--|------|-------|--|
| 3.8 Carrera | 6 | M64.21S | 221/296 | 05/96→09/97 | | | CET2 | OE179 | |
|-------------|---|---------|---------|-------------|--|--|------|-------|--|

911 /Convertible (996)

| | | | | | | | | | |
|------------------------------|---|------------------------|---------|-------------|-------|-----|------|-------|--|
| 3.4 Carrera, 3.4 Carrera 4WD | 6 | M96.01; M96.02; M96.04 | 221/296 | 09/97→09/01 | OE218 | 1,6 | CET2 | OE188 | |
| 3.4 Carrera, 3.4 Carrera 4WD | 6 | M96.02 | 235/315 | 05/01→08/05 | OE218 | 1,6 | CET2 | OE188 | |
| 3.6 3.6 Turbo 4S 4WD, 3.6 S | 6 | M96.70 | 331/444 | 02/03→08/05 | OE216 | 0,8 | CET2 | OE179 | |
| 3.6 3.6 Turbo 4WD | 6 | M96.70 | 309/414 | 06/00→08/05 | OE216 | 0,8 | CET2 | OE188 | |
| 3.6 GT2 | 6 | M96.70 | 340/456 | 04/01→08/05 | OE216 | 0,8 | CET2 | OE188 | |
| 3.6 GT2 | 6 | M96.70 | 355/476 | 10/03→08/05 | OE216 | 0,8 | CET2 | OE188 | |
| 3.6 GT3 | 6 | M96.76 | 265/355 | 03/99→08/05 | OE216 | 0,8 | CET2 | OE188 | |



kW/BHP



eon TITAN

IRIDIUM



...PORSCHE



...911 /Convertible (996)

| | | | | | | | | |
|---------|---|--------|---------|-------------|--------------|-----|-------------|--------------|
| 3.6 GT3 | 6 | M96.79 | 280/375 | 03/03→08/05 | OE216 | 0,8 | CET2 | OE188 |
|---------|---|--------|---------|-------------|--------------|-----|-------------|--------------|

911 /Convertible/Targa (996)

| | | | | | | | | |
|-------------------------------------|---|--------|---------|-------------|--------------|-----|--|--|
| 3.6, 3.6 Carrera, 3.6 Carrera 4 4WD | 6 | M96.03 | 235/315 | 10/01→08/05 | OE257 | 0,5 | | |
|-------------------------------------|---|--------|---------|-------------|--------------|-----|--|--|

| | | | | | | | | |
|-----------------------------------|---|--------|---------|-------------|--------------|-----|--|--|
| 3.6 Carrera 4S 4WD, 3.6 Carrera S | 6 | M96.03 | 254/341 | 06/02→08/05 | OE257 | 0,5 | | |
|-----------------------------------|---|--------|---------|-------------|--------------|-----|--|--|

911 (997)

| | | | | | | | | |
|---------|---|--------|---------|-------------|--------------|-----|---------------|--|
| 3.6 GT3 | 6 | M97.76 | 305/409 | 03/06→12/09 | OE222 | 0,8 | CET11P | BAEA052E ^[277] ModelYear2009→ |
|---------|---|--------|---------|-------------|--------------|-----|---------------|--|

| | | | | | | | | |
|---------|---|--------|---------|-------------|--------------|-----|---------------|----------------------------------|
| 3.8 GT3 | 6 | M97.77 | 320/429 | 05/09→12/11 | OE222 | 0,8 | CET11P | BAEA052E ^[277] |
|---------|---|--------|---------|-------------|--------------|-----|---------------|----------------------------------|

| | | | | | | | | |
|------------|---|---------|---------|-------------|--------------|-----|---------------|----------------------------------|
| 3.8 GT3 RS | 6 | M97.77R | 331/444 | 08/09→12/11 | OE222 | 0,8 | CET11P | BAEA052E ^[277] |
|------------|---|---------|---------|-------------|--------------|-----|---------------|----------------------------------|

| | | | | | | | | |
|------------|---|--------|---------|-------------|--------------|-----|---------------|----------------------------------|
| 4.0 GT3 RS | 6 | M97.74 | 368/493 | 07/11→12/12 | OE222 | 0,8 | CET11P | BAEA052E ^[277] |
|------------|---|--------|---------|-------------|--------------|-----|---------------|----------------------------------|

911 /Convertible (997)

| | | | | | | | | |
|----------|---|---------|---------|-------------|--------------|-----|---------------|--|
| 3.6 GT 2 | 6 | M97.70S | 390/523 | 09/07→12/12 | OE222 | 0,8 | CET11P | |
|----------|---|---------|---------|-------------|--------------|-----|---------------|--|

| | | | | | | | | |
|------------|---|--------|---------|-------------|--------------|-----|---------------|--|
| 3.6 GT2 RS | 6 | M97.70 | 456/611 | 05/10→12/12 | OE222 | 0,8 | CET11P | |
|------------|---|--------|---------|-------------|--------------|-----|---------------|--|

| | | | | | | | | |
|---------------|---|--------|---------|-------------|--------------|-----|---------------|--|
| 3.6 Turbo 4WD | 6 | M97.70 | 353/473 | 03/06→12/09 | OE222 | 0,8 | CET11P | |
|---------------|---|--------|---------|-------------|--------------|-----|---------------|--|

| | | | | | | | | |
|---------------|---|--------|---------|-------------|--------------|-----|--|----------------------------------|
| 3.8 Turbo 4WD | 6 | MA1.70 | 368/493 | 09/09→12/12 | OE210 | 0,8 | | BAEA052E ^[277] |
|---------------|---|--------|---------|-------------|--------------|-----|--|----------------------------------|

| | | | | | | | | |
|---------------|---|--------|---------|-------------|--------------|-----|--|----------------------------------|
| 3.8 Turbo 4WD | 6 | MA1.70 | 373/500 | 09/10→12/11 | OE210 | 0,8 | | BAEA052E ^[277] |
|---------------|---|--------|---------|-------------|--------------|-----|--|----------------------------------|

| | | | | | | | | |
|-----------------|---|--------|---------|-------------|--------------|-----|--|----------------------------------|
| 3.8 Turbo S 4WD | 6 | MA1.70 | 390/523 | 02/10→12/12 | OE210 | 0,8 | | BAEA052E ^[277] |
|-----------------|---|--------|---------|-------------|--------------|-----|--|----------------------------------|

| | | | | | | | | |
|-----------------|---|--------|---------|-------------|--------------|-----|--|----------------------------------|
| 3.8 Turbo S 4WD | 6 | MA1.70 | 395/530 | 09/10→12/11 | OE210 | 0,8 | | BAEA052E ^[277] |
|-----------------|---|--------|---------|-------------|--------------|-----|--|----------------------------------|

911 /Convertible/Targa (997)

| | | | | | | | | |
|-------------|---|--------|---------|-------------|--------------|-----|--|--|
| 3.6 Carrera | 6 | M96.05 | 235/315 | 08/04→07/05 | OE257 | 0,5 | | |
|-------------|---|--------|---------|-------------|--------------|-----|--|--|

| | | | | | | | | |
|------------------------------|---|--------|---------|-------------|--------------|-----|--|--|
| 3.6 Carrera, 3.6 Carrera 4WD | 6 | M96.05 | 239/320 | 07/04→12/08 | OE257 | 0,5 | | |
|------------------------------|---|--------|---------|-------------|--------------|-----|--|--|

| | | | | | | | | |
|------------------------------|---|--------|---------|-------------|--------------|-----|--|--|
| 3.6 Carrera, 3.6 Carrera 4WD | 6 | M96.05 | 242/325 | 07/04→12/08 | OE257 | 0,5 | | |
|------------------------------|---|--------|---------|-------------|--------------|-----|--|--|

| | | | | | | | | |
|------------------------------|---|--------|---------|-------------|--|--|--|----------------------------------|
| 3.6 Carrera, 3.6 Carrera 4WD | 6 | MA1.02 | 254/341 | 06/08→12/12 | | | | BAEA052E ^[277] |
|------------------------------|---|--------|---------|-------------|--|--|--|----------------------------------|

| | | | | | | | | |
|--|---|--------|---------|-------------|--|--|--|----------------------------------|
| 3.8 Carrera 4 GTS 4WD, 3.8 Carrera GTS | 6 | MA1.01 | 300/402 | 06/09→12/12 | | | | BAEA052E ^[277] |
|--|---|--------|---------|-------------|--|--|--|----------------------------------|

| | | | | | | | | |
|-----------------------------------|---|--------|---------|-------------|--------------|-----|--|--|
| 3.8 Carrera 4S 4WD, 3.8 Carrera S | 6 | M97.01 | 261/350 | 07/04→12/08 | OE257 | 0,5 | | |
|-----------------------------------|---|--------|---------|-------------|--------------|-----|--|--|

| | | | | | | | | |
|-----------------------------------|---|--------|---------|-------------|--------------|-----|--|--|
| 3.8 Carrera 4S 4WD, 3.8 Carrera S | 6 | M97.01 | 264/354 | 07/04→12/10 | OE257 | 0,5 | | |
|-----------------------------------|---|--------|---------|-------------|--------------|-----|--|--|

| | | | | | | | | |
|-----------------------------------|---|---------|---------|-------------|--------------|-----|--|--|
| 3.8 Carrera 4S 4WD, 3.8 Carrera S | 6 | M97.01S | 280/375 | 08/05→12/08 | OE257 | 0,5 | | |
|-----------------------------------|---|---------|---------|-------------|--------------|-----|--|--|

| | | | | | | | | |
|-----------------------------------|---|--------|---------|-------------|--|--|--|----------------------------------|
| 3.8 Carrera 4S 4WD, 3.8 Carrera S | 6 | MA1.01 | 283/380 | 06/08→12/12 | | | | BAEA052E ^[277] |
|-----------------------------------|---|--------|---------|-------------|--|--|--|----------------------------------|

968

| | | | | | | | | |
|-------------|---|--|---------|-------------|--------------|-----|-------------|--------------|
| 3.0 Turbo S | 4 | | 224/300 | 03/93→11/95 | OE005 | 0,9 | CET2 | OE179 |
|-------------|---|--|---------|-------------|--------------|-----|-------------|--------------|

BOXSTER (986)

| | | | | | | | | |
|-----|---|--------|---------|-------------|-----------------------------------|-----|-------------|--------------|
| 2.5 | 6 | M96.20 | 150/201 | 09/96→08/99 | OE206 | 0,9 | CET2 | OE188 |
| | | | | | OE216 LPG ^[278] | 0,8 | | |

| | | | | | | | | |
|-----|---|--|---------|-------------|--------------|-----|--|--|
| 2.7 | 6 | | 155/208 | 06/99→12/02 | OE218 | 1,6 | | |
|-----|---|--|---------|-------------|--------------|-----|--|--|

| | | | | | | | | |
|-----|---|--------|---------|-------------|--------------|-----|-------------|--------------|
| 2.7 | 6 | M96.22 | 162/217 | 08/99→07/02 | OE218 | 1,6 | CET2 | OE188 |
|-----|---|--------|---------|-------------|--------------|-----|-------------|--------------|

| | | | | | | | | |
|-----|---|--------|---------|-------------|--------------|-----|-------------|--------------|
| 2.7 | 6 | M96.23 | 168/225 | 07/02→12/04 | OE218 | 1,6 | CET2 | OE188 |
|-----|---|--------|---------|-------------|--------------|-----|-------------|--------------|

| | | | | | | | | |
|-------|---|--------|---------|-------------|--------------|-----|-------------|--------------|
| 3.2 S | 6 | M96.21 | 185/248 | 08/99→07/02 | OE218 | 1,6 | CET2 | OE188 |
|-------|---|--------|---------|-------------|--------------|-----|-------------|--------------|

| | | | | | | | | |
|-------|---|--------|---------|-------------|--------------|-----|-------------|--------------|
| 3.2 S | 6 | M96.24 | 196/263 | 01/04→12/04 | OE218 | 1,6 | CET2 | OE188 |
|-------|---|--------|---------|-------------|--------------|-----|-------------|--------------|

| | | | | | | | | |
|------------|---|--------|---------|-------------|--------------|-----|-------------|--------------|
| 3.2 S 3, 2 | 6 | M96.24 | 191/256 | 07/02→12/04 | OE218 | 1,6 | CET2 | OE188 |
|------------|---|--------|---------|-------------|--------------|-----|-------------|--------------|

BOXSTER (987)

| | | | | | | | | |
|-----|---|--------|---------|-------------|--------------|-----|--|--|
| 2.7 | 6 | M96.25 | 176/236 | 11/04→12/06 | OE257 | 0,5 | | |
|-----|---|--------|---------|-------------|--------------|-----|--|--|

| | | | | | | | | |
|-----|---|--------|---------|-------------|--------------|-----|--|--|
| 2.7 | 6 | M97.20 | 179/240 | 09/06→12/08 | OE257 | 0,5 | | |
|-----|---|--------|---------|-------------|--------------|-----|--|--|

| | | | | | | | | |
|-----|---|--------|---------|-------------|--------------|-----|--|--|
| 2.7 | 6 | M97.20 | 180/241 | 07/06→12/09 | OE257 | 0,5 | | BAEA052E ^[277] ModelYear2009→ |
|-----|---|--------|---------|-------------|--------------|-----|--|--|

| | | | | | | | | |
|--|--|--|--|--|----------------|-----|--|--|
| | | | | | OE262 | 1,4 | | |
| | | | | | ModelYear2009→ | | | |

| | | | | | | | | |
|-----|---|--------|---------|-------------|--|--|--|----------------------------------|
| 2.9 | 6 | MA1.20 | 188/252 | 06/09→12/11 | | | | BAEA052E ^[277] |
|-----|---|--------|---------|-------------|--|--|--|----------------------------------|

| | | | | | | | | |
|-------|---|--------|---------|-------------|--------------|-----|--|--|
| 3.2 S | 6 | M96.26 | 206/276 | 11/04→12/06 | OE257 | 0,5 | | |
|-------|---|--------|---------|-------------|--------------|-----|--|--|

PORSCHE





kW/BHP



eon TITAN

IRIDIUM



...PORSCHE



...BOXSTER (987)

| | | | | | | | | | |
|-------|---|--------|---------|---------------|----------------------------------|-----|--|--|--|
| 3.4 S | 6 | M97.21 | 217/291 | 07/06 → 12/09 | OE257 ModelYear → 2008 | 0,5 | | | BAEA052E ^[277] ModelYear 2009 → |
| | | | | | OE262 ModelYear 2009 → | 1,4 | | | |
| 3.4 S | 6 | M97.22 | 223/299 | 08/08 → 12/09 | OE257 ModelYear → 2008 | 0,5 | | | BAEA052E ^[277] ModelYear 2009 → |
| | | | | | OE262 ModelYear 2009 → | 1,4 | | | |
| 3.4 S | 6 | MA1.21 | 228/306 | 06/09 → 12/11 | OE262 | 1,4 | | | BAEA052E ^[277] |

BOXSTER Spyder (987)

| | | | | | | | | | |
|-----------|---|--------|---------|---------------|--------------|-----|--|--|--|
| 3.4 | 6 | MA1.21 | 235/315 | 06/10 → 12/11 | | | | | BAEA052E ^[277] |
| 3.4 RS 60 | 6 | M97.22 | 223/299 | 09/07 → 12/08 | OE257 | 0,5 | | | BAEA052E ^[277] ModelYear 2009 → |

CAYENNE (9PA)

| | | | | | | | | | |
|-----------------|---|---------|---------|---------------|-------------------------------|-----|----------------|--------------|---|
| 3.2 4WD | 6 | M02.2Y | 177/237 | 08/03 → 09/07 | | | | | BAEA044E ^[356] |
| 3.2 4WD | 6 | M02.2Y | 184/247 | 10/03 → 09/07 | OE215 | 0,9 | | | BAEA044E ^[356] |
| 3.6 4WD | 6 | M55.01 | 213/286 | 02/07 → 09/10 | | | | | BAEA044E ^[356] → 04/10 |
| 4.5 S 4WD | 8 | M48.00 | 250/335 | 09/02 → 09/07 | OE218 | 1,6 | CET2 | OE188 | BAEA012E ^[276] |
| 4.5 Turbo 4WD | 8 | M48.50 | 331/444 | 09/02 → 09/07 | OE136 | 0,8 | CET1 1P | OE179 | BAEA012E ^[276] |
| | | | | | OE222 | 0,8 | CET1 2P | | |
| | | | | | OE257 ^[282] | 0,5 | | | |
| 4.5 Turbo S 4WD | 8 | M48.50S | 368/493 | 01/04 → 09/07 | OE136 | 0,8 | CET1 1P | OE179 | |
| | | | | | OE222 | 0,8 | CET1 2P | | |
| | | | | | OE257 ^[282] | 0,5 | | | |
| 4.5 Turbo S 4WD | 8 | M48.50T | 383/514 | 03/06 → 09/07 | OE136 | 0,8 | CET1 1P | OE179 | |
| | | | | | OE222 | 0,8 | CET1 2P | | |
| | | | | | OE257 ^[282] | 0,5 | | | |
| 4.8 S 4WD | 8 | M48.01 | 283/380 | 02/07 → 09/10 | | | | | BAEA042E [13] [277] |
| 4.8 Turbo S 4WD | 8 | M48.51 | 368/493 | 02/07 → 09/10 | OE210 → 12/08 | 0,8 | | | BAEA042E [13] [277] |
| 4.8 Turbo S 4WD | 8 | M48.51 | 397/532 | 02/07 → 09/10 | OE210 → 12/08 | 0,8 | | | |
| 4.8 Turbo S 4WD | 8 | M48.51 | 404/542 | 08/08 → 09/10 | OE210 | 0,8 | | | |

CAYENNE (92A)

| | | | | | | | | | |
|--------------------|---|-------------------------------|---------|---------|--------------|-----|--|--------------|----------------------------------|
| 3.0 S E-Hybrid 4WD | 6 | M06.EC; MCG.E; MCG.EA; MCG.FA | 245/329 | 06/10 → | | | | | BAEA032E ^[13] |
| 3.0 S E-Hybrid 4WD | 6 | M06.EC; MCG.E; MCG.EA; MCG.FA | 306/410 | 10/14 → | | | | | BAEA032E ^[13] |
| 3.6 4WD | 6 | M55.02; MCE.YA | 220/295 | 06/10 → | | | | | BAEA044E ^[356] |
| 3.6 GTS 4WD | 6 | MCX.ZA | 324/434 | 02/15 → | | | | OE246 | BAEA163E |
| 3.6 S 4WD | 6 | MCU.RA | 309/414 | 10/14 → | | | | OE246 | BAEA163E |
| 4.8 GTS 4WD | 8 | M48.02 | 309/414 | 06/12 → | | | | | BAEA042E [13] [277] |
| 4.8 S 4WD | 8 | M48.02 | 294/394 | 06/10 → | | | | | BAEA042E [13] [277] |
| 4.8 Turbo 4WD | 8 | M48.52 | 368/493 | 06/10 → | OE210 | 0,8 | | | BAEA042E [13] [277] |
| 4.8 Turbo 4WD | 8 | MCF.TB | 382/512 | 10/14 → | OE210 | 0,8 | | | BAEA042E [13] [277] |
| 4.8 Turbo 4WD | 8 | M48.52 | 397/532 | 06/10 → | OE210 | 0,8 | | | BAEA042E [13] [277] |
| 4.8 Turbo S 4WD | 8 | M48.52 | 405/543 | 10/12 → | OE210 | 0,8 | | | BAEA042E [13] [277] |
| 4.8 Turbo S 4WD | 8 | MCY.XA | 419/562 | 01/15 → | OE210 | 0,8 | | | BAEA042E [13] [277] |

CAYMAN (987)

| | | | | | | | | | |
|-----|---|--------|---------|---------------|--------------|-----|--|--|--|
| 2.7 | 6 | M97.20 | 180/241 | 07/06 → 12/09 | OE257 | 0,5 | | | BAEA052E ^[277] ModelYear 2009 → |
|-----|---|--------|---------|---------------|--------------|-----|--|--|--|

PORSCHE





kW/BHP



eon TITAN

IRIDIUM

**...PORSCHE****...CAYMAN (987)**

| | | | | | | | | | | |
|------------------|---|--------|---------|-------------|--|------------|--|--|--|---|
| 2.9 | 6 | MA1.20 | 195/261 | 02/09→12/12 | | | | | | BAEA052E ^[277] |
| 3.4 R | 6 | MA1.21 | 243/326 | 11/10→12/12 | | | | | | BAEA052E ^[277] |
| 3.4 S | 6 | M97.21 | 217/291 | 11/05→12/09 | OE257 | 0,5 | | | | BAEA052E ^[277] ModelYear2009→ |
| 3.4 S | 6 | MA1.21 | 235/315 | 02/09→06/13 | | | | | | BAEA052E ^[277] |
| 3.4 S 3, 4 Sport | 6 | M97.22 | 223/299 | 08/08→12/12 | OE257 ModelYear→2008 OE262 ModelYear2009→ | 0,5 1,4 | | | | BAEA052E ^[277] ModelYear2009→ |

MACAN (95B)

| | | | | | | | | | | |
|---------------|---|----------------|---------|--------|--|--|--|-------|----------|----------|
| 2.0 4WD | 4 | MCN.CC; MCY.NA | 174/233 | 07/14→ | | | | | | BAEA068E |
| 3.0 GTS 4WD | 6 | MDC.NA | 265/355 | 10/15→ | | | | OE246 | | |
| 3.0 S 4WD | 6 | MCT.MA | 250/335 | 02/14→ | | | | OE246 | BAEA163E | |
| 3.6 Turbo 4WD | 6 | MCT.LA | 294/394 | 02/14→ | | | | OE246 | BAEA163E | |

PANAMERA (970)

| | | | | | | | | | | |
|-------------------|---|----------------|---------|-------------|-------|-----|--|-------|---|--|
| 3.0 4S 4WD, 3.0 S | 6 | MCW.DA | 309/414 | 07/13→10/16 | | | | OE246 | BAEA163E | |
| 3.0 S E-Hybrid | 6 | MCG.EA; MCG.FA | 245/329 | 03/11→07/13 | | | | | BAEA032E ^[13] | |
| 3.0 S E-Hybrid | 6 | MCG.EA; MCG.FA | 279/374 | 03/11→07/13 | | | | | BAEA032E ^[13] | |
| 3.0 S E-Hybrid | 6 | MCG.EA; MCG.FA | 306/410 | 07/13→10/16 | | | | | BAEA032E ^[13] | |
| 3.6, 3.6 4WD | 6 | M46.20; M46.40 | 220/295 | 05/10→07/13 | | | | | BAEA042E ^[13] ^[277] | |
| 4.8 4S 4WD, 4.8 S | 8 | M48.20; M48.40 | 294/394 | 09/09→07/13 | | | | | BAEA042E ^[13] ^[277] | |
| 4.8 GTS 4WD | 8 | M48.40 | 316/424 | 01/12→07/13 | | | | | BAEA042E ^[13] ^[277] | |
| 4.8 GTS 4WD | 8 | MCX.PA; MCX.RA | 324/434 | 07/13→10/16 | | | | | BAEA042E ^[13] ^[277] | |
| 4.8 Turbo 4WD | 8 | M48.70 | 368/493 | 09/09→07/13 | OE210 | 0,8 | | | BAEA042E ^[13] ^[277] | |
| 4.8 Turbo 4WD | 8 | MCW.BA | 382/512 | 07/13→10/16 | OE210 | 0,8 | | | | |
| 4.8 Turbo 4WD | 8 | M48.70 | 397/532 | 08/10→07/13 | OE210 | 0,8 | | | | |
| 4.8 Turbo S 4WD | 8 | M48.70 | 404/542 | 05/11→07/13 | OE210 | 0,8 | | | | |
| 4.8 Turbo S 4WD | 8 | MCW.CA | 419/562 | 07/13→10/16 | OE210 | 0,8 | | | | |

PROTON**GEN 2**

| | | | | | | | | | | |
|-----|---|------|--------|--------|-------|-----|------|-------|--|---------|
| 1.3 | 4 | S4PE | 70/94 | 06/04→ | | | | | | BAEA234 |
| 1.6 | 4 | S4PH | 82/110 | 06/04→ | OE011 | 0,9 | CET9 | OE183 | | BAEA234 |

IMPIAN

| | | | | | | | | | | |
|-----|---|--------|--------|--------|-------|-----|------|-------|----------|--------|
| 1.6 | 4 | 4G18-P | 76/102 | 09/01→ | OE003 | 0,9 | CET2 | OE180 | BAEA179E | CLS010 |
|-----|---|--------|--------|--------|-------|-----|------|-------|----------|--------|

JUMBUCK

| | | | | | | | | | | |
|-----|---|------|-------|--------|-------|-----|------|--|---------|--|
| 1.5 | 4 | 4G15 | 64/86 | 05/02→ | OE051 | 0,9 | CET8 | | BAEA234 | |
|-----|---|------|-------|--------|-------|-----|------|--|---------|--|

PERSONA 300

| | | | | | | | | | | |
|------------------|---|------------|---------|-------------|-------|-----|------|-------|--|--|
| 1.3 | 4 | 4G13-M | 55/74 | 08/00→07/04 | OE051 | 0,9 | CET8 | | | |
| 1.3 313i | 4 | G13B | 55/74 | 03/96→01/00 | OE065 | 0,9 | CET8 | | | |
| 1.5 315 GLi/GLSi | 4 | 4G15M | 66/89 | 03/96→07/00 | OE065 | 0,9 | CET8 | | | |
| 1.5 315 GLSi | 4 | G15B | 64/86 | 09/96→07/00 | OE065 | 0,9 | CET8 | | | |
| 1.6 316 | 4 | 4G92 | 70/94 | 03/96→07/04 | OE039 | 1,0 | CET2 | OE180 | | |
| 1.6 316 GLXi | 4 | 4G92 | 83/111 | 03/96→07/00 | | | CET2 | OE179 | | |
| 1.8 318 16V GTI | 4 | 4G93(DOHC) | 99/133 | 03/96→07/00 | OE039 | 1,0 | CET2 | OE180 | | |
| 1.8 GTi | 4 | 4G93(DOHC) | 103/138 | 08/00→07/04 | OE039 | 1,0 | CET2 | OE179 | | |

PERSONA 400

| | | | | | | | | | | |
|--------------|---|--------|-------|-------------|-------|-----|------|--|--|--|
| 1.3 | 4 | 4G13M | 57/76 | 10/05→02/08 | OE051 | 0,9 | CET8 | | | |
| 1.3 413 | 4 | 4G13-P | 55/74 | 01/94→06/03 | OE065 | 0,9 | CET8 | | | |
| 1.3 413 GLSi | 4 | 4G13 | 55/74 | 01/94→01/00 | OE051 | 0,9 | CET8 | | | |
| 1.5 | 4 | 4G15M | 67/90 | 05/95→02/08 | OE051 | 0,9 | CET8 | | | |

PROTON





kW/BHP



eon TITAN

IRIDIUM



PROTON

...PROTON



...PERSONA 400

| | | | | | | | | | |
|-----------------------|---|------------|--------|-------------|-------|-----|------|-------|--|
| 1.5 415 GLi/GLSi | 4 | 4G15 | 66/89 | 01/94→07/00 | OE048 | 1,0 | CET8 | OE195 | |
| 1.6 416 | 4 | 4G92 | 70/94 | 08/00→02/02 | OE039 | 1,0 | CET2 | OE179 | |
| 1.6 416 GLXi | 4 | 4G92 | 83/111 | 01/94→07/00 | OE039 | 1,0 | CET2 | OE180 | |
| 1.6 416 i | 4 | 4G92 | 70/94 | 12/95→07/00 | OE039 | 1,0 | CET2 | OE180 | |
| 1.8 | 4 | 4G93(DOHC) | 99/133 | 08/00→12/01 | OE039 | 1,0 | CET2 | OE179 | |
| 1.8 418, 1.8 418 GLXi | 4 | 4G93(DOHC) | 85/114 | 05/96→07/00 | | | CET2 | OE179 | |
| 2.0 420 D, 2.0 420 TD | 4 | 4D68T | 60/80 | 09/96→07/00 | CH256 | 11v | | | |
| 2.0 420 GLS D | 4 | 4D68 | 48/64 | 05/96→04/99 | CH256 | 11v | | | |

SAGA II

| | | | | | | | | | |
|---------|---|------|-------|--------|--|--|--|--|---------|
| 1.3 FLX | 4 | S4PE | 70/94 | 04/10→ | | | | | BAEA234 |
|---------|---|------|-------|--------|--|--|--|--|---------|

SATRIA

| | | | | | | | | | |
|-----|---|--------|-------|-------------|-------|-----|------|--|---------|
| 1.3 | 4 | 4G13-M | 55/74 | 07/96→05/06 | OE051 | 0,9 | CET8 | | |
| 1.3 | 4 | 4G13 | 55/74 | 07/96→05/06 | OE051 | 0,9 | CET8 | | BAEA234 |
| 1.5 | 4 | 4G15 | 64/86 | 07/00→05/06 | OE051 | 0,9 | CET8 | | |

SATRIA NEO

| | | | | | | | | | |
|-----|---|------|--------|-------------|--|--|--|--|---------|
| 1.3 | 4 | S4PE | 70/94 | 02/07→09/08 | | | | | BAEA234 |
| 1.6 | 4 | S4PH | 81/109 | 02/07→ | | | | | BAEA234 |

SAVVY

| | | | | | | | | | |
|-----|---|--|-------|--------|--|--|--|--|--------------------------|
| 1.2 | 4 | | 55/74 | 10/05→ | | | | | BAEA454 ^[149] |
|-----|---|--|-------|--------|--|--|--|--|--------------------------|

WIRA

| | | | | | | | | | |
|-----|---|-------------|--------|-------------|-------|-----|------|-------|---------|
| 1.3 | 4 | 4G13 | 55/74 | 08/00→ | OE051 | 0,9 | CET8 | | BAEA234 |
| 1.3 | 4 | 4G13M | 57/76 | 10/05→ | OE051 | 0,9 | CET8 | | |
| 1.5 | 4 | 4G15; 4G15M | 64/86 | 08/00→ | OE051 | 0,9 | CET8 | | BAEA234 |
| 1.5 | 4 | 4G15M | 67/90 | 10/05→ | OE051 | 0,9 | CET8 | | |
| 1.6 | 4 | 4G92 | 70/94 | 08/00→02/02 | OE039 | 1,0 | CET2 | OE179 | |
| 1.8 | 4 | 4G93(DOHC) | 99/133 | 08/00→12/01 | OE039 | 1,0 | CET2 | OE179 | |

PUCH



G-MODELL

| | | | | | | | | | |
|------------------|---|-----------|---------|-------------|------------------------|-------|--------|-------|----------------|
| 2.9 G 290 TD 4WD | 5 | OM602.983 | 88/118 | 07/97→12/99 | CH176 | 11.5v | | | |
| 3.0 G 300 TD 4WD | 6 | OM606.964 | 130/174 | 08/96→12/99 | CH177 ^[293] | 11.5v | | | |
| 3.2 G 320 4WD | 6 | M104.996 | 155/208 | 09/94→12/97 | OE005 | 0,9 | CET2 | OE179 | BAEA340 |
| 5.0 G 500 4WD | 8 | M113.962 | 218/292 | 04/98→12/99 | OE191 | 1,0 | CET12P | OE180 | BAEA297 CLS242 |
| 5.5 G 55 AMG 4WD | 8 | M113.982 | 260/349 | 04/99→12/99 | OE191 | 1,0 | CET12P | OE180 | BAEA297 |

RELIANT



SCIMITAR SABRE

| | | | | | | | | | |
|----------|---|-------|--------|-------------|-------|-----|------|-------|--|
| 1.4 1400 | 4 | | 55/74 | 01/93→08/93 | OE014 | 0,9 | CET2 | OE179 | |
| 1.4 i | 4 | 14K4E | 76/102 | 08/93→12/95 | OE005 | 0,9 | CET2 | OE180 | |

RENAULT



19 II

| | | | | | | | | | |
|-----|---|----------------|-------|-------------|-------|-----|------|-------|--------------------------------|
| 1.4 | 4 | E6J700 | 57/76 | 05/93→12/98 | OE005 | 0,9 | CET2 | OE179 | BAEA251 ^{[265] [292]} |
| 1.4 | 4 | E6J706 | 60/80 | 10/96→06/01 | | | | | BAEA251 ^{[265] [292]} |
| 1.7 | 4 | F2N720; F2N721 | 68/91 | 01/93→08/95 | | | CET8 | OE195 | BAEA251 ^{[265] [292]} |
| 1.7 | 4 | F3N747 | 69/93 | 10/96→06/01 | OE087 | 0,9 | CET8 | | |

AVANTIME

| | | | | | | | | | |
|---------------|---|----------------|---------|-------------|-------|-----|--------|-------|------------------------|
| 2.0 16V Turbo | 4 | F4R760; F4R761 | 120/161 | 11/01→05/03 | | | CET12P | OE179 | BAE409A |
| 2.2 dCi | 4 | G9T712 | 110/148 | 05/02→05/03 | CH232 | 11v | | | CCU154 ^[10] |
| 3.0 V6 | 6 | L7X720; L7X721 | 152/204 | 09/01→05/03 | OE175 | 1,0 | CET14P | OE190 | BAEA347 |



kW/BHP

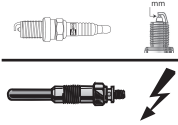

eon TITAN

IRIDIUM

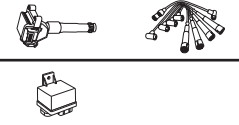

...RENAULT



CAPTUR

| | | | | | | | | | |
|-------------|---|----------------|--------|--------|--|--|--|---|-----------------|
| 0.9 TCe 90 | 3 | H4B400 | 66/89 | 06/13→ | | | | OE261 Eng.130429→ Eng.140609 | BAEA131E |
| 1.2 TCe 120 | 4 | H5F408; H5F412 | 87/117 | 01/16→ | | | | OE261 | BAEA131E |
| 1.2 TCe 120 | 4 | H5F403 | 88/118 | 06/13→ | | | | OE261 Eng.130429→ Eng.140609 | BAEA131E |

CLIO

| | | | | | | | | | | |
|----------------|---|----------------|--------|-------------|---------------------------|-----|-------------------|--------------|--------------------------|-------------------------------|
| 1.2 16V | 4 | D4F740 | 55/74 | 02/08→ | OE130 | 0,9 | CET13P [6] | | BAE947A →05/08 | CLS084 [296] 06/08→ |
| | | | | | OE225 [6] [254] | 0,7 | CET4 | | BAEA325 06/08→ | |
| 1.2 16V | 4 | D4F764 | 58/78 | 02/08→ | OE130 | 0,9 | CET4 | | BAE947A →05/08 | CLS084 [296] 06/08→ |
| | | | | | | | | | BAEA325 06/08→ | |
| 1.2 16V | 4 | D4F784 | 74/99 | 02/08→ | OE225 | 0,7 | CET13P | | BAE947A →05/08 | CLS084 [296] 06/08→ |
| | | | | | | | | | BAEA325 06/08→ | |
| | | | | | BAEA354 [275] | | | | | |
| 1.2 16V | 4 | D4F786 | 76/102 | 03/10→ | OE130 | 0,9 | CET13P | | BAEA354 | CLS084 [296] |
| | | | | | OE225 [6] [254] | 0,7 | | | | |
| 1.2 16VHi-Flex | 4 | D4F740 | 55/74 | 07/08→ | OE130 | 0,9 | CET13P [6] | | BAE947A | CLS084 [296] |
| | | | | | OE225 [6] [254] | 0,7 | CET4 | | BAEA325 | |
| 1.4 16V | 4 | K4J780 | 72/97 | 02/10→ | OE033 | 0,9 | CET2 | OE179 | BAE409A | |
| 1.5 dCi | 4 | K9K752 | 48/64 | 02/10→ | CH271 | 11v | | | CCU154 [10] | |
| 1.5 dCi | 4 | K9K714; K9K768 | 50/67 | 02/08→ | CH271 | 11v | | | CCU154 [10] | |
| 1.5 dCi | 4 | K9K770 | 55/74 | 08/10→ | CH271 | 11v | | | CCU154 [10] | |
| 1.5 dCi | 4 | K9K766 | 63/84 | 02/08→ | CH271 | 11v | | | CCU154 [10] | |
| 1.5 dCi | 4 | K9K770; K9K772 | 65/87 | 08/10→ | CH271 | 11v | | | CCU154 [10] | |
| 1.5 dCi | 4 | K9K772 | 76/102 | 02/08→ | CH271 | 11v | | | CCU154 [10] | |
| 1.5 dCi | 4 | K9K764; K9K774 | 78/105 | 02/08→12/12 | CH271 | 11v | | | CCU154 [10] | |
| 1.6 16V | 4 | K4M800; K4M801 | 82/110 | 02/08→ | OE033 | 0,9 | CET2 | OE179 | BAE409A | |
| 1.6 16V | 4 | K4M862 | 94/126 | 11/08→ | OE033 | 0,9 | CET2 | OE179 | BAE409A | |

CLIO I

| | | | | | | | | | |
|--------------|---|--------------------------------|---------|-------------|------------------------|-----|-------------|--------------|-------------------------------|
| 1.8 Rsi | 4 | F3P758 | 79/106 | 08/95→09/98 | OE006 →08/96 | 0,9 | CET8 | OE195 | BAEA251 [265] [292] |
| 1.8 Rsi | 4 | F3P712 | 80/107 | 01/93→08/95 | OE006 | 0,9 | CET8 | OE195 | BAEA251 [265] [292] |
| 1.9 D | 4 | F8Q678 | 40/54 | 01/97→09/98 | CH173 | 11v | | | |
| 1.9 D | 4 | F8Q632; F8Q676; F8Q696; F8Q714 | 48/64 | 05/96→02/98 | CH206 | 11v | | | |
| 2.0 Williams | 4 | F7R700 | 108/145 | 01/94→09/98 | | | CET2 | OE179 | BAEA251 [265] [292] |

CLIO II

| | | | | | | | | | | |
|-----|---|--|-------|-------------|--------------|-----|-------------|--------------|--|-------------------------------|
| 1.0 | 4 | CG10DE | 40/54 | 02/00→05/01 | OE063 | 1,0 | CET2 | OE180 | BAEA354 | |
| 1.0 | 4 | | 52/70 | 06/01→04/05 | OE130 | 0,9 | CET4 | | | |
| 1.2 | 4 | D7F710; D7F722; D7F746; D7F764; D7F766 | 43/58 | 09/98→ | OE026 | 0,9 | CET2 | OE179 | BAEA345 →10/98 →Eng.981020 BAEA354 11/98→ Eng.981021→ | |
| 1.2 | 4 | D7F720; D7F726 | 43/58 | 09/98→ | OE026 | 0,9 | CET2 | OE179 | BAEA345 →10/98 →Eng.981020 BAEA354 11/98→ Eng.981021→ | CLS083 [275] 10/99→ |

RENAULT





kW/BHP

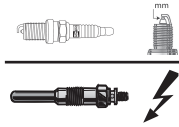

eon TITAN

IRIDIUM

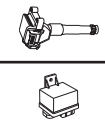

...RENAULT



...CLIO II

| | | | | | | | | | | |
|-------------------|---|--|---------|---------------|---------------------------------|------|---------------|--------------|---------------------------------|-------------------------------------|
| 1.2 16V | 4 | D4F706; D4F712 | 54/72 | 06/06 → | OE130 | 0,9 | CET4 | | | |
| 1.2 16V | 4 | D4F706; D4F712; D4F714; D4F722; D4F728 | 55/74 | 06/01 → | OE130 | 0,9 | CET4 | | BAEA325 [151] [275] | CLS084 [296] |
| | | | | | | | | | BAEA454 [150] [275] | |
| 1.2 LPG | 4 | D7F764; D7F766 | 43/58 | 09/98 → 06/09 | OE026 | 0,9 | CET2 | OE179 | BAEA354 | CLS084 [152] [296] |
| | | | | | | | | | | CLS040 [275] → Eng.991002 |
| 1.2 LPG | 4 | D7F722 | 44/59 | 03/99 → 05/01 | OE026 | 0,9 | CET2 | OE179 | BAEA354 | CLS040 [275] → 09/99 |
| | | | | | | | | | | CLS083 [275] 10/99 → |
| 1.4 | 4 | E7J634; E7J780; K7J700 | 55/74 | 09/98 → 05/05 | OE033 *to be adjusted | 1,0* | CET2 | OE179 | BAEA242 [7] [37] | CLS019 |
| | | | | | | | | | BAEA243 [14] [39] | |
| 1.4 | 4 | E7J.6.34; E7J.6.35 | 55/74 | 09/98 → 05/05 | | | | | BAEA354 03/99 → | |
| 1.4 16V | 4 | K4J712; K4J713 | 70/94 | 10/99 → 09/04 | OE033 | 0,9 | CET2 | OE179 | BAE409A | |
| 1.4 16V | 4 | K4J710; K4J711; K4J712; K4J713; K4J715 | 72/97 | 08/00 → | OE033 | 0,9 | CET2 | OE179 | BAE409A | |
| 1.5 dCi | 4 | K9K704 | 42/56 | 06/01 → 12/06 | CH271 | 11v | | | CCU154 [10] | |
| 1.5 dCi | 4 | K9K740 | 47/63 | 06/05 → | CH271 | 11v | | | CCU154 [10] | |
| 1.5 dCi | 4 | K9K700; K9K704 | 48/64 | 06/01 → | CH271 | 11v | | | CCU154 [10] | |
| 1.5 dCi | 4 | K9K700; K9K714 | 50/67 | 08/04 → | CH271 | 11v | | | CCU154 [10] | |
| 1.5 dCi | 4 | K9K702 | 59/79 | 06/01 → 10/03 | CH271 | 11v | | | CCU154 [10] | |
| 1.5 dCi | 4 | K9K702 | 60/80 | 06/01 → | CH271 | 11v | | | CCU154 [10] | |
| 1.5 dCi | 4 | K9K718 | 62/83 | 02/07 → 06/09 | CH271 | 11v | | | CCU154 [10] | |
| 1.5 dCi | 4 | K9K712 | 74/99 | 01/04 → | CH271 | 11v | | | CCU154 [10] | |
| 1.6 | 4 | K7M744; K7M745; K7M746 | 66/89 | 09/98 → 05/05 | OE026 | 0,9 | CET2 | OE179 | BAE409A → 03/01 | CLS011 |
| | | | | | OE216 LPG [278] | 0,8 | | | BAEA354 09/99 → 12/02 | |
| | | | | | | | | | BAEA242 [7] [37] | |
| | | | | | | | | | BAEA243 [14] [39] | |
| 1.6, 1.6 Flex | 4 | K4M740; K4M748 | 81/109 | 05/00 → 02/09 | OE033 | 0,9 | CET2 | OE179 | | |
| 1.6, 1.6 Flex | 4 | K4M | 81/109 | 05/00 → 02/09 | | | | | BAE409A | |
| 1.6 16V | 4 | K4M708; K4M740; K4M742; K4M743; K4M744; K4M745; K4M748 | 79/106 | 09/98 → | OE033 | 0,9 | CET2 | OE179 | BAE409A | |
| 1.6 Hi-Flex | 4 | K4M748 | 86/115 | 01/05 → 02/10 | OE033 | 0,9 | CET2 | OE179 | BAE409A | |
| 1.9 D | 4 | F8Q630 | 47/63 | 09/98 → 05/05 | CH217 → 02/99 | 11v | | | CCU128 [329] | |
| | | | | | CH233 03/99 → | 11v | | | CCU129 [338] | |
| 1.9 D | 4 | F8Q630; F8Q632 | 48/64 | 02/00 → 05/01 | CH217 | 11v | | | CCU128 [329] | |
| | | | | | | | | | CCU129 [338] | |
| 1.9 dTi | 4 | F9Q780 | 59/79 | 12/99 → 05/05 | CH271 | 11v | | | CCU129 [338] | |
| 2.0 2.0 16V Sport | 4 | F4R730; F4R736 | 124/166 | 02/00 → | | | CET12P | OE179 | BAEA345 [275] 04/01 → | CLS194 |
| | | | | | | | | | BAEA354 [275] | |
| 2.0 16V Sport | 4 | F4R738 | 132/177 | 01/04 → | | | CET12P | OE179 | BAEA345 → 05/05 | CLS194 |
| 3.0 V6 Sport | 6 | L7X760 | 166/223 | 11/00 → 12/02 | OE175 | 1,0 | CET14P | OE190 | BAEA347 | |
| 3.0 V6 Sport | 6 | L7X762 | 187/251 | 12/02 → | OE175 | 1,0 | CET14P | OE190 | BAEA347 | |
| CLIO III | | | | | | | | | | |
| 1.2 | 4 | D4F764 | 57/76 | 10/05 → | OE130 | 0,9 | CET4 | | BAE947A | BAEA325 |

RENAULT



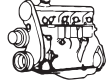

kW/BHP

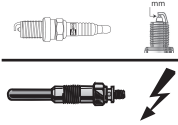

eon TITAN

IRIDIUM

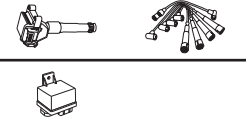

...RENAULT



...CLIO III

| | | | | | | | | | | |
|----------------|---|------------------------|---------|-------------|-------|-----|-----------------------|-------|--|-----------------------------------|
| 1.2 16V | 4 | D4F764 | 43/58 | 06/06→08/10 | | | | | BAE947A BAEA325 BAEA354 ^[275] | |
| 1.2 16V | 4 | D4F740 | 48/64 | 06/05→ | OE130 | 0,9 | CET13P ^[6] | | BAE947A →05/08 BAEA325 06/08→ | CLS084 ^[296] 06/08→ |
| 1.2 16V | 4 | D4F706; D4F740; D4F764 | 55/74 | 06/05→ | OE130 | 0,9 | CET13P ^[6] | | BAE947A →05/08 BAEA325 06/08→ | CLS084 ^[296] 06/08→ |
| 1.2 16V | 4 | D4F764 | 58/78 | 06/05→ | OE130 | 0,9 | CET4 | | BAE947A →05/08 BAEA325 06/08→ | CLS084 ^[296] 06/08→ |
| 1.2 16V | 4 | D4F784 | 74/99 | 05/07→ | OE225 | 0,7 | CET13P | | BAE947A →05/08 BAEA325 06/08→ BAEA354 ^[275] | CLS084 ^[296] 06/08→ |
| 1.2 16V | 4 | D4F786 | 76/102 | 09/10→ | OE130 | 0,9 | CET13P | | BAE947A BAEA325 | CLS084 ^[296] |
| 1.2 16VHi-Flex | 4 | D4F740; D4F742 | 55/74 | 07/08→ | OE130 | 0,9 | CET4 | | BAE947A BAEA325 | CLS084 ^[296] |
| 1.2 Ethanol | 4 | D4F742 | 55/74 | 07/08→ | OE130 | 0,9 | CET4 | | | |
| 1.4 16V | 4 | K4J780 | 72/97 | 06/05→ | OE033 | 0,9 | CET2 | OE179 | BAE409A | |
| 1.5 dCi | 4 | K9K752 | 47/63 | 06/05→ | CH271 | 11v | | | CCU154 ^[10] | |
| 1.5 dCi | 4 | K9K752 | 48/64 | 05/05→ | CH271 | 11v | | | CCU154 ^[10] | |
| 1.5 dCi | 4 | K9K714; K9K768 | 50/67 | 06/05→ | CH271 | 11v | | | CCU154 ^[10] | |
| 1.5 dCi | 4 | K9K770 | 55/74 | 08/10→ | CH271 | 11v | | | CCU154 ^[10] | |
| 1.5 dCi | 4 | K9K750 | 60/80 | 11/07→ | CH271 | 11v | | | CCU154 ^[10] | |
| 1.5 dCi | 4 | K9K766 | 63/84 | 06/05→ | CH271 | 11v | | | CCU154 ^[10] | |
| 1.5 dCi | 4 | K9K770 | 65/87 | 08/10→ | CH271 | 11v | | | CCU154 ^[10] | |
| 1.5 dCi | 4 | K9K772 | 76/102 | 06/05→ | CH271 | 11v | | | CCU154 ^[10] | |
| 1.5 dCi | 4 | K9K764; K9K774 | 78/105 | 06/05→ | CH271 | 11v | | | CCU154 ^[10] | |
| 1.6 16V | 4 | K4M804 | 65/87 | 06/05→ | OE033 | 0,9 | CET2 | OE179 | BAE409A | |
| 1.6 16V | 4 | K4M800; K4M801 | 82/110 | 06/05→ | OE033 | 0,9 | CET2 | OE179 | BAE409A | |
| 1.6 16V GT | 4 | K4M862 | 94/126 | 06/09→ | OE033 | 0,9 | CET2 | OE179 | BAE409A | |
| 2.0 16V | 4 | M4R700; M4R701 | 102/137 | 09/06→ | OE207 | 1,1 | | | BAEA056E | |
| 2.0 16V Sport | 4 | F4R830; F4R832 | 145/194 | 02/06→ | | | CET11P | OE179 | BAE409A | |
| 2.0 16V Sport | 4 | F4R832 | 148/198 | 09/08→ | OE033 | 0,9 | CET2 | OE179 | BAE409A | |

CLIO IV

| | | | | | | | | | | |
|----------------|---|--------|--------|--------|---|-------------------|---|------------------------------------|-------------------------------------|-------------------------|
| 0.9 TCe 90 | 3 | H4B400 | 66/89 | 11/12→ | | | | OE261 Eng.130429→ Eng.140609 | BAEA131E | |
| 0.9 TCe 90 LPG | 3 | H4B400 | 66/89 | 06/16→ | | | | OE261 | BAEA131E | |
| 1.2 16V | 4 | D4F728 | 54/72 | 11/12→ | OE225 | 0,7 | CET13P | | BAE947A BAEA325 ^[323] | CLS084 ^[296] |
| 1.2 16V | 4 | D4F740 | 54/72 | 11/12→ | OE130 OE225 OE225 ^[6] ^[254] | 0,9 0,7 0,7 | CET13P CET13P ^[6] CET4 | | BAE947A BAEA325 ^[323] | CLS084 ^[296] |
| 1.2 TCe 120 | 4 | H5F412 | 87/117 | 01/16→ | | | | OE261 | BAEA131E | |
| 1.2 TCe 120 | 4 | H5F403 | 88/118 | 03/13→ | | | | OE261 | BAEA131E | |

DUSTER

| | | | | | | | | | | |
|----------------------|---|------------------------|--------|--------|----------------------|-----|--|--|------------------------|--|
| 1.5 dCi | 4 | K9K796 | 63/84 | 02/12→ | CH271 ^[9] | 11v | | | CCU147 ^[11] | |
| 1.5 dCi, 1.5 dCi 4WD | 4 | K9K884 | 66/89 | 06/09→ | CH271 ^[9] | 11v | | | CCU147 ^[11] | |
| 1.5 dCi, 1.5 dCi 4WD | 4 | K9K856; K9K858; K9K898 | 80/107 | 09/13→ | CH271 ^[9] | 11v | | | CCU147 ^[11] | |

RENAULT





kW/BHP



eon TITAN

IRIDIUM

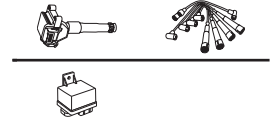

RENAULT

| ...RENAULT | | | | | | | | | |
|--------------------------------------|---|--|---------|-------------|----------------------|-----|------|-------|---------------------------------|
| ...DUSTER | | | | | | | | | |
| 1.5 dCi, 1.5 dCi 4WD | 4 | ; K9K896 | 81/109 | 02/12→ | CH271 [9] | 11v | | | CCU147 [11] |
| 1.6 16V | 4 | K4M718 | 76/102 | 02/12→ | OE005 →Eng.140324 | 0,9 | CET2 | OE179 | BAE409A |
| | | | | | OE033 Eng.140325→ | 0,9 | | | |
| 1.6 16V | 4 | K4M616 | 77/103 | 06/11→ | OE005 →Eng.140324 | 0,9 | CET2 | OE179 | BAE409A |
| | | | | | OE033 Eng.140325→ | 0,9 | | | |
| 1.6 16V | 4 | K4M690 | 81/109 | 01/11→ | OE005 →Eng.140324 | 0,9 | CET2 | OE179 | BAE409A |
| | | | | | OE033 Eng.140325→ | 0,9 | | | |
| 1.6 16V, 1.6 16V 4WD | 4 | K4M616 | 75/101 | 06/11→ | OE005 →Eng.140324 | 0,9 | CET2 | OE179 | BAE409A |
| | | | | | OE033 Eng.140325→ | 0,9 | | | |
| 1.6 16V, 1.6 16V 4WD | 4 | K4M690 | 84/113 | 06/15→ | OE005 →Eng.140324 | 0,9 | CET2 | OE179 | BAE409A |
| | | | | | OE033 Eng.140325→ | 0,9 | | | |
| 1.6 Hi-Flex | 4 | K4M690 | 85/114 | 09/14→12/15 | OE005 →Eng.140324 | 0,9 | CET2 | OE179 | BAE409A |
| | | | | | OE033 Eng.140325→ | 0,9 | | | |
| 1.6 Hi-Flex | 4 | | 88/118 | 01/17→ | OE005 →Eng.140324 | 0,9 | CET2 | OE179 | BAE409A |
| | | | | | OE033 Eng.140325→ | 0,9 | | | |
| 2.0 | 4 | F4R403; F4R405 | 98/131 | 02/12→ | OE014 | 0,9 | CET2 | OE179 | BAE409A |
| | | | | | OE033 | 0,9 | | | |
| 2.0 | 4 | | 102/137 | 10/11→ | OE014 | 0,9 | CET2 | OE179 | BAE409A |
| | | | | | OE033 | 0,9 | | | |
| 2.0, 2.0 4WD | 4 | F4R400; F4R402; F4R404 | 101/135 | 01/11→ | OE014 | 0,9 | CET2 | OE179 | BAE409A |
| | | | | | OE033 | 0,9 | | | |
| 2.0, 2.0 4WD, 2.0 Flex, 2.0 Flex 4WD | 4 | F4R400; F4R402; F4R403; F4R408 | 105/141 | 10/11→ | OE014 | 0,9 | CET2 | OE179 | BAE409A |
| | | | | | OE033 | 0,9 | | | |
| 2.0 4WD | 4 | F4R | 99/133 | 02/12→ | OE014 | 0,9 | CET2 | OE179 | BAE409A |
| | | | | | OE033 | 0,9 | | | |
| 2.0 Flex, 2.0 Flex 4WD | 4 | F4R402; F4R403 | 109/146 | 01/16→ | OE014 | 0,9 | CET2 | OE179 | BAE409A |
| | | | | | OE033 | 0,9 | | | |
| 2.0 Hi-Flex, 2.0 Hi-Flex 4WD | 4 | F4R400; F4R402; F4R403; F4R404; F4R405; F4R408 | 104/139 | 01/11→ | OE014 | 0,9 | CET2 | OE179 | BAE409A |
| | | | | | OE033 | 0,9 | | | |
| ESPACE II | | | | | | | | | |
| 2.1 TD | 4 | J8S612 | 66/89 | 11/94→10/96 | CH189 | 11v | | | |
| ESPACE III | | | | | | | | | |
| 1.9 dTi | 4 | F9Q722 | 72/97 | 02/99→10/02 | CH271 | 11v | | | CCU129 [338] |
| 2.0 | 4 | F3R728; F3R729; F3R742; F3R768; F3R769 | 84/113 | 11/96→10/00 | | | CET8 | OE195 | CLS039 |
| | | | | | | | | | CLS052 |
| 2.0 | 4 | F4R700; F4R701 | 102/137 | 09/01→10/02 | OE033 | 0,9 | CET2 | OE179 | BAE409A |
| 2.0 16V | 4 | F4R700; F4R701 | 103/138 | 10/98→10/02 | OE033 | 0,9 | CET2 | OE179 | BAE409A |
| 2.2 12V TD | 4 | G8T714; G8T716; G8T760 | 83/111 | 11/96→10/00 | CH169 | 11v | | | |
| 2.2 D | 4 | G8T716 | 84/113 | 11/97→01/00 | CH169 | 11v | | | |
| 2.2 dCi | 4 | G9T710 | 85/114 | 07/00→10/02 | CH232 | 11v | | | CCU154 [10] |
| 2.2 dCi | 4 | G9T642; G9T710 | 95/127 | 10/00→10/02 | CH232 | 11v | | | CCU154 [10] |
| 3.0 | 6 | Z7X775 | 123/165 | 11/96→10/98 | OE033 | 0,9 | | OE179 | BAEA251 [265] [275] [292] [372] |





kW/BHP



eon TITAN

IRIDIUM



...RENAULT



...ESPACE III

| | | | | | | | | | |
|------------|---|--------|---------|-------------|--------------|-----|-------------|--------------|--|
| 3.0 V6 24V | 6 | L7X727 | 140/188 | 10/98→10/02 | OE026 | 0,9 | CET2 | OE179 | |
|------------|---|--------|---------|-------------|--------------|-----|-------------|--------------|--|

ESPACE IV

| | | | | | | | | | |
|---------|---|--------|--------|-------------|--------------|-----|--|--|--|
| 1.9 dCi | 4 | F9Q820 | 85/114 | 04/03→02/05 | CH271 | 11v | | | CCU154 →Eng.070828 [10] [360] |
|---------|---|--------|--------|-------------|--------------|-----|--|--|--|

| | | | | | | | | | |
|--|--|--|--|--|--|--|--|--|--|
| | | | | | | | | | CCU147 Eng.070829→ [11] [352] |
|--|--|--|--|--|--|--|--|--|--|

| | | | | | | | | | |
|---------|---|------------------------|--------|--------|--------------|-----|--|--|--|
| 1.9 dCi | 4 | F9Q680; F9Q820; F9Q826 | 88/118 | 11/02→ | CH271 | 11v | | | CCU154 →Eng.070828 [10] [360] |
|---------|---|------------------------|--------|--------|--------------|-----|--|--|--|

| | | | | | | | | | |
|--|--|--|--|--|--|--|--|--|--|
| | | | | | | | | | CCU147 Eng.070829→ [11] [352] |
|--|--|--|--|--|--|--|--|--|--|

| | | | | | | | | | |
|-----|---|--------|--------|-------------|--------------|-----|-------------|--------------|----------------|
| 2.0 | 4 | F4R790 | 98/131 | 11/02→02/05 | OE033 | 0,9 | CET2 | OE179 | BAE409A |
|-----|---|--------|--------|-------------|--------------|-----|-------------|--------------|----------------|

| | | | | | | | | | |
|-----|---|--------|---------|--------|--------------|-----|---------------|--------------|----------------|
| 2.0 | 4 | F4R792 | 100/134 | 11/02→ | OE136 | 0,8 | CET12P | OE179 | BAE409A |
|-----|---|--------|---------|--------|--------------|-----|---------------|--------------|----------------|

| | | | | | | | | | |
|-----|---|--------------------------------|---------|--------|--------------|-----|---------------|--------------|----------------|
| 2.0 | 4 | F4R796; F4R797; F4R896; F4R897 | 125/168 | 04/05→ | OE136 | 0,8 | CET12P | OE179 | BAE409A |
|-----|---|--------------------------------|---------|--------|--------------|-----|---------------|--------------|----------------|

| | | | | | | | | | |
|---------|---|--|--------|--------|---|----|--|--|--|
| 2.0 dCi | 4 | M9R740; M9R750; M9R760; M9R761; M9R762; M9R763 | 96/129 | 01/06→ | CCGP007 Eng.060314 060904→ [14] [154] | 7v | | | |
|---------|---|--|--------|--------|---|----|--|--|--|

| | | | | | | | | | |
|---------|---|--------------------------------|---------|--------|---|----|--|--|--|
| 2.0 dCi | 4 | M9R740; M9R750; M9R814; M9R815 | 110/148 | 01/06→ | CCGP007 Eng.060314 060904→ [14] [154] | 7v | | | |
|---------|---|--------------------------------|---------|--------|---|----|--|--|--|

| | | | | | | | | | |
|---------|---|--|---------|--------|---|----|--|--|--|
| 2.0 dCi | 4 | M9R760; M9R761; M9R762; M9R763; M9R812; M9R815; M9R859 | 127/170 | 01/06→ | CCGP007 Eng.060314 060904→ [14] [154] | 7v | | | |
|---------|---|--|---------|--------|---|----|--|--|--|

| | | | | | | | | | |
|-----------|---|--------------------------------|---------|--------|--------------|-----|---------------|--------------|----------------|
| 2.0 Turbo | 4 | F4R794; F4R795; F4R796; F4R797 | 120/161 | 11/02→ | OE136 | 0,8 | CET12P | OE179 | BAE409A |
|-----------|---|--------------------------------|---------|--------|--------------|-----|---------------|--------------|----------------|

| | | | | | | | | | |
|---------|---|--------|---------|--------|--------------|-----|--|--|--------------------|
| 2.2 dCi | 4 | G9T645 | 102/137 | 02/06→ | CH232 | 11v | | | CCU154 [10] |
|---------|---|--------|---------|--------|--------------|-----|--|--|--------------------|

| | | | | | | | | | |
|---------|---|----------------|---------|--------|--------------|-----|--|--|--------------------|
| 2.2 dCi | 4 | G9T742; G9T743 | 110/148 | 11/02→ | CH232 | 11v | | | CCU154 [10] |
|---------|---|----------------|---------|--------|--------------|-----|--|--|--------------------|

| | | | | | | | | | |
|--------|---|----------------|---------|--------|--------------|-----|---------------|--------------|-----------------|
| 3.5 V6 | 6 | V4Y711; V4Y715 | 177/237 | 11/02→ | OE175 | 1,0 | CET14P | OE190 | BAEA079E |
|--------|---|----------------|---------|--------|--------------|-----|---------------|--------------|-----------------|

EXPRESS

| | | | | | | | | | |
|-------|---|--------|-------|-------------|-----------------------------|-----|--|--|--|
| 1.9 D | 4 | F8Q640 | 40/54 | 07/95→10/97 | CH206 [287] [327] | 11v | | | |
|-------|---|--------|-------|-------------|-----------------------------|-----|--|--|--|

| | | | | | | | | | |
|-------|---|----------------|-------|-------------|-----------------------------|-----|--|--|--|
| 1.9 D | 4 | F8Q724; F8Q776 | 47/63 | 07/95→10/99 | CH206 [287] [327] | 11v | | | |
|-------|---|----------------|-------|-------------|-----------------------------|-----|--|--|--|

FLUENCE

| | | | | | | | | | |
|-----|---|--------|--------|--------|--|--|--|--|--------------------------------|
| 1.6 | 4 | H4M729 | 86/115 | 01/13→ | | | | | BAEA131E [105] [375] |
|-----|---|--------|--------|--------|--|--|--|--|--------------------------------|

| | | | | | | | | | |
|---------|---|--------|--------|--------|--|--|--|--|----------------|
| 1.6 16V | 4 | K4M838 | 78/105 | 02/10→ | | | | | BAE409A |
|---------|---|--------|--------|--------|--|--|--|--|----------------|

| | | | | | | | | | |
|---------|---|----------------|--------|--------|--------------|-----|-------------|--|----------------|
| 1.6 16V | 4 | K4M838; K4M839 | 81/109 | 02/10→ | OE207 | 1,1 | CET2 | | BAE409A |
|---------|---|----------------|--------|--------|--------------|-----|-------------|--|----------------|

| | | | | | | | | | |
|---------|---|-----|--------|--------|--------------|-----|--|--------------|--|
| 1.6 16V | 4 | K4M | 81/109 | 02/10→ | OE033 | 0,9 | | OE179 | |
|---------|---|-----|--------|--------|--------------|-----|--|--------------|--|

| | | | | | | | | | |
|---------|---|--------|--------|--------|--------------|-----|-------------|--------------|----------------|
| 1.6 16V | 4 | K4M838 | 82/110 | 02/10→ | OE033 | 0,9 | CET2 | OE179 | BAE409A |
|---------|---|--------|--------|--------|--------------|-----|-------------|--------------|----------------|

| | | | | | | | | | |
|---------|---|----------------|---------|--------|--------------|-----|--|--|-----------------------|
| 2.0 16V | 4 | M4R714; M4R751 | 103/138 | 02/10→ | OE207 | 1,1 | | | BAEA161E [300] |
|---------|---|----------------|---------|--------|--------------|-----|--|--|-----------------------|

GRAND SCÉNIC II

| | | | | | | | | | |
|---------|---|--------|-------|--------|--------------|-----|--|--|--|
| 1.5 dCi | 4 | K9K722 | 60/80 | 04/04→ | CH271 | 11v | | | |
|---------|---|--------|-------|--------|--------------|-----|--|--|--|

| | | | | | | | | | |
|---------|---|--------|-------|--------|--------------|-----|--|--|--|
| 1.5 dCi | 4 | K9K728 | 74/99 | 04/04→ | CH271 | 11v | | | |
|---------|---|--------|-------|--------|--------------|-----|--|--|--|

| | | | | | | | | | |
|---------|---|--------|--------|--------|--------------|-----|--|--|--|
| 1.5 dCi | 4 | K9K732 | 78/105 | 05/05→ | CH271 | 11v | | | |
|---------|---|--------|--------|--------|--------------|-----|--|--|--|

| | | | | | | | | | |
|-----|---|--------|--------|--------|--------------|-----|-------------|--------------|----------------|
| 1.6 | 4 | K4M788 | 77/103 | 06/06→ | OE033 | 0,9 | CET2 | OE179 | BAE409A |
|-----|---|--------|--------|--------|--------------|-----|-------------|--------------|----------------|

| | | | | | | | | | |
|-----|---|--------|--------|-------------|--------------|-----|-------------|--------------|----------------|
| 1.6 | 4 | K4M812 | 82/110 | 06/06→11/08 | OE033 | 0,9 | CET2 | OE179 | BAE409A |
|-----|---|--------|--------|-------------|--------------|-----|-------------|--------------|----------------|

| | | | | | | | | | |
|-----|---|----------------|--------|--------|--------------|-----|-------------|--------------|----------------|
| 1.6 | 4 | K4M761; K4M782 | 83/111 | 04/04→ | OE033 | 0,9 | CET2 | OE179 | BAE409A |
|-----|---|----------------|--------|--------|--------------|-----|-------------|--------------|----------------|

| | | | | | | | | | |
|----------|---|--------|--------|-------------|--|--|--|--|----------------|
| 1.6 Flex | 4 | K4M766 | 82/110 | 06/06→11/08 | | | | | BAE409A |
|----------|---|--------|--------|-------------|--|--|--|--|----------------|

| | | | | | | | | | |
|---------|---|---------|--------|--------|--------------|-----|--|--|--|
| 1.9 dCi | 4 | F9QE804 | 81/109 | 05/05→ | CH271 | 11v | | | |
|---------|---|---------|--------|--------|--------------|-----|--|--|--|

| | | | | | | | | | |
|---------|---|------------------------|--------|-------------|--------------|-----|--|--|--|
| 1.9 dCi | 4 | F9Q803; F9Q804; F9Q812 | 85/114 | 05/05→01/09 | CH271 | 11v | | | |
|---------|---|------------------------|--------|-------------|--------------|-----|--|--|--|

RENAULT





kW/BHP

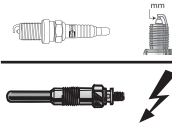

eon TITAN

IRIDIUM



...RENAULT



...GRAND SCÉNIC II

| | | | | | | | | | | |
|---------|---|--------------------------------------|---------|--------|--------------------------------------|-----|------|-------|---------|--|
| 1.9 dCi | 4 | F9Q812 | 88/118 | 04/04→ | CH271 | 11v | | | | CCU154 →Eng.050111 [10] [360] CCU147 Eng.050112→ [11] [352] |
| 1.9 dCi | 4 | F9Q816; F9Q818; F9QEE804; F9QJ803 | 96/129 | 05/05→ | CH271 | 11v | | | | CCU154 →Eng.050111 [10] [360] CCU147 Eng.050112→ [11] [352] |
| 2.0 | 4 | F4R770; F4R771 | 99/133 | 04/04→ | OE033 | 0,9 | CET2 | OE179 | BAE409A | |
| 2.0 | 4 | F4R776 | 120/161 | 04/04→ | OE033 | 0,9 | CET2 | OE179 | BAE409A | |
| 2.0 dCi | 4 | M9R700; M9R721; M9R722 | 110/148 | 09/05→ | CCGP007 Eng.061129→ [14] [154] | 7v | | | | |

GRAND SCÉNIC III

| | | | | | | | | | | |
|----------------|---|----------|---------|--------|-------------------------|-----|---------|-------|---------------------------|--|
| 1.2 TCe | 4 | H5F400 | 85/114 | 04/12→ | | | | OE261 | BAEA131E | |
| 1.2 TCe | 4 | H5F404 | 97/130 | 01/13→ | | | | OE261 | BAEA131E | |
| 1.4 16V | 4 | H4J700 | 96/129 | 02/09→ | OE225 | 0,7 | CET1 3P | | BAEA066E | |
| 1.6 16V | 4 | K4M858 | 81/109 | 02/09→ | OE033 | 0,9 | CET2 | OE179 | | |
| 1.6 16V | 4 | K4M.8.66 | 81/109 | 02/09→ | | | | | BAE409A 06/09→ | |
| 1.6 16V Bifuel | 4 | K4M866 | 81/109 | 02/09→ | OE033 | 0,9 | CET2 | OE179 | BAE409A | |
| 2.0 16V | 4 | M4R711 | 103/138 | 02/09→ | OE207 | 1,1 | | | BAEA161E ^[300] | |
| 2.0 dCi | 4 | M9R615 | 110/148 | 02/09→ | CCGP007 ^[14] | 7v | | | | |
| 2.0 dCi | 4 | M9R610 | 118/158 | 04/09→ | CCGP007 ^[14] | 7v | | | | |

GRAND SCÉNIC IV

| | | | | | | | | | | |
|-------------|---|--------|--------|--------|--|--|--|--|----------|--|
| 1.2 TCe 115 | 4 | H5F408 | 85/114 | 09/16→ | | | | | BAEA131E | |
| 1.2 TCe 130 | 4 | H5F408 | 96/129 | 09/16→ | | | | | BAEA131E | |

KADJAR

| | | | | | | | | | | |
|-------------|---|--------|--------|--------|--|--|--|-------|----------|--|
| 1.2 TCe 130 | 4 | H5F408 | 96/129 | 06/15→ | | | | OE261 | BAEA131E | |
|-------------|---|--------|--------|--------|--|--|--|-------|----------|--|

KANGOO

| | | | | | | | | | | |
|---------|---|---|-------|-------------|-------------------------------------|------------|------|-------|--|--|
| 1.2 | 4 | D7F710; D7F720; D7F722; D7F726; D7F744; D7F746 | 43/58 | 08/97→ | OE026 | 0,9 | CET2 | OE179 | BAEA345 →10/98 BAEA354 11/98→ | CLS040 ^[275] →09/99 CLS083 ^[275] 10/99→ |
| 1.2 16V | 4 | D4F712; D4F714; D4F716; D4F730 | 55/74 | 06/01→ | OE130 *to be adjusted | 0,8* | CET4 | | BAEA345 ^[275] 03/03→ BAE947A ^[275] 07/04→ BAEA325 ^[275] 07/04→ BAEA454 [150] [275] | CLS084 ^[296] |
| 1.4 | 4 | E7J634; E7J635 | 55/74 | 08/97→ | OE026 | 0,9 | CET2 | OE179 | BAEA354 09/98→12/07 | CLS117 →08/98 |
| 1.4 | 4 | E7J780 | 55/74 | 08/97→ | OE026 | 0,9 | CET2 | OE179 | BAEA242 [7] [37] BAEA243 [14] [39] | CLS011 |
| 1.4 | 4 | K7J700; K7J701 | 55/74 | 08/97→ | OE026 OE216 ^{LPG [278]} | 0,9 0,8 | CET2 | OE179 | BAEA354 09/98→12/07 | CLS117 →08/98 |
| 1.5 dCi | 4 | K9K704 | 42/56 | 07/03→ | CH271 | 11v | | | CCU154 ^[10] | |
| 1.5 dCi | 4 | K9K700; K9K702 | 45/60 | 04/05→06/10 | CH271 | 11v | | | CCU154 ^[10] | |
| 1.5 dCi | 4 | K9K700; K9K704 | 48/64 | 12/01→ | CH271 | 11v | | | CCU154 ^[10] | |
| 1.5 dCi | 4 | K9K714 | 50/67 | 06/05→ | CH271 | 11v | | | CCU154 ^[10] | |
| 1.5 dCi | 4 | K9K702; K9K710 | 60/80 | 07/02→ | CH271 | 11v | | | CCU154 ^[10] | |

RENAULT





KW/BHP



eon TITAN

IRIDIUM

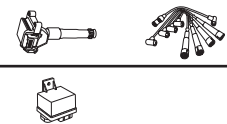

...RENAULT



...KANGOO

| | | | | | | | | | |
|----------------------|---|-----------------------------------|-------|-------------|----------------------------|-----|------|-------|--|
| 1.5 dCi | 4 | K9K718 | 62/83 | 06/05→ | CH271 | 11v | | | CCU154 ^[10] |
| 1.6 | 4 | K7M746 | 66/89 | 09/99→06/01 | OE026 | 0,9 | CET2 | OE179 | BAEA354 |
| | | | | | OE216 ^{LPG [278]} | 0,8 | | | |
| 1.6 16V, 1.6 16V 4WD | 4 | K4M706; K4M750; K4M752; K4M753 | 70/94 | 06/01→ | OE033 | 0,9 | CET2 | OE179 | BAE409A |
| 1.6 16V bivalent | 4 | K4M850 | 60/80 | 06/05→ | OE033 | 0,9 | CET2 | OE179 | |
| 1.9 D 55 | 4 | F8Q662 | 40/54 | 08/97→ | CH217 →02/99 | 11v | | | CCU128 ^[329] |
| | | | | | CH233 03/99→ | 11v | | | CCU129 ^[338] |
| 1.9 D 65 | 4 | F8Q632 | 47/63 | 08/97→ | CH233 | 11v | | | CCU128 ^[329] CCU129 ^[338] |
| 1.9 D 65 | 4 | F8Q630 | 47/63 | 08/97→ | CH217 | 11v | | | CCU128 ^[329] CCU129 ^[338] |
| 1.9 dCi 4WD | 4 | F9Q790 | 62/83 | 10/03→ | CH271 | 11v | | | CCU129 ^[338] CCU154 ^[10] |
| 1.9 dCi 4WD, 1.9 dTi | 4 | F9Q780; F9Q782; F9Q790 | 59/79 | 02/00→ | CH271 | 11v | | | CCU129 ^[338] CCU154 ^[10] |
| 1.9 RXED | 4 | F8Q630; F8Q632 | 48/64 | 09/99→06/01 | CH217 | 11v | | | CCU128 ^[329] CCU129 ^[338] |

KANGOO / GRAND KANGOO

| | | | | | | | | | |
|-------------------------|---|-----------------------------------|--------|--------|----------------------------|-----|------|-------|---------------------------------|
| 1.2 TCe 115 | 4 | H5F400; H5F408; H5F412 | 84/113 | 07/13→ | | | | OE261 | BAEA131E |
| 1.6 | 4 | K7M750 | 64/86 | 02/08→ | OE026 | 0,9 | CET2 | OE179 | BAEA354 ^[101] CLS019 |
| | | | | | OE216 ^{LPG [278]} | 0,8 | | | |
| 1.6 16V | 4 | K4M.8.30 | 78/105 | 02/08→ | | | | | BAE409A |
| 1.6 16V, 1.6 16VHi-Flex | 4 | K4M830; K4M831; K4M834; K4M850 | 78/105 | 02/08→ | OE033 | 0,9 | CET2 | OE179 | |
| 1.6 16VHi-Flex | 4 | K4M.8.34 | 78/105 | 02/08→ | | | | | BAE409A 01/09→ |

KANGOO BE BOP

| | | | | | | | | | |
|-----|---|--------|--------|--------|-------|-----|------|-------|---------|
| 1.6 | 4 | K4M830 | 78/105 | 02/09→ | OE033 | 0,9 | CET2 | OE179 | BAE409A |
|-----|---|--------|--------|--------|-------|-----|------|-------|---------|

KAPTUR

| | | | | | | | | | |
|-----|---|----------------|--------|--------|--|--|--|--|-------------------------|
| 1.6 | 4 | H4M429; H4M438 | 84/113 | 03/16→ | | | | | BAEA131E [105] [375] |
|-----|---|----------------|--------|--------|--|--|--|--|-------------------------|

KOLEOS I

| | | | | | | | | | |
|----------------------|---|---|---------|--------|-------------------------|-----|--|--|----------|
| 2.0 dCi, 2.0 dCi 4WD | 4 | M9R832; M9R833; M9R834; M9R835; M9R836; M9R838; M9R850; M9R855; M9R856; M9R862; M9R865; M9R866 | 110/148 | 09/08→ | CCGP007 ^[14] | 7v | | | |
| 2.0 dCi 4WD | 4 | M9R830 | 127/170 | 09/08→ | CCGP007 ^[14] | 7v | | | |
| 2.5, 2.5 4WD | 4 | 2TR700; 2TR702; 2TR703 | 126/169 | 09/08→ | OE207 | 1,1 | | | BAEA088E |

LAGUNA

| | | | | | | | | | |
|---------------|---|--|---------|-------------|-------------------------|-----|------|-------|---------|
| 2.0 16V Turbo | 4 | F4R811; F4Ri811 | 125/168 | 09/08→12/15 | OE033 | 0,9 | CET2 | OE179 | BAE409A |
| 2.0 dCi | 4 | M9R744; M9R748; M9R754; M9R802; M9R805; M9R808; M9R814; M9R845; M9R854; M9R858 | 110/148 | 09/08→12/15 | CCGP007 [14] [154] | 7v | | | |
| 2.0 dCi | 4 | M9R800; M9R806; M9R809; M9R815; M9R849; M9R854; M9R857 | 127/170 | 09/08→12/15 | CCGP007 [14] [154] | 7v | | | |
| 2.0 dCi GT | 4 | M9R816; M9R820; M9R828 | 131/176 | 09/08→12/15 | CCGP007 [14] [154] | 7v | | | |
| 2.0 GT | 4 | F4R800 | 150/201 | 09/08→12/15 | OE033 | 0,9 | CET2 | OE179 | BAE409A |
| 3.0 dCi | 6 | V9X791; V9X891 | 173/232 | 09/08→12/15 | CCGP007 ^[14] | 7v | | | |
| 3.0 dCi | 6 | V9X891 | 177/237 | 01/12→12/15 | CCGP007 ^[14] | 7v | | | |

RENAULT



kW/BHP

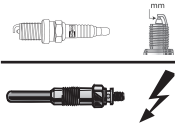

eon TITAN

IRIDIUM

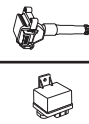

...RENAULT



...LAGUNA

| | | | | | | | | | |
|--------|---|--------|---------|---------------|-------|-----|--|--|----------|
| 3.5 V6 | 6 | V4Y713 | 175/235 | 09/08 → 12/15 | OE207 | 1,1 | | | BAEA158E |
|--------|---|--------|---------|---------------|-------|-----|--|--|----------|

LAGUNA I

| | | | | | | | | | |
|---------|---|----------------|--------|---------------|-------|-----|------|-------|---------|
| 1.6 16V | 4 | K4M720; K4M724 | 79/106 | 11/97 → 03/01 | OE033 | 0,9 | CET2 | OE179 | BAE409A |
|---------|---|----------------|--------|---------------|-------|-----|------|-------|---------|

| | | | | | | | | | |
|-----|---|--------|-------|---------------|--|--|------|-------|--|
| 1.8 | 4 | F3P720 | 66/89 | 11/93 → 03/01 | | | CET8 | OE195 | |
|-----|---|--------|-------|---------------|--|--|------|-------|--|

| | | | | | | | | | |
|-----|---|--------|-------|---------------|--|--|------|-------|------------------------|
| 1.8 | 4 | F3P724 | 66/89 | 11/93 → 03/01 | | | CET8 | OE195 | BAEA251 [265] [292] |
|-----|---|--------|-------|---------------|--|--|------|-------|------------------------|

| | | | | | | | | | |
|-----|---|--------|-------|---------------|--|--|------|-------|--------------|
| 1.8 | 4 | F3P670 | 66/89 | 11/93 → 03/01 | | | CET8 | OE195 | CLS116 [292] |
|-----|---|--------|-------|---------------|--|--|------|-------|--------------|

| | | | | | | | | | |
|-----|---|--------|-------|---------------|--|--|------|-------|------------------------------|
| 1.8 | 4 | F3P678 | 66/89 | 11/93 → 03/01 | | | CET8 | OE195 | BAEA251 [265] [292] |
| | | | | | | | | | BAEA251 [265] [275] [292] |

| | | | | | | | | | |
|-----|---|--------|-------|---------------|--|--|--|--|------------------|
| 1.8 | 4 | F3P670 | 66/89 | 11/93 → 03/01 | | | | | CLS039 CLS052 |
|-----|---|--------|-------|---------------|--|--|--|--|------------------|

| | | | | | | | | | |
|-----|---|--------|-------|---------------|--|--|--|--|--------------|
| 1.8 | 4 | F3P720 | 66/89 | 11/93 → 03/01 | | | | | CLS116 [292] |
|-----|---|--------|-------|---------------|--|--|--|--|--------------|

| | | | | | | | | | |
|-----|---|--------|-------|---------------|--|--|------|-------|--|
| 1.8 | 4 | F3P674 | 69/93 | 06/95 → 03/01 | | | CET8 | OE195 | |
|-----|---|--------|-------|---------------|--|--|------|-------|--|

| | | | | | | | | | |
|-----|---|------------------------|-------|---------------|--|--|------|-------|------------------------------|
| 1.8 | 4 | F3P678; F3P720; F3P724 | 69/93 | 06/95 → 03/01 | | | CET8 | OE195 | BAEA251 [265] [275] [292] |
|-----|---|------------------------|-------|---------------|--|--|------|-------|------------------------------|

| | | | | | | | | | |
|-----|---|--------|-------|---------------|-------|-----|------|-------|--|
| 1.8 | 4 | F3P676 | 70/94 | 06/95 → 06/98 | OE006 | 0,9 | CET8 | OE195 | |
|-----|---|--------|-------|---------------|-------|-----|------|-------|--|

| | | | | | | | | | |
|---------|---|----------------|--------|---------------|-------|-----|------|-------|---------|
| 1.8 16V | 4 | F4P760; F4P770 | 88/118 | 04/98 → 03/01 | OE033 | 0,9 | CET2 | OE179 | BAE409A |
|---------|---|----------------|--------|---------------|-------|-----|------|-------|---------|

| | | | | | | | | | |
|---------|---|--------|--------|---------------|-------|-----|--|--|-----------------------------|
| 1.9 dCi | 4 | F9Q718 | 79/106 | 09/99 → 03/01 | CH271 | 11v | | | CCU129 [338] CCU154 [10] |
|---------|---|--------|--------|---------------|-------|-----|--|--|-----------------------------|

| | | | | | | | | | |
|---------|---|--------|-------|---------------|-------|-----|--|--|-----------------------------|
| 1.9 dTi | 4 | F9Q710 | 72/97 | 10/97 → 03/01 | CH271 | 11v | | | CCU129 [338] CCU154 [10] |
|---------|---|--------|-------|---------------|-------|-----|--|--|-----------------------------|

| | | | | | | | | | |
|---------|---|--------|-------|---------------|-------|-----|--|--|-----------------------------|
| 1.9 dTi | 4 | F9Q716 | 72/97 | 10/97 → 03/01 | CH169 | 11v | | | CCU129 [338] CCU154 [10] |
|---------|---|--------|-------|---------------|-------|-----|--|--|-----------------------------|

| | | | | | | | | | |
|---------|---|--------|-------|---------------|--|--|--|--|-----------------------------|
| 1.9 dTi | 4 | F9Q717 | 72/97 | 10/97 → 03/01 | | | | | CCU129 [338] CCU154 [10] |
|---------|---|--------|-------|---------------|--|--|--|--|-----------------------------|

| | | | | | | | | | |
|-----|---|--|-------|---------------|-------|-----|------|-------|--|
| 2.0 | 4 | | 70/94 | 11/93 → 03/01 | OE006 | 0,9 | CET8 | OE195 | |
|-----|---|--|-------|---------------|-------|-----|------|-------|--|

| | | | | | | | | | |
|-----|---|--------|--------|---------------|-------|-----|------|-------|------------------|
| 2.0 | 4 | F3R611 | 80/107 | 03/99 → 03/01 | OE006 | 0,9 | CET8 | OE195 | CLS039 CLS052 |
|-----|---|--------|--------|---------------|-------|-----|------|-------|------------------|

| | | | | | | | | | |
|-----|---|----------------|--------|---------------|--|--|------|-------|-----------------------------------|
| 2.0 | 4 | F3R722; F3R723 | 83/111 | 11/93 → 03/01 | | | CET8 | OE195 | BAEA251 01/96 → [265] [292] |
|-----|---|----------------|--------|---------------|--|--|------|-------|-----------------------------------|

| | | | | | | | | | |
|-----|---|--------|--------|---------------|--|--|------|-------|--|
| 2.0 | 4 | F3R722 | 84/113 | 06/95 → 02/01 | | | CET8 | OE195 | |
|-----|---|--------|--------|---------------|--|--|------|-------|--|

| | | | | | | | | | |
|-----|---|----------------|--------|---------------|--|--|------|-------|--------|
| 2.0 | 4 | F3R728; F3R768 | 84/113 | 06/95 → 02/01 | | | CET8 | OE195 | CLS039 |
|-----|---|----------------|--------|---------------|--|--|------|-------|--------|

| | | | | | | | | | |
|-----|---|--------|---------|---------------|-------|-----|------|-------|---------------|
| 2.0 | 4 | F4R780 | 102/137 | 09/99 → 02/01 | OE033 | 0,9 | CET2 | OE179 | BAE409A [275] |
|-----|---|--------|---------|---------------|-------|-----|------|-------|---------------|

| | | | | | | | | | |
|-----|---|----------------|---------|---------------|-------|-----|------|--|---|
| 2.0 | 4 | N7Q700; N7Q704 | 103/138 | 06/95 → 02/01 | OE120 | 0,6 | CET2 | | BAEA254 [7] [37] [275] BAEA255 [14] [39] [275] |
|-----|---|----------------|---------|---------------|-------|-----|------|--|---|

| | | | | | | | | | |
|---------|---|----------------|---------|---------------|-------|-----|------|-------|--|
| 2.0 16V | 4 | N7Q700; N7Q704 | 102/137 | 06/95 → 03/01 | OE120 | 0,6 | CET2 | OE179 | BAEA254 [7] [37] BAEA254 [7] [37] [275] BAEA255 [14] [39] BAEA255 [14] [39] [275] |
|---------|---|----------------|---------|---------------|-------|-----|------|-------|--|

| | | | | | | | | | |
|---------|---|--------|---------|---------------|-------|-----|------|-------|---------|
| 2.0 16V | 4 | F4R780 | 103/138 | 09/99 → 03/01 | OE033 | 0,9 | CET2 | OE179 | BAE409A |
|---------|---|--------|---------|---------------|-------|-----|------|-------|---------|

| | | | | | | | | | |
|-------|---|-----------------------------------|-------|---------------|-------|-----|--|--|--|
| 2.2 D | 4 | G8T706; G8T752; G8T790; G8T794 | 61/82 | 11/93 → 03/01 | CH169 | 11v | | | |
|-------|---|-----------------------------------|-------|---------------|-------|-----|--|--|--|

| | | | | | | | | | |
|--------|---|--------|--------|---------------|-------|-----|--|--|--|
| 2.2 dT | 4 | G8T760 | 83/111 | 03/96 → 03/01 | CH169 | 11v | | | |
|--------|---|--------|--------|---------------|-------|-----|--|--|--|

| | | | | | | | | | |
|-----|---|----------------|---------|---------------|--|--|------|-------|---------------------------------------|
| 3.0 | 6 | Z7X760; Z7X765 | 123/165 | 11/93 → 03/01 | | | CET2 | OE179 | BAEA251 [265] [275] [292] [372] |
|-----|---|----------------|---------|---------------|--|--|------|-------|---------------------------------------|

| | | | | | | | | | |
|---------|---|----------------|---------|---------------|--------------------------|------------|------|-------|--|
| 3.0 24V | 6 | L7X700; L7X701 | 140/188 | 03/97 → 03/01 | OE026 OE218 LPG [278] | 0,9 1,6 | CET2 | OE179 | |
|---------|---|----------------|---------|---------------|--------------------------|------------|------|-------|--|

LAGUNA II

| | | | | | | | | | |
|-----|---|--------|--------|---------------|-------|-----|--|--|---------|
| 1.6 | 4 | K4M710 | 76/102 | 03/01 → 10/05 | OE033 | 0,9 | | | BAE409A |
|-----|---|--------|--------|---------------|-------|-----|--|--|---------|

RENAULT





kW/BHP

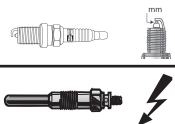

eon TITAN

IRIDIUM

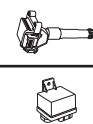

...RENAULT



...LAGUNA II

| | | | | | | | | | |
|--------------------------|---|--|---------|-------------|---|------------|--------|-------|--|
| 1.6 16V | 4 | K4M710; K4M714 | 79/106 | 03/01→12/07 | OE033 | 0,9 | CET2 | OE179 | BAE409A |
| 1.6 16V | 4 | K4M716 | 82/110 | 02/05→08/07 | OE033 | 0,9 | CET2 | OE179 | BAE409A |
| 1.6 FlexFuel | 4 | K4M718 | 76/102 | 06/01→10/03 | OE033 | 0,9 | CET2 | OE179 | |
| 1.6 LPG | 4 | K4M714 | 79/106 | 03/01→05/05 | | | | | BAE409A |
| 1.8 16V | 4 | F4P770; F4P771; F4P773; F4P774; F4P775 | 85/114 | 03/01→12/07 | OE033 | 0,9 | CET2 | OE179 | BAE409A |
| 1.8 16V | 4 | F4P770; F4P774 | 86/115 | 03/01→05/05 | OE033 | 0,9 | CET2 | OE179 | BAE409A |
| 1.8 16V | 4 | F4P770; F4P773 | 88/118 | 03/01→09/07 | OE033 | 0,9 | CET2 | OE179 | BAE409A |
| 1.8 16V | 4 | F4P770; F4P772; F4P774 | 89/119 | 03/01→05/05 | OE033 | 0,9 | CET2 | OE179 | BAE409A |
| 1.9 dCi | 4 | F9Q664 | 66/89 | 08/03→09/07 | CH271 | 11v | | | CCU154 ^[10] |
| 1.9 dCi | 4 | F9Q664 | 68/91 | 03/04→05/05 | CH271 | 11v | | | CCU154 ^[10] |
| 1.9 dCi | 4 | F9Q752; F9Q754 | 74/99 | 10/01→05/05 | CH271 | 11v | | | CCU154 ^[10] |
| 1.9 dCi | 4 | F9Q752 | 77/103 | 06/01→05/05 | CH271 | 11v | | | CCU154 ^[10] |
| 1.9 dCi | 4 | F9Q718; F9Q754 | 79/106 | 03/01→12/07 | CH271 | 11v | | | CCU154 ^[10] |
| 1.9 dCi | 4 | F9Q674; F9Q758 | 81/109 | 01/05→12/07 | CH271 | 11v | | | CCU154 ^[10] |
| 1.9 dCi | 4 | F9Q750; F9Q758; F9Q759 | 85/114 | 08/05→12/07 | CH271 | 11v | | | CCU154 ^[10] |
| 1.9 dCi | 4 | F9Q650; F9Q670; F9Q674; F9Q750 | 88/118 | 03/01→09/07 | CH271 | 11v | | | CCU154 ^[10] |
| 1.9 dCi | 4 | F9Q750 | 92/123 | 09/05→12/07 | CH271 | 11v | | | CCU154 ^[10] |
| 1.9 dCi | 4 | F9Q758; F9Q759 | 96/129 | 05/05→12/07 | CH271 | 11v | | | CCU154 ^[10] |
| 2.0 16V | 4 | F4R712; F4R713; F4R714; F4R715 | 98/131 | 08/02→09/07 | OE033 | 0,9 | CET2 | OE179 | BAE409A |
| 2.0 16V | 4 | F4R712; F4R713; F4R714; F4R715 | 99/133 | 08/02→12/07 | OE033 | 0,9 | CET2 | OE179 | BAE409A |
| 2.0 16V | 4 | F4R784; F4R786; F4R787 | 125/168 | 01/05→09/07 | OE033 | 0,9 | CET2 | OE179 | BAE409A |
| 2.0 16V | 4 | F4R886; F4R887 | 150/201 | 01/05→09/07 | OE033 | 0,9 | CET2 | OE179 | BAE409A →09/07 |
| 2.0 16V | 4 | F4R.784; F4R.786 | 150/201 | 01/05→09/07 | | | | | BAE409A |
| 2.0 16V IDE | 4 | F5R700 | 103/138 | 04/01→09/07 | OE175 | 1,0 | | | BAEA345 ^[275] |
| 2.0 16V IDE | 4 | F5R701 | 103/138 | 04/01→09/07 | OE175 | 1,0 | | | BAE409A BAEA345 ^[275] |
| 2.0 16V Turbo | 4 | F4R764; F4R765 | 120/161 | 01/03→08/05 | OE136 | 0,8 | CET12P | OE179 | BAE409A |
| 2.0 dCi | 4 | M9R740 | 110/148 | 08/05→08/06 | CH271 CCGP007 Eng.060904 061127→ [14] [154] | 11v 7v | | | CCU154 ^[10] |
| 2.0 dCi | 4 | M9R760 | 127/170 | 01/06→12/07 | CH271 CCGP007 Eng.060904 061127→ [14] [154] | 11v 7v | | | CCU154 ^[10] |
| 2.2 dCi | 4 | G9T600 | 85/114 | 04/04→10/05 | CH232 | 11v | | | CCU154 ^[10] |
| 2.2 dCi | 4 | G9T600; G9T605; G9T706; G9T707 | 102/137 | 05/05→12/07 | CH232 | 11v | | | CCU154 ^[10] |
| 2.2 dCi | 4 | G9T700; G9T702 | 110/148 | 10/01→08/06 | CH232 | 11v | | | CCU154 ^[10] |
| 3.0 V6 24V | 6 | L7X731 | 152/204 | 03/01→12/07 | OE175 | 1,0 | CET14P | OE190 | BAEA347 |
| LAGUNA III | | | | | | | | | |
| 1.5 dCi | 4 | K9K780; K9K782 | 81/109 | 10/07→12/15 | CH271 [289] [374] CH271 [9] [289] [337] | 11v 11v | | | |
| 1.6 16V | 4 | K4M824 | 81/109 | 10/07→12/15 | OE033 | 0,9 | CET2 | OE179 | BAE409A |
| 2.0 16V, 2.0 16V Hi-Flex | 4 | M4R704; M4R726 | 103/138 | 10/07→12/15 | OE207 | 1,1 | | | BAEA056E ^[275] BAEA161E [275] [300] |
| 2.0 16V Turbo | 4 | F4R811 | 125/168 | 10/07→12/15 | OE136 | 0,8 | CET12P | OE179 | BAE409A |

RENAULT



kW/BHP



eon TITAN

IRIDIUM



...RENAULT



...LAGUNA III

| | | | | | | | | | |
|------------|---|--|---------|-------------|-----------------------------|-----|-------------|--|-----------------|
| 2.0 dCi | 4 | M9R742; M9R744; M9R802; M9R814; M9R854; M9R858 | 96/129 | 10/07→12/15 | CCGP007 [14][154] | 7v | | | |
| 2.0 dCi | 4 | M9R742; M9R744; M9R746; M9R748; M9R754; M9R802; M9R805; M9R808; M9R814; M9R845; M9R854; M9R858 | 110/148 | 10/07→12/15 | CCGP007 [14][154] | 7v | | | |
| 2.0 dCi | 4 | M9R800; M9R806; M9R809; M9R815; M9R849; M9R854; M9R857; M9R858 | 127/170 | 01/08→12/15 | CCGP007 [14][154] | 7v | | | |
| 2.0 dCi GT | 4 | M9R816; M9R820; M9R828 | 131/176 | 03/08→12/15 | CCGP007 [14][154] | 7v | | | |
| 2.0 GT | 4 | F4R800 | 150/201 | 03/08→12/15 | OE136 | 0,8 | CET2 | | BAE409A |
| 3.0 dCi | 6 | V9X791; V9X891 | 173/232 | 09/08→12/15 | CCGP007 [14] | 7v | | | |
| 3.5 V6 | 6 | V4Y713 | 175/235 | 04/08→12/15 | OE207 | 1,1 | | | BAEA158E |

LATITUDE

| | | | | | | | | | |
|--------------------------------|---|------------------------|---------|--------|-----------------------------|-----|--|--|-----------------------|
| 2.0 16V, 2.0 16V eco2 Flexfuel | 4 | M4R746 | 103/138 | 02/11→ | OE207 | 1,1 | | | BAEA161E [300] |
| 2.0 dCi 150 | 4 | M9R824; M9R846 | 110/148 | 02/11→ | CCGP007 [14][154] | 7v | | | |
| 2.0 dCi 175 | 4 | M9R804; M9R817; M9R844 | 127/170 | 05/11→ | CCGP007 [14][154] | 7v | | | |
| 2.5 V6 | 6 | 2ZV604 | 130/174 | 05/11→ | OE207 | 1,1 | | | BAEA158E |
| 3.0 dCi 240 | 6 | V9X891 | 177/237 | 02/11→ | CCGP007 [14] | 7v | | | |

LOGAN I

| | | | | | | | | | | |
|---------|---|--|--------|-------------|---|---------------------------------|-------------|--------------|----------------|---------------|
| 1.4 | 4 | K7J710 | 55/74 | 09/04→ | OE033 →04/05 OE026 05/05→ OE033 →Eng.050425 OE026 Eng.050425→ OE216 LPG [278] Eng.050425→ | 0,9 0,9 0,9 0,9 0,8 | CET2 | OE179 | BAEA354 | CLS076 |
| 1.5 dCi | 4 | K9K792 | 50/67 | 04/07→ | CH271 | 11v | | | | |
| 1.5 dCi | 4 | K9K796 | 63/84 | 02/08→06/15 | CH271 | 11v | | | | |
| 1.6 | 4 | K7M710 | 64/86 | 09/04→ | OE033 →04/05 OE026 OE216 LPG [278] | 0,9 0,9 0,8 | CET2 | OE179 | BAEA354 | CLS076 |
| 1.6 | 4 | K4M690; K4M694; K4M696; K4M697; K4M698 | 77/103 | 04/07→ | OE033 | 0,9 | CET2 | OE179 | BAE409A | |

LOGAN II

| | | | | | | | | | | |
|-----|---|--------|--------|--------|--------------|-----|--|--|----------------|--|
| 1.6 | 4 | K7M812 | 60/80 | 04/14→ | OE026 | 0,9 | | | BAEA354 | |
| 1.6 | 4 | K4M842 | 75/101 | 04/14→ | | | | | BAE409A | |

MEGANE

| | | | | | | | | | | |
|---------|---|--------------------------------|--------|-------------|--------------|-----|-------------|--------------|------------------------------|---------------|
| 1.4 i | 4 | E7J764 | 55/74 | 01/97→09/99 | OE033 | 0,9 | CET2 | OE179 | BAEA251 [265][292] | CLS117 |
| 1.6 16V | 4 | K4M700; K4M701; K4M704; K4M708 | 79/106 | 04/98→10/99 | OE033 | 0,9 | CET2 | OE179 | BAE409A | |

RENAULT





kW/BHP

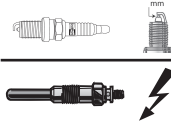

eon TITAN

IRIDIUM

**...RENAULT****...MEGANE**

| | | | | | | | | | | |
|------------------|---|------------------------|---------|-------------|----------------------------------|-----|--------|-------|---|-----------------------|
| 1.6 e | 4 | K7M702; K7M703 | 66/89 | 10/96→10/99 | OE033 | 0,9 | CET2 | OE179 | BAEA245 →03/97 [7] [37] | CLS014 →03/97 |
| | | | | | | | | | BAEA246 →03/97 [14] [39] [275] | CLS011 04/97→06/98 |
| | | | | | | | | | BAEA242 04/97→ [7] [37] | CLS019 07/98→ |
| | | | | | | | | | BAEA243 04/97→ [14] [39] [275] | |
| | | | | | | | | | BAEA354 09/97→ | |
| 1.6 i | 4 | K7M720 | 55/74 | 01/97→09/99 | OE033 | 0,9 | CET2 | OE179 | BAEA245 →03/97 [7] [37] | CLS014 →03/97 |
| | | | | | | | | | BAEA246 →03/97 [14] [39] | CLS011 04/97→06/98 |
| | | | | | | | | | BAEA242 04/97→ [7] [37] | CLS019 07/98→ |
| | | | | | | | | | BAEA243 04/97→ [14] [39] | |
| | | | | | | | | | BAEA354 09/97→ | |
| 1.9 D | 4 | F8Q790 | 47/63 | 03/97→09/99 | CH217 | 11v | | | | |
| 1.9 dT | 4 | F8Q784; F8Q786 | 66/89 | 01/97→09/99 | CH260 | 11v | | | | |
| 1.9 dTi | 4 | F9Q730; F9Q734 | 72/97 | 04/97→09/99 | CH169 | 11v | | | CCU129 ^[338] | |
| 2.0 i | 4 | F3R791; F3R796 | 80/107 | 01/99→09/99 | | | CET8 | OE195 | | CLS039 CLS052 |
| 2.0 i | 4 | F3R750; F3R751 | 84/113 | 01/97→09/99 | | | CET8 | OE195 | | CLS039 CLS052 |
| MEGANE CC | | | | | | | | | | |
| 1.2 TCe | 4 | H5F400 | 85/114 | 09/12→08/15 | | | | | BAEA131E | |
| 1.2 TCe | 4 | H5F404 | 97/130 | 01/13→ | | | | OE261 | BAEA131E | |
| 1.4 TCe | 4 | H4J700 | 96/129 | 06/10→ | OE225 | 0,7 | CET13P | | BAEA066E | |
| 1.6 16V | 4 | K4M858 | 81/109 | 06/10→ | OE033 | 0,9 | CET2 | OE179 | | |
| 1.6 16V | 4 | K4M.8.58 | 81/109 | 06/10→ | | | | | BAE409A | |
| 1.9 dCi | 4 | F9Q870 | 96/129 | 06/10→ | | | | | CCU129 ^[338] | |
| 2.0 CVT | 4 | M4R711; M4R713 | 103/138 | 06/10→ | OE207 | 1,1 | | | BAEA161E ^[300] | |
| 2.0 dCi | 4 | M9R610 | 118/158 | 06/10→ | CCGP007 ^{[14] [154]} | 7v | | | | |
| 2.0 TCe | 4 | F4R872 | 132/177 | 06/10→ | OE033 | 0,9 | CET2 | OE179 | BAE409A | |
| 2.0 TCe | 4 | F4R870 | 132/177 | 06/10→ | OE033 | 0,9 | CET2 | OE179 | | |
| 2.0 Turbo | 4 | F4R874 | 195/261 | 10/11→ | OE146 | 1,0 | CET12P | OE179 | BAE409A | |
| MEGANE I | | | | | | | | | | |
| 1.4 | 4 | E7J626 | 55/74 | 09/96→08/03 | OE033 | 0,9 | CET2 | OE179 | BAE409A BAEA354 | CLS019 CLS117 |
| 1.4 | 4 | E7J764 | 55/74 | 09/96→08/03 | OE033 | 0,9 | CET2 | OE179 | BAEA251 ^{[265] [292]} | CLS019 CLS117 |
| 1.4 16V | 4 | K4J700; K4J714; K4J750 | 70/94 | 03/99→08/03 | OE033 | 0,9 | CET2 | OE179 | BAE409A | |
| 1.4 e | 4 | E7J626 | 55/74 | 01/96→08/03 | OE033 | 0,9 | CET2 | OE179 | BAEA251 →02/99 ^{[265] [292]} BAE409A BAEA354 | CLS019 CLS117 |

RENAULT



kW/BHP

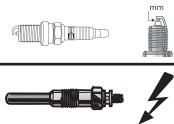

eon TITAN

IRIDIUM



...RENAULT



...MEGANE I

| | | | | | | | | | | |
|---------|---|---|--------|-------------|-------|-----|------|-------|---|---|
| 1.4 e | 4 | E7J764 | 55/74 | 01/96→08/03 | OE033 | 0,9 | CET2 | OE179 | BAEA251 →02/99 [265] [292] BAEA354 02/99→ | CLS117 |
| 1.4 Eco | 4 | E7J624 | 52/70 | 01/96→03/99 | OE033 | 0,9 | CET2 | OE179 | BAEA251 [265] [292] | CLS117 |
| 1.6 16V | 4 | K4M700; K4M701; K4M706; K4M708; K4M709 | 79/106 | 03/99→08/03 | OE033 | 0,9 | CET2 | OE179 | BAE409A | |
| 1.6 e | 4 | K7M702; K7M703 | 66/89 | 01/96→08/03 | OE033 | 0,9 | CET2 | OE179 | BAEA245 →03/97 [7] [37] BAEA246 →03/97 [14] [39] BAEA242 04/97→ [7] [37] BAEA243 04/97→ [14] [39] BAEA354 BAEA354 ^[144] BAEA245 →Eng.970310 [7] [37] [145] BAEA246 →Eng.970310 [14] [39] [146] BAEA242 Eng.970310→ Eng.980708 [7] [37] [140] BAEA243 Eng.970310→ Eng.980708 [14] [39] [141] | CLS014 →03/97 CLS011 04/97→06/98 CLS019 |
| 1.6 e | 4 | K7M790 | 66/89 | 01/96→08/03 | OE033 | 0,9 | CET2 | OE179 | BAEA245 →03/97 [7] [37] BAEA246 →03/97 [14] [39] BAEA242 04/97→ [7] [37] BAEA243 04/97→ [14] [39] BAEA354 08/98→ | CLS014 →03/97 CLS011 04/97→06/98 CLS019 07/98→ |
| 1.6 i | 4 | K7M720 | 55/74 | 01/96→03/99 | OE033 | 0,9 | CET2 | OE179 | BAEA245 →03/97 [7] [37] BAEA246 →03/97 [14] [39] BAEA242 04/97→ [7] [37] BAEA243 04/97→ [14] [39] | CLS014 →03/97 CLS011 04/97→06/98 CLS019 07/98→ |
| 1.6 LPG | 4 | K4M704 | 80/107 | 10/00→08/02 | OE033 | 0,9 | CET2 | OE179 | BAE409A | |
| 1.8 16V | 4 | F4P720; F4P722 | 85/114 | 01/01→08/03 | OE033 | 0,9 | CET2 | OE179 | BAE409A | |



kW/BHP

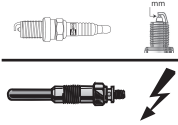

eon TITAN

IRIDIUM

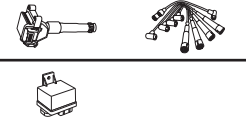

...RENAULT



...MEGANE I

| | | | | | | | | | | |
|------------------|---|--|---------|-------------|---|------|------|-------|--|------------------|
| 1.9 D | 4 | F8Q622 | 47/63 | 09/96→08/03 | CH233 | 11v | | | CCU129 ^[338] CCU129 ^[338] →Eng.000400 CCU154 Eng.000401→ [10] [360] | |
| 1.9 D | 4 | F8Q790 | 47/63 | 09/96→08/03 | CH233 | 11v | | | CCU129 ^[338] →Eng.000400 CCU154 Eng.000401→ [10] [360] | |
| 1.9 D, 1.9 D Eco | 4 | F8Q620; F8Q622; F8Q624 | 47/63 | 01/96→08/03 | CH206 | 11v | | | CCU129 ^[338] | |
| 1.9 D, 1.9 TDI | 4 | F8Q784 | 69/93 | 04/96→08/03 | CH260 | 11v | | | CCU129 ^[338] | |
| 1.9 dCi | 4 | F9Q732; F9Q733; F9Q738 | 75/101 | 02/01→08/03 | CH271 | 11v | | | CCU129 ^[338] CCU154 ^[10] | |
| 1.9 dCi, 1.9 dCi | 4 | F9Q732; F9Q733; F9Q738 | 77/103 | 03/99→08/03 | CH271 | 11v | | | CCU129 ^[338] | |
| 1.9 dT | 4 | F8Q784; F8Q786 | 66/89 | 01/96→08/03 | CH260 | 11v | | | CCU129 ^[338] | |
| 1.9 dTi | 4 | F9Q744 | 59/79 | 02/01→08/03 | CH271 | 11v | | | CCU129 ^[338] CCU154 ^[10] | |
| 1.9 DTi | 4 | F9Q730 | 60/80 | 02/00→09/00 | CH169 | 11v | | | CCU129 ^[338] | |
| 1.9 dTi | 4 | F9Q731; F9Q736 | 72/97 | 03/97→02/01 | CH271 | 11v | | | CCU129 ^[338] | |
| 1.9 dTi | 4 | F9Q730; F9Q734 | 72/97 | 03/97→02/01 | CH169 | 11v | | | CCU129 ^[338] | |
| 2.0 | 4 | F3R750; F3R751; F3R752; F3R791; F3R796; F3R797; F3R798 | 85/114 | 05/98→05/01 | OE006 | 0,9 | CET8 | | | |
| 2.0, 2.0 i | 4 | F3R750; F3R752; F3R791; F3R796; F3R797; F3R798 | 84/113 | 01/96→08/03 | | | CET8 | OE195 | | CLS039 CLS052 |
| 2.0 16V | 4 | F4R746; F4R770 | 102/137 | 01/02→08/03 | OE033 | 0,9 | CET2 | OE179 | BAE409A | |
| 2.0 16V | 4 | F7R710; F7R714 | 108/145 | 03/96→08/03 | | | CET2 | OE179 | BAEA345 02/99→ BAE409A | |
| 2.0 16V IDE | 4 | F5R740 | 103/138 | 11/99→08/03 | OE175 | 1,0 | | | BAEA345 | CLS039 CLS052 |
| 2.0 i | 4 | F3R750; F3R751; F3R752; F3R797; F3R798 | 80/107 | 03/99→08/03 | OE006 <small>*to be adjusted</small> | 0,8* | CET8 | OE195 | | CLS039 CLS052 |
| 2.0 i | 4 | F3R791; F3R796 | 80/107 | 03/99→08/03 | OE006 <small>*to be adjusted</small> | 0,8* | CET8 | OE195 | BAEA345 | CLS039 CLS052 |
| 2.0 i | 4 | F3R750; F3R751; F3R798 | 84/113 | 01/96→08/03 | | | CET8 | OE195 | | CLS039 CLS052 |
| 2.0 RT | 4 | F4R747; F5R740 | 103/138 | 03/01→08/03 | OE033 | 0,9 | | | BAE409A | |
| MEGANE II | | | | | | | | | | |
| 1.4, 1.4 16V | 4 | K4J732 | 60/80 | 09/03→ | OE033 | 0,9 | CET2 | OE179 | BAE409A | |
| 1.4, 1.4 16V | 4 | K4J730; K4J740 | 72/97 | 11/02→ | OE033 | 0,9 | CET2 | OE179 | BAE409A | |
| 1.5 dCi | 4 | K9K722 | 60/80 | 09/02→12/10 | CH271 | 11v | | | CCU154 →Eng.050116 [10] [360] CCU147 Eng.050117→ [11] [352] | |
| 1.5 dCi | 4 | K9K724 | 63/84 | 05/05→12/10 | CH271 | 11v | | | CCU154 →Eng.050116 [10] [360] CCU147 Eng.050117→ [11] [352] | |

RENAULT



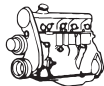

kW/BHP

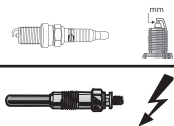

eon TITAN

IRIDIUM



...RENAULT



...MEGANE II

| | | | | | | | | | |
|--|---|-----------------------------------|--------|-------------|-------|-----|------|-------|--|
| 1.5 dCi | 4 | K9K728; K9K729 | 74/99 | 10/03→12/10 | CH271 | 11v | | | CCU154 →Eng.050116 [10] [360] CCU147 Eng.050117→ [11] [352] |
| 1.5 dCi | 4 | K9K734 | 76/102 | 10/03→12/10 | CH271 | 11v | | | CCU147 [11] [352] CCU154 →Eng.050116 [10] [360] CCU147 Eng.050117→ [11] [352] |
| 1.5 dCi | 4 | K9K732 | 78/105 | 05/05→12/10 | CH271 | 11v | | | CCU147 [11] [352] CCU154 →Eng.050116 [10] [360] CCU147 Eng.050117→ [11] [352] |
| 1.6 | 4 | K4M768 | 75/101 | 09/03→ | OE033 | 0,9 | CET2 | OE179 | BAE409A |
| 1.6 | 4 | K4M762 | 77/103 | 05/05→ | OE033 | 0,9 | CET2 | OE179 | |
| 1.6 | 4 | K4M.7.64 | 77/103 | 05/05→ | | | | | BAE409A |
| 1.6 | 4 | K4M760; K4M761 | 81/109 | 09/03→11/08 | OE033 | 0,9 | CET2 | OE179 | |
| 1.6, 1.6 16V | 4 | K4M760; K4M761 | 83/111 | 11/02→ | OE033 | 0,9 | CET2 | OE179 | BAE409A |
| 1.6, 1.6 16V, 1.6 16VHi-Flex, 1.6 Flex-Fuel | 4 | K4M762; K4M788; K4M856 | 77/103 | 05/05→ | OE033 | 0,9 | CET2 | OE179 | BAE409A |
| 1.6 16V | 4 | K4M760; K4M761; K4M812; K4M813 | 82/110 | 01/06→ | OE033 | 0,9 | CET2 | OE179 | BAE409A |
| 1.6 Bifuel | 4 | K4M788 | 77/103 | 06/05→02/08 | OE033 | 0,9 | | | BAE409A |
| 1.6 Hi-Flex | 4 | K4M766 | 85/114 | 03/06→ | OE033 | 0,9 | CET2 | OE179 | BAE409A |
| 1.9 dCi | 4 | F9Q808 | 66/89 | 11/02→12/05 | CH271 | 11v | | | CCU154 →Eng.050111 [10] [360] CCU154 →Eng.050116 [10] [360] CCU147 [352] Eng.050112→ CCU147 Eng.050117→ [11] [352] |
| 1.9 dCi | 4 | F9Q808 | 68/91 | 03/04→ | CH271 | 11v | | | CCU154 →Eng.050111 [10] [360] CCU154 →Eng.050116 [10] [360] CCU147 [352] Eng.050112→ CCU147 Eng.050117→ [11] [352] |
| 1.9 dCi | 4 | F9Q804; F9Q818 | 81/109 | 05/05→ | CH271 | 11v | | | CCU154 →Eng.050111 [10] [360] CCU154 →Eng.050116 [10] [360] CCU147 [352] Eng.050112→ CCU147 Eng.050117→ [11] [352] |



kW/BHP



eon TITAN

IRIDIUM



...RENAULT



...MEGANE II

| | | | | | | | | | | |
|-------------------------|---|------------------------|---------|-------------|--------------------------------------|-----|--------|-------|--|---|
| 1.9 dCi | 4 | F9Q803; F9Q816 | 81/109 | 05/05→ | CH271 | 11v | | | | CCU154 →Eng.050111 [10] [360] CCU147 ^[352] Eng.050112→ |
| 1.9 dCi | 4 | F9Q804; F9Q816; F9Q818 | 85/114 | 11/02→07/09 | CH271 | 11v | | | | CCU154 →Eng.050111 [10] [360] CCU154 →Eng.050116 [10] [360] CCU147 ^[352] Eng.050112→ CCU147 Eng.050117→ [11] [352] |
| 1.9 dCi | 4 | F9Q800 | 88/118 | 11/02→ | CH271 | 11v | | | | CCU154 →Eng.050111 [10] [360] CCU154 →Eng.050116 [10] [360] CCU147 ^[352] Eng.050112→ CCU147 Eng.050117→ [11] [352] |
| 1.9 dCi | 4 | F9Q816; F9Q818 | 96/129 | 05/05→ | CH271 | 11v | | | | CCU154 →Eng.050116 [10] [360] CCU147 Eng.050117→ [11] [352] |
| 1.9 dCi | 4 | F9Q803; F9Q804 | 96/129 | 05/05→ | CH271 | 11v | | | | CCU154 →Eng.050111 [10] [360] CCU154 →Eng.050116 [10] [360] CCU147 ^[352] Eng.050112→ CCU147 Eng.050117→ [11] [352] |
| 2.0 | 4 | F4R770; F4R771 | 102/137 | 09/03→01/11 | | | | | | BAE409A |
| 2.0 | 4 | F4R774 | 169/227 | 08/06→02/08 | OE033 | 0,9 | CET2 | OE179 | | BAE409A |
| 2.0, 2.0 16V | 4 | F4R770; F4R771 | 99/133 | 11/02→ | OE033 | 0,9 | CET2 | OE179 | | BAE409A |
| 2.0 16V Turbo | 4 | F4R776 | 120/161 | 05/04→03/09 | OE136 | 0,8 | CET12P | OE179 | | BAE409A |
| 2.0 dCi | 4 | M9R700; M9R722 | 110/148 | 09/05→ | CCGP007 Eng.061129→ [14] [154] | 7v | | | | |
| 2.0 dCi | 4 | M9R724 | 127/170 | 01/07→02/08 | CCGP007 Eng.061129→ [14] [154] | 7v | | | | |
| 2.0 Renault Sport | 4 | F4R774; F4R774 | 165/221 | 05/04→10/09 | | | CET11P | OE179 | | BAE409A |
| MEGANE III | | | | | | | | | | |
| 1.2 TCe | 4 | H5F400 | 85/114 | 03/12→ | | | | | | BAEA131E |
| 1.2 TCe | 4 | H5F404 | 97/130 | 01/13→ | | | | OE261 | | BAEA131E |
| 1.4 TCe | 4 | H4J700 | 96/129 | 04/09→ | OE225 | 0,7 | CET13P | | | BAEA066E |
| 1.6 16V | 4 | K4M848 | 74/99 | 11/08→ | OE033 | 0,9 | CET2 | OE179 | | BAE409A |
| 1.6 16V | 4 | K4M858; K4M866 | 82/110 | 11/08→ | OE033 | 0,9 | CET2 | | | BAE409A |
| 1.6 16V | 4 | K4M | 82/110 | 11/08→ | | | | OE179 | | |
| 1.6 16V, 1.6 16V Bifuel | 4 | K4M858; K4M866 | 81/109 | 11/08→ | OE033 | 0,9 | CET2 | OE179 | | BAE409A |
| 2.0 | 4 | M4R710; M4R714 | 105/141 | 01/11→ | OE207 | 1,1 | | | | BAEA161E ^[300] |

RENAULT





kW/BHP



eon TITAN

IRIDIUM



...RENAULT



...MEGANE III

| | | | | | | | | | | |
|-------------|---|----------------------------|---------|--------|-------------------------|-----|--------|-------|--|---------------------------|
| 2.0 CVT | 4 | M4R711; M4R713; M4RF713 | 103/138 | 02/09→ | OE207 | 1,1 | | | | BAEA161E ^[300] |
| 2.0 dCi | 4 | M9R615 | 110/148 | 04/09→ | CCGP007 ^[14] | 7v | | | | |
| 2.0 dCi | 4 | M9R610 | 118/158 | 04/09→ | CCGP007 ^[14] | 7v | | | | |
| 2.0 dCi | 4 | M9R610 | 120/161 | 07/12→ | CCGP007 ^[14] | 7v | | | | |
| 2.0 R.S. | 4 | F4R874 | 195/261 | 11/08→ | OE146 | 1,0 | CET12P | OE179 | | BAE409A |
| 2.0 R.S. | 4 | F4R874 | 201/270 | 07/14→ | OE146 | 1,0 | CET12P | OE179 | | BAE409A |
| 2.0 TCe | 4 | F4R870; F4R872 | 132/177 | 11/08→ | OE033 | 0,9 | CET2 | OE179 | | BAE409A |
| 2.0 TCe | 4 | F4R | 140/188 | 06/12→ | | | | | | BAE409A |
| 2.0 TCe | 4 | F4R874 | 162/217 | 09/12→ | OE146 | 1,0 | CET12P | OE179 | | BAE409A |
| 2.0 TCe | 4 | F4R | 162/217 | 09/12→ | | | | | | BAE409A |
| 2.0 TCe | 4 | F4R874 | 184/247 | 05/09→ | OE146 | 1,0 | CET12P | OE179 | | BAE409A |
| 2.0 TCe 220 | 4 | F4R874 | 162/217 | 11/13→ | OE146 | 1,0 | CET12P | OE179 | | BAE409A |

MEGANE IV

| | | | | | | | | | | |
|--------------|---|---|--------|--------|--|--|--|-------|--|------------------------------------|
| 1.2 TCe 100 | 4 | H5F408 | 74/99 | 11/15→ | | | | OE261 | | BAEA131E |
| 1.2 TCe 130 | 4 | H5F408 | 97/130 | 11/15→ | | | | OE261 | | BAEA131E |
| 1.2 Tce 130 | 4 | H5F408 | 97/130 | 10/16→ | | | | | | BAEA131E |
| 1.6 1.6 S Ce | 4 | | 84/113 | 10/16→ | | | | | | BAEA131E |
| 1.6 16V | 4 | H4M738; H4M748; H4M749; H4M750; H4M751 | 84/113 | 11/15→ | | | | | | BAEA131E ^{[105] [375]} |

MODUS / GRAND MODUS

| | | | | | | | | | | | |
|----------------------|---|-----------------------------------|--------|--------|--|------------|--------------------------------|-------|--|------------------------|-------------------------|
| 1.2 | 4 | D4F740 | 48/64 | 05/05→ | OE130 OE225 ^{[6] [254]} | 0,9 0,7 | CET1 3P ^[6] CET4 | | | BAE947A BAEA325 | CLS084 ^[296] |
| 1.2 | 4 | D4F764 | 58/78 | 12/04→ | OE130 | 0,9 | CET4 | | | BAE947A BAEA325 | CLS084 ^[296] |
| 1.2 | 4 | D4F786 | 76/102 | 04/11→ | OE130 | 0,9 | CET1 3P | | | BAEA354 | CLS084 ^[296] |
| 1.2, 1.2 16V Hi-Flex | 4 | D4F740 | 55/74 | 12/04→ | OE130 OE225 ^{[6] [254]} | 0,9 0,7 | CET1 3P ^[6] CET4 | | | BAE947A BAEA325 | CLS084 ^[296] |
| 1.2 16V | 4 | D4F784 | 74/99 | 05/07→ | OE225 | 0,7 | CET1 3P | | | BAEA354 | CLS084 ^[296] |
| 1.4 | 4 | K4J770; K4J780 | 72/97 | 12/04→ | OE033 | 0,9 | CET2 | OE179 | | BAE409A | |
| 1.5 dCi | 4 | K9K752; K9K768 | 48/64 | 12/04→ | CH271 | 11v | | | | CCU154 ^[10] | |
| 1.5 dCi | 4 | K9K768 | 50/67 | 12/04→ | CH271 | 11v | | | | CCU154 ^[10] | |
| 1.5 dCi | 4 | K9K750 | 60/80 | 09/04→ | CH271 | 11v | | | | CCU154 ^[10] | |
| 1.5 dCi | 4 | K9K760; K9K766 | 63/84 | 12/04→ | CH271 | 11v | | | | CCU154 ^[10] | |
| 1.5 dCi | 4 | K9K772 | 76/102 | 05/07→ | CH271 | 11v | | | | CCU154 ^[10] | |
| 1.5 dCi | 4 | K9K764 | 78/105 | 05/05→ | CH271 | 11v | | | | CCU154 ^[10] | |
| 1.5 dCi 75 | 4 | K9K770 | 55/74 | 10/10→ | CH271 | 11v | | | | CCU154 ^[10] | |
| 1.5 dCi 90 | 4 | K9K750; K9K770 | 65/87 | 10/10→ | CH271 | 11v | | | | CCU154 ^[10] | |
| 1.6 | 4 | K4M794 | 65/87 | 12/04→ | OE033 | 0,9 | CET2 | OE179 | | BAE409A | |
| 1.6 | 4 | K4M790; K4M791; K4M800; K4M801 | 82/110 | 12/04→ | OE033 | 0,9 | CET2 | OE179 | | BAE409A BAEA354 | |

SAFRANE I

| | | | | | | | | | | | |
|-----------------|---|----------------|---------|-------------|-------|-----|------|--|--|---|--|
| 2.1 dT | 4 | J8S760 | 65/87 | 11/93→07/96 | CH189 | 11v | | | | | |
| 3.0 | 6 | Z7X721; Z7X723 | 125/168 | 02/93→10/96 | | | | | | BAEA251 ^{[265] [275] [292] [372]} | |
| 3.0 Biturbo 4WD | 6 | Z7X726 | 193/259 | 02/93→07/96 | OE094 | 0,9 | CET2 | | | BAEA251 ^{[265] [275] [292] [372]} | |

SAFRANE II

| | | | | | | | | | | | |
|---------|---|----------------|---------|-------------|--|--|------|-------|--|--|--------|
| 2.0 16V | 4 | N7Q710; N7Q711 | 100/134 | 07/96→12/00 | | | CET2 | OE179 | | BAEA254 ^{[71] [37]} BAEA255 ^{[14] [39]} | CLS051 |
|---------|---|----------------|---------|-------------|--|--|------|-------|--|--|--------|



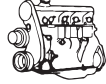

KW/BHP



eon TITAN

IRIDIUM

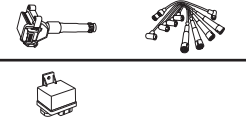

...RENAULT



...SAFRANE II

| | | | | | | | | | | |
|---------|---|----------------|---------|-------------|-----------------|-----|------|-------|---------------------------------|--------|
| 2.2 dT | 4 | G8T740 | 83/111 | 07/96→12/00 | CH169 | 11v | | | | |
| 2.5 20V | 5 | N7U700; N7U701 | 121/162 | 07/96→12/00 | OE005 | 0,9 | CET2 | OE180 | BAEA037E [292] | CLS050 |
| 2.9 24V | 6 | L7X713 | 140/188 | 03/99→12/00 | OE026 | 0,9 | CET2 | OE179 | | |
| | | | | | OE218 LPG [278] | 1,6 | | | | |
| 3.0 V6 | 6 | Z7X755 | 123/165 | 07/96→12/00 | | | | OE179 | BAEA251 [265] [275] [292] [372] | |

SANDERO/STEPWAY I

| | | | | | | | | | | |
|-----|---|--------|--------|--------|-----------------|-----|------|-------|---------|--------|
| 1.4 | 4 | K7J710 | 55/74 | 02/09→ | OE026 | 0,9 | CET2 | OE179 | BAEA354 | CLS076 |
| | | | | | OE216 LPG [278] | 0,8 | | | | |
| 1.6 | 4 | K7M718 | 62/83 | 11/10→ | OE026 | 0,9 | CET2 | OE179 | BAEA354 | |
| | | | | | OE216 LPG [278] | 0,8 | | | | |
| 1.6 | 4 | K7M710 | 64/86 | 02/09→ | OE026 | 0,9 | CET2 | OE179 | BAEA338 | |
| | | | | | OE216 LPG [278] | 0,8 | | | | |
| 1.6 | 4 | K7M710 | 75/101 | 12/07→ | OE026 | 0,9 | CET2 | OE179 | BAEA354 | |
| | | | | | OE216 LPG [278] | 0,8 | | | | |
| 1.6 | 4 | K4M690 | 76/102 | 12/07→ | OE026 | 0,9 | CET2 | OE179 | BAE409A | |
| | | | | | OE216 LPG [278] | 0,8 | | | | |

SANDERO/STEPWAY II

| | | | | | | | | | | |
|-----|---|--|-------|--------|--|--|--|--|---------|--|
| 1.6 | 4 | | 61/82 | 11/13→ | | | | | BAEA354 | |
|-----|---|--|-------|--------|--|--|--|--|---------|--|

SCÉNIC I

| | | | | | | | | | | |
|----------------------|---|--|---------|-------------|---|------|------|-------|--------------|--|
| 1.4 16V | 4 | K4J714; K4J750 | 70/94 | 09/99→08/03 | OE033 <small>*to be adjusted</small> | 1,0* | CET2 | OE179 | BAE409A | |
| 1.6 | 4 | K4M708; K4M709 | 75/101 | 03/01→08/03 | OE033 | 0,9 | CET2 | OE179 | BAE409A | |
| 1.6 | 4 | K4M700; K4M701; K4M708 | 81/109 | 06/01→09/03 | OE033 | 0,9 | CET2 | OE179 | | |
| 1.6 | 4 | K4M | 81/109 | 06/01→09/03 | | | | | BAE409A | |
| 1.6, 1.6 BiFuel | 4 | K4M700; K4M704; K4M706; K4M707; K4M712; K4M776 | 79/106 | 09/99→09/03 | OE033 | 0,9 | CET2 | OE179 | BAE409A | |
| 1.6 16V | 4 | | 85/114 | 09/99→08/03 | OE026 | 0,9 | CET2 | OE179 | | |
| | | | | | OE216 LPG [278] | 0,8 | | | | |
| 1.8 4WD, 1.8 16V | 4 | F4P720; F4P722 | 85/114 | 07/00→08/03 | OE033 | 0,9 | CET2 | OE179 | BAE409A | |
| 1.9 D | 4 | F8Q788; F8Q790 | 47/63 | 09/99→03/01 | CH233 | 11v | | | | |
| 1.9 dCi, 1.9 dCi 4WD | 4 | F9Q732; F9Q733; F9Q740 | 75/101 | 09/99→08/03 | CH271 | 11v | | | CCU129 [338] | |
| 1.9 dCi 4WD | 4 | F9Q732; F9Q748; F9Q796 | 74/99 | 12/02→08/03 | CH271 | 11v | | | CCU129 [338] | |
| 1.9 dTi | 4 | F9Q744 | 59/79 | 02/01→08/03 | CH271 | 11v | | | CCU129 [338] | |
| 1.9 dTi | 4 | F9Q731; F9Q736 | 72/97 | 09/99→08/03 | CH271 | 11v | | | CCU129 [338] | |
| 1.9 dTi | 4 | F9Q734 | 72/97 | 09/99→08/03 | CH169 | 11v | | | CCU129 [338] | |
| 2.0 16V | 4 | F4R740; F4R741; F4R744; F4R747 | 103/138 | 09/99→08/03 | OE033 | 0,9 | CET2 | OE179 | BAE409A | |
| 2.0 16V, 2.0 16V 4WD | 4 | F4R740; F4R741; F4R744; F4R746 | 102/137 | 06/00→08/03 | OE033 | 0,9 | CET2 | OE179 | BAE409A | |

SCÉNIC II

| | | | | | | | | | | |
|---------|---|------------------------|-------|--------|-------|-----|------|-------|--|--|
| 1.4 | 4 | K4J730; K4J740; K4J770 | 72/97 | 06/03→ | OE033 | 0,9 | CET2 | OE179 | BAE409A | |
| 1.5 dCi | 4 | K9K722 | 60/80 | 06/03→ | CH271 | 11v | | | CCU154 →Eng.050116 [10] [360] CCU147 Eng.050117→ [11] [352] | |
| 1.5 dCi | 4 | K9K724 | 63/84 | 05/05→ | CH271 | 11v | | | CCU154 →Eng.050116 [10] [360] CCU147 Eng.050117→ [11] [352] | |

RENAULT





kW/BHP



eon TITAN

IRIDIUM



...RENAULT



...SCÉNIC II

| | | | | | | | | | | |
|---------------|---|------------------------------------|---------|-------------|--------------------------------------|-----|---------|-------|---------|--|
| 1.5 dCi | 4 | K9K728; K9K729 | 74/99 | 11/03→ | CH271 | 11v | | | | CCU154 →Eng.050116 [10] [360] CCU147 Eng.050117→ [11] [352] |
| 1.5 dCi | 4 | K9K734 | 76/102 | 01/07→ | CH271 | 11v | | | | CCU154 →Eng.050116 [10] [360] CCU147 Eng.050117→ [11] [352] |
| 1.5 dCi | 4 | K9K732 | 78/105 | 05/05→ | CH271 | 11v | | | | CCU154 →Eng.050116 [10] [360] CCU147 Eng.050117→ [11] [352] |
| 1.6 | 4 | K4M788 | 77/103 | 06/06→ | OE033 | 0,9 | CET2 | OE179 | BAE409A | |
| 1.6 | 4 | K4M761; K4M782 | 83/111 | 06/03→ | OE033 | 0,9 | CET2 | OE179 | BAE409A | |
| 1.6 16V | 4 | K4M706; K4M766; K4M812; K4M813 | 82/110 | 10/05→ | OE033 | 0,9 | CET2 | OE179 | BAE409A | |
| 1.6 Hi-Flex | 4 | K4M766 | 81/109 | 03/05→07/10 | | | | | BAE409A | |
| 1.9 D | 4 | F9Q812; F9QJ803 | 85/114 | 06/06→ | CH271 | 11v | | | | CCU154 →Eng.050111 [10] [360] CCU147 [352] Eng.050112→ |
| 1.9 dCi | 4 | F9Q804 | 81/109 | 05/05→ | CH271 | 11v | | | | CCU154 →Eng.050111 [10] [360] CCU147 [352] Eng.050112→ |
| 1.9 dCi | 4 | F9Q812 | 88/118 | 06/03→ | CH271 | 11v | | | | CCU154 →Eng.050111 [10] [360] CCU147 [352] Eng.050112→ |
| 1.9 dCi | 4 | F9Q804 | 92/123 | 06/03→ | CH271 | 11v | | | | CCU154 →Eng.050111 [10] [360] CCU147 [352] Eng.050112→ |
| 1.9 dCi | 4 | F9Q804; F9Q816; F9Q818; F9QJ803 | 96/129 | 05/05→ | CH271 | 11v | | | | CCU154 →Eng.050111 [10] [360] CCU147 [352] Eng.050112→ |
| 2.0 | 4 | F4R770; F4R771 | 99/133 | 06/03→ | OE033 | 0,9 | CET2 | OE179 | BAE409A | |
| 2.0 | 4 | F4R770 | 101/135 | 02/08→04/09 | | | | | BAE409A | |
| 2.0 16V Turbo | 4 | F4R776 | 120/161 | 05/04→ | OE136 | 0,8 | CET1 2P | OE179 | BAE409A | |
| 2.0 dCi | 4 | M9R700; M9R721; M9R722 | 110/148 | 09/05→ | CCGP007 Eng.061129→ [14] [154] | 7v | | | | |

SCÉNIC III

| | | | | | | | | | | |
|------------------|---|----------------------------|---------|--------|-------------------------|-----|---------|-------|----------|--|
| 1.2 TCe | 4 | H5F400 | 85/114 | 04/12→ | | | | OE261 | BAEA131E | |
| 1.2 TCe | 4 | H5F404; H5F408 | 97/130 | 01/13→ | | | | OE261 | BAEA131E | |
| 1.4 16V | 4 | H4J700 | 96/129 | 02/09→ | OE225 | 0,7 | CET1 3P | | BAEA066E | |
| 1.6 16V, 1.6 E85 | 4 | K4M858; K4M866; K4MR858 | 81/109 | 02/09→ | OE033 | 0,9 | CET2 | OE179 | BAE409A | |
| 2.0 16V | 4 | M4R713 | 103/138 | 02/09→ | OE207 | 1,1 | | | | |
| 2.0 16V | 4 | M4R710; M4R711 | 103/138 | 02/09→ | OE207 | 1,1 | | | BAEA161E | |
| 2.0 dCi | 4 | M9R615 | 110/148 | 02/09→ | CCGP007 ^[14] | 7v | | | | |
| 2.0 dCi | 4 | M9R610 | 118/158 | 04/09→ | CCGP007 ^[14] | 7v | | | | |



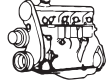

kW/BHP



eon TITAN

IRIDIUM

**...RENAULT****SCÉNIC IV**

| | | | | | | | | | |
|-------------|---|--------|--------|--------|--|--|--------------|--|-----------------|
| 1.2 TCe 115 | 4 | H5F408 | 85/114 | 09/16→ | | | | | BAEA131E |
| 1.2 TCe 130 | 4 | H5F408 | 96/129 | 09/16→ | | | OE261 | | BAEA131E |

SPORT SPIDER

| | | | | | | | | | |
|---------|---|--------|---------|-------------|--------------|-----|-------------|--------------|--|
| 2.0 16V | 4 | F7R710 | 110/148 | 03/95→10/99 | OE216 | 0,8 | CET2 | OE179 | |
|---------|---|--------|---------|-------------|--------------|-----|-------------|--------------|--|

THALIA I

| | | | | | | | | | |
|---------|---|------------------------|-------|-------------|--------------|-----|-------------|--------------|---|
| 1.2 | 4 | D7F744; D7F746 | 43/58 | 02/98→10/03 | OE026 | 0,9 | CET2 | OE179 | BAEA345 |
| 1.2 16V | 4 | D4F706; D4F712; D4F728 | 55/74 | 04/02→ | OE130 | 0,9 | CET4 | | BAE947A ^[275] CLS084 ^[296] BAEA325 ^[275] BAEA454 ^[150] ^[275] |

| | | | | | | | | | |
|-----|---|--------|-------|--------|---|------------|-------------|--------------|----------------|
| 1.4 | 4 | K7J700 | 55/74 | 08/00→ | OE026 OE216 LPG ^[278] | 0,9 0,8 | CET2 | OE179 | BAEA354 |
|-----|---|--------|-------|--------|---|------------|-------------|--------------|----------------|

| | | | | | | | | | |
|---------|---|--------|-------|--------|--------------|-----|-------------|--------------|----------------|
| 1.4 16V | 4 | K4J712 | 72/97 | 08/00→ | OE033 | 0,9 | CET2 | OE179 | BAE409A |
|---------|---|--------|-------|--------|--------------|-----|-------------|--------------|----------------|

| | | | | | | | | | |
|---------|---|--------|-------|--------|--------------|-----|--|--|-------------------------------|
| 1.5 dCi | 4 | K9K740 | 47/63 | 06/05→ | CH271 | 11v | | | CCU154 ^[10] |
|---------|---|--------|-------|--------|--------------|-----|--|--|-------------------------------|

| | | | | | | | | | |
|---------|---|--------|-------|--------|--------------|-----|--|--|-------------------------------|
| 1.5 dCi | 4 | K9K700 | 48/64 | 04/02→ | CH271 | 11v | | | CCU154 ^[10] |
|---------|---|--------|-------|--------|--------------|-----|--|--|-------------------------------|

| | | | | | | | | | |
|---------|---|----------------|-------|--------|--------------|-----|--|--|-------------------------------|
| 1.5 dCi | 4 | K9K700; K9K714 | 50/67 | 02/03→ | CH271 | 11v | | | CCU154 ^[10] |
|---------|---|----------------|-------|--------|--------------|-----|--|--|-------------------------------|

| | | | | | | | | | |
|---------|---|--------|-------|--------|--------------|-----|--|--|-------------------------------|
| 1.5 dCi | 4 | K9K702 | 60/80 | 06/01→ | CH271 | 11v | | | CCU154 ^[10] |
|---------|---|--------|-------|--------|--------------|-----|--|--|-------------------------------|

| | | | | | | | | | |
|-----|---|--------|-------|--------|---|------------|-------------|--------------|----------------|
| 1.6 | 4 | K7M746 | 66/89 | 03/98→ | OE026 OE216 LPG ^[278] | 0,9 0,8 | CET2 | OE179 | BAEA354 |
|-----|---|--------|-------|--------|---|------------|-------------|--------------|----------------|

| | | | | | | | | | |
|---------|---|--------|--------|--------|--------------|-----|-------------|--------------|----------------|
| 1.6 16V | 4 | K4M740 | 79/106 | 04/02→ | OE033 | 0,9 | CET2 | OE179 | BAE409A |
|---------|---|--------|--------|--------|--------------|-----|-------------|--------------|----------------|

| | | | | | | | | | |
|-------|---|--------|-------|-------------|--------------|-----|--|--|--|
| 1.9 D | 4 | F8Q630 | 48/64 | 02/98→05/01 | CH217 | 11v | | | |
|-------|---|--------|-------|-------------|--------------|-----|--|--|--|

THALIA II

| | | | | | | | | | |
|---------|---|--------|-------|--------|--------------|-----|-------------|--|---|
| 1.2 16V | 4 | D4F728 | 55/74 | 09/08→ | OE130 | 0,9 | CET4 | | BAE947A CLS084 ^[296] BAEA325 |
|---------|---|--------|-------|--------|--------------|-----|-------------|--|---|

| | | | | | | | | | |
|---------|---|--------|-------|--------|--------------|-----|--|--|--|
| 1.5 dCi | 4 | K9K740 | 47/63 | 09/08→ | CH271 | 11v | | | |
|---------|---|--------|-------|--------|--------------|-----|--|--|--|

| | | | | | | | | | |
|---------|---|--------|-------|--------|--------------|-----|--|--|--|
| 1.5 dCi | 4 | K9K700 | 48/64 | 01/09→ | CH271 | 11v | | | |
|---------|---|--------|-------|--------|--------------|-----|--|--|--|

| | | | | | | | | | |
|---------|---|--------|-------|--------|--------------|-----|--|--|--|
| 1.5 dCi | 4 | K9K718 | 62/83 | 09/08→ | CH271 | 11v | | | |
|---------|---|--------|-------|--------|--------------|-----|--|--|--|

| | | | | | | | | | |
|---------|---|--------|--------|--------|--------------|-----|-------------|--------------|----------------|
| 1.6 16V | 4 | K4M743 | 77/103 | 09/08→ | OE033 | 0,9 | CET2 | OE179 | BAE409A |
|---------|---|--------|--------|--------|--------------|-----|-------------|--------------|----------------|

THALIA III

| | | | | | | | | | |
|---------|---|--|-------|--------|--|--|--|--|-----------------|
| 0.9 TCe | 3 | | 66/89 | 04/14→ | | | | | BAEA131E |
|---------|---|--|-------|--------|--|--|--|--|-----------------|

TWINGO I

| | | | | | | | | | |
|-----|---|----------------|-------|-------------|--------------|-----|-------------|--|------------------------------|
| 1.2 | 4 | C3G700; C3G702 | 40/54 | 03/93→03/07 | OE015 | 0,9 | CET8 | | BAE504L CLS126 |
|-----|---|----------------|-------|-------------|--------------|-----|-------------|--|------------------------------|

| | | | | | | | | | |
|-----|---|----------------|-------|-------------|---|------------|-------------|--------------|--|
| 1.2 | 4 | D7F700; D7F701 | 40/54 | 03/93→03/07 | OE026 OE216 LPG ^[278] | 0,9 0,8 | CET2 | OE179 | BAEA345 CLS040 ^[275] →10/98 →11/99 BAEA354 CLS083 ^[275] 11/98→ 12/99→ |
|-----|---|----------------|-------|-------------|---|------------|-------------|--------------|--|

| | | | | | | | | | |
|-----|---|--|-------|-------------|---|------------|-------------|--------------|--|
| 1.2 | 4 | D7F700; D7F701; D7F702; D7F703; D7F704 | 43/58 | 05/96→06/07 | OE026 OE216 LPG ^[278] | 0,9 0,8 | CET2 | OE179 | BAEA345 CLS040 ^[275] →10/98 →11/99 →Eng.981020 BAEA354 CLS083 ^[275] 11/98→ 12/99→ →Eng.981021 |
|-----|---|--|-------|-------------|---|------------|-------------|--------------|--|

| | | | | | | | | | |
|-----|---|------------------------|-------|-------------|--------------|-----|-------------|--------------|---|
| 1.2 | 4 | D7F702; D7F703; D7F704 | 44/59 | 09/98→08/00 | OE026 | 0,9 | CET2 | OE179 | BAEA345 →Eng.981021 BAEA354 ^[275] Eng.981021→ Eng.111215 |
|-----|---|------------------------|-------|-------------|--------------|-----|-------------|--------------|---|

| | | | | | | | | | |
|---------|---|--------|-------|-------------|--------------|-----|-------------|--|---|
| 1.2 16V | 4 | D4F708 | 44/59 | 08/04→06/07 | OE130 | 0,9 | CET4 | | BAE947A CLS084 ^[296] BAEA325 |
|---------|---|--------|-------|-------------|--------------|-----|-------------|--|---|

| | | | | | | | | | |
|---------|---|--------|-------|-------------|--------------|-----|-------------|--|---|
| 1.2 16V | 4 | D4F702 | 55/74 | 01/01→06/07 | OE130 | 0,9 | CET4 | | BAEA454 ^[150] →06/04 BAE947A ^[156] 07/04→ BAEA325 ^[156] 07/04→ |
|---------|---|--------|-------|-------------|--------------|-----|-------------|--|---|

| | | | | | | | | | |
|---------|---|----------------|-------|-------------|--------------|-----|-------------|--------------|--|
| 1.2 LPG | 4 | D7F702; D7F708 | 44/59 | 10/03→06/07 | OE026 | 0,9 | CET2 | OE179 | |
|---------|---|----------------|-------|-------------|--------------|-----|-------------|--------------|--|

RENAULT





kW/BHP

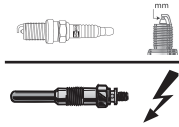

eon TITAN

IRIDIUM



...RENAULT



TWINGO II

| | | | | | | | | | | |
|-------------|---|------------------------|--------|--------|--------------------|------------|---------------------|-------|--|--------------|
| 1.2 | 4 | D7F800 | 43/58 | 03/07→ | OE026 | 0,9 | CET2 | OE179 | BAEA354 | CLS083 [275] |
| 1.2 16V | 4 | D4F764; D4F770; D4F772 | 55/74 | 03/07→ | OE130 | 0,9 | CET4 | | BAE947A BAEA325 | CLS084 [296] |
| 1.2 16V | 4 | D4F772 | 56/75 | 03/07→ | OE130 | 0,9 | CET4 | | BAE947A BAEA325 | CLS084 [296] |
| 1.2 TCe 100 | 4 | D4F780; D4F782 | 75/101 | 02/11→ | OE130 OE225 [6] | 0,9 0,7 | CET1 3P [6] CET4 | | BAEA354 | |
| 1.2 Turbo | 4 | D4F780; D4F782 | 74/99 | 03/07→ | OE130 OE225 [6] | 0,9 0,7 | CET1 3P [6] CET4 | | BAEA354 | |
| 1.5 dCi | 4 | K9K740 | 47/63 | 03/07→ | CH271 | 11v | | | CCU147 [11] [352] CCU154 [10] [360] | |
| 1.5 dCi | 4 | K9K718 | 62/83 | 04/08→ | CH271 | 11v | | | CCU147 [11] [352] CCU154 [10] [360] | |
| 1.5 dCi 75 | 4 | K9K820 | 55/74 | 10/10→ | CH271 [9] [337] | 11v | | | CCU147 [11] [352] CCU154 [10] [360] | |
| 1.5 dCi 90 | 4 | K9K820 | 63/84 | 10/10→ | CH271 [9] [337] | 11v | | | CCU147 [11] [352] CCU154 [10] [360] | |
| 1.6 RS | 4 | K4M854 | 98/131 | 05/08→ | OE146 | 1,0 | CET12P | OE179 | BAE409A | |

TWINGO III

| | | | | | | | | | | |
|-------------|---|--------|--------|--------|-------|-----|------|-------|----------|--|
| 0.9 TCe 90 | 3 | H4B401 | 66/89 | 09/14→ | OE130 | 0,9 | CET4 | OE261 | BAEA131E | |
| 0.9 TCe 110 | 3 | H4B401 | 80/107 | 11/16→ | | | | OE261 | BAEA131E | |
| 1.0 SCe 70 | 3 | | 51/68 | 09/15→ | | | | | BAEA131E | |
| 1.0 SCe 70 | 3 | H4D400 | 52/70 | 09/14→ | OE130 | 0,9 | | | BAEA131E | |

VEL SATIS

| | | | | | | | | | | |
|----------------|---|---|---------|--------|--------------------------------------|-----|--------|-------|--|--|
| 2.0 16V Turbo | 4 | F4R762; F4R763 | 120/161 | 06/02→ | | | CET12P | OE179 | BAE409A | |
| 2.0 16 V Turbo | 4 | F4R766; F4R767 | 125/168 | 04/04→ | | | CET12P | OE179 | BAE409A | |
| 2.0 dCi | 4 | M9R760 | 110/148 | 08/05→ | CCGP007 Eng.060904→ [14] [154] | 7v | | | | |
| 2.0 dCi | 4 | M9R760; M9R762; M9R763 | 127/170 | 01/06→ | CCGP007 Eng.060904→ [14] [154] | 7v | | | | |
| 2.0 Turbo | 4 | F4R867 | 108/145 | 04/05→ | OE033 | 0,9 | CET2 | OE179 | BAE409A | |
| 2.2 dCi | 4 | G9T700; G9T702 | 83/111 | 12/04→ | CH232 | 11v | | | CCU154 →Eng.070828 [10] [360] CCU147 Eng.070829→ [11] [352] | |
| 2.2 dCi | 4 | G9T600; G9T702 | 85/114 | 04/04→ | CH232 | 11v | | | CCU154 →Eng.070828 [10] [360] CCU147 Eng.070829→ [11] [352] | |
| 2.2 dCi | 4 | G9T600; G9T606; G9T607; G9T700; G9T702 | 102/137 | 09/04→ | CH232 | 11v | | | CCU154 →Eng.070828 [10] [360] CCU147 Eng.070829→ [11] [352] | |

RENAULT





kW/BHP



eon TITAN

IRIDIUM



...RENAULT



...VEL SATIS

| | | | | | | | | | |
|-------------|---|------------------------|---------|--------|-------|-----|--------|-------|--|
| 2.2 dCi | 4 | G9T702; G9T703 | 110/148 | 06/02→ | CH232 | 11v | | | CCU154 →Eng.070828 [10] [360] CCU147 Eng.070829→ [11] [352] |
| 3.5 | 6 | V4Y715 | 170/228 | 10/04→ | OE175 | 1,0 | CET14P | OE190 | BAEA079E |
| 3.5 V6 | 6 | V4Y701; V4Y711; V4Y715 | 177/237 | 06/02→ | OE175 | 1,0 | CET14P | OE190 | BAEA079E |
| WIND | | | | | | | | | |
| 1.2 | 4 | D4F782 | 74/99 | 07/10→ | OE225 | 0,7 | CET13P | | BAEA354 CLS084 [296] |
| 1.2 TCe 100 | 4 | D4F780 | 75/101 | 02/11→ | OE225 | 0,7 | CET13P | | BAEA354 CLS084 [296] |
| 1.6 | 4 | K4M854 | 98/131 | 07/10→ | OE146 | 1,0 | CET12P | OE179 | BAE409A |

RENAULT



CLIO I

| | | | | | | | | | |
|---------|---|--------|-------|-------------|-------------|-----|--|--|--|
| 1.9 RND | 4 | F8Q678 | 40/54 | 04/96→02/98 | CH206 [275] | 11v | | | |
|---------|---|--------|-------|-------------|-------------|-----|--|--|--|

CLIO II

| | | | | | | | | | |
|---------|---|------------------------|-------|-------------|-------|-----|------|-------|--|
| 1.2 | 4 | D7F720 | 43/58 | 09/98→ | OE026 | 0,9 | CET2 | OE179 | BAEA345 →Eng.981021 BAEA354 [275] Eng.981021→ Eng.111215 CLS083 [275] 10/99→ |
| 1.2 | 4 | D7F726; D7F746 | 43/58 | 09/98→ | OE026 | 0,9 | CET2 | OE179 | BAEA345 →Eng.981021 BAEA354 [275] Eng.981021→ Eng.111215 CLS083 [275] |
| 1.2 | 4 | D7F722; D7F726; D7F746 | 44/59 | 03/99→10/03 | OE026 | 0,9 | CET2 | OE179 | BAEA354 CLS083 [275] |
| 1.5 dCi | 4 | K9K700; K9K704 | 48/64 | 06/01→ | CH271 | 11v | | | CCU154 [10] |
| 1.5 dCi | 4 | K9K714 | 50/67 | 04/04→ | CH271 | 11v | | | CCU154 [10] |
| 1.5 dCi | 4 | K9K702 | 59/79 | 06/01→10/04 | CH271 | 11v | | | CCU154 [10] |
| 1.5 dCi | 4 | K9K702; K9K710; K9K716 | 60/80 | 11/03→ | CH271 | 11v | | | CCU154 [10] |
| 1.9 D | 4 | F8Q630 | 47/63 | 09/98→ | CH217 | 11v | | | CCU128 [329] CCU129 [338] |
| 1.9 D | 4 | F8Q632 | 48/64 | 02/00→05/01 | CH217 | 11v | | | CCU128 [329] CCU129 [338] |
| 1.9 DTi | 4 | F9Q780 | 59/79 | 02/00→05/01 | CH271 | 11v | | | CCU129 [338] |

CLIO IV

| | | | | | | | | | |
|------------|---|----------------|-------|--------|--|--|--|-------|----------|
| 0.9 TCe 90 | 3 | H4B400; H4B408 | 66/89 | 01/14→ | | | | OE261 | BAEA131E |
|------------|---|----------------|-------|--------|--|--|--|-------|----------|

KANGOO

| | | | | | | | | | |
|-------------|---|--|--------|-------------|--------------------------|------|--------|-------|---|
| 1.0 | 4 | CG10DE | 40/54 | 07/03→ | OE175 | 1,0 | CET14P | OE190 | |
| 1.2 | 4 | D7F710; D7F720; D7F722; D7F726; D7F744; D7F746 | 43/58 | 08/97→ | OE026 | 0,9 | CET2 | OE179 | BAEA345 →10/98 BAEA354 11/98→ CLS040 [275] →09/99 CLS083 [275] 10/99→ |
| 1.2 | 4 | D7F710; D7F722; D7F744; D7F764; D7F766 | 44/59 | 07/98→07/01 | OE026 | 0,9 | CET2 | OE179 | BAEA345 Eng.981022→ |
| 1.2 16V | 4 | D4F712; D4F714; D4F730 | 55/74 | 10/01→ | OE130 *to be adjusted | 0,8* | CET4 | | BAEA345 [275] 03/03→ BAE947A [275] 06/08→ BAEA325 [275] 06/08→ BAEA454 [150] [275] CLS084 [296] |
| 1.2 BiFuel | 4 | D7F710; D7F744 | 43/58 | 07/98→07/01 | OE026 | 0,9 | CET2 | OE179 | BAEA354 Eng.981021→ |
| 1.2 TCe 115 | 4 | H5F400; H5F408; H5F412 | 84/113 | 07/13→ | | | | OE261 | BAEA131E |

RENAULT





kW/BHP



eon TITAN

IRIDIUM

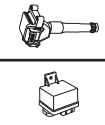

...RENAULT



...KANGOO

| | | | | | | | | | | |
|----------------------|---|-----------------------------------|--------|-------------|-------------------|-----|------|-------|---|---|
| 1.4 | 4 | E7J634; E7J635 | 55/74 | 08/97→06/08 | | | CET2 | OE179 | BAEA354 09/98→12/07 | CLS011 [142][287] CLS019 [143] |
| 1.4 | 4 | E7J780 | 55/74 | 08/97→06/08 | | | CET2 | OE179 | BAEA354 09/98→12/07 BAEA242 [7][37] BAEA243 [14][39] | CLS011 [142][287] CLS019 [143] |
| 1.4 | 4 | K7J700 | 55/74 | 08/97→06/08 | | | CET2 | OE179 | BAEA354 09/98→12/07 | |
| 1.4 | 4 | K7J701 | 55/74 | 08/97→06/08 | OE026 | 0,9 | CET2 | OE179 | BAEA354 09/98→12/07 | CLS019 [143] →Eng.050317 CLS076 [153] Eng.050318→ Eng.090920 CLS088 [157] Eng.090921→ Eng.150325 |
| | | | | | OE216 LPG [278] | 0,8 | | | | |
| 1.5 dCi | 4 | K9K704 | 42/56 | 12/02→ | CH271 | 11v | | | CCU154[10] | |
| 1.5 dCi | 4 | K9K716 | 45/60 | 10/05→ | CH271 | 11v | | | CCU154[10] | |
| 1.5 dCi | 4 | K9K700; K9K702; K9K704 | 48/64 | 12/01→ | CH271 | 11v | | | CCU154[10] | |
| 1.5 dCi | 4 | K9K714 | 50/67 | 06/05→ | CH271 | 11v | | | CCU154[10] | |
| 1.5 dCi | 4 | K9K702; K9K710 | 60/80 | 04/03→ | CH271 | 11v | | | CCU154[10] | |
| 1.5 dCi | 4 | K9K718 | 62/83 | 06/05→ | CH271 | 11v | | | CCU154[10] | |
| 1.6 | 4 | K7M750 | 64/86 | 02/08→ | OE026 | 0,9 | CET2 | OE179 | BAEA354 | |
| | | | | | OE216 LPG [278] | 0,8 | | | | |
| 1.6 16V | 4 | K4M830 | 78/105 | 02/08→ | OE033 | 0,9 | CET2 | OE179 | BAE409A | |
| 1.6 16V, 1.6 16V 4WD | 4 | K4M706; K4M750; K4M752; K4M753 | 70/94 | 10/01→ | OE033 | 0,9 | CET2 | OE179 | BAE409A | |
| 1.6 16V bivalent | 4 | K4M850 | 60/80 | 06/05→ | OE033 | 0,9 | CET2 | OE179 | BAE409A | |
| 1.6 16V LPG | 4 | K4M834 | 72/97 | 02/08→ | OE033 | 0,9 | CET2 | OE179 | BAE409A | |
| 1.9 D | 4 | F8Q632 | 48/64 | 09/99→06/03 | CH233 | 11v | | | CCU128[329] CCU129[338] | |
| 1.9 D 55 | 4 | F8Q662 | 40/54 | 08/97→ | CH217 →02/99 | 11v | | | CCU128[329] | |
| | | | | | CH233 03/99→ | 11v | | | CCU129[338] | |
| 1.9 D 65 | 4 | F8Q632 | 47/63 | 08/97→ | CH233 | 11v | | | CCU128[329] CCU129[338] | |
| 1.9 D 65 | 4 | F8Q630 | 47/63 | 08/97→ | CH217 | 11v | | | CCU128[329] CCU129[338] | |
| 1.9 dCi, 1.9 dCi 4WD | 4 | F9Q782; F9Q790 | 62/83 | 07/03→ | CH271 | 11v | | | CCU129[338] CCU154[10] | |
| 1.9 dCi 4WD, 1.9 dTi | 4 | F9Q780; F9Q782; F9Q790 | 59/79 | 02/00→ | CH271 | 11v | | | CCU129[338] CCU154[10] | |
| LOGAN EXPRESS | | | | | | | | | | |
| 1.5 dCi | 4 | K9K792 | 50/67 | 04/07→ | CH271 [9][337] | 11v | | | | |
| 1.6 | 4 | K7M710 | 64/86 | 04/07→ | OE026 | 0,9 | CET2 | OE179 | BAEA354 | |
| | | | | | OE216 LPG [278] | 0,8 | | | | |
| MASTER II | | | | | | | | | | |
| 1.9 dCi 80 | 4 | F9Q772; F9Q774 | 60/80 | 11/01→ | CH271 | 11v | | | CCU129[339] CCU154 [10][370] | |
| 1.9 dTi | 4 | F9Q770 | 59/79 | 09/00→ | CH271 | 11v | | | CCU129[339] CCU154 [10][370] | |
| 2.2 dCi 90 | 4 | G9T720; G9T722; G9T750 | 66/89 | 09/00→ | CH232 | 11v | | | CCU154[10] | |

RENAULT





kW/BHP



eon TITAN

IRIDIUM



...RENAULT



...MASTER II

| | | | | | | | | | |
|-------------|---|--------------------------------|---------|-------------|-------|-----|--|--|------------------------|
| 2.5 dCi | 4 | G9U650; G9U754 | 74/99 | 08/06→ | CH232 | 11v | | | |
| 2.5 dCi | 4 | G9U650 | 88/118 | 08/06→ | CH232 | 11v | | | |
| 2.5 dCi | 4 | G9U632 | 107/143 | 08/06→ | CH232 | 11v | | | |
| 2.5 dCi 100 | 4 | G9U754 | 73/98 | 10/03→ | CH232 | 11v | | | |
| 2.5 dCi 120 | 4 | G9U720; G9U724; G9U750; G9U754 | 84/113 | 10/01→ | CH232 | 11v | | | CCU147 |
| 2.8 dTi | 4 | S9W702 | 84/113 | 07/98→10/01 | CH216 | 11v | | | |
| 3.0 dCi 120 | 4 | ZD3600 | 85/114 | 06/05→ | | | | | CCU154 ^[10] |
| 3.0 dCi 140 | 4 | ZD3200; ZD3202 | 100/134 | 10/03→ | | | | | CCU154 ^[10] |
| 3.0 dCi 160 | 4 | ZD3A604 | 115/154 | 06/05→ | | | | | CCU154 ^[10] |

MASTER III

| | | | | | | | | | |
|-------------|---|--|---------|--------|-------------------------------|----|--|--|--|
| 2.3 dCi 100 | 4 | M9T670; M9T672; M9T676; M9T690; M9T692; M9T870; M9T890 | 74/99 | 02/10→ | CCGP007 ^{[14] [154]} | 7v | | | |
| 2.3 dCi 125 | 4 | M9T670; M9T672; M9T676; M9T686; M9T690; M9T692; M9T696; M9T698; M9T870; M9T890; M9T896 | 92/123 | 02/10→ | CCGP007 ^{[14] [154]} | 7v | | | |
| 2.3 dCi 145 | 4 | M9T678; M9T680; M9T694; M9T696; M9T698; M9T706; M9T896 | 107/143 | 02/10→ | CCGP007 ^{[14] [154]} | 7v | | | |

RAPID

| | | | | | | | | | |
|-------|---|----------------|-------|-------------|-------|-----|------|-------|--------------------------------------|
| 1.1 | 4 | C1E762 | 35/47 | 09/93→04/95 | OE001 | 0,9 | CET8 | OE195 | |
| 1.2 | 4 | E7F708 | 48/64 | 05/95→11/98 | OE005 | 0,9 | CET2 | OE180 | |
| 1.4 | 4 | E7J728 | 58/78 | 01/94→03/98 | OE005 | 0,9 | CET2 | OE180 | BAEA251 ^{[265] [275] [292]} |
| 1.4 | 4 | E7J773 | 59/79 | 05/95→08/97 | OE005 | 0,9 | CET2 | OE179 | BAEA251 ^{[265] [275] [292]} |
| 1.9 D | 4 | F8Q640; F8Q682 | 40/54 | 09/94→03/98 | CH206 | 11v | | | |

TRAFIC

| | | | | | | | | | |
|------------------|---|----------------|-------|-------------|-------|-------|------|-------|--------------------------------------|
| 1.9 D | 4 | F8Q606 | 44/59 | 06/97→03/01 | CH217 | 11v | | | |
| 2.1 D | 4 | J8S620; J8S758 | 47/63 | 06/94→04/98 | CH189 | 11v | | | |
| 2.2, 2.2 4WD | 4 | J7T600 | 74/99 | 06/94→04/98 | OE011 | 0,9 | CET9 | OE183 | BAEA251 ^{[265] [275] [292]} |
| 2.5 D, 2.5 D 4WD | 4 | S8U758 | 58/78 | 09/94→01/99 | CH147 | 11.5v | | | |

TRAFIC II

| | | | | | | | | | |
|--------------------------|---|--------------------------------|--------|-------------|-------------------------------|-----|------|-------|--|
| 1.9 dCi | 4 | F9Q762 | 59/79 | 04/01→07/03 | CH271 | 11v | | | |
| 1.9 dCi | 4 | F9Q760 | 75/101 | 03/01→ | CH271 | 11v | | | CCU154 →Eng.060809 [10] [360] CCU147 Eng.060810→ [11] [352] |
| 1.9 dCi 80, 1.9 dCi 80 | 4 | F9Q760; F9Q762 | 60/80 | 03/01→ | CH271 | 11v | | | CCU154 →Eng.060809 [10] [360] CCU147 Eng.060810→ [11] [352] |
| 1.9 dCi 100, 1.9 dCi 100 | 4 | F9Q760 | 74/99 | 03/01→ | CH271 | 11v | | | CCU154 →Eng.060809 [10] [360] CCU147 Eng.060810→ [11] [352] |
| 2.0 | 4 | F4R720; F4R722 | 88/118 | 03/01→ | OE033 | 0,9 | CET2 | OE179 | BAE409A |
| 2.0 16V | 4 | F4R820 | 86/115 | 08/06→ | OE033 | 0,9 | CET2 | OE179 | BAE409A |
| 2.0 dCi 90 | 4 | M9R630; M9R780; M9R782 | 66/89 | 08/06→ | CCGP007 ^{[14] [154]} | 7v | | | |
| 2.0 dCi 115 | 4 | M9R692; M9R780; M9R782; M9R786 | 84/113 | 08/06→ | CCGP007 ^{[14] [154]} | 7v | | | |

RENAULT





kW/BHP

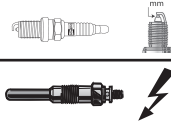

eon TITAN

IRIDIUM

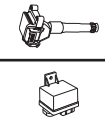
**...RENAULT****...TRAFIC II**

| | | | | | | | | | |
|----------------------|---|--------|---------|--------|-------|-----|--|--|--|
| 2.5 dCi, 2.5 dCi 115 | 4 | G9U630 | 84/113 | 08/07→ | CH232 | 11v | | | |
| 2.5 dCi 135, 2.5 DTi | 4 | G9U730 | 99/133 | 03/01→ | CH232 | 11v | | | |
| 2.5 dCi 145 | 4 | G9U630 | 107/143 | 08/06→ | CH232 | 11v | | | |

TWINGO I

| | | | | | | | | | | |
|-----|---|-----------------------------------|-------|-------------|-------|-----|------|-------|--|------------------------|
| 1.2 | 4 | C3G700; C3G702 | 40/54 | 03/93→05/96 | OE015 | 0,9 | CET8 | | BAE504L | CLS126 |
| 1.2 | 4 | D7F700; D7F701 | 43/58 | 05/96→08/04 | OE026 | 0,9 | CET2 | OE179 | BAEA345 →Eng.981021 | CLS040 [275] →11/99 |
| | | | | | | | | | BAEA354 [275] Eng.981021→ Eng.111215 | CLS083 [275] 12/99→ |
| 1.2 | 4 | D7F702; D7F703; D7F704; D7F706 | 43/58 | 05/96→08/04 | OE026 | 0,9 | CET2 | OE179 | BAEA345 →Eng.981021 | CLS040 [275] →11/99 |
| | | | | | | | | | BAEA354 [275] Eng.981021→ Eng.111215 | |

RENAULT TRUCKS**MASCOTT**

| | | | | | | | | | | |
|------------------------------------|---|-----------------------------------|---------|-------------|-------|-----|--|--|--|--|
| 2.8 130, 2.8 130.35, 2.8 130.55 | 4 | 8140.43.S.2585; 8140.43.S.3585 | 92/123 | 01/99→06/04 | CH216 | 11v | | | | |
| 2.8 150.35, 2.8 150.55, 2.8 150.65 | 4 | 8140.43N.3585 | 107/143 | 10/01→06/04 | CH216 | 11v | | | | |

ROLLS-ROYCE**CORNICHE IV**

| | | | | | | | | | | |
|-----|---|-------|---------|-------------|-------|-----|------|--|--|--|
| 6.7 | 8 | L410I | 165/221 | 01/93→12/00 | OE051 | 0,9 | CET8 | | | |
|-----|---|-------|---------|-------------|-------|-----|------|--|--|--|

CORNICHE V

| | | | | | | | | | | |
|--------------|---|---------|---------|-------------|-------|-----|------|--|--|--|
| 6.7 V8 Turbo | 8 | L410MIT | 242/325 | 01/00→09/02 | OE006 | 0,9 | CET8 | | | |
|--------------|---|---------|---------|-------------|-------|-----|------|--|--|--|

GHOST

| | | | | | | | | | | |
|---------|----|---------|---------|--------|-------|-----|--|--|-------------------|--|
| 6.6 V12 | 12 | N74B66A | 420/563 | 08/08→ | OE242 | 0,8 | | | BAEA143 12/09→ | |
| 6.6 V12 | 12 | N74B66A | 442/593 | 08/08→ | OE242 | 0,8 | | | | |

PARK WARD

| | | | | | | | | | | |
|-----|----|--------|---------|-------------|-------|-----|--------|--|--|--|
| 5.4 | 12 | M73B54 | 240/322 | 10/00→12/02 | OE223 | 1,6 | CET12P | | | |
|-----|----|--------|---------|-------------|-------|-----|--------|--|--|--|

PHANTOM VII

| | | | | | | | | | | |
|---------|----|---------|---------|--------|-------|-----|--------|--|------------------------|--|
| 6.8 | 12 | N73B68A | 338/453 | 08/02→ | OE223 | 1,6 | CET12P | | BAEA324 →02/09 | |
| 6.8 V12 | 12 | N73B68A | 338/453 | 03/06→ | OE223 | 1,6 | CET12P | | BAEA324 06/07→02/09 | |

SILVER SERAPH

| | | | | | | | | | | |
|-----|----|--------|---------|-------------|-------|-----|--------|--|---------|--|
| 5.4 | 12 | M73B54 | 240/322 | 03/98→09/02 | OE223 | 1,6 | CET12P | | BAEA302 | |
|-----|----|--------|---------|-------------|-------|-----|--------|--|---------|--|

WRAITH

| | | | | | | | | | | |
|---------|----|---------|---------|--------|-------|-----|--|--|---------|--|
| 6.6 V12 | 12 | N74B66A | 465/624 | 07/13→ | OE242 | 0,8 | | | BAEA143 | |
|---------|----|---------|---------|--------|-------|-----|--|--|---------|--|

ROVER**25**

| | | | | | | | | | | |
|--------------|---|-------|--------|-------------|-------|-----|--------|-------|--|------------------------------|
| 1.1 | 4 | | 44/59 | 11/99→05/05 | | | | | BAEA501 | |
| 1.1, 1.1 16V | 4 | 11K4F | 55/74 | 09/99→05/05 | OE146 | 1,0 | CET12P | OE179 | BAEA501 | |
| 1.4 16V | 4 | 14K4M | 62/83 | 10/99→05/05 | OE146 | 1,0 | CET12P | OE179 | BAEA469 →Ch.YD471564 [185] [260] | CLS061 [292] →Ch.YD471564 |
| 1.4 16V | 4 | 14K4F | 76/102 | 10/99→05/05 | OE146 | 1,0 | CET12P | OE179 | BAEA469 →Ch.YD471564 [185] [260] | CLS061 [292] →Ch.YD471564 |
| | | | | | | | | | BAEA501 Ch.YD471565→ | |



kW/BHP



eon TITAN

IRIDIUM



...ROVER



...25

| | | | | | | | | | | |
|---------|---|-------|---------|-------------|-------|-----|--------|-------|---|------------------------------|
| 1.6 16V | 4 | 16K4F | 80/107 | 10/99→05/05 | OE146 | 1,0 | CET12P | OE179 | BAEA469 →Ch.YD471564 [185] [260] BAEA501 Ch.YD471565→ | CLS061 [292] →Ch.YD471564 |
| 1.8 16V | 4 | 18K4F | 85/114 | 10/99→05/05 | OE146 | 1,0 | CET12P | OE179 | BAEA469 →Ch.YD471564 [185] [260] | CLS061 [292] →Ch.YD471564 |
| 1.8 16V | 4 | 18K4K | 107/143 | 02/00→05/05 | OE146 | 1,0 | CET12P | OE179 | | |
| 2.0 iDT | 4 | 20T2N | 74/99 | 10/99→05/05 | CH169 | 11v | | | | |
| 2.0 iDT | 4 | 20T2N | 83/111 | 01/02→12/04 | CH169 | 11v | | | | |

45

| | | | | | | | | | | |
|---------|---|-------|---------|-------------|-------|-----|--------|-------|-------------------------|--|
| 1.4 | 4 | 14K4F | 76/102 | 02/00→05/05 | OE146 | 1,0 | CET12P | OE179 | BAEA501 Ch.YD471064→ | |
| 1.6 | 4 | 16K4F | 80/107 | 02/00→05/05 | OE146 | 1,0 | CET12P | OE179 | BAEA501 Ch.YD471064→ | |
| 1.8 | 4 | 18K4F | 86/115 | 02/00→05/05 | OE146 | 1,0 | CET12P | OE179 | | |
| 2.0 V6 | 6 | 20K4F | 110/148 | 02/00→05/05 | OE146 | 1,0 | CET12P | OE179 | | |
| 2.0 iDT | 4 | 20T2N | 74/99 | 02/00→05/05 | CH169 | 11v | | | | |
| 2.0 iDT | 4 | 20T2N | 83/111 | 01/04→05/05 | CH169 | 11v | | | | |

75

| | | | | | | | | | | |
|-----------|---|---------------|---------|-------------|-------|-----|--------|-------|---------|--------|
| 1.8 | 4 | K1.8 | 88/118 | 02/99→05/05 | OE146 | 1,0 | CET12P | OE179 | BAEA501 | CLS045 |
| 1.8 | 4 | K1.8 | 88/118 | 02/99→05/05 | | | | | BAEA501 | |
| 1.8 Turbo | 4 | 18K4G | 110/148 | 05/03→05/05 | OE146 | 1,0 | CET12P | OE179 | BAEA501 | |
| 1.8 Turbo | 4 | 18K4G | 110/148 | 05/03→05/05 | | | | | BAEA501 | |
| 2.0 CDT | 4 | M47R | 85/114 | 02/99→05/05 | CH203 | 11v | | | | |
| 2.0 CDTi | 4 | 204D2 | 96/129 | 02/03→05/05 | CH203 | 11v | | | | |
| 2.0 V6 | 6 | 20K4F | 110/148 | 02/99→05/05 | OE146 | 1,0 | CET12P | OE179 | | |
| 2.5 V6 | 6 | KV6 | 129/173 | 02/99→10/01 | OE146 | 1,0 | CET12P | OE179 | | |
| 2.5 V6 | 6 | 25K4F; KV6 | 130/174 | 08/01→05/05 | OE146 | 1,0 | CET12P | OE179 | | |
| 4.6 V8 | 8 | 46F2F; V99WFH | 191/256 | 10/03→05/05 | | | CET9 | | | |

100

| | | | | | | | | | | |
|---------|---|--------------|--------|-------------|-------|-----|------|-------|------------------------|--|
| 1.1 111 | 4 | 11K2D | 44/59 | 04/94→10/97 | OE002 | 0,9 | CET2 | OE180 | BAEA469 [185] [260] | |
| 1.4 114 | 4 | 14K2A; 14K2D | 55/74 | 04/94→10/97 | OE002 | 0,9 | CET2 | OE180 | BAEA469 [185] [260] | |
| 1.4 114 | 4 | 14K4F | 75/101 | 03/97→10/98 | OE002 | 0,9 | CET2 | OE179 | BAEA469 [185] [260] | |

100 / METRO

| | | | | | | | | | | |
|-------------|---|-------|--------|-------------|-------|-----|------|-------|------------------------|--|
| 1.4 114 GSi | 4 | 14K4F | 76/102 | 10/94→10/95 | OE002 | 0,9 | CET2 | OE179 | BAEA469 [185] [260] | |
| 1.5 115 D | 4 | TUD5 | 42/56 | 12/94→12/98 | CH185 | 11v | | | | |

200

| | | | | | | | | | | |
|------------------|---|--------------|--------|-------------|-------|-----|------|-------|---|------------------------------|
| 1.1 211 | 4 | 11K2D | 44/59 | 01/98→03/00 | OE002 | 0,9 | CET2 | OE180 | BAEA469 [185] | |
| 1.4 214 | 4 | 14K2A; 14K2D | 55/74 | 09/93→12/95 | OE005 | 0,9 | CET2 | OE180 | BAEA115 [8] [275] | |
| 1.4 214 1.4i 16V | 4 | 14K4F | 76/102 | 01/93→11/99 | OE002 | 0,9 | CET2 | OE180 | BAEA469 [185] [260] | |
| 1.4 214 i | 4 | 14K2F | 55/74 | 11/95→03/00 | L82C | 0,6 | CET2 | OE180 | BAEA469 [185] [260] | CLS095 |
| | | | | | OE002 | 0,9 | | | | |
| 1.4 214 Si | 4 | 14K4F | 76/102 | 11/95→03/00 | OE002 | 0,9 | CET2 | OE180 | BAEA469 →Ch.YD471564 [185] [260] [275] BAEA501 [275] Ch.YD471565→ | CLS061 [292] →Ch.YD471564 |
| 1.6 216 1.6i 16V | 4 | 16K4F | 82/110 | 01/96→11/99 | OE002 | 0,9 | CET2 | OE180 | BAEA469 [185] [260] | CLS095 |

ROVER



kW/BHP

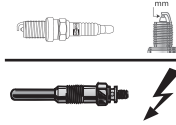

eon TITAN

IRIDIUM

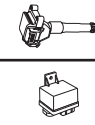

ROVER

| ...ROVER | | | | | | | | | | |
|----------------------------|---|---------------------|---------|-------------|------------------------------------|----------------|--------|-------|--------------------------------------|--|
| ...200 | | | | | | | | | | |
| 1.6 216 Si | 4 | 16K4F | 82/110 | 11/95→06/99 | OE002 | 0,9 | CET2 | OE180 | BAEA469 →Ch.471564 [185] [260] | CLS061 [292] |
| 1.8 218 K Vi | 4 | 18K4K | 107/143 | 11/95→03/00 | OE146 | 1,0 | CET12P | OE179 | | |
| 1.8 218 Si | 4 | 18K4F | 88/118 | 08/99→03/00 | OE002 | 0,9 | CET2 | OE179 | | CLS095 |
| 2.0 220 D/SD | 4 | 20T2R | 63/84 | 11/95→03/00 | CH169 | 11v | | | | |
| 2.0 220 GSi | 4 | 20T4H | 100/134 | 05/94→06/99 | OE002 | 0,9 | CET2 | OE180 | BAEA115 [8] [275] | |
| 2.0 220 GTi | 4 | 20T4H | 100/134 | 01/93→10/95 | OE002 | 0,9 | CET2 | OE180 | | |
| 2.0 220 SDi | 4 | 20T2N | 77/103 | 11/95→03/00 | CH169 | 11v | | | | |
| 400 | | | | | | | | | | |
| 1.4 414 | 4 | 14K2F | 55/74 | 03/96→12/99 | OE002 | 0,9 | CET2 | OE179 | BAEA469 BAEA469 [185] [260] | |
| 1.4 414 | 4 | 14K4C | 70/94 | 01/93→04/95 | OE002 | 0,9 | CET2 | OE180 | BAEA469 | |
| 1.4 414 Si | 4 | 14K4F | 76/102 | 05/95→03/00 | OE002 | 0,9 | CET2 | OE180 | BAEA469 [185] [260] | CLS095 |
| 1.6 416 Si | 4 | 16K4F | 82/110 | 05/95→03/00 | OE002 | 0,9 | CET2 | OE180 | BAEA469 →Ch.74464 [185] [260] | CLS095 |
| 1.6 416 Si | 4 | D16Y2 | 83/111 | 05/95→03/00 | | | CET2 | OE179 | BAEA469 →Ch.74464 | CLS095 |
| 1.6 416 Si | 4 | D16B2 | 85/114 | 05/95→03/00 | OE002 | 0,9 | CET2 | OE180 | | CLS095 |
| 1.6 i | 4 | D16Z2 | 82/110 | 05/94→11/98 | OE002 | 0,9 | CET2 | OE180 | BAEA469 [185] [260] | CLS095 →02/96 CLS129 [296] 02/96→ |
| 1.6 i | 4 | D16A8 | 90/121 | 05/94→11/98 | OE039 | 1,0 | CET2 | OE180 | BAEA469 [185] [260] | |
| 1.8 i | 4 | 18K4K | 107/143 | 06/96→11/98 | OE146 | 1,0 | CET12P | OE179 | | |
| 2.0 420 D | 4 | 20T2R | 63/84 | 11/95→03/00 | CH169 | 11v | | | | |
| 2.0 420 Di | 4 | 20T2N | 77/103 | 05/95→03/00 | CH169 | 11v | | | | |
| 2.0 420 GSi/SLI/GTI/Vite | 4 | 20T4H | 100/134 | 01/93→04/95 | OE002 | 0,9 | CET2 | OE180 | | |
| 2.0 420 Si Lux, 2.0 i | 4 | 20T4H | 100/134 | 05/94→03/00 | OE002 | 0,9 | CET2 | OE180 | BAEA231 | |
| 2.0 420 Turbo | 4 | 20T4G | 147/197 | 01/93→04/95 | OE002 | 0,9 | CET2 | OE180 | | |
| 600 | | | | | | | | | | |
| 1.9 618 i/Si | 4 | F18A3 | 85/114 | 03/96→02/99 | OE089 | 1,0 | CET2 | OE184 | | |
| | | | | | OE216 LPG [278] | 0,8 | | | | |
| 2.0 620 i | 4 | F20Z2 | 85/114 | 08/93→06/96 | OE089 | 1,0 | CET2 | OE184 | BAEA275 [292] →Ch.246796 | |
| | | | | | OE216 LPG [278] | 0,8 | | | | |
| 2.0 620 Sdi | 4 | 20T2N | 77/103 | 05/94→06/99 | CH169 | 11v | | | | |
| 2.0 620 Si | 4 | F20Z1 | 96/129 | 08/93→02/99 | OE089 | 1,0 | CET2 | OE184 | BAEA275 [292] →Ch.246796 | |
| | | | | | OE216 LPG [278] | 0,8 | | | | |
| 2.0 620 Ti Vitesse | 4 | 20T4G | 147/197 | 05/94→08/98 | OE002 | 0,9 | CET2 | OE180 | BAEA275 [292] | |
| 2.3 623 Si | 4 | H23A3 | 116/156 | 08/93→06/99 | OE089 | 1,0 | CET2 | OE184 | BAEA275 [292] | |
| | | | | | OE216 LPG [278] | 0,8 | | | | |
| 800 | | | | | | | | | | |
| 2.0 820 Sport | 4 | 20T4G | 145/194 | 04/94→03/96 | | | CET2 | OE179 | BAEA231 01/96→ Ch.230967→ | |
| 2.5, 2.5 Si | 6 | 25K4F | 129/173 | 02/96→10/98 | OE005 | 0,9 | CET2 | OE179 | | |
| 2.5 825 SD | 4 | 425SL1RR; 4924SHIRG | 87/117 | 09/93→02/99 | CH189 →04/95 CH181 05/95→ | 11v 11v | | | | |
| 2.5 825 Si, 2.5 825 Si Lux | 6 | 25K4F | 129/173 | 04/96→02/99 | | | CET2 | OE179 | | |





kW/BHP



eon TITAN

IRIDIUM

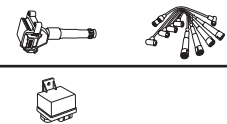

...ROVER



CITYROVER

| | | | | | | | | | |
|--------------|---|-------------|-------|-------------|-------|-----|------|-------|--------------------------|
| 1.4 Elegance | 4 | 14K2; 475Si | 62/83 | 09/03→12/05 | OE005 | 0,9 | CET2 | OE179 | BAEA232 ^[275] |
|--------------|---|-------------|-------|-------------|-------|-----|------|-------|--------------------------|

COUPE

| | | | | | | | | | | |
|----------|---|-------|--------|-------------|-------|-----|------|-------|--------------------------------|--------|
| 1.6 16 V | 4 | 16K4F | 82/110 | 03/96→11/99 | OE002 | 0,9 | CET2 | OE180 | BAEA469 ^{[185] [260]} | CLS095 |
|----------|---|-------|--------|-------------|-------|-----|------|-------|--------------------------------|--------|

| | | | | | | | | | |
|----------|---|-------|---------|-------------|-------|-----|--------|-------|--|
| 1.8 16 V | 4 | 18K4K | 107/143 | 03/96→11/99 | OE146 | 1,0 | CET12P | OE179 | |
|----------|---|-------|---------|-------------|-------|-----|--------|-------|--|

MINI

| | | | | | | | | | |
|-----|---|--|-------|-------------|-------|-----|------|--|--|
| 1.3 | 4 | | 63/84 | 11/96→05/01 | OE006 | 0,9 | CET8 | | |
|-----|---|--|-------|-------------|-------|-----|------|--|--|

| | | | | | | | | | |
|--------------|---|--|-------|-------------|-------|-----|------|--|--|
| 1.3 Cooper S | 4 | | 59/79 | 06/95→11/00 | OE006 | 0,9 | CET8 | | |
|--------------|---|--|-------|-------------|-------|-----|------|--|--|

| | | | | | | | | | |
|-------|---|-------|-------|-------------|-------|-----|------|--|---------------------------------|
| 1.3 S | 4 | 12A2L | 46/62 | 02/98→05/01 | OE006 | 0,9 | CET8 | | BAEA231 ^{Ch.BD134455→} |
|-------|---|-------|-------|-------------|-------|-----|------|--|---------------------------------|

STREETWISE

| | | | | | | | | | |
|-----|---|-------|-------|-------------|-------|-----|--------|-------|---------|
| 1.4 | 4 | 14K4M | 62/83 | 08/03→05/05 | OE146 | 1,0 | CET12P | OE179 | BAEA501 |
|-----|---|-------|-------|-------------|-------|-----|--------|-------|---------|

| | | | | | | | | | |
|-----|---|-------|--------|-------------|-------|-----|--------|-------|---------|
| 1.4 | 4 | 14K4F | 76/102 | 08/03→05/05 | OE146 | 1,0 | CET12P | OE179 | BAEA501 |
|-----|---|-------|--------|-------------|-------|-----|--------|-------|---------|

| | | | | | | | | | |
|-----|---|-------|--------|-------------|-------|-----|--------|-------|---------|
| 1.6 | 4 | 16K4F | 80/107 | 01/04→05/05 | OE146 | 1,0 | CET12P | OE179 | BAEA501 |
|-----|---|-------|--------|-------------|-------|-----|--------|-------|---------|

| | | | | | | | | | |
|-----|---|-------|--------|-------------|-------|-----|--------|-------|---------|
| 1.8 | 4 | 18K4F | 86/115 | 08/03→05/05 | OE146 | 1,0 | CET12P | OE179 | BAEA501 |
|-----|---|-------|--------|-------------|-------|-----|--------|-------|---------|

| | | | | | | | | | |
|--------|---|-------|-------|-------------|-------|-----|--|--|--|
| 2.0 TD | 4 | 20T2N | 74/99 | 08/03→05/05 | CH169 | 11v | | | |
|--------|---|-------|-------|-------------|-------|-----|--|--|--|

SAAB



9-3

| | | | | | | | | | |
|-------|---|-------|--------|-------------|-------|-----|------|-------|---------|
| 1.8 i | 4 | Z18XE | 90/121 | 01/04→02/15 | OE019 | 0,9 | CET2 | OE184 | BAEA342 |
|-------|---|-------|--------|-------------|-------|-----|------|-------|---------|

| | | | | | | | | | |
|---------|---|-------|--------|-------------|-------|-----|--|--|--|
| 1.9 TiD | 4 | Z19DT | 88/118 | 09/04→02/15 | CH222 | 11v | | | |
|---------|---|-------|--------|-------------|-------|-----|--|--|--|

→Ch.71019398
76004481

CH269

Ch.71100001
76100001→

| | | | | | | | | | |
|---------|---|--------|---------|-------------|-------|-----|--|--|--|
| 1.9 TiD | 4 | Z19DTH | 110/148 | 09/04→02/15 | CH224 | 11v | | | |
|---------|---|--------|---------|-------------|-------|-----|--|--|--|

| | | | | | | | | | |
|-----------|---|-------|---------|-------------|-------|-----|--------|-------|--|
| 2.0 1, 8t | 4 | B207E | 110/148 | 09/02→02/15 | OE136 | 0,8 | CET12P | OE179 | |
|-----------|---|-------|---------|-------------|-------|-----|--------|-------|--|

| | | | | | | | | | |
|---|---|-------|---------|-------------|-------|-----|--------|-------|--|
| 2.0 1, 8t BioPower, 2.0 1.8t, 2.0 t, 2.0 t BioPower | 4 | B207E | 110/148 | 03/05→02/15 | OE136 | 0,8 | CET12P | OE179 | |
|---|---|-------|---------|-------------|-------|-----|--------|-------|--|

| | | | | | | | | | |
|---|---|-------|---------|-------------|-------|-----|--------|-------|--|
| 2.0 1, 8t BioPower, 2.0 t, 2.0 t BioPower | 4 | B207L | 129/173 | 09/02→02/15 | OE136 | 0,8 | CET12P | OE179 | |
|---|---|-------|---------|-------------|-------|-----|--------|-------|--|

| | | | | | | | | | |
|-------|---|-------|--------|-------------|--|--|------|-------|--------|
| 2.0 i | 4 | B204I | 96/129 | 02/98→08/03 | | | CET2 | OE182 | CLS150 |
|-------|---|-------|--------|-------------|--|--|------|-------|--------|

| | | | | | | | | | |
|--------------|---|-------|---------|-------------|--|--|------|-------|--|
| 2.0 SE Turbo | 4 | B204R | 147/197 | 02/98→08/03 | | | CET2 | OE179 | |
|--------------|---|-------|---------|-------------|--|--|------|-------|--|

| | | | | | | | | | |
|------------------|---|-------|---------|-------------|-------|-----|--------|-------|--|
| 2.0 t, 2.0 t 4WD | 4 | B207G | 120/161 | 01/07→02/15 | OE136 | 0,8 | CET12P | OE179 | |
|------------------|---|-------|---------|-------------|-------|-----|--------|-------|--|

| | | | | | | | | | |
|--|---|--------|---------|-------------|--|--|--------|-------|---------------|
| 2.0 t, 2.0 t 4WD, 2.0 t BioPower, 2.0 t BioPower, 2.0 t BioPower 4WD | 4 | A20NFT | 162/217 | 01/08→02/15 | | | CET17P | OE189 | *tobeadjusted |
|--|---|--------|---------|-------------|--|--|--------|-------|---------------|

| | | | | | | | | | |
|----------------------|---|-------|---------|-------------|-------|-----|--------|-------|--|
| 2.0 t, 2.0 Turbo 4WD | 4 | B207R | 154/207 | 09/02→02/15 | OE136 | 0,8 | CET12P | OE179 | |
|----------------------|---|-------|---------|-------------|-------|-----|--------|-------|--|

| | | | | | | | | | |
|-----------|---|-------|---------|-------------|-------|-----|--------|-------|--------|
| 2.0 Turbo | 4 | B205E | 110/148 | 03/99→08/03 | OE136 | 0,8 | CET12P | OE179 | CLS150 |
|-----------|---|-------|---------|-------------|-------|-----|--------|-------|--------|

| | | | | | | | | | |
|-----------|---|-------|---------|-------------|-------|-----|--------|-------|--------|
| 2.0 Turbo | 4 | B204E | 113/152 | 10/98→08/03 | OE136 | 0,8 | CET12P | OE179 | CLS150 |
|-----------|---|-------|---------|-------------|-------|-----|--------|-------|--------|

| | | | | | | | | | |
|-----------|---|---------------------|---------|-------------|-------|-----|--------|-------|--|
| 2.0 Turbo | 4 | B204L; B205E; B205L | 136/182 | 02/98→08/03 | OE136 | 0,8 | CET12P | OE179 | |
|-----------|---|---------------------|---------|-------------|-------|-----|--------|-------|--|

| | | | | | | | | | |
|-----------|---|-------|---------|-------------|-------|-----|--------|-------|--------|
| 2.0 Turbo | 4 | B205R | 151/202 | 10/99→08/03 | OE136 | 0,8 | CET12P | OE179 | CLS150 |
|-----------|---|-------|---------|-------------|-------|-----|--------|-------|--------|

| | | | | | | | | | |
|---------|---|---------------|--------|-------------|-------|-----|--|--|--|
| 2.2 TiD | 4 | D223L; X22DTH | 85/114 | 02/98→11/00 | CH207 | 11v | | | |
|---------|---|---------------|--------|-------------|-------|-----|--|--|--|

| | | | | | | | | | |
|---------|---|-------|--------|-------------|-------|-----|--|--|--|
| 2.2 TiD | 4 | D223L | 92/123 | 11/00→02/15 | CH231 | 11v | | | |
|---------|---|-------|--------|-------------|-------|-----|--|--|--|

| | | | | | | | | | |
|-----|---|-------|---------|-------------|-------|-----|--------|-------|--|
| 2.3 | 4 | B235R | 169/227 | 09/99→01/02 | OE136 | 0,8 | CET12P | OE179 | |
|-----|---|-------|---------|-------------|-------|-----|--------|-------|--|

| | | | | | | | | | |
|-------|---|-------|---------|-------------|--|--|------|-------|--|
| 2.3 i | 4 | B234I | 110/148 | 02/98→08/03 | | | CET2 | OE182 | |
|-------|---|-------|---------|-------------|--|--|------|-------|--|

| | | | | | | | | | |
|-----------|---|-------|---------|-------------|-------|-----|--------|-------|--|
| 2.3 Turbo | 4 | B235R | 165/221 | 10/98→08/03 | OE136 | 0,8 | CET12P | OE179 | |
|-----------|---|-------|---------|-------------|-------|-----|--------|-------|--|

| | | | | | | | | | |
|--------------|---|------------|---------|-------------|-------|-----|--|--|----------|
| 2.8 Turbo V6 | 6 | B284L; LP9 | 169/227 | 03/05→02/15 | OE238 | 1,0 | | | BAEA174E |
|--------------|---|------------|---------|-------------|-------|-----|--|--|----------|

| | | | | | | | | | |
|--------------|---|-----|---------|-------------|-------|-----|--|--|----------|
| 2.8 Turbo V6 | 6 | LP9 | 184/247 | 03/05→02/15 | OE238 | 1,0 | | | BAEA174E |
|--------------|---|-----|---------|-------------|-------|-----|--|--|----------|

| | | | | | | | | | |
|--------------|---|-------|---------|-------------|-------|-----|--|--|----------|
| 2.8 Turbo V6 | 6 | B284L | 188/252 | 12/07→02/15 | OE238 | 1,0 | | | BAEA174E |
|--------------|---|-------|---------|-------------|-------|-----|--|--|----------|

| | | | | | | | | | |
|--------------|---|--------------|---------|-------------|-------|-----|--|--|----------|
| 2.8 Turbo V6 | 6 | B284L; B284R | 203/272 | 04/08→02/15 | OE238 | 1,0 | | | BAEA174E |
|--------------|---|--------------|---------|-------------|-------|-----|--|--|----------|

| | | | | | | | | | |
|--------------------------------|---|-------|---------|-------------|-------|-----|--|--|----------|
| 2.8 Turbo V6, 2.8 Turbo V6 4WD | 6 | B284R | 206/276 | 05/08→02/15 | OE238 | 1,0 | | | BAEA174E |
|--------------------------------|---|-------|---------|-------------|-------|-----|--|--|----------|

SAAB





kW/BHP

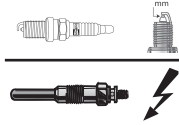

eon TITAN

IRIDIUM



...SAAB



9-3X

| | | | | | | | | | |
|--------------------|---|--------|---------|-------------|--|--|--------|---------------------------------------|--|
| 2.0 † BioPower 4WD | 4 | A20NFT | 162/217 | 01/11→12/12 | | | CET17P | OE189 <small>*tobeadjusted</small> | |
|--------------------|---|--------|---------|-------------|--|--|--------|---------------------------------------|--|

9-4X

| | | | | | | | | | |
|---------------|---|----------|---------|-------------|-------|-----|--|--|--|
| 2.8 Turbo 4WD | 6 | LAU; LP9 | 224/300 | 02/11→12/11 | OE238 | 1,0 | | | |
|---------------|---|----------|---------|-------------|-------|-----|--|--|--|

9-5

| | | | | | | | | | |
|---------|---|--------|---------|-------------|-------|-----|--|--|--|
| 1.9 TiD | 4 | Z19DTH | 110/148 | 01/06→12/09 | CH224 | 11v | | | |
|---------|---|--------|---------|-------------|-------|-----|--|--|--|

| | | | | | | | | | |
|-----|---|--------|---------|-------------|--|--|--------|---------------------------------------|--|
| 2.0 | 4 | A20NFT | 164/220 | 09/10→01/12 | | | CET17P | OE189 <small>*tobeadjusted</small> | |
|-----|---|--------|---------|-------------|--|--|--------|---------------------------------------|--|

| | | | | | | | | | |
|-------|---|-------|---------|-------------|-------|-----|--------|-------|--|
| 2.0 † | 4 | B205L | 136/182 | 07/00→12/09 | OE136 | 0,8 | CET12P | OE179 | |
|-------|---|-------|---------|-------------|-------|-----|--------|-------|--|

| | | | | | | | | | |
|-----------------------|---|-------|---------|-------------|-------|-----|--------|-------|--|
| 2.0 †, 2.0 † BioPower | 4 | B205E | 110/148 | 09/97→12/09 | OE136 | 0,8 | CET12P | OE179 | |
|-----------------------|---|-------|---------|-------------|-------|-----|--------|-------|--|

| | | | | | | | | | |
|---------------------|---|-------|---------|-------------|-------|-----|--------|-------|--|
| 2.0 †, 2.0 Turbo SE | 4 | B205E | 141/189 | 10/98→07/00 | OE136 | 0,8 | CET12P | OE179 | |
|---------------------|---|-------|---------|-------------|-------|-----|--------|-------|--|

| | | | | | | | | | |
|----------------|---|--------|---------|-------------|--|--|--------|---------------------------------------|--|
| 2.0 † BioPower | 4 | A20NFT | 162/217 | 05/10→01/12 | | | CET17P | OE189 <small>*tobeadjusted</small> | |
|----------------|---|--------|---------|-------------|--|--|--------|---------------------------------------|--|

| | | | | | | | | | |
|--|---|--------|---------|-------------|--|--|-------------------------|--|--|
| 2.0 † BioPower 4WD, 2.0 Turbo, 2.0 Turbo 4WD | 4 | A20NHT | 162/217 | 05/10→01/12 | | | CET17P ^[331] | OE189 ^[331] <small>*tobeadjusted</small> | |
|--|---|--------|---------|-------------|--|--|-------------------------|--|--|

| | | | | | | | | | |
|---------|---|-------|--------|-------------|-------|-----|--|--|--|
| 2.2 TiD | 4 | D223L | 88/118 | 03/02→12/09 | CH207 | 11v | | | |
|---------|---|-------|--------|-------------|-------|-----|--|--|--|

| | | | | | | | | | |
|-------|---|-------|---------|-------------|-------|-----|--------|-------|--|
| 2.3 † | 4 | B235E | 125/168 | 09/97→12/09 | OE136 | 0,8 | CET12P | OE179 | |
|-------|---|-------|---------|-------------|-------|-----|--------|-------|--|

| | | | | | | | | | |
|-----------------------|---|-------|---------|-------------|-------|-----|--------|-------|--|
| 2.3 †, 2.3 † BioPower | 4 | B235E | 136/182 | 01/01→12/09 | OE136 | 0,8 | CET12P | OE179 | |
|-----------------------|---|-------|---------|-------------|-------|-----|--------|-------|--|

| | | | | | | | | | |
|-----------|---|-------|---------|-------------|-------|-----|--------|-------|--|
| 2.3 Turbo | 4 | B235L | 162/217 | 07/03→12/09 | OE136 | 0,8 | CET12P | OE179 | |
|-----------|---|-------|---------|-------------|-------|-----|--------|-------|--|

| | | | | | | | | | |
|-----------|---|-------|---------|-------------|-------|-----|--------|-------|--|
| 2.3 Turbo | 4 | B235R | 169/227 | 10/99→09/01 | OE136 | 0,8 | CET12P | OE179 | |
|-----------|---|-------|---------|-------------|-------|-----|--------|-------|--|

| | | | | | | | | | |
|-----------|---|-------|---------|-------------|-------|-----|--------|-------|--|
| 2.3 Turbo | 4 | B235R | 184/247 | 09/01→12/09 | OE136 | 0,8 | CET12P | OE179 | |
|-----------|---|-------|---------|-------------|-------|-----|--------|-------|--|

| | | | | | | | | | |
|-----------|---|-------|---------|-------------|-------|-----|--------|-------|--|
| 2.3 Turbo | 4 | B235R | 191/256 | 11/05→12/09 | OE136 | 0,8 | CET12P | OE179 | |
|-----------|---|-------|---------|-------------|-------|-----|--------|-------|--|

| | | | | | | | | | |
|------------------|---|--------|---------|-------------|-------|-----|--|--|--|
| 2.8 Turbo V6 4WD | 6 | A28NER | 221/296 | 05/10→01/12 | OE238 | 1,0 | | | |
|------------------|---|--------|---------|-------------|-------|-----|--|--|--|

| | | | | | | | | | |
|---------|---|-------|---------|-------------|-------|-----|--------|-------|--|
| 3.0 V6† | 6 | B308E | 147/197 | 01/98→12/09 | OE136 | 0,8 | CET12P | OE179 | |
|---------|---|-------|---------|-------------|-------|-----|--------|-------|--|

9-7X

| | | | | | | | | | |
|---------|---|-----|---------|-------------|--|--|--------|-------|--|
| 4.2 4WD | 6 | LL8 | 213/286 | 12/05→07/12 | | | CET17P | OE189 | |
|---------|---|-----|---------|-------------|--|--|--------|-------|--|

900 I

| | | | | | | | | | |
|--------------|---|-------|---------|-------------|--|--|------|-------|--------|
| 2.0 Turbo-16 | 4 | B202L | 132/177 | 01/93→06/94 | | | CET2 | OE179 | CLS182 |
|--------------|---|-------|---------|-------------|--|--|------|-------|--------|

900 II

| | | | | | | | | | |
|---------------|---|-------|---------|-------------|--|--|------|-------|--------|
| 2.0 -16 Turbo | 4 | B204L | 136/182 | 07/93→02/98 | | | CET2 | OE179 | CLS150 |
|---------------|---|-------|---------|-------------|--|--|------|-------|--------|

| | | | | | | | | | |
|-------|---|-------|--------|-------------|-------|-----|------|-------|--------|
| 2.0 i | 4 | B204I | 96/129 | 12/93→02/98 | OE005 | 0,9 | CET2 | OE179 | CLS150 |
|-------|---|-------|--------|-------------|-------|-----|------|-------|--------|

| | | | | | | | | | |
|-------|---|-------|--------|-------------|-------|-----|------|-------|--------|
| 2.0 i | 4 | B206I | 98/131 | 07/93→07/94 | OE005 | 0,9 | CET2 | OE179 | CLS150 |
|-------|---|-------|--------|-------------|-------|-----|------|-------|--------|

| | | | | | | | | | |
|---------|---|-------|---------|-------------|-------|-----|------|-------|--------|
| 2.3 -16 | 4 | B234I | 110/148 | 07/93→02/98 | OE005 | 0,9 | CET2 | OE179 | CLS150 |
|---------|---|-------|---------|-------------|-------|-----|------|-------|--------|

| | | | | | | | | | |
|------------|---|-------|---------|-------------|-------|-----|--------|-------|--|
| 2.5 -24 V6 | 6 | B258I | 125/168 | 07/93→02/98 | OE223 | 1,6 | CET12P | OE184 | |
|------------|---|-------|---------|-------------|-------|-----|--------|-------|--|

9000

| | | | | | | | | | |
|------------------------|---|--------------|--------|-------------|-------|-----|------|-------|--------|
| 2.0 -16 CD, 2.0 -16 CS | 4 | B202I; B204I | 96/129 | 09/93→12/98 | OE005 | 0,9 | CET2 | OE179 | CLS150 |
|------------------------|---|--------------|--------|-------------|-------|-----|------|-------|--------|

| | | | | | | | | | |
|------------------------------|---|---------------------|---------|-------------|-------|-----|------|-------|--------|
| 2.0 -16 CD, 2.0 -16 ND Turbo | 4 | B202S; B204E; B204S | 110/148 | 09/93→12/98 | OE005 | 0,9 | CET2 | OE179 | CLS150 |
|------------------------------|---|---------------------|---------|-------------|-------|-----|------|-------|--------|

| | | | | | | | | | |
|-----------------|---|-------|---------|-------------|--|--|------|-------|--------|
| 2.3 -16 Aero CS | 4 | B234R | 162/217 | 02/93→12/98 | | | CET2 | OE179 | CLS150 |
|-----------------|---|-------|---------|-------------|--|--|------|-------|--------|

| | | | | | | | | | |
|-----------------|---|-------|---------|-------------|--|--|------|-------|--------|
| 2.3 -16 Aero CS | 4 | B234R | 165/221 | 02/93→12/98 | | | CET2 | OE179 | CLS150 |
|-----------------|---|-------|---------|-------------|--|--|------|-------|--------|

| | | | | | | | | | |
|-------------|---|-------|---------|-------------|--|--|------|-------|--------|
| 2.3 -16 CDE | 4 | B234I | 108/145 | 09/93→12/98 | | | CET2 | OE179 | CLS150 |
|-------------|---|-------|---------|-------------|--|--|------|-------|--------|

| | | | | | | | | | |
|--|---|-------|---------|-------------|--|--|------|-------|--------|
| 2.3 -16 CDE Eco-Power, 2.3 -16 CSE Eco Power | 4 | B234E | 125/168 | 09/93→12/98 | | | CET2 | OE179 | CLS150 |
|--|---|-------|---------|-------------|--|--|------|-------|--------|

| | | | | | | | | | |
|-------------|---|-------|---------|-------------|--|--|------|-------|--|
| 2.3 -16 CSE | 4 | B234I | 108/145 | 09/93→12/98 | | | CET2 | OE179 | |
|-------------|---|-------|---------|-------------|--|--|------|-------|--|

| | | | | | | | | | |
|-------------------|---|-------|---------|-------------|--|--|------|-------|--------|
| 2.3 -16 Turbo CSE | 4 | B234L | 147/197 | 09/93→12/98 | | | CET2 | OE179 | CLS150 |
|-------------------|---|-------|---------|-------------|--|--|------|-------|--------|

| | | | | | | | | | |
|--------------------------------------|---|-------|---------|-------------|-------|-----|------|-------|--|
| 3.0 -24 V6 CD/CDE, 3.0 -24 V6 CS/CSE | 6 | B308I | 155/208 | 07/94→12/98 | OE019 | 0,9 | CET2 | OE184 | |
|--------------------------------------|---|-------|---------|-------------|-------|-----|------|-------|--|

| | | | | | | | | | |
|--------------------------------------|---|-------|---------|-------------|-------|-----|------|-------|--|
| 3.0 -24 V6 CD/CDE, 3.0 -24 V6 CS/CSE | 6 | B308I | 155/208 | 07/94→12/98 | OE019 | 0,9 | CET2 | OE184 | |
|--------------------------------------|---|-------|---------|-------------|-------|-----|------|-------|--|

| | | | | | | | | | |
|--------------------------------------|---|-------|---------|-------------|-------|-----|------|-------|--|
| 3.0 -24 V6 CD/CDE, 3.0 -24 V6 CS/CSE | 6 | B308I | 155/208 | 07/94→12/98 | OE019 | 0,9 | CET2 | OE184 | |
|--------------------------------------|---|-------|---------|-------------|-------|-----|------|-------|--|

SANTANA



300/350

| | | | | | | | | | |
|------------------------|---|----------|-------|--------|-------|-----|--|--|--|
| 1.6 D 4WD, 1.6 HDi 4WD | 4 | DV6ATED4 | 66/89 | 09/98→ | CH201 | 11v | | | |
|------------------------|---|----------|-------|--------|-------|-----|--|--|--|

PS10/ANIBAL

| | | | | | | | | | |
|-----------|---|----------|--------|--------|------------------------|-----|--|--|--|
| 2.8 D 4WD | 4 | 8140.43P | 78/105 | 03/03→ | CH216 ^[275] | 11v | | | |
|-----------|---|----------|--------|--------|------------------------|-----|--|--|--|





kW/BHP

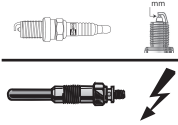

eon TITAN

IRIDIUM

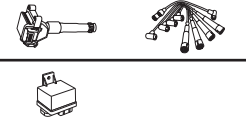

SEAT



ALHAMBRA

| | | | | | | | | | |
|----------------------|---|------------------|---------|-------------|---------------------------------------|------|----------------|-------|---|
| 1.4 TSI | 4 | CAVA; CNWB; CTHA | 110/148 | 06/10→ | OE244 ModelYear2016→ [25] [193] | 0,8 | | | BAE408AE |
| 1.4 TSI | 4 | CZDA | 110/148 | 06/10→ | OE244 [25] [193] | 0,8 | | | |
| 1.8 T 20V | 4 | AJH | 110/148 | 10/97→03/10 | OE032 | 1,0 | CET12P CET2 | OE179 | BAEA016 |
| 1.8 T 20V | 4 | AWC | 110/148 | 10/97→03/10 | OE136 | 0,8 | CET12P CET2 | OE179 | BAEA009E |
| 1.8 TSI | 4 | CDA | 118/158 | 11/12→ | OE214 | 0,7 | CET11P | | BAEA033E ^[7] |
| 1.9 TDI | 4 | I2; AHU; ANU | 66/89 | 04/96→03/10 | CH271 | 11v | | | CCU152 ^[199] 05/05→04/08 CCU081 ^[198] |
| 1.9 TDI | 4 | AFN; AVG | 81/109 | 08/96→06/00 | CH271 | 11v | | | CCU081 |
| 1.9 TDI | 4 | ASZ | 96/129 | 11/02→11/08 | CH181 | 11v | | | CCU152 ^[199] 05/05→ CCU081 ^[198] |
| 1.9 TDI | 4 | BTB | 110/148 | 05/05→05/07 | | | | | CCU081 ^[198] CCU152 ^[199] |
| 1.9 TDI, 1.9 TDI 4WD | 4 | AUY; BVK | 85/114 | 06/00→03/10 | CH271 | 11v | | | CCU152 ^[199] 05/05→04/08 CCU081 ^[198] |
| 2.0 i | 4 | ADY | 85/114 | 04/96→03/10 | OE032 | 1,0 | CET2 | OE179 | BAE851AE [261] [292] |
| 2.0 i | 4 | ATM | 85/114 | 04/96→03/10 | OE032 | 1,0 | CET2 | OE179 | BAE907AE ^[262] CLS017 |
| 2.0 TDI | 4 | CFFE; CUVA | 85/114 | 05/11→ | | | | | CCU151 |
| 2.0 TDI | 4 | CFFA | 100/134 | 06/10→05/11 | | | | | CCU151 |
| 2.0 TDI | 4 | BRT | 103/138 | 11/05→ | CCGP002 | 7v | | | CCU152 →04/08 |
| 2.0 TDI | 4 | CFGB | 125/168 | 06/10→ | | | | | CCU151 |
| 2.0 TDI | 4 | CFGC | 130/174 | 11/12→ | | | | | CCU151 |
| 2.0 TDI, 2.0 TDI 4WD | 4 | CFFB | 103/138 | 11/05→ | | | | | CCU151 |
| 2.0 TDI, 2.0 TDI 4WD | 4 | CUVC; DFLA | 110/148 | 05/15→ | CPSG007 | 4.4v | | | |
| 2.0 TDI, 2.0 TDI 4WD | 4 | CUWA; DFMA | 135/181 | 05/15→ | CPSG007 | 4.4v | | | |
| 2.0 TSI | 4 | CCZA | 147/197 | 11/10→ | OE214 | 0,7 | CET11P | | BAEA033E ^[7] |
| 2.0 TSI | 4 | DEDA | 162/217 | 05/15→ | | | | | BAEA068E →01/16 |
| 2.8 V6, 2.8 V6 4WD | 6 | AUE; AYL | 150/201 | 06/00→03/10 | OE176 | 1,0 | CET3 | | BAEA063E |

ALTEA

| | | | | | | | | | |
|----------|---|---------------------------|---------|-------------|------------------------|-----|----------------|-------|----------------------------------|
| 1.2 TSI | 4 | CBZB | 77/103 | 04/10→ | | | | OE260 | BAE907AE ^[262] CLS090 |
| 1.4 16V | 4 | BXW; CGGB | 63/84 | 05/06→ | OE177 | 0,9 | CET3 | | BAE408AE |
| 1.4 TSI | 4 | CAXC | 92/123 | 11/07→ | OE213 | 0,9 | | | BAE408AE |
| 1.6 | 4 | BGU; BSE; BSF; CCSA; CMXA | 75/101 | 03/04→ | OE032 | 1,0 | CET2 | OE179 | BAE907AE ^[262] CLS017 |
| 1.6 LPG | 4 | CHGA | 75/101 | 09/09→ | OE032 | 1,0 | CET2 | OE179 | BAE907AE ^[262] CLS048 |
| 1.6 TDI | 4 | CAYB | 66/89 | 11/10→ | | | | | CCU152 |
| 1.6 TDI | 4 | CAYC | 77/103 | 10/09→ | | | | | CCU152 |
| 1.8 TFSI | 4 | BYT; BZB; CDA | 118/158 | 01/07→ | OE214 | 0,7 | CET11P | | BAEA033E ^[7] |
| 1.9 TDI | 4 | BXF | 66/89 | 08/09→ | | | | | CCU152 |
| 1.9 TDI | 4 | BKC | 77/103 | 04/04→ | | | | | CCU152 |
| 1.9 TDI | 4 | BLS | 77/103 | 04/04→ | CCGP002 [183] [275] | 7v | | | CCU152 |
| 1.9 TDI | 4 | BXE | 77/103 | 04/04→ | | | | | CCU152 Ch.5P-6-053001→ |
| 2.0 FSI | 4 | BLR; BVY | 110/148 | 05/04→03/09 | OE234 | 1,0 | CET12P CET3 | | BAEA033E ^[7] |
| 2.0 FSI | 4 | BLY; BVZ | 110/148 | 05/04→03/09 | OE146 | 1,0 | CET12P CET3 | OE179 | BAEA033E ^[7] |

SEAT





kW/BHP



eon TITAN

IRIDIUM

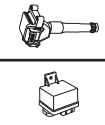

...SEAT



...ALTEA

| | | | | | | | | | | | | |
|-------------|---|------|---------|---------------|-----------------------------|-----|--------|--|--|--|--|----------------------------|
| 2.0 TDI | 4 | AZV | 100/134 | 03/04 → 05/09 | | | | | | | | CCU152 Ch.5P-6-053001 → |
| 2.0 TDI | 4 | BMM | 103/138 | 11/05 → | CCGP002 ModelYear → 2010 | 7v | | | | | | CCU152 |
| 2.0 TDI | 4 | BMN | 125/168 | 03/06 → | CCGP003 | 7v | | | | | | CCU152 |
| 2.0 TDI | 4 | CEGA | 125/168 | 03/06 → | | | | | | | | CCU152 |
| 2.0 TDI 16V | 4 | BKD | 103/138 | 03/04 → | | | | | | | | CCU152 Ch.5P-6-053001 → |
| 2.0 TFSI | 4 | BWA | 147/197 | 04/06 → 05/09 | OE214 | 0,7 | CET11P | | | | | BAEA033E ^[7] |

ALTEA XL

| | | | | | | | | | | | | | |
|----------------------|---|----------------------|---------|---------------|-----------------------------------|-----|----------------|--|-------|--|--|----------------------------------|--------|
| 1.2 TSI | 4 | CBZB | 77/103 | 04/10 → | | | | | OE260 | | | BAE907AE ^[262] | CLS090 |
| 1.4 16V | 4 | BXW; CGGB | 63/84 | 10/06 → | OE177 | 0,9 | CET3 | | | | | BAE408AE | |
| 1.4 TSI | 4 | CBZB | 89/119 | 09/09 → 12/12 | OE213 | 0,9 | | | | | | | |
| 1.4 TSI | 4 | CAXC | 92/123 | 11/07 → | OE213 | 0,9 | | | | | | BAE408AE | |
| 1.6 | 4 | BSE; BSF; CCSA; CMXA | 75/101 | 10/06 → | OE032 | 1,0 | CET2 | | OE179 | | | BAE907AE ^[262] | |
| 1.6 LPG | 4 | CHGA | 75/101 | 09/09 → | OE032 | 1,0 | CET2 | | OE179 | | | BAE907AE ^[262] | CLS048 |
| 1.6 Multifuel | 4 | CCSA | 75/101 | 10/06 → | | | | | | | | BAE907AE ^[262] | |
| 1.6 TDI | 4 | CAYB | 66/89 | 11/10 → | | | | | | | | CCU152 | |
| 1.6 TDI | 4 | CAYC | 77/103 | 10/09 → | | | | | | | | CCU152 | |
| 1.8 TFSI | 4 | BYT; BZB; CDAA | 118/158 | 01/07 → | OE214 | 0,7 | CET11P | | | | | BAEA033E ^[7] | |
| 1.9 TDI | 4 | BXF | 66/89 | 08/09 → | | | | | | | | CCU152 | |
| 1.9 TDI | 4 | BKC | 77/103 | 10/06 → | | | | | | | | CCU152 | |
| 1.9 TDI | 4 | BLS | 77/103 | 10/06 → | CCGP002 ^{[183] [275]} | 7v | | | | | | CCU152 | |
| 1.9 TDI 4WD | 4 | BLS | 77/103 | 06/09 → 12/10 | CCGP002 ^{[183] [275]} | 7v | | | | | | CCU152 Ch.5P-6-053001 → | |
| 2.0 FSI | 4 | BVY | 110/148 | 10/06 → 03/09 | OE234 | 1,0 | CET12P CET3 | | | | | BAEA033E ^[7] | |
| 2.0 FSI | 4 | BVZ | 110/148 | 10/06 → 03/09 | OE146 | 1,0 | CET12P CET3 | | OE179 | | | BAEA033E ^[7] | |
| 2.0 TDI | 4 | AZV | 100/134 | 11/06 → 03/09 | | | | | | | | CCU152 Ch.5P-6-053001 → | |
| 2.0 TDI, 2.0 TDI 4WD | 4 | BMM | 103/138 | 10/06 → | CCGP002 ModelYear → 2010 | 7v | | | | | | CCU152 | |
| 2.0 TDI, 2.0 TDI 4WD | 4 | BMN | 125/168 | 06/07 → | CCGP003 | 7v | | | | | | CCU152 | |
| 2.0 TDI, 2.0 TDI 4WD | 4 | CEGA | 125/168 | 06/07 → | | | | | | | | CCU152 | |
| 2.0 TDI 16V | 4 | BKD | 103/138 | 10/06 → | | | | | | | | CCU152 Ch.5P-6-053001 → | |
| 2.0 TFSI | 4 | BWA | 147/197 | 10/06 → 05/09 | OE214 | 0,7 | CET11P | | | | | BAEA033E ^{[7] [249]} | |
| 2.0 TFSI 4WD | 4 | BWA | 147/197 | 06/07 → 05/09 | OE214 | 0,7 | CET11P | | | | | BAEA033E ^[7] | |
| 2.0 TFSI 4WD | 4 | CCZB | 155/208 | 05/09 → | OE214 | 0,7 | CET11P | | | | | BAEA033E ^[7] | |

AROSA

| | | | | | | | | | | | | | |
|-----|---|-------------|-------|---------------|-------|-----|--------|--|-------|--|--|--|--------|
| 1.0 | 4 | AHT | 37/50 | 05/97 → 06/04 | OE136 | 0,8 | CET12P | | OE179 | | | BAE961AE | |
| 1.0 | 4 | AER; ALL | 37/50 | 05/97 → 06/04 | | | CET3 | | | | | BAE851AE ^{[261] [275] [292]} | CLS041 |
| | | | | | | | CET8 | | | | | BAE961AE ^[275] | |
| 1.0 | 4 | ALD; ANV | 37/50 | 05/97 → 06/04 | | | CET3 | | | | | BAE907AE ^{[262] [275]} | CLS038 |
| | | | | | | | CET8 | | | | | BAE961AE ^[275] | |
| 1.0 | 4 | AUC | 37/50 | 05/97 → 06/04 | | | CET3 | | | | | BAE907AE ^{[262] [275]} | CLS053 |
| | | | | | | | CET8 | | | | | BAE961AE ^[275] | |
| 1.0 | 4 | AER/ALL | 37/50 | 05/97 → 06/04 | OE025 | 1,0 | | | OE195 | | | | |
| 1.0 | 4 | ANV/ALD/AUC | 37/50 | 05/97 → 06/04 | OE176 | 1,0 | | | | | | | |





kW/BHP



eon TITAN

IRIDIUM



...SEAT



...AROSA

| | | | | | | | | | | |
|-------------|---|----------|-------|-------------|-----------------|-----|------|-------|---------------------------------|--------|
| 1.4 | 4 | AEX | 44/59 | 05/97→06/04 | OE027 | 1,0 | CET3 | | BAE851AE [261] [292] | CLS100 |
| | | | | | | | CET8 | | | |
| 1.4 | 4 | AKK | 44/59 | 05/97→06/04 | OE176 | 1,0 | CET3 | | BAE907AE [262] | |
| | | | | | | | CET8 | | | |
| 1.4 | 4 | AKV; APQ | 44/59 | 05/97→06/04 | OE027 | 1,0 | CET3 | | BAE851AE [261] [292] | CLS109 |
| | | | | | | | CET8 | | | |
| 1.4 | 4 | ANW; AUD | 44/59 | 05/97→06/04 | OE025 | 1,0 | CET3 | OE195 | BAE907AE [262] | CLS053 |
| | | | | | | | CET8 | | | |
| 1.4 1.4 TDI | 3 | AMF | 55/74 | 01/00→06/04 | CH271 →10/01 | 11v | | | CCU081 [127] →Ch.6H-3-007207 | |
| | | | | | CH181 11/01→ | 11v | | | | |
| 1.4 16V | 4 | AFK | 74/99 | 01/00→06/04 | OE032 | 1,0 | CET2 | OE179 | BAE907AE [262] | |
| 1.4 16V | 4 | AQQ | 74/99 | 01/00→06/04 | OE032 | 1,0 | CET2 | OE179 | | |
| 1.4 16V | 4 | AUB | 74/99 | 01/00→06/04 | OE032 | 1,0 | CET2 | OE179 | BAE907AE [262] | CLS260 |
| 1.4 16V | 4 | ANM | 74/99 | 01/00→06/04 | | | | | BAE907AE [262] | |
| 1.7 SDI | 4 | AKU | 44/59 | 08/97→06/04 | CH271 | 11v | | | CCU081 [127] →Ch.6H-3-007207 | |

ATECA

| | | | | | | | | | | |
|----------------------|---|------|---------|--------|---------------|------|--|--|--|--|
| 1.4 TSI, 1.4 TSI 4WD | 4 | CZEA | 110/148 | 06/16→ | OE244 | 0,8 | | | | |
| 1.6 TDI | 4 | DDYA | 85/114 | 04/16→ | CPSG007 [193] | 4.4v | | | | |
| 2.0 TDI, 2.0 TDI 4WD | 4 | DFFA | 110/148 | 04/16→ | CPSG007 [193] | 4.4v | | | | |
| 2.0 TDI 4WD | 4 | DFHA | 140/188 | 06/16→ | CPSG007 [193] | 4.4v | | | | |

CORDOBA

| | | | | | | | | | | |
|-----------|---|--------------------|-------|-------------|-------------|-----|------------|----------------|-------------------------|--------|
| 1.0 i | 4 | AER; ALD; ANV; AUC | 37/50 | 09/96→10/02 | OE027 | 1,0 | CET8 | | BAE851AE [261] [292] | CLS041 |
| 1.2 | 3 | AZQ; BME | 47/63 | 10/02→06/06 | OE177 | 0,9 | CET3 | | BAE408AE | |
| 1.2 12V | 3 | BXV | 51/68 | 05/06→11/09 | OE177 | 0,9 | CET3 | | BAE408AE | |
| 1.3 | 4 | 2G; AAV | 40/54 | 02/93→08/94 | OE012 | 0,8 | CET8 | OE195 | BAE851AE [261] [292] | |
| 1.4 | 4 | ANX | 40/54 | 12/97→04/99 | OE025 | 1,0 | CET8 | OE195 | BAE851AE [261] [292] | CLS028 |
| 1.4 16V | 4 | APE; AUA | 55/74 | 06/99→12/07 | OE032 | 1,0 | CET2 | OE179 OE188 | BAE907AE [262] | CLS260 |
| 1.4 16V | 4 | BBY | 55/74 | 06/99→12/07 | OE032 [287] | 1,0 | CET2 [287] | OE179 [287] | BAE408AE | |
| | | | | | OE176 [285] | 1,0 | CET3 [285] | | | |
| 1.4 16V | 4 | BKY | 55/74 | 06/99→12/07 | OE176 [285] | 1,0 | CET3 [287] | | BAE408AE | |
| | | | | | OE177 [287] | 0,9 | CET3 [285] | | | |
| 1.4 16V | 4 | BXW | 63/84 | 05/06→11/09 | OE177 | 0,9 | CET3 | | BAE408AE | |
| 1.4 16V | 4 | AUB; BBZ | 74/99 | 10/02→11/09 | OE032 | 1,0 | CET2 | OE188 | BAE408AE | |
| 1.4 i | 4 | ANX | 44/59 | 06/94→12/02 | OE025 | 1,0 | | OE195 | | |
| 1.4 i | 4 | ABD | 44/59 | 06/94→12/02 | OE027 | 1,0 | CET8 | | BAE851AE [261] [292] | CLS028 |
| 1.4 i | 4 | AEX | 44/59 | 06/94→12/02 | OE027 | 1,0 | CET8 | | BAE851AE [261] [292] | CLS109 |
| 1.4 i | 4 | AKK; ANW; AUD | 44/59 | 06/94→12/02 | | | CET8 | | BAE851AE [261] [292] | CLS109 |
| 1.4 i | 4 | AKV; APQ | 44/59 | 06/94→12/02 | OE025 | 1,0 | CET8 | OE195 | BAE851AE [261] [292] | CLS109 |
| 1.4 i 16V | 4 | AFH; AQQ; AUB | 74/99 | 09/96→10/02 | OE032 | 1,0 | CET2 | OE179 | BAE851AE [261] [292] | CLS178 |
| 1.4 TDI | 3 | BNM | 51/68 | 05/05→11/09 | CH181 | 11v | | | CCU081 | |
| 1.4 TDI | 3 | AMF | 55/74 | 10/02→12/05 | CH181 | 11v | | | CCU081 | |
| 1.4 TDI | 3 | BNV | 59/79 | 06/05→11/09 | CH181 | 11v | | | CCU081 | |
| 1.4 TDI | 3 | BMS | 59/79 | 06/05→11/09 | CGP002 | 7v | | | | |
| 1.6 | 4 | BAH | 74/99 | 04/03→11/09 | OE235 | 1,0 | CET3 | | BAE907AE [262] | |

SEAT





kW/BHP



eon TITAN

IRIDIUM

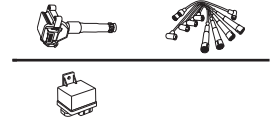

SEAT

...SEAT



...CORDOBA

| | | | | | | | | | | |
|-----------------|---|-------------------------|---------|-------------|----------------|------------|--------|-------|--|--------------|
| 1.6 16V | 4 | BTS | 77/103 | 11/06→11/09 | OE177 | 0,9 | CET3 | | BAE408AE | |
| 1.6 i | 4 | ABU | 55/74 | 02/93→12/02 | OE027 | 1,0 | CET8 | | BAE851AE [261] [292] | CLS099 |
| 1.6 i | 4 | AEE; ALM | 55/74 | 02/93→12/02 | OE027 | 1,0 | CET8 | | BAE851AE [261] [292] | CLS100 |
| 1.6 i | 4 | 1F | 55/74 | 02/93→12/02 | OE027 | 1,0 | CET8 | | BAE851AE [261] [292] | CLS079 [292] |
| 1.6 i | 4 | AEH; AFT; AKL; APF; AUR | 74/99 | 07/96→12/02 | OE032 | 1,0 | CET2 | OE179 | BAE851AE [261] [292] | CLS034 |
| 1.8 i | 4 | ABS | 66/89 | 02/93→09/02 | OE025 | 1,0 | CET8 | OE195 | BAE851AE [261] [292] | CLS027 |
| 1.8 i | 4 | ACC | 66/89 | 02/93→09/02 | OE025 | 1,0 | CET8 | OE195 | | |
| 1.8 i | 4 | ADZ | 66/89 | 02/93→09/02 | OE025 | 1,0 | CET8 | OE195 | | CLS110 [292] |
| 1.8 i 16V | 4 | ADL | 95/127 | 10/93→08/96 | OE032 | 1,0 | CET11P | | BAEA002E →Ch.6K-ZR132108 6K-ZR671000 [261] [292] BAE851AE Ch.6K-ZR132109 6K-ZR672000→ [261] [292] | CLS174 |
| 1.8 T 20V Cupra | 4 | AQX | 115/154 | 07/00→10/02 | OE032 | 1,0 | CET2 | OE179 | BAEA009E | |
| 1.8 T 20V Cupra | 4 | AYP | 115/154 | 07/00→10/02 | OE032 | 1,0 | CET2 | OE179 | BAEA043E | |
| 1.9 D | 4 | 1Y | 47/63 | 01/96→08/96 | CH260 | 11v | | | | |
| 1.9 D | 4 | 1Y | 50/67 | 02/93→08/96 | CH260 | 11v | | | | |
| 1.9 SDI | 4 | AEY | 47/63 | 08/96→11/09 | CH271 | 11v | | | CCU081 | |
| 1.9 SDI | 4 | ASY | 47/63 | 08/96→11/09 | CH181 | 11v | | | CCU081 | |
| 1.9 SDI | 4 | AGP; AQM | 50/67 | 06/99→12/02 | CH271 | 11v | | | CCU081 | |
| 1.9 TD | 4 | AAZ | 55/74 | 02/93→08/96 | CH260 | 11v | | | | |
| 1.9 TDI | 4 | 1Z; AGR; AHU; ALH | 66/89 | 08/96→12/02 | CH271 | 11v | | | CCU081 | |
| 1.9 TDI | 4 | ATD; AXR | 74/99 | 09/02→11/09 | CH181 | 11v | | | CCU081 | |
| 1.9 TDI | 4 | BMT | 74/99 | 09/02→11/09 | CCGP002 | 7v | | | CCU152 | |
| 1.9 TDI | 4 | AFN; ASK; ASV | 81/109 | 03/97→12/02 | CH271 | 11v | | | CCU081 | |
| 1.9 TDI | 4 | ASZ; BLT | 96/129 | 10/02→11/09 | CH181 | 11v | | | CCU081 | |
| 2.0 | 4 | AZL; BBX | 85/114 | 09/02→11/09 | OE032 | 1,0 | CET2 | OE179 | BAE907AE ^[262] | CLS017 |
| 2.0 i | 4 | AGG | 85/114 | 02/93→06/99 | OE025 | 1,0 | CET8 | OE195 | | |
| 2.0 i | 4 | 2E | 85/114 | 02/93→06/99 | OE025 | 1,0 | CET8 | OE195 | BAE851AE [261] [292] | CLS097 |
| 2.0 i 16V | 4 | ABF | 110/148 | 08/96→06/99 | OE032 | 1,0 | CET11P | | BAE851AE [261] [292] | CLS174 |
| EXEO | | | | | | | | | | |
| 1.6 | 4 | ALZ | 75/101 | 03/09→09/10 | OE032 | 1,0 | CET2 | OE179 | BAE907AE ^[262] | CLS048 |
| 1.8 T | 4 | CFMA | 110/148 | 12/08→05/10 | OE136 OE146 | 0,8 1,0 | CET12P | OE179 | BAEA043E | CLS048 |
| 1.8 TSI | 4 | CDHA | 88/118 | 09/10→ | OE214 | 0,7 | CET11P | | BAEA033E ^[7] | |
| 1.8 TSI | 4 | CDHB | 118/158 | 05/10→ | OE214 | 0,7 | CET11P | | BAEA033E ^[7] | |
| 2.0 TDI | 4 | CAGC; CJCC | 88/118 | 12/08→ | | | | | CCU151 | |
| 2.0 TDI | 4 | CAGA; CJCA | 105/141 | 12/08→ | | | | | CCU151 | |
| 2.0 TDI | 4 | CAHA; CGLB | 125/168 | 02/09→ | | | | | CCU151 | |
| 2.0 TFSI | 4 | BWE | 147/197 | 03/09→ | OE214 | 0,7 | CET11P | | BAEA033E ^[7] | |
| 2.0 TFSI | 4 | CDND | 155/208 | 05/10→ | OE214 | 0,7 | CET11P | | BAEA033E ^[7] | |
| IBIZA II | | | | | | | | | | |
| 1.0 | 4 | AAU | 33/44 | 03/93→09/96 | OE025 | 1,0 | CET8 | OE195 | BAE851AE [261] [292] | CLS109 |
| 1.0 16V | 4 | AST; AVZ | 51/68 | 10/99→02/02 | OE120 | 0,6 | CET2 | OE188 | BAE851AE [261] [292] | |
| 1.0 i | 4 | AER | 37/50 | 09/96→02/02 | OE027 | 1,0 | CET8 | | BAE851AE [261] [292] | CLS041 |





kW/BHP

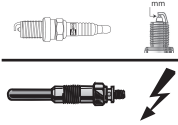

eon TITAN

IRIDIUM



...SEAT



...IBIZA II

| | | | | | | | | | | |
|------------------|---|-------------------------|---------|-------------|--|------------|--|------------------------|---------------------------|-------------------------|
| 1.0 i | 4 | ALD; ANV; AUC | 37/50 | 09/96→02/02 | OE027 | 1,0 | CET8 | | BAE851AE [261] [292] | |
| 1.3 i | 4 | 2G | 40/54 | 03/93→08/99 | OE012 | 0,8 | CET8 | OE195 | BAEA002E [261] [292] | CLS109 |
| 1.3 i | 4 | AAV | 40/54 | 03/93→08/99 | OE012 | 0,8 | CET8 | OE195 | BAE851AE [261] [292] | CLS109 |
| 1.4 | 4 | ANX | 40/54 | 12/97→04/99 | OE025 | 1,0 | CET8 | OE195 | BAE851AE [261] [292] | |
| 1.4 16V | 4 | AUA | 55/74 | 05/00→02/02 | OE032 | 1,0 | CET2 | OE179 | BAE907AE ^[262] | |
| 1.4 16V | 4 | APE | 55/74 | 05/00→02/02 | OE032 | 1,0 | CET2 | OE179 | BAE907AE ^[262] | CLS260 |
| 1.4 i | 4 | AKK; ANW; AUD | 44/59 | 09/93→02/02 | OE027 | 1,0 | CET8 | | BAE851AE [261] [292] | |
| 1.4 i | 4 | ABD | 44/59 | 09/93→02/02 | OE027 | 1,0 | CET8 | | BAE851AE [261] [292] | CLS028 |
| 1.4 i | 4 | AEX; AKV | 44/59 | 09/93→02/02 | OE044 OE025 | 0,9 1,0 | CET8 | | BAE851AE [261] [292] | CLS109 |
| 1.4 i | 4 | APQ | 44/59 | 09/93→02/02 | OE027 OE025 | 1,0 1,0 | CET8 | | BAE851AE [261] [292] | |
| 1.4 i 16V | 4 | AFH; AQQ; AUB | 74/99 | 06/97→02/02 | OE027 | 1,0 | CET8 | | BAE851AE [261] [292] | CLS178 |
| 1.6 i | 4 | 1F; ABU | 55/74 | 03/93→02/02 | OE027 | 1,0 | CET8 | | BAE851AE [261] [292] | CLS099 |
| 1.6 i | 4 | ALM | 55/74 | 03/93→02/02 | OE027 | 1,0 | CET8 | | BAE851AE [261] [292] | CLS100 |
| 1.6 i | 4 | AEE | 55/74 | 03/93→02/02 | OE027 | 1,0 | CET8 | OE195 | BAE851AE [261] [292] | CLS100 |
| 1.6 i | 4 | AEH; AFT; AKL; APF; AUR | 74/99 | 04/96→02/02 | OE032 | 1,0 | CET2 | OE179 | BAE851AE [261] [292] | CLS034 |
| 1.8 i | 4 | ABS | 66/89 | 03/93→08/99 | OE025 | 1,0 | CET8 | OE195 | BAEA002E [261] [292] | CLS027 |
| 1.8 i | 4 | ACC; ADZ | 66/89 | 03/93→08/99 | OE025 | 1,0 | CET8 | OE195 | BAEA002E [261] [292] | CLS110 ^[292] |
| 1.8 i 16V | 4 | ADL | 95/127 | 11/93→08/96 | | | CET2 | OE188 | BAE851AE [261] [292] | CLS174 |
| 1.8 T 20V Cupra | 4 | AQX | 115/154 | 07/00→02/02 | OE032 | 1,0 | CET2 | OE179 | BAEA009E ^[74] | |
| 1.8 T 20V Cupra | 4 | AYP | 115/154 | 07/00→02/02 | OE032 | 1,0 | CET2 | OE179 | BAEA043E ^[73] | |
| 1.9 D | 4 | 1Y | 47/63 | 04/93→08/96 | CH260 | 11v | | | | |
| 1.9 D | 4 | 1Y | 50/67 | 10/94→08/96 | CH260 | 11v | | | | |
| 1.9 SDI | 4 | AEY | 47/63 | 08/96→08/99 | CH271 | 11v | | | CCU081 | |
| 1.9 SDI | 4 | AGP; AQM | 50/67 | 08/99→02/02 | CH271 | 11v | | | CCU081 [127] [365] | |
| 1.9 TD | 4 | AAZ | 55/74 | 03/93→08/96 | CH260 | 11v | | | | |
| 1.9 TDI | 4 | 1Z; AGR; AHU; ALH | 66/89 | 08/96→02/02 | CH271 | 11v | | | CCU081 | |
| 1.9 TDI | 4 | AFN; ASK; ASV | 81/109 | 02/97→02/02 | CH271 | 11v | | | CCU081 | |
| 2.0 i | 4 | 2E; AGG | 85/114 | 03/93→08/99 | OE025 | 1,0 | CET8 | OE195 | BAEA002E [261] [292] | |
| 2.0 i 16V | 4 | ABF | 110/148 | 08/96→08/99 | OE032 | 1,0 | CET11P | | BAE851AE [261] [292] | CLS174 |
| IBIZA III | | | | | | | | | | |
| 1.2 | 3 | BBM | 44/59 | 06/07→05/08 | OE177 | 0,9 | CET3 | | BAEA059E | |
| 1.2 | 3 | AZQ; BME | 47/63 | 02/02→06/06 | OE177 | 0,9 | CET3 | | BAE408AE | |
| 1.2 12V | 3 | BXV | 51/68 | 05/06→11/09 | OE177 | 0,9 | CET3 | | BAE408AE | |
| 1.4 16V | 4 | BBY | 55/74 | 02/02→12/07 | OE032 ^[287] OE176 ^[285] | 1,0 1,0 | CET2 ^[287] CET3 ^[285] | OE179 ^[287] | BAE408AE | CLS260 |
| 1.4 16V | 4 | BKY | 55/74 | 02/02→12/07 | OE176 ^[285] OE177 ^[287] | 1,0 0,9 | CET3 ^[287] CET3 ^[285] | | BAE408AE | CLS260 |
| 1.4 16V | 4 | BXW | 63/84 | 05/06→11/09 | OE177 | 0,9 | CET3 | | BAE408AE | |

SEAT





kW/BHP

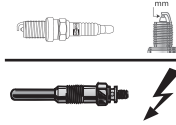

eon TITAN

IRIDIUM

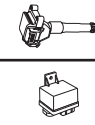

...SEAT



...IBIZA III

| | | | | | | | | | | |
|-----------------|---|----------|---------|-------------|---------|-----|--------|-------|---------------------------|--------|
| 1.4 16V | 4 | BBZ | 74/99 | 02/02→11/09 | OE032 | 1,0 | CET2 | OE188 | BAE408AE | |
| 1.4 16V | 4 | AUB | 74/99 | 02/02→11/09 | OE032 | 1,0 | CET2 | OE188 | BAE907AE ^[262] | CLS260 |
| 1.4 TDI | 3 | BNM | 51/68 | 05/05→11/09 | CH181 | 11v | | | CCU081 | |
| 1.4 TDI | 3 | AMF | 55/74 | 05/02→12/05 | CH181 | 11v | | | CCU081 | |
| 1.4 TDI | 3 | BNV | 59/79 | 06/05→11/09 | CH181 | 11v | | | CCU081 | |
| 1.4 TDI | 3 | BMS | 59/79 | 06/05→11/09 | CCGP002 | 7v | | | | |
| 1.6 | 4 | BAH | 74/99 | 02/03→11/09 | OE235 | 1,0 | CET3 | | BAE907AE ^[262] | |
| 1.6 16V | 4 | BTS | 77/103 | 11/06→11/09 | OE177 | 0,9 | CET3 | | BAE408AE | |
| 1.8 T Cupra R | 4 | BBU; BLZ | 132/177 | 01/04→02/08 | OE136 | 0,8 | CET12P | OE179 | BAEA043E | |
| 1.8 T FR | 4 | BKV | 110/148 | 12/03→05/08 | OE136 | 0,8 | CET12P | OE179 | | |
| 1.8 T FR | 4 | BJX | 110/148 | 12/03→05/08 | OE136 | 0,8 | CET12P | OE179 | BAEA043E | |
| 1.9 SDI | 4 | ASY | 47/63 | 02/02→12/05 | CH181 | 11v | | | CCU081 | |
| 1.9 TDI | 4 | ATD; AXR | 74/99 | 02/02→11/09 | CH181 | 11v | | | CCU081 | |
| 1.9 TDI | 4 | BMT | 74/99 | 02/02→11/09 | CCGP002 | 7v | | | CCU152 | |
| 1.9 TDI | 4 | ASZ; BLT | 96/129 | 02/02→11/09 | CH181 | 11v | | | CCU081 | |
| 1.9 TDI Cupra R | 4 | BPX; BUK | 118/158 | 03/04→02/08 | CH181 | 11v | | | CCU081 | |
| 2.0 | 4 | AZL; BBX | 85/114 | 04/02→11/09 | OE032 | 1,0 | CET2 | OE179 | BAE907AE ^[262] | CLS017 |

IBIZA IV

| | | | | | | | | | | |
|---------------|---|------------------------|---------|-------------|---------|------|------|-------|---------------------------|-------------------------------------|
| 1.0 | 3 | CHYB | 55/74 | 05/15→ | OE247 | 1,0 | | | BAEA067E ^[240] | |
| 1.0 TSI | 3 | CHZB | 70/94 | 05/15→ | | | | | BAEA067E ^[240] | |
| 1.0 TSI | 3 | CHZC | 81/109 | 05/15→ | | | | | BAEA067E ^[240] | |
| 1.2 | 3 | CGPB | 44/59 | 07/09→ | OE177 | 0,9 | CET3 | | BAE408AE | |
| 1.2 | 3 | BZG; CGPA; CJLB | 51/68 | 03/08→ | OE177 | 0,9 | CET3 | | BAE408AE | |
| 1.2 TDI | 3 | CFWA | 55/74 | 04/10→ | | | | | CCU152 | Prod.28.05.2013→ Prod.28.10.2013 |
| 1.2 TSI | 4 | CBZA | 63/84 | 08/12→ | | | | OE260 | BAE907AE ^[262] | CLS090 |
| 1.2 TSI | 4 | CJZC | 66/89 | 05/15→ | OE244 | 0,8 | | | BAEA067E ^[240] | |
| 1.2 TSI | 4 | CBZB | 77/103 | 09/10→ | | | | OE260 | BAE907AE ^[262] | CLS090 |
| 1.2 TSI | 4 | CJZD | 81/109 | 09/15→ | OE244 | 0,8 | | | | |
| 1.4 | 4 | BXW; CGGB | 63/84 | 03/08→ | OE177 | 0,9 | CET3 | | BAE408AE | |
| 1.4 TDI | 3 | CUSA | 55/74 | 05/15→ | CP5G007 | 4.4v | | | | |
| 1.4 TDI | 3 | BMS | 59/79 | 07/08→06/10 | CCGP002 | 7v | | | | |
| 1.4 TDI | 3 | CUSB | 66/89 | 05/15→ | CP5G007 | 4.4v | | | | |
| 1.4 TDI | 3 | CUTA; CYZA | 77/103 | 05/15→ | CP5G007 | 4.4v | | | | |
| 1.4 TSI | 4 | CPTA | 103/138 | 10/13→ | OE244 | 0,8 | | | BAEA067E ^[240] | |
| 1.4 TSI | 4 | CAVF; CNUB; CTHF; CTJB | 110/148 | 06/09→ | OE213 | 0,9 | | | BAE408AE | |
| 1.4 TSI | 4 | CZEA | 110/148 | 06/09→ | OE244 | 0,8 | | | | |
| 1.4 TSI Cupra | 4 | CAVE; CTHE; CTJC | 132/177 | 06/09→ | OE213 | 0,9 | | | BAE408AE | |
| 1.6 | 4 | BTS | 77/103 | 05/08→ | OE177 | 0,9 | CET3 | | BAE408AE | |
| 1.6 LPG | 4 | CNKA | 60/80 | 05/11→ | OE177 | 0,9 | CET3 | | BAE408AE | |
| 1.6 TDI | 4 | CAYB | 66/89 | 05/09→ | | | | | CCU152 | |
| 1.6 TDI | 4 | CAYC; CLNA | 77/103 | 05/09→ | | | | | CCU152 | |
| 1.8 TSI Cupra | 4 | DAJA | 141/189 | 11/15→ | | | | | BAEA068E | →01/16 |
| 1.9 TDI | 4 | BXJ | 66/89 | 07/08→06/10 | CCGP002 | 7v | | | CCU152 | |
| 1.9 TDI | 4 | BLS | 77/103 | 03/08→06/10 | CCGP002 | 7v | | | CCU152 | |
| 2.0 | 4 | CEKA | 85/114 | 10/08→ | OE032 | 1,0 | CET2 | OE179 | BAE907AE ^[262] | |
| 2.0 TDI | 4 | CFHD | 105/141 | 01/10→ | | | | | CCU152 | |

IBIZA V

| | | | | | | | | | | |
|-----|---|------|-------|--------|-------|-----|--|--|--|--|
| 1.0 | 3 | CHYB | 55/74 | 01/17→ | OE247 | 1,0 | | | | |
|-----|---|------|-------|--------|-------|-----|--|--|--|--|





kW/BHP

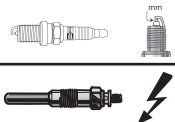

eon TITAN

IRIDIUM

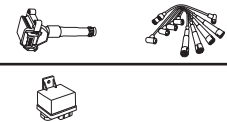

...SEAT



LEON

| | | | | | | | | | | |
|----------------------|---|------------------|---------|-------------|----------------------|------|--------|-------|-----------------------------------|--------|
| 1.2 TSI | 4 | CJZB; CYVA | 63/84 | 12/12→ | OE244 [223] [302] | 0,8 | | | BAEA126E →09/13 [249] [275] | |
| | | | | | | | | | BAEA067E [240] [275] | |
| 1.2 TSI | 4 | CJZA | 77/103 | 02/10→ | OE244 [223] [302] | 0,8 | | | BAEA126E →09/13 [249] [275] | |
| | | | | | | | | | BAEA067E [240] [275] | |
| 1.2 TSI | 4 | CBZB | 77/103 | 02/10→ | | | | OE260 | BAE907AE [262] | CLS090 |
| 1.2 TSI | 4 | CVVB | 81/109 | 04/14→ | OE244 [223] [302] | 0,8 | | | BAEA067E [240] | |
| 1.4 16V | 4 | BCA | 55/74 | 11/99→06/06 | OE032 | 1,0 | CET2 | OE188 | BAE408AE | |
| 1.4 16V | 4 | AHW; AXP | 55/74 | 11/99→06/06 | OE032 | 1,0 | CET2 | OE188 | BAE907AE [262] | CLS260 |
| 1.4 16V | 4 | APE | 55/74 | 11/99→06/06 | | | CET2 | | BAE907AE [262] | CLS260 |
| 1.4 16V | 4 | AUA | 55/74 | 11/99→06/06 | | | CET2 | | | |
| 1.4 16V | 4 | BXW; CGGB | 63/84 | 06/06→12/12 | OE177 | 0,9 | CET3 | | BAE408AE | |
| 1.4 TGI | 4 | CPWA | 81/109 | 02/13→ | OE244 [219] [306] | 0,8 | | | BAEA067E [240] | |
| 1.4 TSI | 4 | CMBA; CXSA | 90/121 | 11/12→ | OE244 [220] [307] | 0,8 | | | BAEA126E →09/13 [249] [275] | |
| | | | | | | | | | BAEA067E [240] [275] | |
| 1.4 TSI | 4 | CAXC | 92/123 | 11/07→ | OE213 | 0,9 | | | BAE408AE | |
| 1.4 TSI | 4 | CZCA | 92/123 | 11/07→ | OE244 [219] [306] | 0,8 | | | BAEA067E [240] | |
| 1.4 TSI | 4 | CHPA; CPTA | 103/138 | 09/12→ | OE244 [219] [306] | 0,8 | | | BAEA126E →09/13 [249] [275] | |
| | | | | | | | | | BAEA067E [240] [275] | |
| 1.4 TSI | 4 | CZDA; CZEA | 110/148 | 05/14→ | OE244 [219] [306] | 0,8 | | | BAEA067E [240] | |
| 1.6 | 4 | APF | 74/99 | 11/99→06/06 | OE032 | 1,0 | CET2 | OE179 | | |
| 1.6 | 4 | AEH; AKL | 74/99 | 11/99→06/06 | OE032 | 1,0 | CET2 | OE179 | BAE907AE [262] | CLS139 |
| 1.6 | 4 | BFQ | 75/101 | 07/05→12/12 | OE032 | 1,0 | CET2 | OE188 | BAE907AE [262] | |
| 1.6 | 4 | BGU | 75/101 | 07/05→12/12 | | | CET2 | OE188 | | |
| 1.6 | 4 | BSE; BSF | 75/101 | 07/05→12/12 | OE136 | 0,8 | CET12P | OE179 | BAE907AE [262] | CLS017 |
| 1.6 | 4 | CCSA; CMXA | 75/101 | 07/05→12/12 | OE136 | 0,8 | CET12P | OE179 | BAE907AE [262] | |
| 1.6 16 V | 4 | ATN | 77/103 | 09/00→06/06 | | | CET2 | | | |
| 1.6 16 V | 4 | AUS | 77/103 | 09/00→06/06 | OE032 →01/02 | 1,0 | CET2 | OE188 | BAE907AE [262] | CLS260 |
| 1.6 16 V | 4 | AZD; BCB | 77/103 | 09/00→06/06 | OE176 | 1,0 | CET2 | OE188 | BAE408AE | |
| 1.6 LPG | 4 | CHGA | 75/101 | 12/09→12/12 | | | | | BAE907AE [262] | |
| 1.6 MultiFuel | 4 | BSE; CMXA | 75/101 | 11/10→12/12 | OE032 | 1,0 | CET2 | OE179 | BAE907AE [262] | |
| 1.6 TDI | 4 | CLHB; CXXA; DDYB | 66/89 | 11/10→ | CPSG007 | 4.4v | | | CCU151 | |
| 1.6 TDI | 4 | CAYB | 66/89 | 11/10→ | | | | | CCU152 | |
| 1.6 TDI | 4 | CAYC | 77/103 | 02/10→ | | | | | CCU152 Ch. 1P-6-075001→ | |
| 1.6 TDI, 1.6 TDI 4WD | 4 | CLHA | 77/103 | 02/10→ | CPSG007 | 4.4v | | | CCU151 | |
| 1.6 TDI, 1.6 TDI 4WD | 4 | CRKB; CXXB; DBKA | 81/109 | 09/13→ | CPSG007 | 4.4v | | | CCU151 | |
| 1.8 20V | 4 | AGN; APG | 92/123 | 11/99→06/06 | OE032 | 1,0 | CET2 | OE179 | BAE907AE [262] | CLS140 |
| 1.8 20V T | 4 | AUQ | 132/177 | 11/99→06/06 | OE136 | 0,8 | CET12P | OE179 | BAEA043E | |
| 1.8 20V T | 4 | APP | 132/177 | 11/99→06/06 | OE136 | 0,8 | CET12P | OE179 | BAEA009E | |
| 1.8 20V T 4WD | 4 | ARY | 132/177 | 11/99→06/06 | OE136 | 0,8 | CET12P | OE179 | | |
| 1.8 20V T 4WD | 4 | AJQ | 132/177 | 11/99→06/06 | OE136 | 0,8 | CET12P | OE179 | BAEA016 | |
| 1.8 T Cupra R | 4 | AMK | 154/207 | 02/02→06/06 | OE136 | 0,8 | CET12P | OE179 | BAEA043E | |
| 1.8 T Cupra R | 4 | BAM | 165/221 | 07/03→06/06 | OE136 | 0,8 | CET12P | OE179 | BAEA043E | |

SEAT



kW/BHP



eon TITAN

IRIDIUM

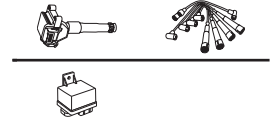

SEAT

| ...SEAT | | | | | | | | | |
|----------------------|---|------------------------|---------|-------------|---------|------|----------------|-------|--|
| ...LEON | | | | | | | | | |
| 1.8 TSI | 4 | BZB; CDA | 118/158 | 06/07→12/12 | OE214 | 0,7 | CET11P | | BAEA033E ^[7] |
| 1.8 TSI | 4 | CJSA | 132/177 | 02/13→ | | | | OE246 | BAEA068E |
| 1.8 TSI 4WD | 4 | CJSB | 132/177 | 11/14→ | | | | OE246 | BAEA068E →01/16 |
| 1.9 SDI | 4 | AQM | 50/67 | 11/99→06/06 | CH271 | 11v | | | CCU081 ^[364] |
| 1.9 TDI | 4 | AGR; ALH | 66/89 | 11/99→12/10 | CH271 | 11v | | | CCU081 ^[364] |
| 1.9 TDI | 4 | BXF | 66/89 | 11/99→12/10 | | | | | CCU152 Ch.1P-6-075001→ |
| 1.9 TDI | 4 | AXR | 74/99 | 10/05→06/06 | | | | | CCU081 ^[364] |
| 1.9 TDI | 4 | BXE | 77/103 | 07/05→12/10 | | | | | CCU152 Ch.1P-6-075001→ |
| 1.9 TDI | 4 | BLS | 77/103 | 07/05→12/10 | CCGP002 | 7v | | | CCU152 Ch.1P-6-075001→ |
| 1.9 TDI | 4 | AHF; ASV | 81/109 | 11/99→06/06 | CH271 | 11v | | | CCU081 ^[364] |
| 1.9 TDI | 4 | ASZ | 96/129 | 05/03→06/06 | CH181 | 11v | | | CCU081 ^[364] |
| 1.9 TDI, 1.9 TDI 4WD | 4 | ARL | 110/148 | 09/00→06/06 | CH271 | 11v | | | CCU081 ^[364] →Ch.1M-3-148000 |
| 2.0 Cupra | 4 | CJXE | 195/261 | 10/13→ | | | | OE246 | BAEA068E →06/16 |
| 2.0 Cupra | 4 | CJXA | 206/276 | 10/13→ | | | | OE246 | BAEA068E →06/16 |
| 2.0 Cupra | 4 | CJXH | 213/286 | 10/15→ | | | | | BAEA068E →06/16 |
| 2.0 Cupra R | 4 | CDLA | 195/261 | 09/09→12/12 | OE214 | 0,7 | CET11P | | BAEA033E ^[7] |
| 2.0 FSI | 4 | BLR; BVY | 110/148 | 07/05→05/10 | OE234 | 1,0 | CET12P CET3 | | BAEA033E ^[7] |
| 2.0 FSI | 4 | BLY; BVZ | 110/148 | 07/05→05/10 | OE146 | 1,0 | CET12P CET3 | OE179 | BAEA033E ^[7] |
| 2.0 TDI | 4 | CRVA | 81/109 | 02/13→ | CPSG007 | 4.4v | | | CCU151 |
| 2.0 TDI | 4 | AZV | 100/134 | 07/05→05/10 | | | | | CCU152 Ch.1P-6-075001→ |
| 2.0 TDI | 4 | BMM | 103/138 | 10/05→10/10 | | | | | CCU152 |
| 2.0 TDI | 4 | CRVC | 105/141 | 05/13→ | CPSG007 | 4.4v | | | CCU151 |
| 2.0 TDI | 4 | BMN | 125/168 | 05/06→12/12 | CCGP003 | 7v | | | CCU152 |
| 2.0 TDI | 4 | CEGA; CFJA | 125/168 | 05/06→12/12 | | | | | CCU152 |
| 2.0 TDI, 2.0 TDI 4WD | 4 | CKFC; CRBC; CRLB; CRMB | 110/148 | 10/12→ | CPSG007 | 4.4v | | | CCU151 |
| 2.0 TDI, 2.0 TDI 4WD | 4 | CUNA; CUPA | 135/181 | 09/12→ | CPSG007 | 4.4v | | | CCU151 |
| 2.0 TDI 16V | 4 | BKD | 103/138 | 07/05→12/12 | | | | | CCU152 Ch.1P-6-075001→ |
| 2.0 TDI 16V | 4 | CFHC; CLCB | 103/138 | 07/05→12/12 | | | | | CCU152 |
| 2.0 TFSI | 4 | BWA1 | 136/182 | 09/05→05/06 | OE214 | 0,7 | CET11P | | BAEA033E ^[7] |
| 2.0 TFSI | 4 | BWA | 147/197 | 05/05→03/09 | OE214 | 0,7 | CET11P | | BAEA033E ^[7] |
| 2.0 TFSI | 4 | CCZB | 155/208 | 06/09→12/12 | OE214 | 0,7 | CET11P | | BAEA033E ^[7] |
| 2.0 TFSI | 4 | BWJ; CDLD | 177/237 | 11/06→05/11 | OE214 | 0,7 | CET11P | | BAEA033E ^[7] |
| 2.8 | 6 | BDE | 150/201 | 05/02→06/04 | OE176 | 1,0 | CET3 | | BAEA044E ^[356] |
| 2.8 Cupra 4WD | 6 | AUE | 150/201 | 02/01→06/06 | OE176 | 1,0 | CET3 | | BAEA013E BAEA044E ^[356] |
| MARBELLA | | | | | | | | | |
| 0.9 | 4 | 08NCB | 32/43 | 07/97→10/98 | OE042 | 0,9 | CET8 | | CLS005 |
| 0.9 Cat | 4 | 08NCB | 30/40 | 11/96→10/98 | OE042 | 0,9 | CET8 | | CLS005 |
| Mii | | | | | | | | | |
| 1.0 | 3 | CHYA; DAFA | 44/59 | 10/11→ | OE247 | 1,0 | | | BAEA126E →01/12 [249] [275] BAEA067E [240] [275] |





kW/BHP

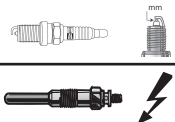

eon TITAN

IRIDIUM

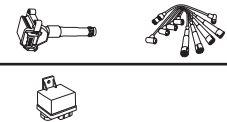

...SEAT



...Mii

| | | | | | | | | | | |
|-------------|---|------|-------|--------|-------|-----|--|--|--|--|
| 1.0 | 3 | CHYB | 55/74 | 10/11→ | OE247 | 1,0 | | | BAEA126E →01/12 [249] [275] | |
| | | | | | | | | | BAEA067E [240] [275] | |
| 1.0 EcoFuel | 3 | CPGA | 50/67 | 11/12→ | OE244 | 0,8 | | | BAEA067E [240] [275] | |
| | | | | | | | | | BAEA126E [249] [275] | |

TOLEDO I

| | | | | | | | | | | |
|-----------|---|----------|---------|-------------|-------|-----|--------|-------|---|---------------------|
| 1.6 i | 4 | 1F | 55/74 | 01/93→03/99 | OE027 | 1,0 | CET8 | | BAE851AE [261] [292] | CLS099 |
| 1.6 i | 4 | AFT | 74/99 | 11/96→03/99 | OE032 | 1,0 | CET2 | OE179 | BAE851AE [261] [292] | CLS034 |
| 1.8 i | 4 | ABS | 66/89 | 11/93→12/96 | OE025 | 1,0 | CET8 | OE195 | BAE851AE Ch.1L-ZR001001→ [261] [292] | CLS027 |
| | | | | | | | | | | CLS110 [292] |
| 1.8 i | 4 | ACC; ADZ | 66/89 | 11/93→12/96 | OE025 | 1,0 | CET8 | OE195 | BAE851AE Ch.1L-ZR001001→ [261] [292] | CLS110 [292] |
| 1.9 D | 4 | 1Y | 47/63 | 12/95→03/99 | CH260 | 11v | | | | |
| 1.9 TDI | 4 | 1Z; AHU | 66/89 | 08/95→03/99 | CH271 | 11v | | | CCU081 | |
| 1.9 TDI | 4 | AFN | 81/109 | 11/96→03/99 | CH271 | 11v | | | CCU081 | |
| 2.0 i 16V | 4 | ABF | 110/148 | 11/93→03/99 | OE032 | 1,0 | CET11P | | BAEA002E →Ch.1L-ZR001000 [261] [292] | CLS174 |
| | | | | | | | | | BAE851AE Ch.1L-ZR001001→ [261] [292] | |

TOLEDO II

| | | | | | | | | | | |
|------------|---|----------|---------|-------------|----------------------|-----|--------|-------|--|---------------|
| 1.4 16V | 4 | AHW | 55/74 | 01/00→05/02 | OE032 | 1,0 | CET2 | OE188 | BAE907AE [262] | CLS260 |
| 1.4 16V | 4 | AUA | 55/74 | 01/00→05/02 | | | CET2 | OE188 | | |
| 1.4 16V | 4 | APE; BCA | 55/74 | 01/00→05/02 | OE032 | 1,0 | CET2 | OE188 | | |
| 1.4 16V | 4 | AXP | 55/74 | 01/00→05/02 | OE032 | 1,0 | CET2 | OE188 | | CLS260 |
| 1.6 | 4 | APF | 74/99 | 10/98→07/04 | OE032 | 1,0 | CET2 | OE188 | | |
| 1.6 | 4 | AEH; AKL | 74/99 | 10/98→07/04 | OE032 | 1,0 | CET2 | OE188 | BAE907AE [262] | CLS139 |
| 1.6 | 4 | BFQ | 75/101 | 08/05→05/06 | | | | | BAE907AE [262] | |
| 1.6 16V | 4 | AUS | 77/103 | 06/00→05/06 | OE032 →12/01 | 1,0 | CET2 | OE188 | BAE907AE [262] | CLS260 |
| 1.6 16V | 4 | AZD | 77/103 | 06/00→05/06 | OE032 →12/01 | 1,0 | CET2 | OE188 | BAE408AE | |
| | | | | | OE176 01/02→07/04 | 1,0 | | | | |
| 1.6 16V | 4 | BCB | 77/103 | 06/00→05/06 | OE176 01/02→07/04 | 1,0 | CET2 | OE188 | BAE408AE | |
| 1.8 20V | 4 | AGN; APG | 92/123 | 10/98→07/04 | OE032 | 1,0 | CET2 | OE179 | BAE907AE [262] | CLS140 |
| 1.8 20VT | 4 | AUQ | 132/177 | 09/00→07/04 | OE136 | 0,8 | CET12P | OE179 | BAEA043E | |
| 1.8 20VT | 4 | APP | 132/177 | 09/00→07/04 | OE136 | 0,8 | CET12P | OE179 | BAEA009E | |
| 1.9 TDI | 4 | AGR; ALH | 66/89 | 03/99→07/04 | CH271 | 11v | | | CCU081 [364] | |
| 1.9 TDI | 4 | AHF; ASV | 81/109 | 10/98→07/04 | CH271 | 11v | | | CCU081 [364] | |
| 1.9 TDI | 4 | ASZ | 96/129 | 05/03→05/06 | CH181 | 11v | | | CCU081 [364] | |
| 1.9 TDI | 4 | ARL | 110/148 | 10/00→07/04 | CH271 | 11v | | | CCU081 [364] →Ch.1M-3-148000 | |
| 2.3 V5 | 5 | AGZ | 110/148 | 10/98→11/00 | | | CET2 | OE188 | BAEA037 | |
| 2.3 V5 20V | 5 | AQN | 125/168 | 09/00→11/03 | OE176 | 1,0 | CET3 | | BAEA063E | |

TOLEDO III

| | | | | | | | | | | |
|---------|---|---------------------|--------|-------------|-------|-----|------|-------|-----------------------|---------------|
| 1.4 16V | 4 | BXW | 63/84 | 05/06→05/09 | OE177 | 0,9 | CET3 | | BAE408AE | |
| 1.4 TSI | 4 | CAXC | 92/123 | 11/07→05/09 | OE213 | 0,9 | | | | |
| 1.6 | 4 | BGU; BSE; BSF; CCSA | 75/101 | 10/04→05/09 | OE026 | 0,9 | CET2 | OE188 | BAE907AE [262] | CLS017 |

SEAT





kW/BHP



eon TITAN

IRIDIUM



...SEAT



...TOLEDO III

| | | | | | | | | | |
|-------------|---|----------------|---------|-------------|---------|-----|----------------|-------|---------------------------|
| 1.8 TFSI | 4 | BYT; BZB; CDAA | 118/158 | 01/07→05/09 | OE214 | 0,7 | CET11P | | BAEA033E ^[7] |
| 1.9 TDI | 4 | BXE | 77/103 | 10/04→05/09 | | | | | CCU152 Ch.5P-6-053001→ |
| 1.9 TDI | 4 | BLS | 77/103 | 10/04→05/09 | CCGP002 | 7v | | | CCU152 Ch.5P-6-053001→ |
| 2.0 FSI | 4 | BLR; BVY | 110/148 | 10/04→05/09 | OE234 | 1,0 | CET12P CET3 | | BAEA033E ^[7] |
| 2.0 FSI | 4 | BLY; BVZ | 110/148 | 10/04→05/09 | OE146 | 1,0 | CET12P CET3 | OE179 | BAEA033E ^[7] |
| 2.0 TDI | 4 | AZV | 100/134 | 09/04→05/09 | | | | | CCU152 Ch.5P-6-053001→ |
| 2.0 TDI | 4 | BMM | 103/138 | 11/05→05/09 | CCGP002 | 7v | | | CCU152 |
| 2.0 TDI | 4 | BMN | 125/168 | 01/06→05/09 | CCGP003 | 7v | | | CCU152 |
| 2.0 TDI 16V | 4 | BKD | 103/138 | 04/04→05/09 | | | | | CCU152 Ch.5P-6-053001→ |
| 2.0 TFSI | 4 | BWA | 147/197 | 11/05→05/09 | OE214 | 0,7 | CET11P | | BAEA033E ^[7] |

TOLEDO IV

| | | | | | | | | | |
|---------|---|------------|--------|--------|---------|------|------|-------|----------------------------------|
| 1.2 | 3 | CGPC | 55/74 | 07/12→ | OE177 | 0,9 | CET3 | | BAE408AE |
| 1.2 TSI | 4 | CBZA | 63/84 | 07/12→ | | | | OE260 | BAE907AE ^[262] CLS090 |
| 1.2 TSI | 4 | CJZC | 66/89 | 05/15→ | OE244 | 0,8 | | | |
| 1.2 TSI | 4 | CBZB | 77/103 | 07/12→ | | | | OE260 | BAE907AE ^[262] CLS090 |
| 1.2 TSI | 4 | | 78/105 | 09/12→ | | | | OE260 | |
| 1.2 TSI | 4 | CJZD | 81/109 | 05/15→ | OE244 | 0,8 | | | |
| 1.4 TDI | 3 | CUSB | 66/89 | 05/15→ | CPSG007 | 4.4v | | | |
| 1.4 TSI | 4 | CAXA | 90/121 | 07/12→ | OE213 | 0,9 | | | BAE408AE |
| 1.4 TSI | 4 | CZCA | 92/123 | 05/15→ | OE244 | 0,8 | | | |
| 1.6 | 4 | CFNA | 77/103 | 07/13→ | OE177 | 0,9 | CET3 | | BAE408AE |
| 1.6 TDI | 4 | CAYB | 66/89 | 06/13→ | | | | | CCU152 |
| 1.6 TDI | 4 | CAYC; CLNA | 77/103 | 07/12→ | | | | | CCU152 |
| 1.6 TDI | 4 | CXMA | 85/114 | 05/15→ | CPSG007 | 4.4v | | | |

SEAT



INCA

| | | | | | | | | | |
|---------|---|---------------|-------|-------------|-------|-----|------|-------|---|
| 1.4 16V | 4 | AUA | 55/74 | 04/00→06/03 | OE032 | 1,0 | CET2 | OE179 | BAE907AE ^[262] |
| 1.4 i | 4 | AEX; AKV; APQ | 44/59 | 11/95→06/03 | OE027 | 1,0 | CET8 | | BAE851AE ^[261] CLS109 ^[292] |
| 1.4 i | 4 | AUD | 44/59 | 11/95→06/03 | OE025 | 1,0 | CET8 | OE195 | BAE907AE ^[262] CLS053 CLS109 |
| 1.6 i | 4 | 1F | 55/74 | 11/95→09/00 | OE027 | 1,0 | CET8 | | BAE851AE ^[261] CLS099 ^[292] |
| 1.6 i | 4 | AEE; ALM | 55/74 | 11/95→09/00 | OE027 | 1,0 | CET8 | | BAE851AE ^[261] CLS099 ^[292] |
| 1.7 D | 4 | AHB | 42/56 | 09/96→06/03 | CH260 | 11v | | | CCU081 →Ch.9K-3-001600 |
| 1.9 D | 4 | 1Y | 47/63 | 11/95→06/03 | CH260 | 11v | | | |
| 1.9 SDI | 4 | AEY; AVQ | 47/63 | 11/95→06/03 | CH271 | 11v | | | CCU081 →Ch.9K-3-001600 |
| 1.9 TDI | 4 | ALH | 66/89 | 09/96→06/03 | CH271 | 11v | | | |

LEON

| | | | | | | | | | |
|---------|---|------------|---------|-------------|------------------------------|-----|--|--|--|
| 1.2 TSI | 4 | CJZB; CYVA | 63/84 | 01/13→ | OE244 ^[223] [302] | 0,8 | | | |
| 1.2 TSI | 4 | CYVB | 81/109 | 04/14→ | OE244 ^[223] [302] | 0,8 | | | |
| 1.4 TSI | 4 | CMBA; CXSA | 90/121 | 09/12→10/16 | OE244 ^[220] [307] | 0,8 | | | |
| 1.4 TSI | 4 | CHPA; CPTA | 103/138 | 09/12→10/16 | OE244 ^[219] [306] | 0,8 | | | |
| 1.4 TSI | 4 | CZEA | 110/148 | 05/14→ | OE244 ^[219] [306] | 0,8 | | | |



kW/BHP



eon TITAN

IRIDIUM



...SEAT



LEON ST

| | | | | | | | | | |
|---------|---|------------|---------|--------|-----------------------------|-----|--|--|--|
| 1.2 TSI | 4 | CJZB; CYVA | 63/84 | 01/13→ | OE244 [223] [302] | 0,8 | | | |
| 1.2 TSI | 4 | CYVB | 81/109 | 05/14→ | OE244 [223] [302] | 0,8 | | | |
| 1.4 TSI | 4 | CZDA; CZEA | 110/148 | 05/14→ | OE244 [219] [306] | 0,8 | | | |

SKODA



CITIGO

| | | | | | | | | | |
|---------|---|------|-------|--------|--------------|-----|--|--|--|
| 1.0 | 3 | CHYA | 44/59 | 10/11→ | OE247 | 1,0 | | | BAEA067E [240] [275] BAEA126E [249] [275] |
| 1.0 | 3 | CHYB | 55/74 | 10/11→ | OE247 | 1,0 | | | BAEA067E [240] [275] BAEA126E [249] [275] |
| 1.0 CNG | 3 | CPGA | 50/67 | 11/12→ | OE244 | 0,8 | | | BAEA067E [240] |

FABIA I

| | | | | | | | | | |
|------------|---|---------------|--------|-------------|--|------------|--|--------------------|--|
| 1.0 | 4 | AQV; ARV | 37/50 | 12/99→08/02 | OE032 | 1,0 | CET2 | OE188 | BAE961AE |
| 1.2 | 3 | AWY; BMD | 40/54 | 07/01→12/07 | OE177 | 0,9 | CET3 | | BAEA059E |
| 1.2 | 3 | AZQ; BME | 47/63 | 01/03→03/08 | OE177 | 0,9 | CET3 | | BAE408AE |
| 1.4 | 4 | AZE; AZF | 44/59 | 04/00→03/03 | OE145 | 0,8 | CET12P | OE182 | BAE961AE |
| 1.4 | 4 | AME; AQW; ATZ | 50/67 | 08/99→05/03 | OE145 | 0,8 | CET12P | OE182 | BAE961AE |
| 1.4 16V | 4 | AUA; BBY | 55/74 | 10/99→03/08 | OE032 [287] OE176 [285] | 1,0 1,0 | CET2 [287] CET3 [285] | OE179 [287] | BAE408AE [275] CLS260 BAE907AE [262] [275] BAE961AE [275] |
| 1.4 16V | 4 | BKY | 55/74 | 10/99→03/08 | OE176 [285] OE177 [287] | 1,0 0,9 | CET3 [285] CET3 [287] | | BAE408AE [275] CLS260 BAE907AE [262] [275] BAE961AE [275] |
| 1.4 16V | 4 | BUD | 59/79 | 04/06→12/07 | OE177 | 0,9 | CET3 | | BAE408AE |
| 1.4 16V | 4 | AUB; BBZ | 74/99 | 12/99→03/08 | OE032 | 1,0 | CET2 | OE179 | BAE408AE [275] CLS260 BAE907AE [262] [275] BAE961AE [275] |
| 1.4 TDI | 3 | BNM | 51/68 | 10/05→03/08 | CH181 | 11v | | | CCU081 →Ch.6Y-64648255 |
| 1.4 TDI | 3 | AMF | 55/74 | 04/03→03/08 | CH181 | 11v | | | CCU081 →Ch.6Y-64648255 |
| 1.4 TDI | 3 | BNV | 59/79 | 10/05→03/08 | CH181 | 11v | | | CCU081 →Ch.6Y-64648255 |
| 1.9 SDI | 4 | ASY | 47/63 | 11/99→03/08 | CH271 | 11v | | | CCU081 →Ch.6Y-64648255 |
| 1.9 TDI | 4 | ATD; AXR | 74/99 | 01/00→03/08 | CH271 | 11v | | | CCU081 →Ch.6Y-64648255 |
| 1.9 TDI RS | 4 | ASZ; BLT | 96/129 | 06/03→03/08 | CH181 | 11v | | | CCU081 →Ch.6Y-64648255 |
| 2.0 | 4 | AZL | 85/114 | 12/99→03/08 | OE032 | 1,0 | CET2 | OE179 | BAE907AE [262] CLS017 |

FABIA II

| | | | | | | | | | |
|---------|---|------------------|-------|-------------|--|------------|-------------|--|--|
| 1.2 | 3 | BBM; CHFA | 44/59 | 12/06→12/14 | OE177 | 0,9 | CET3 | | BAEA059E |
| 1.2 | 3 | CEVA; CGPA; CHTA | 51/68 | 01/07→12/14 | OE177 | 0,9 | CET3 | | BAE408AE |
| 1.2 | 3 | BZG | 51/68 | 01/07→12/14 | OE177 →Ch.SJ-83074394 OE177 →Ch.SJ-88501225 | 0,9 0,9 | CET3 | | BAE408AE |
| 1.2 12V | 3 | CGPB | 44/59 | 11/11→12/14 | OE177 | 0,9 | CET3 | | BAE408AE |
| 1.2 TDI | 3 | CFWA | 55/74 | 05/10→12/14 | | | | | CCU152 Prod.27.05.2013→ Prod.18.11.2013 |

SKODA





kW/BHP

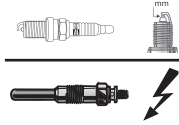

eon TITAN

IRIDIUM

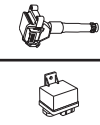

SKODA

| ...SKODA | | | | | | | | | |
|----------------------|---|------------|---------|-------------|-----------------|------|--------|-----------------|--|
| ...FABIA II | | | | | | | | | |
| 1.2 TSI | 4 | CBZA | 63/84 | 03/10→12/14 | | | | OE260 | BAE907AE ^[262] CLS090 |
| 1.2 TSI | 4 | CBZB | 77/103 | 03/10→12/14 | | | | OE260 | BAE907AE ^[262] CLS090 |
| 1.4 | 4 | BXW; CGGB | 63/84 | 01/07→12/14 | OE177 | 0,9 | CET3 | | BAE408AE Ch.5J-7-000001→ |
| 1.4 TDI | 3 | BNM | 51/68 | 02/07→03/10 | CH181 | 11v | | | |
| 1.4 TDI | 3 | BNV | 59/79 | 01/07→03/10 | CH181 | 11v | | | |
| 1.4 TDI | 3 | BMS | 59/79 | 01/07→03/10 | CCGP002 | 7v | | | |
| 1.4 TSI RS | 4 | CAVE | 132/177 | 05/10→12/14 | | | | | BAE408AE |
| 1.6 | 4 | BTS | 77/103 | 04/07→12/14 | OE177 | 0,9 | CET3 | | BAE408AE Ch.5J-7-000001→ |
| 1.6 | 4 | CFNA; CLSA | 77/103 | 04/07→12/14 | OE177 | 0,9 | CET3 | | |
| 1.6 TDI | 4 | CAYA | 55/74 | 04/10→12/14 | | | | | CCU152 |
| 1.6 TDI | 4 | CAYB | 66/89 | 03/10→12/14 | | | | | CCU152 |
| 1.6 TDI | 4 | CAYC | 77/103 | 03/10→12/14 | | | | | CCU152 |
| 1.9 TDI | 4 | BLS | 77/103 | 04/07→03/10 | CCGP002 | 7v | | | CCU152 |
| FABIA III | | | | | | | | | |
| 1.0 | 3 | CHYA | 44/59 | 08/14→ | OE247 | 1,0 | | | BAEA067E ^[240] |
| 1.0 | 3 | CHYB | 55/74 | 08/14→ | OE247 | 1,0 | | | BAEA067E ^[240] |
| 1.2 TSI | 4 | CJZC | 66/89 | 08/14→ | OE244 | 0,8 | | | BAEA067E ^[240] |
| 1.2 TSI | 4 | CJZD | 81/109 | 08/14→ | OE244 | 0,8 | | | BAEA067E ^[240] |
| 1.4 TDI | 3 | CUSA | 55/74 | 05/15→ | CPSG007 | 4.4v | | | |
| 1.4 TDI | 3 | CUSB | 66/89 | 08/14→ | CPSG007 | 4.4v | | | |
| 1.4 TDI | 3 | CUTA | 77/103 | 08/14→ | CPSG007 | 4.4v | | | |
| FAVORIT | | | | | | | | | |
| 1.3 | 4 | 781.135 | 43/58 | 01/93→12/93 | OE005 | 0,9 | CET2 | OE180 | |
| FELICIA I | | | | | | | | | |
| 1.3 | 4 | 135B; AMG | 40/54 | 10/94→04/02 | OE013 | 0,8 | CET12P | OE182 | BAE851AE ^{[261] [292]} |
| | | | | | OE145 | 0,8 | CET2 | OE193 | |
| 1.3 | 4 | 135M | 40/54 | 10/94→04/02 | OE013 | 0,8 | CET12P | OE182 | BAE851AE ^{[261] [292]} |
| | | | | | OE145 | 0,8 | CET2 | OE193 | |
| 1.3 | 4 | AMJ | 43/58 | 10/94→04/02 | OE005 | 0,9 | CET2 | OE180 | BAE851AE ^{[261] [292]} |
| 1.3 | 4 | 135L | 43/58 | 10/94→04/02 | | | CET2 | | BAE851AE ^{[261] [292]} |
| 1.3 | 4 | 135L | 43/58 | 10/94→04/02 | OE013 | 0,8 | | OE193 | |
| 1.3 | 4 | 136B; AMH | 50/67 | 10/94→04/02 | OE005 | 0,9 | CET12P | OE180 | BAE851AE ^{[261] [292]} |
| | | | | | OE145 | 0,8 | CET2 | OE182 | |
| 1.3 | 4 | 136M | 50/67 | 10/94→04/02 | OE005 | 0,9 | CET12P | OE180 | BAE851AE ^{[261] [292]} |
| | | | | | OE145 | 0,8 | CET2 | OE182 | |
| 1.3 LX | 4 | 135B; AMG | 40/54 | 08/95→03/98 | OE013 →08/96 | 0,8 | CET12P | OE193 →08/96 | BAE851AE ^{[261] [292]} |
| | | | | | | | CET2 | OE182 08/96→ | |
| 1.3 LXI | 4 | 136B; AMH | 50/67 | 08/95→03/98 | OE005 →08/96 | 0,9 | CET12P | OE180 →08/96 | BAE851AE ^{[261] [292]} |
| | | | | | | | CET2 | OE182 08/96→ | |
| 1.6, 1.6 GLX, 1.6 LX | 4 | AEE | 55/74 | 08/95→04/02 | OE025 | 1,0 | CET8 | OE195 | BAE851AE ^{[261] [292]} CLS100 |
| 1.9 D | 4 | AEF | 47/63 | 10/95→04/02 | CH260 | 11v | | | |
| FELICIA II | | | | | | | | | |
| 1.3 | 4 | AMG | 40/54 | 01/98→06/01 | OE145 | 0,8 | CET12P | OE182 | BAE851AE ^{[261] [292]} BAE960AE |



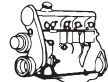

kW/BHP

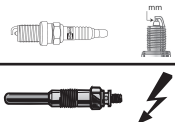

eon TITAN

IRIDIUM

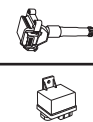

...SKODA



...FELICIA II

| | | | | | | | | | | |
|-----|---|-----|-------|-------------|-------|-----|--------|-------|-------------------------|--------|
| 1.3 | 4 | AMJ | 43/58 | 01/98→06/01 | OE005 | 0,9 | CET2 | OE180 | BAE960AE | |
| 1.3 | 4 | AMH | 50/67 | 01/98→06/01 | OE145 | 0,8 | CET12P | OE182 | BAE851AE [261] [292] | |
| | | | | | | | | | BAE960AE | |
| 1.6 | 4 | AEE | 55/74 | 01/98→06/01 | OE025 | 1,0 | CET8 | OE195 | BAE851AE [261] [292] | CLS109 |
| | | | | | | | | | BAE960AE | |

| | | | | | | | | | | |
|-------|---|-----|-------|-------------|-------|-----|--|--|--|--|
| 1.9 D | 4 | AEF | 47/63 | 01/98→06/01 | CH260 | 11v | | | | |
|-------|---|-----|-------|-------------|-------|-----|--|--|--|--|

KODIAQ

| | | | | | | | | | | |
|----------------------|---|-----------------|---------|--------|-----------------------------|------|--|--|----------|--|
| 2.0 TDI, 2.0 TDI 4WD | 4 | DBG; DBGC; DFGA | 110/148 | 10/16→ | CPSG007 →Prod.31.10.2017 | 4.4v | | | | |
| 2.0 TDI 4WD | 4 | DFHA | 140/188 | 10/16→ | CPSG007 →Prod.31.10.2017 | 4.4v | | | | |
| 2.0 TSI 4WD | 4 | CZPA | 132/177 | 10/16→ | | | | | BAEA137E | |

OCTAVIA I

| | | | | | | | | | | |
|----------------------|---|----------|---------|-------------|-----------------|-----|--------|-------|--|------------------|
| 1.4 | 4 | AMD | 44/59 | 04/99→03/01 | OE145 | 0,8 | CET12P | OE182 | BAE961AE | |
| 1.4 16V | 4 | AXP | 55/74 | 08/00→12/10 | OE032 [287] | 1,0 | CET2 | OE188 | BAE907AE →Prod.28.02.2002 [64] [262] [275] | CLS260 |
| | | | | | OE176 [285] | 1,0 | | | | |
| 1.4 16V | 4 | BCA | 55/74 | 08/00→12/10 | OE032 [287] | 1,0 | CET2 | OE188 | BAE408AE [65] [275] | CLS260 |
| | | | | | | | | | BAE907AE →Prod.28.02.2002 [64] [262] [275] | |
| 1.6 | 4 | AEE | 55/74 | 09/96→09/04 | OE025 | 1,0 | CET8 | OE195 | BAE851AE [261] [292] | CLS100 |
| 1.6 | 4 | AEH; AKL | 74/99 | 02/97→12/07 | OE032 | 1,0 | CET2 | OE179 | BAE907AE [262] | CLS139 |
| 1.6 | 4 | AVU; BFQ | 75/101 | 09/00→12/10 | OE032 | 1,0 | CET2 | OE188 | BAE907AE [262] | CLS048 |
| 1.8 | 4 | AGN | 92/123 | 09/96→07/00 | OE032 | 1,0 | CET2 | OE179 | BAE907AE [262] | CLS140 04/97→ |
| 1.8 20V | 4 | AGN | 92/123 | 07/98→07/00 | OE032 | 1,0 | CET2 | OE179 | BAE907AE [262] | CLS140 |
| 1.8 RS 1.8 T | 4 | AUQ | 132/177 | 05/01→01/06 | OE136 | 0,8 | CET12P | OE179 | BAEA043E | |
| 1.8 T | 4 | AGU | 110/148 | 08/97→12/10 | OE136 | 0,8 | CET12P | OE179 | BAEA016 | |
| 1.8 T | 4 | ARX; AUM | 110/148 | 08/97→12/10 | OE136 | 0,8 | CET12P | OE179 | BAEA043E ModelYear2001→ | |
| 1.8 T | 4 | ARZ | 110/148 | 08/97→12/10 | OE136 | 0,8 | CET12P | OE179 | BAEA009E ModelYear→2000 | |
| 1.8 T 4WD | 4 | ARX | 110/148 | 05/01→05/06 | OE136 | 0,8 | CET12P | OE179 | BAEA043E | |
| 1.9 SDI | 4 | AGP; AQM | 50/67 | 06/97→12/03 | CH271 | 11v | | | CCU081 | |
| 1.9 TDI | 4 | AHF; ASV | 81/109 | 08/97→01/06 | CH271 | 11v | | | CCU081 | |
| 1.9 TDI | 4 | ASZ | 96/129 | 09/02→09/04 | CH181 | 11v | | | CCU081 | |
| 1.9 TDI, 1.9 TDI 4WD | 4 | AGR; ALH | 66/89 | 09/96→03/10 | CH271 | 11v | | | CCU081 | |
| 1.9 TDI, 1.9 TDI 4WD | 4 | ATD; AXR | 74/99 | 08/00→12/10 | CH271 →11/01 | 11v | | | CCU081 | |
| | | | | | CH181 12/01→ | 11v | | | | |

| | | | | | | | | | | |
|--------------|---|--------------------|--------|-------------|-------|-----|------|-------|----------------|--------|
| 2.0 | 4 | AZJ | 85/114 | 04/99→05/07 | OE032 | 1,0 | CET2 | OE179 | BAEA029E | |
| 2.0, 2.0 4WD | 4 | AEG; APK; AQY; AZH | 85/114 | 04/99→05/07 | OE032 | 1,0 | CET2 | OE179 | BAE907AE [262] | CLS017 |
| 2.0 4WD | 4 | AZJ | 85/114 | 08/00→09/04 | OE032 | 1,0 | CET2 | OE179 | BAEA029E | CLS070 |
| 2.0 4WD | 4 | ATF | 88/118 | 01/00→12/10 | OE176 | 1,0 | CET3 | | BAE907AE [262] | |

OCTAVIA II

| | | | | | | | | | | |
|---------|---|-----------|--------|-------------|-------|-----|------|-------|----------------------------|--------|
| 1.2 TSI | 4 | CBZB | 77/103 | 02/10→06/13 | | | | OE260 | BAE907AE [262] | CLS090 |
| 1.4 | 4 | BCA | 55/74 | 05/04→05/06 | OE032 | 1,0 | CET2 | OE179 | BAE408AE [275] | |
| | | | | | | | | OE188 | BAE408AE BAE961AE [275] | |
| 1.4 | 4 | BUD; CGGA | 59/79 | 06/04→06/13 | OE177 | 0,9 | CET3 | OE188 | BAE408AE [275] →12/11 | |
| 1.4 TSI | 4 | CAXA | 90/121 | 11/08→06/13 | OE213 | 0,9 | | | BAE408AE | |

SKODA





kW/BHP



eon TITAN

IRIDIUM



...SKODA



...OCTAVIA II

| | | | | | | | | | | |
|------------------------------|---|---------------------------|---------|-------------|-------------------|------------|----------------|-------|---------------------------|--------|
| 1.6 | 4 | BGU; BSE; BSF; CCSA; CMXA | 75/101 | 06/04→06/13 | OE026 OE032 | 0,9 1,0 | CET2 | OE188 | BAE907AE ^[262] | CLS048 |
| 1.6 FSI | 4 | BLF | 85/114 | 02/04→10/08 | | | | | BAE408AE | |
| 1.6 LPG, 1.6 MultiFuel | 4 | CCSA; CHGA | 75/101 | 01/08→06/13 | OE032 | 1,0 | CET2 | OE179 | BAE907AE ^[262] | CLS048 |
| 1.6 MultiFuel | 4 | CMXA | 75/101 | 01/08→06/13 | OE032 | 1,0 | CET2 | OE179 | | |
| 1.6 TDI, 1.6 TDI 4WD | 4 | CAYC | 77/103 | 06/09→04/13 | | | | | CCU152 | |
| 1.8 TSI | 4 | CDAB | 112/150 | 03/09→06/13 | OE214 | 0,7 | CET11P | | | |
| 1.8 TSI, 1.8 TSI 4WD | 4 | BZB; CDA | 118/158 | 06/07→04/13 | OE214 | 0,7 | CET11P | | BAEA033E ^[7] | |
| 1.8 TSI 4WD | 4 | CDAB | 112/150 | 03/09→02/13 | OE214 | 0,7 | CET11P | | BAEA033E ^[7] | |
| 1.9 TDI, 1.9 TDI 4WD | 4 | BLS; BXE | 77/103 | 06/04→12/10 | | | | | CCU152 03/06→ | |
| 2.0 FSI | 4 | BLR; BVY | 110/148 | 11/04→10/08 | OE234 | 1,0 | CET12P CET3 | | BAEA033E ^[7] | |
| 2.0 FSI | 4 | BLY; BVZ | 110/148 | 11/04→10/08 | OE146 | 1,0 | CET12P CET3 | OE179 | BAEA033E ^[7] | |
| 2.0 FSI 4WD | 4 | BLX; BVX | 110/148 | 11/04→10/08 | OE234 | 1,0 | CET3 | | BAEA033E ^[7] | |
| 2.0 RS | 4 | BWA; CCZA | 147/197 | 10/05→02/13 | OE214 | 0,7 | CET11P | | BAEA033E ^[7] | |
| 2.0 TDI | 4 | BMM | 103/138 | 11/05→05/10 | CCGP002 →12/05 | 7v | | | CCU152 | |
| 2.0 TDI, 2.0 TDI 4WD | 4 | CFHF; CLCA | 81/109 | 03/10→06/13 | | | | | CCU152 | |
| 2.0 TDI, 2.0 TDI 16V | 4 | AZV | 100/134 | 02/04→05/10 | | | | | CCU152 03/06→ | |
| 2.0 TDI 4WD | 4 | BMM | 103/138 | 07/06→05/10 | | | | | CCU152 | |
| 2.0 TDI 16V | 4 | BKD | 103/138 | 02/04→05/13 | | | | | CCU152 03/06→ | |
| 2.0 TDI 16V, 2.0 TDI 16V 4WD | 4 | CFHC; CLCB | 103/138 | 02/04→05/13 | | | | | CCU152 | |
| 2.0 TDI RS | 4 | BMN | 125/168 | 04/06→02/13 | CCGP003 | 7v | | | CCU152 | |
| 2.0 TDI RS | 4 | CEGA | 125/168 | 04/06→02/13 | | | | | CCU152 | |

OCTAVIA III

| | | | | | | | | | | |
|----------------------------------|---|------------------------|---------|--------|-------------------------|------|--|-------|--|--|
| 1.2 TSI | 4 | CJZB; CYVA | 63/84 | 11/12→ | OE244 | 0,8 | | | BAEA067E ^{[240] [275]} BAEA126E ^{[249] [275]} | |
| 1.2 TSI | 4 | CJZA | 77/103 | 11/12→ | OE244 | 0,8 | | | BAEA067E ^{[240] [275]} BAEA126E ^{[249] [275]} | |
| 1.2 TSI | 4 | CYVB | 81/109 | 05/15→ | OE244 | 0,8 | | | | |
| 1.4 TSI | 4 | CHPA | 103/138 | 11/12→ | OE244 | 0,8 | | | BAEA067E ^{[240] [275]} BAEA126E ^{[249] [275]} | |
| 1.4 TSI | 4 | CZDA | 110/148 | 08/14→ | OE244 | 0,8 | | | | |
| 1.4 TSI G-TEC | 4 | CPWA | 81/109 | 11/13→ | OE244 | 0,8 | | | BAEA067E ^[240] | |
| 1.6 | 4 | CWVA | 81/109 | 01/14→ | OE247 | 1,0 | | | BAEA067E ^[240] | |
| 1.6 TDI | 4 | CLHB; CXXA; DDYB | 66/89 | 11/12→ | CPSG007 ^[25] | 4.4v | | | CCU151 | |
| 1.6 TDI | 4 | CXXB; DBKA | 81/109 | 05/13→ | CPSG007 ^[25] | 4.4v | | | CCU151 | |
| 1.6 TDI | 4 | CRKB | 81/109 | 05/13→ | CPSG007 ^[22] | 4.4v | | | CCU151 | |
| 1.6 TDI | 4 | DDYA | 85/114 | 02/17→ | CPSG007 | 4.4v | | | | |
| 1.6 TDI, 1.6 TDI 4WD | 4 | CLHA | 77/103 | 11/12→ | CPSG007 ^[25] | 4.4v | | | CCU151 | |
| 1.6 TDI 4WD | 4 | CXXB | 81/109 | 05/15→ | CPSG007 ^[25] | 4.4v | | | | |
| 1.8 TSI | 4 | CJSA | 132/177 | 11/12→ | | | | OE246 | BAEA068E | |
| 1.8 TSI 4WD | 4 | CJSB | 132/177 | 11/12→ | | | | OE246 | BAEA068E | |
| 2.0 TDI | 4 | CKFB; CRVC | 105/141 | 11/12→ | CPSG007 ^[25] | 4.4v | | | CCU151 | |
| 2.0 TDI, 2.0 TDI 4WD | 4 | CKFC; CRMB; CYKA; DCYA | 110/148 | 11/12→ | CPSG007 ^[25] | 4.4v | | | CCU151 | |
| 2.0 TDI RS, 2.0 TDI / TDI RS 4WD | 4 | CUNA; CUPA; DJGA | 135/181 | 05/13→ | CPSG007 ^[25] | 4.4v | | | CCU151 | |
| 2.0 TSI RS | 4 | CHHB | 162/217 | 11/12→ | | | | OE246 | BAEA068E | |

CHAMPION

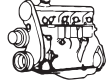

kW/BHP

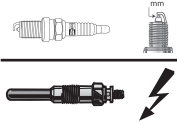

eon TITAN

IRIDIUM

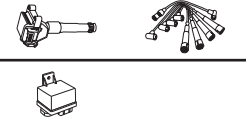

...SKODA



...OCTAVIA III

| | | | | | | | | | | |
|------------|---|------|---------|--------|--|--|--|--------------|---------------------------|--|
| 2.0 TSI RS | 4 | CHHA | 169/227 | 05/15→ | | | | OE246 | BAEA068E →07/16 | |
|------------|---|------|---------|--------|--|--|--|--------------|---------------------------|--|

RAPID

| | | | | | | | | | | |
|---------|---|------------|--------|--------|----------------|------|-------------|--------------|----------------------------------|---|
| 1.2 | 3 | CGPC | 55/74 | 07/12→ | OE177 | 0,9 | CET3 | | BAE408AE | |
| 1.2 TSI | 4 | CBZA | 63/84 | 07/12→ | | | | OE260 | BAE907AE ^[262] | CLS090 ^[66] →10/12 |
| 1.2 TSI | 4 | CJZC | 66/89 | 05/15→ | OE244 | 0,8 | | | | |
| 1.2 TSI | 4 | CBZB | 77/103 | 07/12→ | | | | OE260 | BAE907AE ^[262] | CLS090 ^[66] →10/12 |
| 1.2 TSI | 4 | CJZD | 81/109 | 05/15→ | OE244 | 0,8 | | | | |
| 1.4 TDI | 3 | CUSB | 66/89 | 05/15→ | CP5G007 | 4.4v | | | | |
| 1.4 TSI | 4 | CAXA | 90/121 | 07/12→ | OE213 | 0,9 | | | BAE408AE | |
| 1.4 TSI | 4 | CZCA | 92/123 | 05/15→ | OE244 | 0,8 | | | | |
| 1.6 | 4 | CFNA | 77/103 | 10/11→ | OE177 | 0,9 | CET3 | | BAE408AE | |
| 1.6 | 4 | CLSA | 77/103 | 10/11→ | | | | | BAE408AE | |
| 1.6 TDI | 4 | CAYB | 66/89 | 08/13→ | | | | | CCU152 | |
| 1.6 TDI | 4 | CAYC; CLNA | 77/103 | 10/11→ | | | | | CCU152 | |

ROOMSTER

| | | | | | | | | | | |
|---------|---|-----------|--------|-------------|----------------|-----|-------------|--------------|--|---------------|
| 1.2 | 3 | BME | 47/63 | 05/06→01/07 | OE177 | 0,9 | CET3 | | BAE408AE | |
| 1.2 | 3 | BZG; CGPA | 51/68 | 01/07→05/15 | OE177 | 0,9 | CET3 | | BAE408AE | |
| 1.2 TDI | 3 | CFWA | 55/74 | 03/10→05/15 | | | | | CCU152 Prod.27.05.2013→ Prod.18.11.2013 | |
| 1.2 TSI | 4 | CBZA | 63/84 | 03/10→05/15 | | | | OE260 | BAE907AE ^[262] | CLS090 |
| 1.2 TSI | 4 | CBZB | 77/103 | 03/10→05/15 | | | | OE260 | BAE907AE ^[262] | CLS090 |
| 1.4 | 4 | BXW; CGGB | 63/84 | 09/06→05/15 | OE177 | 0,9 | CET3 | | BAE408AE →12/11 | |
| 1.4 TDI | 3 | BNM | 51/68 | 07/06→03/10 | CH181 | 11v | | | | |
| 1.4 TDI | 3 | BNV | 59/79 | 09/06→03/10 | CH181 | 11v | | | | |
| 1.4 TDI | 3 | BMS | 59/79 | 09/06→03/10 | CCGP002 | 7v | | | | |
| 1.6 | 4 | BTS; CFNA | 77/103 | 09/06→05/15 | OE177 | 0,9 | CET3 | | BAE408AE →12/11 | |
| 1.6 TDI | 4 | CAYB | 66/89 | 03/10→05/15 | | | | | CCU152 | |
| 1.6 TDI | 4 | CAYC | 77/103 | 03/10→05/15 | | | | | CCU152 | |
| 1.9 TDI | 4 | AXR | 74/99 | 03/06→05/06 | CH181 | 11v | | | | |
| 1.9 TDI | 4 | BLS | 77/103 | 09/06→03/10 | CCGP002 | 7v | | | CCU152 | |

SUPERB I

| | | | | | | | | | | |
|---------|---|----------|---------|-------------|----------------|-----|---------------|--------------|----------------------------------|---------------|
| 1.8 T | 4 | AWT | 110/148 | 12/01→03/08 | OE136 | 0,8 | CET12P | OE179 | BAEA043E | |
| 1.9 TDI | 4 | AVB | 74/99 | 08/02→10/05 | CH181 | 11v | | | | |
| 1.9 TDI | 4 | BSV | 77/103 | 10/05→05/07 | CCGP002 | 7v | | | CCU152 | |
| 1.9 TDI | 4 | BPZ | 85/114 | 01/07→03/08 | CCGP002 | 7v | | | | |
| 1.9 TDI | 4 | AVF; AWX | 96/129 | 12/01→03/08 | CH181 | 11v | | | | |
| 2.0 | 4 | AZM | 85/114 | 12/01→03/08 | OE032 | 1,0 | CET2 | OE188 | BAE907AE ^[262] | CLS017 |
| 2.0 TDI | 4 | BSS | 103/138 | 10/05→03/08 | CCGP002 | 7v | | | CCU152 | |
| 2.5 TDI | 6 | AYM | 114/153 | 12/01→08/03 | CH215 | 12v | | | | |
| 2.5 TDI | 6 | BDG | 120/161 | 06/03→03/08 | CH215 | 12v | | | | |
| 2.8 V6 | 6 | BBG | 140/188 | 06/02→03/08 | OE237 | 1,6 | CET2 | OE179 | | CLS046 |
| 2.8 V6 | 6 | AMX | 142/190 | 12/01→03/08 | OE237 | 1,6 | CET2 | OE179 | BAEA154E | CLS046 |

SUPERB II

| | | | | | | | | | | |
|----------------------|---|-----------|---------|-------------|----------------|-----|---------------|--|--|--|
| 1.4 TSI | 4 | CAXC | 92/123 | 07/08→05/15 | OE213 | 0,9 | | | BAE408AE | |
| 1.6 TDI | 4 | CAYC | 77/103 | 09/10→05/15 | | | | | CCU152 | |
| 1.8 TSI, 1.8 TSI 4WD | 4 | CDAB | 112/150 | 03/09→05/15 | OE214 | 0,7 | CET11P | | BAEA033E ^[7] | |
| 1.8 TSI, 1.8 TSI 4WD | 4 | BZB; CDAA | 118/158 | 03/08→05/15 | OE214 | 0,7 | CET11P | | BAEA033E ^[7] 08/12→ | |
| 1.9 TDI | 4 | BLS; BXE | 77/103 | 03/08→11/10 | | | | | CCU152 | |
| 2.0 TDI | 4 | BMP | 103/138 | 03/08→05/10 | CCGP002 | 7v | | | CCU152 | |

SKODA





kW/BHP



eon TITAN

IRIDIUM



...SKODA



...SUPERB II

| | | | | | | | | | |
|------------------------------|---|------------|---------|---------------|-------|-----|--------|--|-------------------------|
| 2.0 TDI, 2.0 TDI 4WD | 4 | CBBB; CFGB | 125/168 | 07/08 → 05/15 | | | | | CCU152 |
| 2.0 TDI 16V | 4 | BKD | 103/138 | 01/09 → 05/15 | | | | | CCU152 |
| 2.0 TDI 16V, 2.0 TDI 16V 4WD | 4 | CFFB; CLJA | 103/138 | 01/09 → 05/15 | | | | | CCU152 |
| 2.0 TSI | 4 | CCZA | 147/197 | 05/10 → 05/15 | OE214 | 0,7 | CET11P | | |
| 3.6 FSI 4WD, 3.6 V6 4WD | 6 | CDVA | 191/256 | 11/08 → 05/15 | | | | | BAEA041E [277] [324] |

SUPERB III

| | | | | | | | | | |
|----------------------|---|------------------|---------|---------|---------|------|--|-------|--------------------|
| 1.4 TSI | 4 | CZCA | 92/123 | 03/15 → | OE244 | 0,8 | | | |
| 1.4 TSI, 1.4 TSI 4WD | 4 | CZDA; CZEZ | 110/148 | 03/15 → | OE244 | 0,8 | | | |
| 1.6 TDI | 4 | DCXA; DCZA | 88/118 | 03/15 → | CPSG007 | 4.4v | | | CCU151 |
| 1.8 TSI | 4 | CJSA; CJSC | 132/177 | 03/15 → | | | | OE246 | BAEA068E →01/16 |
| 2.0 TDI | 4 | CRGA | 130/174 | 03/15 → | CPSG007 | 4.4v | | | |
| 2.0 TDI, 2.0 TDI 4WD | 4 | CRLB; DFEA; DFGA | 110/148 | 03/15 → | CPSG007 | 4.4v | | | CCU151 |
| 2.0 TDI, 2.0 TDI 4WD | 4 | DDAA; DFCA | 140/188 | 03/15 → | CPSG007 | 4.4v | | | CCU151 |
| 2.0 TSI | 4 | CHHB | 162/217 | 03/15 → | | | | OE246 | BAEA068E →07/16 |
| 2.0 TSI 4WD | 4 | CJXA | 206/276 | 03/15 → | | | | | BAEA068E →07/16 |

YETI

| | | | | | | | | | |
|----------------------|---|------------------------------|---------|---------------|------------------------------|------|--------|-------|----------------------------------|
| 1.2 TSI | 4 | CBZB | 77/103 | 09/09 → 05/15 | | | | OE260 | BAE907AE ^[262] CLS090 |
| 1.2 TSI | 4 | CYVB | 81/109 | 05/15 → 12/17 | OE244 | 0,8 | | | |
| 1.4 TSI | 4 | CAXA | 90/121 | 06/10 → 05/15 | OE213 | 0,9 | | | BAE408AE |
| 1.4 TSI | 4 | CZCA | 92/123 | 05/15 → 12/17 | OE244 | 0,8 | | | |
| 1.4 TSI 4WD | 4 | CZDA | 110/148 | 05/15 → 12/17 | OE244 | 0,8 | | | |
| 1.6 | 4 | CWVA | 81/109 | 04/14 → 12/17 | OE247 | 1,0 | | | BAEA067E ^[240] |
| 1.6 TDI | 4 | CAYC | 77/103 | 11/10 → 05/15 | | | | | CCU152 |
| 1.8 TSI 4WD | 4 | CDAB | 112/150 | 11/09 → 12/17 | OE214 | 0,7 | CET11P | | BAEA033E ^[7] |
| 1.8 TSI 4WD | 4 | CDAZ | 118/158 | 05/09 → 12/17 | OE214 | 0,7 | CET11P | | BAEA033E ^[7] |
| 2.0 TDI, 2.0 TDI 4WD | 4 | CFHA; CFHF; CLCA; CUUA; DFSA | 81/109 | 11/09 → 12/17 | | | | | CCU152 |
| 2.0 TDI, 2.0 TDI 4WD | 4 | CUUB; DFSB | 110/148 | 05/15 → 12/17 | CPSG007 Prod.25.05.2015 → | 4.4v | | | CCU152 |
| 2.0 TDI, 2.0 TDI 4WD | 4 | CBDB; CFHC; CLCB | 103/138 | 05/09 → 12/17 | | | | | CCU152 |
| 2.0 TDI 4WD | 4 | CEGA; CFJA | 125/168 | 11/09 → 05/15 | | | | | CCU152 |

SKODA



FABIA I

| | | | | | | | | | |
|---------|---|---------------|-------|---------------|-------|-----|--------|-------|---------------------------|
| 1.2 | 3 | AWY; BMD | 40/54 | 07/01 → 12/07 | OE177 | 0,9 | CET3 | | BAEA059E |
| 1.2 | 3 | AZQ; BME | 47/63 | 01/03 → 12/07 | OE177 | 0,9 | CET3 | | BAE408AE |
| 1.4 | 4 | AME; AQW; ATZ | 50/67 | 07/01 → 05/03 | OE145 | 0,8 | CET12P | OE182 | BAE961AE |
| 1.4 TDI | 3 | BNM | 51/68 | 10/05 → 12/07 | CH181 | 11v | | | CCU081 →Ch.6Y-64648255 |
| 1.9 SDI | 4 | ASY | 47/63 | 07/01 → 12/07 | CH271 | 11v | | | CCU081 →Ch.6Y-64648255 |

ROOMSTER Praktik

| | | | | | | | | | |
|---------|---|-----------|-------|---------------|---------|-----|------|-------|--|
| 1.2 | 3 | BZG; CGPA | 51/68 | 03/07 → 05/15 | OE177 | 0,9 | CET3 | | BAE408AE |
| 1.2 TDI | 3 | CFWA | 55/74 | 03/10 → 05/15 | | | | | CCU152 Prod.27.05.2013 → Prod.18.11.2013 |
| 1.2 TSI | 4 | CBZA | 63/84 | 03/10 → 05/15 | | | | OE260 | BAE907AE ^[262] CLS090 |
| 1.4 | 4 | BXW; CGGB | 63/84 | 03/07 → 05/15 | OE177 | 0,9 | CET3 | | BAE408AE →12/11 |
| 1.4 TDI | 3 | BNM | 51/68 | 03/07 → 03/10 | CH181 | 11v | | | |
| 1.4 TDI | 3 | BNV | 59/79 | 03/07 → 03/10 | CH181 | 11v | | | |
| 1.4 TDI | 3 | BMS | 59/79 | 03/07 → 03/10 | CCGP002 | 7v | | | |
| 1.6 TDI | 4 | CAYB | 66/89 | 03/10 → 05/15 | | | | | CCU152 |

CHAMPION



kW/BHP

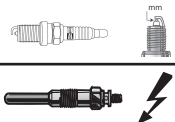

eon TITAN

IRIDIUM

**SMART****CABRIO**

| | | | | | | | | | | |
|-----|---|-----------------------|-------|-------------|-------|-----|------|--|---------|--------|
| 0.6 | 3 | M160E6ALB03; M160.910 | 40/54 | 03/00→01/04 | OE217 | 0,6 | CET2 | | BAEA304 | CLS068 |
| 0.6 | 3 | M160E6ALB05; M160.910 | 45/60 | 01/01→01/04 | OE217 | 0,6 | CET2 | | BAEA304 | CLS068 |
| | | | | | | | | | →12/02 | |
| 0.6 | 3 | M160.910 | 52/70 | 06/02→01/04 | OE217 | 0,6 | CET2 | | BAEA304 | CLS068 |
| 0.7 | 3 | M160.920 | 40/54 | 01/01→01/03 | OE217 | 0,6 | | | BAEA304 | |
| 0.7 | 3 | M160.920 | 45/60 | 01/03→01/04 | OE211 | 0,6 | | | BAEA304 | CLS068 |
| 0.7 | 3 | M160.920 | 55/74 | 01/03→01/04 | OE211 | 0,6 | | | BAEA304 | CLS068 |

CITY-COUPÉ

| | | | | | | | | | | |
|-----|---|-----------------------|-------|-------------|-------|-----|------|--|---------|--------|
| 0.6 | 3 | M160E6ALB04; M160.910 | 33/44 | 07/98→01/04 | OE217 | 0,6 | CET2 | | BAEA304 | CLS068 |
| 0.6 | 3 | M160E6ALB03; M160.910 | 40/54 | 07/98→01/04 | OE217 | 0,6 | CET2 | | BAEA304 | CLS068 |
| 0.6 | 3 | M160E6ALB05; M160.910 | 45/60 | 01/01→01/04 | OE217 | 0,6 | CET2 | | BAEA304 | CLS068 |
| | | | | | | | | | →12/02 | →12/02 |
| 0.6 | 3 | M160.910 | 52/70 | 06/02→01/04 | OE217 | 0,6 | CET2 | | BAEA304 | CLS068 |
| 0.7 | 3 | M160.920 | 33/44 | 07/98→01/04 | OE211 | 0,6 | | | BAEA304 | |
| 0.7 | 3 | M160.920 | 37/50 | 01/03→01/04 | OE211 | 0,6 | | | BAEA304 | CLS068 |
| 0.7 | 3 | M160.920 | 45/60 | 01/03→01/04 | OE211 | 0,6 | | | BAEA304 | CLS068 |
| 0.7 | 3 | M160.920 | 55/74 | 01/03→01/04 | OE211 | 0,6 | | | BAEA304 | CLS068 |

CROSSBLADE

| | | | | | | | | | | |
|-----|---|----------|-------|-------------|-------|-----|------|--|---------|--------|
| 0.6 | 3 | M160.910 | 52/70 | 06/02→12/03 | OE217 | 0,6 | CET2 | | | CLS068 |
| 0.6 | 3 | M160.920 | 52/70 | 06/02→12/03 | | | | | BAEA304 | |

FORFOUR

| | | | | | | | | | | |
|------------|---|-------------------|---------|-------------|-------|-----|------|-------|----------|--|
| 0.9 | 3 | H4B409; M281.910 | 66/89 | 11/14→ | | | | OE261 | BAEA131E | |
| 0.9 Brabus | 3 | M281.910 | 80/107 | 07/16→ | | | | OE261 | BAEA131E | |
| 1.0 | 3 | M281.920 | 45/60 | 11/14→ | OE130 | 0,9 | CET4 | | BAEA131E | |
| 1.0 | 3 | H4DA401; M281.920 | 52/70 | 07/14→ | OE130 | 0,9 | CET4 | | BAEA131E | |
| 1.1 | 3 | M134.911 | 47/63 | 02/05→06/06 | OE238 | 1,0 | | | | |
| 1.1 | 3 | M134.910 | 55/74 | 01/04→06/06 | OE238 | 1,0 | | | | |
| 1.3 | 4 | M135.930 | 70/94 | 01/04→06/06 | OE238 | 1,0 | | | | |
| 1.5 | 4 | M135.950 | 80/107 | 01/04→06/06 | OE238 | 1,0 | | | | |
| 1.5 | 4 | M135.950 | 90/121 | 01/04→06/06 | OE238 | 1,0 | | | | |
| 1.5 BRABUS | 4 | M122.950 | 130/174 | 05/05→06/06 | OE035 | 0,9 | CET5 | OE190 | | |

FORTWO

| | | | | | | | | | | |
|------------------|---|----------|--------|-------------|-------|-----|--------|-------|----------|--------|
| 0.6 | 3 | M160.910 | 45/60 | 01/04→02/07 | OE217 | 0,6 | CET2 | | | |
| 0.7 | 3 | M160.920 | 37/50 | 01/04→01/07 | OE211 | 0,6 | | | BAEA304 | CLS068 |
| 0.7 | 3 | M160.920 | 45/60 | 01/04→01/07 | OE211 | 0,6 | | | BAEA304 | CLS068 |
| 0.7 | 3 | M160.920 | 55/74 | 01/04→01/07 | OE211 | 0,6 | | | BAEA304 | CLS068 |
| 0.9 | 3 | M281.910 | 66/89 | 09/14→ | | | | OE261 | BAEA131E | |
| 0.9 Brabus | 3 | M281.910 | 80/107 | 07/16→ | | | | OE261 | BAEA131E | |
| 1.0 | 3 | M132.910 | 45/60 | 01/07→ | OE212 | 0,9 | CET15P | | | |
| 1.0 | 3 | M281.920 | 45/60 | 01/07→ | OE130 | 0,9 | CET4 | | BAEA131E | |
| 1.0 | 3 | M132.910 | 52/70 | 01/07→ | OE212 | 0,9 | CET15P | | | |
| 1.0 | 3 | M281.920 | 52/70 | 01/07→ | OE130 | 0,9 | CET4 | | BAEA131E | |
| 1.0 Brabus | 3 | M132.930 | 72/97 | 01/08→ | OE212 | 0,9 | CET15P | | | |
| 1.0 Brabus | 3 | M132.930 | 88/118 | 04/12→ | OE212 | 0,9 | CET15P | | | |
| 1.0 Turbo | 3 | M132.930 | 62/83 | 01/07→ | OE212 | 0,9 | CET15P | | | |
| 1.0 Turbo Brabus | 3 | M132.930 | 75/101 | 07/10→ | OE212 | 0,9 | CET15P | | | |

ROADSTER

| | | | | | | | | | | |
|------------|---|--------------------|-------|-------------|-------|-----|--|--|---------|--------|
| 0.7 | 3 | M160.921; M160.922 | 45/60 | 04/03→11/05 | OE211 | 0,6 | | | BAEA304 | CLS068 |
| 0.7 | 3 | M160.921; M160.922 | 60/80 | 04/03→11/05 | OE211 | 0,6 | | | BAEA304 | CLS068 |
| 0.7 Brabus | 3 | M160.923 | 74/99 | 12/03→11/05 | OE211 | 0,6 | | | BAEA304 | |

SMART



kW/BHP



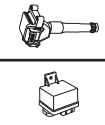

eon TITAN

IRIDIUM



SSANGYONG

| SSANGYONG  | | | | | | | | | |
|--|---|---------------------|---------|---------------|-------------------------------------|-------|------------------|----------------|---|
| ACTYON I | | | | | | | | | |
| 2.3, 2.3 4WD | 4 | G23D | 110/148 | 11/06 → | | | | | BAEA340 |
| KORANDO | | | | | | | | | |
| 2.0 4WD | 4 | E20 | 94/126 | 05/97 → 10/02 | | | | | BAEA340 →10/01 |
| 2.3 4WD | 4 | ; M111.970 | 103/138 | 05/97 → 02/00 | OE191 | 1,0 | CET12P | OE180 | BAEA340 |
| 2.3 4WD | 4 | | 105/141 | 01/99 → 11/06 | | | | | BAEA340 →10/01 |
| 2.3 D 4WD | 4 | OM601.940 | 58/78 | 12/96 → 06/98 | CH176 | 11.5v | | | |
| 2.9 D 4WD | 5 | MB-OM662 | 72/97 | 12/96 → 10/00 | CH176 | 11.5v | | | |
| 2.9 D 4WD | 5 | MB-OM662 | 73/98 | 06/97 → 10/00 | CH176 | 11.5v | | | |
| 2.9 TD 4WD | 5 | | 88/118 | 04/98 → 11/06 | CH176 | 11.5v | | | |
| 3.2 4WD | 6 | M104.995 | 154/207 | 12/96 → 11/02 | OE087 | 0,9 | CET8 | | BAEA340 |
| 3.2 4WD | 6 | M104.995 | 156/209 | 01/99 → 11/02 | OE005 | 0,9 | CET2 | OE179 | BAEA340 |
| KYRON | | | | | | | | | |
| 3.2 M320 4WD | 6 | G32D | 162/217 | 03/08 → | OE057 | 0,9 | CET2 | OE180 | BAEA340 |
| MUSSO | | | | | | | | | |
| 2.0 4WD | 4 | E20 | 93/125 | 10/96 → 05/05 | OE057 | 0,9 | CET2 | OE180 | BAEA340 |
| 2.3 4WD | 4 | M111.970 | 103/138 | 10/96 → 11/02 | OE003 | 0,9 | CET2 | OE180 | BAEA340 CLS063 CLS071 |
| 2.3 4WD | 4 | | 110/148 | 04/03 → 08/06 | | | | | BAEA340 |
| 2.3 D 4WD | 4 | OM661.940 | 58/78 | 03/93 → 04/97 | CH176 | 11.5v | | | |
| 2.3 D 4WD | 4 | MB-OM661; OM601.940 | 59/79 | 10/95 → 04/99 | CH176 | 11.5v | | | |
| 2.9 D 4WD | 5 | MB-OM662 | 73/98 | 03/96 → 11/98 | CH176 | 11.5v | | | |
| 2.9 TD 4WD | 5 | | 88/118 | 04/98 → 09/07 | CH176 | 11.5v | | | |
| 3.2 4WD | 6 | M104.992 | 162/217 | 06/96 → 09/04 | OE016 | 0,9 | CET2 | OE180 | BAEA340 |
| REXTON | | | | | | | | | |
| 2.3 RX230 4WD | 4 | G23D | 110/148 | 05/02 → | OE057 | 0,9 | CET2 | OE180 | BAEA340 |
| 2.9 TD 4WD | 5 | | 88/118 | 04/02 → | CH176 | 11.5v | | | |
| 3.2 4WD | 6 | G32D | 162/217 | 04/02 → | OE057 | 0,9 | CET2 | OE180 | BAEA340 |
| RODIUS | | | | | | | | | |
| 3.2, 3.2 4WD | 6 | G32D | 162/217 | 05/05 → | OE057 | 0,9 | CET2 | OE180 | BAEA340 |
| SSANGYONG  | | | | | | | | | |
| ISTANA | | | | | | | | | |
| 2.9 D | 5 | OM602.980 | 90/121 | 06/95 → 11/03 | CH204 [285] →03/00 Eng.137 → | 11.5v | | | |
| | | | | | CH204 [287] →03/00 Eng.9850 → | 11.5v | | | |
| SUBARU  | | | | | | | | | |
| FORESTER | | | | | | | | | |
| 2.0 4WD | 4 | EJ202 | 90/121 | 08/97 → 09/02 | OE063 | 1,0 | CET2 | OE180 | BAEA191E CLS170 →05/98 CLS192 06/98 → |
| 2.0 4WD | 4 | EJ202 | 92/123 | 06/98 → 05/05 | OE063 | 1,0 | CET2 | OE180 | BAEA191E CLS192 |
| 2.0 4WD | 4 | EJ201 | 92/123 | 06/98 → 05/05 | OE063 | 1,0 | CET2 | OE180 | BAEA191E CLS080 |
| 2.0 4WD | 4 | EJ204 | 110/148 | 01/08 → | | | CET14P | OE190 | |
| 2.0 X 4WD | 4 | EJ201; EJ204 | 116/156 | 06/05 → 05/08 | OE136 | 0,8 | CET12P CET14P | OE179 OE190 | BAEA191E |
| 2.0 S Turbo 4WD | 4 | EJ205 | 125/168 | 06/98 → 04/01 | OE136 | 0,8 | CET12P | OE179 | |
| 2.0 S Turbo 4WD | 4 | EJ205 | 130/174 | 04/01 → 05/05 | OE136 | 0,8 | CET12P | OE179 | BAEA191E CLS080 |
| 2.5 4WD | 4 | EJ25 | 126/169 | 01/09 → | | | CET14P | OE190 | |
| 2.5 4WD | 4 | EJ25 | 155/208 | 12/03 → 05/05 | OE146 | 1,0 | CET12P | OE179 | BAEA191E |





kW/BHP



eon TITAN

IRIDIUM

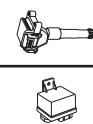

...SUBARU



...FORESTER

| | | | | | | | | | | |
|---------------------|---|-------|---------|---------------|--|--|--------|-------|----------|--|
| 2.5 4WD, 2.5 XT 4WD | 4 | EJ255 | 169/227 | 06/05 → 09/13 | | | CET14P | OE190 | | |
| 2.5 RX Nato 4WD | 4 | EJ25 | 115/154 | 11/02 → 12/08 | | | CET14P | OE190 | BAEA191E | |

IMPREZA

| | | | | | | | | | | |
|--|---|--------------------|---------|---------------|-------|-----|--------|-------|----------|--------|
| 1.5 4WD | 4 | EL15 | 77/103 | 05/06 → 03/07 | | | CET14P | OE190 | | |
| 1.5 4WD, 1.5 F | 4 | EL15 | 79/106 | 02/08 → | | | CET14P | OE190 | | |
| 1.6 4WD, 1.6 i, 1.6 i 4WD | 4 | EJ161 | 70/94 | 06/98 → 06/09 | OE063 | 1,0 | CET2 | OE180 | | |
| 2.0 4WD | 4 | EJ20E; EJ201 | 85/114 | 12/95 → 12/00 | OE136 | 0,8 | CET12P | OE179 | | |
| 2.0 4WD | 4 | EJ201 | 92/123 | 03/99 → 12/07 | OE063 | 1,0 | CET2 | OE180 | BAEA191E | CLS080 |
| 2.0 4WD | 4 | EJ205 | 184/247 | 10/05 → 03/07 | OE224 | 0,8 | CET14P | | BAEA191E | |
| 2.0 4WD | 4 | EJ20(Turbo) | 184/247 | 10/05 → 03/07 | OE224 | 0,8 | CET14P | | | |
| 2.0 4WD, 2.0 WRX STi 4WD | 4 | EJ205P; EJ207 | 206/276 | 09/98 → 12/08 | OE224 | 0,8 | CET14P | | | |
| 2.0 i | 4 | EJ201 | 92/123 | 09/98 → 09/00 | OE039 | 1,0 | CET2 | OE179 | BAEA191E | |
| 2.0 i 4WD | 4 | EJ20E; EJ201 | 85/114 | 10/95 → 12/00 | OE136 | 0,8 | CET12P | OE179 | | CLS170 |
| 2.0 i 4WD | 4 | EJ201 | 92/123 | 06/98 → 06/09 | OE063 | 1,0 | CET12P | OE179 | BAEA191E | CLS080 |
| | | | | | OE136 | 0,8 | CET2 | OE180 | | |
| 2.0 i 4WD, 2.0 R 4WD | 4 | EJ204 | 110/148 | 01/08 → | OE224 | 0,8 | CET14P | | | |
| 2.0 i 16V 4WD | 4 | EJ20E; EJ201 | 92/123 | 06/98 → 12/00 | OE136 | 0,8 | CET12P | OE179 | BAEA191E | |
| 2.0 i R 4WD | 4 | EJ204 | 118/158 | 09/05 → 06/07 | OE035 | 0,9 | CET14P | OE190 | BAEA191E | |
| | | | | | OE224 | 0,8 | CET5 | | | |
| 2.0 i Turbo 4WD, 2.0 Turbo 4WD, 2.0 Turbo GT 4WD | 4 | EJ20(Turbo); EJ20G | 155/208 | 03/94 → 12/00 | OE136 | 0,8 | CET12P | OE179 | | |
| 2.0 Turbo 4WD, 2.0 Turbo GT 4WD, 2.0 WRX Turbo 4WD | 4 | EJ205 | 160/215 | 06/98 → 12/05 | OE136 | 0,8 | CET12P | OE179 | | |
| 2.0 WRX STi 4WD | 4 | EJ207 | 195/261 | 11/01 → 07/05 | OE136 | 0,8 | CET12P | OE179 | | |
| 2.0 WRX STi 4WD | 4 | EJ207 | 235/315 | 02/04 → 07/05 | OE136 | 0,8 | CET12P | OE179 | | |
| 2.0 WRX Turbo 4WD | 4 | EJ205 | 165/221 | 12/02 → 03/07 | OE136 | 0,8 | CET12P | OE179 | | |
| 2.2 GX 4WD | 4 | EJ22E | 96/129 | 09/98 → 09/00 | | | | | BAEA191E | |
| 2.2 GX 4WD | 4 | EJ22 | 97/130 | 11/95 → 08/98 | | | | | BAEA191E | |
| 2.5 4WD | 4 | EJ251 | 130/174 | 03/01 → 09/05 | | | | | BAEA191E | |
| 2.5 4WD, 2.5 i WRX 4WD, 2.5 WRX 4WD | 4 | EJ255 | 169/227 | 09/05 → | OE224 | 0,8 | CET14P | | | |
| 2.5 4WD, 2.5 WRX STi 4WD | 4 | EJ257 | 221/296 | 10/05 → | OE224 | 0,8 | CET14P | | | |
| 2.5 i 4WD | 4 | EJ251 | 112/150 | 12/02 → 09/05 | | | | | BAEA191E | |
| 2.5 STi CS400 4WD | 4 | EJ257 | 294/394 | 04/10 → 08/13 | OE224 | 0,8 | CET14P | | | |
| 2.5 WRX STi 4WD | 4 | EJ257 | 206/276 | 09/05 → 12/07 | OE224 | 0,8 | CET14P | | | |

JUSTY II

| | | | | | | | | | | |
|------------|---|-------|-------|---------------|-------|-----|------|-------|--|--------|
| 1.3 4WD | 4 | G13BB | 63/84 | 04/01 → 11/03 | OE005 | 0,9 | CET2 | OE180 | | CLS026 |
| 1.3 GX 4WD | 4 | EF13 | 50/67 | 10/95 → 11/03 | OE006 | 0,9 | CET8 | OE195 | | |

JUSTY III

| | | | | | | | | | | |
|---------|---|------|-------|---------|--|--|--------|-------|----------|--|
| 1.3 4WD | 4 | M13A | 69/93 | 09/03 → | | | CET12P | OE179 | BAEA181E | |
| 1.5 4WD | 4 | M15A | 73/98 | 09/03 → | | | CET12P | OE179 | BAEA181E | |

JUSTY IV

| | | | | | | | | | | |
|-----|---|--------|-------|---------|--|--|--------|-------|----------|--|
| 1.0 | 3 | 1KR-FE | 51/68 | 01/07 → | | | CET14P | OE190 | BAEA164E | |
|-----|---|--------|-------|---------|--|--|--------|-------|----------|--|

LEGACY II

| | | | | | | | | | | |
|------------------|---|------------------------|---------|---------------|-------|-----|--------|-------|--|--|
| 2.0 i, 2.0 i 4WD | 4 | EJ20E; EJ20EMPI; EJ201 | 85/114 | 09/94 → 03/99 | OE063 | 1,0 | CET2 | OE180 | | |
| 2.2, 2.2 i 4WD | 4 | EJ22; EJ22EMPI | 94/126 | 02/94 → 03/99 | OE005 | 0,9 | CET2 | OE180 | | |
| 2.2 i 4WD | 4 | EJ22EMPI | 96/129 | 06/96 → 03/99 | OE005 | 0,9 | CET2 | OE180 | | |
| 2.5 i 4WD | 4 | EJ25D | 110/148 | 06/96 → 03/99 | OE146 | 1,0 | CET12P | OE179 | | |
| | | | | | | | | OE180 | | |

LEGACY III

| | | | | | | | | | | |
|---------|---|-------|---------|---------------|-------|-----|------|-------|----------|--------|
| 2.0 4WD | 4 | EJ201 | 92/123 | 12/98 → 08/03 | OE063 | 1,0 | CET2 | OE180 | BAEA191E | CLS080 |
| 2.5 4WD | 4 | EJ25 | 115/154 | 10/98 → 08/03 | OE063 | 1,0 | CET2 | OE180 | BAEA191E | CLS080 |

SUBARU





kW/BHP



eon TITAN

IRIDIUM

**...SUBARU****LEGACY IV**

| | | | | | | | | | | |
|-----------|---|--------------|---------|-------------|--------------|-----|---------------|--------------|-----------------|--|
| 2.0 4WD | 4 | EJ202 | 101/135 | 09/03→10/05 | OE063 | 1,0 | CET2 | OE180 | | |
| 2.0 4WD | 4 | EJ20X; EJ204 | 121/162 | 06/05→04/09 | | | CET12P | OE180 | BAEA191E | |
| 2.0 4WD | 4 | EJ20Y | 132/177 | 06/05→04/09 | | | CET12P | OE180 | | |
| 2.0 4WD | 4 | EJ20Y | 140/188 | 06/05→04/09 | | | CET12P | OE180 | | |
| 2.0 R 4WD | 4 | EJ204 | 110/148 | 09/07→12/09 | OE224 | 0,8 | CET14P | | | |
| 2.5 4WD | 4 | EJ25 | 121/162 | 09/03→04/09 | OE146 | 1,0 | CET12P | OE179 | BAEA191E | |
| 2.5 i 4WD | 4 | EJ25 | 127/170 | 09/07→12/09 | | | CET12P | OE188 | | |
| 3.0 R 4WD | 6 | EZ30 | 180/241 | 09/03→06/09 | OE035 | 0,9 | CET5 | OE190 | | |

LEGACY V

| | | | | | | | | | | |
|------------|---|-------|---------|-------------|--------------|-----|---------------|--------------|--|--|
| 2.0 i 4WD | 4 | EJ204 | 110/148 | 09/09→12/14 | OE224 | 0,8 | CET14P | | | |
| 2.5 GT 4WD | 4 | EJ255 | 195/261 | 07/10→12/14 | | | CET14P | OE190 | | |
| 2.5 i 4WD | 4 | EJ253 | 123/165 | 09/09→12/14 | | | CET12P | OE180 | | |

LEGACY OUTBACK

| | | | | | | | | | | |
|------------|---|-------|---------|-------------|--------------|-----|---------------|--------------|-----------------|---------------|
| 2.5 4WD | 4 | EJ25D | 110/148 | 01/96→12/99 | OE063 | 1,0 | CET2 | OE180 | | |
| 2.0 4WD | 4 | EJ202 | 101/135 | 09/03→10/05 | | | CET12P | OE180 | | |
| 2.5 4WD | 4 | EJ25 | 115/154 | 10/00→08/03 | OE063 | 1,0 | CET2 | OE180 | BAEA191E | CLS080 |
| 2.5 4WD | 4 | EJ25D | 121/162 | 11/03→09/09 | OE146 | 1,0 | CET12P | OE179 | | |
| 2.5 4WD | 4 | EJ251 | 127/170 | 09/08→ | | | CET12P | OE188 | BAEA191E | |
| 2.5 i 4WD | 4 | EJ253 | 123/165 | 09/09→ | | | CET12P | OE180 | | |
| 3.0 4WD | 6 | EZ30 | 180/241 | 11/03→09/09 | OE035 | 0,9 | CET5 | OE190 | | |
| 3.0 H6 4WD | 6 | EZ30 | 154/207 | 10/00→08/03 | | | CET14P | OE190 | | |
| 3.6 R 4WD | 6 | EZ36D | 191/256 | 09/09→ | | | CET14P | OE190 | | |

SVX

| | | | | | | | | | | |
|---------------|---|----------|---------|-------------|--------------|-----|-------------|--------------|--|--|
| 3.3 i 24V 4WD | 6 | EG33DOHC | 162/217 | 09/94→12/97 | OE039 | 1,0 | CET2 | OE180 | | |
|---------------|---|----------|---------|-------------|--------------|-----|-------------|--------------|--|--|

TREZIA

| | | | | | | | | | | |
|-----|---|-----------------|-------|--------|--|--|--|--|-----------------|--|
| 1.3 | 4 | 1NR-FE; 1NR-FKE | 73/98 | 03/11→ | | | | | BAEA172E | |
|-----|---|-----------------|-------|--------|--|--|--|--|-----------------|--|

TRIBECA

| | | | | | | | | | | |
|---------|---|-------|---------|--------|--------------|-----|---------------|--------------|--|--|
| 3.0 4WD | 6 | EZ30 | 180/241 | 10/06→ | | | CET14P | OE190 | | |
| 3.0 4WD | 6 | EZ30 | 184/247 | 01/05→ | OE035 | 0,9 | CET5 | OE190 | | |
| 3.6 4WD | 6 | EZ36D | 190/255 | 09/07→ | | | CET14P | OE190 | | |

SUZUKI**ALTO (EF)**

| | | | | | | | | | | |
|-----|---|-------|-------|-------------|--------------|-----|-------------|--|--|--|
| 1.0 | 4 | G10BB | 39/52 | 09/94→09/98 | OE051 | 0,9 | CET8 | | | |
|-----|---|-------|-------|-------------|--------------|-----|-------------|--|--|--|

ALTO (FF)

| | | | | | | | | | | |
|-----|---|-------------|-------|-------------|------------------------------|------------|-------------|--------------|-----------------|---------------|
| 1.1 | 4 | F10D; F10DN | 46/62 | 09/04→12/08 | OE083 OE199 | 0,7 0,9 | CET1 | OE187 | BAEA181E | CLS026 |
|-----|---|-------------|-------|-------------|------------------------------|------------|-------------|--------------|-----------------|---------------|

ALTO (GF)

| | | | | | | | | | | |
|-----|---|------|-------|--------|--|------------|---------------|--|--|--|
| 1.0 | 3 | K10B | 50/67 | 01/09→ | OE226 OE230 LPG [278] | 1,1 0,9 | CET10P | | | |
|-----|---|------|-------|--------|--|------------|---------------|--|--|--|

ALTO (HA12, HA23)

| | | | | | | | | | | |
|-----|---|-------|-------|-------------|--------------|-----|-------------|--------------|--|--|
| 1.0 | 4 | G10BB | 43/58 | 01/00→06/02 | OE005 | 0,9 | CET2 | OE180 | | |
|-----|---|-------|-------|-------------|--------------|-----|-------------|--------------|--|--|

BALENO /Estate/Hatchback (EG)

| | | | | | | | | | | |
|--------------------------|---|------------------------------|--------|-------------|--------------|-----|-------------|--------------|-----------------|--|
| 1.3 | 4 | G13BA | 52/70 | 09/96→05/02 | OE005 | 0,9 | CET2 | OE180 | BAEA181E | |
| 1.3 16V, 1.3 i 16V | 4 | G13BB | 63/84 | 07/95→05/02 | OE005 | 0,9 | CET2 | OE180 | BAEA181E | |
| 1.6 i 16V, 1.6 i 16V 4WD | 4 | G16B | 72/97 | 07/95→05/02 | OE005 | 0,9 | CET2 | OE180 | BAEA181E | |
| 1.6 i 16V, 1.6 i 16V 4WD | 4 | G16B | 73/98 | 08/96→05/02 | OE005 | 0,9 | CET2 | OE180 | BAEA181E | |
| 1.8 GTX, 1.8 i 16V | 4 | J18A | 89/119 | 03/96→05/02 | OE039 | 1,0 | CET2 | OE180 | BAEA072E | |
| 1.9 TD | 4 | DHV(XUD9BSD); DHW(XUD9SD) | 55/74 | 04/98→05/02 | CH189 | 11v | | | | |

GRAND VITARA I (FT, HT)

| | | | | | | | | | | |
|---------|---|------|-------|-------------|--|--|---------------|--------------|-----------------|---------------|
| 1.6 4WD | 4 | G16B | 69/93 | 03/98→07/03 | | | CET12P | OE179 | BAEA136E | CLS026 |
|---------|---|------|-------|-------------|--|--|---------------|--------------|-----------------|---------------|





kW/BHP

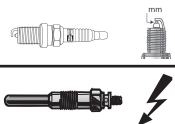

eon TITAN

IRIDIUM

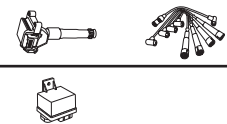
**...SUZUKI****...GRAND VITARA I (FT, HT)**

| | | | | | | | | | | |
|--------------------------------------|---|----------|---------|-------------|------------------------|-----|--------|-------|----------|--------|
| 1.6 4WD | 4 | G16B | 73/98 | 02/00→09/02 | OE039 | 1,0 | CET2 | | BAEA136E | CLS026 |
| 2.0 4WD | 4 | J20A | 94/126 | 03/98→07/03 | | | CET12P | OE179 | BAEA072E | |
| 2.0 4WD | 4 | J20A | 103/138 | 04/98→08/05 | | | | | BAEA072E | |
| 2.0 HDI 110 4WD, 2.0 HDI 110 16V 4WD | 4 | RHW; RHZ | 80/107 | 07/01→09/05 | CH170 ^[275] | 11v | | | | |
| | | | | | CH268 ^[275] | 11v | | | | |
| 2.0 TD 4WD | 4 | RFM | 63/84 | 04/00→09/05 | CH242 | 11v | | | | |
| 2.0 TD 4WD | 4 | RF | 64/86 | 03/98→07/03 | CH242 | 11v | | | | |
| 2.5 V6 24V 4WD | 6 | H25A | 106/142 | 04/98→07/03 | | | CET12P | OE179 | BAEA072E | |
| 2.5 V6 24V 4WD | 6 | H25A | 116/156 | 04/01→07/03 | | | CET12P | OE180 | BAEA072E | |
| 2.7 | 6 | H27A | 135/181 | 09/03→08/06 | | | CET12P | OE180 | | |
| 2.7 4WD | 6 | H27A | 127/170 | 09/01→07/03 | | | CET12P | OE180 | BAEA072E | |
| 2.7 4WD | 6 | H27A | 135/181 | 04/03→07/03 | | | CET12P | OE180 | BAEA072E | |

GRAND VITARA II (JT)

| | | | | | | | | | | |
|---------|---|------|-------|-------------|-------|-----|------|-------|----------|--------|
| 1.6 4WD | 4 | M16A | 73/98 | 09/05→02/15 | OE016 | 0,9 | CET2 | OE180 | BAEA181E | CLS167 |
|---------|---|------|-------|-------------|-------|-----|------|-------|----------|--------|

GRAND VITARA II (JT, TE, TD)

| | | | | | | | | | | |
|---------|---|------|---------|-------------|-------|-----|--------|-------|----------|--------|
| 1.6 4WD | 4 | M16A | 78/105 | 04/05→ | OE016 | 0,9 | CET2 | OE180 | BAEA181E | CLS167 |
| 2.0 4WD | 4 | J20A | 103/138 | 10/05→02/15 | OE191 | 1,0 | CET12P | OE180 | BAEA072E | |
| 2.4 4WD | 4 | J24B | 122/164 | 01/09→ | OE175 | 1,0 | CET14P | OE190 | | |
| 2.4 4WD | 4 | J24B | 124/166 | 01/09→ | OE175 | 1,0 | CET14P | OE190 | | |
| 3.2 4WD | 6 | N32A | 171/229 | 01/09→02/15 | | | CET17P | OE189 | | |

IGNIS I (FH)

| | | | | | | | | | | |
|--------------|---|------|-------|-------------|--|--|--------|-------|----------|--------|
| 1.3, 1.3 4WD | 4 | M13A | 61/82 | 10/00→09/03 | | | CET12P | OE180 | BAEA181E | CLS167 |
|--------------|---|------|-------|-------------|--|--|--------|-------|----------|--------|

IGNIS II (MH)

| | | | | | | | | | | |
|--------------|---|------|--------|--------|-------|-----|--------|-------|----------|--------|
| 1.3 | 4 | M13A | 69/93 | 09/03→ | | | CET12P | OE179 | BAEA181E | CLS167 |
| 1.3 4WD | 4 | M13A | 69/93 | 09/03→ | OE136 | 0,8 | CET12P | OE179 | BAEA181E | CLS167 |
| 1.5, 1.5 4WD | 4 | M15A | 73/98 | 09/03→ | | | CET12P | OE179 | BAEA181E | CLS167 |
| 1.5 Sport | 4 | M15A | 80/107 | 12/03→ | | | CET12P | OE179 | BAEA181E | CLS167 |

JIMNY (FJ)

| | | | | | | | | | | |
|---------|---|-------|-------|-------------|-------|-----|------|-------|----------|--------|
| 1.0 4WD | 4 | F10AC | 39/52 | 09/98→10/03 | OE006 | 0,9 | CET8 | OE195 | | |
| 1.3 4WD | 4 | M13A | 65/87 | 09/00→08/02 | OE005 | 0,9 | CET2 | OE180 | BAEA136E | CLS167 |

JIMNY Closed Off-Road Vehicle (SN)

| | | | | | | | | | | |
|----------------------|---|--------|-------|-------------|-------|-----|------|-------|---|--------|
| 1.3 | 4 | M13A | 63/84 | 08/04→ | OE039 | 1,0 | | | BAEA136E ^[275] →Ch.00200000 | |
| 1.3 4WD | 4 | G13BB | 63/84 | 09/98→08/00 | OE005 | 0,9 | CET2 | OE180 | BAEA136E | CLS026 |
| 1.3 16V, 1.3 16V 4WD | 4 | G13BB | 59/79 | 09/98→ | OE005 | 0,9 | CET2 | OE180 | BAEA136E | CLS026 |
| 1.3 16V, 1.3 16V 4WD | 4 | M13A | 60/80 | 02/01→ | OE005 | 0,9 | CET2 | OE180 | BAEA136E | CLS167 |
| 1.3 16V 4WD | 4 | M13A | 63/84 | 08/05→ | OE005 | 0,9 | CET2 | OE180 | BAEA136E | CLS167 |
| 1.5 DDiS 4WD | 4 | K9K700 | 48/64 | 12/03→ | CH271 | 11v | | | | |
| 1.5 DDiS 4WD | 4 | K9K266 | 63/84 | 08/05→ | CH271 | 11v | | | | |

KIZASHI (FR)

| | | | | | | | | | | |
|--------------|---|------|---------|--------|-------|-----|--------|-------|--|--|
| 2.4, 2.4 4WD | 4 | J24B | 131/176 | 10/10→ | OE175 | 1,0 | CET14P | OE190 | | |
| 2.4, 2.4 4WD | 4 | J24B | 138/185 | 04/12→ | OE175 | 1,0 | CET14P | OE190 | | |

LIANA Hatchback

| | | | | | | | | | | |
|----------------|---|------|--------|-------------|-------|-----|--------|-------|----------|--------|
| 1.3 | 4 | M13A | 66/89 | 07/01→12/07 | | | CET2 | OE179 | BAEA181E | CLS167 |
| 1.6 | 4 | M16A | 79/106 | 01/05→12/07 | OE016 | 0,9 | CET2 | OE180 | BAEA181E | CLS167 |
| 1.6, 1.6 4WD | 4 | M16A | 76/102 | 07/01→12/07 | | | CET2 | OE179 | BAEA181E | CLS167 |
| 1.6 4WD | 4 | M16A | 79/106 | 01/05→12/07 | OE136 | 0,8 | CET12P | OE179 | BAEA181E | CLS167 |
| 1.6 4WD, 1.6 i | 4 | M16A | 78/105 | 04/02→12/07 | | | CET2 | OE179 | BAEA181E | CLS167 |

LIANA Estate (ER)

| | | | | | | | | | | |
|-------|---|------|--------|-------------|-------|-----|------|-------|--|--|
| 1.8 i | 4 | M18A | 92/123 | 10/01→12/07 | OE014 | 0,9 | CET2 | OE179 | | |
|-------|---|------|--------|-------------|-------|-----|------|-------|--|--|

SUZUKI





kW/BHP

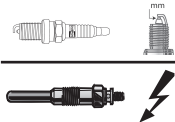

eon TITAN

IRIDIUM



...SUZUKI



LIANA (ER, RH)

| | | | | | | | | | | |
|----------------|---|------|--------|--------|-------|-----|------|-------|----------|--------|
| 1.3 | 4 | M13A | 66/89 | 03/02→ | | | CET2 | OE179 | BAEA181E | CLS167 |
| 1.6, 1.6 4WD | 4 | M16A | 76/102 | 03/02→ | | | CET2 | OE179 | BAEA181E | CLS167 |
| 1.6, 1.6 4WD | 4 | M16A | 79/106 | 01/05→ | OE016 | 0,9 | CET2 | OE180 | BAEA181E | CLS167 |
| 1.6 4WD, 1.6 i | 4 | M16A | 78/105 | 04/02→ | | | CET2 | OE179 | BAEA181E | CLS167 |

SAMURAI Closed Off-Road Vehicle (SJ)

| | | | | | | | | | | |
|------------|---|-------|-------|-------------|-------|-----|------|--|--|--|
| 1.3 4WD | 4 | G13BA | 59/79 | 01/00→12/04 | OE051 | 0,9 | CET8 | | | |
| 1.9 TD 4WD | 4 | XUD9 | 46/62 | 11/98→12/04 | CH189 | 11v | | | | |

SPLASH (EX)

| | | | | | | | | | | |
|---------|---|------|-------|--------|-----------------|-----|--------|--|----------|--|
| 1.0 | 3 | K10B | 48/64 | 01/08→ | OE226 | 1,1 | CET10P | | | |
| | | | | | OE230 LPG [278] | 0,9 | | | | |
| 1.0 | 3 | K10B | 50/67 | 06/11→ | OE226 | 1,1 | CET10P | | BAEA189E | |
| | | | | | OE230 LPG [278] | 0,9 | | | | |
| 1.2 | 4 | K12B | 63/84 | 01/08→ | OE226 | 1,1 | CET10P | | BAEA189E | |
| | | | | | OE230 LPG [278] | 0,9 | | | | |
| 1.2 VVT | 4 | K12B | 66/89 | 06/11→ | OE226 | 1,1 | CET10P | | BAEA189E | |
| | | | | | OE230 LPG [278] | 0,9 | | | | |
| 1.2 VVT | 4 | K12B | 69/93 | 09/10→ | OE226 | 1,1 | CET10P | | BAEA189E | |
| | | | | | OE230 LPG [278] | 0,9 | | | | |

SWIFT II Hatchback (EA, MA)

| | | | | | | | | | | |
|-------|---|-------|-------|-------------|-------|-----|------|-------|--|--|
| 1.0 i | 3 | G10A | 39/52 | 01/95→12/05 | OE006 | 0,9 | CET8 | OE195 | | |
| 1.3 | 4 | G13BB | 63/84 | 06/01→12/03 | | | CET8 | OE195 | | |

SWIFT III (MZ, EZ)

| | | | | | | | | | | |
|---------|---|------|--------|--------|-------|-----|--------|-------|----------|--------|
| 1.3 | 4 | M13A | 68/91 | 02/05→ | | | CET12P | OE179 | BAEA181E | CLS167 |
| 1.3 4WD | 4 | M13A | 66/89 | 01/06→ | | | CET12P | OE179 | BAEA181E | CLS167 |
| 1.3 4WD | 4 | M13A | 68/91 | 02/05→ | OE136 | 0,8 | CET12P | OE179 | BAEA181E | CLS167 |
| 1.5 | 4 | M15A | 75/101 | 02/05→ | | | CET12P | OE179 | BAEA181E | CLS167 |
| 1.5 4WD | 4 | M15A | 74/99 | 02/05→ | OE136 | 0,8 | CET12P | OE179 | BAEA181E | CLS167 |
| 1.6 | 4 | M16A | 92/123 | 05/06→ | | | CET12P | OE179 | BAEA181E | CLS167 |

SWIFT IV (FZ, NZ)

| | | | | | | | | | | |
|--------------|---|------|---------|--------|-----------------|-----|--------|-------|----------|--|
| 1.2, 1.2 4WD | 4 | K12B | 66/89 | 10/10→ | OE226 | 1,1 | CET10P | | | |
| | | | | | OE230 LPG [278] | 0,9 | | | | |
| 1.2, 1.2 4WD | 4 | K12B | 69/93 | 10/10→ | OE226 | 1,1 | CET10P | | BAEA189E | |
| | | | | | OE230 LPG [278] | 0,9 | | | | |
| 1.6 | 4 | M16A | 100/134 | 01/12→ | OE175 | 1,0 | CET14P | OE190 | BAEA181E | |

SX4 (EY, GY)

| | | | | | | | | | | |
|------------------------|---|-------|---------|-------------|-------|-----|--------|-------|----------|--------|
| 1.5 | 4 | M15A | 73/98 | 06/06→07/10 | OE016 | 0,9 | CET2 | OE180 | BAEA181E | CLS167 |
| 1.5 VVT | 4 | M15A | 82/110 | 07/10→ | OE016 | 0,9 | CET2 | OE180 | BAEA181E | CLS167 |
| 1.5 VVT 4WD | 4 | M15A | 82/110 | 07/10→ | | | | | BAEA181E | CLS167 |
| 1.6 DDIS | 4 | 9HX | 66/89 | 04/07→ | CH201 | 11v | | | | |
| 1.6 VVT, 1.6 VVT 4WD | 4 | M16A | 79/106 | 06/06→ | OE016 | 0,9 | CET2 | OE180 | BAEA181E | CLS167 |
| 1.6 VVT, 1.6 VVT 4WD | 4 | M16A | 88/118 | 07/09→ | OE016 | 0,9 | CET2 | OE180 | BAEA181E | CLS167 |
| 1.6 VVT 4WD | 4 | M16A | 82/110 | 07/09→ | OE016 | 0,9 | CET2 | OE180 | BAEA181E | CLS167 |
| 1.9 DDIS, 1.9 DDIS 4WD | 4 | D19AA | 88/118 | 06/06→ | CH222 | 11v | | | | |
| 2.0, 2.0 4WD | 4 | J20A | 107/143 | 06/06→ | OE175 | 1,0 | CET14P | OE190 | | |

SX4 /Saloon (GY)

| | | | | | | | | | | |
|-----|---|------|--------|--------|-------|-----|------|-------|----------|--------|
| 1.6 | 4 | M16A | 74/99 | 06/06→ | OE016 | 0,9 | CET2 | OE180 | BAEA181E | CLS167 |
| 1.6 | 4 | M16A | 88/118 | 10/07→ | OE016 | 0,9 | CET2 | OE180 | BAEA181E | CLS167 |

SX4 Saloon (GY)

| | | | | | | | | | | |
|-----|---|------|--------|--------|-------|-----|------|--|----------|--------|
| 1.6 | 4 | M16A | 79/106 | 10/07→ | OE016 | 0,9 | CET2 | | BAEA181E | CLS167 |
|-----|---|------|--------|--------|-------|-----|------|--|----------|--------|

SX4 S-Cross (JY)

| | | | | | | | | | | |
|--------------|---|------|--------|--------|-------|-----|------|-------|----------|--------|
| 1.6, 1.6 4WD | 4 | M16A | 86/115 | 12/13→ | OE016 | 0,9 | CET2 | OE180 | BAEA181E | CLS167 |
|--------------|---|------|--------|--------|-------|-----|------|-------|----------|--------|

SUZUKI





kW/BHP



eon TITAN

IRIDIUM

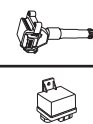
**...SUZUKI****...SX4 S-Cross (JY)**

| | | | | | | | | | | |
|--------------|---|------|--------|--------|-------|-----|------|-------|----------|--------|
| 1.6, 1.6 4WD | 4 | M16A | 88/118 | 08/13→ | OE016 | 0,9 | CET2 | OE180 | BAEA181E | CLS167 |
|--------------|---|------|--------|--------|-------|-----|------|-------|----------|--------|

VITARA (ET, TA)

| | | | | | | | | | | |
|------------|---|----|-------|-------------|-------|-----|--|--|--|--|
| 2.0 TD 4WD | 4 | RF | 52/70 | 12/94→03/98 | CH242 | 11v | | | | |
|------------|---|----|-------|-------------|-------|-----|--|--|--|--|

| | | | | | | | | | | |
|------------------------|---|----|-------|-------------|-------|-----|--|--|--|--|
| 2.0 TD Intercooler 4WD | 4 | RF | 64/86 | 12/95→03/98 | CH242 | 11v | | | | |
|------------------------|---|----|-------|-------------|-------|-----|--|--|--|--|

| | | | | | | | | | | |
|----------------|---|------|---------|-------------|-------|-----|------|-------|----------|--|
| 2.5 V6 24V 4WD | 6 | H25A | 118/158 | 12/95→03/98 | OE005 | 0,9 | CET2 | OE179 | BAEA072E | |
|----------------|---|------|---------|-------------|-------|-----|------|-------|----------|--|

VITARA /Cabrio (ET, TA)

| | | | | | | | | | | |
|-----------|---|-------|-------|-------------|-------|-----|--|--|--|--|
| 1.9 D 4WD | 4 | XUD9A | 50/67 | 01/95→03/98 | CH189 | 11v | | | | |
|-----------|---|-------|-------|-------------|-------|-----|--|--|--|--|

| | | | | | | | | | | |
|-----------|---|--------|-------|-------------|-------|-----|--|--|--|--|
| 1.9 D 4WD | 4 | XUD9SD | 55/74 | 08/96→03/99 | CH189 | 11v | | | | |
|-----------|---|--------|-------|-------------|-------|-----|--|--|--|--|

| | | | | | | | | | | |
|-------------|---|------|--------|-------------|-------|-----|------|-------|----------|--|
| 2.0 16V 4WD | 4 | J20A | 97/130 | 12/96→03/99 | OE005 | 0,9 | CET2 | OE180 | BAEA072E | |
|-------------|---|------|--------|-------------|-------|-----|------|-------|----------|--|

| | | | | | | | | | | |
|----------------|---|------|---------|-------------|-------|-----|------|-------|----------|--|
| 2.0 V6 24V 4WD | 6 | H20A | 100/134 | 12/94→03/98 | OE005 | 0,9 | CET2 | OE180 | BAEA072E | |
|----------------|---|------|---------|-------------|-------|-----|------|-------|----------|--|

WAGON R+ Hatchback (EM)

| | | | | | | | | | | |
|-----|---|------|-------|-------------|-------|-----|------|-------|--|--|
| 1.0 | 4 | K10A | 48/64 | 02/98→05/00 | OE083 | 0,7 | CET1 | OE187 | | |
|-----|---|------|-------|-------------|-------|-----|------|-------|--|--|

| | | | | | | | | | | |
|--------------|---|------|-------|-------------|-------|-----|------|-------|--|--|
| 1.2, 1.2 4WD | 4 | K12A | 51/68 | 02/98→05/00 | OE083 | 0,7 | CET1 | OE187 | | |
|--------------|---|------|-------|-------------|-------|-----|------|-------|--|--|

WAGON R+ (MM)

| | | | | | | | | | | |
|-----|---|------|-------|-------------|-------|-----|------|-------|--|--|
| 1.0 | 4 | K10A | 51/68 | 08/00→07/03 | OE083 | 0,7 | CET1 | OE187 | | |
|-----|---|------|-------|-------------|-------|-----|------|-------|--|--|

| | | | | | | | | | | |
|-----|---|------|-------|--------|-------|-----|--------|-------|--|--|
| 1.3 | 4 | M13A | 65/87 | 08/01→ | OE136 | 0,8 | CET12P | OE179 | | |
|-----|---|------|-------|--------|-------|-----|--------|-------|--|--|

WAGON R+ Hatchback (MM)

| | | | | | | | | | | |
|-----|---|------|-------|--------|--|--|--------|-------|----------|--------|
| 1.3 | 4 | M13A | 69/93 | 09/03→ | | | CET12P | OE179 | BAEA181E | CLS167 |
|-----|---|------|-------|--------|--|--|--------|-------|----------|--------|

| | | | | | | | | | | |
|--------------|---|-------|-------|--------|-------|-----|------|-------|----------|--------|
| 1.3, 1.3 4WD | 4 | G13BB | 56/75 | 05/00→ | OE005 | 0,9 | CET2 | OE180 | BAEA181E | CLS026 |
|--------------|---|-------|-------|--------|-------|-----|------|-------|----------|--------|

| | | | | | | | | | | |
|---------|---|------|-------|--------|-------|-----|--------|-------|----------|--------|
| 1.3 4WD | 4 | M13A | 69/93 | 09/03→ | OE136 | 0,8 | CET12P | OE179 | BAEA181E | CLS167 |
|---------|---|------|-------|--------|-------|-----|--------|-------|----------|--------|

WAGON R Hatchback

| | | | | | | | | | | |
|-----|---|------|-------|-------------|-------|-----|------|-------|--|--|
| 1.0 | 3 | G10A | 39/52 | 07/03→08/05 | OE006 | 0,9 | CET8 | OE195 | | |
|-----|---|------|-------|-------------|-------|-----|------|-------|--|--|

| | | | | | | | | | | |
|-----|---|--------|-------|-------------|-------|-----|------|-------|--|--|
| 1.0 | 3 | Z10XEP | 44/59 | 06/04→08/05 | OE198 | 0,9 | CET2 | OE184 | | |
|-----|---|--------|-------|-------------|-------|-----|------|-------|--|--|

| | | | | | | | | | | |
|-----|---|--------|-------|-------------|-------|-----|------|-------|---------|--|
| 1.2 | 4 | Z12XEP | 59/79 | 06/04→08/05 | OE198 | 0,9 | CET2 | OE184 | BAEA338 | |
|-----|---|--------|-------|-------------|-------|-----|------|-------|---------|--|

X-90 (EL)

| | | | | | | | | | | |
|--------------------------|---|------|-------|-------------|--|--|--------|-------|--|--------|
| 1.6 i 16V, 1.6 i 16V 4WD | 4 | G16B | 71/95 | 09/95→12/97 | | | CET12P | OE179 | | CLS230 |
|--------------------------|---|------|-------|-------------|--|--|--------|-------|--|--------|

SUZUKI**CARRY Box (FD)**

| | | | | | | | | | | |
|---------------|---|-------|-------|--------|-------|-----|------|-------|----------|--|
| 1.3, 1.3 16 V | 4 | G13BB | 58/78 | 03/99→ | OE005 | 0,9 | CET2 | OE180 | BAEA181E | |
|---------------|---|-------|-------|--------|-------|-----|------|-------|----------|--|

| | | | | | | | | | | |
|---------|---|-------|-------|-------------|-------|-----|------|-------|--|--|
| 1.3 4WD | 4 | G13BB | 56/75 | 02/99→09/04 | OE005 | 0,9 | CET2 | OE180 | | |
|---------|---|-------|-------|-------------|-------|-----|------|-------|--|--|

SUPER CARRY Bus (ED)

| | | | | | | | | | | |
|-----|---|------|-------|-------------|-------|-----|------|-------|--|--------|
| 1.0 | 4 | F10A | 30/40 | 09/94→03/99 | OE006 | 0,9 | CET8 | OE195 | | CLS225 |
|-----|---|------|-------|-------------|-------|-----|------|-------|--|--------|

TATA**INDICA**

| | | | | | | | | | | |
|-------|---|-------|-------|--------|-------|-----|--|--|--|--|
| 1.4 D | 4 | 475DL | 39/52 | 10/98→ | CH185 | 11v | | | | |
|-------|---|-------|-------|--------|-------|-----|--|--|--|--|

| | | | | | | | | | | |
|-------|---|-------|-------|--------|-------|-----|------|-------|--|--|
| 1.4 i | 4 | 475Si | 55/74 | 10/98→ | OE005 | 0,9 | CET2 | OE179 | | |
|-------|---|-------|-------|--------|-------|-----|------|-------|--|--|

| | | | | | | | | | | |
|-------|---|--|-------|-------------|-------|-----|------|-------|--|--|
| 1.4 L | 4 | | 44/59 | 06/98→09/02 | OE005 | 0,9 | CET2 | OE179 | | |
|-------|---|--|-------|-------------|-------|-----|------|-------|--|--|

INDIGO

| | | | | | | | | | | |
|-----|---|-------|-------|--------|-------|-----|------|-------|--|--|
| 1.4 | 4 | 475Si | 62/83 | 01/03→ | OE005 | 0,9 | CET2 | OE179 | | |
|-----|---|-------|-------|--------|-------|-----|------|-------|--|--|

LOADBETA

| | | | | | | | | | | |
|-------|---|---------|-------|-------------|-------|-----|--|--|--|--|
| 1.9 D | 4 | 483DL45 | 50/67 | 08/94→12/06 | CH189 | 11v | | | | |
|-------|---|---------|-------|-------------|-------|-----|--|--|--|--|

| | | | | | | | | | | |
|------------------|---|-------|-------|-------------|-------|-----|--|--|--|--|
| 1.9 D, 1.9 D 4WD | 4 | 483DL | 66/89 | 11/95→12/06 | CH189 | 11v | | | | |
|------------------|---|-------|-------|-------------|-------|-----|--|--|--|--|

SAFARI

| | | | | | | | | | | |
|-------------|---|-------|---------|--------|-------|-----|------|-------|--|--|
| 2.0 16V 4WD | 4 | 483PL | 101/135 | 06/99→ | OE005 | 0,9 | CET2 | OE179 | | |
|-------------|---|-------|---------|--------|-------|-----|------|-------|--|--|

TOFAS**DOGAN**

| | | | | | | | | | | |
|---------|---|--|-------|-------------|-------|-----|------|-------|--|--|
| 1.6 i.e | 4 | | 61/82 | 01/99→12/02 | OE018 | 1,0 | CET8 | OE195 | | |
|---------|---|--|-------|-------------|-------|-----|------|-------|--|--|

| | | | | | | | | | | |
|--------|---|--|-------|-------------|-------|-----|------|-------|--|--|
| 1.6 IE | 4 | | 66/89 | 01/97→07/02 | OE018 | 1,0 | CET8 | OE195 | | |
|--------|---|--|-------|-------------|-------|-----|------|-------|--|--|

TOFAS



kW/BHP



eon TITAN

IRIDIUM



...TOFAS



KARTAL

| | | | | | | | |
|--------|---|-------|-------------|-------|-----|------|-------|
| 1.6 IE | 4 | 66/89 | 01/97→07/02 | OE018 | 1,0 | CET8 | OE195 |
|--------|---|-------|-------------|-------|-----|------|-------|

SAHIN

| | | | | | | | |
|--------|---|-------|-------------|-------|-----|------|-------|
| 1.6 IE | 4 | 63/84 | 01/97→07/02 | OE018 | 1,0 | CET8 | OE195 |
|--------|---|-------|-------------|-------|-----|------|-------|

TOYOTA



4 RUNNER

| | | | | | | | |
|--------------|---|--------|---------|-------------|-------|-----|------|
| 2.7, 2.7 4WD | 4 | 3RZ-FE | 112/150 | 11/95→08/02 | OE039 | 1,0 | CET2 |
|--------------|---|--------|---------|-------------|-------|-----|------|

| | | | | | | | |
|-----------------|---|-------|--------|-------------|-------|-----|--|
| 3.0 Turbo-D 4WD | 4 | 1KZ-T | 92/123 | 10/93→11/02 | CH608 | 11v | |
|-----------------|---|-------|--------|-------------|-------|-----|--|

| | | | | | | | |
|-----|---|--------|---------|-------------|-------|-----|------|
| 3.4 | 6 | 5VZ-FE | 136/182 | 11/95→07/02 | OE019 | 0,9 | CET2 |
|-----|---|--------|---------|-------------|-------|-----|------|

ALLION I

| | | | | | | | | |
|-----|---|--------|--------|-------------|-------|-----|------|-------|
| 1.5 | 4 | 1NZ-FE | 80/107 | 06/01→04/05 | OE093 | 1,0 | CET2 | OE182 |
|-----|---|--------|--------|-------------|-------|-----|------|-------|

| | | | | | | | | |
|--------------|---|--------|--------|-------------|-------|-----|------|-------|
| 1.8, 1.8 4WD | 4 | 1ZZ-FE | 97/130 | 06/01→06/07 | OE093 | 1,0 | CET2 | OE182 |
|--------------|---|--------|--------|-------------|-------|-----|------|-------|

| | | | | | | | | |
|--------------|---|---------|---------|-------------|--|--|--------|-------|
| 2.0, 2.0 4WD | 4 | 1AZ-FSE | 114/153 | 06/01→06/07 | | | CET12P | OE182 |
|--------------|---|---------|---------|-------------|--|--|--------|-------|

ALLION II

| | | | | | | | | | |
|-----|---|--------|--------|-------------|--|--|--------|-------|----------|
| 1.5 | 4 | 1NZ-FE | 81/109 | 07/07→11/12 | | | CET14P | OE190 | BAEA167E |
|-----|---|--------|--------|-------------|--|--|--------|-------|----------|

| | | | | | | | | | |
|-----|---|---------|---------|--------|--|--|--|--|----------|
| 1.8 | 4 | 2ZR-FAE | 106/142 | 07/07→ | | | | | BAEA184E |
|-----|---|---------|---------|--------|--|--|--|--|----------|

| | | | | | | | | | |
|---------|---|---------|--------|--------|--|--|--|--|----------|
| 1.8 4WD | 4 | 2ZR-FAE | 98/131 | 07/07→ | | | | | BAEA184E |
|---------|---|---------|--------|--------|--|--|--|--|----------|

| | | | | | | | | | |
|-----|---|---------|---------|--------|--|--|--|--|----------|
| 2.0 | 4 | 3ZR-FAE | 116/156 | 07/07→ | | | | | BAEA184E |
|-----|---|---------|---------|--------|--|--|--|--|----------|

ALPHARD

| | | | | | | | | |
|--------------|---|--------|---------|-------------|--|--|--------|-------|
| 2.4, 2.4 4WD | 4 | 2AZ-FE | 117/157 | 09/03→04/08 | | | CET12P | OE182 |
|--------------|---|--------|---------|-------------|--|--|--------|-------|

| | | | | | | | | |
|--------------|---|--------|---------|-------------|--|--|--------|-------|
| 3.0, 3.0 4WD | 6 | 1MZ-FE | 162/217 | 04/03→04/08 | | | CET12P | OE182 |
|--------------|---|--------|---------|-------------|--|--|--------|-------|

ALPHARD / VELLFIRE

| | | | | | | | | |
|--------------|---|--------|---------|-------------|--|--|--------|-------|
| 2.4, 2.4 4WD | 4 | 2AZ-FE | 125/168 | 04/08→12/14 | | | CET12P | OE182 |
|--------------|---|--------|---------|-------------|--|--|--------|-------|

| | | | | | | | | |
|-----|---|--------|---------|--------|--|--|--------|-------|
| 3.5 | 6 | 2GR-FE | 202/271 | 04/08→ | | | CET14P | OE190 |
|-----|---|--------|---------|--------|--|--|--------|-------|

| | | | | | | | | |
|--------------|---|--------|---------|--------|--|--|--------|-------|
| 3.5, 3.5 4WD | 6 | 2GR-FE | 206/276 | 04/08→ | | | CET14P | OE190 |
|--------------|---|--------|---------|--------|--|--|--------|-------|

ALTEZZA

| | | | | | | | | |
|-----|---|--------------|---------|-------------|--|--|--------|-------|
| 2.0 | 6 | 1G-FE; 1G-GE | 114/153 | 01/99→07/05 | | | CET12P | OE182 |
|-----|---|--------------|---------|-------------|--|--|--------|-------|

| | | | | | | | | |
|----------|---|-------|---------|-------------|-------|-----|--------|--|
| 2.0 VVTi | 4 | 3S-GE | 147/197 | 02/99→07/05 | OE136 | 0,8 | CET12P | |
|----------|---|-------|---------|-------------|-------|-----|--------|--|

| | | | | | | | | |
|----------|---|-------|---------|-------------|--|--|--------|-------|
| 2.0 VVTi | 6 | 1G-FE | 118/158 | 01/99→07/05 | | | CET12P | OE182 |
|----------|---|-------|---------|-------------|--|--|--------|-------|

| | | | | | | | | |
|-----|---|--------|---------|-------------|-------|-----|--------|-------|
| 3.0 | 6 | 2JZ-GE | 157/211 | 07/01→07/05 | OE191 | 1,0 | CET12P | OE180 |
|-----|---|--------|---------|-------------|-------|-----|--------|-------|

ALTEZZA GITA

| | | | | | | | | |
|--------------|---|--------------|---------|-------------|--|--|--------|-------|
| 2.0, 2.0 4WD | 6 | 1G-FE; 1G-GE | 114/153 | 01/99→06/01 | | | CET12P | OE182 |
|--------------|---|--------------|---------|-------------|--|--|--------|-------|

| | | | | | | | | |
|-----|---|--------|---------|-------------|-------|-----|--------|-------|
| 3.0 | 6 | 2JZ-GE | 157/211 | 07/01→06/05 | OE191 | 1,0 | CET12P | OE180 |
|-----|---|--------|---------|-------------|-------|-----|--------|-------|

AQUA

| | | | | | | | | |
|------------|---|---------|-------|--------|--|--|--------|--|
| 1.5 Hybrid | 4 | 1NZ-FXE | 54/72 | 12/11→ | | | CET12P | |
|------------|---|---------|-------|--------|--|--|--------|--|

ARISTO

| | | | | | | | | |
|-----|---|--------|---------|-------------|-------|-----|--------|-------|
| 3.0 | 6 | 2JZ-GE | 170/228 | 08/97→09/04 | OE191 | 1,0 | CET12P | OE180 |
|-----|---|--------|---------|-------------|-------|-----|--------|-------|

| | | | | | | | | |
|-----|---|---------|---------|-------------|-------|-----|--------|--|
| 3.0 | 6 | 2JZ-GTE | 206/276 | 08/97→09/04 | OE136 | 0,8 | CET12P | |
|-----|---|---------|---------|-------------|-------|-----|--------|--|

ASCENT

| | | | | | | | | |
|-----|---|-------|--------|-------------|-------|-----|--------|-------|
| 1.8 | 4 | 7A-FE | 81/109 | 06/01→10/03 | OE138 | 1,0 | CET12P | OE193 |
|-----|---|-------|--------|-------------|-------|-----|--------|-------|

AURION

| | | | | | | | | |
|-----|---|---------|---------|-------------|--|--|--------|-------|
| 2.0 | 4 | 1AZ-FSE | 114/153 | 03/06→07/09 | | | CET12P | OE182 |
|-----|---|---------|---------|-------------|--|--|--------|-------|

| | | | | | | | | |
|-----|---|--------|---------|--------|--|--|--------|-------|
| 3.5 | 6 | 2GR-FE | 200/268 | 03/06→ | | | CET14P | OE190 |
|-----|---|--------|---------|--------|--|--|--------|-------|

| | | | | | | | | |
|-----|---|---------|---------|-------------|--|--|--------|-------|
| 3.5 | 6 | 2GR-FSE | 235/315 | 03/06→09/11 | | | CET14P | OE190 |
|-----|---|---------|---------|-------------|--|--|--------|-------|

AURIS

| | | | | | | | | | |
|-----|---|--------|-------|--------|--|--|--|--|----------|
| 1.3 | 4 | 1NR-FE | 73/98 | 10/12→ | | | | | BAEA192E |
|-----|---|--------|-------|--------|--|--|--|--|----------|

| | | | | | | | | | |
|---------------|---|--------|-------|-------------|--|--|--|--|----------|
| 1.3 Dual-VVTi | 4 | 1NR-FE | 73/98 | 01/10→09/12 | | | | | BAEA172E |
|---------------|---|--------|-------|-------------|--|--|--|--|----------|

| | | | | | | | | | |
|---------------|---|--------|-------|-------------|--|--|--|--|----------|
| 1.3 Dual-VVTi | 4 | 1NR-FE | 74/99 | 05/09→09/12 | | | | | BAEA184E |
|---------------|---|--------|-------|-------------|--|--|--|--|----------|

| | | | | | | | | | |
|-----|---|--------|-------|-------------|-------|-----|------|-------|---------------------------|
| 1.4 | 4 | 4ZZ-FE | 71/95 | 03/07→09/12 | OE039 | 1,0 | CET2 | OE180 | BAEA164E ^[167] |
|-----|---|--------|-------|-------------|-------|-----|------|-------|---------------------------|

| | | | | | | | | |
|-----|---|--------|--------|--------|--|--|--------|-------|
| 1.5 | 4 | 1NZ-FE | 80/107 | 10/12→ | | | CET14P | OE190 |
|-----|---|--------|--------|--------|--|--|--------|-------|

| | | | | | | | | |
|-----|---|--------|--------|-------------|--|--|--------|-------|
| 1.5 | 4 | 1NZ-FE | 81/109 | 09/09→09/12 | | | CET14P | OE190 |
|-----|---|--------|--------|-------------|--|--|--------|-------|





kW/BHP



eon TITAN

IRIDIUM

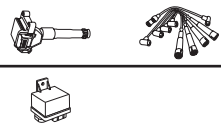

...TOYOTA



...AURIS

| | | | | | | | | | |
|--------------|---|-----------------|---------|-------------|--|--|--------|-------|----------|
| 1.5 4WD | 4 | 1NZ-FE | 77/103 | 09/09→ | | | CET14P | OE190 | |
| 1.6 | 4 | 1ZR-FE | 91/122 | 03/07→09/12 | | | | | BAEA184E |
| 1.6 | 4 | 1ZR-FAE | 97/130 | 05/09→ | | | | | BAEA184E |
| 1.8 | 4 | 2ZR-FAE | 106/142 | 02/09→ | | | | | BAEA184E |
| 1.8 | 4 | 2ZR-FAE | 108/145 | 02/09→09/12 | | | | | BAEA184E |
| 1.8, 1.8 4WD | 4 | 2ZR-FAE; 2ZR-FE | 100/134 | 10/06→09/12 | | | | | BAEA184E |
| 1.8 Hybrid | 4 | 2ZR-FXE | 73/98 | 09/10→ | | | | | BAEA184E |

AURIS TOURING SPORTS

| | | | | | | | | | |
|------------|---|---------|--------|--------|--|--|--|--|----------|
| 1.6 | 4 | 1ZR-FAE | 97/130 | 07/13→ | | | | | BAEA184E |
| 1.8 Hybrid | 4 | 2ZR-FXE | 73/98 | 07/13→ | | | | | BAEA184E |

AVALON

| | | | | | | | | | |
|----------|---|--------|---------|-------------|-------|-----|--------|-------|--|
| 3.0 | 6 | 1MZ-FE | 137/184 | 08/01→04/05 | | | CET12P | OE182 | |
| 3.0 | 6 | 1MZ-FE | 140/188 | 03/95→05/05 | OE026 | 0,9 | CET2 | OE188 | |
| 3.0 | 6 | 1MZ-FE | 145/194 | 04/00→03/06 | | | CET12P | OE182 | |
| 3.0 | 6 | 1MZ-FE | 157/211 | 09/99→12/04 | | | CET12P | OE182 | |
| 3.5 VVTi | 6 | 2GR-FE | 206/276 | 01/05→09/12 | | | CET14P | OE190 | |

AVANZA

| | | | | | | | | | |
|-----|---|--------|--------|-------------|-------|-----|--------|-------|--|
| 1.3 | 4 | K3-VE | 63/84 | 12/03→10/11 | OE136 | 0,8 | CET12P | | |
| 1.3 | 4 | K3-VE | 67/90 | 08/06→12/11 | OE136 | 0,8 | CET12P | | |
| 1.5 | 4 | 3SZ-VE | 76/102 | 08/06→12/11 | | | CET10P | OE187 | |

AVENSIS

| | | | | | | | | | |
|----------------|---|-----------------|---------|-------------|-----------------|-----|--------|-------|---|
| 1.6 | 4 | 4A-FE | 74/99 | 09/97→10/00 | OE138 | 1,0 | CET12P | OE193 | CLS058 [292] |
| | | | | | OE218 LPG [278] | 1,6 | | | |
| 1.6 | 4 | 4A-FE | 81/109 | 09/97→02/03 | OE218 LPG [278] | 1,6 | CET2 | OE179 | CLS058 [292] |
| 1.6 | 4 | 3ZZ-FE | 81/109 | 09/97→02/03 | OE093 | 1,0 | CET2 | OE182 | BAEA164E [167] |
| | | | | | OE218 LPG [278] | 1,6 | | | |
| 1.6 | 4 | 1ZR-FAE | 97/130 | 11/08→ | | | | | BAEA184E |
| 1.6 VVT-i | 4 | 3ZZ-FE | 81/109 | 10/00→11/08 | OE093 | 1,0 | CET2 | OE182 | BAEA164E [167] |
| 1.8 | 4 | 7A-FE | 81/109 | 09/97→10/00 | OE138 | 1,0 | CET12P | OE193 | |
| 1.8 | 4 | 2ZR-FAE | 108/145 | 11/08→ | | | | | BAEA184E |
| 1.8, 1.8 VVT-i | 4 | 1ZZ-FE | 95/127 | 10/00→11/08 | | | CET2 | OE182 | BAEA164E [167] |
| 2.0 | 4 | 3S-FE | 94/126 | 09/97→10/00 | OE026 | 0,9 | CET2 | OE188 | CLS171 |
| 2.0 | 4 | 1AZ-FSE | 108/145 | 03/03→11/08 | | | CET12P | OE188 | BAEA167E [275] BAEA171E [165] [275] |
| 2.0 | 4 | 3ZR-FAE; 3ZR-FE | 112/150 | 11/08→ | | | | | BAEA184E |
| 2.0, 2.0 VVT-i | 4 | 1AZ-FSE | 110/148 | 10/00→02/03 | | | CET12P | OE182 | BAEA167E [166] BAEA171E [165] |
| 2.0 D | 4 | 2C-T | 61/82 | 10/97→05/98 | CH302 | 11v | | | |
| 2.0 TD | 4 | 2C-TE | 66/89 | 09/97→02/03 | CH302 | 11v | | | |
| 2.0 VVTi | 4 | 1AZ-FE | 114/153 | 04/03→11/08 | OE136 | 0,8 | CET12P | OE179 | BAEA171E →09/05 OE182 BAEA167E 09/05→ |
| 2.4 | 4 | 2AZ-FSE | 120/161 | 10/03→10/08 | | | CET12P | OE188 | BAEA167E |
| 2.4 | 4 | 2AZ-FSE | 125/168 | 09/03→11/08 | | | CET12P | OE188 | BAEA167E |

AVENSIS VERSO

| | | | | | | | | | |
|--------------|---|--------|---------|-------------|--|--|--------|-------|--|
| 2.0 | 4 | 1AZ-FE | 110/148 | 08/01→11/09 | | | CET12P | OE182 | BAEA167E [275] BAEA171E [169] [275] |
| 2.4, 2.4 4WD | 4 | 2AZ-FE | 115/154 | 08/01→08/07 | | | CET12P | OE182 | |

TOYOTA





kW/BHP

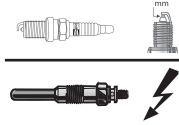

eon TITAN

IRIDIUM



...TOYOTA



| AYGO | | | | | | | | | |
|-----------------------------|---|--------------|---------|-------------|----------------|------------|--------|----------------|---|
| 1.0 | 3 | 1KR-FE | 50/67 | 07/05→ | OE035 | 0,9 | CET5 | OE190 | BAEA164E [167] [275] BAEA165E [275] |
| 1.0 | 3 | 1KR-FE | 51/68 | 05/14→ | | | CET14P | OE190 | BAEA164E |
| 1.0 GPL | 3 | 1KR-FE | 50/67 | 07/05→ | OE035 | 0,9 | CET5 | OE190 | |
| bb I | | | | | | | | | |
| 1.5 | 4 | 1NZ-FE | 80/107 | 03/00→12/05 | OE093 | 1,0 | CET2 | OE182 | |
| bb II | | | | | | | | | |
| 1.3, 1.3 4WD | 4 | K3-VE | 68/91 | 12/05→ | OE136 | 0,8 | CET12P | | |
| 1.5 | 4 | 3S-VE | 80/107 | 12/05→ | | | CET10P | OE187 | |
| BREVIS | | | | | | | | | |
| 2.5 | 6 | 1JZ-FSE | 147/197 | 10/99→09/02 | | | CET12P | OE188 | |
| 3.0 | 6 | 2JZ-FSE | 162/217 | 10/99→06/07 | | | CET12P | OE188 | |
| CALDINA | | | | | | | | | |
| 1.8 | 4 | 7A-FE | 85/114 | 10/97→08/02 | OE138 | 1,0 | CET12P | OE193 | |
| 2.0 | 4 | 1AZ-FSE | 112/150 | 09/02→06/07 | | | CET12P | OE182 | |
| 2.0 4WD | 4 | 3S-GTE | 140/188 | 10/97→09/01 | OE136 | 0,8 | CET12P | | |
| 2.0 4WD | 4 | 3S-GTE | 192/257 | 02/00→09/01 | OE136 | 0,8 | CET12P | | |
| 2.0 TD | 4 | 2C | 56/75 | 06/94→09/97 | CH302 | 11v | | | |
| CAMI | | | | | | | | | |
| 1.3 | 4 | K3-VE; K3-VT | 66/89 | 06/99→12/05 | OE136 | 0,8 | CET12P | | |
| 1.3, 1.3 4WD | 4 | K3-VE | 63/84 | 02/01→12/05 | OE136 | 0,8 | CET12P | | |
| 1.3 4WD | 4 | HC-EJ | 61/82 | 05/99→09/00 | OE136 | 0,8 | CET12P | | |
| 1.3 4WD | 4 | K3-VT | 103/138 | 06/99→12/05 | | | CET12P | OE179 | |
| CAMRY | | | | | | | | | |
| 2.0 | 4 | 1AZ-FE | 109/146 | 09/11→ | | | CET12P | OE182 | BAEA167E 12/11→ |
| 2.0 | 4 | 1AZ-FE | 110/148 | 08/01→ | | | CET12P | OE182 | BAEA171E →09/05 BAEA167E 09/05→ |
| 2.0 4WD | 4 | 3S-FE | 100/134 | 08/93→09/97 | OE039 | 1,0 | CET2 | OE179 | |
| 2.0 TD | 4 | 2C-T | 66/89 | 08/96→09/99 | CH302 | 11v | | | |
| 2.0 VVT-i | 4 | 1AZ-FE | 108/145 | 01/06→09/11 | OE136 | 0,8 | CET12P | OE179 | BAEA167E |
| 2.2 | 4 | 5S-FE | 93/125 | 02/93→09/02 | OE026 OE039 | 0,9 1,0 | CET2 | OE179 OE188 | BAEA445 |
| 2.2 | 4 | 5S-FE | 96/129 | 08/96→11/01 | OE026 | 0,9 | CET2 | OE188 | CLS259 |
| 2.4 | 4 | 2AZ-FE | 112/150 | 11/01→11/06 | | | CET12P | OE182 | BAEA167E [275] BAEA171E [169] [275] |
| 2.4 | 4 | 2AZ-FE | 116/156 | 01/06→09/11 | | | CET12P | OE182 | BAEA167E |
| 2.4 | 4 | 2AZ-FE | 123/165 | 01/06→09/11 | | | CET12P | OE182 | BAEA167E |
| 2.4 | 4 | 2AZ-FE | 127/170 | 01/02→09/11 | | | | | BAEA167E |
| 2.4 Hybrid, 2.4 VVTi Hybrid | 4 | 2AZ-FXE | 105/141 | 01/06→07/11 | | | CET12P | OE182 | |
| 2.4 VVT-i Hybrid | 4 | 2AZ-FXE | 110/148 | 01/06→09/11 | | | CET12P | OE182 | |
| 2.5 | 4 | 2AR-FE | 133/178 | 09/09→ | | | CET14P | OE190 | BAEA192E |
| 2.5 VVTi | 4 | 2AR-FE | 129/173 | 01/10→09/11 | | | CET14P | OE190 | BAEA192E |
| 3.0 | 6 | 1MZ-FE | 135/181 | 09/93→07/96 | OE026 | 0,9 | CET2 | OE188 | |
| 3.0 | 6 | 1MZ-FE | 137/184 | 08/01→11/06 | | | CET12P | OE182 | BAEA173E [163] [275] |
| 3.0 | 6 | 1MZ-FE | 141/189 | 09/02→11/06 | | | CET12P | OE182 | |
| 3.0 24V | 6 | 1MZ-FE | 140/188 | 08/96→11/01 | OE026 | 0,9 | CET2 | OE188 | BAEA173E [162] [275] |
| 3.0 V6 | 6 | 1MZ-FE | 135/181 | 08/96→11/01 | OE026 | 0,9 | CET2 | OE188 | BAEA173E [162] [275] |

TOYOTA





kW/BHP



eon TITAN

IRIDIUM

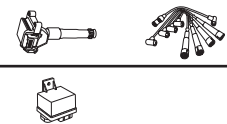

...TOYOTA



...CAMRY

| | | | | | | | | | |
|-----|---|--------|---------|-------------|--|--|--------|-------|--|
| 3.3 | 6 | 3MZ-FE | 165/221 | 08/02→11/06 | | | CET12P | OE182 | |
| 3.5 | 6 | 2GR-FE | 204/274 | 01/08→ | | | CET14P | OE190 | |

CAMRY SOLARA

| | | | | | | | | | |
|-----|---|--------|---------|-------------|-------|-----|--------|-------|--|
| 2.2 | 4 | 5S-FE | 100/134 | 06/98→06/01 | OE039 | 1,0 | CET2 | OE179 | |
| 2.2 | 4 | 5S-FE | 101/135 | 02/00→11/02 | OE039 | 1,0 | CET2 | OE179 | |
| 3.0 | 6 | 1MZ-FE | 140/188 | 02/00→11/02 | | | CET12P | OE182 | |
| 3.0 | 6 | 1MZ-FE | 147/197 | 06/98→11/02 | OE026 | 0,9 | CET12P | OE182 | |
| | | | | | | | CET2 | OE188 | |
| 3.3 | 6 | 3MZ-FE | 155/208 | 07/03→11/08 | | | CET12P | OE182 | |
| 3.3 | 6 | 3MZ-FE | 165/221 | 07/03→11/08 | | | CET12P | OE182 | |

CARIBE

| | | | | | | | | | |
|---------|---|-------|--------|-------------|-------|-----|--------|-------|--|
| 1.3 | 4 | 4E-FE | 55/74 | 09/94→08/96 | OE063 | 1,0 | CET2 | OE180 | |
| 1.6 | 4 | 4A-FE | 84/113 | 09/94→08/03 | OE005 | 0,9 | CET2 | OE179 | |
| 1.8 4WD | 4 | 4S-FE | 85/114 | 09/94→08/03 | OE146 | 1,0 | CET12P | OE179 | |

CARINA E

| | | | | | | | | | |
|-----------------------|---|-------|---------|-------------|-----------------|-----|--------|-------|--------------|
| 1.6 | 4 | 4A-FE | 73/98 | 12/93→09/97 | OE063 | 1,0 | CET12P | OE193 | CLS058 [292] |
| | | | | | OE138 | 1,0 | CET2 | | |
| | | | | | OE218 LPG [278] | 1,6 | | | |
| 1.6, 1.6 16V | 4 | 4A-FE | 78/105 | 10/95→09/97 | OE138 | 1,0 | CET12P | OE193 | CLS058 [292] |
| | | | | | OE218 LPG [278] | 1,6 | | | |
| 1.6 16V | 4 | 4A-FE | 85/114 | 12/94→09/97 | OE138 | 1,0 | CET12P | OE193 | CLS058 [292] |
| | | | | | OE218 LPG [278] | 1,6 | | | |
| 1.6 i | 4 | 4A-FE | 73/98 | 02/95→09/97 | OE138 | 1,0 | CET12P | OE193 | CLS058 [292] |
| | | | | | OE218 LPG [278] | 1,6 | | | |
| 1.8, 1.8 i, 1.8 i 16V | 4 | 7A-FE | 79/106 | 01/95→09/97 | OE138 | 1,0 | CET12P | OE193 | CLS058 [292] |
| 1.8 GL | 4 | 7A-FE | 92/123 | 10/94→09/97 | OE138 | 1,0 | CET12P | | CLS058 [292] |
| 2.0 GTi 16V | 4 | 3S-GE | 129/173 | 03/94→09/97 | OE136 | 0,8 | CET12P | OE179 | |
| | | | | | OE218 LPG [278] | 1,6 | | | |
| 2.0 TD | 4 | 2C-T | 61/82 | 01/96→09/97 | CH302 | 11v | | | |

CELICA

| | | | | | | | | | |
|-----------------|---|--------|---------|-------------|-----------------|-----|--------|-------|----------------|
| 1.8 16V TS | 4 | 2ZZ-GE | 141/189 | 08/99→09/05 | | | CET12P | OE182 | BAEA168E [164] |
| 1.8 16V VT-i | 4 | 1ZZ-FE | 105/141 | 08/99→07/05 | | | CET2 | OE182 | BAEA164E [167] |
| | | | | | | | | | BAEA168E [164] |
| 1.8 i 16V | 4 | 7A-FE | 85/114 | 11/93→11/99 | | | CET2 | OE179 | |
| 2.0 GTi | 4 | 3S-GE | 129/173 | 08/94→08/99 | OE136 | 0,8 | CET12P | | |
| 2.0 i 16V | 4 | 3S-GE | 125/168 | 11/93→11/99 | OE136 | 0,8 | CET12P | OE179 | |
| | | | | | OE218 LPG [278] | 1,6 | | | |
| 2.0 i 16V | 4 | 3S-GE | 129/173 | 11/93→11/99 | OE136 | 0,8 | CET12P | OE179 | |
| | | | | | OE218 LPG [278] | 1,6 | | | |
| 2.0 i Turbo 4WD | 4 | 3S-GTE | 178/239 | 02/94→11/99 | OE136 | 0,8 | CET12P | OE179 | |
| | | | | | OE218 LPG [278] | 1,6 | | | |

CELSIOR

| | | | | | | | | | |
|---------|---|--------|---------|-------------|--|--|--------|-------|--|
| 4.3 VVi | 8 | 3UZ-FE | 208/279 | 09/00→08/06 | | | CET12P | OE182 | |
|---------|---|--------|---------|-------------|--|--|--------|-------|--|

CENTURY

| | | | | | | | | | |
|-----|----|--------|---------|--------|-------|-----|--------|--|--|
| 5.0 | 12 | 1GZ-FE | 206/276 | 04/97→ | OE146 | 1,0 | CET12P | | |
|-----|----|--------|---------|--------|-------|-----|--------|--|--|

CHASER

| | | | | | | | | | |
|---------|---|---------|---------|-------------|-------|-----|--------|-------|--|
| 2.5 VVi | 6 | 1JZ-GE | 147/197 | 10/96→05/01 | OE191 | 1,0 | CET12P | OE180 | |
| 2.5 VVi | 6 | 1JZ-GTE | 206/276 | 10/96→05/01 | OE136 | 0,8 | CET12P | OE179 | |
| 3.0 VVi | 6 | 2JZ-FSE | 162/217 | 10/96→05/01 | | | CET12P | OE188 | |

COROLLA

| | | | | | | | | | |
|-----|---|--------|-------|-------------|-------|-----|------|-------|----------|
| 1.3 | 4 | 2NZ-FE | 65/87 | 08/00→05/04 | OE093 | 1,0 | CET2 | OE182 | |
| 1.3 | 4 | 1NR-FE | 73/98 | 06/13→ | | | | | BAEA192E |

TOYOTA





kW/BHP



eon TITAN

IRIDIUM

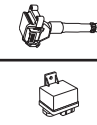

TOYOTA

| ...TOYOTA | | | | | | | | | |
|------------------------|---|-----------------|---------|-------------|-----------------|-----|----------------|-------------------------|---|
| ...COROLLA | | | | | | | | | |
| 1.3 | 4 | 1NR-FE | 74/99 | 01/07→ | | | | | BAEA192E |
| 1.3 VVTi | 4 | 8A-FE | 64/86 | 03/04→03/09 | OE063 | 1,0 | CET2 | OE180 | |
| 1.3 XLI | 4 | 4E-FE | 55/74 | 08/95→04/97 | OE063 | 1,0 | CET2 | OE180 | CLS231 [292] |
| 1.4 | 4 | 4E-FE | 63/84 | 04/97→02/00 | OE019 | 0,9 | CET2 | OE184 | CLS096 |
| 1.4, 1.4 16V | 4 | 4ZZ-FE | 71/95 | 02/00→01/02 | OE039 | 1,0 | CET2 | OE180 | BAEA449 |
| 1.4 VVT-i | 4 | 4ZZ-FE | 71/95 | 10/01→11/13 | OE039 | 1,0 | CET2 | OE180 | BAEA164E ^[167] BAEA164E ^[275] BAEA164E BAEA169E ^{[167] [275]} |
| 1.5 | 4 | 1NZ-FE | 78/105 | 09/99→06/07 | OE093 | 1,0 | CET2 | OE182 | |
| 1.5 | 4 | 1NZ-FE | 80/107 | 07/01→ | OE093 | 1,0 | CET14P CET2 | OE182 OE190 | |
| 1.5 | 4 | 1NZ-FE | 81/109 | 03/01→ | OE093 | 1,0 | CET14P CET2 | OE190 | |
| 1.5 4WD | 4 | 1NZ-FE | 76/102 | 05/12→ | | | CET14P | OE190 | |
| 1.5 4WD | 4 | 1NZ-FE | 77/103 | 09/06→ | | | CET14P | OE190 | |
| 1.5 G 4WD | 4 | 1NZ-FE | 80/107 | 11/01→05/04 | OE093 | 1,0 | CET2 | OE182 | |
| 1.6 | 4 | 4A-FE | 81/109 | 04/97→03/09 | OE005 | 0,9 | CET2 | OE180 | |
| 1.6 | 4 | 3ZZ-FE | 81/109 | 04/97→03/09 | OE093 | 1,0 | CET2 | OE182 | BAEA164E BAEA164E ^[167] |
| 1.6 | 4 | 1ZR-FAE; 1ZR-FE | 97/130 | 01/09→ | | | | | BAEA184E |
| 1.6 16V | 4 | 3ZZ-FE | 81/109 | 10/99→10/01 | OE093 | 1,0 | CET2 | OE182 | BAEA164E |
| 1.6 Aut. | 4 | 4A-FE | 79/106 | 04/97→02/00 | OE005 | 0,9 | CET2 | OE179 OE180 OE182 | |
| 1.6 Dual VVTi | 4 | 1ZR-FE | 91/122 | 01/07→ | | | | | BAEA184E |
| 1.6 i | 4 | 4A-FE | 78/105 | 09/94→11/99 | OE063 | 1,0 | CET2 | | |
| 1.6 VVTi | 4 | 1ZR-FE | 90/121 | 07/10→05/14 | | | | | BAEA184E |
| 1.6 VVT-i | 4 | 3ZZ-FE | 81/109 | 08/01→06/13 | OE093 | 1,0 | CET2 | OE182 | BAEA164E ^[167] |
| 1.8 | 4 | 1ZZ-FE | 92/123 | 09/01→03/09 | OE093 | 1,0 | CET2 | OE182 | BAEA164E |
| 1.8 | 4 | 1ZZ-FE | 95/127 | 04/04→03/09 | OE093 | 1,0 | CET2 | OE182 | BAEA164E ^[167] BAEA168E ^[164] |
| 1.8 | 4 | 1ZZ-FE | 96/129 | 03/01→07/05 | OE093 | 1,0 | CET2 | OE182 | BAEA164E |
| 1.8 | 4 | 1ZZ-FE | 97/130 | 09/02→07/14 | OE063 | 1,0 | | | |
| 1.8 | 4 | 2ZR-FE | 100/134 | 11/01→ | | | | | BAEA184E |
| 1.8 | 4 | 2ZR-FAE | 106/142 | 09/06→ | | | | | BAEA184E |
| 1.8 | 4 | | 108/145 | 01/09→ | | | | | BAEA184E |
| 1.8, 1.8 4WD | 4 | 4S-FE | 92/123 | 08/95→03/09 | OE146 | 1,0 | CET12P | OE179 | |
| 1.8, 1.8 4WD, 1.8 VVTi | 4 | 1ZZ-FE | 100/134 | 11/01→ | OE093 | 1,0 | CET2 | OE182 | BAEA164E |
| 1.8 4WD | 4 | 7A-FE | 81/109 | 04/97→10/01 | | | CET12P | OE180 | |
| 1.8 4WD | 4 | 2ZR-FAE | 98/131 | 09/06→ | | | | | BAEA184E |
| 1.8 16V 4WD | 4 | 7A-FE | 81/109 | 09/95→04/97 | | | CET2 | OE179 | |
| 1.8 VVTi | 4 | 1ZZ-FE | 101/135 | 11/06→ | OE063 →03/08 | 1,0 | | | |
| 1.8 VVTi | 4 | 2ZR-FBE; 2ZR-FE | 103/138 | 08/10→ | | | | | BAEA184E |
| 1.8 VVT-i | 4 | 1ZZ-FE | 99/133 | 12/01→05/04 | OE093 | 1,0 | CET2 | OE182 | BAEA164E ^[167] BAEA168E ^[164] |
| 1.8 VVTi 4WD | 4 | 1ZZ-FE | 99/133 | 10/01→02/04 | OE093 | 1,0 | CET2 | OE182 | |
| 1.8 VVTL-i TS | 4 | 2ZZ-GE | 141/189 | 01/02→02/07 | | | CET12P | OE182 | BAEA168E ^[164] |
| 1.8 VVTL-i TS | 4 | 2ZZ-GE | 160/215 | 10/05→12/06 | | | CET12P | OE182 | BAEA168E |
| 1.8 VVTL-i TS | 4 | 2ZZ-GE | 165/221 | 02/05→02/07 | | | CET12P | OE182 | BAEA168E ^[164] |
| 1.9 D | 4 | 1WZ | 51/68 | 02/00→01/02 | CH185 | 11v | | | |
| 2.2 TD | 4 | 3C-TE | 66/89 | 04/98→10/01 | CH608 | 11v | | | |





kW/BHP

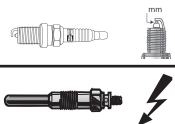

eon TITAN

IRIDIUM

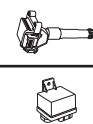
**...TOYOTA****COROLLA RUMION**

| | | | | | | | | | |
|---------|---|---------|---------|--------|--|--|--------|-------|----------|
| 1.5 | 4 | 1NZ-FE | 81/109 | 09/07→ | | | CET14P | OE190 | |
| 1.8 | 4 | 2ZR-FAE | 106/142 | 09/07→ | | | | | BAEA184E |
| 1.8 4WD | 4 | 2ZR-FAE | 100/134 | 09/07→ | | | | | BAEA184E |

CORONA

| | | | | | | | | | |
|--------|---|------|-------|-------------|-------|-----|--|--|--|
| 2.0 TD | 4 | 2C-T | 61/82 | 07/94→09/97 | CH302 | 11v | | | |
|--------|---|------|-------|-------------|-------|-----|--|--|--|

CRESTA

| | | | | | | | | | |
|--------------|---|--------|---------|-------------|-------|-----|--------|-------|--|
| 2.0 VVTi 24V | 6 | 1G-FE | 118/158 | 10/96→09/01 | OE136 | 0,8 | CET12P | OE179 | |
| 2.2 TD | 4 | 3C-TE | 66/89 | 10/96→09/01 | CH608 | 11v | | | |
| 2.5 VVTi | 6 | 1JZ-GE | 147/197 | 10/96→09/01 | OE191 | 1,0 | CET12P | OE180 | |
| 3.0 VVTi | 6 | 2JZ-GE | 162/217 | 10/96→09/01 | OE191 | 1,0 | CET12P | OE180 | |

CROWN

| | | | | | | | | | |
|--|---|---------|---------|-------------|-------|-----|--------|-------|--|
| 2.0 | 6 | 1GZ-EE | 132/177 | 08/96→07/02 | OE136 | 0,8 | CET12P | OE179 | |
| 2.5 | 6 | 1JZ-GTE | 206/276 | 09/99→08/03 | OE136 | 0,8 | CET12P | OE179 | |
| 2.5, 2.5 4WD | 6 | 1JZ-GE | 147/197 | 09/99→08/03 | OE191 | 1,0 | CET12P | OE180 | |
| 2.5 Athlete | 6 | 4GR-FSE | 158/212 | 09/03→02/08 | | | CET14P | OE190 | |
| 2.5 V6, 2.5 V6 4WD | 6 | 4GR-FSE | 149/200 | 02/08→11/12 | | | CET14P | OE190 | |
| 3.0 | 6 | 2JZ-FSE | 147/197 | 09/99→08/03 | | | CET12P | OE188 | |
| 3.5 Hybrid | 6 | 2GR-FSE | 218/292 | 02/08→11/12 | | | CET14P | OE190 | |
| 3.5 V6 | 6 | 2GR-FSE | 232/311 | 02/08→ | | | CET14P | OE190 | |
| 4.3 V8 4WD, 4.3 Royal Saloon, 4.3 Royal Saloon 4WD | 8 | 3UZ-FE | 206/276 | 09/03→11/12 | | | CET12P | OE182 | |

CURREN

| | | | | | | | | | |
|--------------|---|-------|---------|-------------|-------|-----|--------|-------|--|
| 1.8 | 4 | 7A-FE | 85/114 | 11/93→10/98 | OE138 | 1,0 | CET12P | OE193 | |
| 1.8 | 4 | 4S-FE | 92/123 | 10/95→10/98 | OE146 | 1,0 | CET12P | OE179 | |
| 2.0, 2.0 4WD | 4 | 3S-GE | 129/173 | 11/93→10/98 | OE136 | 0,8 | CET12P | | |
| 2.2 | 4 | 5S-FE | 100/134 | 10/95→10/98 | OE039 | 1,0 | CET2 | OE179 | |

DUET

| | | | | | | | | | |
|-----|---|-------|-------|-------------|-------|-----|------|--|--|
| 1.0 | 3 | EJ-VE | 43/58 | 09/98→04/04 | OE019 | 0,9 | CET2 | | |
|-----|---|-------|-------|-------------|-------|-----|------|--|--|

ECHO

| | | | | | | | | | |
|----------|---|--------|--------|-------------|-------|-----|------|-------|--|
| 1.5 VVTi | 4 | 1NZ-FE | 78/105 | 04/99→08/05 | OE093 | 1,0 | CET2 | OE182 | |
|----------|---|--------|--------|-------------|-------|-----|------|-------|--|

FJ CRUISER

| | | | | | | | | | |
|-------------------|---|--------|---------|-------------|-------|-----|------|-------|----------|
| 4.0, 4.0 VVTi 4WD | 6 | 1GR-FE | 178/239 | 01/06→10/10 | OE035 | 0,9 | CET5 | OE190 | |
| 4.0 4WD | 6 | 1GR-FE | 193/259 | 11/10→ | OE035 | 0,9 | CET5 | OE190 | |
| 4.0 4WD | 6 | 1GR-FE | 200/268 | 12/10→ | OE035 | 0,9 | CET5 | OE190 | |
| 4.0 4WD | 6 | 1GR-FE | 203/272 | 01/11→ | OE035 | 0,9 | CET5 | OE190 | BAEA192E |

FORTUNER

| | | | | | | | | | |
|--------------|---|--------|---------|-------------|-------|-----|------|-------|----------|
| 2.7 4WD | 4 | 2TR-FE | 118/158 | 06/04→05/15 | OE035 | 0,9 | CET5 | OE190 | |
| 2.7 Flexfuel | 4 | 2TR-FE | 120/161 | 01/12→05/15 | OE035 | 0,9 | CET5 | | |
| 2.7 VVTi | 4 | 2TR-FE | 118/158 | 06/04→05/15 | OE035 | 0,9 | CET5 | OE190 | BAEA167E |
| 4.0, 4.0 4WD | 6 | 1GR-FE | 173/232 | 07/05→ | OE035 | 0,9 | CET5 | | |

GAIA

| | | | | | | | | | |
|------------------------|---|---------|---------|-------------|-------|-----|--------|-------|--|
| 2.0 VVTi, 2.0 VVTi 4WD | 4 | 1AZ-FSE | 112/150 | 05/98→10/03 | | | CET12P | OE182 | |
| 2.2 TD | 4 | 3C-TE | 69/93 | 10/98→10/03 | CH608 | 11v | | | |

GRANVIA

| | | | | | | | | | |
|---------|---|--------|---------|-------------|-------|-----|------|-------|--|
| 2.7 | 4 | 3RZ-FE | 112/150 | 08/95→09/98 | OE039 | 1,0 | CET2 | | |
| 3.0 TDi | 4 | 1KZ-TE | 96/129 | 08/95→12/04 | CH608 | 11v | | | |
| 3.4 | 6 | 5VZ-FE | 140/188 | 08/95→12/04 | OE019 | 0,9 | CET2 | OE184 | |

HARRIER

| | | | | | | | | | |
|--------------|---|--------|---------|-------------|-------|-----|--------|-------|--|
| 2.2 4WD | 4 | 5S-FE | 103/138 | 03/98→01/03 | OE039 | 1,0 | CET2 | OE179 | |
| 2.4, 2.4 4WD | 4 | 2AZ-FE | 118/158 | 06/00→06/12 | | | CET12P | OE182 | |
| 3.0 4WD | 6 | 1MZ-FE | 150/201 | 10/03→12/08 | | | CET12P | OE182 | |

TOYOTA



kW/BHP

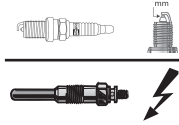

eon TITAN

IRIDIUM

**...TOYOTA****...HARRIER**

| | | | | | | | | |
|----------------|---|--------|---------|---------------|--|--|--------|-------|
| 3.0 4WD | 6 | 1MZ-FE | 164/220 | 03/98 → 01/03 | | | CET12P | OE182 |
| 3.3 4WD | 6 | 3MZ-FE | 171/229 | 10/03 → 12/08 | | | CET12P | OE182 |
| 3.3 Hybrid 4WD | 6 | 3MZ-FE | 155/208 | 04/05 → 05/12 | | | CET12P | OE182 |
| 3.5 4WD | 6 | 2GR-FE | 206/276 | 04/05 → 12/08 | | | CET14P | OE190 |

HIGHLANDER / KLUGER

| | | | | | | | | |
|----------------|---|--------|---------|---------------|--|--|--------|-------|
| 3.3 Hybrid 4WD | 6 | 3MZ-FE | 200/268 | 03/05 → 05/07 | | | CET12P | OE182 |
| 3.5 4WD | 6 | 2GR-FE | 201/270 | 05/07 → | | | CET14P | OE190 |

HILUX

| | | | | | | | | |
|--------------|---|--------|---------|---------------|-----------------|-----|------|-------|
| 2.7 | 4 | 3RZ-FE | 107/143 | 08/01 → 07/04 | OE005 | 0,9 | CET2 | OE179 |
| | | | | | OE218 LPG [278] | 1,6 | | |
| 3.0 TDiC 4WD | 4 | 1KZ-T | 92/123 | 08/93 → 07/97 | CH608 | 11v | | |
| 3.4 4WD | 6 | 5VZ-FE | 131/176 | 11/95 → 07/04 | OE019 | 0,9 | CET2 | OE184 |
| 3.4 4WD | 6 | 5VZ-FE | 136/182 | 11/95 → 07/00 | OE019 | 0,9 | CET2 | OE184 |

HILUX II

| | | | | | | | | |
|--------------|---|--------|---------|---------------|-------|-----|------|-------|
| 2.7, 2.7 4WD | 4 | 3RZ-FE | 110/148 | 08/94 → 07/00 | OE005 | 0,9 | CET2 | |
| 3.0 D | 4 | 5L | 67/90 | 08/02 → 07/04 | CH154 | 11v | | |
| 3.4, 3.4 4WD | 6 | 5VZ-FE | 131/176 | 08/01 → 07/05 | OE019 | 0,9 | CET2 | OE184 |

HILUX V

| | | | | | | | | |
|------------------|---|----|-------|---------------|-------|-----|--|--|
| 2.4 D, 2.4 D 4WD | 4 | 2L | 58/78 | 01/94 → 12/97 | CH154 | 11v | | |
|------------------|---|----|-------|---------------|-------|-----|--|--|

HILUX VI

| | | | | | | | | |
|------------|---|--------|---------|---------------|-----------------|-----|------|-------|
| 2.4 D | 4 | 2L | 55/74 | 08/97 → 04/05 | CH154 | 11v | | |
| 2.4 i 4WD | 4 | 2RZ-FE | 103/138 | 08/97 → 10/05 | OE002 | 0,9 | CET2 | OE180 |
| 2.4 TD 4WD | 4 | 2L-T | 66/89 | 08/98 → 01/02 | CH154 | 11v | | |
| 2.7 | 4 | 3RZ-FE | 107/143 | 01/98 → 07/04 | OE005 | 0,9 | CET2 | OE179 |
| | | | | | OE218 LPG [278] | 1,6 | | |
| 2.7 4WD | 4 | 3RZ-FE | 108/145 | 11/97 → 04/05 | OE005 | 0,9 | CET2 | |
| 2.8 D 4WD | 4 | 3L | 61/82 | 08/97 → 07/01 | CH154 | 11v | | |
| 3.0 D 4WD | 4 | 5L | 67/90 | 01/02 → 07/05 | CH154 | 11v | | |
| 3.0 TD 4WD | 4 | 1KZ-TE | 85/114 | 11/01 → 04/05 | CH608 | 11v | | |

HILUX VII

| | | | | | | | | |
|--------------|---|--------|---------|---------------|-------|-----|--------|----------------|
| 2.0 | 4 | 1TR-FE | 108/145 | 08/05 → 05/15 | | | CET12P | OE188 |
| 2.7, 2.7 4WD | 4 | 2TR-FE | 118/158 | 08/05 → 05/15 | OE035 | 0,9 | CET5 | OE190 |
| 4.0 | 6 | 1GR-FE | 175/235 | 08/05 → | OE035 | 0,9 | CET5 | OE190 |
| 4.0 4WD | 6 | 1GR-FE | 175/235 | 08/05 → | OE035 | 0,9 | CET5 | OE190 BAEA167E |

MARK II

| | | | | | | | | |
|----------|---|--------|---------|---------------|-------|-----|--------|-------|
| 2.0 VVTi | 6 | 1G-FE | 118/158 | 10/96 → 06/07 | OE136 | 0,8 | CET12P | OE179 |
| 2.2 | 4 | 5S-FE | 96/129 | 08/96 → 07/01 | OE039 | 1,0 | CET2 | OE179 |
| 3.0 | 6 | 2JZ-GE | 166/223 | 08/96 → 07/01 | OE191 | 1,0 | CET12P | OE180 |
| 3.0 VVTi | 6 | 2JZ-GE | 162/217 | 10/96 → 09/01 | OE191 | 1,0 | CET12P | OE180 |

MARK X I

| | | | | | | | | |
|------------------------|---|---------|---------|---------------|--|--|--------|----------------|
| 2.5 VVTi, 2.5 VVTi 4WD | 6 | 4GR-FSE | 158/212 | 03/04 → 09/09 | | | CET14P | OE190 BAEA192E |
| 3.0 VVTi | 6 | 3GR-FSE | 183/245 | 05/04 → 09/09 | | | | BAEA192E |

MARK X II

| | | | | | | | | |
|--------------|---|---------|---------|---------|--|--|--------|-------|
| 2.5, 2.5 4WD | 6 | 4GR-FSE | 149/200 | 10/09 → | | | CET14P | OE190 |
| 3.5 | 6 | 2GR-FSE | 234/314 | 10/09 → | | | CET14P | OE190 |

MARK X ZiO

| | | | | | | | | |
|--------------|---|--------|---------|---------|--|--|--------|-------|
| 2.4, 2.4 4WD | 4 | 2AZ-FE | 120/161 | 09/07 → | | | CET12P | OE182 |
| 3.5 | 6 | 2GR-FE | 206/276 | 09/07 → | | | CET14P | OE190 |

INNOVA I

| | | | | | | | | |
|-----|---|--------|---------|---------|-------|-----|------|--|
| 2.7 | 4 | 2TR-FE | 118/158 | 08/04 → | OE035 | 0,9 | CET5 | |
|-----|---|--------|---------|---------|-------|-----|------|--|

TOYOTA





kW/BHP



eon TITAN

IRIDIUM

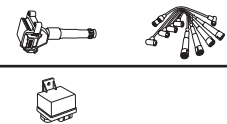

...TOYOTA



| IQ | | | | | | | | | |
|---------------------------|---|---------|---------|-------------|----------------------------|-----|--------|-------|--|
| 1.0 | 3 | 1KR-FE | 50/67 | 01/09→ | OE035 | 0,9 | CET5 | OE190 | BAEA165E ^[168] |
| 1.3 | 4 | 1NR-FE | 72/97 | 01/09→ | | | | | BAEA192E |
| ISIS | | | | | | | | | |
| 1.8 VVTi | 4 | 1ZZ-FE | 97/130 | 07/04→ | OE093 | 1,0 | CET2 | OE182 | |
| 1.8 VVTi | 4 | 2ZR-FAE | 106/142 | 04/07→ | | | | | BAEA184E |
| 1.8 VVTi 4WD | 4 | 2ZR-FAE | 98/131 | 04/07→ | | | | | BAEA184E |
| 2.0 VVTi | 4 | 3ZR-FAE | 116/156 | 04/07→ | | | | | BAEA184E |
| 2.0 VVTi, 2.0 VVTi 4WD | 4 | 1AZ-FSE | 114/153 | 07/04→ | | | CET12P | OE182 | |
| IST | | | | | | | | | |
| 1.3 VVTi | 4 | 2NZ-FE | 63/84 | 05/04→07/07 | OE093 | 1,0 | CET2 | OE182 | |
| 1.5 VVTi | 4 | 1NZ-FE | 80/107 | 05/04→07/07 | OE093 | 1,0 | CET2 | OE182 | |
| KLUGER | | | | | | | | | |
| 2.4, 2.4 4WD | 4 | 2AZ-FE | 115/154 | 06/00→05/07 | | | CET12P | OE182 | |
| 2.4, 2.4 4WD | 4 | 2AZ-FE | 118/158 | 06/00→05/07 | | | CET12P | OE182 | |
| 2.7 VVTi, 2.7 VVTi 4WD | 4 | 1AR-FE | 140/188 | 05/07→ | | | CET14P | OE190 | |
| 3.0, 3.0 4WD | 6 | 1MZ-FE | 164/220 | 06/00→05/07 | | | CET12P | OE182 | |
| 3.0 4WD | 6 | 1MZ-FE | 150/201 | 10/03→05/07 | | | CET12P | OE182 | |
| 3.3, 3.3 4WD | 6 | 3MZ-FE | 171/229 | 10/03→05/07 | | | CET12P | OE182 | |
| 3.3 Hybrid | 6 | 3MZ-FE | 200/268 | 03/05→05/07 | | | CET12P | OE182 | |
| 3.5 | 6 | 2GR-FE | 201/270 | 05/07→ | | | CET14P | OE190 | |
| LAND CRUISER | | | | | | | | | |
| 2.7 4WD | 4 | 3RZ-FE | 112/150 | 09/02→08/04 | OE005 | 0,9 | CET2 | OE179 | BAEA186E |
| | | | | | OE218 ^{LP6 [278]} | 1,6 | | | |
| 2.7 4WD | 4 | 2TR-FE | 120/161 | 11/03→02/10 | OE035 | 0,9 | CET5 | OE190 | BAEA167E |
| 3.0 TD 4WD | 4 | 1KZ-T | 92/123 | 05/93→05/96 | CH608 | 11v | | | |
| 4.6 V8 4WD | 8 | 1UR-FE | 227/304 | 09/10→ | | | CET14P | OE190 | BAEA192E |
| 5.7 V8 4WD | 8 | 3UR-FE | 268/359 | 09/11→ | | | CET14P | OE190 | |
| 5.7 V8 4WD | 8 | 3UR-FE | 284/381 | 08/07→ | | | CET14P | OE190 | |
| LAND CRUISER 90 | | | | | | | | | |
| 2.7 4WD | 4 | 3RZ-FE | 110/148 | 04/95→07/02 | OE005 | 0,9 | CET2 | | |
| 3.0 TD 4WD | 4 | 1KZ-TE | 92/123 | 04/96→12/02 | CH608 | 11v | | | |
| 3.0 TD 4WD | 4 | 1KZ-TE | 103/138 | 04/95→07/00 | CH608 | 11v | | | |
| 3.4 i 24V 4WD | 6 | 5VZ-FE | 131/176 | 03/96→12/02 | OE019 | 0,9 | CET2 | OE184 | |
| 4.7 4WD | 8 | 2UZ-FE | 175/235 | 08/02→ | | | CET12P | OE182 | |
| LAND CRUISER 100 | | | | | | | | | |
| 4.5 4WD | 6 | 1FZ-FE | 173/232 | 03/98→08/07 | OE019 | 0,9 | | | |
| 4.7 4WD | 8 | 2UZ-FE | 173/232 | 01/98→08/07 | | | CET12P | OE182 | BAEA172E ^[161] |
| 4.7 4WD | 8 | 2UZ-FE | 175/235 | 02/02→08/07 | | | CET12P | OE182 | BAEA172E |
| LAND CRUISER 150 | | | | | | | | | |
| 2.7 4WD | 4 | 2TR-FE | 120/161 | 01/10→ | OE035 | 0,9 | CET5 | | BAEA167E ^[275] BAEA171E ^[275] |
| LAND CRUISER 200 | | | | | | | | | |
| 4.6 V8 4WD | 8 | 1UR-FE | 234/314 | 01/12→ | | | CET14P | OE190 | BAEA192E |
| 4.7 V8 4WD | 8 | 2UZ-FE | 202/271 | 08/07→ | | | CET12P | OE182 | |
| 4.7 V8 4WD | 8 | 2UZ-FE | 212/284 | 01/08→ | OE136 | 0,8 | CET12P | OE179 | |
| LAND CRUISER PRADO | | | | | | | | | |
| 3.0 D-4D 4WD | 4 | 1KZ-TE | 92/123 | 09/02→07/09 | CH608 | 11v | | | |
| 3.4 4WD | 6 | 5VZ-FE | 136/182 | 09/02→08/04 | OE019 | 0,9 | CET2 | OE184 | |
| 4.0 4WD | 6 | 1GR-FE | 179/240 | 09/02→08/10 | OE035 | 0,9 | CET5 | OE190 | BAEA167E |
| 4.0 4WD | 6 | 1GR-FE | 183/245 | 12/02→12/09 | OE035 | 0,9 | CET5 | OE190 | BAEA167E ^[166] |

TOYOTA





kW/BHP



eon TITAN

IRIDIUM



...TOYOTA



...LAND CRUISER PRADO

| | | | | | | | | | |
|----------------------|---|--------|---------|--------|--|--|--------|-------|----------------------|
| 4.0 V6 Dual VVTi 4WD | 6 | 1GR-FE | 205/275 | 08/09→ | | | CET14P | OE190 | BAEA172E BAEA192E |
| 4.0 V6 VVTi 4WD | 6 | 1GR-FE | 183/245 | 01/10→ | | | CET14P | OE190 | |
| 4.0 V6 VVTi 4WD | 6 | 1GR-FE | 203/272 | 01/10→ | | | CET14P | OE190 | |
| 4.0 V6 VVT-i 4WD | 6 | 1GR-FE | 207/278 | 01/03→ | | | CET14P | OE190 | BAEA192E |

MAJESTA

| | | | | | | | | | |
|-----|---|--------|---------|-------------|-------|-----|--------|-------|--|
| 4.0 | 8 | 1UZ-FE | 206/276 | 09/99→08/03 | OE136 | 0,8 | CET12P | OE179 | |
|-----|---|--------|---------|-------------|-------|-----|--------|-------|--|

MATRIX

| | | | | | | | | | |
|----------|---|--------|--------|-------------|-------|-----|------|-------|--|
| 1.8 4WD | 4 | 1ZZ-FE | 91/122 | 01/02→02/04 | OE093 | 1,0 | CET2 | OE182 | |
| 1.8 VVTi | 4 | 1ZZ-FE | 96/129 | 01/02→02/04 | OE093 | 1,0 | CET2 | OE182 | |

MR 2 III

| | | | | | | | | | |
|--------------|---|--------|---------|-------------|-------|-----|------|-------|---------------------------|
| 1.8 16V VT-i | 4 | 1ZZ-FE | 103/138 | 10/99→06/07 | OE093 | 1,0 | CET2 | OE182 | BAEA164E ^[167] |
|--------------|---|--------|---------|-------------|-------|-----|------|-------|---------------------------|

NADIA

| | | | | | | | | | |
|---------|---|--------|---------|-------------|-------|-----|------|--|--|
| 2.0 | 4 | 3S-FE | 100/134 | 04/98→08/03 | OE026 | 0,9 | CET2 | | |
| 2.0 4WD | 4 | 3S-FSE | 107/143 | 04/98→08/03 | OE176 | 1,0 | CET3 | | |

NOAH/VOXY

| | | | | | | | | | |
|--------------|---|---------|---------|-------------|--|--|--------|-------|----------|
| 2.0 | 4 | 3ZR-FAE | 116/156 | 06/07→ | | | | | BAEA184E |
| 2.0, 2.0 4WD | 4 | 1AZ-FSE | 112/150 | 12/01→06/07 | | | CET12P | OE182 | |
| 2.0 4WD | 4 | 3ZR-FAE | 114/153 | 06/07→09/13 | | | | | BAEA184E |

OPA

| | | | | | | | | | |
|---------|---|---------|---------|-------------|-------|-----|--------|-------|--|
| 1.8 | 4 | 1ZZ-FE | 100/134 | 04/00→08/03 | OE093 | 1,0 | CET2 | OE182 | |
| 1.8 4WD | 4 | 1ZZ-FE | 92/123 | 04/00→08/03 | OE093 | 1,0 | CET2 | OE182 | |
| 2.0 | 4 | 1AZ-FSE | 112/150 | 08/00→04/05 | | | CET12P | OE182 | |

PASEO

| | | | | | | | | | |
|-----|---|-------|--------|-------------|-------|-----|------|-------|--|
| 1.5 | 4 | 5E-FE | 81/109 | 08/95→06/99 | OE063 | 1,0 | CET2 | OE180 | |
|-----|---|-------|--------|-------------|-------|-----|------|-------|--|

PASSO

| | | | | | | | | | |
|--------------|---|--------|--------|-------------|-------|-----|--------|-------|--|
| 1.0, 1.0 4WD | 3 | 1KR-FE | 51/68 | 06/05→ | OE035 | 0,9 | CET5 | OE190 | |
| 1.3 | 4 | K3-VE | 77/103 | 06/05→12/07 | OE136 | 0,8 | CET12P | | |

PASSO SETTE

| | | | | | | | | | |
|--------------|---|--------|--------|--------|--|--|--------|-------|--|
| 1.5, 1.5 4WD | 4 | 3SZ-VE | 80/107 | 12/08→ | | | CET10P | OE187 | |
|--------------|---|--------|--------|--------|--|--|--------|-------|--|

PICNIC

| | | | | | | | | | |
|---------|---|-------|---------|-------------|-------|-----|------|-------|--------|
| 2.0 | 4 | 3S-FE | 90/121 | 01/01→12/01 | OE026 | 0,9 | CET2 | OE188 | |
| 2.0 | 4 | 3S-FE | 100/134 | 05/96→04/01 | OE026 | 0,9 | CET2 | | |
| 2.0 16V | 4 | 3S-FE | 94/126 | 08/96→09/00 | OE026 | 0,9 | CET2 | OE188 | CLS232 |
| 2.2 D | 4 | 3C-TE | 66/89 | 08/97→12/01 | CH608 | 11v | | | |

PLATZ

| | | | | | | | | | |
|-------------------|---|--------|--------|-------------|-------|-----|------|-------|--|
| 1.0 | 4 | 1SZ-FE | 50/67 | 04/99→08/05 | OE093 | 1,0 | CET2 | OE182 | |
| 1.3, 1.3 VVTi 4WD | 4 | 2NZ-FE | 63/84 | 08/99→08/05 | OE093 | 1,0 | CET2 | OE182 | |
| 1.5, 1.5 VVTi 4WD | 4 | 1NZ-FE | 78/105 | 04/99→08/05 | OE093 | 1,0 | CET2 | OE182 | |

PORTE

| | | | | | | | | | |
|----------|---|--------|--------|-------------|-------|-----|--------|-------|--|
| 1.3 VVTi | 4 | 2NZ-FE | 64/86 | 07/04→07/12 | OE093 | 1,0 | CET2 | OE182 | |
| 1.5 4WD | 4 | 1NZ-FE | 77/103 | 07/04→07/12 | | | CET12P | OE182 | |
| 1.5 VVTi | 4 | 1NZ-FE | 81/109 | 07/04→07/12 | OE093 | 1,0 | CET2 | OE182 | |

PORTE II

| | | | | | | | | | |
|---------|---|--------|--------|--------|--|--|--------|-------|--|
| 1.5 | 4 | 1NZ-FE | 80/107 | 08/12→ | | | CET14P | OE190 | |
| 1.5 4WD | 4 | 1NZ-FE | 76/102 | 08/12→ | | | CET14P | OE190 | |

PREMIO

| | | | | | | | | | |
|---------|---|---------|---------|-------------|--|--|--------|-------|----------|
| 1.5 | 4 | 1NZ-FE | 81/109 | 07/07→ | | | CET14P | OE190 | |
| 1.8 | 4 | 2ZR-FAE | 106/142 | 12/01→11/12 | | | | | BAEA184E |
| 1.8 4WD | 4 | 2ZR-FAE | 98/131 | 07/07→ | | | | | BAEA184E |

TOYOTA





kW/BHP

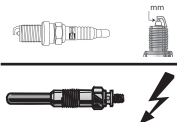

eon TITAN

IRIDIUM

**...TOYOTA****...PREMIO**

2.0, 2.0 4WD 4 3ZR-FAE 116/156 07/07→ BAEA184E

PREVIA

| | | | | | | | | | |
|--------------|---|--------|---------|-------------|-------|-----|--------|-------|--|
| 2.0 | 4 | 3S-FE | 94/126 | 10/00→08/03 | OE026 | 0,9 | CET2 | | |
| 2.4 | 4 | 2AZ-FE | 115/154 | 02/00→02/06 | | | CET12P | OE182 | BAEA167E [275] BAEA171E [169] [275] |
| 3.0, 3.0 4WD | 6 | 1MZ-FE | 162/217 | 02/00→12/05 | | | CET12P | OE182 | |

PREVIA III

| | | | | | | | | | |
|--------------|---|--------|---------|--------|--|--|--------|-------|----------|
| 2.4 | 4 | 2AZ-FE | 125/168 | 10/05→ | | | CET12P | OE182 | BAEA171E |
| 3.5, 3.5 4WD | 6 | 2GR-FE | 206/276 | 01/06→ | | | CET14P | OE190 | |

PRIUS

| | | | | | | | | | |
|------------|---|---------|---------|-------------|--|--|--------|--------------------------------|----------------|
| 1.5 | 4 | 1NZ-FXE | 43/58 | 12/97→08/00 | | | CET12P | OE180 [160] OE193 | |
| 1.5 | 4 | 1NZ-FXE | 57/76 | 09/03→12/09 | | | CET12P | OE193 | BAEA165E [168] |
| 1.5 Hybrid | 4 | 1NZ-FXE | 53/71 | 05/00→01/04 | | | CET12P | OE180 [160] →04/03 OE193 | BAEA165E [168] |
| 1.5 Hybrid | 4 | 1NZ-FXE | 85/114 | 09/00→12/03 | | | CET12P | OE180 [160] →04/03 OE193 | |
| 1.5 Hybrid | 4 | 1NZ-FXE | 107/143 | 09/03→03/09 | | | CET12P | OE193 | |
| 1.8 Hybrid | 4 | 2ZR-FXE | 73/98 | 04/09→ | | | | | BAEA184E |

PRIUS C

| | | | | | | | | | |
|------------|---|---------|-------|--------|--|--|--------|--|----------|
| 1.5 Hybrid | 4 | 1NZ-FXE | 54/72 | 02/12→ | | | CET12P | | BAEA165E |
| 1.5 Hybrid | 4 | 1NZ-FXE | 74/99 | 09/11→ | | | CET12P | | |

PRIUS PLUS

| | | | | | | | | | |
|------------|---|---------|-------|--------|--|--|--|--|----------|
| 1.8 Hybrid | 4 | 2ZR-FXE | 73/98 | 05/11→ | | | | | BAEA184E |
|------------|---|---------|-------|--------|--|--|--|--|----------|

PROBOX/SUCCEED

| | | | | | | | | | |
|------------------------|---|---------|--------|-------------|-------|-----|--------|-------|--|
| 1.3 VVTi | 4 | 2NZ-FE | 64/86 | 07/02→08/14 | OE093 | 1,0 | CET2 | OE182 | |
| 1.5 VVTi, 1.5 VVTi 4WD | 4 | 1NZ-FE | 80/107 | 07/02→08/14 | OE093 | 1,0 | CET2 | OE182 | |
| 1.5 VVTi 4WD | 4 | 1NZ-FE | 77/103 | 07/02→08/14 | OE093 | 1,0 | CET2 | | |
| 1.5 VVTi Hybrid | 4 | 1NZ-FXE | 68/91 | 07/02→08/14 | OE191 | 1,0 | CET12P | OE180 | |

PROGRES

| | | | | | | | | | |
|-----|---|---------|---------|-------------|--|--|--------|-------|--|
| 2.5 | 6 | 1JZ-FSE | 147/197 | 10/97→06/07 | | | CET12P | OE188 | |
| 3.0 | 6 | 2JZ-FSE | 162/217 | 10/97→06/07 | | | CET12P | OE188 | |

RACTIS

| | | | | | | | | | |
|--------------|---|--------|--------|-------------|-------|-----|--------|-------|--|
| 1.3 | 4 | 2SZ-FE | 64/86 | 09/05→08/10 | OE093 | 1,0 | CET2 | | |
| 1.5 VVTi | 4 | 1NZ-FE | 80/107 | 09/05→08/10 | | | CET14P | OE190 | |
| 1.5 VVTi 4WD | 4 | 1NZ-FE | 76/102 | 09/05→08/10 | | | CET14P | OE190 | |

RAUM

| | | | | | | | | | |
|---------|---|--------|--------|-------------|-------|-----|------|-------|--|
| 1.5 | 4 | 5E-FE | 66/89 | 05/97→03/03 | OE063 | 1,0 | CET2 | OE180 | |
| 1.5 | 4 | 5E-FE | 69/93 | 08/97→04/03 | OE063 | 1,0 | CET2 | OE180 | |
| 1.5 | 4 | 1NZ-FE | 80/107 | 05/03→ | OE093 | 1,0 | CET2 | OE182 | |
| 1.5 4WD | 4 | 5E-FE | 67/90 | 08/97→04/03 | OE063 | 1,0 | CET2 | OE180 | |
| 1.5 4WD | 4 | 1NZ-FE | 77/103 | 05/03→ | OE093 | 1,0 | CET2 | OE182 | |

RAV 4 I

| | | | | | | | | | |
|---------|---|-------|---------|-------------|-------|-----|--------|-------|--------------|
| 2.0 | 4 | 3S-FE | 99/133 | 06/97→09/99 | OE026 | 0,9 | CET2 | | |
| 2.0 4WD | 4 | 3S-FE | 94/126 | 07/96→06/00 | OE026 | 0,9 | CET2 | OE188 | CLS233 [292] |
| 2.0 4WD | 4 | 3S-FE | 95/127 | 06/94→06/00 | OE026 | 0,9 | CET2 | OE188 | CLS233 [292] |
| 2.0 4WD | 4 | 3S-FE | 99/133 | 01/94→09/99 | OE026 | 0,9 | CET2 | OE188 | |
| 2.0 4WD | 4 | 3S-GE | 121/162 | 01/94→09/99 | OE136 | 0,8 | CET12P | | |

TOYOTA



kW/BHP



eon TITAN

IRIDIUM



...TOYOTA



RAV 4 II

| | | | | | | | | | |
|---------------|---|--------|---------|-------------|-------|-----|--------|-------|--|
| 1.8 | 4 | 1ZZ-FE | 92/123 | 08/00→11/05 | OE093 | 1,0 | CET2 | OE182 | BAEA164E ^[167] |
| 2.0 4WD | 4 | 1AZ-FE | 110/148 | 06/00→11/05 | | | CET12P | OE182 | BAEA167E ^[275] BAEA171E ^{[169] [275]} |
| 2.4 VVT-i 4WD | 4 | 2AZ-FE | 112/150 | 08/03→11/05 | | | CET12P | OE182 | BAEA167E |

RAV 4 III

| | | | | | | | | | |
|--------------------------|---|---------|---------|--------|--|--|--------|-------|--|
| 2.0, 2.0 4WD | 4 | 3ZR-FAE | 116/156 | 12/08→ | | | | | BAEA184E |
| 2.0 4WD | 4 | 1AZ-FE | 112/150 | 03/06→ | | | CET12P | OE182 | BAEA167E ^[275] BAEA171E ^{[169] [275]} |
| 2.0 VVT-i, 2.0 VVT-i 4WD | 4 | 3ZR-FAE | 109/146 | 03/09→ | | | | | BAEA184E |
| 2.4 | 4 | 2AZ-FE | 125/168 | 11/05→ | | | CET12P | OE182 | BAEA167E ^[275] BAEA171E ^{[169] [275]} |
| 2.4 VVT-i 4WD | 4 | 2AZ-FE | 125/168 | 11/05→ | | | CET12P | OE182 | BAEA171E |
| 3.5 4WD | 6 | 2GR-FE | 206/276 | 08/07→ | | | CET14P | OE190 | |
| 3.5 VVT-i 4WD | 6 | 2GR-FE | 201/270 | 11/05→ | | | CET14P | OE190 | |

RAV 4 IV

| | | | | | | | | | |
|---------------|---|---------|---------|--------|--|--|--------|-------|----------|
| 2.0 4WD | 4 | 3ZR-FAE | 111/149 | 12/12→ | | | | | BAEA184E |
| 2.0 VVT-i | 4 | 3ZR-FAE | 107/143 | 12/12→ | | | | | BAEA184E |
| 2.5 VVT-i 4WD | 4 | 2AR-FE | 132/177 | 12/12→ | | | CET14P | OE190 | BAEA192E |

RUSH

| | | | | | | | | | |
|--------------|---|--------|--------|--------|--|--|--------|-------|--|
| 1.5, 1.5 4WD | 4 | 3SZ-VE | 80/107 | 03/06→ | | | CET10P | OE187 | |
|--------------|---|--------|--------|--------|--|--|--------|-------|--|

SCEPTER

| | | | | | | | | | |
|-----|---|--------|---------|-------------|-------|-----|--------|-------|--|
| 2.5 | 6 | 4VZ-FE | 129/173 | 11/94→09/96 | OE146 | 1,0 | CET12P | OE179 | |
|-----|---|--------|---------|-------------|-------|-----|--------|-------|--|

SEQUOIA

| | | | | | | | | | |
|--------------|---|--------|---------|-------------|--|--|--------|-------|--|
| 4.7 4WD | 8 | 2UZ-FE | 204/274 | 05/00→11/07 | | | CET12P | OE182 | |
| 4.7 4WD | 8 | 2UZ-FE | 206/276 | 09/04→ | | | CET12P | OE182 | |
| 4.7, 4.7 4WD | 8 | 2UZ-FE | 175/235 | 05/00→11/07 | | | CET12P | OE182 | |
| 5.7 4WD | 8 | 3UR-FE | 284/381 | 11/07→ | | | CET14P | OE190 | |

SIENNA

| | | | | | | | | | |
|---------|---|--------|---------|-------------|-------|-----|--------|-------|--|
| 3.0 | 6 | 1MZ-FE | 143/192 | 08/97→12/02 | OE026 | 0,9 | CET2 | OE188 | |
| 3.0 | 6 | 1MZ-FE | 154/207 | 08/97→12/02 | OE026 | 0,9 | CET2 | OE188 | |
| 3.3 4WD | 6 | 3MZ-FE | 169/227 | 01/03→11/09 | | | CET12P | OE182 | |
| 3.5 4WD | 6 | 2GR-FE | 198/266 | 01/07→ | | | CET14P | OE190 | |

SIENTA

| | | | | | | | | | |
|--------------|---|--------|--------|-------------|-------|-----|------|-------|--|
| 1.5, 1.5 4WD | 4 | 1NZ-FE | 81/109 | 05/03→ | OE093 | 1,0 | CET2 | OE182 | |
| 1.5 4WD | 4 | 1NZ-FE | 77/103 | 05/03→05/15 | OE093 | 1,0 | CET2 | | |

SOLARA

| | | | | | | | | | |
|-----|---|--------|---------|-------------|-------|-----|--------|-------|--|
| 2.4 | 4 | 2AZ-FE | 117/157 | 07/03→11/08 | | | CET12P | OE182 | |
| 3.0 | 6 | 1MZ-FE | 140/188 | 06/98→06/01 | OE026 | 0,9 | CET2 | OE188 | |

SOLUNA VIOS

| | | | | | | | | | |
|-----|---|--|-------|-------------|-------|-----|------|--|--|
| 1.5 | 4 | | 68/91 | 07/02→08/13 | OE063 | 1,0 | CET2 | | |
|-----|---|--|-------|-------------|-------|-----|------|--|--|

SPADE

| | | | | | | | | | |
|---------|---|--------|--------|--------|--|--|--------|-------|--|
| 1.5 | 4 | 1NZ-FE | 80/107 | 08/12→ | | | CET14P | OE190 | |
| 1.5 4WD | 4 | 1NZ-FE | 76/102 | 08/12→ | | | CET14P | OE190 | |

SPRINTER

| | | | | | | | | | |
|---------|---|-------|--------|-------------|-------|-----|--------|-------|--|
| 1.8 4WD | 4 | 4S-FE | 92/123 | 04/95→11/02 | OE146 | 1,0 | CET12P | OE179 | |
| 2.2 TD | 4 | 3C-TE | 66/89 | 04/95→11/02 | CH608 | 11v | | | |

SPRINTER CARIB

| | | | | | | | | | |
|--------------|---|-------|--------|-------------|-------|-----|--------|-------|--|
| 1.6 | 4 | 4A-FE | 81/109 | 08/95→10/01 | OE005 | 0,9 | CET2 | OE179 | |
| 1.8, 1.8 4WD | 4 | 7A-FE | 85/114 | 08/95→10/01 | OE138 | 1,0 | CET12P | OE193 | |



kW/BHP



eon TITAN

IRIDIUM

**...TOYOTA****...SPRINTER CARIB**

| | | | | | | | | | |
|---------|---|-------|--------|-------------|-------|-----|--------|-------|--|
| 1.8 4WD | 4 | 4S-FE | 92/123 | 04/95→11/02 | OE146 | 1,0 | CET12P | OE179 | |
|---------|---|-------|--------|-------------|-------|-----|--------|-------|--|

SUPRA

| | | | | | | | | | |
|-----|---|--------|---------|-------------|--|--|--|--|---|
| 3.0 | 6 | 2JZ-GE | 165/221 | 05/93→07/02 | | | | | BAEA445 ^[316] →05/96 BAEA173E ^[317] →09/97 |
|-----|---|--------|---------|-------------|--|--|--|--|---|

3.0 i Bi-Turbo

| | | | | | | | | | |
|----------------|---|---------|---------|-------------|-------|-----|--------|-------|--|
| 3.0 i Bi-Turbo | 6 | 2JZ-GTE | 243/326 | 05/93→07/02 | OE136 | 0,8 | CET12P | OE179 | |
|----------------|---|---------|---------|-------------|-------|-----|--------|-------|--|

TACOMA

| | | | | | | | | | |
|--------------|---|--------|---------|-------------|--|--|--|--|--------------------|
| 2.7, 2.7 4WD | 4 | 3RZ-FE | 112/150 | 01/95→08/04 | | | | | BAEA186E 09/00→ |
|--------------|---|--------|---------|-------------|--|--|--|--|--------------------|

TERCEL

| | | | | | | | | | |
|-----|---|-------|-------|-------------|-------|-----|------|-------|--|
| 1.5 | 4 | 5E-FE | 70/94 | 11/94→09/99 | OE063 | 1,0 | CET2 | OE180 | |
|-----|---|-------|-------|-------------|-------|-----|------|-------|--|

TUNDRA

| | | | | | | | | | |
|--------------|---|--------|---------|-------------|-------|-----|------|--|--|
| 3.4, 3.4 4WD | 6 | 5VZ-FE | 140/188 | 04/99→07/03 | OE019 | 0,9 | CET2 | | |
|--------------|---|--------|---------|-------------|-------|-----|------|--|--|

| | | | | | | | | | |
|--------------|---|--------|---------|-------------|-------|-----|------|-------|--|
| 4.0, 4.0 4WD | 6 | 1GR-FE | 180/241 | 05/03→11/06 | OE035 | 0,9 | CET5 | OE190 | |
|--------------|---|--------|---------|-------------|-------|-----|------|-------|--|

| | | | | | | | | | |
|--------------|---|--------|---------|--------|--|--|--------|-------|--|
| 5.7, 5.7 4WD | 8 | 3UR-FE | 284/381 | 01/07→ | | | CET14P | OE190 | |
|--------------|---|--------|---------|--------|--|--|--------|-------|--|

URBAN CRUISER

| | | | | | | | | | |
|-----|---|--------|-------|--------|--|--|--|--|----------|
| 1.3 | 4 | 1NR-FE | 73/98 | 01/09→ | | | | | BAEA192E |
|-----|---|--------|-------|--------|--|--|--|--|----------|

| | | | | | | | | | |
|-----|---|--------|-------|--------|--|--|--|--|----------|
| 1.3 | 4 | 1NR-FE | 74/99 | 04/09→ | | | | | BAEA192E |
|-----|---|--------|-------|--------|--|--|--|--|----------|

| | | | | | | | | | |
|----------|---|--------|--------|--------|-------|-----|------|--|--|
| 1.5 VVTi | 4 | 1NZ-FE | 80/107 | 07/07→ | OE093 | 1,0 | CET2 | | |
|----------|---|--------|--------|--------|-------|-----|------|--|--|

| | | | | | | | | | |
|--------------|---|--------|--------|--------|-------|-----|------|--|--|
| 1.5 VVTi 4WD | 4 | 1NZ-FE | 76/102 | 07/07→ | OE093 | 1,0 | CET2 | | |
|--------------|---|--------|--------|--------|-------|-----|------|--|--|

VENZA

| | | | | | | | | | |
|--------------|---|--------|---------|--------|--|--|--------|-------|----------|
| 2.7, 2.7 4WD | 4 | 1AR-FE | 136/182 | 11/08→ | | | CET14P | OE190 | BAEA192E |
|--------------|---|--------|---------|--------|--|--|--------|-------|----------|

| | | | | | | | | | |
|--------------|---|--------|---------|--------|--|--|--------|-------|--|
| 3.5, 3.5 4WD | 6 | 2GR-FE | 200/268 | 11/08→ | | | CET14P | OE190 | |
|--------------|---|--------|---------|--------|--|--|--------|-------|--|

VEROSSA

| | | | | | | | | | |
|------------------------|---|-------|---------|-------------|--|--|--------|-------|--|
| 2.0 VVTi, 2.0 VVTi 4WD | 6 | 1G-FE | 118/158 | 10/00→11/03 | | | CET12P | OE182 | |
|------------------------|---|-------|---------|-------------|--|--|--------|-------|--|

| | | | | | | | | | |
|----------|---|---------|---------|-------------|--|--|--------|-------|--|
| 2.5 VVTi | 6 | 1JZ-FSE | 147/197 | 10/00→11/03 | | | CET12P | OE188 | |
|----------|---|---------|---------|-------------|--|--|--------|-------|--|

| | | | | | | | | | |
|----------|---|---------|---------|-------------|-------|-----|--------|--|--|
| 2.5 VVTi | 6 | 1JZ-GTE | 206/276 | 10/00→11/03 | OE136 | 0,8 | CET12P | | |
|----------|---|---------|---------|-------------|-------|-----|--------|--|--|

VERSO

| | | | | | | | | | |
|-----|---|---------|--------|--------|--|--|--|--|----------|
| 1.6 | 4 | 1ZR-FAE | 97/130 | 04/09→ | | | | | BAEA184E |
|-----|---|---------|--------|--------|--|--|--|--|----------|

| | | | | | | | | | |
|-----|---|---------|---------|--------|--|--|--|--|----------|
| 1.8 | 4 | 2ZR-FAE | 108/145 | 04/09→ | | | | | BAEA184E |
|-----|---|---------|---------|--------|--|--|--|--|----------|

VERSO S

| | | | | | | | | | |
|-----|---|--------|-------|-------------|--|--|--|--|----------|
| 1.3 | 4 | 1NR-FE | 70/94 | 11/10→10/16 | | | | | BAEA192E |
|-----|---|--------|-------|-------------|--|--|--|--|----------|

| | | | | | | | | | |
|-----|---|--------|-------|-------------|--|--|--|--|----------|
| 1.3 | 4 | 1NR-FE | 73/98 | 11/10→10/16 | | | | | BAEA192E |
|-----|---|--------|-------|-------------|--|--|--|--|----------|

| | | | | | | | | | |
|-----|---|--------|--------|-------------|--|--|--------|-------|--|
| 1.5 | 4 | 1NZ-FE | 80/107 | 11/10→04/14 | | | CET14P | OE190 | |
|-----|---|--------|--------|-------------|--|--|--------|-------|--|

| | | | | | | | | | |
|---------|---|--------|--------|-------------|--|--|--------|-------|--|
| 1.5 4WD | 4 | 1NZ-FE | 76/102 | 11/10→10/16 | | | CET14P | OE190 | |
|---------|---|--------|--------|-------------|--|--|--------|-------|--|

VIOS

| | | | | | | | | | |
|----------|---|-------|-------|-------------|-------|-----|------|-------|--|
| 1.3 VVTi | 4 | 8A-FE | 64/86 | 07/02→01/08 | OE063 | 1,0 | CET2 | OE180 | |
|----------|---|-------|-------|-------------|-------|-----|------|-------|--|

| | | | | | | | | | |
|-----|---|-------|-------|-------------|-------|-----|------|--|--|
| 1.5 | 4 | 5A-FE | 68/91 | 07/02→01/08 | OE063 | 1,0 | CET2 | | |
|-----|---|-------|-------|-------------|-------|-----|------|--|--|

| | | | | | | | | | |
|----------|---|--------|--------|-------------|-------|-----|------|--|--|
| 1.5 VVTi | 4 | 1NZ-FE | 78/105 | 07/02→01/08 | OE063 | 1,0 | CET2 | | |
|----------|---|--------|--------|-------------|-------|-----|------|--|--|

VIOS/YARIS

| | | | | | | | | | |
|-----|---|--------|-------|--------|-------|-----|------|-------|----------|
| 1.0 | 3 | 1KR-FE | 52/70 | 08/07→ | OE035 | 0,9 | CET5 | OE190 | BAEA164E |
|-----|---|--------|-------|--------|-------|-----|------|-------|----------|

| | | | | | | | | | |
|-----|---|--------|--------|--------|--|--|--------|-------|--|
| 1.5 | 4 | 1NZ-FE | 80/107 | 08/07→ | | | CET14P | OE190 | |
|-----|---|--------|--------|--------|--|--|--------|-------|--|

| | | | | | | | | | |
|-----|---|--------|--------|--------|-------|-----|------|-------|--|
| 1.5 | 4 | 1NZ-FE | 81/109 | 08/07→ | OE093 | 1,0 | CET2 | OE182 | |
|-----|---|--------|--------|--------|-------|-----|------|-------|--|

VISTA

| | | | | | | | | | |
|-----|---|--------|--------|-------------|-------|-----|------|-------|--|
| 1.8 | 4 | 1ZZ-FE | 96/129 | 06/98→08/03 | OE093 | 1,0 | CET2 | OE182 | |
|-----|---|--------|--------|-------------|-------|-----|------|-------|--|

| | | | | | | | | | |
|----------------------|---|-----------------|---------|-------------|--|--|--------|-------|--|
| 2.0, 2.0 D4 N200 4WD | 4 | 1AZ-FE; 1AZ-FSE | 112/150 | 06/98→08/03 | | | CET12P | OE182 | |
|----------------------|---|-----------------|---------|-------------|--|--|--------|-------|--|

| | | | | | | | | | |
|-----|---|--------|---------|-------------|--|--|--------|-------|--|
| 2.4 | 4 | 2AZ-FE | 112/150 | 06/01→08/03 | | | CET12P | OE182 | |
|-----|---|--------|---------|-------------|--|--|--------|-------|--|

| | | | | | | | | | |
|-----|---|--------|---------|-------------|-------|-----|------|-------|--|
| 3.0 | 6 | 1MZ-FE | 140/188 | 06/98→08/02 | OE026 | 0,9 | CET2 | OE188 | |
|-----|---|--------|---------|-------------|-------|-----|------|-------|--|

| | | | | | | | | | |
|-----|---|--------|---------|-------------|--|--|--------|-------|--|
| 3.3 | 6 | 3MZ-FE | 165/221 | 06/02→08/03 | | | CET12P | OE182 | |
|-----|---|--------|---------|-------------|--|--|--------|-------|--|

WILL CYPHA

| | | | | | | | | | |
|----------|---|--------|-------|-------------|-------|-----|------|-------|--|
| 1.3 VVTi | 4 | 2NZ-FE | 62/83 | 05/01→07/05 | OE093 | 1,0 | CET2 | OE182 | |
|----------|---|--------|-------|-------------|-------|-----|------|-------|--|

TOYOTA





kW/BHP

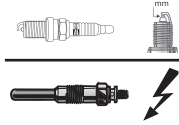

eon TITAN

IRIDIUM



TOYOTA

| ...TOYOTA | | | | | | | | | |
|------------------------|---|-----------------|---------|-------------|-------|-----|----------------|----------------|---|
| ...WILL CYPHA | | | | | | | | | |
| 1.5 VVTi 4WD | 4 | 1NZ-FE | 78/105 | 05/01→07/05 | OE093 | 1,0 | CET2 | OE182 | |
| WILL Vi | | | | | | | | | |
| 1.3 | 4 | 2NZ-FE | 64/86 | 01/00→12/01 | OE093 | 1,0 | CET2 | OE182 | |
| WILL VS | | | | | | | | | |
| 1.5 VVTi 4WD | 4 | 1NZ-FE | 81/109 | 03/01→04/04 | OE093 | 1,0 | CET2 | OE182 | |
| 1.8 VVTi, 1.8 VVTi 4WD | 4 | 1ZZ-FE | 100/134 | 03/01→04/04 | OE093 | 1,0 | CET2 | OE182 | |
| WINDOM | | | | | | | | | |
| 3.0 | 6 | 1MZ-FE | 155/208 | 10/96→07/01 | OE026 | 0,9 | CET2 | OE188 | |
| 3.0 VVTi G | 6 | 1MZ-FE | 158/212 | 08/01→07/04 | | | CET12P | OE182 | |
| WISH | | | | | | | | | |
| 1.8 Hi | 4 | 1ZZ-FE | 97/130 | 04/03→03/09 | OE093 | 1,0 | CET2 | OE182 | BAEA164E |
| 1.8 Hi 4WD | 4 | 1ZZ-FE | 92/123 | 04/03→03/09 | OE093 | 1,0 | CET2 | OE182 | BAEA164E |
| 2.0, 2.0 4WD | 4 | 3ZR-FAE | 116/156 | 04/09→ | | | | | BAEA184E |
| 2.0 Zi | 4 | 1AZ-FSE | 114/153 | 04/03→03/09 | | | CET12P | OE182 | |
| YARIS | | | | | | | | | |
| 1.0 | 4 | 1SZ-FE | 48/64 | 03/03→09/05 | | | CET2 | OE182 | BAEA165E ^[168] |
| 1.0 | 4 | 1SZ-FE | 50/67 | 04/99→09/05 | | | CET2 | OE182 | BAEA165E ^[168] |
| 1.0, 1.0 VVT-i | 3 | 1KR-FE | 51/68 | 01/05→ | OE035 | 0,9 | CET5 | OE190 | BAEA164E ^{[167][275]} BAEA165E ^[275] |
| 1.0 GPL | 3 | 1KR-FE | 51/68 | 01/06→ | OE035 | 0,9 | CET5 | OE190 | |
| 1.3 | 4 | 2NZ-FE | 63/84 | 11/99→ | | | CET2 | OE182 | BAEA165E ^[168] |
| 1.3 | 4 | 2SZ-FE | 64/86 | 04/02→09/05 | | | CET2 | OE182 | BAEA165E |
| 1.3 | 4 | 1NR-FE | 70/94 | 12/10→ | | | | | BAEA192E |
| 1.3, 1.3 VVT-i | 4 | 1NR-FE; 1NR-FKE | 73/98 | 07/10→ | | | | | BAEA192E |
| 1.3 4WD | 4 | 2NZ-FE; 2SZ-FE | 64/86 | 08/07→ | OE093 | 1,0 | CET2 | OE182 | |
| 1.3 VVT-i | 4 | 2NZ-FE; 2SZ-FE | 63/84 | 01/05→ | OE093 | 1,0 | CET2 | OE182 | BAEA165E |
| 1.3 VVT-i | 4 | 2SZ-FE | 64/86 | 08/05→ | | | CET2 | OE182 | BAEA165E ^[168] |
| 1.3 VVT-i | 4 | 1NR-FE | 74/99 | 11/08→ | | | | | BAEA192E |
| 1.5 | 4 | 1NZ-FE | 77/103 | 01/03→11/05 | | | CET2 | OE182 | BAEA165E ^[168] |
| 1.5 | 4 | 1NZ-FE | 78/105 | 04/01→ | | | CET2 | OE182 | BAEA165E ^[168] |
| 1.5 | 4 | 1NZ-FE | 80/107 | 11/05→ | OE093 | 1,0 | CET14P CET2 | OE182 OE190 | BAEA165E |
| 1.5 | 4 | 1NZ-FE | 110/148 | 03/00→07/05 | OE089 | 1,0 | CET2 | OE188 | BAEA165E ^[168] |
| 1.5 Hybrid | 4 | 1NZ-FXE | 54/72 | 04/15→ | | | CET12P | | |
| 1.5 Hybrid | 4 | 1NZ-FXE | 55/74 | 03/12→ | | | CET12P | | BAEA165E ^[168] |
| 1.8 VVTi | 4 | 1ZZ-FE | 97/130 | 11/05→ | OE093 | 1,0 | CET2 | OE182 | |
| 1.8 VVTi | 4 | 2ZR-FE | 98/131 | 01/07→12/11 | | | | | BAEA184E |
| YARIS / VIOS | | | | | | | | | |
| 1.3 | 4 | 2NZ-FE | 63/84 | 08/05→ | OE063 | 1,0 | | | |
| 1.3 | 4 | 2NZ-FE; 2SZ-FE | 64/86 | 09/05→04/14 | OE093 | 1,0 | CET2 | OE182 | BAEA165E |
| 1.3 4WD | 4 | 2NZ-FE | 64/86 | 08/07→ | OE093 | 1,0 | CET2 | OE182 | |
| YARIS VERSO | | | | | | | | | |
| 1.3 | 4 | 2NZ-FE | 62/83 | 11/02→09/05 | OE093 | 1,0 | CET2 | OE182 | BAEA165E ^[168] |
| 1.3 | 4 | 2NZ-FE | 63/84 | 08/99→10/02 | OE093 | 1,0 | CET2 | OE182 | BAEA165E ^[168] |
| 1.5 | 4 | 1NZ-FE | 77/103 | 03/00→09/05 | | | CET2 | OE182 | BAEA165E ^[168] |
| 1.5 | 4 | 1NZ-FE | 78/105 | 03/00→09/05 | | | CET2 | OE182 | BAEA165E ^[168] |
| 1.5 4WD | 4 | 1NZ-FE | 78/105 | 03/00→09/05 | OE093 | 1,0 | CET2 | | |
| ZELAS | | | | | | | | | |
| 2.5 VVT-i | 4 | 2AR-FE | 131/176 | 08/10→ | | | CET14P | OE190 | |





kW/BHP

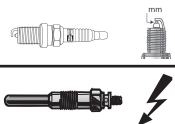

eon TITAN

IRIDIUM

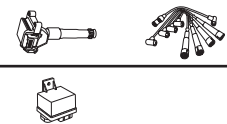

TOYOTA



COASTER

2.7 4 3RZ-FE 112/150 08/99→10/03 **OE039** 1,0 **CET2**

DELIBOY

2.2 D 4 3C-TE 66/89 10/94→10/95 **CH608** 11v

DYNA

2.7 4 2TR-FE 109/146 09/06→ **OE035** 0,9 **CET5**

3.0 D4d 4 5L 65/87 08/01→ **CH154** 11v

DYNA 150

3.0 D 4 5L 65/87 09/98→07/01 **CH154** 11v

DYNA 200

2.2 4 4Y 69/93 10/93→07/01 **OE006** 0,9 **CET8** **OE195**

HIACE / COMMUTER V

2.7 4 2TR-FE 111/149 01/05→ **OE035** 0,9 **CET5**

HIACE III

2.4 4 2RZ-E 85/114 08/95→08/04 **OE006** 0,9 **CET8** **OE195**

3.0 D 4 5L 65/87 08/98→08/04 **CH154** 11v

3.4, 3.4 4WD 6 5VZ-FE 131/176 08/95→08/01 **OE019** 0,9 **CET2** **OE184**

HIACE IV

2.4, 2.4 4WD 4 2RZ-E 85/114 08/95→11/03 **OE006** 0,9 **CET8** **OE195**

2.4 D 4 2L 55/74 08/95→08/01 **CH154** 11v

2.4 D 4 2L 58/78 08/95→08/06 **CH154** 11v

2.4 D 4 2L 61/82 08/95→08/06 **CH154** 11v

2.4 i 4 2RZ-E 88/118 08/95→08/04 **OE006** 0,9 **CET8**

2.4 TD, 2.4 TD 4WD 4 2L-T 66/89 08/95→08/06 **CH154** 11v

2.7 4 3RZ-FE 106/142 11/01→12/06 **OE005** 0,9 **CET2** **OE180**

OE218 LPG [278] 1,6

2.7, 2.7 4WD 4 3RZ-FE 105/141 04/98→08/06 **OE005** 0,9 **CET2** **OE180** **BAEA186E**

08/01→

OE218 LPG [278] 1,6

2.7 4WD 4 3RZ-FE 106/142 04/98→ **OE005** 0,9 **CET2** **OE180** **BAEA186E**

08/01→

OE218 LPG [278] 1,6

HIACE V

2.7 VVTi 4 2TR-FE 111/149 01/05→ **OE035** 0,9 **CET5** **BAEA171E**

HILUX

2.7 4 3RZ-FE 107/143 08/97→08/05 **OE005** 0,9 **CET2**

HILUX III

2.7 4 2TR-FE 118/158 02/05→ **OE035** 0,9 **CET5**

4.0, 4.0 4WD 6 1GR-FE 175/235 02/05→ **OE035** 0,9 **CET5**

LITEACE

1.8 4 1ZZ-FE 96/129 10/97→08/01 **OE093** 1,0 **CET2** **OE182**

2.2 D 4 3C-TE 66/89 02/95→08/97 **CH608** 11v

TARAGO

2.4 4 2RZ-E 85/114 08/95→10/99 **OE006** 0,9 **CET8** **OE195**

2.7 4 3RZ-FE 106/142 08/98→08/04 **OE005** 0,9 **CET2**

TOWN ACE

2.4 4 2AZ-FE 115/154 10/03→07/07 **CET12P** **OE182**

3.0 D 4 5L 65/87 10/01→07/07 **CH154** 11v

TOYOTA (FAW)



PRIUS

1.5 4 1NZ-FXE 57/76 01/06→12/09 **CET12P** **OE193**

1.8 Hybrid 4 5ZR-FXE 73/98 02/12→ **CET12P** **OE193**

TOYOTA (FAW)



kW/BHP



eon TITAN

IRIDIUM



TVR

TVR



CERBERA

| | | | | | | | | | |
|--------|---|----------|---------|-------------|-------|-----|------|-------|--|
| 4.0 | 6 | AJA6 | 268/359 | 01/99→10/03 | OE083 | 0,7 | CET1 | OE187 | |
| 4.2 | 8 | AJP8 | 268/359 | 01/96→10/03 | OE026 | 0,9 | CET2 | OE184 | |
| 4.5 | 8 | AJP8-4.5 | 313/420 | 01/97→10/03 | OE026 | 0,9 | CET2 | OE184 | |
| 4.5 GT | 8 | AJP8-4.5 | 324/434 | 01/96→10/03 | OE026 | 0,9 | CET2 | OE184 | |

CHIMAERA

| | | | | | | | | | |
|-----|---|--------|---------|-------------|-------|-----|------|-------|----------------------|
| 3.9 | 8 | 39SE | 173/232 | 04/98→12/99 | | | | | BAEA115 [8] [275] |
| 3.9 | 8 | 39SE | 177/237 | 01/93→10/03 | OE006 | 0,9 | CET8 | OE195 | BAEA115 [8] [275] |
| 3.9 | 8 | 37A40P | 202/271 | 12/94→06/97 | | | | | BAEA115 [8] [275] |
| 4.3 | 8 | 40D | 206/276 | 01/93→12/93 | OE018 | 1,0 | CET8 | OE195 | |

GRIFFITH

| | | | | | | | | | |
|-----|---|---------------------|---------|-------------|-------|-----|------|-------|--|
| 5.0 | 8 | 37A50P; 47A50P; J8T | 243/326 | 01/93→03/02 | OE018 | 1,0 | CET8 | OE195 | |
|-----|---|---------------------|---------|-------------|-------|-----|------|-------|--|

TUSCAN II

| | | | | | | | | | |
|-----|---|------|---------|-------------|-------|-----|------|-------|--|
| 4.0 | 6 | AJA6 | 268/359 | 01/98→07/06 | OE083 | 0,7 | CET1 | OE187 | |
|-----|---|------|---------|-------------|-------|-----|------|-------|--|

UAZ



3160

| | | | | | | | | | |
|-----------|---|------------|--------|-------------|-------|-----|--|--|--|
| 2.4 i 4WD | 4 | UMZ4178.10 | 76/102 | 01/94→12/03 | OE037 | 0,6 | | | |
| 2.9 4WD | 4 | UMZ-4218 | 76/102 | 01/94→12/03 | OE007 | 0,9 | | | |
| 2.9 i 4WD | 4 | UMZ-421310 | 88/118 | 01/94→12/03 | OE007 | 0,9 | | | |

31512

| | | | | | | | | | |
|------------|---|------------|---------|--------|-------|-----|--|--|--|
| 4.3 V6 4WD | 6 | UMZ-417811 | 135/181 | 01/98→ | OE037 | 0,6 | | | |
|------------|---|------------|---------|--------|-------|-----|--|--|--|

HUNTER

| | | | | | | | | | |
|---------|---|------------|--------|--------|-------|-----|------|-------|--|
| 2.7 4WD | 4 | ZMZ-409.10 | 94/126 | 07/04→ | OE013 | 0,8 | CET2 | OE193 | |
|---------|---|------------|--------|--------|-------|-----|------|-------|--|

PATRIOT

| | | | | | | | | | |
|---------|---|------------|--------|--------|-------|-----|------|-------|--|
| 2.7 4WD | 4 | ZMZ-409210 | 82/110 | 07/04→ | OE013 | 0,8 | CET2 | OE193 | |
| 2.7 4WD | 4 | ZMZ-409.10 | 94/126 | 07/04→ | OE013 | 0,8 | CET2 | OE193 | |

SIMBIR (3162)

| | | | | | | | | | |
|-----------|---|------------|--------|--------|-------|-----|--|--|--|
| 2.9 i 4WD | 4 | UMZ-421310 | 88/118 | 01/97→ | OE007 | 0,9 | | | |
|-----------|---|------------|--------|--------|-------|-----|--|--|--|

UAZ



CARGO

| | | | | | | | | | |
|---------|---|------------|--------|--------|-------|-----|------|-------|--|
| 2.7 4WD | 4 | ZMZ-409.10 | 94/126 | 07/04→ | OE013 | 0,8 | CET2 | OE193 | |
|---------|---|------------|--------|--------|-------|-----|------|-------|--|

VAUXHALL



ADAM

| | | | | | | | | | |
|---------|---|------------------------|--------|--------|--|--|------|-------|----------|
| 1.0 | 3 | | 66/89 | 07/14→ | | | | OE258 | |
| 1.0 | 3 | B10XFT; F10XFT | 85/114 | 07/14→ | | | | OE258 | |
| 1.2 | 4 | A12XEL; B12XEL; B12XER | 51/68 | 10/12→ | | | CET2 | | BAEA185E |
| 1.4 | 4 | A14XEL; B14XER | 64/86 | 10/12→ | | | CET2 | | BAEA185E |
| 1.4 | 4 | A14XER | 74/99 | 10/12→ | | | CET2 | OE184 | BAEA185E |
| 1.4 LPG | 4 | | 64/86 | 07/13→ | | | CET2 | | |

AGILA Mk I (A)

| | | | | | | | | | |
|------------------|---|--------|-------|-------------|-------|-----|------|-------|---|
| 1.0 12V | 3 | Z10XE | 43/58 | 09/00→08/05 | OE198 | 0,9 | CET2 | OE184 | BAEA358 |
| 1.0 12V | 3 | Z10XEP | 44/59 | 02/00→11/06 | OE198 | 0,9 | CET2 | OE184 | BAEA359 |
| 1.2 16V | 4 | Z12XE | 55/74 | 09/00→03/08 | OE019 | 0,9 | CET2 | OE184 | BAEA147E ^[159] BAEA338 ^[170] |
| 1.2 16V Twinport | 4 | Z12XEP | 59/79 | 07/04→11/06 | OE198 | 0,9 | CET2 | OE184 | BAEA338 |

AGILA Mk II (B)

| | | | | | | | | | |
|---------|---|------|-------|-------------|-------|-----|--------|--|--|
| 1.0 12V | 3 | K10B | 48/64 | 01/08→11/14 | OE226 | 1,1 | CET10P | | |
| 1.0 i | 3 | K10B | 50/67 | 08/11→11/14 | OE226 | 1,1 | CET10P | | |

CHAMPION



kW/BHP



eon TITAN

IRIDIUM



...VAUXHALL



...AGILA Mk II (B)

| | | | | | | | | | |
|-----------|---|--------------|-------|-------------|-------|-----|--------|-----------------------|--|
| 1.2 i 16V | 4 | K12B | 63/84 | 01/08→11/14 | OE226 | 1,1 | CET10P | BAEA189E | |
| 1.2 i 16V | 4 | K12B | 69/93 | 01/08→11/14 | OE226 | 1,1 | CET10P | BAEA189E | |
| 1.3 CDTi | 4 | D13A; Z13DTJ | 55/74 | 01/08→11/14 | | | | CCU142 ^[8] | |

AMPERA

| | | | | | | | | | |
|------------|---|---------------|---------|--------|--|--|--|----------|--|
| 1.4 EV 150 | 4 | 4ET50; A14XFL | 111/149 | 03/12→ | | | | BAEA185E | |
|------------|---|---------------|---------|--------|--|--|--|----------|--|

ANTARA

| | | | | | | | | | |
|------------------------|---|--------------|---------|-------------|-------|-----|--------|--------|----------|
| 2.2 CDTi, 2.2 CDTi 4WD | 4 | A22DM | 120/161 | 12/10→ | | | | CCU138 | |
| 2.2 CDTi 4WD | 4 | A22DMH | 135/181 | 12/10→ | | | | CCU138 | |
| 2.4, 2.4 4WD | 4 | A24XE; A24XF | 123/165 | 12/10→04/15 | | | CET17P | OE189 | |
| 2.4, 2.4 4WD | 4 | A24XE; A24XF | 126/169 | 11/10→04/15 | | | CET17P | OE189 | |
| 2.4 4WD | 4 | Z24XED | 103/138 | 08/06→04/15 | OE019 | 0,9 | CET2 | OE184 | BAEA447A |
| 3.0 4WD | 6 | A30XF; A30XH | 188/252 | 11/10→04/15 | | | CET17P | OE189 | |

ASTRA Mk III (F)

| | | | | | | | | | | |
|--------------------|---|---------------|---------|-------------|-------|-----|------|-------|----------|--|
| 1.4 i 16V | 4 | X14XE | 66/89 | 01/96→03/01 | OE019 | 0,9 | CET2 | OE184 | BAEA026E | CLS030 |
| 1.6 | 4 | C16SE | 74/99 | 03/94→08/95 | OE006 | 0,9 | CET8 | OE195 | | |
| 1.6 i | 4 | X16SZ | 52/70 | 02/93→02/98 | OE019 | 0,9 | CET2 | OE184 | BAEA026E | |
| 1.6 i 16V | 4 | X16XEL | 74/99 | 01/94→09/98 | OE019 | 0,9 | CET2 | OE184 | BAEA026E | CLS030 →Ch.20C17332 CLS029 Ch.20C17333→ |
| 1.7 TD | 4 | X17DTL | 50/67 | 01/94→09/98 | CH189 | 11v | | | | |
| 1.8 | 4 | C18XE | 92/123 | 09/94→08/96 | OE019 | 0,9 | CET2 | OE184 | | |
| 1.8 16V, 1.8 i 16V | 4 | C18XEL; X18XE | 85/114 | 01/94→03/01 | OE019 | 0,9 | CET2 | OE184 | BAEA344 | |
| 1.8 i 16V | 4 | 18SE | 82/110 | 09/95→02/98 | OE019 | 0,9 | CET2 | OE184 | | |
| 1.8 i 16V | 4 | C18XE | 92/123 | 06/93→02/98 | OE019 | 0,9 | CET2 | OE184 | BAEA344 | CLS107 |
| 2.0 i 16V | 4 | X20XEV | 100/134 | 01/94→09/98 | OE019 | 0,9 | CET2 | OE184 | BAEA344 | CLS107 |

ASTRA Mk IV (G)

| | | | | | | | | | | |
|------------------|---|-------------------------------|---------|-------------|-------|-----|------|-------|-----------------------|--------|
| 1.2 16V | 4 | X12XE | 48/64 | 02/98→09/00 | OE019 | 0,9 | CET2 | OE184 | BAEA147E | |
| 1.2 16V | 4 | Z12XE | 55/74 | 09/00→05/05 | OE019 | 0,9 | CET2 | OE184 | BAEA147E | |
| 1.4 16V | 4 | X14XE | 66/89 | 02/98→05/05 | OE019 | 0,9 | CET2 | OE184 | BAE965A | CLS030 |
| 1.4 16V | 4 | Z14XE | 66/89 | 02/98→05/05 | OE019 | 0,9 | CET2 | OE184 | BAE965A | |
| 1.6 | 4 | X16SZR | 55/74 | 02/98→04/04 | OE019 | 0,9 | CET2 | OE184 | BAEA026E | |
| 1.6 | 4 | Z16SE | 62/83 | 03/98→05/05 | OE019 | 0,9 | CET2 | OE184 | | CLS114 |
| 1.6, 1.6 16V | 4 | Z16XEP | 76/102 | 03/00→10/05 | OE198 | 0,9 | CET2 | OE184 | BAEA427 | |
| 1.6 16V | 4 | C16SEL; X16XEL; Z16XE; Z16XEP | 74/99 | 02/98→10/05 | OE019 | 0,9 | CET2 | OE184 | BAE965A | |
| | | | | | OE198 | 0,9 | | | | |
| 1.6 Dualfuel | 4 | Z16SE | 62/83 | 07/00→05/05 | OE019 | 0,9 | CET2 | OE184 | | |
| 1.6 Dualfuel | 4 | Z16SE | 63/84 | 03/98→05/05 | OE198 | 0,9 | CET2 | OE179 | BAE965A | |
| 1.7 CDTi 16V | 4 | Z17DTL | 59/79 | 04/03→05/05 | | | | | CCU143 ^[7] | |
| 1.7 DTi 16V | 4 | Y17DT | 55/74 | 02/00→05/05 | | | | | CCU143 ^[7] | |
| 1.7 TD | 4 | X17DTL | 50/67 | 02/98→08/00 | CH189 | 11v | | | CCU143 ^[7] | |
| 1.8 16V | 4 | X18XE1; Z18XEL | 85/114 | 02/98→08/05 | OE019 | 0,9 | CET2 | OE184 | BAEA342 | |
| 1.8 16V | 4 | Z18XE | 92/123 | 02/98→10/05 | OE198 | 0,9 | CET2 | OE184 | BAEA342 | |
| 1.8 16V Dualfuel | 4 | Z18XE | 87/117 | 02/98→08/05 | OE198 | 0,9 | CET2 | OE179 | BAEA342 | |
| 2.0 | 4 | X20XER | 118/158 | 10/99→08/00 | OE019 | 0,9 | CET2 | OE184 | BAEA344 | |
| 2.0 | 4 | Z20LER; Z20LET | 147/197 | 08/02→10/05 | OE019 | 0,9 | CET2 | OE184 | | |
| 2.0 16V | 4 | X20XEV | 100/134 | 02/98→05/05 | OE019 | 0,9 | CET2 | OE184 | BAEA344 | |
| 2.0 16V Turbo | 4 | Z20LET | 140/188 | 09/00→08/05 | OE019 | 0,9 | CET2 | OE184 | | |
| 2.0 DI | 4 | X20DTL; Y20DTL | 60/80 | 02/98→05/05 | CH207 | 11v | | | CCU143 ^[7] | |
| 2.0 DTi 16V | 4 | X20DTH | 74/99 | 02/98→05/05 | CH207 | 11v | | | | |

VAUXHALL





kW/BHP



eon TITAN

IRIDIUM



...VAUXHALL



...ASTRA Mk IV (G)

| | | | | | | | | | | |
|--------------------------|---|--------|---------|-------------|--|-----|---------------|--------------|--|------------------------------|
| 2.0 DTI 16V | 4 | Y20DTH | 74/99 | 02/98→05/05 | CH231 Ch.32000001 35000001 36000001 38000001 38000001 3H000001 4G000001→ | 11v | | | | CCU142 ^[8] |
| 2.0 SRI Turbo, 2.0 Turbo | 4 | Z20LET | 141/189 | 11/01→10/05 | OE019 | 0,9 | CET2 | OE184 | | |
| 2.2 16V | 4 | Z22SE | 108/145 | 03/00→10/05 | OE255 | 1,0 | CET17P | OE189 | | |
| 2.2 DTI | 4 | Y22DTR | 92/123 | 09/02→05/05 | CH231 | 11v | | | | CCU142 ^[8] |

ASTRA Mk V (H)

| | | | | | | | | | | |
|--------------------|---|----------------|---------|-------------|--|------------|---------------|------------------------------|--------------------------|--|
| 1.3 CDTi, 1.3 CDTi | 4 | Z13DTH | 66/89 | 01/04→11/10 | | | | | | CCU142 ^[8] |
| 1.4 | 4 | Z14XEL | 55/74 | 08/04→10/10 | OE198 | 0,9 | CET2 | OE184 | | |
| 1.4, 1.4 i 16V | 4 | Z14XEP | 66/89 | 01/04→11/10 | OE198 | 0,9 | CET2 | OE184 | BAEA338 | |
| 1.6 | 4 | Z16XEP | 77/103 | 01/04→11/10 | OE198 | 0,9 | CET2 | OE184 | BAEA427 | |
| 1.6 | 4 | A16XER; Z16XER | 85/114 | 01/04→05/09 | OE198 | 0,9 | CET2 | OE184 | BAEA427 12/05→ | |
| 1.6 | 4 | Z16LET | 132/177 | 08/04→11/10 | | | CET12P | OE188 | BAEA427 | |
| 1.6 i 16V | 4 | A16XER; Z16XER | 85/114 | 10/06→08/11 | OE198 | 0,9 | CET2 | OE184 | BAEA427 | |
| 1.6 Turbo | 4 | Z16LET | 132/177 | 09/06→09/09 | | | CET12P | OE188 | BAEA427 | |
| 1.7 CDTi | 4 | Z17DTL | 59/79 | 01/04→05/09 | | | | | | CCU143 ^[7] |
| 1.7 CDTi | 4 | A17DTJ; Z17DTJ | 81/109 | 01/04→10/12 | | | | | | CCU143 ^[7] |
| 1.7 CDTi, 1.7 CDTi | 4 | Z17DTH | 74/99 | 01/04→11/10 | | | | | | CCU143 ^[7] |
| 1.8 | 4 | Z18XE | 92/123 | 01/04→11/10 | OE198 | 0,9 | CET2 | OE184 | BAEA342 | |
| 1.8, 1.8 i 16V | 4 | A18XER; Z18XER | 103/138 | 01/04→11/10 | OE198 | 0,9 | CET2 | OE184 | BAEA427 | |
| 1.9 CDTi | 4 | Z19DTL | 74/99 | 08/04→11/10 | CH222 →Ch.72045139 75030986 78007391 7G | 11v | | | | CCU142 ^[8] |
| | | | | | CH269 Ch.72045140 75030987 78007392 88000001 7G→ | 11v | | | | CCU143 ^[7] |
| 1.9 CDTi, 1.9 CDTi | 4 | Z19DT | 88/118 | 01/04→11/10 | CH222 →Ch.72045139 75030986 78007391 7G | 11v | | | | CCU142 ^[8] |
| | | | | | CH269 Ch.72045140 75030987 78007392 88000001 7G→ | 11v | | | | CCU143 ^[7] |
| 1.9 CDTi, 1.9 CDTi | 4 | Z19DTH | 110/148 | 01/04→11/10 | CH224 | 11v | | | | CCU142 ^[8] CCU143 ^[7] |
| 1.9 CDTi 16V | 4 | Z19DTJ | 88/118 | 01/04→05/09 | CH224 | 11v | | | | CCU142 ^[8] |
| 2.0, 2.0 Turbo | 4 | Z20LEL | 125/168 | 01/04→11/10 | OE136 | 0,8 | CET12P | OE179 | | |
| 2.0 Turbo | 4 | Z20LER | 147/197 | 01/04→11/10 | OE089 OE198 | 1,0 0,9 | CET2 | OE179 OE184 | | |
| 2.0 Turbo | 4 | Z20LEH | 177/237 | 01/04→05/09 | OE136 | 0,8 | CET12P | OE179 | | |
| 2.0 VXR | 4 | Z20LEH | 176/236 | 02/09→11/10 | OE198 | 0,9 | CET2 | OE184 | | |

ASTRA Mk VI (J)

| | | | | | | | | | | |
|--------------------|---|--------|-------|--------|--|------|-------------|--------------|-----------------|---------------|
| 1.3 CDTi, 1.3 CDTi | 4 | A13DTE | 70/94 | 12/09→ | CP5G003 ^[37] →Ch.83999999 88999999 86999999 | 4.4v | | | | CCU138 |
| 1.4 | 4 | A14XEL | 64/86 | 12/09→ | | | CET2 | OE184 | BAEA185E | |

VAUXHALL



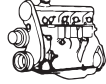

kW/BHP

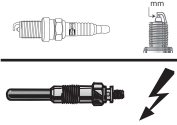

eon TITAN

IRIDIUM



...VAUXHALL



...ASTRA Mk VI (J)

| | | | | | | | | | |
|--------------------|---|----------------|---------|--------|--------------------------|------------|--------|------------------------|--------------------------|
| 1.4 | 4 | A14XER; B14XER | 74/99 | 12/09→ | | | CET2 | OE184 | BAEA185E |
| 1.4, 1.4 Turbo | 4 | A14NEL; B14NEL | 88/118 | 10/10→ | | | | | BAEA185E |
| 1.4, 1.4 Turbo | 4 | A14NET; B14NET | 103/138 | 12/09→ | | | | | BAEA185E |
| 1.6 | 4 | A16XER; B16XER | 85/114 | 12/09→ | OE198 | 0,9 | CET2 | OE184 | BAEA198E Ch.205D0232→ |
| 1.6, 1.6 Turbo | 4 | A16LET | 132/177 | 12/09→ | OE146 OE216 LPG [278] | 1,0 0,8 | CET12P | OE179 | BAEA199E |
| 1.7 CDTi | 4 | A17DTR | 92/123 | 12/09→ | | | | | CCU145 |
| 1.7 CDTi, 1.7 CDTI | 4 | A17DTJ | 81/109 | 12/09→ | | | | | CCU145 |
| 1.7 CDTi, 1.7 CDTI | 4 | A17DTE | 81/109 | 12/09→ | CPSG004 | 4.4v | | | CCU145 |
| 1.7 CDTi, 1.7 CDTI | 4 | A17DTF | 96/129 | 06/11→ | CPSG004 | 4.4v | | | CCU145 |
| 1.7 CDTi, 1.7 CDTI | 4 | A17DTS | 96/129 | 06/11→ | | | | | CCU145 |
| 2.0 BiTurbo CDTI | 4 | ; A20DTR | 143/192 | 12/12→ | CPSG006 | 4.4v | | | CCU138 |
| 2.0 CDTi | 4 | A20DTH | 118/158 | 12/09→ | CPSG006 | 4.4v | | | CCU138 |
| 2.0 CDTi | 4 | A20DTH | 121/162 | 08/11→ | CPSG006 | 4.4v | | | CCU138 |
| 2.0 VXR | 4 | A20NFT; B20NFT | 206/276 | 04/12→ | | | CET17P | OE189 *tobendjusted | |

ASTRA Mk VII (K)

| | | | | | | | | | |
|-----------|---|----------------|---------|--------|--|--|--|-------|--|
| 1.0 | 3 | B10XFL; D10XFL | 77/103 | 07/15→ | | | | OE258 | |
| 1.4 Turbo | 4 | B14XFL | 92/123 | 07/15→ | | | | OE258 | |
| 1.4 Turbo | 4 | B14XFT | 110/148 | 07/15→ | | | | OE258 | |

BRAVA

| | | | | | | | | | |
|----------------------|---|------|-------|-------------|-------|-----|------|-------|--|
| 2.3, 2.3 4WD | 4 | 23P | 72/97 | 08/94→09/96 | OE006 | 0,9 | CET8 | OE195 | |
| 2.5 DTI, 2.5 DTI 4WD | 4 | 4JA1 | 74/99 | 08/01→12/02 | CH306 | 11v | | | |

CALIBRA

| | | | | | | | | | |
|----------|---|--------------|---------|-------------|-------|-----|------|-------|--|
| 2.5 i V6 | 6 | C25XE; X25XE | 125/168 | 04/93→07/97 | OE019 | 0,9 | CET2 | OE184 | |
|----------|---|--------------|---------|-------------|-------|-----|------|-------|--|

CASCADA

| | | | | | | | | | |
|----------|---|----------------|---------|--------|---------|------|--|--|----------|
| 1.4 | 4 | | 88/118 | 02/13→ | | | | | BAEA185E |
| 1.4 | 4 | A14NET; B14NET | 103/138 | 02/13→ | | | | | BAEA185E |
| 2.0 CDTI | 4 | A20DTH | 121/162 | 02/13→ | CPSG006 | 4.4v | | | CCU138 |
| 2.0 CDTI | 4 | A20DTR | 143/192 | 02/13→ | CPSG006 | 4.4v | | | CCU138 |

CAVALIER Mk III

| | | | | | | | | | |
|-------|---|-------|-------|-------------|-------|-----|------|-------|--------------------------------------|
| 1.6 i | 4 | X16SZ | 52/70 | 09/93→11/95 | OE019 | 0,9 | CET2 | OE184 | BAEA026E BAEA253 ^[292] |
|-------|---|-------|-------|-------------|-------|-----|------|-------|--------------------------------------|

COMBO TOUR Mk II (C)

| | | | | | | | | | |
|---------|---|--------|-------|-------------|-------|-----|--------|-------|---------|
| 1.4 | 4 | Z14XEP | 66/89 | 10/04→09/10 | OE198 | 0,9 | CET2 | OE184 | |
| 1.6 CNG | 4 | Z16YNG | 69/93 | 06/06→09/10 | OE136 | 0,8 | CET12P | OE179 | BAE965A |
| 1.6 CNG | 4 | Z16YNG | 71/95 | 04/05→02/12 | OE136 | 0,8 | CET12P | OE179 | BAE965A |

CORSA Mk I (B)

| | | | | | | | | | |
|-----------|---|--------------|-------|-------------|-----------------|-----|------|------------------------------------|--|
| 1.0 i 12V | 3 | X10XE | 40/54 | 11/96→09/00 | OE019 | 0,9 | CET2 | OE184 | BAEA358 |
| 1.2 i | 4 | C12NZ | 33/44 | 03/93→09/00 | OE019 08/95→ | 0,9 | CET2 | OE195 →07/95 OE184 08/95→ | BAEA253 ^[292] CLS114 CLS115 |
| 1.2 i | 4 | X12SZ | 33/44 | 03/93→09/00 | OE019 08/95→ | 0,9 | CET2 | OE195 →07/95 OE184 08/95→ | BAEA253 ^[292] |
| 1.2 i 16V | 4 | X12XE | 48/64 | 03/98→09/00 | OE019 | 0,9 | CET2 | OE184 | BAEA147E |
| 1.4 i | 4 | C14NZ; X14SZ | 44/59 | 03/93→09/00 | OE019 08/95→ | 0,9 | CET2 | OE195 →07/95 OE184 08/95→ | BAEA253 ^[292] CLS114 |
| 1.4 i 16V | 4 | X14XE | 66/89 | 09/94→09/00 | OE019 | 0,9 | CET2 | OE184 | BAEA026E CLS030 |

VAUXHALL





kW/BHP



eon TITAN

IRIDIUM



...VAUXHALL



...CORSA Mk I (B)

| | | | | | | | | | |
|-------------|---|--------------|--------|-------------|-----------------|-----|------|------------------------------------|----------|
| 1.4 iS | 4 | C14SE | 60/80 | 03/93→09/00 | OE019 08/95→ | 0,9 | CET2 | OE195 →07/95 OE184 08/95→ | BAEA026E |
| 1.6 GSI 16V | 4 | C16XE | 80/107 | 03/93→09/00 | OE019 | 0,9 | CET2 | OE184 | BAEA026E |
| 1.6 i 16V | 4 | C16XE; X16XE | 78/105 | 09/94→09/00 | OE019 | 0,9 | CET2 | OE184 | BAEA026E |

CORSA Mk II (C)

| | | | | | | | | | |
|------------------|---|--------|--------|-------------|-------|-----|--------|-------|---|
| 1.0 12V | 3 | Z10XE | 43/58 | 09/00→10/03 | OE198 | 0,9 | CET2 | OE184 | BAEA358 |
| 1.0 12V | 3 | Z10XEP | 44/59 | 11/03→10/06 | OE198 | 0,9 | CET2 | OE184 | BAEA359 |
| 1.2 16V | 4 | Z12XE | 55/74 | 09/00→10/06 | OE019 | 0,9 | CET2 | OE184 | BAEA147E →Eng.33999999 34999999 36999999 BAEA338 Eng.43000001 44000001 46000001→ |
| 1.2 16V Dualfuel | 4 | Z12XE | 55/74 | 08/01→10/06 | OE136 | 0,8 | CET12P | OE179 | BAEA147E →08/04 |
| 1.2 Twinport | 4 | Z12XEP | 59/79 | 07/04→10/06 | OE198 | 0,9 | CET2 | OE184 | BAEA338 |
| 1.3 CDTI 16V | 4 | Z13DT | 52/70 | 08/00→09/06 | | | | | CCU142 ^[8] |
| 1.4 16V | 4 | Z14XE | 66/89 | 09/00→10/06 | OE019 | 0,9 | CET2 | OE184 | BAE965A |
| 1.4 Twinport | 4 | Z14XEP | 66/89 | 06/03→10/06 | OE198 | 0,9 | CET2 | OE184 | BAEA338 |
| 1.7 CDTI 16V | 4 | Z17DTH | 74/99 | 08/00→09/06 | | | | | CCU143 ^[7] |
| 1.7 DI 16V | 4 | Y17DTL | 48/64 | 08/00→09/06 | | | | | CCU143 ^[7] |
| 1.7 DTI 16V | 4 | Y17DT | 55/74 | 08/00→09/06 | | | | | CCU143 ^[7] |
| 1.8 1.8 16V | 4 | Z18XE | 92/123 | 08/00→09/06 | OE198 | 0,9 | CET2 | OE184 | BAEA342 |

CORSA Mk III (D)

| | | | | | | | | | |
|--------------|---|------------------------|---------|-------------|----------------------------|------|--------|-------|----------|
| 1.0 | 3 | A10XEP | 44/59 | 11/06→08/14 | | | CET2 | OE184 | |
| 1.0 | 3 | Z10XEP | 44/59 | 11/06→08/14 | | | CET2 | OE184 | BAEA359 |
| 1.0 i 12V | 3 | A10XEP | 48/64 | 06/10→08/14 | | | CET2 | OE184 | |
| 1.2 | 4 | A12XEL | 51/68 | 06/10→08/14 | | | | | BAEA185E |
| 1.2 | 4 | Z12XEP | 59/79 | 11/06→08/14 | OE198 | 0,9 | CET2 | OE184 | BAEA338 |
| 1.2 i 16V | 4 | A12XER | 63/84 | 11/06→08/14 | | | CET2 | OE184 | BAEA185E |
| 1.2 LPG | 4 | A12XER | 63/84 | 08/11→08/14 | | | | | BAEA185E |
| 1.3 CDTI | 4 | A13DTC | 55/74 | 07/06→08/14 | CP5G003 | 4.4v | | | CCU138 |
| 1.3 CDTI | 4 | Z13DTJ | 55/74 | 07/06→08/14 | | | | | CCU144 |
| 1.3 CDTI | 4 | Z13DTH | 66/89 | 07/06→08/14 | | | | | CCU144 |
| 1.3 CDTI | 4 | A13DTE; A13DTR; Z13DTE | 70/94 | 06/10→08/14 | | | | | CCU138 |
| 1.4 | 4 | Z14XEP | 66/89 | 07/06→08/14 | OE198 | 0,9 | CET2 | OE184 | BAEA338 |
| 1.4 | 4 | A14XER | 74/99 | 07/10→08/14 | | | CET2 | OE184 | BAEA185E |
| 1.4 | 4 | A14NEL | 88/118 | 07/12→08/14 | | | | | BAEA185E |
| 1.4, 1.4 LPG | 4 | A14XEL | 64/86 | 09/09→08/14 | | | CET2 | OE184 | BAEA185E |
| 1.4 LPG | 4 | Z14XEP | 66/89 | 07/06→08/14 | OE198 | 0,9 | CET2 | OE184 | |
| 1.6 SRi | 4 | A16LEL | 110/148 | 05/07→08/14 | OE136 | 0,8 | CET12P | OE179 | BAEA427 |
| | | | | | OE216 ^{LPG [278]} | 0,8 | | | |
| 1.6 VXR | 4 | A16LER; B16LER; Z16LER | 141/189 | 12/13→08/14 | OE136 | 0,8 | CET12P | OE179 | BAEA427 |
| | | | | | OE216 ^{LPG [278]} | 0,8 | | | |
| 1.6 VXR | 4 | A16LES; Z16LER | 150/201 | 06/11→08/14 | | | CET12P | OE188 | BAEA427 |
| 1.7 CDTI | 4 | Z17DTR | 92/123 | 11/06→08/14 | | | | | CCU145 |
| 1.7 CDTI | 4 | A17DTS | 96/129 | 11/06→08/14 | | | | | CCU145 |

CORSA Mk IV (E)

| | | | | | | | | | |
|---------|---|------------------------|---------|--------|--|--|--|-------|----------|
| 1.0 | 3 | B10XFL; F10XFL | 66/89 | 08/14→ | | | | OE258 | |
| 1.0 | 3 | B10XFT; F10XFT | 85/114 | 08/14→ | | | | OE258 | |
| 1.4 | 4 | B14XEJ; B14XEL; B14XER | 66/89 | 08/14→ | | | | | BAEA185E |
| 1.6 VXR | 4 | B16LES | 151/202 | 04/15→ | | | | | BAEA199E |

VAUXHALL





kW/BHP



eon TITAN

IRIDIUM

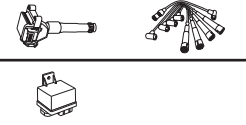

...VAUXHALL



FRONTERA Mk I (A)

| | | | | | | | | | |
|------------|---|---------------|---------|-------------|-------|-----|------|-------|--|
| 2.0 4WD | 4 | C20NE; X20SE | 85/114 | 04/95→08/98 | OE019 | 0,9 | CET2 | OE184 | |
| 2.2 i 4WD | 4 | X22XE | 100/134 | 03/95→10/98 | OE019 | 0,9 | CET2 | OE184 | |
| 2.8 TD 4WD | 4 | 28TDI(4JB1-T) | 83/111 | 01/95→12/96 | CH306 | 11v | | | |

FRONTERA Mk II (B)

| | | | | | | | | | |
|-------------|---|--------------|---------|-------------|-----------------------|-----|--------|-------|-----------------------|
| 2.2 DTI 4WD | 4 | X22DTH | 85/114 | 10/98→09/04 | CH207 →Ch.YV699999 | 11v | | | CCU143 ^[7] |
| 2.2 DTI 4WD | 4 | Y22DTH | 85/114 | 10/98→09/04 | CH231 Ch.1V500001→ | 11v | | | CCU143 ^[7] |
| 2.2 i 4WD | 4 | X22SE; Y22SE | 100/134 | 10/98→10/04 | | | CET12P | OE180 | BAEA025E |
| 3.2 i 4WD | 6 | 6VD1; Y32NE | 151/202 | 10/98→10/04 | | | CET12P | OE180 | |

INSIGNIA Mk I (A)

| | | | | | | | | | |
|--|---|------------------|---------|-------------|-----------------------|------|--------------|---|----------|
| 1.4, 1.4 LPG | 4 | A14NET; B14NET | 103/138 | 04/11→05/17 | | | | OE264 | BAEA185E |
| 1.6 | 4 | A16XER | 85/114 | 07/08→07/12 | OE089 →Ch.91999999 | 1,0 | CET2 | OE188 →Ch.91999999 | |
| | | | | | OE198 Ch.A1000001→ | 0,9 | | OE184 Ch.A1000001→ | |
| 1.6 Turbo | 4 | ; A16XHT; B16SHL | 125/168 | 07/13→05/17 | | | | OE258 | |
| 1.6 Turbo | 4 | A16LET | 132/177 | 01/09→05/17 | OE216 LPG [278] | 0,8 | CET12P | OE188 | BAEA427 |
| 1.8 | 4 | A18XER; B18XER | 103/138 | 07/08→05/17 | OE089 →Ch.91999999 | 1,0 | CET2 | OE188 →Ch.91999999 | BAEA199E |
| | | | | | OE198 Ch.A1000001→ | 0,9 | | OE184 Ch.A1000001→ | |
| 2.0 Biturbo CDTI, 2.0 Biturbo CDTI 4WD | 4 | A20DTR | 143/192 | 03/12→05/17 | CP5G006 | 4.4v | | | CCU138 |
| 2.0 CDTI | 4 | A20DTC; A20DTL | 81/109 | 07/08→05/17 | CP5G006 | 4.4v | | | CCU138 |
| 2.0 CDTI | 4 | A20DTE | 88/118 | 03/12→03/16 | CP5G006 | 4.4v | | | CCU138 |
| 2.0 CDTI | 4 | A20DT; A20DTJ | 96/129 | 07/08→12/14 | CP5G006 | 4.4v | | | CCU138 |
| 2.0 CDTI | 4 | A20DTE | 103/138 | 07/13→05/17 | CP5G006 | 4.4v | | | CCU138 |
| 2.0 CDTI, 2.0 CDTI 4WD | 4 | A20DTH | 118/158 | 07/08→05/17 | CP5G006 | 4.4v | | | CCU138 |
| 2.0 CDTI, 2.0 CDTI 4WD | 4 | A20DTR | 140/188 | 10/08→05/17 | CP5G006 | 4.4v | | | CCU138 |
| 2.0 CDTI, 2.0 CDTI 4WD | 4 | ; A20DTH | 120/161 | 07/13→05/17 | CP5G006 | 4.4v | | | CCU138 |
| 2.0 E85 Turbo | 4 | A20NFT | 162/217 | 09/10→05/17 | | | CET17P [332] | OE189 ^[332] *tobeadjusted | |
| | | | | | | | CET17P | OE189 *tobeadjusted | |
| 2.0 E85 Turbo | 4 | A20NHT | 162/217 | 09/10→05/17 | | | CET17P [332] | OE189 ^[332] *tobeadjusted | |
| | | | | | | | CET17P [331] | OE189 ^[331] *tobeadjusted | |
| 2.0 Turbo, 2.0 Turbo 4WD | 4 | A20NFT; A20NHT | 162/217 | 07/08→05/17 | | | CET17P [332] | OE189 ^[332] *tobeadjusted | |
| 2.0 Turbo, 2.0 Turbo 4WD | 4 | A20NFT; A20NHT | 184/247 | 09/11→05/17 | | | CET17P [332] | OE189 ^[332] *tobeadjusted | |
| 2.8 V6 Turbo 4WD | 6 | A28NET | 191/256 | 07/08→05/17 | OE238 | 1,0 | | | |
| 2.8 VXR 4WD | 6 | A28NER; B28NER | 239/320 | 07/09→05/17 | OE238 | 1,0 | | | |

INSIGNIA Mk II (B)

| | | | | | | | | | |
|-----|---|----------------|---------|--------|--|--|--|-------|--|
| 1.5 | 4 | B15SFL; D15SFL | 103/138 | 03/17→ | | | | OE258 | |
| 1.5 | 4 | B15SFT; D15SFT | 121/162 | 03/17→ | | | | OE258 | |

MERIVA Mk I (A)

| | | | | | | | | | |
|--------------------|---|---------------|---------|-------------|-------|-----|--------|-------|-----------------------|
| 1.3 CDTI | 4 | Z13DTJ | 55/74 | 01/03→10/09 | | | | | CCU142 ^[8] |
| 1.4 16V Twinport | 4 | Z14XEP | 66/89 | 01/03→06/10 | OE198 | 0,9 | CET2 | OE184 | BAEA338 |
| 1.6 i | 4 | Z16SE | 64/86 | 01/03→06/10 | OE019 | 0,9 | CET2 | OE184 | |
| 1.6 i 16V | 4 | Z16XE | 74/99 | 01/03→09/05 | OE198 | 0,9 | CET2 | OE184 | BAE965A |
| 1.6 i 16V Twinport | 4 | Z16XEP | 77/103 | 05/03→06/10 | OE198 | 0,9 | CET2 | OE184 | BAEA427 12/05→ |
| 1.6 Turbo | 4 | Z16LET | 132/177 | 05/06→06/10 | | | CET12P | OE188 | BAEA427 |
| 1.7 CDTi | 4 | Z17DT; Z17DTH | 74/99 | 09/03→06/10 | | | | | CCU143 ^[7] |
| 1.7 DTI | 4 | Y17DT | 55/74 | 06/03→06/10 | | | | | CCU143 ^[7] |

VAUXHALL





kW/BHP



eon TITAN

IRIDIUM

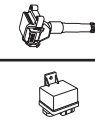

...VAUXHALL



...MERIVA Mk I (A)

| | | | | | | | | | |
|-----------|---|-------|--------|-------------|-------|-----|------|-------|---------|
| 1.8 i 16V | 4 | Z18XE | 92/123 | 05/03→06/10 | OE198 | 0,9 | CET2 | OE188 | BAEA342 |
|-----------|---|-------|--------|-------------|-------|-----|------|-------|---------|

MERIVA Mk II (B)

| | | | | | | | | | |
|--------------|---|----------------|---------|--------|---------|------|------|-------|----------|
| 1.3 CDTI | 4 | A13DTC | 55/74 | 06/10→ | CPSG003 | 4.4v | | | CCU138 |
| 1.3 CDTi | 4 | A13DTE | 70/94 | 06/10→ | CPSG003 | 4.4v | | | CCU138 |
| 1.4 | 4 | A14XER; B14XER | 74/99 | 06/10→ | OE198 | 0,9 | CET2 | OE184 | BAEA185E |
| 1.4 | 4 | A14NET; B14NET | 103/138 | 06/10→ | | | | | BAEA185E |
| 1.4, 1.4 LPG | 4 | A14NEL; B14NEL | 88/118 | 06/10→ | | | | | BAEA185E |
| 1.7 CDTI | 4 | A17DT | 74/99 | 06/10→ | | | | | CCU145 |
| 1.7 CDTi | 4 | A17DTI | 81/109 | 06/10→ | | | | | CCU145 |
| 1.7 CDTi | 4 | A17DTS | 96/129 | 06/10→ | | | | | CCU145 |

MOKKA / MOKKA X

| | | | | | | | | | |
|------------------------|---|------------------------|---------|--------|-------------------|------|------|-------|----------|
| 1.4, 1.4 4WD | 4 | A14NET; B14NET; D14NET | 103/138 | 06/12→ | | | | | BAEA185E |
| 1.4 4WD | 4 | B14XFT | 112/150 | 06/16→ | | | | OE258 | |
| 1.6 | 4 | A16XER; B16XER | 85/114 | 06/12→ | OE198 | 0,9 | CET2 | | BAEA198E |
| 1.7 CDTI, 1.7 CDTI 4WD | 4 | A17DTS | 96/129 | 06/12→ | CPSG004 →11/12 | 4.4v | | | CCU145 |

MONTEREY Mk II

| | | | | | | | | | |
|----------------|---|------|---------|-------------|--|--|--------|-------|--|
| 3.5 V6 24V 4WD | 6 | 6VE1 | 158/212 | 07/98→08/99 | | | CET12P | OE180 | |
|----------------|---|------|---------|-------------|--|--|--------|-------|--|

OMEGA (B)

| | | | | | | | | | |
|-------------|---|-------------------------------|---------|-------------|-------|-----|--------|--|---|
| 2.0 | 4 | 20SE; X20SE | 85/114 | 03/94→09/99 | OE019 | 0,9 | CET2 | OE184 | |
| 2.0 16V | 4 | X20XEV | 100/134 | 03/94→07/01 | OE019 | 0,9 | CET2 | OE184 | BAEA344 |
| 2.0 DTI 16V | 4 | X20DTH | 74/99 | 01/98→09/00 | CH207 | 11v | | | CCU143 ^[7] |
| 2.2 16V | 4 | Y22XE; Z22XE | 106/142 | 01/94→06/03 | OE019 | 0,9 | CET17P | OE184 | BAEA150E ^[277] 09/99→ |
| | | | | | OE029 | 1,0 | CET2 | OE189 | |
| 2.2 DTI 16V | 4 | Y22DTH | 88/118 | 08/00→07/03 | CH231 | 11v | | | CCU143 ^[7] |
| 2.5 DTI 24V | 6 | Y25DT; Y25TD | 110/148 | 09/01→07/03 | CH203 | 11v | | | |
| 2.5 V6 | 6 | X25XE | 125/168 | 03/94→09/00 | OE019 | 0,9 | CET2 | OE184 | BAEA306 ^[275] CLS175 →Ch.08145499 |
| 2.5 TD | 6 | U25DT; U25TD; X25DT; X25TD | 96/129 | 04/94→07/01 | CH189 | 11v | | | |
| 2.6 V6 | 6 | Y26SE | 132/177 | 08/00→07/03 | OE120 | 0,6 | CET2 | OE188 | BAEA152E ^[36] ^[277] |
| | | | | | | | | BAEA153E ^[42] ^[277] | |
| 3.0 V6 | 6 | X30XE | 155/208 | 04/94→07/00 | OE019 | 0,9 | CET2 | OE184 | BAEA306 ^[275] |
| 3.2 V6 | 6 | Y32SE | 160/215 | 02/01→07/03 | OE120 | 0,6 | CET2 | OE188 | BAEA152E ^[36] ^[277] |
| | | | | | | | | BAEA153E ^[42] ^[277] | |

SIGNUM

| | | | | | | | | | |
|--------------|---|--------|---------|-------------|-----------------------|-----|--------|---------------------------------------|---------------------------------------|
| 1.8 | 4 | Z18XE | 90/121 | 06/03→07/05 | OE198 | 0,9 | CET2 | OE184 | BAEA342 |
| 1.8 | 4 | Z18XER | 103/138 | 08/05→05/08 | OE198 | 0,9 | CET2 | OE184 | BAEA427 12/05→ |
| 1.9 CDTI | 4 | Z19DT | 88/118 | 04/04→03/08 | CH222 →Ch.71021891 | 11v | | | CCU143 ^[7] →Ch.61010105 |
| | | | | | CH269 Ch.71021892→ | 11v | | CCU142 ^[8] Ch.61010106→ | |
| 1.9 CDTI 16V | 4 | Z19DTH | 110/148 | 04/04→03/08 | CH224 | 11v | | | CCU143 ^[7] →Ch.61010105 |
| 1.9 Turbo | 4 | Z19DTL | 74/99 | 01/05→05/08 | CH222 →Ch.71021891 | 11v | | | CCU142 ^[8] Ch.61010106→ |
| | | | | | CH269 Ch.71021892→ | 11v | | | |
| 2.0 DTI | 4 | Y20DTH | 74/99 | 05/03→05/08 | CH231 →09/05 | 11v | | | CCU143 ^[7] |
| 2.0 i Turbo | 4 | Z20NET | 129/173 | 03/03→10/08 | OE136 | 0,8 | CET12P | OE179 | |

VAUXHALL





kW/BHP

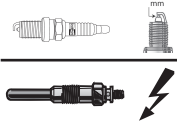

eon TITAN

IRIDIUM



...VAUXHALL



...SIGNUM

| | | | | | | | | | |
|--------------|---|--------|---------|-------------|-------|-----|--------|-------|--|
| 2.2 DTI | 4 | Y22DTR | 92/123 | 05/03→05/08 | CH231 | 11v | | | CCU143 ^[7] |
| 2.2 i | 4 | Z22YH | 114/153 | 05/03→05/08 | OE120 | 0,6 | CET2 | OE188 | BAEA149E |
| 2.8 V6 Turbo | 6 | Z28NEL | 169/227 | 07/05→05/08 | | | CET14P | OE190 | BAEA174E |
| 2.8 V6 Turbo | 6 | Z28NET | 184/247 | 05/07→10/08 | | | | | BAEA174E |
| 3.2 V6 | 6 | Z32SE | 155/208 | 05/03→05/08 | OE120 | 0,6 | CET2 | OE188 | BAEA152E [36] [277] BAEA153E [42] [277] |

SINTRA

| | | | | | | | | | |
|------------|---|--------|---------|-------------|-------|-----|------|-------|-----------------------|
| 2.2 DTI | 4 | X22DTH | 85/114 | 07/97→04/99 | CH207 | 11v | | | CCU143 ^[7] |
| 2.2 i 16 V | 4 | X22XE | 104/139 | 11/96→04/99 | OE019 | 0,9 | CET2 | OE184 | CLS107 |
| 3.0 i 24V | 6 | X30XE | 148/198 | 11/96→04/99 | OE019 | 0,9 | CET2 | OE184 | |

SPEEDSTER

| | | | | | | | | | |
|-----|---|-------|---------|-------------|-------|-----|--|--|--|
| 2.2 | 4 | Z22SE | 108/145 | 03/01→09/06 | OE255 | 1,0 | | | |
|-----|---|-------|---------|-------------|-------|-----|--|--|--|

TIGRA

| | | | | | | | | | |
|----------|---|--------|--------|-------------|-------|-----|------|-------|-----------------------|
| 1.3 CDTI | 4 | Z13DT | 51/68 | 06/04→08/09 | | | | | CCU142 ^[8] |
| 1.4 | 4 | Z14XEP | 66/89 | 06/04→08/09 | OE198 | 0,9 | CET2 | OE184 | BAEA338 |
| 1.8 | 4 | Z18XE | 92/123 | 06/04→08/09 | OE198 | 0,9 | CET2 | OE184 | BAEA342 |

TIGRA Mk I

| | | | | | | | | | | |
|---------|---|-------|--------|-------------|-------|-----|------|-------|----------|--|
| 1.4 16V | 4 | X14XE | 66/89 | 07/94→12/00 | OE019 | 0,9 | CET2 | OE184 | BAEA026E | CLS030 09/94→08/99 →Eng.20C17331 |
| 1.6 16V | 4 | X16XE | 78/105 | 07/94→12/00 | OE019 | 0,9 | CET2 | OE184 | BAEA026E | |

VECTRA (B)

| | | | | | | | | | |
|--------------------------|---|----------------------|---------|-------------|---|-----|--------|-------|---|
| 1.6 i | 4 | X16SZR | 55/74 | 08/95→10/01 | OE019 | 0,9 | CET2 | OE184 | BAEA026E BAEA253 ^[292] |
| 1.6 i 16V | 4 | X16XEL; Y16XE; Z16XE | 74/99 | 08/95→10/01 | OE019 | 0,9 | CET2 | OE184 | BAE965A |
| 1.8 i 16V | 4 | X18XE; X18XE1 | 85/114 | 09/95→09/00 | OE019 | 0,9 | CET2 | OE184 | BAEA342 BAEA344 |
| 1.8 i 16V | 4 | Z18XE | 92/123 | 09/00→07/03 | OE198 | 0,9 | CET2 | OE184 | BAEA342 |
| 2.0 Di 16V, 2.0 Di 16V | 4 | X20DTL | 60/80 | 08/95→10/01 | CH207 Ch.W1000001 W5000001 W7000001 XL000001 WP WS→ | 11v | | | |
| 2.0 DTI 16V, 2.0 DTi 16V | 4 | X20DTH | 74/99 | 08/95→10/01 | CH207 03/98→ | 11v | | | CCU143 ^[7] Ch.W1000001 W5000001 W7000001 XL000001 WS WP→ |
| 2.0 DTI 16V, 2.0 DTi 16V | 4 | Y20DTH | 74/99 | 08/95→10/01 | CH231 | 11v | | | CCU143 ^[7] Ch.W1000001 W5000001 W7000001 XL000001 WS WP→ |
| 2.0 i 16V | 4 | X20XEV | 100/134 | 10/95→01/01 | OE019 | 0,9 | CET2 | OE184 | BAEA344 |
| 2.2 DTI 16V | 4 | Y22DTR | 92/123 | 08/95→10/01 | CH231 | 11v | | | CCU143 ^[7] Ch.W1000001 W5000001 W7000001 XL000001 WS WP→ |
| 2.2 i 16V | 4 | Z22SE | 108/145 | 08/95→07/03 | OE255 | 1,0 | CET17P | OE189 | |
| 2.5 i GSi | 6 | X25XE | 143/192 | 03/98→07/00 | OE019 | 0,9 | CET2 | OE184 | |

VAUXHALL





kW/BHP



eon TITAN

IRIDIUM



...VAUXHALL



...VECTRA (B)

| | | | | | | | | | |
|----------|---|-------|---------|---------------|-------|-----|------|-------|--|
| 2.5 i V6 | 6 | X25XE | 125/168 | 09/95 → 08/00 | OE019 | 0,9 | CET2 | OE184 | |
| 2.6 i V6 | 6 | Y26SE | 125/168 | 09/00 → 07/03 | OE120 | 0,6 | CET2 | OE188 | BAEA152E [36] [277] BAEA153E [42] [277] |

VECTRA Mk II (C)

| | | | | | | | | | |
|---------------------------|---|--------|---------|---------------|------------------------------------|-----|--------|-------|--|
| 1.8 | 4 | Z18XER | 103/138 | 01/06 → 07/08 | OE198 | 0,9 | CET2 | OE184 | BAEA427 |
| 1.8 16V, 1.8 16V Dualfuel | 4 | Z18XE | 90/121 | 04/02 → 07/08 | OE198 | 0,9 | CET2 | OE188 | BAEA342 |
| 1.9 CDTI | 4 | Z19DT | 88/118 | 04/02 → 09/08 | CH222 → Ch.71021891 48999999 | 11v | | | CCU143[7] → Ch.61010105 48999999 |
| | | | | | CH269 Ch.71021892 78 → | 11v | | | CCU142[8] Ch.61010106 68 → |
| 1.9 CDTI 16V | 4 | Z19DTH | 110/148 | 04/04 → 05/09 | CH224 | 11v | | | CCU143[7] → Ch.61010105 48999999 |
| | | | | | | | | | CCU142[8] Ch.61010106 68 → |
| 2.0 16V Turbo | 4 | Z20NET | 129/173 | 01/00 → 10/08 | OE136 | 0,8 | CET12P | OE179 | |
| 2.0 DTI 16V | 4 | Y20DTH | 74/99 | 04/02 → 10/08 | CH231 | 11v | | | CCU143[7] |
| 2.2 16V | 4 | Z22SE | 108/145 | 01/02 → 10/08 | OE255 | 1,0 | CET17P | OE189 | |
| 2.2 direct | 4 | Z22YH | 114/153 | 01/02 → 10/08 | OE120 | 0,6 | CET2 | OE188 | BAEA149E |
| 2.2 DTI 16V | 4 | Y22DTR | 92/123 | 04/02 → 10/08 | CH231 | 11v | | | CCU143[7] |
| 2.8 V6 Turbo | 6 | Z28NEL | 169/227 | 08/05 → 07/08 | OE238 | 1,0 | | | BAEA174E |
| 2.8 V6 Turbo | 6 | Z28NET | 184/247 | 08/06 → 07/08 | OE238 | 1,0 | | | BAEA174E |
| 2.8 V6 Turbo | 6 | Z28NET | 188/252 | 08/05 → 07/08 | OE238 | 1,0 | | | BAEA174E |
| 2.8 V6 Turbo | 6 | Z28NET | 206/276 | 08/06 → 07/08 | OE238 | 1,0 | CET14P | OE190 | BAEA174E |
| 3.2 V6 | 6 | Z32SE | 155/208 | 08/02 → 07/08 | OE120 | 0,6 | CET2 | OE188 | BAEA152E [36] [277] BAEA153E [42] [277] |

VX220

| | | | | | | | | | |
|-------------|---|--------|---------|---------------|-------|-----|--------|-------|--|
| 2.0 i Turbo | 4 | Z20LET | 147/197 | 03/01 → 07/05 | OE019 | 0,9 | CET2 | OE184 | |
| 2.2 i | 4 | Z22SE | 108/145 | 09/00 → 07/05 | OE255 | 1,0 | CET17P | OE189 | |

ZAFIRA Mk I (A)

| | | | | | | | | | |
|---------------|---|---------------|---------|---------------|----------------|------------|--------|-------|-----------|
| 1.6 16V | 4 | X16XEL; Z16XE | 74/99 | 04/99 → 08/05 | OE019 OE198 | 0,9 0,9 | CET2 | OE184 | BAE965A |
| 1.6 CNG | 4 | Z16YNG | 71/95 | 09/01 → 06/05 | OE136 | 0,8 | CET12P | OE179 | BAE965A |
| 1.6 Dualfuel | 4 | X16XEL; Z16XE | 74/99 | 11/98 → 08/05 | OE019 | 0,9 | CET2 | OE184 | BAE965A |
| 1.8 16V | 4 | X18XE1 | 85/114 | 05/99 → 08/00 | OE019 | 0,9 | CET2 | OE184 | BAEA342 |
| 1.8 16V | 4 | Z18XE | 92/123 | 09/00 → 08/05 | OE198 | 0,9 | CET2 | OE184 | BAEA342 |
| 1.8 Dualfuel | 4 | Z18XE | 92/123 | 09/00 → 08/05 | OE198 | 0,9 | CET2 | OE184 | |
| 2.0 | 4 | Z20LET | 147/197 | 06/02 → 06/05 | OE019 | 0,9 | CET2 | OE184 | |
| 2.0 DI 16V | 4 | X20DTL | 60/80 | 10/99 → 08/05 | CH207 | 11v | | | CCU143[7] |
| 2.0 DTI 16V | 4 | Y20DTH | 74/99 | 04/99 → 08/05 | CH207 | 11v | | | CCU142[8] |
| 2.0 GSI Turbo | 4 | Z20LET | 141/189 | 09/01 → 06/05 | OE019 | 0,9 | CET2 | OE184 | |
| 2.2 16V | 4 | Z22SE | 108/145 | 11/98 → 08/04 | OE255 | 1,0 | CET17P | OE189 | |
| 2.2 D | 4 | Y22DTR | 92/123 | 06/01 → 06/05 | CH231 | 11v | | | CCU142[8] |

ZAFIRA Mk II (B)

| | | | | | | | | | |
|---------------|---|----------------|---------|---------------|-------|-----|--------|-------|--------------------|
| 1.6 | 4 | Z16XE1; Z16XEP | 77/103 | 07/05 → 11/14 | OE198 | 0,9 | CET2 | OE184 | BAEA427 12/05 → |
| 1.6 | 4 | A16XER; Z16XER | 85/114 | 12/07 → 11/14 | OE198 | 0,9 | CET2 | OE184 | BAEA427 |
| 1.6 CNG | 4 | Z16YNG | 69/93 | 07/05 → 11/14 | OE136 | 0,8 | CET12P | OE179 | BAE965A |
| 1.6 CNG Turbo | 4 | A16XNT; Z16XNT | 110/148 | 02/09 → 11/14 | | | | | BAEA427 |
| 1.7 CDTI | 4 | A17DTJ; Z17DTJ | 81/109 | 04/09 → 11/14 | | | | | CCU143[7] |

VAUXHALL





kW/BHP

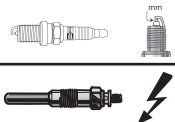

eon TITAN

IRIDIUM

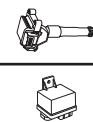
**...VAUXHALL****...ZAFIRA Mk II (B)**

| | | | | | | | | | |
|----------|---|----------------|---------|-------------|-----------------------------------|-----|--------|-------|--|
| 1.7 CDTi | 4 | A17DTR | 92/123 | 01/08→11/14 | | | | | CCU143 ^[7] |
| 1.8 | 4 | A18XEL | 88/118 | 04/13→11/14 | OE198 | 0,9 | | | |
| 1.8 | 4 | A18XER; Z18XER | 103/138 | 04/05→11/14 | OE198 | 0,9 | CET2 | OE184 | BAEA427 12/05→ |
| 1.9 CDTi | 4 | Z19DTL | 74/99 | 07/05→11/14 | CH222 →Ch.62999999 66999999 | 11v | | | CCU142 ^[8] |
| | | | | | CH269 Ch.72000001 76000001→ | 11v | | | CCU143 ^[7] |
| 1.9 CDTi | 4 | Z19DT | 88/118 | 07/05→11/14 | CH222 →Ch.62999999 66999999 | 11v | | | CCU142 ^[8] |
| | | | | | CH269 Ch.72000001 76000001→ | 11v | | | CCU143 ^[7] |
| 1.9 CDTi | 4 | Z19DTH | 110/148 | 07/05→11/14 | CH224 | 11v | | | CCU142 ^[8] CCU143 ^[7] |
| 2.0 | 4 | Z20LER | 147/197 | 07/05→11/14 | OE089 | 1,0 | CET2 | OE188 | |
| 2.0 | 4 | Z20LEH | 176/236 | 01/06→11/14 | OE136 | 0,8 | CET12P | OE179 | |
| 2.2 | 4 | Z22YH | 110/148 | 07/05→11/14 | OE120 | 0,6 | CET2 | OE188 | BAEA149E |

ZAFIRA Mk III

| | | | | | | | | | |
|------------------|---|----------------|---------|--------|--------------------------|------|------|-------|----------|
| 1.4 | 4 | A14NEL | 88/118 | 10/11→ | | | | | BAEA185E |
| 1.4 | 4 | A14NET; B14NET | 103/138 | 10/11→ | | | | | BAEA185E |
| 1.6 CNG | 4 | A16XNT; B16XNT | 110/148 | 10/11→ | | | | | BAEA427 |
| 1.8 | 4 | A18XEL | 85/114 | 10/11→ | OE198 | 0,9 | CET2 | OE184 | BAEA199E |
| 1.8 | 4 | | 88/118 | 10/11→ | OE198 | 0,9 | CET2 | OE184 | BAEA199E |
| 1.8 | 4 | A18XER | 103/138 | 10/11→ | OE198 | 0,9 | CET2 | OE184 | BAEA199E |
| 2.0 BiTurbo CDTi | 4 | A20DTR | 143/192 | 01/13→ | CP5G006 ^[287] | 4.4v | | | CCU138 |
| 2.0 CDTi | 4 | A20DTL | 81/109 | 10/11→ | CP5G006 ^[287] | 4.4v | | | CCU138 |
| 2.0 CDTi | 4 | A20DT | 96/129 | 10/11→ | CP5G006 [287] [298] | 4.4v | | | CCU138 |
| | | | | | CP5G006 [287] [294] | 4.4v | | | |
| 2.0 CDTi | 4 | Y20DTJ; Z20DTJ | 96/129 | 10/11→ | CP5G006 | 4.4v | | | CCU138 |
| 2.0 CDTi | 4 | A20DTH | 121/162 | 10/11→ | CP5G006 | 4.4v | | | CCU138 |

VAUXHALL**ARENA**

| | | | | | | | | | |
|-------|---|------------------------|-------|-------------|-------|-----|--|--|--|
| 1.9 D | 4 | F8Q600; F8Q606 | 44/59 | 03/98→08/01 | CH217 | 11v | | | |
| 2.5 D | 4 | S8U758; S8U780; S8U782 | 55/74 | 03/98→08/01 | CH189 | 11v | | | |

ASTRAVAN Mk III (F)

| | | | | | | | | | |
|--------|---|--------|-------|-------------|-------|-----|------|-------|----------|
| 1.6 i | 4 | X16SZ | 52/70 | 02/94→10/96 | OE019 | 0,9 | CET2 | OE184 | BAEA026E |
| 1.7 TD | 4 | X17DTL | 50/67 | 01/94→08/98 | CH189 | 11v | | | |

ASTRAVAN Mk IV (G)

| | | | | | | | | | |
|-------------|---|--------|-------|-------------|-------|-----|------|-------|-----------------------|
| 1.6 i | 4 | X16SZR | 55/74 | 08/98→09/00 | OE019 | 0,9 | CET2 | OE184 | BAEA026E |
| 1.6 i | 4 | Z16SE | 62/83 | 09/00→08/06 | OE019 | 0,9 | CET2 | OE184 | CLS114 |
| 1.7 CDTi | 4 | Z17DTL | 59/79 | 04/04→08/06 | | | | | CCU143 ^[7] |
| 1.7 DTI 16V | 4 | Y17DT | 55/74 | 04/01→08/06 | | | | | CCU143 ^[7] |
| 1.7 TD | 4 | X17DTL | 50/67 | 08/98→08/06 | CH189 | 11v | | | CCU143 ^[7] |
| 2.0 DI | 4 | X20DTL | 60/80 | 08/98→08/06 | CH207 | 11v | | | CCU143 ^[7] |
| 2.0 DTI | 4 | Y20DTH | 74/99 | 04/04→08/06 | CH207 | 11v | | | CCU142 ^[8] |

ASTRAVAN Mk V (H)

| | | | | | | | | | |
|----------|---|----------------|--------|-------------|-------|-----|------|-------|-----------------------|
| 1.3 CDTi | 4 | Z13DTH | 66/89 | 08/05→ | | | | | CCU142 ^[8] |
| 1.4 i | 4 | Z14XEP | 66/89 | 03/05→ | OE198 | 0,9 | CET2 | OE184 | BAEA338 |
| 1.6 | 4 | Z16XE1; Z16XEP | 76/102 | 03/05→ | OE198 | 0,9 | CET2 | OE184 | BAEA427 |
| 1.7 CDTi | 4 | Z17DTL | 59/79 | 03/05→07/06 | | | | | CCU143 ^[7] |



kW/BHP



eon TITAN

IRIDIUM



...VAUXHALL



...ASTRAVAN Mk V (H)

| | | | | | | | | | |
|----------|---|----------------|---------|-------------|---|-----|--|--|--|
| 1.7 CDTi | 4 | Z17DTH | 74/99 | 03/05→11/11 | | | | | CCU143 ^[7] |
| 1.7 CDTi | 4 | A17DTJ; Z17DTJ | 81/109 | 06/11→12/13 | | | | | CCU143 ^[7] |
| 1.7 CDTi | 4 | A17DTR; Z17DTR | 92/123 | 11/11→ | | | | | CCU143 ^[7] |
| 1.9 CDTi | 4 | Z19DT | 88/118 | 03/05→11/11 | CH222 →Ch.72045139 75030986 78007391 7G | 11v | | | CCU142 ^[8] |
| | | | | | CH269 Ch.72045140 75030987 78007392 88000001 7G→ | 11v | | | CCU143 ^[7] |
| 1.9 CDTi | 4 | Z19DTH | 110/148 | 03/05→11/11 | CH224 | 11v | | | CCU142 ^[8] CCU143 ^[7] |

COMBO Mk I (B)

| | | | | | | | | | |
|-----|---|--------------|-------|-------------|-------|-----|------|-------|--------------------------|
| 1.2 | 4 | C12NZ; X12SZ | 33/44 | 07/94→10/01 | | | | OE195 | |
| 1.4 | 4 | C14NZ | 44/59 | 07/94→10/01 | OE019 | 0,9 | CET2 | OE184 | BAEA253 ^[292] |
| 1.4 | 4 | C14SE | 60/80 | 07/94→10/01 | OE019 | 0,9 | CET2 | OE184 | BAEA253 ^[292] |

COMBO Mk II (C)

| | | | | | | | | | |
|-------------|---|--------|-------|-------------|-------|-----|--------|-------|---------|
| 1.4 16V | 4 | Z14XE | 66/89 | 10/01→05/07 | OE019 | 0,9 | CET2 | OE184 | BAE965A |
| 1.4 i 16V | 4 | Z14XEP | 66/89 | 01/04→11/11 | OE198 | 0,9 | CET2 | OE184 | BAEA338 |
| 1.6 | 4 | Z16SE | 62/83 | 09/01→10/04 | OE019 | 0,9 | CET2 | OE184 | CLS114 |
| 1.6 | 4 | Z16SE | 64/86 | 10/01→11/11 | OE019 | 0,9 | CET2 | OE184 | |
| 1.6 CNG 16V | 4 | Z16YNG | 69/93 | 06/06→02/12 | OE136 | 0,8 | CET12P | OE179 | BAE965A |
| 1.6 CNG 16V | 4 | Z16YNG | 71/95 | 04/05→02/12 | OE136 | 0,8 | CET12P | OE179 | BAE965A |
| 1.7 DI 16V | 4 | Y17DTL | 48/64 | 09/01→11/11 | CH189 | 11v | | | |

COMBO Mk III (D)

| | | | | | | | | | |
|---------|---|--|--------|--------|--|--|--|--|---------|
| 1.4 CNG | 4 | | 88/118 | 11/11→ | | | | | BAEA095 |
|---------|---|--|--------|--------|--|--|--|--|---------|

CORSAVAN Mk I (B)

| | | | | | | | | | |
|-------|---|-------|-------|-------------|-------|-----|------|-------|---------------------------------|
| 1.4 i | 4 | C14NZ | 44/59 | 01/94→09/00 | OE019 | 0,9 | CET2 | OE184 | BAEA253 ^[292] CLS114 |
| 1.5 D | 4 | 15D | 37/50 | 08/94→12/95 | CH158 | 11v | | | |

CORSAVAN Mk II (C)

| | | | | | | | | | |
|------------------|---|--------|-------|-------------|-------|-----|------|-------|-----------------------|
| 1.2 16V | 4 | Z12XE | 55/74 | 09/00→06/06 | OE019 | 0,9 | CET2 | OE184 | BAEA147E →08/04 |
| 1.2 16V Dualfuel | 4 | Z12XE | 55/74 | 08/01→06/06 | | | | | BAEA147E →08/04 |
| 1.3 CDTI 16V | 4 | Z13DT | 52/70 | 04/04→06/06 | | | | | CCU142 ^[8] |
| 1.4 | 4 | Z14XEP | 66/89 | 11/03→06/06 | OE198 | 0,9 | CET2 | OE184 | |
| 1.7 DI 16V | 4 | Y17DTL | 48/64 | 09/00→06/06 | | | | | CCU143 ^[7] |
| 1.7 DTI 16V | 4 | Y17DT | 55/74 | 09/00→06/06 | | | | | CCU143 ^[7] |

CORSAVAN Mk III (D)

| | | | | | | | | | |
|----------|---|--------------------------------|-------|--------|-------|-----|------|-------|----------|
| 1.2 | 4 | A12XEL | 51/68 | 01/10→ | | | CET2 | OE184 | BAEA185E |
| 1.2 | 4 | Z12XEP | 59/79 | 07/09→ | OE198 | 0,9 | CET2 | OE184 | BAEA338 |
| 1.3 CDTI | 4 | Z13DTJ | 55/74 | 07/06→ | | | | | CCU144 |
| 1.3 CDTI | 4 | A13DTC | 55/74 | 07/06→ | | | | | CCU138 |
| 1.3 CDTI | 4 | Z13DTH | 66/89 | 07/06→ | | | | | CCU144 |
| 1.3 CDTI | 4 | A13DTE; A13DTR; B13DTR; Z13DTE | 70/94 | 07/06→ | | | | | CCU138 |

MIDI II

| | | | | | | | | | |
|--------|---|-------|-------|-------------|------------------------|-----|--|--|--|
| 2.4 TD | 4 | 4FG1T | 56/75 | 09/94→08/97 | CH158 ^[275] | 11v | | | |
| 2.4 TD | 4 | 4FG1T | 69/93 | 10/94→08/97 | CH158 ^[275] | 11v | | | |

MOVANO Mk I (A)

| | | | | | | | | | |
|---------|---|--------|-------|-------------|-------|-----|--|--|-------------------------|
| 1.9 DTI | 4 | F9Q770 | 59/79 | 09/00→10/01 | CH271 | 11v | | | CCU129 ^[338] |
| 1.9 DTI | 4 | F9Q774 | 60/80 | 10/01→05/10 | CH271 | 11v | | | CCU129 ^[338] |

VAUXHALL





kW/BHP



eon TITAN

IRIDIUM



...VAUXHALL



...MOVANO Mk I (A)

| | | | | | | | | | | |
|------------------|---|--------------------------------|---------|-------------|-------|-----|--|--|--|--------|
| 2.2 DTI | 4 | G9T720; G9T722; G9T750 | 66/89 | 09/00→05/10 | CH232 | 11v | | | | CCU154 |
| 2.5 CDTI | 4 | G9U650 | 74/99 | 10/01→12/10 | CH232 | 11v | | | | |
| 2.5 CDTI | 4 | G9U632; G9U650 | 88/118 | 02/03→05/10 | CH232 | 11v | | | | |
| 2.5 CDTI | 4 | G9U632; G9U650 | 107/143 | 08/06→05/10 | CH232 | 11v | | | | |
| 2.5 D | 4 | S8U770; S8U772 | 59/79 | 10/98→08/02 | CH189 | 11v | | | | |
| 2.5 DTI | 4 | G9U720; G9U724; G9U750; G9U754 | 84/113 | 01/01→05/10 | CH232 | 11v | | | | |
| 2.8 DTI, 2.8 TDI | 4 | S9W702 | 84/113 | 10/98→10/01 | CH189 | 11v | | | | |

MOVANO Mk II (B)

| | | | | | | | | | | |
|----------|---|--|---------|--------|-------------------------|----|--|--|--|--|
| 2.3 CDTI | 4 | M9T670; M9T672; M9T676; M9T690; M9T692; M9T870 | 74/99 | 05/10→ | CCGP007 ^[14] | 7v | | | | |
| 2.3 CDTI | 4 | M9T670; M9T672; M9T676; M9T680; M9T686; M9T690; M9T692; M9T696; M9T698; M9T876; M9T898 | 92/123 | 05/10→ | CCGP007 ^[14] | 7v | | | | |
| 2.3 CDTI | 4 | M9T678; M9T680; M9T694; M9T696; M9T698 | 107/143 | 05/10→ | CCGP007 ^[14] | 7v | | | | |
| 2.3 CDTI | 4 | | 110/148 | 01/13→ | CCGP007 ^[14] | 7v | | | | |

VIVARO

| | | | | | | | | | | |
|-------------------|---|--------------------------------|---------|-------------|---|-----|------|-------|--|------------------------------|
| 1.9 DI | 4 | F9Q762 | 59/79 | 08/01→07/14 | CH271 | 11v | | | | CCU154 →Ch.6Y 6V699999 |
| 1.9 DTI | 4 | F9Q760 | 74/99 | 08/01→12/06 | CH271 | 11v | | | | |
| 2.0 16V | 4 | F4R720 | 88/118 | 08/01→07/14 | OE034 | 0,9 | CET2 | OE179 | | BAE409A |
| 2.0 CDTI | 4 | M9R630 | 66/89 | 01/06→07/14 | CCGP007 ^[14] →Prod.12.12.2011 | 7v | | | | |
| 2.0 CDTI | 4 | M9R780; M9R782; M9R786 | 66/89 | 01/06→07/14 | CCGP007 ^[14] Ch.C056227→ | 7v | | | | |
| 2.0 CDTI | 4 | M9R630 | 84/113 | 08/06→07/14 | CCGP007 ^[14] →Prod.12.12.2011 | 7v | | | | |
| 2.0 CDTI | 4 | M9R780; M9R784; M9R786; M9R788 | 84/113 | 08/06→07/14 | CCGP007 ^[14] Ch.C056227→ | 7v | | | | |
| 2.0 ECOTEC | 4 | F4R820 | 86/115 | 08/06→07/14 | OE034 | 0,9 | CET2 | OE179 | | BAE409A |
| 2.5 CDTI | 4 | G9U630 | 107/143 | 01/06→07/14 | CH232 | 11v | | | | |
| 2.5 CDTI, 2.5 DTI | 4 | G9U730 | 99/133 | 04/03→07/14 | CH232 | 11v | | | | |

VOLVO



440 K

| | | | | | | | | | | |
|------------------|---|------|--------|-------------|-------|-----|--|--|--|------------------------|
| 1.9 Turbo-Diesel | 4 | D19T | 66/89 | 07/94→12/96 | CH260 | 11v | | | | |
| 2.0 | 4 | B20F | 80/107 | 08/93→07/96 | OE004 | 0,9 | | | | BAEA251 [265] [292] |

460 L

| | | | | | | | | | | |
|------------------|---|------|--------|-------------|-------|-----|--|--|--|------------------------|
| 1.9 Turbo-Diesel | 4 | D19T | 66/89 | 07/94→07/96 | CH260 | 11v | | | | |
| 2.0 | 4 | B20F | 80/107 | 08/93→07/96 | OE004 | 0,9 | | | | BAEA251 [265] [292] |

850

| | | | | | | | | | | |
|-------------|---|-----------------|---------|-------------|-------|-----|--------|-------|---------------------------|-------------------------|
| 2.0 | 5 | B5202S | 93/125 | 08/94→12/96 | OE120 | 0,6 | CET2 | OE188 | BAEA037E ^[292] | CLS050 08/95→ |
| 2.0 Turbo | 5 | B5204T2 | 132/177 | 09/93→10/97 | OE136 | 0,8 | CET12P | OE179 | BAEA037E ^[292] | CLS050 01/96→ |
| 2.0 Turbo | 5 | B5204FT; B5204T | 155/208 | 02/93→12/96 | OE136 | 0,8 | CET12P | OE179 | BAEA037E ^[292] | CLS050 08/95→ |
| 2.3 | 5 | B5234FS | 106/142 | 01/96→10/96 | OE136 | 0,8 | CET12P | OE179 | | |
| 2.3 T5 | 5 | B5234FT | 166/223 | 02/93→12/96 | OE136 | 0,8 | CET12P | OE179 | BAEA037E ^[292] | CLS050 08/95→ 09/94→ |
| 2.3 T5 R | 5 | B5234T2 | 176/236 | 04/96→10/96 | OE136 | 0,8 | CET12P | OE179 | | |
| 2.3 T5-R | 5 | B5234T4 | 184/247 | 08/95→12/96 | OE136 | 0,8 | CET12P | OE179 | BAEA037E ^[292] | CLS050 03/96→ |
| 2.3 Turbo R | 5 | B5234T5 | 177/237 | 06/95→10/97 | OE136 | 0,8 | CET12P | OE179 | | |
| 2.3 Turbo R | 5 | B5234T5 | 179/240 | 09/94→10/97 | OE136 | 0,8 | CET12P | OE179 | | |

VOLVO





kW/BHP

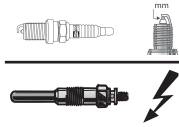

eon TITAN

IRIDIUM



...VOLVO



...850

| | | | | | | | | | | |
|---------|---|---------|---------|-------------|-------|-----|------|-------|-------------------------------------|--------|
| 2.4 | 5 | B5252FS | 106/142 | 08/94→12/96 | OE120 | 0,6 | CET2 | OE188 | BAEA037E ^[292] 08/95→ | CLS050 |
| 2.4 4WD | 5 | B5254T | 142/190 | 04/96→12/96 | | | CET2 | OE179 | BAEA037E ^[292] 09/96→ | CLS050 |
| 2.4 GLE | 5 | B5254T | 142/190 | 09/93→10/97 | OE014 | 0,9 | CET2 | OE179 | | |
| 2.5 TDI | 5 | D5252T | 103/138 | 08/95→12/96 | CH271 | 11v | | | | |

940 II

| | | | | | | | | | | |
|----------------|---|--------|---------|-------------|-------|-----|------|-------|--|--------|
| 2.0 | 4 | B200G | 89/119 | 11/94→12/95 | OE018 | 1,0 | CET8 | OE195 | | |
| 2.0 | 4 | B204FT | 102/137 | 10/94→05/97 | OE018 | 1,0 | CET8 | OE195 | | |
| 2.0 Turbo | 4 | B200FT | 114/153 | 04/96→10/98 | OE018 | 1,0 | CET8 | OE195 | | |
| 2.3 | 4 | B230FD | 85/114 | 08/94→07/95 | OE004 | 0,9 | CET8 | OE195 | | CLS236 |
| 2.3 | 4 | B230FB | 96/129 | 08/94→10/98 | OE004 | 0,9 | CET8 | OE195 | | CLS236 |
| 2.3 ti | 4 | B230FK | 99/133 | 01/95→10/98 | OE004 | 0,9 | CET8 | OE195 | | CLS236 |
| 2.3 Turbo | 4 | B230FT | 121/162 | 08/94→10/98 | OE004 | 0,9 | CET8 | OE195 | | CLS188 |
| 2.3 Turbo | 4 | B230FT | 126/169 | 01/95→12/98 | OE004 | 0,9 | CET8 | OE195 | | CLS188 |
| 2.4 TD Interc. | 6 | D24TIC | 90/121 | 08/94→10/98 | CH260 | 11v | | | | |

960 II

| | | | | | | | | | | |
|-----|---|--------|---------|-------------|-------|-----|------|-------|-------------------------|--|
| 2.5 | 6 | B6254S | 125/168 | 07/94→12/96 | OE120 | 0,6 | CET2 | OE188 | BAEA446 ^[97] | |
| 2.9 | 6 | B6304S | 150/201 | 07/94→12/96 | OE120 | 0,6 | CET2 | OE188 | BAEA446 ^[97] | |

C30

| | | | | | | | | | | |
|-------------------|---|-------------------|---------|-------------|----------------------------|-----|--------|-------|---------------------|--------|
| 1.6 | 4 | B4164S3 | 74/99 | 10/06→12/12 | OE031 | 1,0 | CET7 | OE189 | BAEA387 | CLS077 |
| 1.6 D | 4 | D4164T | 80/107 | 10/06→12/12 | CH201 Eng.16126→ | 11v | | | CCU147 →Ch.39039 | |
| 1.8, 1.8 FlexFuel | 4 | B4184S8; B4184S11 | 92/123 | 10/06→12/12 | OE131 | 1,0 | CET18P | OE183 | BAEA408 | |
| 2.0, 2.0 FlexFuel | 4 | B4204S3; B4204S4 | 107/143 | 10/06→12/12 | OE131 | 1,0 | CET18P | OE183 | BAEA408 | |
| 2.0 D | 4 | D4204T | 100/134 | 10/06→12/12 | CH268 | 11v | | | CCU147 →Ch.39039 | |
| 2.4 i | 5 | B5244S4 | 125/168 | 10/06→12/12 | OE236 | 1,7 | | | BAEA055E | |
| 2.5 T5 | 5 | B5254T3 | 162/217 | 10/06→12/12 | OE206 | 0,7 | CET14P | | BAEA055E →07/07 | |
| 2.5 T5 | 5 | B5254T7 | 169/227 | 03/07→12/12 | OE224 ^{LPG [279]} | 0,8 | | | | |
| 2.5 T5 | 5 | B5254T7 | 169/227 | 03/07→12/12 | OE206 | 0,7 | CET14P | | BAEA055E | |
| 2.5 T5 | 5 | B5254T7 | 169/227 | 03/07→12/12 | OE224 ^{LPG [279]} | 0,8 | | | | |

C70 I

| | | | | | | | | | | |
|---------|---|----------------|---------|-------------|-------|-----|--------|-------|-------------------------------------|------------------|
| 2.0 | 5 | B5204T2 | 132/177 | 03/97→10/05 | OE136 | 0,8 | CET12P | OE179 | BAEA037E ^[292] →07/98 | CLS050 |
| 2.0 T | 5 | B5204T4 | 120/161 | 03/00→10/05 | OE136 | 0,8 | CET12P | OE179 | BAEA019E | |
| 2.0 T | 5 | B5204T3 | 166/223 | 03/97→10/05 | | | CET2 | OE179 | BAEA037E ^[292] →07/98 | CLS050 |
| 2.3 T5 | 5 | B5234T3 | 176/236 | 03/98→10/05 | OE136 | 0,8 | CET12P | OE179 | BAEA019E 08/98→ | CLS050 →08/98 |
| 2.3 T5 | 5 | B5234T9 | 180/241 | 07/02→10/05 | OE136 | 0,8 | CET12P | OE179 | BAEA019E | |
| 2.3 T-5 | 5 | B5234T3 | 176/236 | 03/97→09/02 | OE136 | 0,8 | CET12P | OE179 | BAEA037E ^[292] →07/98 | CLS050 →07/98 |
| 2.4 | 5 | B5254S | 121/162 | 03/99→09/02 | OE120 | 0,6 | CET2 | OE188 | BAEA019E | |
| 2.4 | 5 | B5254S | 125/168 | 06/98→10/05 | OE120 | 0,6 | CET2 | OE188 | BAEA019E ^[126] 03/99→ | |
| 2.4 | 5 | B5244S | 125/168 | 06/98→10/05 | OE120 | 0,6 | CET2 | OE188 | BAEA019E | |
| 2.4 T | 5 | B5244T; B5254T | 142/190 | 03/97→10/05 | OE136 | 0,8 | CET12P | OE179 | BAEA037E ^[292] →07/98 | CLS050 →08/98 |
| 2.4 T | 5 | B5244T7 | 147/197 | 07/02→10/05 | OE136 | 0,8 | CET12P | OE179 | BAEA019E | |



kW/BHP



eon TITAN

IRIDIUM



...VOLVO



C70 II

| | | | | | | | | | |
|--------|---|---------|---------|-------------|------------------------|-----|---------------|--------------|----------------------------|
| 2.0 D | 4 | D4204T | 100/134 | 01/08→10/09 | CH268 | 11v | | | CCU147 →Ch.40042 |
| 2.4 | 5 | B5244S5 | 103/138 | 03/06→10/09 | OE236 | 1,7 | | | BAEA055E |
| 2.4 i | 5 | B5244S4 | 125/168 | 03/06→10/09 | OE236 | 1,7 | CET5 | OE190 | BAEA055E |
| 2.5 T5 | 5 | B5254T3 | 162/217 | 03/06→02/07 | OE206 | 0,7 | CET14P | | BAEA055E |
| | | | | | OE224 LPG [279] | 0,8 | | | |
| 2.5 T5 | 5 | B5254T7 | 169/227 | 03/07→10/09 | OE206 | 0,7 | CET14P | | BAEA055E |
| | | | | | OE224 LPG [279] | 0,8 | | | |

S40 I

| | | | | | | | | | | |
|-------------------|---|-------------------|---------|-------------|----------------------------|-----|---------------|--------------|---|---------------|
| 1.6 | 4 | B4164S | 77/103 | 09/95→08/99 | OE120 | 0,6 | CET2 | OE188 | BAEA254 [7] [37] BAEA255 [14] [39] | CLS051 |
| 1.6 | 4 | B4164S2 | 80/107 | 03/99→12/03 | OE120 | 0,6 | CET2 | OE188 | BAEA429 | CLS195 |
| 1.8 | 4 | B4184S; B4184S3 | 85/114 | 07/95→08/03 | OE120 | 0,6 | CET2 | OE188 | BAEA254 [7] [37] BAEA255 [14] [39] | CLS051 |
| 1.8 | 4 | B4184S2 | 85/114 | 07/95→08/03 | OE120 | 0,6 | CET2 | OE179 | BAEA429 | CLS195 |
| 1.8 | 4 | B4184S2 | 90/121 | 03/99→12/03 | OE120 | 0,6 | CET2 | OE188 | BAEA429 | CLS195 |
| 1.8 i | 4 | B4184SJ | 90/121 | 06/01→12/03 | OE227 | 0,6 | CET12P | OE188 | BAEA254 [7] [37] [137] BAEA255 [14] [39] [138] BAEA446 [97] | |
| | | | | | OE216 LPG [278] | 0,8 | | | | |
| 1.8 i | 4 | B4184SM | 92/123 | 03/98→12/03 | OE227 | 0,6 | CET12P | OE188 | | |
| | | | | | OE216 LPG [278] | 0,8 | | | | |
| 1.9 DI | 4 | D4192T2 | 70/94 | 03/99→07/00 | CH169 | 11v | | | | |
| 1.9 DI | 4 | D4192T4 | 75/101 | 07/00→12/03 | CH271 | 11v | | | | |
| 1.9 DI | 4 | D4192T3 | 85/114 | 07/00→12/03 | CH271 | 11v | | | | |
| 1.9 T4 | 4 | B4194T; B4194T2 | 147/197 | 05/97→07/00 | OE136 | 0,8 | CET12P | OE179 | BAEA429 | CLS195 |
| 1.9 TD | 4 | D4192T | 66/89 | 07/95→08/99 | CH260 | 11v | | | | |
| 2.0 | 4 | B4204S | 100/134 | 07/95→12/03 | OE120 | 0,6 | CET2 | OE188 | BAEA254 →12/99 [7] [37] BAEA255 →12/99 [14] [39] BAEA429 01/00→ | CLS195 |
| 2.0 | 4 | B4204S2 | 100/134 | 07/95→12/03 | OE120 | 0,6 | CET2 | OE188 | BAEA254 →12/99 [7] [37] BAEA255 →12/99 [14] [39] BAEA429 01/00→ | CLS195 |
| 2.0 | 4 | B4204S | 103/138 | 07/95→08/99 | OE120 | 0,6 | CET2 | OE188 | BAEA254 [7] [37] BAEA255 [14] [39] | CLS051 |
| 2.0 T | 4 | B4204T | 118/158 | 10/97→12/03 | OE136 | 0,8 | CET12P | OE179 | BAEA429 | CLS195 |
| 2.0 T | 4 | B4204T3 | 120/161 | 06/01→12/03 | OE136 | 0,8 | CET12P | OE179 | BAEA429 | CLS195 |
| 2.0 T | 4 | B4204T2; B4204T3 | 121/162 | 07/00→06/01 | OE136 | 0,8 | CET12P | OE179 | BAEA429 | CLS195 |
| 2.0 T4 | 4 | B4204T5 | 147/197 | 07/00→12/03 | OE136 | 0,8 | CET12P | OE179 | BAEA429 | CLS195 |
| S40 II | | | | | | | | | | |
| 1.6 | 4 | B4164S3 | 74/99 | 01/05→12/12 | OE031 | 1,0 | CET7 | OE189 | BAEA387 Ch.106167→ | CLS077 |
| 1.6 D | 4 | D4164T | 81/109 | 01/05→12/12 | CH201 Eng.16126→ | 11v | | | CCU147 →Ch.350231 | |
| 1.8, 1.8 FlexFuel | 4 | B4184S8; B4184S11 | 92/123 | 04/04→12/10 | OE131 | 1,0 | CET18P | OE183 | BAEA408 | |
| 2.0 | 4 | B4204S3 | 107/143 | 10/06→12/12 | OE131 | 1,0 | CET18P | OE183 | BAEA408 | |

VOLVO





kW/BHP

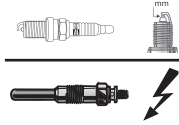

eon TITAN

IRIDIUM



...VOLVO



...S40 II

| | | | | | | | | | |
|--------------------|---|---------|---------|-------------|-----------------|-----|--------|-------|--|
| 2.0 D | 4 | D4204T | 100/134 | 01/04→12/10 | CH268 | 11v | | | CCU147 →Ch.350231 |
| 2.0 D4 | 4 | D4204T2 | 96/129 | 07/05→12/06 | CH268 | 11v | | | |
| 2.0 F | 4 | B4204S4 | 107/143 | 10/09→12/12 | | | CET18P | OE183 | BAEA408 |
| 2.4 | 5 | B5244S5 | 103/138 | 01/04→12/10 | OE236 | 1,7 | | | BAEA055E |
| 2.4 | 5 | B5244S4 | 125/168 | 01/04→12/12 | OE236 | 1,7 | | | BAEA055E ^[275] BAEA446 [97] [275] |
| 2.4 4WD | 5 | B5244S4 | 125/168 | 08/06→12/12 | OE035 | 0,9 | CET5 | OE190 | BAEA055E |
| 2.5 T5, 2.5 T5 4WD | 5 | B5254T3 | 162/217 | 01/04→12/07 | OE206 | 0,7 | CET14P | | BAEA055E →07/07 |
| | | | | | OE224 LPG [279] | 0,8 | | | |
| 2.5 T5, 2.5 T5 4WD | 5 | B5254T7 | 169/227 | 03/07→12/12 | OE206 | 0,7 | CET14P | | BAEA055E |
| | | | | | OE224 LPG [279] | 0,8 | | | |

S60 I

| | | | | | | | | | |
|------------------|---|----------|---------|-------------|---------------------------|-----|------------------|-----------------|--|
| 2.0 T | 5 | B5204T5 | 132/177 | 07/00→04/10 | OE136 →07/04 | 0,8 | CET12P →07/04 | OE179 →07/04 | BAEA019E →07/04 |
| | | | | | OE206 08/04→ | 0,7 | CET14P 08/04→ | | BAEA055E 08/04→ |
| | | | | | OE224 LPG [279] 08/04→ | 0,8 | | | |
| 2.3 T5 | 5 | B5234T3 | 184/247 | 07/00→04/10 | OE136 | 0,8 | CET12P | OE179 | BAEA019E |
| 2.3 T5 | 5 | B5234T7 | 195/261 | 07/00→09/02 | OE136 | 0,8 | CET12P | OE179 | BAEA019E |
| 2.4 | 5 | B5244S2 | 103/138 | 07/00→04/10 | OE120 | 0,6 | CET2 | OE188 | BAEA019E |
| 2.4 | 5 | B5244S | 125/168 | 11/00→04/10 | OE120 | 0,6 | CET2 | OE188 | BAEA019E |
| 2.4 | 5 | B5244T4 | 132/177 | 01/05→10/06 | OE136 | 0,8 | CET12P | OE179 | BAEA055E |
| 2.4 4WD | 5 | B5244T5 | 191/256 | 02/04→04/10 | OE136 | 0,8 | CET12P | OE179 | BAEA055E |
| 2.4 Bifuel (CNG) | 5 | B5244S6 | 103/138 | 07/01→04/10 | OE120 | 0,6 | CET12P | OE179 | BAEA019E |
| 2.4 Bifuel (LPG) | 5 | B5244S62 | 103/138 | 07/01→04/10 | OE120 | 0,6 | | | BAEA019E |
| 2.4 D | 5 | D5244T2 | 96/129 | 05/01→04/10 | CH240 | 11v | | | |
| 2.4 D5 | 5 | D5244T | 120/161 | 01/01→04/10 | CH240 | 11v | | | |
| 2.4 T | 5 | B5244T | 142/190 | 01/01→04/10 | OE136 | 0,8 | CET12P | OE179 | BAEA055E |
| 2.4 T | 5 | B5244T3 | 147/197 | 07/00→04/10 | OE136 →10/01 | 0,8 | CET12P →10/01 | OE179 →10/01 | BAEA019E →07/03 |
| | | | | | OE206 11/01→ | 0,7 | CET14P 11/01→ | | BAEA055E 08/03→ |
| 2.4 T 4WD | 5 | B5244T3 | 147/197 | 06/01→04/10 | OE206 | 0,7 | CET14P | | BAEA019E →07/03 BAEA055E 08/03→ |
| 2.4 T5 | 5 | B5244T5 | 191/256 | 04/04→04/10 | OE206 | 0,7 | CET14P | | BAEA055E |
| 2.5 R 2, 5 T 4WD | 5 | B5254T4 | 221/296 | 01/03→04/10 | OE206 | 0,7 | CET14P | | BAEA055E →07/07 |
| 2.5 T, 2.5 T 4WD | 5 | B5254T2 | 154/207 | 07/02→04/10 | OE136 | 0,8 | CET12P | OE179 | BAEA019E |

S60 II

| | | | | | | | | | |
|-----------------|---|-----------------|---------|-------------|--|--|--------|-------|----------|
| 1.6 T3 | 4 | B4164T3 | 110/148 | 04/10→12/15 | | | CET17P | OE189 | |
| 1.6 T4, 1.6 T4F | 4 | B4164T; B4164T2 | 132/177 | 04/10→12/15 | | | CET17P | OE189 | |
| 2.0 T | 4 | B4204T6 | 149/200 | 04/10→12/11 | | | CET17P | | |
| 2.0 T | 5 | B5204T8 | 132/177 | 05/12→12/15 | | | | | BAEA055E |
| 2.0 T5 | 4 | B4204T7 | 177/237 | 04/10→12/14 | | | CET17P | | |

S70

| | | | | | | | | | |
|-----------|---|-----------------|---------|-------------|-------|-----|--------|-------|--|
| 2.0 | 5 | B5202FS; B5202S | 93/125 | 01/97→11/00 | OE120 | 0,6 | CET2 | OE188 | BAEA037E ^[292] CLS050 |
| 2.0 | 5 | B5204F | 105/141 | 01/97→11/00 | OE120 | 0,6 | CET2 | OE188 | BAEA037E ^[292] CLS050 →07/98 |
| 2.0 | 5 | B5204T4 | 120/161 | 01/97→11/00 | OE136 | 0,8 | CET2 | OE179 | BAEA019E |
| 2.0 | 5 | B5204T2 | 132/177 | 01/97→11/00 | OE136 | 0,8 | CET12P | OE179 | BAEA037E ^[292] CLS050 →07/98 |
| 2.0 Turbo | 5 | B5204T | 155/208 | 01/97→11/00 | OE136 | 0,8 | CET12P | OE179 | BAEA037E ^[292] CLS050 →07/98 |





kW/BHP

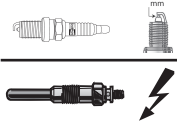

eon TITAN

IRIDIUM

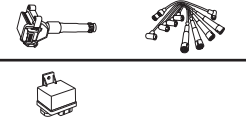
**...VOLVO****...S70**

| | | | | | | | | | | |
|--|---|------------------|---------|-------------|---------------------------|-----|------------------|-----------------|--------------------------|--------|
| 2.0 Turbo | 5 | B5204T3 | 166/223 | 01/97→11/00 | OE136 | 0,8 | CET12P | OE179 | BAEA019E | CLS050 |
| 2.3 | 5 | B5234T3 | 177/237 | 11/96→11/00 | | | | | BAEA019E | |
| 2.3 | 5 | B5234T7 | 195/261 | 04/99→09/00 | OE136 | 0,8 | CET12P | OE179 | BAEA019E | |
| 2.3 T-5 | 5 | B5234T3 | 176/236 | 01/97→11/00 | OE136 | 0,8 | CET12P | OE179 | BAEA037E [292] →07/98 | CLS050 |
| | | | | | | | | | BAEA019E 08/98→ | |
| 2.3 T5 4WD | 5 | B5234T3 | 177/237 | 11/96→09/98 | OE136 | 0,8 | CET12P | OE179 | BAEA019E | |
| 2.3 T5 4WD | 5 | B5234T4 | 184/247 | 07/97→09/00 | OE136 | 0,8 | CET12P | OE179 | | |
| 2.3 Turbo | 5 | B5234FT+ | 184/247 | 01/97→11/00 | OE136 | 0,8 | CET12P | OE179 | BAEA037E [292] →07/98 | CLS050 |
| 2.4 | 5 | B5252F5 | 106/142 | 01/97→11/00 | OE120 | 0,6 | CET2 | OE188 | BAEA037E [292] | CLS050 |
| 2.4 | 5 | B5254S | 121/162 | 06/98→11/00 | OE120 | 0,6 | CET2 | OE188 | BAEA037E [292] →07/98 | |
| | | | | | | | | | BAEA019E 08/98→ | |
| 2.4 | 5 | B5244S; B5254S | 125/168 | 01/97→11/00 | OE120 | 0,6 | CET2 | OE188 | BAEA037E [292] →07/98 | CLS050 |
| | | | | | | | | | BAEA019E 08/98→ | |
| 2.4, 2.4 4WD, 2.4 Bifuel, 2.4 Blu-Fuel | 5 | B5244S2; B5244SG | 103/138 | 07/97→11/00 | OE120 | 0,6 | CET2 | OE188 | BAEA019E | |
| 2.4 4WD | 5 | B5254S | 121/162 | 10/98→05/99 | OE120 | 0,6 | CET2 | | BAEA019E | |
| 2.4 4WD | 5 | B5244S | 125/168 | 04/99→09/00 | OE120 | 0,6 | CET2 | OE188 | BAEA019E | |
| 2.4 4WD, 2.4 Bifuel | 5 | B5252F5; GB5252S | 106/142 | 11/96→11/00 | OE120 | 0,6 | CET2 | OE188 | BAEA037E [292] | |
| 2.4 T5 4WD | 5 | B5254T | 142/190 | 11/96→04/99 | OE136 | 0,8 | CET12P | OE179 | BAEA019E 08/98→ | |
| 2.4 Turbo | 5 | B5244T; B5254T | 142/190 | 01/97→11/00 | OE136 | 0,8 | CET12P | OE179 | BAEA037E [292] →07/98 | CLS050 |
| | | | | | | | | | BAEA019E 08/98→ | |
| 2.5 TDI, 2.5 TDi 4WD | 5 | D5252T | 103/138 | 01/97→11/00 | CH271 | 11v | | | | |
| S80 I | | | | | | | | | | |
| 2.0 | 5 | B5204T4 | 120/161 | 06/98→07/06 | OE136 | 0,8 | CET12P | OE179 | BAEA019E | |
| 2.0 T | 5 | B5204T5 | 132/177 | 12/99→07/06 | OE136 →07/04 | 0,8 | CET12P →07/04 | OE179 →07/04 | BAEA019E →07/04 | |
| | | | | | OE206 08/04→ | 0,7 | CET14P 08/04→ | | BAEA055E 08/04→ | |
| | | | | | OE224 LPG [279] 08/04→ | 0,8 | | | | |
| 2.0 T | 5 | B5204T3 | 166/223 | 06/98→07/06 | OE136 | 0,8 | CET12P | OE179 | BAEA019E | |
| 2.4 | 5 | B5244S2 | 103/138 | 01/99→07/06 | OE120 | 0,6 | CET2 | OE188 | BAEA019E | |
| 2.4 | 5 | B5244S | 125/168 | 01/99→07/06 | OE120 | 0,6 | CET2 | OE188 | BAEA019E | |
| 2.4 Bifuel (CNG) | 5 | B5244SG2 | 103/138 | 09/01→07/06 | OE120 | 0,6 | CET12P | OE179 | BAEA019E | |
| 2.4 Bifuel (LPG) | 5 | B5244SG | 103/138 | 09/01→07/06 | OE120 | 0,6 | | | BAEA019E | |
| 2.4 D | 5 | D5244T2 | 96/129 | 10/01→07/06 | CH240 | 11v | | | | |
| 2.4 D5 | 5 | D5244T | 120/161 | 08/01→07/06 | CH240 | 11v | | | | |
| 2.4 LTP | 5 | B5244T4 | 132/177 | 06/04→07/06 | OE136 | 0,8 | CET12P | OE179 | BAEA055E | |
| 2.4 T, 2.4 T5 4WD | 5 | B5244T3 | 147/197 | 04/00→07/06 | OE136 →10/01 | 0,8 | CET12P →10/01 | OE179 →10/01 | BAEA019E | |
| | | | | | OE206 11/01→ | 0,7 | CET14P 11/01→ | | | |
| 2.5 T, 2.5 T 4WD | 5 | B5254T2 | 154/207 | 03/03→07/06 | OE136 | 0,8 | CET12P | OE179 | BAEA019E | |
| 2.5 TDI | 5 | D5252T | 103/138 | 01/99→07/06 | CH271 | 11v | | | | |
| 2.8 T6 | 6 | B6284T | 200/268 | 05/98→07/06 | OE136 | 0,8 | CET12P | OE179 | BAEA019E | |
| 2.9 | 6 | B6294S | 147/197 | 03/99→07/06 | OE120 | 0,6 | CET2 | OE188 | BAEA019E | |
| 2.9 | 6 | B6304S3 | 150/201 | 05/98→07/06 | OE120 →12/99 | 0,6 | CET2 | OE188 | BAEA019E | |
| 3.0 | 6 | B6294S2 | 144/193 | 06/01→07/06 | OE120 | 0,6 | CET12P | OE179 | BAEA019E | |
| 3.0 T6 | 6 | B6294T | 200/268 | 06/01→07/06 | OE136 | 0,8 | CET12P | OE179 | BAEA019E | |

VOLVO



kW/BHP

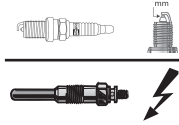

eon TITAN

IRIDIUM

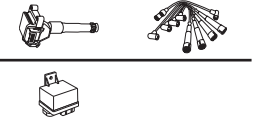

...VOLVO



S80 II

| | | | | | | | | | | |
|-------------------|---|------------------|---------|-------------|-----------------|-----|--------|-------|----------|--|
| 1.6 D DRiVe | 4 | D4164T | 80/107 | 01/10→12/11 | CH201 | 11v | | | | |
| 1.6 T4, 1.6 T4F | 4 | B4164T; B4164T2 | 132/177 | 10/10→ | | | CET17P | OE189 | | |
| 2.0, 2.0 FlexFuel | 4 | B4204S3; B4204S4 | 107/143 | 01/08→09/12 | OE131 | 1,0 | CET18P | OE183 | BAEA408 | |
| 2.0 T | 4 | B4204T6 | 149/200 | 01/10→ | | | CET17P | | | |
| 2.0 T5 | 4 | B4204T7 | 177/237 | 10/10→ | | | CET17P | | | |
| 2.0 TDi | 4 | D4204T | 100/134 | 02/08→03/11 | CH268 | 11v | | | | |
| 2.5 T | 5 | B5254T6 | 147/197 | 03/06→12/11 | OE206 | 0,7 | CET14P | | BAEA055E | |
| | | | | | OE224 LPG [279] | 0,8 | | | | |
| 2.5 T | 5 | B5254T10 | 170/228 | 01/10→12/12 | | | CET14P | | BAEA055E | |
| 2.5 T FlexFuel | 5 | B5254T8 | 147/197 | 05/08→12/11 | | | CET14P | OE190 | BAEA055E | |
| 2.5 T FlexFuel | 5 | B5254T11 | 170/228 | 01/10→12/11 | | | CET14P | OE190 | BAEA055E | |
| 3.0 T6 4WD | 6 | B6304T2 | 210/282 | 01/07→12/10 | OE035 | 0,9 | CET5 | OE190 | | |
| 3.2 | 6 | B6324S | 175/235 | 03/06→ | OE206 | 0,7 | CET14P | | | |
| | | | | | OE224 LPG [279] | 0,8 | | | | |
| 3.2, 3.2 4WD | 6 | B6324S5 | 179/240 | 01/10→ | | | CET14P | | | |
| 3.2 4WD | 6 | B6324S | 175/235 | 01/07→12/10 | | | CET14P | OE190 | | |
| 4.4 V8 4WD | 8 | B8444S | 232/311 | 03/06→03/12 | | | CET12P | OE179 | | |

S90

| | | | | | | | | | | |
|-----|---|---------|---------|-------------|-------|-----|------|-------|-------------------------|--|
| 2.5 | 6 | B6254FS | 125/168 | 11/96→10/98 | OE120 | 0,6 | CET2 | OE188 | BAEA446 | |
| 2.5 | 6 | B6244FS | 132/177 | 11/96→10/97 | OE120 | 0,6 | CET2 | OE188 | | |
| 2.9 | 6 | B6304S2 | 132/177 | 01/97→05/98 | OE120 | 0,6 | CET2 | OE188 | BAEA446 ^[97] | |
| 2.9 | 6 | B6304GS | 150/201 | 01/97→05/98 | OE120 | 0,6 | CET2 | OE188 | BAEA446 ^[97] | |

V40

| | | | | | | | | | | |
|-------------|---|-----------------|---------|-------------|-----------------|-----|--------|-------|---|------------------|
| 1.6 | 4 | B4164S | 77/103 | 12/95→08/99 | OE120 | 0,6 | CET2 | OE188 | BAEA254 ^{[7] [37]} BAEA255 ^{[14] [39]} | CLS051 |
| 1.6 | 4 | B4164S2 | 80/107 | 03/99→06/04 | OE120 | 0,6 | CET2 | OE188 | BAEA429 | CLS195 |
| 1.6 T3 GTDi | 4 | B4164T3 | 110/148 | 03/12→ | | | CET17P | OE189 | | |
| 1.6 T4 GTDi | 4 | B4164T | 132/177 | 03/12→ | | | CET17P | OE189 | | |
| 1.8 | 4 | B4184S; B4184S3 | 85/114 | 07/95→08/99 | OE120 | 0,6 | CET2 | OE188 | BAEA254 ^{[7] [37]} BAEA255 ^{[14] [39]} | CLS051 |
| 1.8 | 4 | B4184S2 | 90/121 | 03/99→06/04 | OE120 | 0,6 | CET2 | OE188 | BAEA429 | CLS195 |
| 1.8 i | 4 | B4184SJ | 90/121 | 06/01→06/04 | OE227 | 0,6 | CET12P | OE188 | BAEA429 | CLS195 |
| | | | | | OE216 LPG [278] | 0,8 | | | | |
| 1.8 i | 4 | B4184SM | 92/123 | 03/98→06/04 | OE227 | 0,6 | CET12P | OE188 | BAEA245 ^{[7] [37]} BAEA246 ^{[14] [39]} | |
| | | | | | OE216 LPG [278] | 0,8 | | | | |
| 1.9 DI | 4 | D4192T2 | 70/94 | 03/99→07/00 | CH169 | 11v | | | | |
| 1.9 DI | 4 | D4192T4 | 75/101 | 07/00→06/04 | CH271 | 11v | | | | |
| 1.9 DI | 4 | D4192T3 | 85/114 | 07/00→06/04 | CH271 | 11v | | | | |
| 1.9 T4 | 4 | B4194T; B4194T2 | 147/197 | 05/97→07/00 | OE136 | 0,8 | CET12P | OE179 | BAEA429 | CLS195 |
| 1.9 TD | 4 | D4192T | 66/89 | 07/95→08/99 | CH260 | 11v | | | | |
| 2.0 | 4 | B4204S; B4204S2 | 100/134 | 07/95→06/04 | OE120 | 0,6 | CET2 | OE188 | BAEA245 ^{[7] [37]} BAEA246 ^{[14] [39]} | CLS051 →08/99 |
| 2.0 | 4 | B4204S | 103/138 | 07/95→08/99 | OE120 | 0,6 | CET2 | OE188 | BAEA254 ^{[7] [37]} BAEA255 ^{[14] [39]} | CLS051 |
| 2.0 T | 4 | B4204T | 118/158 | 10/97→07/00 | OE136 | 0,8 | CET12P | OE179 | BAEA429 | CLS195 |
| 2.0 T | 4 | B4204T3 | 120/161 | 06/01→06/04 | OE136 | 0,8 | CET12P | OE179 | BAEA429 | CLS195 |
| 2.0 T | 4 | B4204T2 | 121/162 | 07/99→ | OE136 | 0,8 | CET12P | OE179 | BAEA429 | CLS195 |

VOLVO





kW/BHP



eon TITAN

IRIDIUM

**...VOLVO****...V40**

| | | | | | | | | | | |
|--------------------|---|----------|---------|-------------|--------------|-----|---------------|--------------|-----------------|---------------|
| 2.0 T4 | 4 | B4204T5 | 147/197 | 07/00→06/04 | OE136 | 0,8 | CET12P | OE179 | BAEA429 | CLS195 |
| 2.0 T4, 2.0 T4 4WD | 5 | B5204T8 | 132/177 | 07/13→ | | | | | BAEA055E | |
| 2.0 T5, 2.0 T5 4WD | 5 | B5204T9 | 157/211 | 03/13→ | | | | | BAEA055E | |
| 2.5 T5, 2.5 T5 4WD | 5 | B5254T12 | 187/251 | 12/12→ | | | | | BAEA055E | |

V50

| | | | | | | | | | | |
|--------------------|---|-------------------|---------|-------------|----------------------------|-----|---------------|--------------|------------------------------|--|
| 1.6 | 4 | B4164S3 | 74/99 | 01/05→12/12 | OE031 | 1,0 | CET7 | OE189 | BAEA387 Ch.105440→ | |
| 1.6 D | 4 | D4164T | 81/109 | 01/05→12/11 | CH201 Eng.16126→ | 11v | | | CCU147 →Ch.367151 | |
| 1.8, 1.8 FlexFuel | 4 | B4184S8; B4184S11 | 92/123 | 04/04→12/10 | OE131 | 1,0 | CET18P | OE183 | BAEA408 | |
| 2.0, 2.0 FlexFuel | 4 | B4204S3; B4204S4 | 107/143 | 10/06→12/12 | OE131 | 1,0 | CET18P | OE183 | BAEA408 | |
| 2.0 D | 4 | D4204T | 100/134 | 04/04→12/10 | CH268 | 11v | | | CCU147 →Ch.367151 | |
| 2.4 | 5 | B5244S5 | 103/138 | 04/04→12/10 | OE236 | 1,7 | | | BAEA055E | |
| 2.4 | 5 | B5244S4 | 125/168 | 04/04→12/10 | OE236 | 1,7 | | | BAEA055E | |
| 2.4 4WD | 5 | B5244S4 | 125/168 | 08/06→12/09 | OE035 | 0,9 | CET5 | OE190 | BAEA055E | |
| 2.5 T5, 2.5 T5 4WD | 5 | B5254T3 | 162/217 | 04/04→12/07 | OE206 | 0,7 | CET14P | | BAEA055E →07/07 | |
| | | | | | OE224 LPG [279] | 0,8 | | | | |
| 2.5 T5, 2.5 T5 4WD | 5 | B5254T7 | 169/227 | 03/07→12/12 | OE206 | 0,7 | CET14P | | BAEA055E | |
| | | | | | OE224 LPG [279] | 0,8 | | | | |

V60

| | | | | | | | | | | |
|-----------------|---|-----------------|---------|-------------|--|--|---------------|--------------|-----------------|--|
| 1.6 T3 | 4 | B4164T3 | 110/148 | 09/10→12/15 | | | CET17P | OE189 | | |
| 1.6 T4, 1.6 T4F | 4 | B4164T; B4164T2 | 132/177 | 09/10→12/15 | | | CET17P | OE189 | | |
| 2.0 T | 4 | B4204T6 | 149/200 | 07/10→12/12 | | | CET17P | | | |
| 2.0 T5 | 4 | B4204T7 | 177/237 | 09/10→12/14 | | | CET17P | | | |
| 2.0 T5 | 5 | B5204T9 | 157/211 | 10/13→ | | | | | BAEA055E | |

V70 I

| | | | | | | | | | | |
|--------------------------|---|-------------------|---------|-------------|--------------|-----|---------------|--------------|---------------------------------|-------------------------|
| 2.0 | 5 | B5202FS; B5202S | 93/125 | 12/95→03/00 | OE120 | 0,6 | CET2 | OE188 | BAEA037E [292] | CLS050 |
| 2.0 | 5 | B5204F | 105/141 | 12/95→03/00 | OE120 | 0,6 | CET2 | OE188 | BAEA037E [292] →07/98 | CLS050 →08/98 |
| | | | | | | | | | BAEA019E 08/98→ | |
| 2.0 | 5 | B5204T4 | 120/161 | 01/97→12/00 | OE136 | 0,8 | CET2 | OE179 | BAEA019E | |
| 2.0 | 5 | B5204T2 | 132/177 | 11/96→03/00 | OE136 | 0,8 | CET12P | OE179 | BAEA037E [292] →07/98 | CLS050 →08/98 |
| 2.0 Turbo | 5 | B5204T | 155/208 | 12/95→03/00 | OE136 | 0,8 | CET12P | OE179 | BAEA037E [292] →07/98 | CLS050 |
| | | | | | | | | | BAEA019E 08/98→ | |
| 2.0 Turbo, 2.0 Turbo 4WD | 5 | B5204T3 | 166/223 | 11/96→12/00 | OE136 | 0,8 | CET12P | OE179 | BAEA037E [292] →07/98 | CLS050 |
| | | | | | | | | | BAEA019E 08/98→ | |
| 2.3 | 5 | B5234T3 | 177/237 | 11/96→11/00 | | | | | BAEA019E | |
| 2.3 4WD | 5 | B5234T3 | 177/237 | 04/97→09/98 | OE136 | 0,8 | CET12P | OE179 | BAEA019E | |
| 2.3 4WD | 5 | B5234T7; B5234T8 | 195/261 | 12/98→02/00 | OE136 | 0,8 | CET12P | OE179 | BAEA019E | |
| 2.3 T 4WD | 5 | B5234FT+; B5234T4 | 184/247 | 04/97→03/00 | OE136 | 0,8 | CET12P | OE179 | BAEA037E [292] →07/98 | CLS050 |
| 2.3 T-5, 2.3 T-5 4WD | 5 | B5234T3 | 176/236 | 11/96→12/00 | OE136 | 0,8 | CET12P | OE179 | BAEA037E [292] →07/98 | CLS050 |
| | | | | | | | | | BAEA019E 08/98→ | |
| 2.3 Turbo | 5 | B5234FT+ | 184/247 | 12/95→03/00 | OE136 | 0,8 | CET12P | OE179 | BAEA037E [292] | CLS050 |
| 2.4 | 5 | B5244S2; B5244S62 | 103/138 | 03/99→12/00 | OE120 | 0,6 | CET2 | OE188 | BAEA019E | |
| 2.4 | 5 | B5254S | 121/162 | 06/98→12/99 | OE120 | 0,6 | CET2 | OE188 | BAEA037E [292] →07/98 | |
| | | | | | | | | | BAEA019E 08/98→ | |

VOLVO





kW/BHP



eon TITAN

IRIDIUM



...VOLVO



...V70 I

| | | | | | | | | | | |
|--------------------------|---|-------------------------|---------|-------------|-------|-----|--------|-------|---|--------|
| 2.4 | 5 | B5244S; B5254FS; B5254S | 125/168 | 12/95→05/00 | OE120 | 0,6 | CET2 | OE188 | BAEA037E ^[292] →07/98 BAEA019E 08/98→ | CLS050 |
| 2.4, 2.4 Bifuel | 5 | B5252FS; GB5252S | 106/142 | 12/95→03/00 | OE120 | 0,6 | CET2 | OE188 | BAEA037E ^[292] | CLS050 |
| 2.4 4WD | 5 | B5254S | 121/162 | 06/98→12/99 | OE120 | 0,6 | CET2 | | BAEA019E | |
| 2.4 Bifuel | 5 | B5244SG | 103/138 | 08/99→12/00 | OE120 | 0,6 | CET12P | OE179 | BAEA019E | |
| 2.4 Turbo, 2.4 Turbo 4WD | 5 | B5244T; B5254T | 142/190 | 04/96→12/00 | OE136 | 0,8 | CET12P | OE179 | BAEA037E ^[292] →07/98 BAEA019E 08/98→ | CLS050 |
| 2.4 Turbo 4WD | 5 | B5244T2 | 195/261 | 03/99→12/00 | OE136 | 0,8 | CET12P | OE179 | BAEA019E | CLS050 |
| 2.5 TDi, 2.5 TDi 4WD | 5 | D5252T | 103/138 | 12/95→12/00 | CH271 | 11v | | | | |

V70 II

| | | | | | | | | | | |
|--------------------|---|-----------------------------|---------|-------------|--|-------------------|--------------------------------------|-----------------|--|--|
| 2.0 T | 5 | B5204T5 | 132/177 | 11/99→08/07 | OE136 →07/04 OE206 08/04→ OE224 LPG ^[279] 08/04→ | 0,8 0,7 0,8 | CET12P →07/04 CET14P 08/04→ | OE179 →07/04 | BAEA019E →07/04 BAEA055E 08/04→ | |
| 2.3 | 5 | B5234T7 | 195/261 | 10/00→09/04 | OE136 | 0,8 | CET12P | OE179 | BAEA019E | |
| 2.3 4WD | 5 | B5234T7; B5234T8 | 195/261 | 10/00→09/04 | OE136 | 0,8 | CET12P | OE179 | | |
| 2.3 4WD | 5 | B5234T7 | 195/261 | 10/00→09/04 | | | | | BAEA019E | |
| 2.3 T5 | 5 | B5234T3 | 184/247 | 11/99→12/04 | OE136 | 0,8 | CET12P | OE179 | BAEA019E | |
| 2.4 | 5 | B5244S2 | 103/138 | 03/00→08/07 | OE120 | 0,6 | CET2 | OE188 | BAEA019E | |
| 2.4 | 5 | B5244S | 125/168 | 03/00→08/07 | OE120 | 0,6 | CET2 | OE188 | BAEA019E | |
| 2.4 Bifuel (CNG) | 5 | B5244SG | 103/138 | 09/01→08/07 | OE120 | 0,6 | CET12P | OE179 | BAEA019E | |
| 2.4 Bifuel (LPG) | 5 | B5244SG2 | 103/138 | 09/01→08/07 | OE120 | 0,6 | | | BAEA019E | |
| 2.4 D | 5 | D5244T2 | 96/129 | 07/01→08/07 | CH240 | 11v | | | | |
| 2.4 D5, 2.4 D5 4WD | 5 | D5244T; D5244T2; D5244T5 | 120/161 | 01/01→12/08 | CH240 | 11v | | | | |
| 2.4 T, 2.4 T 4WD | 5 | B5244T3 | 147/197 | 11/99→08/03 | OE136 →10/01 OE206 11/01→ | 0,8 0,7 | CET12P →10/01 CET14P 11/01→ | OE179 →10/01 | BAEA019E | |
| 2.4 T5 | 5 | B5244T5 | 191/256 | 04/04→08/07 | OE206 OE224 LPG ^[279] | 0,7 0,8 | CET14P | | BAEA055E →07/07 | |
| 2.5 4WD | 5 | B5254T2 | 155/208 | 09/02→12/04 | | | | | BAEA019E | |
| 2.5 R 2, 2.5 T 4WD | 5 | B5254T4 | 221/296 | 03/03→08/07 | OE206 OE224 LPG ^[279] | 0,7 0,8 | CET14P | | BAEA055E →07/07 | |
| 2.5 R Sport | 5 | B5254T4 | 221/296 | 12/02→08/07 | OE206 OE224 LPG ^[279] | 0,7 0,8 | CET14P | | BAEA055E | |
| 2.5 T, 2.5 T 4WD | 5 | B5254T2 | 154/207 | 07/01→08/07 | OE136 | 0,8 | CET12P | OE179 | BAEA019E | |
| 2.5 TDi | 5 | D5252T | 103/138 | 11/99→08/07 | CH271 | 11v | | | | |

V70 III

| | | | | | | | | | | |
|------------------------|---|--------------------|---------|-------------|-------|-----|--------|-------|----------|--|
| 1.6 D | 4 | D4164T | 80/107 | 07/09→12/11 | CH201 | 11v | | | | |
| 1.6 T4, 1.6 T4F | 4 | B4164T; B4164T2 | 132/177 | 10/10→12/15 | | | CET17P | OE189 | | |
| 2.0, 2.0 FlexiFuel | 4 | B4204S3; B4204S4 | 107/143 | 10/07→12/11 | OE131 | 1,0 | CET18P | OE183 | BAEA408 | |
| 2.0 D | 4 | D4204T | 100/134 | 10/07→12/15 | CH268 | 11v | | | CCU147 | |
| 2.0 T | 4 | B4204T6 | 149/200 | 09/09→12/11 | | | CET17P | | | |
| 2.0 T5 | 4 | B4204T7 | 177/237 | 01/10→12/14 | | | CET17P | | | |
| 2.5 T, 2.5 T FlexiFuel | 5 | B5254T6; B5254T8 | 147/197 | 08/07→12/09 | | | CET14P | OE190 | BAEA055E | |
| 2.5 T, 2.5 T FlexiFuel | 5 | B5254T10; B5254T11 | 170/228 | 04/09→12/12 | | | CET14P | OE190 | BAEA055E | |
| 3.0 T6 4WD | 6 | B6304T2 | 210/282 | 08/07→12/10 | | | CET14P | OE190 | | |
| 3.0 T6 4WD | 6 | B6304T4 | 224/300 | 01/10→12/15 | | | CET14P | OE190 | | |
| 3.2, 3.2 4WD | 6 | B6324S | 175/235 | 04/07→12/10 | | | CET14P | OE190 | | |



kW/BHP

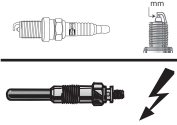

eon TITAN

IRIDIUM

**...VOLVO****...V70 III**

3.2, 3.2 4WD 6 B6324S5 179/240 04/10→12/15

CET14P

OE190

V90

2.5 6 B6254FS 125/168 11/96→10/98 OE120 0,6 CET2 OE188 BAEA446

2.5 6 B6244FS 132/177 11/96→10/97 OE120 0,6 CET2 OE188

2.9 6 B6304S2 132/177 01/97→12/98 OE120 0,6 CET2 OE188 BAEA446^[97]2.9 6 B6304FS; B6304GS 150/201 01/97→12/98 OE120 0,6 CET2 OE188 BAEA446^[97]**XC60**

2.0 T 4 B4204T6 149/200 12/09→12/12 CET17P

2.0 T5 4 B4204T7 177/237 09/10→12/14 CET17P

3.0 T6 4WD 6 B6304T2 210/282 05/08→12/10 OE206 0,7 CET14P

OE224 LPG^[279] 0,8

3.0 T6 4WD 6 B6304T3; B6304T4 242/325 04/14→12/15 BAEA055E

3.2 4WD 6 B6324S5 179/240 03/10→12/15 BAEA115^{[8] [275]}**XC70 CROSS COUNTRY**2.0 T5 4WD 5 B5204T3 166/223 10/97→03/99 BAEA037E^[292]

2.4 D5 4WD 5 D5244T 120/161 09/02→08/07 CH240 11v

2.4 T 4WD 5 B5254T 142/190 11/97→09/02 OE136 0,8 CET12P OE179 BAEA037E^[292]

2.4 T 4WD 5 B5244T3 147/197 03/00→09/02 OE136 0,8 CET12P OE179 BAEA019E

→10/01
OE206 0,7 CET14P
11/01→

2.5 T 4WD 5 B5254T2 154/207 09/02→08/07 OE136 0,8 CET12P OE179 BAEA019E

XC70 II

3.0 T6 4WD 6 B6304T2 210/282 01/08→ OE206 0,7 CET14P

OE224 LPG^[279] 0,8

3.2 4WD 6 B6324S 175/235 08/07→12/11 CET14P OE190

XC90 I

2.4 D5 4WD 5 D5244T 120/161 10/02→12/10 CH240 11v

2.5 T 4WD 5 B5254T2 154/207 10/02→09/14 OE136 0,8 CET12P OE179 BAEA019E

2.5 T 4WD 5 B5254T9 154/207 10/02→09/14 BAEA019E

2.9 T6 4WD 6 B6294T 200/268 10/02→12/06 OE136 0,8 CET12P OE179 BAEA019E

3.2 4WD 6 B6324S 175/235 03/06→12/10 OE206 0,7 CET14P

OE224 LPG^[279] 0,8

4.4 V8 4WD 8 B8444S 232/311 01/05→12/10 CET12P OE179

VW**AMAROK**

2.0 BiTDI, 2.0 BiTDI 4WD 4 CDCA 120/161 09/10→ CCU152

2.0 BiTDI, 2.0 BiTDI 4WD 4 CNEA; CSHA 132/177 11/11→ CCU152

2.0 TDI, 2.0 TDI 4WD 4 CDBA; CNFA 90/121 09/10→ CCU152

2.0 TDI, 2.0 TDI 4WD 4 CNFB 103/138 06/12→ CCU152

2.0 TSI 4 CFPA 118/158 12/10→ OE214 0,7 CET11P BAEA033E^[7]

3.0 TDI, 3.0 TDI 4WD 6 DDXA 120/161 06/16→ CP5G008 4.4v

3.0 TDI 4WD 6 DDXB 150/201 06/16→ CP5G008 4.4v

3.0 TDI 4WD 6 DDXC 165/221 06/16→ CP5G008 4.4v

BEETLE1.2 TSI 4 CBZB 77/103 07/11→ OE260 BAE907AE^[262] CLS090

1.2 TSI 16V 4 CYVD 77/103 12/14→ OE244 0,8

1.4 TSI 4 CZDA 110/148 12/14→ OE244 0,8 BAEA067E^[240]

1.4 TSI 4 CAVD; CNWA; CTHD; CTKA 118/158 10/11→ BAE408AE

1.6 TDI 4 CAYC 77/103 10/11→ CCU151

1.8 TSI 4 CPKA; CPRA 125/168 12/13→ BAEA068E

2.0 TDI 4 CUUA 81/109 06/14→ CP5G007^[275] 4.4v



kW/BHP



eon TITAN

IRIDIUM

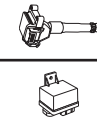

...VW



...BEETLE

| | | | | | | | | | | |
|---------|---|------------------|---------|--------|---------------------------------|------|---------------|--------------|---------------------------|--------------------------------|
| 2.0 TDI | 4 | CFFB | 103/138 | 04/11→ | | | | | | CCU151 |
| 2.0 TDI | 4 | CJAA | 103/138 | 04/11→ | CPSG007 | 4.4v | | | | |
| 2.0 TDI | 4 | CUUB; CVCA; DELA | 110/148 | 07/14→ | CPSG007 ^[275] | 4.4v | | | | |
| 2.0 TSI | 4 | CBFA; CCTA; CCZA | 147/197 | 04/11→ | OE214 | 0,7 | CET11P | | | |
| 2.0 TSI | 4 | CPLA; CPPA | 155/208 | 12/12→ | | | | OE246 | BAEA068E →11/13 | |
| 2.0 TSI | 4 | CULC | 162/217 | 12/14→ | | | | OE246 | BAEA068E | |
| 2.5 | 5 | CBTA; CBUA; CCCA | 125/168 | 04/11→ | OE177 | 0,9 | CET3 | | | BAEA033E ^[7] |

BORA

| | | | | | | | | | | |
|----------------------|---|---------------|---------|-------------|---|-----|----------------------------|--------------|----------------------------------|---|
| 1.4 16V | 4 | BCA | 55/74 | 03/00→05/05 | OE032 | 1,0 | CET2 | OE188 | BAE408AE | |
| 1.4 16V | 4 | AKQ; APE | 55/74 | 03/00→05/05 | OE032 | 1,0 | CET2 | OE188 | BAE907AE ^[262] | CLS260 |
| 1.4 16V | 4 | AHW | 55/74 | 03/00→05/05 | OE032 | 1,0 | CET2 | OE188 | BAE408AE | CLS260 BAE907AE ^[262] |
| 1.4 16V | 4 | AXP | 55/74 | 03/00→05/05 | OE176 ^[285] →07/02 | 1,0 | CET3 | | BAE408AE | CLS260 BAE907AE ^[262] |
| 1.6 | 4 | AEH; AKL; APF | 74/99 | 10/98→05/05 | OE032 | 1,0 | CET2 | OE179 | BAE907AE ^[262] | CLS139 |
| 1.6 | 4 | AVU; BFQ | 75/101 | 08/00→05/05 | OE032 | 1,0 | CET2 | OE179 | BAE907AE ^[262] | CLS048 |
| 1.6 | 4 | BJH | 75/101 | 08/00→05/05 | OE032 | 1,0 | CET2 | OE179 | BAE907AE ^[262] | |
| 1.6 | 4 | AWB | 78/105 | 06/02→10/04 | OE016 | 0,9 | CET2 | OE180 | | |
| 1.6 16V | 4 | ATN; AUS | 77/103 | 02/00→05/05 | OE032 | 1,0 | CET2 | OE188 | BAE907AE ^[262] | CLS260 |
| 1.6 16V | 4 | AZD/BCB | 77/103 | 02/00→05/05 | OE176 | 1,0 | CET3 | | | |
| 1.6 16V | 4 | AZD | 77/103 | 02/00→05/05 | OE176 | 1,0 | CET2 CET3 | OE188 | BAE408AE | CLS260 |
| 1.6 16V | 4 | BCB | 77/103 | 02/00→05/05 | OE176 | 1,0 | CET2 CET3 | OE188 | BAE408AE | |
| 1.6 FSI | 4 | BAD | 81/109 | 01/02→05/05 | | | | | BAE408AE | |
| 1.8 | 4 | BAF | 92/123 | 10/98→05/05 | OE032 | 1,0 | CET2 | OE179 | | |
| 1.8 | 4 | AGN | 92/123 | 10/98→05/05 | OE032 | 1,0 | CET2 | OE179 | BAE907AE ^[262] | CLS140 02/99→10/00 |
| 1.8 4WD | 4 | AGN | 92/123 | 02/99→05/05 | OE032 | 1,0 | CET2 | OE179 | BAE907AE ^[262] | CLS140 →10/00 |
| 1.8 T | 4 | AUM | 110/148 | 05/00→05/05 | OE136 | 0,8 | CET12P | OE179 | BAEA043E | |
| 1.8 T | 4 | ARX | 110/148 | 05/00→05/05 | | | CET12P | | | |
| 1.8 T | 4 | AGU | 110/148 | 05/00→05/05 | OE136 | 0,8 | CET2 | OE179 | BAEA016 | |
| 1.8 T | 4 | AWP | 132/177 | 03/02→05/05 | OE136 | 0,8 | CET12P | OE179 | | |
| 1.8 T | 4 | AUQ | 132/177 | 03/02→05/05 | OE136 | 0,8 | CET12P | OE179 | BAEA043E | |
| 1.9 SDI | 4 | AGP; AQM | 50/67 | 10/98→05/05 | CH271 | 11v | | | CCU081 | |
| 1.9 TDI | 4 | AHF; ASV | 81/109 | 10/98→06/01 | CH271 | 11v | | | CCU081 | |
| 1.9 TDI, 1.9 TDI 4WD | 4 | AGR; ALH | 66/89 | 10/98→05/05 | CH271 | 11v | | | CCU081 | |
| 1.9 TDI, 1.9 TDI 4WD | 4 | ATD; AXR | 74/99 | 09/00→05/05 | CH271 →Ch.1J-2-600000 | 11v | | | CCU081 | |
| | | | | | CH181 Ch.1J-2-600001→ | 11v | | | | |
| 1.9 TDI, 1.9 TDI 4WD | 4 | AJM; AUY | 85/114 | 12/98→01/02 | CH271 →Ch.1J-2-600000 | 11v | | | CCU081 | |
| 1.9 TDI, 1.9 TDI 4WD | 4 | ASZ | 96/129 | 11/00→05/05 | CH271 →Ch.1J-2-600000 | 11v | | | CCU081 | |
| | | | | | CH181 Ch.1J-2-600001→ | 11v | | | | |
| 1.9 TDI, 1.9 TDI 4WD | 4 | ARL | 110/148 | 05/00→05/05 | CH271 →Ch.1J-2-600000 | 11v | | | CCU081 | |
| | | | | | CH181 Ch.1J-2-600001→ | 11v | | | | |
| 2.0 | 4 | APK; AQY; AZH | 85/114 | 10/98→ | OE032 | 1,0 | CET2 | OE179 | BAE907AE ^[262] | CLS017 |
| 2.0 | 4 | AZG; AZJ | 85/114 | 10/98→ | OE176 | 1,0 | CET3 | | BAEA029E | CLS070 |
| 2.0 4WD | 4 | AZH | 85/114 | 04/00→05/05 | OE032 | 1,0 | CET2 CET3 | OE179 | BAE907AE ^[262] | CLS017 |

VW





kW/BHP

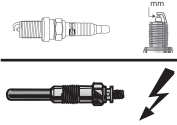

eon TITAN

IRIDIUM

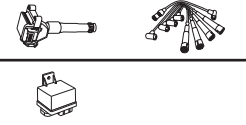

...VW



...BORA

| | | | | | | | | | | |
|--------------------|---|-----|---------|-------------|----------------|------------|--------------|-------|--|--------|
| 2.0 4WD | 4 | AZJ | 85/114 | 04/00→05/05 | OE032 OE176 | 1,0 1,0 | CET2 CET3 | OE179 | BAEA029E | CLS070 |
| 2.3 V5, 2.3 V5 4WD | 5 | AGZ | 110/148 | 10/98→10/00 | | | CET2 | OE188 | BAEA037 | CLS184 |
| 2.3 V5, 2.3 V5 4WD | 5 | AQN | 125/168 | 10/00→05/05 | OE176 | 1,0 | CET3 | | BAEA063E | |
| 2.8 V6 4WD | 6 | AQP | 150/201 | 03/99→05/05 | OE176 | 1,0 | CET3 | | BAEA013E →04/01 →Ch.11-1-900000 | CLS185 |
| 2.8 V6 4WD | 6 | AUE | 150/201 | 03/99→05/05 | OE176 | 1,0 | CET3 | | BAEA013E →04/01 →Ch.11-1-900000 BAEA063E 05/01→ Ch.11-2-000001→ | CLS185 |
| 2.8 V6 4WD | 6 | BDE | 150/201 | 03/99→05/05 | OE176 | 1,0 | CET3 | | BAEA063E 05/01→ Ch.11-2-000001→ | CLS185 |
| 2.8 VR6 | 6 | AUE | 150/201 | 03/00→05/00 | OE176 | 1,0 | CET3 | | BAEA013E →Ch.11-1-900000 | CLS185 |

CADDY ALLTRACK

| | | | | | | | | | | |
|----------------------|---|------------|---------|--------|---------|------|--|--|--------|--|
| 1.2 TSI | 4 | CYVC | 62/83 | 06/15→ | OE244 | 0,8 | | | | |
| 1.4 TSI | 4 | CZCB | 92/123 | 05/15→ | OE244 | 0,8 | | | | |
| 2.0 TDI | 4 | CUUF; DFSF | 55/74 | 05/15→ | CP5G007 | 4.4v | | | CCU152 | |
| 2.0 TDI | 4 | CUUD; DFSD | 75/101 | 05/15→ | CP5G007 | 4.4v | | | CCU152 | |
| 2.0 TDI, 2.0 TDI 4WD | 4 | CUUB; DFSB | 110/148 | 05/15→ | CP5G007 | 4.4v | | | CCU152 | |
| 2.0 TDI 4WD | 4 | CUUE; DFSE | 90/121 | 05/15→ | CP5G007 | 4.4v | | | CCU152 | |

CADDY II

| | | | | | | | | | | |
|---------|---|---------------|-------|-------------|-------|-----|------|-------|-------------------------|--------|
| 1.4 | 4 | AEX; AKV; APQ | 44/59 | 11/95→01/04 | OE025 | 1,0 | CET8 | | BAE851AE [261] [292] | CLS109 |
| 1.4 | 4 | AUD | 44/59 | 11/95→01/04 | OE176 | 1,0 | | | BAE907AE [262] | CLS109 |
| 1.4 16V | 4 | AUA | 55/74 | 08/00→01/04 | OE032 | 1,0 | CET2 | OE179 | BAE907AE [262] | CLS260 |
| 1.6 | 4 | AEE | 55/74 | 11/95→12/00 | OE027 | 1,0 | CET8 | | BAE851AE [261] [292] | CLS109 |
| 1.6 | 4 | 1F | 55/74 | 11/95→12/00 | OE027 | 1,0 | CET8 | | BAE851AE [261] [292] | CLS099 |
| 1.7 SDI | 4 | AHB | 42/56 | 07/96→09/00 | CH271 | 11v | | | CCU081 | |
| 1.9 D | 4 | 1Y; AEF | 47/63 | 11/95→01/04 | CH260 | 11v | | | | |
| 1.9 SDI | 4 | AEY | 47/63 | 11/95→01/04 | CH271 | 11v | | | CCU081 | |
| 1.9 SDI | 4 | AYQ | 47/63 | 11/95→01/04 | | | | | CCU081 | |
| 1.9 TDI | 4 | AHU; ALE; ALH | 66/89 | 10/96→01/04 | CH271 | 11v | | | CCU081 | |

CADDY III

| | | | | | | | | | | |
|-------------|---|---------------|---------|-------------|-------|-----|------|-------|-----------------------------|--------|
| 1.2 TSI | 4 | CBZA | 63/84 | 09/10→05/15 | | | | OE260 | BAE907AE [262] | CLS090 |
| 1.2 TSI | 4 | CBZB | 77/103 | 09/10→05/15 | | | | OE260 | BAE907AE [262] | CLS090 |
| 1.4 | 4 | BCA | 55/74 | 03/04→05/06 | OE032 | 1,0 | CET2 | OE179 | BAE408AE | |
| 1.4 | 4 | BUD | 59/79 | 05/06→08/10 | OE177 | 0,9 | CET3 | | BAE408AE →Ch.1K-8-281299 | |
| 1.6 | 4 | | 74/99 | 03/05→05/15 | OE005 | 0,9 | CET2 | OE179 | | |
| 1.6 | 4 | BGU; BSE; BSF | 75/101 | 04/04→05/15 | OE032 | 1,0 | CET2 | OE179 | BAE907AE [262] | CLS017 |
| 1.6 BiFuel | 4 | CHGA | 75/101 | 05/11→05/15 | OE032 | 1,0 | CET2 | OE179 | BAE907AE [262] | |
| 1.6 TDI | 4 | CAYE | 55/74 | 08/10→05/15 | | | | | CCU152 | |
| 1.6 TDI | 4 | CAYD | 75/101 | 08/10→05/15 | | | | | CCU152 | |
| 1.9 TDI | 4 | BSU | 55/74 | 09/05→08/10 | | | | | CCU152 Ch.2L-6-000001→ | |
| 1.9 TDI | 4 | BLS | 77/103 | 04/04→08/10 | | | | | CCU152 Ch.2L-6-000001→ | |
| 1.9 TDI 4WD | 4 | BLS | 77/103 | 05/08→08/10 | | | | | CCU152 | |
| 2.0 EcoFuel | 4 | BSX | 80/107 | 04/06→05/15 | | | CET2 | OE179 | BAEA029E | CLS070 |
| 2.0 SDI | 4 | BDJ; BST | 51/68 | 03/04→08/10 | | | | | CCU081 | |
| 2.0 TDI | 4 | BMM | 103/138 | 09/07→08/10 | | | | | CCU152 | |



kW/BHP



eon TITAN

IRIDIUM

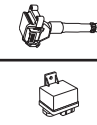

...VW



...CADDY III

| | | | | | | | | | | |
|------------------------------|---|------------|---------|-------------|--|--|--|--|--|--------|
| 2.0 TDI | 4 | CFJA | 125/168 | 05/12→05/15 | | | | | | CCU152 |
| 2.0 TDI, 2.0 TDI 4WD | 4 | CFHF; CLCA | 81/109 | 08/10→05/15 | | | | | | CCU152 |
| 2.0 TDI 16V, 2.0 TDI 16V 4WD | 4 | CFHC; CLCB | 103/138 | 11/10→05/15 | | | | | | CCU152 |

CADDY IV

| | | | | | | | | | | |
|----------------------|---|------------|---------|--------|---------|------|--|--|--|---------------------------|
| 1.2 TSI | 4 | CYVC | 62/83 | 06/15→ | OE244 | 0,8 | | | | BAEA067E ^[240] |
| 1.4 TGI CNG | 4 | CPWA | 81/109 | 06/15→ | | | | | | BAEA067E ^[240] |
| 1.4 TSI | 4 | CZCB | 92/123 | 05/15→ | OE244 | 0,8 | | | | BAEA067E ^[240] |
| 1.6 TDI | 4 | CAYE | 55/74 | 05/15→ | | | | | | CCU152 |
| 1.6 TDI | 4 | CAYD | 75/101 | 05/15→ | | | | | | CCU152 |
| 2.0 TDI | 4 | CUUF; DFSF | 55/74 | 05/15→ | CPSG007 | 4.4v | | | | CCU152 |
| 2.0 TDI | 4 | CUUD; DFSD | 75/101 | 05/15→ | CPSG007 | 4.4v | | | | CCU152 |
| 2.0 TDI, 2.0 TDI 4WD | 4 | CFHC; CLCB | 103/138 | 05/15→ | | | | | | CCU152 |
| 2.0 TDI, 2.0 TDI 4WD | 4 | CUUB; DFSB | 110/148 | 05/15→ | CPSG007 | 4.4v | | | | CCU152 |
| 2.0 TDI 4WD | 4 | CFHF | 81/109 | 05/15→ | | | | | | CCU152 |
| 2.0 TDI 4WD | 4 | CUUE; DFSE | 90/121 | 05/15→ | CPSG007 | 4.4v | | | | CCU152 |

CC

| | | | | | | | | | | |
|----------------------------|---|------------|---------|-------------|---------|------|--------|--|--|---------------------------------|
| 1.4 TSI | 4 | CZDA | 110/148 | 05/15→12/16 | OE244 | 0,8 | | | | BAEA067E ^[240] |
| 1.4 TSI, 1.4 TSI MultiFuel | 4 | CKMA; CTHD | 118/158 | 11/11→12/16 | | | | | | BAE408AE |
| 1.8 TSI | 4 | CDAB | 112/150 | 11/11→12/16 | OE214 | 0,7 | CET11P | | | |
| 1.8 TSI | 4 | CDA A | 118/158 | 11/11→12/16 | OE214 | 0,7 | CET11P | | | |
| 2.0 TDI | 4 | CFFA | 100/134 | 11/11→12/16 | | | | | | CCU151 |
| 2.0 TDI | 4 | CUVC | 110/148 | 05/15→12/16 | CPSG007 | 4.4v | | | | |
| 2.0 TDI | 4 | CUWA | 135/181 | 05/15→12/16 | CPSG007 | 4.4v | | | | |
| 2.0 TDI, 2.0 TDI 4WD | 4 | CFFB | 103/138 | 11/11→12/16 | | | | | | CCU151 |
| 2.0 TDI, 2.0 TDI 4WD | 4 | CFGB; CLLA | 125/168 | 11/11→12/16 | | | | | | CCU151 |
| 2.0 TDI, 2.0 TDI 4WD | 4 | CFG C | 130/174 | 12/12→12/16 | | | | | | CCU151 |
| 2.0 TSI | 4 | CBFA; CCTA | 147/197 | 11/11→12/16 | OE214 | 0,7 | CET11P | | | |
| 2.0 TSI | 4 | CCZB | 155/208 | 11/11→12/16 | OE214 | 0,7 | CET11P | | | |
| 3.6 FSI 4WD | 6 | BWS | 220/295 | 11/11→12/16 | | | | | | BAEA041E ^{[277] [324]} |

CORRADO

| | | | | | | | | | | | |
|-------|---|---------|--------|-------------|-------|-----|------|-------|--|---------------------------------|--------|
| 2.0 i | 4 | 2E; ADY | 85/114 | 04/93→12/95 | OE025 | 1,0 | CET8 | OE195 | | BAE851AE ^{[261] [292]} | CLS099 |
|-------|---|---------|--------|-------------|-------|-----|------|-------|--|---------------------------------|--------|

EOS

| | | | | | | | | | | |
|-------------|---|----------------------------------|---------|-------------|-------|-----|--------|-------|--|---------------------------------|
| 1.4 TSI | 4 | CAXA | 90/121 | 11/07→08/15 | OE213 | 0,9 | | | | BAE408AE |
| 1.4 TSI | 4 | CAVD; CTHD | 118/158 | 05/08→08/15 | | | | | | BAE408AE |
| 1.6 FSI | 4 | BLF | 85/114 | 06/06→05/08 | | | | | | BAE408AE |
| 2.0 FSI | 4 | BVY | 110/148 | 03/06→05/08 | OE234 | 1,0 | CET3 | | | BAEA033E ^[7] |
| 2.0 FSI | 4 | BVZ | 110/148 | 03/06→05/08 | OE146 | 1,0 | CET12P | OE179 | | BAEA033E ^[7] |
| 2.0 TDI | 4 | CFFA | 100/134 | 11/10→08/15 | | | | | | CCU152 |
| 2.0 TDI | 4 | BMM | 103/138 | 06/06→05/08 | | | | | | CCU152 |
| 2.0 TDI 16V | 4 | CBAB; CFFB | 103/138 | 05/08→08/15 | | | | | | CCU152 |
| 2.0 TFSI | 4 | BPY; BWA; CAWB; CBFA; CCTA; CCZA | 147/197 | 03/06→08/15 | OE214 | 0,7 | CET11P | | | BAEA033E ^[7] |
| 2.0 TSI | 4 | CCZB | 155/208 | 11/09→08/15 | OE214 | 0,7 | CET11P | | | BAEA033E ^[7] |
| 3.2 V6 | 6 | BUB | 184/247 | 06/06→05/09 | OE215 | 0,9 | | | | BAEA044E ^[356] |
| 3.6 V6 | 6 | CDVA | 191/256 | 05/09→11/10 | | | | | | BAEA041E ^{[277] [324]} |

FOX

| | | | | | | | | | | | |
|---------|---|----------------|-------|--------|-------|-----|------|--|--|---------------------------|--------|
| 1.2 | 3 | BMD; CHFB | 40/54 | 04/05→ | OE177 | 0,9 | CET3 | | | BAEA059E | |
| 1.2 | 3 | CHFA | 44/59 | 09/10→ | OE177 | 0,9 | CET3 | | | BAEA059E | |
| 1.4 | 4 | BKR | 55/74 | 04/05→ | OE235 | 1,0 | CET3 | | | BAE907AE ^[262] | CLS081 |
| 1.4 TDI | 3 | BNM | 51/68 | 04/05→ | CH181 | 11v | | | | CCU081 | |
| 1.6 | 4 | BAH; BLH; CFZA | 74/99 | 10/03→ | OE235 | 1,0 | CET3 | | | BAE907AE ^[262] | |





kW/BHP



eon TITAN

IRIDIUM

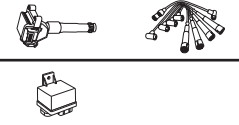

...VW



| ...FOX | | | | | | | | | | |
|----------------------|---|--------------------|---------|-------------|-------------------------------|------|------------------------------------|------------------------------------|---------------------------------|-------------------------|
| 1.6 | 4 | BPA; CCRA | 74/99 | 10/03→ | | | | | BAE907AE ^[262] | |
| 1.6 Total Flex | 4 | BJA | 74/99 | 10/03→ | | | CET12P | OE179 | | |
| 1.6 Total Flex | 4 | BPA; CCRA | 74/99 | 10/03→ | | | CET12P | OE179 | BAE907AE ^[262] | |
| GOLF ALLTRACK | | | | | | | | | | |
| 1.6 TDI 4WD | 4 | CRKB | 81/109 | 12/14→ | CPSG007 ^[194] | 4.4v | | | | |
| 1.6 TDI 4WD | 4 | CXXB | 81/109 | 12/14→ | CPSG007 ^[191] | 4.4v | | | | |
| 2.0 TDI 4WD | 4 | CRBC; CRLB; DCYA | 110/148 | 12/14→ | CPSG007 ^{[25] [193]} | 4.4v | | | | |
| 2.0 TDI 4WD | 4 | CUNA; DGCA | 135/181 | 12/14→ | CPSG007 ^{[25] [193]} | 4.4v | | | | |
| GOLF III | | | | | | | | | | |
| 1.6 | 4 | AFT | 74/99 | 07/94→04/99 | OE032 | 1,0 | CET2 | OE179 | BAE851AE ^{[261] [292]} | CLS034 |
| | | | | | | | | | | CLS139 |
| 1.6 | 4 | AKS | 74/99 | 07/94→04/99 | OE123 | 0,7 | CET2 | OE179 | BAE851AE ^{[261] [292]} | CLS034 |
| | | | | | | | | | | CLS139 |
| 1.6 | 4 | AEK | 74/99 | 07/94→04/99 | OE123 | 0,7 | CET2 | OE179 | BAE851AE ^{[261] [292]} | CLS043 |
| | | | | | | | | | | CLS139 |
| 1.9 SDI | 4 | AEY | 47/63 | 07/95→04/99 | CH271 | 11v | | | CCU081 | |
| 1.9 TDI | 4 | 1Z; AHU; ALE | 66/89 | 09/93→04/99 | CH271 | 11v | | | CCU081 | |
| 1.9 TDI | 4 | AFN | 81/109 | 04/96→04/99 | CH271 | 11v | | | CCU081 | |
| 1.9 TDI 4WD | 4 | 1Z; AHU; ALE | 66/89 | 07/95→04/99 | CH271 | 11v | | | | |
| 2.0 | 4 | AEP | 79/106 | 08/95→04/96 | OE025 | 1,0 | CET8 | OE195 | | |
| 2.0 4WD | 4 | AGG | 85/114 | 08/95→04/99 | OE025 | 1,0 | CET8 | OE195 | BAE851AE ^{[261] [292]} | CLS099 |
| 2.0 GL | 4 | AEP | 79/106 | 08/95→09/97 | OE025 | 1,0 | CET8 | OE195 | BAE851AE ^{[261] [292]} | CLS079 ^[292] |
| 2.8 VR6 | 6 | AAA | 120/161 | 08/95→09/97 | | | CET12P | OE180 | BAEA004E | |
| 2.9 VR6 4WD | 6 | ABV | 140/188 | 10/94→04/99 | OE026 →06/95 | 0,9 | CET2 →06/95 CET12P 07/95→ | OE184 →06/95 OE180 07/95→ | BAEA004E | CLS199 |
| GOLF IV | | | | | | | | | | |
| 1.4 16V | 4 | AHW; AKQ; APE; AXP | 55/74 | 08/97→06/06 | OE032 | 1,0 | CET2 | | BAE907AE ^[262] | CLS260 |
| 1.4 16V | 4 | BCA | 55/74 | 08/97→06/06 | OE032 | 1,0 | CET2 CET3 | | BAE408AE | |
| 1.6 | 4 | BAH | 74/99 | 08/97→05/04 | OE235 | 1,0 | CET3 | | BAE907AE ^[262] | |
| 1.6 | 4 | AEH; AKL; APF | 74/99 | 08/97→05/04 | OE032 | 1,0 | CET2 | OE179 | BAE907AE ^[262] | CLS139 |
| 1.6 | 4 | AFT | 74/99 | 08/97→05/04 | OE032 | 1,0 | CET2 | OE179 | BAE851AE ^{[261] [292]} | CLS034 |
| | | | | | | | | | | CLS139 |
| 1.6 | 4 | AKS | 74/99 | 08/97→05/04 | OE123 | 0,7 | CET2 | OE179 | BAE851AE ^{[261] [292]} | CLS034 |
| | | | | | | | | | | CLS139 |
| 1.6 | 4 | AVU; BFQ | 75/101 | 08/00→06/06 | OE032 | 1,0 | CET2 | OE179 | BAE907AE ^[262] | CLS048 |
| 1.6 | 4 | BJH | 75/101 | 08/00→06/06 | OE032 | 1,0 | CET2 | OE179 | | |
| 1.6 | 4 | AWB | 78/105 | 08/03→06/05 | OE016 | 0,9 | CET2 | OE180 | | |
| 1.6 16V | 4 | ATN; AUS | 77/103 | 02/00→06/06 | OE032 | 1,0 | | | BAE907AE ^[262] | CLS260 |
| 1.6 16V | 4 | AZD | 77/103 | 02/00→06/06 | OE176 | 1,0 | CET3 | | BAE408AE | CLS260 |
| 1.6 16V | 4 | BCB | 77/103 | 02/00→06/06 | OE176 | 1,0 | CET3 | | BAE408AE | |
| 1.6 FSI | 4 | BAD | 81/109 | 01/02→06/06 | | | | | BAE408AE | |
| 1.8 | 4 | ANN | 55/74 | 06/98→06/02 | OE027 | 1,0 | CET8 | | BAE851AE ^{[261] [292]} | CLS027 |
| 1.8 | 4 | AAM | 55/74 | 06/98→06/02 | OE027 | 1,0 | CET8 | | BAE851AE ^{[261] [292]} | CLS079 ^[292] |
| 1.8 | 4 | ACC | 66/89 | 10/97→06/02 | OE025 | 1,0 | CET8 | OE195 | | |

VW





kW/BHP

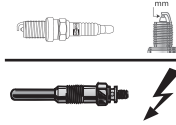

eon TITAN

IRIDIUM

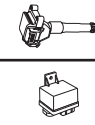

...VW



...GOLF IV

| | | | | | | | | | | |
|----------------------|---|--------------------|---------|-------------|--------------------------|-----|--------|-------|-----------------------------|------------------|
| 1.8 | 4 | ANP | 66/89 | 10/97→06/02 | OE025 | 1,0 | CET8 | OE195 | BAE851AE [261] [292] | CLS099 |
| 1.8 | 4 | ADZ | 66/89 | 10/97→06/02 | OE025 | 1,0 | CET8 | OE195 | BAE851AE [261] [292] | CLS110 [292] |
| 1.8 | 4 | BAF | 92/123 | 08/97→06/05 | OE032 | 1,0 | CET2 | OE179 | | |
| 1.8 | 4 | AGN | 92/123 | 08/97→06/05 | OE032 | 1,0 | CET2 | OE179 | BAE907AE [262] | CLS140 →10/00 |
| 1.8 4WD | 4 | AGN | 92/123 | 05/98→06/06 | OE032 | 1,0 | CET2 | OE179 | BAE907AE [262] | CLS140 |
| 1.8 T | 4 | AQA | 110/148 | 08/97→06/06 | OE136 | 0,8 | CET12P | OE179 | | |
| 1.8 T | 4 | ARZ | 110/148 | 08/97→06/06 | OE136 | 0,8 | CET12P | OE179 | BAEA009E | |
| 1.8 T | 4 | AGU | 110/148 | 08/97→06/06 | OE136 | 0,8 | CET12P | OE179 | BAEA016 | |
| 1.8 T | 4 | AWD | 110/148 | 08/97→06/06 | OE136 | 0,8 | CET12P | OE179 | BAEA009E →Ch.1J-Y-900000 | |
| 1.8 T | 4 | AUM | 110/148 | 08/97→06/06 | OE136 | 0,8 | CET12P | OE179 | BAEA043E Ch.1J-1-000001→ | |
| 1.8 T GTI | 4 | AUQ | 132/177 | 08/01→06/05 | OE136 | 0,8 | CET12P | OE179 | BAEA043E 05/01→ | |
| 1.9 SDI | 4 | AGP; AQM | 50/67 | 08/97→06/06 | CH271 | 11v | | | CCU081 [364] | |
| 1.9 TD | 4 | AAZ | 55/74 | 10/97→09/99 | CH260 | 11v | | | | |
| 1.9 TDI | 4 | AFN; AHF; ASV; AVG | 81/109 | 08/97→05/04 | CH271 | 11v | | | CCU081 [364] | |
| 1.9 TDI, 1.9 TDI 4WD | 4 | AGR; AHU; ALE; ALH | 66/89 | 10/97→05/06 | CH271 | 11v | | | CCU081 [364] | |
| 1.9 TDI, 1.9 TDI 4WD | 4 | ATD; AXR | 74/99 | 09/00→06/06 | CH271 →Ch.1J-2-545141 | 11v | | | CCU081 [364] | |
| | | | | | CH181 Ch.1J-2-545142→ | 11v | | | | |
| 1.9 TDI, 1.9 TDI 4WD | 4 | AJM; AUY | 85/114 | 12/98→06/01 | CH271 | 11v | | | CCU081 [364] | |
| 1.9 TDI, 1.9 TDI 4WD | 4 | ASZ | 96/129 | 11/00→06/06 | CH271 →Ch.1J-2-600000 | 11v | | | CCU081 [364] | |
| | | | | | CH181 Ch.1J-2-600001→ | 11v | | | | |
| 1.9 TDI, 1.9 TDI 4WD | 4 | ARL | 110/148 | 02/00→06/06 | CH271 →Ch.1J-2-545141 | 11v | | | CCU081 [364] | |
| | | | | | CH181 Ch.1J-2-545142→ | 11v | | | | |
| 2.0 | 4 | APK; AQY | 85/114 | 06/98→06/06 | OE032 | 1,0 | CET2 | OE179 | BAE907AE [262] | CLS017 |
| 2.0 | 4 | BER | 85/114 | 06/98→06/06 | | | CET2 | OE179 | | |
| 2.0 | 4 | ATU; AWF; AWG | 85/114 | 06/98→06/06 | OE032 | 1,0 | CET2 | OE179 | | CLS034 |
| 2.0 | 4 | AGG; AKR | 85/114 | 06/98→06/06 | OE025 | 1,0 | CET8 | OE195 | BAE851AE [261] [292] | CLS099 |
| 2.0, 2.0 4WD | 4 | AZG; AZJ | 85/114 | 06/98→06/06 | OE176 | 1,0 | CET3 | OE179 | BAEA029E | CLS070 |
| 2.0 4WD | 4 | AZH | 85/114 | 10/00→06/06 | OE032 | 1,0 | CET2 | OE179 | BAE907AE [262] | CLS017 →06/01 |
| 2.0 Bi-Fuel | 4 | BEH | 85/114 | 02/02→06/06 | OE176 | 1,0 | CET3 | | BAEA029E | CLS070 |
| 2.3 V5 | 5 | AGZ | 110/148 | 08/97→06/06 | OE198 | 0,9 | CET2 | | BAEA037 | CLS181 →09/98 |
| | | | | | | | | | | CLS184 |
| 2.3 V5, 2.3 V5 4WD | 5 | AQN | 125/168 | 10/00→06/06 | OE176 | 1,0 | CET3 | | BAEA063E | |
| 2.3 V5 4WD | 5 | AGZ | 110/148 | 12/98→06/06 | OE198 | 0,9 | CET2 | | BAEA037 | CLS184 |
| 2.8 V6 4WD | 6 | AQP | 150/201 | 03/99→06/06 | OE176 | 1,0 | CET3 | | BAEA013E →04/01 | CLS185 |
| | | | | | | | | | →Ch.1J-1-900000 | |
| 2.8 V6 4WD | 6 | AUE | 150/201 | 03/99→06/06 | OE176 | 1,0 | CET3 | | BAEA013E →04/01 | CLS185 |
| | | | | | | | | | →Ch.1J-1-900000 | |
| | | | | | | | | | BAEA063E 05/01→ | |
| | | | | | | | | | Ch.1J-2-000001→ | |
| 2.8 V6 4WD | 6 | BDE | 150/201 | 03/99→06/06 | OE176 | 1,0 | CET3 | | BAEA063E 05/01→ | CLS185 |
| | | | | | | | | | Ch.1J-2-000001→ | |
| 3.2 R32 4WD | 6 | BFH; BML | 177/237 | 09/02→06/05 | OE215 | 0,9 | | | BAEA044E [356] | |

VW





kW/BHP

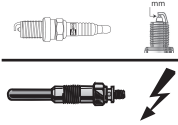

eon TITAN

IRIDIUM



...VW



GOLF V

| | | | | | | | | | |
|----------------------|---|---------------------------------|---------|-------------|----------------------------------|------------|--------|----------------------------------|--|
| 1.4 | 4 | BUD | 59/79 | 06/07→07/09 | OE177 | 0,9 | CET3 | | BAE408AE →Ch.1K-8-281299 |
| 1.4 16V | 4 | BCA | 55/74 | 10/03→05/06 | OE032 | 1,0 | CET2 | OE179 | BAE408AE |
| 1.4 16V | 4 | BUD | 59/79 | 05/06→11/08 | OE177 | 0,9 | CET3 | | BAE408AE |
| 1.4 FSI | 4 | BKG; BLN | 66/89 | 10/03→07/06 | | | | | BAE408AE |
| 1.4 TSI | 4 | CAXA | 90/121 | 05/07→07/09 | | | | | BAE408AE |
| 1.4 TSI | 4 | BMV | 103/138 | 05/06→07/09 | | | | | BAE408AE |
| 1.4 TSI | 4 | CAVD | 118/158 | 07/08→07/09 | OE213 | 0,9 | | | BAE408AE |
| 1.4 TSI | 4 | BLG | 125/168 | 11/05→07/09 | | | | | BAE408AE |
| 1.6 | 4 | BGU; BSE; BSF; CCSA | 75/101 | 01/04→07/09 | OE032 | 1,0 | CET2 | OE179 | BAE907AE ^[262] CLS017 |
| 1.6 FSI | 4 | BAG; BLF; BLP | 85/114 | 10/03→07/08 | | | | | BAE408AE |
| 1.6 MultiFuel | 4 | CCSA | 75/101 | 10/07→07/09 | OE032 | 1,0 | CET2 | OE179 | BAE907AE ^[262] CLS048 |
| 1.9 TDI | 4 | BRU; BXF | 66/89 | 05/04→11/08 | | | | | CCU152 03/06→ |
| 1.9 TDI, 1.9 TDI 4WD | 4 | BKC; BXE | 77/103 | 10/03→07/09 | | | | | CCU152 03/06→ |
| 1.9 TDI, 1.9 TDI 4WD | 4 | BLS; BXE | 77/103 | 10/03→07/09 | | | | | CCU152 |
| 2.0 | 4 | BHY; CBPA | 85/114 | 08/06→11/08 | OE032 | 1,0 | CET2 | OE179 | BAE907AE ^[262] |
| 2.0 | 4 | BWA; CAWB; CCTA | 147/197 | 06/07→07/09 | OE214 | 0,7 | CET11P | | BAEA033E ^[7] |
| 2.0 FSI | 4 | BLY; BVZ | 110/148 | 01/04→11/08 | OE146 | 1,0 | CET12P | OE179 | BAEA033E ^[7] |
| 2.0 FSI, 2.0 FSI 4WD | 4 | AXW; BLR; BLX; BVX; BVY | 110/148 | 01/04→11/08 | OE234 | 1,0 | CET3 | | BAEA033E ^[7] |
| 2.0 GTI | 4 | AXX; BPY; BWA; CAWB; CBFÄ; CCTA | 147/197 | 10/04→02/09 | OE214 | 0,7 | CET11P | | BAEA033E ^[7] →Ch.1K-9W124420 |
| 2.0 GTI | 4 | BYD | 169/227 | 09/06→12/08 | OE214 | 0,7 | CET11P | | BAEA033E ^[7] |
| 2.0 SDI | 4 | BDK | 55/74 | 01/04→11/08 | | | | | CCU151 08/06→ |
| 2.0 TDI | 4 | AZV | 100/134 | 10/03→07/09 | | | | | CCU152 03/06→ |
| 2.0 TDI | 4 | BMN | 125/168 | 11/05→11/08 | CCGP003 Ch.1K-6-000001→ | 7v | | | CCU152 |
| 2.0 TDI, 2.0 TDI 4WD | 4 | BMM | 103/138 | 08/04→07/09 | | | | | CCU152 |
| 2.0 TDI 16V | 4 | BKD | 103/138 | 10/03→07/09 | | | | | CCU151 |
| 2.0 TDI 16V | 4 | CBDB | 103/138 | 10/03→07/09 | | | | | CCU152 |
| 2.0 TDI 16V 4WD | 4 | BKD | 103/138 | 08/04→11/08 | | | | | CCU151 08/06→ |
| 3.2, 3.2 R32 4WD | 6 | BUB | 184/247 | 09/05→11/08 | OE215 | 0,9 | | | BAEA044E ^[356] |
| 3.2 R32 4WD | 6 | BJS | 177/237 | 01/04→11/08 | OE215 | 0,9 | | | |
| 3.2 R32 4WD | 6 | CBRA | 184/247 | 11/05→11/08 | OE215 | 0,9 | | | |
| GOLF VI | | | | | | | | | |
| 1.2 TSI | 4 | CBZA | 63/84 | 05/10→07/13 | | | | OE260 | BAE907AE ^[262] CLS090 |
| 1.2 TSI | 4 | CBZB | 77/103 | 11/08→ | | | | OE260 OE260 ModelYear→2016 | BAE907AE ^[262] CLS090 |
| 1.2 TSI 16V | 4 | CYVD | 77/103 | 11/13→ | OE244 | 0,8 | | | BAEA067E ^[240] |
| 1.2 TSI 16V | 4 | CJZA | 77/103 | 11/13→ | | | | | BAEA067E ^[240] |
| 1.4 | 4 | CGGA | 59/79 | 10/08→07/13 | OE177 | 0,9 | CET3 | | BAE408AE BAE408AE Ch.1K-8-281300→ |
| 1.4 | 4 | BUD | 59/79 | 10/08→07/13 | OE177 | 0,9 | CET3 | | BAE408AE Ch.1K-8-281300→ |
| 1.4 TSI | 4 | CAXA | 90/121 | 10/08→ | OE213 OE213 ModelYear→2016 | 0,9 0,9 | | | BAE408AE |
| 1.4 TSI | 4 | CZCA | 92/123 | 11/13→ | OE244 | 0,8 | | | BAEA067E ^[240] |
| 1.4 TSI | 4 | CZDA | 110/148 | 11/13→ | OE244 | 0,8 | | | BAEA067E ^[240] |
| 1.4 TSI | 4 | CHPB | 110/148 | 11/13→ | OE244 | 0,8 | | | |
| 1.4 TSI | 4 | CAVD; CNWA; CTHD; CTKA | 118/158 | 10/08→ | OE213 →Prod.13.02.2011 | 0,9 | | | BAE408AE |

VW





kW/BHP



eon TITAN

IRIDIUM



...VW



...GOLF VI

| | | | | | | | | | | |
|----------------------------|---|-------------------------|---------|---------------|----------------------------------|------|--------|-------|--|------------------|
| 1.6 | 4 | BSE; BSF; CCSA; CMXA | 75/101 | 10/08 → 07/13 | OE032 | 1,0 | CET2 | OE179 | BAE907AE ^[262] | CLS017 CLS048 |
| 1.6 BiFuel | 4 | CHGA | 75/101 | 03/09 → 11/12 | OE146 | 1,0 | CET12P | OE179 | BAE907AE ^[262] | CLS048 |
| 1.6 MultiFuel | 4 | CCSA; CMXA | 75/101 | 10/08 → 07/13 | OE032 | 1,0 | CET2 | OE179 | BAE907AE ^[262] | |
| 1.6 TDI | 4 | CAYB | 66/89 | 02/09 → 07/13 | | | | | CCU152 | |
| 1.6 TDI, 1.6 TDI 4WD | 4 | CAYC | 77/103 | 02/09 → | | | | | CCU152 | |
| 1.8 TSI | 4 | CDAА | 118/158 | 06/09 → 01/11 | OE214 | 0,7 | CET11P | | BAEA033E → 07/09 [7] [249] | |
| 2.0 GTI | 4 | CCZB | 155/208 | 11/11 → | OE214 | 0,7 | CET11P | | BAEA033E ^[7] | |
| 2.0 GTi | 4 | CCZB | 155/208 | 04/09 → 11/12 | OE214 | 0,7 | CET11P | | BAEA033E → 07/09 [7] [249] | |
| 2.0 GTi | 4 | CDLG | 173/232 | 05/11 → 11/12 | OE214 | 0,7 | CET11P | | BAEA033E ^[7] | |
| 2.0 GTi, 2.0 TSI | 4 | CBFA; CCTA; CCZA | 147/197 | 06/09 → 11/13 | OE214 | 0,7 | CET11P | | | |
| 2.0 R, 2.0 R 4WD | 4 | CDLA | 195/261 | 11/09 → | OE214 | 0,7 | CET11P | | BAEA033E ^[7] | |
| 2.0 R 4WD | 4 | CDLC; CRZA | 188/252 | 11/09 → 11/13 | OE214 | 0,7 | CET11P | | BAEA033E ^[7] | |
| 2.0 R 4WD | 4 | CDLF | 199/267 | 11/09 → 11/12 | OE214 | 0,7 | CET11P | | BAEA033E ^[7] | |
| 2.0 TDI | 4 | CBDC; CLCA | 81/109 | 10/08 → | | | | | CCU152 | |
| 2.0 TDI | 4 | CUUA | 81/109 | 10/08 → | CPSG007 | 4.4v | | | CCU152 | |
| 2.0 TDI | 4 | CBAA; CBDA; CFFA | 100/134 | 10/08 → 07/13 | | | | | CCU152 | |
| 2.0 TDI | 4 | CJAA | 103/138 | 10/08 → | CPSG007 | 4.4v | | | | |
| 2.0 TDI | 4 | CUUB | 110/148 | 11/13 → | CPSG007 | 4.4v | | | CCU152 | |
| 2.0 TDI | 4 | CBBB; CFGB | 125/168 | 04/09 → 11/12 | | | | | CCU152 | |
| 2.0 TDI, 2.0 TDI 4WD | 4 | CBAB; CBDDB; CFFB; CFHC | 103/138 | 10/08 → | | | | | CCU152 | |
| 2.0 TSI | 4 | CULC | 162/217 | 11/13 → | | | | OE246 | BAEA068E | |
| GOLF VII | | | | | | | | | | |
| 1.0 TSI | 3 | CHZD | 85/114 | 05/15 → | | | | | BAEA067E ^[240] | |
| 1.2 TSI | 4 | CJZB; CYVA | 63/84 | 08/12 → | OE244 | 0,8 | | | BAEA067E ^[240] BAEA126E ^[249] | |
| 1.2 TSI | 4 | CJZA | 77/103 | 11/12 → | OE244 | 0,8 | | | BAEA067E ^[240] BAEA126E ^[249] | |
| 1.2 TSI | 4 | CYVB | 81/109 | 04/14 → | OE244 | 0,8 | | | BAEA067E ^[240] | |
| 1.4 Flex, 1.4 TSI | 4 | ; CHPB | 110/148 | 05/14 → | OE244 | 0,8 | | | | |
| 1.4 GTE Hybrid, 1.4 TSI | 4 | CUKB; CZDA; CZEА | 110/148 | 05/14 → | OE244 | 0,8 | | | BAEA067E ^[240] | |
| 1.4 TGI CNG | 4 | CPWA | 81/109 | 06/13 → | | | | | BAEA067E ^[240] | |
| 1.4 TSI | 4 | CHPA; CPTA | 103/138 | 08/12 → | OE244 | 0,8 | | | BAEA067E ^[240] BAEA126E ^[249] | |
| 1.4 TSI, 1.4 TSI MultiFuel | 4 | CMBA; CPVA; CXSA | 90/121 | 11/12 → | OE244 | 0,8 | | | BAEA067E ^[240] BAEA126E ^[249] | |
| 1.4 TSI, 1.4 TSI MultiFuel | 4 | CPVB; CZCA; CZDD | 92/123 | 12/13 → | OE244 | 0,8 | | | BAEA067E ^[240] | |
| 1.6 | 4 | CWVA | 81/109 | 05/14 → | OE247 | 1,0 | | | BAEA067E ^[240] | |
| 1.6 TDI | 4 | CRKA | 66/89 | 04/13 → | | | | | CCU151 | |
| 1.6 TDI | 4 | CXXA; DDYB | 66/89 | 04/13 → | | | | | CCU151 | |
| 1.6 TDI | 4 | CLHB | 66/89 | 04/13 → | CPSG007 ^{[25] [193]} | 4.4v | | | CCU151 | |
| 1.6 TDI | 4 | DBKA | 81/109 | 01/13 → | | | | | CCU151 | |
| 1.6 TDI | 4 | DDYA | 85/114 | 11/16 → | CPSG007 ^[192] | 4.4v | | | | |
| 1.6 TDI, 1.6 TDI 4WD | 4 | CLHA | 77/103 | 08/12 → | CPSG007 ^{[25] [193]} | 4.4v | | | CCU151 | |
| 1.6 TDI, 1.6 TDI 4WD | 4 | CRKB | 81/109 | 01/13 → | CPSG007 ^[194] | 4.4v | | | CCU151 | |
| 1.6 TDI, 1.6 TDI 4WD | 4 | CXXB | 81/109 | 01/13 → | CPSG007 ^[191] | 4.4v | | | CCU151 | |
| 2.0 GTD | 4 | CUNA; DGCA | 135/181 | 04/13 → | CPSG007 ^{[25] [193]} | 4.4v | | | CCU151 | |
| 2.0 GTI | 4 | CHHB; CNTC; CXCB; CXDA | 162/217 | 04/13 → | | | | OE246 | BAEA068E | |
| 2.0 GTI | 4 | CHHA | 169/227 | 04/13 → | | | | OE246 | BAEA068E | |

VW





kW/BHP



eon TITAN

IRIDIUM



...VW



...GOLF VII

| | | | | | | | | | |
|----------------------|---|------------------------------|---------|--------|------------------------------|------|--|--------------|-----------------|
| 2.0 GTI Clubsport | 4 | CJXE | 195/261 | 02/16→ | | | | OE246 | BAEA068E |
| 2.0 GTI Clubsport S | 4 | CJXG | 228/306 | 09/16→ | | | | | BAEA068E |
| 2.0 R 4WD | 4 | CJXB | 206/276 | 11/13→ | | | | OE246 | BAEA068E |
| 2.0 R 4WD | 4 | CJXC | 221/296 | 11/13→ | | | | OE246 | BAEA068E |
| 2.0 TDI | 4 | CRLD; CRVA; CYKB; DCYB; DEJB | 81/109 | 11/12→ | CPSG007 [25] [193] | 4.4v | | | CCU151 |
| 2.0 TDI | 4 | CRBB; CRVC | 105/141 | 08/12→ | | | | | CCU151 |
| 2.0 TDI, 2.0 TDI 4WD | 4 | CKFC; CRMB; CRUA; DCYA; DEJA | 110/148 | 11/12→ | | | | | CCU151 |
| 2.0 TDI, 2.0 TDI 4WD | 4 | CRBC; CRLB | 110/148 | 11/12→ | CPSG007 [25] [193] | 4.4v | | | CCU151 |

GOLF PLUS

| | | | | | | | | | | |
|-----------------------|---|-----------------|---------|-------------|---|-----|---------------|--------------|------------------------------------|---------------|
| 1.2 TSI | 4 | CBZA | 63/84 | 05/10→12/13 | | | | OE260 | BAE907AE [262] | CLS090 |
| 1.2 TSI | 4 | CBZB | 77/103 | 11/09→12/13 | | | | OE260 | BAE907AE [262] | CLS090 |
| 1.4 16V | 4 | BCA | 55/74 | 01/05→11/06 | OE032 | 1,0 | CET2 | OE179 | BAE408AE | |
| 1.4 16V | 4 | BUD | 59/79 | 05/06→12/13 | OE177 | 0,9 | CET3 | | | |
| 1.4 16V | 4 | CGGA | 59/79 | 05/06→12/13 | OE177 | 0,9 | CET3 | | BAE408AE Ch.1K-9-400001→ | |
| 1.4 FSI | 4 | BLN | 66/89 | 07/05→11/06 | | | | | BAE408AE | |
| 1.4 TSI | 4 | CAXA | 90/121 | 06/07→12/13 | OE213 Ch.1KZ9-900001→ ModelYear2009→ | 0,9 | | | BAE408AE →Ch.1K-8-281299 | |
| 1.4 TSI | 4 | BMV | 103/138 | 05/06→06/08 | | | | | BAE408AE →Ch.1K-8-281299 | |
| 1.4 TSI | 4 | CAVD; CNWA | 118/158 | 06/08→12/13 | | | | | BAE408AE | |
| 1.4 TSI | 4 | BLG | 125/168 | 05/06→06/08 | | | | | BAE408AE →Ch.1K-8-281299 | |
| 1.6 | 4 | BSE | 75/101 | 05/05→12/13 | OE032 | 1,0 | CET2 | OE179 | BAE907AE [262] | CLS017 |
| 1.6 | 4 | BSF; CCSA; CMXA | 75/101 | 05/05→12/13 | | | CET2 | | BAE907AE [262] | CLS017 |
| 1.6 BiFuel | 4 | CHGA | 75/101 | 05/09→12/13 | OE032 | 1,0 | CET2 | OE179 | BAE907AE [262] | CLS048 |
| 1.6 FSI | 4 | BLF; BLP | 85/114 | 12/04→05/08 | | | | | BAE408AE | |
| 1.6 MultiFuel | 4 | CCSA; CMXA | 75/101 | 11/07→12/13 | OE146 | 1,0 | CET12P | OE179 | BAE907AE [262] | CLS048 |
| 1.6 TDI | 4 | CAYB | 66/89 | 02/09→12/13 | | | | | CCU152 | |
| 1.6 TDI | 4 | CAYC | 77/103 | 03/09→12/13 | | | | | CCU152 | |
| 1.9 TDI | 4 | BRU; BXF; BXJ | 66/89 | 05/05→12/08 | | | | | CCU081 | |
| 1.9 TDI | 4 | BKC; BXE | 77/103 | 01/05→01/09 | | | | | CCU081 [127] [363] | |
| 1.9 TDI | 4 | BLS | 77/103 | 01/05→01/09 | | | | | CCU081 [127] [363] | |
| | | | | | | | | | CCU152 Ch.5M-6-500001→ | |
| 2.0 FSI | 4 | BLR; BVY | 110/148 | 05/05→06/08 | OE234 | 1,0 | CET3 | | BAEA033E [7] | |
| 2.0 FSI | 4 | BLY; BVZ | 110/148 | 05/05→06/08 | OE146 | 1,0 | CET12P | OE179 | BAEA033E [7] | |
| 2.0 TDI | 4 | CBDC; CLCA | 81/109 | 01/09→12/13 | | | | | CCU152 | |
| 2.0 TDI | 4 | BEE | 96/129 | 05/05→05/07 | | | | | CCU081 | |
| 2.0 TDI | 4 | AZV | 100/134 | 05/05→12/13 | | | | | CCU081 [127] [363] | |
| 2.0 TDI | 4 | CBDA; CFHB | 100/134 | 05/05→12/13 | | | | | CCU152 Ch.1KZ-9W900001→ | |
| 2.0 TDI | 4 | BMM | 103/138 | 12/05→05/11 | | | | | CCU081 | |
| | | | | | | | | | CCU152 Ch.5M-6-500001→ | |
| 2.0 TDI 16V | 4 | BKD | 103/138 | 01/05→12/13 | | | | | CCU081 [127] [363] | |
| 2.0 TDI 16V | 4 | CBDB; CFHC | 103/138 | 01/05→12/13 | | | | | CCU152 Ch.1KZ-9W900001→ | |
| GOLF SPORTSVAN | | | | | | | | | | |
| 1.0 TSI | 3 | CHZD | 85/114 | 05/15→ | | | | | BAEA067E [240] | |
| 1.2 TSI | 4 | CVVA | 63/84 | 05/14→ | OE244 | 0,8 | | | BAEA067E [240] | |

VW





kW/BHP



eon TITAN

IRIDIUM



...VW



...GOLF SPORTSVAN

| | | | | | | | | | |
|----------------------------|---|------------------|---------|--------|----------------|------|--|--|---------------------------------|
| 1.2 TSI | 4 | CYVB | 81/109 | 04/14→ | OE244 | 0,8 | | | BAEA067E^[240] |
| 1.4 TSI | 4 | CZDA | 110/148 | 02/14→ | OE244 | 0,8 | | | BAEA067E^[240] |
| 1.4 TSI, 1.4 TSI MultiFuel | 4 | CPVB; CZCA | 92/123 | 04/14→ | OE244 | 0,8 | | | BAEA067E^[240] |
| 1.6 | 4 | CWVA | 81/109 | 05/14→ | OE247 | 1,0 | | | BAEA067E^[240] |
| 1.6 TDI | 4 | CRKA; CXXA; DDYB | 66/89 | 02/14→ | | | | | CCU151 |
| 1.6 TDI | 4 | CXXB | 81/109 | 02/14→ | | | | | CCU151 |
| 1.6 TDI | 4 | CRKB; DBKA | 81/109 | 02/14→ | | | | | CCU151 |
| 1.6 TDI | 4 | DDYA | 85/114 | 11/16→ | CPSG008 | 4.4v | | | |
| 2.0 TDI | 4 | CRLD; CRVA; DCYB | 81/109 | 05/14→ | | | | | CCU151 |
| 2.0 TDI | 4 | CRLB; DCYA | 110/148 | 02/14→ | CPSG007 | 4.4v | | | CCU151 |

GOL III

| | | | | | | | | | |
|-----|---|-----|-------|-------------|--|-----|-------------|--------------|--|
| 1.6 | 4 | UNF | 68/91 | 08/02→05/08 | OE235 <small>Ch.5W-9P050700 5W-9T061965→</small> | 1,0 | CET3 | | |
| 1.6 | 4 | BWX | 73/98 | 03/99→09/05 | OE032 | 1,0 | CET2 | OE179 | |

GOL IV

| | | | | | | | | | |
|------------|---|-----|-------|-------------|--|-----|-------------|--------------|---|
| 1.0 | 4 | BTY | 53/71 | 10/05→05/08 | OE016 | 0,9 | CET2 | OE180 | BAE907AE^[262] CLS081 |
| 1.6 Hybrid | 4 | UNF | 68/91 | 09/05→05/08 | OE235 <small>Ch.5W-9P050700 5W-9T061965→</small> | 1,0 | CET3 | | |

JETTA III

| | | | | | | | | | |
|---------------|---|---------------------------|---------|-------------|--------------------------------|------------|------------------------------|--------------|---|
| 1.4 TSI | 4 | CAXA | 90/121 | 05/07→10/10 | | | | | BAE408AE |
| 1.4 TSI | 4 | BMY | 103/138 | 07/06→10/10 | | | | | BAE408AE →Ch.1K-8-281299 |
| 1.4 TSI | 4 | CAVD | 118/158 | 07/08→10/10 | | | | | BAE408AE |
| 1.4 TSI | 4 | BLG | 125/168 | 07/06→10/10 | | | | | BAE408AE →Ch.1K-8-281299 |
| 1.6 | 4 | BSE; BSF; CCSA | 75/101 | 10/05→10/10 | OE032 | 1,0 | CET2 | OE179 | BAE907AE^[262] CLS017 |
| 1.6 | 4 | BGU | 75/101 | 10/05→10/10 | OE032 | 1,0 | CET2 | OE179 | |
| 1.6 FSI | 4 | BLF | 85/114 | 09/05→10/10 | | | | | BAE408AE Ch.1K-7-000000→ |
| 1.6 MultiFuel | 4 | CCSA | 75/101 | 01/08→10/10 | OE032 | 1,0 | CET2 | OE179 | BAE907AE^[262] CLS048 |
| 1.6 TDI | 4 | CAYC | 77/103 | 06/09→10/10 | | | | | CCU151 |
| 1.9 TDI | 4 | BKC; BXE | 77/103 | 08/05→10/10 | | | | | CCU152 |
| 1.9 TDI | 4 | BLS | 77/103 | 08/05→10/10 | CCGP002^[184] | 7v | | | CCU152 |
| 2.0 FSI | 4 | BLR; BVY | 110/148 | 08/05→10/10 | OE234 | 1,0 | CET3 | | BAEA033E^[7] |
| 2.0 FSI | 4 | BLX | 110/148 | 08/05→10/10 | | | | | BAEA033E^[7] |
| 2.0 FSI | 4 | BVZ | 110/148 | 08/05→10/10 | OE146 | 1,0 | CET12P | OE179 | BAEA033E^[7] |
| 2.0 FSI | 4 | BLY | 110/148 | 08/05→10/10 | OE146 OE234 | 1,0 1,0 | CET12P CET3 | OE179 | BAEA033E^[7] |
| 2.0 TDI | 4 | CBDA | 100/134 | 09/05→10/10 | | | | | CCU152 |
| 2.0 TDI | 4 | BMM | 103/138 | 10/05→10/10 | | | | | CCU152 |
| 2.0 TDI | 4 | BMN | 125/168 | 10/06→10/10 | CCGP003 | 7v | | | |
| 2.0 TDI | 4 | CEGA | 125/168 | 10/06→10/10 | | | | | CCU152 |
| 2.0 TDI 16V | 4 | CBDB | 103/138 | 08/05→10/10 | | | | | CCU152 |
| 2.0 TDI 16V | 4 | CJAA | 103/138 | 08/05→10/10 | CPSG007 | 4.4v | | | |
| 2.0 TFSI | 4 | CAWA | 125/168 | 07/08→10/10 | OE214 | 0,7 | CET11P | | BAEA033E^[7] |
| 2.0 TFSI | 4 | AXX; BPY; BWA; CAWB; CCTA | 147/197 | 10/05→10/10 | OE214 | 0,7 | CET11P | | BAEA033E^[7] |
| 2.0 TFSI | 4 | CBFA; CCZA | 147/197 | 10/05→10/10 | OE214 | 0,7 | CET11P | | |
| 2.5 | 5 | BGP; BTK | 110/148 | 01/06→10/10 | OE176 | 1,0 | CET3 | | |
| 2.5 | 5 | CBTA; CBUA; CCCA | 125/168 | 07/08→10/10 | | | CET3 | | BAEA033E^[7] |

JETTA IV

| | | | | | | | | | |
|-------------|---|------|--------|--------|--------------|-----|--|--------------|---|
| 1.2 TSI | 4 | CBZB | 77/103 | 10/10→ | | | | OE260 | BAE907AE^[262] CLS090 |
| 1.2 TSI 16V | 4 | CYVD | 77/103 | 08/14→ | OE244 | 0,8 | | | |
| 1.4 TSI | 4 | CAXA | 90/121 | 05/11→ | OE213 | 0,9 | | | BAE408AE |

VW





kW/BHP

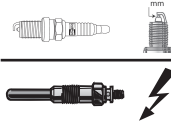

eon TITAN

IRIDIUM



...VW



| ...JETTA IV | | | | | | | | | |
|----------------|---|--------------------|---------|-------------|--|------|--------|--|--|
| 1.4 TSI | 4 | CMSB | 90/121 | 05/11→ | OE213 | 0,9 | | | |
| 1.4 TSI | 4 | CZCA | 92/123 | 08/14→ | OE244 | 0,8 | | BAEA067E [240] | |
| 1.4 TSI | 4 | CZDA; CZTA | 110/148 | 04/11→ | OE244 | 0,8 | | BAEA067E [240] | |
| 1.4 TSI | 4 | CAVA; CTHA | 110/148 | 04/11→ | | | | BAE408AE | |
| 1.4 TSI | 4 | CAVD | 118/158 | 04/11→ | | | | BAE408AE | |
| 1.4 TSI Hybrid | 4 | CNLA | 110/148 | 04/11→ | OE244 | 0,8 | | BAEA067E [240] [275] BAEA126E [249] [275] | |
| 1.4 TSI Hybrid | 4 | CRJA | 110/148 | 04/11→ | OE244 | 0,8 | | | |
| 1.6 | 4 | CFNB | 63/84 | 03/13→ | | | | BAE408AE | |
| 1.6 | 4 | CFNA; CLRA | 77/103 | 12/11→ | OE177 | 0,9 | CET3 | BAE408AE | |
| 1.6 TDI | 4 | CAYC | 77/103 | 04/10→07/14 | | | | CCU151 | |
| 1.8 TSI | 4 | CPKA; CPRA | 125/168 | 07/14→ | | | | BAEA068E | |
| 2.0 | 4 | CKJA | 85/114 | 06/10→ | OE177 | 0,9 | CET3 | BAEA029E | |
| 2.0 | 4 | CBPA | 85/114 | 06/10→ | OE177 | 0,9 | CET3 | BAE907AE [262] | |
| 2.0 TDI | 4 | CLCA | 81/109 | 10/10→ | | | | CCU151 | |
| 2.0 TDI | 4 | CFFB; CFHC; CLCB | 103/138 | 02/11→ | | | | CCU151 | |
| 2.0 TDI | 4 | CJAA | 103/138 | 02/11→ | CPSG007 | 4.4v | | | |
| 2.0 TDI | 4 | CUUB; DELA; DGMA | 110/148 | 08/14→ | CPSG007 [275] | 4.4v | | CCU151 | |
| 2.0 TSI | 4 | CBFA; CCTA; CCZA | 147/197 | 12/10→ | OE214 | 0,7 | CET11P | BAEA033E [7] | |
| 2.0 TSI | 4 | CPLA; CPPA | 155/208 | 12/12→ | | | | OE246 | BAEA068E →Prod.24.11.2013 |
| 2.5 | 5 | CBTA; CBUA; CCCA | 125/168 | 04/10→ | | | CET3 | | |
| LUPO | | | | | | | | | |
| 1.0 | 4 | AHT | 37/50 | 09/98→07/05 | OE136 | 0,8 | CET12P | OE179 | BAE961AE |
| 1.0 | 4 | AER/ALL | 37/50 | 09/98→07/05 | OE025 | 1,0 | CET8 | OE195 | |
| 1.0 | 4 | ANV/ALD/AUC | 37/50 | 09/98→07/05 | OE176 | 1,0 | CET3 | | |
| 1.0 | 4 | ALD; ANV | 37/50 | 09/98→07/05 | | | | | BAE907AE [262] [275] BAE961AE [275] |
| 1.0 | 4 | AER; ALL | 37/50 | 09/98→07/05 | | | | | BAE851AE [261] [275] [292] BAE961AE [275] |
| 1.0 | 4 | AUC | 37/50 | 09/98→07/05 | | | | | BAE907AE [262] [275] BAE961AE [275] |
| 1.2 TDI 3L | 3 | ANY; AYZ | 45/60 | 07/99→07/05 | CH271 →Ch.6X-2-005000 CH181 Ch.6X-2-005001→ | 11v | | | |
| 1.4 | 4 | AUD | 44/59 | 10/00→07/05 | OE176 | 1,0 | CET3 | BAE907AE [262] | CLS053 |
| 1.4 16V | 4 | AHW; AKQ; APE; AUA | 55/74 | 09/98→07/05 | OE032 | 1,0 | CET2 | OE179 | BAE907AE [262] |
| 1.4 16V | 4 | BBY | 55/74 | 09/98→07/05 | OE032 | 1,0 | CET2 | OE179 | BAE408AE |
| 1.4 16V | 4 | AFK; AUB | 74/99 | 08/99→07/05 | OE032 | 1,0 | CET2 | OE188 | BAE907AE [262] |
| 1.4 16V | 4 | AQQ | 74/99 | 08/99→07/05 | OE032 | 1,0 | CET2 | OE188 | BAE907AE [262] |
| 1.4 16V | 4 | ANM | 74/99 | 08/99→07/05 | | | | | BAE907AE [262] |
| 1.4 TDI | 3 | AMF | 55/74 | 01/99→07/05 | CH271 →Ch.6X-2-005000 CH181 Ch.6X-2-005001→ | 11v | | | CCU081 |
| 1.6 GTI | 4 | AVY | 92/123 | 09/00→07/05 | OE032 | 1,0 | CET2 | OE179 | BAE907AE [262] |
| 1.7 SDI | 4 | AKU | 44/59 | 09/98→07/05 | CH271 | 11v | | | CCU081 |
| MULTIVAN V | | | | | | | | | |
| 1.9 TDI | 4 | BRR | 62/83 | 01/06→11/09 | | | | | CCU151 |
| 1.9 TDI | 4 | AXC | 63/84 | 04/03→11/09 | CH181 | 11v | | | CCU151 |
| 1.9 TDI | 4 | BRS | 75/101 | 06/06→11/09 | | | | | CCU151 |

VW



kW/BHP



eon TITAN

IRIDIUM



...VW



...MULTIVAN V

| | | | | | | | | | |
|--------------------------|---|------------|---------|-------------|---------|-----|--------|-------|---------------------------------|
| 1.9 TDI | 4 | AXB | 77/103 | 04/03→11/09 | CH181 | 11v | | | CCU151 |
| 2.0 | 4 | AXA | 85/114 | 11/03→08/15 | | | CET8 | OE195 | BAE907AE ^[262] |
| 2.0 BiTDI, 2.0 BiTDI 4WD | 4 | CFCA | 132/177 | 09/09→08/15 | | | | | CCU151 |
| 2.0 TDI | 4 | CAAA | 62/83 | 09/09→08/15 | | | | | CCU151 |
| 2.0 TDI | 4 | CAAB | 75/101 | 09/09→08/15 | | | | | CCU151 |
| 2.0 TDI | 4 | CAAD | 84/113 | 05/11→08/15 | | | | | CCU151 |
| 2.0 TDI, 2.0 TDI 4WD | 4 | CAAE; CCHB | 100/134 | 05/10→08/15 | | | | | CCU151 |
| 2.0 TDI, 2.0 TDI 4WD | 4 | CAAC; CCHA | 103/138 | 09/09→08/15 | | | | | CCU151 |
| 2.0 TSI | 4 | CJKB | 110/148 | 07/12→08/15 | OE214 | 0,7 | CET11P | | BAEA033E ^[7] |
| 2.0 TSI, 2.0 TSI 4WD | 4 | CJKA | 150/201 | 05/11→08/15 | OE214 | 0,7 | CET11P | | BAEA033E ^[7] |
| 2.5 TDI | 5 | BLJ | 120/161 | 11/03→11/09 | CH181 | 11v | | | |
| 2.5 TDI, 2.5 TDI 4WD | 5 | AXD | 96/129 | 04/03→11/09 | CH181 | 11v | | | |
| 2.5 TDI, 2.5 TDI 4WD | 5 | BNZ | 96/129 | 04/03→11/09 | CCGP002 | 7v | | | |
| 2.5 TDI, 2.5 TDI 4WD | 5 | AXE | 128/172 | 04/03→11/09 | CH181 | 11v | | | |
| 2.5 TDI, 2.5 TDI 4WD | 5 | BPC | 128/172 | 04/03→11/09 | CCGP002 | 7v | | | |
| 3.2 V6 | 6 | BDL | 170/228 | 02/04→06/04 | OE215 | 0,9 | | | BAEA044E ^[356] |
| 3.2 V6 | 6 | CFLA | 173/232 | 02/04→11/09 | | | | | BAEA044E ^{[275] [356]} |
| 3.2 V6, 3.2 V6 4WD | 6 | BKK; CFLA | 173/232 | 02/04→11/09 | OE215 | 0,9 | | | BAEA044E ^{[275] [356]} |

MULTIVAN VI

| | | | | | | | | | |
|----------------------|---|------------|---------|--------|---|------|--|--|-------------------------------|
| 2.0 TDI | 4 | CXGA | 62/83 | 04/15→ | CPSG007 | 4.4v | | | |
| 2.0 TDI | 4 | CXGB | 75/101 | 04/15→ | CPSG007 | 4.4v | | | |
| 2.0 TDI | 4 | CXGC; CXHB | 84/113 | 05/16→ | CPSG007 →Prod.03.07.2017 [67] [240] | 4.4v | | | |
| | | | | | CPSG008 →Prod.03.07.2017 [70] [241] | 4.4v | | | |
| 2.0 TDI, 2.0 TDI 4WD | 4 | CXFA; CXHA | 110/148 | 04/15→ | CPSG007 | 4.4v | | | |
| 2.0 TDI, 2.0 TDI 4WD | 4 | CXEB | 150/201 | 06/15→ | CPSG007 | 4.4v | | | |
| 2.0 TSI | 4 | CJKB | 110/148 | 04/15→ | | | | | BAEA033E ^{[7] [249]} |
| 2.0 TSI, 2.0 TSI 4WD | 4 | CJKA | 150/201 | 04/15→ | | | | | BAEA033E ^{[7] [249]} |

NEW BEETLE

| | | | | | | | | | |
|---------|---|--------------------|---------|-------------|------------------------------------|-----------|--------|-------|---------------------------------------|
| 1.4 | 4 | BCA | 55/74 | 11/01→09/10 | OE176 | 1,0 | CET3 | | BAE408AE |
| 1.6 | 4 | AWH | 74/99 | 10/99→09/00 | OE032 | 1,0 | CET2 | OE188 | BAE907AE ^[262] CLS260 |
| 1.6 | 4 | AYD | 75/101 | 06/00→09/10 | OE176 →07/01 OE032 07/01→ | 1,0 | CET2 | OE188 | BAE907AE ^[262] CLS048 |
| 1.6 | 4 | BFS | 75/101 | 06/00→09/10 | OE032 | 1,0 | CET2 | OE188 | BAE907AE ^[262] CLS048 |
| 1.8 T | 4 | AGU | 110/148 | 10/99→09/10 | OE136 | 0,8 | CET12P | OE179 | |
| 1.8 T | 4 | AVC; AWU; AWW; BKF | 110/148 | 10/99→09/10 | OE136 | 0,8 | CET12P | OE179 | BAEA043E |
| 1.8 T | 4 | APH | 110/148 | 10/99→09/10 | OE136 | 0,8 | CET12P | OE179 | BAEA009E |
| 1.8 T | 4 | AWP; BNU | 132/177 | 11/01→06/05 | OE136 | 0,8 | CET12P | OE179 | BAEA043E |
| 1.9 TDI | 4 | ALH | 66/89 | 01/98→06/04 | CH271 | 11v | | | CCU081 ^[364] |
| 1.9 TDI | 4 | ATD; AXR | 74/99 | 02/01→09/10 | CH181 | 11v | | | CCU081 ^[364] |
| 1.9 TDI | 4 | BEW | 74/99 | 02/01→09/10 | CCGP002 CH181 | 7v 11v | | | |
| 1.9 TDI | 4 | BSW | 77/103 | 07/05→09/10 | | | | | CCU081 ^[364] |
| 2.0 | 4 | AEG; APIK; AQY | 85/114 | 01/98→10/10 | OE032 | 1,0 | CET2 | OE179 | BAE907AE ^{[64] [262]} CLS017 |
| 2.0 | 4 | AZG | 85/114 | 01/98→10/10 | OE032 | 1,0 | CET2 | OE179 | BAEA029E ^[72] CLS070 |





kW/BHP



eon TITAN

IRIDIUM

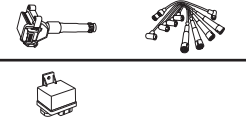

...VW



| ...NEW BEETLE | | | | | | | | | | |
|---------------------------|---|---------------|---------|-------------|--|-------------------|---------------|--------------|---|--------------------------------|
| 2.0 | 4 | AZJ; BEV | 85/114 | 01/98→10/10 | OE032 OE176 ^[258] OE177 ^[242] ModelYear2006→ | 1,0 1,0 0,9 | CET2 | OE179 | BAEA029E ^[72] BAEA029E | CLS070 |
| 2.0 | 4 | BDC; BGD | 85/114 | 01/98→10/10 | OE176 ^[258] | 1,0 | CET2 | OE179 | BAEA029E | CLS070 |
| 2.0 | 4 | AVH; BEJ | 85/114 | 01/98→10/10 | OE032 | 1,0 | CET2 | OE179 | BAEA029E ^[72] | |
| 2.0 | 4 | BHP | 85/114 | 01/98→10/10 | OE032 | 1,0 | CET2 | OE179 | BAE907AE ^[64] ^[262] BAEA029E ^[72] | |
| 2.0 | 4 | BER; CBPA | 85/114 | 01/98→10/10 | OE032 | 1,0 | CET2 | OE179 | BAE907AE ^[64] ^[262] | |
| 2.3 V5 | 5 | AQN | 125/168 | 10/00→09/10 | OE176 | 1,0 | CET3 | | BAEA063E | |
| 2.5 | 5 | BPR; BPS | 110/148 | 07/05→09/10 | OE177 | 0,9 | CET3 | | | |
| 3.2 RSI 3.2 4WD | 6 | AXJ | 165/221 | 04/00→05/01 | OE176 | 1,0 | CET3 | | BAEA013E BAEA063E | |
| PARATI III | | | | | | | | | | |
| 1.8 | 4 | UDH | 73/98 | 08/02→ | OE025 | 1,0 | CET8 | OE195 | | |
| PASSAT | | | | | | | | | | |
| 1.4 GTE Hybrid | 4 | CUKC | 115/154 | 06/15→ | | | | | BAEA067E ^[240] | |
| 1.4 TSI | 4 | CAXA | 90/121 | 05/07→12/14 | OE213 | 0,9 | | | BAE408AE | |
| 1.4 TSI | 4 | CZCA | 92/123 | 11/14→ | OE244 | 0,8 | | | BAEA067E ^[240] | |
| 1.4 TSI | 4 | CTHD | 118/158 | 11/12→12/14 | OE213 ^[275] | 0,9 | | | BAE408AE | |
| 1.4 TSI, 1.4 TSI 4WD | 4 | CZDA; CZEA | 110/148 | 11/14→ | OE244 | 0,8 | | | BAEA067E ^[240] | |
| 1.4 TSI EcoFuel | 4 | CDGA | 110/148 | 01/09→12/14 | | | | | BAE408AE | |
| 1.4 TSI MultiFuel | 4 | CKMA | 118/158 | 11/10→12/14 | | | | | BAE408AE | |
| 1.6 | 4 | AHL; ANA; ARM | 74/99 | 07/94→11/00 | OE032 | 1,0 | CET2 | OE179 | BAE907AE ^[262] | CLS048 |
| 1.6 | 4 | AFT | 74/99 | 07/94→11/00 | OE032 | 1,0 | CET2 | OE179 | BAE851AE ^[261] ^[292] | CLS034 |
| 1.6 | 4 | ADP | 74/99 | 07/94→11/00 | OE032 | 1,0 | CET2 | OE179 | | CLS034 CLS047 |
| 1.6 | 4 | AEK | 74/99 | 07/94→11/00 | OE123 | 0,7 | CET2 | OE179 | BAE851AE ^[261] ^[292] | CLS043 |
| 1.6 | 4 | BSE; BSF | 75/101 | 11/00→11/10 | OE032 | 1,0 | CET2 | OE179 | BAE907AE ^[262] | CLS017 |
| 1.6 | 4 | ALZ | 75/101 | 11/00→11/10 | OE032 | 1,0 | CET2 | OE188 | BAE907AE ^[262] | CLS048 |
| 1.6 FSI | 4 | BLF | 85/114 | 03/05→06/08 | | | | | BAE408AE | |
| 1.6 TDI | 4 | CAYC | 77/103 | 08/09→12/14 | | | | | CCU151 | |
| 1.6 TDI | 4 | DCXA; DCZA | 88/118 | 08/14→ | CPSG007 | 4.4v | | | CCU151 | |
| 1.8 | 4 | AFY | 85/114 | 01/97→03/05 | OE032 | 1,0 | CET2 | OE179 | BAEA162E | CLS057 |
| 1.8 | 4 | ADR; APT; ARG | 92/123 | 10/96→11/00 | OE032 | 1,0 | CET2 | OE179 | BAE851AE ^[261] ^[292] BAEA162E ^[69] BAEA162E | CLS057 |
| 1.8 4WD | 4 | ADR; APT; ARG | 92/123 | 10/96→11/00 | OE032 | 1,0 | CET2 | OE179 | BAEA162E | CLS057 |
| 1.8 4WD, 1.8 T, 1.8 T 4WD | 4 | AWM | 125/168 | 02/01→08/05 | OE136 | 0,8 | CET12P | OE179 | BAEA043E | |
| 1.8 T, 1.8 T 4WD | 4 | AEB; ANB; APU | 110/148 | 10/96→11/00 | OE032 | 1,0 | CET2 | OE179 | BAEA016 | |
| 1.8 T 20V | 4 | AWL; AWT | 110/148 | 11/00→05/05 | OE136 | 0,8 | CET12P | OE179 | BAEA043E | |
| 1.8 TSI | 4 | CGYA | 112/150 | 11/09→12/14 | OE214 | 0,7 | CET11P | | BAEA033E ^[7] | |
| 1.8 TSI | 4 | CDAB | 112/150 | 11/09→12/14 | OE214 | 0,7 | CET11P | | | |
| 1.8 TSI | 4 | BZB; CDAA | 118/158 | 05/07→12/14 | OE214 | 0,7 | CET11P | | BAEA033E ^[7] | |
| 1.8 TSI | 4 | CJSA; CJSC | 132/177 | 02/15→ | | | | OE246 | | |
| 1.9 TDI | 4 | IZ; AHH; AHU | 66/89 | 10/93→11/00 | CH271 | 11v | | | CCU081 | |
| 1.9 TDI | 4 | AVB | 74/99 | 02/00→05/05 | CH271 CH271 →Ch.38-2-350000 CH181 Ch.38-2-350001→ | 11v 11v 11v | | | | |

VW





kW/BHP



eon TITAN

IRIDIUM



...VW



...PASSAT

| | | | | | | | | | |
|----------------------|---|------------------------------------|---------|-------------|---|------|--------|-------|--------------------------------------|
| 1.9 TDI | 4 | BKC; BXE | 77/103 | 03/05→11/10 | | | | | CCU151 →11/05 |
| 1.9 TDI | 4 | BLS | 77/103 | 03/05→11/10 | CCGP002 ^[184] 05/07→05/08 | 7v | | | CCU152 11/05→04/07 |
| 1.9 TDI, 1.9 TDI 4WD | 4 | AFN; AVG | 81/109 | 03/96→11/00 | CH271 | 11v | | | CCU151 →11/05 |
| 1.9 TDI, 1.9 TDI 4WD | 4 | AJM; ATJ | 85/114 | 08/98→11/00 | CH271 | 11v | | | CCU152 11/05→04/07 |
| 1.9 TDI, 1.9 TDI 4WD | 4 | AVF; AWX | 96/129 | 11/00→05/05 | CH271 →Ch.3B-2-350000 | 11v | | | CCU151 →11/05 |
| | | | | | CH181 Ch.3B-2-350001→ | 11v | | | CCU152 11/05→04/07 |
| 2.0 | 4 | AEP | 79/106 | 03/95→08/96 | OE025 | 1,0 | CET8 | OE195 | BAE851AE [261][292] |
| 2.0 | 4 | ALT | 96/129 | 11/01→05/05 | | | CET2 | OE188 | BAEA043E |
| 2.0, 2.0 4WD | 4 | ASU; AUZ | 88/118 | 04/00→11/00 | OE032 | 1,0 | CET2 | OE179 | |
| 2.0 16V | 4 | ABF | 110/148 | 01/94→05/97 | OE032 | 1,0 | CET11P | | BAE851AE [261][292] |
| 2.0 BlueTDI | 4 | CBAC | 105/141 | 01/09→11/10 | | | | | CLS174 |
| 2.0 FSI | 4 | BLY; BVZ | 110/148 | 03/05→11/10 | OE146 | 1,0 | CET12P | OE179 | CCU151 |
| 2.0 FSI | 4 | CCTB | 125/168 | 08/07→07/10 | OE214 | 0,7 | CET11P | | BAEA033E ^[7] |
| 2.0 FSI | 4 | CBFA | 147/197 | 07/05→11/10 | OE214 | 0,7 | CET11P | | BAEA033E ^[7] →09/08 |
| 2.0 FSI | 4 | AXX; BPY; BWA; CAWB; CCTA; CCZA | 147/197 | 07/05→11/10 | OE214 | 0,7 | CET11P | | BAEA033E ^[7] |
| 2.0 FSI, 2.0 FSI 4WD | 4 | BLR; BLX; BLY; BVX; BVY | 110/148 | 03/05→11/10 | OE234 | 1,0 | CET3 | | BAEA033E ^[7] [71][249] |
| 2.0 TDI | 4 | CBDC | 81/109 | 11/08→ | | | | | BAEA033E ^[7] |
| 2.0 TDI | 4 | BWV | 88/118 | 11/05→05/07 | CCGP003 | 7v | | | CCU151 |
| 2.0 TDI | 4 | BVE | 90/121 | 08/05→07/06 | CCGP003 | 7v | | | CCU152 →11/05 |
| | | | | | | | | | CCU152 11/05→ |
| 2.0 TDI | 4 | BMA | 100/134 | 12/03→12/14 | CCGP003 →05/07 | 7v | | | CCU151 →11/05 |
| | | | | | | | | | CCU152 11/05→04/07 |
| 2.0 TDI | 4 | CFFA | 100/134 | 12/03→12/14 | | | | | CCU151 |
| 2.0 TDI | 4 | CBAA | 100/134 | 12/03→12/14 | | | | | CCU151 →11/05 |
| | | | | | | | | | CCU152 11/05→04/07 |
| 2.0 TDI | 4 | BUZ | 120/161 | 08/05→05/09 | CCGP003 | 7v | | | CCU151 →11/05 |
| | | | | | | | | | CCU152 11/05→04/07 |
| 2.0 TDI | 4 | BMR | 125/168 | 08/05→12/14 | CCGP003 | 7v | | | CCU151 →11/05 |
| | | | | | | | | | CCU152 11/05→04/07 |
| 2.0 TDI | 4 | CBBB | 125/168 | 08/05→12/14 | | | | | CCU151 →11/05 |
| | | | | | | | | | CCU152 11/05→04/07 |
| 2.0 TDI | 4 | CUPA | 135/181 | 07/15→ | CPSP007 | 4.4v | | | CCU151 →Prod.06.03.2017 |
| 2.0 TDI, 2.0 TDI 4WD | 4 | BMP | 103/138 | 03/05→06/15 | CCGP002 | 7v | | | CCU151 →11/05 |
| | | | | | | | | | CCU152 11/05→04/07 |
| 2.0 TDI, 2.0 TDI 4WD | 4 | CFFB | 103/138 | 03/05→06/15 | | | | | CCU151 |

VW





kW/BHP



eon TITAN

IRIDIUM



...VW



...PASSAT

| | | | | | | | | | | |
|---|---|---------------------------------|---------|-------------|-------------------|------|------------------------------------|------------------------------------|----------------------------|--------|
| 2.0 TDI, 2.0 TDI 4WD | 4 | CRLB; DBGA; DFEA; DFGA | 110/148 | 06/14→ | CPSG007 | 4.4v | | | CCU151 | |
| 2.0 TDI, 2.0 TDI 4WD | 4 | CFGC | 130/174 | 12/12→ | | | | | CCU151 | |
| 2.0 TDI, 2.0 TDI 4WD | 4 | DDAA; DFCA | 140/188 | 11/14→ | CPSG007 | 4.4v | | | CCU151 | |
| 2.0 TDI, 2.0 TDI 4WD | 4 | CBBB; CFGB; CLLA | 125/168 | 08/05→12/14 | | | | | CCU151 | |
| 2.0 TDI 4WD | 4 | CUAA | 176/236 | 08/14→ | CPSG007 | 4.4v | | | CCU151 | |
| 2.0 TDI 16V | 4 | BKP | 103/138 | 03/05→11/10 | CCGP003 →05/07 | 7v | | | CCU151 →11/05 | |
| | | | | | | | | | CCU152 11/05→04/07 | |
| 2.0 TDI 16V, 2.0 TDI 16V 4WD | 4 | CBAB | 103/138 | 03/05→11/10 | | | | | CCU151 →11/05 | |
| | | | | | | | | | CCU152 11/05→04/07 | |
| 2.0 TDI 16V 4WD | 4 | BKP | 103/138 | 03/05→11/10 | CCGP003 →05/07 | 7v | | | CCU151 →11/05 | |
| | | | | | | | | | CCU152 11/05→04/07 | |
| 2.0 TSI | 4 | CCZB | 155/208 | 11/10→12/14 | OE214 | 0,7 | CET11P | | BAEA033E [7] | |
| 2.0 TSI | 4 | CHHB; CXDA | 162/217 | 02/15→ | | | | OE246 | BAEA068E | |
| 2.0 TSI 4WD | 4 | CJXA | 206/276 | 05/15→ | | | | OE246 | | |
| 2.3 V5, 2.3 V5 4WD, 2.3 VR5, 2.3 VR5 4WD | 5 | AZX | 125/168 | 11/00→05/05 | OE176 | 1,0 | CET3 | | BAEA065E | |
| 2.3 VR5, 2.3 VR5 4WD | 5 | AGZ | 110/148 | 10/96→11/00 | | | CET2 | OE188 | BAEA037 | CLS181 |
| 2.5 TDI | 6 | BDG | 120/161 | 05/03→05/05 | CH215 | 12v | | | | |
| 2.5 TDI, 2.5 TDI 4WD | 6 | AFB; AKN | 110/148 | 07/98→05/05 | CH215 | 12v | | | | |
| 2.5 TDI 4WD | 6 | BAU; BDH | 132/177 | 01/03→05/05 | CH215 | 12v | | | | |
| 2.8 4WD, 2.8 V6 | 6 | AGE | 132/177 | 05/97→09/99 | OE237 | 1,6 | CET2 | OE179 | | CLS046 |
| 2.8 4WD, 2.8 V6, 2.8 V6 4WD | 6 | ACK; ALG; AMX; APR; AQD; ATQ | 142/190 | 08/96→05/05 | OE237 | 1,6 | CET2 | OE179 | BAEA154E | CLS046 |
| 2.8 V6 | 6 | ATX | 140/188 | 09/99→11/00 | OE237 | 1,6 | CET2 | OE179 | BAEA154E | CLS046 |
| 2.8 V6, 2.8 V6 4WD | 6 | AHA | 142/190 | 08/96→11/00 | OE237 | 1,6 | CET2 | OE179 | | |
| 2.8 V6 4WD | 6 | ATX | 140/188 | 09/99→11/00 | OE237 | 1,6 | | | BAEA154E | CLS046 |
| 2.8 V6 4WD | 6 | AQP | 142/190 | 10/96→11/00 | | | | | | CLS046 |
| 2.9 VR6 4WD | 6 | ABV | 135/181 | 01/94→05/97 | OE026 →06/95 | 0,9 | CET2 →06/95 CET12P 07/95→ | OE184 →06/95 OE180 07/95→ | BAEA004E | CLS199 |
| 3.2 FSI 4WD | 6 | AXZ | 184/247 | 11/05→11/10 | | | | | BAEA041E [277] [324] | |
| 3.6 FSI, 3.6 FSI 4WD | 6 | BLV | 206/276 | 06/05→ | | | | | BAEA041E [277] [324] | |
| 3.6 FSI 4WD, 3.6 R36 4WD | 6 | BWS | 220/295 | 04/07→12/14 | | | | | BAEA041E [277] [324] | |
| 4.0 W8 4WD | 8 | BDN; BDP | 202/271 | 09/01→09/04 | OE026 | 0,9 | CET2 | OE188 | BAEA031E [277] | |
| PASSAT ALLTRACK | | | | | | | | | | |
| 1.4 TSI 4WD | 4 | CZEA | 110/148 | 05/15→ | OE244 | 0,8 | | | | |
| 1.8 TSI | 4 | CDAB | 112/150 | 01/12→12/14 | OE214 | 0,7 | CET11P | | | |
| 1.8 TSI | 4 | CDA A | 118/158 | 01/12→12/14 | OE214 | 0,7 | CET11P | | | |
| 2.0 TDI, 2.0 TDI 4WD | 4 | CFFB | 103/138 | 01/12→12/14 | | | | | CCU151 | |
| 2.0 TDI 4WD | 4 | CRLB; DFEA | 110/148 | 05/15→ | CPSG007 | 4.4v | | | CCU151 | |
| 2.0 TDI 4WD | 4 | CFGB | 125/168 | 01/12→12/14 | | | | | CCU151 | |
| 2.0 TDI 4WD | 4 | CFGC | 130/174 | 01/13→12/14 | | | | | CCU151 | |
| 2.0 TDI 4WD | 4 | CUPA | 135/181 | 07/15→ | CPSG007 | 4.4v | | | CCU151 →Prod.06.03.2017 | |
| 2.0 TDI 4WD | 4 | DDAA; DFCA | 140/188 | 05/15→ | CPSG007 | 4.4v | | | CCU151 | |
| 2.0 TDI 4WD | 4 | CUAA | 176/236 | 05/15→ | CPSG007 | 4.4v | | | CCU151 | |
| 2.0 TSI 4WD | 4 | CCZB | 155/208 | 01/12→12/14 | OE214 | 0,7 | CET11P | | | |
| 2.0 TSI 4WD | 4 | CHHB | 162/217 | 07/15→ | | | | OE246 | | |

VW



kW/BHP



eon TITAN

IRIDIUM

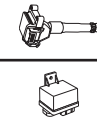

...VW



PASSAT CC

| | | | | | | | | | | |
|----------------------|---|------------------------|---------|-------------|-------|-----|--------|--|--|--|
| 1.4 TSI MultiFuel | 4 | CKMA | 118/158 | 01/11→01/12 | | | | | | BAE408AE |
| 1.8 TSI | 4 | CDAB; CGYA | 112/150 | 11/08→05/10 | OE214 | 0,7 | CET11P | | | |
| 1.8 TSI | 4 | BZB; CDA | 118/158 | 06/08→01/12 | OE214 | 0,7 | CET11P | | | BAEA033E ^[7] |
| 2.0 BlueTDI | 4 | CBAC | 105/141 | 05/09→11/10 | | | | | | CCU151 |
| 2.0 TDI | 4 | CBAA; CFFA | 100/134 | 06/08→05/11 | | | | | | CCU151 |
| 2.0 TDI | 4 | CBBA | 120/161 | 05/08→05/11 | | | | | | CCU151 |
| 2.0 TDI, 2.0 TDI 4WD | 4 | CBAB; CFFB | 103/138 | 06/08→01/12 | | | | | | CCU151 |
| 2.0 TDI, 2.0 TDI 4WD | 4 | CBBB; CFGB; CLLA | 125/168 | 06/08→01/12 | | | | | | CCU151 |
| 2.0 TSI | 4 | CAWB; CBFA; CCTA; CCZA | 147/197 | 06/08→01/12 | OE214 | 0,7 | CET11P | | | BAEA033E ^[7] |
| 2.0 TSI | 4 | CCZB | 155/208 | 11/10→01/12 | OE214 | 0,7 | CET11P | | | BAEA033E ^[7] |
| 3.6 FSI, 3.6 FSI 4WD | 6 | BLV; CNNA | 206/276 | 06/08→01/12 | | | | | | BAEA041E ^[277] ^[324] |
| 3.6 FSI 4WD | 6 | BWS | 220/295 | 06/08→05/10 | | | | | | BAEA041E ^[277] ^[324] |

PHAETON

| | | | | | | | | | | |
|--------------------|----|------------|---------|-------------|-------|-----|------|-------|--|--|
| 3.2 V6, 3.2 V6 4WD | 6 | AYT; BKL | 177/237 | 04/02→11/08 | OE215 | 0,9 | | | | BAEA044E ^[356] |
| 3.2 V6 4WD | 6 | BRK | 177/237 | 02/04→11/08 | | | | | | BAEA044E ^[356] |
| 3.6 V6 4WD | 6 | CHNA; CMVA | 206/276 | 11/08→03/16 | | | | | | BAEA041E ^[277] ^[324] |
| 4.2 V8 4WD | 8 | BGH; BGJ | 246/330 | 05/03→03/16 | | | CET2 | OE188 | | BAEA062E ^[277] |
| 5.0 V10 TDI 4WD | 10 | AJS | 230/308 | 11/02→10/06 | CH181 | 11v | | | | |
| 6.0 W12 4WD | 12 | BAN | 309/414 | 04/02→12/05 | OE176 | 1,0 | CET3 | | | BAEA031E ^[277] Ch.3D-4-030001→ |
| 6.0 W12 4WD | 12 | BRN; BTT | 331/444 | 05/05→03/16 | OE176 | 1,0 | CET3 | | | BAEA031E ^[277] |

POINTER

| | | | | | | | | | | |
|--------|---|--|-------|-------------|-------|-----|--|--|--|--|
| 1.9 TD | 4 | | 55/74 | 08/95→09/97 | CH260 | 11v | | | | |
|--------|---|--|-------|-------------|-------|-----|--|--|--|--|

POLO

| | | | | | | | | | | |
|-------------|---|----------|--------|-------------|-------|-----|------|-------|--|--|
| 1.0 | 3 | CHYA | 44/59 | 01/14→ | OE247 | 1,0 | | | | BAEA067E ^[240] 03/15→ |
| 1.0 | 3 | CHYB | 55/74 | 01/14→ | OE247 | 1,0 | | | | BAEA067E ^[240] 03/15→ |
| 1.0 | 4 | ALD | 37/50 | 08/96→12/01 | OE176 | 1,0 | CET3 | | | BAE907AE ^[262] CLS038 |
| 1.0 | 4 | AUC | 37/50 | 08/96→12/01 | OE176 | 1,0 | CET3 | | | BAE907AE ^[262] CLS053 |
| 1.0 45 | 4 | AEV | 33/44 | 10/94→09/96 | OE025 | 1,0 | CET8 | OE195 | | BAE851AE ^[261] ^[292] CLS100 |
| 1.0 50 | 4 | AER; ALL | 37/50 | 09/96→10/99 | OE027 | 1,0 | CET8 | | | BAE851AE ^[261] ^[292] CLS041 |
| 1.0 TSI | 3 | CHZB | 70/94 | 11/14→ | | | | | | BAEA067E ^[240] 03/15→ |
| 1.0 TSI | 3 | CHZC | 81/109 | 11/14→ | | | | | | BAEA067E ^[240] 03/15→ |
| 1.2 | 3 | AWY; BMD | 40/54 | 01/02→05/07 | OE177 | 0,9 | CET3 | | | BAEA059E |
| 1.2 | 3 | BBM | 44/59 | 05/07→ | OE177 | 0,9 | CET3 | | | BAEA059E |
| 1.2 | 3 | CGPB | 44/59 | 05/07→ | OE177 | 0,9 | CET3 | | | BAE408AE Ch.6R-A-000001→ |
| 1.2 | 3 | CGPA | 51/68 | 06/09→ | OE177 | 0,9 | CET3 | | | BAE408AE Ch.6R-A-000001→ |
| 1.2 12V | 3 | AZQ; BME | 47/63 | 10/01→07/07 | OE177 | 0,9 | CET3 | | | BAE408AE |
| 1.2 12V | 3 | BZG | 51/68 | 05/07→11/09 | OE177 | 0,9 | CET3 | | | BAE408AE |
| 1.2 TSI | 4 | CBZC | 66/89 | 05/11→05/14 | | | | OE260 | | BAE907AE ^[262] CLS090 |
| 1.2 TSI | 4 | CBZB | 77/103 | 11/09→ | | | | OE260 | | BAE907AE ^[262] CLS090 |
| 1.2 TSI | 4 | CJZD | 81/109 | 01/14→ | OE244 | 0,8 | | | | BAEA067E ^[240] 03/15→ |
| 1.2 TSI 16V | 4 | CJZC | 66/89 | 02/14→ | OE244 | 0,8 | | | | BAEA067E ^[240] BAEA126E ^[249] |
| 1.3 55 | 4 | ADX | 40/54 | 10/94→07/95 | OE025 | 1,0 | CET8 | OE195 | | BAE851AE ^[261] ^[292] CLS100 |
| 1.4 | 4 | AKP; ANX | 40/54 | 12/98→09/01 | OE176 | 1,0 | CET3 | | | BAE907AE ^[262] |





kW/BHP



eon TITAN

IRIDIUM



...VW



| ...VW | | | | | | | | | | | |
|--------------------------------------|---|--------------------|---------|-------------|--|------------|--|------------------------|--|---------------------------------------|------------------|
| ...POLO | | | | | | | | | | | |
| 1.4 | 4 | AEX; AKV; ANX; APQ | 44/59 | 05/97→09/01 | OE027 | 1,0 | CET8 | | | BAE851AE [261] [292] | CLS109 |
| 1.4 | 4 | AKK | 44/59 | 05/97→09/01 | OE176 | 1,0 | CET3 | | | BAE907AE ^[262] | CLS053 CLS109 |
| 1.4 | 4 | ANW | 44/59 | 05/97→09/01 | OE176 | 1,0 | CET3 | | | BAE851AE [261] [292] | CLS053 |
| 1.4 | 4 | BKY | 55/74 | 07/06→04/12 | OE176 ^[285] OE177 ^[287] | 1,0 0,9 | CET3 ^[287] CET3 ^[285] | | | BAE408AE | |
| 1.4 | 4 | BLM | 61/82 | 08/02→11/09 | | | | | | BAE408AE | |
| 1.4 | 4 | AGY | 62/83 | 05/96→07/02 | OE032 | 1,0 | CET2 | OE179 | | | |
| 1.4 | 4 | CDDA; CGGB; CLPA | 63/84 | 12/03→ | OE177 | 0,9 | CET3 | | | BAE408AE | |
| 1.4 | 4 | | 63/84 | 12/03→ | | | | | | BAE907AE ^[262] | |
| 1.4 | 4 | BBZ | 74/99 | 11/03→ | OE032 | 1,0 | CET2 | OE188 | | BAE408AE | |
| 1.4, 1.4 16V | 4 | BBY | 55/74 | 10/99→04/12 | OE032 ^[287] OE176 ^[285] | 1,0 1,0 | CET2 ^[287] CET3 ^[285] | OE179 ^[287] | | BAE408AE | |
| 1.4 1.4 16V, 1.4 16V, 1.4 75 1.4 16V | 4 | AHW; APE; AUA | 55/74 | 10/99→05/08 | OE032 | 1,0 | CET2 | OE179 | | BAE907AE ^[262] | CLS260 |
| 1.4, 1.4 60 | 4 | ANW; AUD | 44/59 | 07/95→09/01 | OE176 | 1,0 | CET3 | | | BAE907AE ^[262] | CLS053 |
| 1.4 1.4 TDI | 3 | AMF | 55/74 | 10/99→09/01 | CH271 | 11v | | | | CCU081 | |
| 1.4 16V | 4 | APE | 55/74 | 10/99→05/08 | OE032 | 1,0 | CET2 | OE179 | | | CLS260 |
| 1.4 16V | 4 | AUA | 55/74 | 10/99→05/08 | OE032 | 1,0 | CET2 | OE179 | | BAE907AE ^[262] | CLS260 |
| | | | | | OE032 ^[287] OE176 ^[285] | 1,0 1,0 | CET2 ^[287] CET3 ^[285] | OE179 ^[287] | | | |
| 1.4 16V | 4 | BKY | 55/74 | 10/99→05/08 | OE176 ^[285] OE177 ^[287] | 1,0 0,9 | CET3 ^[285] CET3 ^[287] | | | | |
| 1.4 16V | 4 | BUD | 59/79 | 05/06→11/09 | OE177 | 0,9 | CET3 | | | BAE408AE | |
| 1.4 16V | 4 | AFK | 74/99 | 10/99→05/08 | OE032 | 1,0 | CET2 | OE179 | | BAE907AE ^[262] | CLS178 CLS260 |
| 1.4 16V | 4 | AQQ | 74/99 | 10/99→05/08 | OE032 | 1,0 | CET2 | OE179 | | | CLS178 CLS260 |
| 1.4 16V | 4 | AUB | 74/99 | 10/99→05/08 | OE032 | 1,0 | CET2 | OE179 | | BAE408AE BAE907AE ^[262] | CLS178 CLS260 |
| 1.4 16V | 4 | BBZ | 74/99 | 10/99→05/08 | OE032 | 1,0 | CET2 | | | BAE408AE | |
| 1.4 54 | 4 | ANX | 40/54 | 01/98→08/99 | OE025 | 1,0 | CET8 | OE195 | | BAE851AE [261] [292] | |
| 1.4 55 | 4 | AEX | 40/54 | 08/95→10/99 | OE027 | 1,0 | CET8 | | | BAE851AE [261] [292] | CLS109 |
| 1.4 60 | 4 | ANX | 44/59 | 07/95→09/01 | OE027 | 1,0 | CET8 | | | BAE851AE [261] [292] | |
| 1.4 60 | 4 | AEX; AKV; APQ | 44/59 | 07/95→09/01 | OE025 OE027 | 1,0 1,0 | CET8 CET8 | | | BAE851AE [261] [292] | CLS109 |
| 1.4 60 | 4 | AKK | 44/59 | 07/95→09/01 | OE176 | 1,0 | CET3 | | | BAE907AE ^[262] | CLS109 |
| 1.4 100 1.4 16V | 4 | AFH | 74/99 | 04/96→10/99 | OE032 | 1,0 | CET2 | OE188 | | BAE851AE [261] [292] | CLS178 |
| 1.4 BiFuel | 4 | CMAA | 60/80 | 03/10→01/11 | OE177 | 0,9 | CET3 | | | BAE408AE | |
| 1.4 FSI | 4 | AXU | 63/84 | 02/02→07/06 | | | | | | BAE408AE | |
| 1.4 GTI | 4 | CAVE; CTHE | 132/177 | 05/10→ | | | | | | BAE408AE | |
| 1.4 TDI | 3 | BNM | 51/68 | 04/05→11/09 | CH181 | 11v | | | | CCU081 | |
| 1.4 TDI | 3 | BWB | 51/68 | 04/05→11/09 | CCGP002 | 7v | | | | | |
| 1.4 TDI | 3 | AMF; BAY | 55/74 | 10/01→ | CH181 | 11v | | | | CCU081 | |
| 1.4 TDI | 3 | CUSA; CYZB | 55/74 | 10/01→ | CPSG007 | 4.4v | | | | | |
| 1.4 TDI | 3 | BNV | 59/79 | 04/05→11/09 | CH181 | 11v | | | | CCU081 | |
| 1.4 TDI | 3 | BMS | 59/79 | 04/05→11/09 | CCGP002 | 7v | | | | | |
| 1.4 TDi | 3 | ATL | 66/89 | 01/00→10/00 | | | | | | CCU081 | |
| 1.4 TDI | 3 | CUSB | 66/89 | 02/14→ | CPSG007 | 4.4v | | | | | |

VW





kW/BHP



eon TITAN

IRIDIUM

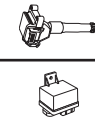

...VW



...POLO

| | | | | | | | | | | |
|------------------------------------|---|--------------------|---------|-------------|--------------------------|-----|---------------|--------------|---------------------------------|---------------------|
| 1.4 TSI | 4 | CPTA | 103/138 | 10/12→ | OE244 | 0,8 | | | BAEA067E [240] [275] | |
| | | | | | | | | | BAEA126E [249] [275] | |
| 1.4 TSI | 4 | CZEA | 110/148 | 05/14→ | OE244 | 0,8 | | | BAEA067E [240] 03/15→ | |
| 1.6 | 4 | ALM | 55/74 | 05/97→09/01 | OE027 | 1,0 | CET8 | | BAE851AE | CLS100 |
| 1.6 | 4 | CFNB | 63/84 | 05/10→ | OE177 | 0,9 | CET3 | | BAE408AE | |
| 1.6 | 4 | BAH | 74/99 | 05/97→ | OE235 | 1,0 | CET3 | | BAE907AE [262] | CLS081 |
| 1.6 | 4 | AEH; AKL; APF; AUR | 74/99 | 05/97→ | OE032 | 1,0 | CET2 | OE179 | BAE907AE [262] 09/99→ | CLS139 |
| 1.6 | 4 | CCRA; CFZA | 74/99 | 05/97→ | OE235 | 1,0 | CET3 | | | |
| 1.6, 1.6 16V | 4 | BTS; CFNA; CLSA | 77/103 | 05/06→ | OE177 | 0,9 | CET3 | | BAE408AE | |
| 1.6 1.6 16V GTI | 4 | ARC; AVY | 92/123 | 10/99→09/01 | OE032 | 1,0 | CET2 | OE179 | BAE907AE [262] | |
| 1.6, 1.6 75 | 4 | AEA; AEE; AHS | 55/74 | 10/94→09/01 | OE025 | 1,0 | CET8 | OE195 | BAE851AE [261] [292] | CLS100 |
| 1.6, 1.6 100 | 4 | AFT | 74/99 | 12/95→ | OE032 | 1,0 | CET2 | OE179 | BAE851AE [261] [292] | CLS034 |
| 1.6 75 | 4 | 1F | 55/74 | 10/94→09/01 | OE027 | 1,0 | CET8 | | BAE851AE [261] [292] | CLS099 |
| 1.6 75 | 4 | AEE | 55/74 | 10/94→09/01 | OE025 | 1,0 | CET8 | OE195 | BAE851AE [261] [292] | CLS100 |
| | | | | | OE027 | 1,0 | | | | |
| 1.6 75 | 4 | ALM | 55/74 | 10/94→09/01 | OE027 | 1,0 | CET8 | | | CLS100 |
| 1.6 100 | 4 | AEH; AKL; APF; AUR | 74/99 | 12/95→09/01 | OE032 | 1,0 | CET2 | OE179 | BAE851AE [261] [292] | CLS139 |
| 1.6 120 1.6 16V GTI | 4 | AJV | 88/118 | 09/98→10/99 | OE032 | 1,0 | CET2 | OE179 | BAE907AE [262] | CLS260 |
| 1.6 BiFuel | 4 | CNKA | 60/80 | 01/11→ | OE177 | 0,9 | CET3 | | BAE408AE | |
| 1.6 TDI | 4 | CAYA | 55/74 | 06/09→ | | | | | CCU152 | |
| 1.6 TDI | 4 | CAYB | 66/89 | 06/09→ | | | | | CCU152 | |
| 1.6 TDI | 4 | CAYC; CLNA | 77/103 | 06/09→ | | | | | CCU152 | |
| 1.6 Total Flex | 4 | CCRA | 74/99 | 10/04→ | | | | | BAE907AE [262] | |
| 1.7 57 1.7 SDI, 1.7 SDI | 4 | AHG; AKW | 42/56 | 04/97→09/01 | CH271 | 11v | | | CCU081 | |
| 1.7 60 1.7 SDI, 1.7 SDI | 4 | AKU | 44/59 | 08/97→09/01 | CH271 | 11v | | | CCU081 | |
| 1.8 | 4 | ADZ | 66/89 | 05/97→09/01 | OE025 | 1,0 | CET8 | OE195 | BAE851AE [261] [292] | CLS110 [292] |
| 1.8 90 | 4 | ABS; ADZ | 66/89 | 01/97→09/01 | OE025 | 1,0 | CET8 | OE195 | BAE851AE [261] [292] | |
| 1.8 90 | 4 | ADD | 66/89 | 01/97→09/01 | OE025 | 1,0 | CET8 | OE195 | BAE851AE [261] [292] | CLS079 [292] |
| 1.8 GTI | 4 | BJX | 110/148 | 09/05→11/09 | OE136 | 0,8 | CET12P | OE179 | BAEA043E | |
| 1.8 GTI | 4 | DAJB | 141/189 | 11/14→ | | | | OE246 | BAEA068E →01/16 | |
| 1.8 GTI | 4 | DAJA | 141/189 | 11/14→ | | | | | BAEA068E →01/16 | |
| 1.8 GTi Cup Edition | 4 | BBU | 132/177 | 05/06→11/09 | OE136 | 0,8 | CET12P | OE179 | BAEA043E | |
| 1.9 64 1, 9 D, 1.9 64 1.9 D, 1.9 D | 4 | 1Y; AEF | 47/63 | 10/94→09/01 | CH260 | 11v | | | | |
| 1.9 64 1.9 SDI, 1.9 SDI | 4 | AEY; AGD; ASX; ASY | 47/63 | 12/95→ | CH271 | 11v | | | CCU081 | |
| 1.9 68 1.9 SDI, 1.9 SDI | 4 | AGP; AQM | 50/67 | 08/99→01/02 | CH271 | 11v | | | CCU081 | |
| 1.9 90 1.9 TDI, 1.9 TDI | 4 | AGR; AHU; ALE; ALH | 66/89 | 09/96→09/01 | CH271 | 11v | | | CCU081 | |
| 1.9 110 1.9 TDI, 1.9 TDI | 4 | AFN; ASV | 81/109 | 06/98→01/02 | CH271 | 11v | | | CCU081 | |
| 1.9 SDI | 4 | AEY | 48/64 | 06/96→09/01 | CH260 | 11v | | | CCU081 | |
| 1.9 TDI | 4 | AHU | 67/90 | 01/97→08/99 | CH271 | 11v | | | CCU081 | |
| 1.9 TDI | 4 | BMT | 74/99 | 10/01→12/10 | CCGP002 05/04→ | 7v | | | CCU152 | |
| 1.9 TDI | 4 | ASZ | 96/129 | 11/03→11/09 | | | | | CCU081 | |
| 1.9 TDI, 1.9 TDi | 4 | ATD; AXR | 74/99 | 10/01→ | CH181 | 11v | | | CCU081 | |
| 2.0 | 4 | BBX | 85/114 | 08/99→ | | | | | BAE907AE [262] →06/11 | |

VW





kW/BHP

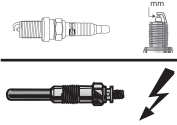

eon TITAN

IRIDIUM



...VW



...POLO

| | | | | | | | | |
|-----------|---|------|---------|--------|-------|-----|--------|-------------------------|
| 2.0 R WRC | 4 | CDLJ | 162/217 | 08/13→ | OE214 | 0,7 | CET11P | BAEA033E ^[7] |
|-----------|---|------|---------|--------|-------|-----|--------|-------------------------|

POLO VIVO

| | | | | | | | | |
|-----|---|------|-------|--------|--|--|--|----------|
| 1.4 | 4 | CLPB | 55/74 | 02/10→ | | | | BAE408AE |
|-----|---|------|-------|--------|--|--|--|----------|

| | | | | | | | | |
|-----|---|------|-------|--------|--|--|--|----------|
| 1.4 | 4 | CLPA | 63/84 | 02/10→ | | | | BAE408AE |
|-----|---|------|-------|--------|--|--|--|----------|

QUANTUM

| | | | | | | | | |
|--------|---|--|-------|-------------|-------|-----|--|--|
| 1.9 TD | 4 | | 55/74 | 10/93→06/97 | CH260 | 11v | | |
|--------|---|--|-------|-------------|-------|-----|--|--|

ROUTAN

| | | | | | | | | |
|-----|---|------|---------|-------------|--|--|--|-------------------------|
| 4.0 | 6 | CGVA | 187/251 | 09/08→11/10 | | | | BAEA453 ^[68] |
|-----|---|------|---------|-------------|--|--|--|-------------------------|

SANTANA

| | | | | | | | | |
|-------|---|-----|-------|-------------|-------|-----|------|--|
| 1.8 i | 4 | AFE | 72/97 | 01/95→09/12 | OE065 | 0,9 | CET8 | |
|-------|---|-----|-------|-------------|-------|-----|------|--|

SCIROCCO

| | | | | | | | | |
|---------|---|------------|--------|-------------|-------|-----|--|----------|
| 1.4 TSI | 4 | CAXA; CMSB | 90/121 | 08/08→11/17 | OE213 | 0,9 | | BAE408AE |
|---------|---|------------|--------|-------------|-------|-----|--|----------|

| | | | | | | | | |
|---------|---|------|--------|-------------|-------|-----|--|--|
| 1.4 TSI | 4 | CZCA | 92/123 | 11/13→11/17 | OE244 | 0,8 | | |
|---------|---|------|--------|-------------|-------|-----|--|--|

| | | | | | | | | |
|---------|---|------|--------|-------------|-------|-----|--|--|
| 1.4 TSI | 4 | CZDC | 96/129 | 07/15→11/17 | OE244 | 0,8 | | |
|---------|---|------|--------|-------------|-------|-----|--|--|

| | | | | | | | | |
|---------|---|------|---------|-------------|-------|-----|--|--|
| 1.4 TSI | 4 | CZDA | 110/148 | 07/15→11/17 | OE244 | 0,8 | | |
|---------|---|------|---------|-------------|-------|-----|--|--|

| | | | | | | | | |
|---------|---|------------------------|---------|-------------|--|--|--|----------|
| 1.4 TSI | 4 | CAVD; CNWA; CTHD; CTKA | 118/158 | 05/08→11/17 | | | | BAE408AE |
|---------|---|------------------------|---------|-------------|--|--|--|----------|

| | | | | | | | | |
|-------|---|------|---------|-------------|-------|-----|--------|-------------------------|
| 2.0 R | 4 | CDLC | 188/252 | 11/09→11/17 | OE214 | 0,7 | CET11P | BAEA033E ^[7] |
|-------|---|------|---------|-------------|-------|-----|--------|-------------------------|

| | | | | | | | | |
|-------|---|------|---------|-------------|-------|-----|--------|-------------------------|
| 2.0 R | 4 | CDLA | 195/261 | 11/09→11/17 | OE214 | 0,7 | CET11P | BAEA033E ^[7] |
|-------|---|------|---------|-------------|-------|-----|--------|-------------------------|

| | | | | | | | | |
|-------|---|------|---------|-------------|--|--|--|--|
| 2.0 R | 4 | CDLK | 206/276 | 05/14→11/17 | | | | BAEA033E ^[7] ^[249] |
|-------|---|------|---------|-------------|--|--|--|--|

| | | | | | | | | |
|---------|---|------|---------|-------------|--|--|--|--------|
| 2.0 TDI | 4 | CFHB | 100/134 | 11/10→11/17 | | | | CCU152 |
|---------|---|------|---------|-------------|--|--|--|--------|

| | | | | | | | | |
|---------|---|------------|---------|-------------|--|--|--|--------|
| 2.0 TDI | 4 | CBDB; CFHC | 103/138 | 08/08→11/17 | | | | CCU152 |
|---------|---|------------|---------|-------------|--|--|--|--------|

| | | | | | | | | |
|---------|---|------|---------|-------------|---------|------|--|--------|
| 2.0 TDI | 4 | CUUB | 110/148 | 11/13→11/17 | CPSG007 | 4.4v | | CCU152 |
|---------|---|------|---------|-------------|---------|------|--|--------|

| | | | | | | | | |
|---------|---|------------|---------|-------------|--|--|--|--------|
| 2.0 TDI | 4 | CBBB; CFGB | 125/168 | 05/09→11/17 | | | | CCU152 |
|---------|---|------------|---------|-------------|--|--|--|--------|

| | | | | | | | | |
|---------|---|------|---------|-------------|--|--|--|--------|
| 2.0 TDI | 4 | CFGC | 130/174 | 01/13→11/17 | | | | CCU152 |
|---------|---|------|---------|-------------|--|--|--|--------|

| | | | | | | | | |
|---------|---|------------|---------|-------------|---------|------|--|--------|
| 2.0 TDI | 4 | CUWA; CUXA | 135/181 | 05/14→11/17 | CPSG007 | 4.4v | | CCU152 |
|---------|---|------------|---------|-------------|---------|------|--|--------|

| | | | | | | | | |
|---------|---|------|---------|-------------|--|--|-----------------|--|
| 2.0 TSI | 4 | CULA | 132/177 | 11/13→11/17 | | | OE246 01/15→ | |
|---------|---|------|---------|-------------|--|--|-----------------|--|

| | | | | | | | | |
|---------|---|------|---------|-------------|-------|-----|--------|-------------------------|
| 2.0 TSI | 4 | CAWB | 147/197 | 05/08→11/09 | OE214 | 0,7 | CET11P | BAEA033E ^[7] |
|---------|---|------|---------|-------------|-------|-----|--------|-------------------------|

| | | | | | | | | |
|---------|---|------|---------|-------------|-------|-----|--------|-------------------------|
| 2.0 TSI | 4 | CCZB | 155/208 | 11/09→11/17 | OE214 | 0,7 | CET11P | BAEA033E ^[7] |
|---------|---|------|---------|-------------|-------|-----|--------|-------------------------|

| | | | | | | | | |
|---------|---|------|---------|-------------|--|--|-----------------|--|
| 2.0 TSI | 4 | CULC | 162/217 | 11/13→11/17 | | | OE246 01/15→ | |
|---------|---|------|---------|-------------|--|--|-----------------|--|

SHARAN

| | | | | | | | | |
|---------|---|------|---------|--------|-------|-----|--|---------------------------|
| 1.4 TSI | 4 | CZDA | 110/148 | 05/10→ | OE244 | 0,8 | | BAEA067E ^[240] |
|---------|---|------|---------|--------|-------|-----|--|---------------------------|

| | | | | | | | | |
|---------|---|------------------|---------|--------|--|--|--|----------|
| 1.4 TSI | 4 | CAVA; CNWB; CTHA | 110/148 | 05/10→ | | | | BAE408AE |
|---------|---|------------------|---------|--------|--|--|--|----------|

| | | | | | | | | |
|-----------|---|-----|---------|-------------|-------|-----|------|-------|
| 1.8 T 20V | 4 | AJH | 110/148 | 09/97→03/10 | OE032 | 1,0 | CET2 | OE179 |
|-----------|---|-----|---------|-------------|-------|-----|------|-------|

| | | | | | | | | |
|-----------|---|-----|---------|-------------|-------|-----|--------|-------|
| 1.8 T 20V | 4 | AWC | 110/148 | 09/97→03/10 | OE136 | 0,8 | CET12P | OE179 |
|-----------|---|-----|---------|-------------|-------|-----|--------|-------|

| | | | | | | | | |
|---------|---|-------|---------|--------|-------|-----|--------|--|
| 1.8 TSI | 4 | CDA A | 118/158 | 11/11→ | OE214 | 0,7 | CET11P | |
|---------|---|-------|---------|--------|-------|-----|--------|--|

| | | | | | | | | |
|---------|---|--------------|-------|-------------|-------|-----|--|--------|
| 1.9 TDI | 4 | 1Z; AHU; ANU | 66/89 | 09/95→03/10 | CH271 | 11v | | CCU081 |
|---------|---|--------------|-------|-------------|-------|-----|--|--------|

| | | | | | | | | |
|---------|---|----------|--------|-------------|-------|-----|--|--------|
| 1.9 TDI | 4 | AFN; AVG | 81/109 | 09/96→04/00 | CH271 | 11v | | CCU081 |
|---------|---|----------|--------|-------------|-------|-----|--|--------|

| | | | | | | | | |
|---------|---|-----|--------|-------------|-------|-----|--|--------|
| 1.9 TDI | 4 | ASZ | 96/129 | 11/02→03/10 | CH181 | 11v | | CCU081 |
|---------|---|-----|--------|-------------|-------|-----|--|--------|

| | | | | | | | | |
|---------|---|-----|---------|-------------|--|--|--|--------|
| 1.9 TDI | 4 | BTB | 110/148 | 06/05→03/10 | | | | CCU081 |
|---------|---|-----|---------|-------------|--|--|--|--------|

| | | | | | | | | |
|----------------------|---|----------|--------|-------------|--------------------------|-----|--|--------|
| 1.9 TDI, 1.9 TDI 4WD | 4 | AUY; BVK | 85/114 | 04/00→03/10 | CH271 →Ch.7M-2-030004 | 11v | | CCU081 |
|----------------------|---|----------|--------|-------------|--------------------------|-----|--|--------|

| | | | | | | | | |
|-----|---|-----|--------|-------------|-------|-----|------|-------|
| 2.0 | 4 | ADY | 85/114 | 09/95→03/10 | OE032 | 1,0 | CET2 | OE179 |
|-----|---|-----|--------|-------------|-------|-----|------|-------|

| | | | | | | | | |
|-----|---|-----|--------|-------------|-------|-----|------|-------|
| 2.0 | 4 | ATM | 85/114 | 09/95→03/10 | OE032 | 1,0 | CET2 | OE179 |
|-----|---|-----|--------|-------------|-------|-----|------|-------|

| | | | | | | | | |
|---------|---|--|---------|-------------|-------|-----|--------|-------|
| 2.0 16V | 4 | | 110/148 | 09/95→02/00 | OE136 | 0,8 | CET12P | OE179 |
|---------|---|--|---------|-------------|-------|-----|--------|-------|

| | | | | | | | | |
|---------|---|-----|--------|-------------|-------|-----|------|-------|
| 2.0 LPG | 4 | ATM | 85/114 | 04/06→03/10 | OE032 | 1,0 | CET2 | OE179 |
|---------|---|-----|--------|-------------|-------|-----|------|-------|

| | | | | | | | | |
|---------|---|------------------|--------|--------|--|--|--|--------|
| 2.0 TDI | 4 | CFFE; CUVA; DFLD | 85/114 | 05/11→ | | | | CCU151 |
|---------|---|------------------|--------|--------|--|--|--|--------|

| | | | | | | | | |
|---------|---|-----|---------|--------|---------|----|--|--|
| 2.0 TDI | 4 | BVH | 100/134 | 11/05→ | CCGP002 | 7v | | |
|---------|---|-----|---------|--------|---------|----|--|--|



kW/BHP

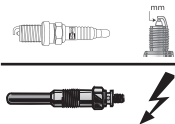

eon TITAN

IRIDIUM



...VW



...SHARAN

| | | | | | | | | | | |
|----------------------------|---|------------|---------|-------------|---------|------|--------|-----------------|--|--|
| 2.0 TDI | 4 | CFFA | 100/134 | 11/05→ | | | | | | CCU151 |
| 2.0 TDI | 4 | BRT | 103/138 | 11/05→ | CCGP002 | 7v | | | | |
| 2.0 TDI | 4 | CFGB | 125/168 | 08/10→ | | | | | | CCU151 |
| 2.0 TDI | 4 | CFGC | 130/174 | 01/13→ | | | | | | CCU151 |
| 2.0 TDI, 2.0 TDI 4WD | 4 | CFFB | 103/138 | 11/05→ | | | | | | CCU151 |
| 2.0 TDI, 2.0 TDI 4WD | 4 | CUVC; DFLA | 110/148 | 05/15→ | CPSG007 | 4.4v | | | | |
| 2.0 TDI, 2.0 TDI 4WD | 4 | CUWA; DFMA | 135/181 | 05/15→ | CPSG007 | 4.4v | | | | |
| 2.0 TSI | 4 | CCZA | 147/197 | 12/10→ | OE214 | 0,7 | CET11P | | | BAEA033E ^[7] |
| 2.0 TSI | 4 | DEDA | 162/217 | 05/15→ | | | | OE246 01/16→ | | |
| 2.8 V6 24V, 2.8 V6 24V 4WD | 6 | AYL | 150/201 | 04/00→03/10 | OE176 | 1,0 | CET3 | | | BAEA063E CLS185 |
| 2.8 VR6 | 6 | AAA | 128/172 | 09/95→04/00 | | | CET12P | OE180 | | BAEA004E CLS240 →Ch.7M-V-060000 |
| 2.8 VR6 | 6 | AMY | 128/172 | 09/95→04/00 | | | CET12P | OE180 | | BAEA004E |
| 2.8 VR6 4WD | 6 | AAA; AMY | 128/172 | 11/96→04/00 | | | CET12P | OE180 | | BAEA004E CLS199 ^[292] CLS240 |

TARO

| | | | | | | | | | | |
|------------------|---|----|-------|-------------|-------|-----|--|--|--|--|
| 2.4 D, 2.4 D 4WD | 4 | 2L | 58/78 | 07/94→03/97 | CH154 | 11v | | | | |
|------------------|---|----|-------|-------------|-------|-----|--|--|--|--|

TIGUAN

| | | | | | | | | | | |
|----------------------|---|------------------|---------|-------------|-------------------------|------|--------|-------|--|---------------------------|
| 1.4 TSI | 4 | CAXA | 90/121 | 08/10→ | OE213 ModelYear→2018 | 0,9 | | | | BAE408AE |
| 1.4 TSI | 4 | CZDB | 92/123 | 05/15→ | OE244 | 0,8 | | | | BAEA067E ^[240] |
| 1.4 TSI | 4 | CZCA | 92/123 | 05/15→ | OE244 | 0,8 | | | | |
| 1.4 TSI | 4 | CZDA | 110/148 | 05/08→ | OE244 | 0,8 | | | | BAEA067E ^[240] |
| 1.4 TSI, 1.4 TSI 4WD | 4 | BWK; CAVA; CTHA | 110/148 | 09/07→ | | | | | | BAE408AE |
| 1.4 TSI, 1.4 TSI 4WD | 4 | CAVD; CTHD | 118/158 | 05/11→ | | | | | | BAE408AE |
| 1.4 TSI, 1.4 TSI 4WD | 4 | CZDA; CZEA; DJVA | 110/148 | 09/07→ | OE244 | 0,8 | | | | |
| 1.6 TDI | 4 | DGDB | 85/114 | 05/16→ | CPSG007 | 4.4v | | | | |
| 2.0 TDI | 4 | CFFD; CUVE | 81/109 | 05/10→ | | | | | | CCU152 |
| 2.0 TDI | 4 | CYKC | 81/109 | 05/10→ | CPSG007 | 4.4v | | | | |
| 2.0 TDI | 4 | DFGC | 85/114 | 05/16→ | CPSG007 | 4.4v | | | | |
| 2.0 TDI, 2.0 TDI 4WD | 4 | CBAB; CFFB; CLJA | 103/138 | 09/07→ | | | | | | CCU152 |
| 2.0 TDI, 2.0 TDI 4WD | 4 | CUVC; DBGK; DFGA | 110/148 | 05/15→ | CPSG007 | 4.4v | | | | |
| 2.0 TDI 4WD | 4 | CBAA; CFFA | 100/134 | 11/07→ | | | | | | CCU152 |
| 2.0 TDI 4WD | 4 | CBBA | 120/161 | 02/08→08/09 | | | | | | CCU152 |
| 2.0 TDI 4WD | 4 | CBBB; CFGB | 125/168 | 09/07→ | | | | | | CCU152 |
| 2.0 TDI 4WD | 4 | CFGC | 130/174 | 11/12→ | | | | | | CCU152 |
| 2.0 TDI 4WD | 4 | CUWA | 135/181 | 05/15→ | CPSG007 | 4.4v | | | | |
| 2.0 TDI 4WD | 4 | DFHA | 140/188 | 04/16→ | CPSG007 | 4.4v | | | | |
| 2.0 TDI 4WD | 4 | CUAA | 176/236 | 05/16→ | CPSG007 | 4.4v | | | | |
| 2.0 TFSI 4WD | 4 | CAWA; CCZC | 125/168 | 09/07→ | OE214 | 0,7 | CET11P | | | BAEA033E ^[7] |
| 2.0 TFSI 4WD | 4 | CAWB; CTA; CCZA | 147/197 | 09/07→ | OE214 | 0,7 | CET11P | | | BAEA033E ^[7] |
| 2.0 TSI 4WD | 4 | CCZD | 132/177 | 05/11→ | OE214 | 0,7 | CET11P | | | BAEA033E ^[7] |
| 2.0 TSI 4WD | 4 | CZPA | 132/177 | 05/11→ | | | | OE246 | | BAEA137E |
| 2.0 TSI 4WD | 4 | CCZB | 155/208 | 05/11→ | OE214 | 0,7 | CET11P | | | BAEA033E ^[7] |
| 2.0 TSI 4WD | 4 | CHHB | 162/217 | 06/16→ | | | | OE246 | | |

TIGUAN ALLSPACE

| | | | | | | | | | | |
|----------------------|---|------------|---------|--------|--------------------------|------|--|--|--|--|
| 1.4 TSI | 4 | CZDA; CZEA | 110/148 | 04/17→ | OE244 | 0,8 | | | | |
| 2.0 TDI, 2.0 TDI 4WD | 4 | DBGK; DFGA | 110/148 | 06/17→ | CPSG007 ^[275] | 4.4v | | | | |
| 2.0 TDI 4WD | 4 | DFHA | 140/188 | 06/17→ | CPSG007 ^[275] | 4.4v | | | | |
| 2.0 TDI 4WD | 4 | CUAA | 176/236 | 06/17→ | CPSG007 ^[275] | 4.4v | | | | |

TOUAREG

| | | | | | | | | | | |
|----------------|---|-----|---------|-------------|---------|-----|--|--|--|--------|
| 2.5 R5 TDI 4WD | 5 | BLK | 120/161 | 08/03→05/10 | CH181 | 11v | | | | CCU081 |
| 2.5 R5 TDI 4WD | 5 | BPD | 120/161 | 08/03→05/10 | CCGP002 | 7v | | | | |

VW





kW/BHP



eon TITAN

IRIDIUM

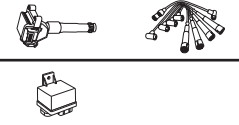

...VW



...TOUAREG

| | | | | | | | | | |
|-----------------------|----|------------------------------|---------|-------------|---------|------|--------|-------|---|
| 2.5 R5 TDI 4WD | 5 | BAC | 128/172 | 01/03→05/10 | CH181 | 11v | | | CCU081 |
| 2.5 R5 TDI 4WD | 5 | BPE | 128/172 | 01/03→05/10 | CCGP002 | 7v | | | |
| 3.0 V6 TDI 4WD | 6 | CATA | 165/221 | 11/04→ | CPSG007 | 4.4v | | | |
| 3.0 V6 TDI 4WD | 6 | CNRB | 176/236 | 11/07→ | CPSG008 | 4.4v | | | |
| 3.0 V6 TSI 4WD | 6 | CJTA | 213/286 | 08/10→ | | | | | BAEA032E [13] |
| 3.0 V6 TSI Hybrid 4WD | 6 | CGEA; CGFA | 245/329 | 04/10→ | OE214 | 0,7 | CET11P | | BAEA032E [13] |
| 3.2 V6 4WD | 6 | AZZ; BAA; BKJ; BMV; BMX; BRJ | 162/217 | 10/02→11/06 | OE215 | 0,9 | | | BAEA044E [356] →06/05 |
| 3.2 V6 4WD | 6 | BMV | 177/237 | 11/04→11/06 | OE215 | 0,9 | | | BAEA044E [356] |
| 3.6 V6 FSI 4WD | 6 | CMTA | 183/245 | 08/10→ | | | | | BAEA041E [277] [324] |
| 3.6 V6 FSI 4WD | 6 | BHK; BHL; CGRA | 206/276 | 10/05→ | | | | | BAEA041E [277] [324] |
| 4.2 V8 4WD | 8 | AXQ; BHX | 228/306 | 12/02→11/06 | | | CET2 | OE188 | BAEA062E [277] |
| 4.2 V8 FSI 4WD | 8 | BAR | 257/345 | 06/06→05/10 | OE209 | 0,8 | CET11P | | BAEA032E [13] [75] BAEA033E [7] [76] [275] |
| 4.2 V8 FSI 4WD | 8 | CGNA | 265/355 | 01/11→ | OE209 | 0,8 | CET11P | | BAEA032E [13] |
| 4.2 V8 TDI 4WD | 8 | CKDA | 250/335 | 01/10→ | | | | | CCU151 |
| 5.0 V10 TDI 4WD | 10 | AYH | 230/308 | 10/02→05/10 | CH181 | 11v | | | |
| 5.0 V10 TDI 4WD | 10 | BLE | 230/308 | 10/02→05/10 | CCGP002 | 7v | | | |
| 5.0 R50 TDI 4WD | 10 | CBWA | 257/345 | 08/07→05/10 | CCGP002 | 7v | | | |
| 6.0 W12 4WD | 12 | BJN; CFRA | 331/444 | 08/04→05/10 | OE176 | 1,0 | CET3 | | BAEA031E [277] |

TOURAN

| | | | | | | | | | | |
|------------------|---|--------------------|---------|-------------|---------|------|--------|-------|--------------------------------------|--------|
| 1.2 TSI | 4 | CBZB | 77/103 | 05/10→05/15 | | | | OE260 | BAE907AE [262] | CLS090 |
| 1.2 TSI | 4 | CVVB | 81/109 | 05/15→ | OE244 | 0,8 | | | BAEA067E [240] | |
| 1.2 TSI | 4 | CZDA | 81/109 | 05/15→ | | | | | BAEA067E [240] | |
| 1.4 FSI, 1.4 TSI | 4 | BLG; CAVB; CTHB | 125/168 | 11/06→05/15 | | | | | BAE408AE | |
| 1.4 TSI | 4 | CTHC | 103/138 | 02/06→05/15 | | | | | BAE408AE | |
| 1.4 TSI | 4 | BMV | 103/138 | 02/06→05/15 | | | | | BAE408AE →Ch.1K-8-281299 | |
| 1.4 TSI | 4 | CAVC | 103/138 | 02/06→05/15 | | | | | BAE408AE BAE408AE →Ch.1K-8-281299 | |
| 1.4 TSI | 4 | CZDA | 110/148 | 05/15→ | OE244 | 0,8 | | | BAEA067E [240] | |
| 1.4 TSI | 4 | CVVB | 110/148 | 05/15→ | | | | | BAEA067E [240] | |
| 1.4 TSI EcoFuel | 4 | CDGA | 110/148 | 05/09→05/15 | | | | | BAE408AE | |
| 1.6 | 4 | BGU; BSE; BSF | 75/101 | 07/03→05/10 | OE032 | 1,0 | CET2 | OE179 | BAE907AE [262] | CLS017 |
| 1.6 FSI | 4 | BAG; BLF; BLP | 85/114 | 02/03→01/07 | | | | | BAE408AE | |
| 1.6 TDI | 4 | CAYB | 66/89 | 05/10→05/15 | | | | | CCU152 | |
| 1.6 TDI | 4 | CAYC | 77/103 | 05/10→05/15 | | | | | CCU152 | |
| 1.6 TDI | 4 | CRKB | 81/109 | 05/15→05/16 | CPSG007 | 4.4v | | | | |
| 1.6 TDI | 4 | DGDA | 85/114 | 05/16→ | CPSG007 | 4.4v | | | | |
| 1.8 TSI | 4 | CJSA | 132/177 | 11/15→ | | | | OE246 | | |
| 1.9 TDI | 4 | BXF | 66/89 | 11/04→05/10 | | | | | CCU152 | |
| 1.9 TDI | 4 | BXE | 77/103 | 08/03→05/10 | | | | | CCU152 | |
| 1.9 TDI | 4 | BLS | 77/103 | 08/03→05/10 | | | | | CCU152 Ch.1T-6-160001→ | |
| 2.0 EcoFuel | 4 | BSX | 80/107 | 02/06→05/09 | | | CET2 | OE179 | BAEA029E | CLS070 |
| 2.0 FSI | 4 | BJZ | 85/114 | 10/04→05/10 | OE176 | 1,0 | CET3 | | | |
| 2.0 FSI | 4 | AXW; BLR; BLX; BVY | 110/148 | 10/03→01/07 | OE234 | 1,0 | CET3 | | BAEA033E [7] | |
| 2.0 FSI | 4 | BLY; BVZ | 110/148 | 10/03→01/07 | OE146 | 1,0 | CET12P | OE179 | BAEA033E [7] | |
| 2.0 TDI | 4 | CFHF; CLCA | 81/109 | 11/10→ | | | | | CCU152 | |
| 2.0 TDI | 4 | AZV | 100/134 | 02/03→05/10 | | | | | CCU152 Ch.1T-6-160001→ | |
| 2.0 TDI | 4 | BMM | 103/138 | 12/05→05/15 | | | | | CCU152 | |

VW





kW/BHP

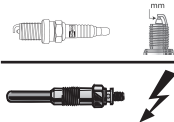

eon TITAN

IRIDIUM



...VW



...TOURAN

| | | | | | | | | | | |
|-------------|---|------------|---------|---------------|---------|------|--|--|--|----------------------------|
| 2.0 TDI | 4 | CFHC | 103/138 | 12/05 → 05/15 | | | | | | CCU152 |
| 2.0 TDI | 4 | DFFA; DFGA | 110/148 | 05/15 → | CP5G007 | 4.4v | | | | |
| 2.0 TDI | 4 | BMN | 125/168 | 12/05 → 01/13 | CCGP003 | 7v | | | | CCU152 |
| 2.0 TDI | 4 | CFJA | 125/168 | 12/05 → 01/13 | | | | | | CCU152 |
| 2.0 TDI | 4 | CFJB | 130/174 | 01/13 → 05/15 | | | | | | CCU152 |
| 2.0 TDI | 4 | DFHA | 140/188 | 11/15 → | CP5G007 | 4.4v | | | | |
| 2.0 TDI 16V | 4 | BKD | 103/138 | 08/03 → 05/10 | | | | | | CCU152 Ch.11-6-160001 → |

UP

| | | | | | | | | | | |
|-------------|---|------------|-------|---------|-------|-----|--|--|--|--|
| 1.0 | 3 | CHYA; DAFA | 44/59 | 08/11 → | OE247 | 1,0 | | | | BAEA067E ^[240] BAEA126E ^[249] |
| 1.0 | 3 | CHYB | 55/74 | 08/11 → | OE247 | 1,0 | | | | BAEA067E ^[240] BAEA126E ^[249] |
| 1.0 EcoFuel | 3 | CPGA | 50/67 | 11/12 → | OE244 | 0,8 | | | | BAEA067E ^[240] ^[275] BAEA126E ^[249] ^[275] |

VENTO

| | | | | | | | | | | |
|---------|---|---------|--------|---------------|-------|-----|------|-------|------------------------------------|--------|
| 1.2 | 4 | CBZB | 77/103 | 01/10 → | | | | OE260 | | |
| 1.6 | 4 | AFT | 74/99 | 10/94 → 09/98 | OE032 | 1,0 | CET2 | OE179 | BAE851AE → 12/95 [261] [292] | CLS034 |
| 1.6 | 4 | AEK | 74/99 | 10/94 → 09/98 | OE123 | 0,7 | CET2 | OE179 | BAE851AE → 12/95 [261] [292] | CLS043 |
| 1.9 SDI | 4 | AEY | 47/63 | 04/97 → 09/98 | CH271 | 11v | | | | CCU081 |
| 1.9 TDI | 4 | ALE | 66/89 | 09/93 → 09/98 | CH271 | 11v | | | | |
| 1.9 TDI | 4 | 1Z; AHU | 66/89 | 09/93 → 09/98 | CH271 | 11v | | | | CCU081 |
| 1.9 TDI | 4 | AFN | 81/109 | 04/96 → 09/98 | CH271 | 11v | | | | CCU081 |
| 2.0 GL | 4 | AEP | 79/106 | 05/96 → 12/97 | OE025 | 1,0 | CET8 | OE195 | | |

VOYAGE

| | | | | | | | | | | |
|----------|---|------|-------|---------------|-------|-----|------|-------|---------------------------|--|
| 1.4 | 4 | AGY | 62/83 | 05/96 → 07/02 | OE032 | 1,0 | CET2 | OE179 | | |
| 1.6 Flex | 4 | CFZA | 74/99 | 07/08 → | OE235 | 1,0 | CET3 | | BAE907AE ^[262] | |
| 1.9 TDi | 4 | 1Z | 66/89 | 09/99 → 09/01 | CH271 | 11v | | | | |

XLI

| | | | | | | | | | | |
|------------------|---|------|-------|---------|---------|------|--|--|--|--|
| 0.8 TDI E-Hybrid | 2 | CSCA | 35/47 | 02/14 → | CP5G007 | 4.4v | | | | |
|------------------|---|------|-------|---------|---------|------|--|--|--|--|

VW



AMAROK

| | | | | | | | | | | |
|----------------------|---|------------|---------|---------|--|--|--|--|--|--------|
| 2.0 TDI | 4 | CDBA; CNFA | 90/121 | 09/11 → | | | | | | CCU152 |
| 2.0 TDI | 4 | CNFB | 103/138 | 09/11 → | | | | | | CCU152 |
| 2.0 TDI, 2.0 TDI 4WD | 4 | CDCA | 120/161 | 09/11 → | | | | | | CCU152 |
| 2.0 TDI, 2.0 TDI 4WD | 4 | CNEA; CSHA | 132/177 | 09/11 → | | | | | | CCU152 |
| 2.0 TDI 4motion 4WD | 4 | CNFB | 103/138 | 09/11 → | | | | | | CCU152 |

CADDY ALLTRACK

| | | | | | | | | | | |
|----------------------|---|------------|---------|---------|---------|------|--|--|--|--------|
| 1.2 TSI | 4 | CYVC | 62/83 | 06/15 → | OE244 | 0,8 | | | | |
| 1.4 TSI | 4 | CZCB | 92/123 | 05/15 → | OE244 | 0,8 | | | | |
| 2.0 TDI | 4 | CUUF; DFSF | 55/74 | 05/15 → | CP5G007 | 4.4v | | | | CCU152 |
| 2.0 TDI | 4 | CUUD; DFSD | 75/101 | 05/15 → | CP5G007 | 4.4v | | | | CCU152 |
| 2.0 TDI, 2.0 TDI 4WD | 4 | CUUB; DFSB | 110/148 | 05/15 → | CP5G007 | 4.4v | | | | CCU152 |
| 2.0 TDI 4WD | 4 | CUUE; DFSE | 90/121 | 05/15 → | CP5G007 | 4.4v | | | | CCU152 |

CADDY II

| | | | | | | | | | | |
|--------|---|-----|-------|---------------|-------|-----|------|-------|---------------------------|--------|
| 1.4 | 4 | AUA | 55/74 | 08/00 → 01/04 | OE032 | 1,0 | CET2 | OE179 | BAE907AE ^[262] | CLS260 |
| 1.4 60 | 4 | AUD | 44/59 | 11/95 → 01/04 | OE176 | 1,0 | | | BAE907AE ^[262] | CLS053 |





kW/BHP



eon TITAN

IRIDIUM



...VW



...CADDY II

| | | | | | | | | | | |
|---------|---|--------------|-------|-------------|-------|-----|------|--|-------------------------|--------|
| 1.4 60 | 4 | AEX; APQ | 44/59 | 11/95→01/04 | OE205 | 1,0 | CET8 | | BAE851AE [261] [292] | CLS109 |
| 1.6 75 | 4 | AEE | 55/74 | 11/95→09/00 | OE207 | 1,0 | CET8 | | BAE851AE [261] [292] | CLS109 |
| 1.6 75 | 4 | 1F | 55/74 | 11/95→09/00 | OE207 | 1,0 | CET8 | | BAE851AE [261] [292] | CLS099 |
| 1.7 SDI | 4 | AHB | 42/56 | 07/96→09/00 | CH271 | 11v | | | CCU081 | |
| 1.9 D | 4 | 1Y | 47/63 | 11/95→01/04 | CH260 | 11v | | | | |
| 1.9 SDI | 4 | AEY | 47/63 | 11/95→01/04 | CH271 | 11v | | | CCU081 | |
| 1.9 SDI | 4 | AYQ | 47/63 | 11/95→01/04 | | | | | CCU081 | |
| 1.9 TDI | 4 | AEY | 66/89 | 09/96→01/04 | CH271 | 11v | | | | |
| 1.9 TDI | 4 | 1Z; AHU; ALH | 66/89 | 09/96→01/04 | | | | | CCU081 | |

CADDY III

| | | | | | | | | | | |
|------------------------------|---|---------------|---------|-------------|-------|-----|------|-------|-----------------------------|--------|
| 1.2 TSI | 4 | CBZA | 63/84 | 09/10→05/15 | | | | OE260 | BAE907AE [262] | CLS090 |
| 1.2 TSI | 4 | CBZB | 77/103 | 09/10→05/15 | | | | OE260 | BAE907AE [262] | CLS090 |
| 1.4 | 4 | BCA | 55/74 | 03/04→05/06 | OE032 | 1,0 | CET2 | OE179 | BAE408AE | |
| 1.4 | 4 | BUD | 59/79 | 05/06→08/10 | OE177 | 0,9 | CET3 | | BAE408AE →Ch.1K-8-281299 | |
| 1.6 | 4 | BGU; BSE; BSF | 75/101 | 04/04→05/15 | OE032 | 1,0 | CET2 | OE179 | BAE907AE [262] | CLS017 |
| 1.6 BiFuel | 4 | CHGA | 75/101 | 05/11→05/15 | OE032 | 1,0 | CET2 | OE179 | BAE907AE [262] | |
| 1.6 TDI | 4 | CAYE | 55/74 | 08/10→05/15 | | | | | CCU152 | |
| 1.6 TDI | 4 | CAYD | 75/101 | 08/10→05/15 | | | | | CCU152 | |
| 1.9 TDI | 4 | BSU | 55/74 | 09/05→08/10 | | | | | CCU152 Ch.2K-6-000001→ | |
| 1.9 TDI | 4 | BLS | 77/103 | 04/04→08/10 | | | | | CCU152 Ch.2L-6-000001→ | |
| 1.9 TDI 4WD | 4 | BLS | 77/103 | 11/08→08/10 | | | | | CCU152 | |
| 2.0 EcoFuel | 4 | BSX | 80/107 | 04/06→05/15 | | | CET2 | OE179 | BAEA029E | CLS070 |
| 2.0 SDI | 4 | BDJ; BST | 51/68 | 03/04→08/10 | CH181 | 11v | | | CCU081 | |
| 2.0 TDI | 4 | BMM | 103/138 | 09/07→08/10 | | | | | CCU152 | |
| 2.0 TDI | 4 | CFJA | 125/168 | 05/12→05/15 | | | | | CCU152 | |
| 2.0 TDI, 2.0 TDI 4WD | 4 | CFHE | 62/83 | 11/10→05/15 | | | | | CCU152 | |
| 2.0 TDI, 2.0 TDI 4WD | 4 | CFHF; CLCA | 81/109 | 08/10→05/15 | | | | | CCU152 | |
| 2.0 TDI 16V, 2.0 TDI 16V 4WD | 4 | CFHC; CLCB | 103/138 | 11/10→05/15 | | | | | CCU152 | |

CADDY IV

| | | | | | | | | | | |
|----------------------|---|------------------|---------|--------|---------|------|--|--|----------------|--|
| 1.2 TSI | 4 | CYVC | 62/83 | 06/15→ | OE244 | 0,8 | | | BAEA067E [240] | |
| 1.4 TGI CNG | 4 | CPWA | 81/109 | 06/15→ | | | | | BAEA067E [240] | |
| 1.4 TSI | 4 | CZCB | 92/123 | 05/15→ | OE244 | 0,8 | | | BAEA067E [240] | |
| 1.6 TDI | 4 | CAYE | 55/74 | 05/15→ | | | | | CCU152 | |
| 1.6 TDI | 4 | CAYD | 75/101 | 05/15→ | | | | | CCU152 | |
| 2.0 TDI | 4 | CUUD; DFSD | 75/101 | 05/15→ | CPSG007 | 4.4v | | | CCU152 | |
| 2.0 TDI, 2.0 TDI 4WD | 4 | CUUF; DFSC; DFSF | 55/74 | 05/15→ | CPSG007 | 4.4v | | | CCU152 | |
| 2.0 TDI, 2.0 TDI 4WD | 4 | CFHC; CLCB | 103/138 | 05/15→ | | | | | CCU152 | |
| 2.0 TDI, 2.0 TDI 4WD | 4 | CUUB; DFSB | 110/148 | 05/15→ | CPSG007 | 4.4v | | | CCU152 | |
| 2.0 TDI 4WD | 4 | CFHF | 81/109 | 05/15→ | | | | | CCU152 | |
| 2.0 TDI 4WD | 4 | CUUE; DFSE | 90/121 | 05/15→ | CPSG007 | 4.4v | | | CCU152 | |

CRAFTER

| | | | | | | | | | | |
|---------|---|------|--------|--------|---|------|--|--|--|--|
| 2.0 TDI | 4 | DAUB | 75/101 | 10/16→ | CPSG007 →Prod.03.07.2017 [67] [240] | 4.4v | | | | |
| | | | | | CPSG008 →Prod.03.07.2017 [70] [241] | 4.4v | | | | |

VW





kW/BHP



eon TITAN

IRIDIUM



...VW



...CRAFTER

| | | | | | | | | | |
|----------------------|---|------|---------|---------|--|------|--|--|--|
| 2.0 TDI | 4 | DAUA | 103/138 | 09/16 → | CPSG007 →Prod.03.07.2017 [67][240] | 4.4v | | | |
| | | | | | CPSG008 →Prod.03.07.2017 [701][241] | 4.4v | | | |
| 2.0 TDI, 2.0 TDI 4WD | 4 | DAVA | 130/174 | 09/16 → | CPSG007 →Prod.03.07.2017 [67][240] | 4.4v | | | |
| | | | | | CPSG008 →Prod.03.07.2017 [701][241] | 4.4v | | | |

CRAFTER 30-35

| | | | | | | | | | |
|----------------------|---|------------|---------|--------------|----------------|----|--|--|---------------|
| 2.0 TDI | 4 | CKTB; CSLA | 80/107 | 05/11 →12/16 | | | | | CCU152 |
| 2.0 TDI | 4 | CSLB | 84/113 | 11/13 →12/16 | | | | | CCU152 |
| 2.0 TDI | 4 | CKTC | 100/134 | 05/11 →12/16 | | | | | CCU152 |
| 2.0 TDI | 4 | CKUC | 105/141 | 10/11 →12/16 | | | | | CCU152 |
| 2.0 TDI, 2.0 TDI 4WD | 4 | CKUB; CSNA | 120/161 | 07/11 →12/16 | | | | | CCU152 |
| 2.5 TDI | 5 | BJJ; CEBA | 65/87 | 04/06 →07/11 | CCGP002 | 7v | | | |
| 2.5 TDI | 5 | BJK; CEBB | 80/107 | 04/06 →05/13 | CCGP002 | 7v | | | |
| 2.5 TDI | 5 | BJL; CECA | 100/134 | 04/06 →05/13 | CCGP002 | 7v | | | |
| 2.5 TDI | 5 | BJM; CECB | 120/161 | 04/06 →07/11 | CCGP002 | 7v | | | |

CRAFTER 30-50

| | | | | | | | | | |
|----------------------|---|------------|---------|--------------|----------------|----|--|--|---------------|
| 2.0 TDI | 4 | CKTB; CSLA | 80/107 | 05/11 →12/16 | | | | | CCU152 |
| 2.0 TDI | 4 | CSLB | 84/113 | 11/13 →12/16 | | | | | CCU152 |
| 2.0 TDI | 4 | CKTC | 100/134 | 05/11 →12/16 | | | | | CCU152 |
| 2.0 TDI | 4 | CSLC | 103/138 | 11/15 →12/16 | | | | | CCU152 |
| 2.0 TDI | 4 | CKUC | 105/141 | 10/11 →12/16 | | | | | CCU152 |
| 2.0 TDI, 2.0 TDI 4WD | 4 | CKUB; CSNA | 120/161 | 07/11 →12/16 | | | | | CCU152 |
| 2.5 TDI | 5 | BJJ; CEBA | 65/87 | 04/06 →07/11 | CCGP002 | 7v | | | |
| 2.5 TDI | 5 | BJK; CEBB | 80/107 | 04/06 →05/13 | CCGP002 | 7v | | | |
| 2.5 TDI | 5 | BJL; CECA | 100/134 | 04/06 →05/13 | CCGP002 | 7v | | | |
| 2.5 TDI | 5 | BJM; CECB | 120/161 | 04/06 →07/11 | CCGP002 | 7v | | | |

LOAD UP

| | | | | | | | | | |
|-----|---|------------|-------|---------|--------------|-----|--|--|--|
| 1.0 | 3 | CHYA; DAFA | 44/59 | 12/14 → | OE247 | 1,0 | | | |
|-----|---|------------|-------|---------|--------------|-----|--|--|--|

LT 28-35 II

| | | | | | | | | | |
|---------|---|----------|---------|--------------|--------------|-----|-------------|--------------|----------------|
| 2.3 | 4 | AGL | 105/141 | 05/96 →07/06 | OE026 | 0,9 | CET2 | OE188 | BAEA340 |
| 2.5 SDI | 5 | AGX | 55/74 | 07/96 →07/06 | CH271 | 11v | | | |
| 2.5 TDI | 5 | BBE | 61/82 | 05/01 →07/06 | CH271 | 11v | | | |
| 2.5 TDI | 5 | APA | 66/89 | 05/99 →07/06 | CH271 | 11v | | | |
| 2.5 TDI | 5 | BBF | 70/94 | 05/01 →07/06 | CH271 | 11v | | | |
| 2.5 TDI | 5 | AHD | 75/101 | 05/96 →08/99 | CH271 | 11v | | | |
| 2.5 TDI | 5 | ANJ; AVR | 80/107 | 05/99 →07/06 | CH271 | 11v | | | |

LT 28-46 II

| | | | | | | | | | |
|---------|---|----------|---------|--------------|--------------|-----|-------------|--------------|----------------|
| 2.3 | 4 | AGL | 105/141 | 05/96 →07/06 | OE026 | 0,9 | CET2 | OE188 | BAEA340 |
| 2.5 SDI | 5 | AGX | 55/74 | 09/96 →07/06 | CH271 | 11v | | | |
| 2.5 TDI | 5 | BBE | 61/82 | 05/01 →07/06 | CH271 | 11v | | | |
| 2.5 TDI | 5 | APA | 66/89 | 05/99 →07/06 | CH271 | 11v | | | |
| 2.5 TDI | 5 | BBF | 70/94 | 05/01 →07/06 | CH271 | 11v | | | |
| 2.5 TDI | 5 | AHD | 75/101 | 05/96 →08/99 | CH271 | 11v | | | |
| 2.5 TDI | 5 | ANJ; AVR | 80/107 | 05/99 →07/06 | CH271 | 11v | | | |

LT 40-55 I

| | | | | | | | | | |
|-------|---|----|-------|--------------|--------------|-----|-------------|------------------------|--|
| 2.4 i | 6 | 1E | 69/93 | 01/93 →06/96 | OE027 | 1,0 | CET8 | OE195 →08/93 | |
|-------|---|----|-------|--------------|--------------|-----|-------------|------------------------|--|

VW





kW/BHP



eon TITAN

IRIDIUM



...VW



POLO Van

| | | | | | | | | | | |
|---------|---|----------|---------|-------------|----------------|------|-------------|--------------|--------------------------------|---------------|
| 1.0 | 3 | CHYA | 44/59 | 01/14→ | OE247 | 1,0 | | | | |
| 1.0 | 3 | CHYB | 55/74 | 01/14→ | OE247 | 1,0 | | | | |
| 1.0 | 4 | AEV | 33/44 | 10/94→12/99 | OE012 | 0,8 | CET8 | OE195 | BAE851AE [261] [292] | CLS109 |
| 1.2 TSI | 4 | CJZC | 66/89 | 02/14→ | OE244 | 0,8 | | | | |
| 1.2 TSI | 4 | CJZD | 81/109 | 01/14→ | OE244 | 0,8 | | | | |
| 1.4 | 4 | AEX; APQ | 44/59 | 08/97→12/99 | OE027 | 1,0 | CET8 | | BAE851AE [261] [292] | CLS109 |
| 1.4 TDI | 3 | CUSA | 55/74 | 03/14→ | CPSG007 | 4.4v | | | | |
| 1.4 TDI | 3 | CUSB | 66/89 | 02/14→ | CPSG007 | 4.4v | | | | |
| 1.4 TSI | 4 | CZEA | 110/148 | 05/14→ | OE244 | 0,8 | | | | |
| 1.7 SDI | 4 | AKU | 44/59 | 08/97→12/99 | CH271 | 11v | | | CCU081 | |
| 1.9 D | 4 | AEF | 47/63 | 10/94→12/99 | CH260 | 11v | | | | |
| 1.9 SDI | 4 | AEY | 47/63 | 07/96→12/99 | CH271 | 11v | | | CCU081 | |

TRANSPORTER IV

| | | | | | | | | | | |
|----------------------|---|--------------------|---------|-------------|--------------|-----|---------------|--------------|--------------------------------|---------------|
| 2.4 D | 5 | AJA | 55/74 | 08/97→04/03 | CH260 | 11v | | | | |
| 2.5, 2.5 4WD | 5 | AET | 85/114 | 07/96→04/03 | OE027 | 1,0 | CET8 | | BAE851AE [261] [292] | CLS108 |
| 2.5, 2.5 4WD | 5 | APL; AVT | 85/114 | 07/96→04/03 | OE123 | 0,7 | CET2 | OE179 | BAE851AE [261] [292] | |
| 2.5 TDI | 5 | AJT; AYY | 65/87 | 05/98→04/03 | CH271 | 11v | | | CCU081 | |
| 2.5 TDI | 5 | AHY; AXG | 111/149 | 05/98→04/03 | CH271 | 11v | | | CCU081 | |
| 2.5 TDI, 2.5 TDI 4WD | 5 | ACV; AUF; AXL; AYC | 75/101 | 09/95→04/03 | CH271 | 11v | | | CCU081 | |
| 2.8 | 6 | AES | 103/138 | 05/96→05/00 | | | CET12P | OE180 | BAEA004E | |
| 2.8 VR6 | 6 | AMV | 150/201 | 04/00→04/03 | OE176 | 1,0 | CET3 | | BAEA004E | |
| 2.8 VR 6, 2.8 VR6 | 6 | AES | 103/138 | 11/95→05/00 | | | CET12P | OE180 | BAEA004E | CLS237 |
| 2.8 VR6 4WD | 6 | AES | 103/138 | 01/96→04/96 | | | CET12P | OE180 | | |

TRANSPORTER V

| | | | | | | | | | | |
|--------------------------|---|------|---------|-------------|--------------|-----|-------------|--------------|--|--|
| 1.9 TDI | 4 | BRR | 62/83 | 01/06→11/09 | | | | | CCU151 Ch.7H-6-080001 7H-6X022501 7J-6-022501→ | |
| 1.9 TDI | 4 | AXC | 63/84 | 04/03→11/09 | CH181 | 11v | | | CCU081 →Ch.7H-6-080000 7H-6X022500 7J-6-022500 CCU151 Ch.7H-6-080001 7H-6X022501 7J-6-022501→ | |
| 1.9 TDI | 4 | BRS | 75/101 | 06/06→11/09 | | | | | CCU151 Ch.7H-6-080001 7H-6X022501 7J-6-022501→ | |
| 1.9 TDI | 4 | AXB | 77/103 | 04/03→11/09 | CH181 | 11v | | | CCU081 →Ch.7H-6-080000 7H-6X022500 7J-6-022500 CCU151 Ch.7H-6-080001 7H-6X022501 7J-6-022501→ | |
| 2.0 | 4 | AXA | 85/114 | 11/03→08/15 | | | CET8 | OE195 | BAE907AE [262] | |
| 2.0 BiTDI, 2.0 BiTDI 4WD | 4 | CFCA | 132/177 | 09/09→08/15 | | | | | CCU151 ModelYear→2011 | |
| 2.0 TDI | 4 | CAAA | 62/83 | 09/09→08/15 | | | | | CCU151 ModelYear→2011 | |
| 2.0 TDI | 4 | CAAB | 75/101 | 09/09→08/15 | | | | | CCU151 ModelYear→2011 | |
| 2.0 TDI | 4 | CAAD | 84/113 | 05/11→08/15 | | | | | CCU151 ModelYear→2011 | |

VW





kW/BHP



eon TITAN

IRIDIUM

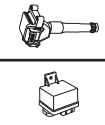

...VW



...TRANSPORTER V

| | | | | | | | | | | |
|-----------------------------|---|------------|---------|-------------|---------|-----|--------|--|--|---|
| 2.0 TDI, 2.0 TDI 4WD | 4 | CAAE; CCHB | 100/134 | 05/10→08/15 | | | | | | CCU151 ModelYear→2011 |
| 2.0 TDI, 2.0 TDI 4WD | 4 | CAAC; CCHA | 103/138 | 09/09→08/15 | | | | | | CCU151 ModelYear→2011 |
| 2.0 TSI | 4 | CJKB | 110/148 | 07/12→08/15 | OE214 | 0,7 | CET11P | | | BAEA033E ^[7] |
| 2.0 TSI, 2.0 TSI 4WD | 4 | CJKA | 150/201 | 05/11→08/15 | OE214 | 0,7 | CET11P | | | BAEA033E ^[7] |
| 2.5 TDi | 5 | BLJ | 120/161 | 11/03→11/09 | CH181 | 11v | | | | CCU081 →Ch.7H-6-080000 7H-6X022500 7J-6-022500 |
| 2.5 TDI, 2.5 TDI 4WD | 5 | AXD | 96/129 | 04/03→11/09 | CH181 | 11v | | | | CCU081 →Ch.7H-6-080000 7H-6X022500 7J-6-022500 |
| 2.5 TDI, 2.5 TDI 4WD | 5 | BNZ | 96/129 | 04/03→11/09 | CCGP002 | 7v | | | | |
| 2.5 TDI, 2.5 TDI 4WD | 5 | AXE | 128/172 | 04/03→11/09 | CH181 | 11v | | | | CCU081 →Ch.7H-6-080000 7H-6X022500 7J-6-022500 |
| 2.5 TDI, 2.5 TDI 4WD | 5 | BPC | 128/172 | 04/03→11/09 | CCGP002 | 7v | | | | |
| 3.2 4WD, 3.2 V6, 3.2 V6 4WD | 6 | BKK | 173/232 | 08/03→11/09 | OE215 | 0,9 | | | | BAEA044E ^[356] |
| 3.2 4WD, 3.2 V6 4WD | 6 | CFLA | 173/232 | 11/03→11/09 | | | | | | BAEA044E ^[356] |
| 3.2 V6 | 6 | BDL | 170/228 | 04/03→11/09 | OE215 | 0,9 | | | | BAEA044E ^[356] |

TRANSPORTER VI

| | | | | | | | | | | |
|----------------------|---|------------|---------|--------|---|----------------------|--|--|--|----------------------|
| 2.0 TDI | 4 | CXGA | 62/83 | 04/15→ | CPSG007 | 4.4v | | | | |
| 2.0 TDI | 4 | CXGB | 75/101 | 04/15→ | CPSG007 | 4.4v | | | | |
| 2.0 TDI | 4 | CXGC; CXHB | 84/113 | 05/16→ | CPSG007 →Prod.03.07.2017 [67][240] CPSG008 →Prod.03.07.2017 [70][241] | 4.4v | | | | |
| 2.0 TDI, 2.0 TDI 4WD | 4 | CXFA; CXHA | 110/148 | 04/15→ | CPSG007 | 4.4v | | | | |
| 2.0 TDI, 2.0 TDI 4WD | 4 | CXEB | 150/201 | 06/15→ | CPSG007 CPSG007 →Prod.03.07.2017 [67][240] CPSG008 →Prod.03.07.2017 [70][241] | 4.4v 4.4v 4.4v | | | | |
| 2.0 TDI 4WD | 4 | CXHA | 110/148 | 08/15→ | CPSG007 CPSG007 →Prod.03.07.2017 [67][240] CPSG008 →Prod.03.07.2017 [70][241] | 4.4v 4.4v 4.4v | | | | |
| 2.0 TSI | 4 | CJKB | 110/148 | 04/15→ | | | | | | BAEA033E [7][249] |
| 2.0 TSI, 2.0 TSI 4WD | 4 | CJKA | 150/201 | 04/15→ | | | | | | BAEA033E [7][249] |

VW (FAW)



GOLF SPORTSVAN

| | | | | | | | | | | |
|-------------|---|-----|---------|--------|-------|-----|--|--|--|--|
| 1.2 T | 4 | CYA | 81/109 | 05/16→ | OE244 | 0,8 | | | | |
| 1.4 280 TSI | 4 | CSS | 110/148 | 05/16→ | OE244 | 0,8 | | | | |
| 1.4 T | 4 | CST | 96/129 | 05/16→ | OE244 | 0,8 | | | | |

WESTFIELD



130

| | | | | | | | | | | |
|--------|---|------|---------|--------|-------|-----|------|-------|--|--|
| 3.9 V8 | 8 | 35DL | 147/197 | 01/97→ | OE018 | 1,0 | CET8 | OE195 | | |
| 3.9 V8 | 8 | 35DH | 201/270 | 01/97→ | OE018 | 1,0 | CET8 | OE195 | | |





kW/BHP



eon TITAN

IRIDIUM

**...WESTFIELD****SE / SEVEN**

2.0 4 184/247 01/05→12/09

CET17P

WIESMANN**MF3**2.8 6 M52(286S1) 142/190 01/96→08/02 **OE238** 1,03.0 6 M54306S3 170/228 07/03→ **CET2** **OE188**3.2 6 S50326S1 236/316 01/96→08/01 **CET10P** **OE187**3.2 6 S54326S4 252/338 07/03→ **CET10P** **OE187****YULON****YULON**1.8 i 4 CA18S 76/102 01/93→12/98 **OE005** 0,9 **CET2****ZASTAVA****10**1.2 60 4 188A4.000 44/59 10/05→ **OE016** 0,9 **CET2** **OE180****ZAZ****CHANCE**1.3 4 ME307 52/70 10/04→ **OE006** 0,9 **CET8** **OE195****FORZA**1.5 4 SQR477F 80/107 01/13→ **OE006** 0,9 **CET8** **OE195****LANOS**1.4 4 A13SM 55/74 10/04→ **OE006** 0,9 **CET8** **OE195** **BAEA025E**1.5 4 A15SM 63/84 10/04→ **OE006** 0,9 **CET8** **OE195** **BAEA025E**1.6 16V 4 A16DMS 78/105 10/04→ **OE006** 0,9 **CET8** **OE195** **BAEA025E****SENS**1.3 4 ME307 52/70 10/04→ **OE006** 0,9 **CET8** **OE195****SLAVUTA**1.1 4 MZ2471 38/51 03/95→10/01 **OE006** 0,9 **CET8** **OE195**1.2 4 VAZ217 43/58 10/01→ **OE006** 0,9 **CET8** **OE195**1.3 4 MENZ310 44/59 10/01→ **OE006** 0,9 **CET8** **OE195****TAVRIA**1.1 4 38/51 06/00→12/07 **OE006** 0,9 **CET8** **OE195**1.2 4 MZ2477 42/56 01/98→12/07 **OE006** 0,9 **CET8** **OE195**1.3 4 MEMZ32457 52/70 10/01→12/07 **OE006** 0,9 **CET8** **OE195****VIDA**1.4 4 F14D3 69/93 01/12→ **OE005** 0,9 **CET2** **OE179**1.5 4 F15S3 62/83 01/12→ **OE006** 0,9 **CET8** **OE195**1.5 4 SQR477F 80/107 01/12→ **OE006** 0,9 **CET8** **OE195****ZAZ****LANOS PICK-UP**1.4 4 A13SM 55/74 10/04→ **OE006** 0,9 **CET8** **OE195**1.5 4 A15SM 63/84 10/04→ **OE006** 0,9 **CET8** **OE195**

WESTFIELD



| L82C | ...OE001 | ...OE001 | ...OE002 |
|---|--|--|--|
| ALPINE 1300 BARKAS B 1000 BMW 503 CONVERTIBLE BORGWARD ISABELLA CITROËN ID FIAT 1000ER-SERIE, 1400, 1900, JAGST FORD TAUNUS 12M, TAUNUS '51 MERCEDES-BENZ 170 (W170), PONTON (W120) MOSKVICHI 403 PORSCHE 356 CABRIOLET /SPEEDSTER /COUPE RENAULT 8 ROVER 200 SKODA 100, 110, OCTAVIA TALBOT SIMCA 1301 TRIUMPH TR 2, TR 3, TR 3A, TR 4A VW 1500, 1600, KAEFER, KARMANN GHIA, TRANSPORTER I, TRANSPORTER II, TRANSPORTER III WARTBURG 353 | BMW 02 /CONVERTIBLE (E10), 02 TOURING (E6), 3 (E21), 3 (E30), 3 /CONVERTIBLE /TOURING (E30), 5 (E12), 5 (E28), 5 (E34), 6 (E24), 7 (E23), 7 (E32), 1500-2000 (115, 116, 118, 121), 1600 GT COUPE, 2000-3.2 COUPE (E9), 2500-3.3 (E3), Z1 ROADSTER BOND EQUIPE, EQUIPE MK. II CITROËN C25, SM FIAT 125, 128, 130, 131, 132, 242-SERIE, 1500, 1500-2300, ARGENTA, DUCATO, ELBA, PREMIO, X 1/9 FORD CONSUL, CORSAIR, CORTINA, ESCORT I, ESCORT II, GRANADA, TAUNUS 15M, TAUNUS 17M, TAUNUS 20M, TAUNUS 20M XL, TRANSIT, ZEPHYR III, ZEPHYR IV, ZODIAC, ZODIAC FORD AUSTRALIA COURIER FORD OTOSAN ANADOL FSO 125P, 126P, 127P, 132P, POLONEZ I, POLONEZ II, POLONEZ III GINETTA G15, G21 GLAS 04, 1700, GT, V 8 HONDA CIVIC I INNOCENTI MINI JENSEN GT, HEALEY LADA 1200-1500, 1200-1600, NIVA, NOVA, SAMARA, TOSCANA MARCOS 2-3 LITRE, 1600 MAZDA 323 I /STATION WAGON (FA), 626 I (CB), 818 ESTATE, 1000, 1300 MERCEDES-BENZ /8 (W114), /8 (W115), /8 /COUPE (W114), COUPE (C123), G-CLASS (W460), G-CLASS (W463), HECKFLOSSE (W110), HECKFLOSSE (W111, W112), HENSCHEL 2-T, PONTON (W121), SALOON (W123), S-CLASS (W108, W109), S-CLASS (W116), S-CLASS (W126), S-CLASS COUPE (C126), SL (R107), SL (W121), SL COUPE (C107), T1 BOX (601, 611), T1 BUS /PLATFORM /CHASSIS (601), T2 /L BOX BODY / ESTATE /DUMPTRUCK /PLATFORM /CHASSIS, T2 /L MUNICIPAL VEHICLE MORRIS MARINA, MINI, MINOR MOSKVICHI 412, 427 | NISSAN CHERRY (E10) I, CHERRY II, CHERRY III, DATSUN 100 A, DATSUN 120, DATSUN 120 Y, DATSUN 160 J, DATSUN 180 B, SUNNY NSU 1000, PRINZ, TTS PEUGEOT 404, 504, 505, J7 PUCH G-MODELL RENAULT 5, 9, 11, 12, 15, 16, 18, 19 I, 19 II, 21, FUEGO, MASTER I, RAPID, SUPER 5, TRAFIC ROVER 2000-3500 SAAB 90, 95, 96, 99, 900 I SEAT 128, RONDA TALBOT 1307-1510, HORIZON, SIMCA 1000, SIMCA 1100, SIMCA 1200 S, SIMCA SUNBEAM TOYOTA LAND CRUISER TRABANT 1.1 TRIUMPH 2.5 PI MK I, 1300, 1500, HERALD, SPITFIRE, TR 5, TR 6, VITESSE VOLVO 240, 340-360 VW CADDY I, GOLF I, GOL I, ILTIS, JETTA I, K 70, LT 28-35 I, LT 40-55 I, PASSAT, POLO, SANTANA, SCIROCCO WARTBURG 353 WOLSELEY 18/85, 1300, HORNET ZASTAVA 101 | LANCIA DELTA II, Y, Y10 LAND ROVER DISCOVERY I NISSAN PRIMERA PLYMOUTH BREEZE ROVER 100, 100 / METRO, 200, 400, 600, 800, COUPE SKODA FAVORIT TOYOTA CARINA E, HILUX VI OE003 BMW 3 (E30), 3 (E36), 3 /CONVERTIBLE /TOURING (E30), 3 TOURING (E30), 7 (E32), 8 (E31) CITROËN AX, BX, C15 DAEWOO MUSSO LADA OKA MERCEDES-BENZ E-CLASS (W124), SALOON (W124), SL (R129) OPEL OMEGA A PEUGEOT 205 I, 205 II, 305 II, 309 I, 309 II, 405 I, 605 PROTON IMPIAN SAAB 900 I, 9000 SEAT IBIZA I SSANGYONG MUSSO VAUXHALL CARLTON MK III OE004 ALFA ROMEO 155 BERTONE FREECLIMBER BMW 3 (E30), 5 (E28), 5 (E34) CHRYSLER SARATOGA, VOYAGER II DAIHATSU HIJET FIAT CINQUECENTO, PANDA, SEICENTO / 600 PIAGGIO PORTER |



| ...OE004 | ...OE005 | ...OE005 | ...OE006 |
|--|---|--|--|
| RENAULT 21 | MAZDA 323 C IV (BG), 323 F IV (BG), 323 F VI (BJ), 323 III HATCHBACK (BF), 323 P V (BA), 323 S IV (BG), 323 S VI (BJ), 626 III /COUPE /HATCHBACK (GD), 626 III STATION WAGON (GV), 626 IV (GE), 626 IV /HATCHBACK (GE), 626 V (GF), 626 V /HATCHBACK (GF), 626 V STATION WAGON (GW), MPV I (LV), XEDOS 9 (TA) | VAUXHALL CARLTON MK III, SENATOR MK II (B) | FOTON SUP, SURFING, VIEW |
| SUBARU LEONE II | MERCEDES-BENZ B-CLASS (W245) | VW CADDY III | FSO LANOS, POLONEZ I |
| VOLVO 440 K, 460 L, 480 E, 740, 760, 940, 940 II, 960 | NISSAN 100 NX, BLUEBIRD, CEFIRO II, CEFIRO III, MAXIMA / MAXIMA QX IV, PRIMERA, SUNNY III | YULON 101 FEELING, YULON | GAZ GAZELLE |
| OE005 | OPEL ASTRA F, KADETT E, OMEGA A | ZAZ VIDA | GEELY HAOQING, HQ, MR, PU, URBAN NANNY |
| ASTON MARTIN VIRAGE | PEUGEOT 106 I, 205 II, 206+, 306, 309 I, 309 II, 405 I | OE006 | GOLDEN DRAGON XML |
| AUSTIN MAESTRO, MONTEGO | PONTIAC TRANS SPORT | AC ME | GREAT WALL DEER, PEGASUS, SAILING, STEED |
| AUTOBIANCHI Y10 | PORSCHE 968 | ALFA ROMEO 75, 90, 164, GTV, SPIDER | HOLDEN SCURRY |
| BITTER TYPE 3 | PUCH G-MODELL | ALPINA B3, B6, C1, C2 | HONDA ACCORD I, ACTY, CIVIC III, PRELUDE I, PRELUDE II, QUINTET |
| CATERHAM 21, SEVEN | RELIANT SCIMITAR SABRE | ASIA MOTORS ROCSTA, TOWNER | HYUNDAI PONY, PONY / EXCEL, PORTER, SONATA II, SONATA III, STELLAR |
| CHERY A1, A3, A5, COWIN, COWIN 2, COWIN 3, COWIN 5, E5, EASTAR CROSS, FULWIN, QQ3, QQ6, TIGGO, TIGGO 3, TIGGO DR, V5, X1 | RENAULT 19 I, 19 II, CLIO I, DUSTER, RAPID, SAFRANE II | AUDI QUATTRO | INNOCENTI ELBA, KORAL, MINI, REGENT |
| CHEVROLET AVEO, AVEO / KALOS, KALOS, LACETTI, NUBIRA | ROVER 200, 800, CITYROVER, MAESTRO, MONTEGO | AUSTIN ALLEGRO, APACHE, MAESTRO, MAXI, MAXI II, METRO, MINI, MONTEGO, PRINCESS, PRINCESS 2 | ISUZU ASKA I, ASKA III, CAMPO, MIDI, PICKUP, TROOPER I |
| CHRYSLER CIRRUS, NEON, NEON II, STRATUS | SAAB 900 II, 9000 | AUSTIN-HEALEY 3000 MK.III, SPRITE MK.III | JAGUAR E-TYPE, E-TYPE 2+2, XJ |
| CITROËN BERLINGO / BERLINGO FIRST, BX, C15, XANTIA, XSARA PICASSO, ZX | SKODA FAVORIT, FELICIA I, FELICIA II | AUTOBIANCHI A 112, Y10 | KIA JOICE, PRIDE, PRIDE VAN, RIO, SEPHIA |
| DACIA SUPERNOVA | SSANGYONG KORANDO | BEDFORD ASTRAMAX, ASTRA VAN, MIDI, RASCAL | LADA 110, 111, 112, 1200-1600, NIVA, NIVA II, NOVA, SAMARA |
| DAEWOO KALOS, KORANDO, LACETTI, MUSSO, NUBIRA, REXTON | SUBARU JUSTY II, LEGACY II | CHEVROLET AVEO, AVEO / KALOS, CORSA, KALOS, LANOS, MATIZ, NIVA, SPARK | LANCIA A 112, DEDRA, DELTA I, Y10 |
| DODGE NEON, NEON II, STRATUS | SUZUKI ALTO (HA12, HA23), BALENO /ESTATE /HATCHBACK (EG), CARRY BOX (FD), JIMNY (FJ), JIMNY CLOSED OFF-ROAD VEHICLE (SN), VITARA (ET, TA), VITARA /CABRIO (ET, TA), WAGON R+ HATCHBACK (MM) | CHRYSLER LE BARON | LAND ROVER 88/109, 90, 110/127, DEFENDER, DISCOVERY I, RANGE ROVER I |
| FIAT PALIO, PANDA, TIPO, UNO | TATA INDICA, INDIGO, SAFARI | CITROËN GS | LDV SHERPA |
| FORD ESCORT '81, ESCORT III, ESCORT IV, ESCORT V, FIESTA II, FIESTA III, ORION I, ORION II, ORION III, SCORPIO I, SIERRA | TOYOTA CARIBE, CARINA E, CARINA II, CELICA, COROLLA, CRESSIDA, CRESTA, CROWN, HIACE IV, HILUX, HILUX II, HILUX VI, LAND CRUISER, LAND CRUISER 90, SPRINTER, SPRINTER CARIB, SUPRA, TARAGO | DADI CITY COURSER | MASERATI BORA, KHAM SIN, KYALAMI, MERAK, QUATTROPORTE III |
| FSO POLONEZ III | | DAEWOO ARANOS, CIELO, ESPERO, KALOS, LANOS, LEGANZA, LEMANS, MATIZ, NEXIA, NUBIRA, PRINCE, REZZO, ROYALE, SUPER SALOON | MAZDA 121 II (DB), 323 I /STATION WAGON (FA), 323 II /HATCHBACK (BD), 323 III /HATCHBACK (BF), 323 III STATION WAGON (BW), 616, 626 I (CB), 626 II /COUPE /HATCHBACK (GC), 626 III /COUPE /HATCHBACK (GD), 929 I (LA), 929 II /COUPE (HB), 929 II ESTATE (HV), B-SERIE (UF), E-SERIE BOX (SR2) |
| GEO TRACKER | | DAIMLER 2.8 - 5.3, COUPE, LANDAULETTE, LIMOUSINE | MERCEDES-BENZ /8 (W114) |
| HONDA CIVIC V | | FIAT 126, 127, 128, 131, 132, 147, 238-SERIE, 900T/E PANORAMA, 900T/E PULMINO, ARGENTA, CAMPAGNOLA, DUCATO, DUNA, ELBA, FIORINO, FIORINO PICK UP, PANDA, PENNY, REGATA, RITMO, TALENTO, TEMpra, TIPO, UNO, X 1/9 | MG 1300 MK.II, EXPRESS, METRO, MGB, MGB GT, MIDGET |
| JAGUAR XJ, XJSC | | | |
| KIA SEPHIA, SHUMA, SHUMA II, SPORTAGE | | | |
| LANCIA THESIS, Y10 | | | |
| LIFAN 320, 520, 620, X60 | | | |
| LOTUS ELAN | | | |



...OE006

MITSUBISHI
CARISMA, COLT I, COLT II, COLT III, COLT V, CORDIA, ECLIPSE, ECLIPSE I, ECLIPSE II, GALANT I, GALANT II, GALANT III, GALANT IV, KUDA, L 200, L 300 / DELICA II, L 300 III, LANCER CELESTE, LANCER F, LANCER I, LANCER II, LANCER III, LANCER IV, LANCER V, MIRAGE III, SAPPORO I, SAPPORO II, SPACE WAGON, TREDIA

MORRIS
ITAL, MARINA II

MOSKVICHI
2140, 2141, ALEKO, ASLK 2137, ASLK 2140

NISSAN
280 ZX, ZXT, BLUEBIRD, BOBBY, CHERRY II, LAUREL, PATROL III/1, PATROL III/2, PICK UP, PRAIRIE, SILVIA, STANZA, SUNNY I, SUNNY II, URVAN, VANETTE

OPEL
ASCONA B, ASCONA C, CAMPO, CORSA A, KADETT D, KADETT E, MANTA B, OMEGA A, REKORD E, VECTRA A, VECTRA B

PEUGEOT
J5, J9

PIAGGIO
PORTER

PININFARINA
SPIDEREUROPA

PORSCHE
911 / CONVERTIBLE, 924, 928, 944 / CONVERTIBLE

PROTON
AEROBACK, SALOON

RENAULT
11, 19 I, 19 II, 21, CLIO I, LAGUNA I, MEGANE I, SUPER 5

RILEY
KESTREL

ROLLS-ROYCE
CORNICHE V

ROVER
2000-3500, MAESTRO, MINI, MINI-MOKE, MONTEGO

SAAB
99, 900 I

SANTANA
SAMURAI

SEAT
124, 127, 128, 131, 850, FURA, IBIZA I, MARBELLÁ, PANDA, RITMO, RONDA, TERRA

SUBARU
JUSTY I, JUSTY II, LEONE I, LEONE II, LIBERO, MV, REX II

SUZUKI
CARRY PICKUP, JIMNY (FJ), SUPER CARRY BUS (ED), SWIFT CONVERTIBLE (SF413), SWIFT I (AA), SWIFT II HATCHBACK (EA, MA), SWIFT II SALOON (AH, AJ), VITARA / CABRIO (ET, TA), WAGON R HATCHBACK

TALBOT
1307-1510, AVENGER, SIMCA 1100, SIMCA SUNBEAM, SOLARA, TAGORA

...OE006

TOYOTA
CAMRY, CARINA II, CELICA, CHASER, COROLLA, COROLLA FX, CRESSIDA, CRESTA, CROWN, DYNA, DYNA 200, HIACE II, HIACE III, HIACE IV, HILUX IV, MARK II, LAND CRUISER, STARLET, STARLET 1000, STOUT, TARAGO, TOWN ACE, VISTA

TRIUMPH
2000 MKII, 2500, ACCLAIM, STAG, TOLEDO

TVR
350, 1600, 3000, CHIMAERA, TAIMAR

VAUXHALL
ASTRA, ASTRA MK II, ASTRA MK III (F), ASTRAMAX, BRAVA, CARLTON MK II, CARLTON MK III, CAVALIER MK II, CAVALIER MK III, CRESTA, MIDI, NOVA, NOVAVAN, RASCAL, VELOX, VENTORA, VICTOR, VISCOUNT

VOLVO
240, 340-360, 440 K, 460 L, 740, 760, 940, 960

VW
CADDY I, DERBY, GOLF I, JETTA I, LT 40-55 I, POLO, TARO

YUGO
311 / 411, 511 / 513, SANA, TEMPO

ZASTAVA
101, YUGO, YUGO FLORIDA

ZAZ
CHANCE, FORZA, LANOS, LANOS PICK-UP, SENS, SLAVUTA, TAVRIA, VIDA

OE007

CITROËN
C35

DAICIA
1304, 1310, NOVA, PICK UP

RENAULT
12, ESTAFETTE

SKODA
RAPID

TRIUMPH
HERALD, SPITFIRE

UAZ
3160, SIMBIR (3162)

VOLVO
P 121, PV 544

OE008

ALFA ROMEO
155, SPIDER

ALPINA
B7, B10

FIAT
COUPE, FIORINO, TIPO

LANCIA
DEDRA, DELTA II, THEMA

RENAULT
19 II, 21

VOLVO
740, 940

OE009

ALPINE
A310

...OE009

AUDI
A6, V8

CITROËN
AXEL, BX, CX I, CX II, DS, LNA, VISA

DAIMLER
2.8 - 5.3

MERCEDES-BENZ
190 (W201), COUPE (C123), COUPE (C124), G-CLASS (W460), G-CLASS (W461), G-CLASS / CABRIO (W463), HECKFLÖSSE (W111, W112), KOMBI T-MODEL (S123), KOMBI T-MODEL (S124), SALOON (W123), SALOON (W124), SALOON (W124), T1 BOX (601, 611), T1 BOX (602), T1 BUS / PLATFORM / CHASSIS (601), T1 PLATFORM / CHASSIS (602), T1 / TN BOX BODY / ESTATE / PLATFORM / CHASSIS, T2 / L BOX BODY / ESTATE / DUMPTRUCK / PLATFORM / CHASSIS, T2 / LN1 BOX BODY / ESTATE / PLATFORM / CHASSIS

OLTCIT
11

OPEL
ASCONA B, MANTA B

PEUGEOT
104, 204, 205 I, 205 II, 304, 305 I, 305 II, 309 I, 504, 505, 604

PUCH
G-MODELL

RENAULT
5, 14, 18, 20, 21, 25, 30, ESPACE II, FUEGO, MASTER I, SAFRANE I, TRAFIC

TALBOT
SAMBA, SIMCA SIM'4, TAGORA

VOLVO
240, 260, 760, 780, 960

OE011

AUDI
100, A6, A8

AUSTIN
AMBASSADOR, PRINCESS 2

DAIMLER
DAIMLER XJ, XJ 40, 81

FORD
ESCORT '81, ESCORT '86, ESCORT '91, ESCORT III, ESCORT IV, ESCORT V, ESCORT VI, ESCORT VII, FIESTA, FIESTA I, FIESTA II, FIESTA III, FIESTA IV, KA, ORION II, ORION III, SCORPIO I, SCORPIO II, SIERRA

JAGUAR
XJ, XJSC

LANCIA
THEMA

MERCEDES-BENZ
190 (W201), COUPE (C124), E-CLASS (W124), E-CLASS T-MODEL (S124), G-CLASS (W463), G-CLASS / CABRIO (W463), KOMBI T-MODEL (S124), SALOON (W124), S-CLASS (W126), SL (R107), SL (R129)

MORRIS
ITAL

...OE011

PEUGEOT
205 II

PROTON
GEN 2

PUCH
G-MODELL

RENAULT
18, 25, MASTER I, TRAFIC

ROVER
2000-3500

TALBOT
SAMBA

TRIUMPH
DOLOMITE

TVR
S

VOLVO
260, 760

OE012

ALFA ROMEO
155, 164

AUDI
80, 90, 100, 200, COUPE, QUATTRO

FIAT
COUPE, CROMA, TIPO

LANCIA
DEDRA, DELTA I, DELTA II, KAPPA, THEMA

PEUGEOT
505

PORSCHE
968 / CONVERTIBLE

SEAT
CORDOBA, IBIZA II

VW
CADDY I, CORRADO, GOLF I, GOLF II, JETTA I, JETTA II, LT 28-35 I, PASSAT, POLO, POLO VAN, SANTANA, SCIROCCO, TRANSPORTER III, TRANSPORTER IV

OE013

CHEVROLET
BERETTA

DODGE
DAKOTA, RAM, RAMCHARGER

JAGUAR
XJ, XJSC

JEEP
GRAND CHEROKEE I

NISSAN
PATHFINDER II

SKODA
FAVORIT, FELICIA I

UAZ
CARGO, HUNTER, PATRIOT

OE014

ALFA ROMEO
75, 164

ASTON MARTIN
DB7

AUDI
80



...OE014

CATERHAM
SEVEN
CITROËN
BX, XANTIA, ZX
FIAT
PALIO, ULYSSE, UNO
FORD
ESCORT '86, ESCORT III, TRANSIT, TRANSIT TOURNEO
HONDA
CAPA, CIVIC I, CIVIC II, DOMANI
JAGUAR
XJ
LANCIA
DEDRA, DELTA II
LOTUS
ELAN, EXIGE
MORGAN
FOUR FOUR
NISSAN
BLUEBIRD
PANTHER
KALLISTA
PEUGEOT
205 II, 309 I, 405 I, EXPERT
PORSCHE
911 SPEEDSTER (964), 911 TARGA (964)
RELIANT
SCIMITAR, SCIMITAR SABRE
RENAULT
DUSTER
SAAB
9000
SEAT
MALAGA
SUZUKI
LIANA ESTATE (ER)
TOYOTA
CELICA, CORONA
VOLVO
850

OE015

BMW
3 (E30), 5 (E28)
FIAT
PREMIO
JAGUAR
MK I, MK II, MK VII, MK VIII, MK IX, MK X, S-TYPE
RENAULT
5, 18, 19 I, 19 II, CLIO I, FUEGO, RAPID, SUPER 5, TRAFIC, TWINGO I
TOYOTA
LAND CRUISER

OE016

AIXAM
500, A.751, CROSSLINE, SCOUTY
BMW
5 GRAN TURISMO (F07)

...OE016

CITROËN
VISA
FIAT
BARCETTA, DOBLO, MAREA, MULTIPLA, PALIO, PANDA, PUNTO, SEDICI, SIENA, STILO, STRADA
HONDA
CIVIC VI
LANCIA
DEDRA, DELTA II, LYBRA
LIGIER
AMBRA, BE UP, NOVA
SSANGYONG
MUSSO
SUZUKI
GRAND VITARA II (JT), GRAND VITARA II (JT, TE, TD), LIANA (ER, RH _), LIANA HATCHBACK, SX4 (EY, GY), SX4 /SALOON (GY), SX4 SALOON (GY), SX4 S-CROSS (JY)
VW
BORA, GOLF IV, GOL IV
ZASTAVA
10

OE018

ABARTH
RITMO
ALFA ROMEO
6, 75, 90, 155, 164, 1750-2000, A11 / A12, ALFETTA, ALFETTA GT, F11 / F12, GIULIA, GIULIETTA, GT, GTV, ROMEO 2, RZ, SPIDER, SZ
ALPINE
BERLINETTE
ASTON MARTIN
LAGONDA I, V8, ZAGATO
AUDI
50, 80, 90, 100, COUPE, QUATTRO
AUSTIN
MAESTRO, MONTEGO
AUTOBIANCHI
A 112
BMW
02 /CONVERTIBLE (E10), 02 TOURING (E6), 5 (E12), 1500-2000 (115, 116, 118, 121)
CATERHAM
SEVEN
CITROËN
AMI, GS
FERRARI
208/308, MONDIAL
FIAT
124, 127, 128, 131, 132, 241-SERIE, 850, ARGENTA, COUPE, CROMA, ELBA, FIORINO, FIORINO PICK UP, PALIO, PREMIO, REGATA, RITMO, TEMPRA, TIPO, UNO, X 1/9
FORD
ESCORT II
FSO
POLONEZ I, POLONEZ II

...OE018

GINETTA
G34
INNOCENTI
ELBA
JAGUAR
XJ
JEEP
CJ5 - CJ8
LANCIA
A 112, BETA, BETAH.P.E., BETA MONTE CARLO, DEDRA, DELTA I, DELTA II, FULVIA, GAMMA, PRISMA, THEMA, TREVI
LOTUS
ECLAT, ELITE, ESPRIT S2, ESPRIT S3, ESPRIT S4, EUROPA, EXCEL
MASERATI
GHIBLI, INDY, MEXICO
MERCEDES-BENZ
COUPE (C123), COUPE (W111), KOMBI T-MODEL (S123), PAGODE (W113), PONTON (W128), SALOON (W123), S-CLASS (W108, W109), SL (R107), SL COUPE (C107)
MG
MAESTRO, METRO, MONTEGO
MITSUBISHI
COLT II, COLT III, L 200, LANCER CELESTE, SAPPORO II
MORGAN
FOUR FOUR, PLUS FOUR
MOSKVICH
407
OPEL
FRONTERA A
PANTHER
KALLISTA
RELIANT
SCIMITAR
RENAULT
9, 11, 16, 17, 18, 19 I, 19 II, 20, 21, CLIO I, FUEGO, SUPER 5, TRAFIC
ROVER
800, MONTEGO
SAAB
99, 600
SEAT
124, 131, 132, 133, RONDA
SUBARU
LEONE II, XT
TALBOT
160, 180, 1307-1510, AVENGER, HORIZON, MATRA BAGHEERA, MURENA, RANCHO, SIMCA 1000, SIMCA 1100, SIMCA 1500, SIMCA 1501, SIMCA 1609/1610, SIMCA SUNBEAM
TOFAS
DOGAN, KARTAL, SAHIN
TVR
280, 390, 400, 420, 450, 2500, CHIMAERA, GRIFFITH, SPEED EIGHT

...OE018

VOLVO
240, 340-360, 440 K, 460 L, 480 E, 740, 760, 940, 940 II, 960
VW
DERBY, GOLF I, GOLF II, JETTA I, JETTA II, PASSAT, POLO, SANTANA, SCIROCCO
WESTFIELD
130

OE019

AUDI
A8
CATERHAM
SUPER SEVEN
CHEVROLET
ASTRA, CAPTIVA, EPICA, EVANDA, MALIBU, NUBIRA, OPTRA, ORLANDO, REZZO, VECTRA, VIVANT, ZAFIRA
DAEWOO
BROUGHAM, EVANDA, KORANDO, LACETTI, LEGANZA, MAGNUS, NUBIRA, PRINCE, REZZO, WINSTORM
DAIHATSU
COO, CUORE V, CUORE VI, MATERIA
FIAT
PALIO, SIENA, ULYSSE
HOLDEN
ASTRA, CAPTIVA
LADA
110
LANCIA
ZETA
LOTUS
EUROPA S
MERCEDES-BENZ
V-CLASS (638/2), VITO BOX/BUS (638)
NISSAN
KUBISTAR
OPEL
AGILA (A), ANTARA, ASTRA F, ASTRA F CLASSIC, ASTRA G, CALIBRA A, COMBO, CORSA B, CORSA C, CORSA CLASSIC, CORSA UTILITY, FRONTERA A, FRONTERA B, KADETT E, MERIVA A, OMEGA B, SINTRA, SPEEDSTER, TIGRA, VECTRA A, VECTRA B, VECTRA C, VIVARO A, ZAFIRA A
PEUGEOT
406
SAAB
9-3, 9000
TOYOTA
4 RUNNER, COROLLA, DUET, GRANVIA, HIACE III, HILUX, HILUX II, LAND CRUISER 90, LAND CRUISER 100, LAND CRUISER PRADO, TUNDRA



...OE019

VAUXHALL
 AGILA MK I (A), ANTARA, ASTRA MK II,
 ASTRA MK III (F), ASTRA MK IV (G),
 ASTRAVAN MK III (F), ASTRAVAN MK IV
 (G), CALIBRA, CAVALIER MK II, CAVALIER
 MK III, COMBO MK I (B), COMBO MK II (C),
 CORSA MK I (B), CORSA MK II (C),
 CORSAVAN MK I (B), CORSAVAN MK II (C),
 FRONTERA MK I (A), MERIVA MK I (A),
 NOVA, OMEGA (B), SINTRA, TIGRA MK I,
 VECTRA (B), VX220, ZAFIRA MK I (A)

OE025

AUDI
 80, 100, A6, CABRIOLET, COUPE
SEAT
 AROSA, CORDOBA, IBIZA II, INCA, TOLEDO
 I
SKODA
 FELICIA I, FELICIA II, OCTAVIA I
VW
 CADDY II, CORRADO, GOLF I, GOLF II,
 GOLF III, GOLF IV, JETTA II, LUPO, PARATI
 III, PASSAT, POLO, VENTO

OE026

ALPINA
 B3, B8, B10, B12
BERTONE
 FREECLIMBER 2
BITTER
 TYPE 3
BMW
 3 (E30), 3 (E36), 3 /COMPACT
 /CONVERTIBLE/COUPE/TOURING (E36),
 3 /COMPACT/COUPE (E36), 3 /COMPACT
 /COUPE/TOURING (E36), 3 CONVERTIBLE
 (E30), 3 CONVERTIBLE (E36), 3
 /CONVERTIBLE/COUPE (E36), 3
 /CONVERTIBLE/TOURING (E36), 3 COUPE
 (E36), 3 TOURING (E30), 5 (E34), 5 (E39),
 5 /TOURING (E34), 5 TOURING (E34), 5
 /TOURING (E39), 5 TOURING (E39), 7
 (E32), 7 (E38), 8 (E31), Z3 ROADSTER
 (E36)

CATERHAM
 SEVEN
CHEVROLET
 LACETTI
CITROËN
 XANTIA, XM, XSARA
DACIA
 LODGY, LOGAN, LOGAN MCV, SANDERO,
 SOLENZA
DAEWOO
 LEGANZA
DAIHATSU
 CUORE V, CUORE VI, MOVE, SIRION,
 TERIOS, TREVIS, YRV
FIAT
 MAREA
IRMSCHER
 SENATOR
LAND ROVER
 DEFENDER

...OE026

LEXUS
 GS
NISSAN
 KUBISTAR
OPEL
 KADETT E, OMEGA A, VECTRA B
PEUGEOT
 406, 605
PORSCHE
 911 (993), 911 /CONVERTIBLE/TARGA
 (993), BOXSTER (986)
RENAULT
 CLIO I, CLIO II, ESPACE III, KANGOO,
 KANGOO / GRAND KANGOO, LAGUNA I,
 LOGAN EXPRESS, LOGAN I, LOGAN II,
 SAFRANE II, SANDERO/STEPWAY I, SCËNIC
 I, THALIA I, TWINGO I, TWINGO II
SEAT
 TOLEDO III
SKODA
 OCTAVIA II
TOYOTA
 AVALON, AVENSIS, CAMRY, CAMRY
 SOLARA, NADIA, PICNIC, PREVIA, RAV 4 I,
 SIENNA, SOLARA, VISTA, WINDOW
TVR
 CERBERA
VAUXHALL
 CALIBRA, CARLTON MK III, CAVALIER MK III
VW
 CORRADO, GOLF III, LT 28-35 II, LT 28-46
 II, PASSAT, VENTO

OE027

AUDI
 80, 100, 200, A6, CABRIOLET, COUPE
SEAT
 AROSA, CORDOBA, IBIZA II, INCA, TOLEDO
 I
VW
 CADDY II, GOLF I, GOLF II, GOLF III, GOLF
 IV, JETTA II, LT 28-35 I, LT 40-55 I,
 PASSAT, POLO, POLO VAN, SCIROCCO,
 TRANSPORTER IV, VENTO

OE029

ALFA ROMEO
 159, BRERA, SPIDER
ASTON MARTIN
 DB7
CHEVROLET
 CAPTIVA, TRAILBLAZER
FORD
 BANTAM, COUGAR, ESCORT CLASSIC,
 ESCORT V, ESCORT VI, ESCORT VII, FIESTA
 V, FOCUS, KA, MAVERICK, MONDEO I,
 MONDEO II, ORION III, PUMA, TOURNEO
 CONNECT, TRANSIT CONNECT
FORD AUSTRALIA
 FIESTA, MONDEO
HOLDEN
 ASTRA, VECTRA, ZAFIRA
MAZDA
 121 III (JASM, JBSM), TRIBUTE (EP)

...OE029

MORGAN
 FOUR FOUR, PLUS FOUR
OPEL
 ANTARA
VAUXHALL
 OMEGA (B)

OE030

DAIHATSU
 CHARADE IV
DE TOMASO
 GUARA
FIAT
 BRAVA, BRAVO I, DOBLO, MAREA,
 MULTIPLA, SIENA
LANCIA
 KAPPA, LYBRA, Y
LOTUS
 ESPRIT S4

OE031

CHEVROLET
 ALERO, COBALT, HHR
FORD
 B-MAX, C-MAX, C-MAX II, COUGAR, FIESTA
 III, FIESTA IV, FIESTA V, FIESTA VI, FOCUS,
 FOCUS C-MAX, FOCUS II, FOCUS III,
 FUSION, GRAND C-MAX, KA, MONDEO IV,
 PUMA, STREET KA
MAZDA
 2 (DY), 6 ESTATE/HATCHBACK (GH), 6
 SALOON (GH)
VOLVO
 C30, S40 II, V50

OE032

AUDI
 80, 100, 200, A2, A3, A4, A6, A8,
 CABRIOLET, COUPE
MERCEDES-BENZ
 A-CLASS (W168), C-CLASS (W202),
 C-CLASS T-MODEL (S202), CLK (C208), CLK
 CONVERTIBLE (A208), E-CLASS (W210),
 E-CLASS T-MODEL (S210), M-CLASS
 (W163), SL (R129), SLK (R170), SPRINTER
 2-T BOX (901, 902), SPRINTER 3-T BOX
 /BUS /PLATFORM /CHASSIS (903)
RENAULT
 25
SEAT
 ALHAMBRA, ALTEA, ALTEA XL, AROSA,
 CORDOBA, EXEO, IBIZA II, IBIZA III, IBIZA
 IV, INCA, LEON, TOLEDO I, TOLEDO II
SKODA
 FABIA I, OCTAVIA I, OCTAVIA II, SUPERB I
VW
 BORA, CADDY II, CADDY III, CORRADO,
 GOLF II, GOLF III, GOLF IV, GOLF V, GOLF
 VI, GOLF PLUS, GOL III, JETTA II, JETTA III,
 LUPO, NEW BEETLE, PASSAT, POLO,
 SHARAN, TOURAN, VENTO, VOYAGE

OE033

DACIA
 DOKKER, DOKKER EXPRESS, DUSTER,
 LODGY, LOGAN, LOGAN MCV, SANDERO

...OE033

LADA
 LARGUS
NISSAN
 KUBISTAR, PRIMERA, SERENA
RENAULT
 CLIO, CLIO II, CLIO III, DUSTER, ESPACE III,
 ESPACE IV, FLUENCE, GRAND SCËNIC II,
 GRAND SCËNIC III, KANGOO, KANGOO BE
 BOP, KANGOO / GRAND KANGOO,
 LAGUNA, LAGUNA I, LAGUNA II, LAGUNA
 III, LOGAN I, MEGANE, MEGANE CC,
 MEGANE I, MEGANE II, MEGANE III,
 MODUS / GRAND MODUS, SCËNIC I,
 SCËNIC II, SCËNIC III, THALIA I, THALIA II,
 TRAFIC II, VEL SATIS

OE034

CITROËN
 AX, BERLINGO, BERLINGO / BERLINGO
 FIRST, BX, C2, C3, C3 I, C3 II, C15,
 EVASION, JUMPER, NEMO, SAXO, XANTIA,
 XM, XSARA, XSARA PICASSO, ZX
EMGRAND
 EC7, EC7-RV
EMGRAND (GEELY)
 EC 7, EC 7 RV

FIAT
 FIORINO, QUBO, TEMPRA, ULYSSE
FORD ASIA / OZEANIA
 FESTIVA, LIATA, TELSTAR
GEELY
 BL, CK, GC2, HISOON, HQ, MARINDO,
 MEIRI, MK, MR, PU, SL, URBAN NANNY,
 VISION

HONDA
 CIVIC VI
KIA
 RIO
LADA
 LARGUS
LANCIA
 ZETA
MEGA
 CLUB, CLUB II
MITSUBISHI
 COLT VI
NISSAN
 BLUEBIRD
OPEL
 ASTRA F

PEUGEOT
 106 I, 106 II, 106 VAN, 205, 205 I, 205
 II, 206, 206+, 207, 207 SW, 305 II, 306,
 307, 309 I, 309 II, 405 I, 405 II, 406,
 605, 806, 1007, BIPPER, BIPPER TEPEE,
 BOXER, EXPERT, PARTNER
ROVER
 200, 400
SUBARU
 REX III
VAUXHALL
 VIVARO
VOLVO
 850



**OE035****CITROËN**

BERLINGO, BERLINGO / BERLINGO FIRST, C1, C2, C3, C3 I, C4, C4 I, C-ELYSEE, SAXO, XSARA, XSARA PICASSO

MITSUBISHI

COLT CZC, COLT VI, COLT PLUS VII, LANCER VIII

PEUGEOT

107, 206, 207, 301, 307, 308, 308 SW, 1007, PARTNER, PARTNER TEPEE

SMART

FORFOUR

SUBARU

IMPREZA, LEGACY IV, OUTBACK, TRIBECA

TOYOTA

AYGO, DYNA, FJ CRUISER, FORTUNER, HIACE / COMMUTER V, HIACE V, HILUX III, HILUX VII, INNOVA I, IQ, LAND CRUISER, LAND CRUISER 150, LAND CRUISER PRADO, PASSO, TUNDRA, VIOS/YARIS, YARIS

VOLVO

S40 II, S80 II, V50

OE037**AUTO UNION**

DKW F11, DKW F12

BORGWARD

ISABELLA

CITROËN

ID

FORD

TAUNUS 12M, TAUNUS 15M, TAUNUS 17M

MOSKVICH

403, 423

OPEL

KADETT B, OLYMPIA REKORD

RENAULT

ESTAFETTE

SKODA

110

UAZ

3160, 31512

VW

181, 1500, 1600, KAEFER, KARMANN GHIA, TRANSPORTER I, TRANSPORTER III

WARTBURG

353

OE039**CHEVROLET**

AVEO, AVEO / KALOS, CRUZE, LACETTI, LUMINA APV, NUBIRA, OPTRA, REZZO, VIVANT

CITROËN

XM

DAEWOO

ESPERO, GENTRA, LACETTI, LANOS, NEXIA, NUBIRA, REZZO

DAIHATSU

ALTIS, APPLAUSE I, APPLAUSE II, CHARADE III, CHARADE IV, HIJET

...OE039**FORD**

ESCORT '86, ESCORT '91, ESCORT IV, ESCORT V, ESCORT VI, ESCORT VII, FIESTA II, FIESTA III, ORION II, ORION III, RANGER, SIERRA, TRANSIT

FORD ASIA / OCEANIA

LASER, LASER / LASER LIDEA

FORD AUSTRALIA

COURIER, TELSTAR

FSO

LANOS

HONDA

ACCORD III, ACCORD VI, CITY, CIVIC II, CIVIC IV, CIVIC V, CIVIC VI, CONCERTO, CRX II, CRX III, JAZZ, JAZZ II, LEGEND I

HYUNDAI

GALLOPER I, TIBURON

JEEP

CHEROKEE

KIA

CLARUS, RETONA, RIO, SHUMA

LADA

110, 111, 112, GRANTA, GRANTA (2349), KALINA, OKA, PRIORA

MAZDA

121 II (DB), 121 III (JASM, JBSM), 323 C IV (BG), 323 C V (BA), 323 F IV (BG), 323 F V (BA), 323 III /HATCHBACK (BF), 323 S IV (BG), 323 S V (BA), 323 S VI (BJ), 626 III /COUPE /HATCHBACK (GD), 626 III STATION WAGON (GV), 626 V /HATCHBACK (GF), 626 V STATION WAGON (GW), 929 III (HC), B-SERIE (UF), B-SERIE (UN), E-SERIE BOX (SR2), MX-5 I (NA), MX-5 II (NB), MX-6 (GE), PREMACY (CP)

MITSUBISHI

CARISMA, COLT IV, COLT V, ECLIPSE, ECLIPSE II, FTO, GALANT V, GALLOPER, LANCER IV, LANCER V, LANCER VI, LANCER VII, MIRAGE, PAJERO II, PAJERO PININ, PAJERO SPORT I, SANTAMO, SPACE RUNNER, SPACE STAR, SPACE WAGON

NISSAN

AVENIR, BLUEBIRD, PRAIRIE, PRAIRIE PRO, SKYLINE, STANZA, SUNNY II

PROTON

PERSONA 300, PERSONA 400, WIRA

ROVER

400, 800

SAAB

9000

SUBARU

IMPREZA, JUSTY I, LEGACY I, SVX

SUZUKI

BALENO /ESTATE /HATCHBACK (EG), GRAND VITARA I (FT, HT), JIMNY CLOSED OFF-ROAD VEHICLE (SN), SWIFT II HATCHBACK (EA, MA), SWIFT II SALOON (AH, AJ), VITARA (ET, TA)

...OE039**TOYOTA**

4 RUNNER, AURIS, CAMRY, CAMRY SOLARA, CARINA E, CARINA II, CELICA, COASTER, COROLLA, CURREN, GRANVIA, HARRIER, MARK II, MR 2 II, SCEPTER, VISTA

OE041**CHRYSLER**

NEW YORKER, VIPER, VISION

DODGE

INTREPID, RAM 1500, VIPER

FORD USA

PROBE I

JEEP

CHEROKEE, COMANCHE, GRAND CHEROKEE I, GRAND CHEROKEE II, WRANGLER I, WRANGLER II

OE042**BRISTOL**

411

CHRYSLER

DAYTONA, LE BARON, SARATOGA, VOYAGER / GRAND VOYAGER III

CITROËN

2 CV

DODGE

CARAVAN

GEO

METRO, STORM, TRACKER

JEEP

CJ5 - CJ8

RELIANT

KITTEN

RENAULT

19 II, RAPID

SEAT

MARBELLA, TERRA

TRIUMPH

2000 MK I, 2000 MKII

OE044**SEAT**

IBIZA II

VW

GOLF III, JETTA I, PASSAT, VENTO

OE048**ACURA**

INTEGRA

CHEVROLET

MATIZ, SPARK

DAEWOO

MATIZ, TICO

DAIHATSU

CHARADE II, CHARADE III, CHARADE IV, CHARMANT, CUORE II, MOVE

FOTON

ALPHA, SEA LION, SURF

GREAT WALL

SAILING

HONDA

ACCORD II, ACCORD III, CIVIC I, CIVIC III, CRX I, INTEGRÁ, PRELUDE II

...OE048**HYUNDAI**

H-1, H-1 / STAREX, H100, LANTRA I, PONY, PONY / EXCEL, S COUPE, SONATA II, SONATA III, SONATA IV

ISUZU

PIAZZA

KIA

AVELLA, CARNIVAL II, MAGENTIS, ROADSTER, SEPHIA

LADA

110, 111, 112, GRANTA, KALINA, LARGUS, NADESCHDA, NIVA, PRIORA, SAMARA, TOSCANA

MAZDA

323 C IV (BG), 323 II HATCHBACK (BD), 323 III /HATCHBACK (BF), 323 III STATION WAGON (BW), 626 II /HATCHBACK (GC), 626 III /COUPE /HATCHBACK (GD), 626 III STATION WAGON (GV)

MITSUBISHI

COLT II, COLT IV, COLT V, COLT VI, GALANT III, L 200, L 300 III, LANCER III, LANCER IV, LANCER V, LANCER VI, MIRAGE, MIRAGE II, MIRAGE V, SIGMA, SPACE WAGON, STARION

NISSAN

PATROL GR V, URVAN, VANETTE

OPEL

ASCONA C, KADETT E, VECTRA A

PROTON

PERSONA 400

RENAULT

19 II

ROVER

200

SUBARU

LEONE II, LIBERO, REX I, REX II

TOYOTA

COROLLA, COROLLA FX, LAND CRUISER 80, SPRINTER, STARLET

VAUXHALL

CAVALIER, CAVALIER CC, FIRENZA, VIVA

OE049**CHEVROLET**

KALOS, MATIZ, SPARK

CHRYSLER

LE BARON, VOYAGER I, VOYAGER II

DAEWOO

KALOS, TICO

DAIHATSU

CHARADE II, CHARADE III, CHARMANT, ROCKY HARD TOP, SKYWING

DAIMLER

2.8 - 5.3

GEO

METRO

HONDA

JAZZ I

HYUNDAI

H100, PORTER



...OE049

KIA
RIO
MARUTI
800
MITSUBISHI
DEBONAIR, LANCER IV, LANCER V, PAJERO I, PAJERO II
NISSAN
CHERRY III, MICRA I, PATROL GR IV, SUNNY I, SUNNY II, URVAN
SUZUKI
ALTO (OS), ALTO HATCHBACK
TOYOTA
CAMRY, CARIBE, CARINA, COROLLA, CORONA, HIACE III, MODELL F, STARLET, TERCEL, TOWN ACE

OE051

ALFA ROMEO

6

AUSTIN

METRO, MINI

BENTLEY

AZURE, CONTINENTAL, CONTINENTAL FLYING SPUR

DACIA

NOVA

DAIHATSU

CHARADE I, CHARMANT, DELTA WIDE, ROCKY SOFT TOP, RUGGER, TAFT

GAZ

GAZELLE, SOBOL (2217), SOBOL (2752), VOLGA

HONDA

CIVIC I, CIVIC II

HYUNDAI

PONY

INNOCENTI

MINI

ISUZU

GEMINI

JAGUAR

E-TYPE, XJ

LAND ROVER

90, 110/127, DEFENDER, DISCOVERY I, RANGE ROVER I, RANGE ROVER II

LDV

SHERPA

MAZDA

121 I (DA), B-SERIE (PE), B-SERIE (UD), B-SERIE (UF), B-SERIE (UN), E-SERIE BOX, E-SERIE BOX (SR2), E-SERIE BUS (SR1)

MG

MGR V8, MIDGET

MITSUBISHI

CORDIA, L 200, L 300 / DELICA II, L 300 II, L 300 III, L 400, LANCER II, PAJERO I, TREDIA

MORGAN

PLUS EIGHT

...OE051

NISSAN

BLUEBIRD, BLUEBIRD (B610), CHERRY II, CHERRY III, DATSUN 160 J, DATSUN 180 B, LAUREL, MICRA I, PICK UP, PRAIRIE, SILVIA, SUNNY, SUNNY I, SUNNY II, VANETTE

PORSCHE

928

PROTON

AEROBACK, JUMBUCK, PERSONA 300, PERSONA 400, SALOON, SATRIA, WIRA

RENAULT

RAPID

ROLLS-ROYCE

CORNICHE IV, SILVER SPIRIT

SUZUKI

ALTO (EF), CARRY BOX (OS), LJ 80 (OL), SAMURAI CLOSED OFF-ROAD VEHICLE (SJ), SJ 410, SJ 410 CABRIO (OS), SJ 413 (OS), SUPER CARRY BUS (ED)

TOFAS

SAHIN

TOYOTA

1000, BLIZZARD, CAMRY, CARINA, CARINA II, CELICA, COASTER, COROLLA, COROLLA FX, CORONA, CRESSIDA, CRESTA, CROWN, DYNA, DYNA 100, DYNA 150, HIACE I, HIACE II, HILUX, HILUX I, HILUX II, HILUX III, HILUX IV, HILUX V, MARK II, LAND CRUISER, LITEACE, MASTER ACE SURF, MODELL F, STARLET, TOWN ACE, VISTA

TRIUMPH

DOLOMITE, SPITFIRE, TR 7

VW

LT 28-35 I, TARO

OE057

MEGA

MONTE CARLO, TRACK

MERCEDES-BENZ

CABRIOLET (A124), C-CLASS (W202), C-CLASS T-MODEL (S202), CLK (C208), CLK CONVERTIBLE (A208), COUPE (C124), E-CLASS (W124), E-CLASS (W210), E-CLASS CONVERTIBLE (A124), E-CLASS COUPE (C124), E-CLASS T-MODEL (S124), E-CLASS T-MODEL (S210), G-CLASS (W463), G-CLASS /CABRIO (W463), KOMBI T-MODEL (S124), SALOON (W124), S-CLASS (W140), S-CLASS COUPE (C140), SL (R129), SLK (R170), SPRINTER 2-T BOX (901, 902), SPRINTER 3-T BOX (903), SPRINTER 3-T BOX /BUS /PLATFORM /CHASSIS (903), SPRINTER 3-T BUS /PLATFORM /CHASSIS (903)

SSANGYONG

KYRON, MUSSO, REXTON, RODIUS

OE059

ARO

10

GAZ

GAZELLE, SOBOL (2217), SOBOL (2310), SOBOL (2752), VOLGA

LAND ROVER

RANGE ROVER I

...OE059

MG

MGB GT

RENAULT

4, 5, 6

ROVER

2000-3500

TRIUMPH

TR 8

UAZ

452, 469 B

OE063

BAOLONG

PEGASUS

BYD

F3

CHENGLONG

FUTURE

CHERY

TIGGO, V5

CHRYSLER

CIRRUS, SEBRING, STRATUS

DADI

CITY COURSER, ELEGANTEST

EUNOS

500

FIAT

PALIO, STRADA

FORD ASIA / OZEANIA

FREDA, TIERRA

GREAT WALL

FENGJUN 5, HOVER H3

HYUNDAI

ACCENT, ACCENT I, ACCENT II, ACCENT III, ATOS, ATOS PRIME, COUPE, ELANTRA, GETZ, I10, I20, I30, LANTRA II, MATRIX, S COUPE, SONATA V, STELLAR, TIBURON, TRAJET

INFINITI

I30, QX4

ISUZU

TROOPER II, VEHICROSS, WIZARD

KIA

CARENS I, CARENS II, CARENS III, CEE'D, CERATO, CLARUS, PICANTO, PRIDE, PRO CEE'D, RIO II, SHUMA, SHUMA II

LANDWIND (JMC)

LANDWIND

MAZDA

2 (DY), 121 I (DA), 121 II (DB), 323 F V (BA), 323 F VI (BJ), 323 III STATION WAGON (BW), 323 P V (BA), 323 S IV (BG), 323 S V (BA), 323 S VI (BJ), 626 IV /HATCHBACK (GE), 929 III (HC), DEMIO (DW), E-SERIE MPV (SG), MX-3 (EC), MX-5 II (NB), PREMACY (CP), XEDOS 6 (CA)

MITSUBISHI

COLT V, L 300 III, L 400, SPACE RUNNER, SPACE STAR

MI TSUOKA

VIEWT, YUGA

...OE063

NISSAN

240 SX, AD VAN, AD WAGON, ALMERA I, ALMERA II, ALMERA TINO, AVENIR, BASSARA, BLUEBIRD, BLUEBIRD SYLPHY I, CARAVAN, CEDRIC, CEFIRO II, CEFIRO III, CUBE, GLORIA, GLORIA VIII, GLORIA XI, LEOPARD, LUCINO, MAXIMA / MAXIMA QX IV, MAXIMA / MAXIMA QX V, MICRA II, PICK UP, PRIMERA, SERENA, SUNNY II, SUNNY III, SUNNY IV, TERRANO I, URVAN

PORSCHE

356 CABRIOLET /SPEEDSTER /COUPE

RENAULT

CLIO II

SUBARU

FORESTER, IMPREZA, LEGACY I, LEGACY II, LEGACY III, LEGACY IV, LEGACY OUTBACK, OUTBACK

TOYOTA

4 RUNNER, CARIBE, CARINA E, CARINA II, CELICA, COROLLA, COROLLA FX, COROLLA LEVIN, CORONA, CORSA, CRESSIDA, CRESTA, CURREN, MR 2 I, PASEO, RAUM, SCEPTER, SOLUNA VIOS, SPRINTER, SPRINTER CARIB, STARLET, TERCEL, VIOS, VISTA, YARIS / VIOS

OE064

ARO

240-244

BEDFORD

BLITZ

DACIA

NOVA

DAEWOO

PRINCE, SUPER SALOON

FIAT

126, PANDA

FORD

TAUNUS 15M

OPEL

ADMIRAL A, ADMIRAL B, ASCONA A, ASCONA B, COMMODORE A, COMMODORE B, COMMODORE C, CORSA A, DIPLOMAT B, FRONTERA A, GT, KADETT A, KADETT B, KADETT C, KADETT D, KADETT E, KAPITAN, MANTA A, MANTA B, MONZA A, OLYMPIA A, OMEGA A, REKORD A, REKORD B, REKORD C, REKORD D, REKORD E, SENATOR A, SENATOR B

PORSCHE

356 CABRIOLET /SPEEDSTER /COUPE, 911 /TARGA

RANGER

REKORD

VAUXHALL

ASTRA, ASTRA MK II, CARLTON MK II, CARLTON MK III, CAVALIER, CAVALIER CC, FRONTERA MK I (A), NOVA, ROYALE, SENATOR, SENATOR MK II (B), VICEROY

OE065

ARO

10

JAGUAR

MK X



...OE065

PROTON
PERSONA 300, PERSONA 400
VW
SANTANA

OE068

ALFA ROMEO
ALFETTA, ALFETTA GT, GIULIETTA, GTV,
SPIDER

BMW
600 (111), 700 (107), 700 COUPE

LAMBORGHINI
COUNTACH, ESPADA, JARAMA

MOSKVIC
2335

NSU

TT

PORSCHE
356 CABRIOLET /SPEEDSTER /COUPE

OE073

FERRARI
348, 348 TB/GTB, 348 TS/GTS, 612
SCAGLIETTI

LAMBORGHINI
LM-002

MASERATI
GHIBLI II, SHAMAL

OE077

ALFA ROMEO
147

CHEVROLET
LACETTI, NUBIRA

FIAT
DUCATO, PUNTO, UNO

MITSUBISHI
PAJERO II, SAPPORO III

NISSAN
280 ZX,ZXT

SUBARU
LEONE II, XT

OE083

BMW
5 (E34), 5 /TOURING (E34)

SUZUKI
ALTO (FF), CAPPUCINO (EE), WAGON R+
(MM), WAGON R+ HATCHBACK (EM)

TVR
CERBERA, TUSCAN II

OE087

ALFA ROMEO
33, 75, 145, 146, 164, 166, ALFASUD,
ARNA, GIULIA, GT, GTA, GTV, MONTREAL

ALPINE
A310

AUDI
80, 100, COUPE, SUPER 90

FERRARI
365 GT 2+2, 365 GTB/4 DAYTONA, 365
GTS/4 DAYTONA, 400 I, 412 I, 512 BB,
DINO GT, DINO GTS, MONDIAL

...OE087

FIAT
ARGENTA, DINO

FORD
CAPRI, ESCORT I

MASERATI
228, 420/430, BITURBO, KARIF,
QUATTROPORTE I, QUATTROPORTE III,
QUATTROPORTE IV

MERCEDES-BENZ
/8 COUPE (W114), CABRIOLET (W111),
COUPE (W111), HECKFLOSSE (W111,
W112), KOMBI T-MODEL (S123), SALOON
(W123), S-CLASS (W108, W109), T2/L
DUMPTRUCK

PEUGEOT
204, 304

PININFARINA
SPIDEREUROPA

PORSCHE
911 (964), 911 /TARGA, 911 TARGA, 924
, 944 /CONVERTIBLE

RENAULT
9, 11, 19 I, 19 II, 21, SUPER 5

SSANGYONG
KORANDO

TALBOT
MATRA BAGHEERA, SIMCA 1000, SIMCA
1100, SIMCA SUNBEAM

TRIUMPH
VITESSE

VW
DERBY, GOLF I, JETTA I, PASSAT, SANTANA,
SCIROCCO

OE089

ALFA ROMEO
159

CADILLAC
BLS

CHRYSLER
NEON II, PT CRUISER

DAIHATSU
SIRION, TERIOS

DODGE
DURANGO, NITRO, RAM 1500

FIAT
CROMA, IDEA, SIENA, STILO

FORD
MAVERICK

FORD USA
PROBE I, PROBE II

HONDA
ACCORD IV, ACCORD V, ACCORD VI,
ACCORD VII, CAPA, CIVIC II, CIVIC V, CIVIC
VI, CIVIC VII, CR-V I, CR-V II, CR-V III,
DOMANI, FR-V, HR-V, INTEGRA, LOGO,
PRELUDE IV, PRELUDE V, SHUTTLE, SMX,
STEPWGN, STREAM

JEEP
CHEROKEE, COMMANDER, GRAND
CHEROKEE III

KIA
RIO

...OE089

LOTUS
ELISE

MAZDA
323 F VI (BJ), 323 S VI (BJ), 626 III (GD),
626 IV HATCHBACK (GE), 929 III (HC),
B-SERIE (UF), B-SERIE (UN), MPV I (LV),
MPV II (LW), MX-6 (GE), PREMACY (CP),
XEDOS 9 (TA)

NISSAN
100 NX, 200 SX, PICK UP, PRAIRIE PRO,
PRIMERA, SUNNY III, TERRANO I, TERRANO
II, VANETTE CARGO

OPEL
ASTRA G, ASTRA H, CALIBRA A, COMBO,
INSIGNIA A, VECTRA A, VECTRA B, ZAFIRA B

ROVER
600, 800

TOYOTA
YARIS

VAUXHALL
ASTRA MK II, ASTRA MK V (H), CAVALIER
MK III, INSIGNIA MK I (A), ZAFIRA MK II
(B)

OE091

ALPINE
1300, 1600

FIAT
850

JAGUAR
XJ

LADA
110

LAMBORGHINI
MIURA

MERCEDES-BENZ
GULLWING (W198), SL (R198)

PORSCHE
356 COUPE, 911 /CONVERTIBLE /TARGA,
924

OE093

TOYOTA
ALLION I, AVENSIS, BB I, COROLLA, ECHO,
ISIS, IST, LAND CRUISER, LAND CRUISER
80, LITEACE, MATRIX, MR 2 III, OPA,
PLATZ, PORTE, PROBOX/SUCCEED, RACTIS,
RAUM, RAV 4 II, SIENTA, URBAN CRUISER,
VIOS/YARIS, VISTA, WILL CYPHA, WILL VI,
WILL VS, WISH, YARIS, YARIS VERSO,
YARIS / VIOS

OE094

ALFA ROMEO
33, 75, 145, 146, 164

ALPINE
A610

CITROËN
AX

LANCIA
KAPPA

PEUGEOT
205 II

PORSCHE
911 (993), 911 /CONVERTIBLE (993)

...OE094

RENAULT
21, SAFRANE I

SEAT
IBIZA I, MALAGA, TOLEDO I

VW
CORRADO, PASSAT, SCIROCCO

OE105

CHRYSLER
CONCORDE, VOYAGER / GRAND VOYAGER
III

DODGE
CARAVAN, INTREPID

PLYMOUTH
VOYAGER / GRAND VOYAGER

OE120

BMW
1 (E81), 1 (E87), 3 (E30), 3 CONVERTIBLE
(E93), 5 (E28), 7 (E65, E66, E67)

CHEVROLET
VECTRA, ZAFIRA

HOLDEN
ASTRA

MERCEDES-BENZ
A-CLASS (W168)

OPEL
VECTRA C

PIAGGIO
PORTER

RENAULT
LAGUNA I

SEAT
IBIZA II

VAUXHALL
OMEGA (B), SIGNUM, VECTRA (B), VECTRA
MK II (C), ZAFIRA MK II (B)

VOLVO
850, 960, 960 II, C70 I, S40 I, S60 I, S70,
S80 I, S90, V40, V70 I, V70 II, V90

OE122

ALFA ROMEO
145, 146, 147, 155, 156, 166, GT, GTV,
SPIDER

FERRARI
360, ENZO FERRARI, F355, F355
BERLINETTA, F430

MASERATI
3200 GT, 4200 GT, 4200 GT SPYDER,
QUATTROPORTE IV, QUATTROPORTE V

OE123

ALFA ROMEO
147, 156, GT, GTV, SPIDER

VW
GOLF III, GOLF IV, PASSAT, TRANSPORTER
IV, VENTO

OE128

DODGE
DAKOTA, RAM, RAM 1500, RAM 2500,
RAMCHARGER, RAMCHARGER II

JEEP
CHEROKEE, COMANCHE, GRAND CHEROKEE
I



OE130

CITROËN
C2, C3 I, C4, C4 I
DACIA
LOGAN, LOGAN II, LOGAN MCV II,
SANDERO, SANDERO II
NISSAN
KUBISTAR
PEUGEOT
206, 207, 307, 1007
RENAULT
CLIO, CLIO II, CLIO III, CLIO IV, KANGOO,
MODUS / GRAND MODUS, THALIA I,
THALIA II, TWINGO I, TWINGO II, TWINGO
III
SMART
FORFOUR, FORTWO
OE131
ASTON MARTIN
DB7, DB9, DBS, RAPIDE, VANQUISH,
VANTAGE, VIRAGE
FORD
B-MAX, C-MAX, C-MAX II, COUGAR, ESCORT
V, ESCORT VI, ESCORT VII, FIESTA, FIESTA
IV, FIESTA V, FIESTA VI, FOCUS C-MAX,
FOCUS II, KA, MONDEO I, MONDEO II,
MONDEO III
FORD AUSTRALIA
COUGAR, FALCON, KA
JAGUAR
S-TYPE, XF, XJ, X-TYPE
LINCOLN
LS
MAZDA
6 HATCHBACK (GG), 121 III (JASM, JBSM)
MORGAN
PLUS FOUR, ROADSTER
VOLVO
C30, S40 II, S80 II, V50, V70 III

OE136

ACURA
LEGEND II, NSX
ALFA ROMEO
156, 159, 164, 166, BRERA, GTV, SPIDER
ALPINA
B5
AUDI
80, 100, A3, A4, A6, ALLROAD, COUPE,
QUATTRO, TT
BENTLEY
CONTINENTAL
CADILLAC
BLS
DAIHATSU
YRV
DAIMLER
DAIMLER XJ
FIAT
COUPE
FORD
GALAXY, SCORPIO II, TRANSIT

...OE136

HONDA
INSPIRE, LEGEND II, NSX I, S2000
JAGUAR
XJ, XK 8
KIA
CARNIVAL I, CARNIVAL II
LAMBORGHINI
GALLARDO, GALLARDO SPYDER
LANCIA
KAPPA, THESIS
LAND ROVER
FREELANDER
LEXUS
ES, GS, IS, IS I, LS, SC
MERCEDES-BENZ
C-CLASS (W202), C-CLASS T-MODEL (S202)
MITSUBISHI
3000 GT, DIAMANTE I, DIAMANTE II,
GALANT V, GALANT VI, MAGNA, SIGMA
NISSAN
180 SX, 200 SX, 300 ZX, SUNNY III
OPEL
ASTRA G, ASTRA H, COMBO, SIGNUM,
VECTRA C, ZAFIRA B
PORSCHE
CAYENNE (9PA)
RENAULT
ESPACE IV, LAGUNA II, LAGUNA III,
MEGANE II, SCÉNIC II
SAAB
9-3, 9-5
SEAT
ALHAMBRA, AROSA, EXEO, IBIZA III, LEON,
TOLEDO II
SKODA
OCTAVIA I, SUPERB I
SUBARU
FORESTER, IMPREZA, LEGACY I
SUZUKI
IGNIS II (MH), LIANA HATCHBACK, SWIFT
III (MZ, EZ), WAGON R+ (MM), WAGON
R+ HATCHBACK (MM)
TOYOTA
ALTEZZA, ARISTO, AVANZA, AVENSIS, BB II,
CALDINA, CAMI, CAMRY, CARINA E, CELICA,
CELSIOR, CHASER, CRESTA, CROWN,
CURREN, MARK II, LAND CRUISER 200,
MAJESTA, MR 2 II, PASSO, RAV 4 I,
SOARER, SUPRA, VEROSSA
Vauxhall
ASTRA MK V (H), COMBO MK II (C),
COMBO TOUR MK II (C), CORSA MK II (C),
CORSA MK III (D), SIGNUM, VECTRA MK II
(C), ZAFIRA MK I (A), ZAFIRA MK II (B)
VOLVO
850, C70 I, S40 I, S60 I, S70, S80 I, V40,
V70 I, V70 II, XC70 CROSS COUNTRY, XC90
I
VW
BORA, GOLF IV, LUPO, NEW BEETLE,
PASSAT, POLO, SHARAN

OE138

INFINITI
Q45 II
LAND ROVER
DISCOVERY II, RANGE ROVER II
TOYOTA
ASCENT, AVENSIS, CALDINA, CARINA E,
COROLLA, CORONA, CURREN, SPRINTER,
SPRINTER CARIB

OE145

SKODA
FABIA I, FELICIA I, FELICIA II, OCTAVIA I

OE146

ACURA
NSX
ALFA ROMEO
147, 156, 166, GT, GTV, SPIDER
AUDI
A4, A5, A6, A8, Q5
BENTLEY
ARNAGE
CHEVROLET
EPICA
DAEWOO
MAGNUS, TOSCA
DAIMLER
DAIMLER XJ
FORD
GALAXY
HONDA
CIVIC VII, CIVIC VIII, NSX I
HYUNDAI
EQUUS / CENTENNIAL
INFINITI
G20, M30
JAGUAR
S-TYPE, XJ
LAND ROVER
FREELANDER
LEXUS
ES
LOTUS
ELISE, ELISE 340 R
MERCEDES-BENZ
C-CLASS COUPE (CL203), SPRINTER 2-T
BOX /BUS /PLATFORM /CHASSIS (901,
902), SPRINTER 3-T BOX /BUS
/PLATFORM /CHASSIS (903)
MG
EXPRESS, MG 6, MGF, MG TF, MG ZR, MG
ZS, MG ZT, MG ZT-
MITSUBISHI
DIAMANTE I, DIAMANTE II, ECLIPSE III, L
300 III, MAGNA, PAJERO II, PAJERO III,
PAJERO IV, PAJERO SPORT II,
PROUDIA/DIGNITY, VERADA
MORGAN
PLUS EIGHT
NISSAN
CEDRIC
RENAULT
MEGANE CC, MEGANE III, TWINGO II, WIND

...OE146

ROVER
25, 45, 75, 200, 400, COUPE, STREETWISE
SEAT
ALTEA, ALTEA XL, EXEO, LEON, TOLEDO III
SKODA
OCTAVIA II
SUBARU
FORESTER, LEGACY II, LEGACY IV, OUTBACK
TOYOTA
CAMRY, CARIBE, CENTURY, COROLLA,
CRESTA, CURREN, MARK II, PREVIA,
SCEPTER, SPRINTER, SPRINTER CARIB,
VISTA, WINDOM
Vauxhall
ASTRA MK VI (J)
VW
EOS, GOLF V, GOLF VI, GOLF PLUS, JETTA
III, PASSAT, TOURAN

OE148

CITROËN
XSARA PICASSO
HYUNDAI
IX35, SANTA FÉ II, SONATA V, SONATA VI
KIA
CERATO II, CERATO KOUP, MAGENTIS,
OPTIMA, SORENTO II, SPORTAGE
NISSAN
ALMERA CLASSIC, ALMERA II, ALTIMA,
AVENIR, BASSARA, PATHFINDER III,
PRIMERA, SENTRA V, X-TRAIL

PEUGEOT

206

OE154

ACURA
RL, SLX
CHRYSLER
SEBRING
DODGE
AVENGER, CALIBER, DAKOTA, DART,
DURANGO, JOURNEY, RAM 1500
FIAT
FREEMONT
HONDA
LEGEND III
JEEP
COMMANDER, COMPASS, GRAND
CHEROKEE II, GRAND CHEROKEE III,
PATRIOT
LANCIA
FLAVIA

OE175

CITROËN
C5 I, C5 II, C5 III, C6, C8
FIAT
ULYSSE
LANCIA
PHEDRA
MITSUOKA
VIEWT



...OE175

NISSAN

350 Z, ALTIMA, CEFIRO I, CUBE, ELGRAND, MAXIMA / MAXIMA QX V, MAXIMA QX V, MICRA C+C III, MICRA III, MURANO I, NOTE, QUEST, SKYLINE, STAGEA, TEANA I, TERRANO II, XTERRA

PEUGEOT

406, 407, 607, 807

RENAULT

AVANTIME, CLIO II, ESPACE IV, KANGOO, LAGUNA II, MEGANE I, VEL SATIS

SUZUKI

GRAND VITARA II (JT, TE, TD), KIZASHI (FR), SWIFT IV (FZ, NZ), SX4 (EY, GY)

OE176

AUDI

A8

FORD

GALAXY

SEAT

ALHAMBRA, AROSA, CORDOBA, IBIZA III, LEON, TOLEDO II

SKODA

FABIA I, OCTAVIA I

TOYOTA

NADIA

VW

BORA, CADDY II, GOLF IV, JETTA III, LUPO, NEW BEETLE, PASSAT, PHAETON, POLO, SHARAN, TOUAREG, TOURAN, TRANSPORTER IV

OE177

SEAT

ALTEA, ALTEA XL, CORDOBA, IBIZA III, IBIZA IV, LEON, TOLEDO III, TOLEDO IV

SKODA

FABIA I, FABIA II, OCTAVIA II, RAPID, ROOMSTER, ROOMSTER PRAKTIK

VW

BEETLE, CADDY III, FOX, GOLF V, GOLF VI, GOLF PLUS, JETTA IV, NEW BEETLE, POLO

OE178

CITROËN

C1, C4, C4 GRAND PICASSO I, C4 I, C4 PICASSO I, C5 I, C5 II, C5 III, C8, EVASION, JUMPY, XSARA, XSARA PICASSO

FIAT

SCUDO, ULYSSE

LANCIA

PHEDRA, ZETA

PEUGEOT

206, 307, 308 SW, 406, 407, 607, 806, 807, EXPÉRT, EXPÉRT TÈPEE

OE186

FIAT

BRAVA, BRAVO I, MAREA, PUNTO

LANCIA

THEMA, Y

OE191

CHRYSLER

CROSSFIRE

...OE191

FORD ASIA / OCEANIA

FALCON

HOLDEN

APOLLO

HYUNDAI

COUPE, SONATA IV, TRAJET

KIA

CADENZA I, PRO CEE'D

MERCEDES-BENZ

C-CLASS (W202), C-CLASS (W203), C-CLASS COUPE (CL203), C-CLASS T-MODEL (S202), C-CLASS T-MODEL (S203), CLK (C208), CLK (C209), CLK CONVERTIBLE (A208), CLK CONVERTIBLE (A209), CLS (C219), E-CLASS (W210), E-CLASS (W211), E-CLASS T-MODEL (S210), E-CLASS T-MODEL (S211), G-CLASS (W463), G-CLASS /CABRIO (W463), G-CLASS CABRIO (W463), M-CLASS (W163), M-CLASS (W164), R-CLASS (W251, V251), S-CLASS (W220), S-CLASS COUPE (C215), SL (R129), SL (R230), SLK (R170), SLK (R171), VIANO (W639), VITO BUS (W639), VITO / MIXTO BOX (W639)

NISSAN

CEDRIC, CEFIRO I, CEFIRO II, GLORIA, MAXIMA / MAXIMA QX V, STAGEA

OPEL

FRONTERA B, MONTEREY A, MONTEREY B

PUCH

G-MODELL

SSANGYONG

KORANDO

SUZUKI

GRAND VITARA II (JT, TE, TD)

TOYOTA

ALTEZZA, ALTEZZA GITA, ARISTO, CHASER, CRESTA, CROWN, MARK II, PROBOX/SUCCEED, SOARER

VW

VENTO

OE192

HYUNDAI

SANTA FÉ I, SONATA II, SONATA III, SONATA IV

KIA

SORENTO I

TOYOTA

CENTURY

OE196

ALFA ROMEO

MITO

CHRYSLER

YPSILON

FIAT

500, 500 C, 500L, BRAVA, BRAVO I, BRAVO II, DOBLO, FIORINO, GRANDE PUNTO, IDEA, LINEA, PALIO, PANDA, PANDA VAN, PUNTO, PUNTO EVO, QUBO, SEICENTO / 600, SIENA, STILO, STRADA

FORD

KA

LANCIA

MUSA, YPSILON

OE197

HYUNDAI

I10, I20

KIA

PICANTO, RIO III

OE198

CHEVROLET

AVEO, CRUZE, NIVA, NUBIRA, ORLANDO, TRAX, VIVA

HOLDEN

ASTRA, BARINA, COMBO, TIGRA, TRAX, VIVA

OPEL

ADAM, AGILA (A), ASTRA G, ASTRA H, ASTRA J, COMBO, CORSA C, CORSA D, INSIGNIA A, MERIVA A, MERIVA B, MOKKA, MOKKA / MOKKA X, SIGNUM, TIGRA, VECTRA B, VECTRA C, ZAFIRA A, ZAFIRA B, ZAFIRA TOURER C

SUZUKI

WAGON R HATCHBACK

VAUXHALL

AGILA MK I (A), ASTRA MK IV (G), ASTRA MK V (H), ASTRA MK VI (J), ASTRAVAN MK V (H), COMBO MK II (C), COMBO TOUR MK II (C), CORSA MK II (C), CORSA MK III (D), CORSAVAN MK II (C), CORSAVAN MK III (D), INSIGNIA MK I (A), MERIVA MK I (A), MERIVA MK II (B), MOKKA / MOKKA X, SIGNUM, TIGRA, VECTRA (B), VECTRA MK II (C), ZAFIRA MK I (A), ZAFIRA MK II (B), ZAFIRA MK III

VW

GOLF IV

OE199

CHEVROLET

AVEO, SPARK

DAIHATSU

SIRION, TERIOS

OPEL

COMBO

PIAGGIO

PORTER

SUZUKI

ALTO (FF)

OE201

HYUNDAI

ACCENT IV, ELANTRA, I20, I30, IX20, VELOSTER

KIA

CARENS III, CEE'D, CERATO, CERATO II, CERATO KOUP, PRO CEE'D, RIO III, SOUL, VENGA

OE203

CITROËN

C3 II, C3 PICASSO, C4 II, DS3

PEUGEOT

207, 207 SW, 308, 308 SW

OE204

MINI

MINI, MINI CLUBMAN, MINI CLUBVAN, MINI COUNTRYMAN, MINI PACEMAN

OE205

BMW

1 (F20), 1 (F21), 3 (F30, F80), 3 TOURING (F31)

CITROËN

BERLINGO, C3 II, C3 PICASSO, C4, C4 GRAND PICASSO I, C4 GRAND PICASSO II, C4 I, C4 II, C4 PICASSO I, C4 PICASSO II, C5 III, DS3, DS4, DS5

MINI

MINI, MINI CLUBMAN, MINI COUNTRYMAN, MINI PACEMAN

PEUGEOT

207, 207 CC, 207 SW, 208, 308, 308 CC, 308 II, 308 SW, 308 SW II, 408, 508 I, 508 SW I, 2008, 3008, 5008, PARTNER, PARTNER TÈPEE, RCZ

OE206

FORD

FOCUS II, MONDEO IV, S-MAX

VOLVO

C30, C70 II, S40 II, S60 I, S80 I, S80 II, V50, V70 II, XC60, XC70 CROSS COUNTRY, XC70 II, XC90 I

OE207

NISSAN

ALTIMA, BLUEBIRD SYLPHY II, ELGRAND, LAFESTA, LIVINA / GRAND LIVINA, MICRA C+C III, MICRA III, NOTE, NV200, NV200 / EVALIA, PRIMERA, QASHQAI / QASHQAI +2 I, SERENA, TEANA II, TIIDA, X-TRAIL

RENAULT

CLIO III, FLUENCE, GRAND SCÉNIC III, KOLEOS I, LAGUNA, LAGUNA III, LATITUDE, MEGANE CC, MEGANE III, SCÉNIC III

OE208

ABARTH

500 / 595 / 695, 500C / 595C / 695C, GRANDE PUNTO, PUNTO

ALFA ROMEO

GIULIETTA, MITO

CHRYSLER

DELTA

FIAT

500X, BRAVO II, DOBLO, GRANDE PUNTO, LINEA, PUNTO, PUNTO EVO

JEEP

RENEGADE

LANCIA

DELTA III

OE209

AUDI

A4, A5, A6, A6 ALLROAD, A8, Q7, R8

VW

TOUAREG

OE210

PORSCHE

911 /CONVERTIBLE (991), 911 /CONVERTIBLE (997), CAYENNE (9PA), CAYENNE (92A), PANAMERA (970)

OE211

SMART

CABRIO, CITY-COUPE, FORTWO, ROADSTER



OE212

SMART
FORTWO

OE213

AUDI
A1, A3
SEAT
ALTEA, ALTEA XL, IBIZA IV, LEON, TOLEDO III, TOLEDO IV

SKODA
OCTAVIA II, RAPID, SUPERB II, YETI
VW

EOS, GOLF V, GOLF VI, GOLF PLUS, JETTA IV, PASSAT, SCIROCCO, TIGUAN

OE214

AUDI
A1, A3, A4, A4 ALLROAD, A5, A6, A6 ALLROAD, A7, A8, Q3, Q5, Q7, R8, TT

SEAT
ALHAMBRA, ALTEA, ALTEA XL, EXEO, LEON, TOLEDO III

SKODA
OCTAVIA II, SUPERB II, YETI

VW
AMAROK, BEETLE, CC, EOS, GOLF V, GOLF VI, JETTA III, JETTA IV, MULTIVAN V, PASSAT, PASSAT ALLTRACK, PASSAT CC, POLO, SCIROCCO, SHARAN, TIGUAN, TOUAREG, TRANSPORTER V

OE215

AUDI
A3, TT
PORSCHE
CAYENNE (9PA)

VW
EOS, GOLF IV, GOLF V, MULTIVAN V, PHAETON, TOUAREG, TRANSPORTER V

OE216

BMW
3 (E36), 3 (E90), 3 /COMPACT /CONVERTIBLE /COUPE /TOURING (E36), 3 /COMPACT /COUPE (E36), 3 /COMPACT /COUPE /TOURING (E36), 3 CONVERTIBLE (E36), 3 CONVERTIBLE (E93), 3 /CONVERTIBLE /COUPE (E36), 3 /CONVERTIBLE /TOURING (E36), 3 COUPE (E36), 3 COUPE (E92), 3 TOURING (E91), 5 (E34), 5 (E39), 5 (E60), 5 /TOURING (E34), 5 TOURING (E34), 5 /TOURING (E39), 5 TOURING (E39), 5 TOURING (E61), 6 (E63), 6 CONVERTIBLE (E64), 7 (E38), 7 (E65, E66, E67), 8 (E31), X1 (E84), X3 (E83), X5 (E53), X5 (E70), Z3 ROADSTER (E36), Z4 ROADSTER (E85)

CITROËN
XSARA
DACIA
LODGY, LOGAN, LOGAN MCV, SANDERO, SOLENZA
DAIHATSU
TERIOS
FIAT
BARCETTA, BRAVA, BRAVO I, COUPE, MAREA, PALIO, STILO

...OE216

FORD USA
PROBE II
HONDA
ACCORD IV, ACCORD V, ACCORD VI, ACCORD VII, CIVIC V, CIVIC VI, CIVIC VII, CIVIC VIII, CR-V I, CR-V II, FR-V, HR-V, INTEGRA, LOGO, PRELUDE IV, PRELUDE V, SHUTTLE, STEPWGN, STREAM

JEEP
CHEROKEE, COMMANDER, GRAND CHEROKEE III

KIA
CARNIVAL I, CARNIVAL II

LANCIA
DEDRA, DELTA II, KAPPA, LYBRA

LOTUS
ESPRIT S4
MAZDA

323 F VI (BJ), 323 S VI (BJ), 626 III STATION WAGON (GV), 626 IV HATCHBACK (GE), B-SERIE (UN), MPV I (LV), MPV II (LW), MX-6 (GE), PREMACY (CP), XEDOS 9 (TA)

MINI
CARISMA, DION, GALANT VI, LANCER VI, LANCER VII, PAJERO II, PAJERO PININ, PAJERO SPORT I, SPACE STAR

OPEL
ASTRA J, CALIBRA A, CORSA D, INSIGNIA A, VECTRA A

PORSCHE
911 (964), 911 (993), 911 /CONVERTIBLE (996), BOXSTER (986)

RENAULT
CLIO II, KANGOO, KANGOO / GRAND KANGOO, LOGAN EXPRESS, LOGAN I, SANDERO /STEPWAY I, SCÉNIC I, SPORT SPIDER, THALIA I, TWINGO I

ROVER
600
VAUXHALL
ASTRA MK VI (J), CALIBRA, CAVALIER MK III, CORSA MK III (D), INSIGNIA MK I (A)

VOLVO
S40 I, V40

OE217

SMART
CABRIO, CITY-COUPE, CROSSBLADE, FORTWO

OE218

AUDI
A6, A8
CITROËN
C15, SAXO, XANTIA

LEXUS
LS

LOTUS
ELISE

PORSCHE
911 /CONVERTIBLE (996), BOXSTER (986), CAYENNE (9PA)

RENAULT
LAGUNA I, SAFRANE II

...OE218

TOYOTA
AVENSIS, CARINA E, CELICA, HIACE IV, HILUX, HILUX VI, LAND CRUISER, MR 2 II

OE219

AUDI
A3, Q3, TT

OE220

AUDI
A6, A7, A8

OE222

PORSCHE
911 (997), 911 /CONVERTIBLE (997), CAYENNE (9PA)

OE223

ALFA ROMEO
145, 146, 147, 155, 156, 166, GT, GTV, SPIDER

ALPINA
B3, B10, B12, ROADSTER V8, ROADSTER S

AUDI
A6, A8

BMW
3 COMPACT (E36), 3 /COMPACT (E46), 3 /COMPACT /CONVERTIBLE /COUPE /TOURING (E46), 3 /COMPACT /TOURING (E46), 3 CONVERTIBLE (E46), 3 /CONVERTIBLE /COUPE /TOURING (E46), 3 /COUPE /TOURING (E46), 5 (E39), 5 (E60), 5 /TOURING (E39), 5 TOURING (E39), 5 TOURING (E61), 6 (E63), 6 CONVERTIBLE (E64), 7 (E38), 7 (E65, E66, E67), 8 (E31), X3 (E83), X5 (E53), Z3 COUPE (E36), Z3 ROADSTER (E36), Z4 ROADSTER (E85), Z8 ROADSTER (E52)

LAND ROVER
RANGE ROVER III

MINI
MINI

MORGAN
AERO 8

ROLLS-ROYCE
PARK WARD, PHANTOM VII, SILVER SERAPH

SAAB
900 II

OE224

CITROËN
BERLINGO, BERLINGO / BERLINGO FIRST, C2, C3, C3 I, C4, C4 I, XSARA, XSARA PICASSO

FORD
FOCUS II, MONDEO IV, S-MAX

MERCEDES-BENZ
C-CLASS (W203), C-CLASS COUPE (CL203), C-CLASS T-MODEL (S203), CLC-CLASS (CL203), CLK (C209), CLK CONVERTIBLE (A209), E-CLASS (W211), E-CLASS T-MODEL (S211), G-CLASS (W463), S-CLASS (W220), S-CLASS COUPE (C215), SL (R230), SLK (R171), SLR (R199), SLR ROADSTER (R199)

MERCEDES-BENZ (BBDC)
E-CLASS

...OE224

NISSAN
ALMERA II, ALMERA TINO, AVENIR, PRIMERA, X-TRAIL

PEUGEOT
206, 207, 307, 1007, PARTNER

SUBARU
IMPREZA, LEGACY IV, LEGACY V

VOLVO
C30, C70 II, S40 II, S60 I, S80 I, S80 II, V50, V70 II, XC60, XC70 II, XC90 I

OE225

RENAULT
CLIO, CLIO III, CLIO IV, GRAND SCÉNIC III, MEGANE CC, MEGANE III, MODUS / GRAND MODUS, SCÉNIC III, TWINGO II, WIND

OE226

NISSAN
PIXO

OPEL
AGILA (B)

SUZUKI
ALTO (GF), SPLASH (EX), SWIFT IV (FZ, NZ)

VAUXHALL
AGILA MK II (B)

OE227

BMW
X5 (E70)

MINI
CARISMA, DION, GALANT VI, LANCER VI, LANCER VII, PAJERO II, PAJERO PININ, PAJERO SPORT I, SPACE STAR

VOLVO
S40 I, V40

OE228

MERCEDES-BENZ
S-CLASS (W140), S-CLASS COUPE (C140), SL (R129)

OE229

MERCEDES-BENZ
C-CLASS (W203), C-CLASS (W204), C-CLASS COUPE (C204), C-CLASS COUPE (CL203), C-CLASS T-MODEL (S203), C-CLASS T-MODEL (S204), CLC-CLASS (CL203), CLK (C209), CLK CONVERTIBLE (A209), CLS (C219), E-CLASS (W211), E-CLASS (W212), E-CLASS CONVERTIBLE (A207), E-CLASS COUPE (C207), E-CLASS T-MODEL (S211), E-CLASS T-MODEL (S212), G-CLASS (W463), G-CLASS CABRIO (W463), GL-CLASS (X164), GLK-CLASS (X204), M-CLASS (W164), R-CLASS (W251, V251), S-CLASS (W221), S-CLASS COUPE (C216), SL (R230), SLK (R171), SLK (R172), SPRINTER 3,5-T BOX (906), SPRINTER 3,5-T BOX /BUS /PLATFORM /CHASSIS (906), SPRINTER 3,5-T BUS /PLATFORM /CHASSIS (906), SPRINTER 3-T BOX (906), SPRINTER 3-T BOX /BUS /PLATFORM /CHASSIS (906), SPRINTER 3-T BUS (906), SPRINTER 3-T PLATFORM /CHASSIS (906), SPRINTER 4,6-T BOX /PLATFORM /CHASSIS (906), SPRINTER 5-T BOX /PLATFORM /CHASSIS (906), SPRINTER 5-T PLATFORM /CHASSIS (906), VIANO (W639), VITO BUS (W639), VITO / MIXTO BOX (W639)

**...OE229****MERCEDES-BENZ (BBDC)**

E-CLASS

MITSUBISHI

I, OUTLANDER II, PAJERO SPORT II

OE230**CHEVROLET**

AVEO, MATIZ, SPARK

FIAT

500, 500 C, 500L, BRAVA, BRAVO I, BRAVO II, DOBLO, IDEA, PALIO, PANDA, PUNTO, SIENA, STILO, STRADA

FORD

KA

LANCIA

MUSA

NISSAN

PIXO

OPEL

AGILA (B)

SUZUKI

ALTO (GF), SPLASH (EX), SWIFT IV (FZ, NZ)

OE232**ALFA ROMEO**

MITO

CHRYSLER

YPSILON

FIAT

500, 500 C, 500L, PANDA, PANDA VAN, PUNTO

LANCIA

YPSILON

OE233**MERCEDES-BENZ**

C-CLASS (W204), C-CLASS COUPE (C204), C-CLASS T-MODEL (S204), CLK (C209), CLK CONVERTIBLE (A209), CLS (C219), E-CLASS (W211), E-CLASS (W212), E-CLASS T-MODEL (S211), E-CLASS T-MODEL (S212), M-CLASS (W164), R-CLASS (W251, V251), S-CLASS (W221), S-CLASS COUPE (C216), SL (R230)

NISSAN

PATROL III

OE234**AUDI**

A3, A4

SEAT

ALTEA, ALTEA XL, LEON, TOLEDO III

SKODA

OCTAVIA II

VW

EOS, GOLF V, GOLF PLUS, JETTA III, PASSAT, TOURAN

OE235**SEAT**

CORDOBA, IBIZA III

VW

FOX, GOLF IV, GOL III, GOL IV, POLO, VOYAGE

OE236**VOLVO**

C30, C70 II, S40 II, V50

OE237**AUDI**

A4, A6, A8

SKODA

SUPERB I

VW

PASSAT

OE238**BMW**

1 (E81), 1 (E87), 1 CONVERTIBLE (E88), 1 COUPE (E82), 3 (E90), 3 CONVERTIBLE (E93), 3 COUPE (E92), 3 TOURING (E91), 5 (E60), 5 (F10), 5 TOURING (E61), 6 (E63), 6 CONVERTIBLE (E64), 7 (E65, E66), 7 (E65, E66, E67), 7 (F01, F02, F03, F04), X1 (E84), X3 (E83), X3 (F25), X5 (E70), Z4 COUPE (E86), Z4 ROADSTER (E85), Z4 ROADSTER (E89)

HOLDEN

INSIGNIA

MITSUBISHI

COLT VI

OPEL

INSIGNIA A, SIGNUM, VECTRA C

SAAB

9-3, 9-4X, 9-5

SMART

FORFOUR

VAUXHALL

INSIGNIA MK I (A), VECTRA MK II (C)

WIESMANN

MF3

OE239**HONDA**

ACCORD VII, ACCORD VIII, CIVIC VIII, CIVIC IX, CR-V III, CR-V IV, CR-Z, ELYSION, FR-V, JAZZ III, LAGREAT, LEGEND IV, ODYSSEY, RIDGELINE

OE242**BMW**

1 (F20), 1 (F21), 1 CONVERTIBLE (E88), 1 COUPE (E82), 2 CONVERTIBLE (F23), 2 COUPE (F22, F87), 3 (E90), 3 (F30, F80), 3 CONVERTIBLE (E93), 3 COUPE (E92), 3 GRAN TURISMO (F34), 3 TOURING (E91), 3 TOURING (F31), 4 CONVERTIBLE (F33, F83), 4 COUPE (F32, F82), 4 GRAN COUPE (F36), 5 (F10), 5 GRAN TURISMO (F07), 5 TOURING (F11), 6 CONVERTIBLE (F12), 6 COUPE (F13), 6 GRAN COUPE (F06), 7 (F01, F02, F03, F04), X3 (F25), X5 (E70), X5 (F15, F85), X6 (E71, E72), X6 (F16, F86)

ROLLS-ROYCE

GHOST, WRAITH

OE243**BMW**

1 (F20), 1 (F21), 2 CONVERTIBLE (F23), 2 COUPE (F22, F87), 3 (F30, F80), 3 TOURING (F31), 4 CONVERTIBLE (F33, F83), 4 COUPE (F32, F82), 4 GRAN COUPE (F36), 5 (F10), 5 GRAN TURISMO (F07), 5 TOURING (F11), 6 CONVERTIBLE (F12), 6 COUPE (F13), 6 GRAN COUPE (F06), 7 (F01, F02, F03, F04), X1 (E84), X3 (F25), X4 (F26), X5 (F15, F85), X6 (F16, F86), Z4 ROADSTER (E89)

OE244**AUDI**

A1, A3, Q2, Q3

AUDI (FAW)

A3, Q3

SEAT

ALHAMBRA, ATECA, IBIZA IV, LEON, LEON ST, MII, TOLEDO IV

SKODA

CITIGO, FABIA III, OCTAVIA III, RAPID, SUPERB III, YETI

VW

BEETLE, CADDY ALLTRACK, CADDY IV, CC, GOLF VI, GOLF VII, GOLF SPORTSVAN, JETTA IV, PASSAT, PASSAT ALLTRACK, POLO, POLO VAN, SCIROCCO, SHARAN, TIGUAN, TIGUAN ALLSPACE, TOURAN, UP

VW (FAW)

GOLF SPORTSVAN

OE247**SEAT**

IBIZA IV, IBIZA V, MII

SKODA

CITIGO, FABIA III, OCTAVIA III, YETI

VW

GOLF VII, GOLF SPORTSVAN, LOAD UP, POLO, POLO VAN, UP

OE254**IVECO**

DAILY CITYS, DAILY III, DAILY IV, DAILY VI, DAILY LINE

OE255**CHEVROLET**

VECTRA

FIAT

CROMA

OPEL

ASTRA G, SPEEDSTER, VECTRA B, VECTRA C, ZAFIRA A

VAUXHALL

ASTRA MK IV (G), SPEEDSTER, VECTRA (B), VECTRA MK II (C), VX220, ZAFIRA MK I (A)

OE257**PORSCHE**

911 /CONVERTIBLE /TARGA (996), 911 /CONVERTIBLE /TARGA (997), BOXSTER (987), BOXSTER SPYDER (987), CAYENNE (9PA), CAYMAN (987)

OE262**PORSCHE**

BOXSTER (987), CAYMAN (987)

RV15YC4**AC**

ACE, ACECA, COBRA MK IV

CHEVROLET

ASTRO, BLAZER, BLAZER S10, C1500, C2500, CAMARO, CAPRICE, G20, S10, S10 PICK UP, SUBURBAN, TAHOE

PONTIAC

FIREBIRD, TRANS SPORT



eon TITAN



CET1

ABARTH
500 / 595 / 695, 500C / 595C / 695C

ALFA ROMEO
MITO

BMW
3 / CONVERTIBLE (E30), 5 (E28), 5 (E34), 5 / TOURING (E34), 6 (E24), M1 (E26)

CHEVROLET
AVEO, SPARK

CHRYSLER
YPSILON

DAIHATSU
SIRION, TERIOS

FERRARI
328 GTB, 328 GTS, 512 TR, MONDIAL, TESTAROSSA

FIAT
500, 500 C, BRAVA, BRAVO I, BRAVO II, DOBLO, FIORINO, GRANDE PUNTO, IDEA, LINEA, MAREA, PALIO, PANDA, PANDA VAN, PUNTO, PUNTO EVO, QUBO, SEICENTO / 600, SIENA, STILO, STRADA

FORD
KA

LANCIA
MUSA, THEMA, Y, YPSILON

SUZUKI
ALTO (FF), CAPPUCINO (EE), WAGON R+ (MM), WAGON R+ HATCHBACK (EM)

TVR
CERBERA, TUSCAN II

CET2

ACURA
RL, SLX

AIXAM
500, A.751, CROSSLINE, SCOUTY

ALFA ROMEO
33, 75, 145, 146, 147, 156, 159, 164, GT, GTV, SPIDER

ALPINA
B3, B8, B10, B12

ALPINE
A610

ASTON MARTIN
DB7, VIRAGE

AUDI
80, 90, 100, A2, A3, A4, A6, A8, CABRIOLET, COUPE

AUSTIN
MAESTRO, MONTEGO

AUTOBIANCHI
Y10

BAOLONG
PEGASUS

BENTLEY
ARNAGE

BERTONE
FREECLIMBER 2

BITTER
TYPE 3

...CET2

BMW
3 (E30), 3 (E36), 3 / COMPACT / CONVERTIBLE / COUPE / TOURING (E36), 3 / COMPACT / COUPE (E36), 3 / COMPACT / COUPE / TOURING (E36), 3 CONVERTIBLE (E30), 3 CONVERTIBLE (E36), 3 CONVERTIBLE (E93), 3 / CONVERTIBLE / COUPE (E36), 3 / CONVERTIBLE / TOURING (E30), 3 / CONVERTIBLE / TOURING (E36), 3 COUPE (E36), 3 TOURING (E30), 5 (E28), 5 (E34), 5 (E39), 5 / TOURING (E34), 5 TOURING (E34), 7 (E32), 7 (E38), 7 (E65, E66, E67), 8 (E31), Z3 ROADSTER (E36)

BYD
F3

CADILLAC
BLS

CATERHAM
21, SEVEN, SUPER SEVEN

CHENGLONG
FUTURE

CHERY
A1, A3, A5, COWIN, COWIN 2, COWIN 3, COWIN 5, E5, EASTAR CROSS, FULWIN, QQ3, QQ6, TIGGO, TIGGO 3, TIGGO DR, V5, X1

CHEVROLET
ASTRA, AVEO, AVEO / KALOS, BERETTA, CAPTIVA, CRUZE, EPICA, EVANDA, KALOS, LACETTI, LUMINA APV, MALIBU, NIVA, NUBIRA, OPTRA, ORLANDO, REZZO, TRAX, VECTRA, VIVA, VIVANT, ZAFIRA

CHRYSLER
CIRRUS, NEON, NEON II, PT CRUISER, SEBRING, STRATUS, VOYAGER / GRAND VOYAGER III

CITROËN
AX, BERLINGO, BERLINGO / BERLINGO FIRST, BX, C2, C3, C3 I, C3 II, C15, EVASION, JUMPER, JUMPY, NEMO, SAXO, VISA, XANTIA, XM, XSARA, XSARA PICASSO, ZX

DACIA
DOKKER, DOKKER EXPRESS, DUSTER, LODGY, LOGAN, LOGAN MCV, SANDERO, SOLENZA, SUPERNOVA

DADI
CITY COURSER, ELEGANTEST

DAEWOO
BROUGHAM, ESPERO, EVANDA, GENRA, KALOS, KORANDO, LACETTI, LANOS, LEGANZA, MAGNUS, MUSSO, NEXIA, NUBIRA, PRINCE, REXTON, REZZO, WINSTORM

DAIHATSU
ALTIS, APPLAUSE I, APPLAUSE II, CHARADE III, CHARADE IV, COO, CUORE V, CUORE VI, HIJET, MATERIA, MOVE, SIRION, TERIOS, TREVIS, YRV

DAIMLER
DAIMLER, DAIMLER XJ, XJ 40, 81

DE TOMASO
GUARA

...CET2

DODGE
AVENGER, CALIBER, CARAVAN, DAKOTA, DART, DURANGO, JOURNEY, NEON, NEON II, NITRO, RAM, RAM 1500, RAM 2500, RAMCHARGER, STRATUS

EMGRAND
EC7, EC7-RV

EMGRAND (GEELY)
EC 7, EC 7 RV

EUNOS
500

FIAT
BARCETTA, BRAVA, BRAVO I, CINQUECENTO, COUPE, CROMA, DOBLO, DUCATO, FIORINO, FREEMONT, IDEA, LINEA, MAREA, MULTIPLA, PALIO, PANDA, PUNTO, QUBO, SCUDO, SEDICI, SEICENTO / 600, SIENA, STILO, STRADA, TEMPRA, TIPO, ULYSSE, UNO

FORD
ESCORT '81, ESCORT '86, ESCORT '91, ESCORT '95, ESCORT III, ESCORT IV, ESCORT V, ESCORT VI, ESCORT VII, FIESTA I, FIESTA II, FIESTA III, MAVERICK, ORION I, ORION II, ORION III, RANGER, SCORPIO I, SIERRA, TRANSIT, TRANSIT TOURNEO

FORD ASIA / OCEANIA
LASER, LASER / LASER LIDEA

FORD ASIA / OZANIA
FESTIVA, FREDIA, LIATA, TELSTAR, TIERRA

FORD AUSTRALIA
COURIER, TELSTAR

FORD USA
PROBE I, PROBE II

FSO
LANOS, POLONEZ III

GEELY
BL, CK, GC2, HISOON, HQ, MARINDO, MEIRI, MK, MR, PU, SL, URBAN NANNY, VISION

GEORG
TRACKER

GREAT WALL
FENGJUN 5, HOVER H3

HOLDEN
ASTRA, BARINA, CAPTIVA, COMBO, TIGRA, TRAX, VIVA

HONDA
ACCORD III, ACCORD IV, ACCORD V, ACCORD VI, ACCORD VII, CAPA, CITY, CIVIC I, CIVIC II, CIVIC IV, CIVIC V, CIVIC VI, CIVIC VII, CONCERTO, CR-V I, CR-V II, CR-V III, CRX II, CRX III, DOMANI, FR-V, HR-V, JAZZ, JAZZ II, LEGEND I, LEGEND III, LOGO, PRELUDE III, PRELUDE IV, PRELUDE V, SHUTTLE, SMX, STEPWGN, STREAM

HYUNDAI
ACCENT, ACCENT I, ACCENT II, ACCENT III, ATOS, ATOS PRIME, COUPE, ELANTRA, GALLOPER I, GETZ, I10, I20, I30, LANTRA II, MATRIX, S COUPE, SONATA V, STELLAR, TIBURON, TRAJET

INFINITI
I30, QX4

...CET2

IRMSCHER
SENATOR

ISUZU
GEMINI, TROOPER II, VEHICROSS, WIZARD

JAGUAR
XJ, XJSC

JEEP
CHEROKEE, COMMANDER, COMPASS, GRAND CHEROKEE I, GRAND CHEROKEE II, GRAND CHEROKEE III, PATRIOT

KIA
CARENS I, CARENS II, CARENS III, CEE'D, CERATO, CLARUS, PICANTO, PRIDE, PRO CEE'D, RETONA, RIO, RIO II, SEPHIA, SHUMA, SHUMA II, SPORTAGE

LADA
110, 111, 112, GRANTA, GRANTA (2349), KALINA, LARGUS, OKA, PRIORA

LANCIA
DEDRA, DELTA II, FLAVIA, KAPPA, LYBRA, THESIS, Y, Y10, ZETA

LAND ROVER
DEFENDER, DISCOVERY I

LANDWIND (JMC)
LANDWIND

LEXUS
GS

LIFAN
320, 520, 620, X60

LIGIER
AMBRA, BE UP, NOVA

LOTUS
ELAN, ELISE, ESPRIT S4, EUROPA S, EXIGE

MAZDA
2 (DY), 121 I (DA), 121 II (DB), 121 III (JASM, JBSM), 323 C IV (BG), 323 C V (BA), 323 F IV (BG), 323 F V (BA), 323 F VI (BJ), 323 III / HATCHBACK (BF), 323 III HATCHBACK (BF), 323 III STATION WAGON (BW), 323 P V (BA), 323 S IV (BG), 323 S V (BA), 323 S VI (BJ), 626 III (GD), 626 III / COUPE / HATCHBACK (GD), 626 III STATION WAGON (GV), 626 IV (GE), 626 IV / HATCHBACK (GE), 626 IV HATCHBACK (GE), 626 V (GF), 626 V / HATCHBACK (GF), 626 V HATCHBACK (GF), 626 V STATION WAGON (GW), 929 III (HC), B-SERIE (UF), B-SERIE (UN), DEMIO (DW), E-SERIE BOX (SR2), E-SERIE MPV (SG), MPV I (LV), MPV II (LW), MX-3 (EC), MX-5 I (NA), MX-5 II (NB), MX-6 (GE), PREMACY (CP), XEDOS 6 (CA), XEDOS 9 (TA)

MEGA
CLUB, CLUB II, MONTE CARLO, TRACK



**CET5**

CITROËN
BERLINGO, BERLINGO / BERLINGO FIRST, C1, C2, C3, C3 I, C4, C4 GRAND PICASSO I, C4 I, C4 PICASSO I, C5 I, C5 II, C5 III, C8, C-ELYSEE, EVASION, JUMPY, SAXO, XSARA, XSARA PICASSO

FIAT
SCUDO, ULYSSE

HYUNDAI
IX35, SANTA FÉ II, SONATA V, SONATA VI

KIA
CERATO II, CERATO KOUP, MAGENTIS, SORENTO II, SPORTAGE

LANCIA
PHEDRA, ZETA

MITSUBISHI
COLT CZC, COLT VI, COLT PLUS VII, LANCER VIII

NISSAN
ALMERA CLASSIC, ALMERA II, ALMERA TINO, ALTIMA, AVENIR, BASSARA, CUBE, PATHFINDER II, PATHFINDER III, PRIMERA, SENTRA V, TEANA I, X-TRAIL

PEUGEOT
107, 206, 207, 301, 307, 308, 308 SW, 406, 407, 607, 806, 807, 1007, EXPERT, EXPERT TĒPEE, PARTNER, PARTNER TĒPEE

SMART
FORFOUR

SUBARU
IMPREZA, LEGACY IV, OUTBACK, TRIBECA

TOYOTA
AYGO, DYNA, FJ CRUISER, FORTUNER, HIACE / COMMUTER V, HIACE V, HILUX III, HILUX VII, INNOVA I, IQ, LAND CRUISER, LAND CRUISER 150, LAND CRUISER PRADO, PASSO, TUNDRA, VIOS/YARIS, YARIS

VOLVO
C70 II, S40 II, S80 II, V50

CET6

HYUNDAI
ACCENT IV, ELANTRA, I10, I20, I30, IX20

KIA
CARENS III, CEE'D, CERATO, CERATO II, CERATO KOUP, PICANTO, PRO CEE'D, RIO III, SOUL, VENGA

CET7

CHEVROLET
ALERO, COBALT, HHR

FORD
B-MAX, C-MAX, C-MAX II, FIESTA III, FIESTA IV, FIESTA V, FIESTA VI, FOCUS, FOCUS C-MAX, FOCUS II, FOCUS III, FUSION, GRAND C-MAX, KA, MONDĒO IV, PUMA, STREET KA

MAZDA
2 (DY)

VOLVO
C30, S40 II, V50

CET8

ABARTH
RITMO

...CET8

AC
ME

ACURA
INTEGRA

ALFA ROMEO
6, 33, 75, 90, 145, 146, 155, 164, 166, 1750-2000, A11 / A12, ALFASUD, ALFETTA, ALFETTA GT, ARNA, F11 / F12, GIULIA, GIULIETTA, GT, GTA, GTV, MONTREAL, ROMEO 2, RZ, SPIDER, SZ

ALPINA
B3, B6, B7, B9, B10, B11, C1, C2

ALPINE
A310, BERLINETTE

ARO
10, SPARTANA

ASIA MOTORS
ROCSTA, TOWNER

ASTON MARTIN
DB6, DBS, LAGONDA I, V8, ZAGATO

AUDI
50, 60, 75, 80, 90, 100, 200, A6, CABRIOLET, COUPE, QUATTRO, SUPER 90

AUSTIN
1000-SERIES MK II, ALLEGRO, APACHE, MAESTRO, MAXI, MAXI II, METRO, MINI, MONTEGO, PRINCESS, PRINCESS 2

AUSTIN-HEALEY
3000 MK.III, SPRITE MK.III, SPRITE MK.IV

AUTOBIANCHI
A 111, A 112, Y10

BEDFORD
ASTRAMAX, ASTRA VAN, MIDI, RASCAL

BENTLEY
AZURE, CONTINENTAL, CONTINENTAL FLYING SPUR

BMW
02 /CONVERTIBLE (E10), 02 TOURING (E6), 3 (E21), 3 (E30), 3 /CONVERTIBLE /TOURING (E30), 5 (E12), 5 (E28), 5 (E34), 6 (E24), 7 (E23), 7 (E32), 1500-2000 (115, 116, 118, 121), 1600 GT COUPE, 2000-3.2 COUPE (E9), 2500-3.3 (E3), Z1 ROADSTER

BOND
EQUIPE, EQUIPE MK. II

BRISTOL
411

CATERHAM
SEVEN

CHEVROLET
AVEO, AVEO / KALOS, CORSA, KALOS, LANOS, MATIZ, NIVA, REZZO, SPARK

CHRYSLER
DAYTONA, LE BARON, SARATOGA, VOYAGER / GRAND VOYAGER III, VOYAGER I, VOYAGER II

CITROËN
2 CV, AMI, C25, GS, SM

DADI
CITY COURSER

...CET8

DAEWOO
ARANOS, CIELO, ESPERO, KALOS, LANOS, LEGANZA, LEMANS, MATIZ, NEXIA, NUBIRA, PRINCE, REZZO, ROYALE, SUPER SALOON, TICO

DAIHATSU
55 WIDE, 1000, CHARADE I, CHARADE II, CHARADE III, CHARADE IV, CHARMANT, CUORE I, CUORE II, CUORE III, CUORE IV, DELTA WIDE, HIJET, MOVE, ROCKY HARD TOP, ROCKY SOFT TOP, RUGGER, SKYWING, SPARCAR, TAFT

DAIMLER
2.8 - 5.3, COUPE, LANDAULETTE, LIMOUSINE

DODGE
CARAVAN

FERRARI
208/308, 365 GT 2+2, 365 GTB/4

DAYTONA, 365 GTS/4 DAYTONA, 400 I, 412 I, 512 BB, DINO GT, DINO GT4, DINO GTS, MONDIAL

FIAT
124, 125, 126, 127, 128, 130, 131, 132, 147, 238-SERIE, 241-SERIE, 242-SERIE, 850, 900T/E PANORAMA, 900T/E PULMINO, 1500, 1500-2300, ARGENTA, CAMPAGNOLA, CINQUECENTO, COUPE, CROMA, DINO, DUCATO, DUNA, ELBA, FIORINO, FIORINO PICK UP, PALIO, PANDA, PENNY, PREMIO, REGATA, RITMO, SEICENTO / 600, TALENTO, TEMPRA, TIPO, UNO, X 1/9

FORD
CAPRI, CAPRI II, CAPRI III, CONSUL, CORSAIR, CORTINA, ECONOVAN, ESCORT I, ESCORT II, FIESTA I, GRANADA, SCORPIO I, SIERRA, TAUNUS, TAUNUS 12M, TAUNUS 15M, TAUNUS 17M, TAUNUS 20M, TAUNUS 20M XL, TAUNUS 26M XL, TAUNUS '80, TRANSIT, ZEPHYR III, ZEPHYR IV, ZODIAC, ZODIAC

FORD AUSTRALIA
COURIER

FORD OTOSAN
ANADOL

FOTON
ALPHA, SEA LION, SUP, SURF, SURFING, VIEW

FSO
125P, 126P, 127P, 132P, LANOS, POLONEZ I, POLONEZ II, POLONEZ III

GAZ
GAZELLE, VOLGA

GEELY
HAOQING, HQ, MR, PU, URBAN NANNY

GEO
METRO, STORM, TRACKER

GINETTA
G15, G21, G34

GLAS
04, 1700, GT, V 8

GOLDEN DRAGON
XML

...CET8

GREAT WALL
DEER, PEGASUS, SAILING, STEED

HOLDEN
SCURRY

HONDA
ACCORD I, ACCORD II, ACCORD III, ACTY, CIVIC I, CIVIC II, CIVIC III, CIVIC IV, CRX I, INTEGRA, JAZZ I, PRELUDE I, PRELUDE II, PRELUDE III, QUINTET

HYUNDAI
H-1, H-1 / STAREX, H100, LANTRA I, PONY, PONY / EXCEL, PORTER, SANTA FÉ I, SANTAMO, S COUPE, SONATA II, SONATA III, SONATA IV, STELLAR

INNOCENTI
ELBA, KORAL, MINI, REGENT

ISUZU
ASKA I, ASKA III, CAMPO, GEMINI, MIDI, PIAZZA, PICKUP, TROOPER I

JAGUAR
E-TYPE, E-TYPE 2+2, MK I, MK II, MK VII, MK VIII, MK IX, MK X, S-TYPE, XJ

JEEP
CJ5 - CJ8

JENSEN
GT, HEALEY

KIA
AVELLA, CARNIVAL II, JOICE, MAGENTIS, PRIDE, PRIDE VAN, RIO, ROADSTER, SEPHIA, SHUMA, SORENTO I

LADA
110, 111, 112, 1200-1500, 1200-1600, KALINA, LARGUS, NADESCHDA, NIVA, NIVA II, NOVA, PRIORA, SAMARA, TOSCANA

LANCIA
A 112, BETA, BETAH.P.E., BETA MONTE CARLO, DEDRA, DELTA I, DELTA II, FLAMINIA, FLAVIA, FULVIA, GAMMA, KAPPA, PRISMA, THEMA, TREVI, Y10

LAND ROVER
88/109, 90, 110/127, DEFENDER, DISCOVERY I, RANGE ROVER I, RANGE ROVER II

LDV
SHERPA

LOTUS
ECLAT, ELITE, ESPRIT S2, ESPRIT S3, ESPRIT S4, EUROPA, EXCEL

MARCOS
2-3 LITRE, 1600

MARUTI
800

MASERATI
228, 420/430, BITURBO, BORA, GHIBLI, INDY, KARIF, KHAM SIN, KYALAMI, MERAK, MEXICO, QUATTROPORTE I, QUATTROPORTE III, QUATTROPORTE IV

**...CET9**

OPEL
ASCONA B, MANTA B
PANOZ
ROADSTER
PEUGEOT
104, 204, 205 I, 205 II, 304, 305 I, 305 II, 309 I, 504, 505, 604
PROTON
GEN 2
PUCH
G-MODELL
RENAULT
5, 14, 18, 20, 21, 25, 30, ESPACE I, ESPACE II, FUEGO, MASTER I, SAFRANE I, TRAFIC
ROVER
75, 2000-3500
TALBOT
SAMBA, SIMCA SIM'4, TAGORA
TRIUMPH
DOLOMITE
TVR
S
VOLVO
240, 260, 760, 780, 960

CET10P

BMW
3 /CONVERTIBLE /COUPE (E36), 3 CONVERTIBLE /COUPE (E46), Z3 COUPE (E36), Z3 ROADSTER (E36), Z4 COUPE (E86), Z4 ROADSTER (E85)
DAIHATSU
MATERIA, TERIOS
NISSAN
PIXO
OPEL
AGILA (B)
SUZUKI
ALTO (GF), SPLASH (EX), SWIFT IV (FZ, NZ)
TOYOTA
AVANZA, BB II, PASSO SETTE, RUSH
VAUXHALL
AGILA MK II (B)
WIESMANN
MF3

CET11P

AUDI
80, 100, 200, A1, A3, A4, A4 ALLROAD, A5, A6, A6 ALLROAD, A7, A8, COUPE, Q3, Q5, Q7, QUATTRO, R8, TT
LANCIA
THESIS
PORSCHE
911 (997), 911 /CONVERTIBLE (997), CAYENNE (9PA)
RENAULT
CLIO III, MEGANE II
SEAT
ALHAMBRA, ALTEA, ALTEA XL, CORDOBA, EXEO, IBIZA II, LEON, TOLEDO I, TOLEDO III

...CET11P

SKODA
OCTAVIA II, SUPERB II, YETI
VW
AMAROK, BEETLE, CC, EOS, GOLF III, GOLF V, GOLF VI, JETTA III, JETTA IV, MULTIVAN V, PASSAT, PASSAT ALLTRACK, PASSAT CC, POLO, SCIROCCO, SHARAN, TIGUAN, TOUAREG, TRANSPORTER V

CET12P

ACURA
LEGEND II, NSX, SLX
ALFA ROMEO
147, 156, 159, 164, 166, BRERA, GT, GTV, SPIDER
ALPINA
B3, B5, B10, B12, ROADSTER V8, ROADSTER S
AUDI
A3, A4, A5, A6, A7, A8, ALLROAD, Q5, TT
BENTLEY
ARNAGE, CONTINENTAL
BMW
3 (E90), 3 COMPACT (E36), 3 /COMPACT (E46), 3 COMPACT /CONVERTIBLE /COUPE (E46), 3 /COMPACT /CONVERTIBLE /COUPE /TOURING (E46), 3 /COMPACT /TOURING (E46), 3 CONVERTIBLE (E46), 3 CONVERTIBLE (E93), 3 /CONVERTIBLE /COUPE /TOURING (E46), 3 COUPE (E92), 3 /COUPE /TOURING (E46), 3 TOURING (E91), 5 (E39), 5 (E60), 5 /TOURING (E39), 5 TOURING (E39), 5 TOURING (E61), 6 (E63), 6 CONVERTIBLE (E64), 7 (E38), 7 (E65, E66, E67), 8 (E31), X1 (E84), X3 (E83), X5 (E53), X5 (E70), Z3 COUPE (E36), Z3 ROADSTER (E36), Z4 ROADSTER (E85), Z8 ROADSTER (E52)
CADILLAC
BLS
CHEVROLET
CRUZE, EPICA
CHRYSLER
CROSSFIRE, STRATUS
CITROËN
C-CROSSER, C-CROSSER ENTERPRISE, XM
DAEWOO
LACETTI, MAGNUS, TOSCA
DAIHATSU
ALTIS, APPLAUSE I, CHARADE III, CHARADE IV, COPEN, FEROZA HARD TOP, FEROZA SOFT TOP, GRAN MOVE, SIRION, YRV
DAIMLER
DAIMLER XJ
DODGE
STRATUS
FIAT
COUPE
FORD
GALAXY, SCORPIO II, TRANSIT
FORD ASIA / OCEANIA
FALCON
HOLDEN
APOLLO

...CET12P

HONDA
ACCORD IV, ACCORD VI, CIVIC II, CIVIC IV, CIVIC VII, CIVIC VIII, CONCERTO, CRX I, CRX II, CRX III, ELEMENT, INSPIRE, INTEGRA, LAGREAT, LEGEND I, LEGEND II, LEGEND III, NSX I, PRELUDE III, PRELUDE IV, PRELUDE V, S2000
HYUNDAI
COUPE, ELANTRA, EQUUS / CENTENNIAL, GALLOPER II, GENESIS, GRANDEUR, HIGHWAY VAN, I30, SANTA FÉ I, SANTA FÉ II, SONATA IV, SONATA V, TERRACAN, TRAJET, TUCSON, XG
INFINITI
G20, J30, M30, Q45 I, Q45 II
ISUZU
TROOPER III
JAGUAR
S-TYPE, XF, XJ, XK, XK 8
KIA
CADENZA I, CARENS II, CARNIVAL I, CARNIVAL II, CEE'D, MAGENTIS, OPIRUS, PRO CEE'D, SORENTO I, SPORTAGE
LAMBORGHINI
GALLARDO, GALLARDO SPYDER
LANCIA
KAPPA, THESIS
LAND ROVER
DISCOVERY II, DISCOVERY III, FREELANDER, RANGE ROVER II, RANGE ROVER III, RANGE ROVER SPORT
LEXUS
ES, GS, GX, HS, IS, IS I, LS, LX, RX, SC
LOTUS
ELISE, ELISE 340 R, EXIGE
MAYBACH
57
MAZDA
2 (DE, DH_3), 3 (BK), 3 /SALOON (BK), 3 /SALOON (BL), 323 C V (BA), 323 F V (BA), 323 S IV (BG), 323 S V (BA), 626 III /COUPE /HATCHBACK (GD), 626 III STATION WAGON (GV), 929 III (HC), MX-3 (EC), MX-5 II (NB), XEDOS 6 (CA), XEDOS 9 (TA)

...CET12P

MERCEDES-BENZ
A-CLASS (W169), B-CLASS (W245), C-CLASS (W202), C-CLASS (W203), C-CLASS COUPE (C203), C-CLASS T-MODEL (S202), C-CLASS T-MODEL (S203), CLK (C208), CLK (C209), CLK CONVERTIBLE (A208), CLK CONVERTIBLE (A209), CLS (C219), E-CLASS (W210), E-CLASS (W211), E-CLASS T-MODEL (S210), E-CLASS T-MODEL (S211), G-CLASS (W463), G-CLASS /CABRIO (W463), G-CLASS CABRIO (W463), M-CLASS (W163), M-CLASS (W164), R-CLASS (W251, V251), S-CLASS (W140), S-CLASS (W220), S-CLASS (W221), S-CLASS (W222, V222, X222), S-CLASS COUPE (C140), S-CLASS COUPE (C215), S-CLASS COUPE (C216), S-CLASS COUPE (C217), SL (R129), SL (R230), SL (R231), SLK (R170), SLK (R171), SPRINTER 2-T BOX /BUS /PLATFORM /CHASSIS (901, 902), SPRINTER 3-T BOX /BUS /PLATFORM /CHASSIS (903), VIANO (W639), VITO BUS (W639), VITO / MIXTO BOX (W639)
MG
EXPRESS, MG 6, MGF, MG TF, MG ZR, MG ZS, MG ZT, MG ZT-
MINI
MINI
MITSUBISHI
380, 3000 GT, ASX, CARISMA, DIAMANTE I, DIAMANTE II, DION, ECLIPSE III, GALANT, GALANT V, GALANT VI, L 300 III, LANCER VI, LANCER VII, LANCER VIII, MAGNA, OUTLANDER I, OUTLANDER II, OUTLANDER III, PAJERO CLASSIC, PAJERO II, PAJERO III, PAJERO IV, PAJERO PININ, PAJERO SPORT I, PAJERO SPORT II, PROUDIA/DIGNITY, SIGMA, SPACE RUNNER, SPACE STAR, SPACE WAGON, VERADA
MORGAN
AERO 8, PLUS EIGHT
NISSAN
180 SX, 200 SX, 300 ZX, BLUEBIRD, CEDRIC, CEFIRO I, CEFIRO II, GLORIA, LAUREL, MAXIMA III, MAXIMA / MAXIMA QX IV, MAXIMA / MAXIMA QX V, PRAIRIE, SKYLINE, STAGEA, SUNNY II, SUNNY III
OPEL
ASTRA G, ASTRA H, ASTRA J, COMBO, CORSA D, FRONTERA B, INSIGNIA A, MERIVA A, MONTEREY A, MONTEREY B, SIGNUM, VECTRA C, ZAFIRA A, ZAFIRA B
PEUGEOT
4007
PORSCHE
CAYENNE (9PA)
PUCH
G-MODELL
RENAULT
AVANTIME, CLIO II, ESPACE IV, LAGUNA II, LAGUNA III, MEGANE CC, MEGANE II, MEGANE III, SCENIC II, TWINGO II, VEL SATIS, WIND
ROLLS-ROYCE
PARK WARD, PHANTOM VII, SILVER SERAPH



**...CET1 2P**

ROVER
25, 45, 75, 200, 400, COUPE, STREETWISE

SAAB
9-3, 9-5, 900 II

SEAT
ALHAMBRA, ALTEA, ALTEA XL, AROSA, EXEO, IBIZA III, LEON, TOLEDO II, TOLEDO III

SKODA
FABIA I, FELICIA I, FELICIA II, OCTAVIA I, OCTAVIA II, SUPERB I

SSANGYONG
KORANDO

SUBARU
FORESTER, IMPREZA, JUSTY III, LEGACY I, LEGACY II, LEGACY IV, LEGACY V, OUTBACK, VIVIO

SUZUKI
GRAND VITARA I (FT, HT), GRAND VITARA II (JT, TE, TD), IGNIS I (FH), IGNIS II (MH), LIANA HATCHBACK, SWIFT II HATCHBACK (EA, MA), SWIFT III (MZ, EZ), VITARA (ET, TA), VITARA CABRIO (ET, TA), WAGON R+ (MM), WAGON R+ HATCHBACK (MM), X-90 (EL)

TOYOTA
ALLION I, ALPHARD, ALPHARD / VELLFIRE, ALTEZZA, ALTEZZA GITA, AQUA, ARISTO, ASCENT, AURION, AVALON, AVANZA, AVENSIS, AVENSIS VERSO, BB II, BREVIS, CALDINA, CAMI, CAMRY, CAMRY SOLARA, CARIBE, CARINA E, CELICA, CELSIOR, CENTURY, CHASER, COROLLA, CORONA, CRESTA, CROWN, CURREN, GAIA, HARRIER, HIGHLANDER / KLUGER, HILUX VII, MARK II, ISIS, KLUGER, LAND CRUISER 90, LAND CRUISER 100, LAND CRUISER 200, MAJESTA, MARK X ZIO, MR 2 I, MR 2 II, NOAH/VOXY, OPA, PASSO, PORTE, PREVIA, PREVIA III, PRIUS, PRIUS C, PROBOX/SUCCEED, PROGRES, RAV 4 I, RAV 4 II, RAV 4 III, SCEPTER, SEQUOIA, SIENNA, SOARER, SOLARA, SPRINTER, SPRINTER CARIB, SUPRA, TOWN ACE, VEROSSA, VISTA, WINDOM, WISH, YARIS

TOYOTA (FAW)
PRIUS

VAUXHALL
ASTRA MK V (H), ASTRA MK VI (J), COMBO MK II (C), COMBO TOUR MK II (C), CORSA MK II (C), CORSA MK III (D), FRONTERA MK II (B), INSIGNIA MK I (A), MERIVA MK I (A), MONTEREY, MONTEREY MK II, SIGNUM, VECTRA MK II (C), ZAFIRA MK I (A), ZAFIRA MK II (B)

VOLVO
850, C70 I, S40 I, S60 I, S70, S80 I, S80 II, V40, V70 I, V70 II, XC70 CROSS COUNTRY, XC90 I

VW
BORA, EOS, FOX, GOLF III, GOLF IV, GOLF V, GOLF VI, GOLF PLUS, JETTA III, LUPO, NEW BEETLE, PASSAT, POLO, SHARAN, TOURAN, TRANSPORTER IV, VENTO

CET1 3P

RENAULT
CLIO, CLIO III, CLIO IV, GRAND SCÉNIC III, MEGANE CC, MEGANE III, MODUS / GRAND MODUS, SCÉNIC III, TWINGO II, WIND

CET1 4P

CADILLAC
BLS, CTS

CHEVROLET
VECTRA

CITROËN
C4 AIRCROSS, C5 I, C5 II, C5 III, C6, C8

DAIHATSU
BOON, CUORE VII, SIRION

FIAT
ULYSSE

FORD
FOCUS II, KUGA I, MONDEO IV, S-MAX

HONDA
CIVIC VIII, INSIGHT, JAZZ III

HYUNDAI
ASLAN, GENESIS, GRANDEUR, GRAND SANTA FÉ, SANTA FÉ I, SANTA FÉ II, SANTA FÉ III, SONATA IV

INFINITI
FX, G, M35, M45, Q45 III

KIA
CADENZA I, CARNIVAL / GRAND CARNIVAL III, MAGENTIS, OPiRUS, QUORIS, SEDONA, SORENTO II, SORENTO III

LANCIA
PHEDRA

LAND ROVER
FREELANDER 2

LEXUS
ES, GS, GX, IS C, IS II, IS III, LS, LX, RX

MERCEDES-BENZ
C-CLASS (W203), C-CLASS COUPE (C1203), C-CLASS T-MODEL (S203), CLC-CLASS (C1203), CLK (C209), CLK CONVERTIBLE (A209), CLS (C219), E-CLASS (W211), E-CLASS T-MODEL (S211), G-CLASS (W463), S-CLASS (W220), S-CLASS COUPE (C215), SL (R230), SLK (R171), SLR (R199), SLR ROADSTER (R199)

MERCEDES-BENZ (BBDC)
E-CLASS

MITSUBISHI
ASX, ECLIPSE IV, GALANT, GALANT VI, GRANDIS, LANCER VIII, OUTLANDER I

MITSUOKA
VIEWT

NISSAN
350 Z, ALMERA II, ALTIMA, CEFIRO I, CUBE, ELGRAND, MAXIMA / MAXIMA QX V, MAXIMA QX V, MICRA C+C III, MICRA III, MURANO I, NOTE, QUEST, SKYLINE, STAGEA, TEANA I, TERRANO II, X-TRAIL

PEUGEOT
206, 406, 407, 607, 807

RENAULT
AVANTIME, CLIO II, ESPACE IV, KANGOO, LAGUNA II, VEL SATIS

...CET1 4P

SUBARU
FORESTER, IMPREZA, JUSTY IV, LEGACY IV, LEGACY V, OUTBACK, TRIBECA

SUZUKI
GRAND VITARA II (JT, TE, TD), KIZASHI (FR), SWIFT IV (FZ, NZ), SX4 (EY, GY)

TOYOTA
ALLION II, ALPHARD / VELLFIRE, AURION, AURIS, AVALON, AYGO, CAMRY, COROLLA, COROLLA RUMION, CROWN, HARRIER, HIGHLANDER / KLUGER, KLUGER, LAND CRUISER, LAND CRUISER 200, LAND CRUISER PRADO, MARK X ZIO, PORTE II, PREMIO, PREVIA III, RACTIS, RAV 4 III, RAV 4 IV, SEQUOIA, SIENNA, SPADE, TUNDRA, VENZA, VERSO S, VIOS/YARIS, MARK X I, MARK X II, YARIS, ZELAS

VAUXHALL
SIGNUM, VECTRA MK II (C)

VOLVO
C30, C70 II, S40 II, S60 I, S80 I, S80 II, V50, V70 II, V70 III, XC60, XC70 CROSS COUNTRY, XC70 II, XC90 I

CET1 5P

ALFA ROMEO
MITO

CHRYSLER
YPSILON

FIAT
500, 500 C, 500L, PANDA, PANDA VAN, PUNTO

LANCIA
YPSILON

MERCEDES-BENZ
C-CLASS (W203), C-CLASS (W204), C-CLASS COUPE (C204), C-CLASS COUPE (C1203), C-CLASS T-MODEL (S203), C-CLASS T-MODEL (S204), CLC-CLASS (C1203), CLK (C209), CLK CONVERTIBLE (A209), CLS (C219), E-CLASS (W211), E-CLASS (W212), E-CLASS CONVERTIBLE (A207), E-CLASS COUPE (C207), E-CLASS T-MODEL (S211), E-CLASS T-MODEL (S212), G-CLASS (W463), G-CLASS CABRIO (W463), GL-CLASS (X164), GLK-CLASS (X204), M-CLASS (W164), R-CLASS (W251, V251), S-CLASS (W221), S-CLASS COUPE (C216), SL (R230), SLK (R171), SLK (R172), SPRINTER 3,5-T BOX (906), SPRINTER 3,5-T BOX /BUS /PLATFORM /CHASSIS (906), SPRINTER 3,5-T BUS /PLATFORM /CHASSIS (906), SPRINTER 3-T BOX (906), SPRINTER 3-T BOX /BUS /PLATFORM /CHASSIS (906), SPRINTER 3-T BUS (906), SPRINTER 3-T PLATFORM /CHASSIS (906), SPRINTER 4,6-T BOX /PLATFORM /CHASSIS (906), SPRINTER 5-T BOX /PLATFORM /CHASSIS (906), SPRINTER 5-T PLATFORM /CHASSIS (906), VIANO (W639), VITO BUS (W639), VITO / MIXTO BOX (W639)

MERCEDES-BENZ (BBDC)
E-CLASS

MITSUBISHI
I, OUTLANDER II, PAJERO SPORT II

SMART
FORTWO

CET1 6P

BMW
1 (F20), 1 (F21), 3 (F30, F80), 3 TOURING (F31)

CITROËN
BERLINGO, C3 II, C3 PICASSO, C4, C4 GRAND PICASSO I, C4 GRAND PICASSO II, C4 I, C4 II, C4 PICASSO I, C4 PICASSO II, C5 III, DS3, DS4, DS5

MINI
MINI, MINI CLUBMAN, MINI CLUBVAN, MINI COOPERMAN, MINI PACEMAN

PEUGEOT
207, 207 CC, 207 SW, 208, 308, 308 CC, 308 II, 308 SW, 308 SW II, 408, 508 I, 508 SW I, 2008, 3008, 5008, PARTNER, PARTNER TEPEE, RCZ

CET1 7P

ALFA ROMEO
159, BRERA, SPIDER

ASTON MARTIN
DB7

CATERHAM
SEVEN

CHEVROLET
CAPTIVA, HHR, MALIBU, TRAILBLAZER, VECTRA

DODGE
CHALLENGER, CHARGER, JOURNEY

FIAT
CROMA

FORD
BANTAM, COUGAR, ESCORT CLASSIC, ESCORT V, ESCORT VI, ESCORT VII, FIESTA V, FIESTA VI, FOCUS, FOCUS III, GALAXY, KA, KA VAN, MAVERICK, MONDEO I, MONDEO II, MONDEO IV, ORION III, PUMA, RANGER, S-MAX, TOURNEO CONNECT, TRANSIT CONNECT

FORD AUSTRALIA
FIESTA, MONDEO

HOLDEN
ASTRA, VECTRA, ZAFIRA

HUMMER
HUMMER H3

ISUZU
ASCENDER

JAGUAR
XF, XJ

JEEP
GRAND CHEROKEE IV

LAND ROVER
DISCOVERY SPORT, FREELANDER 2, RANGE ROVER EVOQUE

MAZDA
3 (BK), 3 (BL), 3 /SALOON (BL), 5 (CR19), 5 (CW), 6 ESTATE /HATCHBACK (GH), 6 ESTATE /HATCHBACK /SALOON (GH), 6 HATCHBACK /SALOON (GG), 6 SALOON (GG), 6 SALOON (GH), 6 STATION WAGON (GY), 121 III (JASM, JBSM), CX-7 (ER), CX-9 (TB), MX-5 III (NC), PREMACY (CP), TRIBUTE (EP)

MORGAN
FOUR FOUR, PLUS FOUR



eon TITAN



...CET17P

OPEL

ANTARA, ASTRA G, ASTRA J, GT, INSIGNIA A, SPEEDSTER, VECTRA B, VECTRA C, ZAFIRA A

SAAB

9-3, 9-3X, 9-5, 9-7X

SUZUKI

GRAND VITARA II (JT, TE, TD)

VAUXHALL

ANTARA, ASTRA MK IV (G), ASTRA MK VI (J), INSIGNIA MK I (A), OMEGA (B), VECTRA (B), VECTRA MK II (C), VX220, ZAFIRA MK I (A)

VOLVO

S60 II, S80 II, V40, V60, V70 III, XC60

WESTFIELD

SE / SEVEN

CET18P

ASTON MARTIN

DB7, DB9, DBS, RAPIDE, VANQUISH, VANTAGE, VIRAGE

FORD

B-MAX, C-MAX, C-MAX II, COUGAR, ESCORT V, ESCORT VI, ESCORT VII, FIESTA, FIESTA IV, FIESTA V, FIESTA VI, FOCUS C-MAX, FOCUS II, GALAXY, KA, MAVERICK, MONDEO I, MONDEO II, MONDEO III, MONDEO IV, S-MAX, TRANSIT

FORD AUSTRALIA

COUGAR, ESCAPE, F150, F350, FALCON, KA, MUSTANG, TAURUS

FORD USA

ESCAPE, EXPEDITION, EXPLORER, F-150, FIVE HUNDRED, MUSTANG, RANGER, TAURUS, WINDSTAR

JAGUAR

S-TYPE, XF, XJ, X-TYPE

LINCOLN

LS

MAZDA

3 (BK), 3 SALOON (BK), 5 (CR19), 5 (CW), 6 ESTATE (GH), 6 HATCHBACK (GG), 6 HATCHBACK /SALOON (GG), 6 HATCHBACK /SALOON (GH), 6 STATION WAGON (GY), 121 III (JASM, JBSM), MPV II (LW), MPV III (LY), MX-5 III (NC), PREMACY (CP), TRIBUTE (EP)

MORGAN

PLUS FOUR, ROADSTER

VOLVO

C30, S40 II, S80 II, V50, V70 III



IRIDIUM



OE179

ACURA
LEGEND II, NSX

ALFA ROMEO
145, 146, 147, 155, 156, 159, 164, 166, BRERA, GT, GTV, SPIDER

ALPINA
B3, B5, B8, B10, B12

ASTON MARTIN
DB7, VIRAGE

AUDI
80, 90, 100, A2, A3, A4, A5, A6, A8, ALLROAD, CABRIOLET, COUPE, Q5, TT

BENTLEY
ARNAGE

BITTER
TYPE 3

BMW
3 CONVERTIBLE (E30)

CADILLAC
BLS

CATERHAM
SEVEN

CHERY
A1, A3, A5, COWIN, COWIN 2, COWIN 3, COWIN 5, E5, EASTAR CROSS, FULWIN, QQ3, QQ6, TIGGO, TIGGO 3, TIGGO DR, V5, X1

CHEVROLET
AVEO, AVEO / KALOS, CRUZE, EPICA, KALOS, LACETTI, NUBIRA, OPTRA, VIVANT

CITROËN
AX, BERLINGO, BERLINGO / BERLINGO FIRST, BX, C2, C3, C3 I, C3 II, C15, EVASION, JUMPER, JUMPY, NEMO, SAXO, XANTIA, XM, XSARA, XSARA PICASSO, ZX

DACIA
DOKKER, DOKKER EXPRESS, DUSTER, LODGY, LOGAN, LOGAN MCV, SANDERO, SOLENZY, SUPERNOVA

DAEWOO
GENTRA, KALOS, LACETTI, LANOS, MAGNUS, NEXIA, NUBIRA, TOSCA

DAIHATSU
ALTIS, APPLAUSE I, CHARADE III, CHARADE IV, COPEN, FERROZA HARD TOP, FERROZA SOFT TOP, GRAN MOVE, SIRION, YRV

DAIMLER
DAIMLER XJ, XJ 40, 81

DE TOMASO
GUARA

EMGRAND
EC7, EC7-RV

EMGRAND (GEELY)
EC 7, EC 7 RV

FIAT
BRAVA, BRAVO I, COUPE, DOBLO, DUCATO, FIORINO, MAREA, MULTIPLA, PALIO, PANDA, PUNTO, QUBO, SCUDO, SIENA, STILO, TEMPRA, ULYSSÉ, UNO

...OE179

FORD
ESCORT '81, ESCORT '86, ESCORT '95, ESCORT III, ESCORT IV, ESCORT VI, ESCORT VII, FIESTA I, GALAXY, ORION III, SCORPIO I, SCORPIO II, TRANSIT, TRANSIT TOURNEO

FORD ASIA / OCEANIA
LASER, LASER / LASER LIDEA

FORD ASIA / OZEAANIA
FESTIVA, LIATA, TELSTAR

FSO
LANOS

GEELY
BL, CK, GC2, HISOON, HQ, MARINDO, MEIRI, MK, MR, PU, SL, URBAN NANNY, VISION

GEO
TRACKER

HONDA
ACCORD IV, ACCORD VI, CAPA, CITY, CIVIC I, CIVIC II, CIVIC IV, CIVIC V, CIVIC VI, CIVIC VII, CIVIC VIII, CONCERTO, CRX I, CRX II, CRX III, DOMANI, INSPIRE, INTEGRA, JAZZ, JAZZ II, LEGEND I, LEGEND II, NSX I, PRELUDE III, PRELUDE IV, PRELUDE V, S2000

HYUNDAI
ACCENT III, EQUUS / CENTENNIAL, GALLOPER I, TIBURON

INFINITI
G20, M30

ISUZU
GEMINI, TROOPER II, VEHICROSS, WIZARD

JAGUAR
S-TYPE, XJ, XK 8

KIA
CARNIVAL I, CARNIVAL II, PRIDE, RIO, RIO II, SEPHIA, SPORTAGE

LADA
110, 111, 112, GRANTA, KALINA, LARGUS, OKA, PRIORA

LAMBORGHINI
GALLARDO, GALLARDO SPYDER

LANCIA
DEDRA, DELTA II, KAPPA, LYBRA, THESIS, Y

LAND ROVER
FREELANDER

LEXUS
ES, GS, IS, IS I, LS

LIFAN
320, 520, 620, X60

LOTUS
ELAN, ELISE, ELISE 340 R, ESPRIT S4, EXIGE

MAZDA
323 C IV (BG), 323 C V (BA), 323 F IV (BG), 323 F V (BA), 323 III HATCHBACK (BF), 323 S IV (BG), 323 S V (BA), 323 S VI (BJ), 626 III /COUPE /HATCHBACK (GD), 626 III STATION WAGON (GV), 929 III (HC), MX-3 (EC), MX-5 I (NA), MX-5 II (NB), XEDOS 6 (CA), XEDOS 9 (TA)

...OE179

MERCEDES-BENZ
A-CLASS (W168), B-CLASS (W245), C-CLASS (W202), C-CLASS T-MODEL (S202), CLK (C208), CLK CONVERTIBLE (A208), E-CLASS (W210), E-CLASS T-MODEL (S210), M-CLASS (W163), S-CLASS (W140), S-CLASS COUPE (C140), SL (R129), SLK (R170), SPRINTER 2-T BOX (901, 902), SPRINTER 2-T BOX /BUS /PLATFORM /CHASSIS (901, 902), SPRINTER 3-T BOX /BUS /PLATFORM /CHASSIS (903)

MG
EXPRESS, MGF, MG TF, MG ZR, MG ZS, MG ZT, MG ZT-

MINISUBISHI
380, 3000 GT, ASX, CARISMA, COLT IV, COLT V, COLT VI, DIAMANTE I, DIAMANTE II, ECLIPSE, ECLIPSE III, FTO, GALANT, GALANT V, GALANT VI, L 300 III, LANCER IV, LANCER V, LANCER VI, LANCER VII, LANCER VIII, MAGNA, MIRAGE, OUTLANDER III, PAJERO CLASSIC, PAJERO III, PAJERO IV, PAJERO PININ, PAJERO SPORT I, PROUDIA/DIGNITY, SIGMA, SPACE RUNNER, SPACE STAR, SPACE WAGON

MINISUOKA
ZERO I

MORGAN
FOUR FOUR, PLUS EIGHT

NISSAN
180 SX, 200 SX, 300 ZX, AVENIR, BLUEBIRD, CEDRIC, KUBISTAR, MAXIMA III, PRAIRIE, PRAIRIE PRO, PRIMASTAR, PRIMERÁ, SERENA, SKYLINE, STANZA, SUNNY II, SUNNY III

OPEL
ASTRA G, ASTRA H, ASTRA J, COMBO, CORSA D, KADETT E, OMEGA A, SIGNUM, VECTRA C, VIVARO A, ZAFIRA A, ZAFIRA B

PANTHER
KALLISTA

PEUGEOT
106 I, 106 II, 106 VAN, 205, 205 I, 205 II, 206, 206+, 207, 207 SW, 305 II, 306, 307, 309 I, 309 II, 405 I, 405 II, 406, 605, 806, 1007, BIPPER, BIPPER TEPEE, BOXER, EXPERT, PARTNER

PLYMOUTH
BREEZE

PORSCHE
911 /CONVERTIBLE (964), 911 /CONVERTIBLE (996), 911 TARGA (993), 968, CAYENNE (9PA)

PROTON
PERSONA 300, PERSONA 400, WIRA

PUCH
G-MODELL

RELIANT
SCIMITAR, SCIMITAR SABRE

...OE179

RENAULT
19 I, 19 II, 21, 25, AVANTIME, CLIO, CLIO I, CLIO II, CLIO III, DUSTER, ESPACE III, ESPACE IV, FLUENCE, GRAND SCÉNIC II, GRAND SCÉNIC III, KANGOO, KANGOO BE BOP, KANGOO / GRAND KANGOO, LAGUNA, LAGUNA I, LAGUNA II, LAGUNA III, LOGAN EXPRESS, LOGAN I, MEGANE, MEGANE CC, MEGANE I, MEGANE II, MEGANE III, MODUS / GRAND MODUS, RAPID, SAFRANE I, SAFRANE II, SANDERO/STEPWAY I, SCÉNIC I, SCÉNIC II, SCÉNIC III, SPORT SPIDER, THALIA I, THALIA II, TRAFIC II, TWINGO I, TWINGO II, VEL SATIS, WIND

ROVER
25, 45, 75, 100, 100 / METRO, 200, 400, 800, CITYROVER, COUPE, MAESTRO, MONTEGO, STREETWISE

SAAB
9-3, 9-5, 900 I, 900 II, 9000

SEAT
ALHAMBRA, ALTEA, ALTEA XL, AROSA, CORDOBA, EXEO, IBIZA I, IBIZA II, IBIZA III, IBIZA IV, INCA, LEON, MALAGA, RÓNDA, TOLEDO I, TOLEDO II, TOLEDO III

SKODA
FABIA I, OCTAVIA I, OCTAVIA II, SUPERB I

SSANGYONG
KORANDO

SUBARU
FORESTER, IMPREZA, JUSTY I, JUSTY III, LEGACY I, LEGACY II, LEGACY IV, OUTBACK, REX III, VIVIO

SUZUKI
GRAND VITARA I (FT, HT), IGNIS II (MH), LIANA (ER, RH), LIANA ESTATE (ER), LIANA HATCHBACK, SWIFT II HATCHBACK (EA, MA), SWIFT III (MZ, EZ), VITARA (ET, TA), VITARA CABRIO (ET, TA), WAGON R+ (MM), WAGON R+ HATCHBACK (MM), X-90 (EL)

TATA
INDICA, INDIGO, SAFARI

TOYOTA
ARISTO, AVENSIS, CAMI, CAMRY, CAMRY SOLARA, CARIBE, CARINA E, CARINA II, CELICA, CELSIOR, CHASER, COROLLA, COROLLA FX, CORONA, CRESSIDA, CRESTA, CROWN, CURREN, HARRIER, HILUX, HILUX VI, MARK II, LAND CRUISER, LAND CRUISER 200, MAJESTA, MR 2 I, MR 2 II, PREVIA, SCEPTER, SOARER, SPRINTER, SPRINTER CARIB, SUPRA, VISTA

VAUXHALL
ASTRA MK IV (G), ASTRA MK V (H), ASTRA MK VI (J), COMBO MK II (C), COMBO TOUR MK II (C), CORSA MK II (C), CORSA MK III (D), SIGNUM, VECTRA MK II (C), VIVARO, ZAFIRA MK I (A), ZAFIRA MK II (B)

VOLVO
850, C70 I, S40 I, S60 I, S70, S80 I, S80 II, V40, V70 I, V70 II, XC70 CROSS COUNTRY, XC90 I





IRIDIUM



...OE179

VW
BORA, CADDY II, CADDY III, CORRADO, EOS, FOX, GOLF II, GOLF III, GOLF IV, GOLF V, GOLF VI, GOLF PLUS, GOL III, JETTA II, JETTA III, LUPO, NEW BEETLE, PASSAT, POLO, SHARAN, TOURAN, TRANSPORTER IV, VENTO, VOYAGE

ZAZ
VIDA

OE180

ACURA
SLX

ASTON MARTIN
VIRAGE

AUSTIN
MAESTRO, MONTEGO

AUTOBIANCHI
Y10

BAOLONG
PEGASUS

BMW
3 (E30), 3 (E36), 3 /CONVERTIBLE /TOURING (E30), 3 TOURING (E30), 7 (E32), 8 (E31)

BYD
F3

CATERHAM
21, SEVEN

CHENGLONG
FUTURE

CHERY
TIGGO, V5

CHEVROLET
LUMINA APV

CHRYSLER
CIRRUS, CROSSFIRE, NEON, NEON II, SEBRING, STRATUS, VOYAGER / GRAND VOYAGER III

CITROËN
AX, BX, C15, C-CROSSER, VISA, XANTIA, XM, ZX

DADI
CITY COURSER, ELEGANTEST

DAEWOO
ESPERO, KORANDO, MUSSO, NEXIA, REXTON

DAIHATSU
APPLAUSE I, APPLAUSE II, CHARADE III, CHARADE IV, HIJET

DODGE
CARAVAN, NEON, NEON II, STRATUS

EUNOS
500

FIAT
BARCETTA, CINQUECENTO, DOBLO, DUCATO, MAREA, MULTIPLA, PALIO, PANDA, PUNTO, SEDICI, SEICENTO / 600, SIENA, STILO, STRADA, TEMPRA, TIPO, UNO

...OE180

FORD
ESCORT '86, ESCORT '91, ESCORT III, ESCORT IV, ESCORT V, ESCORT VI, ESCORT VII, FIESTA II, FIESTA III, GALAXY, ORION I, ORION II, ORION III, SCORPIO I, SCORPIO II, SIERRA, TRANSIT

FORD ASIA / OCEANIA
FALCON

FORD ASIA / OZEANIA
FREDA, TIERRA

FSO
POLONEZ III

GREAT WALL
FENGJUN 5, HOVER H3

HOLDEN
APOLLO

HONDA
ACCORD III, CIVIC II, CIVIC IV, CIVIC V, CIVIC VI, CIVIC VII, CONCERTO, CRX II, CRX III, INTEGRA, LEGEND I, LEGEND III

HYUNDAI
ACCENT, ACCENT I, ACCENT II, ACCENT III, ATOS, ATOS PRIME, COUPE, ELANTRA, GALLOPER II, GENESIS, GETZ, GRANDEUR, HIGHWAY VAN, I10, I20, I30, LANTRA II, MATRIX, SANTA FÉ I, SANTA FÉ II, S COUPE, SONATA IV, SONATA V, TERRACAN, TIBURON, TRAJET, TUCSON, XG

INFINITI
I30, J30, Q45 I, QX4

ISUZU
TROOPER III

JAGUAR
S-TYPE, XF, XJ, XJSC, XK, XK 8

JEEP
CHEROKEE

KIA
CARENS I, CARENS II, CARENS III, CARNIVAL II, CEE'D, CERATO, CLARUS, MAGENTIS, OPIRUS, PICANTO, PRIDE, PRO CEE'D, RETONA, RIO II, SHUMA, SHUMA II, SORENTO I, SPORTAGE

LADA
110, 111, 112

LANCIA
DEDRA, DELTA II, LYBRA, THESIS, Y, Y10

LAND ROVER
DISCOVERY I, DISCOVERY II, DISCOVERY III, RANGE ROVER II, RANGE ROVER III, RANGE ROVER SPORT

LANDWIND (JMC)
LANDWIND

LOTUS
ELAN

...OE180

MAZDA

2 (DE, DH_3), 2 (DY), 3 (BK), 3 /SALOON (BK), 3 /SALOON (BL), 121 I (DA), 121 II (DB), 121 III (JASM, JBSM), 323 C IV (BG), 323 C V (BA), 323 F IV (BG), 323 F V (BA), 323 F VI (BJ), 323 III /HATCHBACK (BF), 323 III STATION WAGON (BW), 323 P V (BA), 323 S IV (BG), 323 S V (BA), 323 S VI (BJ), 626 III /COUPE /HATCHBACK (GD), 626 III STATION WAGON (GV), 626 IV /HATCHBACK (GE), 626 V (GF), 626 V /HATCHBACK (GF), 626 V HATCHBACK (GF), 626 V STATION WAGON (GW), 929 III (HC), DEMIO (DW), E-SERIE BOX (SR2), MPV I (LV), MX-3 (EC), MX-5 I (NA), MX-5 II (NB), MX-6 (GE), PREMACY (CP), XEDOS 6 (CA), XEDOS 9 (TA)

MERCEDES-BENZ

A-CLASS (W169), B-CLASS (W245), CABRIOLET (A124), C-CLASS (W202), C-CLASS (W203), C-CLASS COUPE (CL203), C-CLASS T-MODEL (S202), C-CLASS T-MODEL (S203), CLK (C208), CLK (C209), CLK CONVERTIBLE (A208), CLK CONVERTIBLE (A209), CLS (C219), COUPE (C124), E-CLASS (W124), E-CLASS (W210), E-CLASS (W211), E-CLASS CONVERTIBLE (A124), E-CLASS COUPE (C124), E-CLASS T-MODEL (S124), E-CLASS T-MODEL (S210), E-CLASS T-MODEL (S211), G-CLASS (W463), G-CLASS /CABRIO (W463), G-CLASS CABRIO (W463), KOMBI T-MODEL (S124), M-CLASS (W163), M-CLASS (W164), R-CLASS (W251, V251), SALOON (W124), S-CLASS (W108, W109), S-CLASS (W140), S-CLASS (W220), S-CLASS COUPE (C140), S-CLASS COUPE (C215), SL (R129), SL (R230), SL (R231), SLK (R170), SLK (R171), SPRINTER 2-T BOX (901, 902), SPRINTER 2-T BUS /PLATFORM /CHASSIS (901, 902), SPRINTER 3-T BOX (903), SPRINTER 3-T BOX /BUS /PLATFORM /CHASSIS (903), SPRINTER 3-T BUS /PLATFORM /CHASSIS (903), SPRINTER 4-T BOX /BUS /PLATFORM /CHASSIS (904), VIANO (W639), VITO BUS (W639), VITO / MIXTO BOX (W639)

MINI

COLT V, ECLIPSE II, GALANT VI, GALLOPER, L 300 III, L 400, OUTLANDER I, OUTLANDER II, PAJERO II, PAJERO SPORT I, SANTAMO, SPACE RUNNER, SPACE STAR

MITSUBISHI
VIEWT, YUGA

MORGAN
PLUS FOUR

NISSAN
100 NX, AD VAN, AD WAGON, ALMERA I, ALMERA II, ALMERA TINO, AVENIR, BLUEBIRD, BLUEBIRD SYLPHY I, CARAVAN, CEDRIC, CEFIRO I, CEFIRO II, CEFIRO III, CUBE, GLORIA, GLORIA VIII, LAUREL, LUCINO, MAXIMA / MAXIMA QX IV, MAXIMA / MAXIMA QX V, MICRA II, PRAIRIE PRO, PRIMERA, SERENA, SKYLINE, STAGEA, SUNNY II, SUNNY III, SUNNY IV, TERRANO I

...OE180

OPEL
FRONTERA B, MONTEREY A, MONTEREY B, OMEGA A

PEUGEOT
106 I, 205 I, 205 II, 305 II, 309 I, 309 II, 405 I, 605, 4007

PONTIAC
TRANS SPORT

PORSCHE
356 CABRIOLET /SPEEDSTER /COUPE

PROTON
IMPIAN, PERSONA 300, PERSONA 400

PUCH
G-MODELL

RELIANT
SCIMITAR SABRE

RENAULT
19 I, 19 II, CLIO I, CLIO II, RAPID, SAFRANE II

ROVER
100, 100 / METRO, 200, 400, 600, 800, COUPE

SAAB
900 I, 9000

SEAT
IBIZA I

SKODA
FAVORIT, FELICIA I, FELICIA II

SSANGYONG
KORANDO, KYRON, MUSSO, REXTON, RODIUS

SUBARU
FORESTER, IMPREZA, JUSTY I, JUSTY II, LEGACY I, LEGACY II, LEGACY III, LEGACY IV, LEGACY V, LEGACY OUTBACK, OUTBACK, SVX

SUZUKI
ALTO (HA12, HA23), BALENO /ESTATE /HATCHBACK (EG), CARRY BOX (FD), GRAND VITARA I (FT, HT), GRAND VITARA II (JT), GRAND VITARA II (JT, TE, TD), IGNIS I (FH), JIMNY (FJ), JIMNY CLOSED OFF-ROAD VEHICLE (SN), LIANA (ER, RH), LIANA HATCHBACK, SWIFT II HATCHBACK (EA, MA), SWIFT II SALOON (AH, AJ), SX4 (EY, GY), SX4 /SALOON (GY), SX4 S-CROSS (JY), VITARA (ET, TA), VITARA /CABRIO (ET, TA), WAGON R+ HATCHBACK (MM)

TOYOTA
4 RUNNER, ALTEZZA, ALTEZZA GITA, ARISTO, AURIS, CAMRY, CARIBE, CARINA E, CARINA II, CELICA, CHASER, COROLLA, COROLLA FX, CORONA, CORSA, CRESSIDA, CRESTA, CROWN, CURREN, HIACE IV, HILUX VI, MARK II, MR 2 I, PASEO, PREVIA, PRIUS, PROBOX/SUCCEED, RAUM, SCEPTER, SOARER, SPRINTER, SPRINTER CARIB, STARLET, SUPRA, TERCEL, VIOS, VISTA

VAUXHALL
CARLTON MK III, FRONTERA MK II (B), MONTEREY, MONTEREY MK II, SENATOR MK II (B)





IRIDIUM



...OE180

VW
BORA, GOLF III, GOLF IV, GOL IV, PASSAT, SHARAN, TRANSPORTER IV, VENTO
YULON
101 FEELING
ZASTAVA
10

OE181

AUDI
A6, A7
MERCEDES-BENZ
A-CLASS (W169), B-CLASS (W245), C-CLASS (W203), C-CLASS COUPE (CL203), C-CLASS T-MODEL (S202), C-CLASS T-MODEL (S203), CLK (C208), CLK CONVERTIBLE (A208), E-CLASS (W210), E-CLASS T-MODEL (S210), S-CLASS (W140), S-CLASS (W220), S-CLASS COUPE (C140), S-CLASS COUPE (C215), SL (R129), SLK (R170)

OE182

CITROËN
C-CROSSER, C-CROSSER ENTERPRISE
DAIHATSU
ALTIS, SIRION
FORD
SCORPIO II
LEXUS
ES, GS, GX, HS, IS, IS I, LS, LX, RX, SC
LOTUS
ELISE, EXIGE
MITSUBISHI
ASX, LANCER VIII, OUTLANDER II, OUTLANDER III
PEUGEOT
4007
SAAB
9-3
SKODA
FABIA I, FELICIA I, FELICIA II, OCTAVIA I
TOYOTA
ALLION I, ALPHARD, ALPHARD / VELLFIRE, ALTEZZA, ALTEZZA GITA, AURION, AVALON, AVENSIS, AVENSIS VERSO, BB I, CALDINA, CAMRY, CAMRY SOLARA, CELICA, CELSIOR, COROLLA, CROWN, ECHO, GAIA, HARRIER, HIGHLANDER / KLUGER, ISIS, IST, KLUGER, LAND CRUISER 80, LAND CRUISER 90, LAND CRUISER 100, LAND CRUISER 200, LITEACE, MARK X ZIO, MATRIX, MR 2 III, NOAH/VOXY, OPA, PLATZ, PORTE, PREVIA, PREVIA III, PROBOX/SUCCEED, RAUM, RAV 4 II, RAV 4 III, SEQUOIA, SIENNA, SIENNA, SOLARA, TOWN ACE, VEROSSA, VIOS/YARIS, VISTA, WILL CYPHA, WILL VI, WILL VS, WINDOM, WISH, YARIS, YARIS VERSO, YARIS / VIOS

OE183

ALPINE
A310
ASTON MARTIN
DB7, DB9, DBS, RAPIDE, VANQUISH, VANTAGE, VIRAGE

...OE183

AUDI
100, A6, A8, V8
AUSTIN
AMBASSADOR, PRINCESS 2
CITROËN
AXEL, BX, CX I, CX II, DS, LNA, VISA
DAIMLER
DAIMLER XJ, XJ 40, 81
FORD
B-MAX, C-MAX, C-MAX II, COUGAR, ESCORT '81, ESCORT '86, ESCORT '91, ESCORT III, ESCORT IV, ESCORT V, ESCORT VI, ESCORT VII, FIESTA, FIESTA I, FIESTA II, FIESTA III, FIESTA IV, FIESTA V, FIESTA VI, FOCUS C-MAX, FOCUS II, GALAXY, KA, MAVERICK, MONDEO I, MONDEO II, MONDEO III, MONDEO IV, ORION II, ORION III, SCORPIO I, SCORPIO II, SIERRA, S-MAX
FORD AUSTRALIA
KA
FORD USA
AEROSTAR, EXPLORER, MUSTANG, PROBE I
JAGUAR
S-TYPE, XF, XJ, XJSC, X-TYPE
LANCIA
THEMA
LINCOLN
LS
MAZDA
3 (BK), 3 SALOON (BK), 5 (CR19), 5 (CW), 6 ESTATE (GH), 6 HATCHBACK (GG), 6 HATCHBACK /SALOON (GG), 6 HATCHBACK /SALOON (GH), 6 STATION WAGON (GY), 121 III (JASM, JBSM), MPV II (LW), MPV III (LY), MX-5 III (NC), PREMACY (CP), TRIBUTE (EP)
MERCEDES-BENZ
190 (W201), COUPE (C123), COUPE (C124), E-CLASS (W124), E-CLASS T-MODEL (S124), G-CLASS (W460), G-CLASS (W461), G-CLASS (W463), G-CLASS /CABRIO (W463), HECKFLOSSE (W111, W112), KOMBI T-MODEL (S123), KOMBI T-MODEL (S124), SALOON (W123), SALOON (W124), S-CLASS (W126), SL (R107), SL (R129), T1 BOX (601, 611), T1 BUS /PLATFORM /CHASSIS (601), T1 PLATFORM /CHASSIS (602), T1 /TN BOX BODY / ESTATE /PLATFORM /CHASSIS, T2 /L BOX BODY / ESTATE /DUMPTRUCK /PLATFORM /CHASSIS, T2 /LNT BOX BODY / ESTATE /PLATFORM /CHASSIS
MORGAN
PLUS FOUR, ROADSTER
MORRIS
ITAL
OLTICIT
11
OPEL
ASCONA B, MANTA B
PEUGEOT
104, 204, 205 I, 205 II, 304, 305 I, 305 II, 309 I, 504, 505, 604
PROTON
GEN 2

...OE183

PUCH
G-MODELL
RENAULT
5, 14, 18, 20, 21, 25, 30, ESPACE II, FUEGO, MASTER I, SAFRANE I, TRAFIC
ROVER
2000-3500
TALBOT
SAMBA, SIMCA SIM'4, TAGORA
TRIUMPH
DOLOMITE
TVR
S
VOLVO
240, 260, 760, 780, 960, C30, S40 II, S80 II, V50, V70 III

OE184

AUDI
A8
BMW
7 (E38), 8 (E31)
CATERHAM
SUPER SEVEN
CHEVROLET
ASTRA, AVEO, CAPTIVA, CRUZE, EPICA, EVANDA, MALIBU, NIVA, NUBIRA, OPTRA, ORLANDO, REZZO, TRAX, VECTRA, VIVA, VIVANT, ZAFIRA
CHRYSLER
NEON II, PT CRUISER
DAEWOO
BROUGHAM, EVANDA, KORANDO, LACETTI, LEGANZA, MAGNUS, NUBIRA, PRINCE, REZZO, WINSTORM
DAIHATSU
COO, CUORE V, CUORE VI, MATERIA
DODGE
NITRO
FIAT
SIENA, ULYSSE
FORD
MAVERICK
FORD USA
PROBE I, PROBE II
HOLDEN
ASTRA, BARINA, CAPTIVA, COMBO, TIGRA, VIVA
HONDA
ACCORD IV, ACCORD V, ACCORD VI, ACCORD VII, CAPA, CIVIC V, CIVIC VI, CIVIC VII, CR-V I, CR-V II, CR-V III, FR-V, HR-V, LOGO, PRELUDE IV, PRELUDE V, SHUTTLE, STEPWGN, STREAM
JEEP
CHEROKEE, COMMANDER, GRAND CHEROKEE III
KIA
RIO
LADA
110
LANCIA
ZETA

...OE184

LOTUS
EUROPA S
MAZDA
323 F VI (BJ), 323 S VI (BJ), 626 IV HATCHBACK (GE), 929 III (HC), MPV I (LV), MPV II (LW), MX-6 (GE), XEDOS 9 (TA)
MERCEDES-BENZ
V-CLASS (638/2), VITO BOX/BUS (638)
MITSUBISHI
DIAMANTE I, DIAMANTE II, GALANT, GALANT VI, LANCER VI, LANCER VII, MAGNA, PAJERO II, PAJERO III, PAJERO PININ, PAJERO SPORT I, PAJERO SPORT II, SPACE RUNNER, SPACE WAGON, VERADA
NISSAN
100 NX, 200 SX, KUBISTAR, PICK UP, PRAIRIE PRO, PRIMERA, SUNNY III, TERRANO I, TERRANO II, VANETTE CARGO
OPEL
ADAM, AGILA (A), ANTARA, ASTRA F, ASTRA F CLASSIC, ASTRA G, ASTRA H, ASTRA J, CALIBRA A, COMBO, CORSA B, CORSA C, CORSA D, FRONTERA A, FRONTERA B, INSIGNIA A, KADETT E, MERIVA A, MERIVA B, MOKKA, MOKKA / MOKKA X, OMEGA B, SINTRA, SPEEDSTER, TIGRA, VECTRA A, VECTRA B, VECTRA C, VIVARO A, ZAFIRA A, ZAFIRA B, ZAFIRA TOURER C
PEUGEOT
406
ROVER
600, 800
SAAB
9-3, 900 II, 9000
SUZUKI
WAGON R HATCHBACK
TOYOTA
COROLLA, GRANVIA, HIACE III, HILUX, HILUX II, LAND CRUISER 90, LAND CRUISER PRADO
TVR
CERBERA
VAUXHALL
ADAM, AGILA MK I (A), ANTARA, ASTRA MK II, ASTRA MK III (F), ASTRA MK IV (G), ASTRA MK V (H), ASTRA MK VI (J), ASTRAVAN MK III (F), ASTRAVAN MK IV (G), ASTRAVAN MK V (H), CALIBRA, CAVALIER MK II, CAVALIER MK III, COMBO MK I (B), COMBO MK II (C), COMBO TOUR MK II (C), CORSA MK I (B), CORSA MK II (C), CORSA MK III (D), CORSAVAN MK I (B), CORSAVAN MK II (C), CORSAVAN MK III (D), CORSAVAN MK IV (D), FRONTERA MK I (A), INSIGNIA MK I (A), MERIVA MK I (A), MERIVA MK II (B), NOVA, OMEGA (B), SIGNUM, SINTRA, TIGRA, TIGRA MK I, VECTRA (B), VECTRA MK II (C), VX220, ZAFIRA MK I (A), ZAFIRA MK II (B), ZAFIRA MK III
VW
CORRADO, GOLF III, PASSAT, VENTO





IRIDIUM



OE187

BMW
3 /CONVERTIBLE (E30), 3 /CONVERTIBLE /COUPE (E36), 3 CONVERTIBLE /COUPE (E46), 5 (E28), 5 (E34), 5 /TOURING (E34), 6 (E24), Z3 COUPE (E36), Z3 ROADSTER (E36), Z4 COUPE (E86), Z4 ROADSTER (E85)

CHEVROLET
AVEO, SPARK

DAIHATSU
MATERIA, TERIOS

FERRARI
328 GTB, 328 GTS, 512 TR, MONDIAL, TESTAROSSA

SUZUKI
ALTO (FF), CAPPUCINO (EE), WAGON R+ (MM), WAGON R+ HATCHBACK (EM)

TOYOTA
AVANZA, BB II, PASSO SETTE, RUSH

TVR
CERBERA, TUSCAN II

WIESMANN
MF3

OE188

ALFA ROMEO
159

AUDI
A6, A8, CABRIOLET

BERTONE
FREECLIMBER 2

BITTER
TYPE 3

BMW
1 (E87), 1 CONVERTIBLE (E88), 1 COUPE (E82), 3 (E30), 3 (E36), 3 (E90), 3 COMPACT (E36), 3 /COMPACT (E46), 3 COMPACT /CONVERTIBLE /COUPE (E46), 3 /COMPACT /CONVERTIBLE /COUPE /TOURING (E36), 3 /COMPACT /CONVERTIBLE /COUPE /TOURING (E46), 3 /COMPACT /COUPE /TOURING (E36), 3 /COMPACT /COUPE /TOURING (E36), 3 /COMPACT /TOURING (E46), 3 CONVERTIBLE (E36), 3 CONVERTIBLE (E46), 3 CONVERTIBLE (E93), 3 /CONVERTIBLE /COUPE (E36), 3 /CONVERTIBLE /COUPE /TOURING (E46), 3 /CONVERTIBLE /TOURING (E36), 3 COUPE (E36), 3 COUPE (E92), 3 /COUPE /TOURING (E46), 3 TOURING (E30), 3 TOURING (E91), 5 (E28), 5 (E34), 5 (E39), 5 (E60), 5 /TOURING (E34), 5 TOURING (E34), 5 /TOURING (E39), 5 TOURING (E39), 5 TOURING (E61), 6 (E63), 6 CONVERTIBLE (E64), 7 (E32), 7 (E38), 7 (E65, E66, E67), 8 (E31), X1 (E84), X3 (E83), X5 (E53), X5 (E70), Z3 COUPE (E36), Z3 ROADSTER (E36), Z4 ROADSTER (E85), Z8 ROADSTER (E52)

CADILLAC

BLS

CATERHAM
SEVEN

CHEVROLET
LACETTI, VECTRA, ZAFIRA

...OE188

CITROËN
BX, XANTIA, XM

DAEWOO
LACETTI, LEGANZA

DAIHATSU
CUORE V, CUORE VI, EXTOL, MOVE, SIRION, TERIOS, TREVIS, YRV

FIAT
BRAVA, BRAVO I, CROMA, MAREA, STILO, ULYSSE

HOLDEN
ASTRA

HONDA
CIVIC II, CR-V I, DOMANI, SMX

HYUNDAI
EQUUS / CENTENNIAL, SONATA IV

IRMSCHER
SENATOR

LANCIA
DEDRA, DELTA II, ZETA

LAND ROVER
DEFENDER

LEXUS
GS, SC

MAYBACH
57

MAZDA
626 III (GD), B-SERIE (UN)

MERCEDES-BENZ
S-CLASS (W220), S-CLASS (W221), S-CLASS (W222, V222, X222), S-CLASS COUPE (C215), S-CLASS COUPE (C216), S-CLASS COUPE (C217), SL (R230)

MINI
MINI

MITSUBISHI
CARISMA, DION, GALANT V, GALANT VI, LANCER VI, LANCER VII, PAJERO II, PAJERO PININ, PAJERO SPORT I, SPACE STAR

MORGAN
AERO 8

NISSAN
KUBISTAR, STAGEA

OPEL
ASTRA H, CALIBRA A, COMBO, CORSA D, INSIGNIA A, KADETT E, MERIVA A, OMEGA A, OMEGA B, SIGNUM, TIGRA, VECTRA A, VECTRA B, VECTRA C, ZAFIRA B

PEUGEOT
309 II, 405 I, 405 II, 406, 605

PIAGGIO
PORTER

PORSCHE
911 (964), 911 (993), 911 /CONVERTIBLE (996), 911 /CONVERTIBLE /TARGA (993), BOXSTER (986), CAYENNE (9PA)

SEAT
CORDOBA, IBIZA II, IBIZA III, LEON, TOLEDO II, TOLEDO III

SKODA
FABIA I, OCTAVIA I, OCTAVIA II, SUPERB I

...OE188

SUBARU
LEGACY IV, OUTBACK

TOYOTA
ARISTO, AVALON, AVENSIS, BREVIS, CAMRY, CAMRY SOLARA, CHASER, CROWN, HILUX VII, PICNIC, PROGRES, RAV 4 I, SIENNA, SOLARA, VEROSSA, VISTA, WINDOM, YARIS

VAUXHALL
ASTRA MK V (H), CALIBRA, CARLTON MK III, CAVALIER MK III, CORSA MK III (D), INSIGNIA MK I (A), MERIVA MK I (A), OMEGA (B), SIGNUM, VECTRA (B), VECTRA MK II (C), ZAFIRA MK II (B)

VOLVO
850, 960, 960 II, C70 I, S40 I, S60 I, S70, S80 I, S90, V40, V70 I, V70 II, V90

VW
BORA, LT 28-35 II, LT 28-46 II, LUPO, NEW BEETLE, PASSAT, PHAETON, POLO, TOUAREG

WIESMANN
MF3

OE189

ALFA ROMEO
159, BRERA, SPIDER

ASTON MARTIN
DB7

CHEVROLET
ALERO, CAPTIVA, COBALT, HHR, MALIBU, TRAILBLAZER, VECTRA

DODGE
CHALLENGER, CHARGER, JOURNEY

FIAT
CROMA

FORD
C-MAX, C-MAX II, COUGAR, ESCORT CLASSIC, ESCORT V, ESCORT VI, ESCORT VII, FIESTA III, FIESTA IV, FIESTA V, FIESTA VI, FOCUS, FOCUS C-MAX, FOCUS II, FOCUS III, FUSION, GRAND C-MAX, KA, KA VAN, MAVERICK, MONDEO I, MONDEO II, MONDEO IV, ORION III, PUMA, RANGER, STREET KA, TOURNEO CONNECT, TRANSIT CONNECT

FORD AUSTRALIA
FIESTA, MONDEO

HOLDEN
ASTRA, VECTRA, ZAFIRA

HUMMER
HUMMER H3

ISUZU
ASCENDER

JEEP
GRAND CHEROKEE IV

MAZDA
2 (DY), 3 /SALOON (BL), 5 (CR19), 5 (CW), 6 ESTATE /HATCHBACK (GH), 6 ESTATE /HATCHBACK /SALOON (GH), 6 HATCHBACK /SALOON (GG), 6 SALOON (GH), 6 STATION WAGON (GY), 121 III (JASM, JBSM), CX-7 (ER), CX-9 (TB), MX-5 III (NC), PREMACY (CP), TRIBUTE (EP)

...OE189

MORGAN
FOUR FOUR, PLUS FOUR

OPEL
ANTARA, ASTRA G, ASTRA J, GT, INSIGNIA A, SPEEDSTER, VECTRA B, VECTRA C, ZAFIRA A

SAAB
9-3, 9-3X, 9-5, 9-7X

SUZUKI
GRAND VITARA II (JT, TE, TD)

VAUXHALL
ANTARA, ASTRA MK IV (G), ASTRA MK VI (J), INSIGNIA MK I (A), OMEGA (B), VECTRA (B), VECTRA MK II (C), VX220, ZAFIRA MK I (A)

VOLVO
C30, S40 II, S60 II, S80 II, V40, V50, V60, V70 III

OE190

CADILLAC
BLS, CTS

CHEVROLET
VECTRA

CITROËN
BERLINGO, BERLINGO / BERLINGO FIRST, C1, C2, C3, C3 I, C4, C4 AIRCROSS, C4 I, C5 I, C5 II, C5 III, C6, C8, SAXO, XSARA, XSARA PICASSO

DAIHATSU
BOON, CUORE VII, SIRION

FIAT
ULYSSE

FORD
FOCUS II, KUGA I

HONDA
CIVIC VIII, INSIGHT, JAZZ III

HYUNDAI
ASLAN, GENESIS, GRANDEUR, GRAND SANTA FÉ, IX35, SANTA FÉ I, SANTA FÉ II, SANTA FÉ III, SONATA IV, SONATA V, SONATA VI

INFINITI
FX, G, M35, M45, Q45 III

KIA
CADENZA I, CARNIVAL / GRAND CARNIVAL III, CERATO II, CERATO Koup, MAGENTIS, OPIRUS, QUORIS, SEDONA, SORENTO II, SORENTO III, SPORTAGE

LANCIA
PHEDRA

LAND ROVER
FREELANDER 2

LEXUS
ES, GS, GX, IS C, IS II, IS III, LS, LX, RX

MERCEDES-BENZ
CLK (C209), CLK CONVERTIBLE (A209), CLS (C219), G-CLASS (W463)

MITSUBISHI
ASX, COLT CZC, COLT VI, COLT PLUS VII, ECLIPSE IV, GALANT, GALANT VI, GRANDIS, LANCER VIII, OUTLANDER I

MIITSUOKA
VIEWT





IRIDIUM



...OE261

RENAULT

CAPTUR, CLIO IV, GRAND SCÉNIC III,
KADJAR, KANGOO, KANGOO / GRAND
KANGOO, MEGANE CC, MEGANE III,
MEGANE IV, SCÉNIC III, SCÉNIC IV, TWINGO
III

SMART

FORFOUR, FORTWO

OE263

CITROËN

C3 II

PEUGEOT

208, 2008

OE264

OPEL

ASTRA J, INSIGNIA A, MERIVA B, MOKKA /
MOKKA X

VAUXHALL

INSIGNIA MK I (A)



CCGP001

BMW
3 (E90), 3 (F30, F80), 3 GRAN TURISMO (F34), 3 TOURING (E91), 3 TOURING (F31), 4 CONVERTIBLE (F33, F83), 4 COUPE (F32, F82), 4 GRAN COUPE (F36), 5 (F10), 5 GRAN TURISMO (F07), 5 TOURING (F11), 6 CONVERTIBLE (F12), 6 COUPE (F13), 6 GRAN COUPE (F06), 7 (F01, F02, F03, F04), X1 (E84), X3 (F25), X4 (F26), X5 (E70), X5 (F15, F85), X6 (E71, E72), X6 (F16, F86)

CCGP002

AUDI
A3, A4
SEAT
ALHAMBRA, ALTEA, ALTEA XL, CORDOBA, IBIZA III, IBIZA IV, LEON, TOLEDO III
SKODA
FABIA II, OCTAVIA II, ROOMSTER, ROOMSTER PRAKTIK, SUPERB I, SUPERB II
VW
CRAFTER 30-35, CRAFTER 30-50, JETTA III, MULTIVAN V, NEW BEETLE, PASSAT, POLO, SHARAN, TOUAREG, TRANSPORTER V

CCGP003

AUDI
A3, A4, A6
SEAT
ALTEA, ALTEA XL, LEON, TOLEDO III
SKODA
OCTAVIA II
VW
GOLF V, JETTA III, PASSAT, TOURAN

CCGP007

INFINITI
EX, FX, M, Q70, QX50, QX70
NISSAN
CABSTAR, MURANO II, NP300 NAVARA, NV400, PATHFINDER III, PRIMASTAR, QASHQAI / QASHQAI +2 I, X-TRAIL
OPEL
MOVANO B, VIVARO A
RENAULT
ESPACE IV, GRAND SCÉNIC II, GRAND SCÉNIC III, KOLEOS I, LAGUNA, LAGUNA II, LAGUNA III, LATITUDE, MASTER III, MEGANE CC, MEGANE II, MEGANE III, SCÉNIC II, SCÉNIC III, TRAFIC II, VEL SATIS
VAUXHALL
MOVANO MK II (B), VIVARO

CCGP010

AUDI
A4, A4 ALLROAD, A5, A8, Q5, Q7

CH147

CITROËN
AX, ZX
FIAT
DUCATO
FORD
ESCORT '86, ESCORT '91, ESCORT '95, ESCORT CLASSIC, ESCORT IV, ESCORT V, ESCORT VI, ESCORT VII, FIESTA, FIESTA III, MONDEO I, ORION II, ORION III, P 100 II, SIERRA

...CH147

IVECO
DAILY I, DAILY II
OPEL
ARENA, MOVANO
PEUGEOT
106 I
RENAULT
MASTER I, TRAFIC
ROVER
100 / METRO

CH154

METROCAB
TAXI
TOYOTA
4 RUNNER, CORSA, CRESSIDA, CROWN, DYNA, DYNA 150, HIACE I, HIACE II, HIACE III, HIACE IV, HILUX II, HILUX IV, HILUX V, HILUX VI, MARK II, LAND CRUISER, STARLET, TERCEL, TOWN ACE

VW

TARO

CH158

BEDFORD
MIDI
ISUZU
ASKA I, GEMINI, MIDI
OPEL
ASTRA F, CAMPO, CORSA A, KADETT E, MONTEREY A
VAUXHALL
ASTRA MK II, ASTRA MK III (F), BRAVA, CORSAVAN MK I (B), MIDI II, MONTEREY, NOVA

CH167

FIAT
BRAVA, BRAVO I, MAREA
LANCIA
KAPPA

CH169

CARBODIES
FL2, FX4, FX4R
HONDA
ACCORD V, ACCORD VI, CIVIC VI
LAND ROVER
FREELANDER
MG
EXPRESS, MG ZR, MG ZS
RENAULT
ESPACE III, LAGUNA I, MEGANE, MEGANE I, SAFRANE II, SCÉNIC I
ROVER
25, 45, 200, 400, 600, STREETWISE
VOLVO
S40 I, V40

CH170

CITROËN
BERLINGO / BERLINGO FIRST, C4 GRAND PICASSO I, C5 I, C5 II, C8, EVASION, JUMPER, JUMPY, XANTIA, XSARA, XSARA PICASSO

...CH170

FIAT
DUCATO, SCUDO, ULYSSE
LANCIA
PHEDRA, ZETA
PEUGEOT
206, 306, 307, 406, 607, 806, 807, BOXER, EXPERT, PARTNER
SUZUKI
GRAND VITARA I (FT, HT)

CH173

JEEP
CHEROKEE
RENAULT
9, 11, 19 I, 19 II, CLIO I, RAPID
VOLVO
340-360

CH175

MERCEDES-BENZ
C-CLASS (W202), C-CLASS T-MODEL (S202), E-CLASS (W124), E-CLASS T-MODEL (S124)

CH176

DAEWOO
KORANDO, MUSSO, REXTON
MERCEDES-BENZ
100 BOX (631), 100 BOX/BUS (631), 100 BOX /BUS /PLATFORM /CHASSIS (631), 190 (W201), C-CLASS (W202), E-CLASS (W124), E-CLASS T-MODEL (S124), G-CLASS (W460), G-CLASS (W461), G-CLASS (W463), G-CLASS /CABRIO (W463), KOMBI ESTATE (S124), KOMBI T-MODEL (S124), SALOON (W124), S-CLASS (W140), SPRINTER 2-T BOX /BUS /PLATFORM /CHASSIS (901, 902), SPRINTER 3-T BOX /BUS /PLATFORM /CHASSIS (903), SPRINTER 4-T BOX /PLATFORM /CHASSIS (904), T1 BOX (601, 611), T1 BOX /BUS /PLATFORM /CHASSIS (602), T1 BUS /PLATFORM /CHASSIS (601), T1 /TN BOX BODY / ESTATE /PLATFORM /CHASSIS, T2 /LN1 BOX BODY / ESTATE /DUMPTRUCK, V-CLASS (638/2), VITO BOX/BUS (638)

MERCEDES-BENZ CV

UNIMOG
PUCH
G-MODELL
SSANGYONG
ISTANA, KORANDO, MUSSO, REXTON

CH177

MERCEDES-BENZ
C-CLASS (W202), C-CLASS T-MODEL (S202), E-CLASS (W210), E-CLASS T-MODEL (S124), E-CLASS T-MODEL (S210), G-CLASS /CABRIO (W463), S-CLASS (W140)

PUCH

G-MODELL

CH178

LAND ROVER
DEFENDER, DISCOVERY I, RANGE ROVER I

CH180

CHRYSLER
VOYAGER IV
JEEP
CHEROKEE
LDV
MAXUS
LTI
TX

CH181

ALFA ROMEO
155, 164
AUDI
A2
CHRYSLER
VOYAGER / GRAND VOYAGER III, VOYAGER II
FORD
GALAXY, SCORPIO II
JEEP
CHEROKEE, GRAND CHEROKEE I, GRAND CHEROKEE II

OPEL

FRONTERA A
PLYMOUTH
VOYAGER / GRAND VOYAGER

ROVER

800
SEAT
ALHAMBRA, AROSA, CORDOBA, IBIZA III, LEON, TOLEDO II

SKODA

FABIA I, FABIA II, OCTAVIA I, ROOMSTER, ROOMSTER PRAKTIK, SUPERB I

VAUXHALL

FRONTERA MK I (A)
VW
BORA, CADDY III, FOX, GOLF IV, LUPO, MULTIVAN V, NEW BEETLE, PASSAT, PHAETON, POLO, SHARAN, TOUAREG, TRANSPORTER V

CH185

CITROËN
AX, BERLINGO / BERLINGO FIRST, C15, JUMPY, SAXO, XSARA

FIAT

DUCATO, SCUDO

NISSAN

MICRA II

PEUGEOT

106 I, 106 II, 106 VAN, 206, 206 VAN, 306, EXPERT, PARTNER

ROVER

100 / METRO

TATA

INDICA

TOYOTA

COROLLA

CH186

FORD
MAVERICK



...CH186

LDV
CUB
NISSAN
SERENA, TERRANO I, TRADE, VANETTE
CARGO

CH189

ALFA ROMEO
145, 146, 155, 164, AR 6, AR 8

ARO
10, 240-244

AUSTIN
MAESTRO, MONTEGO

BEDFORD
ASTRAMAX, ASTRA VAN, BLITZ, MIDI

BERTONE
FREECLIMBER

BMW
3 /COMPACT /TOURING (E36), 3 /TOURING (E30), 5 (E28), 5 /TOURING (E34), 5 /TOURING (E39), 7 (E38)

CARBODIES
FX4, FX4S, FX FAIRWAY

CHEVROLET
C1500, C3500

CHRYSLER
VOYAGER II

CITROËN
BERLINGO, BERLINGO / BERLINGO FIRST, BX, C15, C25, C35, CX I, CX II, EVASION, JUMPER, JUMPY, VISA, XANTIA, XM, XSARA, ZX

DAF
400-SERIE

DAIHATSU
HIJET

DALLAS
FUN

DODGE
CARAVAN

FIAT
127, 131, 132, 147, 242-SERIE, ARGENTA, BRAVA, BRAVO I, CAMPAGNOLA, CROMA, DUCATO, DUNA, ELBA, FIORINO, FIORINO PICK UP, PALIO, PANDA, PENNY, PUNTO, REGATA, RITMO, SCUDO, SIENA, STRADA, TALENTO, TEMPRA, TIPO, ULYSSE, UNO

FORD
GRANADA, SCORPIO I, SIERRA, TRANSIT

FSO
POLONEZ II, POLONEZ III

HYUNDAI
LANTRA II

INNOCENTI
ELBA

ISUZU
CAMPO, TFR/TFS

IVECO
DAILY I, DAILY II

JEEP
CHEROKEE, COMANCHE

...CH189

LADA
NIVA
LANCIA
DEDRA, DELTA I, PRISMA, THEMA, ZETA

LAND ROVER
88/109, 110/127, DEFENDER, RANGE ROVER II

LDV
400, CONVOY, PILOT, SHERPA

MAHINDRA
CJ 3, CJ5

MERCEDES-BENZ
100 BOX (631), 100 BOX/BUS (631), 100 PLATFORM /CHASSIS (631), 190 (W201), COUPE (C123), G-CLASS (W460), KOMBI T-MODEL (S123), KOMBI T-MODEL (S124), SALOON (W123), SALOON (W124), SPRINTER 2-T BOX /BUS /PLATFORM /CHASSIS (901, 902), SPRINTER 3-T BOX /BUS /PLATFORM /CHASSIS (903), SPRINTER 4-T BOX /PLATFORM /CHASSIS (904), T1 BOX (601, 611), T1 BOX /PLATFORM /CHASSIS (602), T1 BUS /PLATFORM /CHASSIS (601), T1 /TN BOX BODY / ESTATE /PLATFORM /CHASSIS, T2 /L BOX BODY / ESTATE /PLATFORM /CHASSIS, T2 /LNT BOX BODY / ESTATE /DUMPTRUCK /PLATFORM /CHASSIS

MERCEDES-BENZ CV
UNIMOG

OPEL
ARENA, ASCONA B, ASCONA C, ASTRA F, ASTRA G, COMBO, FRONTERA A, KADETT D, KADETT E, OMEGA A, OMEGA B, REKORD E, SENATOR A, VECTRA A

PEUGEOT
205, 205 I, 205 II, 305 I, 305 II, 306, 309 I, 309 II, 405 I, 405 II, 406, 504, 505, 604, 605, 806, BOXER, EXPERT, J5, J7, J9, PARTNER

PIAGGIO
PORTER

PUCH
G-MODELL

RAYTON FISSORE
MAGNUM

RENAULT
18, 19 I, 20, 21, 25, 30, ESPACE I, ESPACE II, FUEGO, MASTER I, RAPID, SAFRANE I, TRAFIC

RENAULT TRUCKS
B

ROVER
200, 400, 800, MAESTRO, MONTEGO

SEAT
131, 132, IBIZA I, MALAGA, RITMO, RONDA

SUZUKI
BALENO /ESTATE /HATCHBACK (EG), SAMURAI CLOSED OFF-ROAD VEHICLE (SJ), VITARA /CABRIO (ET, TA)

TALBOT
180, EXPRESS 1000 -1500, EXPRESS 1000 -1800, HORIZON, SIMCA 1609/1610, TAGORA

...CH189

TATA
LOADBETA
TOYOTA
LAND CRUISER

VAUXHALL
ARENA, ASTRA, ASTRA MK II, ASTRA MK III (F), ASTRA MK IV (G), ASTRAMAX, ASTRAVAN MK III (F), ASTRAVAN MK IV (G), BRAVA, CARLTON MK II, CARLTON MK III, CAVALIER MK II, CAVALIER MK III, COMBO MK II (C), FRONTERA MK I (A), MOVANO MK I (A), OMEGA (B), ROYALE, SENATOR

CH196

FORD
C-MAX, FIESTA, FIESTA IV, FOCUS, FOCUS C-MAX, FOCUS II, GALAXY, MONDEO IV, S-MAX, TOURNEO CONNECT, TRANSIT CONNECT

CH201

CITROËN
BERLINGO, BERLINGO / BERLINGO FIRST, C1, C2, C3, C3 I, C3 II, C3 PICASSO, C4, C4 GRAND PICASSO I, C4 I, C4 PICASSO I, C5 II, C5 III, JUMPY, NEMO, XSARA PICASSO

FIAT
SCUDO

FORD
C-MAX, FIESTA V, FIESTA VI, FOCUS C-MAX, FOCUS II, FUSION

FORD AUSTRALIA
FIESTA, MONDEO

MAZDA
2 (DE_, DH_3), 3 (BK), 3 /SALOON (BL)

MINI
MINI, MINI CLUBMAN

PEUGEOT
107, 206, 206+, 206 VAN, 207, 207 CC, 207 SW, 307, 308, 308 SW, 407, 1007, 3008, 5008, BIPPER, BIPPER TEPEE, EXPERT, EXPERT TEPEE, PARTNER, PARTNER TEPEE

SANTANA
300/350

SUZUKI
SX4 (EY, GY)

VOLVO
C30, S40 II, S80 II, V50, V70 III

CH203

BMW
3 (E46), 3 /TOURING (E46), 3 TOURING (E46), 5 /TOURING (E39), 7 (E38), X5 (E53)

LAND ROVER
FREELANDER, RANGE ROVER III

MG
MG ZT, MG ZT-

OPEL
OMEGA B

ROVER
75

VAUXHALL
MIDI, OMEGA (B)

CH204

MERCEDES-BENZ
E-CLASS (W210), E-CLASS T-MODEL (S210), G-CLASS (W461), SPRINTER 2-T BOX /BUS /PLATFORM /CHASSIS (901, 902), SPRINTER 3-T BOX (903), SPRINTER 3-T BOX /BUS /PLATFORM /CHASSIS (903), SPRINTER 3-T BUS (903), SPRINTER 3-T PLATFORM /CHASSIS (903), SPRINTER 4-T BOX /PLATFORM /CHASSIS (904), SPRINTER 4-T PLATFORM /CHASSIS (904), VARIO BOX BODY / ESTATE /BUS /DUMPTRUCK /PLATFORM /CHASSIS

CH205

FORD
ESCORT '95, ESCORT VI, ESCORT VII, FIESTA, FIESTA IV, MONDEO II

MAZDA
121 III (JASM, JBSM)

CH206

RENAULT
CLIO I, EXPRESS, MEGANE I, RAPID

CH207

ALPINA
D10

BMW
7 (E38)

OPEL
ASTRA G, FRONTERA B, SINTRA, VECTRA B, ZAFIRA A

SAAB
9-3, 9-5

VAUXHALL
ASTRA MK IV (G), ASTRAVAN MK IV (G), FRONTERA MK II (B), OMEGA (B), SINTRA, VECTRA (B), ZAFIRA MK I (A)

CH209

FIAT
DOBLO, PALIO, PUNTO, STRADA

CH215

AUDI
A4, A6, A8, ALLROAD

SKODA
SUPERB I

VW
PASSAT

CH216

CITROËN
JUMPER

FIAT
DUCATO

IVECO
DAILY II, DAILY III

PEUGEOT
BOXER

RENAULT
MASTER II

RENAULT TRUCKS
MASCOTT

SANTANA
PS10/ANIBAL



| | | | |
|---|--|--|---|
| <p>CH217 DACIA SOLENZA OPEL ARENA RENAULT CLIO II, KANGOO, MEGANE, THALIA I, TRAFIC VAUXHALL ARENA</p> <p>CH219 MERCEDES-BENZ A-CLASS (W168), Vaneo (414)</p> <p>CH221 ALFA ROMEO GIULIETTA HYUNDAI GALLOPER I, GRACE, PORTER LTI TX MITSUBISHI COLT II, COLT III, GALANT II, L 200, L 300 / DELICA II, L 300 III, PAJERO I, PAJERO II NISSAN PATHFINDER II, PATROL GR IV, PICK UP, URVAN</p> <p>CH222 ALFA ROMEO 145, 146, 147, 156, 159, 166 FIAT BRAVA, BRAVO I, CROMA, DOBLO, IDEA, MAREA, MULTIPLA, PALIO, PUNTO, SEDICI, STILO, STRADA LANCIA KAPPA, LYBRA, MUSA, THESIS OPEL ASTRA H, SIGNUM, VECTRA C, ZAFIRA B SAAB 9-3 SUZUKI SX4 (EY, GY) VAUXHALL ASTRA MK V (H), ASTRAVAN MK V (H), SIGNUM, VECTRA MK II (C), ZAFIRA MK II (B)</p> <p>CH224 ALFA ROMEO 147, 156, 159, 166, BRERA, GT, SPIDER CADILLAC BLS FIAT BRAVO II, CROMA, STILO HOLDEN ASTRA LANCIA THESIS OPEL ASTRA H, SIGNUM, VECTRA C, ZAFIRA B SAAB 9-3, 9-5</p> | <p>...CH224 VAUXHALL ASTRA MK V (H), ASTRAVAN MK V (H), SIGNUM, VECTRA MK II (C), ZAFIRA MK II (B)</p> <p>CH225 HYUNDAI H-1, H-1 / STAREX, H100, PORTER, TERRACAN KIA K2500, PREGIO</p> <p>CH226 HYUNDAI ACCENT II, ELANTRA, GETZ, GRANDEUR, I30, MATRIX, SANTA FE I, SANTA FE II, SONATA IV, SONATA V, TRAJET, TUCSON KIA CARENS II, CARENS III, CARNIVAL I, CARNIVAL II, CEE'D, CERATO, MAGENTIS, PRO CEE'D, SPORTAGE</p> <p>CH229 CITROËN JUMPER FIAT DUCATO FORD GALAXY, MONDEO III, TRANSIT, TRANSIT CUSTOM, TRANSIT TOURNEO FORD AUSTRALIA TRANSIT, TRANSIT CUSTOM JAGUAR X-TYPE LAND ROVER DEFENDER LDV CONVOY LTI TX PEUGEOT BOXER PIAGGIO PORTER</p> <p>CH230 NISSAN ALMERA II, ALMERA TINO, CABSTAR, NP300 NAVARA, NP300 PICKUP, PATHFINDER III, PICK UP, PRIMERA, X-TRAIL</p> <p>CH231 CHEVROLET ASTRA OPEL ASTRA G, FRONTERA B, OMEGA B, SIGNUM, VECTRA B, VECTRA C, ZAFIRA A SAAB 9-3 VAUXHALL ASTRA MK IV (G), FRONTERA MK II (B), OMEGA (B), SIGNUM, VECTRA (B), VECTRA MK II (C), ZAFIRA MK I (A)</p> <p>CH232 NISSAN INTERSTAR, PRIMASTAR</p> | <p>...CH232 OPEL MOVANO, VIVARO A RENAULT AVANTIME, ESPACE III, ESPACE IV, LAGUNA II, MASTER II, TRAFIC II, VEL SATIS VAUXHALL MOVANO MK I (A), VIVARO</p> <p>CH233 DACIA SOLENZA RENAULT CLIO II, KANGOO, MEGANE I, SCÉNIC I</p> <p>CH234 HYUNDAI H-1, H-1 / STAREX, PORTER KIA SORENTO I</p> <p>CH240 CITROËN C5 III, C6 JAGUAR S-TYPE, XF, XJ LAND ROVER DISCOVERY III, DISCOVERY IV, RANGE ROVER III, RANGE ROVER SPORT PEUGEOT 407, 607 VOLVO S60 I, S80 I, V70 II, XC70 CROSS COUNTRY, XC90 I</p> <p>CH242 FORD RANGER FORD AUSTRALIA COURIER, RANGER KIA BESTA, K2700, PREGIO, RETONA, SPORTAGE MAZDA 323 C IV (BG), 323 III /HATCHBACK (BF), 323 III STATION WAGON (BW), 323 P V (BA), 323 S IV (BG), 323 S V (BA), 626 II /HATCHBACK (GC), 626 III /HATCHBACK (GD), 626 III STATION WAGON (GV), 626 IV (GE), 626 IV HATCHBACK (GE), B-SERIE (PE), B-SERIE (UD), B-SERIE /PLATFORM /CHASSIS (UF), B-SERIE /PLATFORM /CHASSIS (UN), E-SERIE BOX (SR2), E-SERIE MPV (SG), E-SERIE PLATFORM /CHASSIS (SD1), MPV I (LV) SUZUKI GRAND VITARA I (FT, HT), VITARA (ET, TA)</p> <p>CH256 HYUNDAI GALLOPER I, GALLOPER II, H-1, H-1 / STAREX, PORTER, TERRACAN KIA K2500, PREGIO</p> | <p>...CH256 MITSUBISHI GALANT V, GALANT VI, GALLOPER, L 200, L 300 / DELICA II, L 300 III, L 400, LANCER V, LANCER VI, PAJERO CLASSIC, PAJERO II, PAJERO III, PAJERO SPORT I, PAJERO SPORT VAN I, SPACE RUNNER, SPACE WAGON PROTON PERSONA 400</p> <p>CH260 AUDI 80, 90, 100 BEDFORD BLITZ FORD TRANSIT MITSUBISHI CARISMA NISSAN BLUEBIRD, LAUREL, TRADE RENAULT 19 I, 19 II, MEGANE, MEGANE I SEAT CORDOBA, IBIZA II, INCA, TERRA, TOLEDO I SKODA FELICIA I, FELICIA II VOLVO 240, 440 K, 460 L, 740, 760, 780, 940, 940 II, 960, S40 I, V40 VW CADDY I, CADDY II, GOLF I, GOLF II, GOLF III, GOLF IV, ILTIS, JETTA I, JETTA II, LT 28-35 I, LT 40-55 I, PASSAT, POINTER, POLO, POLO VAN, QUANTUM, SANTANA, TRANSPORTER III, TRANSPORTER IV, VENTO</p> <p>CH263 MITSUBISHI PAJERO III, PAJERO SPORT I</p> <p>CH268 CITROËN C4, C4 I, C4 PICASSO I, C5 I, C5 II, C5 III, C8, JUMPER, JUMPY FIAT SCUDO, ULYSSE FORD C-MAX, FOCUS C-MAX, FOCUS II, GALAXY, KUGA I, MONDEO IV, S-MAX FORD AUSTRALIA FOCUS LANCIA PHEDRA PEUGEOT 307, 308, 308 CC, 308 SW, 406, 407, 508 I, 508 SW I, 607, 807, BOXER, EXPERT, EXPERT TEPEE SUZUKI GRAND VITARA I (FT, HT) VOLVO C30, C70 II, S40 II, S80 II, V50, V70 III</p> <p>CH269 ALFA ROMEO 147, 159</p> |
|---|--|--|---|



...CH269

FIAT

BRAVO II, CROMA, DOBLO, GRANDE PUNTO, MULTIPLA, PUNTO, STILO

OPEL

ASTRA H, SIGNUM, VECTRA C, ZAFIRA B

SAAB

9-3

VAUXHALL

ASTRA MK V (H), ASTRAMAN MK V (H), SIGNUM, VECTRA MK II (C), ZAFIRA MK II (B)

CH270

CITROËN

JUMPER

FIAT

DUCATO

IVECO

DAILY III, DAILY IV, DAILY V, MASSIF

PEUGEOT

BOXER

CH271

AUDI

80, 100, A3, A4, A6, CABRIOLET

DACIA

DUSTER, LOGAN, LOGAN MCV, SANDERO

FORD

GALAXY

MITSUBISHI

CARISMA, SPACE STAR

NISSAN

ALMERA II, INTERSTAR, KUBISTAR, MICRA III, NOTE, NV200, NV200 / EVALIA, PRIMASTAR, PRIMERA, QASHQAI / QASHQAI +2 I, TIDA, TRADE

OPEL

MOVANO, VIVARO A

RENAULT

CLIO, CLIO II, CLIO III, DUSTER, ESPACE III, ESPACE IV, GRAND SCÉNIC II, KANGOO, LAGUNA I, LAGUNA II, LAGUNA III, LOGAN EXPRESS, LOGAN I, MASTER II, MEGANE I, MEGANE II, MODUS / GRAND MODUS, SCÉNIC I, SCÉNIC II, THALIA I, THALIA II, TRAFIC II, TWINGO II

SEAT

ALHAMBRA, AROSA, CORDOBA, IBIZA II, INCA, LEON, TOLEDO I, TOLEDO II

SKODA

FABIA I, OCTAVIA I

SUZUKI

JIMNY CLOSED OFF-ROAD VEHICLE (SN)

VAUXHALL

MOVANO MK I (A), VIVARO

VOLVO

850, S40 I, S70, S80 I, V40, V70 I, V70 II

VW

BORA, CADDY II, GOLF III, GOLF IV, LT 28-35 II, LT 28-46 II, LUPO, NEW BEETLE, PASSAT, POLO, POLO VAN, SHARAN, TRANSPORTER IV, VENTO, VOYAGE

CH272

LAND ROVER

DEFENDER, DISCOVERY II

CH302

DAIHATSU

CHARADE III

TOYOTA

AVENSIS, CALDINA, CAMRY, CARINA E, CARINA II, COROLLA, COROLLA FX, CORONA, DELIBOY, LAND CRUISER, LAND CRUISER 80, LITEACE, MASTER ACE SURF, MODELL F, SCEPTER, SPRINTER, TOWN ACE, VISTA

CH306

DADI

CITY COURSER, PICK UP

FOTON

SURF

HOLDEN

RODEO

ISUZU

D-MAX I, ELF, KB, TROOPER I

LANDWIND (JMC)

LANDWIND

OPEL

CAMPO, FRONTERA A

VAUXHALL

BRAVA, FRONTERA MK I (A)

CH600

NISSAN

AD VAN, ALMERA I, AVENIR, LUCINO, PRIMERA, SUNNY III

CH608

TOYOTA

4 RUNNER, COROLLA, CRESTA, DELIBOY, GAIA, GRANVIA, HILUX, HILUX VI, LAND CRUISER, LAND CRUISER 90, LAND CRUISER PRADO, LITEACE, PICNIC, SPRINTER

CH704

MERCEDES-BENZ

C-CLASS (W203), C-CLASS COUPE (CL203), C-CLASS T-MODEL (S203)

CPSG003

OPEL

ASTRA J, CORSA D, MERIVA B

VAUXHALL

ASTRA MK VI (J), CORSA MK III (D), MERIVA MK II (B)

CPSG004

OPEL

ASTRA J, MOKKA / MOKKA X

VAUXHALL

ASTRA MK VI (J), MOKKA / MOKKA X

CPSG006

OPEL

ASTRA J, CASCADA, INSIGNIA A, ZAFIRA TOURER C

VAUXHALL

ASTRA MK VI (J), CASCADA, INSIGNIA MK I (A), ZAFIRA MK III

CPSG007

AUDI

A1, A3, A4, A4 ALLROAD, A5, A6, A6 ALLROAD, A7, A8, Q2, Q3, Q5, Q7, TT

SEAT

ALHAMBRA, ATECA, IBIZA IV, LEON, TOLEDO IV

SKODA

FABIA III, KODIAQ, OCTAVIA III, RAPID, SUPERB III, YETI

VW

BEETLE, CADDY ALLTRACK, CADDY IV, CC, CRAFTER, GOLF ALLTRACK, GOLF VI, GOLF VII, GOLF SPORTSVAN, JETTA III, JETTA IV, MULTIVAN VI, PASSAT, PASSAT ALLTRACK, POLO, POLO VAN, SCIROCCO, SHARAN, TIGUAN, TIGUAN ALLSPACE, TOUAREG, TOURAN, TRANSPORTER VI, XLT

CPSG008

AUDI

A4, A4 ALLROAD, A5, A6, A7, Q5, Q7

VW

AMAROK, CRAFTER, GOLF SPORTSVAN, MULTIVAN VI, TOUAREG, TRANSPORTER VI

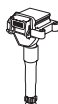
**BAE403B****FIAT**
DOBLO, STILO**BAE403C****ALFA ROMEO**
MITO
DODGE
DART**FIAT**
500, 500 C, 500L, BRAVO II, DOBLO, DUCATO, GRANDE PUNTO, IDEA, PANDA, PANDA VAN, PUNTO, STILO**LANCIA**
MUSA, YPSILON**BAE403D****FIAT**
STILO**BAE408AE****AUDI**
A1, A2, A3**SEAT**
ALHAMBRA, ALTEA, ALTEA XL, CORDOBA, IBIZA III, IBIZA IV, LEON, TOLEDO II, TOLEDO III, TOLEDO IV**SKODA**
FABIA I, FABIA II, OCTAVIA I, OCTAVIA II, RAPID, ROOMSTĚR, ROOMSTER PRAKTIK, SUPERB II, YETI**VW**
BEETLE, BORA, CADDY III, CC, EOS, GOLF IV, GOLF V, GOLF VI, GOLF PLUS, JETTA III, JETTA IV, LUPO, NEW BEETLE, PASSAT, PASSAT CC, POLO, POLO VIVO, SCIROCCO, SHARAN, TIGUAN, TOURAN**BAE409A****DACIA**
DUSTER, LOGAN, LOGAN MCV, SANDERO**LADA**
LARGUS
NISSAN
KUBISTAR, PRIMASTAR**OPEL**
VIVARO A**RENAULT**
AVANTIME, CLIO, CLIO II, CLIO III, DUSTER, ESPACE III, ESPACE IV, FLUENCE, GRAND SCĚNIC II, GRAND SCĚNIC III, KANGOO, KANGOO BE BOP, KANGOO / GRAND KANGOO, LAGUNA, LAGUNA I, LAGUNA II, LAGUNA III, LOGAN I, LOGAN II, MEGANE, MEGANE CC, MEGANE I, MEGANE II, MEGANE III, MODUS / GRAND MODUS, SANDERO / STEPWAY I, SCĚNIC I, SCĚNIC II, SCĚNIC III, THALIA I, THALIA II, TRAFIC II, TWINGO II, VEL SATIS, WIND**VAUXHALL**
VIVARO**BAE504D****FIAT**
CROMA, FIORINO, FIORINO PICK UP, TEMPRA, TIPO, UNO**LANCIA**
DEDRA, DELTA II, THEMA, Y10**BAE504I****RENAULT**
19 II, CLIO I, RAPID, TWINGO I**BAE506D****AUTOBIANCHI**
Y10
FIAT
TEMPRA, TIPO, UNO**LANCIA**
Y10
ZASTAVA
YUGO FLORIDA**BAE506F****FIAT**
CROMA, DUNA, FIORINO, FIORINO PICK UP, PANDA, PENNY, REGATA, RITMO, TIPO, UNO**LANCIA**
DELTA I, PRISMA, THEMA, Y10**BAE700AK****CITROËN**
XANTIA, ZX
MASERATI
GHIBLI II, QUATTROPORTE IV**PEUGEOT**
306, 405 II**BAE800B****ALFA ROMEO**
33, 145, 146, 155
FIAT
CINQUECENTO, COUPE, DOBLO, ELBA, PALIO, PANDA, PREMIO, PUNTO, SEICENTO / 600, SIENA, STRADA, TEMPRA, TIPO**LAMBORGHINI**
DIABLO
LANCIA
DEDRA, DELTA I, DELTA II, THEMA, Y, YPSILON**BAE851AE****AUDI**
80, 100, CABRIOLET, COUPE**SEAT**
ALHAMBRA, AROSA, CORDOBA, IBIZA II, INCA, TOLEDO I**SKODA**
FAVORIT, FELICIA I, FELICIA II, OCTAVIA I
VW
CADDY II, CORRADO, GOLF III, GOLF IV, KAEFER, LUPO, PASSAT, POLO, POLO VAN, SHARAN, TRANSPORTER IV, VENTO**BAE907AE****AUDI**
A1, A2, A3, A4**SEAT**
ALHAMBRA, ALTEA, ALTEA XL, AROSA, CORDOBA, EXEO, IBIZA II, IBIZA III, IBIZA IV, INCA, LEON, TOLEDO II, TOLEDO III, TOLEDO IV**SKODA**
FABIA I, FABIA II, OCTAVIA I, OCTAVIA II, RAPID, ROOMSTĚR, ROOMSTER PRAKTIK, SUPERB I, YETI**...BAE907AE****VW**
BEETLE, BORA, CADDY II, CADDY III, FOX, GOLF IV, GOLF V, GOLF VI, GOLF PLUS, GOL IV, JETTA III, JETTA IV, LUPO, MULTIVAN V, NEW BEETLE, PASSAT, POLO, SHARAN, TOURAN, TRANSPORTER V, VOYAGE**BAE920AX****FIAT**
BRAVA, BRAVO I, DOBLO, MAREA, MULTIPLA, PALIO, SIENA**LANCIA**
DEDRA, DELTA II, LYBRA**BAE940A****ALFA ROMEO**
MITO
FIAT
500, 500 C, DOBLO, FIORINO, GRANDE PUNTO, IDĚA, LINEA, PANDA, PUNTO, PUNTO EVO, QUBO, SIENA**FORD**
KA
LANCIA
MUSA, YPSILON**NISSAN**
TEANA I**BAE946A****CITROËN**
BERLINGO / BERLINGO FIRST, C2, C3, C3 I, SAXO, XSARA, XSARA PICASSO
PEUGEOT
106 II, 206, 306, 307, 1007, PARTNER**BAE947A****DACIA**
LOGAN, LOGAN II, SANDERO, SANDERO II
NISSAN
KUBISTAR**RENAULT**
CLIO, CLIO III, CLIO IV, KANGOO, MODUS / GRAND MODUS, THALIA I, THALIA II, TWINGO I, TWINGO II**BAE960AE****SKODA**
FELICIA II**BAE961AE****SEAT**
AROSA
SKODA
FABIA I, OCTAVIA I, OCTAVIA II**BAE965A****VW**
LUPO
OPEL
ASTRA G, COMBO, CORSA C, CORSA UTILITY, MERIVA A, VECTRA B, VECTRA C, ZAFIRA A, ZAFIRA B**VAUXHALL**
ASTRA MK IV (G), COMBO MK II (C), COMBO TOUR MK II (C), CORSA MK II (C), MERIVA MK I (A), VECTRA (B), ZAFIRA MK I (A), ZAFIRA MK II (B)**BAEA002E****SEAT**
CORDOBA, IBIZA II, TOLEDO I
VW
PASSAT, POLO, TRANSPORTER IV, VENTO**BAEA004E****FORD**
GALAXY
MERCEDES-BENZ
V-CLASS (638/2)**VW**
CORRADO, GOLF III, PASSAT, SHARAN, TRANSPORTER IV, VENTO**BAEA007E****AUDI**
80, 100, A6, CABRIOLET, COUPE**BAEA009E****AUDI**
A3, A6, A8, TT
SEAT
ALHAMBRA, CORDOBA, IBIZA II, LEON, TOLEDO II**SKODA**
OCTAVIA I
VW
GOLF IV, NEW BEETLE, SHARAN**BAEA012E****PORSCHE**
CAYENNE (9PA)**BAEA013E****SEAT**
LEON
VW
BORA, GOLF IV, NEW BEETLE**BAEA014****BMW**
3 (E30), 3 (E36), 3 CONVERTIBLE (E36), 3 / CONVERTIBLE / COUPE (E36), 3 COUPE (E36), 5 (E34), 5 / TOURING (E34), 5 TOURING (E34), 7 (E32), 7 (E38), 8 (E31)**BAEA016****AUDI**
A3, A4, A6, A8, ALLROAD, TT
SEAT
ALHAMBRA, LEON**SKODA**
OCTAVIA I
VW
BORA, GOLF IV, PASSAT, SHARAN**BAEA017****AUDI**
A8
BAEA019E**VOLVO**
C70 I, S60 I, S70, S80 I, V70 I, V70 II, XC70 CROSS COUNTRY, XC90 I**BAEA021E****NISSAN**
ALMERA II, ALMERA TINO, PRIMERA



BAEA025E

CHEVROLET
EVANDA
DAEWOO
LACETTI, LANOS, LEGANZA, MAGNUS,
NUBIRA
FSO
LANOS
OPEL
FRONTERA B
VAUXHALL
FRONTERA MK II (B)
ZAZ
LANOS

BAEA026E

OPEL
ASTRA F, ASTRA F CLASSIC, ASTRA G,
COMBO, CORSA A, CORSA B, TIGRA,
VECTRA A, VECTRA B
VAUXHALL
ASTRA MK III (F), ASTRA MK IV (G),
ASTRAVAN MK III (F), ASTRAVAN MK IV
(G), CAVALIER MK III, CORSA MK I (B),
NOVA, TIGRA MK I, VECTRA (B)

BAEA029E

SKODA
OCTAVIA I
VW
BORA, CADDY III, GOLF IV, JETTA IV, NEW
BEETLE, TOURAN

BAEA031E

AUDI
A8
BENTLEY
CONTINENTAL, CONTINENTAL FLYING
SPUR, FLYING SPUR
VW
PASSAT, PHAETON, TOUAREG

BAEA032E

AUDI
A4, A5, A6, A6 ALLROAD, A7, A8, Q5, Q7,
R8
LAMBORGHINI
GALLARDO, GALLARDO SPYDER
PORSCHE
CAYENNE (92A), PANAMERA (970)
VW
TOUAREG

BAEA033E

AUDI
A1, A3, A4, A4 ALLROAD, A5, A6, A8, Q3,
Q5, R8, TT
LAMBORGHINI
GALLARDO, GALLARDO SPYDER
SEAT
ALHAMBRA, ALTEA, ALTEA XL, EXEO, LEON,
TOLEDO III
SKODA
OCTAVIA II, SUPERB II, YETI

...BAEA033E

VW
AMAROK, BEETLE, EOS, GOLF V, GOLF VI,
GOLF PLUS, JETTA III, JETTA IV, MULTIVAN
V, MULTIVAN VI, PASSAT, PASSAT CC,
POLO, SCIROCCO, SHARAN, TIGUAN,
TOUAREG, TOURAN, TRANSPORTER V,
TRANSPORTER VI

BAEA037

SEAT
TOLEDO II
VW
BORA, GOLF IV, PASSAT

BAEA037E

RENAULT
SAFRANE II
VOLVO
850, C70 I, S70, V70 I, XC70 CROSS
COUNTRY

BAEA041

MERCEDES-BENZ
C-CLASS (W203), C-CLASS COUPE (CL203),
C-CLASS T-MODEL (S202), C-CLASS
T-MODEL (S203), CLK (C208), CLK
CONVERTIBLE (A208), E-CLASS (W210),
E-CLASS T-MODEL (S210), SLK (R170)

BAEA041E

AUDI
Q7
SKODA
SUPERB II
VW
CC, EOS, PASSAT, PASSAT CC, PHAETON,
TOUAREG

BAEA042E

PORSCHE
CAYENNE (9PA), CAYENNE (92A),
PANAMERA (970)

BAEA043

AUDI
80, 100, A6, COUPE

BAEA043E

AUDI
A3, A4, A6, ALLROAD, TT
SEAT
CORDOBA, EXEO, IBIZA II, IBIZA III, LEON,
TOLEDO II
SKODA
OCTAVIA I, SUPERB I
VW
BORA, GOLF IV, NEW BEETLE, PASSAT,
POLO

BAEA044E

AUDI
A3, TT
PORSCHE
CAYENNE (9PA), CAYENNE (92A)
SEAT
LEON
VW
EOS, GOLF IV, GOLF V, MULTIVAN V,
PHAETON, TOUAREG, TRANSPORTER V

BAEA045E

CITROËN
BERLINGO, BERLINGO / BERLINGO FIRST,
C2, C3, C3 I, C4, C4 I, XSARA, XSARA
PICASSO
PEUGEOT
206, 207, 307, 308 SW, 1007, PARTNER,
PARTNER TEPEE

BAEA046E

CITROËN
SAXO
PEUGEOT
106 II

BAEA048E

CITROËN
BERLINGO / BERLINGO FIRST, C3 I, C3 II,
NEMO
FIAT
FIORINO, QUBO

PEUGEOT
206, 206+, 207, 207 SW, 1007, BIPPER,
BIPPER TEPEE, PARTNER

BAEA051E

AUDI
A4, A6, A8
BAEA052E
PORSCHE
911 (997), 911 /CONVERTIBLE (991),
911 /CONVERTIBLE (997), 911
/CONVERTIBLE /TARGA (997), BOXSTER
(987), BOXSTER SPYDER (987), CAYMAN
(987)

BAEA053

MERCEDES-BENZ
C-CLASS (W203), C-CLASS COUPE (CL203),
C-CLASS T-MODEL (S203), CLC-CLASS
(CL203), CLK (C209), CLK CONVERTIBLE
(A209), E-CLASS (W211), E-CLASS
T-MODEL (S211), SLK (R171), SPRINTER
3.5-T BOX /BUS /PLATFORM /CHASSIS
(906), SPRINTER 5-T PLATFORM /CHASSIS
(906)

MERCEDES-BENZ (BBDC)

E-CLASS

BAEA055E

FORD
FOCUS II, KUGA I, MONDEO IV, S-MAX
VOLVO
C30, C70 II, S40 II, S60 I, S60 II, S80 I,
S80 II, V40, V50, V60, V70 II, V70 III,
XC60

BAEA056E

NISSAN
CUBE, MICRA C+C III, MICRA III, NOTE,
NV200, NV200 / EVÁLIA, QASHQAI /
QASHQAI +2 I, TIIDA, X-TRAIL

RENAULT

CLIO III, LAGUNA III

BAEA059E

SEAT
IBIZA III
SKODA
FABIA I, FABIA II

...BAEA059E

VW
FOX, POLO

BAEA061E

AUDI
A4, A6, A8

BAEA062E

AUDI
ALLROAD
VW
PHAETON, TOUAREG

BAEA063E

FORD
GALAXY
SEAT
ALHAMBRA, TOLEDO II

VW
BORA, GOLF IV, NEW BEETLE, SHARAN

BAEA065E

VW
PASSAT

BAEA066E

RENAULT
GRAND SCÉNIC III, MEGANE CC, MEGANE
III, SCÉNIC III

BAEA067E

AUDI
A1, A3, Q3
SEAT
IBIZA IV, LEON, MII

SKODA
CITIGO, FABIA III, OCTAVIA III, YETI

VW
BEETLE, CADDY IV, CC, GOLF VI, GOLF VII,
GOLF SPORTSVAN, JETTA IV, PASSAT, POLO,
SHARAN, TIGUAN, TOURAN, UP

BAEA068E

ASTON MARTIN
RAPIDE

AUDI
A1, A3, A4, A4 ALLROAD, A5, A6, A7, Q3,
Q5, Q7, TT

PORSCHE
MACAN (95B)

SEAT
ALHAMBRA, IBIZA IV, LEON

SKODA
OCTAVIA III, SUPERB III

VW
BEETLE, GOLF VI, GOLF VII, JETTA IV,
PASSAT, POLO

BAEA072E

SUZUKI
BALENO /ESTATE /HATCHBACK (EG),
GRAND VITARA I (FT, HT), GRAND VITARA
II (JT, TE, TD), VITARA (ET, TA), VITARA
/CABRIO (ET, TA)

BAEA073E

INFINITI
I30
NISSAN
CEFIRO II, MAXIMA / MAXIMA QX IV

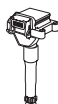
**...BAEA184E**

TOYOTA
ALLION II, AURIS, AURIS TOURING SPORTS, AVENSIS, COROLLA, COROLLA RUMION, ISIS, NOAH/VOXY, PREMIO, PRIUS, PRIUS PLUS, RAV 4 III, RAV 4 IV, VERSO, WISH, YARIS

BAEA185E

CHEVROLET
AVEO, CRUZE, ORLANDO, TRAX, VOLT

OPEL
ADAM, AMPERA, ASTRA J, CASCADA, CORSA D, CORSA E, INSIGNIA A, MERIVA B, MOKKA / MOKKA X, ZAFIRA TOURER C

VAUXHALL
ADAM, AMPERA, ASTRA MK VI (J), CASCADA, CORSA MK III (D), CORSA MK IV (E), CORSAVAN MK III (D), INSIGNIA MK I (A), MERIVA MK II (B), MOKKA / MOKKA X, ZAFIRA MK III

BAEA186E

TOYOTA
HIACE IV, LAND CRUISER, TACOMA

BAEA188E

NISSAN
CUBE, MICRA C+C III, MICRA III, NOTE

BAEA189E

OPEL
AGILA (B)

SUZUKI
SPLASH (EX), SWIFT IV (FZ, NZ)

VAUXHALL
AGILA MK II (B)

BAEA190E

MAZDA
323 F VI (BJ), 323 S VI (BJ)

BAEA191E

SUBARU
FORESTER, IMPREZA, LEGACY III, LEGACY IV, OUTBACK

BAEA192E

LEXUS
ES, GS, GX, IS C, IS II, IS III, LS, LX, RX

TOYOTA

AURIS, CAMRY, COROLLA, FJ CRUISER, IQ, LAND CRUISER, LAND CRUISER 200, LAND CRUISER PRADO, RAV 4 IV, URBAN CRUISER, VENZA, VERSO S, MARK X I, YARIS

BAEA193E

MITSUBISHI
LANCER VII, OUTLANDER I

BAEA194E

DAIHATSU
COPEN, MATERIA, SIRION, TERIOS

BAEA195E

MAZDA
MX-5 I (NA), MX-5 III (NC)

BAEA196E

JAGUAR
S-TYPE, XF, XJ, XK, XK 8

...BAEA196E

LAND ROVER
DISCOVERY III, RANGE ROVER III, RANGE ROVER SPORT

BAEA198E

CHEVROLET
TRAX

OPEL
ASTRA J, MOKKA / MOKKA X

VAUXHALL
ASTRA MK VI (J), MOKKA / MOKKA X

BAEA199E

CHEVROLET
AVEO, TRAX

HOLDEN
TRAX

OPEL
ASTRA J, CORSA E, INSIGNIA A, MOKKA, ZAFIRA TOURER C

VAUXHALL
ASTRA MK VI (J), CORSA MK IV (E), INSIGNIA MK I (A), ZAFIRA MK III

BAEA231

CITROËN
AX, ZX

PEUGEOT
106 I, 106 II, 106 VAN, 205 II, 306, 405 II

ROVER
400, 800, MINI

BAEA232

CITROËN
BX, EVASION, XSARA

FIAT
DUCATO

PEUGEOT
106 II, 205 I, 205 II, 306, 309 II, 405 I, 405 II, 406, 605, 806, BOXER, EXPERT, PARTNER

ROVER
CITYROVER

BAEA234

ALFA ROMEO
33, 145, 146, 155, 164

CITROËN
JUMPY

DACIA
1309, NOVA, PICK UP

FERRARI
348, 348 TB/GTB, 348 TS/GTS, F355, F355 BERLINETTA, MONDIAL

FIAT
BRAVA, BRAVO I, CROMA, FIORINO, FIORINO PICK UP, MAREA, PALIO, PUNTO, SCUDO, SIENA, TEMPRA, TIPO, UNO

FSO
POLONEZ III

KIA
SPORTAGE

LADA
NOVA

...BAEA234

LANCIA
DEDRA, DELTA II, KAPPA, THEMA, Y, Y10

LAND ROVER
DISCOVERY II, RANGE ROVER II

PEUGEOT
EXPERT

PROTON
GEN 2, JUMBUCK, SAGA II, SATRIA, SATRIA NEO, WIRA

BAEA242

RENAULT
CLIO II, KANGOO, MEGANE, MEGANE I

BAEA243

RENAULT
CLIO II, KANGOO, MEGANE, MEGANE I

BAEA245

RENAULT
MEGANE, MEGANE I

VOLVO
V40

BAEA246

RENAULT
MEGANE, MEGANE I

VOLVO
V40

BAEA251

ALPINE
A610, V6

JEEP
CHEROKEE, WRANGLER I

RENAULT
9, 11, 18, 19 I, 19 II, 21, 25, CLIO I, ESPACE I, ESPACE II, ESPACE III, LAGUNA I, MASTER I, MEGANE, MEGANE I, RAPID, SAFRANE I, SAFRANE II, SUPER 5, TRAFIC

VOLVO
340-360, 440 K, 460 L, 480 E, 850

BAEA252

OPEL
ASCONA B, ASCONA C, ASTRA F, CORSA A, KADETT D, KADETT E, MANTA B, VECTRA A

VAUXHALL
ASTRA, ASTRA MK II, ASTRA MK III (F), ASTRAMAX, ASTRAVAN MK III (F), CAVALIER MK II, CAVALIER MK III, NOVA, NOVAVAN

BAEA253

OPEL
ASTRA F, ASTRA F CLASSIC, COMBO, CORSA A, CORSA B, KADETT, KADETT E, OMEGA A, VECTRA A, VECTRA B

VAUXHALL
ASTRA, ASTRA MK II, ASTRA MK III (F), ASTRAMAX, ASTRAVAN MK III (F), CARLTON MK III, CAVALIER MK III, COMBO MK I (B), CORSA MK I (B), CORSAVAN MK I (B), NOVA, VECTRA (B)

BAEA254

RENAULT
LAGUNA I, SAFRANE II

VOLVO
S40 I, V40

BAEA255

RENAULT
LAGUNA I, SAFRANE II

VOLVO
S40 I, V40

BAEA256

CITROËN
XANTIA, XM, ZX

PEUGEOT
306, 406, 605

BAEA264

HYUNDAI
ACCENT, ACCENT I, LANTRA II

MITSUBISHI
COLT V

BAEA266

HYUNDAI
ATOS, ATOS PRIME

BAEA267

HYUNDAI
COUPE, LANTRA II

BAEA269

HYUNDAI
SONATA IV

INFINITI
G20

KIA
MAGENTIS

BAEA275

HONDA
ACCORD IV, ACCORD V, ACCORD VI, CIVIC V, CIVIC VI, CR-V I, CRX III, HR-V, INTEGRA, LOGO, PRELUDE III, PRELUDE IV, PRELUDE V, SHÛTTLE

ROVER
600

BAEA281

FORD
ESCORT '86, ESCORT '91, ESCORT '95, ESCORT CLASSIC, ESCORT IV, ESCORT V, ESCORT VI, ESCORT VII, FIESTA, FIESTA III, FIESTA IV, KA, KA VAN, MONDEO I, MONDEO II, ORION II, ORION III, PUMA, SCORPIO I, SIERRA, TRANSIT CONNECT

MAZDA
626 V (GF), 626 V /HATCHBACK (GF), 626 V HATCHBACK (GF), 626 V STATION WAGON (GW), MPV II (LW)

BAEA296

MERCEDES-BENZ
190 (W201), COUPE (C124), E-CLASS (W124), E-CLASS T-MODEL (S124), KOMBI T-MODEL (S124), SALOON (W124), S-CLASS (W126), S-CLASS (W140), SL (R129)

BAEA297

CHRYSLER
CROSSFIRE

**BAEA489****MAZDA**

2 (DE_, DH_3), 2 (DY), 2 SALOON (DE_), 3 (BK), 3 (BL), 3 /SALOON (BK), 3 SALOON (BK), 3 /SALOON (BL), 3 /SALOON (BM, BN)

BAEA501**FSO**

POLONEZ III

LAND ROVER

FREELANDER

MG

EXPRESS, MGF, MG TF, MG ZR, MG ZS, MG ZT, MG ZT-

ROVER

25, 45, 75, 200, STREETWISE

BAEA502E**HYUNDAI**

H-1 / STAREX, HIGHWAY VAN, SANTA FÉ I, SONATA IV, SONATA V, TIBURON, TRAJET

KIA

MAGENTIS, SORENTO I

BAEA508**CHEVROLET**

LACETTI, NUBIRA, OPTRA

DAEWOO

LACETTI, NUBIRA

BAEA521**HYUNDAI**

SANTAMO

KIA

JOICE

MINISUBISHI

SANTAMO

BAEA531**HYUNDAI**

GENESIS, GRANDEUR, SANTA FÉ II, SONATA V

KIA

CARENS III, MAGENTIS, OPIRUS, SORENTO I

BAEA536**HYUNDAI**

110, 120

KIA

RIO III

BAEA538**BMW**

1 (F20), 1 (F21), 2 ACTIVE TOURER (F45), 2 CONVERTIBLE (F23), 2 COUPE (F22, F87), 2 GRAN TOURER (F46), 3 (F30, F80), 3 GRAN TURISMO (F34), 3 TOURING (F31), 4 CONVERTIBLE (F33, F83), 4 COUPE (F32, F82), 4 GRAN COUPE (F36), 5 (G30, F90), 7 (G11, G12), X1 (F48), X2 (F39)

GMC

SAVANA 2500

MINI

MINI, MINI CLUBMAN, MINI COUNTRYMAN

BAEA539**CHEVROLET**

MATIZ, SPARK

...BAEA539**DAEWOO**

MATIZ, TICO

BAEA540**DAEWOO**

MATIZ, TICO

BAEA543**CHEVROLET**

LACETTI, NUBIRA

DAEWOO

LACETTI, NEXIA, NUBIRA

BAEA547**CITROËN**

C4 AIRCROSS

MINISUBISHI

ASX, COLT VI, LANCER VIII

BAEA548**HYUNDAI**

EQUUS / CENTENNIAL, GENESIS, H-1, IX35, SANTA FÉ II, SANTA FÉ III, SONATA V, SONATA VI

KIA

CERATO II, CERATO Koup, MAGENTIS, OPTIMA, SORENTO II, SPORTAGE

BAEA549**FIAT**

BARCETTA, BRAVA, BRAVO I, COUPE, MAREA

LANCIA

DEDRA, DELTA II

BAEA554**DAEWOO**

CIELO, ESPERO, NEXIA

BAEA555**HYUNDAI**

TUCSON

KIA

SPORTAGE

BAEA556**MAZDA**

6 HATCHBACK /SALOON (GG), 6 HATCHBACK /SALOON (GH), 6 STATION WAGON (GY), MPV II (LW)

BAEA557**CITROËN**

C3 II, C3 PICASSO, C4 CACTUS, C4 GRAND PICASSO II, C4 II, C4 PICASSO II, DS3, DS4

PEUGEOT

208, 308 II, 308 SW II, 2008, 3008, 5008

BAEA560**MAZDA**

121 I (DA), 121 II (DB), 323 C IV (BG), 323 C V (BA), 323 F IV (BG), 323 F VI (BJ), 323 III /HATCHBACK (BF), 323 III HATCHBACK (BF), 323 P V (BA), 323 S IV (BG), 323 S V (BA)

BAEA561**KIA**

RIO



CCU081

AUDI
A3
SEAT
ALHAMBRA, AROSA, CORDOBA, IBIZA II, IBIZA III, INCA, LEON, TOLEDO I, TOLEDO II
SKODA
FABIA I, OCTAVIA I
VW
BORA, CADDY II, CADDY III, FOX, GOLF III, GOLF IV, GOLF PLUS, LUPO, NEW BEETLE, PASSAT, POLO, POLO VAN, SHARAN, TOURÈG, TRANSPORTER IV, TRANSPORTER V, VENTO

CCU101

BMW
1 (E87), 3 (E46), 3 (E90), 3 COMPACT / CONVERTIBLE (E46), 3 / COMPACT / COUPE (E46), 3 TOURING (E46), 3 TOURING (E91), 5 (E60), 5 TOURING (E61), 6 (E63), 6 CONVERTIBLE (E64), 7 (E65, E66, E67), X3 (E83), X5 (E53), X5 (E70), X6 (E71, E72)

CCU102

BMW
3 (E90), 3 CONVERTIBLE (E93), 3 CONVERTIBLE / COUPE (E46), 3 COUPE (E92), 3 / TOURING (E46), 3 TOURING (E91), 5 (E60), 5 TOURING (E61), 6 (E63), 6 CONVERTIBLE (E64), 7 (E65, E66, E67), X3 (E83), X5 (E53), X5 (E70), X6 (E71, E72)

CCU104

MERCEDES-BENZ
C-CLASS (W203), C-CLASS COUPE (CL203), C-CLASS T-MODEL (S203)

CCU105

BMW
1 (E81), 1 (E87), 1 CONVERTIBLE (E88), 1 COUPE (E82), 3 (E90), 3 CONVERTIBLE (E93), 3 COUPE (E92), 3 TOURING (E91), 5 (E60), 5 TOURING (E61), X1 (E84), X3 (E83)

CCU106

BMW
1 (F20), 1 (F21), 2 COUPE (F22, F87), 3 (E90), 3 (F30, F80), 3 CONVERTIBLE (E93), 3 COUPE (E92), 3 GRAN TURISMO (F34), 3 TOURING (E91), 3 TOURING (F31), 4 CONVERTIBLE (F33, F83), 4 COUPE (F32, F82), 4 GRAN COUPE (F36), 5 (F10), 5 GRAN TURISMO (F07), 5 TOURING (F11), X1 (E84), X3 (F25), X5 (F15, F85)

CCU108

BMW
3 (E90), 3 CONVERTIBLE (E93), 3 COUPE (E92), 3 TOURING (E91), 5 (F10), 5 GRAN TURISMO (F07), 5 TOURING (F11), 7 (F01, F02, F03, F04), X5 (E70), X6 (E71, E72)

CCU110

MERCEDES-BENZ
C-CLASS (W204), C-CLASS T-MODEL (S204), E-CLASS (W211), E-CLASS T-MODEL (S211)

CCU113

MERCEDES-BENZ
E-CLASS (W211), E-CLASS T-MODEL (S211)

CCU114

JEEP
GRAND CHEROKEE III
MERCEDES-BENZ
C-CLASS (W203), C-CLASS (W204), C-CLASS T-MODEL (S203), C-CLASS T-MODEL (S204), CLK (C209), CLK CONVERTIBLE (A209), CLS (C219), E-CLASS (W211), E-CLASS T-MODEL (S211), G-CLASS (W461), GL-CLASS (X164), GLK-CLASS (X204), M-CLASS (W164), R-CLASS (W251, V251), S-CLASS (W221), SPRINTER 3,5-T BOX / BUS / PLATFORM / CHASSIS (906), SPRINTER 3-T BOX / PLATFORM / CHASSIS (906), SPRINTER 3-T PLATFORM / CHASSIS (906), SPRINTER 4,6-T BOX / PLATFORM / CHASSIS (906), SPRINTER 4,6-T PLATFORM / CHASSIS (906), SPRINTER 5-T BOX / PLATFORM / CHASSIS (906), SPRINTER 5-T BUS, VIANO (W639), VITO BUS (W639), VITO / MIXTO BOX (W639)

CCU116

MERCEDES-BENZ
C-CLASS (W204), C-CLASS T-MODEL (S204), CLS (C218), CLS (C219), CLS SHOOTING BRAKE (X218), E-CLASS (W211), E-CLASS (W212), E-CLASS CONVERTIBLE (A207), E-CLASS COUPE (C207), E-CLASS T-MODEL (S211), E-CLASS T-MODEL (S212), G-CLASS / CABRIO (W463), GL-CLASS (X164), GL-CLASS (X166), GLK-CLASS (X204), M-CLASS (W164), M-CLASS (W166), R-CLASS (W251, V251), S-CLASS (W221), S-CLASS (W222, V222, X222), SPRINTER 3,5-T BOX / BUS / PLATFORM / CHASSIS (906), SPRINTER 3-T BOX / PLATFORM / CHASSIS (906), SPRINTER 4,6-T BOX / PLATFORM / CHASSIS (906), SPRINTER 4,6-T PLATFORM / CHASSIS (906), SPRINTER 5-T BOX / PLATFORM / CHASSIS (906), SPRINTER 5-T BUS, VITO BUS (W639), VITO / MIXTO BOX (W639)

CCU118

MERCEDES-BENZ
E-CLASS (W211), GL-CLASS (X164), M-CLASS (W164), S-CLASS (W221)

CCU128

RENAULT
CLIO II, KANGOO

CCU129

DACIA
SOLENZA

OPEL
MOVANO

RENAULT
CLIO II, ESPACE III, KANGOO, LAGUNA I, MASTER II, MEGANE, MEGANE CC, MEGANE I, SCÉNIC I

VAUXHALL
MOVANO MK I (A)

CCU138

OPEL
ANTARA, ASTRA J, CASCADA, CORSA D, INSIGNIA A, MERIVA B, ZAFIRA TOURER C

...CCU138

VAUXHALL
ANTARA, ASTRA MK VI (J), CASCADA, CORSA MK III (D), CORSAVAN MK III (D), INSIGNIA MK I (A), MERIVA MK II (B), ZAFIRA MK III

CCU140

MERCEDES-BENZ
A-CLASS (W168), C-CLASS (W202), C-CLASS (W203), C-CLASS COUPE (CL203), C-CLASS T-MODEL (S202), C-CLASS T-MODEL (S203), CLC-CLASS (CL203), CLK (C209), E-CLASS (W210), E-CLASS (W211), E-CLASS T-MODEL (S210), E-CLASS T-MODEL (S211), SPRINTER 2-T BOX / BUS / PLATFORM / CHASSIS (901, 902), SPRINTER 3,5-T BOX / BUS / PLATFORM / CHASSIS (906), SPRINTER 3-T BOX / BUS / PLATFORM / CHASSIS (903), SPRINTER 3-T BOX / BUS / PLATFORM / CHASSIS (906), SPRINTER 4,6-T BOX / PLATFORM / CHASSIS (906), SPRINTER 4-T BOX (904), SPRINTER 4-T BOX / BUS / PLATFORM / CHASSIS (904), SPRINTER 5-T BOX / PLATFORM / CHASSIS (906), VANO (414), V-CLASS (638/2), VIANO (W639), VITO BOX / BUS (638), VITO BUS (W639), VITO / MIXTO BOX (W639)

CCU141

MERCEDES-BENZ
C-CLASS (W202), C-CLASS (W203), C-CLASS T-MODEL (S202), C-CLASS T-MODEL (S203), CLK (C209), E-CLASS (W210), E-CLASS (W211), E-CLASS T-MODEL (S210), E-CLASS T-MODEL (S211), G-CLASS (W461), G-CLASS (W463), G-CLASS / CABRIO (W463), M-CLASS (W163), S-CLASS (W140), S-CLASS (W220), SPRINTER 2-T BOX / BUS / PLATFORM / CHASSIS (901, 902), SPRINTER 3-T BOX (903), SPRINTER 3-T BOX / BUS / PLATFORM / CHASSIS (903), SPRINTER 3-T PLATFORM / CHASSIS (903), SPRINTER 4-T BOX (904), SPRINTER 4-T BOX / BUS / PLATFORM / CHASSIS (904), SPRINTER 4-T BOX / PLATFORM / CHASSIS (904), SPRINTER 5-T PLATFORM / CHASSIS (905), SPRINTER CLASSIC 3,5-T BOX (909), SPRINTER CLASSIC 4,6-T BUS (909), SPRINTER DUMPTRUCK (905)

CCU142

OPEL
AGILA (A), AGILA (B), ASTRA G, ASTRA H, CORSA C, MERIVA A, SIGNUM, TIGRA, VECTRA C, ZAFIRA A, ZAFIRA B

VAUXHALL
AGILA MK II (B), ASTRA MK IV (G), ASTRA MK V (H), ASTRAMAN MK IV (G), ASTRAMAN MK V (H), CORSA MK II (C), CORSAVAN MK II (C), MERIVA MK I (A), SIGNUM, TIGRA, VECTRA MK II (C), ZAFIRA MK I (A), ZAFIRA MK II (B)

CCU143

OPEL
ASTRA G, ASTRA H, CORSA C, FRONTERA B, MERIVA A, OMEGA B, SIGNUM, SINTRA, VECTRA B, VECTRA C, ZAFIRA A, ZAFIRA B

...CCU143

VAUXHALL
ASTRA MK IV (G), ASTRA MK V (H), ASTRAMAN MK IV (G), ASTRAMAN MK V (H), CORSA MK II (C), CORSAVAN MK II (C), FRONTERA MK II (B), MERIVA MK I (A), OMEGA (B), SIGNUM, SINTRA, VECTRA (B), VECTRA MK II (C), ZAFIRA MK I (A), ZAFIRA MK II (B)

CCU144

OPEL
CORSA D
VAUXHALL
CORSA MK III (D), CORSAVAN MK III (D)

CCU145

OPEL
ASTRA J, CORSA D, MERIVA B, MOKKA / MOKKA X

VAUXHALL
ASTRA MK VI (J), CORSA MK III (D), MERIVA MK II (B), MOKKA / MOKKA X

CCU147

CITROËN
BERLINGO, BERLINGO / BERLINGO FIRST, C1, C2, C3, C3 I, C3 II, C3 PICASSO, C4, C4 GRAND PICASSO I, C4 I, C4 PICASSO I, C5 II, C5 III, C6, C8, C-CROSSER, C-CROSSER ENTERPRISE, JUMPY, NEMO, XSARA PICASSO

DACIA
DUSTER, LOGAN

FIAT
SCUDO, ULYSSE

FORD
FIESTA V, FOCUS C-MAX, FOCUS II, FUSION

LANCIA
PHEDRA

MAZDA
2 (DY)

MITSUBISHI
OUTLANDER II

PEUGEOT
206, 206+, 207, 207 CC, 207 SW, 307, 308, 308 SW, 407, 1007, 3008, 5008, PARTNER, PARTNER TEPEË

RENAULT
DUSTER, ESPACE IV, GRAND SCÉNIC II, MASTER II, MEGANÉ II, SCÉNIC II, TRAFIC II, TWINGO II, VEL SATIS

VOLVO
C30, C70 II, S40 II, V50, V70 III

CCU148

CITROËN
XM, ZX

PEUGEOT
306, 605

CCU149

CITROËN
BERLINGO / BERLINGO FIRST, C2, C2 ENTERPRISE, C3 I, C5 I, C8, C15, EVASION, JUMPER, JUMPY, XANTIA, XM, XSARA, XSARA PICASSO

FIAT
SCUDO

**...CCU149****PEUGEOT**

206, 206 VAN, 306, 307, 406, 605, 607, 806, 807, 1007, BOXER, EXPERT, EXPERT TEPEE, PARTNER

CCU150**ALFA ROMEO**

147, 156, 159, 166, BRERA, GT, MITO, SPIDER

FIAT

500, 500 C, BRAVA, BRAVO I, BRAVO II, CROMA, DOBLO, DUCATO, FIORINO, GRANDE PUNTO, IDEA, LINEA, MAREA, MULTIPLA, PALIO, PANDA, PUNTO, PUNTO EVO, QUBO, SIENA, STILO, STRADA

LANCIA

LYBRA, MUSA, THESIS, YPSILON

CCU151**AUDI**

A3, A4, A4 ALLROAD, A5, A6, A8, Q5, Q7, TT

SEAT

ALHAMBRA, EXEO, LEON

SKODA

OCTAVIA III, SUPERB III

VW

BEETLE, CC, GOLF V, GOLF VII, GOLF SPORTSVAN, JETTA III, JETTA IV, MULTIVAN V, PASSAT, PASSAT ALLTRACK, PASSAT CC, SHARAN, TOUAREG, TRANSPORTER V

CCU152**AUDI**

A1, A3, A4, Q3

SEAT

ALHAMBRA, ALTEA, ALTEA XL, CORDOBA, IBIZA III, IBIZA IV, LEON, TOLEDO III, TOLEDO IV

SKODA

FABIA II, OCTAVIA II, RAPID, ROOMSTER, ROOMSTER PRAKTIK, SUPERB I, SUPERB II, YETI

VW

AMAROK, CADDY ALLTRACK, CADDY III, CADDY IV, CRAFTER 30-35, CRAFTER 30-50, EOS, GOLF V, GOLF VI, GOLF PLUS, JETTA III, PASSAT, POLO, SCIROCCO, TIGUAN, TOURAN

CCU153**FIAT**

BRAVA, BRAVO I, FIORINO, FIORINO PICK UP, MAREA, PALIO, PUNTO, SIENA, STRADA, TEMPRA

LANCIA

DEDRA, DELTA II

CCU154**NISSAN**

ALMERA II, KUBISTAR, MICRA III, PRIMASTAR, PRIMERA

OPEL

MOVANO, VIVARO A

...CCU154**RENAULT**

AVANTIME, CLIO, CLIO II, CLIO III, ESPACE III, ESPACE IV, GRAND SCENIC II, KANGOO, LAGUNA I, LAGUNA II, MASTER II, MEGANE I, MEGANE II, MODUS / GRAND MODUS, SCENIC II, THALIA I, TRAFIC II, TWINGO II, VEL SATIS

VAUXHALL

MOVANO MK I (A), VIVARO

CCU156**MERCEDES-BENZ**

A-CLASS (W169), B-CLASS (W245)

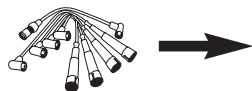

CLS001
AUDI
80, 100, A4, A6, A8, CABRIOLET, COUPE
CLS002
FIAT
TEMPRA, TIPO
LANCIA
DELTA II
CLS003
FIAT
CINQUECENTO, PANDA, SEICENTO / 600
CLS005
CITROËN
EVASION, XANTIA, XM, ZX
FIAT
ULYSSE
LANCIA
DELTA II, ZETA
PEUGEOT
306, 405 I, 405 II, 406, 806
SEAT
MARBELLA, TERRA
CLS007
FIAT
PALIO
CLS009
KIA
RIO
CLS010
MITSUBISHI
COLT V, GALANT VI, LANCER VII, PAJERO
PININ, SPACE RUNNER, SPACE STAR, SPACE
WAGON
PROTON
IMPIAN
CLS011
RENAULT
CLIO II, KANGOO, MEGANE, MEGANE I
CLS012
HONDA
CIVIC V, CIVIC VI
CLS013
DAEWOO
MATIZ
CLS014
RENAULT
MEGANE, MEGANE I
CLS015
FORD
FIESTA, FIESTA IV
CLS016
FORD
COUGAR, FOCUS, FOCUS II, MAVERICK,
MONDEO II
MAZDA
121 III (JASM, JBSM), TRIBUTE (EP)
CLS017
AUDI
A3

...CLS017
SEAT
ALHAMBRA, ALTEA, CORDOBA, IBIZA III,
LEON, TOLEDO III
SKODA
FABIA I, OCTAVIA I, SUPERB I
VW
BORA, CADDY III, GOLF IV, GOLF V, GOLF
VI, GOLF PLUS, JETTA III, NEW BEETLE,
PASSAT, SHARAN, TOURAN
CLS018
OPEL
ASTRA F, ASTRA F CLASSIC, CORSA A,
KADETT E
VAUXHALL
ASTRA MK II
CLS019
DACIA
LOGAN, LOGAN MCV, SANDERO
RENAULT
CLIO II, KANGOO, KANGOO / GRAND
KANGOO, MEGANE, MEGANE I
CLS020
CHEVROLET
AVEO / KALOS, CRUZE, KALOS, REZZO
DAEWOO
KALOS, LACETTI, LANOS, NUBIRA, REZZO
CLS021
HYUNDAI
ATOS
CLS022
FORD
SCORPIO II, SIERRA, TRANSIT
CLS023
HYUNDAI
ACCENT, ACCENT I, ACCENT II, ATOS, GETZ
CLS024
HYUNDAI
ACCENT, ACCENT I, ACCENT II, ACCENT III,
COUPE, ELANTRA, GETZ, MATRIX
KIA
CERATO
CLS025
CHEVROLET
LANOS
DAEWOO
KALOS, LANOS
CLS026
SUBARU
JUSTY II
SUZUKI
ALTO (FF), GRAND VITARA I (FT, HT),
JIMNY CLOSED OFF-ROAD VEHICLE (SN),
SWIFT II HATCHBACK (EA, MA), SWIFT II
SALOON (AH, AJ), WAGON R+ HATCHBACK
(MM)
CLS027
SEAT
CORDOBA, IBIZA II, TOLEDO I
VW
DERBY, GOLF II, GOLF III, GOLF IV, JETTA
II, PASSAT, POLO, TRANSPORTER IV, VENTO

CLS028
SEAT
CORDOBA, IBIZA II
VW
GOLF III
CLS029
OPEL
ASTRA F
VAUXHALL
ASTRA MK III (F)
CLS030
OPEL
ASTRA F, ASTRA F CLASSIC, ASTRA G,
COMBO, CORSA B, TIGRA, VECTRA B
VAUXHALL
ASTRA MK III (F), ASTRA MK IV (G), CORSA
MK I (B), TIGRA MK I
CLS031
MAZDA
323 C V (BA), 323 F V (BA), 323 P V (BA),
323 S V (BA), MX-3 (EC)
CLS032
FORD
FIESTA IV, PUMA
MAZDA
121 III (JASM, JBSM)
CLS033
FORD
FIESTA IV, KA
MAZDA
121 III (JASM, JBSM)
CLS034
SEAT
CORDOBA, IBIZA II, TOLEDO I
VW
GOLF III, GOLF IV, PASSAT, POLO, VENTO
CLS035
FIAT
PUNTO
LANCIA
Y
CLS036
BMW
3 (E36), 3 /COMPACT /COUPE (E36), 3
COUPE (E36), Z3 ROADSTER (E36)
CLS038
SEAT
AROSA
VW
LUPO, POLO
CLS039
RENAULT
ESPACE III, LAGUNA I, MEGANE, MEGANE I
CLS040
RENAULT
CLIO I, CLIO II, KANGOO, TWINGO I
CLS041
SEAT
AROSA, CORDOBA, IBIZA II
VW
LUPO, POLO

CLS042
AUDI
80, 100
VW
TRANSPORTER IV, VENTO
CLS043
VW
GOLF III, PASSAT, VENTO
CLS044
FIAT
BRAVA, BRAVO I, MAREA, PUNTO, SIENA
LANCIA
Y
CLS045
LAND ROVER
FREELANDER
ROVER
75
CLS046
AUDI
A4, A6, A8
SKODA
SUPERB I
VW
PASSAT
CLS047
AUDI
A4
VW
PASSAT
CLS048
AUDI
A3, A4
SEAT
ALHAMBRA, ALTEA, ALTEA XL, EXEO
SKODA
OCTAVIA I, OCTAVIA II
VW
BORA, GOLF IV, GOLF V, GOLF VI, GOLF
PLUS, JETTA III, NEW BEETLE, PASSAT,
SHARAN
CLS049
FORD
GALAXY
CLS050
RENAULT
SAFRANE II
VOLVO
850, C70 I, S70, V70 I
CLS051
RENAULT
LAGUNA I, SAFRANE II
VOLVO
S40 I, V40
CLS052
RENAULT
ESPACE III, LAGUNA I, MEGANE, MEGANE I
CLS053
SEAT
AROSA, INCA

**...CLS053****VW**
CADDY II, LUPO, POLO**CLS054****BMW**
3 COMPACT (E36), 3 /CONVERTIBLE /TOURING (E36), 3 /COUPE /TOURING (E46), 5 /TOURING (E34), Z3 ROADSTER (E36)**CLS055****ALFA ROMEO**
145, 146, 147, 156, 166, GTV, SPIDER**CLS056****MAZDA**
MX-5 I (NA), MX-5 II (NB)**CLS057****AUDI**
A4, A6, CABRIOLET**VW**

PASSAT

CLS058**TOYOTA**
AVENSIS, CARINA E**CLS059****NISSAN**
PRIMERA**CLS061****LOTUS**
ELISE**MG**
MGF, MG TF, MG ZR**ROVER**

25, 200, 400

CLS062**CHRYSLER**
NEW YORKER, VOYAGER / GRAND VOYAGER III, VOYAGER II**CLS063****DAEWOO**
MUSSO**MERCEDES-BENZ**
E-CLASS (W210), E-CLASS T-MODEL (S210), M-CLASS (W163), SLK (R170), SPRINTER 2-T BOX (901, 902), SPRINTER 2-T BOX /BUS /PLATFORM /CHASSIS (901, 902), SPRINTER 3-T BOX /BUS /PLATFORM /CHASSIS (903), SPRINTER 3-T BUS /PLATFORM /CHASSIS (903), SPRINTER 4-T PLATFORM /CHASSIS (904)**SSANGYONG**

MUSSO

CLS064**CHRYSLER**
CROSSFIRE**...CLS064****MERCEDES-BENZ**
C-CLASS (W202), C-CLASS (W203), C-CLASS COUPE (CL203), C-CLASS T-MODEL (S202), C-CLASS T-MODEL (S203), CLK (C208), CLK (C209), CLK CONVERTIBLE (A208), CLK CONVERTIBLE (A209), CLS (C219), E-CLASS (W210), E-CLASS (W211), E-CLASS T-MODEL (S210), E-CLASS T-MODEL (S211), G-CLASS /CABRIO (W463), M-CLASS (W163), S-CLASS (W220), SL (R129), SL (R230), SLK (R170), VIANO (W639), VITO / MIXTO BOX (W639)**CLS065****MERCEDES-BENZ**
C-CLASS (W202), C-CLASS T-MODEL (S202), COUPE (C124), E-CLASS (W124), E-CLASS CONVERTIBLE (A124), E-CLASS COUPE (C124), E-CLASS T-MODEL (S124), KOMBI T-MODEL (S124), SALOON (W124)**CLS066****FORD**
FIESTA, FIESTA IV, KA**MAZDA**
121 III (JASM, JBSM)**CLS067****FIAT**
DOBLO, PALIO, PANDA, PUNTO, SEICENTO / 600, SIENA, STRADA**LANCIA**
Y, YPSILON**CLS068****SMART**
CABRIO, CITY-COUPE, CROSSBLADE, FORTWO, ROADSTER**CLS069****MINI**
MINI**CLS070****SKODA**
OCTAVIA I**VW**
BORA, CADDY III, GOLF IV, NEW BEETLE, TOURAN**CLS071****DAEWOO**
MUSSO
MERCEDES-BENZ
E-CLASS (W210), E-CLASS T-MODEL (S210), M-CLASS (W163), SLK (R170), SPRINTER 2-T BOX (901, 902), SPRINTER 2-T BOX /BUS /PLATFORM /CHASSIS (901, 902), SPRINTER 3-T BOX /BUS /PLATFORM /CHASSIS (903), SPRINTER 3-T BUS /PLATFORM /CHASSIS (903), SPRINTER 4-T PLATFORM /CHASSIS (904)**SSANGYONG**

MUSSO

CLS072**HYUNDAI**
ACCENT II, GETZ**CLS073****HYUNDAI**
ATOS, GETZ**CLS074****FORD**
FIESTA V, MONDEO III**CLS075****MAZDA**
6 HATCHBACK /SALOON (GG), 6 STATION WAGON (GY)**CLS076****DACIA**
LOGAN, LOGAN MCV, SANDERO**RENAULT**

KANGOO, LOGAN I, SANDERO/STEPWAY I

CLS077**FORD**
C-MAX, FIESTA IV, FIESTA V, FIESTA VI, FOCUS, FOCUS C-MAX, FOCUS II, FUSION, MONDEO IV, PUMA**MAZDA**
2 (DY)**VOLVO**
C30, S40 II**CLS078****MERCEDES-BENZ**
A-CLASS (W169), B-CLASS (W245)**CLS079****SEAT**
CORDOBA**VW**
CADDY I, GOLF II, GOLF III, GOLF IV, PASSAT, POLO, VENTO**CLS080****SUBARU**
FORESTER, IMPREZA, LEGACY III, OUTBACK**CLS081****VW**
FOX, GOL IV, POLO**CLS082****ALFA ROMEO**
MITO
FIAT
500, 500 C, DOBLO, GRANDE PUNTO, IDEA, LINEA, PANDA, PUNTO, PUNTO EVO**LANCIA**
MUSA, YPSILON**CLS083****RENAULT**
CLIO II, KANGOO, TWINGO I, TWINGO II**CLS084****DACIA**
LOGAN MCV II, SANDERO**RENAULT**
CLIO, CLIO II, CLIO III, CLIO IV, KANGOO, MODUS / GRAND MODUS, THALIA I, THALIA II, TWINGO I, TWINGO II, WIND**TALBOT**
SIMCA 1000**CLS085****CHEVROLET**
AVEO, KALOS, MATIZ**DAEWOO**
KALOS, MATIZ**CLS086****CHEVROLET**
AVEO, AVEO / KALOS, KALOS**DAEWOO**

KALOS

CLS088**DACIA**
DOKKER, DOKKER EXPRESS, LODGY, LOGAN, LOGAN MCV, SANDERO**RENAULT**

KANGOO

CLS089**FORD**
C-MAX, C-MAX II, FIESTA VI, FOCUS C-MAX, FOCUS II, FOCUS III, FUSION, GRAND C-MAX**CLS090****AUDI**
A1, A3**SEAT**
ALTEA, ALTEA XL, IBIZA IV, LEON, TOLEDO IV**SKODA**
FABIA II, OCTAVIA II, RAPID, ROOMSTER, ROOMSTER PRAKTIK, YETI**VW**
BEETLE, CADDY III, GOLF VI, GOLF PLUS, JETTA IV, POLO, TOURAN**CLS091****FORD**
KA**CLS092****FORD**
FIESTA V, STREET KA**CLS093****HYUNDAI**
ATOS, ATOS PRIME, GETZ, I10**KIA**
PICANTO**CLS094****HYUNDAI**
COUPE, ELANTRA, I30, TRAJET, TUCSON
KIA
CARENS II, CEE'D, CERATO, PRO CEE'D, SPORTAGE**CLS095****MG**
MGF, MG TF, MG ZR**ROVER**

200, 400, COUPE

CLS096**TOYOTA**
COROLLA**CLS097****AUDI**
50, 80, 100**SEAT**
CORDOBA, IBIZA I

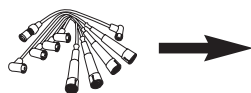
**...CLS097**

VW
CADDY I, DERBY, GOLF I, GOLF II, JETTA I, JETTA II, PASSAT, POLO, SANTANA, SCIROCCO, TRANSPORTER II, TRANSPORTER III

CLS098

MERCEDES-BENZ
190 (W201), COUPE (C123), COUPE (C124), G-CLASS (W460), G-CLASS (W461), G-CLASS /CABRIO (W463), KOMBI T-MODEL (S123), KOMBI T-MODEL (S124), SALOON (W123), SALOON (W124)

CLS099

AUDI
80, COUPE

SEAT
CORDOBA, IBIZA II, INCA, TOLEDO I

VW
CADDY I, CADDY II, CORRADO, GOLF I, GOLF II, GOLF III, GOLF IV, JETTA II, PASSAT, POLO, SANTANA, SCIROCCO, VENTO

WARTBURG

353

CLS100

SEAT
AROSA, CORDOBA, IBIZA II

SKODA
FELICIA I, OCTAVIA I

VW
GOLF I, GOLF II, GOLF III, POLO, SANTANA, TRANSPORTER IV

CLS106

MERCEDES-BENZ
C-CLASS (W202), C-CLASS T-MODEL (S202), COUPE (C124), E-CLASS (W124), E-CLASS CONVERTIBLE (A124), E-CLASS COUPE (C124), E-CLASS T-MODEL (S124), KOMBI T-MODEL (S124), SALOON (W124)

CLS107

DAEWOO
LACETTI

OPEL
ASTRA F, ASTRA G, CALIBRA A, OMEGA B, SINTRA, VECTRA A, VECTRA B

VAUXHALL
ASTRA MK III (F), SINTRA

CLS108

VW
TRANSPORTER IV

CLS109

SEAT
AROSA, CORDOBA, IBIZA II, INCA

SKODA
FELICIA II

VW
CADDY II, GOLF III, POLO, POLO VAN, VENTO

CLS110

SEAT
CORDOBA, IBIZA II, TOLEDO I

...CLS110

VW
GOLF III, GOLF IV, PASSAT, POLO, VENTO

CLS111

FORD
ESCORT CLASSIC, ESCORT V, ESCORT VI, ESCORT VII, FIESTA III, FIESTA IV, MONDEO I, MONDEO II, ORION III

CLS112

LANCIA
Y10

CLS114

OPEL
ASTRA F, ASTRA F CLASSIC, ASTRA G, COMBO, CORSA B, VECTRA A, VECTRA B, ZAFIRA A

VAUXHALL

ASTRA MK IV (G), ASTRAMAN MK IV (G), COMBO MK II (C), CORSA MK I (B), CORSAVAN MK I (B)

CLS115

OPEL
CORSA B

VAUXHALL
CORSA MK I (B)

CLS116

RENAULT
LAGUNA I

CLS117

RENAULT
19 II, CLIO I, KANGOO, MEGANE, MEGANE I, RAPID

CLS121

FORD
ESCORT '86, ESCORT '91, ESCORT IV, ESCORT V, ESCORT VI, ESCORT VII, FIESTA, FIESTA III, ORION II, ORION III

CLS122

FORD
ESCORT '91, ESCORT '95, ESCORT V, ESCORT VI, ESCORT VII, FIESTA II, FIESTA III, ORION II, ORION III

CLS123

CITROËN
BERLINGO / BERLINGO FIRST, JUMPER, JUMPY, XANTIA, XSARA, ZX

FIAT

DUCATO

PEUGEOT
205 I, 205 II, 306, 309 II, 405 II, 406, BOXER, PARTNER

CLS124

CITROËN
C3, C3 I

PEUGEOT
106 I, 306, 309 II

CLS126

RENAULT
SUPER 5, TWINGO I

VOLVO
340-360

CLS128

HONDA
CIVIC II, CIVIC IV, CIVIC V, CIVIC VI

ROVER
400

CLS129

HONDA
CIVIC V, CIVIC VI, CONCERTO, CRX III, HR-V, LOGO

ROVER
400

CLS130

HYUNDAI
COUPE, ELANTRA, LANTRA II

CLS131

KIA
SEPHIA, SHUMA

MAZDA
323 C IV (BG), 323 C V (BA), 323 F IV (BG), 323 III STATION WAGON (BW), 323 P V (BA), 323 S IV (BG), 323 S V (BA)

CLS132

NISSAN
100 NX, ALMERA I, PRIMERA

CLS135

FIAT
SCUDO, TEMPRA, TIPO

LANCIA
DELTA II

CLS136

FIAT
BRAVA, BRAVO I, MAREA

LANCIA
Y

CLS137

FIAT
BRAVA, BRAVO I, MAREA, MULTIPLA, PALIO, SIENA

LANCIA
DEDRA, DELTA II, LYBRA

CLS138

MERCEDES-BENZ
C-CLASS (W202), C-CLASS T-MODEL (S202), CLK (C208), CLK CONVERTIBLE (A208), E-CLASS (W210), E-CLASS T-MODEL (S210), SLK (R170), SPRINTER 2-T BOX (901, 902), SPRINTER 2-T BUS /PLATFORM /CHASSIS (901, 902), SPRINTER 3-T BOX (903), SPRINTER 4-T BOX /BUS /PLATFORM /CHASSIS (904), V-CLASS (638/2), VITO BOX/BUS (638)

CLS139

AUDI
A3

SEAT
LEON, TOLEDO II

SKODA
OCTAVIA I

VW
BORA, GOLF III, GOLF IV, POLO

CLS140

AUDI
A3

SEAT
LEON, TOLEDO II

SKODA
OCTAVIA I

VW

BORA, GOLF IV

CLS141

OPEL
ASTRA F, ASTRA F CLASSIC

CLS147

LADA
NADESCHDA, NIVA, NIVA II

CLS150

SAAB
9-3, 900 I, 900 II, 9000

CLS153

NISSAN
VANETTE CARGO

CLS155

LAND ROVER
FREELANDER

CLS156

FORD
COUGAR, MONDEO III

CLS157

KIA
SHUMA

CLS159

MAZDA
MX-5 II (NB)

CLS163

DAIHATSU
TERIOS

CLS167

FIAT
SEDICI

SUZUKI
GRAND VITARA II (JT), GRAND VITARA II (JT, TE, TD), IGNIS I (FH), IGNIS II (MH), JIMNY (FJ), JIMNY CLOSED OFF-ROAD VEHICLE (SN), LIANA (ER, RH _), LIANA HATCHBACK, SWIFT III (MZ, EZ), SX4 (EY, GY), SX4 /SALOON (GY), SX4 SALOON (GY), SX4 S-CROSS (JY), WAGON R+ HATCHBACK (MM)

CLS168

MAZDA
DEMIO (DW)

CLS169

MITSUBISHI
COLT V, LANCER VI

CLS170

SUBARU
FORESTER, IMPREZA



| | | | |
|---|--|--|---|
| CLS171 TOYOTA AVENSIS | CLS190 CHRYSLER VOYAGER / GRAND VOYAGER III | CLS231 TOYOTA COROLLA | CLS252 MERCEDES-BENZ C-CLASS (W202), COUPE (C124), E-CLASS (W124), E-CLASS (W210), E-CLASS CONVERTIBLE (A124), E-CLASS COUPE (C124), E-CLASS T-MODEL (S124), G-CLASS /CABRIO (W463), KOMBI T-MODEL (S124), SALOON (W124), S-CLASS (W140), SL (R129) |
| CLS173 KIA CARENS I, CARENS II, CLARUS, SEPHIA, SHUMA, SHUMA II | CLS192 SUBARU FORESTER | CLS232 TOYOTA PICNIC | CLS254 MERCEDES-BENZ C-CLASS (W202), E-CLASS (W210), E-CLASS CONVERTIBLE (A124), E-CLASS COUPE (C124), E-CLASS T-MODEL (S124), G-CLASS /CABRIO (W463), S-CLASS (W140), SL (R129) |
| CLS174 SEAT CORDOBA, IBIZA II, TOLEDO I | CLS193 CHRYSLER VOYAGER IV | CLS233 TOYOTA RAV 4 I | CLS255 MERCEDES-BENZ C-CLASS (W202), E-CLASS (W210), E-CLASS CONVERTIBLE (A124), E-CLASS COUPE (C124), E-CLASS T-MODEL (S124), G-CLASS /CABRIO (W463), S-CLASS (W140), SL (R129) |
| CLS175 VW CORRADO, GOLF III, JETTA II, PASSAT, SCIROCCO | CLS194 RENAULT CLIO II | CLS235 ALFA ROMEO 164, GTV, SPIDER | CLS256 KIA CARENS II, RIO, RIO II, SHUMA II |
| CLS176 OPEL OMEGA B, SINTRA | CLS195 VOLVO S40 I, V40 | CLS236 VOLVO 740, 760, 940, 940 II | CLS257 MAZDA 323 F VI (BJ), 323 S VI (BJ) |
| CLS177 VAUXHALL OMEGA (B) | CLS196 CHEVROLET AVEO, AVEO / KALOS, CRUZE, KALOS, LACETTI, NUBIRA | CLS237 VW TRANSPORTER IV | CLS258 FIAT TEMPRA |
| CLS178 OPEL ASTRA G | CLS197 DAEWOO KALOS, LACETTI, NUBIRA | CLS238 VW SHARAN | CLS259 KIA PRIDE |
| CLS179 AUDI A3 | CLS198 KIA PRIDE, RIO II | CLS239 MAZDA 626 V (GF), 626 V /HATCHBACK (GF), 626 V HATCHBACK (GF), 626 V STATION WAGON (GW) | CLS260 TOYOTA CAMRY |
| CLS180 SEAT CORDOBA, IBIZA II | CLS199 MAZDA 323 F VI (BJ), 323 S VI (BJ), MPV II (LW), PREMACY (CP) | CLS240 FORD GALAXY | CLS261 AUDI A2 |
| CLS181 VW POLO | CLS200 VW CORRADO, GOLF III, PASSAT, SHARAN, VENTO | CLS241 CHRYSLER PT CRUISER, SEBRING | CLS262 SEAT AROSA, CORDOBA, IBIZA II, IBIZA III, LEON, TOLEDO II |
| CLS182 AUDI 80, 100, A6, CABRIOLET | CLS201 MERCEDES-BENZ E-CLASS (W124), E-CLASS (W210), E-CLASS T-MODEL (S210), SALOON (W124), S-CLASS (W140), S-CLASS COUPE (C140) | CLS242 MERCEDES-BENZ C-CLASS (W203), CLK (C208), CLK (C209), CLK CONVERTIBLE (A208), CLK CONVERTIBLE (A209), E-CLASS (W210), E-CLASS (W211), E-CLASS T-MODEL (S210), E-CLASS T-MODEL (S211), G-CLASS (W463), G-CLASS CABRIO (W463), M-CLASS (W163), R-CLASS (W251, V251), S-CLASS (W220), S-CLASS COUPE (C215), SL (R129), SL (R230), SLK (R171) | CLS263 SKODA FABIA I, OCTAVIA I |
| CLS183 SAAB 99, 900 I | CLS202 FIAT 900T/E PANORAMA | CLS243 PUCH G-MODELL | CLS264 VW BORA, CADDY II, GOLF IV, LUPO, NEW BEETLE, POLO |
| CLS184 MAZDA 323 F VI (BJ), 323 S VI (BJ) | CLS203 FSO 125P, POLONEZ I | CLS244 FORD GALAXY | CLS265 FIAT CINQUECENTO, PALIO, PANDA, PUNTO, SEICENTO / 600, STRADA |
| CLS185 VW BORA, GOLF IV | CLS204 HYUNDAI STELLAR | CLS245 MERCEDES-BENZ 190 (W201), COUPE (C124), E-CLASS (W124), E-CLASS T-MODEL (S124), G-CLASS (W463), G-CLASS /CABRIO (W463), KOMBI T-MODEL (S124), SALOON (W124), S-CLASS (W126), SL (R107), SL (R129) | CLS266 LANCIA Y |
| CLS186 MITSUBISHI GALANT IV, SPACE WAGON, TREDIA | CLS205 OPEL KADETT A, KADETT B | CLS246 PUCH G-MODELL | CLS267 CITROËN AX, BERLINGO / BERLINGO FIRST, SAXO, XSARA, ZX |
| CLS187 OPEL BORA, GOLF IV, SHARAN | CLS206 SEAT 133 | CLS247 MERCEDES-BENZ 190 (W201), COUPE (C124), E-CLASS (W124), E-CLASS T-MODEL (S124), G-CLASS (W463), G-CLASS /CABRIO (W463), KOMBI T-MODEL (S124), SALOON (W124), S-CLASS (W126), SL (R107), SL (R129) | CLS268 PEUGEOT 106 I, 106 II, 106 VAN, 306, PARTNER |
| CLS188 FORD SCORPIO II | CLS207 SUZUKI CARRY BOX (OS), SUPER CARRY BUS (ED) | CLS248 PUCH G-MODELL | |
| CLS189 VOLVO 740, 940, 940 II | CLS208 MAZDA 626 IV /HATCHBACK (GE), MX-6 (GE) | CLS249 FIAT CINQUECENTO, PALIO, PANDA, PUNTO, SEICENTO / 600, STRADA | |
| CLS190 HYUNDAI COUPE, SANTA FÉ I, SONATA IV | CLS209 SUZUKI SWIFT II SALOON (AH, AJ), VITARA (ET, TA), VITARA CABRIO (ET, TA), X-90 (EL) | CLS250 LANCIA Y | |

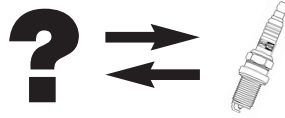

| ACCEL | CHAMPION |
|----------|----------|
| 112 | OE087 |
| 114 | OE001 |
| 115 | OE001 |
| 116 | OE065 |
| 142 | OE068 |
| 143 | OE079 |
| 146 | OE074 |
| 154 | L82C |
| 156 | OE037 |
| 196 | OE049 |
| 276 | RV15YC4 |
| 416 | OE013 |
| 442 | OE108 |
| 496 | OE042 |
| 514 | OE011 |
| 576 | RV15YC4 |
| ACDELCO | CHAMPION |
| 2500 | OE087 |
| 2503 | OE012 |
| 3500 | OE044 |
| 40XLS | OE087 |
| 41 F | OE087 |
| 41-103 | OE189 |
| 41-105 | OE189 |
| 41-106 | OE191 |
| 41-107 | OE189 |
| 41-2 XLS | OE087 |
| 41-602 | OE013 |
| 41-610 | OE013 |
| 41-617 | OE013 |
| 41-627 | OE013 |
| 41-8 XLS | OE001 |
| 41-802 | OE192 |
| 41-812 | OE011 |
| 41-813 | OE042 |
| 41-825 | OE191 |
| 41-828 | OE098 |
| 41-829 | OE039 |
| 41-905 | RV15YC4 |
| 41-907 | OE191 |
| 41-913 | OE191 |
| 41-954 | OE029 |
| 41-991 | OE183 |
| 41F | L78C |
| 42 | L82C |
| 42 F | L78C |
| 42 FF | L82C |
| 42 FS | OE038 |
| 42 LZ | L82C |
| 42 XLS | OE001 |
| 420 Z | L82C |
| 422 Z | L82C |

| ACDELCO | CHAMPION |
|----------|----------|
| 42-5 F | L82C |
| 425 Z | L82C |
| 42-6 FS | OE038 |
| 42CF | OE037 |
| 42CXLS | OE001 |
| 42F | L82C |
| 42LTS | OE011 |
| 42XL | OE068 |
| 42XLS | OE001 |
| 43 F | L82C |
| 43 FO | L82C |
| 43 FS | OE038 |
| 43 N | OE074 |
| 43 XLS | OE015 |
| 430 Z | L78C |
| 430Z | L82C |
| 43-5 XLS | OE015 |
| 43CLS | OE065 |
| 43CXLS | OE065 |
| 43N | OE079 |
| 43TS | RV15YC4 |
| 43XL | OE079 |
| 43XLS | OE001 |
| 44 | J8C |
| 44 F | L82C |
| 44 XL | OE074 |
| 44 XLS | OE001 |
| 440XLS | OE087 |
| 44-5 | J8C |
| 44-5Com | J8C |
| 445Z | L78C |
| 44CF | OE037 |
| 44Com | J8C |
| 44F | OE037 |
| 44FFS | OE059 |
| 44N | OE074 |
| 44XL | OE074 |
| 45 | J8C |
| 45 F | L82C |
| 45 XL | OE074 |
| 45 XLS | OE001 |
| 4500 | OE044 |
| 4501 | OE009 |
| 4502 | L82C |
| 4503 | OE094 |
| 45Com | J8C |
| 45F | OE037 |
| 45FFS | OE059 |
| 45XL | OE074 |
| 46 TS | OE054 |
| 46 XL | OE074 |
| 46 XLS | OE015 |
| 46F | OE037 |

| ACDELCO | CHAMPION |
|----------------|----------|
| 46FFS | OE059 |
| 46N | OE074 |
| 46XL | OE074 |
| 47 XL | OE074 |
| 47XL | OE074 |
| 56 | L82C |
| 6500 | OE044 |
| 6501 | OE009 |
| 6502 | OE015 |
| 7500 | OE057 |
| 7501 | OE009 |
| 7502 | OE038 |
| 83 TS | OE054 |
| 84 TS | OE054 |
| 85 TS | OE054 |
| 8500 | OE037 |
| 8501 | OE001 |
| 8502 | OE007 |
| 9500 | OE001 |
| B45 | J8C |
| C 41 CXLS | OE010 |
| C 42 CFS | OE038 |
| C 42 CXLS | OE010 |
| C 43 CXLS | OE001 |
| C 44 NS | OE010 |
| C 44 XL | OE074 |
| C42CXLS | OE001 |
| C42N | OE079 |
| C43N | OE074 |
| C44 | J8C |
| C44N | OE074 |
| C44NS | OE065 |
| C44XL | OE079 |
| CFR 1 CLS | OE005 |
| CFR 2 CLS | OE014 |
| CFR 3 CLS | OE005 |
| CFR1CLS | OE094 |
| CFR1CLS(black) | OE014 |
| CFR2CLS(black) | OE005 |
| CR 41 CXLS | OE087 |
| CR 42 CFS | OE064 |
| CR 42 CLTS | OE011 |
| CR 42 CXLSX | OE048 |
| CR 42 XLSX | OE048 |
| CR 425 FS | OE064 |
| CR41CXLS | OE018 |
| CR42CLTS | OE011 |
| CR42LTS | OE011 |
| CR42N | OE098 |
| CR42XLSX | OE048 |
| CR43CXLS | OE051 |
| CR43N | OE098 |
| CR43TS | RV15YC4 |

| ACDELCO | CHAMPION |
|-------------|----------|
| CR43TSM | RV15YC4 |
| CR44NS | OE065 |
| F8 | L82C |
| FL7 | OE068 |
| FL9 | OE074 |
| FR 1 LS | OE005 |
| FR 2 LS | OE039 |
| FR 3 CLS | OE005 |
| FR 3 LS | OE005 |
| FR 3 LS 6 | OE039 |
| FR1LS | OE005 |
| FR2CLS | OE005 |
| FR2LS | OE005 |
| FR2LSK | OE013 |
| FR3CLS | OE013 |
| FR3LM | OE041 |
| FR3LS | OE013 |
| FR3LSJ | OE013 |
| FR3LSK | OE013 |
| FR3LX | OE013 |
| FR4LE | OE041 |
| FR5LS | OE013 |
| M42FF | L82C |
| M44C | J8C |
| M45 | J8C |
| M45FF | OE037 |
| MR42FF | OE086 |
| MR43FF | OE037 |
| N 700 | OE038 |
| N 701 | L82C |
| N 705 | OE078 |
| R 2601 | OE094 |
| R 2603 | OE014 |
| R 3600 | OE018 |
| R 3601 | OE018 |
| R 41 CF | L78C |
| R 41 CXLS | OE087 |
| R 41-4 XLS | OE018 |
| R 42 CF | L78C |
| R 42 CFS | OE038 |
| R 42 CLTS | OE011 |
| R 42 CLTS 6 | OE011 |
| R 42 CXLS | OE006 |
| R 42 XLS | OE006 |
| R 42 XLS 6 | OE048 |
| R 42 XLS-11 | OE048 |
| R 42-6 FS | OE064 |
| R 43 CFS | OE064 |
| R 43 CXL | OE098 |
| R 44 CF | L82C |
| R 44 CXL | OE074 |
| R 44 XLS-11 | OE049 |
| R 4602 | OE014 |



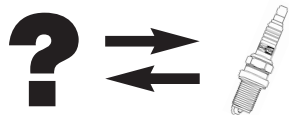

| ACDELCO | CHAMPION | ACDELCO | CHAMPION | AUTOLITE | CHAMPION | AUTOLITE | CHAMPION |
|----------|----------|-----------------|----------|----------|----------|--------------------|----------|
| R 4603 | OE094 | R44F | OE037 | 2616 | OE074 | 53 | OE001 |
| R 4604 | OE094 | R44LT | OE011 | 2635 | L78C | 535 | OE037 |
| R 4605 | OE038 | R44NS | OE042 | 2636 | L82C | 54 | OE065 |
| R 4606 | OE014 | R45NS | OE042 | 2652 | L78C | 5503 | OE005 |
| R 4607 | OE094 | R4606 | OE014 | 2653 | L78C | 62 | OE018 |
| R 5601 | OE077 | R46N | OE074 | 2654 | L82C | 64 | OE049 |
| R 5602 | OE026 | R46XL | OE074 | 2655 | L82C | 65 | OE042 |
| R 5603 | OE030 | R5602 | OE026 | 2656 | OE037 | 726 | RV15YC4 |
| R 5604 | OE039 | R5603 | OE030 | 2755 | OE083 | 893 | OE001 |
| R 5605 | OE033 | R5604 | OE039 | 294 | J8C | 935 | OE041 |
| R 5606 | OE032 | R5605 | OE034 | 295 | J8C | 94 | OE011 |
| R 5607 | OE025 | R5608 | OE002 | 315 | J8C | 985 | OE041 |
| R 5607 | OE027 | R5609 | OE039 | 3176 | OE074 | A5 | J8C |
| R 5609 | OE089 | R5610 | OE154 | 355 | J8C | A7 | J8C |
| R 5610 | OE089 | R6600 | OE004 | 356 | J8C | AE10 | OE074 |
| R 6600 | OE004 | R6601 | OE154 | 3895 | OE041 | AGPR22P | OE145 |
| R 6602 | OE011 | R6605 | OE063 | 3922 | OE039 | AGRF22D1 | OE131 |
| R 6603 | OE011 | R6606 | OE049 | 3923 | OE039 | AGRF22PP | OE131 |
| R 6604 | OE120 | R6608 | OE019 | 3924 | OE013 | AGSF22PPJ | OE131 |
| R 6605 | OE039 | R6609 | OE033 | 393 | OE068 | AN5 | J8C |
| R 6606 | OE049 | R6612 | OE148 | 394 | OE074 | AN7 | J8C |
| R 6607 | OE027 | R7600 | OE013 | 395 | OE074 | AP3923 | OE191 |
| R 6608 | OE019 | R7602 | OE019 | 396 | OE074 | AP646 | OE105 |
| R 6609 | OE033 | R8600 | OE042 | 397 | OE074 | APP3923 | OE191 |
| R 6612 | OE148 | R8601 | OE042 | 402 | OE091 | APP64 | OE192 |
| R 7600 | OE005 | S 41 F | L78C | 403 | OE108 | APP646 | OE105 |
| R 7601 | OE039 | S 44 F | L82C | 404 | OE098 | APP65 | OE192 |
| R 7602 | OE019 | S 44 XL | OE074 | 4055 | OE068 | AR5 | J8C |
| R 7603 | OE128 | S121XL | OE083 | 4056 | OE079 | AR8 | J8C |
| R 83 CTS | OE054 | S40F | L82C | 4092 | L78C | AT8 | J8C |
| R 84 TS | OE054 | S41F | L78C | 4093 | L82C | AWSF22FS | OE131 |
| R121XLS | OE083 | S41FR | L78C | 411 | L78C | XP3923 | OE180 |
| R2601 | OE014 | S41XLR | OE091 | 413 | L82C | BERU | CHAMPION |
| R41CLS | OE018 | S425Z | OE037 | 4132 | OE073 | 0001.330.702.00.01 | OE015 |
| R41CSL | OE108 | S42F | L82C | 4132 | OE083 | 0001.330.707.00.01 | OE003 |
| R41CXL | OE091 | S42FR | L82C | 4133 | OE083 | 0001.330.709.00.01 | OE044 |
| R41CXLS | OE018 | S42XL | OE068 | 414 | OE037 | 0001.330.725.00.01 | OE003 |
| R41XL | OE091 | S42XLR | OE108 | 4143 | OE083 | 0001.335.702.00.01 | OE001 |
| R41XLS | OE018 | S438XLS | OE087 | 415 | OE037 | 0001.335.709.00.01 | OE012 |
| R42CF | OE086 | S43XL | OE074 | 4152 | OE073 | 0001.335.714.00.01 | OE001 |
| R42CLTS | OE011 | S44 | J8C | 4153 | OE083 | 0001.340.702.00.01 | OE010 |
| R42CXL | OE108 | S44F | OE037 | 4162 | OE073 | 0001.340.706.00.01 | OE094 |
| R42F | OE086 | S44XL | OE074 | 4163 | OE083 | 0001.340.717.00.01 | OE094 |
| R42LTS | OE009 | S45F | OE037 | 4164 | OE083 | 0001.340.806.00.01 | OE014 |
| R42XL | OE108 | VF9 | J8C | 417 | OE037 | 0001.345.702.00.01 | OE087 |
| R42XLS6 | OE048 | AUTOLITE | CHAMPION | 4251 | OE087 | 0001.345.704.00.01 | OE012 |
| R43CTS | RV15YC4 | 103 | OE011 | 4253 | OE001 | 0001.430.701.00.01 | OE037 |
| R43CXL | OE098 | 16 | RV15YC4 | 4265 | OE042 | 0001.435.705.00.01 | L82C |
| R43CXLS | OE049 | 25 | RV15YC4 | 483 | OE011 | 0001.450.702.00.01 | L78C |
| R43TS | RV15YC4 | 2594 | OE068 | 4S-140 | J8C | 0001.630.700.00.01 | OE009 |
| R43TSK | RV15YC4 | 26 | RV15YC4 | 4S-165 | J8C | 0001.635.700.00.01 | OE009 |
| R43XLS | OE042 | 2615 | OE079 | 51 | OE087 | 0001.635.709.00.01 | OE009 |
| R44CXLS | OE051 | | | 5224 | OE013 | | |

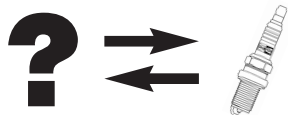

| BERU | CHAMPION |
|--------------------|----------|
| 0001.735.700.00.01 | OE054 |
| 0001.740.700.00.01 | OE054 |
| 0002.330.702.00.01 | OE049 |
| 0002.335.701.00.01 | OE006 |
| 0002.340.701.00.01 | OE018 |
| 0002.435.701.00.01 | OE064 |
| 0002.640.900.00.01 | OE029 |
| 0900.004.109.00.01 | OE029 |
| 0900.004.141.00.01 | OE031 |
| 0900.004.171.00.01 | OE146 |
| 0900.004.173.00.01 | OE136 |
| 10 FR-6 CPU03 | OE122 |
| 10 FR-7 KDUS | OE122 |
| 12 FR-6 DU | OE199 |
| 12 FR-6 DUT | OE199 |
| 12 FR-6 LUX | OE196 |
| 12 FR-7 DU | OE196 |
| 14 F-5 DPUR2T | OE136 |
| 14 F-6 DSR | OE014 |
| 14 F-6 DTU | OE094 |
| 14 F-6 DUOR | OE014 |
| 14 F-6 KPURW2 | OE181 |
| 14 F-7 DPUR02 | OE136 |
| 14 F-7 DPURU2 | OE146 |
| 14 F-7 DPURX2 | OE146 |
| 14 F-7 DUOR | OE014 |
| 14 F-7 HPURX2 | OE176 |
| 14 F-7 HUR2 | OE177 |
| 14 F-7 HURU02 | OE177 |
| 14 F-7 KPPRU2 | OE188 |
| 14 F-7 LDUR4 | OE026 |
| 14 F-8 DU0 | OE003 |
| 14 F-8 DU4 | OE057 |
| 14 F-8 DUR | OE005 |
| 14 F-8 LDUSR | OE019 |
| 14 F-8DU | OE003 |
| 14 FG-8 DTU | OE123 |
| 14 FGH-6 DTUR | OE094 |
| 14 FGH-7 DPURX2 | OE136 |
| 14 FGH-7 DTURX | OE032 |
| 14 FGH-7 DTURX0 | OE032 |
| 14 FGH-8 DTUR | OE123 |
| 14 FGH-8 DTURW | OE123 |
| 14 FGH-8 DTURX0 | OE032 |
| 14 FGHR-7 DTUU | OE077 |
| 14 FGHR-7 LDUW | OE019 |
| 14 FGR-7 CTU | OE077 |
| 14 FGR-8 MQPU | OE175 |
| 14 FR-5 DPPUX | OE136 |
| 14 FR-5 DPUX | OE136 |
| 14 FR-5 DTU | OE014 |
| 14 FR-5 DU | OE094 |
| 14 FR-5 DUU | OE094 |

| BERU | CHAMPION |
|----------------|----------|
| 14 FR-5 LPUOX | OE136 |
| 14 FR-6 DPOX | OE136 |
| 14 FR-6 DPU02S | OE136 |
| 14 FR-6 DPUW2 | OE136 |
| 14 FR-6 DPUX | OE136 |
| 14 FR-6 DPUX02 | OE136 |
| 14 FR-6 DPUX2 | OE136 |
| 14 FR-6 DU | OE014 |
| 14 FR-6 DUW | OE014 |
| 14 FR-6 DUW2 | OE014 |
| 14 FR-6 LDUW | OE030 |
| 14 FR-7 DPPUS2 | OE136 |
| 14 FR-7 DPPUW2 | OE146 |
| 14 FR-7 DPU3 | OE146 |
| 14 FR-7 DPUV02 | OE146 |
| 14 FR-7 DPUX02 | OE146 |
| 14 FR-7 DU | OE005 |
| 14 FR-7 DU2 | OE033 |
| 14 FR-7 DU2S | OE002 |
| 14 FR-7 DU2T | OE002 |
| 14 FR-7 DUW | OE005 |
| 14 FR-7 DUX | OE039 |
| 14 FR-7 HUX | OE089 |
| 14 FR-7 KDU | OE030 |
| 14 FR-7 KPPU | OE188 |
| 14 FR-7 KPU | OE227 |
| 14 FR-7 KPUV | OE188 |
| 14 FR-7 KPUX | OE188 |
| 14 FR-7 KPUX02 | OE188 |
| 14 FR-7 KUOX | OE089 |
| 14 FR-7 LDU | OE026 |
| 14 FR-7 LDUW | OE026 |
| 14 FR-7 LPU02 | OE227 |
| 14 FR-7 LPUT02 | OE188 |
| 14 FR-7 LPUX0 | OE146 |
| 14 FR-7 LPUX02 | OE188 |
| 14 FR-7 LUX | OE089 |
| 14 FR-7 LUX0 | OE039 |
| 14 FR-7 MU2 | OE035 |
| 14 FR-7 MUX2 | OE035 |
| 14 FR-7 NUX2 | OE178 |
| 14 FR-8 DPPUX | OE191 |
| 14 FR-8 DPU2 | OE145 |
| 14 FR-8 DPUX | OE191 |
| 14 FR-8 DU | OE005 |
| 14 FR-8 DUS | OE005 |
| 14 FR-8 DUW | OE039 |
| 14 FR-8 DUX | OE039 |
| 14 FR-8 HU | OE128 |
| 14 FR-8 HUT | OE128 |
| 14 FR-8 KUOU | OE063 |
| 14 FR-8 LDU3 | OE019 |
| 14 FR-8 LDUOX4 | OE019 |

| BERU | CHAMPION |
|----------------|----------|
| 14 FR-8 LPU0 | OE184 |
| 14 FR-8 LPU02 | OE184 |
| 14 FR-8 LPUX | OE184 |
| 14 FR-8 LU2 | OE198 |
| 14 FR-8 LU2T | OE198 |
| 14 FR-8 MPUX02 | OE175 |
| 14 FR-8 MPUX2 | OE175 |
| 14 FR-8 MU2 | OE148 |
| 14 FR-8 NQU23 | OE178 |
| 14 FR-9 KUX2 | OE154 |
| 14 G-8 DTU | OE027 |
| 14 GH-7 DTUR | OE025 |
| 14 GH-8 DTUR | OE027 |
| 14 GH-8 DTURX | OE027 |
| 14 GR-8 DTU | OE027 |
| 14 K-7 DU | OE009 |
| 14 K-7 DU0 | OE009 |
| 14 K-8 DU | OE009 |
| 14 K-8 DU0 | OE009 |
| 14 K-9 BU | RV15YC4 |
| 14 KG-8 DTU | OE009 |
| 14 KGR-7 KQU | OE011 |
| 14 KR-6 DPUV02 | OE131 |
| 14 KR-6 KPUV02 | OE183 |
| 14 KR-6 MUU | OE031 |
| 14 KR-7 DPUV | OE131 |
| 14 KR-7 DU | OE011 |
| 14 KR-7 DUX | OE011 |
| 14 KR-7 MPUV2 | OE189 |
| 14 KR-7 MPUX2 | OE029 |
| 14 KR-8 DPUX | OE131 |
| 14 KR-8 LQPU07 | OE183 |
| 14 KR-8 MPUV2 | OE029 |
| 14 KR-8 MPX | OE029 |
| 14 KR-8 MUV | OE031 |
| 14 KR-9 DPUX | OE131 |
| 14 KR-9 DUX | OE011 |
| 14 KR-9 LPUX | OE131 |
| 14 R-5 DU | OE087 |
| 14 R-6 DU | OE018 |
| 14 R-6 DUX | OE018 |
| 14 R-7 CU | OE098 |
| 14 R-7 DPU | OE195 |
| 14 R-7 DU | OE006 |
| 14 R-7 DUX | OE048 |
| 14 R-8 DPU | OE192 |
| 14 R-8 DPUU | OE192 |
| 14 R-8 DUX | OE049 |
| 14 R-9 KPUV2 | OE105 |
| 14 R-9 LPU1 | OE105 |
| 14 X-AU | L82C |
| 14 Z-4 AU | L78C |
| 14-4 DPO | OE078 |

| BERU | CHAMPION |
|-------------|----------|
| 14-5 AU | L82C |
| 14-5 DTU | OE012 |
| 14-5 DU | OE087 |
| 14-5 DU0 | OE087 |
| 14-6 DPO | OE008 |
| 14-6 DTU | OE012 |
| 14-7 AU | L82C |
| 14-7 CU | OE074 |
| 14-7 DTU | OE012 |
| 14-7 DU | OE001 |
| 14-7 DU0 | OE001 |
| 14-8 AU | OE037 |
| 14-8 DTU | OE044 |
| 14-8 LUR | OE004 |
| 14-9 DTU | OE027 |
| 14-9 DU | OE001 |
| A 7 | L82C |
| A 7 D | OE009 |
| FM 14-225/2 | OE087 |
| M 14-175 | L82C |
| M 14-225 | L78C |
| M14-175 | L82C |
| M14-225 | L78C |
| UPT1 | CET1 |
| UPT10P | CET10P |
| UPT11P | CET11P |
| UPT12P | CET12P |
| UPT13P | CET13P |
| UPT14P | CET14P |
| UPT15P | CET15P |
| UPT16P | CET16P |
| UPT17P | CET17P |
| UPT18P | CET18P |
| UPT2 | CET2 |
| UPT3 | CET3 |
| UPT4 | CET4 |
| UPT5 | CET5 |
| UPT6 | CET6 |
| UPT7 | CET7 |
| UPT8 | CET8 |
| UPT9 | CET9 |
| UXT1 | CET2 |
| UXT10 | CET12P |
| UXT11 | CET12P |
| UXT12 | CET11P |
| UXT13 | CET14P |
| UXT14 | CET11P |
| UXT15 | CET18P |
| UXT2 | CET8 |
| UXT3 | CET2 |
| UXT4 | CET9 |
| UXT5 | CET2 |
| UXT6 | CET8 |



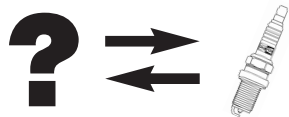

| BERU | CHAMPION | BERU | CHAMPION | BERU | CHAMPION | BERU | CHAMPION |
|--------|----------|--------|----------|--------|----------|--------|----------|
| UXT7 | CET17P | Z169 | OE015 | Z221SB | OE136 | Z255SB | OE039 |
| UXT8 | CET17P | Z16SB | OE039 | Z222 | OE255 | Z257 | OE026 |
| UXT9 | CET12P | Z17 | OE009 | Z223 | OE178 | Z257SB | OE026 |
| Z1 | OE015 | Z170 | OE146 | Z223SB | OE178 | Z27 | OE018 |
| Z10 | OE038 | Z170SB | OE146 | Z224 | OE146 | Z272 | OE177 |
| Z100 | OE057 | Z171 | OE146 | Z224SB | OE146 | Z273 | OE178 |
| Z100SB | OE057 | Z173 | OE198 | Z225 | OE089 | Z274 | OE225 |
| Z101 | OE019 | Z173SB | OE198 | Z226 | OE224 | Z275 | OE239 |
| Z103 | OE078 | Z174 | RV15YC4 | Z226SB | OE224 | Z277 | OE210 |
| Z104 | OE008 | Z176 | OE176 | Z227 | OE005 | Z278 | OE184 |
| Z105 | OE014 | Z176SB | OE176 | Z227SB | OE005 | Z279 | OE227 |
| Z10SB | OE038 | Z177 | OE031 | Z228 | OE146 | Z27SB | OE018 |
| Z11 | OE001 | Z17SB | OE009 | Z228SB | OE146 | Z28 | OE018 |
| Z116 | OE216 | Z18 | OE009 | Z229 | OE184 | Z280 | OE188 |
| Z116SB | OE216 | Z183 | OE148 | Z22SB | OE010 | Z282 | OE136 |
| Z117 | OE011 | Z183SB | OE148 | Z22SB | OE018 | Z284 | OE136 |
| Z118 | OE007 | Z184 | OE035 | Z23 | OE014 | Z285 | OE105 |
| Z118SB | OE007 | Z184SB | OE035 | Z230 | OE183 | Z286 | OE211 |
| Z11SB | OE001 | Z185 | OE222 | Z230SB | OE183 | Z287 | OE198 |
| Z12 | OE012 | Z188 | OE136 | Z233 | OE204 | Z288 | OE203 |
| Z120 | OE032 | Z188SB | OE136 | Z233SB | OE204 | Z28SB | OE018 |
| Z120SB | OE032 | Z18SB | OE009 | Z234 | OE196 | Z291 | OE230 |
| Z121 | OE032 | Z19 | OE064 | Z234SB | OE196 | Z292 | OE199 |
| Z121SB | OE032 | Z190 | OE019 | Z235 | OE238 | Z293 | OE196 |
| Z122 | OE228 | Z190SB | OE019 | Z235SB | OE238 | Z293SB | OE196 |
| Z122SB | OE228 | Z193 | OE034 | Z236 | OE234 | Z294 | OE236 |
| Z123 | OE030 | Z193SB | OE034 | Z236SB | OE234 | Z295 | OE209 |
| Z126 | OE123 | Z194 | OE217 | Z237 | OE223 | Z296 | OE131 |
| Z126SB | OE123 | Z194SB | OE217 | Z237SB | OE223 | Z297 | OE146 |
| Z127 | OE011 | Z19SB | OE064 | Z238 | OE145 | Z299 | OE039 |
| Z128 | OE123 | Z1SB | OE015 | Z238SB | OE145 | Z2SB | OE044 |
| Z129 | OE218 | Z2 | OE044 | Z23SB | OE014 | Z3 | OE004 |
| Z12SB | OE012 | Z20 | OE006 | Z24 | OE014 | Z30 | OE094 |
| Z13 | OE014 | Z200 | OE177 | Z240 | OE191 | Z301 | OE188 |
| Z130 | OE136 | Z200SB | OE177 | Z240SB | OE191 | Z302 | OE175 |
| Z13SB | OE014 | Z203 | OE198 | Z243 | OE130 | Z303 | OE035 |
| Z14 | OE026 | Z203SB | OE198 | Z243SB | OE130 | Z304 | OE077 |
| Z145 | OE237 | Z206 | OE136 | Z245 | OE030 | Z305 | OE031 |
| Z145SB | OE237 | Z206SB | OE136 | Z245SB | OE030 | Z306 | OE215 |
| Z149 | OE188 | Z207 | OE009 | Z246 | OE123 | Z307 | OE146 |
| Z14SB | OE026 | Z208 | OE019 | Z246SB | OE123 | Z308 | OE212 |
| Z15 | OE005 | Z209 | OE131 | Z247 | OE005 | Z309 | OE183 |
| Z150 | OE188 | Z209SB | OE131 | Z247SB | OE005 | Z30SB | OE094 |
| Z151 | OE227 | Z20SB | OE006 | Z248 | OE114 | Z310 | OE029 |
| Z152 | OE128 | Z21 | OE048 | Z248 | OE128 | Z310SB | OE029 |
| Z154 | OE093 | Z210 | OE122 | Z249 | OE063 | Z311 | OE192 |
| Z157 | OE089 | Z211 | OE175 | Z24SB | OE014 | Z312 | OE188 |
| Z157SB | OE089 | Z219 | OE175 | Z250 | OE002 | Z313 | OE136 |
| Z158 | OE089 | Z21SB | OE048 | Z251 | OE002 | Z314 | OE136 |
| Z158SB | OE089 | Z22 | OE010 | Z252 | OE014 | Z317 | OE136 |
| Z159 | OE136 | Z22 | OE018 | Z253 | OE094 | Z318 | OE205 |
| Z15SB | OE005 | Z220 | OE154 | Z254 | OE005 | Z32 | OE054 |
| Z16 | OE039 | Z221 | OE136 | Z255 | OE039 | Z320 | OE203 |

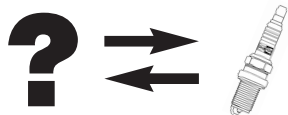

| BERU | CHAMPION |
|--------|----------|
| Z321 | OE188 |
| Z322 | OE181 |
| Z323 | OE136 |
| Z324 | OE019 |
| Z325 | OE207 |
| Z326 | OE206 |
| Z326SB | OE206 |
| Z33 | OE054 |
| Z332 | OE205 |
| Z333 | OE226 |
| Z335 | OE014 |
| Z336 | OE204 |
| Z337 | OE146 |
| Z338 | OE208 |
| Z339 | OE219 |
| Z340 | OE136 |
| Z340SB | OE136 |
| Z341 | OE122 |
| Z342 | OE189 |
| Z343 | OE191 |
| Z344 | OE235 |
| Z345 | OE220 |
| Z346 | OE188 |
| Z347 | OE214 |
| Z348 | OE246 |
| Z349 | OE213 |
| Z354 | OE136 |
| Z355 | OE233 |
| Z356 | OE029 |
| Z357 | OE232 |
| Z358 | OE199 |
| Z359 | OE229 |
| Z360 | OE077 |
| Z361 | OE197 |
| Z362 | OE201 |
| Z363 | OE242 |
| Z366 | OE245 |
| Z367 | OE246 |
| Z368 | OE247 |
| Z370 | OE253 |
| Z374 | OE256 |
| Z375 | OE257 |
| Z376 | OE258 |
| Z378 | OE260 |
| Z379 | OE261 |
| Z380 | OE262 |
| Z381 | OE263 |
| Z382 | OE264 |
| Z39 | L78C |
| Z3SB | OE004 |
| Z40 | L82C |
| Z400 | OE191 |
| Z401 | OE192 |

| BERU | CHAMPION |
|-------|----------|
| Z402 | OE131 |
| Z404 | OE195 |
| Z406 | OE131 |
| Z408 | OE184 |
| Z409 | OE131 |
| Z41 | OE038 |
| Z410 | OE105 |
| Z41SB | OE038 |
| Z42 | OE087 |
| Z42SB | OE087 |
| Z43 | OE087 |
| Z44 | OE012 |
| Z45 | OE014 |
| Z47 | OE087 |
| Z47SB | OE087 |
| Z48 | OE038 |
| Z5 | OE003 |
| Z50 | OE010 |
| Z51 | OE012 |
| Z52 | OE094 |
| Z53 | OE094 |
| Z57 | L82C |
| Z58 | OE074 |
| Z59 | OE098 |
| Z59SB | OE098 |
| Z5SB | OE003 |
| Z6 | OE009 |
| Z60 | OE077 |
| Z61 | OE001 |
| Z62 | OE001 |
| Z67 | OE011 |
| Z67SB | OE011 |
| Z68 | OE037 |
| Z69 | OE015 |
| Z6SB | OE009 |
| Z7 | OE009 |
| Z70 | OE015 |
| Z71 | OE003 |
| Z72 | OE005 |
| Z72SB | OE005 |
| Z73 | OE039 |
| Z73SB | OE039 |
| Z74 | OE019 |
| Z74SB | OE019 |
| Z75 | OE027 |
| Z76 | OE001 |
| Z76SB | OE001 |
| Z78 | OE027 |
| Z7SB | OE009 |
| Z8 | OE051 |
| Z80 | OE099 |
| Z85 | L82C |
| Z89 | OE094 |

| BERU | CHAMPION |
|---------------|----------|
| Z89SB | OE094 |
| Z9 | OE049 |
| Z90 | OE032 |
| Z90SB | OE032 |
| Z91 | OE025 |
| Z91SB | OE025 |
| Z92 | OE027 |
| Z92SB | OE027 |
| Z93 | OE027 |
| Z93SB | OE027 |
| Z94 | OE027 |
| Z94SB | OE027 |
| Z95 | OE011 |
| Z95SB | OE011 |
| Z97 | OE029 |
| Z98 | OE026 |
| Z98SB | OE026 |
| Z9SB | OE049 |
| ZM14-260 | L78C |
| BONON | CHAMPION |
| F5TC | OE065 |
| BOSCH | CHAMPION |
| 0 241 135 515 | OE247 |
| 0 241 140 519 | OE247 |
| 0 241 145 515 | OE244 |
| 0 241 219 543 | L82C |
| 0 241 219 891 | L82C |
| 0 241 225 012 | OE004 |
| 0 241 225 013 | OE001 |
| 0 241 225 544 | L82C |
| 0 241 225 545 | OE001 |
| 0 241 225 549 | L82C |
| 0 241 225 550 | OE001 |
| 0 241 225 556 | OE001 |
| 0 241 225 576 | OE027 |
| 0 241 229 059 | OE004 |
| 0 241 229 060 | OE044 |
| 0 241 229 061 | OE015 |
| 0 241 229 062 | OE015 |
| 0 241 229 565 | OE037 |
| 0 241 229 574 | OE015 |
| 0 241 229 578 | OE007 |
| 0 241 229 579 | OE074 |
| 0 241 229 588 | OE015 |
| 0 241 229 596 | OE015 |
| 0 241 229 600 | OE074 |
| 0 241 229 604 | OE037 |
| 0 241 229 612 | OE037 |
| 0 241 229 617 | OE009 |
| 0 241 229 619 | OE044 |
| 0 241 229 633 | OE044 |

| BOSCH | CHAMPION |
|---------------|----------|
| 0 241 229 634 | OE057 |
| 0 241 229 638 | OE044 |
| 0 241 229 641 | OE007 |
| 0 241 229 649 | OE009 |
| 0 241 229 650 | OE003 |
| 0 241 229 656 | OE026 |
| 0 241 229 658 | OE027 |
| 0 241 229 663 | OE027 |
| 0 241 229 665 | OE027 |
| 0 241 229 676 | OE032 |
| 0 241 229 685 | OE057 |
| 0 241 229 689 | OE228 |
| 0 241 229 704 | OE228 |
| 0 241 229 715 | OE015 |
| 0 241 229 716 | OE044 |
| 0 241 229 855 | OE007 |
| 0 241 229 857 | OE037 |
| 0 241 229 887 | OE037 |
| 0 241 229 918 | OE037 |
| 0 241 229 919 | OE007 |
| 0 241 229 923 | OE037 |
| 0 241 229 961 | OE057 |
| 0 241 235 001 | L82C |
| 0 241 235 089 | OE074 |
| 0 241 235 098 | OE074 |
| 0 241 235 102 | OE001 |
| 0 241 235 103 | OE001 |
| 0 241 235 515 | L82C |
| 0 241 235 536 | OE038 |
| 0 241 235 563 | OE001 |
| 0 241 235 564 | OE038 |
| 0 241 235 574 | OE074 |
| 0 241 235 585 | OE038 |
| 0 241 235 601 | L82C |
| 0 241 235 602 | OE001 |
| 0 241 235 607 | L82C |
| 0 241 235 609 | OE074 |
| 0 241 235 610 | OE001 |
| 0 241 235 633 | OE012 |
| 0 241 235 635 | OE009 |
| 0 241 235 636 | OE009 |
| 0 241 235 643 | OE012 |
| 0 241 235 666 | OE001 |
| 0 241 235 668 | OE009 |
| 0 241 235 675 | OE009 |
| 0 241 235 681 | OE009 |
| 0 241 235 682 | OE014 |
| 0 241 235 686 | OE026 |
| 0 241 235 690 | OE026 |
| 0 241 235 693 | OE001 |
| 0 241 235 697 | OE032 |
| 0 241 235 698 | OE025 |
| 0 241 235 705 | OE001 |

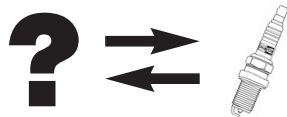

| BOSCH | CHAMPION | BOSCH | CHAMPION | BOSCH | CHAMPION | BOSCH | CHAMPION |
|---------------|-----------------|---------------|-----------------|---------------|-----------------|---------------|-----------------|
| 0 241 235 706 | OE032 | 0 242 129 521 | OE197 | 0 242 229 654 | OE019 | 0 242 235 542 | OE011 |
| 0 241 235 715 | OE176 | 0 242 129 801 | OE130 | 0 242 229 656 | OE051 | 0 242 235 544 | OE039 |
| 0 241 235 718 | OE176 | 0 242 132 800 | CET5 | 0 242 229 658 | OE027 | 0 242 235 547 | OE136 |
| 0 241 235 720 | OE136 | 0 242 132 801 | CET1 | 0 242 229 659 | OE016 | 0 242 235 549 | OE005 |
| 0 241 235 735 | OE177 | 0 242 135 501 | OE196 | 0 242 229 660 | OE039 | 0 242 235 551 | OE002 |
| 0 241 235 751 | OE026 | 0 242 135 509 | OE229 | 0 242 229 661 | OE255 | 0 242 235 566 | OE011 |
| 0 241 235 752 | OE032 | 0 242 135 510 | OE215 | 0 242 229 671 | OE019 | 0 242 235 567 | OE089 |
| 0 241 235 753 | OE009 | 0 242 135 515 | OE196 | 0 242 229 673 | OE005 | 0 242 235 587 | OE033 |
| 0 241 235 754 | OE038 | 0 242 135 515 | OE199 | 0 242 229 687 | OE049 | 0 242 235 589 | OE026 |
| 0 241 235 755 | OE001 | 0 242 135 515 | OE230 | 0 242 229 698 | OE198 | 0 242 235 592 | OE011 |
| 0 241 235 756 | OE012 | 0 242 135 524 | OE207 | 0 242 229 699 | OE198 | 0 242 235 597 | OE005 |
| 0 241 235 757 | OE025 | 0 242 135 527 | OE201 | 0 242 229 702 | OE035 | 0 242 235 602 | OE089 |
| 0 241 235 769 | OE177 | 0 242 135 529 | OE253 | 0 242 229 706 | OE032 | 0 242 235 607 | OE011 |
| 0 241 235 804 | OE038 | 0 242 135 545 | OE197 | 0 242 229 713 | OE191 | 0 242 235 609 | OE030 |
| 0 241 235 911 | OE001 | 0 242 135 802 | OE196 | 0 242 229 715 | OE198 | 0 242 235 610 | OE188 |
| 0 241 240 057 | OE010 | 0 242 140 512 | OE229 | 0 242 229 724 | OE016 | 0 242 235 615 | OE077 |
| 0 241 240 058 | OE010 | 0 242 140 530 | OE130 | 0 242 229 739 | OE189 | 0 242 235 617 | OE223 |
| 0 241 240 532 | OE038 | 0 242 145 515 | OE242 | 0 242 229 775 | OE011 | 0 242 235 624 | OE033 |
| 0 241 240 539 | OE010 | 0 242 145 518 | OE242 | 0 242 229 782 | OE019 | 0 242 235 636 | OE035 |
| 0 241 240 542 | OE014 | 0 242 145 541 | OE243 | 0 242 229 785 | OE031 | 0 242 235 640 | OE005 |
| 0 241 240 558 | OE012 | 0 242 219 516 | RV15YC4 | 0 242 229 796 | OE029 | 0 242 235 642 | OE237 |
| 0 241 240 564 | OE094 | 0 242 219 517 | RV15YC4 | 0 242 229 797 | OE178 | 0 242 235 643 | OE029 |
| 0 241 240 580 | OE014 | 0 242 222 801 | CET8 | 0 242 229 798 | OE002 | 0 242 235 644 | OE005 |
| 0 241 240 585 | OE014 | 0 242 222 802 | CET8 | 0 242 229 799 | OE032 | 0 242 235 656 | OE227 |
| 0 241 240 587 | OE014 | 0 242 222 803 | CET2 | 0 242 229 865 | OE019 | 0 242 235 658 | OE029 |
| 0 241 240 590 | OE094 | 0 242 222 804 | CET2 | 0 242 229 877 | OE031 | 0 242 235 663 | OE006 |
| 0 241 240 592 | OE094 | 0 242 225 534 | OE011 | 0 242 229 878 | OE019 | 0 242 235 664 | OE025 |
| 0 241 240 603 | L82C | 0 242 225 560 | RV15YC4 | 0 242 229 882 | OE027 | 0 242 235 665 | OE064 |
| 0 241 240 609 | OE094 | 0 242 225 573 | RV15YC4 | 0 242 229 883 | OE016 | 0 242 235 666 | OE005 |
| 0 241 242 802 | CET9 | 0 242 225 580 | OE198 | 0 242 229 884 | OE039 | 0 242 235 666 | OE034 |
| 0 241 243 501 | OE008 | 0 242 225 622 | RV15YC4 | 0 242 229 885 | OE049 | 0 242 235 667 | OE039 |
| 0 241 245 070 | OE012 | 0 242 229 530 | OE039 | 0 242 229 902 | OE031 | 0 242 235 668 | OE026 |
| 0 241 245 071 | OE087 | 0 242 229 555 | OE192 | 0 242 229 923 | OE035 | 0 242 235 690 | OE146 |
| 0 241 245 552 | OE087 | 0 242 229 566 | OE049 | 0 242 229 924 | OE032 | 0 242 235 692 | OE089 |
| 0 241 245 553 | OE038 | 0 242 229 568 | OE005 | 0 242 229 925 | OE191 | 0 242 235 699 | OE136 |
| 0 241 245 580 | L82C | 0 242 229 579 | OE184 | 0 242 229 995 | OE035 | 0 242 235 700 | OE131 |
| 0 241 245 599 | OE087 | 0 242 229 583 | OE041 | 0 242 230 500 | OE191 | 0 242 235 707 | OE048 |
| 0 241 245 602 | L82C | 0 242 229 586 | OE064 | 0 242 230 528 | OE180 | 0 242 235 715 | OE120 |
| 0 241 245 619 | OE038 | 0 242 229 587 | OE005 | 0 242 230 530 | OE189 | 0 242 235 733 | OE131 |
| 0 241 245 673 | OE246 | 0 242 229 590 | OE128 | 0 242 230 607 | OE035 | 0 242 235 740 | OE136 |
| 0 241 246 001 | OE087 | 0 242 229 591 | OE019 | 0 242 232 801 | CET2 | 0 242 235 743 | OE206 |
| 0 241 248 531 | L78C | 0 242 229 594 | OE005 | 0 242 232 802 | CET2 | 0 242 235 746 | OE029 |
| 0 241 248 540 | L78C | 0 242 229 598 | OE016 | 0 242 232 803 | CET8 | 0 242 235 748 | OE120 |
| 0 241 250 502 | OE078 | 0 242 229 605 | OE019 | 0 242 232 804 | CET8 | 0 242 235 749 | OE136 |
| 0 241 250 512 | OE078 | 0 242 229 606 | OE019 | 0 242 232 806 | CET9 | 0 242 235 749 | OE191 |
| 0 241 256 524 | OE108 | 0 242 229 613 | OE198 | 0 242 232 814 | CET7 | 0 242 235 756 | OE238 |
| 0 241 329 520 | OE054 | 0 242 229 615 | OE019 | 0 242 235 511 | OE006 | 0 242 235 758 | OE238 |
| 0 241 335 516 | OE054 | 0 242 229 626 | OE019 | 0 242 235 522 | OE064 | 0 242 235 764 | OE176 |
| 0 241 340 501 | OE054 | 0 242 229 630 | OE148 | 0 242 235 529 | OE006 | 0 242 235 766 | OE032 |
| 0 242 129 508 | OE130 | 0 242 229 634 | OE175 | 0 242 235 530 | OE048 | 0 242 235 767 | OE029 |
| 0 242 129 510 | OE130 | 0 242 229 635 | OE063 | 0 242 235 532 | OE098 | 0 242 235 776 | OE188 |
| 0 242 129 512 | OE205 | 0 242 229 648 | OE198 | 0 242 235 537 | OE006 | 0 242 235 788 | OE235 |
| 0 242 129 515 | OE201 | 0 242 229 650 | OE031 | 0 242 235 538 | OE011 | 0 242 235 791 | OE035 |

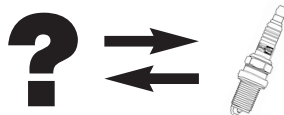

| BOSCH | CHAMPION |
|---------------|-----------------|
| 0 242 235 797 | OE035 |
| 0 242 235 894 | OE005 |
| 0 242 235 908 | OE011 |
| 0 242 235 909 | OE006 |
| 0 242 235 910 | OE025 |
| 0 242 235 911 | OE064 |
| 0 242 235 912 | OE005 |
| 0 242 235 913 | OE039 |
| 0 242 235 914 | OE026 |
| 0 242 235 915 | OE048 |
| 0 242 235 916 | OE029 |
| 0 242 235 918 | OE136 |
| 0 242 235 979 | OE011 |
| 0 242 235 981 | OE223 |
| 0 242 235 982 | OE136 |
| 0 242 235 985 | OE089 |
| 0 242 235 986 | OE089 |
| 0 242 235 987 | OE188 |
| 0 242 236 510 | OE190 |
| 0 242 236 510 | OE238 |
| 0 242 236 511 | OE136 |
| 0 242 236 512 | OE223 |
| 0 242 236 530 | OE177 |
| 0 242 236 539 | OE176 |
| 0 242 236 541 | OE089 |
| 0 242 236 542 | OE089 |
| 0 242 236 544 | OE188 |
| 0 242 236 558 | OE184 |
| 0 242 236 560 | OE011 |
| 0 242 236 562 | OE223 |
| 0 242 236 563 | OE131 |
| 0 242 236 564 | OE136 |
| 0 242 236 564 | OE146 |
| 0 242 236 565 | OE177 |
| 0 242 236 566 | OE176 |
| 0 242 236 572 | OE227 |
| 0 242 236 583 | OE146 |
| 0 242 240 511 | OE018 |
| 0 242 240 522 | OE131 |
| 0 242 240 523 | OE032 |
| 0 242 240 526 | OE014 |
| 0 242 240 528 | OE032 |
| 0 242 240 530 | OE227 |
| 0 242 240 531 | OE018 |
| 0 242 240 533 | OE180 |
| 0 242 240 548 | OE227 |
| 0 242 240 557 | OE216 |
| 0 242 240 566 | OE030 |
| 0 242 240 577 | OE014 |
| 0 242 240 584 | OE217 |
| 0 242 240 587 | OE218 |
| 0 242 240 606 | OE227 |
| 0 242 240 615 | OE136 |

| BOSCH | CHAMPION |
|---------------|-----------------|
| 0 242 240 619 | OE224 |
| 0 242 240 620 | OE183 |
| 0 242 240 621 | OE136 |
| 0 242 240 625 | OE136 |
| 0 242 240 627 | OE214 |
| 0 242 240 628 | OE222 |
| 0 242 240 635 | OE035 |
| 0 242 240 635 | OE236 |
| 0 242 240 637 | OE210 |
| 0 242 240 649 | OE146 |
| 0 242 240 650 | OE136 |
| 0 242 240 653 | OE179 |
| 0 242 240 665 | OE260 |
| 0 242 240 692 | OE181 |
| 0 242 240 849 | OE018 |
| 0 242 240 850 | OE014 |
| 0 242 242 801 | CET2 |
| 0 242 242 802 | CET8 |
| 0 242 245 515 | OE094 |
| 0 242 245 516 | OE087 |
| 0 242 245 536 | OE094 |
| 0 242 245 537 | OE087 |
| 0 242 245 539 | OE014 |
| 0 242 245 546 | OE136 |
| 0 242 245 548 | OE136 |
| 0 242 245 552 | OE087 |
| 0 242 245 556 | OE086 |
| 0 242 245 557 | OE098 |
| 0 242 245 559 | OE257 |
| 0 242 245 576 | OE214 |
| 0 242 245 581 | OE262 |
| 0 242 245 585 | OE246 |
| 0 242 245 812 | OE087 |
| 0 242 250 506 | L78C |
| 0 242 250 512 | OE087 |
| 0 242 260 001 | OE091 |
| 0 242 329 503 | OE054 |
| 0 242 329 504 | OE054 |
| 0 242 340 501 | OE054 |
| 4303 | OE191 |
| 4307 | OE192 |
| 4310 | OE192 |
| 4417 | OE180 |
| 4418 | OE194 |
| 4419 | OE193 |
| 4457 | OE183 |
| 4477 | OE195 |
| 4478 | OE195 |
| 4479 | OE195 |
| D6BC | OE054 |
| D7BC | OE054 |
| D8BC | OE054 |
| DR6BC | OE054 |

| BOSCH | CHAMPION |
|--------------|-----------------|
| DR7BC | OE054 |
| DR8BC | OE054 |
| F03DAR | OE005 |
| F03DAR | OE026 |
| F04DAR | OE013 |
| F04DAR | OE026 |
| F5DC | OE094 |
| F5DPOR | OE136 |
| F5DTC | OE094 |
| F5KPP332SBN | OE214 |
| F6DCOR | OE039 |
| F6DCO | OE014 |
| F6DCOR | OE014 |
| F6DP | OE145 |
| F6DPP332 | OE181 |
| F6DPX | OE145 |
| F6DSR | OE014 |
| F6DSR | OE039 |
| F6DTC | OE094 |
| F6DTC1 | OE039 |
| F6LTCR | OE032 |
| F6LTCR | OE094 |
| F6MPP33 | OE175 |
| F7DC | OE003 |
| F7DCO | OE003 |
| F7DCOR | OE039 |
| F7DCOR | OE014 |
| F7DPER | OE136 |
| F7DPP222T | OE136 |
| F7DTC | OE094 |
| F7HER2 | OE177 |
| F7HPP2 | OE176 |
| F7HPP22 | OE176 |
| F7HPP222 | OE176 |
| F7HPP222U | OE176 |
| F7KPP332U | OE188 |
| F7KTCR | OE032 |
| F7LDCR | OE026 |
| F7LTCR | OE032 |
| F8DC | OE057 |
| F8DCO | OE013 |
| F8DCOR | OE013 |
| F8DC4 | OE057 |
| F8DCO | OE003 |
| F8DER | OE005 |
| F8DPER | OE228 |
| F8DPP222U | OE228 |
| F8DPP33 | OE228 |
| F8DPP332 | OE228 |
| F8DPP33S | OE191 |
| F8KTCR | OE032 |
| F8KTCR | OE120 |
| F8LDCR | OE013 |

| BOSCH | CHAMPION |
|--------------|-----------------|
| F8LTCR | OE120 |
| F9DCO | OE057 |
| F9LCR2 | OE154 |
| FGR5KQE0 | OE257 |
| FGR5NQE04 | OE262 |
| FGR6KQC | OE218 |
| FGR6KQE | OE218 |
| FGR6NQE0 | OE236 |
| FGR7DQC | OE077 |
| FGR7DQE | OE120 |
| FGR7DQE+ | OE120 |
| FGR7DQE0 | OE013 |
| FGR7DQE0 | OE237 |
| FGR7DQI | OE223 |
| FGR7DQP | OE223 |
| FGR7DQP+ | OE223 |
| FGR7KQE | OE120 |
| FGR7KQE0 | OE120 |
| FGR8DQI | OE223 |
| FGR8KQC | OE198 |
| FGR8KQE | OE120 |
| FGR8KQE | OE198 |
| FGR8KQE0 | OE120 |
| FGR8KQE0 | OE198 |
| FGR8MQPE | OE175 |
| FL7HTCOR | OE235 |
| FLR7HTCO | OE235 |
| FLR8LDCU | OE019 |
| FLR8LDCU+ | OE019 |
| FLR8LDU+ | OE019 |
| FLR9LTE | OE013 |
| FQ5NPP332S | OE246 |
| FQR7ME | OE035 |
| FQR7ME | OE178 |
| FQR8DE | OE005 |
| FQR8LE2 | OE198 |
| FQR8LEU2 | OE198 |
| FR10DC | OE013 |
| FR10DCX | OE013 |
| FR10DX | OE013 |
| FR56 | CET2 |
| FR5DC | OE094 |
| FR5DCX | OE014 |
| FR5DP | OE136 |
| FR5DP1 | OE136 |
| FR5DP1X | OE136 |
| FR5DPP222 | OE146 |
| FR5DPP222U | OE146 |
| FR5DPP332 | OE146 |
| FR5DTC | OE014 |
| FR5DTC | OE026 |
| FR5KPP332S | OE214 |
| FR5NPP332S | OE246 |



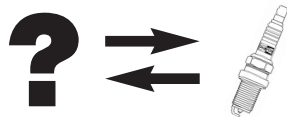

| BOSCH | | CHAMPION | BOSCH | | CHAMPION | BOSCH | | CHAMPION | BOSCH | | CHAMPION |
|------------|-------|----------|------------|-------|----------|-----------|---------|----------|------------|---------|----------|
| FR6D+ | OE014 | | FR7DPP33+ | OE191 | | FR8DII33X | OE193 | | HR10BCX | RV15YC4 | |
| FR6DC | OE014 | | FR7DPP332 | OE136 | | FR8DP | OE191 | | HR10BX | RV15YC4 | |
| FR6DC+ | OE014 | | FR7DPP332 | OE191 | | FR8DPP33 | OE191 | | HR5KI332S | OE183 | |
| FR6DC2 | OE014 | | FR7DPX | OE191 | | FR8DPP33+ | OE191 | | HR6DP | OE131 | |
| FR6DCP | OE191 | | FR7DTC | OE120 | | FR8DPX | OE191 | | HR6DPP33V | OE183 | |
| FR6DDC | OE026 | | FR7HC | OE177 | | FR8DS | OE016 | | HR6DS | OE011 | |
| FR6DP | OE191 | | FR7HC+ | OE177 | | FR8HC | OE041 | | HR6KI332S | OE183 | |
| FR6DP | OE227 | | FR7HCOX | OE089 | | FR8HC | OE128 | | HR78 | CET9 | |
| FR6DP1 | OE191 | | FR7HCOX | OE089 | | FR8HDC | OE019 | | HR78NX | CET7 | |
| FR6DP1 | OE227 | | FR7HE02 | OE177 | | FR8HDC+ | OE019 | | HR7D+ | OE011 | |
| FR6DPP22 | OE136 | | FR7HE2 | OE177 | | FR8HP | OE041 | | HR7DC | OE011 | |
| FR6DPP22U | OE136 | | FR7HPP22 | OE176 | | FR8HP0 | OE041 | | HR7DC+ | OE011 | |
| FR6DPP332S | OE222 | | FR7HPP22 | OE176 | | FR8HPX | OE041 | | HR7DC0 | OE011 | |
| FR6DPP332X | OE136 | | FR7HPP33+ | OE176 | | FR8KC+ | OE002 | | HR7DCX | OE011 | |
| FR6DPP33X | OE136 | | FR7HPP332W | OE176 | | FR8KCO | OE002 | | HR7DCX+ | OE011 | |
| FR6DPX | OE180 | | FR7KC | OE089 | | FR8KCU | OE039 | | HR7DCY+ | OE011 | |
| FR6DTC | OE032 | | FR7KC+ | OE089 | | FR8KDC | OE026 | | HR7DII33V | OE183 | |
| FR6DTCW | OE077 | | FR7KCW | OE089 | | FR8KII33X | OE193 | | HR7DP | OE131 | |
| FR6HI332 | OE213 | | FR7KCX | OE089 | | FR8KTC | OE032 | | HR7DPP22 | OE131 | |
| FR6KDO | OE217 | | FR7KCX+ | OE089 | | FR8KTC+ | OE032 | | HR7KPP33 | OE131 | |
| FR6KDE0 | OE217 | | FR7KPP33 | OE146 | | FR8LCX | OE089 | | HR7KPP33+ | OE131 | |
| FR6KI332S | OE179 | | FR7KPP33+ | OE136 | | FR8LDC | OE019 | | HR7MEW | OE031 | |
| FR6KPP33+ | OE136 | | FR7KPP332 | OE188 | | FR8LI332S | OE194 | | HR7MPP+ | OE029 | |
| FR6KPP332S | OE214 | | FR7KPP332U | OE146 | | FR8LPX | OE184 | | HR7MPP+V | OE029 | |
| FR6KPP332U | OE181 | | FR7KPP33U+ | OE188 | | FR8ME | OE035 | | HR7MPP22+ | OE029 | |
| FR6KPP33X+ | OE146 | | FR7KTC | OE032 | | FR8NEU | OE035 | | HR7MPP22U | OE029 | |
| FR6KTC | OE120 | | FR7LCX | OE089 | | FR8NII33W | OE190 | | HR7MPP22V | OE029 | |
| FR6LDC | OE030 | | FR7LCX+ | OE089 | | FR8SC | OE035 | | HR7MPP302X | OE029 | |
| FR6LDC | OE216 | | FR7LD+ | OE026 | | FR8SC+ | OE035 | | HR7NI332W | OE189 | |
| FR6LTC | OE120 | | FR7LDC | OE026 | | FR8SEO | OE035 | | HR8DPP22U | OE131 | |
| FR6MPP332 | OE224 | | FR7LDC+ | OE026 | | FR8SPP332 | OE175 | | HR8MCV+ | OE031 | |
| FR6NPP332 | OE210 | | FR7LDC4 | OE026 | | FR91 | CET2 | | HR8MEV | OE031 | |
| FR78 | CET2 | | FR7LDCU | OE026 | | FR91X | CET2 | | HR8MPV | OE029 | |
| FR78X | CET2 | | FR7LI332S | OE227 | | FR9DC | OE013 | | HR8NII332X | OE189 | |
| FR7D+ | OE005 | | FR7LPX | OE184 | | FR9LCX | OE198 | | HR8NPP302 | OE189 | |
| FR7DC | OE005 | | FR7LTC | OE120 | | FRDPP10 | OE136 | | HR91GX | RV15YC4 | |
| FR7DC+ | OE005 | | FR7ME | OE035 | | H10B | RV15YC4 | | HR9BC+ | RV15YC4 | |
| FR7DC2 | OE002 | | FR7ME | OE178 | | H56 | CET9 | | HR9BP | RV15YC4 | |
| FR7DC9 | OE005 | | FR7MPP10 | OE175 | | H6D | OE011 | | HR9BPX | RV15YC4 | |
| FR7DC0 | OE005 | | FR7MPP10 | OE206 | | H6DC0 | OE011 | | HR9DCX | OE011 | |
| FR7DCX | OE039 | | FR7NES | OE035 | | H7DC | OE009 | | MA175T7 | OE054 | |
| FR7DCX+ | OE039 | | FR7NI33 | OE190 | | H7DC0 | OE009 | | MA200T7 | OE054 | |
| FR7DE | OE005 | | FR7NI332S | OE190 | | H8DC | OE009 | | VR6NE | OE130 | |
| FR7DE2 | OE033 | | FR7NII35U | OE190 | | H8DC0 | OE009 | | VR7SPP33 | OE207 | |
| FR7DP | OE136 | | FR7NPP33 | OE238 | | H9BP | RV15YC4 | | VR8SC+ | OE130 | |
| FR7DPP | OE136 | | FR7NPP332 | OE238 | | H9BPX | RV15YC4 | | VR8SEW | OE130 | |
| FR7DPP+ | OE136 | | FR7SE | OE035 | | H9DC | OE099 | | W10A | L82C | |
| FR7DPP10 | OE136 | | FR7SE | OE238 | | H9DC0 | OE099 | | W10AC | L82C | |
| FR7DPP10 | OE191 | | FR8D+ | OE016 | | HGR7DQI | OE183 | | W10AC | OE037 | |
| FR7DPP22U | OE146 | | FR8DC | OE016 | | HGR7KQC | OE011 | | W125T1 | L82C | |
| FR7DPP22U | OE191 | | FR8DCX | OE063 | | HLR8STEX | OE255 | | W125T30 | OE001 | |
| FR7DPP33 | OE136 | | FR8DCX+ | OE063 | | HR10B | RV15YC4 | | W125T4 | L82C | |
| FR7DPP33 | OE191 | | FR8DE | OE016 | | HR10BC | RV15YC4 | | W145M1 | OE037 | |

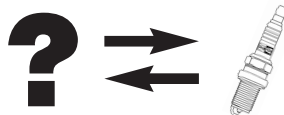

| BOSCH | |
|--------------|-------|
| W145M2 | OE074 |
| W145T1 | OE037 |
| W145T2 | OE074 |
| W145T30 | OE015 |
| W145T35 | OE007 |
| W145TR2 | OE098 |
| W175M2 | OE074 |
| W175T1 | L82C |
| W175T2 | OE074 |
| W175T27 | OE001 |
| W175T30 | OE001 |
| W175T35 | OE038 |
| W175T4 | J8C |
| W175TR2 | OE098 |
| W175TR35 | OE064 |
| W190M11S | L82C |
| W200RT27 | OE018 |
| W200RT30 | OE018 |
| W200T27 | OE010 |
| W200T30 | OE010 |
| W200T35 | OE038 |
| W215P21 | OE008 |
| W215T30 | OE010 |
| W225P11S | L82C |
| W225T1 | L82C |
| W225T2 | OE074 |
| W225T27 | OE087 |
| W225T28 | OE087 |
| W225T35 | OE038 |
| W225T7 | OE038 |
| W225TR30 | OE087 |
| W230T30 | OE087 |
| W240P11S | L78C |
| W240T1 | L78C |
| W240T2 | OE068 |
| W250P21 | OE078 |
| W250T1 | L78C |
| W260T1 | L78C |
| W260T1 | L82C |
| W260T2 | OE068 |
| W3D | OE087 |
| W3DP | OE087 |
| W3DP0 | OE087 |
| W4AC | L78C |
| W4AC | L82C |
| W4C1 | OE068 |
| W4C2 | OE068 |
| W4C3 | OE068 |
| W4CC | OE068 |
| W4CP | OE078 |
| W4CS | OE078 |
| W4DP | OE087 |
| W4DP0 | OE078 |

| BOSCH | |
|--------------|-------|
| W4DP0 | OE078 |
| W5A | L78C |
| W5AC | L82C |
| W5AS | L78C |
| W5BC | OE038 |
| W5C | OE079 |
| W5CC | OE068 |
| W5CS | OE078 |
| W5DC | OE087 |
| W5DCO | OE087 |
| W5DP0 | OE068 |
| W5DTC | OE012 |
| W6AC | L82C |
| W6AS | L82C |
| W6BC | OE038 |
| W6BP | L82C |
| W6CC | OE079 |
| W6D | OE001 |
| W6D1 | OE001 |
| W6DC | OE010 |
| W6DCO | OE010 |
| W6DP | OE001 |
| W6DP0 | OE001 |
| W6DP0 | OE008 |
| W6DTC | OE012 |
| W78X | CET8 |
| W7A | OE037 |
| W7AC | L82C |
| W7AC | OE037 |
| W7BC | OE038 |
| W7C | OE079 |
| W7CC | OE074 |
| W7CCO | OE079 |
| W7CCO | OE074 |
| W7CCX | OE098 |
| W7CX | OE079 |
| W7D | OE001 |
| W7D0 | OE001 |
| W7DC | OE001 |
| W7DCO | OE001 |
| W7DCO | OE001 |
| W7DCX | OE001 |
| W7DP | OE001 |
| W7DSR | OE001 |
| W7DTC | OE012 |
| W7DX | OE048 |
| W7EC | J8C |
| W7LTCR | OE025 |
| W8A | OE037 |
| W8AO | OE037 |
| W8AC | OE037 |
| W8AP | OE037 |
| W8AS | OE037 |

| BOSCH | |
|--------------|-------|
| W8BC | OE007 |
| W8BC | OE059 |
| W8C | OE074 |
| W8CO | OE074 |
| W8CC | OE074 |
| W8CD | OE074 |
| W8D | OE065 |
| W8DC | OE015 |
| W8DC | OE065 |
| W8DCO | OE001 |
| W8DCO | OE015 |
| W8DCX | OE015 |
| W8DCX | OE049 |
| W8DP | OE065 |
| W8DPX | OE065 |
| W8DTC | OE044 |
| W8DX | OE048 |
| W8E | J8C |
| W8LCR | OE004 |
| W8LDCR | OE027 |
| W8LTCR | OE027 |
| W95T1 | L82C |
| W95T2 | OE074 |
| W9A | OE037 |
| W9AC | L82C |
| W9AC | OE037 |
| W9ACO | OE037 |
| W9ACO | L82C |
| W9C | OE074 |
| W9CC | OE074 |
| W9CL | OE074 |
| W9DC | OE001 |
| W9DCO | OE001 |
| W9DTC | OE027 |
| W9LC | OE004 |
| WA125TR30 | OE011 |
| WA175T30 | OE009 |
| WGR7DQP | OE027 |
| WR175TR30 | OE006 |
| WR3CC | OE091 |
| WR3CTC | OE091 |
| WR4AC | L78C |
| WR4AC | OE086 |
| WR4CC | OE108 |
| WR4CP | OE108 |
| WR4DP0 | OE087 |
| WR56 | CET8 |
| WR5AC | OE086 |
| WR5AP | OE086 |
| WR5CC | OE108 |
| WR5CP | OE098 |
| WR6D+ | OE018 |
| WR6DC | OE018 |

| BOSCH | |
|--------------|-------|
| WR6DC+ | OE018 |
| WR6DC2 | OE008 |
| WR6DCX | OE077 |
| WR6DP | OE018 |
| WR6DTC | OE012 |
| WR6KI33S | OE195 |
| WR78 | CET8 |
| WR7B+ | OE064 |
| WR7BC | OE064 |
| WR7BC+ | OE064 |
| WR7CC | OE098 |
| WR7CCX | OE098 |
| WR7CP | OE098 |
| WR7CPX | OE098 |
| WR7D+ | OE006 |
| WR7DC | OE006 |
| WR7DC+ | OE006 |
| WR7DC2 | OE004 |
| WR7DCX | OE048 |
| WR7DCX+ | OE048 |
| WR7DP | OE004 |
| WR7DTC | OE044 |
| WR7KI33S | OE195 |
| WR7LC | OE004 |
| WR7LT+ | OE025 |
| WR7LTC+ | OE025 |
| WR8AC | OE037 |
| WR8D | OE042 |
| WR8D+ | OE051 |
| WR8DC | OE051 |
| WR8DC+ | OE051 |
| WR8DC4 | OE051 |
| WR8DCX | OE049 |
| WR8DCX+ | OE049 |
| WR8DP | OE192 |
| WR8LC | OE051 |
| WR8LC+ | OE051 |
| WR8LP | OE051 |
| WR8LT+ | OE027 |
| WR8LTC | OE027 |
| WR8LTC+ | OE027 |
| WR91 | CET8 |
| WR91V | OE105 |
| WR91V0 | OE105 |
| WR91X | CET8 |
| WR9D | OE051 |
| WR9D+ | OE051 |
| WR9DC | OE051 |
| WR9DC+ | OE051 |
| WR9DCX | OE049 |
| WR9DCX+ | OE049 |
| WR9DP | OE042 |
| WR9DPX | OE042 |



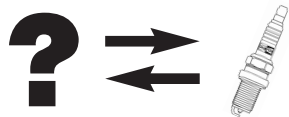

| | | | | | | | |
|--------------|-------|------------------------------|---------|------------------------------|---------|-----------------|-------|
| BOSCH | | BOSNA | | BRIGGS & STRATTON | | CHAMPION | |
| WR9DX | OE042 | FE55P | OE065 | 491055S | OE013 | C6BYC4/T10 | OE094 |
| X4C | OE083 | FE55PR | OE051 | 499608 | OE013 | C6VPYC | OE032 |
| X4DC | OE083 | FE65CP | OE001 | 692051 | OE013 | C6VPYC/103 | OE032 |
| X5DC | OE083 | FE65CPD | OE012 | 711252 | OE086 | C6YC | OE094 |
| X5DTC | OE083 | FE65CPR | OE006 | 797235 | OE051 | C6YCC | OE094 |
| XR2CS | OE073 | FE65P | OE001 | 798615 | OE065 | C6YCX | OE094 |
| XR4DC | OE083 | FE65PR | OE006 | BRISK | | C7YC | OE014 |
| XR5DC | OE083 | FE70 | OE074 | 1851 | OE240 | C7YC/184 | OE014 |
| Y5KPP332S | OE244 | FE70C | OE074 | DR15YC | OE005 | C7YCC | OE014 |
| Y6DC | OE083 | FE75 | OE079 | DR15YC1 | OE039 | C7YCC/093 | OE014 |
| Y6LERO2 | OE247 | FE75C | OE079 | DR15YCY | OE002 | C7YCX | OE014 |
| Y6NPP332 | OE229 | FE75CR | OE098 | DR15YP | OE145 | C9BMC | OE026 |
| Y7LERO2 | OE247 | FE75R | OE098 | DR15YP1 | OE145 | C9MCC | OE089 |
| YR5DDE | OE073 | FE80 | OE068 | DR15YPP | OE145 | C9YCC | OE005 |
| YR6NPP332 | OE229 | FE80C | OE068 | DR15YPP1 | OE145 | C9YCC/033 | OE005 |
| YR78X | CET1 | FE80CR | OE108 | DR15YPP1 | OE145 | C9YCC/290 | OE002 |
| YR7DC | OE199 | FE80R | OE108 | DR15YS | OE002 | CCH3455 | OE204 |
| YR7DC+ | OE199 | FE85CP | OE087 | DR17YPP | OE191 | CCH450 | OE196 |
| YR7DE | OE073 | FE85CPD | OE012 | DR17YPP1 | OE191 | CCH455 | OE177 |
| YR7LPP332W | OE215 | FE85P | OE010 | DR17YS | OE016 | CCH460 | OE216 |
| YR7ME | OE197 | FE95CPR | OE087 | F 14 YC | OE054 | CCH461 | OE237 |
| YR7MPP33 | OE229 | FE95P | OE087 | F 15YC | OE054 | CCH464 | OE026 |
| YR7NE | OE201 | FE95PR | OE087 | CARLTON | | CCH465 | OE218 |
| YR7SEU | OE201 | FET65CP | OE099 | C8A | J8C | CCH488 | OE223 |
| YR8MEU | OE197 | FET65CPR | OE011 | SCR11C | OE051 | CCH7140 | OE215 |
| ZQR8S1302 | OE205 | FET75CP | OE009 | CHAMPION | | CCH7144 | OE210 |
| ZR5TPP33 | OE242 | FET75P | OE011 | 159010-03520 | OE037 | CCH7146 | OE219 |
| ZR5TPP330 | OE243 | FS50 | J8C | 159010-04120 | L82C | CCH7166 | OE214 |
| ZR5TPP33S | OE242 | FS50C | J8C | 425 | CCH425 | CCH7168 | OE222 |
| BOSNA | | FS70 | J8C | 730 | OE007 | CCH7175 | OE209 |
| F100 | L82C | FT25PR | RV15YC4 | A25 | CCH425 | CCH7190 | OE228 |
| F55CP | OE059 | FT45P | RV15YC4 | A4HC | OE073 | CCH7418 | OE238 |
| F55P | OE059 | FT45PR | RV15YC4 | A5YC | OE073 | CCH7422 | OE224 |
| F65CP | OE007 | MT65CP | OE054 | A6 | OE083 | CCH7426 | OE205 |
| F65P | OE007 | MT65P | OE054 | A6G | OE112 | CCH7428 | OE242 |
| F70 | L82C | SFE45CLR | OE041 | A6G/101 | OE112 | CCH7429 | OE243 |
| F70C | L82C | SFE45CPR | OE013 | A6HC | OE083 | CCH7445 | OE233 |
| F75C | OE037 | SFE55CPR10 | OE063 | A6Y | OE083 | CCH7600 | OE220 |
| F80 | L82C | SFE65CLR | OE089 | A6YC | OE083 | CCH7695 | OE208 |
| F80CR | OE086 | SFE65CLU | OE026 | BL13Y | RV15YC4 | CCH800 | OE212 |
| F85 | OE037 | SFE65CP | OE003 | BL15Y | RV15YC4 | CCH9069 | OE246 |
| F85CP | OE038 | SFE65CPDR | OE237 | BN89Y | OE011 | CCH9425 | OE245 |
| F85CPR | OE064 | SFE65CPDR10 | OE077 | BN9Y | OE011 | EON1/286 | CET2 |
| F85P | OE038 | SFE65CPR | OE005 | C10YCC | OE005 | EON10/286 | CET1 |
| FE100 | OE108 | SFE65CPUR | OE026 | C12YCC | OE013 | EON2/286 | CET2 |
| FE35CP | OE015 | SFE65P | OE014 | C279YC | OE014 | EON3/286 | CET9 |
| FE45CLR | OE004 | SFE85CP | OE094 | C281YC | OE003 | EON4/286 | CET7 |
| FE50 | OE074 | SFE85CPR | OE014 | C6BMC | OE094 | EON5/286 | CET8 |
| FE55CP | OE065 | SFE85CPR10 | OE014 | C6BMC/T10 | OE094 | EON6/286 | CET8 |
| FE55CP10 | OE049 | TWE65CPR | OE073 | C6BYC | OE094 | EON7/286 | CET3 |
| FE55CPD | OE044 | BRIGGS & STRATTON | | C6BYC/094 | OE094 | EON8/286 | CET4 |
| FE55CPR | OE051 | 491055 | OE013 | C6BYC4 | OE094 | EON9/286 | CET5 |
| | | | | | | F100S | L78C |

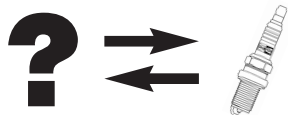



| CHAMPION | CHAMPION |
|--------------|----------|
| F50 | OE037 |
| F55PS | OE059 |
| F65PRS | OE064 |
| F65PS | OE007 |
| F70 | OE037 |
| F75S | L82C |
| F7Y | OE054 |
| F7YC | OE054 |
| F7YCC | OE054 |
| F805RS | OE086 |
| F80S | L82C |
| F85PS | OE007 |
| F95PS | OE007 |
| FE45P | OE015 |
| FE50 | OE074 |
| FE55LRS | OE004 |
| FE55LTXS | OE027 |
| FE55LXS | OE004 |
| FE55PRS | OE051 |
| FE55PS | OE015 |
| FE55PTS | OE044 |
| FE65LTXS | OE025 |
| FE65PP2 | OE004 |
| FE65PRP2 | OE006 |
| FE65PRS | OE006 |
| FE65PS | OE001 |
| FE65PTRS | OE012 |
| FE65PTS | OE012 |
| FE75RS | OE098 |
| FE75S | OE079 |
| FE80RS | OE108 |
| FE85PRS | OE018 |
| FE85PS | OE010 |
| FE85PTRS | OE012 |
| FE85PTS | OE012 |
| FET55PS | OE009 |
| FET65PRS | OE011 |
| FET65PS | OE009 |
| FUT55PRP2-13 | OE029 |
| J43 | J8C |
| J7 | J8C |
| J7J | J8C |
| J7JM | J8C |
| J8 | J8C |
| J8C/032 | J8C |
| J8C/053 | J8C |
| J8J | J8C |
| J8JM | J8C |
| KC11PYP | OE191 |
| L10S | L82C |
| L11S | L82C |
| L12Y | OE007 |
| L15Y | OE059 |

| CHAMPION | CHAMPION |
|-----------|----------|
| L287YC | OE007 |
| L288 | OE037 |
| L4J | L82C |
| L5 | L82C |
| L5J | L82C |
| L66Y | OE038 |
| L6G | L82C |
| L7 | L82C |
| L78 | L78C |
| L78C/053 | L78C |
| L78C/220 | L78C |
| L78C/R02 | L78C |
| L7J | L82C |
| L7Y | OE038 |
| L81 | L82C |
| L81Y | OE038 |
| L82 | L82C |
| L82C/053 | L82C |
| L82C/110 | L82C |
| L82C/R02 | L82C |
| L82Y | OE038 |
| L82YC/051 | OE038 |
| L82YCC | OE038 |
| L85 | L82C |
| L86 | OE037 |
| L86C/053 | OE037 |
| L86C/060 | OE037 |
| L86C/171 | OE037 |
| L86C/182 | OE037 |
| L86C/B01 | OE037 |
| L86C/R02 | OE037 |
| L86CC | OE037 |
| L87Y | OE007 |
| L87YC/051 | OE007 |
| L87YC/092 | OE007 |
| L87YCC | OE007 |
| L88 | OE037 |
| L88A | OE037 |
| L88YC | OE007 |
| L88YCC | OE007 |
| L89CM | OE037 |
| L92Y | OE059 |
| L95YC | OE059 |
| L95YC/T10 | OE059 |
| L9G | L82C |
| MT65PRS | OE054 |
| MT65PS | OE054 |
| MW5ES | OE015 |
| N10PY | OE065 |
| N10Y | OE065 |
| N10Y4 | OE049 |
| N11Y | OE065 |
| N11YC4 | OE049 |

| CHAMPION | CHAMPION |
|------------|----------|
| N11YCC | OE065 |
| N12Y | OE015 |
| N12YC/184 | OE015 |
| N12YCC | OE015 |
| N16YC | OE015 |
| N16YC/T10 | OE015 |
| N279YC | OE010 |
| N279YC/092 | OE010 |
| N281YC | OE001 |
| N281YC/T10 | OE001 |
| N288 | OE074 |
| N2C | OE091 |
| N3 | OE068 |
| N4 | OE079 |
| N4G | OE079 |
| N5 | OE074 |
| N5G | OE074 |
| N5M | OE074 |
| N6 | OE074 |
| N64Y | OE087 |
| N65Y | OE010 |
| N66Y | OE001 |
| N6BYC | OE012 |
| N6GY | OE087 |
| N6Y | OE087 |
| N6YCC | OE087 |
| N6YCX | OE087 |
| N7 | OE079 |
| N74C | OE001 |
| N79Y | OE010 |
| N7BMC | OE025 |
| N7BYC/033 | OE012 |
| N7BYC/094 | OE012 |
| N7BYC/184 | OE012 |
| N7BYC/C04 | OE012 |
| N7GY | OE010 |
| N7Y | OE010 |
| N7YCC | OE010 |
| N7YCX | OE010 |
| N8 | OE074 |
| N88 | OE079 |
| N89GY | OE001 |
| N89Y | OE001 |
| N8B | OE074 |
| N8GY | OE001 |
| N8Y | OE001 |
| N92Y | OE065 |
| N9BMC | OE027 |
| N9BYC4 | OE044 |
| N9Y | OE001 |
| N9YC/R17 | OE001 |
| N9YCC/033 | OE004 |
| N9YCX | OE001 |

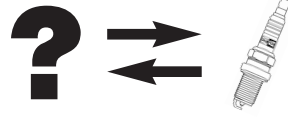
| CHAMPION | CHAMPION |
|-----------|----------|
| NA10 | OE068 |
| NA8 | OE074 |
| OE001/U04 | OE001 |
| OE002/B04 | OE002 |
| OE002/T10 | OE002 |
| OE002/U04 | OE002 |
| OE003/017 | OE003 |
| OE003/R04 | OE002 |
| OE003/U04 | OE002 |
| OE004/U04 | OE004 |
| OE005/B04 | OE002 |
| OE005/R04 | OE002 |
| OE005/U04 | OE002 |
| OE006/U04 | OE006 |
| OE007/017 | OE007 |
| OE008/R04 | OE018 |
| OE008/U04 | OE018 |
| OE009/B04 | OE011 |
| OE009/R04 | OE011 |
| OE009/R17 | OE011 |
| OE010/B04 | OE018 |
| OE010/U04 | OE018 |
| OE011/B04 | OE011 |
| OE011/U04 | OE011 |
| OE012/B04 | OE012 |
| OE012/U04 | OE012 |
| OE014/R04 | OE014 |
| OE014/U04 | OE014 |
| OE015/B04 | OE015 |
| OE015/U04 | OE015 |
| OE016/U04 | OE016 |
| OE017 | OE014 |
| OE017/B04 | OE014 |
| OE017/R04 | OE014 |
| OE018/U04 | OE018 |
| OE019/U04 | OE019 |
| OE020 | OE011 |
| OE020/R04 | OE011 |
| OE020/U04 | OE011 |
| OE021/R04 | OE216 |
| OE022/T10 | OE004 |
| OE023 | OE005 |
| OE023/R04 | OE002 |
| OE023/U04 | OE002 |
| OE024 | OE039 |
| OE024/R04 | OE039 |
| OE024/U04 | OE039 |
| OE025/U04 | OE025 |
| OE026/017 | OE026 |
| OE027/U04 | OE027 |
| OE028 | OE044 |
| OE029/U04 | OE029 |
| OE030/R04 | OE030 |



| CHAMPION  | | CHAMPION  | | CHAMPION  | | CHAMPION  | |
|--|-------|--|-------|--|---------|--|-------|
| OE031/U04 | OE031 | OE081 | OE034 | OE142 | OE073 | RC12LYC5 | OE041 |
| OE032/U04 | OE032 | OE084 | OE087 | OE142/T10 | OE073 | RC12MCC | OE154 |
| OE033/R04 | OE033 | OE085 | OE026 | OE143 | OE146 | RC12MCC/T10 | OE154 |
| OE034/O17 | OE034 | OE086/R02 | OE086 | OE144 | OE136 | RC12MCC4/T04 | OE154 |
| OE035/R04 | OE035 | OE087/R04 | OE087 | OE145/U04 | OE145 | RC12PYP | OE138 |
| OE036 | OE009 | OE088 | OE063 | OE147 | OE089 | RC12PYP/103 | OE138 |
| OE036/R04 | OE011 | OE089/R04 | OE089 | OE149 | OE191 | RC12YC/T06 | OE013 |
| OE038/R04 | OE064 | OE090/R04 | OE009 | OE149/T10 | OE191 | RC12YCC | OE013 |
| OE040 | OE091 | OE095 | OE025 | OE150 | OE122 | RC12YCC4 | OE013 |
| OE041/T04 | OE041 | OE095/R04 | OE025 | OE152 | OE034 | RC14E5 | OE041 |
| OE043 | OE014 | OE096 | OE037 | OE152/T04 | OE034 | RC6PYP | OE136 |
| OE043/T10 | OE014 | OE096/T10 | OE037 | OE152/T10 | OE034 | RC6YC | OE094 |
| OE043/U04 | OE014 | OE097 | OE004 | OE177/R04 | OE177 | RC7BMC/094 | OE216 |
| OE045/R04 | OE051 | OE100 | OE027 | OE186/R04 | OE186 | RC7BMC/290 | OE216 |
| OE045/T10 | OE051 | OE101 | OE049 | OE191/R04 | OE191 | RC7BYC | OE077 |
| OE045/U04 | OE051 | OE101/T10 | OE049 | ON11Y | OE049 | RC7YC | OE014 |
| OE046 | OE010 | OE102/T10 | OE217 | ON12Y | OE042 | RC7YC/092 | OE014 |
| OE046/T10 | OE010 | OE104 | OE038 | ON3 | OE108 | RC7YC4 | OE014 |
| OE047 | OE004 | OE106/T10 | OE065 | QL77J5 | OE086 | RC7YCC/033 | OE014 |
| OE047/R04 | OE048 | OE107 | OE077 | QN2 | OE091 | RC7YCC/093 | OE014 |
| OE047/U04 | OE048 | OE109 | OE012 | QN2C | OE091 | RC7YCC4 | OE014 |
| OE051/R04 | OE051 | OE109/T10 | OE012 | QN2G | OE091 | RC87PYC | OE136 |
| OE053 | OE054 | OE110 | OE094 | QN3 | OE108 | RC87PYC/113 | OE136 |
| OE053/T10 | OE054 | OE111 | OE051 | QN3C | OE108 | RC89PYC/113 | OE145 |
| OE054/U04 | OE054 | OE113 | OE049 | QN504YC | OE042 | RC8DMC/094 | OE026 |
| OE055 | OE015 | OE113/R04 | OE049 | R6 | OE083 | RC8DMC/C04 | OE026 |
| OE055/T10 | OE015 | OE116 | OE087 | R6G | OE083 | RC8MCC | OE089 |
| OE056 | OE014 | OE117 | OE018 | RA4GHC | OE073 | RC8MCC4 | OE089 |
| OE056/R04 | OE014 | OE118 | OE077 | RA4HCC | OE073 | RC8PYCB | OE146 |
| OE056/U04 | OE014 | OE118/T10 | OE077 | RA6 | OE083 | RC8PYX | OE034 |
| OE057/R04 | OE057 | OE119 | OE034 | RA6Y | OE083 | RC8YC | OE034 |
| OE058 | OE014 | OE119/T10 | OE034 | RA6YC | OE083 | RC8YC4 | OE034 |
| OE058/B04 | OE014 | OE120/U04 | OE120 | RBL13Y | RV15YC4 | RC8YCC | OE034 |
| OE058/R04 | OE014 | OE122/R04 | OE122 | RBL15Y | RV15YC4 | RC8YCC4 | OE034 |
| OE060 | OE004 | OE122/U04 | OE122 | RBL15Y4 | RV15YC4 | RC9BMC | OE026 |
| OE060/R04 | OE004 | OE124 | OE191 | RBN9GY | OE011 | RC9MCC | OE089 |
| OE061 | OE054 | OE124/T10 | OE191 | RBN9Y | OE011 | RC9MCC/093 | OE089 |
| OE061/T10 | OE054 | OE126 | OE136 | RC10DMC/C04 | OE019 | RC9TMC | OE120 |
| OE062 | OE016 | OE126/R04 | OE136 | RC10DMC4 | OE019 | RC9YC/092 | OE002 |
| OE062/T10 | OE016 | OE127 | OE034 | RC10ECC/052 | OE041 | RC9YC/C04 | OE002 |
| OE066 | OE089 | OE129 | OE032 | RC10PYC | OE191 | RC9YC/T04 | OE005 |
| OE066/R04 | OE089 | OE131/U04 | OE131 | RC10PYP4 | OE191 | RC9YC4/T04 | OE039 |
| OE069 | OE005 | OE132 | OE083 | RC10PYP4/T06 | OE191 | RC9YCC/033 | OE002 |
| OE070 | OE007 | OE132/T10 | OE083 | RC10VTYC4 | OE120 | RC9YCC/093 | OE002 |
| OE071 | OE064 | OE134 | OE138 | RC10YC | OE063 | RC9YCC/194 | OE002 |
| OE072 | OE011 | OE134/R04 | OE138 | RC10YC4/012 | OE063 | RC9YCC/290 | OE002 |
| OE075 | OE094 | OE135 | OE175 | RC10YCC/093 | OE016 | RC9YCC/C04 | OE002 |
| OE075/T10 | OE094 | OE136/R04 | OE136 | RC10YCC/290 | OE016 | RC9YCC4 | OE039 |
| OE076 | OE094 | OE136/U04 | OE136 | RC10YCC/C04 | OE016 | RC9YCC4/093 | OE039 |
| OE076/O17 | OE094 | OE137 | OE013 | RC10YCC4 | OE016 | RE7PYC5 | OE029 |
| OE076/R04 | OE094 | OE140 | OE089 | RC10YCL | OE033 | RE7PYC5/103 | OE029 |
| OE076/T10 | OE094 | OE140/T10 | OE089 | RC12ECC/T04 | OE041 | RE7YCC | OE031 |
| OE080 | OE014 | OE141 | OE191 | RC12LYC/T04 | OE041 | REA8MCL | OE130 |

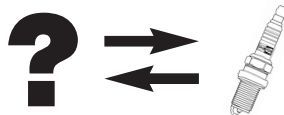

| CHAMPION | CHAMPION |
|--------------|----------|
| REC14PYC | OE175 |
| RES9PYP4/113 | OE029 |
| RES9YCC4/C04 | OE031 |
| RF7YC/092 | OE054 |
| RF7YCC | OE054 |
| RG2PHP | OE122 |
| RG4PHP/103 | OE122 |
| RG4PHP/113 | OE122 |
| RG6PP | OE122 |
| RL4J | OE086 |
| RL7J | OE086 |
| RL82 | OE086 |
| RL82C/051 | OE086 |
| RL82C/110 | OE086 |
| RL82Y | OE064 |
| RL82YC/053 | OE064 |
| RL82YC/C04 | OE064 |
| RL82YCC | OE064 |
| RL85 | OE086 |
| RN10GY | OE051 |
| RN10Y | OE051 |
| RN10Y4 | OE049 |
| RN10YC | OE051 |
| RN10YC4 | OE049 |
| RN11Y | OE051 |
| RN11YCC/093 | OE051 |
| RN11YCC4 | OE049 |
| RN12GY | OE042 |
| RN12Y | OE042 |
| RN14PMP5/T06 | OE105 |
| RN2 | OE091 |
| RN2C/053 | OE091 |
| RN2G | OE091 |
| RN3 | OE108 |
| RN3G | OE108 |
| RN4 | OE098 |
| RN4C/051 | OE098 |
| RN4G | OE098 |
| RN6GY | OE087 |
| RN6Y | OE087 |
| RN6YC | OE087 |
| RN74C | OE006 |
| RN77B | OE091 |
| RN7GY | OE018 |
| RN7LCC | OE004 |
| RN7Y | OE018 |
| RN7YC/092 | OE018 |
| RN7YC4 | OE018 |
| RN7YCC/033 | OE008 |
| RN7YCC4 | OE077 |
| RN8VTYC4/290 | OE025 |
| RN8VTYC4/C04 | OE025 |
| RN9GY | OE006 |

| CHAMPION | CHAMPION |
|-------------|----------|
| RN9LCC | OE004 |
| RN9Y | OE006 |
| RN9YC/092 | OE006 |
| RN9YC/290 | OE006 |
| RN9YC4/264 | OE048 |
| RN9YC4/290 | OE048 |
| RN9YCC/033 | OE004 |
| RN9YCC/093 | OE004 |
| RN9YCC4 | OE004 |
| RN9YCC4/093 | OE048 |
| RS9YC/092 | OE011 |
| RS9YC/290 | OE011 |
| RS9YC/C04 | OE011 |
| RS9YCC | OE011 |
| RS9YCC/033 | OE011 |
| RV15YC | RV15YC4 |
| RV15YC4/053 | RV15YC4 |
| RV15YC4/R02 | RV15YC4 |
| RV15YC4/T04 | RV15YC4 |
| S10YCC | OE011 |
| S12YCC | OE099 |
| S279YC/101 | OE009 |
| S7YC/C04 | OE009 |
| S9YCC | OE009 |
| S9YCC/093 | OE011 |
| SE12RCY | OE013 |
| SFE55LRS | OE198 |
| SFE55LXS | OE198 |
| SFE55PRS | OE005 |
| SFE55PS | OE003 |
| SFE55PTRS | OE032 |
| SFE55PTS | OE032 |
| SFE65LDRS | OE019 |
| SFE65LRS | OE089 |
| SFE65LTXS | OE032 |
| SFE65LXS | OE089 |
| SFE65PDRS | OE026 |
| SFE65PRS | OE005 |
| SFE65PS | OE003 |
| SFE65PTS | OE032 |
| SFE85LDRS | OE026 |
| SFE85LTRS | OE032 |
| SFE85PRS | OE014 |
| SFE85PTRS | OE014 |
| SFE85PTS | OE094 |
| TWE85PRS | OE073 |
| TWE85PS | OE083 |
| UBL13Y | RV15YC4 |
| UJ8 | J8C |
| UL12Y | OE007 |
| UL15Y | OE059 |
| UL82Y | OE038 |
| UN12Y | OE015 |

| CHAMPION | CHAMPION |
|------------|----------|
| UN79Y | OE010 |
| UN9Y | OE001 |
| X/T10 | CCH425 |
| XL10 | OE086 |
| XL10S | OE086 |
| XL7 | OE086 |
| XL85 | OE086 |
| XN10Y | OE049 |
| XN12Y | OE042 |
| XN3 | OE108 |
| XN4 | OE098 |
| XN9Y | OE006 |
| DENSO | CHAMPION |
| 16 | OE029 |
| 3121 | OE039 |
| 3329 | OE019 |
| 3374 | OE039 |
| 3395 | OE180 |
| 3427 | OE130 |
| 3443 | OE179 |
| 4711 | CET4 |
| 5067 | OE025 |
| D1 | OE025 |
| D110 | OE039 |
| D12 | OE005 |
| D14 | OE039 |
| D20 | OE019 |
| D21 | OE063 |
| D22 | OE002 |
| D4 | OE001 |
| D7 | OE011 |
| D76 | OE120 |
| DK20PR-D13 | OE239 |
| FK16HQR11 | OE190 |
| FK16HR11 | OE190 |
| FK20HBR11 | OE190 |
| FK20HR11 | OE190 |
| FXE16HR11 | OE240 |
| FXE20HE11 | OE240 |
| FXE20HR11 | OE240 |
| FXE22HR11 | OE233 |
| IK16 | OE145 |
| IK16 | OE180 |
| IK16TT | CET12P |
| IK20 | OE179 |
| IK20G | OE179 |
| IK20L | OE182 |
| IK20TT | CET11P |
| IK22 | OE179 |
| IK24 | OE214 |
| IKBH20TT | CET14P |
| IKH16 | OE190 |

| DENSO | CHAMPION |
|------------|----------|
| IKH16TT | CET14P |
| IKH20 | OE190 |
| IKH20TT | CET14P |
| IKH22 | OE210 |
| IKH24 | OE210 |
| IQ16TT | CET12P |
| IQ20TT | CET11P |
| IT16TT | CET18P |
| IT20 | OE183 |
| IT20TT | CET18P |
| ITV16 | OE189 |
| ITV16TT | CET17P |
| ITV20 | OE189 |
| ITV20TT | CET17P |
| IU22 | OE122 |
| IU27 | OE122 |
| IU27A | OE122 |
| IW16 | OE195 |
| IW16TT | CET8 |
| IW20 | OE195 |
| IW20TT | CET8 |
| IW22 | OE195 |
| IW24 | OE078 |
| IW24 | OE108 |
| IW27 | OE091 |
| IW31 | OE091 |
| IX24 | OE112 |
| IXEH20TT | CET4 |
| IXEH22TT | CET13P |
| IXU22 | OE187 |
| IXU24 | OE187 |
| IXU27 | OE208 |
| IXUH22I | OE263 |
| J16ARU11 | OE114 |
| J16CRU | OE004 |
| K16HPRU11 | OE148 |
| K16HPR-U11 | OE175 |
| K16HRU11 | OE148 |
| K16PR-U | OE016 |
| K16PRU11 | OE063 |
| K16PRZU11 | OE145 |
| K16PSRB8 | OE180 |
| K16RU | OE093 |
| K16RU11 | OE063 |
| K16TNRS9 | OE026 |
| K16TNR-S9 | OE019 |
| K16TR11 | OE019 |
| K16TT | CET2 |
| K20BRS10 | OE032 |
| K20CRL11 | OE089 |
| K20HRU11 | OE035 |
| K20HR-U11 | OE178 |
| K20PBR | OE120 |



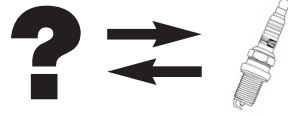

| DENSO | CHAMPION |
|--------------|----------|
| K20PBR510 | OE032 |
| K20PBR-S10 | OE120 |
| K20PRT11 | OE179 |
| K20PRU | OE005 |
| K20PR-U | OE002 |
| K20PR-U | OE033 |
| K20PR-U11 | OE039 |
| K20PRZU11 | OE191 |
| K20PSRB8 | OE179 |
| K20RU | OE089 |
| K20RU11 | OE089 |
| K20TNR | OE030 |
| K20TNR5 | OE120 |
| K20TNR510 | OE120 |
| K20TNR59 | OE120 |
| K20TR11 | OE026 |
| K20TT | CET2 |
| K20TXR | OE026 |
| K20U11 | OE089 |
| K22PB | OE094 |
| K22PBR7 | OE077 |
| K22PBRS | OE077 |
| K22PRU | OE014 |
| K22PRZU | OE032 |
| K22PURZU11 | OE136 |
| KH16TT | CET5 |
| KH20TT | CET5 |
| KJ14CR11 | OE154 |
| KJ14CRL11 | OE154 |
| KJ16CR11 | OE154 |
| KJ16CRL11 | OE089 |
| KJ16CR-L11 | OE177 |
| KJ20CR-11 ND | OE089 |
| KJ20CRL | OE089 |
| KJ20CRL11 | OE089 |
| KJ20CR-L11 | OE089 |
| KJ20CR-L11 | OE198 |
| KJ20DRM11 | OE089 |
| MA20PRU | OE054 |
| P16 | OE029 |
| P16PR11 | OE192 |
| P16R | OE042 |
| P16R13 | OE105 |
| P18 | OE131 |
| P20PR11 | OE191 |
| P20PR13 | OE191 |
| P20PR8 | OE018 |
| P20PRS11 | OE191 |
| P20R11 | OE048 |
| PK16PR-L11 | OE191 |
| PK16PR11 | OE191 |
| PK16PR-L11 | OE138 |
| PK16PRP11 | OE146 |

| DENSO | CHAMPION |
|-------------|----------|
| PK20GR8 | OE176 |
| PK20PR11 | OE146 |
| PK20PRL11 | OE146 |
| PK20PRP8 | OE136 |
| PK20PTRS9 | OE136 |
| PK20R11 | OE191 |
| PK20R13 | OE138 |
| PK22PR8 | OE136 |
| PKJ16CR8 | OE191 |
| PKJ16CR-L11 | OE176 |
| PKJ20CR8 | OE213 |
| PKJ20CRL11 | OE146 |
| PT16VR13 | OE029 |
| PT16VR13 | OE031 |
| Q14RU11 | OE039 |
| Q16HRU | OE041 |
| Q16PRU11 | OE039 |
| Q16RU | OE013 |
| Q16RU11 | OE039 |
| Q16TT | CET2 |
| Q16U11 | OE057 |
| Q20PRU | OE005 |
| Q20PRU11 | OE039 |
| Q20PRZU11 | OE191 |
| Q20PU | OE003 |
| Q20PU11 | OE039 |
| Q20RU | OE005 |
| Q20RU11 | OE039 |
| Q20TT | CET2 |
| Q22PRU | OE014 |
| Q22PRZU | OE191 |
| QJ16AARU | OE114 |
| QJ16ARU | OE128 |
| QJ16ARU11 | OE128 |
| QJ16CR11 | OE154 |
| QJ16HRU | OE041 |
| QJ6ARU11 | OE114 |
| S34 | OE180 |
| S47 | OE179 |
| SK16PR | OE193 |
| SK16PRA11 | OE193 |
| SK16PR-A11 | OE180 |
| SK16PRE11 | OE193 |
| SK16PRE13 | OE146 |
| SK16PRE13 | OE193 |
| SK16PR-L11 | OE180 |
| SK16R11 | OE193 |
| SK20BR11 | OE188 |
| SK20PRA11 | OE179 |
| SK20PRA8 | OE179 |
| SK20PRL11 | OE181 |
| SK20PR-L11 | OE179 |
| SK20PRL9 | OE136 |

| DENSO | CHAMPION |
|-------------|----------|
| SK20PRL9 | OE181 |
| SK20R11 | OE182 |
| SKJ16CRA8 | OE194 |
| SKJ16CRL11 | OE176 |
| SKJ16DRM11 | OE194 |
| SKJ20CRA8 | OE213 |
| SKJ20DRM11 | OE239 |
| SKJ20DRM11S | OE239 |
| SVK20RZ11 | OE179 |
| SVK20RZ8 | OE179 |
| SXU22HDR8 | OE250 |
| SXU22PR9 | OE187 |
| T16EPRU | OE011 |
| T16EPR-U | OE099 |
| T16EPRU15 | OE011 |
| T16PRU11 | RV15YC4 |
| T16PU | RV15YC4 |
| T16TT | CET9 |
| T16VRU10 | OE031 |
| T20EPRU | OE011 |
| T20EPR-U | OE009 |
| T20EPRU15 | OE011 |
| T20EPU | OE009 |
| T20PU | OE054 |
| T20TT | CET9 |
| T20VRU10 | OE189 |
| TU22 | OE122 |
| TV16TT | CET7 |
| U22ETR | OE122 |
| U24ESRNZU | OE122 |
| VCH20 | OE253 |
| VFK20F | OE239 |
| VFKBH20 | OE190 |
| VFKH16 | OE190 |
| VFXEH20 | OE240 |
| VK16 | OE180 |
| VK20 | OE179 |
| VK20G | OE179 |
| VK20PRZ11 | OE179 |
| VK20Y | OE181 |
| VK22 | OE179 |
| VK22G | OE179 |
| VKB16 | OE184 |
| VKB20 | OE227 |
| VKH16 | OE190 |
| VKH20 | OE190 |
| VKH20Y | OE190 |
| VKH22 | OE210 |
| VT20 | OE183 |
| VW16 | OE195 |
| VW20 | OE195 |
| VXU22 | OE187 |
| VXU24 | OE187 |

| DENSO | CHAMPION |
|-----------|----------|
| VXUH221 | OE263 |
| W14E | OE074 |
| W14EP | OE015 |
| W14EPRU | OE042 |
| W14EXRU | OE042 |
| W14EXU | OE015 |
| W14FP | OE038 |
| W14FPUL | OE059 |
| W14FU | L82C |
| W14FU | OE037 |
| W14U | J8C |
| W14US | J8C |
| W16EKRS11 | OE049 |
| W16EP | OE001 |
| W16EPB10 | OE044 |
| W16EPRS11 | OE049 |
| W16EPRU | OE051 |
| W16EPR-U | OE015 |
| W16EPR-U | OE042 |
| W16EPR-U | OE065 |
| W16EPRU10 | OE049 |
| W16EPRU11 | OE049 |
| W16EPU | OE065 |
| W16EPU10 | OE049 |
| W16EPZU | OE065 |
| W16ESL | OE065 |
| W16ESL | OE074 |
| W16ESL11 | OE074 |
| W16ESRL | OE051 |
| W16ESRL11 | OE049 |
| W16ESU | OE074 |
| W16ETRS | OE027 |
| W16EX | OE015 |
| W16EXRU | OE051 |
| W16EXRU11 | OE049 |
| W16EXRU13 | OE049 |
| W16EXRUA | OE051 |
| W16EXU | OE015 |
| W16EXU11 | OE049 |
| W16EXU13 | OE049 |
| W16FPRU | OE059 |
| W16FPU | OE059 |
| W16FSU | OE037 |
| W16SU | J8C |
| W16TT | CET8 |
| W17ES | OE074 |
| W17ESU | OE074 |
| W17EV | OE074 |
| W17EWU | OE001 |
| W17FU | OE037 |
| W20EKRS11 | OE087 |
| W20EP | OE001 |
| W20EPB | OE044 |

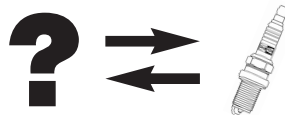

| DENSO | CHAMPION |
|-----------|----------|
| W20EPBR-S | OE025 |
| W20EPBR-S | OE027 |
| W20EPR-U | OE006 |
| W20EPRU10 | OE048 |
| W20EPRU10 | OE049 |
| W20EPRU11 | OE048 |
| W20EPRZU | OE004 |
| W20EPU | OE001 |
| W20EPU11 | OE049 |
| W20EPZU | OE001 |
| W20EPZU | OE079 |
| W20ESL | OE001 |
| W20ESL11 | OE079 |
| W20ESRL11 | OE048 |
| W20ESRL11 | OE098 |
| W20ESRU | OE098 |
| W20ESU | OE074 |
| W20ESZU | OE079 |
| W20ET | OE010 |
| W20ETL | OE027 |
| W20ETRL | OE027 |
| W20ETS | OE001 |
| W20EX | OE010 |
| W20EXRU | OE006 |
| W20EXRU11 | OE048 |
| W20EXRU13 | OE048 |
| W20EXU | OE001 |
| W20EXU11 | OE001 |
| W20EXU13 | OE001 |
| W20FP | OE038 |
| W20FPRU | OE064 |
| W20FPU | OE038 |
| W20FSU | L82C |
| W20FSZU | OE037 |
| W20TT | CET8 |
| W21ESRL11 | OE018 |
| W22EP | OE087 |
| W22EPB | OE012 |
| W22EPRS11 | OE049 |
| W22EPRU | OE018 |
| W22EPR-U | OE018 |
| W22EPRU11 | OE077 |
| W22EPU | OE087 |
| W22EPZU | OE068 |
| W22ESL11 | OE001 |
| W22ESRL | OE018 |
| W22ESRU | OE098 |
| W22ESR-U | OE079 |
| W22ESU | OE079 |
| W22ESU11 | OE079 |
| W22ESZU | OE008 |
| W22ESZU | OE079 |
| W22ETRL | OE025 |

| DENSO | CHAMPION |
|-----------|----------|
| W22EU | OE074 |
| W22EXRU | OE018 |
| W22FPRU | OE064 |
| W22FSR | OE086 |
| W22FSRU | OE086 |
| W22FSU | L82C |
| W22FSZU | OE037 |
| W22FU | OE037 |
| W22TT | CET8 |
| W24EPRU | OE087 |
| W24EPU | OE087 |
| W24ESR | OE108 |
| W24ESRU | OE108 |
| W24ESU | OE068 |
| W24ESU11 | OE068 |
| W24ESZU | OE078 |
| W24EU | OE068 |
| W24FPRU10 | OE064 |
| W24FSU | L78C |
| W24FSZU | L82C |
| W24FU | L82C |
| W25ECU | L78C |
| W27ESRU | OE091 |
| W27FSU10 | L78C |
| W27FSZU | L78C |
| W31EMRC | OE091 |
| W31ESRU | OE091 |
| WU14EU | OE074 |
| WU9EU | OE074 |
| X22EPU9 | OE083 |
| X24EPRU9 | OE083 |
| X24EPRZU9 | OE083 |
| X24EPZU9 | OE083 |
| X24ESRU | OE083 |
| X24ESU | OE083 |
| X24ESZU | OE112 |
| X24EU | OE083 |
| X24GPRU | OE083 |
| X27EPRU9 | OE073 |
| X27EPRZU9 | OE073 |
| X27EPRZU9 | OE083 |
| X27EPZU9 | OE083 |
| X31ESZU | OE073 |
| XE20HRU9 | OE130 |
| XE20HR-U9 | OE130 |
| XU22EPRU | OE083 |
| XU22EPR-U | OE199 |
| XU22EPU | OE083 |
| XU22HDR9 | OE201 |
| XU22HDR9 | OE212 |
| XU22PR9 | OE196 |
| XU22TT | CET1 |
| XU24EPRU | OE083 |

| DENSO | CHAMPION |
|---------------|----------|
| XU27EPRU | OE073 |
| XU27EPRZU | OE073 |
| XUH22TT | CET6 |
| ZK20R11 | OE182 |
| ZK20R13 | OE182 |
| ZT20EPR11 | OE183 |
| ZXE20HR13 | OE240 |
| ZXU20PR11 | OE226 |
| DUCELLIER | CHAMPION |
| 599247 | OE087 |
| 599248 | OE010 |
| 599249 | OE010 |
| 599250 | OE001 |
| 599251 | OE015 |
| 599252 | OE001 |
| 599256 | OE038 |
| 599257 | L82C |
| 599258 | OE038 |
| 599301 | OE087 |
| 599302 | OE010 |
| 599303 | OE010 |
| 599304 | OE001 |
| 599305 | OE015 |
| 599306 | OE001 |
| 599310 | OE038 |
| 599311 | L82C |
| 599312 | OE038 |
| 599313 | OE054 |
| 599314 | OE001 |
| 599316 | L82C |
| 599323 | OE038 |
| 599330 | OE018 |
| 599331 | OE006 |
| 599528 | OE038 |
| EYQUEM | CHAMPION |
| 0 001 355 783 | OE177 |
| 0 911 007 241 | OE014 |
| 0 911 007 303 | OE027 |
| 0 911 007 355 | OE178 |
| 0 911 007 383 | OE031 |
| 0 911 007 394 | OE191 |
| 0 911 007 395 | OE146 |
| 0 911 007 396 | OE184 |
| 0 911 007 397 | OE145 |
| 0 911 007 399 | OE234 |
| 0 911 007 400 | OE238 |
| 0 911 007 402 | OE223 |
| 0 911 007 404 | OE130 |
| 0 911 007 405 | OE204 |
| 0 911 007 406 | OE196 |
| 0 911 007 408 | OE122 |

| EYQUEM | CHAMPION |
|---------------|----------|
| 0 911 007 410 | OE203 |
| 1000 | L78C |
| 200 | L82C |
| 406 | OE037 |
| 4065 | OE037 |
| 500 | OE037 |
| 502 | OE037 |
| 550LS | OE001 |
| 550S | OE038 |
| 580L | OE074 |
| 580LS | OE015 |
| 580S | OE038 |
| 600L | OE074 |
| 600LS | OE001 |
| 600S | OE038 |
| 60L | OE074 |
| 60LS | OE015 |
| 700 | L82C |
| 705L | OE074 |
| 705S | OE038 |
| 707LS | OE010 |
| 707LSX | OE001 |
| 750 | L82C |
| 750LS | OE001 |
| 755 | L82C |
| 755LJS | OE009 |
| 755LS | OE087 |
| 755S | OE038 |
| 755SX | OE038 |
| 755X | L82C |
| 75806 | OE216 |
| 75LS | OE001 |
| 800LS | OE010 |
| 80266 | OE014 |
| 805LP | OE078 |
| 805LPA | OE078 |
| 80LS | OE010 |
| 850 | L82C |
| 850LS | OE087 |
| A100 | OE178 |
| A179 | OE031 |
| A183 | OE177 |
| A188 | OE184 |
| A189 | OE204 |
| A190 | OE196 |
| A191 | OE238 |
| A192 | OE234 |
| A193 | OE223 |
| A194 | OE145 |
| A195 | OE191 |
| A197 | OE130 |
| A199 | OE122 |
| A500 | OE203 |



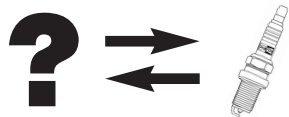







| EYQUEM | CHAMPION |
|--------------|----------|
| A71 | OE014 |
| C30LS | OE001 |
| C32 | OE037 |
| C32LS | OE001 |
| C32S | OE007 |
| C42 | L82C |
| C42LJS3 | OE009 |
| C42S | OE038 |
| C52LJS | OE009 |
| C52LS | OE001 |
| C52LS3X | OE044 |
| C62 | L82C |
| C62LJS | OE009 |
| C62LS | OE001 |
| C62LS3X | OE012 |
| C62S | OE038 |
| C72 | L78C |
| C72LS | OE010 |
| C72LS3X | OE012 |
| C82LS | OE087 |
| C82LS3X | OE012 |
| FC42LS | OE003 |
| FC52LS | OE003 |
| FC58LS3X | OE077 |
| FC62LS | OE014 |
| FC62LS3X | OE094 |
| FN42LZDPR5 | OE191 |
| FN52LS | OE003 |
| FN62LZFDPR2A | OE234 |
| K450JS | OE054 |
| K550JS | OE054 |
| KC52JS | OE054 |
| KC62JS | OE054 |
| N43 | OE038 |
| R850 | L78C |
| RC42HJS3E5 | OE031 |
| RC42S | OE064 |
| RC52LJS | OE011 |
| RC52LJS5 | OE011 |
| RC52LS5 | OE049 |
| RC52LZ3EX | OE027 |
| RC52LZE | OE004 |
| RC58LZ3EX | OE025 |
| RC62HJS6 | OE031 |
| RC62HJS5DP | OE029 |
| RC62HJSP | OE029 |
| RC62LJS | OE011 |
| RC62LS | OE006 |
| RC62LS5 | OE048 |
| RC62S | OE038 |
| RC72 | L78C |
| RC72LJS | OE011 |
| RC72LS | OE018 |

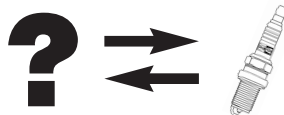

| EYQUEM | CHAMPION |
|-------------|----------|
| RC72LS5 | OE018 |
| RC82LS | OE087 |
| RFC42HZDP5 | OE175 |
| RFC42LS | OE005 |
| RFC42LS2E | OE019 |
| RFC42LS5 | OE039 |
| RFC42LZ2E | OE019 |
| RFC42LZDP | OE184 |
| RFC50LZ2E | OE019 |
| RFC52LS | OE005 |
| RFC52LS2E | OE026 |
| RFC52LS3 | OE120 |
| RFC52LS5 | OE039 |
| RFC52LSP | OE146 |
| RFC52LZDP | OE227 |
| RFC52LZDP5 | OE188 |
| RFC58HZEDP5 | OE238 |
| RFC58LS | OE014 |
| RFC58LS2E | OE026 |
| RFC58LS3 | OE077 |
| RFC58LS3X | OE077 |
| RFC58LZ | OE002 |
| RFC58LZ2 | OE030 |
| RFC58LZ2E | OE026 |
| RFC58LZ3EX | OE032 |
| RFC58LZ5 | OE089 |
| RFC58LZDP | OE136 |
| RFC58LZE5 | OE089 |
| RFC58LZF5 | OE089 |
| RFC58LZK | OE005 |
| RFC58LZP | OE136 |
| RFC58LZP4 | OE223 |
| RFC62LS | OE014 |
| RFC62LS3 | OE077 |
| RFC62LS3X | OE094 |
| RFC62LZ2 | OE237 |
| RFC62LZ3E | OE032 |
| RFC62LZ3EX | OE094 |
| RFC72LS | OE094 |
| RFC82LS | OE094 |
| RFC82LS3 | OE014 |
| RFN42LZG5 | OE128 |
| RFN42LZP | OE145 |
| RFN52HZ | OE148 |
| RFN52HZ3A | OE178 |
| RFN52LZ | OE016 |
| RFN52LZDPF5 | OE176 |
| RFN58HZ | OE035 |
| RFN58LZ | OE033 |
| RFN58LZ | OE034 |
| RFN58LZDP5 | OE146 |
| RFN59HZ | OE035 |
| RFN62LZ | OE014 |

| EYQUEM | CHAMPION |
|---------------------------|----------|
| RFN62LZDP5 | OE136 |
| RKC52JS | OE054 |
| RKC62JS | OE054 |
| RWC52HSK | OE130 |
| RXC58HSEDP | OE203 |
| RXC62HSEDP | OE204 |
| RZC58LS | OE196 |
| XKC62JS | OE054 |
| XRC52JS | OE054 |
| GPG GATEWAY | CHAMPION |
| 6082025 | L82C |
| 8004025 | OE079 |
| HERCULES | CHAMPION |
| 029 808 70 06 | L82C |
| 099 800 40 01 | L82C |
| HERTH+BUSS ELPARTS | CHAMPION |
| LOPK 20R13 | OE188 |
| HIRIH | CHAMPION |
| H12D6TC | OE083 |
| H12D8C | OE112 |
| H12D8RTC | OE083 |
| H12D8TC | OE073 |
| H12DK7RTC | OE073 |
| H14E11C | L78C |
| H14E6TC | OE059 |
| H14E7RC | OE086 |
| H14E8C | L82C |
| H14E9C | L82C |
| H14E9RC | OE086 |
| H14F10RC | OE108 |
| H14F11RC | OE091 |
| H14F5RTC | OE042 |
| H14F5TC | OE065 |
| H14F6C | OE074 |
| H14F6RTC | OE051 |
| H14F6RTC-10 | OE049 |
| H14F6TC | OE065 |
| H14F6TC-10 | OE049 |
| H14F6TJC | OE044 |
| H14F7C | OE079 |
| H14F7RC | OE098 |
| H14F7RLC | OE004 |
| H14F7RLC-10 | OE004 |
| H14F7RTC-10 | OE048 |
| H14F7TC | OE001 |
| H14F7TJC | OE012 |
| H14F8RTC | OE018 |
| H14F8RTC-10 | OE077 |
| H14F9C | OE068 |
| H14F9RC | OE108 |





| HIRIH | CHAMPION |
|-----------------|----------|
| H14F9RTC | OE087 |
| H14F9TC | OE087 |
| H14F9TJC | OE012 |
| H14K5RTC | OE013 |
| H14K6RFC | OE041 |
| H14K6RLC-10 | OE114 |
| H14K6RTC | OE016 |
| H14K6RTC-10 | OE063 |
| H14K6TC | OE057 |
| H14K7RLC-10 | OE089 |
| H14K7RTC | OE005 |
| H14K7RTC-10 | OE039 |
| H14K7TC | OE003 |
| H14K8RTC | OE014 |
| H14K8RTJC | OE077 |
| H14K9RTC | OE094 |
| H14K9TC | OE094 |
| H14P4RTC-10 | RV15YC4 |
| H14P5RTC | RV15YC4 |
| H14P5RTC-10 | RV15YC4 |
| H14P5TC | RV15YC4 |
| H14Q6TC | OE009 |
| H14Q7RTC | OE011 |
| H14Q7RTC-15 | OE011 |
| H14Q7TC | OE009 |
| H14Q7TC-15 | OE009 |
| H18T7TC | OE054 |
| H18T8TC | OE054 |
| HITACHI | CHAMPION |
| L 44 P | OE087 |
| L 45 PW | OE010 |
| L 45 PW-11 | OE001 |
| L 45 PX | OE001 |
| L 45 W | OE074 |
| L 45 X | OE074 |
| L 46 X | OE074 |
| M 43 W | L78C |
| M 44 | L82C |
| M 44 P | OE038 |
| M 44 W | L82C |
| M 45 | L82C |
| M 45 PW | L82C |
| M 46 | L82C |
| ISOLATOR | CHAMPION |
| FM.14-145/2 | OE065 |
| FM.14-175/2 | OE001 |
| M.14-125 | OE037 |
| M.14-145 | OE037 |
| M.14-175 | OE037 |
| M.14-225/2 | OE079 |
| M.14-240/2 | OE068 |



| ISOLATOR  | |
|---|---|
| PM.14-145 | OE059 |
| JF |  |
| D8TC | OE083 |
| E7C | L82C |
| F7TC | OE001 |
| K6RTC | OE005 |
| K6TC | OE003 |
| K7DC | OE003 |
| KLG |  |
| F100 | L82C |
| F70 | L82C |
| F80 | L82C |
| FE100 | OE068 |
| FE50 | OE074 |
| FE70 | OE074 |
| FE80 | OE074 |
| TFS50 | J8C |
| KREIDLER |  |
| 08 1103 | L82C |
| 215 02 03 | L82C |
| LETRIKA |  |
| F 100 S | L78C |
| F 50 | OE037 |
| F 55 PS | OE007 |
| F 65 P | OE038 |
| F 65 PRS | OE064 |
| F 65 PS | OE038 |
| F 70 | L82C |
| F 70 | OE037 |
| F 80 S | L82C |
| F 85 PS | OE038 |
| F 95 PS | OE038 |
| F.70/M75 | OE037 |
| FE 45 P | OE001 |
| FE 55 P | OE001 |
| FE 55 PS | OE015 |
| FE 55 PTS | OE044 |
| FE 65 P | OE001 |
| FE 65 PRS | OE006 |
| FE 65 PS | OE001 |
| FE 65 PTS | OE012 |
| FE 75 RS | OE098 |
| FE 75 S | OE074 |
| FE 85 PRS | OE018 |
| FE 85 PS | OE010 |
| FE 85 PTS | OE012 |
| FET 55 PS | OE009 |
| FET 65 PRS | OE011 |
| FET 65 PS | OE009 |
| M.14-145 | OE037 |





| LETRIKA  | |
|--|---|
| M.14-225 | L82C |
| MT 65 RS | OE054 |
| SFE 55 PS | OE057 |
| SFE 65 PRS | OE005 |
| SFE 65 PS | OE001 |
| SFE 85 PRS | OE014 |
| SFE 85 PS | OE014 |
| SFE 85 PTS | OE094 |
| LODGE |  |
| 25HL | OE087 |
| 25HLD | OE094 |
| 25HLE | OE087 |
| 2HL | OE012 |
| 2HLDR | OE014 |
| 2HLE | OE079 |
| 2HLN | OE068 |
| 3HLNY | OE087 |
| 3HN | L82C |
| CAN | J8C |
| CB14 | OE074 |
| CL14 | OE074 |
| CLN | OE074 |
| CLN-H | OE074 |
| CLN-P | OE074 |
| H14 | L82C |
| H14S | L82C |
| HBLT | OE009 |
| HH14 | L82C |
| HHN | L82C |
| HL | OE001 |
| HL14 | OE074 |
| HLD | OE003 |
| HLN | OE074 |
| HLNP | OE074 |
| HN | L82C |
| HNP | L82C |
| L6Y | OE001 |
| RL47 | OE068 |
| MAGNETI MARELLI |  |
| 45LDC | OE057 |
| 6LC1R | OE063 |
| 6LDCR | OE016 |
| 7 LC | OE014 |
| 7 LCR | OE014 |
| 75LMCR | OE030 |
| 7LC | OE003 |
| 7LC1R | OE039 |
| 7LCR | OE005 |
| 8LCR | OE014 |
| 8LDC | OE014 |
| 9LC | OE094 |

| MAGNETI MARELLI  | |
|--|-------|
| 9LCR | OE094 |
| 9LMC | OE094 |
| CW 5 N | L82C |
| CW 55 N | L82C |
| CW 6 L | OE074 |
| CW 6 LP | OE015 |
| CW 6 N | L82C |
| CW 6 NP | OE038 |
| CW 7 LP | OE001 |
| CW 7 N | L78C |
| CW 7 NJ | L78C |
| CW 7 NP | OE038 |
| CW 78 LP | OE010 |
| CW 8 LP | OE087 |
| CW 8 LPS | OE087 |
| CW 8 N | L78C |
| CW 8 NP | OE038 |
| CW 89 LP | OE087 |
| CW5N | OE037 |
| CW78LPR | OE018 |
| CW8LPR | OE018 |
| CWP 7 L | OE010 |
| F 6 NC | OE038 |
| F 7 LCR | OE006 |
| F45LCR | OE051 |
| F4LCR | OE042 |
| F6LMC1R | OE027 |
| F75LMC1R | OE025 |
| F7LC | OE001 |
| F7LC1R | OE048 |
| F7LDCR | OE004 |
| F7LMC | OE044 |
| F7LSC | OE027 |
| F8LCR | OE018 |
| F8LDCR | OE008 |
| F8LNCR | OE004 |
| F8LSC | OE025 |
| F9LC | OE087 |
| F9LDCR | OE094 |
| FC7N | L82C |
| FC7NR | OE086 |
| FL7MCR | OE012 |
| FL8LCR | OE018 |
| L10BPCPR | OE122 |
| L10CR | OE073 |
| L10DCR | OE186 |
| L6LPYCR | OE136 |
| L6LSCR | OE019 |
| L75LMC1R | OE032 |
| L75LSCR | OE026 |
| L7LCR | OE005 |
| L7LDCR | OE002 |
| L8LCR | OE014 |

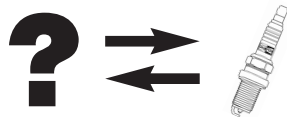
| MAGNETI MARELLI  | |
|--|---|
| L8LDC1R | OE014 |
| L8LDCR | OE014 |
| L9LPCPR | OE136 |
| L9LSPYC | OE032 |
| T7LC | OE009 |
| T7LCR | OE011 |
| T7LDCR | OE011 |
| TW7LP | OE009 |
| MIGHTY |  |
| M4E4 | OE037 |
| M4G22 | OE001 |
| M4G3 | OE074 |
| M4G32A | OE065 |
| M4G4 | OE074 |
| M4GR32 | OE049 |
| M4GR42 | OE042 |
| M4GR52 | OE042 |
| M4RF52 | RV15YC4 |
| MOPAR PARTS |  |
| 3874934 | RV15YC4 |
| 4091713 | OE042 |
| 4106122 | OE001 |
| 4106129 | OE051 |
| 4318130 | OE065 |
| 4318131 | OE049 |
| 4339413 | RV15YC4 |
| 4339491 | J8C |
| 4504278 | OE011 |
| 4504279 | OE039 |
| 4609040 | OE128 |
| 4671057 | OE005 |
| 4727114 | OE105 |
| 4796779 | OE191 |
| 4864462 | OE013 |
| 4864463 | OE049 |
| 5213693 | OE042 |
| 5234975 | OE011 |
| 5369556 | OE039 |
| 56006240 | OE013 |
| 56027275 | OE041 |
| 82300312 | OE108 |
| 82300313 | OE039 |
| MOTORCRAFT |  |
| 1Y00-18-110 | OE051 |
| 1Y03-18-110 | OE049 |
| 1Y07-18-110 | OE002 |
| 1Y09-18-110 | OE063 |
| 1Y0F-18-110 | OE083 |
| 1Y0G-18-110 | OE089 |
| 1Y0H-18-110 | OE089 |
| 1Y0K-18-110 | OE049 |





| MOTORCRAFT  | | MOTORCRAFT  | | MOTORCRAFT  | | MOTORCRAFT  | |
|--|---------|--|-------|--|-------|--|---------|
| 1YOL-18-110 | OE114 | AG1C | OE068 | AGPS 12 C | OE094 | AGSF22C | OE011 |
| 1YR1-18-110 | OE002 | AG1CX | OE068 | AGPS 12 C 1 | OE094 | AGSF22FCM | OE131 |
| 1YR7-18-110 | OE002 | AG1X | OE068 | AGPS 12 P 1 | OE136 | AGSF22FE13J | OE131 |
| 1YR9-18-110 | OE063 | AG2 | OE079 | AGPS 22 C | OE014 | AGSF22PP | OE131 |
| 1YRF-18-110 | OE083 | AG22 | OE001 | AGPS 32 C 1 | OE039 | AGSF22PPJ | OE131 |
| 1YRG-18-110 | OE089 | AG224 | OE001 | AGPS 44 F11J | OE176 | AGSF22WM | OE131 |
| 1YRH-18-110 | OE089 | AG22-4 | OE001 | AGPS22C | OE005 | AGSF32WM | OE183 |
| A5 | J8C | AG22C | OE001 | AGPS22CD | OE014 | AGSF32WM1 | OE183 |
| A5X | J8C | AG25 | OE001 | AGPS22P1 | OE136 | AGSP 092 P | OE136 |
| A7 | J8C | AG2C | OE079 | AGPS22PP1 | OE136 | AGSP 32 | OE014 |
| A7C | J8C | AG2X | OE079 | AGR 12 C | OE087 | AGSP 32 C | OE014 |
| A7CX | J8C | AG3 | OE074 | AGR 22 | OE006 | AGSP 33 C | OE089 |
| A7X | J8C | AG32 | OE065 | AGR 22 BC | OE018 | AGSP22C | OE013 |
| AE 2 | L78C | AG32A | OE065 | AGR 22 C | OE006 | AGSP22YE11 | OE182 |
| AE 22 | OE038 | AG32C | OE065 | AGR 22-3 C | OE018 | AGSP22YE13 | OE182 |
| AE 3 | L82C | AG3C | OE074 | AGR 252 C | OE006 | AGSP32 | OE013 |
| AE 32 | OE038 | AG3X | OE074 | AGR12 | OE018 | AGSP32C | OE013 |
| AE 4 | L82C | AG4 | OE074 | AGR12C | OE018 | AGSP33C | OE014 |
| AE 42 | OE038 | AG5 | OE074 | AGR1X | OE108 | AGSP52 | OE013 |
| AE 52 | L82C | AG7 | OE074 | AGR21 | OE098 | AGSP52C | OE013 |
| AE 6 | L82C | AG901C | OE068 | AGR2C | OE098 | AGSP54 | OE041 |
| AE 62 | L82C | AG902 | OE087 | AGR2X | OE098 | AGSP54C | OE041 |
| AE 82 | L82C | AGF22 | OE009 | AGR32 | OE049 | AJFS 32 CJ | OE031 |
| AE091 | L78C | AGF22C | OE009 | AGR32C | OE051 | ARF52 | RV15YC4 |
| AE1X | L78C | AGFS 22 C | OE011 | AGR42 | OE042 | ASF52 | RV15YC4 |
| AE2 | L82C | AGFS 22 C 1 | OE011 | AGR42C | OE042 | ASF52C | RV15YC4 |
| AE2X | L82C | AGFS 22 F 13J | OE183 | AGR52 | OE042 | ASWF32F | OE131 |
| AE3 | L82C | AGFS 22 IPJ | OE131 | AGRF 22 | OE011 | AT6 | J8C |
| AE3X | L82C | AGFS 32 C 1 | OE011 | AGRF 22 C | OE011 | AV1X | L78C |
| AE3XF | L82C | AGFS22CM1 | OE131 | AGRF 22 C 1 | OE011 | AV2X | L82C |
| AE4 | OE037 | AGN 42 | OE015 | AGRF 22 CD | OE011 | AV4 | OE037 |
| AE42 | OE059 | AGP 22 C | OE014 | AGRF 22 CD 1 | OE011 | AWRF 42 | OE011 |
| AE4C | OE037 | AGP 22 CD | OE014 | AGRF 32 C 1 | OE011 | AWSF 32 | OE009 |
| AE4X | OE037 | AGP22C | OE003 | AGRF2 | OE011 | AWSF 32 C | OE009 |
| AE6 | OE037 | AGPR 12 C | OE094 | AGRF22 | OE011 | AWSF 42 | OE011 |
| AE62 | OE059 | AGPR 12 C 1 | OE094 | AGRF22C | OE011 | AWSF 42 C | OE011 |
| AE8 | OE037 | AGPR 12 P | OE136 | AGRF22D1 | OE131 | AWSF 52 | OE011 |
| AER 32 | OE064 | AGPR 22 C | OE014 | AGRF22DD1 | OE131 | AWSF 52 C | OE011 |
| AER22 | OE086 | AGPR 22 CD | OE014 | AGRF22P1 | OE029 | AWSF22C | OE011 |
| AER2X | OE086 | AGPR 22 P 1 | OE136 | AGRF22PP | OE131 | AWSF22FS | OE131 |
| AF52 | RV15YC4 | AGPR 22 PP | OE136 | AGRF22PP1 | OE131 | AWSFA12C | OE011 |
| AF52C | RV15YC4 | AGPR 22 PPJ | OE136 | AGS 22 C | OE006 | AYFS 22 C | OE031 |
| AG 12 C | OE087 | AGPR 32 C | OE005 | AGS12 | OE018 | AYFS 22 CB | OE031 |
| AG 12 Racing | OE087 | AGPR 32 C 1 | OE039 | AGS12C | OE018 | AYFS 22 CJ | OE031 |
| AG 2 | OE074 | AGPR 32 CD | OE005 | AGS1C | OE108 | AYFS 22 F | OE029 |
| AG 22 | OE010 | AGPR 32 CD 1 | OE039 | AGS2C | OE098 | AYFS 22 FM | OE029 |
| AG 22 C | OE010 | AGPR 32 PD | OE198 | AGS32C | OE042 | AYFS 22 PP 1 | OE029 |
| AG 3 | OE074 | AGPR12C | OE014 | AGS42C | OE042 | AYFS 32 CJ | OE031 |
| AG 32 | OE001 | AGPR22C | OE005 | AGS52C | OE042 | AYFS092FEC | OE029 |
| AG 42 | OE001 | AGPR22CD | OE014 | AGSF 22 FE13J | OE131 | AYFS22C | OE031 |
| AG 52 | OE015 | AGPR22P | OE145 | AGSF 22 FSCM | OE131 | AYFS22CB | OE031 |
| AG091 | OE018 | AGPR32C1 | OE014 | AGSF 22 PPJ | OE131 | AYFS22F1 | OE029 |
| AG092C | OE087 | AGPR902C | OE094 | AGSF2 | OE011 | AYFS22PP | OE029 |

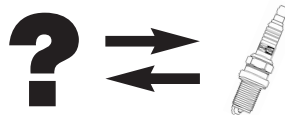

| MOTORCRAFT | | NEWSTAR | | NGK | | NGK | |
|-------------------|-------|----------------|---------|------------|---------|------------|---------|
| AYFS22PP1 | OE029 | F10RC | OE108 | 1052 | OE037 | 2075 | OE063 |
| AYFS32CJ | OE031 | F11RC | OE091 | 1086 | OE057 | 2077 | OE091 |
| AYRF 22 FF | OE029 | F5RTC | OE042 | 1091 | OE001 | 2078 | OE094 |
| AYRF 22 PP | OE029 | F5RTC-15 | OE042 | 1092 | OE064 | 2081 | OE004 |
| AYRF22PP | OE029 | F5TC | OE065 | 1094 | OE011 | 2087 | OE093 |
| AZFS22C | OE031 | F6C | OE074 | 1095 | OE094 | 2095 | OE026 |
| BF 22 | OE054 | F6RTC | OE051 | 1098 | OE086 | 2097 | OE191 |
| BF 22 C | OE054 | F6RTC-10 | OE049 | 1111 | OE079 | 2127 | OE054 |
| BF 22 CX | OE054 | F6TC | OE065 | 1127 | RV15YC4 | 2129 | L82C |
| BF 32 | OE054 | F6TC-10 | OE065 | 1128 | OE018 | 214 | OE064 |
| BF 32 C | OE054 | F6TJC | OE044 | 1142 | OE018 | 2145 | OE091 |
| BF 32 CX | OE054 | F7C | OE079 | 1145 | OE016 | 2164 | OE014 |
| BF 42 | OE054 | F7RC | OE098 | 1149 | OE018 | 2171 | OE091 |
| BFS 22 C | OE054 | F7RLC | OE004 | 1154 | OE049 | 2175 | OE001 |
| BFS 32 C | OE054 | F7RLC-10 | OE004 | 1179 | OE186 | 2197 | OE120 |
| BFS 32 C1 | OE054 | F7RTC-10 | OE048 | 1183 | OE011 | 2202 | OE187 |
| BRF 22 | OE054 | F7TC | OE001 | 1208 | OE238 | 2213 | OE026 |
| BRF 22 C | OE054 | F7TJC | OE044 | 1212 | OE048 | 2215 | OE227 |
| BRF 22 CX | OE054 | F8RTC | OE018 | 1263 | OE012 | 2251 | OE136 |
| BRF 22 X | OE054 | F8RTC-10 | OE077 | 1266 | OE016 | 2262 | OE154 |
| BRF 32 | OE054 | F9C | OE068 | 1269 | OE005 | 2268 | OE006 |
| BRF 32 C | OE054 | F9RC | OE108 | 1272 | OE014 | 2285 | OE015 |
| BRF 32 CX | OE054 | F9RTC | OE087 | 1273 | OE063 | 2287 | OE044 |
| BRF 32 X | OE054 | F9TC | OE087 | 1283 | OE014 | 2288 | OE026 |
| BRF 42 | OE054 | F9TJC | OE012 | 1313 | OE180 | 2300 | OE138 |
| BRF 42 C | OE054 | G5C | J8C | 1314 | OE179 | 2316 | OE073 |
| BRF 42 X | OE054 | K5FC | OE041 | 1496 | OE179 | 2317 | OE114 |
| BSF 42 | OE054 | K5RTC | OE013 | 1497 | OE195 | 2330 | OE005 |
| CYFS12VN4 | OE031 | K6RFC | OE041 | 1498 | OE180 | 2341 | OE146 |
| HG2 | OE083 | K6RLC-10 | OE114 | 1501 | OE190 | 2347 | OE195 |
| HGS22C | OE083 | K6RTC-10 | OE063 | 1511 | OE189 | 2355 | OE016 |
| NCOSP | | K6TC | OE057 | 1516 | OE183 | 2357 | OE087 |
| D8TC | OE083 | K7RLC-10 | OE089 | 1565 | OE184 | 2358 | OE065 |
| E7C | L82C | K7RTC | OE005 | 1567 | OE120 | 2363 | OE083 |
| F7TC | OE001 | K7RTC-10 | OE039 | 1578 | OE201 | 2364 | OE015 |
| K6RTC | OE005 | K7RTJC | OE077 | 1632 | OE146 | 2382 | OE063 |
| K6TC | OE003 | K7TC | OE003 | 1640 | OE190 | 2397 | OE032 |
| K7DC | OE003 | K8RTC | OE014 | 1662 | OE063 | 2412 | OE010 |
| NEWSTAR | | K9RTC | OE094 | 1664 | OE176 | 2412 | OE018 |
| D6TC | OE083 | K9TC | OE094 | 1667 | OE016 | 2417 | L82C |
| D8C | OE112 | P5RTC | RV15YC4 | 1669 | OE148 | 2417 | OE037 |
| D8RTC | OE083 | P5RTC-10 | RV15YC4 | 1675 | OE214 | 2421 | L82C |
| D8TC | OE083 | P5TC | RV15YC4 | 1691 | OE196 | 2423 | RV15YC4 |
| DK7RTC | OE073 | Q6TC | OE099 | 1748 | OE188 | 2460 | OE063 |
| E11C | L78C | Q7RTC | OE011 | 1989 | OE250 | 2467 | OE029 |
| E6C | OE037 | Q7RTC-15 | OE011 | 2023 | OE018 | 2470 | OE027 |
| E6TC | OE059 | Q7TC | OE009 | 203 | L82C | 2477 | OE194 |
| E7C | OE037 | Q7TC-15 | OE009 | 204 | L82C | 2499 | OE089 |
| E8C | L82C | T8TC | OE054 | 2042 | OE009 | 2513 | OE223 |
| E9C | L82C | NGK | | 2046 | OE078 | 2526 | OE093 |
| E9RC | OE086 | 0005 | OE031 | 205 | L78C | 2527 | RV15YC4 |
| | | 1041 | OE089 | 206 | OE010 | 2528 | OE018 |
| | | | | 2074 | OE128 | 2530 | OE048 |

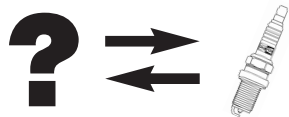

| NGK | CHAMPION | NGK | CHAMPION | NGK | CHAMPION | NGK | CHAMPION |
|------|----------|------|----------|------|----------|------|----------|
| 2550 | OE188 | 3232 | OE018 | 3789 | OE029 | 4424 | OE049 |
| 2563 | OE179 | 3236 | OE108 | 3811 | OE189 | 4435 | OE089 |
| 2609 | OE011 | 3243 | OE154 | 3812 | OE009 | 4457 | OE091 |
| 2621 | L78C | 3245 | OE091 | 3837 | OE188 | 4458 | OE190 |
| 2633 | OE064 | 3252 | OE091 | 3859 | OE002 | 4477 | OE183 |
| 2641 | OE073 | 3271 | OE188 | 3862 | OE044 | 4483 | OE019 |
| 2673 | OE004 | 3311 | OE038 | 3869 | OE089 | 4489 | OE054 |
| 2684 | OE146 | 3330 | OE094 | 3903 | OE195 | 4492 | OE108 |
| 2689 | OE091 | 3346 | OE011 | 3923 | OE087 | 4497 | OE145 |
| 2710 | OE054 | 3350 | OE188 | 3932 | OE196 | 4510 | L82C |
| 2726 | OE011 | 3355 | OE010 | 3933 | OE136 | 4510 | OE037 |
| 2743 | OE146 | 3355 | OE018 | 3967 | OE019 | 4511 | OE038 |
| 2756 | OE039 | 3356 | OE179 | 3971 | OE192 | 4528 | OE091 |
| 2761 | OE138 | 3377 | OE027 | 3972 | OE091 | 4553 | OE064 |
| 2789 | OE123 | 3384 | OE120 | 3975 | OE038 | 4555 | OE007 |
| 2792 | L82C | 3430 | OE078 | 3978 | OE136 | 4559 | OE031 |
| 2848 | OE026 | 3436 | OE042 | 3985 | OE054 | 4589 | OE188 |
| 2848 | OE030 | 3440 | OE191 | 3987 | OE042 | 4619 | OE033 |
| 2876 | OE012 | 3452 | OE026 | 4014 | OE146 | 4632 | OE038 |
| 2876 | OE025 | 3500 | OE136 | 4043 | OE154 | 4642 | OE138 |
| 2890 | OE198 | 3508 | OE180 | 4045 | OE136 | 4665 | OE011 |
| 2912 | OE087 | 3524 | OE063 | 4055 | OE195 | 4666 | OE009 |
| 2921 | OE074 | 3536 | OE003 | 4073 | OE089 | 4669 | OE015 |
| 2922 | OE054 | 3539 | OE136 | 4080 | OE184 | 4685 | OE136 |
| 2924 | RV15YC4 | 3540 | OE136 | 4095 | OE188 | 4691 | OE065 |
| 2941 | OE004 | 3544 | OE014 | 4111 | OE059 | 4696 | OE191 |
| 2950 | OE191 | 3546 | OE146 | 4120 | OE063 | 4696 | OE228 |
| 2975 | OE089 | 3566 | OE120 | 4122 | OE086 | 4704 | OE236 |
| 2978 | OE146 | 3570 | OE091 | 4129 | OE074 | 4717 | OE122 |
| 2989 | OE054 | 3573 | OE042 | 4157 | OE016 | 4729 | OE014 |
| 3000 | OE138 | 3577 | OE048 | 4179 | OE073 | 4741 | OE091 |
| 3014 | L78C | 3583 | OE026 | 4192 | OE004 | 4759 | OE187 |
| 3028 | OE049 | 3584 | OE237 | 4210 | OE037 | 4768 | OE013 |
| 3035 | OE091 | 3586 | OE176 | 4221 | OE091 | 4775 | OE175 |
| 3045 | OE032 | 3587 | OE029 | 4224 | OE049 | 4783 | OE063 |
| 3100 | OE136 | 3588 | OE224 | 4228 | OE048 | 4785 | OE049 |
| 3106 | OE195 | 3605 | OE187 | 4259 | OE122 | 4787 | OE026 |
| 3107 | OE180 | 3606 | OE187 | 4285 | OE257 | 4795 | OE196 |
| 3116 | OE227 | 3611 | OE038 | 4288 | OE229 | 4824 | OE048 |
| 3123 | OE083 | 3623 | OE011 | 4291 | OE089 | 4830 | OE073 |
| 3130 | OE108 | 3639 | OE108 | 4292 | OE191 | 4837 | OE049 |
| 3132 | OE039 | 3641 | OE187 | 4293 | OE002 | 4853 | OE146 |
| 3137 | OE001 | 3656 | OE190 | 4294 | OE188 | 4856 | OE005 |
| 3141 | OE138 | 3672 | OE148 | 4339 | OE073 | 4877 | OE146 |
| 3153 | OE044 | 3688 | OE146 | 4339 | OE199 | 4904 | OE190 |
| 3154 | OE049 | 3712 | OE009 | 4363 | OE184 | 4919 | OE179 |
| 3158 | OE039 | 3712 | OE099 | 4364 | OE146 | 4922 | OE098 |
| 3172 | OE012 | 3720 | OE089 | 4368 | OE089 | 4968 | OE131 |
| 3172 | OE025 | 3725 | OE064 | 4371 | OE146 | 4983 | OE196 |
| 3177 | OE011 | 3737 | OE005 | 4377 | OE146 | 4984 | OE018 |
| 3199 | OE223 | 3764 | OE179 | 4388 | OE026 | 4996 | OE180 |
| 3200 | OE195 | 3783 | OE005 | 4392 | OE011 | 5044 | OE108 |
| 3230 | OE091 | 3784 | OE011 | 4421 | OE013 | 5055 | OE029 |

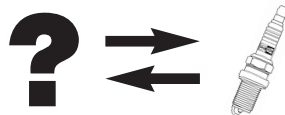

| NGK | CHAMPION | NGK | CHAMPION | NGK | CHAMPION | NGK | CHAMPION |
|------|----------|------|----------|------|----------|------|----------|
| 5084 | OE154 | 5692 | OE186 | 6326 | OE007 | 6903 | OE180 |
| 5110 | L82C | 5703 | OE182 | 6341 | OE180 | 6921 | L82C |
| 5111 | OE038 | 5705 | OE188 | 6342 | OE123 | 6928 | OE065 |
| 5118 | OE207 | 5724 | OE039 | 6343 | OE223 | 6953 | OE063 |
| 5122 | OE098 | 5730 | OE087 | 6344 | OE011 | 6962 | OE005 |
| 5126 | L78C | 5742 | OE077 | 6345 | OE016 | 6989 | OE131 |
| 5135 | OE077 | 5743 | OE195 | 6368 | OE136 | 6992 | OE077 |
| 5156 | OE044 | 5756 | OE208 | 6376 | OE148 | 6993 | OE019 |
| 5165 | OE128 | 5757 | OE146 | 6378 | OE122 | 7004 | OE122 |
| 5165 | OE198 | 5758 | OE213 | 6410 | OE074 | 7022 | OE064 |
| 5195 | OE030 | 5760 | OE192 | 6411 | OE001 | 7075 | OE042 |
| 5208 | OE063 | 5773 | OE136 | 6418 | OE179 | 7113 | OE035 |
| 5214 | OE211 | 5788 | OE178 | 6422 | OE064 | 7113 | OE148 |
| 5216 | OE019 | 5809 | OE183 | 6427 | OE006 | 7121 | OE039 |
| 5236 | OE014 | 5811 | OE015 | 6436 | OE073 | 7126 | OE054 |
| 5259 | OE008 | 5823 | OE006 | 6437 | OE032 | 7168 | OE186 |
| 5271 | OE003 | 5832 | OE008 | 6441 | OE188 | 7210 | OE039 |
| 5275 | OE145 | 5838 | OE138 | 6458 | OE136 | 7222 | OE051 |
| 5282 | OE039 | 5839 | OE004 | 6464 | OE006 | 7226 | OE018 |
| 5328 | OE010 | 5843 | OE205 | 6465 | OE039 | 7252 | OE041 |
| 5339 | OE048 | 5847 | OE212 | 6466 | OE009 | 7264 | OE027 |
| 5343 | OE064 | 5851 | OE122 | 6481 | OE190 | 7265 | OE018 |
| 5344 | OE146 | 5860 | OE003 | 6502 | OE180 | 7270 | OE195 |
| 5399 | OE009 | 5874 | OE191 | 6511 | OE065 | 7310 | OE074 |
| 5422 | OE108 | 5881 | OE032 | 6546 | OE187 | 7311 | OE049 |
| 5428 | OE018 | 5887 | OE184 | 6597 | OE195 | 7311 | OE065 |
| 5459 | OE138 | 5932 | OE027 | 6637 | OE195 | 7327 | OE015 |
| 5461 | OE032 | 5942 | OE130 | 6643 | OE240 | 7345 | OE004 |
| 5464 | OE180 | 5948 | OE255 | 6644 | OE131 | 7354 | OE026 |
| 5476 | OE189 | 5960 | OE177 | 6645 | OE190 | 7415 | OE187 |
| 5492 | OE073 | 5987 | OE238 | 6648 | OE048 | 7418 | OE180 |
| 5510 | L78C | 5992 | OE205 | 6651 | OE199 | 7422 | OE051 |
| 5521 | OE012 | 6002 | OE120 | 6664 | OE195 | 7496 | OE063 |
| 5539 | L78C | 6043 | OE233 | 6677 | OE035 | 7529 | OE001 |
| 5542 | OE191 | 6046 | OE187 | 6684 | OE195 | 7548 | OE091 |
| 5547 | OE209 | 6096 | OE032 | 6687 | OE195 | 7550 | OE184 |
| 5555 | OE136 | 6097 | OE014 | 6711 | OE089 | 7553 | OE032 |
| 5567 | OE091 | 6098 | OE044 | 6714 | OE016 | 7553 | OE120 |
| 5572 | OE063 | 6129 | OE005 | 6717 | OE005 | 7564 | OE002 |
| 5584 | OE154 | 6129 | OE014 | 6717 | OE033 | 7569 | OE131 |
| 5585 | OE089 | 6130 | OE016 | 6723 | OE006 | 7586 | OE029 |
| 5592 | OE209 | 6161 | OE003 | 6741 | OE180 | 7639 | OE001 |
| 5598 | OE131 | 6194 | OE009 | 6799 | OE130 | 7642 | OE016 |
| 5621 | OE012 | 6203 | OE004 | 6837 | OE011 | 7658 | OE179 |
| 5627 | OE078 | 6211 | OE001 | 6838 | OE179 | 7675 | OE032 |
| 5637 | OE001 | 6223 | OE048 | 6840 | OE209 | 7727 | OE001 |
| 5648 | OE181 | 6234 | OE003 | 6853 | OE091 | 7738 | OE008 |
| 5649 | OE217 | 6240 | OE175 | 6858 | OE190 | 7742 | OE234 |
| 5685 | OE027 | 6289 | OE122 | 6872 | OE120 | 7743 | OE176 |
| 5688 | OE180 | 6290 | OE146 | 6883 | OE011 | 7772 | OE136 |
| 5689 | OE179 | 6313 | OE014 | 6893 | OE177 | 7795 | OE073 |
| 5690 | OE179 | 6314 | OE146 | 6895 | OE026 | 7810 | OE063 |
| 5691 | OE179 | 6323 | OE136 | 6895 | OE030 | 7811 | OE001 |

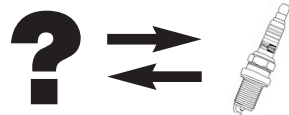

| NGK | CHAMPION | NGK | CHAMPION | NGK | CHAMPION | NGK | CHAMPION |
|-------|----------|-----------|----------|------------|----------|-------------|----------|
| 7822 | OE006 | 99404 | OE179 | B7HZ | L78C | BCPR6EP8 | OE136 |
| 7829 | OE007 | A7FS22C | OE029 | B8EG | OE078 | BCPR6EPN11 | OE145 |
| 7854 | OE180 | A7FS22PP1 | OE029 | B8EGP | OE078 | BCPR6EPN8 | OE145 |
| 7866 | OE180 | A8FS | OE054 | B8EGV | OE078 | BCPR6ER | OE026 |
| 7873 | OE094 | AP6FS | OE054 | B8EGV | OE078 | BCPR6ES | OE005 |
| 7877 | OE016 | AP6FSVP4 | OE054 | B8ES | OE068 | BCPR6ES11 | OE039 |
| 7912 | OE083 | AP6FVG | OE054 | B8EV | OE078 | BCPR6ESVP4 | OE005 |
| 7938 | OE063 | AP6FVG4 | OE054 | B8EVX | OE078 | BCPR6ET | OE120 |
| 7956 | OE019 | AP7FS | OE054 | B8H | L78C | BCPR6EY | OE002 |
| 7963 | OE136 | APR6FS | OE054 | B8HCS | L78C | BCPR6EY11 | OE089 |
| 7968 | OE176 | APR6FVG4 | OE054 | B8HS | L78C | BCPR6EYN11 | OE039 |
| 7980 | OE226 | B10SEGP | OE091 | B8HS10 | L78C | BCPR7E | OE014 |
| 7986 | OE108 | B10SEGV | OE091 | B9SEGV | OE091 | BCPR7EIX | OE179 |
| 7994 | OE039 | B4ES | OE074 | BCP4ES11 | OE057 | BCPR7EIX11 | OE179 |
| 7998 | OE120 | B5EB | OE074 | BCP5E | OE063 | BCPR7ER | OE013 |
| 8894 | OE198 | B5ES | OE074 | BCP5E11 | OE063 | BCPR7ER | OE013 |
| 90061 | OE261 | B5EV | OE074 | BCP5ES | OE063 | BCPR7ES | OE014 |
| 90117 | OE189 | B5HS | OE037 | BCP5ES11 | OE063 | BCPR7ES | OE094 |
| 90223 | OE205 | B6E | OE074 | BCP5ESVP4 | OE063 | BCPR7ES11 | OE094 |
| 91015 | OE177 | B6EB | OE074 | BCP5ET | OE063 | BCPR7ESVP4 | OE014 |
| 91039 | OE264 | B6EB11 | OE074 | BCP6E | OE003 | BCPR7ET | OE014 |
| 91432 | OE225 | B6EBL | OE074 | BCP6E | OE003 | BCPR7EVG4 | OE014 |
| 91763 | OE154 | B6EFS | OE009 | BCP6ES | OE003 | BCPR7EY | OE014 |
| 92483 | OE201 | B6EM | OE074 | BCP6ES11 | OE039 | BCPR9ES11 | OE094 |
| 93311 | OE208 | B6EM | OE074 | BCP6ESVP4 | OE003 | BCRE527Y | OE114 |
| 93607 | OE256 | B6ES | OE074 | BCP6ET | OE032 | BCRE527Y | OE128 |
| 94124 | OE253 | B6ES11 | OE079 | BCP6EV | OE136 | BCRE527YVG4 | OE114 |
| 94201 | OE245 | B6EV | OE098 | BCP6EVG4 | OE003 | BK5E | OE003 |
| 94460 | OE214 | B6H | L82C | BCP6EVX | OE136 | BK5E11 | OE003 |
| 94658 | OE183 | B6HS | L82C | BCP6EY | OE003 | BK5ESZ | OE026 |
| 94716 | OE229 | B6HS | OE037 | BCP7ET | OE094 | BK6E | OE003 |
| 94786 | OE232 | B6HS10 | OE037 | BCP7EV | OE014 | BKR4E | OE013 |
| 94833 | OE246 | B6HS5 | OE037 | BCP7EVX | OE014 | BKR5E | OE016 |
| 94951 | OE130 | B6HSA | OE037 | BCPR4ES | OE013 | BKR5E | OE063 |
| 94968 | OE244 | B6HSA | OE037 | BCPR5E | OE016 | BKR5E11 | OE063 |
| 94977 | OE207 | B6HV | OE037 | BCPR5E11 | OE063 | BKR5E11VG | OE063 |
| 95262 | OE213 | B6HVX | OE037 | BCPR5EIX | OE180 | BKR5E11VG4 | OE063 |
| 95369 | OE189 | B6S | J8C | BCPR5EIX11 | OE180 | BKR5EIX | OE180 |
| 95420 | OE011 | B6SVP1 | J8C | BCPR5EP11 | OE191 | BKR5EIX11 | OE180 |
| 95712 | OE238 | B7E | OE074 | BCPR5EP8 | OE191 | BKR5EK | OE019 |
| 95770 | OE205 | B7EB | OE079 | BCPR5EP8 | OE191 | BKR5EK | OE019 |
| 96463 | OE031 | B7EB11 | OE079 | BCPR5ES | OE016 | BKR5EK | OE019 |
| 96569 | OE197 | B7ECS | OE018 | BCPR5ES11 | OE063 | BKR5EK | OE019 |
| 96596 | OE247 | B7ECS | OE018 | BCPR5ESVP4 | OE016 | BKR5EK | OE019 |
| 96779 | OE190 | B7ES | OE079 | BCPR5ET | OE077 | BKR5EK | OE019 |
| 97153 | OE260 | B7ES | OE079 | BCPR5EVG4 | OE016 | BKR5EK | OE030 |
| 97168 | OE232 | B7ES11 | OE068 | BCPR5EY | OE016 | BKR5EKUP | OE198 |
| 97218 | OE238 | B7EV | OE079 | BCPR5EY11 | OE063 | BKR5EN11 | OE039 |
| 97237 | OE177 | B7EVX | OE079 | BCPR5EY11 | OE063 | BKR5EP | OE191 |
| 97439 | OE240 | B7H | L78C | BCPR5EY11 | OE063 | BKR5EP11 | OE191 |
| 97472 | OE196 | B7HC | L82C | BCPR5EY11 | OE063 | BKR5EP11 | OE191 |
| 97506 | OE243 | B7HCS | L82C | BCPR6E | OE005 | BKR5EP11 | OE191 |
| 97999 | OE263 | B7HCS | L82C | BCPR6E | OE005 | BKR5EP11 | OE191 |
| | | B7HS | L82C | BCPR6E11 | OE039 | BKR5EQUB | OE120 |
| | | B7HS10 | L82C | BCPR6EIX | OE179 | BKR5EQUB | OE120 |
| | | B7HV | L78C | BCPR6EIX11 | OE179 | BKR5EQUPA | OE120 |
| | | B7HV | L82C | BCPR6EP11 | OE188 | BKR5ES | OE063 |
| | | B7HVX | L82C | BCPR6EP11 | OE188 | BKR5ES11 | OE063 |
| | | | | BCPR6EP11 | OE191 | BKR5ES13 | OE063 |
| | | | | BCPR6EP13 | OE188 | BKR5EY | OE016 |

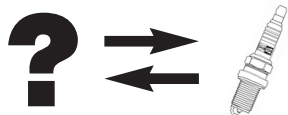

| NGK | CHAMPION |
|------------|----------|
| BKR5EY11 | OE016 |
| BKR5EYA | OE093 |
| BKR5EYA1 | OE093 |
| BKR5EYA11 | OE093 |
| BKR5EZ | OE016 |
| BKR6E | OE005 |
| BKR6E-11 | OE039 |
| BKR6E11VG | OE039 |
| BKR6E11VG4 | OE039 |
| BKR6EIX | OE179 |
| BKR6EIX11 | OE179 |
| BKR6EIXLPG | OE179 |
| BKR6EK | OE026 |
| BKR6EK11 | OE026 |
| BKR6EKB11 | OE026 |
| BKR6EKC | OE026 |
| BKR6EKC | OE030 |
| BKR6EKCVP4 | OE030 |
| BKR6EKE | OE026 |
| BKR6EKE | OE217 |
| BKR6EKPA | OE223 |
| BKR6EKP11 | OE026 |
| BKR6EKU | OE019 |
| BKR6EKUB | OE237 |
| BKR6EKVP4 | OE026 |
| BKR6EN11 | OE039 |
| BKR6EP | OE136 |
| BKR6EP11 | OE146 |
| BKR6EP13 | OE146 |
| BKR6EP13 | OE188 |
| BKR6EP8 | OE136 |
| BKR6EP8 | OE227 |
| BKR6EPN11 | OE191 |
| BKR6EQU | OE120 |
| BKR6EQUA | OE120 |
| BKR6EQUAP | OE120 |
| BKR6EQUP | OE223 |
| BKR6ES | OE005 |
| BKR6ES | OE014 |
| BKR6ES11 | OE039 |
| BKR6ET10 | OE032 |
| BKR6ETA10 | OE120 |
| BKR6ETUC | OE120 |
| BKR6EVG4 | OE002 |
| BKR6EVX | OE136 |
| BKR6EVX11 | OE136 |
| BKR6EVXA11 | OE179 |
| BKR6EVXA13 | OE179 |
| BKR6EY | OE002 |
| BKR6EY11 | OE089 |
| BKR6EYA | OE002 |
| BKR6EYA11 | OE089 |
| BKR6EYAVG4 | OE002 |

| NGK | CHAMPION |
|--------------|----------|
| BKR6EZ | OE033 |
| BKR6EZ | OE034 |
| BKR6EZB | OE002 |
| BKR7E | OE014 |
| BKR7E11 | OE014 |
| BKR7EKC | OE026 |
| BKR7EKN | OE026 |
| BKR7EKN11 | OE026 |
| BKR7EQU | OE032 |
| BKR7ESC11 | OE014 |
| BKR7EVX | OE014 |
| BKR7EVX11 | OE014 |
| BKR7EVX11 | OE136 |
| BKR8E | OE094 |
| BKR8E11 | OE094 |
| BKRUR6ET | OE120 |
| BKUR5EK | OE013 |
| BKUR5ET | OE120 |
| BKUR5ET | OE123 |
| BKUR5ET10 | OE032 |
| BKUR5ET10 | OE120 |
| BKUR5ETC10 | OE120 |
| BKUR6EK | OE026 |
| BKUR6ET | OE032 |
| BKUR6ET10 | OE032 |
| BKUR6ET10VP4 | OE032 |
| BKUR6ETB | OE077 |
| BKUR6ETB10 | OE032 |
| BKUR6ETB10 | OE077 |
| BKUR7ET | OE032 |
| BKUR7ET | OE094 |
| BKUR7ETVP4 | OE032 |
| BL6H | L82C |
| BP4ES | OE065 |
| BP4H | OE038 |
| BP4HS | OE007 |
| BP4HS | OE038 |
| BP4HS | OE059 |
| BP5E | OE015 |
| BP5EA | OE015 |
| BP5EAL | OE001 |
| BP5EAL11 | OE065 |
| BP5EAL11 | OE065 |
| BP5EFS | OE009 |
| BP5EFS | OE099 |
| BP5EKA | OE012 |
| BP5ES | OE065 |
| BP5ES11 | OE049 |
| BP5ES11 | OE065 |
| BP5ESA | OE015 |
| BP5ESVP4 | OE065 |

| NGK | CHAMPION |
|-----------|----------|
| BP5ESZ | OE065 |
| BP5ET | OE044 |
| BP5ET10 | OE044 |
| BP5ETVP4 | OE044 |
| BP5EV | OE065 |
| BP5EVG4 | OE001 |
| BP5EVX | OE001 |
| BP5EY | OE015 |
| BP5EY | OE065 |
| BP5EZ | OE015 |
| BP5HS | OE059 |
| BP6E | OE001 |
| BP6EF | OE009 |
| BP6EFS | OE009 |
| BP6EFS13 | OE009 |
| BP6EFSVP4 | OE009 |
| BP6EFG4 | OE009 |
| BP6EK | OE012 |
| BP6EKA | OE001 |
| BP6EKA | OE012 |
| BP6EQ13 | OE049 |
| BP6ES | OE001 |
| BP6ES11 | OE001 |
| BP6ES11 | OE048 |
| BP6ES13 | OE049 |
| BP6ESVP4 | OE001 |
| BP6ESZ | OE001 |
| BP6ET | OE012 |
| BP6ETVP4 | OE044 |
| BP6EV | OE001 |
| BP6EVG4 | OE001 |
| BP6EVX | OE004 |
| BP6EVX | OE008 |
| BP6EY | OE001 |
| BP6EY11 | OE048 |
| BP6EZ | OE001 |
| BP6H | OE038 |
| BP6HS | OE007 |
| BP6HS | OE038 |
| BP6HS10 | OE007 |
| BP6HVG | OE007 |
| BP7E | OE087 |
| BP7ES | OE010 |
| BP7ET | OE012 |
| BP7EVX | OE195 |
| BP7HS | OE007 |
| BP7HS | OE038 |
| BP7HS10 | OE007 |
| BP8ES | OE087 |
| BP8EV | OE087 |
| BPR4E | OE042 |
| BPR4E11 | OE042 |
| BPR4ES | OE051 |

| NGK | CHAMPION |
|-------------|----------|
| BPR4ES11 | OE049 |
| BPR4ESL11 | OE049 |
| BPR4EVX | OE042 |
| BPR4EY11 | OE049 |
| BPR4FS | RV15YC4 |
| BPR4FS11 | RV15YC4 |
| BPR5E | OE042 |
| BPR5E11 | OE049 |
| BPR5EA11 | OE049 |
| BPR5EAL | OE006 |
| BPR5EAL11 | OE048 |
| BPR5EGP | OE192 |
| BPR5EIX | OE195 |
| BPR5EQU | OE027 |
| BPR5EP11 | OE192 |
| BPR5ES | OE051 |
| BPR5ES11 | OE049 |
| BPR5ES13 | OE049 |
| BPR5ES15 | OE049 |
| BPR5ESVP4 | OE049 |
| BPR5EV10 | OE049 |
| BPR5EVG4 | OE049 |
| BPR5EVX | OE192 |
| BPR5EY11 | OE049 |
| BPR5EYV4 | OE049 |
| BPR5FS | RV15YC4 |
| BPR5FS11 | RV15YC4 |
| BPR6E | OE006 |
| BPR6E11 | OE048 |
| BPR6EF | OE011 |
| BPR6EF11 | OE011 |
| BPR6EF13 | OE011 |
| BPR6EFIX10 | OE183 |
| BPR6EFIX11 | OE183 |
| BPR6EFIX15 | OE183 |
| BPR6EFS | OE011 |
| BPR6EFS15 | OE011 |
| BPR6EFSVP4 | OE011 |
| BPR6EFG | OE011 |
| BPR6EFG4 | OE011 |
| BPR6EIX | OE195 |
| BPR6EIX11 | OE195 |
| BPR6EIXLPG | OE195 |
| BPR6EKN | OE018 |
| BPR6ES | OE006 |
| BPR6ES11 | OE048 |
| BPR6ES11VP4 | OE048 |
| BPR6ES13 | OE048 |
| BPR6ESN11 | OE048 |
| BPR6ESVP4 | OE004 |
| BPR6EV | OE004 |
| BPR6EVG | OE004 |
| BPR6EVG4 | OE004 |

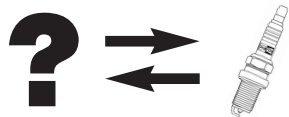

| NGK | CHAMPION | NGK | CHAMPION | NGK | CHAMPION | NGK | CHAMPION |
|-------------|----------|-----------|----------|--------------|----------|------------|----------|
| BPR6EVX | OE004 | BR9ECM | OE091 | DFH6B-11A | OE190 | IFR6D10 | OE181 |
| BPR6EY | OE006 | BR9ECS | OE091 | DILFR5A11 | OE190 | IFR6E11 | OE180 |
| BPR6EY11 | OE048 | BR9EG | OE091 | DILFR5C11 | OE190 | IFR6G-11K | OE179 |
| BPR6EY11VG4 | OE048 | BR9EGN8 | OE091 | DILFR7B10G | OE238 | IFR6J11 | OE179 |
| BPR6H | OE064 | BR9ES | OE091 | DILKAR7E11HS | OE240 | IFR6QG | OE181 |
| BPR6HS | OE064 | BR9ET | OE091 | DILZKAR6A11 | OE240 | IFR6S | OE179 |
| BPR6HS10 | OE064 | BR9EV | OE091 | DP7EA9 | OE083 | IFR6T11 | OE180 |
| BPR6HSA | OE038 | BR9EVX | OE091 | DP7EV9 | OE083 | IFR6T11 | OE182 |
| BPR7E | OE018 | BR9EYA | OE091 | DP8EV9 | OE083 | IFR6T11 | OE188 |
| BPR7EFS | OE011 | BRE527Y11 | OE114 | DP9EV9 | OE073 | IFR7X-7G | OE264 |
| BPR7EIX | OE195 | BU5EB11 | OE010 | DPR8EIX9 | OE187 | IGR6A11 | OE195 |
| BPR7EKN | OE008 | BU6EA11 | OE010 | DPR8EV9 | OE083 | IGR7A | OE195 |
| BPR7ES | OE018 | BU6EB11 | OE087 | DPR8EVX | OE083 | IGR7AG | OE195 |
| BPR7ES11 | OE018 | BU7EA11 | OE087 | DPR8EVX9 | OE083 | IKR6G11 | OE226 |
| BPR7ES11 | OE077 | BU8ET | OE001 | DPR9EV9 | OE073 | IKR7A | OE187 |
| BPR7EVG4 | OE008 | BUR5EB11 | OE018 | DPR9EVX9 | OE073 | IKR7B | OE187 |
| BPR7EY | OE018 | BUR5ET | OE027 | DPR9Z | OE073 | IKR7C | OE187 |
| BPR7EY11 | OE018 | BUR5ET10 | OE027 | DR7ES | OE083 | IKR7D | OE187 |
| BPR7HS | OE064 | BUR5ET10A | OE027 | FR2AD | OE013 | IKR9F8 | OE208 |
| BPR7HS10 | OE064 | BUR6EA11 | OE018 | FR4 | OE013 | IKR9J8 | OE208 |
| BPR8EIX | OE195 | BUR6EB11 | OE087 | FR51 | OE041 | ILFR5B11 | OE190 |
| BPR8ES | OE087 | BUR6EFSZ | OE011 | FR5AP10 | OE013 | ILFR5C | OE190 |
| BPR8EVX | OE087 | BUR6ET | OE025 | FR5AP11 | OE191 | ILFR5T11 | OE190 |
| BPR8HS | OE064 | BUR7EA11 | OE018 | FR5CP | OE136 | ILFR6A | OE190 |
| BPR9EIX | OE091 | BUR7EB11 | OE018 | FR5EI | OE180 | ILFR6A | OE224 |
| BPSESZ | OE065 | BZ8ES | OE091 | FR6AP10 | OE063 | ILFR6B | OE190 |
| BR527Y11 | OE049 | CR7EKC | OE122 | FR6F11K | OE039 | ILFR6D11 | OE190 |
| BR529Y11 | OE049 | CR9EIA9 | OE122 | GR4 | OE042 | ILFR6G | OE190 |
| BR6EB | OE006 | D7EA | OE083 | GR45 | OE049 | ILFR6J-11K | OE190 |
| BR6EB11 | OE048 | D7ES | OE083 | GR4VX | OE105 | ILFR6K8 | OE190 |
| BR6EF | OE011 | D7EV | OE112 | GR55 | OE048 | ILFR6T11 | OE190 |
| BR6ES | OE098 | D7EVX | OE112 | HB6AIX11P | OE182 | ILKAR7A7 | OE225 |
| BR7EB | OE098 | D8EV | OE112 | HB6BIX11P | OE188 | ILKAR7D6G | OE256 |
| BR7EB11 | OE098 | D8EVX | OE112 | IFR5A11 | OE180 | ILKAR7F7G | OE261 |
| BR7EF | OE011 | DCP7E | OE083 | IFR5D10 | OE191 | ILKAR7L11 | OE253 |
| BR7EFS | OE011 | DCPR7E | OE196 | IFR5D10 | OE228 | ILKR7B8 | OE250 |
| BR7EIX | OE195 | DCPR7EA9 | OE199 | IFR5E11 | OE039 | ILKR9G8 | OE232 |
| BR7ES | OE098 | DCPR7EIX | OE187 | IFR5E11 | OE180 | ILTR5A13G | OE189 |
| BR7ES11 | OE108 | DCPR7EN | OE196 | IFR5E13 | OE180 | ILTR5B | OE189 |
| BR7HS | OE086 | DCPR7EN10 | OE196 | IFR5G11 | OE180 | ILTR5B11 | OE189 |
| BR7HS10 | OE086 | DCPR7EVX | OE186 | IFR5G-11K | OE180 | ILTR5C | OE189 |
| BR8ECM | OE091 | DCPR8E | OE073 | IFR5J11 | OE180 | ILTR5D | OE189 |
| BR8ECMVX | OE091 | DCPR8EA | OE073 | IFR5L11 | OE180 | ILTR6A13G | OE029 |
| BR8ECS | OE091 | DCPR8EIX | OE187 | IFR5N10 | OE180 | ILTR6A13G | OE189 |
| BR8EG | OE108 | DCPR8EKC | OE186 | IFR5T11 | OE180 | ILTR6B | OE189 |
| BR8EIX | OE108 | DCPR8EKP | OE187 | IFR5T8N | OE180 | ILTR6E11 | OE189 |
| BR8ES | OE108 | DCPR8EN | OE186 | IFR6A | OE182 | ILZFR5B | OE190 |
| BR8ES11 | OE108 | DCPR9E | OE073 | IFR6A11 | OE182 | ILZFR6A11 | OE190 |
| BR8ESA | OE091 | DCPR9EIX | OE073 | IFR6A11T | OE188 | ILZFR6CK | OE190 |
| BR8ET | OE091 | DCPR9EVX | OE073 | IFR6B11 | OE180 | ILZFR6D11 | OE190 |
| BR8EV | OE108 | DCR7EIX | OE187 | IFR6BK | OE179 | ILZFR6D11 | OE238 |
| BR8EVX | OE108 | DCR8EIX | OE187 | IFR6C | OE181 | ILZKAR7A10 | OE233 |
| BR8HSA | L78C | DFH6B11A | OE190 | IFR6D10 | OE146 | ILZKBR7A8G | OE205 |

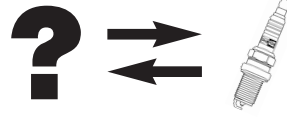

| NGK | CHAMPION |
|-------------|----------|
| ILZKBR7B8DG | OE205 |
| IRIMAC8 | OE187 |
| ITR6F13 | OE183 |
| IZFR5B | OE184 |
| IZFR5F11 | OE194 |
| IZFR5G | OE184 |
| IZFR5L11 | OE194 |
| IZFR6B | OE227 |
| IZFR6F11 | OE188 |
| IZFR6H11 | OE188 |
| IZFR6P7 | OE260 |
| KR7AI | OE187 |
| KR8BI | OE187 |
| KR9CI | OE073 |
| LFR5A11 | OE148 |
| LFR5AAA | OE035 |
| LFR5AGP | OE175 |
| LFR5AIX11 | OE190 |
| LFR5AP11 | OE175 |
| LFR5B | OE035 |
| LFR5B | OE148 |
| LFR5E11 | OE148 |
| LFR6A11 | OE148 |
| LFR6AIX11 | OE190 |
| LFR6B | OE035 |
| LFR6C-11 | OE035 |
| LFR6C-11 | OE178 |
| LFR6D | OE035 |
| LFR6D | OE236 |
| LKR6C | OE201 |
| LKR6C10E | OE201 |
| LKR6D10E | OE197 |
| LKR7B9 | OE212 |
| LKR8A | OE211 |
| LKR9CI8 | OE232 |
| LPG1 | OE179 |
| LPG2 | OE195 |
| LPG3 | OE180 |
| LPG4 | OE189 |
| LPG5 | OE183 |
| LPG6 | OE184 |
| LPG7 | OE190 |
| LTR6B10T | OE255 |
| LZFR6A1 | OE148 |
| LZFR6AI | OE190 |
| LZFR6AP11GS | OE238 |
| LZKAR6AP11 | OE240 |
| LZKAR7A | OE130 |
| LZKAR7B | OE130 |
| LZKAR7D9D | OE130 |
| LZKR6AI10G | OE263 |
| LZKR6B-10E | OE201 |
| PFR5B | OE138 |

| NGK | CHAMPION |
|----------|----------|
| PFR5B11 | OE138 |
| PFR5B11B | OE138 |
| PFR5C11 | OE138 |
| PFR5G | OE138 |
| PFR5G11 | OE138 |
| PFR5G11E | OE138 |
| PFR5G13E | OE138 |
| PFR5J11 | OE138 |
| PFR5L11 | OE138 |
| PFR5N11 | OE138 |
| PFR5R11 | OE138 |
| PFR5R11 | OE191 |
| PFR6A11 | OE136 |
| PFR6B | OE136 |
| PFR6B11 | OE146 |
| PFR6B11C | OE146 |
| PFR6B9 | OE136 |
| PFR6B9 | OE146 |
| PFR6D10G | OE146 |
| PFR6E10 | OE146 |
| PFR6G | OE146 |
| PFR6G11 | OE136 |
| PFR6G11 | OE146 |
| PFR6G13 | OE146 |
| PFR6G13E | OE146 |
| PFR6G9 | OE146 |
| PFR6H10 | OE146 |
| PFR6J11 | OE146 |
| PFR6L-13 | OE138 |
| PFR6N11 | OE146 |
| PFR6Q | OE136 |
| PFR6T10G | OE191 |
| PFR6TG | OE146 |
| PFR6U11G | OE191 |
| PFR6WTG | OE209 |
| PFR6X11 | OE146 |
| PFR7B | OE146 |
| PFR7BD | OE146 |
| PFR7G | OE146 |
| PFR7G11 | OE146 |
| PFR7G11S | OE136 |
| PFR7G11S | OE146 |
| PFR7G9 | OE146 |
| PFR7H10 | OE136 |
| PFR7H10 | OE146 |
| PFR7M | OE146 |
| PFR7Q | OE136 |
| PFR7S8EG | OE214 |
| PFR7WT | OE209 |
| PFR7WTG | OE209 |
| PFR8S8EG | OE214 |
| PGR5A | OE042 |
| PGR5A11 | OE042 |

| NGK | CHAMPION |
|-------------|----------|
| PGR5C11 | OE192 |
| PGR6A | OE018 |
| PGR7A | OE195 |
| PKR7A | OE187 |
| PKR9B | OE073 |
| PLFR7A8EG | OE246 |
| PLFR5A | OE175 |
| PLFR5A11 | OE175 |
| PLFR6A | OE206 |
| PLKR7A | OE229 |
| PLKR7B8E | OE229 |
| PLKR9C8 | OE232 |
| PLTR6A10G | OE029 |
| PLZFR6A-11S | OE238 |
| PLZKAR6A-11 | OE207 |
| PLZKAR6A11D | OE207 |
| PLZKBR7AG | OE205 |
| PLZKBR7B8DG | OE205 |
| PMR7A | OE122 |
| PMR8A | OE122 |
| PMR8B | OE122 |
| PMR9B | OE122 |
| PTR5A10 | OE029 |
| PTR5A13 | OE029 |
| PTR5A13VP4 | OE029 |
| PTR5D10 | OE011 |
| PTR5D10 | OE131 |
| PTR5D13 | OE131 |
| PTR5F13 | OE131 |
| PTR6D13 | OE131 |
| PTR6D13G | OE131 |
| PTR6F | OE131 |
| PTR6F13 | OE131 |
| PZFR5D | OE176 |
| PZFR5D11 | OE176 |
| PZFR5F | OE184 |
| PZFR5F11 | OE184 |
| PZFR5J11 | OE176 |
| PZFR5N11T | OE176 |
| PZFR5N11T | OE234 |
| PZFR5N11TG | OE176 |
| PZFR5N11TG | OE234 |
| PZFR5Q11 | OE176 |
| PZFR6B | OE227 |
| PZFR6F | OE184 |
| PZFR6F | OE188 |
| PZFR6F11 | OE188 |
| PZFR6J11 | OE176 |
| PZFR6R | OE213 |
| PZKER7A8EGS | OE244 |
| R0179 | OE122 |
| R4118S8 | OE108 |
| R4118S9 | OE091 |

| NGK | CHAMPION |
|-------------|----------|
| R4118S9S | OE091 |
| R5672A8 | OE087 |
| R6021E8 | OE108 |
| R6021E9 | OE091 |
| R6021E9S | OE091 |
| R6252E9 | OE091 |
| R6918B8 | OE108 |
| R737610 | OE091 |
| SIFR6A11 | OE179 |
| SILTR6A7G | OE189 |
| SILZKBR8C8S | OE243 |
| SILZKBR8D8S | OE243 |
| SILZKGR8B8S | OE245 |
| T40227C-G08 | OE260 |
| TR4 | OE011 |
| TR55 | OE011 |
| TR55IX | OE183 |
| TR55VX | OE131 |
| TR5A10 | OE031 |
| TR5B | OE031 |
| TR5B13 | OE031 |
| TR5F13 | OE031 |
| TR5IX | OE183 |
| TR6AP13 | OE131 |
| TR6AP13 | OE183 |
| TR6AP13E | OE131 |
| TR6B10 | OE031 |
| UR4 | RV15YC4 |
| V29 | OE120 |
| V31 | OE120 |
| V32 | OE005 |
| V-Line 1 | OE025 |
| V-Line 10 | OE048 |
| V-Line 11 | OE039 |
| V-Line 12 | OE005 |
| V-Line 13 | OE048 |
| V-Line 14 | OE039 |
| V-Line 15 | OE004 |
| V-Line 16 | OE057 |
| V-Line 18 | OE038 |
| V-Line 19 | OE018 |
| V-Line 2 | OE006 |
| V-Line 20 | OE026 |
| V-Line 21 | OE027 |
| V-Line 22 | OE027 |
| V-Line 23 | OE019 |
| V-Line 24 | OE032 |
| V-Line 25 | OE029 |
| V-Line 26 | OE026 |
| V-Line 27 | OE032 |
| V-Line 28 | OE005 |
| V-Line 29 | OE123 |
| V-Line 3 | OE064 |





| NGK | CHAMPION |
|-------------|----------|
| V-Line 30 | OE223 |
| V-Line 31 | OE011 |
| V-Line 32 | OE005 |
| V-Line 33 | OE039 |
| V-Line 34 | OE176 |
| V-Line 35 | OE005 |
| V-Line 36 | OE005 |
| V-Line 37 | OE136 |
| V-Line 38 | OE033 |
| V-Line 39 | OE063 |
| V-Line 4 | OE001 |
| V-Line 5 | OE009 |
| V-Line 52 | OE213 |
| V-Line 7 | OE011 |
| V-Line 8 | OE015 |
| V-Line 9 | OE044 |
| ZFR4F11 | OE154 |
| ZFR5A11 | OE154 |
| ZFR5E11 | OE089 |
| ZFR5E11 | OE154 |
| ZFR5F | OE128 |
| ZFR5F | OE198 |
| ZFR5F11 | OE089 |
| ZFR5F11 | OE154 |
| ZFR5F11VP4 | OE154 |
| ZFR5FIX11 | OE194 |
| ZFR5J | OE154 |
| ZFR5J11 | OE089 |
| ZFR5J11 | OE154 |
| ZFR5P11 | OE177 |
| ZFR5PG | OE177 |
| ZFR6A11 | OE089 |
| ZFR6BP-G | OE188 |
| ZFR6F-11 | OE089 |
| ZFR6F11G | OE089 |
| ZFR6F11VP4 | OE089 |
| ZFR6FIX11 | OE188 |
| ZFR6FR | OE026 |
| ZFR6J | OE089 |
| ZFR6J11 | OE089 |
| ZFR6K | OE089 |
| ZFR6K11 | OE089 |
| ZFR6T11G | OE177 |
| ZFR6U11 | OE089 |
| ZFR6VG | OE198 |
| ZFR7F11 | OE089 |
| ZGR5A | OE004 |
| ZGR5AVG6 | OE004 |
| ZGR5B | OE004 |
| ZGR5BVG4 | OE004 |
| ZKER6A-10EG | OE247 |
| ZKR7A | OE196 |
| ZKR7A10 | OE196 |

| NGK | CHAMPION |
|----------|----------|
| ZKR7B10 | OE196 |
| NHSP LD | CHAMPION |
| D7 | OE083 |
| EST | OE059 |
| E6C | OE037 |
| F5RTC | OE042 |
| F6REC4 | OE051 |
| F6RTC | OE051 |
| F6TC | OE065 |
| F6TJC | OE044 |
| F7TC | OE001 |
| F7TJC | OE012 |
| F9TC | OE087 |
| FEREPP | OE004 |
| G6 | J8C |
| K6EPPOR | OE191 |
| K6RKCCX | OE154 |
| K6RKDC | OE019 |
| K6RLCX | OE093 |
| K6RZC | OE114 |
| K6TC | OE003 |
| K7RLC | OE093 |
| K7RTC | OE005 |
| K7RTCX | OE039 |
| K7RTDC | OE026 |
| K7TC | OE003 |
| K7TJC | OE032 |
| K7YKJCR | OE120 |
| K7YRKDC | OE120 |
| K8RTJC | OE077 |
| KH6RK3 | OE148 |
| Q7TC | OE009 |
| PAL | CHAMPION |
| D 14 Y | OE014 |
| D 14 YC | OE014 |
| D 17 Y | OE057 |
| D 17 YC | OE057 |
| DR 14 YC | OE014 |
| DR 15 TC | OE145 |
| DR 15 YC | OE005 |
| DR 17 YC | OE005 |
| G 15 Y | OE009 |
| G 15 YC | OE009 |
| G 17 Y | OE009 |
| G 17 YC | OE009 |
| GR 15 YC | OE009 |
| L 12 Y | OE087 |
| L 12 YC | OE087 |
| L 14 Y | OE010 |
| L 14 YC | OE010 |
| L 15 | OE074 |

| PAL | CHAMPION |
|---------------------|----------|
| L 15 C | OE074 |
| L 15 Y | OE001 |
| L 15 YC | OE001 |
| L 17 | OE074 |
| L 17 C | OE074 |
| L 17 Y | OE015 |
| L 17 YC | OE001 |
| L 19 C | OE074 |
| L 5 Y | OE001 |
| L 7 Y | OE015 |
| L 8 | OE074 |
| L 8 Y | OE087 |
| LR 14 YC | OE018 |
| LR 15 YC | OE006 |
| N 12 Y | OE038 |
| N 12 YC | OE038 |
| N 14 | L82C |
| N 14 C | L82C |
| N 15 | L82C |
| N 15 C | L82C |
| N 15 Y | OE038 |
| N 15 YC | OE038 |
| N 17 | L82C |
| N 17 C | L82C |
| N 17 Y | OE038 |
| N 17 YC | OE038 |
| N 7 | L82C |
| N 7 Y | OE038 |
| N 8 | L82C |
| N 8 Y | OE038 |
| NR 15 YC | OE064 |
| Super.G7Y | OE009 |
| Super.L7Y | OE065 |
| Super.N7 | OE037 |
| Super.N8 | L82C |
| PRESTOLITE ELECTRIC | CHAMPION |
| 12G2 | OE083 |
| 12G3 | OE083 |
| 14 E 22 | OE038 |
| 14 E 4 | L82C |
| 14 E 42 | OE038 |
| 14 G 2 | OE074 |
| 14 G 22 | OE010 |
| 14 G 32 | OE001 |
| 14 G 42 | OE015 |
| 14 G 52 | OE015 |
| 1400 | L82C |
| 140000 | OE037 |
| 14-4 | J8C |
| 14-5 | J8C |
| 14-7 | J8C |
| 14-7X | J8C |

| PRESTOLITE ELECTRIC | CHAMPION |
|---------------------|----------|
| 14E1 | L78C |
| 14F42 | RV15YC4 |
| 14F52 | RV15YC4 |
| 14G1 | OE068 |
| 14G12 | OE087 |
| 14G2 | OE079 |
| 14G22 | OE001 |
| 14G3 | OE074 |
| 14G32 | OE065 |
| 14G4 | OE074 |
| 14G5 | OE074 |
| 14G7 | OE074 |
| 14GR32 | OE049 |
| 14GR42 | OE042 |
| 14RF42 | RV15YC4 |
| 18 F 82 | OE054 |
| ROTAX | CHAMPION |
| 297 310 | L82C |
| 899 121 | L78C |
| 999 190 | L78C |
| 999 370 | L82C |
| SABO | CHAMPION |
| M802138 | OE051 |
| SAU11692 | OE013 |
| SACHS | CHAMPION |
| 0 265 156 004 | L78C |
| 0 265 156 015 | L78C |
| 0 298 087 002 | L82C |
| 0 298 087 003 | L82C |
| 0 298 087 006 | L82C |
| 0 298 087 008 | L78C |
| 0 298 087 009 | L78C |
| 0 298 087 011 | L78C |
| 0 298 087 012 | L78C |
| 0 965 155 000 | L82C |
| 0 998 004 000 | L82C |
| 0 998 004 001 | L82C |
| 2 765 045 000 | OE038 |
| 2 865 022 002 | OE038 |
| 80 480 305 | L82C |
| SAGEM | CHAMPION |
| 75806 | OE216 |
| RC 42 S | OE064 |
| RC 52 LJS | OE011 |
| RC 52 LJS 5 | OE011 |
| RC 62 HJSDP | OE029 |
| RC 62 LJS | OE011 |
| RC 72 LS | OE018 |
| RC 72 LS 5 | OE018 |
| RC 82 LS | OE087 |

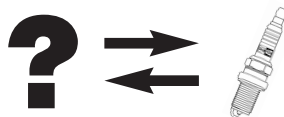

| SAGEM | | |
|--------------------|-------|--|
| RFC 82 LS | OE094 | |
| RFN 52 HZ | OE148 | |
| RFN 58 HZ | OE035 | |
| SEV-MARCHAL | | |
| 34 S | L78C | |
| 34HS | OE068 | |
| 34S | L82C | |
| 35 | L78C | |
| 35 B | L82C | |
| 35 S | L78C | |
| 35/1 | OE038 | |
| 35/1 B | OE038 | |
| 35/36 | OE038 | |
| 35/36 R | OE038 | |
| 36 | OE037 | |
| 36 B | L82C | |
| 36 HS | OE074 | |
| 37 S | L82C | |
| 4 N | L78C | |
| 4N | L82C | |
| 5 N | OE038 | |
| 5H | OE068 | |
| 5HA | OE001 | |
| 6 H | OE087 | |
| 6 N | L82C | |
| 6N | OE037 | |
| 7 H | OE087 | |
| 8 H | OE010 | |
| 9 H | OE001 | |
| 9H | OE001 | |
| GT 34 | OE038 | |
| GT 34 D | OE038 | |
| GT 34 H | OE087 | |
| GT 34 HD | OE087 | |
| GT 34.2 H | OE010 | |
| GT 34.5 | OE038 | |
| GT 34.5 H | OE001 | |
| GT 34.5 HA | OE001 | |
| GT 35 D | OE038 | |
| GT34 | OE001 | |
| GT35H | OE001 | |
| SOGEDAC | | |
| CC10 | OE009 | |
| CF10 | OE014 | |
| CP10 | OE001 | |
| XC10 | OE009 | |
| XP10 | OE001 | |
| XP4 | OE087 | |
| XPC7 | OE037 | |
| SPLITFIRE | | |
| SF265F | OE037 | |

| SPLITFIRE | | |
|------------------|---------|--|
| SF29E | J8C | |
| SF405D | OE068 | |
| SF405F | OE079 | |
| SF409B | L78C | |
| SF409C | L82C | |
| SF415B | OE073 | |
| SF415C | OE083 | |
| SF416B | OE073 | |
| SF425C | OE001 | |
| SF5C | OE001 | |
| SM29E | J8C | |
| SM2E | RV15YC4 | |
| SM40D | OE098 | |
| SM6E | OE042 | |
| STITT | | |
| 407L | OE086 | |
| 407XL | OE039 | |
| R407XL | OE039 | |
| TORCH | | |
| 8008 | OE042 | |
| 8010 | OE018 | |
| 8012 | OE011 | |
| 9007 | OE042 | |
| 9009 | OE018 | |
| D7C | OE083 | |
| D7CA | OE083 | |
| D7RC | OE083 | |
| D8C | OE073 | |
| D8RC | OE083 | |
| D8RTC | OE083 | |
| D8RTC-9 | OE083 | |
| D8TC | OE083 | |
| DK7RTC | OE083 | |
| DK8RTC | OE083 | |
| E5C | OE037 | |
| E5P | OE037 | |
| E7C | L82C | |
| E7RC | OE086 | |
| E8C | L78C | |
| E8RC | L78C | |
| E8RTC | L78C | |
| E8TC | L78C | |
| F4RF | OE042 | |
| F4RTC | OE042 | |
| F5C | OE074 | |
| F5RF | OE049 | |
| F5RF-11 | OE049 | |
| F5RTC | OE042 | |
| F6C | OE079 | |
| F6RC | OE098 | |
| F6RD | OE018 | |

| TORCH | | |
|--------------|---------|--|
| F6RDY | OE027 | |
| F6TC-11 | OE048 | |
| F6TJC | OE044 | |
| F6TP | OE001 | |
| F7RC | OE108 | |
| F7RTC | OE018 | |
| F7RTJC | OE018 | |
| F7TC | OE018 | |
| F7TJC | OE018 | |
| F8C | OE098 | |
| F8RC | OE098 | |
| F8RP | OE098 | |
| F8RTC | OE087 | |
| F8TC | OE087 | |
| F9RC | OE091 | |
| G6C | J8C | |
| K4RTC | OE013 | |
| K4RTC-11 | OE013 | |
| K4RTC3 | OE013 | |
| K4RTV | OE013 | |
| K5RD | OE019 | |
| K5RDY | OE013 | |
| K5RF-11 | OE013 | |
| K5RJY | OE120 | |
| K5RTC | OE013 | |
| K5RTC-11 | OE013 | |
| K5RTJY | OE013 | |
| K5TC | OE013 | |
| K6RD | OE026 | |
| K6RDY | OE026 | |
| K6RF-11 | OE039 | |
| K6RJY | OE120 | |
| K6RJY-10 | OE120 | |
| K6RTC | OE014 | |
| K6RTC-11 | OE039 | |
| K6RTJC | OE039 | |
| K6RTJY | OE032 | |
| K6RTMIP | OE190 | |
| K6RTP | OE191 | |
| K6RTP-11 | OE191 | |
| K6TC | OE003 | |
| K6TC-11 | OE003 | |
| K6TJC | OE003 | |
| K6TP | OE145 | |
| K6TP-11 | OE145 | |
| K7RF | OE014 | |
| K7RJY | OE032 | |
| K7RTC | OE039 | |
| K7RTJC | OE032 | |
| K7RTP | OE136 | |
| K7RTPF | OE136 | |
| K7TC | OE039 | |
| P4RTV | RV15YC4 | |

| TORCH | | |
|----------------|---------|--|
| P5RTP | RV15YC4 | |
| P5RTP-11 | RV15YC4 | |
| Q6RTC | OE011 | |
| Q6TC | OE011 | |
| Q7RC | OE011 | |
| T7TC | OE054 | |
| UNIPART | | |
| GSP 4154 | OE054 | |
| GSP 4352 | OE010 | |
| GSP 4356 | OE038 | |
| GSP 4362 | OE001 | |
| GSP 4366 | OE038 | |
| GSP 4382 | OE015 | |
| GSP 4462 | OE006 | |
| GSP 4652 | OE014 | |
| GSP 4662 | OE005 | |
| GSP 5658 | OE039 | |
| GSP 634 | OE039 | |
| GSP 664 | OE005 | |
| GSP 6662 | OE005 | |
| GSP 684 | OE014 | |
| GSP 685 | OE014 | |
| GSP 7664 | OE089 | |
| GSP 9652 | OE188 | |
| GSP130 | OE074 | |
| GSP131 | OE065 | |
| GSP141 | OE065 | |
| GSP151 | OE001 | |
| GSP160 | OE079 | |
| GSP163 | OE001 | |
| GSP171 | OE001 | |
| GSP191 | OE087 | |
| GSP2001 | OE002 | |
| GSP2003 | OE005 | |
| GSP2005 | OE039 | |
| GSP2006 | OE011 | |
| GSP2010 | OE012 | |
| GSP2011 | OE029 | |
| GSP2013 | OE004 | |
| GSP2015 | OE013 | |
| GSP2017 | OE019 | |
| GSP2018 | OE019 | |
| GSP2021 | OE054 | |
| GSP2023 | OE014 | |
| GSP2024 | OE087 | |
| GSP2025 | OE013 | |
| GSP2027 | OE011 | |
| GSP2028 | OE016 | |
| GSP2031 | OE044 | |
| GSP2032 | OE037 | |
| GSP2035 | OE003 | |
| GSP2036 | OE018 | |



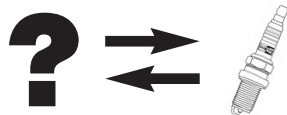

| UNIPART | CHAMPION | UNIPART | CHAMPION | VALEO | CHAMPION |
|---------|----------|--------------|----------|-------------|----------|
| GSP2038 | OE027 | GSP4342 | OE087 | 76H | OE001 |
| GSP2039 | OE049 | GSP4347 | OE012 | 76Hb | OE001 |
| GSP2040 | OE099 | GSP4357 | OE012 | 7H | OE087 |
| GSP2041 | OE120 | GSP4362 | OE001 | 84H | OE001 |
| GSP2044 | OE136 | GSP4367 | OE044 | 84Hb | OE001 |
| GSP2045 | OE013 | GSP4372 | OE065 | 8H | OE001 |
| GSP2046 | OE079 | GSP4376 | OE059 | 90 H | OE001 |
| GSP2048 | OE032 | GSP4452 | OE018 | 9H | OE065 |
| GSP2049 | OE037 | GSP44623 | OE027 | C 72 H | OE009 |
| GSP2050 | L82C | GSP4472 | OE051 | C68H | OE009 |
| GSP2051 | OE091 | GSP4482 | OE042 | C68Hb | OE009 |
| GSP2053 | OE026 | GSP4547 | OE094 | F 72 H | OE014 |
| GSP2055 | OE136 | GSP4562 | OE003 | F 72 H3E | OE094 |
| GSP2059 | OE120 | GSP4563 | OE009 | F 74 H | OE014 |
| GSP2065 | OE059 | GSP4573 | OE099 | F 80 H | OE014 |
| GSP2066 | OE030 | GSP461 | OE011 | F 82 H | OE003 |
| GSP2070 | OE030 | GSP4642 | OE094 | F 82 H | OE057 |
| GSP2071 | OE041 | GSP4652 | OE014 | F68H3 | OE094 |
| GSP2073 | OE120 | GSP46522 | OE026 | F80H | OE003 |
| GSP2074 | OE004 | GSP46523 | OE032 | F80Hb | OE003 |
| GSP2085 | OE014 | GSP4662 | OE005 | GC 68 N | OE054 |
| GSP2087 | OE039 | GSP46622 | OE019 | R 64 H | OE087 |
| GSP2090 | OE108 | GSP4663 | OE011 | R 70 H | OE018 |
| GSP2094 | OE099 | GSP531 | OE059 | R 70 H11 | OE018 |
| GSP2098 | OE001 | GSP540 | OE037 | R 76 H | OE006 |
| GSP2099 | OE065 | GSP550 | OE037 | R 76 H11 | OE048 |
| GSP2100 | OE003 | GSP560 | L82C | R 84 H11 | OE049 |
| GSP2101 | OE009 | GSP6382 | OE065 | R 88 N | OE064 |
| GSP2102 | OE009 | GSP6452 | OE008 | R76H11 | OE048 |
| GSP2103 | OE003 | GSP6462 | OE004 | RC 68 LPP | OE029 |
| GSP2106 | OE031 | GSP65721 | OE057 | RC 72 H | OE011 |
| GSP2108 | OE196 | GSP664 | OE013 | RC 72 H11 | OE011 |
| GSP2110 | OE013 | GSP665 | OE003 | RF 74 H | OE014 |
| GSP2112 | OE013 | GSP6651 | OE031 | RF 80 H | OE005 |
| GSP2114 | OE063 | GSP6652 | OE014 | RF 82 H | OE005 |
| GSP2115 | OE011 | GSP66527 | OE146 | RF74H | OE014 |
| GSP2116 | OE014 | GSP6658 | OE014 | RF74HZDC | OE034 |
| GSP2120 | OE011 | GSP6662 | OE002 | RF74LZD | OE178 |
| GSP2121 | OE099 | GSP6663 | OE011 | RF80H | OE005 |
| GSP2136 | OE120 | GSP684 | OE014 | RF82HZ2Y | OE019 |
| GSP2137 | OE035 | GSP9652 | OE136 | | |
| GSP2138 | OE035 | GSP981 | OE054 | | |
| GSP2149 | OE177 | | | YURA | CHAMPION |
| GSP2151 | OE187 | VALEO | CHAMPION | ELR11ISPC8+ | OE248 |
| GSP281 | OE018 | 246176 | OE005 | ELR9IQP9+ | OE249 |
| GSP30 | J8C | 246327 | OE048 | ELR9ISP8+ | OE250 |
| GSP331 | OE099 | 246487 | OE034 | ELR9QC10 | OE201 |
| GSP351 | OE099 | 246490 | OE019 | ELR9QC8 | OE201 |
| GSP361 | OE009 | 4N | L82C | | |
| GSP381 | OE011 | 64H | OE087 | | |
| GSP4154 | OE054 | 64Hb | OE087 | | |
| GSP4256 | L82C | 67HP | OE078 | | |
| GSP4266 | OE037 | 6N | OE037 | | |

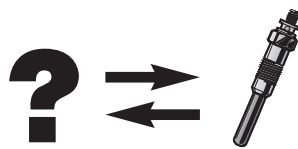

| ACDELCO | | |
|-------------------|-------|--|
| 102G | CH181 | |
| 103G | CH215 | |
| 104G | CH219 | |
| 106G | CH205 | |
| 109G | CH203 | |
| 110G | CH271 | |
| 114G | CH175 | |
| 116G | CH189 | |
| 117G | CH185 | |
| 118G | CH177 | |
| 120G | CH189 | |
| 128G | CH260 | |
| 138G | CH167 | |
| 148G | CH176 | |
| 149G | CH189 | |
| 230G | CH189 | |
| 239G | CH189 | |
| 241G | CH189 | |
| 242G | CH189 | |
| 243G | CH147 | |
| 244G | CH189 | |
| 245G | CH147 | |
| 246G | CH189 | |
| 247G | CH173 | |
| 28G | CH260 | |
| 30G | CH189 | |
| 500 GG/93893040 | CH260 | |
| 501 E | CH233 | |
| 503 E | CH216 | |
| 503 GG/93893043 | CH189 | |
| 507 GG/93893047 | CH189 | |
| 508 GG/93893048 | CH260 | |
| 51 GG/93893052 | CH189 | |
| 511 GG/93893051 | CH189 | |
| 518 GG/93893058 | CH221 | |
| 521 GG/93893061 | CH154 | |
| 522 GG/93893062 | CH260 | |
| 525 GG/93893065 | CH189 | |
| 526 GG/93893066 | CH189 | |
| 527 GG/93893067 | CH260 | |
| ASHIKA | | |
| B 120 | CH234 | |
| B065 | CH189 | |
| B071 | CH189 | |
| B081 | CH189 | |
| CP 72 | CH230 | |
| PM 168 | CH263 | |
| PN 139 | CH186 | |
| AUTO DELTA | | |
| GP2003/1 | CH189 | |
| GP4162 | CH158 | |

| AUTOLITE | | |
|-----------------|---------|--|
| 1101 | CH260 | |
| 1103 | CH189 | |
| 1104 | CH260 | |
| 1116 | CH271 | |
| BERU | | |
| 0 100 266 046 | CH704 | |
| 0 103 010 101 | CP5G004 | |
| 0 103 010 103 | CP5G004 | |
| 0 103 010 904 | CP5G006 | |
| 0 103 010 906 | CP5G006 | |
| 0 103 110 903 | CP5G003 | |
| 0 103 110 905 | CP5G003 | |
| 105MJ | CH189 | |
| 105MN | CH189 | |
| 141M | CH260 | |
| 141MJ | CH260 | |
| 151MJ | CH189 | |
| 161MJ | CH189 | |
| 162MJ | CH260 | |
| 276 010 | CH224 | |
| 601MJ | CH260 | |
| 602MJ | CH189 | |
| 603MJ | CH189 | |
| 604MJ | CH189 | |
| 605MJ | CH260 | |
| 607MJ | CH189 | |
| 609MJ | CH189 | |
| 613MJ | CH189 | |
| 633MJ | CH189 | |
| 636MJ | CH189 | |
| 642MJ | CH189 | |
| 651MJ | CH189 | |
| 661MJ | CH147 | |
| 663MJ | CH189 | |
| 666MJ | CH147 | |
| 673MJ | CH221 | |
| 687MJ | CH260 | |
| 688MJ | CH154 | |
| 689MJ | CH260 | |
| 691MJ | CH189 | |
| 719MJ | CH189 | |
| 724MJ | CH189 | |
| 727MJ | CH189 | |
| 783MJ | CH178 | |
| 798MJ | CH189 | |
| 844MJ | CH260 | |
| 852MJ | CH173 | |
| 853MJ | CH186 | |
| 854MJ | CH186 | |
| 855MJ | CH271 | |
| 857MJ | CH260 | |
| 858MJ | CH176 | |

| BERU | | |
|-------------|---------|--|
| 8631607 | CH240 | |
| 897MJ | CH302 | |
| 905MJ | CH169 | |
| 908MJ | CH189 | |
| 909MJ | CH189 | |
| 912MJ | CH185 | |
| 917MJ | CH189 | |
| 921MJ | CH221 | |
| 947MJ | CH158 | |
| 948MJ | CH177 | |
| 950MJ | CH271 | |
| 968MJ | CH154 | |
| 970MJ | CH167 | |
| 999MJ | CH169 | |
| CGP001 | CCGP001 | |
| CGP002 | CCGP002 | |
| CGP003 | CCGP003 | |
| CGP007 | CCGP007 | |
| CGP010 | CCGP010 | |
| GE104 | CH704 | |
| GE116 | CH704 | |
| GN005 | CH242 | |
| GN007 | CH181 | |
| GN008 | CH215 | |
| GN010 | CH219 | |
| GN012 | CH216 | |
| GN013 | CH189 | |
| GN016 | CH185 | |
| GN018 | CH271 | |
| GN019 | CH233 | |
| GN022 | CH205 | |
| GN024 | CH203 | |
| GN025 | CH207 | |
| GN026 | CH232 | |
| GN027 | CH170 | |
| GN030 | CH209 | |
| GN033 | CH231 | |
| GN035 | CH226 | |
| GN037 | CH270 | |
| GN039 | CH186 | |
| GN041 | CH222 | |
| GN043 | CH302 | |
| GN045 | CH240 | |
| GN046 | CH181 | |
| GN054 | CH268 | |
| GN055 | CH180 | |
| GN056 | CH201 | |
| GN057 | CH234 | |
| GN059 | CH224 | |
| GN061 | CH306 | |
| GN070 | CH263 | |
| GN097 | CH269 | |
| GN102 | CH600 | |

| BERU | | |
|-------------|---------|--|
| GN107 | CH256 | |
| GN109 | CH230 | |
| GN110 | CH608 | |
| GN853 | CH186 | |
| GN854 | CH186 | |
| GN855 | CH271 | |
| GN857 | CH260 | |
| GN858 | CH176 | |
| GN860 | CH175 | |
| GN905 | CH169 | |
| GN908 | CH189 | |
| GN909 | CH189 | |
| GN912 | CH185 | |
| GN917 | CH189 | |
| GN927 | CH147 | |
| GN939 | CH229 | |
| GN948 | CH177 | |
| GN954 | CH189 | |
| GN955 | CH225 | |
| GN959 | CH260 | |
| GN961 | CH204 | |
| GN963 | CH217 | |
| GN970 | CH167 | |
| GN985 | CH272 | |
| GN991 | CH206 | |
| GN992 | CH207 | |
| GN993 | CH196 | |
| GN999 | CH169 | |
| GV602 | CH189 | |
| GV603 | CH189 | |
| GV604 | CH260 | |
| GV636 | CH189 | |
| GV642 | CH189 | |
| GV661 | CH147 | |
| GV663 | CH189 | |
| GV666 | CH147 | |
| GV673 | CH221 | |
| GV688 | CH154 | |
| GV689 | CH260 | |
| GV691 | CH189 | |
| GV719 | CH189 | |
| GV724 | CH189 | |
| GV727 | CH189 | |
| GV783 | CH178 | |
| GV798 | CH167 | |
| GV844 | CH260 | |
| GV852 | CH173 | |
| GV897 | CH302 | |
| GV921 | CH221 | |
| GV947 | CH158 | |
| GV967 | CH302 | |
| GV968 | CH154 | |
| PSG003 | CP5G003 | |



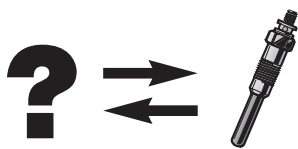

| BERU | |
|-------------|---------|
| PSG004 | CPSG004 |
| PSG006 | CPSG006 |
| PSG007 | CPSG007 |
| PSG008 | CPSG008 |

| BORGWARNER | |
|-------------------|---------|
| E2500033668A2 | CCGP001 |
| E2500033669A2 | CCGP002 |
| E2500033670A2 | CCGP003 |
| E2500033671A2 | CCGP007 |
| E2500043983A2 | CCGP010 |
| E2509671108A1 | CCGP002 |
| E2509671111A1 | CCGP007 |
| E2509671802A1 | CCGP003 |
| E2520026551A1 | CPSG008 |
| E2520028814A1 | CPSG007 |
| E2520033645A2 | CPSG003 |
| E2520033646A2 | CPSG004 |
| E2520033647A2 | CPSG006 |
| E2520033648A2 | CPSG007 |
| E2520033649A2 | CPSG008 |

| BOSCH | |
|---------------|-------|
| 0 250 001 782 | CH268 |
| 0 250 200 052 | CH260 |
| 0 250 200 054 | CH189 |
| 0 250 200 056 | CH189 |
| 0 250 200 057 | CH189 |
| 0 250 200 058 | CH189 |
| 0 250 200 059 | CH189 |
| 0 250 200 060 | CH189 |
| 0 250 200 061 | CH189 |
| 0 250 200 063 | CH260 |
| 0 250 200 064 | CH189 |
| 0 250 200 065 | CH189 |
| 0 250 200 066 | CH189 |
| 0 250 200 068 | CH189 |
| 0 250 200 069 | CH189 |
| 0 250 200 454 | CH189 |
| 0 250 200 456 | CH189 |
| 0 250 200 465 | CH189 |
| 0 250 200 468 | CH189 |
| 0 250 200 469 | CH189 |
| 0 250 201 001 | CH189 |
| 0 250 201 004 | CH260 |
| 0 250 201 005 | CH189 |
| 0 250 201 006 | CH189 |
| 0 250 201 008 | CH189 |
| 0 250 201 009 | CH189 |
| 0 250 201 010 | CH185 |
| 0 250 201 011 | CH260 |
| 0 250 201 015 | CH260 |
| 0 250 201 019 | CH189 |

| BOSCH | |
|---------------|-------|
| 0 250 201 020 | CH185 |
| 0 250 201 021 | CH260 |
| 0 250 201 026 | CH176 |
| 0 250 201 027 | CH189 |
| 0 250 201 029 | CH173 |
| 0 250 201 030 | CH189 |
| 0 250 201 031 | CH260 |
| 0 250 201 032 | CH260 |
| 0 250 201 033 | CH189 |
| 0 250 201 035 | CH175 |
| 0 250 201 036 | CH271 |
| 0 250 201 037 | CH189 |
| 0 250 201 038 | CH177 |
| 0 250 201 039 | CH189 |
| 0 250 201 040 | CH260 |
| 0 250 201 041 | CH176 |
| 0 250 201 042 | CH189 |
| 0 250 201 043 | CH173 |
| 0 250 201 043 | CH189 |
| 0 250 201 045 | CH189 |
| 0 250 201 046 | CH260 |
| 0 250 201 047 | CH176 |
| 0 250 201 048 | CH177 |
| 0 250 201 049 | CH205 |
| 0 250 201 050 | CH260 |
| 0 250 201 053 | CH209 |
| 0 250 201 054 | CH177 |
| 0 250 201 055 | CH176 |
| 0 250 201 405 | CH189 |
| 0 250 201 415 | CH260 |
| 0 250 201 469 | CH189 |
| 0 250 201 927 | CH189 |
| 0 250 201 929 | CH189 |
| 0 250 201 930 | CH260 |
| 0 250 201 932 | CH189 |
| 0 250 201 933 | CH260 |
| 0 250 201 935 | CH173 |
| 0 250 201 936 | CH189 |
| 0 250 201 937 | CH189 |
| 0 250 201 938 | CH260 |
| 0 250 201 940 | CH176 |
| 0 250 201 944 | CH260 |
| 0 250 201 945 | CH189 |
| 0 250 201 946 | CH176 |
| 0 250 201 950 | CH189 |
| 0 250 201 952 | CH189 |
| 0 250 201 953 | CH189 |
| 0 250 201 954 | CH176 |
| 0 250 202 001 | CH147 |
| 0 250 202 002 | CH216 |
| 0 250 202 003 | CH221 |
| 0 250 202 006 | CH154 |
| 0 250 202 009 | CH271 |

| BOSCH | |
|---------------|-------|
| 0 250 202 010 | CH260 |
| 0 250 202 018 | CH147 |
| 0 250 202 019 | CH189 |
| 0 250 202 020 | CH185 |
| 0 250 202 021 | CH206 |
| 0 250 202 022 | CH271 |
| 0 250 202 023 | CH181 |
| 0 250 202 024 | CH206 |
| 0 250 202 025 | CH169 |
| 0 250 202 026 | CH204 |
| 0 250 202 032 | CH170 |
| 0 250 202 033 | CH147 |
| 0 250 202 034 | CH167 |
| 0 250 202 035 | CH217 |
| 0 250 202 036 | CH222 |
| 0 250 202 038 | CH180 |
| 0 250 202 039 | CH207 |
| 0 250 202 040 | CH178 |
| 0 250 202 041 | CH219 |
| 0 250 202 042 | CH207 |
| 0 250 202 043 | CH231 |
| 0 250 202 046 | CH181 |
| 0 250 202 048 | CH268 |
| 0 250 202 052 | CH302 |
| 0 250 202 053 | CH154 |
| 0 250 202 058 | CH302 |
| 0 250 202 060 | CH221 |
| 0 250 202 065 | CH306 |
| 0 250 202 079 | CH302 |
| 0 250 202 087 | CH158 |
| 0 250 202 089 | CH242 |
| 0 250 202 090 | CH242 |
| 0 250 202 092 | CH256 |
| 0 250 202 093 | CH186 |
| 0 250 202 094 | CH221 |
| 0 250 202 095 | CH302 |
| 0 250 202 096 | CH154 |
| 0 250 202 102 | CH215 |
| 0 250 202 103 | CH203 |
| 0 250 202 124 | CH263 |
| 0 250 202 128 | CH232 |
| 0 250 202 129 | CH233 |
| 0 250 202 130 | CH229 |
| 0 250 202 131 | CH196 |
| 0 250 202 132 | CH269 |
| 0 250 202 135 | CH268 |
| 0 250 202 911 | CH271 |
| 0 250 203 001 | CH224 |
| 0 250 203 004 | CH240 |
| 0 250 203 009 | CH270 |
| 0 250 204 002 | CH201 |
| 0 250 212 006 | CH226 |
| 0 250 212 009 | CH271 |

| BOSCH | |
|---------------|---------|
| 0 250 251 471 | CH167 |
| 0 250 312 002 | CH600 |
| 0 250 312 007 | CH256 |
| 0 250 403 001 | CH240 |
| 0 250 603 001 | CCGP007 |
| 80006 | CH189 |
| 80007 | CH189 |
| 80008 | CH189 |
| 80009 | CH176 |
| 80010 | CH260 |
| 80011 | CH175 |
| 80012 | CH271 |
| 80013 | CH177 |
| 80031 | CH176 |
| F 002 G50 048 | CH270 |
| F 005 X04 828 | CH306 |
| F 005 X04 869 | CH600 |
| F 005 X12 978 | CH600 |
| F 005 X12 981 | CH186 |
| F 005 X13 002 | CH302 |
| GLP001 | CH189 |
| GLP002 | CH260 |
| GLP003 | CH271 |
| GLP004 | CH185 |
| GLP005 | CH189 |
| GLP006 | CH176 |
| GLP007 | CH222 |
| GLP009 | CH217 |
| GLP010 | CH147 |
| GLP011 | CH233 |
| GLP012 | CH205 |
| GLP013 | CH170 |
| GLP014 | CH169 |
| GLP015 | CH189 |
| GLP017 | CH177 |
| GLP019 | CH207 |
| GLP020 | CH206 |
| GLP023 | CH181 |
| GLP024 | CH196 |
| GLP025 | CH175 |
| GLP026 | CH167 |
| GLP030 | CH231 |
| GLP031 | CH215 |
| GLP034 | CH221 |
| GLP036 | CH260 |
| GLP038 | CH242 |
| GLP039 | CH256 |
| GLP040 | CH203 |
| GLP041 | CH216 |
| GLP042 | CH154 |
| GLP043 | CH224 |
| GLP045 | CH209 |
| GLP046 | CH158 |

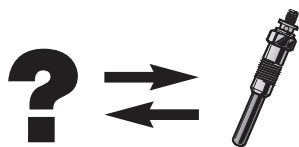

| BOSCH | |
|--------------|---------|
| GLP048 | CH178 |
| GLP049 | CH186 |
| GLP051 | CH229 |
| GLP054 | CH256 |
| GLP055 | CH268 |
| GLP057 | CH232 |
| GLP058 | CH189 |
| GLP066 | CH269 |
| GLP073 | CH271 |
| GLP074 | CH302 |
| GLP086 | CH260 |
| GLP089 | CH189 |
| GLP094 | CH201 |
| GLP102 | CH219 |
| GLP103 | CH306 |
| GLP105 | CH600 |
| GLP109 | CH180 |
| GLP111 | CH268 |
| GLP112 | CH271 |
| GLP113 | CH170 |
| GLP115 | CH240 |
| GLP137 | CH263 |
| GLP142 | CH302 |
| GLP144 | CH240 |
| GLP154 | CCGP007 |
| GLP156 | CH242 |
| GLP158 | CH176 |
| GLP203 | CH226 |
| GLP205 | CH270 |
| GLP224 | CH271 |
| BRISK | |
| 01R447E | CH158 |
| 01S355E | CH271 |
| 01S405E | CH169 |
| 01S412E | CH185 |
| 01S439E | CH229 |
| 01S492E | CH207 |
| 01S507E | CH181 |
| 01S508E | CH215 |
| 01S510E | CH219 |
| 01S512E | CH216 |
| 01S527E | CH170 |
| 01S533E | CH231 |
| 01S541E | CH222 |
| 11R173E | CH221 |
| 11R421E | CH221 |
| 11R468E | CH154 |
| 11S505E | CH242 |
| 11S543E | CH302 |
| 21R136E | CH189 |
| 21R21 | CH189 |
| 21R352E | CH173 |

| BRISK | |
|-----------------|-------|
| 21S357E | CH260 |
| 21S358E | CH176 |
| 21S427E | CH147 |
| 21S448E | CH177 |
| 21S461E | CH204 |
| 21S522E | CH205 |
| CHAMPION | |
| AG60 | CH260 |
| CH103 | CH154 |
| CH133 | CH302 |
| CH133/002 | CH302 |
| CH137 | CH189 |
| CH137/077 | CH189 |
| CH137/181 | CH189 |
| CH137/C02 | CH189 |
| CH147/002 | CH147 |
| CH147/C02 | CH147 |
| CH147Y/002 | CH147 |
| CH154/002 | CH154 |
| CH155 | CH173 |
| CH155/002 | CH173 |
| CH156 | CH176 |
| CH158/002 | CH158 |
| CH159 | CH189 |
| CH159/282 | CH189 |
| CH160 | CH260 |
| CH160/077 | CH260 |
| CH160/272 | CH260 |
| CH160/C02 | CH260 |
| CH162 | CH221 |
| CH162/002 | CH221 |
| CH163 | CH189 |
| CH163/077 | CH189 |
| CH163/C02 | CH189 |
| CH163F/002 | CH189 |
| CH163Y/002 | CH189 |
| CH164 | CH189 |
| CH164/002 | CH189 |
| CH167/002 | CH167 |
| CH167Y/002 | CH167 |
| CH168 | CH185 |
| CH168/002 | CH185 |
| CH168/077 | CH185 |
| CH168/C02 | CH185 |
| CH168F/002 | CH185 |
| CH168Y/002 | CH185 |
| CH169/002 | CH169 |
| CH169/272 | CH169 |
| CH169/C02 | CH169 |
| CH169Y/002 | CH169 |
| CH170/002 | CH170 |
| CH170Y/002 | CH170 |

| CHAMPION | |
|-----------------|-------|
| CH171 | CH271 |
| CH171/272 | CH271 |
| CH172 | CH169 |
| CH172Y/002 | CH169 |
| CH173/002 | CH173 |
| CH173/102 | CH173 |
| CH173/282 | CH173 |
| CH173/C02 | CH173 |
| CH173Y/002 | CH173 |
| CH174 | CH189 |
| CH175/002 | CH175 |
| CH176/002 | CH176 |
| CH176/102 | CH176 |
| CH177/002 | CH177 |
| CH178/002 | CH178 |
| CH179 | CH260 |
| CH179/077 | CH260 |
| CH179/C02 | CH260 |
| CH179Y/002 | CH260 |
| CH180/002 | CH180 |
| CH181/002 | CH181 |
| CH181Y/002 | CH181 |
| CH184 | CH271 |
| CH184Y/002 | CH271 |
| CH185/002 | CH185 |
| CH185F/002 | CH185 |
| CH185Y/002 | CH185 |
| CH186/002 | CH186 |
| CH187 | CH186 |
| CH187/002 | CH186 |
| CH189/102 | CH189 |
| CH189/C02 | CH189 |
| CH196/002 | CH196 |
| CH196Y/002 | CH196 |
| CH201/002 | CH201 |
| CH203/002 | CH203 |
| CH204/002 | CH204 |
| CH205/002 | CH205 |
| CH206/002 | CH206 |
| CH206Y/002 | CH206 |
| CH207/002 | CH207 |
| CH209/002 | CH209 |
| CH215/002 | CH215 |
| CH216/002 | CH216 |
| CH217/002 | CH217 |
| CH217Y/002 | CH217 |
| CH219/002 | CH219 |
| CH219Y/002 | CH219 |
| CH221/002 | CH221 |
| CH222/002 | CH222 |
| CH222Y/002 | CH222 |
| CH224/002 | CH224 |
| CH225/002 | CH225 |

| CHAMPION | |
|-----------------|-------|
| CH226/002 | CH226 |
| CH229/002 | CH229 |
| CH230/002 | CH230 |
| CH231/002 | CH231 |
| CH232/002 | CH232 |
| CH232Y/002 | CH232 |
| CH233/002 | CH233 |
| CH233Y/002 | CH233 |
| CH234/002 | CH234 |
| CH240/002 | CH240 |
| CH242/002 | CH242 |
| CH256/002 | CH256 |
| CH260/002 | CH260 |
| CH263/002 | CH263 |
| CH268/002 | CH268 |
| CH269/002 | CH269 |
| CH270/002 | CH270 |
| CH271/102 | CH271 |
| CH271Y/002 | CH271 |
| CH272/002 | CH272 |
| CH302/002 | CH302 |
| CH306/002 | CH306 |
| CH60 | CH260 |
| CH600/002 | CH600 |
| CH608/002 | CH608 |
| CH614/002 | CH242 |
| CH63 | CH189 |
| CH63Y/002 | CH189 |
| CH68 | CH189 |
| CH68Y/002 | CH189 |
| CH69 | CH260 |
| CH704/002 | CH704 |
| CH87 | CH189 |
| CH88 | CH189 |
| CH94 | CH221 |
| DELPHI | |
| D 1 | CH189 |
| D 10 | CH260 |
| D 11 | CH205 |
| D 12 | CH147 |
| D 13 | CH271 |
| D 14 | CH169 |
| D 15 | CH271 |
| D 16 | CH176 |
| D 17 | CH207 |
| D 18 | CH167 |
| D 2 | CH173 |
| D 21 | CH177 |
| D 22 | CH181 |
| D 24 | CH196 |
| D 25 | CH158 |
| D 26 | CH175 |

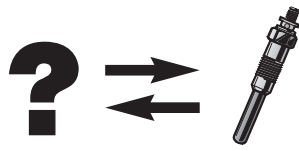

| DELPHI | | CHAMPION | | DENSO | | CHAMPION | | DENSO | | CHAMPION | |
|---------|-------|--------------|-----------------|-------------|-------|----------|-------|-------|--|----------|--|
| D 27 | CH170 | HDS342 | CH271 | 067100-1270 | CH154 | DG 180 | CH201 | | | | |
| D 28 | CH204 | HDS343 | CH260 | 067100-1330 | CH302 | DG 181 | CH268 | | | | |
| D 29 | CH232 | HDS346 | CH158 | 067100-1591 | CH306 | DG 182 | CH272 | | | | |
| D 3 | CH260 | HDS347 | CH173 | 067100-1630 | CH154 | DG 189 | CH234 | | | | |
| D 31 | CH222 | HDS348 | CH189 | 067100-1690 | CH302 | DG 192 | CH704 | | | | |
| D 33 | CH215 | HDS349 | CH189 | 067100-1710 | CH154 | DG 195 | CH270 | | | | |
| D 34 | CH209 | HDS350 | CH185 | 067100-1840 | CH154 | DG 196 | CH269 | | | | |
| D 36 | CH203 | HDS351 | CH189 | 067100-1841 | CH154 | DG 198 | CH221 | | | | |
| D 37 | CH229 | HDS352 | CH176 | 067100-1860 | CH302 | DG 211 | CH154 | | | | |
| D 39 | CH219 | HDS353 | CH189 | 067100-1861 | CH302 | DG 212 | CH154 | | | | |
| D 4 | CH189 | HDS354 | CH177 | DG 001 | CH189 | DG 214 | CH302 | | | | |
| D 40 | CH216 | HDS355 | CH169 | DG 002 | CH260 | DG 216 | CH302 | | | | |
| D 5 | CH233 | HDS356 | CH167 | DG 003 | CH185 | DG 218 | CH154 | | | | |
| D 6 | CH185 | HDS358 | CH186 | DG 004 | CH147 | DG 221 | CH154 | | | | |
| D 7 | CH217 | HDS359 | CH186 | DG 005 | CH271 | DG 232 | CH302 | | | | |
| D 8 | CH206 | HDS360 | CH207 | DG 006 | CH173 | DG 301 | CH256 | | | | |
| D 9 | CH169 | HDS361 | CH181 | DG 007 | CH205 | DG 304 | CH600 | | | | |
| HDS 360 | CH207 | HDS362 | CH205 | DG 008 | CH217 | DG 305 | CH608 | | | | |
| HDS 367 | CH170 | HDS363 | CH175 | DG 009 | CH206 | DG001 | CH189 | | | | |
| HDS 392 | CH263 | HDS366 | CH206 | DG 010 | CH176 | DG002 | CH260 | | | | |
| HDS 400 | CH306 | HDS367 | CH170 | DG 012 | CH260 | DG003 | CH185 | | | | |
| HDS 401 | CH600 | HDS368 | CH271 | DG 101 | CH169 | DG004 | CH147 | | | | |
| HDS 403 | CH256 | HDS369 | CH185 | DG 102 | CH167 | DG005 | CH271 | | | | |
| HDS 404 | CH240 | HDS370 | CH169 | DG 103 | CH260 | DG006 | CH173 | | | | |
| HDS 409 | CH224 | HDS371 | CH189 | DG 104 | CH158 | DG007 | CH205 | | | | |
| HDS 420 | CH234 | HDS372 | CH203 | DG 105 | CH221 | DG008 | CH217 | | | | |
| HDS211 | CH189 | HDS373 | CH204 | DG 106 | CH177 | DG009 | CH206 | | | | |
| HDS216 | CH189 | HDS374 | CH215 | DG 108 | CH306 | DG010 | CH176 | | | | |
| HDS217 | CH260 | HDS375 | CH216 | DG 109 | CH181 | DG012 | CH260 | | | | |
| HDS218 | CH189 | HDS376 | CH217 | DG 110 | CH204 | DG101 | CH169 | | | | |
| HDS221 | CH189 | HDS378 | CH219 | DG 111 | CH216 | DG102 | CH167 | | | | |
| HDS222 | CH260 | HDS379 | CH196 | DG 112 | CH233 | DG103 | CH260 | | | | |
| HDS229 | CH173 | HDS380 | CH209 | DG 115 | CH178 | DG104 | CH158 | | | | |
| HDS232 | CH221 | HDS382 | CH222 | DG 116 | CH170 | DG105 | CH221 | | | | |
| HDS234 | CH154 | HDS383 | CH229 | DG 118 | CH207 | DG106 | CH177 | | | | |
| HDS254 | CH260 | HDS384 | CH231 | DG 119 | CH175 | DG107 | CH271 | | | | |
| HDS255 | CH189 | HDS385 | CH233 | DG 120 | CH221 | DG108 | CH306 | | | | |
| HDS258 | CH260 | HDS391 | CH256 | DG 121 | CH196 | DG109 | CH181 | | | | |
| HDS262 | CH154 | HDS392 | CH263 | DG 122 | CH222 | DG110 | CH204 | | | | |
| HDS268 | CH302 | HDS394 | CH242 | DG 125 | CH189 | DG111 | CH216 | | | | |
| HDS273 | CH147 | HDS396 | CH232 | DG 126 | CH232 | DG112 | CH233 | | | | |
| HDS274 | CH189 | HDS397 | CH226 | DG 129 | CH209 | DG115 | CH178 | | | | |
| HDS275 | CH302 | HDS400 | CH306 | DG 130 | CH229 | DG116 | CH170 | | | | |
| HDS276 | CH221 | HDS401 | CH600 | DG 137 | CH186 | DG118 | CH207 | | | | |
| HDS295 | CH189 | HDS403 | CH256 | DG 142 | CH231 | DG119 | CH175 | | | | |
| HDS296 | CH189 | HDS404 | CH240 | DG 144 | CH215 | DG120 | CH221 | | | | |
| HDS297 | CH176 | HDS406 | CH268 | DG 145 | CH203 | DG121 | CH196 | | | | |
| HDS299 | CH189 | HDS407 | CH272 | DG 146 | CH242 | DG122 | CH222 | | | | |
| HDS303 | CH178 | HDS408 | CH180 | DG 155 | CH219 | DG125 | CH167 | | | | |
| HDS304 | CH189 | HDS409 | CH224 | DG 172 | CH225 | DG126 | CH232 | | | | |
| HDS337 | CH189 | HDS420 | CH234 | DG 173 | CH226 | DG129 | CH209 | | | | |
| HDS339 | CH147 | DENSO | CHAMPION | DG 174 | CH256 | DG130 | CH229 | | | | |
| HDS341 | CH260 | 0671001270 | CH154 | DG 176 | CH180 | DG137 | CH186 | | | | |

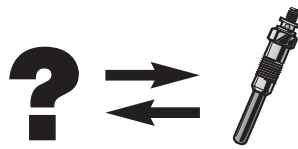

| DENSO | | |
|---------------|-------|--|
| DG140 | CH240 | |
| DG-140 | CH240 | |
| DG142 | CH231 | |
| DG144 | CH215 | |
| DG145 | CH203 | |
| DG146 | CH242 | |
| DG155 | CH219 | |
| DG170 | CH224 | |
| DG-170 | CH224 | |
| DG172 | CH225 | |
| DG173 | CH226 | |
| DG174 | CH256 | |
| DG176 | CH180 | |
| DG180 | CH201 | |
| DG181 | CH268 | |
| DG182 | CH272 | |
| DG187 | CH263 | |
| DG189 | CH234 | |
| DG195 | CH270 | |
| DG196 | CH269 | |
| DG197 | CH230 | |
| DG198 | CH221 | |
| DG201 | CH154 | |
| DG203 | CH154 | |
| DG205 | CH302 | |
| DG207 | CH302 | |
| DG304 | CH600 | |
| EYQUEM | | |
| 0 911 101 138 | CH215 | |
| 0 911 101 195 | CH242 | |
| 0 911 101 196 | CH225 | |
| 0 911 101 197 | CH221 | |
| 0 911 101 199 | CH600 | |
| 0 911 101 203 | CH201 | |
| 0 911 101 233 | CH230 | |
| 0 911 101 234 | CH234 | |
| ACL588S | CH221 | |
| CD566R | CH147 | |
| CD659R | CH260 | |
| CD660R | CH260 | |
| CD661R | CH260 | |
| CD670T | CH189 | |
| CL580P | CH158 | |
| CL588S | CH221 | |
| CL588Y | CH154 | |
| CL596V | CH302 | |
| DD6120V | CH177 | |
| DD659R | CH260 | |
| DD665T | CH173 | |
| DD668S | CH176 | |
| DD670T | CH189 | |
| DD671T | CH189 | |

| EYQUEM | | |
|---------------|-------|--|
| DD678S | CH189 | |
| DT584T | CH169 | |
| DT589V | CH185 | |
| DT592T | CH271 | |
| G1 | CH242 | |
| G20 | CH215 | |
| G27 | CH173 | |
| G30 | CH268 | |
| G31 | CH225 | |
| G32 | CH221 | |
| G34 | CH185 | |
| G38 | CH600 | |
| G5 | CH240 | |
| G54 | CH217 | |
| G72 | CH201 | |
| G76 | CH230 | |
| G77 | CH234 | |
| G9 | CH270 | |
| KTB501 | CH147 | |
| KTB601 | CH260 | |
| KTB602 | CH260 | |
| KTD602 | CH189 | |
| KTD603 | CH189 | |
| KTE601 | CH177 | |
| KWE501 | CH185 | |
| PTA601 | CH205 | |
| PTB501 | CH147 | |
| PTB601 | CH260 | |
| PTB602 | CH260 | |
| PTB603 | CH147 | |
| PTC601 | CH176 | |
| PTD501 | CH206 | |
| PTD502 | CH167 | |
| PTD601 | CH173 | |
| PTD603 | CH189 | |
| PTE502 | CH204 | |
| PTE601 | CH175 | |
| PTE603 | CH177 | |
| PVC503 | CH221 | |
| PWD501 | CH271 | |
| PWD503 | CH271 | |
| PWD504 | CH217 | |
| PWD505 | CH222 | |
| PWD506 | CH216 | |
| PWD509 | CH196 | |
| PWD510 | CH233 | |
| PWE501 | CH185 | |
| PWE502 | CH170 | |
| PWE503 | CH178 | |
| PWE506 | CH207 | |
| PWF501 | CH219 | |
| PWF502 | CH185 | |
| PWF503 | CH181 | |

| EYQUEM | | |
|---------------|-------|--|
| PWG501 | CH203 | |
| PWG503 | CH215 | |
| PWG504 | CH229 | |
| STB502 | CH260 | |
| SVA504 | CH158 | |
| SVC504 | CH221 | |
| SVE501 | CH302 | |
| SVE503 | CH302 | |
| SVG501 | CH154 | |
| SVG502 | CH154 | |
| FAE | | |
| 7407 | CH189 | |
| 7409 | CH173 | |
| 74140 | CH189 | |
| 74141 | CH260 | |
| 74142 | CH147 | |
| 74144 | CH176 | |
| 74145 | CH271 | |
| 74146 | CH206 | |
| 74147 | CH175 | |
| 74151 | CH185 | |
| 74152 | CH181 | |
| 74154 | CH204 | |
| 74183 | CH229 | |
| 74191 | CH233 | |
| 7619 | CH221 | |
| FAI | | |
| FG100 | CH260 | |
| FG101 | CH260 | |
| FG103 | CH189 | |
| FG104 | CH189 | |
| FG106 | CH189 | |
| FG107 | CH189 | |
| FG108 | CH189 | |
| FG109 | CH189 | |
| FG110 | CH189 | |
| FG111 | CH189 | |
| FG114 | CH147 | |
| FG117 | CH154 | |
| FG121 | CH147 | |
| FG124 | CH221 | |
| FG125 | CH221 | |
| FG128 | CH221 | |
| FG129 | CH221 | |
| FG132 | CH189 | |
| FG133 | CH189 | |
| FG135 | CH189 | |
| FG137 | CH189 | |
| FG146 | CH158 | |
| FG147 | CH173 | |
| FG150 | CH189 | |

| FAI | | |
|----------------------|-------|--|
| FG153 | CH147 | |
| FG154 | CH189 | |
| FG155 | CH185 | |
| GGP01 | CH260 | |
| GGP02 | CH260 | |
| GGP04 | CH189 | |
| GGP09 | CH189 | |
| GGP11 | CH147 | |
| GGP14 | CH154 | |
| GGP15 | CH189 | |
| GGP16 | CH260 | |
| GGP18 | CH147 | |
| GGP26 | CH221 | |
| GGP29 | CH189 | |
| GGP30 | CH178 | |
| GGP32 | CH189 | |
| GGP33 | CH271 | |
| GGP34 | CH189 | |
| GGP35 | CH302 | |
| GGP36 | CH186 | |
| GGP38 | CH186 | |
| GGP40 | CH158 | |
| GGP41 | CH176 | |
| GGP42 | CH173 | |
| GGP43 | CH302 | |
| GGP44 | CH260 | |
| GGP46 | CH189 | |
| GGP47 | CH185 | |
| GGP49 | CH169 | |
| GGP52 | CH154 | |
| GGP53 | CH205 | |
| GGP54 | CH181 | |
| GGP56 | CH167 | |
| GGP58 | CH204 | |
| GGP59 | CH175 | |
| GGP60 | CH177 | |
| GGP61 | CH206 | |
| GGP62 | CH169 | |
| GGP65 | CH217 | |
| GGP67 | CH170 | |
| GGP68 | CH189 | |
| GGP69 | CH189 | |
| GGP72 | CH215 | |
| GGP74 | CH203 | |
| GGP75 | CH216 | |
| GGP77 | CH219 | |
| GGP79 | CH207 | |
| GGP84 | CH271 | |
| FEBI BILSTEIN | | |
| 01002 | CH233 | |
| 15949 | CH181 | |
| 15953 | CH205 | |

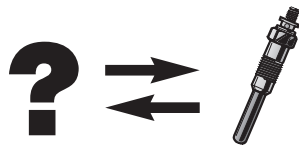

| FEBI BILSTEIN | |
|---------------------------|-------|
| 15956 | CH260 |
| 15957 | CH170 |
| 15959 | CH222 |
| 15961 | CH189 |
| 15962 | CH147 |
| 15963 | CH189 |
| 15964 | CH175 |
| 15965 | CH189 |
| 15966 | CH177 |
| 17700 | CH189 |
| 17788 | CH207 |
| 17979 | CH271 |
| 17981 | CH169 |
| 18404 | CH204 |
| 18408 | CH219 |
| 19099 | CH185 |
| 19103 | CH154 |
| 19223 | CH176 |
| 19249 | CH217 |
| 19447 | CH196 |
| 19882 | CH203 |
| 21864 | CH229 |
| 21866 | CH232 |
| 21957 | CH209 |
| 24095 | CH240 |
| 24428 | CH231 |
| 24483 | CH224 |
| 24771 | CH226 |
| 24917 | CH242 |
| 26585 | CH302 |
| 27226 | CH181 |
| 31233 | CH186 |
| 31248 | CH201 |
| HELLA | |
| 8EG 008 497-501 | CH215 |
| 8EG 008 497-511 | CH219 |
| 8EG 008 497-521 | CH216 |
| 8EG 008 497-571 | CH203 |
| 8EG 008 497-581 | CH209 |
| 8EG 008-497-551 | CH271 |
| 8EG 008-497-561 | CH233 |
| 8EH 008 497-611 | CH196 |
| PO 750 | CH215 |
| PO 751 | CH219 |
| PO 752 | CH216 |
| PO 755 | CH271 |
| PO 756 | CH233 |
| PO 757 | CH203 |
| PO 758 | CH209 |
| PO 761 | CH196 |
| HERTH+BUSS ELPARTS | |
| 29 200 010 | CH260 |

| HERTH+BUSS ELPARTS | |
|-----------------------------|-------|
| 29 200 011 | CH189 |
| 29 200 012 | CH260 |
| 29 200 014 | CH189 |
| 29 200 015 | CH260 |
| J 571 2013 | CH608 |
| J 5711023 | CH186 |
| HERTH+BUSS JAKOPARTS | |
| J 5711016 | CH600 |
| J 5711023 | CH186 |
| J5711017 | CH186 |
| J5715000 | CH221 |
| HKT | |
| B040 | CH189 |
| CP02 | CH600 |
| PD191 | CH302 |
| PI49 | CH306 |
| PI57 | CH158 |
| PI59 | CH158 |
| PM164 | CH256 |
| PM75 | CH221 |
| PN135 | CH221 |
| PN138 | CH186 |
| PN86 | CH189 |
| PN89 | CH260 |
| PT103 | CH154 |
| PT144 | CH154 |
| PT145 | CH302 |
| PT147 | CH154 |
| PT150 | CH302 |
| PT151 | CH154 |
| PT152 | CH302 |
| PZ38 | CH242 |
| PZ39 | CH242 |
| INTERMOTOR | |
| 80000 | CH189 |
| 80015 | CH189 |
| 80021 | CH260 |
| 80024 | CH271 |
| 80026 | CH260 |
| 80031 | CH189 |
| 80034 | CH189 |
| 80040 | CH260 |
| 80044 | CH147 |
| 80060 | CH173 |
| 80100 | CH221 |
| 80111 | CH260 |
| 80121 | CH154 |
| 80136 | CH158 |
| 80140 | CH189 |
| 80142 | CH178 |
| 80144 | CH147 |

| INTERMOTOR | |
|-------------------------|-------|
| 80152 | CH260 |
| 80153 | CH260 |
| 80155 | CH189 |
| 80157 | CH167 |
| 80158 | CH169 |
| 80161 | CH154 |
| JAPANPARTS | |
| CP 22 | CH608 |
| JAPCAR | |
| CP 02 | CH600 |
| CP 07 | CH256 |
| JKC 64031 | CH302 |
| LETRIKA | |
| 11 721 003 | CH260 |
| 11 721 004 | CH189 |
| LUCAS | |
| DS001 | CH189 |
| DS002 | CH260 |
| DS003 | CH189 |
| DS004 | CH260 |
| DS006 | CH189 |
| DS007 | CH260 |
| DS014 | CH173 |
| DS017 | CH221 |
| DS019 | CH154 |
| DS040 | CH189 |
| DS043 | CH260 |
| DS058 | CH147 |
| DS122 | CH189 |
| DS850 | CH147 |
| LP005 | CH147 |
| LP021 | CH176 |
| LP022 | CH260 |
| LP027 | CH271 |
| LP033 | CH189 |
| LP035 | CH189 |
| LP037 | CH185 |
| LP040 | CH177 |
| LP045 | CH204 |
| LP048 | CH205 |
| LP050 | CH217 |
| LP059 | CH207 |
| LP062 | CH233 |
| LP073 | CH271 |
| LUCAS CAV | |
| HDS 396 | CH232 |
| HDS 420 | CH234 |
| LUCAS ELECTRICAL | |
| 6415-4 | CH189 |

| LUCAS ELECTRICAL | |
|-------------------------|-------|
| DS 001 | CH189 |
| DS 003 | CH189 |
| DS 006 | CH189 |
| DS 007 | CH260 |
| DS 014 | CH173 |
| DS 017 | CH221 |
| DS 019 | CH154 |
| DS 040 | CH189 |
| DS 043 | CH260 |
| DS 058 | CH147 |
| DS 122 | CH189 |
| DS 850 | CH147 |
| HDS 211 | CH189 |
| HDS 216 | CH189 |
| HDS 218 | CH189 |
| HDS 222 | CH260 |
| HDS 229 | CH173 |
| HDS 232 | CH221 |
| HDS 234 | CH154 |
| HDS 254 | CH260 |
| HDS 255 | CH189 |
| HDS 258 | CH260 |
| HDS 273 | CH147 |
| HDS 274 | CH189 |
| HDS 295 | CH189 |
| HDS 297 | CH176 |
| HDS 299 | CH189 |
| HDS 303 | CH178 |
| HDS 304 | CH167 |
| HDS 337 | CH189 |
| HDS 339 | CH147 |
| HDS 341 | CH260 |
| HDS 342 | CH271 |
| HDS 347 | CH173 |
| HDS 348 | CH189 |
| HDS 349 | CH189 |
| HDS 358 | CH186 |
| HDS 359 | CH186 |
| HDS 371 | CH189 |
| HDS 372 | CH203 |
| HDS 373 | CH204 |
| HDS 374 | CH215 |
| HDS 375 | CH216 |
| HDS 376 | CH217 |
| HDS 379 | CH196 |
| HDS 401 | CH600 |
| HDS 403 | CH256 |
| MAGNETI MARELLI | |
| TIX 2 A | CH189 |
| TIX 4 A | CH189 |
| TIX 6 A | CH189 |
| TIX1A | CH260 |

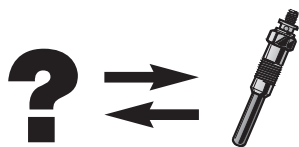

| MAGNETI MARELLI | CHAMPION |
|-----------------|----------|
| TIX2A | CH189 |
| TLX 2 A | CH189 |
| UC 12A | CH170 |
| UC 13A | CH217 |
| UC 14A | CH181 |
| UC 15A | CH185 |
| UC 16A | CH207 |
| UC 18A | CH219 |
| UC 3 A | CH271 |
| UC 4 A | CH167 |
| UC 7 A | CH185 |
| UC 8 A | CH169 |
| UC04F | CH704 |
| UC12A | CH170 |
| UC13A | CH169 |
| UC14A | CH181 |
| UC15A | CH185 |
| UC16A | CH207 |
| UC18A | CH219 |
| UC19A | CH222 |
| UC20A | CH271 |
| UC21A | CH217 |
| UC22A | CH196 |
| UC23A | CH221 |
| UC24A | CH178 |
| UC25A | CH186 |
| UC26A | CH203 |
| UC27A | CH229 |
| UC28A | CH231 |
| UC29A | CH232 |
| UC30A | CH233 |
| UC31A | CH271 |
| UC33A | CH226 |
| UC34A | CH256 |
| UC36A | CH186 |
| UC37A | CH216 |
| UC38A | CH302 |
| UC3A | CH271 |
| UC41A | CH268 |
| UC43A | CH269 |
| UC4A | CH167 |
| UC7A | CH185 |
| UC8A | CH169 |
| UC9A | CH158 |
| UX 11 A | CH147 |
| UX 13 A | CH176 |
| UX 14 A | CH173 |
| UX 15 A | CH189 |
| UX 16A | CH175 |
| UX 17A | CH177 |
| UX 18A | CH260 |
| UX 19A | CH205 |
| UX 20A | CH189 |

| MAGNETI MARELLI | CHAMPION |
|-----------------|----------|
| UX 21A | CH209 |
| UX 4 A | CH189 |
| UX 5 A | CH173 |
| UX 8 A | CH260 |
| UX11A | CH147 |
| UX13A | CH176 |
| UX14A | CH173 |
| UX15A | CH189 |
| UX16A | CH175 |
| UX17A | CH177 |
| UX18A | CH260 |
| UX19A | CH205 |
| UX20A | CH189 |
| UX21A | CH209 |
| UX22A | CH206 |
| UX23A | CH204 |
| UX24A | CH230 |
| UX2A | CH189 |
| UX4A | CH189 |
| UX8A | CH260 |
| UX9A | CH189 |
| UY3A | CH224 |
| UY4A | CH240 |
| UY5A | CH201 |
| UZ3A | CH600 |
| MONARK | CHAMPION |
| 90 505 052 | CH260 |
| 90 505 066 | CH260 |
| 90 505 907 | CH189 |
| 90 505 910 | CH260 |
| 90 905 063 | CH260 |
| MOPAR PARTS | CHAMPION |
| 4720600 | CH189 |
| 4863826 | CH181 |
| MOTORCRAFT | CHAMPION |
| ESD10 | CH260 |
| EZD 10 | CH260 |
| EZD 11 | CH189 |
| EZD 14 | CH189 |
| EZD 15 | CH189 |
| EZD 16 | CH189 |
| EZD 18 | CH221 |
| EZD 2 | CH189 |
| EZD 21 | CH154 |
| EZD 25 | CH260 |
| EZD 27 | CH260 |
| EZD 29 | CH173 |
| EZD 30 | CH189 |
| EZD 33 | CH271 |
| EZD 36 | CH181 |
| EZD 37 | CH196 |

| MOTORCRAFT | CHAMPION |
|------------|----------|
| EZD 38 | CH229 |
| EZD 39 | CH205 |
| EZD 4 | CH260 |
| EZD 41 | CH268 |
| EZD 5 | CH189 |
| EZD 8 | CH147 |
| EZD10 | CH260 |
| EZD11 | CH189 |
| EZD12 | CH189 |
| EZD14 | CH189 |
| EZD15 | CH189 |
| EZD16 | CH189 |
| EZD18 | CH221 |
| EZD2 | CH189 |
| EZD21 | CH154 |
| EZD4 | CH189 |
| EZD5 | CH189 |
| EZD8 | CH147 |
| EZDA | CH260 |
| EZDB | CH189 |
| EZDC | CH189 |
| EZDE | CH189 |
| EZDF | CH189 |
| EZDG | CH189 |
| EZDU | CH221 |
| EZDX | CH154 |
| NGK | CHAMPION |
| 1009 | CH185 |
| 1239 | CH260 |
| 1250 | CH189 |
| 1436 | CH233 |
| 1441 | CH170 |
| 1566 | CH242 |
| 1749 | CH204 |
| 2189 | CH221 |
| 2203 | CH178 |
| 2237 | CH189 |
| 2273 | CH169 |
| 2408 | CH271 |
| 2419 | CH217 |
| 2500 | CH230 |
| 2643 | CH189 |
| 2686 | CH225 |
| 2691 | CH203 |
| 2785 | CH176 |
| 2951 | CH154 |
| 3017 | CH600 |
| 3040 | CH263 |
| 3078 | CH219 |
| 3219 | CH189 |
| 3319 | CH232 |
| 3380 | CH189 |

| NGK | CHAMPION |
|------|----------|
| 3413 | CH222 |
| 3473 | CH189 |
| 3617 | CH147 |
| 3645 | CH189 |
| 3687 | CH158 |
| 3703 | CH231 |
| 3704 | CH260 |
| 3709 | CH234 |
| 3782 | CH302 |
| 3786 | CH215 |
| 3829 | CH260 |
| 3852 | CH216 |
| 3873 | CH147 |
| 3965 | CH173 |
| 4090 | CH229 |
| 4118 | CH205 |
| 4119 | CH178 |
| 4182 | CH260 |
| 4187 | CH215 |
| 4275 | CH175 |
| 4279 | CH185 |
| 4290 | CH147 |
| 4309 | CH272 |
| 4356 | CH189 |
| 4359 | CH170 |
| 4389 | CH167 |
| 4409 | CH217 |
| 4454 | CH176 |
| 4467 | CH158 |
| 4520 | CH196 |
| 4585 | CH189 |
| 4600 | CH203 |
| 4751 | CH147 |
| 4791 | CH147 |
| 4818 | CH169 |
| 4842 | CH219 |
| 4902 | CH217 |
| 4916 | CH206 |
| 4937 | CH221 |
| 4950 | CH189 |
| 4956 | CH260 |
| 4994 | CH256 |
| 5000 | CH207 |
| 5005 | CH185 |
| 5013 | CH226 |
| 5045 | CH177 |
| 5059 | CH209 |
| 5065 | CH181 |
| 5104 | CH169 |
| 5116 | CH242 |
| 5148 | CH205 |
| 5171 | CH206 |
| 5207 | CH201 |

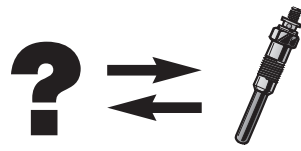

| NGK | CHAMPION | NGK | CHAMPION | NGK | CHAMPION | NGK | CHAMPION |
|-------|----------|-------|----------|------------|----------|------------|----------|
| 5264 | CH158 | 91766 | CH232 | DP41 | CH204 | D-Power 59 | CH263 |
| 5267 | CH189 | 93293 | CH230 | DP43 | CH209 | D-Power 6 | CH176 |
| 5287 | CH256 | 94629 | CH270 | DP5 | CH205 | D-Power 61 | CH230 |
| 5317 | CH173 | 94832 | CH229 | DP52 | CCGP002 | D-Power 64 | CH270 |
| 5376 | CH154 | 96037 | CH229 | DP55 | CCGP003 | D-Power 66 | CH232 |
| 5413 | CH173 | 96853 | CH270 | DP56 | CH268 | D-Power 7 | CH217 |
| 5486 | CH186 | 9810 | CCGP002 | DP59 | CH263 | D-Power 70 | CH269 |
| 5540 | CH222 | 9826 | CCGP002 | DP6 | CH176 | D-Power 73 | CH201 |
| 5568 | CH175 | 9835 | CCGP003 | DP61 | CH230 | D-Power 75 | CH229 |
| 5605 | CH271 | 9864 | CCGP003 | DP64 | CH270 | D-Power 9 | CH185 |
| 5700 | CH167 | 9974 | CH225 | DP66 | CH232 | Y1005J | CH268 |
| 5740 | CH177 | CY02 | CH600 | DP7 | CH217 | Y1007J | CH263 |
| 5906 | CH176 | CY07 | CH256 | DP70 | CH269 | Y1030J | CH269 |
| 5909 | CH271 | CY08 | CH186 | DP73 | CH201 | Y-115T | CH221 |
| 5979 | CH209 | CY52 | CH600 | DP75 | CH229 | Y-115T1 | CH221 |
| 5986 | CH196 | CY57 | CH256 | DP9 | CH185 | Y-118T | CH154 |
| 5996 | CH206 | CY58 | CH186 | D-Power 1 | CH189 | Y-118T1 | CH154 |
| 6003 | CH204 | CZ101 | CCGP002 | D-Power 10 | CH185 | Y-147T | CH302 |
| 6092 | CH224 | CZ104 | CCGP002 | D-Power 12 | CH233 | Y-154RS | CH306 |
| 6136 | CH260 | CZ301 | CCGP003 | D-Power 13 | CH256 | Y-204TS | CH260 |
| 6140 | CH186 | CZ304 | CCGP003 | D-Power 14 | CH207 | Y-204TS1 | CH260 |
| 6246 | CH170 | DP1 | CH189 | D-Power 15 | CH173 | Y-204V | CH260 |
| 6281 | CH185 | DP10 | CH185 | D-Power 16 | CH177 | Y-206T | CH189 |
| 6285 | CH260 | DP12 | CH233 | D-Power 17 | CH169 | Y-207T | CH260 |
| 6298 | CH231 | DP13 | CH256 | D-Power 19 | CH206 | Y-207TS | CH260 |
| 6416 | CH233 | DP14 | CH207 | D-Power 2 | CH260 | Y-208T | CH189 |
| 6586 | CH186 | DP15 | CH173 | D-Power 20 | CH181 | Y-501U | CH215 |
| 6592 | CH256 | DP16 | CH177 | D-Power 21 | CH256 | Y-502R | CH216 |
| 6599 | CH260 | DP17 | CH169 | D-Power 22 | CH169 | Y-503J | CH185 |
| 6649 | CH207 | DP18 | CH271 | D-Power 23 | CH147 | Y-503R | CH185 |
| 6704 | CH169 | DP19 | CH206 | D-Power 24 | CH170 | Y-504J | CH170 |
| 6848 | CH177 | DP2 | CH260 | D-Power 25 | CH260 | Y-504R | CH170 |
| 6892 | CH271 | DP20 | CH181 | D-Power 27 | CH196 | Y-506J | CH217 |
| 6897 | CH203 | DP21 | CH256 | D-Power 28 | CH158 | Y-506R | CH217 |
| 6900 | CH158 | DP22 | CH169 | D-Power 29 | CH167 | Y-507J | CH203 |
| 6943 | CH181 | DP23 | CH147 | D-Power 3 | CH147 | Y-507R | CH203 |
| 7464 | CH242 | DP24 | CH170 | D-Power 30 | CH175 | Y-508J | CH234 |
| 7493 | CH302 | DP25 | CH260 | D-Power 31 | CH215 | Y-509J | CH186 |
| 7503 | CH205 | DP27 | CH196 | D-Power 32 | CH203 | Y-515J | CH271 |
| 7545 | CH147 | DP28 | CH158 | D-Power 33 | CH147 | Y-516J | CH233 |
| 7782 | CH302 | DP29 | CH167 | D-Power 34 | CH178 | Y-517J | CH232 |
| 7794 | CH240 | DP3 | CH147 | D-Power 35 | CH229 | Y-519J | CH230 |
| 7906 | CH189 | DP30 | CH175 | D-Power 36 | CH222 | Y-523J | CH231 |
| 7947 | CH260 | DP31 | CH215 | D-Power 37 | CH231 | Y-524J | CH196 |
| 7957 | CH268 | DP32 | CH203 | D-Power 38 | CH219 | Y-525J | CH229 |
| 7992 | CH219 | DP33 | CH147 | D-Power 39 | CH242 | Y-530J | CH186 |
| 7995 | CH306 | DP34 | CH178 | D-Power 4 | CH271 | Y-532J | CH302 |
| 8902 | CH263 | DP35 | CH229 | D-Power 41 | CH204 | Y-534J | CH222 |
| 8939 | CH268 | DP36 | CH222 | D-Power 43 | CH209 | Y-548J | CH229 |
| 8944 | CH256 | DP37 | CH231 | D-Power 5 | CH205 | Y-605J | CH272 |
| 90002 | CH269 | DP38 | CH219 | D-Power 52 | CCGP002 | Y-701J | CH242 |
| 90828 | CH269 | DP39 | CH242 | D-Power 55 | CCGP003 | Y-701R | CH242 |
| 91322 | CH201 | DP4 | CH271 | D-Power 56 | CH268 | Y-703R | CH302 |

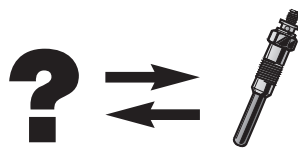

| NGK | CHAMPION |
|----------|----------|
| Y-707RS | CH221 |
| Y-711J | CH158 |
| Y-711RS | CH158 |
| Y-712RS | CH186 |
| Y-715R | CH154 |
| Y-719RS1 | CH158 |
| Y-721RS | CH158 |
| Y-722J | CH225 |
| Y-722JS | CH225 |
| Y-729U | CH178 |
| Y-730U | CH169 |
| Y-731U | CH185 |
| Y-732J | CH271 |
| Y-732U | CH271 |
| Y-733J | CH256 |
| Y-740 | CH169 |
| Y-740U | CH169 |
| Y-741U | CH181 |
| Y-743U | CH158 |
| Y-746J | CH219 |
| Y-746R | CH219 |
| Y-748U | CH207 |
| Y-749J | CH226 |
| Y-752M | CH189 |
| Y8005J | CH270 |
| Y-901R | CH260 |
| Y-902R | CH189 |
| Y-904M1 | CH306 |
| Y-908R | CH189 |
| Y-910J | CH147 |
| Y-910R | CH147 |
| Y-911J | CH147 |
| Y-911R | CH147 |
| Y-912M | CH173 |
| Y-912R | CH147 |
| Y-913J | CH173 |
| Y-913M | CH173 |
| Y-914U | CH189 |
| Y-916J | CH176 |
| Y-916R | CH176 |
| Y-917U | CH189 |
| Y-918J | CH260 |
| Y-918R | CH260 |
| Y-920R | CH189 |
| Y-922R | CH189 |
| Y-923U | CH189 |
| Y-924J | CH189 |
| Y-924U | CH189 |
| Y-925J | CH177 |
| Y-925R | CH177 |
| Y-927J | CH206 |
| Y-927R | CH206 |
| Y-928U | CH167 |

| NGK | CHAMPION |
|----------------|----------|
| Y-929U | CH204 |
| Y-930U | CH175 |
| Y-930Y | CH175 |
| Y-932R | CH260 |
| Y-933J | CH260 |
| Y-933R | CH260 |
| Y-935U | CH147 |
| Y-937J | CH205 |
| Y-937R | CH205 |
| Y-938R | CH189 |
| Y-939J | CH209 |
| YE05 | CH201 |
| YE07 | CH224 |
| YE12 | CH240 |
| NIPPARTS | CHAMPION |
| 5710501 | CH226 |
| J 5719002 | CH306 |
| J5174002 | CH169 |
| J5710301 | CH242 |
| J5710302 | CH234 |
| J5710400 | CH176 |
| J5710401 | CH176 |
| J5710500 | CH221 |
| J5710501 | CH226 |
| J5711009 | CH221 |
| J5711012 | CH186 |
| J5711016 | CH600 |
| J5711022 | CH221 |
| J5711026 | CH230 |
| J5711028 | CH185 |
| J5711031 | CH232 |
| J5712009 | CH302 |
| J5712013 | CH608 |
| J5712014 | CH154 |
| J5712016 | CH302 |
| J5712018 | CH154 |
| J5713000 | CH242 |
| J5713008 | CH242 |
| J5714000 | CH169 |
| J5715004 | CH256 |
| J5715008 | CH256 |
| J5715010 | CH263 |
| J5715012 | CH256 |
| J5715014 | CH271 |
| J5719003 | CH158 |
| J5719009 | CH158 |
| QUINTON HAZELL | CHAMPION |
| CH 306/002 | CH306 |
| QGP105 | CH260 |
| QGP107 | CH189 |
| QGP110 | CH189 |

| QUINTON HAZELL | CHAMPION |
|----------------|----------|
| QGP111 | CH189 |
| QGP112 | CH260 |
| QGP115 | CH189 |
| QGP117 | CH221 |
| QGP125 | CH154 |
| QGP131 | CH260 |
| QGP147 | CH147 |
| QGP148 | CH176 |
| QGP151 | CH189 |
| QGP154 | CH189 |
| QGP155 | CH271 |
| QGP165 | CH154 |
| QGP168 | CH221 |
| QGP169 | CH158 |
| QGP174 | CH178 |
| QGP175 | CH185 |
| QGP178 | CH205 |
| QGP179 | CH169 |
| QGP181 | CH260 |
| SWAG | CHAMPION |
| 70 91 5959 | CH222 |
| TEROSON | CHAMPION |
| CH 171 | CH271 |
| TOPRAN | CHAMPION |
| 207046 | CH232 |
| UNIPART | CHAMPION |
| GGP1 | CH189 |
| GGP12 | CH154 |
| GGP16 | CH158 |
| GGP17 | CH260 |
| GGP18 | CH189 |
| GGP2 | CH189 |
| GGP20 | CH221 |
| GGP22 | CH189 |
| GGP23 | CH185 |
| GGP24 | CH169 |
| GGP25 | CH271 |
| GGP26 | CH167 |
| GGP27 | CH175 |
| GGP28 | CH173 |
| GGP29 | CH189 |
| GGP30 | CH177 |
| GGP31 | CH178 |
| GGP32 | CH260 |
| GGP4 | CH260 |
| GGP7 | CH189 |
| GGP8 | CH147 |
| VALEO | CHAMPION |
| 344875 | CH189 |
| 344876 | CH260 |

| VALEO | CHAMPION |
|---------|----------|
| 344877 | CH189 |
| 344878 | CH189 |
| 344881 | CH176 |
| 344882 | CH147 |
| 344883 | CH189 |
| 344884 | CH189 |
| 344885 | CH147 |
| 344887 | CH189 |
| 344888 | CH189 |
| 344889 | CH173 |
| 344893 | CH271 |
| 344894 | CH189 |
| 344895 | CH185 |
| 344896 | CH189 |
| 344918 | CH158 |
| 344921 | CH169 |
| 344922 | CH189 |
| 344923 | CH189 |
| 344932 | CH189 |
| 344953 | CH189 |
| 344955 | CH205 |
| 344957 | CH175 |
| 344959 | CH177 |
| 344961 | CH217 |
| 344964 | CH207 |
| 344967 | CH169 |
| 344973 | CH271 |
| 344988 | CH219 |
| 344991 | CH203 |
| 344993 | CH232 |
| 345005 | CH196 |
| 345014 | CH221 |
| C 100 S | CH189 |
| C 101 S | CH189 |
| C 102 S | CH189 |
| C 105 S | CH147 |
| C 106 S | CH189 |
| C 107 S | CH189 |
| C 108 S | CH147 |
| C 110 S | CH189 |
| C 111 R | CH189 |
| C 112 R | CH260 |
| C 117 S | CH158 |
| C 118 S | CH260 |
| C 200 S | CH260 |
| C 201 S | CH176 |
| C 202 R | CH173 |
| C 203 R | CH147 |
| C 204 R | CH189 |
| C 205 R | CH271 |
| C 206 R | CH189 |
| C 207 R | CH185 |
| C 208 R | CH189 |

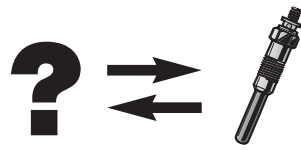
**VALEO**

| | |
|---------|-------|
| C 209 S | CH189 |
| C 210 S | CH169 |
| C100S | CH189 |
| C101S | CH189 |
| C102S | CH189 |
| C105S | CH147 |
| C106S | CH189 |
| C107S | CH189 |
| C108S | CH147 |
| C110S | CH189 |
| C111R | CH189 |
| C117S | CH158 |
| C118S | CH260 |
| C200S | CH260 |
| C201S | CH176 |
| C204R | CH189 |
| C205R | CH271 |
| C206R | CH189 |
| C207R | CH185 |
| C208R | CH189 |
| C210S | CH169 |
| C213S | CH169 |
| C215S | CH189 |
| C217S | CH205 |
| C219S | CH175 |
| C221S | CH177 |
| C223S | CH217 |
| C226S | CH207 |
| C228S | CH271 |
| C241S | CH203 |
| C243S | CH232 |
| C255S | CH196 |
| C264S | CH221 |

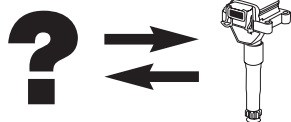

| AIRTEX | | CHAMPION |
|---------------|----------|-----------------|
| 5C 1071 | BAEA136E | |
| 5C 1166 | BAEA073E | |
| 5C 1208 | BAEA083E | |
| 5C 1287 | BAEA072E | |
| 5C 1394 | BAEA081E | |
| 5C 1403 | BAEA079E | |
| 5C 1430 | BAEA132E | |
| 5C 16127 | BAEA080E | |
| 5C1153 | BAEA521 | |
| 5C1317 | BAEA429 | |

| ANGLI | | CHAMPION |
|--------------|---------|-----------------|
| 15067 | BAE947A | |

| ASHIKA | | CHAMPION |
|---------------|----------|-----------------|
| 7801111 | BAEA188E | |
| 78-05-500 | BAEA179E | |
| 78-0W-W05 | BAEA543 | |

| ASHUKI | | CHAMPION |
|---------------|----------|-----------------|
| C980-05 | BAEA179E | |
| C980-050 | BAEA179E | |
| H595-03 | BAEA169E | |
| J840-03 | BAEA543 | |
| J840-05 | BAEA539 | |
| N84003 | BAEA188E | |

| AUTOMEGA | | CHAMPION |
|-----------------|---------|-----------------|
| 3012080071 | BAEA344 | |
| 3012080306 | BAEA358 | |
| 3012080307 | BAE965A | |

| BBT | | CHAMPION |
|------------|----------|-----------------|
| IC 03128 | BAEA137E | |
| IC 04114 | BAEA140E | |
| IC 07104 | BAEA026E | |
| IC 13100 | BAE800B | |
| IC 13116 | BAEA095 | |
| IC 16103 | BAEA073E | |
| IC 16109 | BAEA072E | |
| IC 16110 | BAEA433 | |
| IC 16112 | BAEA081E | |
| IC 16127 | BAEA080E | |
| IC 16128 | BAEA088E | |
| IC 17124 | BAEA083E | |
| IC0 3101 | BAE408AE | |
| IC0 3104 | BAE907AE | |
| IC01101 | BAEA055E | |
| IC03100 | BAE851AE | |
| IC03102 | BAEA043E | |
| IC03106 | BAEA016 | |
| IC03107 | BAEA017 | |
| IC03108 | BAEA154E | |
| IC03109 | BAEA002E | |
| IC03110 | BAEA033E | |

| BBT | | CHAMPION |
|------------|----------|-----------------|
| IC03111 | BAEA032E | |
| IC03112 | BAEA031E | |
| IC03114 | BAE960AE | |
| IC03114 | BAE961AE | |
| IC03118 | BAEA063E | |
| IC03119 | BAEA029E | |
| IC03121 | BAEA051E | |
| IC03122 | BAEA059E | |
| IC03123 | BAEA044E | |
| IC03127 | BAEA067E | |
| IC03127 | BAEA126E | |
| IC03128 | BAEA068E | |
| IC04101 | BAEA313 | |
| IC04102 | BAEA340 | |
| IC04104 | BAEA339 | |
| IC04105 | BAEA298 | |
| IC04108 | BAEA340 | |
| IC04110 | BAEA146E | |
| IC04112 | BAEA053 | |
| IC04113 | BAEA077 | |
| IC04119 | BAEA093E | |
| IC07100 | BAEA344 | |
| IC07102 | BAE965A | |
| IC07103 | BAEA252 | |
| IC07105 | BAEA342 | |
| IC07106 | BAEA358 | |
| IC07107 | BAEA147E | |
| IC07109 | BAEA427 | |
| IC07112 | BAEA306 | |
| IC07116 | BAEA152E | |
| IC07117 | BAEA153E | |
| IC07121 | BAEA150E | |
| IC07122 | BAEA359 | |
| IC07124 | BAEA185E | |
| IC09100 | BAEA014 | |
| IC09102 | BAEA014 | |
| IC09103 | BAEA302 | |
| IC09107 | BAEA324 | |
| IC09108 | BAEA143 | |
| IC10101 | BAEA309 | |
| IC11101 | BAEA554 | |
| IC11102 | BAEA447A | |
| IC11103 | BAEA540 | |
| IC11104 | BAEA543 | |
| IC12101 | BAEA469 | |
| IC13101 | BAE506D | |
| IC13102 | BAE506F | |
| IC13105 | BAE920AX | |
| IC13106 | BAE403B | |
| IC15100 | BAE409A | |
| IC15101 | BAEA231 | |
| IC15103 | BAEA232 | |
| IC15105 | BAEA256 | |

| BBT | | CHAMPION |
|------------|----------|-----------------|
| IC15108 | BAEA242 | |
| IC15112 | BAE504L | |
| IC15116 | BAEA255 | |
| IC15117 | BAEA243 | |
| IC15119 | BAEA345 | |
| IC15120 | BAEA354 | |
| IC15125 | BAEA347 | |
| IC15126 | BAEA045E | |
| IC15127 | BAEA046E | |
| IC15128 | BAEA348 | |
| IC15129 | BAEA351 | |
| IC15130 | BAEA352 | |
| IC15138 | BAEA066E | |
| IC15142 | BAEA131E | |
| IC15144 | BAEA557 | |
| IC16100 | BAEA276 | |
| IC16101 | BAEA275 | |
| IC16108 | BAEA179E | |
| IC16113 | BAEA056E | |
| IC16117 | BAEA521 | |
| IC16118 | BAEA477 | |
| IC16119 | BAEA561 | |
| IC16125 | BAEA188E | |
| IC16131 | BAEA475 | |
| IC16132 | BAEA476 | |
| IC-16135 | BAEA170E | |
| IC16139 | BAEA182E | |
| IC16140 | BAEA181E | |
| IC1622 | BAEA486 | |
| IC17105 | BAEA173E | |
| IC17106 | BAEA168E | |
| IC17107 | BAEA172E | |
| IC17113 | BAEA165E | |
| IC17114 | BAEA502E | |
| IC17115 | BAEA167E | |
| IC17116 | BAEA269 | |
| IC17119 | BAEA480 | |
| IC17120 | BAEA479 | |
| IC17121 | BAEA483 | |
| IC17125 | BAEA084E | |
| IC17126 | BAEA489 | |
| IC-17131 | BAEA171E | |
| IC18100 | BAEA281 | |
| IC18101 | BAEA350 | |
| IC18105 | BAEA448 | |
| IC18106 | BAEA387 | |
| IC4102 | BAEA198E | |
| ZK15102 | BAE946A | |
| ZK15106 | BAE946A | |
| ZK15132 | BAEA048E | |

| BERU | | CHAMPION |
|-------------|---------|-----------------|
| 0040100015 | BAEA017 | |

| BERU | | CHAMPION |
|-------------|----------|-----------------|
| 0040100060 | BAEA017 | |
| 0040100062 | BAEA043 | |
| 0040100293 | BAEA269 | |
| 0040102002 | BAEA012E | |
| 0040102004 | BAEA042E | |
| 0040102005 | BAEA052E | |
| 0040102006 | BAEA042E | |
| ZS009 | BAEA043 | |
| ZS014 | BAEA014 | |
| ZS016 | BAEA016 | |
| ZS017 | BAEA017 | |
| ZS029 | BAE920AX | |
| ZS037 | BAEA037 | |
| ZS041 | BAEA041 | |
| ZS043 | BAEA043 | |
| ZS052 | BAE409A | |
| ZS053 | BAEA053 | |
| ZS077 | BAEA077 | |
| ZS079 | BAE940A | |
| ZS090 | BAEA090 | |
| ZS095 | BAEA095 | |
| ZS110 | BAEA110 | |
| ZS115 | BAEA115 | |
| ZS231 | BAEA231 | |
| ZS232 | BAEA232 | |
| ZS234 | BAEA234 | |
| ZS242 | BAEA242 | |
| ZS243 | BAEA243 | |
| ZS244 | BAE506D | |
| ZS245 | BAEA245 | |
| ZS246 | BAEA246 | |
| ZS247 | BAEA247 | |
| ZS248 | BAE506F | |
| ZS250 | BAE504L | |
| ZS251 | BAEA251 | |
| ZS252 | BAEA252 | |
| ZS253 | BAEA253 | |
| ZS254 | BAEA254 | |
| ZS255 | BAEA255 | |
| ZS256 | BAEA256 | |
| ZS259 | BAE965A | |
| ZS264 | BAEA264 | |
| ZS266 | BAEA266 | |
| ZS267 | BAEA267 | |
| ZS269 | BAEA269 | |
| ZS275 | BAEA275 | |
| ZS276 | BAEA276 | |
| ZS281 | BAEA281 | |
| ZS283 | BAE800B | |
| ZS296 | BAEA296 | |
| ZS297 | BAEA297 | |
| ZS298 | BAEA298 | |
| ZS299 | BAEA299 | |



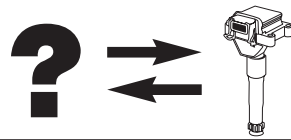

| BERU | CHAMPION |
|--------|----------|
| ZS302 | BAEA302 |
| ZS304 | BAEA304 |
| ZS306 | BAEA306 |
| ZS307 | BAEA307 |
| ZS308 | BAEA308 |
| ZS309 | BAEA309 |
| ZS313 | BAEA313 |
| ZS320 | BAE403B |
| ZS321 | BAE403D |
| ZS322 | BAE403C |
| ZS323 | BAE700AK |
| ZS324 | BAEA324 |
| ZS325 | BAEA325 |
| ZS337 | BAEA337 |
| ZS338 | BAEA338 |
| ZS339 | BAEA339 |
| ZS340 | BAEA340 |
| ZS342 | BAEA342 |
| ZS344 | BAEA344 |
| ZS345 | BAEA345 |
| ZS347 | BAEA347 |
| ZS348 | BAEA348 |
| ZS350 | BAEA350 |
| ZS351 | BAEA351 |
| ZS352 | BAEA352 |
| ZS354 | BAEA354 |
| ZS358 | BAEA358 |
| ZS359 | BAEA359 |
| ZS365 | BAEA365 |
| ZS367 | BAEA367 |
| ZS368 | BAEA368 |
| ZS372 | BAEA372 |
| ZS375 | BAE947A |
| ZS380 | BAEA380 |
| ZS382 | BAEA382 |
| ZS387 | BAEA387 |
| ZS394 | BAEA394 |
| ZS395 | BAEA395 |
| ZS408 | BAEA408 |
| ZS410 | BAEA410 |
| ZS422 | BAEA422 |
| ZS426 | BAEA426 |
| ZS427 | BAEA427 |
| ZS428 | BAEA428 |
| ZS429 | BAEA429 |
| ZS432 | BAEA432 |
| ZS433 | BAEA433 |
| ZS434 | BAEA434 |
| ZS445 | BAEA445 |
| ZS446 | BAEA446 |
| ZS447A | BAEA447A |
| ZS448 | BAEA448 |
| ZS449 | BAEA449 |

| BERU | CHAMPION |
|--------|----------|
| ZS453 | BAEA453 |
| ZS454 | BAEA454 |
| ZS469 | BAEA469 |
| ZS472 | BAEA472 |
| ZS474 | BAEA474 |
| ZS475 | BAEA475 |
| ZS476 | BAEA476 |
| ZS477 | BAEA477 |
| ZS479 | BAEA479 |
| ZS480 | BAEA480 |
| ZS482 | BAEA482 |
| ZS483 | BAEA483 |
| ZS486 | BAEA486 |
| ZS489 | BAEA489 |
| ZS501 | BAEA501 |
| ZS508 | BAEA508 |
| ZS521 | BAEA521 |
| ZS531 | BAEA531 |
| ZS536 | BAEA536 |
| ZS538 | BAEA538 |
| ZS539 | BAEA539 |
| ZS540 | BAEA540 |
| ZS543 | BAEA543 |
| ZS546 | BAEA546 |
| ZS547 | BAEA547 |
| ZS548 | BAEA548 |
| ZS549 | BAEA549 |
| ZS554 | BAEA554 |
| ZS555 | BAEA555 |
| ZS556 | BAEA556 |
| ZS557 | BAEA557 |
| ZS560 | BAEA560 |
| ZS561 | BAEA561 |
| ZSE001 | BAE851AE |
| ZSE002 | BAEA002E |
| ZSE003 | BAE907AE |
| ZSE004 | BAEA004E |
| ZSE007 | BAEA007E |
| ZSE009 | BAEA009E |
| ZSE012 | BAEA012E |
| ZSE013 | BAEA013E |
| ZSE019 | BAEA019E |
| ZSE021 | BAEA021E |
| ZSE025 | BAEA025E |
| ZSE026 | BAEA026E |
| ZSE029 | BAEA029E |
| ZSE030 | BAE408AE |
| ZSE031 | BAEA031E |
| ZSE032 | BAEA032E |
| ZSE033 | BAEA033E |
| ZSE037 | BAEA037E |
| ZSE039 | BAE960AE |
| ZSE040 | BAE961AE |

| BERU | CHAMPION |
|--------|----------|
| ZSE041 | BAEA041E |
| ZSE042 | BAEA042E |
| ZSE043 | BAEA043E |
| ZSE044 | BAEA044E |
| ZSE045 | BAEA045E |
| ZSE046 | BAEA046E |
| ZSE047 | BAE946A |
| ZSE048 | BAEA048E |
| ZSE051 | BAEA051E |
| ZSE052 | BAEA052E |
| ZSE053 | BAEA042E |
| ZSE055 | BAEA055E |
| ZSE056 | BAEA056E |
| ZSE059 | BAEA059E |
| ZSE061 | BAEA061E |
| ZSE062 | BAEA062E |
| ZSE063 | BAEA063E |
| ZSE065 | BAEA065E |
| ZSE066 | BAEA066E |
| ZSE067 | BAEA067E |
| ZSE068 | BAEA068E |
| ZSE072 | BAEA072E |
| ZSE073 | BAEA073E |
| ZSE079 | BAEA079E |
| ZSE080 | BAEA080E |
| ZSE081 | BAEA081E |
| ZSE083 | BAEA083E |
| ZSE084 | BAEA084E |
| ZSE088 | BAEA088E |
| ZSE093 | BAEA093E |
| ZSE126 | BAEA126E |
| ZSE131 | BAEA131E |
| ZSE132 | BAEA132E |
| ZSE136 | BAEA136E |
| ZSE137 | BAEA137E |
| ZSE140 | BAEA140E |
| ZSE143 | BAEA143 |
| ZSE144 | BAEA144E |
| ZSE145 | BAEA145E |
| ZSE146 | BAEA146E |
| ZSE147 | BAEA147E |
| ZSE149 | BAEA149E |
| ZSE150 | BAEA150E |
| ZSE152 | BAEA152E |
| ZSE153 | BAEA153E |
| ZSE154 | BAEA154E |
| ZSE158 | BAEA158E |
| ZSE159 | BAEA159E |
| ZSE161 | BAEA161E |
| ZSE162 | BAEA162E |
| ZSE163 | BAEA163E |
| ZSE164 | BAEA164E |
| ZSE165 | BAEA165E |

| BERU | CHAMPION |
|--------|----------|
| ZSE167 | BAEA167E |
| ZSE168 | BAEA168E |
| ZSE169 | BAEA169E |
| ZSE170 | BAEA170E |
| ZSE171 | BAEA171E |
| ZSE172 | BAEA172E |
| ZSE173 | BAEA173E |
| ZSE174 | BAEA174E |
| ZSE175 | BAEA175E |
| ZSE176 | BAEA176E |
| ZSE178 | BAEA178E |
| ZSE179 | BAEA179E |
| ZSE180 | BAEA180E |
| ZSE181 | BAEA181E |
| ZSE182 | BAEA182E |
| ZSE184 | BAEA184E |
| ZSE185 | BAEA185E |
| ZSE186 | BAEA186E |
| ZSE188 | BAEA188E |
| ZSE189 | BAEA189E |
| ZSE190 | BAEA190E |
| ZSE191 | BAEA191E |
| ZSE192 | BAEA192E |
| ZSE193 | BAEA193E |
| ZSE194 | BAEA194E |
| ZSE195 | BAEA195E |
| ZSE196 | BAEA196E |
| ZSE198 | BAEA198E |
| ZSE199 | BAEA199E |
| ZSE502 | BAEA502E |

| BORGWARNER | CHAMPION |
|---------------|----------|
| E 233 | BAEA380 |
| E2010025068A1 | BAEA539 |
| E2010025069A1 | BAEA179E |
| E2010025070A1 | BAEA543 |
| E2010026657A5 | BAEA181E |
| E2010028087A5 | BAEA185E |
| E2010028152A1 | BAEA489 |
| E2010028203A5 | BAEA186E |
| E2010028551A5 | BAEA188E |
| E2010031001A5 | BAEA189E |
| E2010031001B1 | BAEA189E |
| E2010031712A5 | BAEA548 |
| E2010031712B5 | BAEA548 |
| E2010032490A5 | BAEA549 |
| E2010032997A1 | BAEA554 |
| E2010033122A1 | BAEA191E |
| E2010033305A5 | BAEA192E |
| E2010033318A1 | BAEA555 |
| E2010033321A1 | BAEA193E |
| E2010033322A1 | BAEA556 |
| E2010033323A5 | BAEA557 |

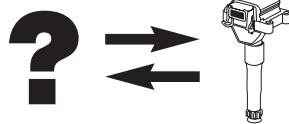

| BOUGICORD | CHAMPION | BOUGICORD | CHAMPION | BREMI | CHAMPION | BREMI | CHAMPION |
|------------------|-----------------|------------------|-----------------|--------------|-----------------|--------------|-----------------|
| 155106 | BAEA063E | 155450 | BAEA178E | 11882 | BAEA232 | 20155 | BAEA350 |
| 155109 | BAEA065E | 155452 | BAEA548 | 11883 | BAEA234 | 20155 | BAEA422 |
| 155110 | BAEA051E | 155456 | BAEA476 | 11886 | BAEA276 | 20157 | BAEA304 |
| 155111 | BAEA061E | 155465 | BAEA043 | 11891 | BAEA252 | 20160 | BAEA026E |
| 155112 | BAEA013E | 155473 | BAEA195E | 11892 | BAEA002E | 20161 | BAE946A |
| 155113 | BAEA483 | 155478 | BAEA190E | 11893 | BAE851AE | 20164 | BAEA479 |
| 155114 | BAEA560 | 155492 | BAEA132E | 11896 | BAEA252 | 20166 | BAEA447A |
| 155115 | BAEA539 | 155600 | BAEA017 | 11897 | BAE504D | 20167 | BAE947A |
| 155119 | BAEA477 | 155700 | BAEA014 | 11897 | BAE506F | 20167 | BAEA454 |
| 155121 | BAEA486 | 156100 | BAE907AE | 11898 | BAE506D | 20168 | BAEA037E |
| 155125 | BAEA188E | 156200 | BAE409A | 11899 | BAE800B | 20170 | BAEA264 |
| 155132 | BAEA429 | 156300 | BAE965A | 11900 | BAE504D | 20172 | BAEA501 |
| 155140 | BAEA164E | 156500 | BAEA256 | 11915 | BAEA275 | 20174 | BAEA309 |
| 155141 | BAEA171E | 156600 | BAE700AK | 11917 | BAE504L | 20176 | BAEA387 |
| 155142 | BAEA167E | 156800 | BAEA045E | 11918 | BAEA350 | 20179 | BAEA306 |
| 155146 | BAEA095 | 157000 | BAEA549 | 11922 | BAEA344 | 20180 | BAEA053 |
| 155152 | BAEA179E | 157200 | BAE960AE | 11923 | BAEA234 | 20183 | BAEA045E |
| 155153 | BAEA501 | 157300 | BAE403B | 11926 | BAEA234 | 20184 | BAEA147E |
| 155158 | BAEA561 | 157400 | BAE408AE | 11929 | BAE920AX | 20185 | BAEA077 |
| 155159 | BAEA073E | 157500 | BAEA043E | 11930 | BAEA245 | 20186 | BAEA019E |
| 155166 | BAEA543 | 157700 | BAEA032E | 11930 | BAEA254 | 20188 | BAEA296 |
| 155167 | BAEA434 | 157800 | BAEA031E | 11931 | BAEA246 | 20189 | BAEA338 |
| 155173 | BAEA368 | BRECAV | CHAMPION | 11931 | BAEA255 | 20190 | BAEA308 |
| 155175 | BAEA168E | 106.001 | BAE403B | 11935 | BAEA469 | 20190 | BAEA308 |
| 155176 | BAEA169E | 106.002 | BAE403C | 20110 | BAEA324 | 20191 | BAEA165E |
| 155177 | BAEA482 | 106.007 | BAE403D | 20111 | BAE409A | 20193 | BAEA342 |
| 155181 | BAEA380 | 109.001 | BAE965A | 20112 | BAEA031E | 20195 | BAEA146E |
| 155181 | BAEA382 | 110.004 | BAE700AK | 20113 | BAEA043E | 20198 | BAEA181E |
| 155184 | BAEA181E | 114.003 | BAE961AE | 20114 | BAEA032E | 20199 | BAEA299 |
| 155194 | BAEA489 | 124.001 | BAE960AE | 20115 | BAEA062E | 20300 | BAEA540 |
| 155200 | BAEA302 | BREMI | CHAMPION | 20116 | BAEA059E | 20301 | BAEA445 |
| 155204 | BAEA193E | 11720 | BAEA354 | 20117 | BAE408AE | 20303 | BAEA448 |
| 155214 | BAEA185E | 11722 | BAEA242 | 20119 | BAEA324 | 20304 | BAEA267 |
| 155215 | BAEA182E | 11723 | BAEA243 | 20120 | BAEA033E | 20306 | BAEA347 |
| 155224 | BAEA176E | 11731 | BAE907AE | 20121 | BAEA063E | 20307 | BAEA340 |
| 155229 | BAEA184E | 11732 | BAEA307 | 20122 | BAEA044E | 20312 | BAEA428 |
| 155231 | BAEA077 | 11803 | BAEA110 | 20124 | BAEA065E | 20314 | BAEA449 |
| 155237 | BAEA367 | 11821 | BAEA115 | 20125 | BAEA051E | 20315 | BAEA433 |
| 155244 | BAEA531 | 11855T | BAEA014 | 20126 | BAEA061E | 20318 | BAEA056E |
| 155248 | BAEA306 | 11856T | BAEA014 | 20129 | BAEA029E | 20319 | BAEA298 |
| 155251 | BAEA041E | 11857T | BAEA014 | 20130 | BAEA009E | 20320 | BAEA348 |
| 155253 | BAEA432 | 11860T | BAEA302 | 20131 | BAEA021E | 20321 | BAEA359 |
| 155258 | BAEA410 | 11866T | BAEA154E | 20132 | BAEA004E | 20322 | BAEA081E |
| 155287 | BAEA394 | 11869 | BAEA016 | 20133 | BAEA013E | 20326 | BAEA269 |
| 155309 | BAEA269 | 11871 | BAEA017 | 20134 | BAEA340 | 20328 | BAEA337 |
| 155310 | BAEA556 | 11873 | BAEA297 | 20135 | BAEA502E | 20331 | BAEA041E |
| 155313 | BAEA131E | 11875 | BAEA281 | 20136 | BAE965A | 20333 | BAEA170E |
| 155365 | BAEA298 | 11876 | BAEA253 | 20138 | BAEA025E | 20334 | BAEA352 |
| 155381 | BAEA547 | 11877 | BAEA251 | 20143 | BAEA266 | 20335 | BAEA358 |
| 155383 | BAEA192E | 11878 | BAEA247 | 20145 | BAEA041 | 20337 | BAEA080E |
| 155384 | BAEA475 | 11881 | BAEA231 | 20149 | BAEA073E | 20339 | BAEA483 |
| 155395 | BAEA521 | | | 20151 | BAEA072E | 20344 | BAEA482 |
| 155430 | BAEA186E | | | 20153 | BAEA313 | 20346 | BAEA186E |
| | | | | | | 20350 | BAEA543 |

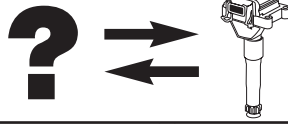

| BREMI | |
|--------------|----------|
| 20353 | BAEA556 |
| 20356 | BAEA394 |
| 20364 | BAEA429 |
| 20365 | BAEA153E |
| 20366 | BAEA007E |
| 20367 | BAEA554 |
| 20368 | BAEA152E |
| 20369 | BAEA434 |
| 20370 | BAEA175E |
| 20371 | BAE960AE |
| 20372 | BAEA380 |
| 20372 | BAEA382 |
| 20374 | BAEA446 |
| 20376 | BAEA477 |
| 20377 | BAEA472 |
| 20378 | BAEA474 |
| 20379 | BAEA190E |
| 20380 | BAE403B |
| 20381 | BAEA395 |
| 20383 | BAEA046E |
| 20386 | BAEA168E |
| 20396 | BAEA172E |
| 20400 | BAEA169E |
| 20403 | BAEA176E |
| 20405 | BAEA432 |
| 20412 | BAEA549 |
| 20415 | BAEA180E |
| 20424 | BAEA159E |
| 20427 | BAEA174E |
| 20428 | BAEA178E |
| 20432 | BAEA531 |
| 20433 | BAEA367 |
| 20434 | BAEA410 |
| 20438 | BAEA143 |
| 20439 | BAEA167E |
| 20441 | BAEA188E |
| 20442 | BAEA132E |
| 20443 | BAEA184E |
| 20450 | BAE961AE |
| 20453 | BAEA368 |
| 20467 | BAEA193E |
| 20469 | BAEA560 |
| 20475 | BAEA555 |
| 20476 | BAEA150E |
| 20479 | BAEA084E |
| 20487 | BAE403D |
| 20490 | BAEA539 |
| 20491 | BAE940A |
| 20492 | BAE940A |
| 20495 | BAEA475 |
| 20496 | BAE947A |
| 20496 | BAEA325 |
| 20497 | BAEA185E |

| BREMI | |
|-------------------|----------|
| 20501 | BAEA548 |
| 20503 | BAEA199E |
| 20505 | BAEA067E |
| 20515 | BAEA191E |
| 20522 | BAEA182E |
| 20524 | BAEA189E |
| 20546 | BAEA194E |
| 20547 | BAEA198E |
| 20553 | BAE403C |
| 20559 | BAEA561 |
| 20561 | BAEA196E |
| 20617 | BAE907AE |
| BSG | |
| BSG 30-835-002 | BAEA387 |
| CHAMPION | |
| AMC504D | BAE504D |
| AMC504F | BAE504F |
| AMC504L | BAE504L |
| AMC506D | BAE506D |
| AMC506F | BAE506F |
| AMC700AK | BAE700AK |
| AMC800B | BAE800B |
| AMC920AX | BAE920AX |
| BAE 947 A | BAEA325 |
| BAE947A/245 | BAEA454 |
| DELCO REMY | |
| 3474221 | BAEA252 |
| 3474232 | BAEA252 |
| 3474282 | BAEA252 |
| DELPHI | |
| 19005252 | BAEA025E |
| CE01841-12B1 | BAEA198E |
| CE10000-12B1 | BAE965A |
| CE10023-12B1 | BAE851AE |
| CE10512-12B1 | BAEA501 |
| CE20009-12B1 | BAEA427 |
| CE20011-12B1 | BAE946A |
| CE20018-12B1 | BAE947A |
| CE20030-12B1 | BAE408AE |
| CE20039-12B1 | BAEA309 |
| CE20042-12B1 | BAEA365 |
| CE20048-12B1 | BAEA354 |
| CE20058-12B1 | BAE800B |
| DS10000-12B1 | BAEA026E |
| GN10018 | BAE907AE |
| GN10204-12B1 | BAEA147E |
| GN10230 | BAEA447A |
| GN10234-12B1 | BAEA199E |
| GN10235-12B1 | BAEA140E |
| GN10239-12B1 | BAEA472 |

| DELPHI | |
|------------------|----------|
| GN10244 | BAEA158E |
| GN10246 | BAEA132E |
| GN10248 | BAEA176E |
| GN10309-12B1 | BAEA174E |
| GN10554-12B1 | BAEA195E |
| GN10572-12B1 | BAEA143 |
| GN10584-12B1 | BAEA557 |
| GN10632-12B1 | BAEA068E |
| DENSO | |
| 029 700-8291 | BAE409A |
| DIC-0102 | BAEA171E |
| DIC-0103 | BAEA184E |
| DIC-0106 | BAEA181E |
| DIC-0107 | BAEA178E |
| DIC-0110 | BAEA480 |
| DIC-0113 | BAEA482 |
| DIC-0116 | BAEA540 |
| GCL 209 | BAEA501 |
| MB 029700-8230 | BAEA501 |
| DODUCO | |
| 7402 | BAEA115 |
| 7403 | BAEA110 |
| DUCELLIER | |
| 2526023 | BAEA251 |
| 2526023 A | BAEA251 |
| 2526049 A | BAEA253 |
| 2526050 A | BAEA252 |
| 520 073 A | BAEA247 |
| 520064 | BAEA251 |
| ELDOR | |
| 78419001 | BAE409A |
| EPS | |
| 1.970.272 | BAEA344 |
| 1.970.365 | BAEA345 |
| 1.970.377 | BAEA354 |
| 1.970.379 S | BAEA350 |
| 1.970.380 S | BAEA365 |
| 1.970.425 | BAEA062E |
| 1.970.427 | BAEA032E |
| 1.970.429 | BAEA043E |
| 1.970.431 | BAEA059E |
| 1.970.433 | BAEA061E |
| 1.970.434 | BAEA044E |
| 1.970.435 | BAEA063E |
| 1.970.436 | BAEA051E |
| 1.970.437 | BAEA065E |
| ERA | |
| 880001 | BAE851AE |
| 880003 | BAE907AE |

| ERA | |
|------------|----------|
| 880006 | BAE408AE |
| 880007 | BAEA043E |
| 880008 | BAE800B |
| 880009 | BAE409A |
| 880010 | BAEA549 |
| 880015 | BAEA344 |
| 880027 | BAE504L |
| 880030 | BAEA546 |
| 880033 | BAE961AE |
| 880035 | BAE946A |
| 880036 | BAE947A |
| 880036 | BAEA454 |
| 880038 | BAE403B |
| 880039 | BAE965A |
| 880040 | BAEA026E |
| 880044 | BAEA025E |
| 880049 | BAEA350 |
| 880052 | BAEA276 |
| 880053 | BAEA275 |
| 880056 | BAEA345 |
| 880057 | BAEA469 |
| 880058 | BAEA354 |
| 880065 | BAEA032E |
| 880066 | BAEA031E |
| 880068 | BAE403C |
| 880070 | BAEA540 |
| 880071 | BAEA165E |
| 880073 | BAEA348 |
| 880074 | BAEA154E |
| 880076 | BAEA021E |
| 880078 | BAEA358 |
| 880085 | BAEA045E |
| 880087 | BAEA351 |
| 880088 | BAE947A |
| 880088 | BAEA325 |
| 880089 | BAE700AK |
| 880091 | BAE940A |
| 880095 | BAEA347 |
| 880098 | BAEA337 |
| 880103 | BAEA387 |
| 880103 | BAEA448 |
| 880109 | BAEA234 |
| 880112 | BAEA560 |
| 880113 | BAEA554 |
| 880114 | BAEA539 |
| 880117 | BAEA048E |
| 880118 | BAEA352 |
| 880121 | BAEA046E |
| 880122 | BAEA041E |
| 880122 | BAEA044E |
| 880124 | BAEA081E |
| 880125 | BAEA359 |
| 880129 | BAEA309 |

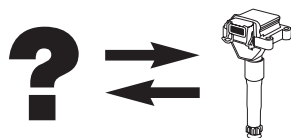

| ERA | CHAMPION | ERA | CHAMPION | FACET | CHAMPION | FACET | CHAMPION |
|--------|----------|------------------|----------|-------------|----------|----------|----------|
| 880131 | BAEA234 | 880278 | BAEA095 | 1.970.105 | BAEA247 | 470108 | BAE506D |
| 880132 | BAEA428 | 880294 | BAEA410 | 1.970.107 | BAEA251 | 470110 | BAEA252 |
| 880138 | BAEA266 | 880295 | BAEA372 | 1.970.108 | BAE506D | 470111 | BAEA252 |
| 880139 | BAEA264 | 880296 | BAEA281 | 1.970.110 | BAEA252 | 470135 | BAEA281 |
| 880140 | BAEA479 | 880297 | BAEA380 | 1.970.111 | BAEA252 | 470140 | BAEA253 |
| 880141 | BAEA267 | 880302 | BAEA080E | 1.970.135 | BAEA281 | 470146 | BAE800B |
| 880145 | BAEA502E | 880307 | BAEA445 | 1.970.140 | BAEA253 | 470158 | BAE506F |
| 880146 | BAEA269 | 880311 | BAEA193E | 1.970.146 | BAE800B | 470159 | BAEA002E |
| 880147 | BAEA561 | 880314 | BAEA531 | 1.970.158 | BAE506F | 470168 | BAEA234 |
| 880148 | BAEA486 | 880317 | BAEA178E | 1.970.159 | BAEA002E | 470174 | BAEA234 |
| 880150 | BAEA521 | 880318 | BAEA088E | 1.970.168 | BAEA234 | 470178 | BAEA296 |
| 880151 | BAEA447A | 880318 | BAEA158E | 1.970.174 | BAEA234 | 470188 | BAEA232 |
| 880152 | BAEA136E | 880320 | BAEA548 | 1.970.178 | BAEA296 | 470189 | BAEA231 |
| 880153 | BAEA427 | 880325 | BAEA453 | 1.970.178 | BAEA339 | 470213 | BAEA276 |
| 880155 | BAEA188E | 880326 | BAEA476 | 1.970.179 | BAEA298 | 470214 | BAEA275 |
| 880157 | BAEA306 | 880334 | BAEA184E | 1.970.188 | BAEA232 | 470228 | BAE504L |
| 880158 | BAEA073E | 880339 | BAEA126E | 1.970.189 | BAEA231 | 470299 S | BAEA281 |
| 880164 | BAEA477 | 880341 | BAEA043 | 1.970.213 | BAEA276 | 470307 | BAEA307 |
| 880165 | BAEA298 | 880345 | BAEA068E | 1.970.214 | BAEA275 | 470341 | BAEA252 |
| 880166 | BAEA059E | 880345 | BAEA137E | 1.970.228 | BAE504L | 470345 | BAE920AX |
| 880179 | BAEA299 | 880347 | BAEA199E | 1.970.299 S | BAEA281 | 470355 | BAEA245 |
| 880180 | BAEA340 | 880348 | BAEA140E | 1.970.307 | BAEA307 | 470355 | BAEA254 |
| 880184 | BAEA234 | 880354 | BAEA185E | 1.970.316 | BAEA340 | 470356 | BAEA246 |
| 880186 | BAEA433 | 880358 | BAEA446 | 1.970.317 | BAEA313 | 470356 | BAEA255 |
| 880188 | BAEA483 | 880362 | BAEA555 | 1.970.341 | BAEA252 | 470376 | BAEA242 |
| 880189 | BAEA543 | 880368 | BAEA394 | 1.970.345 | BAE920AX | 470378 | BAEA243 |
| 880190 | BAEA179E | 880373 | BAEA395 | 1.970.354 | BAEA016 | 470379 S | BAEA350 |
| 880191 | BAEA501 | 880375 | BAEA090 | 1.970.355 | BAEA245 | 470412 | BAEA014 |
| 880193 | BAEA365 | 880376 | BAEA198E | 1.970.355 | BAEA254 | 470417 | BAEA297 |
| 880196 | BAEA434 | 880377 | BAEA131E | 1.970.356 | BAEA246 | 490 423 | BAEA037E |
| 880200 | BAEA143 | 880381 | BAEA432 | 1.970.356 | BAEA255 | 490420 | BAE907AE |
| 880203 | BAEA480 | 880384 | BAEA190E | 1.970.376 | BAEA242 | 9.6002 | BAE506F |
| 880213 | BAEA056E | 880385 | BAEA489 | 1.970.378 | BAEA243 | 9.6005 | BAEA247 |
| 880227 | BAEA368 | 880388 | BAEA084E | 1.970.379 S | BAEA350 | 9.6007 | BAEA251 |
| 880241 | BAEA173E | 880392 | BAEA189E | 1.970.387 | BAEA309 | 9.6008 | BAE506D |
| 880242 | BAEA192E | 880393 | BAEA191E | 1.970.412 | BAEA014 | 9.6010 | BAEA252 |
| 880243 | BAEA164E | 880396 | BAEA132E | 1.970.414 | BAEA304 | 9.6011 | BAEA252 |
| 880244 | BAEA186E | 880399 | BAEA159E | 1.970.417 | BAEA297 | 9.6035 | BAEA281 |
| 880245 | BAEA171E | 880400 | BAEA189E | 1.970.450 | BAEA427 | 9.6040 | BAEA253 |
| 880246 | BAEA474 | 880405 | BAEA556 | 1.990.420 | BAE907AE | 9.6046 | BAE800B |
| 880247 | BAEA181E | 880407 | BAEA180E | 1.990.423 | BAEA037E | 9.6048 | BAE504D |
| 880254 | BAEA367 | 880412 | BAEA182E | 470 178 | BAEA339 | 9.6058 | BAE506F |
| 880255 | BAEA167E | 880439 | BAEA382 | 470 179 | BAEA298 | 9.6059 | BAEA002E |
| 880256 | BAEA172E | 880445 | BAEA557 | 470 316 | BAEA340 | 9.6062 | BAEA014 |
| 880257 | BAEA168E | EUROCABLE | CHAMPION | 470 317 | BAEA313 | 9.6068 | BAEA234 |
| 880258 | BAEA169E | DC-1203 | BAEA486 | 470 352 | BAEA302 | 9.6074 | BAEA234 |
| 880259 | BAEA475 | DC-1225 | BAEA140E | 470 354 | BAEA016 | 9.6075 | BAEA115 |
| 880264 | BAEA175E | EYQUEM | CHAMPION | 470 387 | BAEA309 | 9.6076 | BAEA110 |
| 880266 | BAEA170E | B 6040 | BAEA232 | 470 450 | BAEA427 | 9.6078 | BAEA296 |
| 880272 | BAEA176E | FACET | CHAMPION | 470 414 | BAEA304 | 9.6078 | BAEA339 |
| 880273 | BAEA482 | 1.970.102 | BAE506F | 470102 | BAE506F | 9.6079 | BAEA298 |
| 880274 | BAEA066E | | | 470105 | BAEA247 | 9.6088 | BAEA232 |
| 880277 | BAEA194E | | | 470107 | BAEA251 | 9.6089 | BAEA231 |

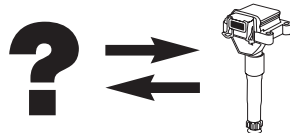

| FACET | |
|----------|----------|
| 9.6113 | BAEA276 |
| 9.6114 | BAEA275 |
| 9.6128 | BAE504L |
| 9.6172 | BAEA344 |
| 9.6199 S | BAEA281 |
| 9.6207 | BAEA307 |
| 9.6213 | BAEA428 |
| 9.6216 | BAEA340 |
| 9.6217 | BAEA313 |
| 9.6223 | BAEA173E |
| 9.6241 | BAEA252 |
| 9.6245 | BAE920AX |
| 9.6254 | BAEA016 |
| 9.6255 | BAEA245 |
| 9.6255 | BAEA254 |
| 9.6256 | BAEA246 |
| 9.6256 | BAEA255 |
| 9.6265 | BAEA345 |
| 9.6276 | BAEA242 |
| 9.6277 | BAEA354 |
| 9.6278 | BAEA243 |
| 9.6279 S | BAEA350 |
| 9.6280 S | BAEA365 |
| 9.6287 | BAEA309 |
| 9.6300 | BAEA147E |
| 9.6305 | BAE946A |
| 9.6312 | BAEA014 |
| 9.6314 | BAEA304 |
| 9.6317 | BAEA297 |
| 9.6319 | BAE947A |
| 9.6325 | BAEA062E |
| 9.6327 | BAEA032E |
| 9.6329 | BAEA043E |
| 9.6331 | BAEA059E |
| 9.6333 | BAEA061E |
| 9.6334 | BAEA044E |
| 9.6336 | BAEA051E |
| 9.6337 | BAEA065E |
| 9.6350 | BAEA427 |
| 9.6361 | BAEA164E |
| 9.6374 | BAE408AE |
| 9.6375 | BAEA143 |
| 9.6375 | BAEA145E |
| 9.6381 | BAEA387 |
| 9.6381 | BAEA448 |
| 9.6392 | BAEA531 |
| 9.6405 | BAEA547 |
| 9.6416 | BAEA489 |
| 9.6422 | BAEA182E |
| 9.6432 | BAEA422 |
| 9.6479 | BAEA536 |
| 9.6485 | BAEA543 |
| 9.8114 | BAE851AE |

| FACET | |
|---------------|----------|
| 9.8118 | BAEA025E |
| 9.8120 | BAE907AE |
| 9.8123 | BAEA037E |
| 96383 | BAEA472 |
| EPS 1.970.377 | BAEA354 |
| EPS 1.970.532 | BAEA422 |
| KW 470 377 | BAEA354 |
| KW 470 532 | BAEA422 |
| FAE | |
| 80209 | BAE965A |
| 80210 | BAEA026E |
| 80254 | BAEA501 |
| FARCOM | |
| 103006 | BAEA174E |
| 103011 | BAEA152E |
| 103013 | BAEA150E |
| FEBI BILSTEIN | |
| 17194 | BAE851AE |
| 19032 | BAE907AE |
| 19929 | BAE800B |
| 21109 | BAEA014 |
| 21524 | BAEA354 |
| 21525 | BAEA345 |
| 21526 | BAEA243 |
| 21527 | BAEA242 |
| 21528 | BAEA251 |
| 21569 | BAEA350 |
| 21666 | BAE409A |
| 22038 | BAE408AE |
| 22389 | BAE965A |
| 22581 | BAEA231 |
| 22697 | BAE920AX |
| 23187 | BAEA342 |
| 23258 | BAEA033E |
| 23260 | BAEA032E |
| 24106 | BAEA043E |
| 24108 | BAEA009E |
| 24435 | BAEA347 |
| 24500 | BAEA059E |
| 24997 | BAE946A |
| 26496 | BAE947A |
| 26869 | BAEA350 |
| 27132 | BAE907AE |
| 27168 | BAEA358 |
| 27470 | BAEA043E |
| 27522 | BAEA359 |
| 28108 | BAEA427 |
| 28487 | BAEA033E |
| 28533 | BAEA339 |
| 28538 | BAEA340 |
| 28548 | BAEA146E |

| FEBI BILSTEIN | |
|---------------|----------|
| 29147 | BAEA302 |
| 29319 | BAEA029E |
| 29412 | BAEA016 |
| 29859 | BAEA051E |
| 30261 | BAEA502E |
| 33666 | BAEA147E |
| 36080 | BAEA144E |
| 36100 | BAEA143 |
| 36113 | BAEA145E |
| 36358 | BAEA033E |
| 36999 | BAEA422 |
| FISPA | |
| 85 30292 | BAEA434 |
| 85 30368 | BAEA137E |
| 85.30006 | BAEA269 |
| 85.30020 | BAEA521 |
| 85.30027 | BAE504F |
| 85.30031 | BAE403D |
| 85.30032 | BAE506D |
| 85.30034 | BAE920AX |
| 85.30036 | BAE800B |
| 85.30040 | BAE504D |
| 85.30041 | BAE506F |
| 85.30042 | BAE504L |
| 85.30043 | BAE403B |
| 85.30044 | BAE700AK |
| 85.30045 | BAE403C |
| 85.30062 | BAE907AE |
| 85.30072 | BAEA051E |
| 85.30089 | BAEA017 |
| 85.30106 | BAE851AE |
| 85.30109 | BAE965A |
| 85.30110 | BAEA063E |
| 85.30111 | BAE946A |
| 85.30144 | BAE947A |
| 85.30153 | BAEA428 |
| 85.30163 | BAEA031E |
| 85.30164 | BAE409A |
| 85.30165 | BAE408AE |
| 85.30166 | BAEA026E |
| 85.30177 | BAEA031E |
| 85.30185 | BAE960AE |
| 85.30190 | BAE940A |
| 85.30194 | BAEA041E |
| 85.30195 | BAEA065E |
| 85.30196 | BAEA061E |
| 85.30197 | BAEA062E |
| 85.30205 | BAEA046E |
| 85.30222 | BAEA306 |
| 85.30237 | BAEA298 |
| 85.30238 | BAEA299 |
| 85.30250 | BAEA095 |

| FISPA | |
|-----------------|----------|
| 85.30251 | BAEA143 |
| 85.30257 | BAEA043 |
| 85.30267 | BAEA136E |
| 85.30279 | BAEA013E |
| 85.30307 | BAEA382 |
| 85.30323 | BAEA073E |
| 85.30335 | BAEA394 |
| 85.30347 | BAEA395 |
| 85.30366 | BAEA067E |
| 85.30366 | BAEA126E |
| 85.30368 | BAEA068E |
| 85.30373 | BAEA140E |
| 85.30393 | BAEA432 |
| 85.30425 | BAEA547 |
| 85.30428 | BAEA084E |
| 85.30441 | BAEA367 |
| 85.30444 | BAEA410 |
| 85.30453 | BAEA042E |
| 85.30454 | BAEA012E |
| 85.30457 | BAEA368 |
| 85.30460 | BAEA132E |
| 85.30503 | BAEA052E |
| HAVAM | |
| 1970272 | BAEA344 |
| 1970308 S | BAEA365 |
| 1970365 | BAEA345 |
| 1970377 | BAEA354 |
| HELLA | |
| 5DA 006 623 711 | BAE851AE |
| 5DA 006 623-621 | BAE851AE |
| 5DA 006 623-701 | BAEA002E |
| 5DA 749 245-291 | BAEA297 |
| 5DA 749 475-001 | BAE800B |
| 5DA 749 475-011 | BAEA231 |
| 5DA 749 475-021 | BAEA232 |
| 5DA 749 475-031 | BAEA354 |
| 5DA 749 475-041 | BAEA234 |
| 5DA 749 475-051 | BAEA307 |
| 5DA 749 475-061 | BAEA340 |
| 5DA 749 475-071 | BAEA313 |
| 5DA 749 475-091 | BAE920AX |
| 5DA 749 475-101 | BAEA245 |
| 5DA 749 475-101 | BAEA254 |
| 5DA 749 475-111 | BAEA242 |
| 5DA 749 475-121 | BAEA016 |
| 5DA 749 475-141 | BAEA021E |
| 5DA 749 475-151 | BAEA281 |
| 5DA 749 475-161 | BAE409A |
| 5DA 749 475-171 | BAE907AE |
| 5DA 749 475-191 | BAEA026E |
| 5DA 749 475-201 | BAEA255 |



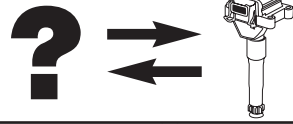

| HELLA | | HERTH+BUSS ELPARTS | | HOFFER | | HÜCO | |
|---------------------------|----------|---------------------------|----------|---------------|----------|--------------|----------|
| 5DA 749 475-211 | BAEA243 | 19050002 | BAE946A | 8010405 | BAEA045E | 133815 | BAEA358 |
| 5DA 749 475-221 | BAEA014 | 19050003 | BAE946A | 8010409 | BAEA380 | 133830 | BAEA031E |
| 5DA 749 475-231 | BAE965A | 19050004 | BAE408AE | 8010414 | BAEA181E | 133834 | BAEA051E |
| 5DA 749 475-281 | BAEA304 | 19050005 | BAEA014 | 8010418 | BAEA347 | 133837 | BAEA501 |
| 5DA 749 475-311 | BAEA302 | 19050007 | BAEA302 | 8010419 | BAEA351 | 133851 | BAEA446 |
| 5DA 749 475-341 | BAEA309 | 19050008 | BAEA309 | 8010420 | BAE947A | 133854 | BAEA472 |
| 5DA 749 475-351 | BAEA162E | 19050010 | BAE409A | 8010421 | BAEA048E | 133864 | BAEA174E |
| 5DA 749 475-401 | BAEA308 | 19050019 | BAE409A | 8010458 | BAEA521 | 133867 | BAEA161E |
| 5DA 749 475-411 | BAEA387 | 19050020 | BAEA032E | 8010460 | BAEA059E | 133878 | BAEA172E |
| 5DA 749 475-441 | BAEA342 | 19050022 | BAEA307 | 8010462 | BAEA387 | 133902 | BAEA158E |
| 5DA 749 475-451 | BAEA358 | 19050025 | BAE965A | 8010470 | BAEA046E | 133909 | BAEA188E |
| 5DA 749 475-461 | BAEA045E | 19050026 | BAEA313 | 8010472 | BAEA352 | 133930 | BAEA176E |
| 5DA 749 475-561 | BAEA501 | 19050029 | BAEA358 | 8010478 | BAE408AE | 133936 | BAEA489 |
| 5DA 749 475-601 | BAEA352 | 19050033 | BAEA055E | 8010480 | BAEA427 | 133941 | BAEA184E |
| 5DA 749 475-611 | BAEA351 | 19050036 | BAEA347 | 8010483 | BAEA359 | 133947 | BAEA181E |
| 5DA 749 475-621 | BAEA256 | 19050037 | BAEA045E | 8010497 | BAEA051E | 133951 | BAEA543 |
| 5DA 749 475-631 | BAEA338 | 19050038 | BAEA046E | 8010498 | BAEA063E | 134008 | BAEA186E |
| 5DA 749 475-641 | BAE946A | 19050039 | BAEA348 | 8010500 | BAEA056E | 134017 | BAEA179E |
| 5DA 749 475-671 | BAEA428 | 19050040 | BAEA351 | 8010501 | BAEA031E | 134044 | BAEA182E |
| 5DA 749 475-691 | BAEA059E | 19050041 | BAEA352 | 8010503 | BAEA065E | 134048 | BAEA185E |
| 5DA 749 475-701 | BAEA061E | 19050043 | BAEA048E | 8010504 | BAEA061E | 134050 | BAEA178E |
| 5DA 749 475-771 | BAEA016 | 19050048 | BAEA051E | 8010505 | BAEA062E | 134058 | BAEA131E |
| 5DA 749 475-781 | BAE409A | 19050049 | BAEA427 | 8010512 | BAEA136E | 138434 | BAEA004E |
| 5DA 749 475-791 | BAEA053 | HITACHI | | 8010541 | BAEA095 | 138435 | BAEA162E |
| 5DA 749 475-801 | BAEA077 | | | 8010559 | BAEA186E | 138438 | BAEA029E |
| 5DA 749 475-811 | BAE965A | 133849 | BAEA549 | 8010573 | BAEA395 | 138708 | BAEA004E |
| 5DA 749 475-821 | BAE907AE | 133854 | BAEA472 | 8010578 | BAEA066E | 138724 | BAEA486 |
| 5DA 749 475-831 | BAEA009E | 133891 | BAEA196E | 8010579 | BAEA194E | 138828 | BAEA159E |
| 5DA 749 475-851 | BAEA143 | 134001 | BAEA410 | 8010599 | BAEA067E | 138877 | BAEA469 |
| 5DA 749 475-851 | BAEA145E | 134006 | BAEA531 | 8010599 | BAEA126E | 139910 | BAEA175E |
| 5DA 749 475-861 | BAE408AE | 134015 | BAEA198E | 8010600 | BAEA140E | 2503909 | BAEA188E |
| 5DA 749 475-871 | BAEA043E | 134019 | BAEA432 | 8010602 | BAEA137E | 2503910 | BAEA175E |
| 5DA 749 475-941 | BAEA081E | 134038 | BAEA192E | 8010606 | BAEA185E | 2503930 | BAEA176E |
| 5DA 749 475-951 | BAEA080E | 138743 | BAEA555 | 8010618 | BAEA531 | HUECO | |
| 5DA 749 475-971 | BAEA132E | 138809 | BAEA448 | 8010662 | BAEA547 | | |
| 5DA749475-661 | BAEA350 | 138823 | BAEA191E | 8010674 | BAEA190E | 024-138811 | BAEA422 |
| HERTH+BUSS ELPARTS | | CM11-201D | BAEA009E | 8010697 | BAEA042E | 13 3800 | BAE409A |
| | | CM11-205 | BAEA021E | 8010711 | BAEA180E | 13 3801 | BAE403C |
| 19 050 028 | BAEA147E | HOFFER | | 8010713 | BAEA131E | 13 3803 | BAEA347 |
| 19 050 031 | BAEA146E | | | 8010759 | BAEA189E | 13 3805 | BAEA016 |
| 19020001 | BAE851AE | 8010315 | BAE965A | 8810391 | BAEA348 | 13 3806 | BAEA043E |
| 19020002 | BAEA002E | 8010324 | BAE946A | HÜCO | | 13 3807 | BAE408AE |
| 19020005 | BAEA002E | 8010326 | BAEA358 | | | 13 3808 | BAEA033E |
| 19020007 | BAE907AE | 8010328 | BAEA043E | 13 3809 | BAE965A | 13 3811 | BAEA014 |
| 19020008 | BAE800B | 8010329 | BAE408AE | 13 3812 | BAEA059E | 13 3816 | BAEA147E |
| 19020009 | BAEA422 | 8010334 | BAEA549 | 13 3832 | BAEA427 | 13 3822 | BAEA146E |
| 19020010 | BAE851AE | 8010336 | BAEA354 | 13 3852 | BAEA408 | 13 3825 | BAEA324 |
| 19020012 | BAEA281 | 8010372 | BAEA031E | 13 3856 | BAEA153E | 13 3827 | BAE403B |
| 19020022 | BAEA344 | 8010373 | BAEA032E | 13 3860 | BAEA081E | 13 3847 | BAEA044E |
| 19020030 | BAEA354 | 8010378 | BAEA309 | 13 3907 | BAEA080E | 13 3850 | BAEA429 |
| 19020035 | BAEA387 | 8010384 | BAEA344 | 13 8814 | BAEA276 | 13 3855 | BAEA152E |
| 19020059 | BAEA422 | 8010395 | BAE940A | 133810 | BAEA342 | 13 3875 | BAEA143 |
| 19050001 | BAEA043E | 8010401 | BAEA502E | 133814 | BAEA340 | 13 3876 | BAEA144E |

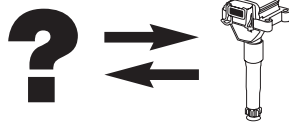

| HUECO | |
|-------------------|----------|
| 13 3880 | BAEA150E |
| 13 3901 | BAEA088E |
| 13 3906 | BAEA132E |
| 13 8416 | BAEA002E |
| 13 8419 | BAE851AE |
| 13 8425 | BAE907AE |
| 13 8430 | BAEA026E |
| 13 8437 | BAEA013E |
| 13 8701 | BAEA002E |
| 13 8702 | BAE851AE |
| 13 8704 | BAE907AE |
| 13 8709 | BAEA297 |
| 13 8710 | BAEA304 |
| 13 8730 | BAE800B |
| 13 8751 | BAEA251 |
| 13 8754 | BAEA247 |
| 13 8756 | BAEA231 |
| 13 8757 | BAEA254 |
| 13 8758 | BAEA255 |
| 13 8759 | BAEA242 |
| 13 8760 | BAEA232 |
| 13 8766 | BAEA243 |
| 13 8780 | BAEA253 |
| 13 8781 | BAEA252 |
| 13 8803 | BAEA350 |
| 13 8805 | BAEA025E |
| 13 8808 | BAEA387 |
| 13 8812 | BAEA275 |
| 13 8817 | BAEA372 |
| 133858 | BAEA021E |
| 133911 | BAEA021E |
| 138717 | BAEA395 |
| 138811 | BAEA422 |
| INTERMOTOR | |
| 11150 | BAEA115 |
| 11220 | BAEA115 |
| 12200 | BAEA252 |
| 12202 | BAEA252 |
| 12203 | BAEA253 |
| 12301 | BAEA251 |
| 12302 | BAEA247 |
| 12428 | BAEA372 |
| 12589 | BAEA242 |
| 12596 | BAEA354 |
| 12602 | BAE506F |
| 12606 | BAEA016 |
| 12607 | BAEA243 |
| 12608 | BAEA014 |
| 12609 | BAEA302 |
| 12613 | BAEA232 |
| 12614 | BAEA281 |
| 12616 | BAEA231 |

| INTERMOTOR | |
|-------------------|----------|
| 12618 | BAEA276 |
| 12621 | BAEA002E |
| 12622 | BAEA014 |
| 12623 | BAEA234 |
| 12626 | BAEA252 |
| 12637 | BAEA234 |
| 12639 | BAEA339 |
| 12659 | BAEA275 |
| 12678 | BAEA344 |
| 12701 | BAEA254 |
| 12702 | BAEA255 |
| 12703 | BAEA281 |
| 12705 | BAEA345 |
| 12710 | BAEA307 |
| 12714 | BAEA350 |
| 12715 | BAEA365 |
| 12717 | BAEA309 |
| 12720 | BAE946A |
| 12722 | BAEA358 |
| 12723 | BAE965A |
| 12724 | BAEA342 |
| 12726 | BAEA029E |
| 12731 | BAEA256 |
| 12736 | BAEA340 |
| 12739 | BAEA501 |
| 12747 | BAEA348 |
| 12749 | BAEA045E |
| 12756 | BAEA351 |
| 12758 | BAEA324 |
| 12764 | BAEA345 |
| 12766 | BAEA347 |
| 12772 | BAEA387 |
| 12778 | BAEA059E |
| 12790 | BAEA044E |
| 12812 | BAEA502E |
| 12818 | BAEA055E |
| 12832 | BAEA056E |
| 12851 | BAEA154E |
| 12859 | BAEA055E |
| 12916 | BAE851AE |
| 12919 | BAE907AE |
| JANMOR | |
| JM5011 | BAE408AE |
| JM5028 | BAEA354 |
| JM5070 | BAEA380 |
| JM5084 | BAEA059E |
| JM5085 | BAEA501 |
| JM5093 | BAEA387 |
| JM5108 | BAEA521 |
| JM5111 | BAEA502E |
| JM5253 | BAEA061E |
| JM5254 | BAEA062E |

| JANMOR | |
|-----------------|----------|
| JM5268 | BAEA065E |
| JM5372 | BAEA088E |
| JM5431 | BAEA140E |
| ODM251 | BAE965A |
| ODM253 | BAEA358 |
| ODM258 | BAEA427 |
| JP GROUP | |
| 881208307 | BAE965A |
| 905062001 | BAE907AE |
| 905066001 | BAE408AE |
| KAGER | |
| 00-0911 | BAE961AE |
| 00-0912 | BAE907AE |
| 00-0914 | BAE408AE |
| 00-0915 | BAEA043E |
| 00-0916 | BAEA029E |
| 60-0020 | BAEA043E |
| 60-0035 | BAEA045E |
| 60-0042 | BAEA354 |
| 60-0061 | BAE408AE |
| 60-0068 | BAE946A |
| 60-0070 | BAEA348 |
| 60-0076 | BAEA032E |
| 60-0078 | BAEA351 |
| 60-0079 | BAEA345 |
| 60-0080 | BAE965A |
| 60-0086 | BAEA358 |
| 60-0094 | BAEA048E |
| 60-0095 | BAEA352 |
| 60-0098 | BAEA046E |
| 60-0108 | BAEA359 |
| 60-0109 | BAE940A |
| 60-0113 | BAEA347 |
| 60-0114 | BAEA427 |
| 60-0121 | BAEA066E |
| KW (KW) | |
| 470 272 | BAEA344 |
| 470 365 | BAEA345 |
| 470 377 | BAEA354 |
| 470 379 S | BAEA350 |
| 470 380 S | BAEA365 |
| 470 427 | BAEA032E |
| 470 429 | BAEA043E |
| 470 431 | BAEA059E |
| 470 433 | BAEA061E |
| 470 434 | BAEA044E |
| 470 435 | BAEA063E |
| 470 436 | BAEA051E |
| LUCAS | |
| DMB 1013 | BAEA434 |

| LUCAS | |
|-------------------------|----------|
| DMB 1026 | BAEA433 |
| DMB 897 | BAEA387 |
| DMB 984 | BAEA084E |
| LUCAS ELECTRICAL | |
| DLB 204 | BAEA251 |
| DLB 205 | BAEA247 |
| DLB 801 | BAE506F |
| DMB 1102 | BAEA429 |
| DMB 408 | BAEA354 |
| DMB 808 | BAEA043E |
| DMB 810 | BAEA365 |
| DMB 816 | BAE965A |
| DMB 851 | BAEA309 |
| DMB 868 | BAEA045E |
| DMB 875 | BAEA351 |
| DMB 886 | BAEA046E |
| DMB 893 | BAEA367 |
| DMB 903 | BAE947A |
| DMB 907 | BAEA059E |
| DMB 910 | BAEA063E |
| DMB 912 | BAEA044E |
| DMB2027 | BAEA198E |
| DMB2070 | BAEA547 |
| DMB406 | BAEA345 |
| DMB408 | BAEA354 |
| LUO'S | |
| L630310 | BAEA502E |
| L740401 | BAE408AE |
| L830106 | BAEA380 |
| MAGNETI MARELLI | |
| 0 60708038010 | BAE800B |
| 0 60740303010 | BAE403C |
| 0 60740304010 | BAE403D |
| 0 60780002010 | BAE800B |
| 0 60794001010 | BAE940A |
| 0 60801012010 | BAEA427 |
| 060705404010 | BAE504D |
| 060705406010 | BAE504F |
| 060705409010 | BAE504L |
| 060705604010 | BAE506D |
| 060705606010 | BAE506F |
| 060705607010 | BAE506D |
| 060707038010 | BAE700AK |
| 060740302010 | BAE403B |
| 060740303010 | BAE403C |
| 060740304010 | BAE403D |
| 060780002010 | BAE800B |
| 060780003010 | BAE800B |
| 060792001010 | BAE920AX |
| 060796105010 | BAE961AE |
| 060801008010 | BAE965A |

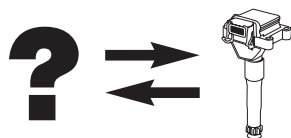

| MAGNETI MARELLI | |
|-------------------------|----------|
| 060810226010 | BAEA174E |
| 60705404 | BAE506F |
| 60705409 | BAE504L |
| 60705606 | BAE506F |
| 60707038 | BAE700AK |
| 60708038 | BAE800B |
| 60740303 | BAE403C |
| 60740304 | BAE403D |
| 60792001 | BAE920AX |
| BAE 403 B | BAE403B |
| BAE 403 C | BAE403C |
| BAE 403 D | BAE403D |
| BAE 504 L | BAE504L |
| BAE 506 | BAE506D |
| BAE 506 D | BAE506D |
| BAE 506 F | BAE506F |
| BAE 608 F | BAE965A |
| BAE 700 AK | BAE700AK |
| BAE 800 AK | BAE800B |
| BAE 800 B | BAE800B |
| BAE 800 DK | BAE800B |
| BAE 920 A | BAE920AX |
| BAE 920 AX | BAE920AX |
| BAE 9961 EA | BAE961AE |
| BAE504D | BAE506F |
| BAE506G | BAE506D |
| BAE680CF | BAEA174E |
| BAE800AK | BAE800B |
| BAE800BAM | BAE800B |
| MAPCO | |
| 80042 | BAE800B |
| 80043 | BAE506D |
| 80100 | BAEA251 |
| 80103 | BAEA354 |
| 80402 | BAEA232 |
| 80563 | BAEA449 |
| 80571 | BAEA502E |
| 80613 | BAEA252 |
| 80616 | BAE965A |
| 80618 | BAEA358 |
| 80619 | BAEA147E |
| 80751 | BAEA281 |
| 80752 | BAEA350 |
| 80752 | BAEA422 |
| 80883 | BAEA043E |
| 80885 | BAE851AE |
| 80886 | BAE408AE |
| 80888 | BAE907AE |
| 80894 | BAEA051E |
| MEAT & DORIA | |
| 0880190 | BAEA140E |

| MEAT & DORIA | |
|-------------------------|----------|
| 10300 | BAE409A |
| 10302 | BAE800B |
| 10303 | BAE920AX |
| 10304 | BAE506F |
| 10305 | BAE506D |
| 10306 | BAEA002E |
| 10307 | BAE907AE |
| 10308 | BAE851AE |
| 10309 | BAE504F |
| 10311 | BAEA234 |
| 10314 | BAEA281 |
| 10315 | BAE965A |
| 10324 | BAE946A |
| 10325 | BAE947A |
| 10326 | BAEA358 |
| 10328 | BAEA043E |
| 10329 | BAE408AE |
| 10331 | BAE403B |
| 10333 | BAE961AE |
| 10336 | BAEA354 |
| 10339 | BAE403D |
| 10340 | BAE700AK |
| 10342 | BAEA016 |
| 10343 | BAEA232 |
| 10344 | BAEA275 |
| 10345 | BAEA242 |
| 10347 | BAEA243 |
| 10349 | BAEA234 |
| 10351 | BAEA324 |
| 10353 | BAEA014 |
| 10356 | BAE403D |
| 10362 | BAEA297 |
| 10366 | BAEA313 |
| 10372 | BAEA031E |
| 10373 | BAEA032E |
| 10374 | BAEA029E |
| 10375 | BAEA256 |
| 10378 | BAEA309 |
| 10380 | BAEA255 |
| 10382 | BAEA307 |
| 10388 | BAEA231 |
| 10391 | BAEA348 |
| 10394 | BAE960AE |
| 10395 | BAE940A |
| 10398 | BAEA342 |
| 10401 | BAEA502E |
| 10405 | BAEA045E |
| 10409 | BAEA380 |
| 10418 | BAEA347 |
| 10419 | BAEA351 |
| 10420 | BAE947A |
| 10439 | BAEA501 |
| 10458 | BAEA521 |

| MEAT & DORIA | |
|-------------------------|----------|
| 10460 | BAEA059E |
| 10462 | BAEA387 |
| 10470 | BAEA046E |
| 10471 | BAEA048E |
| 10472 | BAEA352 |
| 10478 | BAE408AE |
| 10480 | BAEA427 |
| 10483 | BAEA359 |
| 10498 | BAEA063E |
| 10500 | BAEA056E |
| 10501 | BAEA031E |
| 10503 | BAEA065E |
| 10504 | BAEA061E |
| 10505 | BAEA062E |
| 10541 | BAEA095 |
| 10573 | BAEA395 |
| 10599 | BAEA067E |
| 10599 | BAEA126E |
| 10602 | BAEA137E |
| METZGER | |
| 0880002 | BAE965A |
| 0880004 | BAEA342 |
| 0880007 | BAEA358 |
| 0880008 | BAEA147E |
| 0880012 | BAEA427 |
| 0880014 | BAEA143 |
| 0880040 | BAEA152E |
| 0880041 | BAEA153E |
| 0880047 | BAEA549 |
| 0880051 | BAEA340 |
| 0880052 | BAEA146E |
| 0880061 | BAEA004E |
| 0880063 | BAEA149E |
| 0880073 | BAEA387 |
| 0880076 | BAEA502E |
| 0880078 | BAEA051E |
| 0880090 | BAEA501 |
| 0880100 | BAE851AE |
| 0880101 | BAE408AE |
| 0880102 | BAEA043E |
| 0880103 | BAE907AE |
| 0880124 | BAEA181E |
| 0880130 | BAEA382 |
| 0880139 | BAEA144E |
| 0880157 | BAEA174E |
| 0880161 | BAEA145E |
| 0880172 | BAEA422 |
| 0880175 | BAEA449 |
| 0880180 | BAEA095 |
| 0880191 | BAEA150E |
| 0880197 | BAEA472 |
| 0880198 | BAEA126E |

| METZGER | |
|----------------|----------|
| 0880200 | BAE409A |
| 0880204 | BAEA137E |
| 0880205 | BAEA161E |
| 0880250 | BAEA324 |
| 0880350 | BAE800B |
| 0880356 | BAE403B |
| 0880400 | BAEA019E |
| 0880401 | BAEA055E |
| 0880406 | BAEA090 |
| 0880431 | BAEA131E |
| VM-M308 | BAEA351 |
| WM-M003 | BAEA344 |
| WM-M102 | BAEA043E |
| WM-M301 | BAE946A |
| WM-M305 | BAEA045E |
| WM-M306 | BAEA046E |
| MEYLE | |
| 014 158 0000 | BAEA340 |
| 014 885 0006 | BAEA146E |
| 100 885 0007 | BAEA051E |
| 100 885 0040 | BAE408AE |
| 100 905 0007 | BAE851AE |
| 100 905 0019 | BAEA043E |
| 100 905 0021 | BAE907AE |
| 161 488 50002 | BAE409A |
| 214 800 0000 | BAEA115 |
| 214 800 0001 | BAE800B |
| 214 885 0004 | BAE403B |
| 314 131 0000 | BAEA302 |
| 314 139 0000 | BAEA014 |
| 314 885 0000 | BAEA324 |
| 514 885 0004 | BAEA429 |
| 614 885 0004 | BAEA342 |
| 614 885 0006 | BAE965A |
| 614 885 0007 | BAEA427 |
| 614 885 0019 | BAEA174E |
| 714 885 0001 | BAEA387 |
| 714 885 0003 | BAEA422 |
| 7148850000 | BAEA350 |
| NGK | |
| 48000 | BAE851AE |
| 48001 | BAEA350 |
| 48001 | BAEA365 |
| 48001 | BAEA422 |
| 48002 | BAE409A |
| 48003 | BAE408AE |
| 48004 | BAEA427 |
| 48005 | BAEA043E |
| 48006 | BAE965A |
| 48007 | BAEA454 |
| 48008 | BAEA016 |

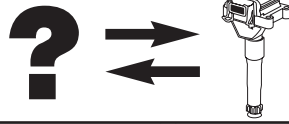

| NGK | CHAMPION |
|-------|----------|
| 48009 | BAEA302 |
| 48010 | BAE907AE |
| 48011 | BAEA342 |
| 48012 | BAEA026E |
| 48013 | BAE800B |
| 48014 | BAEA045E |
| 48015 | BAEA059E |
| 48016 | BAE946A |
| 48017 | BAEA146E |
| 48018 | BAEA340 |
| 48019 | BAEA242 |
| 48020 | BAEA243 |
| 48021 | BAEA281 |
| 48022 | BAEA358 |
| 48024 | BAEA297 |
| 48025 | BAEA234 |
| 48026 | BAEA354 |
| 48027 | BAEA387 |
| 48029 | BAEA252 |
| 48030 | BAEA232 |
| 48031 | BAEA347 |
| 48032 | BAEA348 |
| 48033 | BAEA324 |
| 48034 | BAE403B |
| 48035 | BAEA063E |
| 48036 | BAEA014 |
| 48037 | BAEA154E |
| 48038 | BAEA029E |
| 48039 | BAEA002E |
| 48040 | BAEA051E |
| 48041 | BAEA032E |
| 48042 | BAEA033E |
| 48043 | BAEA147E |
| 48044 | BAEA448 |
| 48047 | BAEA031E |
| 48048 | BAEA162E |
| 48050 | BAEA313 |
| 48051 | BAEA256 |
| 48052 | BAE920AX |
| 48054 | BAEA275 |
| 48055 | BAEA501 |
| 48056 | BAEA344 |
| 48057 | BAEA253 |
| 48058 | BAEA246 |
| 48058 | BAEA255 |
| 48059 | BAEA469 |
| 48061 | BAE403C |
| 48062 | BAEA247 |
| 48063 | BAEA408 |
| 48064 | BAE506D |
| 48065 | BAEA041E |
| 48065 | BAEA044E |
| 48067 | BAEA231 |

| NGK | CHAMPION |
|-------|----------|
| 48068 | BAEA245 |
| 48068 | BAEA254 |
| 48070 | BAEA025E |
| 48071 | BAEA352 |
| 48072 | BAEA351 |
| 48074 | BAEA048E |
| 48076 | BAEA046E |
| 48078 | BAEA345 |
| 48082 | BAEA009E |
| 48083 | BAEA338 |
| 48085 | BAEA304 |
| 48086 | BAEA372 |
| 48087 | BAEA004E |
| 48088 | BAEA061E |
| 48089 | BAEA041 |
| 48092 | BAEA251 |
| 48095 | BAEA165E |
| 48098 | BAEA276 |
| 48101 | BAEA013E |
| 48102 | BAEA549 |
| 48105 | BAEA445 |
| 48106 | BAEA306 |
| 48107 | BAEA164E |
| 48108 | BAE947A |
| 48108 | BAEA325 |
| 48114 | BAE961AE |
| 48115 | BAEA296 |
| 48115 | BAEA298 |
| 48115 | BAEA339 |
| 48116 | BAEA449 |
| 48119 | BAEA308 |
| 48120 | BAEA367 |
| 48122 | BAEA021E |
| 48123 | BAE504L |
| 48124 | BAEA472 |
| 48126 | BAEA359 |
| 48127 | BAEA019E |
| 48129 | BAEA540 |
| 48131 | BAEA053 |
| 48133 | BAEA307 |
| 48134 | BAEA502E |
| 48139 | BAEA081E |
| 48140 | BAEA055E |
| 48141 | BAEA554 |
| 48142 | BAEA447A |
| 48144 | BAEA368 |
| 48147 | BAEA144E |
| 48148 | BAEA560 |
| 48149 | BAEA309 |
| 48150 | BAEA037 |
| 48151 | BAEA149E |
| 48153 | BAEA539 |
| 48154 | BAEA428 |

| NGK | CHAMPION |
|-------|----------|
| 48155 | BAEA337 |
| 48156 | BAEA037E |
| 48157 | BAEA181E |
| 48159 | BAEA150E |
| 48160 | BAEA267 |
| 48162 | BAEA056E |
| 48163 | BAE700AK |
| 48165 | BAEA065E |
| 48167 | BAEA195E |
| 48169 | BAE940A |
| 48170 | BAEA266 |
| 48171 | BAEA429 |
| 48172 | BAE403D |
| 48173 | BAEA264 |
| 48174 | BAEA174E |
| 48178 | BAEA152E |
| 48179 | BAEA170E |
| 48183 | BAEA136E |
| 48184 | BAEA171E |
| 48185 | BAEA380 |
| 48192 | BAEA153E |
| 48201 | BAEA188E |
| 48204 | BAEA394 |
| 48206 | BAEA143 |
| 48206 | BAEA324 |
| 48207 | BAEA077 |
| 48208 | BAEA083E |
| 48209 | BAEA479 |
| 48216 | BAEA145E |
| 48223 | BAEA084E |
| 48225 | BAEA179E |
| 48226 | BAEA080E |
| 48230 | BAEA482 |
| 48234 | BAE960AE |
| 48235 | BAEA172E |
| 48237 | BAEA446 |
| 48239 | BAEA475 |
| 48240 | BAEA168E |
| 48241 | BAEA161E |
| 48242 | BAEA190E |
| 48244 | BAEA073E |
| 48245 | BAEA474 |
| 48254 | BAEA191E |
| 48258 | BAEA194E |
| 48259 | BAEA432 |
| 48266 | BAEA182E |
| 48267 | BAEA196E |
| 48269 | BAEA192E |
| 48273 | BAEA186E |
| 48274 | BAEA531 |
| 48276 | BAEA410 |
| 48278 | BAEA167E |
| 48281 | BAEA072E |

| NGK | CHAMPION |
|-------|----------|
| 48284 | BAEA066E |
| 48286 | BAEA095 |
| 48287 | BAEA483 |
| 48288 | BAEA486 |
| 48289 | BAEA543 |
| 48290 | BAEA477 |
| 48291 | BAEA434 |
| 48292 | BAEA175E |
| 48293 | BAEA176E |
| 48294 | BAEA433 |
| 48295 | BAEA169E |
| 48296 | BAEA561 |
| 48297 | BAEA173E |
| 48302 | BAEA115 |
| 48303 | BAEA115 |
| 48311 | BAEA299 |
| 48312 | BAEA395 |
| 48315 | BAEA480 |
| 48316 | BAEA521 |
| 48318 | BAEA508 |
| 48322 | BAEA453 |
| 48332 | BAEA079E |
| 48337 | BAEA140E |
| 48345 | BAEA546 |
| 48347 | BAEA088E |
| 48348 | BAEA158E |
| 48350 | BAEA132E |
| 48368 | BAEA382 |
| 48369 | BAEA556 |
| 48371 | BAEA269 |
| 48372 | BAEA555 |
| 48376 | BAEA193E |
| 48395 | BAEA184E |
| 48404 | BAEA185E |
| 48406 | BAEA199E |
| 48407 | BAEA198E |
| 48409 | BAEA137E |
| 48410 | BAEA131E |
| 49052 | BAEA548 |
| 49086 | BAE940A |
| U1001 | BAE851AE |
| U1002 | BAEA252 |
| U1003 | BAEA002E |
| U1004 | BAEA275 |
| U1005 | BAEA253 |
| U1006 | BAEA469 |
| U1007 | BAEA247 |
| U1008 | BAE506D |
| U1016 | BAEA276 |
| U1018 | BAEA445 |
| U1023 | BAEA296 |
| U1026 | BAE504L |
| U1028 | BAEA540 |

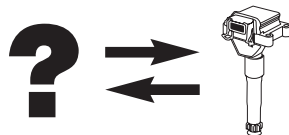

| | | | | | | | |
|------------|----------|------------|----------|------------|----------|-------------------------|----------|
| NGK | | NGK | | NGK | | NGK | |
| U1033 | BAEA560 | U3007 | BAEA255 | U5048 | BAE403D | U6027 | BAEA149E |
| U1035 | BAEA037E | U3009 | BAEA245 | U5049 | BAEA174E | U6028 | BAEA150E |
| U1065 | BAEA115 | U3009 | BAEA254 | U5051 | BAEA170E | U6029 | BAEA152E |
| U1066 | BAEA115 | U3010 | BAEA304 | U5052 | BAEA171E | U6030 | BAEA153E |
| U1074 | BAEA299 | U4001 | BAEA501 | U5055 | BAEA143 | U6033 | BAE960AE |
| U1086 | BAEA394 | U4005 | BAEA308 | U5055 | BAEA324 | U6035 | BAEA508 |
| U2001 | BAEA350 | U4006 | BAEA502E | U5056 | BAEA077 | U6036 | BAEA454 |
| U2001 | BAEA365 | U4007 | BAEA309 | U5058 | BAEA145E | U6037 | BAEA162E |
| U2001 | BAEA422 | U4009 | BAEA429 | U5061 | BAEA080E | U6041 | BAEA199E |
| U2003 | BAE907AE | U4010 | BAEA136E | U5065 | BAEA172E | U6042 | BAEA198E |
| U2004 | BAEA026E | U4011 | BAEA083E | U5066 | BAEA446 | U6055 | BAE940A |
| U2005 | BAEA281 | U4013 | BAEA084E | U5067 | BAEA475 | NIPPARTS | |
| U2006 | BAEA234 | U4020 | BAEA434 | U5068 | BAEA168E | J5368002 | BAEA072E |
| U2007 | BAEA354 | U4021 | BAEA433 | U5069 | BAEA161E | N5363006 | BAEA195E |
| U2008 | BAEA387 | U4026 | BAEA340 | U5071 | BAEA073E | N5366004 | BAEA180E |
| U2010 | BAEA154E | U5001 | BAE409A | U5072 | BAEA474 | NPS | |
| U2011 | BAEA029E | U5002 | BAE408AE | U5077 | BAEA194E | H536111 | BAEA502E |
| U2012 | BAEA448 | U5003 | BAEA043E | U5078 | BAEA432 | OPTIMAL | |
| U2014 | BAE920AX | U5004 | BAEA016 | U5082 | BAEA196E | SPE-116209 | BAE907AE |
| U2016 | BAEA344 | U5005 | BAEA302 | U5089 | BAEA410 | PEX | |
| U2017 | BAEA231 | U5006 | BAEA059E | U5090 | BAEA167E | 110.037 | BAE408AE |
| U2018 | BAEA025E | U5008 | BAEA347 | U5092 | BAEA072E | 110.044 | BAEA345 |
| U2019 | BAEA345 | U5009 | BAEA324 | U5094 | BAEA066E | 110026 | BAEA350 |
| U2023 | BAEA372 | U5010 | BAE403B | U5096 | BAEA095 | 111.034 | BAEA043E |
| U2024 | BAEA004E | U5011 | BAEA063E | U5097 | BAEA175E | 11720 | BAEA354 |
| U2026 | BAEA013E | U5012 | BAEA014 | U5098 | BAEA176E | QH INTERNATIONAL | |
| U2027 | BAEA306 | U5013 | BAEA051E | U5099 | BAEA169E | HP206641 | BAEA358 |
| U2028 | BAE947A | U5014 | BAEA032E | U5100 | BAEA173E | QUINTON HAZELL | |
| U2028 | BAEA325 | U5015 | BAEA033E | U5105 | BAEA453 | XIC 8200 | BAE408AE |
| U2030 | BAEA307 | U5017 | BAEA031E | U5112 | BAEA079E | XIC 8209 | BAEA428 |
| U2031 | BAEA447A | U5018 | BAE403C | U5117 | BAEA140E | XIC 8236 | BAE940A |
| U2033 | BAEA037 | U5019 | BAEA408 | U5119 | BAEA088E | XIC 8254 | BAEA427 |
| U2035 | BAEA267 | U5020 | BAEA044E | U5123 | BAEA132E | XIC 8263 | BAEA387 |
| U2037 | BAEA195E | U5022 | BAEA009E | U5128 | BAEA158E | XIC 8387 | BAEA434 |
| U2038 | BAE940A | U5024 | BAEA061E | U5154 | BAEA137E | XIC 8405 | BAEA433 |
| U2039 | BAEA266 | U5025 | BAEA041 | U6001 | BAEA427 | XIC 8448 | BAEA410 |
| U2040 | BAEA264 | U5027 | BAEA165E | U6002 | BAE965A | XIC8352 | BAEA472 |
| U2041 | BAEA380 | U5028 | BAEA549 | U6003 | BAEA342 | XIC8374 | BAEA174E |
| U2048 | BAEA479 | U5029 | BAEA164E | U6004 | BAEA045E | XIC8417 | BAEA161E |
| U2051 | BAEA482 | U5030 | BAEA449 | U6005 | BAE946A | SAGEM | |
| U2060 | BAEA483 | U5031 | BAEA367 | U6006 | BAEA146E | 21595273-2 | BAE409A |
| U2061 | BAEA486 | U5032 | BAEA021E | U6007 | BAEA358 | 21603121-9 | BAE409A |
| U2063 | BAEA477 | U5033 | BAEA019E | U6009 | BAEA348 | 2526015 | BAE506F |
| U2064 | BAEA561 | U5034 | BAEA053 | U6010 | BAEA147E | 2526015 A | BAE506F |
| U2065 | BAEA395 | U5036 | BAEA081E | U6012 | BAEA256 | 2526030 | BAE506D |
| U2066 | BAEA480 | U5037 | BAEA055E | U6013 | BAEA352 | 2526030 A | BAE506D |
| U2067 | BAEA521 | U5038 | BAEA368 | U6014 | BAEA351 | 2526034 | BAE504L |
| U3001 | BAE800B | U5039 | BAEA144E | U6015 | BAEA048E | 2526034 A | BAE504L |
| U3002 | BAEA242 | U5040 | BAEA428 | U6017 | BAEA046E | | |
| U3003 | BAEA243 | U5041 | BAEA337 | U6019 | BAEA338 | | |
| U3004 | BAEA297 | U5043 | BAEA056E | U6020 | BAE961AE | | |
| U3006 | BAEA313 | U5044 | BAE700AK | U6021 | BAEA472 | | |
| U3007 | BAEA246 | U5046 | BAEA065E | U6022 | BAEA359 | | |

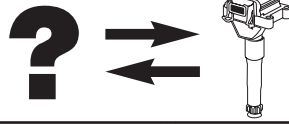

| SAGEM | CHAMPION |
|-----------|----------|
| 2526048 | BAEA251 |
| 2526048 A | BAEA251 |
| 2526049 | BAEA253 |
| 2526049 A | BAEA253 |
| 2526050 | BAEA252 |
| 2526050 A | BAEA252 |
| 2526051 | BAEA254 |
| 2526051 A | BAEA254 |
| 2526052 | BAEA255 |
| 2526052 A | BAEA255 |
| 2526055 A | BAEA344 |
| 2526059 | BAEA256 |
| 2526059 A | BAEA256 |
| 2526078 B | BAEA345 |
| 2526110 | BAEA245 |
| 2526110 A | BAEA245 |
| 2526111 | BAEA246 |
| 2526111 A | BAEA246 |
| 2526114 | BAEA242 |
| 2526114 A | BAEA242 |
| 2526115 | BAEA243 |
| 2526115 A | BAEA243 |
| 2526118 A | BAEA348 |
| 2526131 A | BAEA351 |
| 2526151 A | BAEA354 |
| 2526180 A | BAE409A |
| 2526182 A | BAEA045E |
| 2526182 B | BAEA045E |
| 2526210 | BAEA046E |
| 2526210 A | BAEA046E |
| 2528208 B | BAE946A |
| 520073 | BAEA247 |
| B 6039 | BAEA231 |
| B 6051 | BAEA254 |
| B 6052 | BAEA255 |
| B 6059 | BAEA256 |
| B 6110 | BAEA245 |
| B 6111 | BAEA246 |
| B 6114 | BAEA242 |
| B 6115 | BAEA243 |
| B 6162 | BAEA247 |
| B 6168 | BAE504L |
| B 6171 | BAEA251 |
| B 6172 | BAEA252 |
| B 6186 | BAE506D |
| B 6192 | BAEA253 |
| SIDAT | CHAMPION |
| 85.30273 | BAEA433 |
| 85.30292 | BAEA434 |
| 85.30368 | BAEA137E |
| 85.30001 | BAEA502E |
| 85.30006 | BAEA269 |

| SIDAT | CHAMPION |
|-----------|----------|
| 85.30020 | BAEA521 |
| 85.30027 | BAE504F |
| 85.30031 | BAE403D |
| 85.30032 | BAE506D |
| 85.30034 | BAE920AX |
| 85.30036 | BAE800B |
| 85.30040 | BAE504D |
| 85.30041 | BAE506F |
| 85.30042 | BAE504L |
| 85.30043 | BAE403B |
| 85.30044 | BAE700AK |
| 85.30045 | BAE403C |
| 85.30062 | BAE907AE |
| 85.30089 | BAEA017 |
| 85.30106 | BAE851AE |
| 85.30109 | BAE965A |
| 85.30110 | BAEA063E |
| 85.30111 | BAE946A |
| 85.30144 | BAE947A |
| 85.30153 | BAEA428 |
| 85.30163 | BAEA031E |
| 85.30164 | BAE409A |
| 85.30165 | BAE408AE |
| 85.30177 | BAEA031E |
| 85.30185 | BAE960AE |
| 85.30189 | BAE961AE |
| 85.30190 | BAE940A |
| 85.30194 | BAEA041E |
| 85.30195 | BAEA065E |
| 85.30196 | BAEA061E |
| 85.30197 | BAEA062E |
| 85.30205 | BAEA046E |
| 85.30222 | BAEA306 |
| 85.30237 | BAEA298 |
| 85.30238 | BAEA299 |
| 85.30250 | BAEA095 |
| 85.30251 | BAEA143 |
| 85.30257 | BAEA043 |
| 85.30268 | BAEA427 |
| 85.30275 | BAEA501 |
| 85.30279 | BAEA013E |
| 85.30307 | BAEA382 |
| 85.30323 | BAEA073E |
| 85.30335 | BAEA394 |
| 85.30347 | BAEA395 |
| 85.30366 | BAEA126E |
| 85.-30366 | BAEA067E |
| 85.30368 | BAEA068E |
| 85.30373 | BAEA140E |
| 85.30393 | BAEA432 |
| 85.30425 | BAEA547 |
| 85.30428 | BAEA084E |
| 85.30441 | BAEA367 |

| SIDAT | CHAMPION |
|-------------------|----------|
| 85.30444 | BAEA410 |
| 85.30445 | BAEA180E |
| 85.30453 | BAEA042E |
| 85.30454 | BAEA012E |
| 85.30457 | BAEA368 |
| 85.30460 | BAEA132E |
| 85.30503 | BAEA052E |
| SIDRA | CHAMPION |
| 60705604 | BAE506D |
| BBN0250 | BAE504L |
| BBN0283 | BAE800B |
| SIEMENS | CHAMPION |
| 5 WK9 0611 | BAEA344 |
| STANDARD | CHAMPION |
| 11490 | BAEA546 |
| 12100 | BAEA382 |
| 12101 | BAEA126E |
| 12102 | BAEA068E |
| 12102 | BAEA137E |
| 12103 | BAEA269 |
| 12105 | BAEA017 |
| 12106 | BAEA043 |
| 12108 | BAEA189E |
| 12117 | BAEA052E |
| 12118 | BAEA158E |
| 12119 | BAEA556 |
| 12125 | BAEA395 |
| 12126 | BAEA185E |
| 12129 | BAEA131E |
| 12133 | BAEA555 |
| 12144 | BAEA178E |
| 12145 | BAEA193E |
| 12149 | BAEA547 |
| 12153 | BAEA548 |
| 12154 | BAEA198E |
| 12157 | BAEA189E |
| 12163 | BAEA489 |
| 12164 | BAEA476 |
| 12182 | BAEA557 |
| 12271 | BAEA367 |
| 12400 | BAEA475 |
| 12401 | BAEA168E |
| 12403 | BAEA190E |
| 12405 | BAEA073E |
| 12406 | BAEA474 |
| 12411 | BAEA132E |
| 12417 | BAEA062E |
| 12423 | BAEA521 |
| 12424 | BAEA191E |
| 12428 Interomotor | BAEA372 |
| 12432 | BAEA194E |

| STANDARD | CHAMPION |
|-------------------|----------|
| 12433 | BAEA432 |
| 12441 | BAEA182E |
| 12442 | BAEA196E |
| 12446 | BAEA172E |
| 12446 | BAEA192E |
| 12454 | BAEA186E |
| 12457 | BAEA531 |
| 12459 | BAEA410 |
| 12469 | BAEA453 |
| 12473 | BAEA446 |
| 12481 | BAEA079E |
| 12498 | BAEA199E |
| 12601 | BAE506D |
| 12602 Interomotor | BAE506F |
| 12605 | BAE506F |
| 12605 Interomotor | BAE506F |
| 12619 | BAE800B |
| 12619 Interomotor | BAE800B |
| 12620 | BAE504D |
| 12621 Interomotor | BAEA002E |
| 12640 | BAEA298 |
| 12652 | BAEA445 |
| 12662 | BAE504L |
| 12662 Interomotor | BAE504L |
| 12667 | BAEA560 |
| 12678 Interomotor | BAEA344 |
| 12700 | BAE920AX |
| 12700 Interomotor | BAE920AX |
| 12707 | BAEA469 |
| 12711 | BAE409A |
| 12713 | BAEA306 |
| 12715 Interomotor | BAEA365 |
| 12720 Interomotor | BAE946A |
| 12722 Interomotor | BAEA358 |
| 12723 Interomotor | BAE965A |
| 12725 | BAEA454 |
| 12726 Interomotor | BAEA029E |
| 12727 Interomotor | BAE408AE |
| 12728 Interomotor | BAEA043E |
| 12729 | BAEA549 |
| 12736 Interomotor | BAEA340 |
| 12737 | BAE403B |
| 12737 Interomotor | BAE403B |
| 12739 | BAEA501 |
| 12749 Interomotor | BAEA045E |
| 12754 | BAEA037 |
| 12759 | BAEA150E |
| 12766 Interomotor | BAEA347 |
| 12767 | BAEA046E |
| 12769 | BAEA428 |
| 12772 Interomotor | BAEA387 |
| 12778 Interomotor | BAEA059E |
| 12779 | BAEA554 |

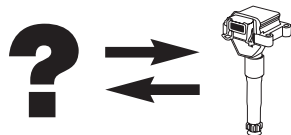

| STANDARD | CHAMPION | STANDARD | CHAMPION | STANDARD | CHAMPION | STANDARD | CHAMPION |
|------------------|----------|----------|----------|----------|----------|----------|----------|
| 12790 | BAEA041E | CP071 | BAEA555 | CU 1409 | BAEA132E | CU1372 | BAEA453 |
| 12791 | BAEA065E | CP079 | BAEA178E | CU 1489 | BAEA137E | CU1380 | BAEA189E |
| 12793 | BAEA539 | CP080 | BAEA193E | CU 1490 | BAEA126E | CU1403 | BAEA172E |
| 12798 | BAEA081E | CP083 | BAEA547 | CU 1509 | BAEA395 | CU1403 | BAEA192E |
| 12802 Intermotor | BAEA427 | CP087 | BAEA548 | CU1001 | BAEA306 | CU1422 | BAEA184E |
| 12807 | BAEA448 | CP088 | BAEA198E | CU1014 | BAEA367 | CU1424 | BAEA195E |
| 12809 | BAEA188E | CP090 | BAEA189E | CU1025 | BAEA017 | CU1425 | BAEA394 |
| 12810 | BAEA136E | CP094 | BAEA489 | CU1029 | BAEA037 | CU1430 | BAEA474 |
| 12818 Intermotor | BAEA055E | CP114 | BAEA190E | CU1031 | BAEA043 | CU1432 | BAEA168E |
| 12824 | BAEA184E | CP127 | BAEA062E | CU1052 | BAEA560 | CU1433 | BAEA084E |
| 12826 | BAEA195E | CP133 | BAEA521 | CU1061 | BAEA269 | CU1438 | BAEA521 |
| 12830 | BAEA031E | CP134 | BAEA191E | CU1069 | BAEA077 | CU1443 | BAEA190E |
| 12832 Intermotor | BAEA056E | CP142 | BAEA194E | CU1080 | BAEA543 | CU1449 | BAEA298 |
| 12840 | BAEA380 | CP143 | BAEA432 | CU1090 | BAEA549 | CU1455 | BAEA191E |
| 12842 | BAEA394 | CP151 | BAEA196E | CU1093 | BAEA486 | CU1463 | BAEA432 |
| 12843 | BAEA174E | CP153 | BAEA192E | CU1098 | BAEA150E | CU1489 | BAEA068E |
| 12846 | BAEA143 | CP160 | BAEA186E | CU1133 | BAEA428 | CU1495 | BAEA546 |
| 12850 | BAEA167E | CP163 | BAEA531 | CU1139 | BAEA454 | CU1500 | BAEA052E |
| 12851 | BAEA154E | CP165 | BAEA410 | CU1160 | BAEA031E | CU1503 | BAEA158E |
| 12853 | BAEA012E | CP171 | BAEA453 | CU1163 | BAEA540 | CU1504 | BAEA556 |
| 12856 | BAEA084E | CP175 | BAEA446 | CU1169 | BAEA013E | CU1510 | BAEA185E |
| 12857 | BAEA077 | CP217 | BAEA298 | CU1173 | BAEA012E | CU1511 | BAEA131E |
| 12858 | BAEA472 | CP226 | BAEA560 | CU1182 | BAEA179E | CU1518 | BAEA382 |
| 12864 | BAEA083E | CP245 | BAEA306 | CU1195 | BAEA434 | CU1521 | BAEA178E |
| 12865 | BAEA179E | CP250 | BAEA549 | CU1204 | BAEA046E | CU1522 | BAEA193E |
| 12867 | BAEA080E | CP260 | BAEA540 | CU1207 | BAEA154E | CU1526 | BAEA548 |
| 12877 | BAEA072E | CP269 | BAEA037 | CU1208 | BAEA065E | CU1530 | BAEA489 |
| 12884 | BAEA095 | CP273 | BAEA150E | CU1211 | BAEA041E | CU1536 | BAEA547 |
| 12887 | BAEA543 | CP279 | BAEA046E | CU1227 | BAEA198E | CU1539 | BAEA189E |
| 12888 | BAEA477 | CP281 | BAEA428 | CU1230 | BAEA448 | CU1558 | BAEA557 |
| 12889 | BAEA140E | CP283 | BAEA367 | CU1237 | BAEA539 | DMB813 | BAE946A |
| 12891 | BAEA434 | CP287 | BAEA554 | CU1241 | BAEA062E | IIS 022 | BAEA072E |
| 12893 | BAEA175E | CP292 | BAEA041E | CU1250 | BAEA561 | IIS 029 | BAEA073E |
| 12897 | BAEA169E | CP293 | BAEA065E | CU1253 | BAEA477 | IIS 058 | BAEA083E |
| 12898 | BAEA561 | CP295 | BAEA539 | CU1256 | BAEA143 | IIS 174 | BAEA081E |
| 12916 Intermotor | BAE851AE | CP308 | BAEA188E | CU1259 | BAEA554 | IIS 220 | BAEA136E |
| 12919 Intermotor | BAE907AE | CP321 | BAEA184E | CU1273 | BAEA172E | IIS 247 | BAEA084E |
| 12923 | BAEA013E | CP326 | BAEA031E | CU1274 | BAEA445 | IIS 252 | BAEA080E |
| CP012 | BAEA454 | CP336 | BAEA380 | CU1282 | BAEA482 | IIS 270 | BAEA095 |
| CP030 | BAEA448 | CP338 | BAEA394 | CU1288 | BAEA410 | IIS 289 | BAEA140E |
| CP033 | BAEA472 | CP339 | BAEA174E | CU1289 | BAEA472 | IIS 300 | BAEA132E |
| CP038 | BAEA199E | CP346 | BAEA154E | CU1291 | BAEA167E | IIS 349 | BAEA410 |
| CP039 | BAEA143 | CP348 | BAEA012E | CU1296 | BAEA380 | IIS 370 | BAEA079E |
| CP040 | BAEA185E | CP351 | BAEA084E | CU1306 | BAEA174E | IIS 389 | BAEA126E |
| CP042 | BAEA382 | CP352 | BAEA077 | CU1309 | BAEA199E | IIS 390 | BAEA137E |
| CP044 | BAEA068E | CP358 | BAEA179E | CU1313 | BAEA164E | IIS001 | BAEA043E |
| CP045 | BAEA269 | CP380 | BAEA543 | CU1315 | BAEA186E | IIS014 | BAEA428 |
| CP047 | BAEA017 | CP384 | BAEA434 | CU1329 | BAEA196E | IIS026 | BAEA170E |
| CP048 | BAEA043 | CP391 | BAEA561 | CU1334 | BAEA446 | IIS030 | BAEA165E |
| CP050 | BAEA189E | CP397 | BAEA013E | CU1339 | BAEA175E | IIS036 | BAEA501 |
| CP057 | BAEA052E | CP411 | BAEA557 | CU1348 | BAEA194E | IIS052 | BAEA031E |
| CP059 | BAEA556 | CU 1374 | BAEA095 | CU1354 | BAEA555 | IIS057 | BAEA190E |
| CP068 | BAEA131E | CU 1385 | BAEA140E | CU1355 | BAEA531 | IIS059 | BAEA549 |

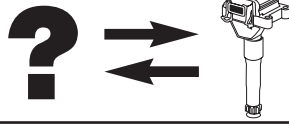





| STANDARD | CHAMPION |
|----------|----------|
| IIS064 | BAEA150E |
| IIS066 | BAEA046E |
| IIS068 | BAEA367 |
| IIS079 | BAEA469 |
| IIS-080 | BAEA365 |
| IIS081 | BAEA445 |
| IIS125 | BAEA041E |
| IIS134 | BAEA540 |
| IIS139 | BAEA546 |
| IIS141 | BAEA037 |
| IIS151 | BAEA448 |
| IIS166 | BAEA306 |
| IIS184 | BAEA013E |
| IIS194 | BAEA560 |
| IIS201 | BAEA188E |
| IIS212 | BAEA472 |
| IIS214 | BAEA539 |
| IIS216 | BAEA298 |
| IIS218 | BAEA143 |
| IIS225 | BAEA195E |
| IIS232 | BAEA065E |
| IIS235 | BAEA174E |
| IIS240 | BAEA380 |
| IIS242 | BAEA394 |
| IIS247 | BAEA084E |
| IIS250 | BAEA179E |
| IIS251 | BAEA077 |
| IIS261 | BAEA154E |
| IIS266 | BAEA454 |
| IIS272 | BAEA543 |
| IIS273 | BAEA477 |
| IIS275 | BAEA434 |
| IIS278 | BAEA175E |
| IIS283 | BAEA561 |
| IIS292 | BAEA475 |
| IIS306 | BAEA531 |
| IIS310 | BAEA521 |
| IIS311 | BAEA191E |
| IIS321 | BAEA194E |
| IIS323 | BAEA432 |
| IIS332 | BAEA196E |
| IIS336 | BAEA192E |
| IIS344 | BAEA186E |
| IIS349 | BAEA410 |
| IIS359 | BAEA453 |
| IIS363 | BAEA446 |
| IIS387 | BAEA199E |
| IIS388 | BAEA382 |
| IIS390 | BAEA068E |
| IIS391 | BAEA269 |
| IIS393 | BAEA017 |
| IIS394 | BAEA043 |
| IIS396 | BAEA189E |

| STANDARD | CHAMPION |
|--------------|-----------------|
| IIS403 | BAEA062E |
| IIS416 | BAEA012E |
| IIS426 | BAEA052E |
| IIS427 | BAEA158E |
| IIS428 | BAEA556 |
| IIS435 | BAEA185E |
| IIS441 | BAEA555 |
| IIS443 | BAEA093E |
| IIS486 | BAEA184E |
| IIS493 | BAEA178E |
| IIS494 | BAEA193E |
| IIS504 | BAEA131E |
| IIS508 | BAEA547 |
| IIS511 | BAEA548 |
| IIS512 | BAEA198E |
| IIS515 | BAEA189E |
| IIS518 | BAEA489 |
| IIS533 | BAEA557 |
| IIS183 | BAEA554 |
| SWAG | CHAMPION |
| 10 92 8548 | BAEA146E |
| 20 92 1109 | BAEA014 |
| 20 93 6080 | BAEA144E |
| 20 93 6100 | BAEA143 |
| 20 93 6113 | BAEA145E |
| 26 92 2581 | BAEA231 |
| 30 91 7194 | BAE851AE |
| 30 91 9032 | BAE907AE |
| 30 92 2038 | BAE408AE |
| 30 92 4500 | BAEA059E |
| 30 92 9859 | BAEA051E |
| 32 92 3260 | BAEA032E |
| 40 92 3187 | BAE965A |
| 40 92 3187 | BAEA342 |
| 40 92 7168 | BAEA358 |
| 40 92 7522 | BAEA359 |
| 40 92 8108 | BAEA427 |
| 40 93 3666 | BAEA147E |
| 50926869 | BAEA350 |
| 60 92 1524 | BAEA354 |
| 60 92 1525 | BAEA345 |
| 60 92 1526 | BAEA243 |
| 60 92 1527 | BAEA242 |
| 60 92 1666 | BAE409A |
| 60 92 4435 | BAEA347 |
| 62 92 4997 | BAE946A |
| 70 91 9929 | BAE800B |
| 70 92 2697 | BAE920AX |
| 90 93 0261 | BAEA502E |
| TESLA | CHAMPION |
| CL 032 | BAEA137E |

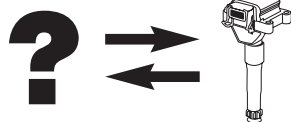



| TESLA | CHAMPION |
|----------------|-----------------|
| CL 548 | BAEA434 |
| CL001 | BAE851AE |
| CL002 | BAE907AE |
| CL003 | BAE408AE |
| CL007 | BAE961AE |
| CL008 | BAE960AE |
| CL024 | BAEA065E |
| CL031 | BAEA126E |
| CL221 | BAEA427 |
| CL323 | BAEA095 |
| CL403 | BAEA387 |
| CL515 | BAEA502E |
| CL532 | BAEA521 |
| CL533 | BAEA136E |
| CL621 | BAEA140E |
| CL707 | BAEA429 |
| CL711 | BAEA501 |
| TOPRAN | CHAMPION |
| 109039 | BAE408AE |
| 109541 | BAEA043E |
| 206 642 | BAEA147E |
| 206638 | BAEA344 |
| 206640 | BAE965A |
| 206641 | BAEA358 |
| 207466 | BAEA427 |
| 302 104 | BAEA422 |
| 302104 | BAEA350 |
| 501401 | BAEA382 |
| 721405 | BAE946A |
| 721409 | BAEA347 |
| TRISCAN | CHAMPION |
| 8860 15014 | BAEA309 |
| 8860 15016 | BAEA428 |
| 8860 24011 | BAEA358 |
| 8860 24012 | BAE965A |
| 8860 28002 | BAE946A |
| 8860 28004 | BAEA045E |
| 8860 29020 | BAEA043E |
| 8860 29023 | BAEA032E |
| 8860 29024 | BAE408AE |
| 8860 43007 | BAEA502E |
| 886011012 | BAEA145E |
| 886011013 | BAEA143 |
| 886011014 | BAEA144E |
| 886013017 | BAEA449 |
| 8860-17009 | BAEA501 |
| 886023010 | BAEA146E |
| 886024009 | BAEA147E |
| 886024016 | BAEA149E |
| VALEO | CHAMPION |
| 138419 | BAE851AE |

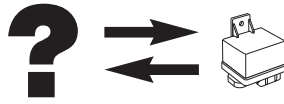

| VALEO | CHAMPION |
|-------------|----------|
| 2 526 037 A | BAEA232 |
| 2 526 040 | BAEA232 |
| 2 526 040 A | BAEA232 |
| 21597716-4 | BAEA352 |
| 21603121-9 | BAE409A |
| 245 040 | BAEA232 |
| 245000 | BAEA110 |
| 245027 | BAEA247 |
| 245041 | BAEA231 |
| 245042 | BAEA253 |
| 245043 | BAEA252 |
| 245046 | BAEA256 |
| 245049 | BAE506D |
| 245052 | BAE506F |
| 245054 | BAEA251 |
| 245057 | BAEA344 |
| 245058 | BAEA115 |
| 245062 | BAEA252 |
| 245066 | BAEA254 |
| 245067 | BAEA255 |
| 245068 | BAE504L |
| 245076 | BAEA245 |
| 245077 | BAEA246 |
| 245079 | BAEA345 |
| 245080 | BAEA296 |
| 245092 | BAE851AE |
| 245093 | BAEA002E |
| 245094 | BAEA347 |
| 245095 | BAEA045E |
| 245096 | BAEA046E |
| 245097 | BAE946A |
| 245098 | BAEA348 |
| 245100 | BAEA351 |
| 245101 | BAEA352 |
| 245103 | BAEA048E |
| 245104 | BAE409A |
| 245105 | BAEA354 |
| 245106 | BAEA242 |
| 245107 | BAEA243 |
| 245108 | BAEA342 |
| 245111 | BAE800B |
| 245116 | BAE403B |
| 245139 | BAEA350 |
| 245141 | BAE408AE |
| 245178 | BAEA164E |
| 245179 | BAEA026E |
| 2526015 | BAE506F |
| 2526023 | BAEA251 |
| 2526030 | BAE506D |
| 2526034 | BAE504L |
| 2526035 A | BAEA231 |
| 2526039 | BAEA231 |
| 2526048 | BAEA251 |



| VALEO |  | VEMO |  |
|---------------|---|---------------|---|
| 2526049 | BAEA253 | V10-70-0063 | BAEA044E |
| 2526050 | BAEA252 | V10-70-0064 | BAEA063E |
| 2526051 | BAEA254 | V10-70-0066 | BAEA065E |
| 2526052 | BAEA255 | V10-70-0067 | BAEA062E |
| 2526059 | BAEA256 | V10-70-0068 | BAEA061E |
| 2526062 | BAEA252 | V10-70-0069 | BAEA004E |
| 2526110 | BAEA245 | V10-70-0098 | BAEA067E |
| 2526111 | BAEA246 | V10-70-0098 | BAEA126E |
| 2526116A | BAEA342 | V10-70-0099 | BAEA137E |
| 520019 | BAEA110 | V20-70-0013 | BAEA143 |
| 520041 | BAEA115 | V20-70-0013 | BAEA144E |
| 520064 A | BAEA251 | V20-70-0013 | BAEA324 |
| B 6051 | BAEA254 | V20-70-0014 | BAEA324 |
| B 6052 | BAEA255 | V20-70-0017 | BAEA143 |
| B 6114 | BAEA242 | V24-70-0003 | BAE800B |
| CD 308 | BAEA247 | V24-70-0004 | BAE403B |
| CD 325 | BAEA251 | V24-70-0008 | BAEA428 |
| CD 331 | BAEA232 | V25-70-0001 | BAEA350 |
| CD 338 | BAEA253 | V25-70-0001 | BAEA422 |
| CD 339 | BAEA252 | V25-70-0001-1 | BAEA350 |
| CD 440 | BAEA344 | V25-70-0001-1 | BAEA422 |
| CD 443 | BAEA252 | V25-70-0003 | BAEA281 |
| VEMO |  | V25-70-0009 | BAEA387 |
| 10-70-0012 | BAE408AE | V26-70-0021 | BAEA175E |
| 10-70-0013 | BAEA043E | V30-70-0012 | BAEA340 |
| 10-70-0014 | BAEA002E | V30-70-0015 | BAEA146E |
| 10-70-0044 | BAE907AE | V40-70-0010 | BAEA026E |
| 10-70-0045 | BAEA016 | V40-70-0015 | BAEA342 |
| 10-70-0046 | BAEA029E | V40-70-0015-1 | BAEA342 |
| 10-70-0047 | BAE961AE | V40-70-0017 | BAEA427 |
| 10-70-0058 | BAEA031E | V40-70-0044 | BAEA358 |
| 20-70-0011 | BAEA014 | V40-70-0045 | BAEA147E |
| 20-70-0012 | BAEA302 | V40-70-0048 | BAEA359 |
| 20-70-0013 | BAEA324 | V40-70-0067 | BAEA150E |
| 20-70-0014 | BAEA324 | V40-70-0069 | BAEA152E |
| 25-70-0001 | BAEA350 | V40-70-0071 | BAEA149E |
| 25-70-0003 | BAEA281 | V40-70-0072 | BAEA153E |
| 30-70-0012 | BAEA340 | V40-70-0074 | BAEA174E |
| 40-70-0011 | BAEA253 | V42-70-0001 | BAE946A |
| 40-70-0015 | BAEA342 | V42-70-0012 | BAEA472 |
| 40-70-0016 | BAE965A | V46-70-0001 | BAE409A |
| V 37-70-0032 | BAEA395 | V46-70-0002 | BAEA354 |
| V10-70-0010 | BAE851AE | V49-70-0003 | BAEA501 |
| V10-70-0012 | BAE408AE | V52-70-0014 | BAEA536 |
| V10-70-0013 | BAEA043E | V64-70-0009 | BAEA136E |
| V10-70-0013-1 | BAEA043E | V70-70-0015 | BAEA449 |
| V10-70-0044 | BAE907AE | V95-70-0007 | BAEA429 |
| V10-70-0046 | BAEA029E | | |
| V10-70-0054 | BAEA032E | | |
| V10-70-0059 | BAEA059E | | |
| V10-70-0060 | BAEA033E | | |
| V10-70-0062 | BAEA051E | | |



| BERU  | |
|--|--------|
| 0 522 140 202 | CCU114 |
| 0 522 140 205 | CCU114 |
| 0 522 140 207 | CCU116 |
| 0 522 140 209 | CCU116 |
| 0 522 140 210 | CCU114 |
| GR081 | CCU081 |
| GSE101 | CCU101 |
| GSE102 | CCU102 |
| GSE104 | CCU104 |
| GSE105 | CCU105 |
| GSE106 | CCU106 |
| GSE108 | CCU108 |
| GSE110 | CCU110 |
| GSE113 | CCU113 |
| GSE114 | CCU114 |
| GSE116 | CCU116 |
| GSE118 | CCU118 |
| GSE128 | CCU128 |
| GSE129 | CCU129 |
| GSE138 | CCU138 |
| GSE140 | CCU140 |
| GSE141 | CCU141 |
| GSE142 | CCU142 |
| GSE143 | CCU143 |
| GSE144 | CCU144 |
| GSE145 | CCU145 |
| GSE147 | CCU147 |
| GSE148 | CCU148 |
| GSE149 | CCU149 |
| GSE150 | CCU150 |
| GSE151 | CCU151 |
| GSE152 | CCU152 |
| GSE153 | CCU153 |
| GSE154 | CCU154 |
| GSE156 | CCU156 |
| BORGWARNER  | |
| B2110017780A0 | CCU138 |
| E2110022364A0 | CCU118 |
| E2110022365A0 | CCU110 |
| E2110022366A0 | CCU113 |
| E2110022368A0 | CCU108 |
| E2110022583A1 | CCU152 |
| E2110022584A1 | CCU153 |
| E2110033672A0 | CCU154 |
| E6018815652A1 | CCU104 |
| DELPHI  | |
| HDC139 | CCU149 |
| HDC142 | CCU148 |
| FEBI BILSTEIN  | |
| 18342 | CCU149 |
| 38310 | CCU156 |

| HELLA  | |
|--|--------|
| 4RV008188-271 | CCU148 |
| HÜCO  | |
| 132074 | CCU129 |
| 132079 | CCU128 |
| 132080 | CCU148 |
| 132088 | CCU149 |
| SWAG  | |
| 10938310 | CCU156 |
| 62918342 | CCU149 |



| BERU | CHAMPION | BERU | CHAMPION | BERU | CHAMPION | BERU | CHAMPION |
|-------------|-----------------|-------------|-----------------|-------------|-----------------|-------------|-----------------|
| ZEF765 | CLS001 | ZEF1190 | CLS179 | ZEF1539 | CLS074 | ZEF463 | CLS203 |
| ZEF1012 | CLS002 | ZEF1193 | CLS236 | ZEF1540 | CLS075 | ZEF466 | CLS098 |
| ZEF1015 | CLS003 | ZEF1194 | CLS180 | ZEF1545 | CLS193 | ZEF470 | CLS204 |
| ZEF1023 | CLS004 | ZEF1196 | CLS181 | ZEF1546 | CLS076 | ZEF471 | CLS205 |
| ZEF1044 | CLS005 | ZEF1197 | CLS237 | ZEF1549 | CLS077 | ZEF472 | CLS206 |
| ZEF1058 | CLS006 | ZEF1198 | CLS042 | ZEF1556 | CLS078 | ZEF487 | CLS207 |
| ZEF1066 | CLS007 | ZEF1199 | CLS043 | ZEF1557 | CLS079 | ZEF501 | CLS208 |
| ZEF1072 | CLS008 | ZEF1200 | CLS182 | ZEF1561 | CLS080 | ZEF520 | CLS249 |
| ZEF1076 | CLS009 | ZEF1201 | CLS044 | ZEF1572 | CLS081 | ZEF558 | CLS250 |
| ZEF1082 | CLS010 | ZEF1203 | CLS045 | ZEF1596 | CLS243 | ZEF561 | CLS099 |
| ZEF1094 | CLS011 | ZEF1219 | CLS046 | ZEF1598 | CLS082 | ZEF562 | CLS100 |
| ZEF1099 | CLS012 | ZEF1222 | CLS238 | ZEF1602 | CLS083 | ZEF567 | CLS210 |
| ZEF1103 | CLS168 | ZEF1223 | CLS047 | ZEF1604 | CLS084 | ZEF570 | CLS101 |
| ZEF1104 | CLS169 | ZEF1224 | CLS048 | ZEF1608 | CLS085 | ZEF571 | CLS166 |
| ZEF1105 | CLS013 | ZEF1226 | CLS049 | ZEF1609 | CLS086 | ZEF573 | CLS211 |
| ZEF1108 | CLS170 | ZEF1228 | CLS183 | ZEF1612 | CLS194 | ZEF574 | CLS212 |
| ZEF1111 | CLS171 | ZEF1230 | CLS184 | ZEF1625 | CLS195 | ZEF578 | CLS213 |
| ZEF1113 | CLS014 | ZEF1231 | CLS050 | ZEF1627 | CLS088 | ZEF579 | CLS214 |
| ZEF1114 | CLS015 | ZEF1232 | CLS051 | ZEF1628 | CLS089 | ZEF580 | CLS102 |
| ZEF1115 | CLS016 | ZEF1233 | CLS185 | ZEF1629 | CLS090 | ZEF581 | CLS103 |
| ZEF1117 | CLS017 | ZEF1236 | CLS186 | ZEF1633 | CLS091 | ZEF586 | CLS215 |
| ZEF1118 | CLS018 | ZEF1251 | CLS052 | ZEF1634 | CLS092 | ZEF597 | CLS216 |
| ZEF1127 | CLS172 | ZEF1252 | CLS239 | ZEF1635 | CLS196 | ZEF598 | CLS217 |
| ZEF1128 | CLS019 | ZEF1253 | CLS187 | ZEF1636 | CLS167 | ZEF601 | CLS251 |
| ZEF1129 | CLS020 | ZEF1255 | CLS053 | ZEF1638 | CLS093 | ZEF607 | CLS104 |
| ZEF1130 | CLS021 | ZEF1260 | CLS240 | ZEF1639 | CLS094 | ZEF612 | CLS105 |
| ZEF1131 | CLS022 | ZEF1262 | CLS188 | ZEF1640 | CLS197 | ZEF627 | CLS218 |
| ZEF1135 | CLS023 | ZEF1272 | CLS189 | ZEF1641 | CLS256 | ZEF635 | CLS219 |
| ZEF1136 | CLS024 | ZEF1327 | CLS241 | ZEF1642 | CLS257 | ZEF641 | CLS252 |
| ZEF1140 | CLS173 | ZEF1338 | CLS054 | ZEF1643 | CLS198 | ZEF642 | CLS106 |
| ZEF1142 | CLS025 | ZEF1340 | CLS190 | ZEF1644 | CLS095 | ZEF665 | CLS220 |
| ZEF1147 | CLS026 | ZEF1348 | CLS055 | ZEF1646 | CLS096 | ZEF670 | CLS253 |
| ZEF1148 | CLS174 | ZEF1360 | CLS056 | ZEF1652 | CLS144 | ZEF672 | CLS107 |
| ZEF1149 | CLS027 | ZEF1367 | CLS057 | ZEF1655 | CLS147 | ZEF707 | CLS108 |
| ZEF1150 | CLS028 | ZEF1370 | CLS058 | ZEF1656 | CLS148 | ZEF716 | CLS109 |
| ZEF1152 | CLS175 | ZEF1377 | CLS059 | ZEF1657 | CLS149 | ZEF717 | CLS110 |
| ZEF1159 | CLS029 | ZEF1391 | CLS060 | ZEF1661 | CLS153 | ZEF719 | CLS111 |
| ZEF1160 | CLS030 | ZEF1397 | CLS061 | ZEF1663 | CLS155 | ZEF720 | CLS112 |
| ZEF1161 | CLS176 | ZEF1399 | CLS191 | ZEF1664 | CLS156 | ZEF724 | CLS113 |
| ZEF1166 | CLS031 | ZEF1409 | CLS062 | ZEF1665 | CLS157 | ZEF725 | CLS114 |
| ZEF1168 | CLS150 | ZEF1412 | CLS063 | ZEF1667 | CLS159 | ZEF727 | CLS115 |
| ZEF1173 | CLS032 | ZEF1442 | CLS064 | ZEF1669 | CLS161 | ZEF731 | CLS116 |
| ZEF1175 | CLS177 | ZEF1450 | CLS065 | ZEF1671 | CLS163 | ZEF734 | CLS221 |
| ZEF1178 | CLS033 | ZEF1475 | CLS066 | ZEF298 | CLS199 | ZEF735 | CLS117 |
| ZEF1180 | CLS034 | ZEF1477 | CLS067 | ZEF303 | CLS244 | ZEF739 | CLS222 |
| ZEF1181 | CLS035 | ZEF1479 | CLS068 | ZEF304 | CLS245 | ZEF755 | CLS223 |
| ZEF1182 | CLS036 | ZEF1480 | CLS069 | ZEF309 | CLS246 | ZEF757 | CLS224 |
| ZEF1183 | CLS037 | ZEF1488 | CLS242 | ZEF363 | CLS247 | ZEF765 | CLS255 |
| ZEF1184 | CLS038 | ZEF1496 | CLS070 | ZEF364 | CLS200 | ZEF769 | CLS225 |
| ZEF1185 | CLS039 | ZEF1497 | CLS192 | ZEF406 | CLS201 | ZEF771 | CLS118 |
| ZEF1186 | CLS040 | ZEF1515 | CLS071 | ZEF408 | CLS248 | ZEF776 | CLS258 |
| ZEF1187 | CLS178 | ZEF1519 | CLS072 | ZEF432 | CLS097 | ZEF777 | CLS119 |
| ZEF1189 | CLS041 | ZEF1530 | CLS073 | ZEF437 | CLS202 | ZEF781 | CLS120 |



| BERU | |
|-------------|--------|
| ZEF783 | CLS121 |
| ZEF784 | CLS122 |
| ZEF787 | CLS261 |
| ZEF789 | CLS226 |
| ZEF793 | CLS123 |
| ZEF795 | CLS124 |
| ZEF796 | CLS125 |
| ZEF797 | CLS126 |
| ZEF802 | CLS227 |
| ZEF811 | CLS127 |
| ZEF813 | CLS262 |
| ZEF830 | CLS228 |
| ZEF839 | CLS128 |
| ZEF840 | CLS129 |
| ZEF850 | CLS130 |
| ZEF856 | CLS131 |
| ZEF859 | CLS229 |
| ZEF891 | CLS132 |
| ZEF895 | CLS133 |
| ZEF913 | CLS134 |
| ZEF915 | CLS230 |
| ZEF917 | CLS259 |
| ZEF934 | CLS231 |
| ZEF947 | CLS232 |
| ZEF949 | CLS233 |
| ZEF952 | CLS234 |
| ZEF967 | CLS135 |
| ZEF968 | CLS136 |
| ZEF983 | CLS137 |
| ZEF985 | CLS235 |
| ZEF987 | CLS254 |
| ZEF988 | CLS138 |
| ZEF989 | CLS139 |
| ZEF990 | CLS260 |
| ZEF991 | CLS140 |
| ZEF995 | CLS141 |

| BOSCH | |
|---------------|--------|
| 0 356 901 821 | CLS104 |
| 0 356 912 820 | CLS235 |
| 0 356 912 821 | CLS235 |
| 0 356 912 825 | CLS235 |
| 0 356 912 828 | CLS227 |
| 0 356 912 844 | CLS235 |
| 0 356 912 860 | CLS055 |
| 0 356 912 862 | CLS055 |
| 0 356 912 874 | CLS098 |
| 0 356 912 881 | CLS136 |
| 0 356 912 946 | CLS235 |
| 0 356 912 947 | CLS235 |
| 0 356 912 981 | CLS055 |
| 0 986 356 308 | CLS260 |
| 0 986 356 317 | CLS110 |

| BOSCH | |
|---------------|--------|
| 0 986 356 371 | CLS095 |
| 0 986 356 700 | CLS121 |
| 0 986 356 705 | CLS133 |
| 0 986 356 706 | CLS127 |
| 0 986 356 710 | CLS225 |
| 0 986 356 715 | CLS116 |
| 0 986 356 717 | CLS003 |
| 0 986 356 718 | CLS004 |
| 0 986 356 719 | CLS255 |
| 0 986 356 720 | CLS182 |
| 0 986 356 727 | CLS005 |
| 0 986 356 728 | CLS228 |
| 0 986 356 731 | CLS061 |
| 0 986 356 735 | CLS131 |
| 0 986 356 742 | CLS056 |
| 0 986 356 747 | CLS018 |
| 0 986 356 748 | CLS061 |
| 0 986 356 754 | CLS261 |
| 0 986 356 756 | CLS230 |
| 0 986 356 761 | CLS118 |
| 0 986 356 767 | CLS123 |
| 0 986 356 773 | CLS179 |
| 0 986 356 778 | CLS030 |
| 0 986 356 785 | CLS118 |
| 0 986 356 787 | CLS137 |
| 0 986 356 795 | CLS223 |
| 0 986 356 798 | CLS126 |
| 0 986 356 801 | CLS102 |
| 0 986 356 802 | CLS022 |
| 0 986 356 805 | CLS111 |
| 0 986 356 808 | CLS107 |
| 0 986 356 817 | CLS051 |
| 0 986 356 818 | CLS136 |
| 0 986 356 821 | CLS132 |
| 0 986 356 827 | CLS222 |
| 0 986 356 837 | CLS229 |
| 0 986 356 849 | CLS127 |
| 0 986 356 853 | CLS119 |
| 0 986 356 854 | CLS123 |
| 0 986 356 855 | CLS134 |
| 0 986 356 859 | CLS131 |
| 0 986 356 862 | CLS101 |
| 0 986 356 863 | CLS226 |
| 0 986 356 866 | CLS179 |
| 0 986 356 886 | CLS211 |
| 0 986 356 887 | CLS122 |
| 0 986 356 888 | CLS117 |
| 0 986 356 898 | CLS072 |
| 0 986 356 923 | CLS171 |
| 0 986 356 940 | CLS125 |
| 0 986 356 961 | CLS014 |
| 0 986 356 967 | CLS039 |
| 0 986 356 989 | CLS024 |

| BOSCH | |
|---------------|--------|
| 0 986 357 055 | CLS175 |
| 0 986 357 077 | CLS227 |
| 0 986 357 090 | CLS049 |
| 0 986 357 181 | CLS044 |
| 0 986 357 184 | CLS011 |
| 0 986 357 210 | CLS052 |
| 0 986 357 259 | CLS096 |
| 0 986 357 271 | CLS074 |
| B 271 | CLS074 |
| B 855 | CLS134 |

| BOUGICORD | |
|------------------|--------|
| 1420 | CLS116 |
| 1431 | CLS039 |
| 2451 | CLS221 |
| 2456 | CLS117 |
| 2457 | CLS019 |
| 3104 | CLS222 |
| 3395 | CLS223 |
| 3413 | CLS224 |
| 4003 | CLS255 |
| 4008 | CLS225 |
| 4020 | CLS118 |
| 4061 | CLS258 |
| 4081 | CLS119 |
| 4086 | CLS179 |
| 4102 | CLS027 |
| 4103 | CLS105 |
| 4110 | CLS098 |
| 4111 | CLS250 |
| 4113 | CLS027 |
| 4114 | CLS208 |
| 4115 | CLS204 |
| 4122 | CLS211 |
| 4123 | CLS101 |
| 4125 | CLS105 |
| 4147 | CLS120 |
| 4149 | CLS121 |
| 4150 | CLS122 |
| 4154 | CLS210 |
| 4155 | CLS174 |
| 4158 | CLS261 |
| 4162 | CLS136 |
| 4166 | CLS248 |
| 4204 | CLS035 |
| 4205 | CLS178 |
| 4206 | CLS044 |
| 4207 | CLS260 |
| 4304 | CLS226 |
| 4331 | CLS123 |
| 4334 | CLS124 |
| 4404 | CLS125 |
| 4405 | CLS126 |

| BOUGICORD | |
|------------------|--------|
| 6104 | CLS129 |
| 6202 | CLS227 |
| 6462 | CLS051 |
| 6469 | CLS050 |
| 6475 | CLS195 |
| 6812 | CLS133 |
| 7153 | CLS199 |
| 7155 | CLS098 |
| 7160 | CLS204 |
| 7162 | CLS201 |
| 7164 | CLS203 |
| 7168 | CLS250 |
| 7192 | CLS259 |
| 7214 | CLS061 |
| 7214 | CLS095 |
| 7219 | CLS127 |
| 7240 | CLS180 |
| 7241 | CLS102 |
| 7242 | CLS097 |
| 7243 | CLS097 |
| 7244 | CLS097 |
| 7245 | CLS027 |
| 7283 | CLS002 |
| 7284 | CLS135 |
| 7416 | CLS055 |
| 7418 | CLS111 |
| 7419 | CLS015 |
| 7420 | CLS052 |
| 7421 | CLS017 |
| 7423 | CLS140 |

| BRECAV | |
|---------------|--------|
| 06.5100 | CLS067 |
| 06.580 | CLS137 |
| 06.598 | CLS044 |
| 15.543 | CLS077 |
| CBR25100 | CLS067 |
| CBR2571 | CLS137 |
| CBR2598 | CLS044 |
| CBR2643 | CLS077 |

| BREMI | |
|--------------|--------|
| 203/200 | CLS054 |
| 205/200 | CLS181 |
| 205F200 | CLS184 |
| 206F200 | CLS017 |
| 206M200 | CLS048 |
| 206N200 | CLS070 |
| 206P200 | CLS048 |
| 210 | CLS107 |
| 212F200 | CLS240 |
| 220G200 | CLS260 |
| 220H200 | CLS260 |



| BREMI | CHAMPION |
|---------|----------|
| 221/200 | CLS048 |
| 221E200 | CLS048 |
| 221F200 | CLS048 |
| 221H200 | CLS048 |
| 222D200 | CLS177 |
| 222G200 | CLS140 |
| 223E200 | CLS139 |
| 223H200 | CLS139 |
| 225 | CLS216 |
| 225 | CLS254 |
| 226 | CLS252 |
| 226 | CLS254 |
| 227 | CLS106 |
| 229K200 | CLS237 |
| 231J100 | CLS041 |
| 233/200 | CLS046 |
| 236 | CLS180 |
| 251 | CLS001 |
| 255 | CLS172 |
| 257 | CLS204 |
| 258 | CLS098 |
| 259 | CLS207 |
| 260 | CLS208 |
| 260M200 | CLS017 |
| 261 | CLS205 |
| 262 | CLS206 |
| 263 | CLS250 |
| 264 | CLS217 |
| 266 | CLS219 |
| 267 | CLS027 |
| 270 | CLS027 |
| 271 | CLS027 |
| 280 | CLS216 |
| 281/100 | CLS036 |
| 287/200 | CLS037 |
| 295 | CLS028 |
| 296 | CLS027 |
| 296 B | CLS079 |
| 299 | CLS249 |
| 300/176 | CLS119 |
| 300/201 | CLS107 |
| 300/373 | CLS166 |
| 300/374 | CLS101 |
| 300/375 | CLS166 |
| 300/378 | CLS214 |
| 300/379 | CLS101 |
| 300/380 | CLS211 |
| 300/381 | CLS212 |
| 300/381 | CLS213 |
| 300/382 | CLS218 |
| 300/390 | CLS018 |
| 300/391 | CLS102 |
| 300/393 | CLS220 |

| BREMI | CHAMPION |
|----------|----------|
| 300/398 | CLS018 |
| 300/399 | CLS213 |
| 300/529 | CLS213 |
| 300/629 | CLS226 |
| 300/652 | CLS018 |
| 300/667 | CLS220 |
| 300/673 | CLS030 |
| 300/675 | CLS107 |
| 300/678 | CLS114 |
| 300/681 | CLS115 |
| 300/690 | CLS029 |
| 300/692 | CLS113 |
| 300/694 | CLS018 |
| 300/694 | CLS141 |
| 300/698 | CLS173 |
| 300/700 | CLS023 |
| 300/701 | CLS130 |
| 300/705 | CLS169 |
| 300/711 | CLS031 |
| 300/715 | CLS056 |
| 300/731 | CLS061 |
| 300/758 | CLS025 |
| 300/759 | CLS020 |
| 300/759 | CLS196 |
| 300/766 | CLS114 |
| 300/771 | CLS062 |
| 300/788 | CLS212 |
| 300/869 | CLS213 |
| 300/912 | CLS134 |
| 300/913 | CLS258 |
| 300/919 | CLS103 |
| 300/920 | CLS018 |
| 3A00/125 | CLS013 |
| 3A00/162 | CLS080 |
| 3A00/166 | CLS241 |
| 3A00/172 | CLS192 |
| 3A00/184 | CLS092 |
| 3A00/185 | CLS193 |
| 3A00/186 | CLS073 |
| 3A35/48 | CLS230 |
| 403 | CLS253 |
| 404 | CLS203 |
| 447 | CLS105 |
| 449A200 | CLS199 |
| 473/100 | CLS210 |
| 481 | CLS099 |
| 500/111 | CLS231 |
| 500/118 | CLS096 |
| 500/130 | CLS257 |
| 517/100 | CLS186 |
| 522 | CLS250 |
| 534 | CLS206 |
| 539 | CLS100 |

| BREMI | CHAMPION |
|---------|----------|
| 560 | CLS208 |
| 561 | CLS207 |
| 569/100 | CLS104 |
| 600/104 | CLS117 |
| 600/118 | CLS262 |
| 600/123 | CLS050 |
| 600/124 | CLS236 |
| 600/138 | CLS123 |
| 600/143 | CLS005 |
| 600/186 | CLS060 |
| 600/196 | CLS051 |
| 600/200 | CLS052 |
| 600/205 | CLS040 |
| 600/213 | CLS182 |
| 600/215 | CLS137 |
| 600/217 | CLS261 |
| 600/220 | CLS226 |
| 600/227 | CLS132 |
| 600/228 | CLS129 |
| 600/234 | CLS129 |
| 600/239 | CLS229 |
| 600/250 | CLS133 |
| 600/262 | CLS003 |
| 600/268 | CLS002 |
| 600/281 | CLS179 |
| 600/282 | CLS188 |
| 600/283 | CLS188 |
| 600/298 | CLS058 |
| 600/330 | CLS012 |
| 600/365 | CLS059 |
| 600/409 | CLS121 |
| 600/412 | CLS011 |
| 600/427 | CLS035 |
| 600/428 | CLS044 |
| 600/447 | CLS190 |
| 600/454 | CLS005 |
| 600/478 | CLS069 |
| 600/479 | CLS167 |
| 600/481 | CLS072 |
| 600/486 | CLS189 |
| 600/494 | CLS024 |
| 600/496 | CLS091 |
| 600/497 | CLS094 |
| 600-251 | CLS150 |
| 600-433 | CLS150 |
| 626 | CLS245 |
| 626 T | CLS245 |
| 778 RA | CLS097 |
| 793 | CLS098 |
| 797 | CLS204 |
| 800/175 | CLS066 |
| 800/179 | CLS033 |
| 800/190 | CLS016 |

| BREMI | CHAMPION |
|----------|----------|
| 800/198 | CLS049 |
| 800/203 | CLS022 |
| 800/210 | CLS120 |
| 800/210 | CLS122 |
| 800/211 | CLS033 |
| 800/212 | CLS022 |
| 800/213 | CLS111 |
| 800/215 | CLS032 |
| 912 | CLS055 |
| 913 | CLS235 |
| 919 | CLS108 |
| 923/100 | CLS109 |
| 924 | CLS110 |
| 925 | CLS110 |
| 931 | CLS042 |
| 933 | CLS064 |
| 939C200 | CLS053 |
| 954 | CLS174 |
| 958 | CLS100 |
| 959 | CLS034 |
| 962 | CLS043 |
| 963 | CLS034 |
| 964 | CLS238 |
| 968G100 | CLS260 |
| 974/200 | CLS054 |
| 977 | CLS178 |
| 979 | CLS136 |
| 983 | CLS138 |
| 990 | CLS042 |
| 992 | CLS174 |
| 998 | CLS047 |
| 9A04 | CLS242 |
| 9A09 | CLS172 |
| 9A15/200 | CLS081 |
| 9A16 | CLS063 |
| 9A30B200 | CLS090 |
| CHAMPION | CHAMPION |
| LS 01 | CLS255 |
| LS 103 | CLS018 |
| LS 11 | CLS101 |
| LS 123 | CLS116 |
| LS 130 | CLS230 |
| LS 135 | CLS112 |
| LS 14 | CLS127 |
| LS 16 | CLS213 |
| LS 173 | CLS137 |
| LS 175 | CLS136 |
| LS 20 | CLS119 |
| LS 200 | CLS210 |
| LS 201 | CLS099 |
| LS 204 | CLS100 |
| LS 205 | CLS099 |



| CHAMPION | | |
|-------------------|--------|--|
| LS 21 | CLS125 | |
| LS 219 | CLS098 | |
| LS 220 | CLS041 | |
| LS 221 | CLS099 | |
| LS 26 | CLS120 | |
| LS 27 | CLS122 | |
| LS 28 | CLS121 | |
| LS 31 | CLS128 | |
| LS 35 | CLS166 | |
| LS 36 | CLS018 | |
| LS 40 | CLS221 | |
| LS 47 | CLS126 | |
| LS 53 | CLS226 | |
| LS 71 | CLS117 | |
| LS 73 | CLS111 | |
| LS 77 | CLS125 | |
| LS 80 | CLS225 | |
| LS 81 | CLS004 | |
| LS 83 | CLS118 | |
| LS 94 | CLS030 | |
| LS 98 | CLS123 | |
| DELCO REMY | | |
| DRL 376 | CLS175 | |
| DRL 907 | CLS198 | |
| DRL690 | CLS008 | |
| DOWAL | | |
| 23 344 | CLS245 | |
| 23 379 | CLS099 | |
| 23 411 | CLS246 | |
| 23 655 | CLS248 | |
| FACET | | |
| 4.7006 | CLS085 | |
| 4.7013 | CLS167 | |
| 4.7059 | CLS195 | |
| 4.7230 | CLS084 | |
| 4.7235 | CLS093 | |
| 4.7246 | CLS084 | |
| 4.9385 | CLS094 | |
| 4.9614 | CLS074 | |
| 4.9680 | CLS086 | |
| 4.9720 | CLS081 | |
| 4.9729 | CLS257 | |
| 4.9809 | CLS080 | |
| 4.9880 | CLS096 | |
| 4.9888 | CLS095 | |
| FAE | | |
| 83563 | CLS086 | |
| 83588 | CLS096 | |
| 85481 | CLS195 | |
| 85765 | CLS095 | |

| FAE | | |
|-----------------------------|--------|--|
| 85806 | CLS167 | |
| HERTH+BUSS ELPARTS | | |
| 51 278 753 | CLS074 | |
| HERTH+BUSS JAKOPARTS | | |
| J5381002 | CLS133 | |
| J5383000 | CLS131 | |
| J5383008 | CLS229 | |
| J5383021 | CLS229 | |
| J5383026 | CLS239 | |
| J5387004 | CLS170 | |
| J5387009 | CLS170 | |
| J5387011 | CLS080 | |
| J5387019 | CLS192 | |
| HUECO | | |
| 134132 | CLS096 | |
| 134287 | CLS095 | |
| 134528 | CLS094 | |
| NGK | | |
| 0501 | CLS177 | |
| 0502 | CLS099 | |
| 0502 | CLS180 | |
| 0504 | CLS001 | |
| 0507 | CLS172 | |
| 0510 | CLS099 | |
| 0511 | CLS105 | |
| 0511 | CLS249 | |
| 0515 | CLS047 | |
| 0518 | CLS046 | |
| 0518 | CLS099 | |
| 0519 | CLS042 | |
| 0548 | CLS036 | |
| 0551 | CLS037 | |
| 0565 | CLS104 | |
| 0579 | CLS054 | |
| 0583 | CLS222 | |
| 0604 | CLS127 | |
| 0632 | CLS122 | |
| 0639 | CLS033 | |
| 0640 | CLS022 | |
| 0641 | CLS111 | |
| 0643 | CLS136 | |
| 0645 | CLS135 | |
| 0691 | CLS023 | |
| 0709 | CLS130 | |
| 0710 | CLS130 | |
| 0714 | CLS131 | |
| 0715 | CLS131 | |
| 0715 | CLS258 | |
| 0736 | CLS252 | |
| 0737 | CLS252 | |

| NGK | | |
|------------|--------|--|
| 0737 | CLS254 | |
| 0738 | CLS106 | |
| 0741 | CLS204 | |
| 0742 | CLS098 | |
| 0743 | CLS207 | |
| 0744 | CLS208 | |
| 0746 | CLS250 | |
| 0747 | CLS217 | |
| 0748 | CLS219 | |
| 0749 | CLS216 | |
| 0750 | CLS253 | |
| 0751 | CLS203 | |
| 0757 | CLS063 | |
| 0757 | CLS138 | |
| 0766 | CLS107 | |
| 0772 | CLS166 | |
| 0773 | CLS101 | |
| 0778 | CLS211 | |
| 0788 | CLS220 | |
| 0789 | CLS018 | |
| 0793 | CLS018 | |
| 0808 | CLS030 | |
| 0810 | CLS107 | |
| 0814 | CLS115 | |
| 0823 | CLS113 | |
| 0825 | CLS213 | |
| 0890 | CLS061 | |
| 0901 | CLS028 | |
| 0932 | CLS199 | |
| 0932 | CLS240 | |
| 0934 | CLS139 | |
| 0937 | CLS027 | |
| 0938 | CLS099 | |
| 0939 | CLS027 | |
| 0939 | CLS099 | |
| 0941 | CLS027 | |
| 0941 | CLS249 | |
| 0944 | CLS199 | |
| 0945 | CLS210 | |
| 0946 | CLS099 | |
| 0947 | CLS099 | |
| 0947 | CLS100 | |
| 0948 | CLS245 | |
| 0949 | CLS097 | |
| 0951 | CLS042 | |
| 0956 | CLS034 | |
| 0958 | CLS043 | |
| 0961 | CLS238 | |
| 0963 | CLS178 | |
| 0964 | CLS041 | |
| 0967 | CLS140 | |
| 0970 | CLS174 | |
| 1801 | CLS167 | |

| NGK | | |
|------------|--------|--|
| 2571 | CLS137 | |
| 2584 | CLS066 | |
| 2585 | CLS155 | |
| 2995 | CLS044 | |
| 2999 | CLS137 | |
| 4070 | CLS068 | |
| 44250 | CLS015 | |
| 44278 | CLS084 | |
| 4746 | CLS082 | |
| 5355 | CLS096 | |
| 5506 | CLS072 | |
| 6020 | CLS085 | |
| 6022 | CLS196 | |
| 6299 | CLS093 | |
| 6304 | CLS195 | |
| 6317 | CLS091 | |
| 6349 | CLS078 | |
| 6794 | CLS083 | |
| 7044 | CLS048 | |
| 7109 | CLS223 | |
| 7153 | CLS221 | |
| 7175 | CLS014 | |
| 7176 | CLS226 | |
| 7200 | CLS011 | |
| 7200 | CLS019 | |
| 7209 | CLS035 | |
| 7211 | CLS044 | |
| 7248 | CLS190 | |
| 7285 | CLS124 | |
| 7285 | CLS262 | |
| 7302 | CLS038 | |
| 7303 | CLS053 | |
| 7306 | CLS260 | |
| 7318 | CLS043 | |
| 7367 | CLS013 | |
| 7368 | CLS117 | |
| 7379 | CLS224 | |
| 7381 | CLS137 | |
| 8047 | CLS258 | |
| 8183 | CLS052 | |
| 8185 | CLS040 | |
| 8192 | CLS009 | |
| 8192 | CLS261 | |
| 8200 | CLS150 | |
| 8205 | CLS003 | |
| 8206 | CLS118 | |
| 8220 | CLS004 | |
| 8223 | CLS179 | |
| 8234 | CLS039 | |
| 8262 | CLS041 | |
| 8275 | CLS025 | |
| 8276 | CLS020 | |
| 8287 | CLS062 | |









| NGK | CHAMPION | NGK | CHAMPION | NGK | CHAMPION | NGK | CHAMPION |
|-----------|----------|-----------|----------|-----------|----------|-----------|----------|
| 8468 | CLS050 | RC-FD1203 | CLS187 | RC-MB202 | CLS252 | RC-RN603 | CLS040 |
| 8469 | CLS236 | RC-FD1205 | CLS066 | RC-MB202 | CLS254 | RC-RN606 | CLS039 |
| 8471 | CLS123 | RC-FD1207 | CLS074 | RC-MB203 | CLS106 | RC-RN620 | CLS060 |
| 8474 | CLS129 | RC-FD1210 | CLS091 | RC-MB206 | CLS204 | RC-RN620 | CLS126 |
| 8487 | CLS060 | RC-FD1217 | CLS015 | RC-MB207 | CLS098 | RC-RN623 | CLS116 |
| 8487 | CLS126 | RC-FD509 | CLS127 | RC-MB208 | CLS207 | RC-RN637 | CLS117 |
| 8493 | CLS116 | RC-FD531 | CLS111 | RC-MB209 | CLS208 | RC-RN640 | CLS224 |
| 8541 | CLS077 | RC-FD537 | CLS122 | RC-MB210 | CLS205 | RC-RN648 | CLS221 |
| 8542 | CLS016 | RC-FD538 | CLS121 | RC-MB211 | CLS250 | RC-RN652 | CLS014 |
| 8571 | CLS120 | RC-FD544 | CLS033 | RC-MB212 | CLS217 | RC-RN658 | CLS011 |
| 8573 | CLS128 | RC-FD545 | CLS022 | RC-MB213 | CLS219 | RC-RN658 | CLS019 |
| 8618 | CLS108 | RC-FD546 | CLS111 | RC-MB214 | CLS216 | RC-RV1201 | CLS155 |
| 8621 | CLS109 | RC-FD548 | CLS032 | RC-MB215 | CLS253 | RC-RV1301 | CLS069 |
| 8647 | CLS257 | RC-FD807 | CLS077 | RC-MB216 | CLS203 | RC-RV415 | CLS061 |
| 8650 | CLS128 | RC-FD808 | CLS016 | RC-MB222 | CLS063 | RC-SB605 | CLS150 |
| 8655 | CLS129 | RC-FD816 | CLS049 | RC-MB222 | CLS138 | RC-SE45 | CLS167 |
| 9262 | CLS067 | RC-FD819 | CLS022 | RC-NE09 | CLS133 | RC-SE77 | CLS258 |
| 9459 | CLS132 | RC-FD826 | CLS120 | RC-NX07 | CLS132 | RC-ST201 | CLS028 |
| 9618 | CLS259 | RC-FT1202 | CLS137 | RC-OP1101 | CLS029 | RC-ST901 | CLS053 |
| 9846 | CLS131 | RC-FT1203 | CLS044 | RC-OP201 | CLS107 | RC-TE43 | CLS259 |
| 9856 | CLS056 | RC-FT1208 | CLS067 | RC-OP402 | CLS166 | RC-TE51 | CLS096 |
| 9925 | CLS229 | RC-FT1209 | CLS082 | RC-OP403 | CLS101 | RC-VL1305 | CLS195 |
| RC-AD201 | CLS177 | RC-FT201 | CLS136 | RC-OP404 | CLS166 | RC-VL601 | CLS179 |
| RC-AD202 | CLS099 | RC-FT203 | CLS135 | RC-OP407 | CLS214 | RC-VL605 | CLS050 |
| RC-AD202 | CLS180 | RC-FT407 | CLS119 | RC-OP408 | CLS211 | RC-VL606 | CLS236 |
| RC-AD204 | CLS001 | RC-FT435 | CLS006 | RC-OP409 | CLS212 | RC-VW1105 | CLS081 |
| RC-AD207 | CLS172 | RC-FT444 | CLS023 | RC-OP410 | CLS218 | RC-VW201 | CLS199 |
| RC-AD210 | CLS099 | RC-FT601 | CLS009 | RC-OP415 | CLS018 | RC-VW201 | CLS240 |
| RC-AD211 | CLS105 | RC-FT601 | CLS261 | RC-OP416 | CLS102 | RC-VW202 | CLS048 |
| RC-AD211 | CLS249 | RC-FT604 | CLS003 | RC-OP418 | CLS220 | RC-VW203 | CLS017 |
| RC-AD215 | CLS047 | RC-FT605 | CLS118 | RC-OP419 | CLS018 | RC-VW203 | CLS139 |
| RC-AD218 | CLS046 | RC-FT623 | CLS137 | RC-OP423 | CLS018 | RC-VW204 | CLS237 |
| RC-AD218 | CLS099 | RC-FT632 | CLS035 | RC-OP424 | CLS213 | RC-VW206 | CLS027 |
| RC-AD219 | CLS042 | RC-FT633 | CLS044 | RC-OP428 | CLS213 | RC-VW207 | CLS099 |
| RC-AR903 | CLS055 | RC-HD1202 | CLS072 | RC-OP433 | CLS018 | RC-VW208 | CLS027 |
| RC-AR904 | CLS235 | RC-HD301 | CLS021 | RC-OP435 | CLS107 | RC-VW208 | CLS099 |
| RC-AR908 | CLS137 | RC-HD407 | CLS130 | RC-OP437 | CLS220 | RC-VW210 | CLS027 |
| RC-BW205 | CLS036 | RC-HD408 | CLS130 | RC-OP438 | CLS030 | RC-VW210 | CLS249 |
| RC-BW208 | CLS037 | RC-HE53 | CLS128 | RC-OP440 | CLS107 | RC-VW213 | CLS199 |
| RC-BW214 | CLS186 | RC-HE71 | CLS128 | RC-OP441 | CLS114 | RC-VW214 | CLS210 |
| RC-BW222 | CLS104 | RC-HE73 | CLS129 | RC-OP444 | CLS115 | RC-VW215 | CLS099 |
| RC-BW235 | CLS054 | RC-HE76 | CLS129 | RC-OP453 | CLS113 | RC-VW216 | CLS099 |
| RC-CR305 | CLS062 | RC-KA1204 | CLS073 | RC-OP454 | CLS018 | RC-VW216 | CLS100 |
| RC-CR601 | CLS123 | RC-KA1204 | CLS093 | RC-OP454 | CLS141 | RC-VW217 | CLS245 |
| RC-CR606 | CLS190 | RC-KA401 | CLS131 | RC-OP455 | CLS213 | RC-VW218 | CLS097 |
| RC-CT402 | CLS222 | RC-KA402 | CLS131 | RC-OP456 | CLS103 | RC-VW220 | CLS042 |
| RC-CT615 | CLS124 | RC-KA402 | CLS258 | RC-OP463 | CLS103 | RC-VW225 | CLS034 |
| RC-CT615 | CLS262 | RC-KA405 | CLS173 | RC-PG608 | CLS223 | RC-VW227 | CLS043 |
| RC-DW1202 | CLS085 | RC-LC1302 | CLS137 | RC-PG610 | CLS005 | RC-VW228 | CLS043 |
| RC-DW1203 | CLS196 | RC-LC604 | CLS004 | RC-PG615 | CLS226 | RC-VW229 | CLS034 |
| RC-DW301 | CLS025 | RC-MB1104 | CLS068 | RC-RN1204 | CLS083 | RC-VW230 | CLS238 |
| RC-DW302 | CLS020 | RC-MB1106 | CLS078 | RC-RN1311 | CLS084 | RC-VW232 | CLS178 |
| RC-DW304 | CLS013 | RC-MB201 | CLS252 | RC-RN601 | CLS052 | RC-VW233 | CLS041 |











| | | | | | | |
|-----------------|--------|--------------|--------|--|--|--|
| NGK | | VALEO | | | | |
| RC-VW234 | CLS181 | 346558 | CLS096 | | | |
| RC-VW236 | CLS140 | | | | | |
| RC-VW239 | CLS174 | | | | | |
| RC-VW242 | CLS041 | | | | | |
| RC-VW254 | CLS048 | | | | | |
| RC-VW902 | CLS108 | | | | | |
| RC-VW903 | CLS109 | | | | | |
| RC-VW907 | CLS038 | | | | | |
| RC-VW910 | CLS260 | | | | | |
| RC-VW912 | CLS043 | | | | | |
| RC-ZE07 | CLS131 | | | | | |
| RC-ZE11 | CLS131 | | | | | |
| RC-ZE21 | CLS056 | | | | | |
| RC-ZE53 | CLS257 | | | | | |
| RC-ZX29 | CLS229 | | | | | |
| NIPPARTS | | | | | | |
| IC-K09 | CLS256 | | | | | |
| J 5380514 | CLS094 | | | | | |
| J 5382058 | CLS096 | | | | | |
| J 5383028 | CLS198 | | | | | |
| PVL | | | | | | |
| 027 | CLS245 | | | | | |
| 031 S | CLS246 | | | | | |
| 067 SL | CLS099 | | | | | |
| 072 | CLS200 | | | | | |
| 121 R | CLS097 | | | | | |
| 124 | CLS248 | | | | | |
| 125 | CLS204 | | | | | |
| 126 | CLS201 | | | | | |
| 126 | CLS206 | | | | | |
| 182 | CLS202 | | | | | |
| 185 | CLS098 | | | | | |
| 186 | CLS203 | | | | | |
| 207 | CLS207 | | | | | |
| 211 | CLS249 | | | | | |
| 214 | CLS250 | | | | | |
| 220 R | CLS097 | | | | | |
| 221 | CLS099 | | | | | |
| 231 | CLS191 | | | | | |
| 70875 | CLS212 | | | | | |
| TESLA | | | | | | |
| T 382 B | CLS195 | | | | | |
| T 711 B | CLS086 | | | | | |
| T 888 B | CLS085 | | | | | |
| TRISCAN | | | | | | |
| 8860 10002 | CLS195 | | | | | |
| 8860 16011 | CLS074 | | | | | |
| VALEO | | | | | | |
| 346089 | CLS175 | | | | | |
| 346546 | CLS095 | | | | | |

OE ?

| | |
|-------------------|---|
| AGRIA |  |
| 031 150 | L82C |
| 031 160 | L82C |
| 031 170 | L78C |
| 1137 51 680 1 | L82C |
| 283 340 | L82C |
| 426 43 | L82C |
| 509 12 | OE038 |
| 516 80 | L82C |
| 599 99 | OE015 |
| ALFA ROMEO |  |
| 0046550992 | OE122 |
| 12NC | OE014 |
| 12NDK | OE030 |
| 462 29 251 | OE001 |
| 46449690 | OE223 |
| 46521529 | OE223 |
| 46521530 | OE122 |
| 46550991 | OE077 |
| 46550992 | OE122 |
| 55217232 | OE256 |
| 589 45 85 | OE018 |
| 589 45 86 | OE014 |
| 589 45 87 | OE006 |
| 589 45 88 | OE014 |
| 589 61 77 | OE026 |
| 598 40 36 | OE006 |
| 605 04 563 | OE087 |
| 605 12 929 | OE087 |
| 605 99 495 | OE122 |
| 60579903 | OE014 |
| 608 00 325 | OE018 |
| 608 10 689 | OE136 |
| 60810689 | OE014 |
| 717 116 38 | OE005 |
| 717 116 39 | OE018 |
| 717 116 40 | OE006 |
| 717 118 06 | OE005 |
| 717 412 08 | OE029 |
| 71736276 | OE014 |
| 71736282 | OE030 |
| 754 651 9 | OE005 |
| 755 443 6 | OE018 |
| 755 444 4 | OE006 |
| 755 444 5 | OE038 |
| 776 038 1 | OE018 |
| 776 038 2 | OE006 |
| 776 038 3 | OE005 |
| 776 038 4 | OE014 |
| 777 245 3 | OE014 |
| 915 170 018 0 | OE015 |
| 961 473 868 0 | OE026 |
| 961 962 458 0 | OE019 |

| | |
|-----------------------|---|
| ALFA ROMEO |  |
| 962 800 028 0 | OE026 |
| ALLIS-CHALMERS |  |
| 4905797 | OE074 |
| 4907335 | J8C |
| 74905796 | OE074 |
| 74905798 | OE074 |
| 79001651 | OE074 |
| AUDI |  |
| 06H 905 601 A | OE214 |
| 06H 905 611 | OE214 |
| 06H 905 621 | OE214 |
| 06H 905 621 A | OE214 |
| 101 000 054 AC | OE227 |
| 101 905 631 | OE214 |
| AUTO UNION |  |
| 001 270 051 700 9 | OE010 |
| 009 33 02 331 009 | OE074 |
| 011 18 00 068 000 | L82C |
| 7821 700 10 10 000 | OE087 |
| N 017 811 1 | OE074 |
| N 017 811 19 | OE074 |
| N 017 811 20 | OE010 |
| N 017 811 23 | OE087 |
| N 017 812 13 | OE010 |
| BMW |  |
| 1 265 595 | OE001 |
| 12 12 0 030 548 | OE223 |
| 12 12 0 032 134 | OE227 |
| 12 12 0 032 135 | OE227 |
| 12 12 0 032 136 | OE120 |
| 12 12 0 032 137 | OE238 |
| 12 12 0 032 138 | OE238 |
| 12 12 0 034 098 | OE205 |
| 12 12 0 034 677 | OE204 |
| 12 12 0 035 915 | OE238 |
| 12 12 0 035 933 | OE204 |
| 12 12 0 037 580 | OE242 |
| 12 12 0 037 582 | OE242 |
| 12 12 0 037 607 | OE223 |
| 12 12 0 037 608 | OE223 |
| 12 12 0 038 894 | OE243 |
| 12 12 0 038 896 | OE243 |
| 12 12 0 039 664 | OE243 |
| 12 12 0 040 551 | OE245 |
| 12 12 0 040 581 | OE243 |
| 12 12 0 041 666 | OE245 |
| 12 12 0 141 871 | OE223 |
| 12 12 1 257 081 | OE010 |
| 12 12 1 257 082 | OE010 |
| 12 12 1 257 513 | OE001 |

| | |
|-----------------|---|
| BMW |  |
| 12 12 1 258 158 | OE001 |
| 12 12 1 258 159 | OE001 |
| 12 12 1 258 973 | OE001 |
| 12 12 1 262 360 | OE015 |
| 12 12 1 262 361 | OE015 |
| 12 12 1 263 070 | OE015 |
| 12 12 1 265 595 | OE001 |
| 12 12 1 267 485 | OE001 |
| 12 12 1 269 333 | OE001 |
| 12 12 1 276 283 | OE015 |
| 12 12 1 279 526 | OE015 |
| 12 12 1 286 682 | OE015 |
| 12 12 1 288 234 | OE015 |
| 12 12 1 334 315 | OE015 |
| 12 12 1 338 145 | OE010 |
| 12 12 1 338 146 | OE087 |
| 12 12 1 351 716 | OE074 |
| 12 12 1 353 286 | OE010 |
| 12 12 1 353 673 | OE001 |
| 12 12 1 435 955 | OE223 |
| 12 12 1 435 956 | OE223 |
| 12 12 1 714 751 | OE004 |
| 12 12 1 882 34 | OE001 |
| 12 12 2 158 165 | OE204 |
| 12 12 2 158 252 | OE188 |
| 12 12 2 158 253 | OE238 |
| 12 12 2 163 332 | OE205 |
| 12 12 2 293 697 | OE205 |
| 12 12 8 353 286 | OE010 |
| 12 12 8 636 155 | OE087 |
| 12 12 8 636 166 | OE010 |
| 12 12 8 636 167 | OE087 |
| 12 12 8 636 168 | OE010 |
| 12 12 8 636 169 | OE087 |
| 12 12 9 005 913 | OE015 |
| 12 12 9 005 914 | OE001 |
| 12 12 9 055 912 | OE001 |
| 12 12 9 056 446 | OE015 |
| 12 12 9 056 447 | OE015 |
| 12 12 9 057 189 | OE015 |
| 12 12 9 057 190 | OE015 |
| 12 12 9 057 749 | OE015 |
| 12 12 9 057 750 | OE015 |
| 12 12 9 057 992 | OE015 |
| 12 12 9 059 162 | OE026 |
| 12 12 9 059 794 | OE026 |
| 12 12 9 059 869 | OE004 |
| 12 12 9 061 383 | OE004 |
| 12 12 9 061 811 | OE026 |
| 12 12 9 061 869 | OE004 |
| 12 12 9 063 428 | OE026 |
| 12 12 9 064 619 | OE026 |
| 12 12 9 068 016 | OE154 |

| | |
|--------------------|---|
| BMW |  |
| 12 12 9 070 999 | OE154 |
| 12 12 9 071 003 | OE223 |
| 12 12 9 976 330 | L78C |
| 12 65 5 95 | OE001 |
| 12 79 5 264 | OE015 |
| 12121338145 | OE010 |
| 2 158 165 | OE204 |
| 7 749 743 | OE237 |
| BOMAG |  |
| 057 439 95 | L78C |
| CASE IH |  |
| A05999AB | J8C |
| TM20699 | OE037 |
| CATERPILLAR |  |
| 2W-9486 | OE001 |
| CHEVROLET |  |
| 92 06 7204 | OE029 |
| 96 307 729 | OE077 |
| 96 417 176 | OE077 |
| EC 229626 | OE019 |
| CHRYSLER |  |
| 4609076 | OE154 |
| 4727114 | OE105 |
| 4796779 | OE191 |
| 56027275 | OE128 |
| 56028189 | OE128 |
| 56028236 AA | OE154 |
| 56028236AA | OE154 |
| A1005N02 | OE004 |
| A1005N04 | OE049 |
| CITROËN |  |
| 5 403 277 | OE038 |
| 5 403 277 X | OE038 |
| 5 416 222 D | L82C |
| 5 417 768 | OE001 |
| 5 417 768 H | OE001 |
| 5 417 769 U | OE001 |
| 5 417 998 | OE001 |
| 5 417 998 H | OE001 |
| 5 425 202 | OE001 |
| 5 425 202 H | OE001 |
| 5 425 202 M | OE001 |
| 5 433 737 | OE038 |
| 5 433 737 J | OE038 |
| 5 433 738 | OE038 |
| 5 433 738 V | OE038 |
| 5 451 444 | OE038 |
| 5 451 444 B | OE038 |
| 5432 057 Y | OE015 |

OE ? ⇒

| CITROËN | CHAMPION |
|---------------|----------|
| 5960 14 | OE035 |
| 5960 54 | OE178 |
| 5960 73 | OE178 |
| 5960 75 | OE178 |
| 5960 84 | OE130 |
| 5960 90 | OE035 |
| 5960 91 | OE035 |
| 5960 92 | OE205 |
| 5960 97 | OE035 |
| 5960 98 | OE035 |
| 5960 E2 | OE205 |
| 5960 F7 | OE178 |
| 5960 H9 | OE205 |
| 5960 J3 | OE005 |
| 5960 K8 | OE035 |
| 5960 L2 | OE035 |
| 5960 L3 | OE203 |
| 5962 2T | OE030 |
| 5962 5C | OE035 |
| 5962 5G | OE034 |
| 5962 5M | OE035 |
| 5962 7E | OE175 |
| 5962 7S | OE034 |
| 5962 7W | OE035 |
| 5962 7X | OE035 |
| 5962 8A | OE175 |
| 5962 F0 | OE034 |
| 5962 H8 | OE039 |
| 5962 S9 | OE014 |
| 75 491 694 | OE010 |
| 75 491 695 | OE010 |
| 75 491 697 | OE010 |
| 75 492 437 | OE038 |
| 78 260 993 00 | OE001 |
| 91 517 001 | OE001 |
| 91 517 002 | OE001 |
| 91 517 007 | OE009 |
| 91 517 008 | OE009 |
| 95 496 692 | OE038 |
| 95 605 398 | L82C |
| 95 611 941 | OE009 |
| 95 618 380 | OE038 |
| 95 619 043 | OE001 |
| 95619038 | L82C |
| 96 009 090 | OE014 |
| 96 037 952 | OE057 |
| 96 040 824 | OE005 |
| 96 064 066 | OE014 |
| 96 070 663 | OE016 |
| 96 073 353 | OE077 |
| 96 088 669 | OE014 |
| 96 089 220 | OE002 |
| 96 145 071 | OE077 |

| CITROËN | CHAMPION |
|------------------|----------|
| 96.024.607 | OE014 |
| 9636393380 | OE035 |
| 9638127380 | OE034 |
| 9639814380 | OE034 |
| 9650889380 | OE178 |
| 97 535 383 | OE009 |
| A 212 7C | L78C |
| AM 212 207 A | L82C |
| AYB 212-7 | L78C |
| AZ 212 7A | L78C |
| DS 212 7G | OE038 |
| DV 212 207 A | OE038 |
| DX 212 7A | OE038 |
| DX 212 7B | L82C |
| DX 212 7C | OE038 |
| DY 212 207 A | OE038 |
| GX 06 188 06 1 | OE038 |
| GX 06 188 08 A | OE010 |
| GX 06 188 10 A | OE087 |
| MKP 000 73 | OE087 |
| MYC000006N | OE087 |
| MYC000006R | OE094 |
| MYC000007R | OE014 |
| ZA 3406 176 | OE010 |
| ZA 4233 922 | OE010 |
| ZB.9000.065.U | L82C |
| ZB9000062U | OE009 |
| ZB9000063U | OE014 |
| ZC 9456 074 U | L78C |
| ZC 9457 707 U | L78C |
| ZC 9852 109 U | L78C |
| ZC 9862 090 U | OE015 |
| ZC9862093U | OE001 |
| ZC9862095U | OE009 |
| ZCT 000 012 | OE010 |
| CITROËN/ PEUGEOT | CHAMPION |
| 96 762 881 80 | OE263 |
| 9673 806 380 | OE203 |
| DACIA | CHAMPION |
| 6001544293 | OE005 |
| 82 00 662 185 | OE130 |
| DAF | CHAMPION |
| 215206 | OE074 |
| 225190 | L82C |
| DAIHATSU | CHAMPION |
| 9004851106 | OE039 |
| 90048-51163 | OE089 |
| 90048-51164 | OE019 |
| 90048-51168-000 | OE077 |
| 90048-51196 | OE199 |

| DAIHATSU | CHAMPION |
|-------------------|----------|
| 90048-51197 | OE196 |
| DUCATI | CHAMPION |
| 67040071A | OE073 |
| 67040081A | OE073 |
| 67040141A | OE083 |
| 67040171A | OE083 |
| 67040331A | OE073 |
| 67040351A | OE083 |
| 67040351A | OE186 |
| EZGO | CHAMPION |
| 25523-G5 | OE013 |
| FERRARI (FERRARI) | CHAMPION |
| 113538 | OE074 |
| FIAT | CHAMPION |
| 04NE | OE001 |
| 1 L 4 J | OE001 |
| 1 L 4 JR | OE006 |
| 1 L 45 J | OE010 |
| 1 L 45 JR | OE018 |
| 1 S 3 | L82C |
| 1 S 5 J | OE038 |
| 12NE | OE005 |
| 14NC | OE018 |
| 2284662 | OE010 |
| 2301710 | OE087 |
| 2301711 | OE010 |
| 3233922 | OE010 |
| 4113022 | L82C |
| 4170472 | OE087 |
| 4172173 | OE087 |
| 4249164 | OE010 |
| 4345041 | OE010 |
| 4346196 | OE006 |
| 4346796 | OE006 |
| 4346797 | OE018 |
| 4347776 | OE018 |
| 4359422 | OE001 |
| 4359423 | OE001 |
| 4359424 | OE006 |
| 4361799 | OE038 |
| 4361800 | OE038 |
| 4378107 | OE064 |
| 4401547 | OE038 |
| 4401549 | OE001 |
| 4401550 | OE006 |
| 4401551 | OE001 |
| 4401552 | OE018 |
| 4401586 | L82C |
| 4425057 | OE038 |
| 46417010 | OE039 |

| FIAT | CHAMPION |
|-----------|----------|
| 46461873 | OE196 |
| 46463801 | OE030 |
| 46471078 | OE120 |
| 46472021 | OE030 |
| 46480307 | OE026 |
| 46480362 | OE005 |
| 46480363 | OE005 |
| 46481273 | OE083 |
| 46531917 | OE186 |
| 46531918 | OE016 |
| 46531919 | OE186 |
| 46531935 | OE039 |
| 46541450 | OE136 |
| 46551935 | OE016 |
| 46750545 | OE196 |
| 46799928 | OE196 |
| 46823299 | OE196 |
| 55188857 | OE196 |
| 55190788 | OE196 |
| 55198201 | OE196 |
| 55210685 | OE208 |
| 55226083 | OE196 |
| 55229633 | OE232 |
| 55233997 | OE232 |
| 55249868 | OE208 |
| 5882087 | OE038 |
| 5894585 | OE008 |
| 5894586 | OE002 |
| 5894587 | OE004 |
| 5894588 | OE014 |
| 5896177 | OE026 |
| 5896824-1 | OE026 |
| 5984036 | OE006 |
| 60504563 | OE087 |
| 60512929 | OE087 |
| 60569957 | OE136 |
| 60800325 | OE018 |
| 60810689 | OE136 |
| 7 FYSSR | OE018 |
| 7 GBMSR | OE026 |
| 7 GYSSR | OE014 |
| 71711638 | OE005 |
| 71711639 | OE018 |
| 71711640 | OE006 |
| 71711806 | OE006 |
| 71719244 | OE016 |
| 71736275 | OE001 |
| 71736278 | OE018 |
| 71737139 | OE196 |
| 71739210 | OE029 |
| 71741208 | OE029 |
| 7546519 | OE005 |
| 7554419 | OE010 |

OE ? \rightleftharpoons







| FIAT | CHAMPION |
|------------|----------|
| 7554420 | OE001 |
| 7554421 | OE001 |
| 7554436 | OE018 |
| 7554437 | OE018 |
| 7554438 | OE087 |
| 7554444 | OE006 |
| 7554445 | OE038 |
| 7554447 | OE038 |
| 7554448 | OE038 |
| 7554449 | OE087 |
| 7554451 | OE006 |
| 7554452 | OE087 |
| 7554453 | OE010 |
| 7565476 | OE108 |
| 7565853 | OE094 |
| 7571541 | OE039 |
| 7686643 | OE008 |
| 7760381 | OE018 |
| 7760382 | OE004 |
| 7760383 | OE005 |
| 7760384 | OE014 |
| 7769243 | OE026 |
| 7772453 | OE014 |
| 7772515 | OE018 |
| 7782067 | OE077 |
| 7FYSR | OE018 |
| 7FYSSR | OE008 |
| 7GBYSR4 | OE077 |
| 9 FY | OE001 |
| 9 FYSR | OE006 |
| 9 FYSSR | OE006 |
| 9 GYSSR | OE033 |
| 9151700180 | OE015 |
| 9614738680 | OE026 |
| 9619624580 | OE019 |
| 9628000280 | OE026 |
| 9636393480 | OE148 |
| 9649464080 | OE178 |
| 9FYSR | OE018 |
| 9FYSSR | OE008 |
| 9GYSR | OE014 |
| 9GYSSR | OE014 |
| V 45 LSR | OE018 |
| FORD | CHAMPION |
| 01505812 | OE206 |
| 1 012 639 | OE011 |
| 1 023 706 | OE136 |
| 1 032 705 | OE198 |
| 1 088 847 | OE031 |
| 1 097 080 | OE031 |
| 1 120 170 | OE176 |
| 1 120 818 | OE054 |





| FORD | CHAMPION |
|---------------|----------|
| 1 128 053 | OE131 |
| 1 202 935 | OE031 |
| 1 204 572 | OE131 |
| 1 233 897 | OE031 |
| 1 240 5AD | OE054 |
| 1 240 5JE | OE054 |
| 1 255 464 | OE031 |
| 1 307 093 | OE131 |
| 1 315 691 | OE131 |
| 1 327 341 | OE031 |
| 1 335 367 | OE031 |
| 1 350 742 | OE031 |
| 1 362 012 | OE031 |
| 1 369 704 | OE183 |
| 1 379 739 | OE189 |
| 1 493 001 | OE031 |
| 1 505 812 | OE206 |
| 1 506 413 | OE010 |
| 1 506 415 | OE001 |
| 1 507 572 | OE054 |
| 1 518 878 | OE018 |
| 1 523 608 | OE006 |
| 1 542 499 | OE196 |
| 1 787 829 | OE031 |
| 1000996 | OE136 |
| 1086020 | OE146 |
| 1307093 | OE131 |
| 1369704 | OE183 |
| 1698597 | OE029 |
| 1787829 | OE031 |
| 1M50 12405 CA | OE031 |
| 1S7J 12405 DA | OE131 |
| 1S7J 12405 EB | OE131 |
| 2S7E 12405 AA | OE131 |
| 2S7E 12405 AB | OE131 |
| 2U7J 12405 AA | OE031 |
| 4 440 367 | OE131 |
| 4 454 955 | OE131 |
| 4M5G 12405 AA | OE031 |
| 4M5G 12405 XA | OE031 |
| 4M5G 12405 XB | OE031 |
| 4M5G 12405 XC | OE031 |
| 4M5G12405AA | OE031 |
| 5 099 295 | OE014 |
| 5 099 721 | OE005 |
| 5 099 727 | OE014 |
| 5 099 731 | OE054 |
| 5 099 732 | OE054 |
| 5 099 733 | OE054 |
| 5 099 735 | OE054 |
| 5 099 741 | OE011 |
| 5 099 846 | OE054 |
| 5 099 848 | OE054 |





| FORD | CHAMPION |
|-----------------|----------|
| 5 099 884 | OE006 |
| 5 099 885 | OE001 |
| 5 099 949 | OE087 |
| 5 099 950 | OE087 |
| 5 099 952 | OE014 |
| 5 099 961 | OE010 |
| 5 099 962 | OE018 |
| 5M5G 12405 AA | OE183 |
| 5M5G12405AA | OE183 |
| 6 073 379 | OE018 |
| 6 080 256 | OE014 |
| 6 173 150 | OE011 |
| 6 726 180 | OE029 |
| 6080256 | OE014 |
| 6M5J 12405 AA | OE206 |
| 6M8G 12405 BB | OE189 |
| 7 335 128 | OE136 |
| 73 OF 12405 AA | OE054 |
| 73 OF 12405 JA | OE014 |
| 730F 12405 AA | OE054 |
| 730F 12405 JA | OE014 |
| 78 HF 12405 AA | OE054 |
| 78 IF 12405 AA | OE087 |
| 78 TF 12405 BA | OE006 |
| 78GB 12405 CA | OE018 |
| 78GB 12405 HA | OE018 |
| 78HF 12405 AA | OE054 |
| 78IF 12405 AA | OE087 |
| 78IF 12405 BA | OE018 |
| 78TF 12405 AA | OE018 |
| 78TF 12405 BA | OE006 |
| 790F 12405 ACA | OE018 |
| 790F 12405 YA | OE018 |
| 80 GB 12405 AA | OE087 |
| 80 OF 12405 CA | OE094 |
| 80 OF 12405 DA | OE087 |
| 80 OF 12405 EA | OE087 |
| 80GB 12405 AA | OE087 |
| 800F 12405 CA | OE094 |
| 800F 12405 DA | OE087 |
| 800F 12405 EA | OE087 |
| 81 OF 12405 AAA | OE014 |
| 81 SF 12405 BA | OE014 |
| 81 SF 12405 DA | OE094 |
| 81GB 12405 AA | OE018 |
| 810F 12405 AAA | OE014 |
| 81SF 12405 BA | OE014 |
| 81SF 12405 DA | OE094 |
| 83 BB 12405 CA | OE054 |
| 83 OF | OE054 |
| 83 SF 12405 GA | OE094 |
| 83BB 12405 CA | OE054 |
| 830F | OE054 |



| FORD | CHAMPION |
|-----------------|----------|
| 83SF 12405 GA | OE094 |
| 840F 12405 JD | OE054 |
| 88 HF | OE054 |
| 88HF | OE054 |
| 920F 12405 EA | OE011 |
| 920F 12405EA | OE011 |
| 920F12405EA | OE011 |
| 959 F 12405 AA | OE136 |
| 96XF-12405-BB | OE146 |
| D 3 PF 12405 BA | OE087 |
| D3PF 12405 BA | OE087 |
| DZPF 12405 | OE054 |
| DZPF 12405 BUA | OE054 |
| XES4F 12405 DA | OE029 |
| XES4F12405DA | OE029 |
| XS6F 12405 BA | OE031 |
| XS6F 12405 CA | OE031 |
| YN2F 12405 AA | OE031 |
| YN2F-12405AA | OE031 |
| YN2J 12405 AA | OE031 |
| GENERAL MOTORS | CHAMPION |
| 12620540 | OE189 |
| 12637199 | OE258 |
| 12656517 | OE258 |
| 12673528 | OE258 |
| 12788884 | OE238 |
| 24538286 | OE199 |
| 25 324 618 | OE031 |
| 25193473 | OE198 |
| 55350481 | OE019 |
| 55490097 | OE258 |
| 55564748 | OE238 |
| 55564763 | OE188 |
| 55565219 | OE198 |
| 55576026 | OE264 |
| 90444723 | OE019 |
| 90542918 | OE019 |
| 91 95 868 | OE198 |
| 91 99 038 | OE031 |
| 91132086 | OE019 |
| 9146369 | OE019 |
| 9195109 | OE019 |
| 92 06 7204 | OE029 |
| 92 702 93 | OE136 |
| 93 175 994 | OE136 |
| 93 193 723 | OE226 |
| 93175880 | OE019 |
| 93175935 | OE019 |
| 93176801 | OE089 |
| 93180485 | OE198 |
| 95519055 | OE019 |
| 96130723 | OE039 |

OE ? ⇌

| GENERAL MOTORS  | |
|--|-------|
| 96464000 | OE199 |
| 96990231 | OE199 |
| GLAS  | |
| 156 | OE054 |
| 273 | OE038 |
| 274 | OE038 |
| 275 | OE038 |
| 284 | OE064 |
| 33 | OE054 |
| 34 | OE054 |
| 35 | OE054 |
| 393 | OE074 |
| 413 | L78C |
| 414 | L82C |
| 415 | L82C |
| 416 | L82C |
| 44 | OE054 |
| 53 | OE010 |
| 64 | OE048 |
| 745 | OE054 |
| 764 | OE011 |
| 765 | OE011 |
| GMC  | |
| 96 307 729 | OE077 |
| 96 417 176 | OE077 |
| HANOMAG  | |
| 151 123 014 | L82C |
| HANOMAG HENSCHEL  | |
| 151 123 014 | L82C |
| HOLDEN  | |
| 92 06 7204 | OE029 |
| HONDA  | |
| 12290-PNDA01 | OE136 |
| 12290-PNE004 | OE039 |
| 12290-RMX-003 | OE190 |
| 12290-RMX-004 | OE190 |
| 12290-RMX-013 | OE190 |
| 12290-RMX-014 | OE190 |
| 98079-5515V | OE180 |
| 98079-5517V | OE180 |
| 98079-55846 | OE006 |
| 98079-55871 | OE006 |
| 98079-55881 | OE006 |
| 98079-55946 | OE006 |
| 98079-5614E | OE039 |
| 98079-561-4G | OE089 |
| 98079-561-4P | OE089 |
| 98079-5615E | OE039 |
| 98079-5615V | OE179 |







| HONDA  | |
|--|-------|
| 98079-5617V | OE179 |
| 98079-56832 | OE006 |
| 98079-56846 | OE006 |
| 98079-56846-02 | OE006 |
| 98079-56946 | OE006 |
| 98079-571 BH | OE136 |
| 98079-5714H | OE136 |
| 9807B-5615P | OE039 |
| 9807B-5615W | OE179 |
| 9807B-5617P | OE089 |
| 9807B-5617W | OE179 |
| 9807-B5617W | OE136 |
| 9807B-561BW | OE239 |
| 9807B-561CW | OE239 |
| 9807B-56A7W | OE179 |
| HYUNDAI  | |
| 17710-12930 | OE180 |
| 18811-11061 | OE063 |
| 18813-11051 | OE192 |
| 18814-11051 | OE063 |
| 18817-11051 | OE191 |
| 18818-11051 | OE192 |
| 18822-11091 | OE048 |
| 18823-08101 | OE063 |
| 18823-11101 | OE063 |
| 18825-11101 | OE192 |
| 18826-11101 | OE146 |
| 18827-09080 | OE197 |
| 18829 11050 | OE089 |
| 18835-11161 | OE192 |
| 18843-10062 | OE197 |
| 18844-10060 | OE197 |
| 18854-09080 | OE201 |
| 18854-10080 | OE201 |
| 18855-10060 | OE201 |
| 18858-08090 | OE201 |
| 18858-10090 | OE201 |
| 18867-09095 | OE249 |
| 18868-08095 | OE250 |
| 18868-08115 | OE248 |
| 18869-09095 | OE249 |
| 27410-23700 | OE180 |
| 27410-3C000 | OE190 |
| 9803916 | OE248 |
| 9803943 | OE250 |
| IRAN KHODRO (IKCO)  | |
| IK00135680 | OE034 |
| K914563508A | OE034 |
| ISUZU  | |
| 97125969 | OE191 |



| IVECO  | |
|--|-------|
| 504209850 | OE254 |
| 5801436103 | OE254 |
| JAGUAR  | |
| C2A1535 | OE180 |
| C2S46895 | OE131 |
| EAC008584 | OE011 |
| EAC8916 | OE051 |
| EAC8917 | OE051 |
| EBC004021 | OE011 |
| EBC11480 | OE002 |
| EBC8143 | OE013 |
| EBL 11480 | OE005 |
| EBL 2230 | OE005 |
| NAB3850DA | OE011 |
| NCA3850DA/2 | OE136 |
| NCA3850HA2 | OE146 |
| XR842795 | OE131 |
| JEEP  | |
| 56027275 | OE128 |
| KHD  | |
| 345 9769 | L82C |
| 350 3132 | L82C |
| 419 11680 | L82C |
| KIA  | |
| 17710-12930 | OE180 |
| 18811-11061 | OE063 |
| 18813-11051 | OE192 |
| 18814-11051 | OE063 |
| 18817-11051 | OE191 |
| 18818-11051 | OE192 |
| 18822-11091 | OE048 |
| 18823-08101 | OE063 |
| 18823-11101 | OE063 |
| 18825-11101 | OE192 |
| 18826-11101 | OE146 |
| 18827-09080 | OE197 |
| 18829 11050 | OE089 |
| 18835-11161 | OE192 |
| 18843-10062 | OE197 |
| 18844-10060 | OE197 |
| 18854-09080 | OE201 |
| 18854-10080 | OE201 |
| 18855-10060 | OE201 |
| 18858-08090 | OE201 |
| 18867-09095 | OE249 |
| 18868-08095 | OE250 |
| 18868-08115 | OE248 |
| 27410-23700 | OE180 |
| 27410-3C000 | OE190 |

| KUBOTA  | |
|--|-------|
| 12268-6771-1 | OE001 |
| 12273-6771-1 | OE059 |
| 12392-6771-1 | OE015 |
| 12647-6771-1 | OE064 |
| 12691-6771-1 | OE057 |
| 12863-6771-1 | OE015 |
| 12866-6771-1 | OE015 |
| 12992-6771-1 | OE051 |
| 13078-6771-6 | OE001 |
| 13375-6774-0 | OE015 |
| 13451-6771-6 | L82C |
| 13581-6771-6 | L82C |
| 13582-6771-1 | L82C |
| 13901-6771-6 | OE007 |
| 13979-6771-1 | OE007 |
| LADA  | |
| 2112-3707010 | OE039 |
| LANCIA  | |
| 2 284 662 | OE010 |
| 2 301 710 | OE087 |
| 2 301 711 | OE010 |
| 4 170 472 | OE087 |
| 4 172 173 | OE087 |
| 4 233 922 | OE010 |
| 4 249 164 | OE010 |
| 4 345 040 | OE010 |
| 4 345 041 | OE010 |
| 46 229 251 | OE001 |
| 58 945 85 | OE018 |
| 58 945 86 | OE014 |
| 58 945 87 | OE006 |
| 58 961 77 | OE026 |
| 59 840 36 | OE006 |
| 60 504 563 | OE087 |
| 60 512 929 | OE087 |
| 60 800 325 | OE018 |
| 60 810 689 | OE136 |
| 71 711 638 | OE005 |
| 71 711 639 | OE018 |
| 71 711 640 | OE006 |
| 71 711 806 | OE006 |
| 75 444 44 | OE006 |
| 75 444 45 | OE038 |
| 75 465 19 | OE005 |
| 75 544 36 | OE018 |
| 77 603 81 | OE018 |
| 77 603 82 | OE006 |
| 77 603 83 | OE005 |
| 77 603 84 | OE014 |
| 77 724 53 | OE014 |
| 9151700180 | OE015 |



OE ? \rightleftharpoons

| LANCIA  | |
|--|--------------|
| 96 147 386 80 | OE026 |
| 96 196 245 80 | OE019 |
| 9628000280 | OE026 |
| LAND ROVER  | |
| 4550157 | OE180 |
| ETC7244 | OE042 |
| LR001394 | OE190 |
| LR005253 | OE180 |
| LR005483 | OE190 |
| LR021006 | OE120 |
| RTC3569 | OE074 |
| RTC3571 | OE001 |
| RTC3573 | OE059 |
| RTC3812 | OE001 |
| MAN  | |
| 51 25923 0020 | OE010 |
| 51 25923 0022 | OE010 |
| 51 25923 0023 | OE010 |
| MARUTI SUZUKI  | |
| 9482M00567 | OE199 |
| MASSEY FERGUSON  | |
| 834225-MI | J8C |
| 834230-MI | J8C |
| 834234-MI | OE037 |
| 834245-MI | OE074 |
| 834247-MI | OE037 |
| MAZDA  | |
| 1A02-18-110 | OE196 |
| BP 01-18-110 | OE039 |
| BP 02-18-110 | OE039 |
| BP 03-18-110 | OE039 |
| BP 04-18-110 | OE039 |
| BP118110 | OE063 |
| C 401-18-110 | OE031 |
| C 402-18-110 A | OE031 |
| C 402-18-110A | OE031 |
| F 20118101 | OE089 |
| F 220-18-110 | OE039 |
| F 288 18110 | OE089 |
| F28518110 | OE089 |
| F28618110 | OE089 |
| F28718110 | OE089 |
| JE 41 18 110 | OE146 |
| KJ 14 18 110 | OE184 |
| L3G2-18-110 | OE029 |
| L3Y 2-18-110 | OE189 |
| L3Y1-18-110 | OE029 |
| L813 18 110 | OE183 |
| LFG 18-110 | OE189 |
| P51R-18110 | OE253 |

| MAZDA  | |
|--|--------------|
| PE5R-18-110 | OE253 |
| PE5S-18-110 | OE253 |
| SKIT BKG 12020 | OE189 |
| SKIT BKG 18020 | OE189 |
| SKIT GG1 00F3 | OE189 |
| SKIT GG2 00F0 | OE189 |
| SKIT GG2 00F3 | OE189 |
| SKIT GGG 100F0 | OE189 |
| ZJ46-18-110 | OE146 |
| ZJY618110 | OE180 |
| ZJY6-18-110 | OE146 |
| MERCEDES-BENZ  | |
| 000 159 10 03 | OE001 |
| 000 159 12 03 | L82C |
| 000 159 15 03 | OE038 |
| 000 159 36 03 | L78C |
| 000 159 43 03 | OE038 |
| 000 159 54 03 | OE018 |
| 000 159 65 03 | OE038 |
| 000 159 68 03 | OE001 |
| 000 159 72 03 | OE038 |
| 000 159 79 03 | L82C |
| 000 159 94 03 | OE018 |
| 000 162 94 01 | OE009 |
| 001 158 88 03 | OE087 |
| 001 159 19 03 | OE087 |
| 001 159 27 03 | OE087 |
| 001 159 29 03 | L82C |
| 001 159 31 03 | OE087 |
| 001 159 34 03 | OE087 |
| 001 159 45 03 | OE087 |
| 001 159 47 03 | OE010 |
| 001 159 50 03 | OE087 |
| 001 159 51 03 | OE010 |
| 001 159 52 03 | OE087 |
| 001 159 53 03 | OE087 |
| 001 159 55 03 | OE087 |
| 001 159 60 03 | L82C |
| 001 159 61 03 | OE087 |
| 001 159 62 03 | OE087 |
| 001 159 65 03 | OE074 |
| 001 159 68 03 | OE010 |
| 001 159 69 03 | OE087 |
| 001 159 71 03 | OE010 |
| 001 159 76 03 | OE032 |
| 001 159 81 03 | OE001 |
| 001 159 82 03 | OE001 |
| 001 159 84 03 | OE010 |
| 001 159 84 04 | OE087 |
| 001 159 85 03 | OE010 |
| 001 159 87 03 | OE087 |
| 001 159 88 03 | OE087 |

| MERCEDES-BENZ  | |
|--|--------------|
| 001 159 89 03 | OE087 |
| 001 159 93 03 | OE087 |
| 001 159 94 03 | OE010 |
| 001 159 95 03 | OE001 |
| 001 635 40 0 | OE009 |
| 002 159 04 03 | OE015 |
| 002 159 05 03 | OE015 |
| 002 159 06 03 | OE015 |
| 002 159 07 03 | OE015 |
| 002 159 08 03 | OE010 |
| 002 159 09 03 | OE010 |
| 002 159 10 03 | OE001 |
| 002 159 11 03 | OE001 |
| 002 159 14 03 | OE010 |
| 002 159 15 03 | OE010 |
| 002 159 16 03 | OE015 |
| 002 159 17 03 | OE015 |
| 002 159 18 03 | OE087 |
| 002 159 19 03 | OE001 |
| 002 159 20 03 | OE001 |
| 002 159 21 03 | OE001 |
| 002 159 24 03 | OE001 |
| 002 159 25 03 | OE001 |
| 002 159 26 03 | OE001 |
| 002 159 27 03 | OE087 |
| 002 159 28 03 | OE001 |
| 002 159 29 03 | OE001 |
| 002 159 30 03 | OE001 |
| 002 159 31 03 | OE001 |
| 002 159 35 03 | OE009 |
| 002 159 37 03 | OE009 |
| 002 159 41 03 | OE010 |
| 002 159 42 03 | OE010 |
| 002 159 47 03 | OE001 |
| 002 159 48 03 | OE015 |
| 002 159 49 03 | OE009 |
| 002 159 51 03 | OE087 |
| 002 159 54 03 | OE009 |
| 002 159 56 03 | OE009 |
| 002 159 57 03 | OE009 |
| 002 159 58 03 | OE009 |
| 002 159 59 03 | OE015 |
| 002 159 60 03 | OE015 |
| 002 159 61 03 | OE001 |
| 002 159 62 03 | OE087 |
| 002 159 63 03 | OE087 |
| 002 159 66 03 | OE009 |
| 002 159 72 03 | OE038 |
| 002 159 74 03 | OE074 |
| 002 159 78 03 | OE009 |
| 003 159 06 03 | OE009 |
| 003 159 10 03 | OE001 |
| 003 159 11 03 | OE015 |

| MERCEDES-BENZ  | |
|--|--------------|
| 003 159 13 03 | OE010 |
| 003 159 14 03 | OE087 |
| 003 159 23 03 | OE009 |
| 003 159 24 03 | OE009 |
| 003 159 27 03 | OE001 |
| 003 159 28 03 | OE009 |
| 003 159 29 03 | OE015 |
| 003 159 30 03 | OE003 |
| 003 159 32 03 | OE087 |
| 003 159 35 03 | OE009 |
| 003 159 36 03 | OE009 |
| 003 159 41 03 | OE003 |
| 003 159 45 03 | OE001 |
| 003 159 46 03 | OE015 |
| 003 159 47 03 | OE001 |
| 003 159 53 03 | OE003 |
| 003 159 56 03 | OE087 |
| 003 159 57 03 | OE010 |
| 003 159 58 03 | OE010 |
| 003 159 62 03 | L82C |
| 003 159 65 03 | OE019 |
| 003 159 66 03 | OE191 |
| 003 159 67 03 | OE057 |
| 003 159 68 03 | OE057 |
| 003 159 71 03 | OE057 |
| 003 159 72 03 | OE032 |
| 003 159 75 03 | OE032 |
| 003 159 76 03 | OE032 |
| 003 159 78 03 | OE032 |
| 003 159 80 03 | OE136 |
| 003 159 81 03 | OE228 |
| 003 159 93 03 | OE146 |
| 003 159 94 03 | OE191 |
| 003 159 96 03 | OE191 |
| 003 159 96 03 | OE228 |
| 003 159 97 03 | OE181 |
| 003 159 97 03 26 | OE146 |
| 003 159 97 03 98 | OE146 |
| 004 159 07 03 | OE146 |
| 004 159 13 03 | OE224 |
| 004 159 14 03 | OE188 |
| 004 159 18 03 | OE229 |
| 004 159 19 03 | OE191 |
| 004 159 20 03 | OE136 |
| 004 159 23 03 | OE224 |
| 004 159 26 03 | OE005 |
| 004 159 30 03 | OE005 |
| 004 159 34 03 | OE229 |
| 004 159 36 03 | OE005 |
| 004 159 39 03 | OE233 |
| 004 159 43 03 | OE181 |
| 004 159 44 03 | OE229 |
| 004 159 45 03 | OE224 |

OE ? ⇌

| MERCEDES-BENZ | CHAMPION |
|--------------------|----------|
| 004 159 49 03 | OE229 |
| 004 159 50 03 | OE191 |
| 050 981 67 AA | OE191 |
| 102 159 00 03 | OE009 |
| 102 159 01 03 | OE009 |
| 102 159 03 03 | OE009 |
| 102 159 06 03 | OE009 |
| 102 159 11 03 | OE009 |
| 103 159 00 01 | OE009 |
| 103 159 00 03 | OE009 |
| 110 159 00 03 | OE010 |
| 116 159 00 03 | OE001 |
| 116 159 01 03 | OE015 |
| 116 159 02 03 | OE001 |
| 116 159 99 93 | OE001 |
| 132 159 00 03 | OE212 |
| A 001 159 76 03 | OE032 |
| A 003 159 14 03 | OE087 |
| A 003 159 35 03 | OE009 |
| A 003 159 36 03 | OE009 |
| A 003 159 41 03 | OE003 |
| A 003 159 45 03 | OE001 |
| A 003 159 46 03 | OE015 |
| A 003 159 56 03 | OE087 |
| A 003 159 57 03 | OE010 |
| A 003 159 65 03 | OE019 |
| A 003 159 66 03 | OE191 |
| A 003 159 67 03 | OE057 |
| A 003 159 67 03 26 | OE057 |
| A 003 159 68 03 | OE057 |
| A 003 159 71 03 | OE057 |
| A 003 159 75 03 | OE032 |
| A 003 159 76 03 | OE032 |
| A 003 159 80 03 | OE136 |
| A 003 159 81 03 | OE228 |
| A 003 159 93 03 | OE146 |
| A 003 159 94 03 | OE191 |
| A 003 159 96 03 | OE191 |
| A 003 159 96 03 | OE228 |
| A 003 159 97 03 | OE146 |
| A 003 159 97 03 26 | OE146 |
| A 003 159 97 03 98 | OE146 |
| A 004 159 07 03 | OE146 |
| A 004 159 13 03 | OE224 |
| A 004 159 18 03 | OE229 |
| A 004 159 19 03 | OE191 |
| A 004 159 19 03 26 | OE191 |
| A 004 159 20 03 | OE136 |
| A 004 159 23 03 | OE224 |
| A 004 159 26 03 | OE005 |
| A 004 159 30 03 | OE005 |
| A 004 159 30 03 26 | OE005 |
| A 004 159 34 03 | OE229 |

| MERCEDES-BENZ | CHAMPION |
|--------------------|----------|
| A 004 159 36 03 | OE005 |
| A 004 159 39 03 | OE233 |
| A 004 159 43 03 | OE181 |
| A 004 159 44 03 | OE229 |
| A 004 159 45 03 | OE224 |
| A 004 159 45 03 26 | OE224 |
| A 004 159 49 03 | OE229 |
| A 004 159 50 03 | OE191 |
| A 004 159 58 03 | OE229 |
| A 132 159 00 03 | OE212 |
| A 281 159 00 03 | OE261 |
| MINI | CHAMPION |
| 12 12 2 293 697 | OE205 |
| V 75 70 259 | OE204 |
| V 75 77 104 | OE204 |
| MITSUBISHI | CHAMPION |
| 1822A011 | OE250 |
| MA 848 593 | OE238 |
| MD 313 443 | OE146 |
| MD 360 019 | OE227 |
| MD 360 383 | OE184 |
| MN 128 362 | OE238 |
| MN 128 363 | OE238 |
| MN119487 | OE179 |
| MN119942 | OE120 |
| MN158596 | OE190 |
| MN163236 | OE179 |
| MN163807 | OE179 |
| MR984943 | OE179 |
| MS 851 183 | OE001 |
| MS 851 232 | OE006 |
| MS 851 233 | OE006 |
| MS 851 234 | OE087 |
| MS 851 237 | OE049 |
| MS 851 238 | OE048 |
| MS 851 335 | OE136 |
| MS 851 336 | OE146 |
| MS 851 357 | OE039 |
| MS 851 358 | OE039 |
| MS 851 412 | OE006 |
| MS 851 413 | OE087 |
| MS 851 473 | OE146 |
| MS 851 501 | OE136 |
| MS 851 502 | OE146 |
| MS 851 728 | OE039 |
| MS851368 | OE002 |
| MWM | CHAMPION |
| 6 0579 415 0007 | L78C |
| NISSAN | CHAMPION |
| 22101-AX015 | OE175 |

| NISSAN | CHAMPION |
|--------------|----------|
| 22401-01P15 | OE039 |
| 22401-01P16 | OE039 |
| 22401-10F16 | OE005 |
| 22401-1HC1B | OE240 |
| 22401-1KT1B | OE240 |
| 22401-1P116 | OE146 |
| 22401-20J05 | OE005 |
| 22401-20J06 | OE002 |
| 22401-20J06 | OE039 |
| 22401-27N66 | OE146 |
| 22401-2F200 | OE089 |
| 22401-53J06 | OE002 |
| 22401-53J13 | OE136 |
| 22401-53J66 | OE136 |
| 22401-58S16 | OE136 |
| 22401-70J13 | OE154 |
| 22401-70J17 | OE014 |
| 22401-70J19 | OE002 |
| 22401-70J22 | OE002 |
| 22401-74B00 | OE016 |
| 22401-74B07 | OE016 |
| 22401-74B11 | OE063 |
| 22401-74B18 | OE063 |
| 22401-8H315 | OE175 |
| 22401-8H514 | OE035 |
| 22401-8H514 | OE148 |
| 22401-8H515 | OE035 |
| 22401-8H516 | OE035 |
| 22401-8H516 | OE148 |
| 22401-99B17 | OE014 |
| 22401-99B22 | OE013 |
| 22401-AU015 | OE148 |
| 22401-AU075 | OE148 |
| 22401-AX015 | OE175 |
| 22401-AX075 | OE175 |
| 22401-BC01B | OE175 |
| 22401-BC05A | OE175 |
| 22401-CK81 B | OE207 |
| 22401-ED715 | OE240 |
| 22401-ED71B | OE240 |
| 22401-ED815 | OE240 |
| 22401-FU412 | OE013 |
| 22401-M7715 | OE001 |
| 22401-V5016 | OE039 |
| 22401-W8915 | OE065 |
| 22401-W8916 | OE001 |
| 22401-ZE01B | OE190 |
| 82000-46337 | OE136 |
| B2401-4A00A | OE226 |
| NSU | CHAMPION |
| 11 17 00 068 | L82C |
| 48 17 00 003 | L78C |

| OPEL | CHAMPION |
|-------------|----------|
| 09199038 | OE255 |
| 12 14 000 | OE019 |
| 12 14 003 | OE026 |
| 12 14 005 | OE019 |
| 12 14 007 | OE048 |
| 12 14 008 | OE048 |
| 12 14 009 | OE039 |
| 12 14 011 | OE120 |
| 12 14 012 | OE031 |
| 12 14 015 | OE019 |
| 12 14 016 | OE198 |
| 12 14 019 | OE038 |
| 12 14 020 | L82C |
| 12 14 021 | OE038 |
| 12 14 023 | OE038 |
| 12 14 025 | OE010 |
| 12 14 026 | OE136 |
| 12 14 027 | OE019 |
| 12 14 029 | OE136 |
| 12 14 031 | OE089 |
| 12 14 039 | OE010 |
| 12 14 041 | OE198 |
| 12 14 046 | L82C |
| 12 14 065 | OE238 |
| 12 14 066 | OE264 |
| 12 14 105 | OE258 |
| 12 14 108 | OE018 |
| 12 14 110 | OE010 |
| 12 14 112 | OE198 |
| 12 14 117 | OE019 |
| 12 14 119 | OE018 |
| 12 14 122 | OE018 |
| 12 14 128 | OE258 |
| 12 14 132 | OE018 |
| 12 14 139 | OE006 |
| 12 14 144 | OE005 |
| 12 14 145 | OE089 |
| 12 14 148 | OE039 |
| 12 14 149 | OE004 |
| 12 14 193 | OE006 |
| 12 14 455 | OE019 |
| 12 14 462 | OE191 |
| 12 14 527 | OE238 |
| 12 14 528 | OE188 |
| 12 14 702 | OE018 |
| 12 14 802 | OE018 |
| 12 14 803 | OE048 |
| 12 14 804 | OE005 |
| 12 14 805 | OE064 |
| 12 14 806 | OE018 |
| 12 14 807 | OE006 |
| 12 59 746 4 | OE189 |
| 12.141.49 | OE004 |

OE ?

| OPEL | CHAMPION |
|------------|----------|
| 12.144.62 | OE191 |
| 12.148.03 | OE077 |
| 1214013 | OE255 |
| 1214118 | OE255 |
| 25324618 | OE255 |
| 44 08 937 | OE146 |
| 44 10 220 | OE146 |
| 44 13 288 | OE146 |
| 44 32 200 | OE146 |
| 47 08 892 | OE226 |
| 48 05 484 | OE029 |
| 48 11 581 | OE189 |
| 90 350 018 | OE006 |
| 91 160 172 | OE146 |
| 92 063 303 | OE191 |
| 93 160 201 | OE146 |
| 93 161 199 | OE146 |
| 93 161 947 | OE146 |
| 93 190 948 | OE031 |
| 95519057 | OE255 |
| 97 125 696 | OE146 |
| 97 125 969 | OE191 |
| 97 170 268 | OE191 |
| 97125969 | OE191 |

| PEUGEOT | CHAMPION |
|--------------|----------|
| 1105 693 600 | L82C |
| 5960 10 | OE001 |
| 5960 13 | OE035 |
| 5960 15 | OE034 |
| 5960 16 | OE035 |
| 5960 16 | OE178 |
| 5960 17 | OE035 |
| 5960 17 | OE148 |
| 5960 18 | OE026 |
| 5960 18 | OE030 |
| 5960 53 | OE178 |
| 5960 57 | OE178 |
| 5960 58 | OE178 |
| 5960 75 | OE178 |
| 5960 7X | OE035 |
| 5960 83 | OE130 |
| 5960 86 | OE178 |
| 5960 90 | OE035 |
| 5960 91 | OE035 |
| 5960 97 | OE035 |
| 5960 98 | OE035 |
| 5960 E1 | OE203 |
| 5960 E2 | OE203 |
| 5960 F0 | OE034 |
| 5960 F3 | OE035 |
| 5960 F7 | OE178 |
| 5960 G1 | OE130 |

| PEUGEOT | CHAMPION |
|---------|----------|
| 5960 G4 | OE205 |
| 5960 J2 | OE034 |
| 5960 K8 | OE035 |
| 5960 K9 | OE205 |
| 5960 L0 | OE205 |
| 5960 L2 | OE035 |
| 5960 L3 | OE203 |
| 5960 L5 | OE205 |
| 5961 07 | L78C |
| 5961 08 | L82C |
| 5961 09 | L82C |
| 5961 10 | L78C |
| 5961 12 | OE074 |
| 5961 15 | OE074 |
| 5961 19 | OE001 |
| 5961 20 | OE087 |
| 5961 23 | OE074 |
| 5961 26 | OE087 |
| 5961 27 | OE010 |
| 5961 29 | OE087 |
| 5961 41 | OE087 |
| 5961 42 | OE087 |
| 5961 43 | OE010 |
| 5961 47 | OE001 |
| 5961 48 | OE087 |
| 5961 93 | OE001 |
| 5961 96 | OE001 |
| 5962 05 | OE009 |
| 5962 11 | OE001 |
| 5962 13 | OE001 |
| 5962 15 | OE009 |
| 5962 16 | OE001 |
| 5962 16 | OE010 |
| 5962 19 | OE001 |
| 5962 21 | OE012 |
| 5962 2T | OE030 |
| 5962 44 | OE087 |
| 5962 45 | OE010 |
| 5962 47 | OE009 |
| 5962 48 | OE009 |
| 5962 51 | OE001 |
| 5962 52 | OE001 |
| 5962 58 | L82C |
| 5962 5C | OE035 |
| 5962 5E | OE035 |
| 5962 5M | OE035 |
| 5962 5M | OE148 |
| 5962 60 | OE001 |
| 5962 61 | OE009 |
| 5962 65 | OE001 |
| 5962 65 | OE010 |
| 5962 67 | L82C |
| 5962 68 | OE009 |





| PEUGEOT | CHAMPION |
|--------------|----------|
| 5962 6K | OE034 |
| 5962 6W | OE005 |
| 5962 70 | OE001 |
| 5962 71 | OE014 |
| 5962 72 | OE009 |
| 5962 7E | OE175 |
| 5962 7R | OE034 |
| 5962 7W | OE035 |
| 5962 7W | OE178 |
| 5962 88 | OE087 |
| 5962 89 | OE087 |
| 5962 8A | OE175 |
| 5962 96 | L82C |
| 5962 A0 | OE087 |
| 5962 A1 | OE010 |
| 5962 A2 | OE015 |
| 5962 A3 | OE038 |
| 5962 A4 | OE001 |
| 5962 C0 | OE009 |
| 5962 C5 | OE014 |
| 5962 E2 | OE057 |
| 5962 F6 | OE014 |
| 5962 H2 | OE014 |
| 5962 H4 | OE094 |
| 5962 H5 | OE059 |
| 5962 H6 | OE014 |
| 5962 H7 | OE077 |
| 5962 H8 | OE039 |
| 5962 H9 | OE005 |
| 5962 J1 | OE005 |
| 5962 J1 | OE016 |
| 5962 J3 | OE005 |
| 5962 K0 | OE005 |
| 5962 K1 | OE014 |
| 5962 K4 | OE005 |
| 5962 K7 | OE077 |
| 5962 R5 | OE077 |
| 5962 W9 | OE034 |
| 9151 400 080 | OE001 |
| 9151 700 080 | OE001 |
| 9151 700 380 | OE009 |
| 9151 700 680 | OE009 |
| 9151 873 580 | OE012 |
| 9151 944 680 | OE009 |
| 9151873580 | OE012 |
| 9152 106 780 | OE001 |
| 9456190680 | OE034 |
| 9561 837 880 | OE010 |
| 96363933 | OE035 |
| 9636393380 | OE035 |
| 9636419280 | OE034 |
| 9638127380 | OE217 |
| 9650684480 | OE035 |

| PEUGEOT | CHAMPION |
|------------|----------|
| 9650889380 | OE178 |
| 9661959180 | OE035 |
| A0P | OE010 |
| CC 10 | OE009 |
| CP 10 | OE001 |
| Super 14-7 | L82C |
| Super 14-8 | L78C |
| Super 14-9 | L78C |

| PIAGGIO | CHAMPION |
|---------|----------|
| 438064 | OE077 |
| P4M | OE079 |
| P82M | L82C |
| P86M | OE037 |
| RP2M | OE091 |

| PORSCHE | CHAMPION |
|----------------|----------|
| 905 071 4 | OE015 |
| 928 094 602 03 | OE001 |
| 95817022190 | OE214 |
| 999 020 802 10 | L82C |
| 999 170 023 90 | L82C |
| 999 170 050 90 | OE087 |
| 999 170 051 90 | OE087 |
| 999 170 052 90 | OE087 |
| 999 170 055 90 | OE087 |
| 999 170 056 90 | OE087 |
| 999 170 103 90 | OE222 |
| 999 170 111 90 | OE087 |
| 999 170 119 90 | OE001 |
| 999 170 122 90 | OE262 |
| 999 170 126 90 | OE001 |
| 999 170 130 90 | OE262 |
| 999 170 132 90 | OE015 |
| 999 170 133 90 | OE015 |
| 999 170 135 90 | OE087 |
| 999 170 136 90 | OE015 |
| 999 170 138 90 | OE010 |
| 999 170 139 90 | OE010 |
| 999 170 141 90 | OE006 |
| 999 170 142 90 | OE006 |
| 999 170 146 90 | OE001 |
| 999 170 148 90 | OE001 |
| 999 170 151 90 | OE262 |
| 999 170 156 90 | OE006 |
| 999 170 158 90 | OE006 |
| 999 170 165 90 | OE087 |
| 999 170 167 90 | OE038 |
| 999 170 168 90 | OE010 |
| 999 170 170 90 | OE015 |
| 999 170 182 90 | OE014 |
| 999 170 195 90 | OE216 |
| 999 170 201 90 | OE026 |

OE ? ⇌

| PORSCHE | |  |
|----------------|--------------|--|
| 999 170 207 91 | OE218 | |
| 999 170 218 90 | OE218 | |
| 999 170 219 90 | OE218 | |
| 999 170 220 90 | OE216 | |
| 999 170 221 90 | OE222 | |
| 999 170 223 90 | OE257 | |
| 999 170 228 90 | OE210 | |
| 999 170 229 90 | OE210 | |
| 999 170 233 90 | OE246 | |
| 99917000290 | OE038 | |
| 99917020190 | OE026 | |
| 99917020490 | OE120 | |
| 99917020491 | OE120 | |
| 99917021890 | OE120 | |
| 99917021990 | OE120 | |
| 99917022190 | OE136 | |
| PROTON | |  |
| MS851237E | OE039 | |
| PUCH | |  |
| 905 0714 | OE015 | |
| RENAULT | |  |
| 08 51 798 700 | L82C | |
| 08 51 798 800 | OE038 | |
| 08 54 407 100 | L82C | |
| 08 54 864 700 | L82C | |
| 08 55 800 600 | OE074 | |
| 08 55 836 400 | OE038 | |
| 08 55 836 500 | OE038 | |
| 08 55 939 100 | OE074 | |
| 22 40 123 31R | OE207 | |
| 22401-2047R | OE261 | |
| 224013682R | OE026 | |
| 224017726R | OE014 | |
| 224018651R | OE005 | |
| 224018760R | OE130 | |
| 515 | OE136 | |
| 60 01 040 356 | OE077 | |
| 60 01 040 357 | OE077 | |
| 60 01 040 543 | OE009 | |
| 60 01 544 293 | OE005 | |
| 6001544293 | OE033 | |
| 74 33 517 980 | OE005 | |
| 74 39 146 775 | OE077 | |
| 77 00 100 403 | OE026 | |
| 77 00 101 401 | OE005 | |
| 77 00 103 533 | OE019 | |
| 77 00 107 916 | OE019 | |
| 77 00 115 827 | OE026 | |
| 77 00 260 637 | OE014 | |
| 77 00 273 462 | OE005 | |
| 77 00 273 490 | OE005 | |



| RENAULT | |  |
|----------------|--------------|---|
| 77 00 274 004 | OE005 | |
| 77 00 274 154 | OE033 | |
| 77 00 500 000 | OE001 | |
| 77 00 500 012 | OE001 | |
| 77 00 500 024 | OE087 | |
| 77 00 500 036 | OE078 | |
| 77 00 500 072 | OE009 | |
| 77 00 500 120 | OE018 | |
| 77 00 500 132 | OE077 | |
| 77 00 500 168 | OE026 | |
| 77 00 500 180 | OE005 | |
| 77 00 500 204 | OE009 | |
| 77 00 529 980 | OE038 | |
| 77 00 546 241 | OE038 | |
| 77 00 553 622 | OE001 | |
| 77 00 558 395 | OE038 | |
| 77 00 571 635 | OE038 | |
| 77 00 580 479 | OE038 | |
| 77 00 583 895 | OE001 | |
| 77 00 612 290 | OE001 | |
| 77 00 613 828 | OE015 | |
| 77 00 616 459 | OE038 | |
| 77 00 619 329 | L82C | |
| 77 00 621 029 | OE038 | |
| 77 00 647 263 | OE038 | |
| 77 00 647 265 | OE015 | |
| 77 00 647 267 | OE038 | |
| 77 00 647 269 | L82C | |
| 77 00 647 270 | OE038 | |
| 77 00 647 272 | OE001 | |
| 77 00 647 273 | OE010 | |
| 77 00 647 275 | L82C | |
| 77 00 647 276 | OE038 | |
| 77 00 647 278 | OE038 | |
| 77 00 647 279 | OE038 | |
| 77 00 647 280 | L82C | |
| 77 00 647 284 | L82C | |
| 77 00 647 285 | OE038 | |
| 77 00 647 286 | OE038 | |
| 77 00 659 130 | OE001 | |
| 77 00 659 152 | OE010 | |
| 77 00 659 262 | L82C | |
| 77 00 660 006 | OE001 | |
| 77 00 661 752 | OE015 | |
| 77 00 662 849 | OE038 | |
| 77 00 664 569 | OE064 | |
| 77 00 670 734 | OE015 | |
| 77 00 681 298 | OE006 | |
| 77 00 683 771 | OE015 | |
| 77 00 683 772 | OE038 | |
| 77 00 714 317 | OE011 | |
| 77 00 714 540 | OE011 | |
| 77 00 724 821 | OE015 | |





| RENAULT | |  |
|----------------|--------------|---|
| 77 00 724 822 | OE015 | |
| 77 00 727 383 | OE006 | |
| 77 00 732 626 | OE087 | |
| 77 00 733 422 | OE007 | |
| 77 00 737 459 | OE087 | |
| 77 00 742 094 | OE018 | |
| 77 00 743 137 | OE057 | |
| 77 00 743 920 | OE015 | |
| 77 00 745 305 | OE014 | |
| 77 00 749 163 | OE057 | |
| 77 00 824 821 | OE015 | |
| 77 00 855 463 | OE094 | |
| 77 00 855 918 | OE009 | |
| 77 00 856 342 | OE094 | |
| 77 00 858 444 | OE077 | |
| 77 00 859 967 | OE001 | |
| 77 00 860 235 | OE001 | |
| 77 00 861 471 | OE010 | |
| 77 00 861 472 | OE001 | |
| 77 00 862 054 | OE015 | |
| 77 00 868 864 | OE018 | |
| 77 01 023 079 | OE001 | |
| 77 01 023 080 | OE001 | |
| 77 01 023 325 | OE015 | |
| 77 01 023 391 | OE038 | |
| 77 01 041 214 | OE015 | |
| 77 01 041 215 | OE009 | |
| 77 01 042 816 | OE005 | |
| 77 01 043 624 | OE216 | |
| 77 01 065 085 | OE207 | |
| 77 01 365 111 | OE087 | |
| 77 01 366 057 | OE038 | |
| 77 01 366 085 | OE078 | |
| 77 01 366 086 | OE010 | |
| 77 01 366 087 | OE010 | |
| 77 01 366 138 | OE010 | |
| 77 01 366 267 | OE038 | |
| 77 01 366 268 | OE010 | |
| 77 01 366 269 | OE001 | |
| 77 01 366 270 | OE009 | |
| 77 01 366 513 | OE007 | |
| 77 01 366 514 | OE009 | |
| 77 01 366 515 | OE038 | |
| 77 01 366 516 | OE001 | |
| 77 01 366 533 | OE037 | |
| 77 01 366 539 | OE001 | |
| 77 01 366 903 | OE001 | |
| 77 01 392 263 | L82C | |
| 77 01 414 022 | OE007 | |
| 77 01 414 023 | OE001 | |
| 77 01 414 024 | OE087 | |
| 77 01 414 026 | OE015 | |
| 77 01 414 030 | OE011 | |









| RENAULT | |  |
|----------------|--------------|---|
| 77 01 414 031 | OE006 | |
| 77 01 414 036 | OE038 | |
| 77 01 414 037 | L82C | |
| 77 01 414 038 | OE009 | |
| 77 01 414 040 | OE005 | |
| 77 01 414 044 | OE010 | |
| 77 01 414 058 | OE009 | |
| 77 01 414 105 | OE001 | |
| 77 01 414 110 | OE005 | |
| 77 01 414 111 | OE005 | |
| 77 01 414 112 | OE005 | |
| 77 01 414 113 | OE006 | |
| 77 01 414 114 | OE012 | |
| 77 01 414 119 | OE012 | |
| 77 01 414 121 | OE054 | |
| 77 01 414 138 | OE011 | |
| 77 01 414 139 | OE005 | |
| 77 01 414 140 | OE012 | |
| 77 01 414 141 | OE014 | |
| 77 01 414 142 | OE006 | |
| 77 01 414 143 | OE018 | |
| 77 01 414 144 | OE038 | |
| 77 01 414 145 | OE005 | |
| 77 01 417 651 | OE009 | |
| 77 01 417 654 | OE087 | |
| 77 01 612 290 | OE001 | |
| 77 01 742 094 | OE018 | |
| 77 02 124 101 | OE015 | |
| 77 02 125 001 | OE038 | |
| 77 51 023 082 | OE001 | |
| 77.00.273.462 | OE016 | |
| 77.00.273.698 | OE191 | |
| 77.00.714.540 | OE011 | |
| 77.00.724.821 | OE001 | |
| 77.00.725.302 | OE042 | |
| 77.00.733.422 | OE059 | |
| 77.00.868.864 | OE008 | |
| 77.01.366.084 | OE078 | |
| 77.01.366.269 | OE001 | |
| 77.01.366.270 | OE009 | |
| 77.01.366.533 | OE037 | |
| 77.01.414.022 | OE059 | |
| 77.01.414.023 | OE001 | |
| 77.01.414.025 | OE001 | |
| 77.01.414.030 | OE011 | |
| 77.01.414.032 | OE042 | |
| 77.01.414.037 | L82C | |
| 77.01.414.038 | OE009 | |
| 77.01.414.040 | OE014 | |
| 77.01.414.056 | OE009 | |
| 77.01.414.065 | OE094 | |
| 7700 500 180 | OE033 | |
| 7700500024 | OE087 | |







OE ?





| RENAULT  | |
|--|--------------|
| 7700500036 | OE078 |
| 7700500072 | OE011 |
| 7700500155 | OE033 |
| 7700500168 | OE026 |
| 7700500180 | OE005 |
| 7700500216 | OE011 |
| 7700714540 | OE011 |
| 7700724821 | OE001 |
| 7700725302 | OE042 |
| 7700732626 | OE087 |
| 7700733422 | OE059 |
| 7700868864 | OE008 |
| 7701366084 | OE078 |
| 7701366269 | OE001 |
| 7701366270 | OE009 |
| 7701366533 | OE037 |
| 7701414022 | OE059 |
| 7701414023 | OE001 |
| 7701414025 | OE001 |
| 7701414030 | OE011 |
| 7701414032 | OE042 |
| 7701414038 | OE009 |
| 7701414040 | OE014 |
| 7701414056 | OE009 |
| 7701414065 | OE094 |
| 82 00 030 765 | OE130 |
| 82 00 046 337 | OE146 |
| 82 00 209 310 | OE033 |
| 82 00 307 688 | OE146 |
| 82 00 363 384 | OE146 |
| 82 00 492 426 | OE136 |
| 82 00 587 901 | OE225 |
| 82 00 662 185 | OE130 |
| 8200020791 | OE033 |
| 8200020796 | OE033 |
| 8200021856 | OE033 |
| 8200033622 | OE033 |
| 8200046337 | OE136 |
| 83 04 504 277 | OE128 |
| 86 71 016 885 | OE006 |
| 8671019515 | OE136 |
| 89 33 003 862 | OE005 |
| 89.33.003.862 | OE005 |
| 8933003862 | OE005 |
| 96 26 195 980 | OE030 |
| 96 26 575 480 | OE030 |
| 96 36 415 880 | OE175 |
| 9636415880 | OE175 |
| ROVER  | |
| GSP 66527 | OE146 |
| GSP 9652 | OE146 |
| NLP000030 | OE120 |

| ROVER  | |
|--|--------------|
| NLP000040 | OE136 |
| NLP10003 | OE002 |
| NLP10004 | OE014 |
| NLP100190 | OE136 |
| NLP100290 | OE146 |
| NLP100290L | OE146 |
| NLP100320 | OE138 |
| NLP1004 | OE014 |
| NPL 100190 | OE146 |
| SAAB  | |
| 23412600 | L82C |
| 23413800 | OE038 |
| 23415300 | OE038 |
| 75 05 142 | OE014 |
| 83 55 007 | OE001 |
| 9188681 | OE136 |
| 9399866 | OE136 |
| T 40 238 921 001 | OE001 |
| T 40 238 924 005 | OE001 |
| SEAT  | |
| 0003901171 | OE010 |
| 0003908857 | OE015 |
| 0003910649 | OE010 |
| 0003911398 | OE001 |
| 0004359424 | OE006 |
| 06H 905 601 A | OE214 |
| 06H 905 611 | OE214 |
| 06H 905 621 | OE214 |
| 06H 905 621 A | OE214 |
| 101 000 035 AH | OE198 |
| 101 000 040 AC | OE027 |
| 101 000 040 AD | OE025 |
| 101 905 603 B | OE177 |
| 101 905 609 | OE235 |
| 101 905 631 | OE214 |
| 101 905 631 B | OE214 |
| 101 905 631 H | OE214 |
| EA 919000 04 | OE074 |
| FH 919000 02 | OE001 |
| SKODA  | |
| 06H 905 601 A | OE214 |
| 06H 905 611 | OE214 |
| 06H 905 621 | OE214 |
| 06H 905 621 A | OE214 |
| 101 000 040 AD | OE025 |
| 101 000 049 AC | OE145 |
| 101 000 060 AA | OE145 |
| 101 905 603 B | OE177 |
| 101 905 631 | OE214 |
| 101 905 631 B | OE214 |
| 101 905 631 H | OE214 |



| SKODA  | |
|--|--------------|
| 101000049AC | OE145 |
| 101000049AD | OE136 |
| 101000060AA | OE145 |
| BBC 057 008 | OE038 |
| BBC 057 009 | OE038 |
| BBC 057 011 | OE005 |
| BBC 057 012 | OE005 |
| BBC057010 | OE003 |
| BBC057012 | OE005 |
| SMART  | |
| 000 3085V005 | OE217 |
| 281 159 01 00 | OE130 |
| A 132 159 00 03 | OE212 |
| A 135 150 01 18 | OE238 |
| A 281 159 00 03 | OE261 |
| A 281 159 01 00 | OE130 |
| Q 000 3085V005 000 000 | OE217 |
| Q0012468V002000000 | OE211 |
| SOLO  | |
| 23 00 101 | L82C |
| 23 00 103 | L78C |
| 23 00 106 | L82C |
| 23 00 323 | L78C |
| 23 00 428 | OE038 |
| 23 00 441 | L82C |
| 23 00 500 | L78C |
| SSANGYONG  | |
| A 003 159 41 03 | OE003 |
| A 003 159 68 03 | OE057 |
| STEINBOCK  | |
| 014046 | L82C |
| 024153 | OE018 |
| STEYR  | |
| 23 733 | L78C |
| 902 0724 | L82C |
| 902 0726 | L82C |
| 902 0741 | L78C |
| 904 0784 | OE038 |
| 905 0702 | OE074 |
| 905 0703 | OE074 |
| 905 0711 | OE010 |
| STIHL  | |
| 0000 405 0101 | OE038 |
| 0000 405 0102 | L78C |
| 0000 405 0107 | L78C |
| 1107 400 7000 | L82C |
| SUBARU  | |
| 22401 AA 310 | OE227 |

| SUBARU  | |
|---|--------------|
| 22401 AA 501 | OE188 |
| 22401 KA 210 | OE039 |
| 22401-AA371 | OE191 |
| 22401-AA731 | OE179 |
| SAB 330 NG 0608 | OE188 |
| SAB 330 NG 0611 | OE188 |
| SAB 330 NG 8608 | OE188 |
| SAB 330 NG 8611 | OE188 |
| SUZUKI  | |
| 09482-00527 | OE196 |
| 09482-00602 | OE226 |
| 09482-00602-A00 | OE226 |
| 09482-00603 | OE226 |
| 09482-00603-000 | OE226 |
| 09482-M00611 | OE226 |
| 90482-00448 | OE196 |
| 905 0712 | OE064 |
| 9482369 | OE196 |
| 96464000 | OE199 |
| TALBOT  | |
| 00 00 VSP 118 | OE006 |
| 00 00 VSP 120 | OE018 |
| 00 043 456 00 | OE010 |
| 00 044 629 00 | OE087 |
| 00 131 120 00 | OE010 |
| 00 136 956 00 | OE038 |
| 00 157 973 00 | OE001 |
| 00 165 081 00 | OE001 |
| 00 166 316 00 | OE010 |
| 00 429 049 00 | OE001 |
| 00 553 549 00 | OE001 |
| 00 553 552 00 | OE087 |
| 00 566 133 00 | OE001 |
| 00 792 270 42 | OE006 |
| 00 792 270 44 | OE018 |
| A 519 383 80 | OE012 |
| G 517 562 80 | OE001 |
| TOYOTA  | |
| 90048-51172 | OE188 |
| 90080-91194 | OE063 |
| 90910-01153 | OE013 |
| 90919-01020 | OE015 |
| 90919-01056 | OE015 |
| 90919-01059 | OE015 |
| 90919-01064 | OE051 |
| 90919-01083 | OE001 |
| 90919-01121 | OE136 |
| 90919-01122 | OE188 |
| 90919-01127 | OE188 |
| 90919-01128 | OE227 |
| 90919-01155 | OE128 |

OE ? ⇌

| TOYOTA | |  |
|-----------------|--------------|---|
| 90919-01164 | OE093 | |
| 90919-01169 | OE188 | |
| 90919-01176 | OE093 | |
| 90919-01180 | OE227 | |
| 90919-01182 | OE188 | |
| 90919-01184 | OE089 | |
| 90919-01191 | OE182 | |
| 90919-01192 | OE019 | |
| 90919-01193 | OE019 | |
| 90919-01198 | OE026 | |
| 90919-01210 | OE182 | |
| 90919-01211 | OE188 | |
| 90919-01226 | OE188 | |
| 90919-01230 | OE188 | |
| 90919-01235 | OE035 | |
| 90919-01236 | OE035 | |
| 90919-01237 | OE182 | |
| 90919-01238 | OE188 | |
| 90919-01247 | OE190 | |
| 90919-01258 | OE035 | |
| 90919-W1001 | OE035 | |
| 90919-YZZAG | OE089 | |
| VAG | |  |
| 03F 905 600 | OE260 | |
| 03F 905 600 A | OE260 | |
| 04E 905 601 | OE244 | |
| 04E 905 601 B | OE244 | |
| 04E 905 612 | OE244 | |
| 04E 905 612 C | OE244 | |
| 101 905 626 | OE213 | |
| VAUXHALL | |  |
| 092063308 | OE063 | |
| 1214118 | OE255 | |
| 90 509 739 | OE026 | |
| 91132006 | OE019 | |
| 92 06 7204 | OE029 | |
| 93 175 935 | OE019 | |
| 95519057 | OE255 | |
| VOLVO | |  |
| 000057007 | OE074 | |
| 000057011 | OE001 | |
| 000057015 | L82C | |
| 000057022 | OE010 | |
| 000057023 A | OE010 | |
| 1150278 | OE179 | |
| 1276056 | OE001 | |
| 1276057 | OE087 | |
| 1276058 | OE087 | |
| 1276514 | OE010 | |
| 1306604 | OE010 | |
| 1306605 | OE001 | |

| VOLVO | |  |
|--------------|--------------|---|
| 1346541 | OE006 | |
| 1357828 | OE038 | |
| 135827 | OE038 | |
| 1367015 | OE018 | |
| 1367526 | OE001 | |
| 1367528 | OE006 | |
| 1367529 | OE018 | |
| 1457826 | OE038 | |
| 1467015 | OE018 | |
| 22401 AA670 | OE179 | |
| 2301710 | OE087 | |
| 238624 | L78C | |
| 238808 | L78C | |
| 239446 | L82C | |
| 241402 | OE038 | |
| 241627 | OE038 | |
| 241946 | OE038 | |
| 270746-1 | OE006 | |
| 270747-9 | OE018 | |
| 271239 | OE227 | |
| 271239-6 | OE227 | |
| 271409 | OE006 | |
| 271410 | OE038 | |
| 271411 | OE038 | |
| 271412 | OE038 | |
| 271415-2 | OE018 | |
| 271603-3 | OE014 | |
| 271636-3 | OE005 | |
| 271727-0 | OE005 | |
| 272207 | OE120 | |
| 272344 | OE136 | |
| 273525 | OE038 | |
| 273546 | OE010 | |
| 273558 | OE038 | |
| 273591 | OE010 | |
| 273596 | OE010 | |
| 298196 | OE006 | |
| 30637385 | OE236 | |
| 30650379 | OE206 | |
| 30650843 | OE236 | |
| 30731383 | OE179 | |
| 30731425 | OE031 | |
| 30731877 | OE031 | |
| 30735760 | OE031 | |
| 3104124 | L82C | |
| 3104530 | OE038 | |
| 3213327-4 | OE004 | |
| 3343929-0 | OE087 | |
| 3344315-1 | OE051 | |
| 334444720 | OE004 | |
| 3344472-0 | OE004 | |
| 3344473 | OE004 | |
| 3344473-8 | OE004 | |

| VOLVO | |  |
|----------------|----------------|---|
| 3344898-6 | OE004 | |
| 3344899 | OE004 | |
| 3344899-4 | OE004 | |
| 3517629 | OE014 | |
| 3517980 | OE005 | |
| 3551943 | L78C | |
| 3551945 | L78C | |
| 3551946 | L78C | |
| 3576753 | OE038 | |
| 3576846 | OE038 | |
| 3851859 | RV15YC4 | |
| 3851861 | RV15YC4 | |
| 460540 | OE038 | |
| 463511 | OE001 | |
| 463512 | OE010 | |
| 463513 | OE087 | |
| 570306 | L82C | |
| 570334 | L78C | |
| 7072153 | L82C | |
| 72153 | L82C | |
| 8642660 | OE120 | |
| 8642661 | OE120 | |
| 8670057 | OE136 | |
| 8687 990 H 939 | OE179 | |
| 8692070 | OE136 | |
| 9146775 | OE120 | |
| 917910 | OE136 | |
| 9179100 | OE136 | |
| 9202064 | OE120 | |
| RF 80 H3 | OE120 | |
| RF80H3 | OE120 | |
| X 9146775 | OE120 | |
| X9146775 | OE120 | |
| VW | |  |
| 000 057 001 | L82C | |
| 000 057 001 A | L82C | |
| 000 057 003 | L82C | |
| 000 057 004 | L82C | |
| 000 057 005 | OE074 | |
| 000 057 006 | OE074 | |
| 000 057 007 | OE074 | |
| 000 057 011 | OE001 | |
| 000 057 015 | L82C | |
| 000 057 022 | OE010 | |
| 000 057 023 A | OE010 | |
| 000 057 066 A | OE044 | |
| 000 057 067 A | OE012 | |
| 04C 905 606 | OE247 | |
| 04C 905 606 A | OE247 | |
| 04C 905 616 | OE247 | |
| 04C 905 616 A | OE247 | |
| 06H 905 601 A | OE214 | |

| VW | |  |
|----------------|--------------|---|
| 06H 905 611 | OE214 | |
| 06H 905 621 | OE214 | |
| 06H 905 621 A | OE214 | |
| 06K 905 601 B | OE246 | |
| 06K 905 601 D | OE246 | |
| 06K 905 611 C | OE246 | |
| 06K 905 621 | OE246 | |
| 079 905 626 B | OE219 | |
| 079 905 626 D | OE220 | |
| 079 905 626 E | OE219 | |
| 079 905 626 G | OE220 | |
| 101 000 000 AA | OE087 | |
| 101 000 000 AB | OE001 | |
| 101 000 000 AC | OE015 | |
| 101 000 001 AA | OE012 | |
| 101 000 001 AB | OE012 | |
| 101 000 001 AC | OE012 | |
| 101 000 001 AD | OE044 | |
| 101 000 001 AE | OE044 | |
| 101 000 002 AA | OE015 | |
| 101 000 002 AB | OE001 | |
| 101 000 002 AC | OE010 | |
| 101 000 002 AD | OE087 | |
| 101 000 002 AE | OE008 | |
| 101 000 003 AA | OE094 | |
| 101 000 003 AB | OE094 | |
| 101 000 004 AA | OE094 | |
| 101 000 005 AA | OE012 | |
| 101 000 005 AB | OE012 | |
| 101 000 005 AC | OE012 | |
| 101 000 005 AD | OE044 | |
| 101 000 005 AE | OE044 | |
| 101 000 005 AF | OE027 | |
| 101 000 006 AA | OE087 | |
| 101 000 006 AB | OE010 | |
| 101 000 006 AC | OE001 | |
| 101 000 006 AD | OE015 | |
| 101 000 006 AF | OE008 | |
| 101 000 007 AA | OE012 | |
| 101 000 007 AB | OE012 | |
| 101 000 007 AC | OE044 | |
| 101 000 007 AD | OE044 | |
| 101 000 009 AA | OE074 | |
| 101 000 012 AA | OE074 | |
| 101 000 013 AA | OE014 | |
| 101 000 014 AA | OE014 | |
| 101 000 015 AA | OE009 | |
| 101 000 015 AC | OE009 | |
| 101 000 016 AA | OE136 | |
| 101 000 017 AA | OE094 | |
| 101 000 018 AA | OE015 | |
| 101 000 019 AA | OE015 | |
| 101 000 020 AA | OE015 | |



OE ? ⇌

| VW | CHAMPION | VW | CHAMPION | VW | CHAMPION | VW | CHAMPION |
|----------------|----------|----------------|----------|--------------|----------|--------------|----------|
| 101 000 026 AA | OE027 | 101 905 620 | OE136 | N 017 801 2 | L82C | N 017 811 70 | OE074 |
| 101 000 026 AB | OE025 | 101 905 620 | OE234 | N 017 801 3 | L78C | N 017 811 71 | OE087 |
| 101 000 027 AA | OE012 | 101 905 621 | OE209 | N 017 801 7 | L82C | N 017 811 72 | OE012 |
| 101 000 027 AB | OE044 | 101 905 621 A | OE209 | N 017 801 8 | L82C | N 017 811 73 | OE012 |
| 101 000 027 AC | OE044 | 101 905 621 B | OE209 | N 017 802 1 | L82C | N 017 811 74 | OE012 |
| 101 000 029 AB | OE011 | 101 905 621 C | OE209 | N 017 802 13 | L82C | N 017 811 75 | OE015 |
| 101 000 033 AA | OE032 | 101 905 631 | OE214 | N 017 803 9 | L82C | N 017 811 76 | OE087 |
| 101 000 033 AB | OE094 | 101 905 631 A | OE146 | N 017 811 1 | OE074 | N 017 811 77 | OE010 |
| 101 000 033 AC | OE123 | 101 905 631 B | OE214 | N 017 811 12 | OE010 | N 017 811 78 | OE001 |
| 101 000 033 AF | OE032 | 101 905 631 F | OE188 | N 017 811 13 | OE010 | N 017 811 79 | OE015 |
| 101 000 033 AG | OE019 | 101 905 631 G | OE214 | N 017 811 14 | OE010 | N 017 811 8 | OE074 |
| 101 000 033 AG | OE032 | 101 905 631 H | OE214 | N 017 811 17 | OE074 | N 017 812 1 | OE074 |
| 101 000 034 AA | OE001 | 101 905 640 D | OE209 | N 017 811 18 | OE010 | N 017 812 12 | OE010 |
| 101 000 035 AB | OE123 | 101 905 641 | OE219 | N 017 811 19 | OE074 | N 017 812 13 | OE010 |
| 101 000 035 AH | OE198 | 101.000.007.AA | OE012 | N 017 811 20 | OE010 | N 017 812 15 | OE074 |
| 101 000 035 HJ | OE237 | 101.000.007.AB | OE012 | N 017 811 21 | OE001 | N 017 812 18 | OE087 |
| 101 000 036 AA | OE025 | 101.000.017.AA | OE094 | N 017 811 22 | OE010 | N 017 812 19 | OE001 |
| 101 000 036 AB | OE027 | 101.905.611 | OE136 | N 017 811 23 | OE087 | N 017 812 20 | OE010 |
| 101 000 036 AC | OE027 | 101000005AB | OE044 | N 017 811 24 | OE074 | N 017 812 21 | OE087 |
| 101 000 038 AA | OE027 | 101000035AH | OE191 | N 017 811 25 | OE087 | N 017 812 22 | OE074 |
| 101 000 038 AB | OE027 | 101905600 | OE176 | N 017 811 26 | OE015 | N 017 812 23 | OE010 |
| 101 000 039 AA | OE027 | 101905600A | OE176 | N 017 811 27 | OE001 | N 017 812 24 | OE015 |
| 101 000 039 AB | OE027 | 101905601B | OE177 | N 017 811 28 | OE001 | N 017 812 25 | OE074 |
| 101 000 040 AC | OE027 | 101905601E | OE177 | N 017 811 30 | OE074 | N 017 812 27 | OE001 |
| 101 000 040 AD | OE025 | 101905601F | OE177 | N 017 811 31 | OE001 | N 017 812 30 | OE001 |
| 101 000 040 AE | OE027 | 101905603B | OE177 | N 017 811 32 | OE087 | N 017 812 34 | OE015 |
| 101 000 041 AC | OE032 | 101905617 | OE177 | N 017 811 36 | OE015 | N 017 812 35 | OE087 |
| 101 000 041 AE | OE094 | 101905620 | OE176 | N 017 811 39 | OE001 | N 017 812 36 | OE001 |
| 101 000 041 AF | OE123 | 191 905 450 | OE012 | N 017 811 40 | OE012 | N 017 812 37 | OE010 |
| 101 000 041 AG | OE032 | 191 905 450 A | OE012 | N 017 811 41 | OE010 | N 017 812 39 | OE087 |
| 101 000 045 AA | OE032 | 191 905 450 B | OE044 | N 017 811 47 | OE015 | N 017 812 4 | OE010 |
| 101 000 050 AA | OE027 | 191 905 450 C | OE012 | N 017 811 48 | OE015 | N 017 812 40 | OE010 |
| 101 000 050 AB | OE027 | 191 905 450 G | OE094 | N 017 811 49 | OE087 | N 017 812 41 | OE015 |
| 101 000 050 AC | OE025 | 191 905 450 H | OE012 | N 017 811 50 | OE010 | N 017 812 44 | OE087 |
| 101 000 051 AA | OE032 | 191 905 450 J | OE094 | N 017 811 51 | OE001 | N 017 812 46 | OE012 |
| 101 000 052 AA | OE011 | 191 905 450 K | OE044 | N 017 811 52 | OE010 | N 017 812 47 | OE012 |
| 101 000 055 AA | OE019 | 191 905 450 L | OE087 | N 017 811 53 | OE015 | N 017 812 48 | OE012 |
| 101 000 062 AB | OE176 | 191 905 450 M | OE010 | N 017 811 54 | OE012 | N 017 812 49 | OE012 |
| 101 000 063 AA | OE136 | 191 905 450 N | OE001 | N 017 811 55 | OE010 | N 017 812 50 | OE044 |
| 101 000 063 AC | OE136 | 191 905 450 P | OE015 | N 017 811 56 | OE044 | N 017 812 51 | OE012 |
| 101 000 065 AA | OE136 | 191 905 452 | OE087 | N 017 811 57 | OE012 | N 017 812 52 | OE012 |
| 101 905 600 | OE176 | 191 905 452 A | OE010 | N 017 811 58 | OE044 | N 017 812 56 | OE044 |
| 101 905 600 A | OE176 | 191 905 452 B | OE001 | N 017 811 59 | OE087 | N 017 812 57 | OE015 |
| 101 905 600 C | OE176 | 191 905 452 C | OE015 | N 017 811 6 | OE087 | N 017 812 58 | OE001 |
| 101 905 601 | OE176 | 191 905 452 D | OE012 | N 017 811 60 | OE012 | N 017 812 6 | OE087 |
| 101 905 601 B | OE177 | 191 905 452 E | OE012 | N 017 811 61 | OE012 | N 017 812 60 | OE087 |
| 101 905 601 F | OE177 | 191 905 452 F | OE012 | N 017 811 63 | OE001 | N 017 812 7 | OE012 |
| 101 905 603 B | OE177 | 191 905 452 G | OE044 | N 017 811 64 | OE012 | N 017 812 9 | OE087 |
| 101 905 609 | OE235 | 191 905 452 H | OE094 | N 017 811 65 | OE044 | N 017 813 1 | OE074 |
| 101 905 610 A | OE146 | N 012 812 36 | OE001 | N 017 811 66 | OE001 | N 017 813 10 | OE010 |
| 101 905 611 G | OE214 | N 017 801 1 | L82C | N 017 811 67 | OE012 | N 017 813 11 | OE015 |
| 101 905 617 | OE177 | N 017 801 11 | L82C | N 017 811 68 | OE012 | N 017 813 12 | OE010 |
| 101 905 617 C | OE177 | N 017 801 13 | L82C | N 017 811 69 | OE012 | N 017 813 13 | OE010 |

OE ? ⇔



| VW | CHAMPION |
|--------------|----------|
| N 017 813 14 | OE074 |
| N 017 813 15 | OE074 |
| N 017 813 16 | OE087 |
| N 017 813 17 | OE087 |
| N 017 813 18 | OE010 |
| N 017 813 19 | OE001 |
| N 017 813 20 | OE001 |
| N 017 813 24 | OE010 |
| N 017 813 26 | OE001 |
| N 017 813 3 | OE074 |
| N 017 813 30 | OE010 |
| N 017 813 32 | OE087 |
| N 017 813 33 | OE001 |
| N 017 813 39 | OE087 |
| N 017 813 40 | OE001 |
| N 017 813 42 | OE001 |
| N 017 813 43 | OE087 |
| N 017 813 45 | OE012 |
| N 017 813 46 | OE012 |
| N 017 813 47 | OE012 |
| N 017 813 50 | OE012 |
| N 017 813 53 | OE087 |
| N 017 813 54 | OE010 |
| N 017 813 55 | OE015 |
| N 017 813 6 | OE010 |
| N 017 813 7 | OE010 |
| N 017 813 8 | OE087 |
| N 017 813 9 | OE010 |
| N 017 821 1 | OE001 |
| N 017 832 1 | OE087 |
| N 017 832 2 | OE087 |
| N 100 807 02 | OE094 |
| N 100 807 1 | OE094 |
| N 101 172 01 | OE094 |
| N 101 251 05 | OE009 |
| Z 057 003 | L82C |
| Z 057 004 | OE074 |
| Z 057 005 | OE015 |
| Z 057 008 | OE074 |
| Z 057 011 | OE001 |
| Z 057 012 | OE087 |
| Z 057 020 | OE094 |
| Z 057 023 | OE010 |
| Z 057 037 | OE074 |
| Z 057 040 | OE010 |
| Z 057 056 | OE001 |
| Z 057 057 | OE074 |
| Z 057 058 | OE087 |
| Z 057 059 | OE074 |
| Z 057 060 | L82C |
| Z 057 062 | OE010 |
| Z 057 064 | L82C |
| Z 057 065 | OE074 |

| VW | CHAMPION |
|-----------------|-----------------|
| Z 057 066 | OE012 |
| Z 057 067 | OE012 |
| Z 057 068 | OE012 |
| Z 057 069 | OE044 |
| Z 057 073 | OE094 |
| Z 057 127 | OE015 |
| Z 057 128 | OE078 |
| Z 057 136 | OE015 |
| Z 057 140 | OE087 |
| Z 057 141 | OE010 |
| Z 057 142 | OE001 |
| Z 057 143 | OE015 |
| Z 057 145 | OE009 |
| Z 057 173 | OE014 |
| ZUENDAPP | CHAMPION |
| 247 07 106 | L82C |
| 250 07 604 | L82C |
| 265 07 101 | L82C |
| 276 07 106 | L78C |
| 280 07 140 | OE074 |
| 280 07 142 | OE001 |
| 280 07 143 | OE087 |

OE ? ⇒



| ALFA ROMEO | |
|-------------------|---------|
| 46072001 | CH189 |
| 46754154 | CH222 |
| 472 95 95 | CH189 |
| 55200817 | CH269 |
| 605 96 245 | CH189 |
| 60596245 | CH189 |
| 606 17 002 | CH181 |
| 60617002 | CH181 |
| 60816139 | CH222 |
| 71735458 | CH222 |
| 71735465 | CH181 |
| AUDI | |
| 059 963 319 AC | CCGP010 |
| 059 963 319 T | CCGP010 |
| 059963319A | CH215 |
| BMW | |
| 0 038 490 | CCGP001 |
| 12 12 1 286 059 | CH189 |
| 12 12 1 288 161 | CH189 |
| 12 23 0 038 490 | CCGP001 |
| 12 23 1 288 245 | CH189 |
| 12 23 2 240 255 | CH189 |
| 12 23 2 241 387 | CH189 |
| 12 23 2 241 388 | CH189 |
| 12 23 2 241 389 | CH189 |
| 12 23 2 248 059 | CH203 |
| 12 23 22 48 422 | CH207 |
| 12 23 9 061 353 | CH189 |
| 12 23 9 061 354 | CH189 |
| 12231288245 | CH189 |
| 12232240255 | CH189 |
| 12232241387 | CH189 |
| 12232241389 | CH189 |
| 12232248059 | CH203 |
| 12239061353 | CH189 |
| 12239061354 | CH189 |
| 7 810 858 | CCGP001 |
| 7 810 858 01 | CCGP001 |
| 7 810 858 02 | CCGP001 |
| CHEVROLET | |
| 71735458 | CH222 |
| 89 417 515 81 | CH306 |
| CHRYSLER | |
| 05066840 AA | CH180 |
| 05066840AA | CH180 |
| T0701 130 | CH189 |
| CITROËN | |
| 5 962 58 | CH189 |
| 5960 64 | CH268 |
| 5960 65 | CH268 |

| CITROËN | |
|----------------|-------|
| 5960 66 | CH170 |
| 5960 67 | CH170 |
| 5960 69 | CH185 |
| 5960 77 | CH240 |
| 5960 78 | CH201 |
| 5960 A4 | CH270 |
| 5960 F4 | CH268 |
| 5960.79 | CH201 |
| 596064 | CH268 |
| 596065 | CH268 |
| 596069 | CH185 |
| 5960F9 | CH201 |
| 5961 54 | CH189 |
| 5962 008 | CH189 |
| 5962 1R | CH189 |
| 5962 1T | CH189 |
| 5962 1V | CH189 |
| 5962 1W | CH147 |
| 5962 1X | CH260 |
| 5962 1Y | CH173 |
| 5962 1Z | CH260 |
| 5962 2Z | CH185 |
| 5962 3C | CH170 |
| 5962 3E | CH170 |
| 5962 3H | CH189 |
| 5962 3J | CH189 |
| 5962 5A | CH216 |
| 5962 7F | CH170 |
| 5962 7G | CH170 |
| 5962 J3 | CH147 |
| 5962 J4 | CH189 |
| 5962 J7 | CH260 |
| 5962 R8 | CH189 |
| 5962 S8 | CH189 |
| 5962 T1 | CH173 |
| 5962 T1 | CH189 |
| 5962 T2 | CH260 |
| 5962 W2 | CH185 |
| 5962 W8 | CH189 |
| 5962 X1 | CH189 |
| 5962008 | CH189 |
| 596203 | CH189 |
| 59621R | CH189 |
| 59621T | CH189 |
| 59621V | CH189 |
| 59621W | CH147 |
| 59621X | CH260 |
| 59621Y | CH173 |
| 59621Z | CH260 |
| 59622Z | CH185 |
| 59623E | CH170 |
| 59623J | CH189 |
| 596258 | CH189 |

| CITROËN | |
|--------------------------|-------|
| 5962T1 | CH173 |
| 5962T2 | CH260 |
| 5962W2 | CH185 |
| 5962W8 | CH189 |
| 9 633 214 380 | CH189 |
| 90 041 002 80 | CH147 |
| 91 536 646 | CH189 |
| 91 538 910 99 | CH147 |
| 91536646 | CH189 |
| 95 493 206 | CH189 |
| 95 534 788 | CH189 |
| 96 070 388 80 | CH147 |
| 96 076 258 | CH147 |
| 96 076 258 | CH189 |
| 96 141 678 | CH189 |
| 96 165 724 | CH189 |
| 96 236 383 | CH170 |
| 96 316 589 80 | CH185 |
| 96 389 858 | CH170 |
| 96141678 | CH189 |
| 9631658980 | CH185 |
| MKP 000 65 | CH189 |
| MKP 000 71 | CH260 |
| MKP00071 | CH260 |
| CITROËN / PEUGEOT | |
| 5960 88 | CH229 |
| 5960 89 | CH229 |
| DAF | |
| 0192618 | CH189 |
| 105977 | CH189 |
| 1353958 | CH189 |
| DAIHATSU | |
| 1985054030000 | CH154 |
| 19850-54030-000 | CH154 |
| 1985054090000 | CH154 |
| 19850-54090-000 | CH154 |
| 19850-64020-000 | CH302 |
| 19850-68010 | CH302 |
| 1985068010000 | CH302 |
| 19850-87702-000 | CH302 |
| FIAT | |
| 07029585 | CH189 |
| 4393814 | CH189 |
| 4474413 | CH189 |
| 46447610 | CH167 |
| 46751764 | CH209 |
| 46754154 | CH222 |
| 46792355 | CH224 |
| 4714294 | CH189 |
| 4729585 | CH189 |

| FIAT | |
|---------------|-------|
| 4754011 | CH189 |
| 4774412 | CH189 |
| 4774413 | CH189 |
| 4781356 | CH189 |
| 4849406 | CH189 |
| 500303569 | CH216 |
| 500316493 | CH216 |
| 500351992 | CH270 |
| 5493206 | CH189 |
| 55187863 | CH224 |
| 55200817 | CH269 |
| 5950464 | CH189 |
| 5951861 | CH189 |
| 5951861(FU2B) | CH189 |
| 5951879 | CH189 |
| 5951881 | CH189 |
| 5951881(FU2A) | CH189 |
| 5951882 | CH189 |
| 5973752 | CH189 |
| 5973753 | CH189 |
| 606 17 002 | CH181 |
| 60812292 | CH189 |
| 71719015 | CH189 |
| 71735458 | CH222 |
| 71735459 | CH167 |
| 71735460 | CH147 |
| 71735461 | CH189 |
| 71735462 | CH216 |
| 71735464 | CH209 |
| 762266740 | CH189 |
| 7702960 | CH189 |
| 7735920 | CH189 |
| 77359200 | CH189 |
| 7777837 | CH147 |
| 96 515 836 80 | CH268 |
| 9616472480 | CH189 |
| 96165724 | CH189 |
| 9623638380 | CH170 |
| 9631658980 | CH185 |
| 9633214380 | CH189 |
| 9638985980 | CH170 |
| 9650100080 | CH201 |
| 9651029780 | CH170 |
| 9651029880 | CH185 |
| 98462490 | CH189 |
| 98498630 | CH147 |
| F 2 VB | CH189 |
| F 4 VB | CH189 |
| F2VB | CH189 |
| FU 2 A | CH189 |
| FU 4 A | CH189 |
| FU2A | CH189 |
| FU4A | CH189 |

OE ? ⇒



| FORD | CHAMPION |
|------------------|----------|
| 1 001 049 | CH205 |
| 1 008 792 | CH205 |
| 1 045 261 | CH205 |
| 1 079 401 | CH196 |
| 1 309 471 | CH229 |
| 1 313 809 | CH268 |
| 1 473 356 | CH268 |
| 1 587 444 | CH189 |
| 1 590 417 | CH260 |
| 1 952 464 | CH186 |
| 1008792 | CH205 |
| 1037204 | CH271 |
| 105 68 57 | CH205 |
| 1056857 | CH205 |
| 1079401 | CH196 |
| 1207068 | CH181 |
| 1313809 | CH268 |
| 1447128 | CH201 |
| 1536023 | CH242 |
| 1669977 | CH271 |
| 1690048 | CH181 |
| 1952464 | CH186 |
| 1M21-18B515-AA | CH181 |
| 2S6Q 6M090 BB | CH201 |
| 3M5Q 6M090AB | CH268 |
| 3M5Q 6M090AC | CH268 |
| 4 025 139 | CH242 |
| 4 612 191 | CH229 |
| 4U3Q-6M090-AA | CH240 |
| 4U3Q-6M090-AB | CH240 |
| 4U3Q-AA | CH240 |
| 4U3Q-AB | CH240 |
| 6 063 505 | CH189 |
| 6 075 812 | CH147 |
| 6 075 812 | CH260 |
| 6 154 593 | CH189 |
| 6 163 811 | CH147 |
| 6075812 | CH260 |
| 6154593 | CH189 |
| 7 072 673 | CH189 |
| 7 088 988 | CH147 |
| 7072673 | CH189 |
| 7088988 | CH147 |
| 78 GB 6 M 090 CA | CH189 |
| 785 F 6M090 BA | CH189 |
| 785 F 6M090 CB | CH189 |
| 786 B 6M090 CA | CH189 |
| 795 F 6M090 AA | CH260 |
| 795 F 6M090 CA | CH260 |
| 795F6M090AA | CH260 |
| 795F6M090CA | CH260 |
| 83 BB 6M090 A1A | CH189 |
| 83 BB 6M090 A2A | CH189 |

| FORD | CHAMPION |
|-----------------|----------|
| 83BB6M090A1A | CH189 |
| 83BB6M090A2A | CH189 |
| 84 BB 6M090 AA | CH189 |
| 84 FF 6M090 B2A | CH189 |
| 84BB6M090AA | CH189 |
| 89 FF 6M090 AA | CH147 |
| 89 FF 6M091 AA | CH147 |
| 89 FF 6M091 AA | CH189 |
| 89FF6M090AA | CH147 |
| 910 X 6M090 AA | CH173 |
| 910 X 6M090 BA | CH189 |
| 910X6M090AA | CH173 |
| 910X6M090BA | CH189 |
| 93 FF 6M090 AA | CH147 |
| 93FF6M090AA | CH147 |
| 94 DD 6M090 AA | CH189 |
| 95 DD 6M 090 AA | CH181 |
| 95VW-6M090-AA | CH271 |
| 95VW-6M090-AB | CH271 |
| 96 FF 6M090 AA | CH205 |
| 96 FF 6M090 AB | CH205 |
| 96 FF 6M090 BA | CH205 |
| 96 FF 6M090 BB | CH205 |
| 96 FF 6M090 CA | CH205 |
| 96FF6M090AA | CH205 |
| 96FF6M090AB | CH205 |
| 96FF6M090BA | CH205 |
| 96FF6M090BB | CH205 |
| 99 FF 6M090 AA | CH205 |
| 99FF6M090AA | CH205 |
| V94DX6M090AA | CH189 |
| XM 34 12A342 BA | CH242 |
| XS 7U 6M090 BA | CH229 |
| XS 7U 6M090 BB | CH229 |
| XS4U6M090AB | CH196 |
| FORD OTOSAN | CHAMPION |
| 1C10 6M090 AA | CH229 |
| GENERAL MOTORS | CHAMPION |
| 09118201 | CH207 |
| 55 233 532 | CPSG003 |
| 55 237 483 | CPSG003 |
| 55 565 634 | CPSG003 |
| 55 568 366 | CPSG004 |
| 55 577 419 | CPSG003 |
| 55 579 436 | CPSG006 |
| 55 580 403 | CPSG003 |
| 55 590 466 | CPSG004 |
| 55 590 467 | CPSG006 |
| 88 900 716 | CH181 |
| 88 900 717 | CH215 |
| 88 900 718 | CH219 |

| GENERAL MOTORS | CHAMPION |
|----------------|----------|
| 88 900 720 | CH205 |
| 88 900 721 | CH203 |
| 88 900 722 | CH271 |
| 88 900 723 | CH260 |
| 88 900 724 | CH175 |
| 88 900 728 | CH189 |
| 88 900 729 | CH167 |
| 88 900 730 | CH189 |
| 88 900 731 | CH189 |
| 88 900 734 | CH189 |
| 88 900 735 | CH147 |
| 88 900 736 | CH189 |
| 88 900 737 | CH147 |
| 88 900 741 | CH176 |
| 90 487 858 | CH189 |
| 90 569 338 | CH207 |
| 91 153 919 | CH181 |
| 91 182 01 | CH207 |
| 9111145 | CH147 |
| 9196669 | CH231 |
| 9201698 | CH232 |
| 93 190 433 | CH269 |
| 93161342 | CH232 |
| 93161489 | CH232 |
| 93178225 | CH231 |
| 93178411 | CH224 |
| 93180295 | CH222 |
| 93197244 | CH231 |
| 93198468 | CCGP007 |
| 94 133 759 | CH306 |
| 94 140 115 | CH306 |
| 94 175 158 | CH306 |
| 95508487 | CH224 |
| 95508488 | CH231 |
| 95508489 | CH222 |
| 95508493 | CH232 |
| 97 464 737 | CH231 |
| GLAS | CHAMPION |
| B 18 N | CH260 |
| B 19 N | CH189 |
| B 20 N | CH189 |
| B 22 N | CH189 |
| B 23 R | CH189 |
| B 26 SR | CH173 |
| B 27 SR | CH147 |
| B 29 SR | CH189 |
| B 30 SR | CH189 |
| B 31 SR | CH189 |
| B 32 R | CH189 |
| B 41 SR | CH176 |
| B 42 SR | CH147 |
| B 44 SR | CH189 |

| GLAS | CHAMPION |
|----------------|----------|
| B 48 R | CH173 |
| HONDA | CHAMPION |
| 12291P5TG02 | CH169 |
| 31812-ZG5-0030 | CH302 |
| HYUNDAI | CHAMPION |
| 36710-27000 | CH226 |
| 36710-27010 | CH226 |
| 36710-42000 | CH225 |
| 36710-42010 | CH225 |
| 36710-42020 | CH225 |
| 36710-42021 | CH225 |
| 36710-42060 | CH225 |
| 36710-42500 | CH256 |
| 36710-42510 | CH225 |
| 36710-4A000 | CH234 |
| 36710-4A100 | CH234 |
| IFA | CHAMPION |
| 834019 | CH260 |
| ISUZU | CHAMPION |
| 5-81410-040-0 | CH302 |
| 5-81410-057-3 | CH215 |
| 8 94133 759 2 | CH306 |
| 8 94133 759 3 | CH306 |
| 8 94133 759 5 | CH306 |
| 8 94133 759 6 | CH306 |
| 8 94140 153 | CH306 |
| 8 94175 158 0 | CH306 |
| 8 94481 972 0 | CH158 |
| 8-94133-759-0 | CH306 |
| 8-94133-759-1 | CH306 |
| 8-94133-759-4 | CH306 |
| 8-94133-759-7 | CH306 |
| 8944819720 | CH158 |
| 8-94751-581 | CH306 |
| 8-97073-641-0 | CH306 |
| IVECO | CHAMPION |
| 004 729 585 | CH189 |
| 27600323 | CH270 |
| 4841294 | CH189 |
| 98459883 | CH147 |
| JAGUAR | CHAMPION |
| 02 JD 61164 | CH229 |
| 02 JD 61604 | CH240 |
| JEEP | CHAMPION |
| 0 506 6840 AA | CH180 |
| 04 86 38 26 | CH181 |
| 04 86 38 26 AA | CH181 |



OE ? ⇒



| | | | | | | | |
|-------------------|-------|----------------------|---------|---------------|---------|-------------|---------|
| KHD | | MERCEDES-BENZ | | NISSAN | | OPEL | |
| 472 9585 | CH189 | 000 159 75 01 | CH189 | 11065-00Q00 | CH271 | 12 14 088 | CPSG004 |
| 478 1356 | CH189 | 000 159 77 01 | CH189 | 11065-00Q0A | CH232 | 12 14 101 | CPSG006 |
| KIA | | 000 159 81 01 | CH189 | 11065-00QAA | CH271 | 12 14 104 | CPSG004 |
| OK054-18140 | CH242 | 000 159 83 01 | CH189 | 11065-00QAF | CH271 | 12 14 304 | CH189 |
| OK710-18140 | CH242 | 000 159 96 01 | CH189 | 11065-00QAG | CH271 | 12 14 305 | CH231 |
| OK710-18140A | CH242 | 000 159 99 01 | CH189 | 11065-0W801 | CH186 | 12 14 306 | CH189 |
| OK71E-18140A | CH242 | 001 159 00 01 | CH176 | 11065-31N00 | CH186 | 12 14 307 | CH189 |
| OK75A-18140 | CH242 | 001 159 02 01 | CH189 | 11065-43G01 | CH221 | 12 14 310 | CH158 |
| OK75B-18140 | CH242 | 001 159 15 01 | CH175 | 11065-57J00 | CH600 | 12 14 317 | CH189 |
| 36710-27000 | CH226 | 001 159 16 01 | CH175 | 11065-5C900 | CH600 | 12 14 319 | CH189 |
| 36710-27010 | CH226 | 001 159 17 01 | CH176 | 11065-63G00 | CH221 | 12 14 320 | CH158 |
| 36710-42000 | CH225 | 001 159 21 01 | CH177 | 11065-65N01 | CH186 | 12 14 321 | CH306 |
| 36710-42010 | CH225 | 001 159 22 01 | CH189 | 11065-7C000 | CH186 | 12 14 323 | CH306 |
| 36710-42020 | CH225 | 001 159 26 01 | CH204 | 11065-9C600 | CH186 | 12 14 324 | CH189 |
| 36710-42021 | CH225 | 001 159 27 01 | CH219 | 11065-AD 200 | CH230 | 12 14 427 | CH181 |
| 36710-42060 | CH225 | 001 159 35 01 | CH189 | 11065-AD 201 | CH230 | 12 14 456 | CH207 |
| 36710-42500 | CH256 | 001 159 36 01 | CH176 | 11065-AD 20A | CH230 | 12 14 457 | CH207 |
| 36710-42510 | CH225 | 001 159 51 01 | CH704 | 11065-AD200 | CH230 | 1214033 | CH189 |
| 36710-4A000 | CH234 | 001 159 52 01 | CH704 | 11065-AD201 | CH230 | 121418 | CH203 |
| 36710-4A100 | CH234 | 001 159 75 01 | CH704 | 11065-AD210 | CH230 | 1214304 | CH189 |
| LANCIA | | A 000 159 75 01 | CH189 | 11065-AD220 | CH230 | 1214305 | CH189 |
| 46754154 | CH222 | A 000 159 81 01 | CH189 | 11065-BN701 | CH271 | 1214306 | CH189 |
| 60 812 292 | CH189 | A 000 159 83 01 | CH189 | 11065-G2400 | CH186 | 1214307 | CH189 |
| 606 17 002 | CH181 | A 001 159 15 01 | CH175 | 11065-HA300 | CH242 | 1214310 | CH158 |
| 71735458 | CH222 | A 001 159 16 01 | CH175 | 11065-V0700 | CH260 | 1214317 | CH189 |
| 77359200 | CH189 | A 001 159 20 01 | CH177 | 11065-V0710 | CH260 | 1214319 | CH189 |
| LAND ROVER | | A 001 159 21 01 | CH177 | 11065-Y 9703 | CH260 | 1214427 | CH181 |
| 1354289 | CH240 | A 001 159 26 01 | CH204 | 758 000 06-0 | CH189 | 1214457 | CH207 |
| ERR6066 | CH272 | A 001 159 27 01 | CH219 | OPEL | | 43 00 425 | CH306 |
| STC3103 | CH189 | A 001 159 51 01 | CH704 | 09 110 945 | CH217 | 43 00 615 | CH306 |
| LEYLAND | | A 001 159 52 01 | CH704 | 12 14 018 | CH203 | 44 02 724 | CH271 |
| 075 95 77 | CH167 | A 001 159 75 01 | CH704 | 12 14 020 | CH271 | 44 02 945 | CH217 |
| LOMBARDINI | | MITSUBISHI | | 12 14 033 | CH231 | 44 03 145 | CH147 |
| 21001110 | CH189 | 3671042500 | CH256 | 12 14 034 | CH224 | 44 09 469 | CH271 |
| MAN | | M 816 732 | CH260 | 12 14 040 | CH222 | 44 16 912 | CH271 |
| 000 159 8101 | CH189 | M 883 828 | CH271 | 12 14 042 | CH158 | 44 30 069 | CH232 |
| 000 159 83 01 | CH189 | MD 050 212 | CH221 | 12 14 044 | CH189 | 44 30 920 | CH232 |
| MAZDA | | MD 070 194 | CH221 | 12 14 054 | CH207 | 44 35 091 | CCGP007 |
| RF 1M-18-601 | CH242 | MD 077 167 | CH221 | 12 14 056 | CH231 | 4403145 | CH147 |
| RFG 1 18 601 | CH242 | MD 197511 | CH256 | 12 14 057 | CPSG003 | 45 06 155 | CH232 |
| RFN 1 18 601 | CH242 | MD 301950 | CH256 | 12 14 061 | CPSG003 | 55 187 863 | CH224 |
| RFN 1 18 601 A | CH242 | MD 344469 | CH256 | 12 14 064 | CH269 | 55568366 | CPSG004 |
| RFR 1 18 601 | CH242 | MD 354500 | CH256 | 12 14 071 | CH224 | 56 14 218 | CH189 |
| S 210 18 140 | CH242 | ME 203 539 | CH263 | 12 14 072 | CH231 | 5614216 | CH260 |
| VS01-18-601 | CH158 | ME203539 | CH263 | 12 14 073 | CH222 | 5614218 | CH189 |
| WL 01 18 601 | CH242 | MQ 901659 | CH242 | 12 14 074 | CH189 | 5614219 | CH260 |
| WL 03 18 601 | CH242 | MR 577131 | CH256 | 12 14 074 | CH189 | 88 900 716 | CH181 |
| WL 81-18-601 | CH242 | MRS77131 | CH256 | 12 14 080 | CH232 | 88 900 717 | CH215 |
| | | NISSAN | | 12 14 082 | CH271 | 88 900 718 | CH219 |
| | | 11065 00Q0C | CCGP007 | 12 14 084 | CH207 | 88 900 720 | CH205 |
| | | 11065 5X00A | CCGP007 | 12 14 085 | CH158 | 88 900 721 | CH203 |
| | | | | 12 14 086 | CPSG003 | 88 900 722 | CH271 |
| | | | | 12 14 087 | CPSG006 | 88 900 723 | CH260 |

OE ? ⇒



| OPEL | CHAMPION |
|------------|----------|
| 88 900 724 | CH175 |
| 88 900 725 | CH189 |
| 88 900 728 | CH189 |
| 88 900 729 | CH167 |
| 88 900 730 | CH189 |
| 88 900 731 | CH189 |
| 88 900 734 | CH189 |
| 88 900 735 | CH147 |
| 88 900 736 | CH189 |
| 88 900 737 | CH147 |
| 88 900 740 | CH173 |
| 88 900 741 | CH176 |
| 88900716 | CH181 |
| 88900717 | CH215 |
| 88900718 | CH219 |
| 88900720 | CH205 |
| 88900721 | CH203 |
| 88900722 | CH271 |
| 88900723 | CH260 |
| 88900724 | CH175 |
| 88900725 | CH189 |
| 88900726 | CH185 |
| 88900727 | CH177 |
| 88900728 | CH189 |
| 88900729 | CH167 |
| 88900731 | CH189 |
| 88900733 | CH189 |
| 88900734 | CH189 |
| 88900736 | CH189 |
| 88900737 | CH147 |
| 88900738 | CH189 |
| 88900740 | CH173 |
| 90 051 950 | CH189 |
| 90 093 867 | CH189 |
| 90 093 897 | CH189 |
| 90 166 155 | CH189 |
| 90 210 824 | CH189 |
| 90 487 858 | CH189 |
| 90 509 368 | CH189 |
| 90 510 924 | CH189 |
| 90 540 864 | CH189 |
| 90 569 338 | CH207 |
| 90051950 | CH189 |
| 90093867 | CH189 |
| 90093897 | CH189 |
| 90166155 | CH189 |
| 90210824 | CH189 |
| 90487858 | CH189 |
| 90569338 | CH207 |
| 91 10 724 | CH271 |
| 91 10 945 | CH217 |
| 91 111 45 | CH147 |
| 91 182 01 | CH207 |

| OPEL | CHAMPION |
|----------------|----------|
| 91153919 | CH181 |
| 9118201 | CH207 |
| 93 171 875 | CH203 |
| 93 178 411 | CH224 |
| 93 183 738 | CH158 |
| 93 183 740 | CH189 |
| 93 189 648 | CH271 |
| 93 197 242 | CH207 |
| 93171875 | CH203 |
| 94 387 612 | CH158 |
| 94 481 972 | CH158 |
| 94481972 | CH158 |
| 95 508 201 | CH207 |
| 95 508 487 | CH224 |
| 95 508 490 | CH189 |
| 95 508 494 | CH271 |
| 95 508 508 | CH158 |
| PERKINS | CHAMPION |
| 2666A004 | CH167 |
| K 166 AF 01 | CH189 |
| PEUGEOT | CHAMPION |
| 5960 64 | CH268 |
| 5960 65 | CH268 |
| 5960 66 | CH170 |
| 5960 67 | CH170 |
| 5960 76 | CH240 |
| 5960 79 | CH201 |
| 5960 A3 | CH270 |
| 5960 A4 | CH270 |
| 5960 F4 | CH268 |
| 5960 K4 | CH270 |
| 5960.78 | CH201 |
| 596064 | CH268 |
| 596065 | CH268 |
| 5960F9 | CH201 |
| 5961 39 | CH189 |
| 5961 40 | CH189 |
| 5961 53 | CH189 |
| 5961 54 | CH189 |
| 5961 57 | CH189 |
| 5961 58 | CH189 |
| 596139 | CH189 |
| 596140 | CH189 |
| 596153 | CH189 |
| 596157 | CH189 |
| 5962 03 | CH189 |
| 5962 1Z | CH260 |
| 5962 2Y | CH185 |
| 5962 35 | CH189 |
| 5962 3C | CH170 |
| 5962 3E | CH170 |

| PEUGEOT | CHAMPION |
|---------------|----------|
| 5962 3H | CH189 |
| 5962 3J | CH189 |
| 5962 4Z | CH216 |
| 5962 74 | CH189 |
| 5962 7A | CH189 |
| 5962 7F | CH170 |
| 5962 7G | CH170 |
| 5962 J2 | CH173 |
| 5962 J3 | CH147 |
| 5962 J3 | CH189 |
| 5962 J4 | CH189 |
| 5962 J5 | CH189 |
| 5962 J6 | CH189 |
| 5962 J7 | CH260 |
| 5962 K5 | CH189 |
| 5962 R8 | CH189 |
| 5962 S8 | CH189 |
| 5962 T1 | CH173 |
| 5962 T2 | CH260 |
| 5962 T7 | CH147 |
| 5962 W3 | CH185 |
| 5962 X1 | CH189 |
| 59622Y | CH185 |
| 596235 | CH189 |
| 59623C | CH170 |
| 59623H | CH189 |
| 596274 | CH189 |
| 5962J2 | CH173 |
| 5962J4 | CH189 |
| 5962J5 | CH189 |
| 5962J6 | CH189 |
| 5962J7 | CH260 |
| 5962K5 | CH189 |
| 5962R8 | CH189 |
| 5962S8 | CH189 |
| 5962T7 | CH147 |
| 5962W3 | CH185 |
| 7932 567 718 | CH189 |
| 7932567718 | CH189 |
| 9 633 214 380 | CH189 |
| 9150 860 280 | CH189 |
| 9150 861 080 | CH189 |
| 9150860280 | CH260 |
| 9150861080 | CH260 |
| 9152 184 980 | CH189 |
| 9152184980 | CH189 |
| 9153 664 680 | CH189 |
| 9153664680 | CH189 |
| 95 493 206 | CH189 |
| 95 534 788 | CH189 |
| 95 943 206 | CH189 |
| 95534788 | CH189 |
| 96 009 783 | CH147 |

| PEUGEOT | CHAMPION |
|----------------|----------|
| 96 009 783 | CH189 |
| 96 076 258 | CH189 |
| 96 141 678 | CH189 |
| 96 165 724 | CH189 |
| 96 236 383 | CH170 |
| 96 316 589 80 | CH185 |
| 96 389 858 | CH170 |
| 9616572480 | CH189 |
| MKP 000 065 | CH189 |
| MKP 000 65 | CH189 |
| MKP 000 71 | CH260 |
| PIAGGIO | CHAMPION |
| 438036 | CH260 |
| 493061 | CH189 |
| L2100097 | CH205 |
| RENAULT | CHAMPION |
| 50 01 001 587 | CH189 |
| 5001001587 | CH189 |
| 77 00 100 558 | CH217 |
| 77 00 100 586 | CH169 |
| 77 00 100 635 | CH233 |
| 77 00 103 674 | CH232 |
| 77 00 105 290 | CH206 |
| 77 00 111 323 | CH271 |
| 77 00 111 940 | CH233 |
| 77 00 662 199 | CH189 |
| 77 00 673 874 | CH189 |
| 77 00 701 130 | CH189 |
| 77 00 704 185 | CH189 |
| 77 00 715 768 | CH189 |
| 77 00 733 076 | CH189 |
| 77 00 734 956 | CH173 |
| 77 00 741 144 | CH189 |
| 77 00 854 538 | CH260 |
| 77 00 855 865 | CH189 |
| 77 00 856 238 | CH189 |
| 77 00 856 292 | CH260 |
| 77 00 858 208 | CH169 |
| 77 00 860 796 | CH169 |
| 77 00 861 906 | CH169 |
| 77 00 867 002 | CH206 |
| 77 00 867 617 | CH260 |
| 77 00 874 336 | CH206 |
| 77 01 029 762 | CH189 |
| 77 01 035 956 | CH189 |
| 77 01 039 387 | CH189 |
| 77 01 040 208 | CH147 |
| 77 01 069 730 | CH271 |
| 77 01 069 731 | CH189 |
| 77 01 349 475 | CH189 |
| 77 01 349 943 | CH189 |



OE ? ⇒



| RENAULT | | CHAMPION |
|---------------|-------|----------|
| 77 01 349 949 | CH260 | |
| 77 01 414 072 | CH189 | |
| 77 01 414 076 | CH189 | |
| 77 01 414 077 | CH260 | |
| 77 01 414 079 | CH189 | |
| 77 01 414 080 | CH189 | |
| 77 01 414 081 | CH147 | |
| 77 01 414 083 | CH147 | |
| 77 01 414 086 | CH189 | |
| 77 01 414 088 | CH260 | |
| 77 01 414 089 | CH147 | |
| 77 01 414 089 | CH189 | |
| 77 01 414 108 | CH189 | |
| 77 01 414 123 | CH189 | |
| 77 01 414 157 | CH176 | |
| 77 01 414 162 | CH189 | |
| 7700100558 | CH217 | |
| 7700100586 | CH169 | |
| 7700100635 | CH233 | |
| 7700105290 | CH206 | |
| 7700111940 | CH233 | |
| 7700701130 | CH189 | |
| 7700704185 | CH189 | |
| 7700715768 | CH189 | |
| 7700741144 | CH189 | |
| 7700854538 | CH260 | |
| 7700855865 | CH173 | |
| 7700856238 | CH173 | |
| 7700856292 | CH260 | |
| 7700860796 | CH169 | |
| 7700861906 | CH169 | |
| 7700867002 | CH206 | |
| 7700867617 | CH260 | |
| 7700874336 | CH206 | |
| 7701033403 | CH189 | |
| 7701035956 | CH189 | |
| 7701039387 | CH189 | |
| 7701040208 | CH147 | |
| 7701349475 | CH189 | |
| 7701349943 | CH173 | |
| 7701349949 | CH260 | |
| 7701414072 | CH189 | |
| 7701414076 | CH189 | |
| 7701414077 | CH260 | |
| 7701414080 | CH189 | |
| 7701414081 | CH147 | |
| 7701414086 | CH189 | |
| 7701414088 | CH260 | |
| 7701414107 | CH176 | |
| 7701414108 | CH189 | |
| 7701414123 | CH189 | |
| 7701414157 | CH176 | |
| 79 32 567 717 | CH189 | |

| RENAULT | | CHAMPION |
|---------------|---------|----------|
| 82 00 012 099 | CH232 | |
| 82 00 090 817 | CH189 | |
| 82 00 421 091 | CH271 | |
| 82 00 423 224 | CH217 | |
| 82 00 423 227 | CH217 | |
| 82 00 434 855 | CH271 | |
| 82 00 445 627 | CH232 | |
| 82 00 464 077 | CH271 | |
| 82 00 490 950 | CH271 | |
| 82 00 517 313 | CH232 | |
| 82 00 561 251 | CCGP007 | |
| 82 00 787 721 | CH233 | |
| 82000012099 | CH232 | |
| 8200445627 | CH232 | |
| 8200787721 | CH233 | |
| 86 71 004 016 | CH260 | |
| 86 71 004 018 | CH189 | |

| ROVER | | CHAMPION |
|--------------|-------|----------|
| ERC 8450 | CH189 | |
| ERR 6066 | CH272 | |
| ETC 8847 | CH178 | |
| ETC8847 | CH178 | |
| NCC 100050 | CH169 | |
| NCC 100120 | CH203 | |
| NCC 100120 L | CH203 | |
| NCC100050 | CH169 | |
| NCC100120 | CH203 | |
| NCC100120L | CH203 | |

| SEAT | | CHAMPION |
|-----------------|-------|----------|
| 0003940685 | CH189 | |
| N 105 792 01 | CH181 | |
| N 105 792 02 | CH181 | |
| SE 138919 000 A | CH189 | |
| SE138919000A | CH189 | |
| X 0396 550 20 | CH189 | |
| X03965520 | CH189 | |

| SUZUKI | | CHAMPION |
|-----------------|-------|----------|
| 09900-HD101 | CH170 | |
| 09900-RF001 | CH242 | |
| 09900-TD001 | CH189 | |
| 09900-TD001-000 | CH189 | |
| 18550-66G00 | CH189 | |
| 18550-66G00-000 | CH189 | |
| 1855067G00000 | CH170 | |
| 1855067G10000 | CH170 | |
| 18550-67G11 | CH268 | |
| 1855067G11000 | CH170 | |
| 18550-78E00 | CH242 | |
| 18550-78E10 | CH242 | |
| 18550-78E11 | CH242 | |
| 18550-79J50 | CH269 | |

| SUZUKI | | CHAMPION |
|-----------------|-------|----------|
| 18550-79J50 000 | CH269 | |
| 1855084A00000 | CH271 | |
| 1855084A50000 | CH271 | |
| 1855084A51000 | CH271 | |
| 18550-84A51-000 | CH271 | |
| 1855084CT0000 | CH233 | |

| TALBOT | | CHAMPION |
|---------------|-------|----------|
| 91 507 715 80 | CH189 | |
| 91 507 719 80 | CH189 | |

| TOYOTA | | CHAMPION |
|--------------|-------|----------|
| 19850-45030 | CH154 | |
| 19850-45031 | CH154 | |
| 19850-54030 | CH154 | |
| 19850-54031 | CH154 | |
| 19850-54090 | CH154 | |
| 19850-56010 | CH302 | |
| 19850-56012 | CH302 | |
| 19850-58010 | CH302 | |
| 19850-64020 | CH302 | |
| 19850-64030 | CH302 | |
| 19850-64031 | CH302 | |
| 19850-64031B | CH302 | |
| 19850-64050 | CH302 | |
| 19850-67020 | CH608 | |
| 19850-67030 | CH608 | |
| 19850-68010 | CH302 | |
| 19850-68040 | CH302 | |
| 19850-68050 | CH302 | |
| SU001-00351 | CH185 | |

| VAG | | CHAMPION |
|---------------|---------|----------|
| 03L 905 061 G | CPSG007 | |
| 03L 905 061 K | CPSG007 | |
| 059 905 061 E | CPSG008 | |
| 059 905 061 H | CPSG008 | |
| N 105 798 03 | CCGP003 | |
| N 105 798 05 | CCGP003 | |
| N 105 916 04 | CCGP002 | |
| N 105 916 08 | CCGP002 | |

| VAUXHALL | | CHAMPION |
|-----------|-------|----------|
| 900 33357 | CH189 | |
| 900 93897 | CH189 | |
| 902 10824 | CH189 | |

| VM | | CHAMPION |
|--------------|-------|----------|
| 46 072 007 F | CH180 | |

| VOLVO | | CHAMPION |
|-------------|-------|----------|
| 1257141 | CH260 | |
| 1257889 | CH260 | |
| 30 72 506 9 | CH268 | |
| 30862690 | CH169 | |

| VOLVO | | CHAMPION |
|-----------|-------|----------|
| 31216248 | CH201 | |
| 840643 | CH189 | |
| 86 53 698 | CH268 | |
| 8653698 | CH268 | |

| VW | | CHAMPION |
|---------------|-------|----------|
| 059 963 319 | CH215 | |
| 059 963 319 A | CH215 | |
| 059 963 319 H | CH215 | |
| 059963319 | CH215 | |
| 061905061 | CH260 | |
| 068 905 061 | CH260 | |
| 068905061 | CH260 | |
| N 019 081 1 | CH260 | |
| N 019 081 2 | CH260 | |
| N 019 081 4 | CH260 | |
| N 019 097 1 | CH260 | |
| N 019 100 01 | CH260 | |
| N 019 100 2 | CH260 | |
| N 019 100 5 | CH260 | |
| N 019 100 6 | CH260 | |
| N 101 401 01 | CH271 | |
| N 101 401 02 | CH271 | |
| N 101 401 03 | CH271 | |
| N 101 401 04 | CH271 | |
| N 101 401 05 | CH271 | |
| N 102 130 01 | CH260 | |
| N 102 130 02 | CH260 | |
| N 105 792 01 | CH181 | |
| N 105 792 02 | CH181 | |
| N0190811 | CH260 | |
| N0190812 | CH260 | |
| N0190814 | CH260 | |
| N0190971 | CH260 | |
| N0191001 | CH260 | |
| N0191002 | CH260 | |
| N0191005 | CH260 | |
| N0191006 | CH260 | |
| N10213001 | CH260 | |
| N10213002 | CH260 | |
| N10579202 | CH181 | |

OE ?

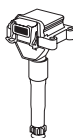

| ALFA ROMEO | |
|---------------------|----------|
| 116 55 65 079 00/00 | BAEA115 |
| 116 55 65 079 01/00 | BAEA115 |
| 46460582 | BAEA549 |
| 46469863 | BAEA309 |
| 55213613 | BAEA095 |
| 60558152 | BAEA234 |
| 60562701 | BAEA428 |
| 60586072 | BAEA234 |
| 60805420 | BAE800B |
| 60809492 | BAE800B |
| 60809606 | BAEA234 |
| 60810690 | BAEA428 |
| 71739725 | BAEA427 |
| 71741133 | BAEA174E |
| 71744369 | BAEA427 |
| 71751445 | BAEA174E |
| 71753911 | BAEA174E |
| 7648797 | BAEA234 |
| 76487970 | BAEA234 |
| ASTON MARTIN | |
| 4G4E-12A366-AA | BAEA426 |
| AUDI | |
| 058905101A | BAEA162E |
| 078 905 101 A | BAEA007E |
| BMW | |
| 0 495 289 | BAEA324 |
| 1 703 227 | BAEA302 |
| 1 703 359 | BAEA014 |
| 1 712 219 | BAEA324 |
| 1 712 223 | BAEA324 |
| 1 720 166 | BAEA014 |
| 1 720 877 | BAEA014 |
| 1 726 176 | BAEA014 |
| 1 726 177 | BAEA014 |
| 1 726 178 | BAEA014 |
| 1 726 178 B | BAEA014 |
| 1 730 765 | BAEA014 |
| 1 731 134 B | BAEA014 |
| 1 731 178 B | BAEA014 |
| 1 742 925 | BAEA014 |
| 1 748 394 | BAEA014 |
| 1 777 666 | BAEA014 |
| 12 13 0 148 594 | BAEA324 |
| 12 13 0 390 064 | BAEA324 |
| 12 13 0 495 289 | BAEA324 |
| 12 13 1 247 281 | BAEA307 |
| 12 13 1 273 216 | BAEA546 |
| 12 13 1 317 585 | BAEA014 |
| 12 13 1 326 684 | BAEA115 |
| 12 13 1 357 294 | BAEA115 |
| 12 13 1 357 295 | BAEA115 |

| BMW | |
|-----------------|----------|
| 12 13 1 402 440 | BAEA014 |
| 12 13 1 402 713 | BAEA014 |
| 12 13 1 703 227 | BAEA302 |
| 12 13 1 703 228 | BAEA302 |
| 12 13 1 703 359 | BAEA014 |
| 12 13 1 703 825 | BAEA302 |
| 12 13 1 712 219 | BAEA324 |
| 12 13 1 712 223 | BAEA324 |
| 12 13 1 720 166 | BAEA014 |
| 12 13 1 726 176 | BAEA014 |
| 12 13 1 726 177 | BAEA014 |
| 12 13 1 726 178 | BAEA014 |
| 12 13 1 727 108 | BAEA014 |
| 12 13 1 729 842 | BAEA014 |
| 12 13 1 730 765 | BAEA014 |
| 12 13 1 730 766 | BAEA014 |
| 12 13 1 731 134 | BAEA014 |
| 12 13 1 731 884 | BAEA014 |
| 12 13 1 748 017 | BAEA302 |
| 12 13 1 748 018 | BAEA302 |
| 12 13 1 748 394 | BAEA014 |
| 12 13 1 777 666 | BAEA014 |
| 12 13 7 523 345 | BAEA145E |
| 12 13 7 548 553 | BAEA145E |
| 12 13 7 550 012 | BAEA143 |
| 12 13 7 551 049 | BAEA143 |
| 12 13 7 551 260 | BAEA324 |
| 12 13 7 559 842 | BAEA144E |
| 12 13 7 562 744 | BAEA143 |
| 12 13 7 562 745 | BAEA144E |
| 12 13 7 571 643 | BAEA143 |
| 12 13 7 571 644 | BAEA144E |
| 12 13 7 575 010 | BAEA143 |
| 12 13 7 582 627 | BAEA144E |
| 12 13 7 594 596 | BAEA143 |
| 12 13 7 594 935 | BAEA144E |
| 12 13 7 594 936 | BAEA145E |
| 12 13 7 594 937 | BAEA143 |
| 12 13 7 594 938 | BAEA324 |
| 12 13 7 599 219 | BAEA302 |
| 12 13 7 619 385 | BAEA538 |
| 12 13 7 638 477 | BAEA144E |
| 12 13 7 703 359 | BAEA014 |
| 12 13 7 841 558 | BAEA324 |
| 12 13 8 616 153 | BAEA143 |
| 12 13 8 647 689 | BAEA143 |
| 12 13 8 678 438 | BAEA538 |
| 12 13 8 730 002 | BAEA115 |
| 12 13 9 066 468 | BAEA014 |
| 12 13 9 067 830 | BAEA302 |
| 1213 1 487 707 | BAEA382 |
| 1213 7510 738 | BAEA382 |
| 1247281 | BAEA307 |

| BMW | |
|------------------|----------|
| 1273216 | BAEA546 |
| 1404309 | BAEA302 |
| 1703825 | BAEA302 |
| 1748017 | BAEA302 |
| 1748018 | BAEA302 |
| 7 551 260 | BAEA324 |
| 7 599 218 | BAEA014 |
| 7 841 558 | BAEA324 |
| 9 066 468 | BAEA014 |
| BUICK | |
| 1 104 091 | BAEA472 |
| CHEVROLET | |
| 1115467 | BAEA554 |
| 25182496 | BAEA447A |
| 25186687 | BAEA198E |
| 96165049 | BAEA554 |
| 96253555 | BAEA447A |
| 96291054 | BAEA539 |
| 96336522 | BAEA540 |
| 96453420 | BAEA543 |
| 96476983 | BAEA199E |
| 96566260 | BAEA447A |
| CHRYSLER | |
| 0000K04557468 | BAEA380 |
| 00K 04609088 AG | BAEA432 |
| 00K 04609088 AI | BAEA432 |
| 00K 04797 293 AB | BAEA394 |
| 00K04606869AC | BAEA453 |
| 00K04606869AD | BAEA453 |
| 00K05234210 | BAEA394 |
| 04606869AB | BAEA453 |
| 04606869AC | BAEA453 |
| 04609088 AB | BAEA432 |
| 04609088 AC | BAEA432 |
| 04609088 AD | BAEA432 |
| 04609088 AE | BAEA432 |
| 04609088 AF | BAEA432 |
| 04797293AB | BAEA394 |
| 4797293 | BAEA394 |
| 5234210 | BAEA394 |
| 5252577 | BAEA394 |
| 5269670 | BAEA380 |
| 56032521 | BAEA380 |
| 56032521AB | BAEA380 |
| 56032521AC | BAEA380 |
| K 04609088 AF | BAEA432 |
| K 04609088 AH | BAEA432 |
| K04609103 | BAEA380 |
| K04609103AB | BAEA380 |
| K04609103AC | BAEA380 |
| K04797293 | BAEA394 |

| CHRYSLER | |
|--------------------------|----------|
| K05252577 | BAEA394 |
| T1031135 | BAEA251 |
| CITROËN | |
| 0000597075 | BAEA348 |
| 0000597077 | BAEA347 |
| 0000597078 | BAE946A |
| 0000597079 | BAE946A |
| 0000597084 | BAEA351 |
| 0000597087 | BAEA352 |
| 0000597090 | BAEA048E |
| 0000597094 | BAEA347 |
| 0000597097 | BAEA048E |
| 0000597098 | BAEA348 |
| 00005970A0 | BAEA352 |
| 00005970A5 | BAEA351 |
| 1607576780 | BAEA547 |
| 5 412 342 | BAEA110 |
| 5 412 977 | BAEA110 |
| 5 490 504 | BAEA115 |
| 5 491 302 | BAEA115 |
| 5 491 559 | BAEA115 |
| 5970-79 | BAE946A |
| 75 455 219 | BAEA115 |
| 96 062 288 | BAEA231 |
| 96 165 97 080 | BAEA231 |
| 96 211 048 | BAEA256 |
| 96 228 897 | BAEA232 |
| 96010513 | BAEA247 |
| 9611412080 | BAE700AK |
| 96341314 | BAEA348 |
| 9634131480 | BAEA348 |
| 96358649 | BAE946A |
| 9654347080 | BAEA048E |
| 97530780 | BAEA247 |
| MA 5455 219 | BAEA115 |
| CITROËN / PEUGEOT | |
| 59070 C1 | BAEA164E |
| 5970 53 | BAEA234 |
| 5970 64 | BAEA143 |
| 5970 76 | BAEA351 |
| 5970 80 | BAEA045E |
| 5970 85 | BAEA472 |
| 5970 88 | BAEA164E |
| 5970 99 | BAEA045E |
| 5970 C0 | BAEA164E |
| 96 753 909 80 | BAEA557 |
| 9651710680 | BAEA472 |
| 9806702780 | BAEA143 |
| DACIA | |
| 224332428R | BAEA131E |
| 224336134R | BAEA354 |



OE ? ⇒

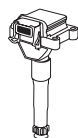

| DACIA | | FIAT | | FORD | | FORD | | | | |
|-------------------|----------|--|----------|----------------|----------|---|----------------|---------|----------|--|
| CHAMPION | | CHAMPION | | CHAMPION | | CHAMPION | | | | |
| 6001543604 | BAEA354 | 55224494 | BAEA095 | 12029AB | BAEA422 | 5008190 | BAEA372 | | | |
| 77 00 274 008 | BAEA354 | 55231256 | BAEA090 | 1224925 | BAEA408 | 5047437 | BAEA408 | | | |
| 82 00 360 911 | BAEA325 | 55234131 | BAEA090 | 1229419 | BAEA308 | 5F2E-12029-AA | BAEA372 | | | |
| 82 00 702 693 | BAEA325 | 55234133 | BAEA090 | 1314271 | BAEA408 | 5F2E-12029-AB | BAEA372 | | | |
| DAEWOO | | CHAMPION | | CHAMPION | | CHAMPION | | | | |
| 0001587503 | BAEA340 | 60558152 | BAEA234 | 1317972 | BAEA350 | 6485688 | BAEA308 | | | |
| 1 104 091 | BAEA472 | 60562701 | BAEA428 | 1319788 | BAEA365 | 6860288 | BAEA281 | | | |
| 1115467 | BAEA554 | 60809606 | BAEA234 | 1319929 | BAEA422 | 6M5G12029AA | BAEA055E | | | |
| 19 017 110 | BAEA394 | 60810690 | BAEA428 | 1322402 | BAEA408 | 6R83-12A366-AA | BAEA196E | | | |
| 88921374 | BAEA025E | 60815150 | BAE800B | 1350562 | BAEA387 | 7053859 | BAE907AE | | | |
| 96165049 | BAEA554 | 71739725 | BAEA427 | 1371601 | BAEA055E | 7U2J-12029-AB | BAEA281 | | | |
| 96253555 | BAEA447A | 71741133 | BAEA174E | 1459278 | BAEA387 | 885F-12029-A2A | BAEA281 | | | |
| 96291054 | BAEA539 | 71742420 | BAEA181E | 1517813 | BAEA422 | 885F-12029-A2B | BAEA281 | | | |
| 96336522 | BAEA540 | 71744369 | BAEA427 | 1535713 | BAE940A | 91XF 12029 AA | BAEA308 | | | |
| 96350585 | BAEA025E | 71751445 | BAEA174E | 1578771 | BAEA408 | 91XF-12029-BA | BAEA308 | | | |
| 96453420 | BAEA543 | 71753911 | BAEA174E | 1619343 | BAEA365 | 928F-12029-CA | BAEA281 | | | |
| 96566260 | BAEA447A | 7553120 | BAE506F | 1619343 | BAEA422 | 95VW12029AA | BAEA004E | | | |
| E586A | BAEA025E | 7582152 | BAE506D | 1671690 | BAE940A | 95WF12029BA | BAE907AE | | | |
| DAIHATSU | | CHAMPION | | CHAMPION | | CHAMPION | | | | |
| 19070-B1020 | BAEA194E | 7588435 | BAE506F | 1727629 | BAEA387 | 988F12029AA | BAEA350 | | | |
| 90048-52125 | BAEA180E | 7626232 | BAE800B | 1S7G-12029-AB | BAEA365 | 988F12029AB | BAEA350 | | | |
| 90048-52126 | BAEA180E | 7646974 | BAE506F | 1S7G-12029-AC | BAEA365 | 988F12029AC | BAEA350 | | | |
| DUCATI | | CHAMPION | | CHAMPION | | CHAMPION | | | | |
| 285.2.015.2A | BAE800B | 7646975 | BAE504F | 1S7Z-12029AA | BAEA350 | 988F12029AD | BAEA350 | | | |
| 380.4.010.1B | BAE800B | 7648797 | BAEA234 | 1S7Z-12029AA | BAEA365 | 988F-12029-BA | BAEA365 | | | |
| FERRARI (FERRARI) | | CHAMPION | | CHAMPION | | CHAMPION | | | | |
| 134386 | BAEA234 | 7663177 | BAE506D | 1S7Z-12029AA | BAEA422 | 988F-12029-BA | BAEA422 | | | |
| FIAT | | CHAMPION | | CHAMPION | | CHAMPION | | | | |
| 0009633001580 | BAEA347 | 7672018 | BAE800B | 2W4E-12A366-AC | BAEA367 | 988F12024AB | BAEA350 | | | |
| 0009663278480 | BAEA347 | 7698431 | BAE506D | 2W4E-12A366-AD | BAEA367 | 9L8E-12A366-AA | BAEA410 | | | |
| 04606869AC | BAEA453 | 7746151 | BAE504D | 2W4E-12A366-BB | BAEA368 | 9S5 112 029 AA | BAE940A | | | |
| 187284R46772871 | BAE403D | 7746152 | BAE506D | 2W4E-12A366-BC | BAEA368 | 9S5 112 029 AB | BAE940A | | | |
| 46446039 | BAE920AX | 7746153 | BAE506F | 2W4E-12A366-BD | BAEA368 | AJ810445 | BAEA196E | | | |
| 46460582 | BAEA549 | 7746154 | BAE506D | 2W4E-12A366-BE | BAEA368 | AM5E-12A366-AA | BAEA408 | | | |
| 46469863 | BAEA309 | 7753777 | BAE504F | 2W4Z-12029-B | BAEA368 | AM5E-12A366-AB | BAEA408 | | | |
| 46472440 | BAE920AX | 7789346 | BAE920AX | 2W4Z-12029-BC | BAEA368 | CM5G-12029-FA | BAEA387 | | | |
| 46480361 | BAE920AX | 96 228 897 80 | BAEA232 | 2W4Z-12029-BD | BAEA368 | CM5G-12029-FB | BAEA387 | | | |
| 46543562 | BAE800B | 9634131380 | BAEA348 | 4088000 | BAEA372 | E9TF-12029-AA | BAEA281 | | | |
| 46548037 | BAE800B | A880093 | BAE403D | 4093748 | BAEA410 | YM2F 12029 AD | BAEA350 | | | |
| 46776830 | BAE403D | A88038 | BAE403B | 4424413 | BAEA368 | YM2F-12024-AB | BAEA422 | | | |
| 46777286 | BAE403B | A88068 | BAE403C | 4448245 | BAEA410 | YM2F-12024-AC | BAEA422 | | | |
| 46777287 | BAE403D | A88089 | BAE700AK | 448 298 | BAEA115 | YM2F-12029-AB | BAEA422 | | | |
| 46777288 | BAE403C | A8808M | BAE800B | 4586554 | BAEA368 | <th colspan="2">GENERAL MOTORS</th> <th colspan="2">CHAMPION</th> | GENERAL MOTORS | | CHAMPION | |
| 46790073 | BAE800B | A88094 | BAE960AE | 4619092 | BAEA410 | 03 474 233 | BAEA253 | | | |
| 55180004 | BAE403B | <th colspan="2">FORD</th> <th colspan="2">CHAMPION</th> <td>03474232</td> <td>BAEA252</td> | FORD | | CHAMPION | | 03474232 | BAEA252 | | |
| 55200112 | BAE940A | 1008464 | BAEA004E | 4667153 | BAEA368 | 03474282 | BAEA252 | | | |
| 55200486 | BAE940A | 1052492 | BAEA350 | 4744015 | BAEA196E | 09 119 567 | BAEA342 | | | |
| 55208723 | BAE940A | 1053904 | BAEA350 | 4751265 | BAEA372 | 10450424 | BAEA025E | | | |
| 55209603 | BAEA095 | 1066102 | BAEA350 | 4M5E12A366AA | BAEA408 | 10458316 | BAEA427 | | | |
| 55213613 | BAEA095 | 1067601 | BAEA350 | 4M5G-12029-ZA | BAEA387 | 10490192 | BAEA025E | | | |
| | | 1075786 | BAEA350 | 4M5G-12029-ZB | BAEA387 | 1104038 | BAEA025E | | | |
| | | 1111213 | BAEA422 | 4M5G12A366BA | BAEA408 | 1104091 | BAEA472 | | | |
| | | 1119835 | BAEA365 | 4M5G12A366BB | BAEA408 | 1115467 | BAEA554 | | | |
| | | 1130402 | BAEA350 | 4M5G-12A366-BC | BAEA408 | 12570616 | BAEA159E | | | |
| | | 1133237 | BAEA308 | 4M5G12A366-BD | BAEA408 | 12611424 | BAEA159E | | | |
| | | 12029AB | BAEA350 | 4M5U-12A366-BC | BAEA408 | 12629037 | BAEA174E | | | |
| | | 12029AB | BAEA365 | 457G 12029 AB | BAEA448 | 19005212 | BAE965A | | | |

OE ? ⇒

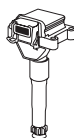

| | | | | | | | |
|-----------------------|----------|----------------|----------|--------------------|----------|----------------------|----------|
| GENERAL MOTORS | | HONDA | | KIA | | MAZDA | |
| 25195107 | BAEA185E | 30521PWA013 | BAEA176E | OK 247-18100 | BAEA433 | C201-18-100 | BAEA350 |
| 25198623 | BAEA185E | 30521PWAS01 | BAEA176E | OK 247-18100 A | BAEA433 | C201-18-100A | BAEA350 |
| 3474233 | BAEA253 | 30521REAZ01 | BAEA176E | OK0131 8100 | BAEA434 | C201-18-100B | BAEA350 |
| 55 575 499 | BAEA185E | 30521RLB003 | BAEA176E | OK30A-18-10X | BAEA561 | FDS7-18-100 | BAEA281 |
| 55561655 | BAEA199E | HYUNDAI | | OK30E-18-10X | BAEA486 | FFY 118 100 | BAEA083E |
| 55573735 | BAEA185E | OK 247-18100 | BAEA433 | 27300-3F100 | BAEA548 | FP 85 18 100 A | BAEA083E |
| 55577898 | BAEA185E | OK0131 8100 | BAEA434 | 27301-02700 | BAEA477 | FP 85 18 100 B | BAEA083E |
| 55579072 | BAEA185E | OK30A-18-10X | BAEA561 | 27301-02710 | BAEA477 | FP 85 18 100 C | BAEA083E |
| 55584404 | BAEA198E | 27300-3F100 | BAEA548 | 27301-04000 | BAEA476 | FPY 118 100 | BAEA083E |
| 55584745 | BAEA198E | 27301-02100 | BAEA480 | 27301-23700 | BAEA482 | K 013-18-100 | BAEA434 |
| 90 449 740 | BAEA252 | 27301-02600 | BAEA266 | 27301-26600 | BAEA483 | K 247-18100 | BAEA433 |
| 90 458 250 | BAEA344 | 27301-02700 | BAEA477 | 27301-2B000 | BAEA474 | L813-18-100 | BAEA556 |
| 90 510 387 | BAEA252 | 27301-02710 | BAEA477 | 27301-2B010 | BAEA475 | YF091810X | BAEA350 |
| 90 536 194 | BAEA342 | 27301-02710 | BAEA477 | 27301-37150 | BAEA555 | ZJ20-18-100 | BAEA489 |
| 90 541 062 | BAEA306 | 27301-03000 | BAEA536 | 27301-3C000 | BAEA531 | ZJ20-18100-A | BAEA489 |
| 90 563 160 | BAEA306 | 27301-03010 | BAEA536 | OK 011-18-100 | BAEA234 | ZL01-18-100-A | BAEA190E |
| 90350929 | BAEA546 | 27301-03030 | BAEA536 | LADA | | ZL01-18-100-B | BAEA190E |
| 90449739 | BAEA253 | 27301-04000 | BAEA476 | 21110370501000 | BAEA395 | MERCEDES-BENZ | |
| 90510386 | BAEA253 | 27301-22040 | BAEA264 | 21113705010 | BAEA395 | 000 150 04 80 | BAEA313 |
| 90532618 | BAEA358 | 27301-22050 | BAEA264 | LAMBORGHINI | | 000 150 05 80 | BAEA313 |
| 90543059 | BAEA358 | 27301-22600 | BAEA479 | 16004528 | BAE800B | 000 150 15 80 | BAEA053 |
| 90543253 | BAEA147E | 27301-23003 | BAEA267 | LANCIA | | 000 150 17 80 | BAEA041 |
| 9118114 | BAEA152E | 27301-23700 | BAEA482 | 46460582 | BAEA549 | 000 150 19 80 | BAEA140E |
| 9119567 | BAEA342 | 27301-26600 | BAEA483 | 46469863 | BAEA309 | 000 150 25 80 | BAEA077 |
| 93173708 | BAEA153E | 27301-28000 | BAEA474 | 55213613 | BAEA095 | 000 150 27 80 | BAEA140E |
| 93177212 | BAEA338 | 27301-28010 | BAEA475 | 7588435 | BAE504D | 000 150 28 80 | BAEA041 |
| 93180806 | BAEA359 | 27301-33510 | BAEA521 | 7663177 | BAE506D | 000 150 29 80 | BAEA053 |
| 93194165 | BAEA189E | 27301-33520 | BAEA521 | 82 281 560 | BAEA115 | 000 158 06 03 | BAEA115 |
| 95507901 | BAEA189E | 27301-37100 | BAEA269 | LAND ROVER | | 000 158 48 03 | BAEA296 |
| 96 415 010 | BAEA508 | 27301-37150 | BAEA555 | NEC000120 L | BAEA501 | 000 158 06 03 | BAEA296 |
| 96165049 | BAEA554 | 27301-38020 | BAEA502E | NEC100730 L | BAEA501 | 000 158 50 03 | BAEA339 |
| 96253555 | BAEA447A | 27301-3C000 | BAEA531 | LOMBARDINI | | 000 158 55 03 | BAEA299 |
| 96336522 | BAEA540 | ISUZU | | 011200156719030 | BAE800B | 000 158 56 03 | BAEA298 |
| HONDA | | 8-01104-038-0 | BAEA025E | MAN | | 000 158 57 03 | BAEA299 |
| 30500PM5A02 | BAEA276 | IVECO | | 51 25919 0016 | BAEA297 | 000 158 58 03 | BAEA298 |
| 30500PM5A03 | BAEA276 | 464724400 | BAE920AX | MASERATI | | 000 158 58 03 | BAEA298 |
| 30510P73A01 | BAEA275 | 467772871 | BAE403D | 477084200 | BAE504F | 000 158 61 03 | BAEA296 |
| 30510P73A02 | BAEA275 | 467772880 | BAE403C | 571.08.42.00 | BAE700AK | 000 158 62 03 | BAEA339 |
| 30510PT2006 | BAEA275 | 500309816 | BAE920AX | 571084200 | BAE700AK | 000 158 64 03 | BAEA298 |
| 30520 PDFE 00 | BAEA234 | 504142675 | BAE403C | MAZDA | | 000 158 65 03 | BAEA299 |
| 30520-PGK-A01 | BAEA170E | JAGUAR | | 1E03-18-10X | BAEA350 | 000 158 65 03 | BAEA299 |
| 30520-PNA-007 | BAEA169E | AJ81373 | BAEA368 | 1E04-18-10X | BAEA350 | 000 158 68 03 | BAEA313 |
| 30520-PVF-A01 | BAEA170E | AJ82545 | BAEA368 | 1E05-18-100B | BAEA350 | 000 158 71 03 | BAEA340 |
| 30520-PVJ-A01 | BAEA170E | AJ86468 | BAEA368 | 1E08-18-10X | BAEA350 | 000 158 73 03 | BAEA297 |
| 30520-PWA-003 | BAEA175E | C2542751 | BAEA367 | 1E08-18-10X | BAEA350 | 000 158 75 03 | BAEA340 |
| 30520PWA013 | BAEA175E | XR814052 | BAEA367 | 1E09-18-10X | BAEA350 | 000 158 77 03 | BAEA304 |
| 30520PWAS01 | BAEA175E | XR816250 | BAEA367 | B 542 18 10XA | BAEA560 | 000 158 78 03 | BAEA297 |
| 30520-RAA-007 | BAEA169E | XR827823 | BAEA368 | BP6D-18-100A | BAEA084E | 000150048081 | BAEA313 |
| 30520REAZ01 | BAEA175E | XR842741 | BAEA367 | BPE81810XC | BAEA195E | 003 158 50 01 | BAEA004E |
| 30520-RNA-A01 | BAEA182E | KIA | | MAZDA | | 160 158 77 03 | BAEA304 |
| 30520-RRA-007 | BAEA169E | OK 011-18-100 | BAEA234 | 1E03-18-10X | BAEA350 | 272 150 02 80 | BAEA093E |
| 30521-PWA-003 | BAEA176E | | | 1E04-18-10X | BAEA350 | 272 906 00 60 | BAEA140E |
| | | | | 1E05-18-100B | BAEA350 | 276 150 00 80 | BAEA093E |
| | | | | 1E08-18-10X | BAEA350 | 276 906 01 60 | BAEA093E |
| | | | | 1E08-18-10X | BAEA350 | 276 906 02 59 | BAEA093E |
| | | | | 1E09-18-10X | BAEA350 | | |
| | | | | B 542 18 10XA | BAEA560 | | |
| | | | | BP6D-18-100A | BAEA084E | | |
| | | | | BPE81810XC | BAEA195E | | |



OE ? ⇒

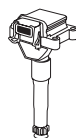

| MERCEDES-BENZ | CHAMPION | MOTO GUZZI | CHAMPION | OPEL | CHAMPION | PEUGEOT | CHAMPION |
|-------------------|----------|------------------|----------|------------|----------|----------------|----------|
| 276 906 02 60 | BAEA093E | 57165300 | BAE800B | 12 08 004 | BAEA252 | 5940 29 | BAE504L |
| 276 906 35 00 | BAEA093E | BAE800BG | BAE800B | 12 08 008 | BAEA342 | 5970 13 | BAEA110 |
| 276 906 37 00 | BAEA093E | MV AGUSTA | CHAMPION | 12 08 012 | BAEA147E | 5970 15 | BAEA110 |
| A 000 150 04 80 | BAEA313 | 800091235 | BAE800B | 12 08 015 | BAEA115 | 5970 A3 | BAEA046E |
| A 000 150 05 80 | BAEA313 | NISSAN | CHAMPION | 12 08 015 | BAEA153E | 5970 A7 | BAEA256 |
| A 000 150 07 80 | BAEA146E | 22433-8J115 | BAEA079E | 12 08 017 | BAEA115 | 5970 A8 | BAE946A |
| A 000 150 12 80 | BAEA146E | 22433-8J11C | BAEA079E | 12 08 020 | BAEA338 | 5970.43 | BAEA247 |
| A 000 150 13 80 | BAEA146E | 22448 1F700 | BAEA337 | 12 08 021 | BAEA427 | 5970.49 | BAEA231 |
| A 000 150 15 80 | BAEA053 | 22448 4M500 | BAEA021E | 12 08 028 | BAEA359 | 5970.50 | BAE700AK |
| A 000 150 17 80 | BAEA041 | 22448 4M50A | BAEA021E | 12 08 036 | BAEA252 | 5970.51 | BAEA256 |
| A 000 150 19 80 | BAEA140E | 22448-00QAA | BAE409A | 12 08 039 | BAEA174E | 5970.70 | BAEA232 |
| A 000 150 25 80 | BAEA077 | 22448-00QAC | BAEA354 | 12 08 048 | BAEA252 | 5970.75 | BAEA348 |
| A 000 150 27 80 | BAEA140E | 22448-00QAD | BAEA454 | 12 08 054 | BAEA253 | 5970.77 | BAEA347 |
| A 000 150 28 80 | BAEA041 | 22448-00QAE | BAE409A | 12 08 063 | BAEA026E | 5970.81 | BAEA046E |
| A 000 150 29 80 | BAEA053 | 22448-00QAF | BAE947A | 12 08 070 | BAEA253 | 5970.84 | BAEA351 |
| A 000 158 48 03 | BAEA296 | 22448-00QAF | BAE947A | 12 08 071 | BAEA344 | 5970.87 | BAEA352 |
| A 000 158 61 03 | BAEA296 | 22448-1KTOA | BAEA088E | 12 08 075 | BAEA306 | 5970.90 | BAEA048E |
| A 000 158 62 03 | BAEA339 | 22448-31U00 | BAEA073E | 12 08 081 | BAEA174E | 5970.94 | BAEA347 |
| A 000 158 64 03 | BAEA298 | 22448-31U01 | BAEA073E | 12 08 086 | BAEA199E | 5970.97 | BAEA048E |
| A 000 158 65 03 | BAEA299 | 22448-6N000 | BAEA081E | 12 08 092 | BAEA185E | 5970.98 | BAEA348 |
| A 000 158 68 03 | BAEA313 | 22448-6N002 | BAEA081E | 12 08 093 | BAEA185E | 5970.A0 | BAEA352 |
| A 000 158 71 03 | BAEA340 | 22448-6N010 | BAEA081E | 12 08 096 | BAEA185E | 5970.A5 | BAEA351 |
| A 000 158 73 03 | BAEA297 | 22448-6N011 | BAE409A | 12 08 098 | BAEA198E | 597078 | BAE946A |
| A 000 158 75 03 | BAEA340 | 22448-6N012 | BAEA081E | 12 08 123 | BAEA185E | 597079 | BAE946A |
| A 000 158 78 03 | BAEA297 | 22448-6N015 | BAEA081E | 12 08 209 | BAEA152E | 5970-79 | BAE946A |
| A 003 158 50 01 | BAEA004E | 22448-8H310 | BAEA080E | 12 08 210 | BAEA153E | 597083 | BAEA454 |
| A 272 150 02 80 | BAEA093E | 22448-8H311 | BAEA080E | 12 08 213 | BAEA150E | PIAGGIO | CHAMPION |
| A 272 906 00 60 | BAEA140E | 22448-8H314 | BAEA080E | 12 08 306 | BAEA358 | 57165300 | BAE800B |
| A 276 150 00 80 | BAEA093E | 22448-8H315 | BAEA080E | 12 08 307 | BAE965A | 639187 | BAE800B |
| A 276 906 01 60 | BAEA093E | 224488J100 | BAEA079E | 1208051 | BAEA025E | GU05716530 | BAE800B |
| A 276 906 02 59 | BAEA093E | 224488J110 | BAEA079E | 1208107 | BAEA095 | PONTIAC | CHAMPION |
| A 276 906 02 60 | BAEA093E | 224488J111 | BAEA079E | 1208307 | BAE965A | 1 104 091 | BAEA472 |
| A 276 906 35 00 | BAEA093E | 224488J115 | BAEA079E | 12583514 | BAEA174E | PORSCHE | CHAMPION |
| A 276 906 37 00 | BAEA093E | 22448-8J11C | BAEA079E | 12629037 | BAEA174E | 000 043 990 01 | BAEA052E |
| MINI | CHAMPION | 22448-AL615 | BAEA132E | 12768422 | BAEA115 | 901 602 102 01 | BAEA115 |
| 12 13 7 619 385 | BAEA538 | 22448-AL61C | BAEA132E | 24 420 584 | BAEA338 | 928 602 501 00 | BAEA115 |
| 1213 1 487 707 | BAEA382 | 22448AX001 | BAEA188E | 24 420 622 | BAEA359 | 946 602 104 00 | BAEA163E |
| 1213 7510 738 | BAEA382 | 22448-ED00 0 | BAEA088E | 4408 389 | BAE409A | 948 602 104 00 | BAEA012E |
| MITSUBISHI | CHAMPION | 22448-ED800 | BAEA056E | 4413 233 | BAE409A | 948 602 104 01 | BAEA012E |
| 04609103AB | BAEA380 | 22448-ED800EP | BAEA056E | 4701049 | BAEA189E | 948 602 104 02 | BAEA042E |
| 9311600 | BAEA395 | 22448ED80A | BAEA056E | 4709290 | BAEA189E | 948 602 104 03 | BAEA012E |
| M04609103 | BAEA380 | 22448-JA00 A | BAEA088E | 4711572 | BAEA189E | 948 602 104 04 | BAEA042E |
| M05269670 | BAEA380 | 22448-JA00 C | BAEA088E | 4805507 | BAEA447A | 948 602 104 05 | BAEA012E |
| MD 003 820 | BAEA110 | 22448-JA10A | BAEA158E | 55213613 | BAEA095 | 948 602 104 06 | BAEA012E |
| MD 003 821 | BAEA110 | 22448-JA10C | BAEA158E | 62 35 124 | BAEA149E | 948 602 104 07 | BAEA012E |
| MD 363552 | BAEA193E | OPEL | CHAMPION | 90 560 110 | BAEA147E | 948 602 104 08 | BAEA012E |
| MD 623072 | BAEA193E | 03474283 | BAEA253 | 90 564 334 | BAEA150E | 948 602 104 09 | BAEA012E |
| MD361710 | BAEA178E | 10 45 7075 | BAEA026E | 90510387 | BAEA252 | 948 602 104 10 | BAEA042E |
| MD362903 | BAEA178E | 11 03 872 | BAEA026E | 90536194 | BAEA342 | 948 602 104 11 | BAEA042E |
| MD362907 | BAEA179E | 11 03 905 | BAEA026E | 91 53 250 | BAEA149E | 948 602 104 12 | BAEA042E |
| MN195805 | BAEA547 | 12 08 002 | BAEA252 | 91 95 819 | BAEA150E | 948 602 104 13 | BAEA042E |
| | | 12 08 003 | BAEA253 | 91159996 | BAE409A | | |

OE ? ⇒

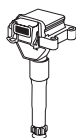

| | | | | | | | |
|----------------|----------|----------------------|----------|------------------------|----------|-----------------|----------|
| PORSCHE | | RENAULT | | SKODA | | STANDARD | |
| 948 602 104 20 | BAEA012E | 82 00 360 911 | BAEA325 | 032 905 106 B | BAE907AE | IIS287 | BAEA167E |
| 955 602 101 03 | BAEA044E | 82 00 702 693 | BAE947A | 032 905 106B | BAE907AE | IIS293 | BAEA168E |
| 955 602 101 05 | BAEA044E | 82 00 702 693 | BAEA325 | 032 905 715 | BAE408AE | IIS295 | BAEA474 |
| 958 602 101 00 | BAEA044E | 82 00 726 341 | BAEA066E | 032 905 715A | BAE408AE | IIS336 | BAEA172E |
| 958 602 102 00 | BAEA032E | 82 00 959 964 | BAEA066E | 032 905 715C | BAE408AE | IIS519 | BAEA476 |
| 958 905 110 00 | BAEA068E | 8200025256 | BAEA454 | 032 905 715E | BAE408AE | SUBARU | |
| 9A1 602 104 00 | BAEA052E | 8200084401 | BAE947A | 047905104 | BAE960AE | 22433-AA570 | BAEA191E |
| 9A1 602 104 01 | BAEA052E | 8200084401 | BAEA454 | 047905104A | BAE961AE | SUZUKI | |
| 9A1 602 104 02 | BAEA052E | 8200154186 | BAE409A | 06A 905 097 | BAEA029E | 33400-51K10 | BAEA189E |
| 9A1 602 104 03 | BAEA052E | 8200154186A | BAE409A | 06A 905 097 A | BAEA029E | 33400-65G00 | BAEA181E |
| 9A1 602 104 04 | BAEA052E | 8200208611 | BAE409A | 357 905 104 | BAE851AE | 33410-66D00 | BAEA136E |
| 9A1 602 104 05 | BAEA052E | 8200380267 | BAE409A | 6 NO 905 104 | BAE851AE | 33410-66D00-000 | BAEA136E |
| 9A1 602 104 06 | BAEA052E | 8200405098 | BAE409A | 6N0905104 | BAE851AE | 33410-66D01 | BAEA136E |
| PROTON | | 8200568671 | BAE409A | 867 905 104 | BAE851AE | 33410-66D01-000 | BAEA136E |
| 8200051128 | BAEA454 | 8200672564 | BAE409A | 867 905 104A | BAE851AE | 33410-66D10 | BAEA136E |
| RENAULT | | 8200699627 | BAEA161E | BAE960AE010 | BAE960AE | 33410-66D10-000 | BAEA136E |
| 22 43 324 28R | BAEA131E | 8200765882 | BAE409A | SMART | | 33410-77E20 | BAEA072E |
| 22 43 361 34R | BAEA354 | 9633001580 | BAEA347 | 000 3100 V003 | BAEA304 | 33410-77E21 | BAEA072E |
| 22433 7085R | BAEA066E | 9664401880 | BAEA347 | 000 3100 V004 | BAEA304 | 33410-77E22 | BAEA072E |
| 224333529R | BAE409A | ROVER | | 000 3100 V005 | BAEA304 | TOYOTA | |
| 22448-ED00 0 | BAEA088E | ERR6045 | BAEA234 | A 281 906 00 00 | BAEA131E | 19080-46020 | BAEA173E |
| 22448-JA00 A | BAEA088E | GCL 195 | BAEA275 | C 000 3100 V003 | BAEA304 | 19080-46030 | BAEA445 |
| 22448-JA00 C | BAEA088E | GCL 307 | BAEA302 | C 000 3100 V004 | BAEA304 | 90080-19015 | BAEA164E |
| 2526180A | BAE409A | GCL161 | BAEA276 | C 000 3100 V005 | BAEA304 | 90080-19016 | BAEA173E |
| 60 00 581 617 | BAEA234 | NEC000120 | BAEA501 | Q 000 3100 V005 000000 | BAEA304 | 90080-19017 | BAEA449 |
| 7401275174 | BAEA037E | NEC100530 | BAEA275 | STANDARD | | 90080-19017 | BAEA449 |
| 77 00 100 589 | BAEA242 | NEC100630 | BAEA469 | 12143 | BAEA093E | 90080-1901700 | BAEA449 |
| 77 00 100 643 | BAEA243 | NEC100730 | BAEA501 | 12469 | BAEA453 | 90080-19019 | BAEA164E |
| 77 00 274 008 | BAEA354 | NEC101000 | BAEA302 | 12473 | BAEA446 | 90080-19021 | BAEA165E |
| 77 00 669 324 | BAEA110 | NEC101000SLP | BAEA302 | 12742 | BAEA540 | 90919-02197 | BAEA445 |
| 77 00 749 450 | BAE504L | NEC101010 | BAEA302 | 12774 | BAEA165E | 90919-02207 | BAEA173E |
| 77 00 858 138 | BAE504L | SAAB | | 12774 | BAEA165E | 90919-02227 | BAEA165E |
| 77 00 863 020 | BAEA254 | 73 09 859 | BAEA115 | 12825 | BAEA171E | 90919-02229 | BAEA165E |
| 77 00 863 021 | BAEA255 | 83 00 584 | BAEA115 | 12855 | BAEA170E | 90919-02230 | BAEA172E |
| 77 00 865 923 | BAEA254 | 85 02 098 | BAEA115 | 12866 | BAEA164E | 90919-02234 | BAEA173E |
| 77 00 872 834 | BAEA345 | 85 06 636 | BAEA115 | 12868 | BAEA172E | 90919-02237 | BAEA186E |
| 77 01 031 135 | BAEA251 | SAIC HUIZHONG | | 12874 | BAEA482 | 90919-02238 | BAEA168E |
| 77 01 041 607 | BAEA245 | NEC90012A | BAEA501 | 12886 | BAEA486 | 90919-02239 | BAEA164E |
| 77 01 041 608 | BAEA246 | SCANIA | | CP0020 | BAEA165E | 90919-02240 | BAEA165E |
| 77 02 218 697 | BAE504L | 1789358 | BAEA297 | CU1043 | BAEA170E | 90919-02243 | BAEA171E |
| 7700107177 | BAE409A | SEAT | | CU1119 | BAEA469 | 90919-02244 | BAEA171E |
| 7700113357 | BAE409A | 032 905 106 B | BAE907AE | CU1178 | BAEA165E | 90919-02247 | BAEA167E |
| 7700113357A | BAE409A | 82 00 584 | BAEA115 | CU1317 | BAEA171E | 90919-02248 | BAEA167E |
| 7700749450 | BAE504L | 85 02 098 | BAEA115 | CU1331 | BAEA475 | 90919-02250 | BAEA192E |
| 7700749450-D | BAE504L | 85 06 636 | BAEA115 | CU1337 | BAEA169E | 90919-02252 | BAEA184E |
| 7700858138 | BAE504L | SKODA | | CU1517 | BAEA093E | 90919-02256 | BAEA192E |
| 7700875000 | BAE409A | 004 050 016 | BAE851AE | CU1531 | BAEA476 | 90919-02257 | BAEA192E |
| 7701479027 | BAEA347 | 032 905 100A | BAE408AE | IIS004 | BAEA164E | 90919-02258 | BAEA184E |
| 7702218697 | BAE504L | 032 905 100B | BAE408AE | IIS234 | BAEA171E | 90919-02260 | BAEA167E |
| 82 00 141 149 | BAEA345 | 032 905 100C | BAE408AE | IIS259 | BAEA482 | 90919-02262 | BAEA164E |
| 82 00 360 911 | BAE947A | 032 905 100D | BAE408AE | IIS276 | BAEA486 | 90919-02265 | BAEA165E |
| | | 032 905 106 | BAE907AE | IIS282 | BAEA169E | 90919-A2001 | BAEA167E |

OE ? ⇒

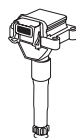

| TOYOTA | CHAMPION |
|----------------|----------|
| 90919-C2002 | BAEA167E |
| 90919-T2002 | BAEA164E |
| TRACK MARSHALL | CHAMPION |
| ME 72-14 | BAEA408 |
| VAG | CHAMPION |
| 021 905 106 | BAEA004E |
| 021 905 106 A | BAEA004E |
| 022 905 100 B | BAEA044E |
| 022 905 100 E | BAEA044E |
| 022 905 100 H | BAEA044E |
| 022 905 100 L | BAEA044E |
| 022 905 100 P | BAEA044E |
| 022 905 100 S | BAEA044E |
| 022 905 100 T | BAEA044E |
| 022 905 715 | BAEA044E |
| 022 905 715 A | BAEA041E |
| 022 905 715 B | BAEA044E |
| 034 905 101 | BAEA043 |
| 034 905 105 | BAEA043 |
| 03D 905 115 | BAEA059E |
| 03D 905 115 A | BAEA059E |
| 03D 905 115 B | BAEA059E |
| 03D 905 115 C | BAEA059E |
| 03D 905 115 D | BAEA059E |
| 03D 905 115 E | BAEA059E |
| 03D 905 115 F | BAEA059E |
| 03D 905 115 G | BAEA059E |
| 03D 905 715 A | BAEA059E |
| 04C 905 110 A | BAEA067E |
| 04C 905 110 B | BAEA067E |
| 04C 905 110 D | BAEA067E |
| 04C 905 110 F | BAEA067E |
| 04C 905 110 H | BAEA067E |
| 04C 905 110 J | BAEA067E |
| 04C 905 110 K | BAEA067E |
| 04E 905 110 | BAEA126E |
| 04E 905 110 A | BAEA126E |
| 04E 905 110 B | BAEA126E |
| 04E 905 110 C | BAEA126E |
| 04E 905 110 E | BAEA126E |
| 058 905 101 | BAEA016 |
| 058 905 101 A | BAEA162E |
| 058 905 105 | BAEA016 |
| 058 905 105 | BAEA017 |
| 066 905 100 | BAEA065E |
| 066 905 100 B | BAEA065E |
| 066 905 100 C | BAEA065E |
| 066 905 100 D | BAEA065E |
| 066 905 100 G | BAEA065E |
| 06B 905 115 | BAEA009E |
| 06B 905 115 B | BAEA009E |

| VAG | CHAMPION |
|---------------|----------|
| 06B 905 115 E | BAEA009E |
| 06D 905 115 | BAEA032E |
| 06D 905 115 A | BAEA032E |
| 06D 905 115 C | BAEA032E |
| 06D 905 115 D | BAEA032E |
| 06D 905 115 F | BAEA032E |
| 06D 905 115 G | BAEA032E |
| 06D 905 115 J | BAEA032E |
| 06D 905 115 K | BAEA032E |
| 06E 905 115 | BAEA032E |
| 06E 905 115 A | BAEA032E |
| 06E 905 115 B | BAEA032E |
| 06E 905 115 C | BAEA032E |
| 06E 905 115 D | BAEA032E |
| 06E 905 115 E | BAEA032E |
| 06F 905 115 | BAEA033E |
| 06F 905 115 A | BAEA033E |
| 06F 905 115 B | BAEA033E |
| 06F 905 115 C | BAEA033E |
| 06F 905 115 D | BAEA033E |
| 06F 905 115 E | BAEA033E |
| 06F 905 115 F | BAEA033E |
| 06J 905 110 B | BAEA068E |
| 06J 905 110 C | BAEA068E |
| 06J 905 110 D | BAEA068E |
| 06J 905 110 E | BAEA068E |
| 06J 905 110 F | BAEA068E |
| 06J 905 110 G | BAEA068E |
| 06J 905 110 K | BAEA068E |
| 06K 905 110 G | BAEA137E |
| 06K 905 110 J | BAEA068E |
| 06K 905 110 K | BAEA068E |
| 06L 905 110 B | BAEA068E |
| 06L 905 110 C | BAEA068E |
| 06L 905 110 D | BAEA068E |
| 06L 905 110 E | BAEA068E |
| 06L 905 110 F | BAEA068E |
| 077 905 104 | BAEA017 |
| 078 905 104 | BAEA154E |
| 078 905 104 A | BAEA154E |
| 07C 905 115 | BAEA031E |
| 07C 905 115 C | BAEA031E |
| 07C 905 115 D | BAEA031E |
| 07C 905 115 E | BAEA031E |
| 07C 905 115 F | BAEA031E |
| 07C 905 115 H | BAEA031E |
| 07C 905 115 J | BAEA031E |
| 07C 905 715 | BAEA031E |
| 07C 905 715 A | BAEA031E |
| 07K 905 715 | BAEA033E |
| 07K 905 715 A | BAEA033E |
| 07K 905 715 B | BAEA033E |
| 07K 905 715 C | BAEA033E |

| VAG | CHAMPION |
|---------------|----------|
| 07K 905 715 D | BAEA033E |
| 07K 905 715 E | BAEA033E |
| 07K 905 715 F | BAEA033E |
| 171 905 115 | BAEA115 |
| 310 880 01 | BAEA004E |
| 6N0 905 104 | BAEA002E |
| 867 905 105 A | BAEA002E |
| VAUXHALL | CHAMPION |
| 55213613 | BAEA095 |
| 90458250 | BAEA344 |
| 9118115 | BAEA153E |
| VOLVO | CHAMPION |
| 1 275 602 | BAEA429 |
| 1207458 | BAEA115 |
| 1275174 | BAEA037E |
| 1275971 | BAEA446 |
| 241086 | BAEA115 |
| 30713416 | BAEA019E |
| 30713417 | BAEA055E |
| 30731416 | BAEA387 |
| 30731419 | BAEA387 |
| 30735759 | BAEA350 |
| 31216444 | BAEA350 |
| 31216444 | BAEA387 |
| 31359976 | BAEA350 |
| 3287677 | BAEA251 |
| 3287677-3 | BAEA251 |
| 70863020 | BAEA254 |
| 70863020-7 | BAEA245 |
| 70863021 | BAEA255 |
| 70863021-5 | BAEA246 |
| 826490 | BAEA115 |
| 841931 | BAEA115 |
| 8677837 | BAEA055E |
| 870909 | BAEA115 |
| 870943 | BAEA115 |
| 9125601 | BAEA019E |
| VW | CHAMPION |
| 021 905 106 B | BAEA013E |
| 021 905 106 C | BAEA013E |
| 022 905 100 A | BAEA063E |
| 022 905 100 D | BAEA063E |
| 022 905 100 G | BAEA063E |
| 022 905 100 K | BAEA063E |
| 022 905 100 N | BAEA063E |
| 022 905 715 C | BAEA063E |
| 032 905 106 B | BAE907AE |
| 032 905 106 D | BAE907AE |
| 032 905 106 E | BAE907AE |
| 032 905 106D | BAE907AE |
| 032905106B | BAE907AE |

| VW | CHAMPION |
|---------------|----------|
| 032905106D | BAE907AE |
| 036 905 100 A | BAE408AE |
| 036 905 100 B | BAE408AE |
| 036 905 100 C | BAE408AE |
| 036 905 100 D | BAE408AE |
| 036 905 715 | BAE408AE |
| 036 905 715 A | BAE408AE |
| 036 905 715 C | BAE408AE |
| 036 905 715 E | BAE408AE |
| 036 905 715 F | BAE408AE |
| 036 905 715 G | BAE408AE |
| 036905100A | BAE408AE |
| 036905100B | BAE408AE |
| 036905100C | BAE408AE |
| 036905100D | BAE408AE |
| 036905715 | BAE408AE |
| 036905715A | BAE408AE |
| 036905715C | BAE408AE |
| 036905715E | BAE408AE |
| 036905715F | BAE408AE |
| 047 905 104 | BAE960AE |
| 047 905 104 A | BAE961AE |
| 047 905 104 B | BAE961AE |
| 0489051051 | BAEA234 |
| 059 905 105 | BAEA115 |
| 059 905 105 B | BAEA115 |
| 06A 905 097 | BAEA029E |
| 06A 905 097 A | BAEA029E |
| 06A 905 104 | BAEA029E |
| 06A 905 115 | BAEA043E |
| 06A 905 115 A | BAEA043E |
| 06A 905 115 B | BAEA043E |
| 06A 905 115 C | BAEA043E |
| 06A 905 115 D | BAEA043E |
| 06B 905 115 D | BAEA043E |
| 06B 905 115 G | BAEA043E |
| 06B 905 115 H | BAEA043E |
| 06B 905 115 J | BAEA043E |
| 06B 905 115 L | BAEA043E |
| 06B 905 115 M | BAEA043E |
| 06B 905 115 N | BAEA043E |
| 06B 905 115 P | BAEA043E |
| 06B 905 115 Q | BAEA043E |
| 06B 905 115 R | BAEA043E |
| 06B 905 115 S | BAEA043E |
| 06C 905 115 A | BAEA051E |
| 06C 905 115 B | BAEA051E |
| 06C 905 115 C | BAEA043E |
| 06C 905 115 D | BAEA051E |
| 06C 905 115 E | BAEA051E |
| 06C 905 115 F | BAEA051E |
| 06C 905 115 G | BAEA051E |
| 06C 905 115 H | BAEA051E |



OE ? ⇔



| VW |  |
|----------------|---|
| 06C 905 115 K | BAEA051E |
| 06C 905 115 L | BAEA051E |
| 06C 905 115 M | BAEA051E |
| 06H 905 110 D | BAEA137E |
| 06H 905 110 E | BAEA137E |
| 06H 905 110F | BAEA137E |
| 071 905 106 | BAEA037 |
| 077 905 115 AA | BAEA062E |
| 077 905 115 B | BAEA061E |
| 077 905 115 C | BAEA061E |
| 077 905 115 E | BAEA061E |
| 077 905 115 F | BAEA061E |
| 077 905 115 G | BAEA062E |
| 077 905 115 H | BAEA061E |
| 077 905 115 J | BAEA062E |
| 077 905 115 K | BAEA061E |
| 077 905 115 M | BAEA062E |
| 077 905 115 P | BAEA061E |
| 077 905 115 Q | BAEA061E |
| 077 905 115 R | BAEA062E |
| 077 905 115 S | BAEA062E |
| 077 905 115 T | BAEA061E |
| 171 905 115 A | BAEA115 |
| 6N0905104 | BAE851AE |
| 6N0 905 104 | BAE851AE |
| 701 905 104 | BAEA002E |
| 701 905 104 A | BAEA002E |
| 867 905 104 A | BAE851AE |
| 867905104 A | BAE851AE |













| | |
|-------------------------|--------|
| BMW | |
| 12 21 7 786 821 | CCU101 |
| 12 21 7 788 327 | CCU102 |
| 12 21 7 798 000 | CCU105 |
| 12 21 7 800 156 | CCU108 |
| 12 21 7 801 200 | CCU101 |
| 12 21 7 801 201 | CCU102 |
| 12 21 7 810 856 | CCU106 |
| 12 21 8 519 471 | CCU106 |
| 12 21 8 570 087 | CCU106 |
| 12 21 8 591 723 | CCU105 |
| 12 21 8 591 724 | CCU108 |
| 7 786 821 | CCU101 |
| 7 788 327 | CCU102 |
| 7 801 200 | CCU101 |
| 7 801 201 | CCU102 |
| CHRYSLER | |
| 05175759AA | CCU114 |
| 05175759AB | CCU114 |
| 68013182AA | CCU114 |
| 68013182AB | CCU114 |
| 68013182AC | CCU114 |
| 68013182AD | CCU114 |
| CITROEN/ PEUGEOT | |
| 5981 16 | CCU148 |
| 5981 20 | CCU148 |
| 5981 31 | CCU149 |
| 5981 38 | CCU149 |
| 5981 40 | CCU147 |
| 9640469680 | CCU147 |
| FIAT | |
| 2374720 | CCU150 |
| 46414088 | CCU153 |
| 46432278 | CCU153 |
| 46438456 | CCU153 |
| 46772573 | CCU153 |
| 51233720 | CCU150 |
| 51888255 | CCU150 |
| 55199051 | CCU150 |
| 60812527 | CCU153 |
| 7735921 | CCU153 |
| 9615959448 | CCU153 |
| 9639912580 | CCU149 |
| FORD | |
| 1252609 | CCU147 |
| 3M5T-12A343-AA | CCU147 |
| GENERAL MOTORS | |
| 55563423 | CCU138 |
| 55574293 | CCU138 |
| 91167210 | CCU154 |
| 9201699 | CCU154 |





| | |
|-----------------------|--------|
| GENERAL MOTORS | |
| 992121 | CCU154 |
| LANCIA | |
| 46438456 | CCU153 |
| MERCEDES-BENZ | |
| 000 545 35 16 | CCU140 |
| 000 545 36 16 | CCU141 |
| 019 545 69 32 | CCU141 |
| 025 545 28 32 | CCU140 |
| 025 545 29 32 | CCU141 |
| 028 545 40 32 | CCU141 |
| 032 545 05 32 | CCU104 |
| 034 545 64 32 | CCU104 |
| 629 153 06 79 | CCU118 |
| 640 153 04 79 | CCU156 |
| 640 153 27 79 | CCU156 |
| 646 153 25 79 | CCU110 |
| 646 153 65 79 | CCU140 |
| 648 153 02 79 | CCU113 |
| 648 900 00 00 | CCU141 |
| A 000 545 35 16 | CCU140 |
| A 000 545 36 16 | CCU141 |
| A 019 545 69 32 | CCU141 |
| A 025 545 28 32 | CCU140 |
| A 025 545 29 32 | CCU141 |
| A 028 545 40 32 | CCU141 |
| A 032 545 05 32 | CCU104 |
| A 034 545 64 32 | CCU104 |
| A 629 153 06 79 | CCU118 |
| A 640 153 04 79 | CCU156 |
| A 640 153 27 79 | CCU156 |
| A 642 153 03 79 | CCU114 |
| A 642 153 19 79 | CCU114 |
| A 642 153 20 79 | CCU114 |
| A 642 153 37 79 | CCU116 |
| A 642 900 27 00 | CCU116 |
| A 642 900 28 00 | CCU114 |
| A 642 900 57 01 | CCU116 |
| A 642 900 58 01 | CCU114 |
| A 642 900 77 01 | CCU116 |
| A 642 900 78 01 | CCU114 |
| A 646 153 25 79 | CCU110 |
| A 646 153 65 79 | CCU140 |
| A 648 153 02 79 | CCU113 |
| A 648 900 00 00 | CCU141 |
| NISSAN | |
| 11067BN700 | CCU154 |
| OPEL | |
| 12 32 077 | CCU145 |
| 12 32 331 | CCU138 |
| 12 37 783 | CCU138 |







| | |
|----------------|--------|
| OPEL | |
| 1232076 | CCU144 |
| 44 09 990 | CCU154 |
| 45 06 156 | CCU154 |
| 55353011 | CCU142 |
| 55354141 | CCU143 |
| 55557760 | CCU144 |
| 55557761 | CCU145 |
| 6235240 | CCU142 |
| 6235303 | CCU143 |
| RENAULT | |
| 77 00 100 703 | CCU129 |
| 77 00 109 860 | CCU128 |
| 77 00 111 525 | CCU129 |
| 7700115078 | CCU154 |
| 9611751080 | CCU148 |
| VAG | |
| 038 907 281 B | CCU151 |
| 038 907 281 D | CCU152 |
| 04L 907 281 | CCU152 |
| 04L 907 282 | CCU151 |
| 357911253 | CCU081 |
| VOLVO | |
| 8692616 | CCU147 |

OE ? ⇌

| | |
|-------------------|---|
| ALFA ROMEO |  |
| 4646919 | CLS055 |
| 4646920 | CLS055 |
| 46755606 | CLS055 |
| BMW |  |
| 12 12 1 247 361 | CLS037 |
| 12 12 1 247 512 | CLS036 |
| 12 12 1 247 513 | CLS036 |
| 12 12 1 310 008 | CLS191 |
| 12 12 1 311 735 | CLS191 |
| 12 12 1 311 803 | CLS191 |
| 12 12 1 316 688 | CLS191 |
| 12 12 1 717 646 | CLS104 |
| 12 12 1 720 530 | CLS186 |
| 12 12 1 726 037 | CLS186 |
| 12 12 1 727 686 | CLS104 |
| CHEVROLET |  |
| 25 183 557 | CLS144 |
| 25 183 763 | CLS144 |
| 25 183 764 | CLS144 |
| 25 183 765 | CLS144 |
| 25 183 766 | CLS144 |
| 96 288 956 | CLS085 |
| 96 450 249 | CLS196 |
| 96 497 773 | CLS086 |
| CHRYSLER |  |
| 5013601 AB | CLS241 |
| 5018394 AA | CLS241 |
| 5018394 AC | CLS241 |
| 5018394 AD | CLS241 |
| 5018394 AG | CLS241 |
| 5019593 AA | CLS193 |
| DACIA |  |
| 82 00 506 297 | CLS076 |
| 82 00 943 801 | CLS088 |
| DAEWOO |  |
| 96 190 263 | CLS107 |
| 96 211 948 | CLS020 |
| 96 256 433 | CLS013 |
| 9A 418 150 B | CLS025 |
| DAIHATSU |  |
| 19901-87186-000 | CLS228 |
| 90048-58273-000 | CLS163 |
| 90048-58274-000 | CLS163 |
| FIAT |  |
| 1462110080 | CLS123 |
| 46413088 | CLS137 |
| 46425912 | CLS035 |
| 46474814 | CLS044 |

| | |
|-------------|---|
| FIAT |  |
| 46743086 | CLS044 |
| 46749624 | CLS067 |
| 55195775 | CLS082 |
| 55195776 | CLS082 |
| 60564150 | CLS235 |
| 60564151 | CLS235 |
| 60567866 | CLS235 |
| 60573733 | CLS235 |
| 60584943 | CLS235 |
| 71742423 | CLS167 |
| 7552294 | CLS118 |
| 7604907 | CLS118 |
| 7604977 | CLS006 |
| 7694366 | CLS003 |
| 7716092 | CLS002 |
| 7716094 | CLS004 |
| 7730698 | CLS008 |
| 7735397 | CLS135 |
| 7760523 | CLS136 |
| 7775810 | CLS009 |
| 7776810 | CLS261 |
| 9617237080 | CLS005 |
| FORD |  |
| 1004427 | CLS032 |
| 1004430 | CLS032 |
| 1004431 | CLS032 |
| 1004432 | CLS032 |
| 1012436 | CLS111 |
| 1063615 | CLS111 |
| 1063621 | CLS122 |
| 1071985 | CLS015 |
| 1071986 | CLS015 |
| 1071987 | CLS015 |
| 1071988 | CLS015 |
| 1110740 | CLS077 |
| 1110741 | CLS077 |
| 1110742 | CLS077 |
| 1110743 | CLS077 |
| 1111216 | CLS243 |
| 1111218 | CLS243 |
| 1111219 | CLS243 |
| 1111223 | CLS243 |
| 1119840 | CLS074 |
| 1119841 | CLS074 |
| 1119842 | CLS074 |
| 1119843 | CLS074 |
| 1214216 | CLS092 |
| 1319060 | CLS091 |
| 1319061 | CLS091 |
| 1319062 | CLS091 |
| 1319063 | CLS091 |
| 1335369 | CLS077 |

| | |
|-----------------------|---|
| FORD |  |
| 1335371 | CLS077 |
| 1335374 | CLS077 |
| 1335377 | CLS077 |
| 1502365 | CLS089 |
| 1502366 | CLS089 |
| 1502367 | CLS089 |
| 1502368 | CLS089 |
| 157E-12280-BC | CLS156 |
| 157E-12280-BE | CLS156 |
| 157E-12281-BC | CLS156 |
| 157E-12281-BE | CLS156 |
| 4138501 | CLS156 |
| 4138502 | CLS156 |
| 4155357 | CLS156 |
| 4335003 | CLS156 |
| 4454954 | CLS156 |
| 6592244 | CLS122 |
| 6592245 | CLS122 |
| 6592246 | CLS122 |
| 6592247 | CLS122 |
| 7053862 | CLS022 |
| 7053866 | CLS022 |
| 7262796 | CLS022 |
| 7262798 | CLS022 |
| 96MF-12283-BA | CLS032 |
| 96MF-12284-BA | CLS032 |
| 96MF-12286-BA | CLS032 |
| 96MF-12287-BA | CLS032 |
| YS6F-12283-A1A | CLS077 |
| YS6F-12283-B1A | CLS089 |
| YS6F-12284-A1A | CLS077 |
| YS6F-12284-B1A | CLS089 |
| YS6F-12286-A1A | CLS077 |
| YS6F-12286-B1A | CLS089 |
| YS6F-12287-A1A | CLS077 |
| YS6F-12287-B1A | CLS089 |
| GENERAL MOTORS |  |
| 96305387 | CLS025 |
| HONDA |  |
| 32700-P1J-E01 | CLS012 |
| 32722-P03-000 | CLS129 |
| 32722-P07-000 | CLS129 |
| 32722-P1K-E01 | CLS128 |
| 32722-P2A-003 | CLS129 |
| 32722-P2A-J00 | CLS129 |
| 32722-PM1-B01 | CLS128 |
| 32722-PM6-B00 | CLS128 |
| HYUNDAI |  |
| 27501-02A00 | CLS021 |
| 27501-02D00 | CLS023 |
| 27501-02H00 | CLS073 |

| | |
|-------------------|---|
| HYUNDAI |  |
| 27501-22B00 | CLS023 |
| 27501-22B10 | CLS072 |
| 27501-23A00 | CLS130 |
| 27501-23B70 | CLS094 |
| 27501-26A00 | CLS024 |
| 27501-26C00 | CLS024 |
| 27501-26D00 | CLS024 |
| 27501-37A00 | CLS189 |
| 27501-37B00 | CLS189 |
| KIA |  |
| OK2011 8140 | CLS131 |
| OK2011 8150A | CLS131 |
| OK2471 8160A | CLS173 |
| OK2471 8160B | CLS173 |
| OK2471 8180A | CLS173 |
| OK2471 8180B | CLS173 |
| OK2A31 8160A | CLS157 |
| OK2A31 8180A | CLS157 |
| OK30E1 8140 | CLS256 |
| 27420-02670 | CLS197 |
| 27420-23700 | CLS130 |
| 27430-23700 | CLS130 |
| 27440-23700 | CLS130 |
| 27450-23700 | CLS130 |
| 27501-02W00 | CLS093 |
| LADA |  |
| 2121 437 17080 | CLS147 |
| LANCIA |  |
| 46425912 | CLS035 |
| 7742005 | CLS112 |
| LAND ROVER |  |
| NGC500370 | CLS155 |
| NGC500380 | CLS155 |
| NGC500390 | CLS155 |
| NGC500400 | CLS155 |
| NGC500410 | CLS155 |
| MAZDA |  |
| 1E05-18-160 B | CLS075 |
| 1E05-18-170 B | CLS075 |
| 1E05-18-180 B | CLS075 |
| 1E05-18-190 B | CLS075 |
| 83M5-18-140 | CLS131 |
| B31R-18-140 | CLS168 |
| B6MC-18-160 B | CLS056 |
| B6MC-18-170 B | CLS056 |
| B6MC-18-180 B | CLS056 |
| B6MC-18-190 B | CLS056 |
| BP6D-18-140 A | CLS159 |
| BP6E-18-140 A | CLS159 |
| BPE8-18-140 A | CLS056 |





| MAZDA | |
|----------------------|---------------|
| FP85-18-140 A | CLS198 |
| FP86-18-140 A | CLS198 |
| FSD7-18-140 B | CLS239 |
| Z501-18-140 A | CLS031 |
| ZL01-18-140 A | CLS257 |
| ZX18-18-140 | CLS131 |
| ZX19-18-140 | CLS131 |
| ZX29-18-140 | CLS229 |
| MERCEDES-BENZ | |
| 102 150 19 18 | CLS098 |
| 102 150 20 18 | CLS098 |
| 102 150 21 18 | CLS098 |
| 102 150 28 18 | CLS098 |
| 102 150 29 18 | CLS098 |
| 110 150 40 18 | CLS207 |
| 110 150 63 18 | CLS208 |
| 110 150 69 18 | CLS208 |
| 110 150 70 18 | CLS208 |
| 110 150 71 18 | CLS208 |
| 110 150 72 18 | CLS208 |
| 110 150 73 18 | CLS208 |
| 110 150 74 18 | CLS208 |
| 112 150 01 18 | CLS064 |
| 112 150 02 18 | CLS064 |
| 112 150 03 18 | CLS242 |
| 112 150 04 18 | CLS242 |
| 114 150 00 18 | CLS200 |
| 116 150 00 18 | CLS201 |
| 116 150 01 18 | CLS206 |
| 116 150 12 19 | CLS203 |
| 116 150 13 19 | CLS203 |
| 116 150 46 18 | CLS201 |
| 266 150 01 18 | CLS078 |
| 266 150 02 18 | CLS078 |
| 266 150 06 18 | CLS078 |
| 266 150 07 18 | CLS078 |
| A 102 150 19 18 | CLS098 |
| A 102 150 20 18 | CLS098 |
| A 102 150 21 18 | CLS098 |
| A 102 150 28 18 | CLS098 |
| A 102 150 29 18 | CLS098 |
| A 110 150 40 18 | CLS207 |
| A 110 150 63 18 | CLS208 |
| A 110 150 69 18 | CLS208 |
| A 110 150 70 18 | CLS208 |
| A 110 150 71 18 | CLS208 |
| A 110 150 72 18 | CLS208 |
| A 110 150 73 18 | CLS208 |
| A 110 150 74 18 | CLS208 |
| A 112 150 01 18 | CLS064 |
| A 112 150 02 18 | CLS064 |
| A 112 150 03 18 | CLS242 |

| MERCEDES-BENZ | |
|----------------------|---------------|
| A 112 150 04 18 | CLS242 |
| A 114 150 00 18 | CLS200 |
| A 116 150 00 18 | CLS201 |
| A 116 150 01 18 | CLS206 |
| A 116 150 12 19 | CLS203 |
| A 116 150 13 19 | CLS203 |
| A 116 150 46 18 | CLS201 |
| A 266 150 01 18 | CLS078 |
| A 266 150 02 18 | CLS078 |
| A 266 150 06 18 | CLS078 |
| A 266 150 07 18 | CLS078 |
| MINI | |
| 12 12 7 513 032 | CLS069 |
| 12 12 7 513 033 | CLS069 |
| 12 12 7 513 034 | CLS069 |
| 12 12 7 513 035 | CLS069 |
| MITSUBISHI | |
| MD332343 | CLS169 |
| MD365102 | CLS010 |
| NISSAN | |
| 22440-1C710 | CLS153 |
| 22440-2J210 | CLS132 |
| 22440-86J10 | CLS059 |
| 22440-99B05 | CLS133 |
| OPEL | |
| 12 82 153 | CLS030 |
| 12 82 154 | CLS030 |
| 12 82 155 | CLS030 |
| 12 82 156 | CLS030 |
| 12 82 163 | CLS176 |
| 12 82 164 | CLS176 |
| 12 82 165 | CLS176 |
| 12 82 166 | CLS176 |
| 16 12 400 | CLS166 |
| 16 12 429 | CLS166 |
| 16 12 430 | CLS218 |
| 16 12 434 | CLS101 |
| 16 12 436 | CLS166 |
| 16 12 447 | CLS214 |
| 16 12 458 | CLS211 |
| 16 12 459 | CLS212 |
| 16 12 476 | CLS218 |
| 16 12 477 | CLS213 |
| 16 12 479 | CLS213 |
| 16 12 509 | CLS018 |
| 16 12 523 | CLS103 |
| 16 12 527 | CLS103 |
| 16 12 533 | CLS018 |
| 16 12 536 | CLS102 |
| 16 12 537 | CLS102 |

| OPEL | |
|----------------|---------------|
| 16 12 541 | CLS018 |
| 16 12 542 | CLS103 |
| 16 12 545 | CLS103 |
| 16 12 551 | CLS220 |
| 16 12 556 | CLS018 |
| 16 12 561 | CLS029 |
| 16 12 598 | CLS107 |
| 16 12 603 | CLS175 |
| 16 12 606 | CLS115 |
| 16 12 607 | CLS141 |
| 16 12 608 | CLS114 |
| 16 12 609 | CLS113 |
| 16 12 619 | CLS175 |
| 16 12 639 | CLS115 |
| 90 008 241 | CLS212 |
| 90 491 944 | CLS175 |
| PEUGEOT | |
| 5967 K9 | CLS226 |
| 5967 L0 | CLS123 |
| 5967 L3 | CLS005 |
| 5967 L6 | CLS005 |
| 5967 L7 | CLS123 |
| 5967 L8 | CLS005 |
| 5967 N1 | CLS005 |
| 5967.L5 | CLS262 |
| 5967.L9 | CLS262 |
| 5967.N6 | CLS262 |
| 9608885180 | CLS005 |
| 9609493380 | CLS123 |
| PORSCHE | |
| 901 609 061 00 | CLS246 |
| 901 609 100 00 | CLS246 |
| 928 602 040 00 | CLS215 |
| 928 602 055 00 | CLS215 |
| 928 602 056 00 | CLS215 |
| 993 602 060 01 | CLS251 |
| 993 602 060 02 | CLS251 |
| 993 602 060 03 | CLS251 |
| 993 602 060 04 | CLS251 |
| 993 602 060 05 | CLS251 |
| 993 602 060 06 | CLS251 |
| 993 602 060 11 | CLS251 |
| 993 602 060 12 | CLS251 |
| 993 602 060 13 | CLS251 |
| 993 602 060 14 | CLS251 |
| 993 602 060 15 | CLS251 |
| 993 602 060 16 | CLS251 |
| RENAULT | |
| 74 31 275 284 | CLS051 |
| 74 31 335 874 | CLS050 |
| 74 39 135 700 | CLS050 |

| RENAULT | |
|------------------------|---------------|
| 77 00 106 221 | CLS039 |
| 77 00 107 662 | CLS040 |
| 77 00 114 549 | CLS083 |
| 77 00 273 226 | CLS011 |
| 77 00 273 826 | CLS019 |
| 77 00 742 835 | CLS117 |
| 77 00 749 521 | CLS126 |
| 77 00 866 923 | CLS014 |
| 77 00 874 109 | CLS040 |
| 77 00 874 564 | CLS052 |
| 77 01 025 483 | CLS149 |
| 77 01 349 467 | CLS149 |
| 82 00 334 440 | CLS194 |
| 82 00 486 877 | CLS084 |
| 82 00 506 297 | CLS076 |
| 82 00 713 680 | CLS084 |
| 82 00 805 133 | CLS083 |
| ROVER | |
| GHT 252 | CLS161 |
| GHT 261 | CLS161 |
| GHT 263 | CLS148 |
| GHT 284 | CLS061 |
| GHT 291 | CLS045 |
| NGC 000 090 | CLS095 |
| NGC 000 094 | CLS061 |
| NGC104170L | CLS045 |
| SAAB | |
| 9146895 | CLS150 |
| 9146903 | CLS150 |
| 9146911 | CLS150 |
| 9146929 | CLS150 |
| 9321910 | CLS150 |
| 9337346 | CLS182 |
| SMART | |
| Q 000 2576 V002 000000 | CLS068 |
| SUBARU | |
| 22451-AA630 | CLS170 |
| 22451-AA640 | CLS170 |
| 22451-AA720 | CLS080 |
| 22451-AA730 | CLS080 |
| 22451-AA800 | CLS080 |
| 22451-AA810 | CLS080 |
| SUZUKI | |
| 33700-82011 | CLS258 |
| 33705-57B21 | CLS230 |
| 33705-66D00 | CLS026 |
| 33705-80G00 | CLS167 |
| 33705-83020 | CLS134 |
| 33705-86G00 | CLS167 |
| 33730-86G00 | CLS167 |

OE ? ⇌

SUZUKI

33740-86G00 **CLS167**

TOYOTA

6307 **CLS058**

90919-22319 **CLS259**

90919-22325 **CLS231**

90919-22370 **CLS233**

90919-22373 **CLS234**

90919-22386 **CLS171**

90919-22395 **CLS096**

90919-22400 **CLS171**

90998-99002 **CLS058**

VAG

021 905 409 **CLS199**

021 905 409 B **CLS199**

056 998 031 A **CLS097**

059 998 031 **CLS099**

06A 905 405 N **CLS070**

06A 905 409 M **CLS048**

06A 905 409 P **CLS048**

06B 905 431 A **CLS048**

06B 905 433 A **CLS048**

06B 905 435 A **CLS048**

06B 905 437 A **CLS048**

071 998 031 **CLS249**

078 905 113 **CLS046**

078 905 401 **CLS001**

111 998 031 **CLS245**

111 998 031 A **CLS245**

171 998 031 B **CLS097**

321 998 031 **CLS097**

321 998 031 A **CLS097**

477 998 031 **CLS248**

803 998 031 **CLS099**

N 101 902 02 **CLS172**

N 101 902 03 **CLS172**

N 101 902 04 **CLS172**

N 101 902 05 **CLS172**

N 101 903 02 **CLS172**

VOLVO

127528-4 **CLS051**

127560-3 **CLS195**

1306696-4 **CLS179**

1335874-2 **CLS050**

270800-6 **CLS179**

270898-0 **CLS179**

271483-0 **CLS236**

272193-4 **CLS179**

3073142-4 **CLS077**

3531277-6 **CLS236**

9135546-1 **CLS050**

9135700-4 **CLS050**

VOLVO

9146403-2 **CLS050**

9445258-8 **CLS050**

VW

021 905 409 AA **CLS237**

021 905 409 G **CLS237**

021 905 409 K **CLS237**

021 905 409 M **CLS237**

030 905 430 E **CLS041**

030 905 430 F **CLS041**

030 905 430 G **CLS041**

030 905 430 H **CLS041**

030 905 430 N **CLS053**

030 905 430 P **CLS053**

030 905 430 Q **CLS053**

030 905 430 R **CLS053**

032 905 409 B **CLS081**

032 905 430 K **CLS081**

032 905 430 L **CLS081**

032 905 430 M **CLS081**

032 905 430 N **CLS081**

036 905 409 K **CLS260**

036 905 483 G **CLS260**

037 905 409 B **CLS174**

037 905 409 D **CLS238**

037 905 483 C **CLS034**

03F 905 409 B **CLS090**

03F 905 409 C **CLS090**

03F 905 430 **CLS090**

03F 905 430 D **CLS090**

03F 905 430 E **CLS090**

03F 905 430 F **CLS090**

03F 905 430 G **CLS090**

03F 905 430 H **CLS090**

03F 905 430 J **CLS090**

03F 905 430 K **CLS090**

03F 905 430 L **CLS090**

06A 905 409 A **CLS139**

06A 905 409 D **CLS177**

06A 905 409 E **CLS139**

06A 905 409 F **CLS017**

06A 905 409 G **CLS140**

06A 905 409 L **CLS017**

06F 905 430 D **CLS090**

06F 905 430 E **CLS090**

06F 905 430 F **CLS090**

06F 905 430 G **CLS090**

071 905 409 C **CLS181**

071 905 409 G **CLS181**

071 905 409 J **CLS181**

078 905 531 A **CLS001**

078 905 532 A **CLS001**

078 905 533 A **CLS001**

VW

078 905 534 A **CLS001**

078 905 535 A **CLS001**

078 905 536 A **CLS001**

437 998 031 B **CLS105**

N 100 502 05 **CLS079**

N 100 529 04 **CLS109**

N 100 529 06 **CLS174**









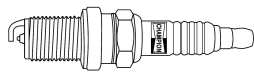













N 100 529 07 **CLS079**

N 102 044 02 **CLS047**









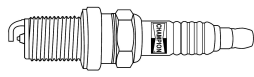















N 102 436 11 **CLS047**

N 104 529 11 **CLS178**









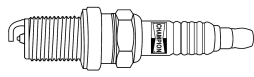

















| | | | | | |
|--|--|--|--|--|--|
| CCH306C  | CCH425 <p>No Image</p> | CET1  | CET2  | CET3  | CET4  |
| CET5  | CET6  | CET7  | CET8  | CET9  | CET10P  |
| CET11P  | CET12P  | CET13P  | CET14P  | CET15P  | CET16P  |
| CET17P  | CET18P  | CJ6  | CJ7Y  | CJ8  | D16  |









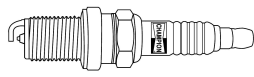

















| | | | | | |
|---|---|---|---|---|---|
| DJ8J  | J8C  | J17LM  | J19LM  | L77JC4  | L78C  |
| L82C  | OE001  | OE002  | OE003  | OE004  | OE005  |
| OE006  | OE007  | OE008  | OE009  | OE010  | OE011  |
| OE012  | OE013  | OE014  | OE015  | OE016  | OE018  |









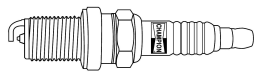

















| | | | | | |
|---|---|---|---|---|---|
| OE019  | OE025  | OE026  | OE027  | OE029  | OE030  |
| OE031  | OE032  | OE033  | OE034  | OE035  | OE037  |
| OE038  | OE039  | OE041  | OE042  | OE044  | OE048  |
| OE049  | OE051  | OE052  | OE054  | OE057  | OE059  |









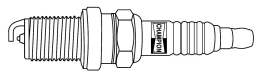

















| | | | | | |
|---|---|---|---|---|---|
| OE063  | OE064  | OE065  | OE068  | OE073  | OE074  |
| OE077  | OE078  | OE079  | OE083  | OE086  | OE087  |
| OE089  | OE091  | OE093  | OE094  | OE098  | OE099  |
| OE105  | OE108  | OE112  | OE114  | OE120  | OE122  |









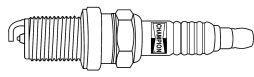

















| | | | | | |
|---|---|---|---|---|---|
| OE123  | OE128  | OE130  | OE131  | OE136  | OE138  |
| OE145  | OE146  | OE148  | OE154  | OE175  | OE176  |
| OE177  | OE178  | OE179  | OE180  | OE181  | OE182  |
| OE183  | OE184  | OE186  | OE187  | OE188  | OE189  |









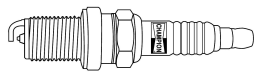







| | | | | | |
|---|---|---|---|---|---|
| OE190  | OE191  | OE192  | OE193  | OE194  | OE195  |
| OE196  | OE197  | OE198  | OE199  | OE201  | OE203  |
| OE204  | OE205  | OE206  | OE207  | OE208  | OE209  |
| OE210  | OE211  | OE212  | OE213  | OE214  | OE215  |









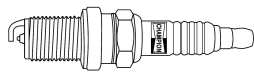













| | | | | | |
|---|---|---|---|---|---|
| OE216  | OE217  | OE218  | OE219  | OE220  | OE222  |
| OE223  | OE224  | OE225  | OE226  | OE227  | OE228  |
| OE229  | OE230  | OE231  | OE232  | OE233  | OE234  |
| OE235  | OE236  | OE237  | OE238  | OE239  | OE240  |









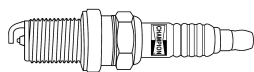



| | | | | | |
|---|---|--|---|--|--|
| OE241  | OE242  | OE243  | OE244  | OE245  | OE246  |
| OE247 <p>No Image</p> | OE248  | OE249  | OE250  | OE253  | OE254 <p>No Image</p> |
| OE255  | OE256  | OE257 <p>No Image</p> | OE258 <p>No Image</p> | OE260 <p>No Image</p> | OE261 <p>No Image</p> |
| OE262 <p>No Image</p> | OE263 <p>No Image</p> | OE264 <p>No Image</p> | P-RA7HC  | P-RG4HCC  | P-RG6HCC  |



| | | | | | |
|---|---|---|---|---|--|
| P-RG7C  | P-RZ7HC  | P-RZ9HC  | QCJ6Y  | QCJ8Y  | QL77JC4  |
| RCJ8  | RG6YC  | RG6YCA  | RJ17LM  | RJ19LM  | RJ19LMC  |
| RL78C  | RN1C  | RV8C  | RV15YC4  | RX12ZYC  | RY4C  |
| RZ7C  | Z9Y  | | | | |



|  |  |  |  |  |
|--|---|---|---|---|
| CCH306C | L86C | 21 mm | M14x1,25 | 0,6 |
| CCH425 | X | 24 mm | 1/2"-14 | 0,7 |
| CJ6 | CJ6 | 19 mm | M14x1,25 | 0,5 |
| CJ7Y | CJ7Y | 19 mm | M14x1,25 | 0,5 |
| CJ8 | CJ8 | 19 mm | M14x1,25 | 0,6 |
| D16 | D16 | 23 mm | M18x1,5 | 0,6 |
| DJ8J | DJ8J | 16 mm | M14x1,25 | 0,7 |
| J8C | J8C | 21 mm | M14x1,25 | 0,8 |
| J17LM | J17LM | 21 mm | M14x1,25 | 0,8 |
| J19LM | J19LM | 21 mm | M14x1,25 | 0,7 |
| L77JC4 | L77JC4 | 21 mm | M14x1,25 | 0,8 |
| L78C | L78C | 21 mm | M14x1,25 | 0,6 |
| L82C | L82C | 21 mm | M14x1,25 | 0,6 |
| OE001 | N9YC | 21 mm | M14x1,25 | 0,9 |
| OE002 | RC9YCC | 16 mm | M14x1,25 | 0,9 |
| OE003 | C9YC | 16 mm | M14x1,25 | 0,9 |
| OE004 | RN9YCC | 21 mm | M14x1,25 | 0,9 |
| OE005 | RC9YC | 16 mm | M14x1,25 | 0,9 |
| OE006 | RN9YC | 21 mm | M14x1,25 | 0,9 |
| OE007 | L87YC | 21 mm | M14x1,25 | 0,9 |
| OE008 | RN7YCC | 21 mm | M14x1,25 | 0,9 |
| OE009 | S9YC | 16 mm | M14x1,25 | 0,9 |
| OE010 | N7YC | 21 mm | M14x1,25 | 0,9 |
| OE011 | RS9YC | 16 mm | M14x1,25 | 0,9 |
| OE012 | N7BYC | 21 mm | M14x1,25 | 0,8 |
| OE013 | RC12YC | 16 mm | M14x1,25 | 0,8 |
| OE014 | RC7YCC | 16 mm | M14x1,25 | 0,9 |
| OE015 | N12YC | 21 mm | M14x1,25 | 0,9 |
| OE016 | RC10YCC | 16 mm | M14x1,25 | 0,9 |
| OE018 | RN7YC | 21 mm | M14x1,25 | 1,0 |
| OE019 | RC10DMC | 16 mm | M14x1,25 | 0,9 |
| OE025 | RN8VTYC4 | 21 mm | M14x1,25 | 1,0 |
| OE026 | RC8DMC | 16 mm | M14x1,25 | 0,9 |
| OE027 | RN10VTYC4 | 21 mm | M14x1,25 | 1,0 |
| OE029 | RES9PYP4 | 16 mm | M14x1,25 | 1,0 |
| OE030 | RC8BYC | 16 mm | M14x1,25 | 0,9 |
| OE031 | RES9YCC4 | 16 mm | M14x1,25 | 1,0 |
| OE032 | RC8VTYC4 | 16 mm | M14x1,25 | 1,0 |
| OE033 | RC87YCL | 16 mm | M14x1,25 | 0,9 |
| OE034 | RC8YCL | 16 mm | M14x1,25 | 0,9 |
| OE035 | REC9YCL | 16 mm | M14x1,25 | 0,9 |
| OE037 | L86C | 21 mm | M14x1,25 | 0,6 |
| OE038 | L82YC | 21 mm | M14x1,25 | 0,9 |
| OE039 | RC9YC4 | 16 mm | M14x1,25 | 1,0 |
| OE041 | RC12LYC | 16 mm | M14x1,25 | 0,9 |
| OE042 | RN12YC | 21 mm | M14x1,25 | 0,9 |
| OE044 | N9BYC | 21 mm | M14x1,25 | 0,9 |
| OE048 | RN9YC4 | 21 mm | M14x1,25 | 1,0 |
| OE049 | RN11YC4 | 21 mm | M14x1,25 | 1,0 |
| OE051 | RN11YC | 21 mm | M14x1,25 | 0,9 |
| OE052 | RA4HCX | 16 mm | M12x1,25 | 0,9 |
| OE054 | RF7YC | 21 mm | M18x1,5 | 0,8 |
| OE057 | C11YCC | 16 mm | M14x1,25 | 0,9 |

|  |  |  |  |  |
|---|--|---|---|---|
| OE059 | L92YC | 21 mm | M14x1,25 | 0,8 |
| OE063 | RC10YC4 | 16 mm | M14x1,25 | 1,0 |
| OE064 | RL82YC | 21 mm | M14x1,25 | 0,9 |
| OE065 | N11YC | 21 mm | M14x1,25 | 0,9 |
| OE068 | N3C | 21 mm | M14x1,25 | 0,7 |
| OE073 | RA4HC | 16 mm | M12x1,25 | 0,8 |
| OE074 | N5C | 21 mm | M14x1,25 | 0,7 |
| OE077 | RC7BYC4 | 16 mm | M14x1,25 | 1,0 |
| OE078 | N3G | 21 mm | M14x1,25 | 0,5 |
| OE079 | N4C | 21 mm | M14x1,25 | 0,7 |
| OE083 | RA6HC | 16 mm | M12x1,25 | 0,7 |
| OE086 | RL82C | 21 mm | M14x1,25 | 0,6 |
| OE087 | N6YC | 21 mm | M14x1,25 | 0,9 |
| OE089 | RC9MCC4 | 16 mm | M14x1,25 | 1,0 |
| OE091 | RN2C | 21 mm | M14x1,25 | 0,7 |
| OE093 | RC89YCC | 16 mm | M14x1,25 | 1,0 |
| OE094 | RC6YCC | 16 mm | M14x1,25 | 0,9 |
| OE098 | RN4C | 21 mm | M14x1,25 | 0,6 |
| OE099 | S12YC | 16 mm | M14x1,25 | 0,9 |
| OE105 | RN14PMP5 | 21 mm | M14x1,25 | 1,3 |
| OE108 | RN3C | 21 mm | M14x1,25 | 0,7 |
| OE112 | A6GC | 16 mm | M12x1,25 | 0,7 |
| OE114 | RC11LCC4 | 16 mm | M14x1,25 | 1,0 |
| OE120 | RC89TMC | 16 mm | M14x1,25 | 0,6 |
| OE122 | RG4PHP | 16 mm | M10x1,0 | 0,7 |
| OE123 | RC8TYC | 16 mm | M14x1,25 | 0,7 |
| OE128 | RC12LC4 | 16 mm | M14x1,25 | 1,0 |
| OE130 | RE8MX | 14 mm | M12x1,25 | 0,9 |
| OE131 | RS9PYP4 | 16 mm | M14x1,25 | 1,0 |
| OE136 | RC8PYP | 16 mm | M14x1,25 | 0,8 |
| OE138 | RC11PYPB4 | 16 mm | M14x1,25 | 1,0 |
| OE145 | RC89PYC | 16 mm | M14x1,25 | 0,8 |
| OE146 | RC8PYPB4 | 16 mm | M14x1,25 | 1,0 |
| OE148 | REC10YC4 | 16 mm | M14x1,25 | 1,0 |
| OE154 | RC12MCC4 | 16 mm | M14x1,25 | 1,0 |
| OE175 | REC10PYC4 | 16 mm | M14x1,25 | 1,0 |
| OE176 | KC8ZPYPB4 | 16 mm | M14x1,25 | 1,0 |
| OE177 | KC8ZMCC | 16 mm | M14x1,25 | 0,9 |
| OE178 | REC9MCLX | 16 mm | M14x1,25 | 0,9 |
| OE186 | RA8YCX4 | 16 mm | M12x1,25 | 1,0 |
| OE191 | KC10PYPB4 | 16 mm | M14x1,25 | 1,0 |
| OE192 | RN10PYP4 | 21 mm | M14x1,25 | 1,0 |
| OE196 | RA8MCX4 | 16 mm | M12x1,25 | 1,0 |
| OE197 | RER8YC | 16 mm | M12x1,25 | 0,9 |
| OE198 | RC10MCC | 16 mm | M14x1,25 | 0,9 |
| OE199 | RA7YC | 16 mm | M12x1,25 | 0,9 |
| OE201 | RER8MC | 16 mm | M12x1,25 | 0,9 |
| OE203 | RERX8PMPBX4 | 14/bi-hex | M12x1,25 | 1,0 |
| OE204 | RERX6PMCB4 | 14/bi-hex | M12x1,25 | 1,0 |
| OE205 | RERX4PMPB | 14/bi-hex | M12x1,25 | 0,7 |
| OE206 | REC8PYB | 16 mm | M14x1,25 | 0,7 |
| OE207 | RE8PMPB5 | 14 mm | M12x1,25 | 1,1 |
| OE208 | RA2PYPB | 16 mm | M12x1,25 | 0,8 |

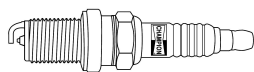





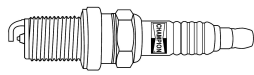

| CHAMPION | | | | |
|-----------------|-------------|-----------|----------|-----|
| OE209 | KC7PYPBX | 16 mm | M14x1,25 | 0,8 |
| OE210 | KEC4PYPB | 16 mm | M14x1,25 | 0,8 |
| OE211 | RER6DMC | 16 mm | M12x1,25 | 0,6 |
| OE212 | RER6YC | 16 mm | M12x1,25 | 0,9 |
| OE213 | KC7ZPYPB4 | 16 mm | M14x1,25 | 0,9 |
| OE214 | KC6PYPB | 16 mm | M14x1,25 | 0,7 |
| OE215 | KA4ZPYPB4 | 16 mm | M12x1,25 | 0,9 |
| OE216 | RC7BMC | 16 mm | M14x1,25 | 0,8 |
| OE217 | RC7DYC | 16 mm | M14x1,25 | 0,6 |
| OE218 | RC8QMC | 16 mm | M14x1,25 | 1,6 |
| OE219 | KEC4PYPBF | 16 mm | M14x1,25 | 0,7 |
| OE220 | KEC4PYPBF-1 | 16 mm | M14x1,25 | 0,7 |
| OE222 | KC6PYPBX | 16 mm | M14x1,25 | 0,8 |
| OE223 | RC9QMP | 16 mm | M14x1,25 | 1,6 |
| OE224 | REC8PYPB | 16 mm | M14x1,25 | 0,8 |
| OE225 | REA6PYPB | 14 mm | M12x1,25 | 0,7 |
| OE226 | RA7PYPB4 | 16 mm | M12x1,25 | 1,1 |
| OE227 | RC8PMPB | 16 mm | M14x1,25 | 0,6 |
| OE228 | KC8PYP4 | 16 mm | M14x1,25 | 1,0 |
| OE229 | KER4PYPB | 16 mm | M12x1,25 | 0,8 |
| OE230 | RA4YC | 16 mm | M12x1,25 | 0,9 |
| OE231 | REA6YC | 14 mm | M12x1,25 | 0,8 |
| OE232 | RER2PYPB | 16 mm | M12x1,25 | 0,7 |
| OE233 | REA4PMPB4 | 14 mm | M12x1,25 | 1,0 |
| OE234 | KC7ZPMPBX4 | 16 mm | M14x1,25 | 1,0 |
| OE235 | KC7ZTMC4 | 16 mm | M14x1,25 | 1,0 |
| OE236 | REC6TMC | 16 mm | M14x1,25 | 1,7 |
| OE237 | RC7BYC | 16 mm | M14x1,25 | 1,6 |
| OE238 | REC7PMPB4 | 16 mm | M14x1,25 | 1,0 |
| OE239 | RC8ZPYPB4 | 16 mm | M14x1,25 | 1,1 |
| OE241 | RG4HCX | 16 mm | M10x1,0 | 0,8 |
| OE242 | RERX5PMPB | 14/bi-hex | M12x1,25 | 0,8 |
| OE243 | RERX5ZPYPB | 14/bi-hex | M12x1,25 | 0,8 |
| OE244 | KA6ZPHPB-1 | 16 mm | M12x1,25 | 0,8 |
| OE247 | KA8ZYCC-1 | 16 mm | M12x1,25 | 1,0 |
| OE254 | RC7BYC | 16 mm | M14x1,25 | 0,5 |
| OE255 | REST10TMC4 | 16 mm | M14x1,25 | 1,0 |
| OE257 | RC7QMC | 16 mm | M14x1,25 | 0,5 |
| OE262 | REC7QMC | 16 mm | M14x1,25 | 1,4 |
| P-RA7HC | P-RA7HC | 18 mm | M12x1,25 | 0,9 |
| P-RG4HCC | P-RG4HCC | 16 mm | M10x1,0 | 0,9 |
| P-RG6HCC | P-RG6HCC | 16 mm | M10x1,0 | 0,8 |
| P-RG7C | P-RG7C | 16 mm | M10x1,0 | 0,7 |
| P-RZ7HC | P-RZ7HC | 16 mm | M10x1,0 | 0,7 |
| P-RZ9HC | P-RZ9HC | 16 mm | M10x1,0 | 0,7 |
| QCJ6Y | QCJ6Y | 19 mm | M14x1,25 | 0,7 |
| QCJ8Y | QCJ8Y | 19 mm | M14x1,25 | 0,7 |
| QL77JC4 | QL77JC4 | 21 mm | M14x1,25 | 0,8 |
| RCJ8 | RCJ8 | 19 mm | M14x1,25 | 0,8 |
| RG6YC | RG6YC | 16 mm | M10x1,0 | 0,8 |
| RG6YCA | RG6YCA | 16 mm | M10x1,0 | 0,6 |
| RJ17LM | RJ17LM | 21 mm | M14x1,25 | 0,8 |
| RJ19LM | RJ19LM | 21 mm | M14x1,25 | 0,8 |

| CHAMPION | | | | |
|----------------|---------|-------|----------|-----|
| RJ19LMC | RJ19LMC | 21 mm | M14x1,25 | 0,5 |
| RL78C | RL78C | 21 mm | M14x1,25 | 0,5 |
| RN1C | RN1C | 21 mm | M14x1,25 | 0,5 |
| RV8C | RV8C | 16 mm | M14x1,25 | 1,0 |
| RV15YC4 | RV15YC4 | 16 mm | M14x1,25 | 1,0 |
| RX12ZYC | RX12ZYC | 16 mm | M14x1,25 | 0,7 |
| RY4C | RY4C | 16 mm | M10x1,0 | 0,7 |
| RZ7C | RZ7C | 16 mm | M10x1,0 | 0,7 |
| Z9Y | Z9Y | 16 mm | M10x1,0 | 0,7 |



















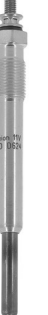



| eon TITAN | | | | |
|---------------|--|-----------|----------|-----|
| CET1 | | 16 mm | M12x1,25 | 0,9 |
| CET2 | | 16 mm | M14x1,25 | 0,9 |
| CET3 | | 16 mm | M14x1,25 | 0,9 |
| CET4 | | 14 mm | M12x1,25 | 0,9 |
| CET5 | | 16 mm | M14x1,25 | 0,9 |
| CET6 | | 16 mm | M12x1,25 | 0,9 |
| CET7 | | 16 mm | M14x1,25 | 0,9 |
| CET8 | | 21 mm | M14x1,25 | 0,9 |
| CET9 | | 16 mm | M14x1,25 | 0,9 |
| CET10P | | 16 mm | M12x1,25 | 0,8 |
| CET11P | | 16 mm | M14x1,25 | 0,8 |
| CET12P | | 16 mm | M14x1,25 | 0,8 |
| CET13P | | 14 mm | M12x1,25 | 0,8 |
| CET14P | | 16 mm | M14x1,25 | 0,8 |
| CET15P | | 16 mm | M12x1,25 | 0,8 |
| CET16P | | 14/bi-hex | M12x1,25 | 0,8 |
| CET17P | | 16 mm | M14x1,25 | 0,8 |
| CET18P | | 16 mm | M14x1,25 | 0,8 |

| IRIDIUM | | | | |
|--------------|------------|-----------|----------|-----|
| OE179 | RC8WYPB4 | 16 mm | M14x1,25 | 1,0 |
| OE180 | RC10WYPB4 | 16 mm | M14x1,25 | 1,0 |
| OE181 | KC8WYPB4 | 16 mm | M14x1,25 | 1,0 |
| OE182 | RC89WYPB4 | 16 mm | M14x1,25 | 1,0 |
| OE183 | RS8WYPB5 | 16 mm | M14x1,25 | 1,3 |
| OE184 | RC10WMPB2 | 16 mm | M14x1,25 | 0,6 |
| OE187 | RA7WHPB | 16 mm | M12x1,25 | 0,9 |
| OE188 | RC8WMPB4 | 16 mm | M14x1,25 | 1,0 |
| OE189 | RES9WYPB5 | 16 mm | M14x1,25 | 1,3 |
| OE190 | REC10WYPB4 | 16 mm | M14x1,25 | 1,0 |
| OE193 | RC12WYPB4 | 16 mm | M14x1,25 | 1,0 |
| OE194 | RC12WMPB4 | 16 mm | M14x1,25 | 1,0 |
| OE195 | RN8WYPB | 21 mm | M14x1,25 | 0,8 |
| OE240 | REA12WMB4 | 14 mm | M12x1,25 | 1,0 |
| OE245 | RERX4ZWYPB | 14/bi-hex | M12x1,25 | 0,8 |
| OE246 | KEC6WYPB-1 | 16 mm | M14x1,25 | 0,8 |



























|  IRIDIUM |  |  |  |  mm |
|--|---|---|---|---|
| OE248 | RER3WYPB | 16 mm | M12x1,25 | 0,8 |
| OE249 | RER8WMPB | 16 mm | M12x1,25 | 0,9 |
| OE250 | RER8WYPB | 16 mm | M16x1,25 | 0,8 |
| OE253 | REA8WYPB4 | 14 mm | M12x1,25 | 1,0 |
| OE256 | REA8WYPB | 14 mm | M12x1,25 | 0,7 |
| OE258 | RET4WYPBX | 14 mm | M12x1,25 | 0,7 |
| OE260 | KC6ZWYPB | 16 mm | M14x1,25 | 0,7 |
| OE261 | REA10WYPB | 14 mm | M12x1,25 | 0,7 |
| OE263 | RER12WMPB | 16 mm | M12x1,25 | 0,9 |
| OE264 | RC6WYPBX | 16 mm | M14x1,25 | 0,7 |



























| | | | | | |
|---|---|---|---|---|---|
| CCGP001 No Image | CCGP002  | CCGP003  | CCGP007  | CCGP010  | CH147  |
| CH154  | CH158  | CH167  | CH169  | CH170  | CH173  |
| CH175  | CH176  | CH177  | CH178  | CH180  | CH181  |
| CH185  | CH186  | CH189  | CH196  | CH200  | CH201  |



























| | | | | | |
|---|---|---|---|---|---|
| CH203  | CH204  | CH205  | CH206  | CH207  | CH209  |
| CH210  | CH215  | CH216  | CH217  | CH218  | CH219  |
| CH221  | CH222  | CH223  | CH224  | CH225  | CH226  |
| CH228  | CH229  | CH230  | CH231  | CH232  | CH233  |













| | | | | | |
|---|---|---|---|---|---|
| CH234  | CH240  | CH242  | CH252  | CH256  | CH258  |
| CH260  | CH263  | CH268  | CH269  | CH270  | CH271  |
| CH272  | CH273  | CH302  | CH306  | CH400  | CH401  |
| CH402  | CH403  | CH404  | CH405  | CH406  | CH407  |









| | | | | | |
|---|---|---|---|---|---|
| CH408  | CH409  | CH410  | CH411  | CH600  | CH601  |
| CH603  | CH607  | CH608  | CH700  | CH701  | CH702  |
| CH704  | CH705  | CH709  | CH710  | CH711  | CH712  |
| CH713  | CH714  | CH715  | CH716  | CH717  | CH718  |

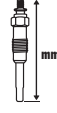
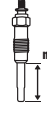



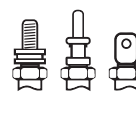
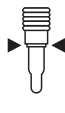





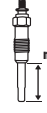

| | | | | | |
|--|--|--|--|--|---|
| CH719  | CH721  | CH722  | CH723  | CH724  | CH725  |
| CPSG003  | CPSG004  | CPSG006  | CPSG007  | CPSG008  | |
| | | | | | |
| | | | | | |













|  |  |  |  |  |  |  |  |  |  |  |
|---|---|---|---|---|---|---|--|---|---|---|
| | mm | mm | | mm | Nm | Nm Max. | | | V | A |
| CCGP001 | 134 | 29 | M10x1,0 | 10 mm | 15 | 20 | 4 mm | 63 | 5.4 | 45 |
| CCGP002 | 98.2 | 30 | M10x1,0 | 10 mm | 15 | 20 | 4 mm | 63 | 7 | 45 |
| CCGP003 | 118.5 | 30 | M8x1,0 | 8 mm | 8 | 10 | 4 mm | 93 | 7 | 45 |
| CCGP007 | 167.7 | 26 | M10x1,0 | 10 mm | 15 | 20 | 4 mm | 63 | 7 | 45 |
| CCGP010 | 130.7 | 28 | M10x1,0 | 10 mm | 15 | 20 | PIN | | 6.2 | |
| CH147 | 70 | 20.3 | M12x1,25 | 12 mm | 15 | 25 | M4 | | 11.5 | |
| CH154 | 95 | 32.1 | M10x1,25 | 12 mm | 15 | 20 | M4 | | 11 | |
| CH158 | 85 | 19 | M10x1,25 | 12 mm | 15 | 20 | M4 | 119 | 11 | 6 |
| CH167 | 71 | 25 | M12x1,25 | 12 mm | 15 | 25 | M4 | 63 | 11 | 14 |
| CH169 | 84 | 24.6 | M10x1,0 | 10 mm | 15 | 20 | M4 | | 11 | |
| CH170 | 107 | 28 | M10x1,0 | 10 mm | 15 | 20 | M4 | 63 | 11 | 18.5 |
| CH173 | 67 | 25 | M12x1,25 | 12 mm | 15 | 25 | M5 | 63 | 11 | 13.5 |
| CH175 | 119.5 | 28 | M12x1,25 | 12 mm | 15 | 25 | 5 mm | 63 | 11.5 | 12 |
| CH176 | 69 | 23 | M12x1,25 | 12 mm | 15 | 25 | M5 | 63 | 11.5 | 15.5 |
| CH177 | 115 | 28 | M12x1,25 | 12 mm | 15 | 25 | 4 mm | 63 | 11.5 | 15 |
| CH178 | 125 | 26 | M10x1,0 | 10 mm | 15 | 20 | M4 | 90 | 11.5 | 16 |
| CH180 | 129.5 | 25.8 | M10x1,0 | 10 mm | 15 | 20 | 4 mm | 63 | 11 | 14 |
| CH181 | 97 | 29.6 | M10x1,0 | 10 mm | 15 | 20 | 4 mm | | 11 | |
| CH185 | 89 | 29.6 | M10x1,0 | 10 mm | 15 | 20 | M4 | | 11 | |
| CH186 | 85 | 19.1 | M10x1,25 | 12 mm | 15 | 20 | M4 | | 11 | |
| CH189 | 72 | 24.3 | M12x1,25 | 12 mm | 15 | 25 | M5 | | 11 | |
| CH196 | 96 | 24.5 | M10x1,0 | 10 mm | 15 | 20 | M4 | 93 | 10 | 16.5 |
| CH200 | 118.5 | 28 | M8x1,0 | 8 mm | 8 | 10 | M4 | 123 | 11 | 11 |
| CH201 | 124.5 | 28 | M8x1,0 | 8 mm | 8 | 10 | 4 mm | 123 | 11 | 10 |
| CH203 | 106.5 | 33 | M10x1,0 | 10 mm | 15 | 20 | 4 mm | 63 | 11 | 15 |
| CH204 | 86 | 28 | M12x1,25 | 12 mm | 15 | 25 | 4 mm | 63 | 11.5 | 13 |
| CH205 | 62 | 18 | M12x1,25 | 12 mm | 15 | 25 | M5 | 63 | 10 | 18 |
| CH206 | 68 | 26 | M12x1,25 | 12 mm | 15 | 25 | M4 | 63 | 11 | 16 |
| CH207 | 133 | 28.6 | M10x1,0 | 10 mm | 15 | 20 | 4 mm | | 11 | |
| CH209 | 76 | 21 | M12x1,25 | 12 mm | 15 | 25 | 4 mm | 63 | 11 | 18 |
| CH210 | 119.5 | 31 | M10x1,25 | 12 mm | 15 | 20 | M4 | 119 | 11 | 14.5 |
| CH215 | 126 | 35 | M10x1,0 | 10 mm | 15 | 20 | 4 mm | 63 | 12 | 18 |
| CH216 | 75 | 25 | M10x1,0 | 10 mm | 15 | 20 | M4 | 63 | 11 | 15.5 |
| CH217 | 93 | 25 | M10x1,0 | 10 mm | 15 | 20 | M4 | 63 | 11 | 15.5 |
| CH218 | 130 | 28 | M10x1,0 | 10 mm | 15 | 20 | 4 mm | 63 | 11.5 | 13 |
| CH219 | 128 | 30.5 | M10x1,0 | 10 mm | 15 | 20 | M4 | 63 | 11 | 14 |
| CH221 | 87 | 21.85 | M10x1,25 | 12 mm | 15 | 20 | M4 | | 11 | |
| CH222 | 102.5 | 25 | M10x1,0 | 10 mm | 15 | 20 | 4 mm | 63 | 11 | 17.5 |
| CH223 | 119.4 | 28 | M8x1,0 | 8 mm | 8 | 10 | 4 mm | 93 | 11 | 13 |
| CH224 | 151.5 | 30 | M9x1,0 | 9 mm | 8 | 10 | 4 mm | 93 | 11 | 13 |
| CH225 | 95 | 22 | M10x1,25 | 12 mm | 15 | 20 | M4 | 119 | 11 | 20 |
| CH226 | 111.5 | 29.6 | M10x1,0 | 10 mm | 15 | 20 | M4 | 63 | 11 | 16 |
| CH228 | 121 | 40 | M10x1,0 | 10 mm | 15 | 20 | 4 mm | 63 | 11 | 14 |
| CH229 | 147 | 35 | M10x1,0 | 10 mm | 15 | 20 | M4 | 93 | 11.5 | 15.5 |
| CH230 | 179 | 20.8 | M10x1,0 | 12 mm | 15 | 20 | M4 | 119 | 11 | 11.7 |
| CH231 | 135 | 31 | M10x1,0 | 10 mm | 15 | 20 | 4 mm | 63 | 11 | 15.5 |
| CH232 | 151 | 25 | M10x1,0 | 10 mm | 15 | 20 | 4 mm | 63 | 11 | 17 |
| CH233 | 99 | 25 | M10x1,0 | 10 mm | 15 | 20 | 4 mm | 63 | 11 | 11 |
| CH234 | 153.5 | 31 | M10x1,25 | 12 mm | 15 | 20 | M4 | 120 | 11 | 14.5 |
| CH240 | 126.5 | 25 | M8x1,0 | 8 mm | 8 | 10 | 4 mm | 93 | 11 | 9 |
| CH242 | 87.5 | 22 | M10x1,25 | 12 mm | 15 | 20 | M4 | 120 | 11 | 13 |
| CH252 | 160 | 36 | M10x1,25 | 10 mm | 15 | 20 | M4 | 93 | 11 | 17.5 |
| CH256 | 84.5 | 18 | M10x1,25 | 12 mm | 15 | 20 | M4 | 123 | 11 | 17 |



|  |  |  |  |  |  |  |  |  |  |  |
|---|---|---|---|---|---|---|--|---|---|---|
| | mm | mm | | mm | Nm | Nm Max. | | | V | A |
| CH258 | 171 | 36.7 | M10x1,25 | 12 mm | 15 | 20 | M4 | 119 | 11 | 14.5 |
| CH260 | 62 | 21 | M12x1,25 | 12 mm | 15 | 25 | M5 | | 11 | |
| CH263 | 170 | 35 | M10x1,25 | 12 mm | 15 | 20 | M4 | 93 | 11 | 10 |
| CH268 | 118.4 | 27.75 | M10x1,0 | 10 mm | 15 | 20 | M4 | 63 | 11 | 18.5 |
| CH269 | 108 | 30 | M10x1,0 | 10 mm | 15 | 20 | 4 mm | 63 | 11 | 31 |
| CH270 | 152 | 40 | M8x1,0 | 8 mm | 8 | 10 | 4 mm | 93 | 11 | 11 |
| CH271 | 92 | 24.6 | M10x1,0 | 10 mm | 15 | 20 | 4 mm | | 11 | |
| CH272 | 106.5 | 25 | M10x1,0 | 10 mm | 15 | 20 | 4 mm | 63 | 11 | 15.5 |
| CH273 | 151 | 24.5 | M10x1,0 | 10 mm | 15 | 20 | 4 mm | 63 | 11 | 11 |
| CH302 | 97 | 28.1 | M10x1,25 | 12 mm | 15 | 20 | M4 | | 11 | |
| CH306 | 140 | 24 | M12x1,25 | 12 mm | 15 | 25 | M4 | 119 | 11 | 7 |
| CH400 | 148.5 | 27 | M8x1,0 | 8 mm | 8 | 10 | 4 mm | 93 | 11.5 | 13 |
| CH401 | 134.5 | 30 | M10x1,25 | 12 mm | 15 | 20 | M4 | 120 | 11 | 13 |
| CH402 | 97 | 28 | M8x1,0 | 8 mm | 8 | 10 | 4 mm | 123 | 11 | 11.5 |
| CH403 | 170 | 36.6 | M10x1,25 | 12 mm | 15 | 20 | M4 | 93 | 11 | 16 |
| CH404 | 156.5 | 35 | M9x1,0 | 9 mm | 8 | 10 | 4 mm | 93 | 11 | 20 |
| CH405 | 213 | 23 | M10x1,25 | 12 mm | 15 | 20 | M4 | 123 | 11 | 10 |
| CH406 | 161 | 31 | M10x1,25 | 12 mm | 15 | 20 | 4 mm | 119 | 11 | 10 |
| CH407 | 151.5 | 36 | M10x1,25 | 12 mm | 15 | 20 | M4 | 119 | 11 | 11 |
| CH408 | 160 | 28 | M10x1,25 | 10 mm | 15 | 20 | M4 | 93 | 11 | 10 |
| CH409 | 132 | 24 | M10x1,25 | 12 mm | 15 | 20 | M4 | 119 | 11 | 14.5 |
| CH410 | 160 | 28.3 | M10x1,25 | 10 mm | 15 | 20 | M4 | 93 | 11 | 8.5 |
| CH411 | 82 | 16 | M10x1,25 | 12 mm | 15 | 20 | M4 | 119 | 11 | 18 |
| CH600 | 94.5 | 18.5 | M10x1,25 | 10 mm | 15 | 20 | M4 | 123 | 11 | 17 |
| CH601 | 85 | 19 | M10x1,25 | 12 mm | 15 | 20 | M4 | 119 | 11 | 11.5 |
| CH603 | 143 | 24 | M10x1,25 | 12 mm | 15 | 20 | 4 mm | 119 | 11 | 15 |
| CH607 | 81 | 20 | M10x1,25 | 12 mm | 15 | 20 | M4 | 123 | 11 | 10 |
| CH608 | 101 | 25.4 | M10x1,25 | 12 mm | 15 | 20 | M4 | 93 | 11 | 10 |
| CH700 | 97 | 30 | M10x1,0 | 10 mm | 15 | 20 | 4 mm | 63 | 5 | 25 |
| CH701 | 106.5 | 33 | M10x1,0 | 10 mm | 15 | 20 | 4 mm | 63 | 5 | 25 |
| CH702 | 117 | 30 | M8x1,0 | 8 mm | 8 | 10 | 4 mm | 93 | 4.4 | 25 |
| CH704 | 133 | 31 | M10x1,0 | 10 mm | 15 | 20 | 4 mm | 63 | 5 | 25 |
| CH705 | 130 | 28 | M10x1,0 | 10 mm | 15 | 20 | 4 mm | 63 | 4.4 | 25 |
| CH709 | 148.5 | 27 | M8x1,0 | 8 mm | 8 | 10 | 4 mm | 93 | 4.4 | 25 |
| CH710 | 132 | 28 | M8x1,0 | 8 mm | 8 | 10 | 4 mm | 93 | 4.4 | 9 |
| CH711 | 156 | 26 | M10x1,25 | 10 mm | 15 | 20 | 4 mm | 119 | 4.4 | 8.5 |
| CH712 | 96.5 | 24.5 | M10x1,0 | 10 mm | 15 | 20 | 4 mm | 63 | 4.4 | 25 |
| CH713 | 90.5 | 24.5 | M10x1,0 | 10 mm | 15 | 20 | 4 mm | 63 | 4.4 | 25 |
| CH714 | 119.5 | 28 | M9x1,0 | 9 mm | 8 | 10 | 4 mm | 93 | 4.4 | 25 |
| CH715 | 156.5 | 35 | M9x1,0 | 9 mm | 8 | 10 | 4 mm | 93 | 4.4 | 25 |
| CH716 | 137.1 | 24 | M10x1,25 | 10 mm | 15 | 20 | 4 mm | 121 | 4.4 | 8.5 |
| CH717 | 134 | 29 | M10x1,0 | 10 mm | 15 | 20 | 4 mm | 63 | 4.4 | 8.5 |
| CH718 | 94 | 26 | M10x1,0 | 10 mm | 15 | 20 | 4 mm | 63 | 5 | 9 |
| CH719 | 112 | 28 | M8x1,0 | 8 mm | 8 | 10 | 4 mm | 123 | 5 | 30 |
| CH721 | 134 | 28 | M8x1,0 | 8 mm | 8 | 10 | 4 mm | 93 | 4.4 | 7.9 |
| CH722 | 162.7 | 26 | M10x1,0 | 10 mm | 15 | 20 | 4 mm | 93 | 4.6 | 10 |
| CH723 | 92.7 | 29.5 | M8x1,0 | 8 mm | 8 | 10 | 4 mm | 93 | 4.4 | 7.9 |
| CH724 | 146 | 31.4 | M10x1,0 | 10 mm | 15 | 20 | 4 mm | 93 | 4.4 | 8.1 |
| CH725 | 148.5 | 35.5 | M10x1,0 | 10 mm | 15 | 20 | M4 | 93 | 4.4 | 10 |
| CPSG003 | 132.2 | 28 | M9x1,0 | 12 mm | 8 | 10 | 4 mm PIN (PSG) | 93 | 4.4 | 8.5 |
| CPSG004 | 168 | 24 | M10x1,25 | 12 mm | 15 | 20 | 4 mm PIN (PSG) | 121 | 4.4 | 25 |
| CPSG006 | 179.95 | 35 | M9x1,0 | 12 mm | 8 | 10 | 4 mm PIN (PSG) | 93 | 4.4 | 8.5 |
| CPSG007 | 148.5 | 28 | M10x1,0 | 12 mm | 15 | 20 | 4 mm PIN (PSG) | 63 | 4.4 | |

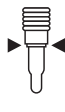

| | | | | | | | | | | |
|---|---|---|---|---|---|---|--|---|---|---|
|  |  |  |  |  |  |  |  |  |  |  |
| CPSG008 | 165.1 | 28 | M10x1,0 | 12 mm | Nm 15 | Nm Max. 20 | 4 mm PIN (PSG) | 63 | 4.4 | |



BAE403B

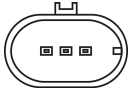

BAE403C

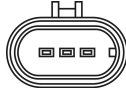

BAE403D

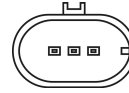

BAE408AE

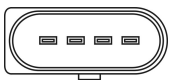

BAE409A



BAE504D

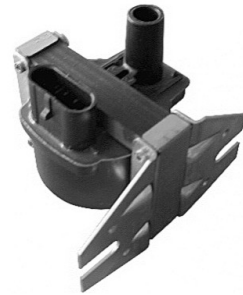

BAE504F

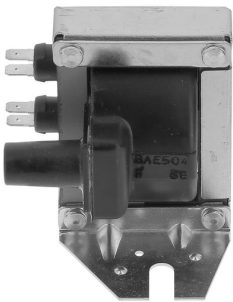

BAE504L

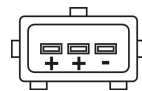

BAE506D

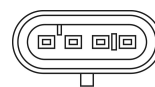

BAE506F



BAE700AK

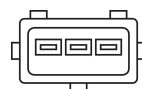

BAE800B





BAE850AK

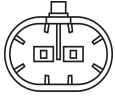

BAE851AE



BAE907AE

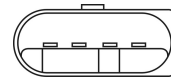

BAE920AX

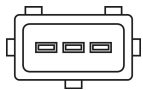

BAE940A

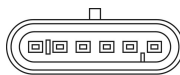

BAE946A

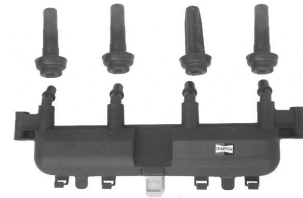

BAE947A

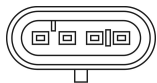

BAE960AE

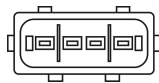

BAE961AE



BAE965A

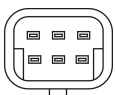







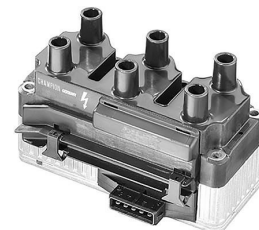





BAEA002E

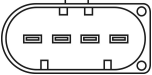
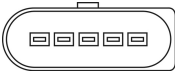

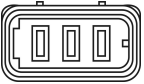
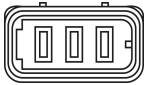
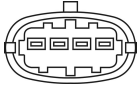

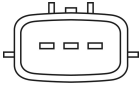

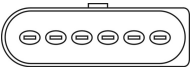

BAEA004E



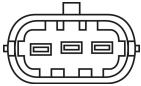

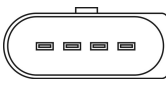
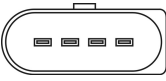

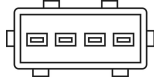
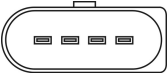

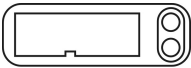







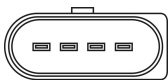

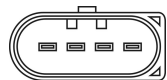

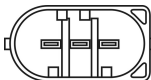

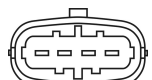

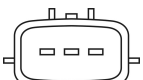

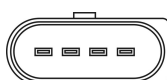
| | | |
|--|---|--|
| <p>BAEA007E</p>    | <p>BAEA009E</p> <p>No Image</p>  | <p>BAEA012E</p> <p>No Image</p>  |
| <p>BAEA013E</p> <p>No Image</p>  | <p>BAEA014</p> <p>No Image</p>  | <p>BAEA016</p> <p>No Image</p>  |
| <p>BAEA017</p> <p>No Image</p>  | <p>BAEA019E</p> <p>No Image</p>  | <p>BAEA021E</p>   |
| <p>BAEA025E</p>   | <p>BAEA026E</p>   | <p>BAEA029E</p> <p>No Image</p>  |

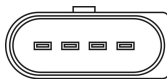

| | | |
|---|--|---|
| BAEA030 No Image  | BAEA031E No Image  | BAEA032E No Image  |
| BAEA033E No Image  | BAEA037 No Image  | BAEA037E No Image  |
| BAEA041 No Image  | BAEA041E No Image  | BAEA042E No Image |
| BAEA043 No Image  | BAEA043E No Image | BAEA044E No Image |

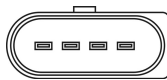

| | | |
|--|---|--|
| <p>BAEA045E</p>   | <p>BAEA046E</p> <p>No Image</p>  | <p>BAEA048E</p> <p>No Image</p>  |
| <p>BAEA051E</p> <p>No Image</p>   | <p>BAEA052E</p> <p>No Image</p>   | <p>BAEA053</p>    |
| <p>BAEA055E</p> <p>No Image</p>   | <p>BAEA056E</p> <p>No Image</p>   | <p>BAEA059E</p> <p>No Image</p>   |
| <p>BAEA061E</p> <p>No Image</p>   | <p>BAEA062E</p> <p>No Image</p>   | <p>BAEA063E</p> <p>No Image</p>   |











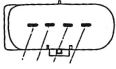

| | | |
|--|--|--|
| <p>BAEA065E</p> <p>No Image</p>   | <p>BAEA066E</p> <p>No Image</p>   | <p>BAEA067E</p> <p>No Image</p>  |
| <p>BAEA068E</p> <p>No Image</p>  | <p>BAEA069E</p> <p>No Image</p>  | <p>BAEA072E</p>   |
| <p>BAEA073E</p> <p>No Image</p>  | <p>BAEA077</p> <p>No Image</p>   | <p>BAEA079E</p>   |
| <p>BAEA080E</p>   | <p>BAEA081E</p>   | <p>BAEA083E</p>   |



| | | |
|---|--|--|
| <p>BAEA084E</p> <p>No Image</p>  | <p>BAEA085</p> <p>No Image</p>   | <p>BAEA088E</p>   |
| <p>BAEA090</p>   | <p>BAEA093E</p>   | <p>BAEA095</p> <p>No Image</p>  |
| <p>BAEA110</p>   | <p>BAEA115</p> <p>No Image</p>  | <p>BAEA126E</p> <p>No Image</p>  |
| <p>BAEA131E</p> <p>No Image</p>  | <p>BAEA132E</p> <p>No Image</p>  | <p>BAEA136E</p>   |



| | | |
|--|--|--|
| <p>BAEA137E</p> <p>No Image</p>  | <p>BAEA140E</p> <p>No Image</p>   | <p>BAEA143</p> <p>No Image</p>  |
| <p>BAEA144E</p> <p>No Image</p>  | <p>BAEA145E</p> <p>No Image</p>  | <p>BAEA146E</p> <p>No Image</p>  |
| <p>BAEA147E</p> <p>No Image</p>  | <p>BAEA149E</p> <p>No Image</p>  | <p>BAEA150E</p> <p>No Image</p>  |
| <p>BAEA152E</p> <p>No Image</p>  | <p>BAEA153E</p> <p>No Image</p>  | <p>BAEA154E</p> <p>No Image</p> |















| | | |
|--|---|--|
| <p>BAEA158E</p>   | <p>BAEA159E</p> <p>No Image</p>  | <p>BAEA161E</p>   |
| <p>BAEA162E</p>  | <p>BAEA163E</p> <p>No Image</p>  | <p>BAEA164E</p>   |
| <p>BAEA165E</p>   | <p>BAEA167E</p>   | <p>BAEA168E</p>   |
| <p>BAEA169E</p> <p>No Image</p>  | <p>BAEA170E</p> <p>No Image</p>  | <p>BAEA171E</p> <p>No Image</p>  |



| | | |
|--|--|--|
| <p>BAEA172E</p>   | <p>BAEA173E</p> <p>No Image</p>  | <p>BAEA174E</p> <p>No Image</p>  |
| <p>BAEA175E</p>   | <p>BAEA176E</p>   | <p>BAEA178E</p> <p>No Image</p>  |
| <p>BAEA179E</p>    | <p>BAEA180E</p> <p>No Image</p>  | <p>BAEA181E</p> <p>No Image</p>  |
| <p>BAEA182E</p> <p>No Image</p>  | <p>BAEA183E</p> <p>No Image</p>  | <p>BAEA184E</p> <p>No Image</p>  |



| | | |
|--|---|--|
| <p>BAEA185E</p> <p>No Image</p>  | <p>BAEA186E</p> <p>No Image</p>  | <p>BAEA188E</p>   |
| <p>BAEA189E</p> <p>No Image</p>  | <p>BAEA190E</p> <p>No Image</p>  | <p>BAEA191E</p> <p>No Image</p>  |
| <p>BAEA192E</p> <p>No Image</p>  | <p>BAEA193E</p> <p>No Image</p> | <p>BAEA194E</p> <p>No Image</p>  |
| <p>BAEA195E</p> <p>No Image</p>  | <p>BAEA196E</p> <p>No Image</p>  | <p>BAEA198E</p> <p>No Image</p>  |



BAEA199E

No Image



BAEA231

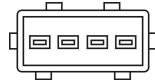

BAEA232

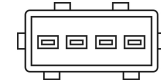

BAEA234

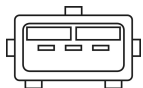
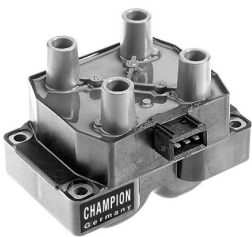

BAEA242

No Image

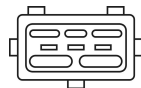

BAEA243

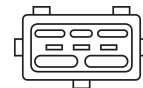

BAEA245

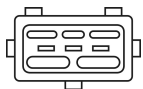

BAEA246

No Image

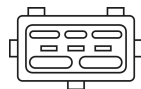

BAEA247

No Image

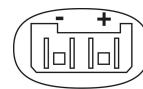

BAEA251

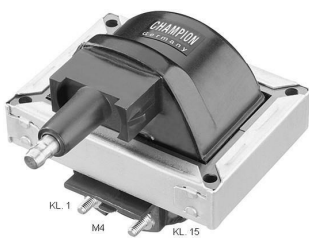

BAEA252

No Image

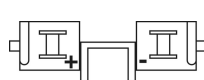

BAEA253

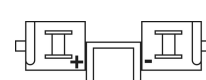



BAEA254

No Image

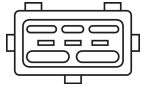

BAEA255

No Image

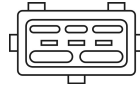

BAEA256

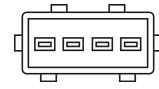

BAEA264

No Image



BAEA266



BAEA267

No Image



BAEA269

No Image



BAEA275



BAEA276

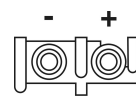

BAEA281

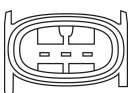

BAEA296







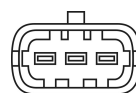





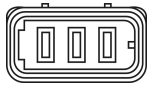

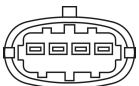

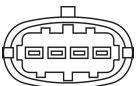



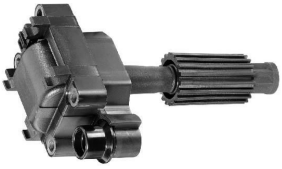

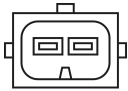
No Image

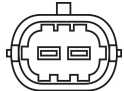

BAEA297



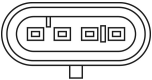

| | | |
|---|---|--|
| <p>BAEA298</p> <p>No Image</p>  | <p>BAEA299</p> <p>No Image</p>  | <p>BAEA302</p> <p>No Image</p>   |
| <p>BAEA304</p> <p>No Image</p>   | <p>BAEA306</p> <p>No Image</p>   | <p>BAEA307</p>    |
| <p>BAEA308</p>     | <p>BAEA309</p>  <p>Stecker ZLE 288</p>   | <p>BAEA313</p>   |
| <p>BAEA324</p> <p>No Image</p>   | <p>BAEA325</p>    | <p>BAEA326</p> <p>No Image</p>   |



BAEA337

No Image

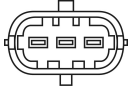

BAEA338

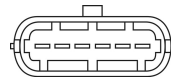

BAEA339

No Image



BAEA340



BAEA342

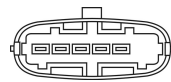

BAEA344

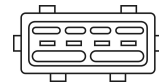

BAEA345

No Image

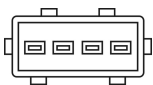

BAEA347

No Image



BAEA348

No Image

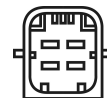

BAEA350



BAEA351

No Image

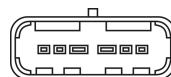





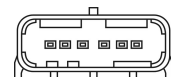



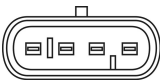

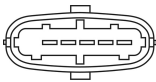

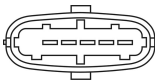

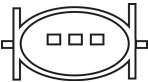





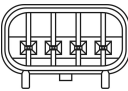

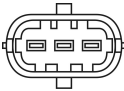
BAEA352

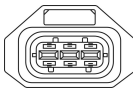
No Image





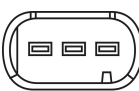











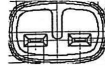

| | | |
|---|---|---|
| <p>BAEA354</p> <p>No Image</p>   | <p>BAEA358</p>    | <p>BAEA359</p> <p>No Image</p>   |
| <p>BAEA365</p> <p>No Image</p>   | <p>BAEA367</p> <p>No Image</p>   | <p>BAEA368</p> <p>No Image</p>   |
| <p>BAEA372</p>    | <p>BAEA377</p> <p>No Image</p>   | <p>BAEA378</p> <p>No Image</p>   |
| <p>BAEA380</p>    | <p>BAEA382</p>   | <p>BAEA383</p> <p>No Image</p>   |













| | | |
|---|--|---|
| <p>BAEA384</p> <p>No Image</p>   | <p>BAEA385</p> <p>No Image</p>   | <p>BAEA386</p> <p>No Image</p>  |
| <p>BAEA387</p>    | <p>BAEA388</p> <p>No Image</p>   | <p>BAEA394</p> <p>No Image</p>   |
| <p>BAEA395</p>   | <p>BAEA408</p>    | <p>BAEA409</p> <p>No Image</p>   |
| <p>BAEA410</p> <p>No Image</p>   | <p>BAEA422</p>   | <p>BAEA426</p> <p>No Image</p>  |



| | | |
|---|--|---|
| <p>BAEA427</p>   <p>No Image</p> | <p>BAEA428</p> <p>No Image</p>  | <p>BAEA429</p>   |
| <p>BAEA432</p> <p>No Image</p>  | <p>BAEA433</p> <p>No Image</p>   | <p>BAEA434</p> <p>No Image</p>  |
| <p>BAEA445</p>   | <p>BAEA446</p> <p>No Image</p>  | <p>BAEA447A</p>  |
| <p>BAEA448</p> <p>No Image</p>  | <p>BAEA449</p> <p>No Image</p>  | <p>BAEA453</p> <p>No Image</p>  |

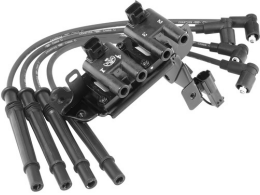









| | | |
|---|--|---|
| <p>BAEA454</p>   | <p>BAEA469</p>   | <p>BAEA472</p>   |
| <p>BAEA474</p> <p>No Image</p>  | <p>BAEA475</p> <p>No Image</p>  | <p>BAEA476</p> <p>No Image</p>  |
| <p>BAEA477</p> <p>No Image</p>  | <p>BAEA479</p>   | <p>BAEA480</p> <p>No Image</p>  |
| <p>BAEA482</p> <p>No Image</p>  | <p>BAEA483</p>   | <p>BAEA486</p> <p>No Image</p>  |



















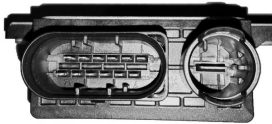

















| | | |
|---|--|--|
| <p>BAEA489</p> <p>No Image</p>  | <p>BAEA501</p> <p>No Image</p>    | <p>BAEA502E</p>     |
| <p>BAEA508</p>   | <p>BAEA521</p> <p>No Image</p>  | <p>BAEA531</p> <p>No Image</p>  |
| <p>BAEA536</p> <p>No Image</p>  | <p>BAEA538</p>   | <p>BAEA539</p> <p>No Image</p>  |
| <p>BAEA540</p> <p>No Image</p>  | <p>BAEA543</p> <p>No Image</p>  | <p>BAEA546</p> <p>No Image</p> |



| | | |
|---|--|---|
| <p>BAEA547</p> <p>No Image</p>  | <p>BAEA548</p> <p>No Image</p>  | <p>BAEA549</p> <p>No Image</p>  |
| <p>BAEA554</p> <p>No Image</p>  | <p>BAEA555</p> <p>No Image</p>  | <p>BAEA556</p> <p>No Image</p> |
| <p>BAEA557</p> <p>No Image</p>  | <p>BAEA560</p> <p>No Image</p>  | <p>BAEA561</p> <p>No Image</p>  |
| | | |

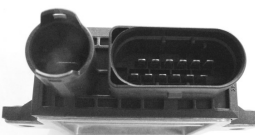

| | | | | | |
|--|---|--|---|--|---|
| CCU081  CHAMPION 0201010081 Made in Germany >PA6 6-GF30% 30 87 86 08/12 |  12  3;4;5 | CCU101  |  12  4 | CCU102  |  12  6 |
| CCU104  |  12  5 | CCU105  |  12  4 | CCU106 No Image  3;4 |  12  3;4 |
| CCU108  |  12  6 | CCU110  |  12  4 | CCU113  |  12  6 |
| CCU114  |  12  6 | CCU116  |  12  6 | CCU118  |  12  8 |



CCU128



12



4

CCU129



12



4

CCU138

No Image



12



4

CCU140



12



4

CCU141



12



5;6

CCU142



12



4

CCU143



12



4

CCU144



12



4

CCU145



12



4

CCU147



12



4

CCU148



12



4

CCU149













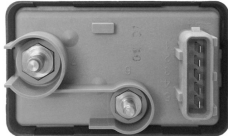



12

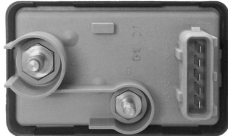

4



| | | | | | |
|---|--|--|--|--|--|
| <p>CCU150</p>  <p>55 238 720 0272 5 238 0120 12V CHAMPION E2110022581A1</p> |  <p>12</p>  <p>4;5</p> | <p>CCU151</p>  |  <p>12</p>  <p>4;8</p> | <p>CCU152</p>  <p>CCU152 E2110022581A1 Made in Germany 3029 14</p> |  <p>12</p>  <p>3;4</p> |
| <p>CCU153</p>  |  <p>12</p>  <p>4</p> | <p>CCU154</p> <p>No Image</p> |  <p>12</p>  <p>4</p> | <p>CCU156</p> <p>No Image</p> |  <p>12</p>  <p>4</p> |
| | | | | | |
| | | | | | |

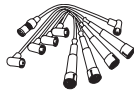

CLS001



CLS002



CLS003



CLS004



CLS005



CLS006





CLS007

| | |
|----|----------|
| mm | |
| ∅ | |
| | 4 |
| | |
| | |
| | |

CLS008

| | |
|----|----------|
| mm | |
| ∅ | |
| | 5 |
| | |
| | |
| | |

CLS009

| | |
|----|----------|
| mm | |
| ∅ | |
| | 4 |
| | |
| | |
| | |

CLS010

| | |
|----|----------|
| mm | |
| ∅ | |
| | 2 |
| | |
| | |
| | |

CLS011

| | |
|----|----------|
| mm | |
| ∅ | |
| | 4 |
| | |
| | |
| | |

CLS012

| | |
|----|----------|
| mm | |
| ∅ | |
| | 4 |
| | |
| | |
| | |

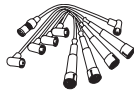

CLS013



CLS014



CLS015



CLS016



CLS017

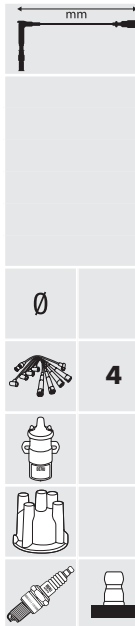

CLS018





CLS019



CLS020

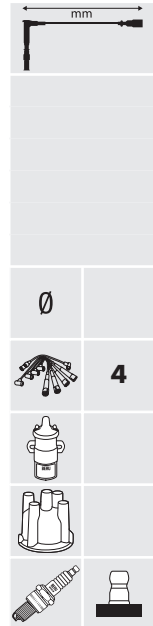

CLS021



CLS022

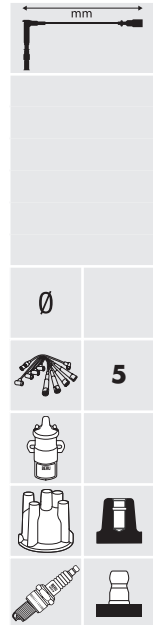

CLS023



CLS024





CLS025



CLS026

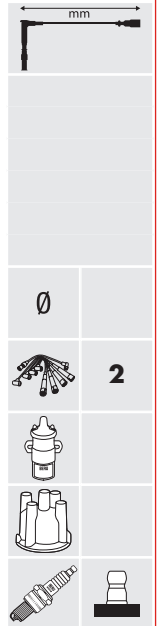

CLS027



CLS028

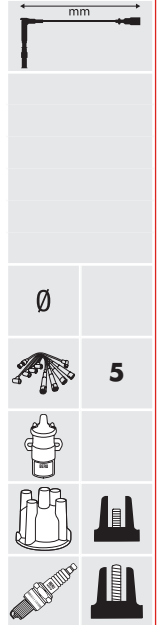

CLS029

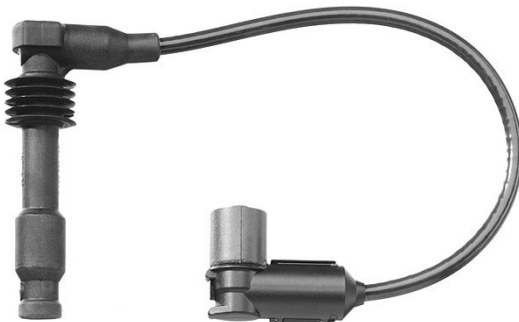

CLS030

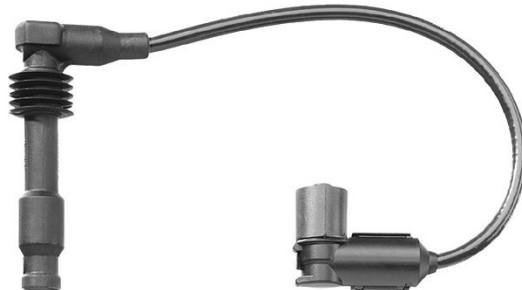



CLS031

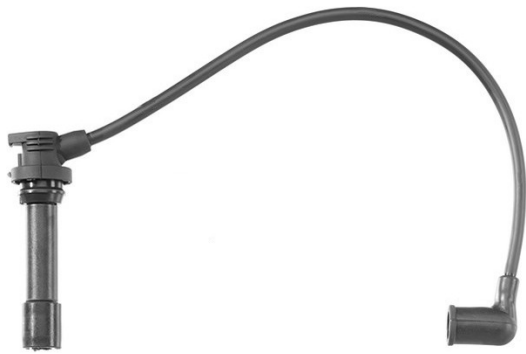

| | |
|----|---|
| mm | |
| ∅ | |
| | 4 |
| | |
| | |
| | |

CLS032



| | |
|----|---|
| mm | |
| ∅ | |
| | 4 |
| | |
| | |
| | |

CLS033

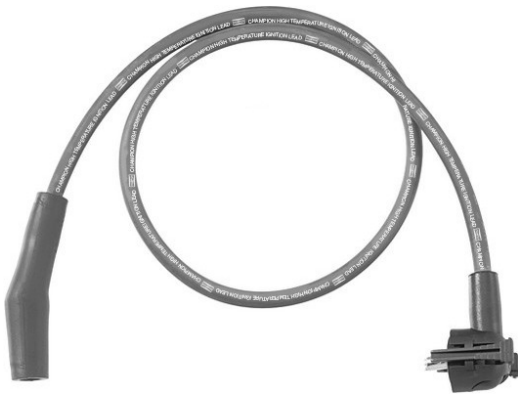

| | |
|----|---|
| mm | |
| ∅ | |
| | 4 |
| | |
| | |
| | |

CLS034



| | |
|----|---|
| mm | |
| ∅ | |
| | 6 |
| | |
| | |
| | |

CLS035



| | |
|----|---|
| mm | |
| ∅ | |
| | 4 |
| | |
| | |
| | |

CLS036



| | |
|----|---|
| mm | |
| ∅ | |
| | 4 |
| | |
| | |
| | |



CLS037



CLS038

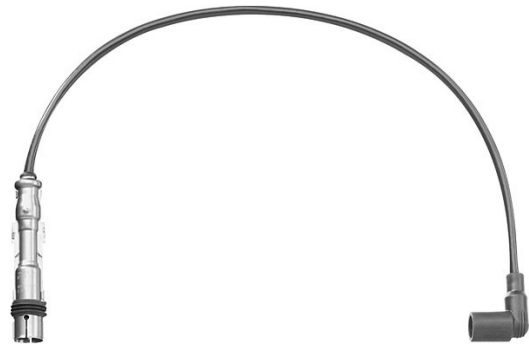

CLS039



CLS040



CLS041



CLS042





CLS043



CLS044



CLS045



CLS046

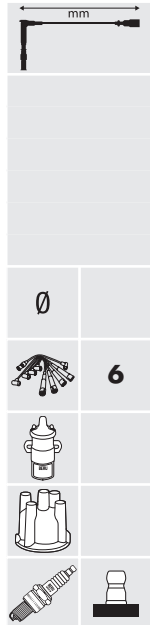

CLS047



CLS048



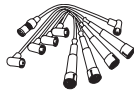

CLS049



| | |
|----|---|
| mm | |
| ∅ | |
| | 4 |
| | |
| | |
| | |

CLS050



| | |
|----|---|
| mm | |
| ∅ | |
| | 6 |
| | |
| | |
| | |

CLS051

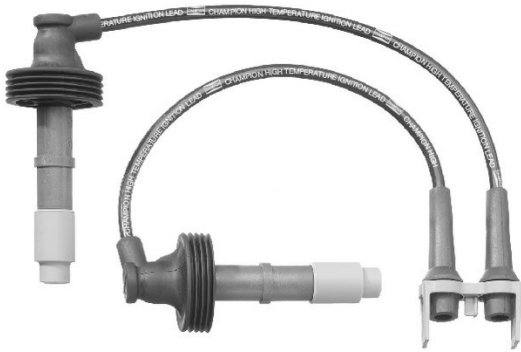

| | |
|----|---|
| mm | |
| ∅ | |
| | 4 |
| | |
| | |
| | |

CLS052



| | |
|----|---|
| mm | |
| ∅ | |
| | 4 |
| | |
| | |
| | |

CLS053

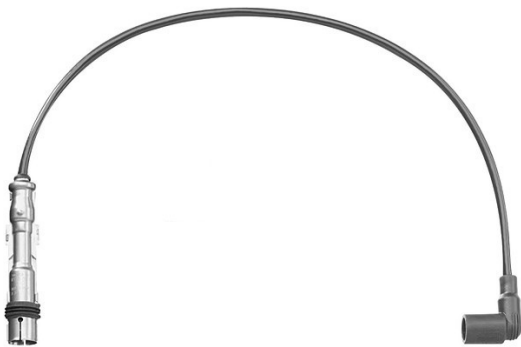

| | |
|----|---|
| mm | |
| ∅ | |
| | 4 |
| | |
| | |
| | |

CLS054



| | |
|----|---|
| mm | |
| ∅ | |
| | 4 |
| | |
| | |
| | |



CLS055



CLS056

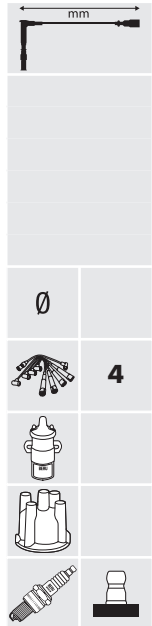

CLS057

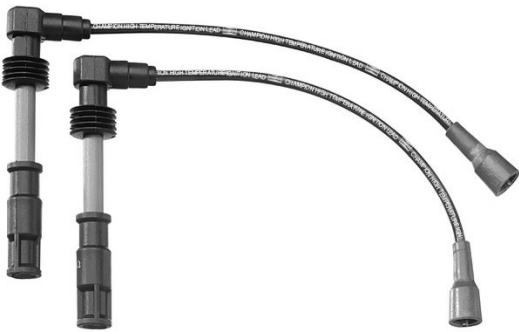

CLS058

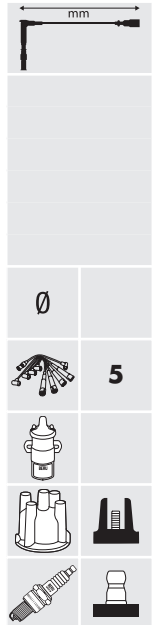

CLS059



CLS060

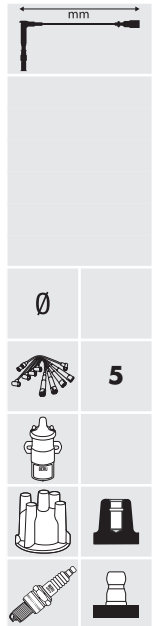

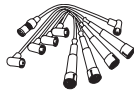

CLS061



| | |
|----|---|
| mm | |
| ∅ | |
| | 5 |
| | |
| | |
| | |

CLS062



| | |
|----|---|
| mm | |
| ∅ | |
| | 7 |
| | |
| | |
| | |

CLS063



| | |
|----|---|
| mm | |
| ∅ | |
| | 2 |
| | |
| | |
| | |

CLS064



| | |
|----|----|
| mm | |
| ∅ | |
| | 12 |
| | |
| | |
| | |

CLS065



| | |
|----|---|
| mm | |
| ∅ | |
| | 4 |
| | |
| | |
| | |

CLS066



| | |
|----|---|
| mm | |
| ∅ | |
| | 4 |
| | |
| | |
| | |



CLS067



CLS068

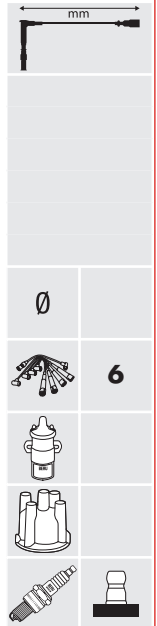
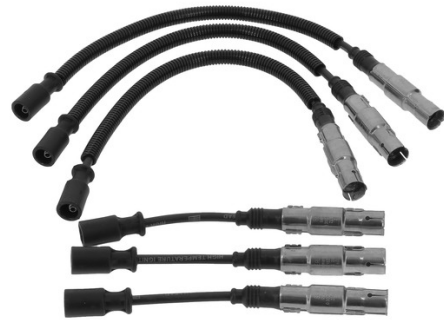

CLS069



CLS070



CLS071



CLS072





CLS073



| | |
|----|---|
| mm | |
| ∅ | |
| | 4 |
| | |
| | |
| | |

CLS074



| | |
|----|-----|
| mm | |
| ∅ | 8mm |
| | 4 |
| | |
| | |
| | |

CLS075



| | |
|----|---|
| mm | |
| ∅ | |
| | 4 |
| | |
| | |
| | |

CLS076



| | |
|----|---|
| mm | |
| ∅ | |
| | 4 |
| | |
| | |
| | |

CLS077



| | |
|----|-----|
| mm | |
| ∅ | 8mm |
| | 4 |
| | |
| | |
| | |

CLS078



| | |
|----|---|
| mm | |
| ∅ | |
| | 4 |
| | |
| | |
| | |



CLS079



CLS080



CLS081



CLS082



CLS083



CLS084



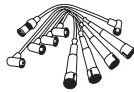

CLS085



| | |
|----|---|
| mm | |
| ∅ | |
| | 4 |
| | |
| | |
| | |

CLS086



| | |
|----|---|
| mm | |
| ∅ | |
| | 4 |
| | |
| | |
| | |

CLS087

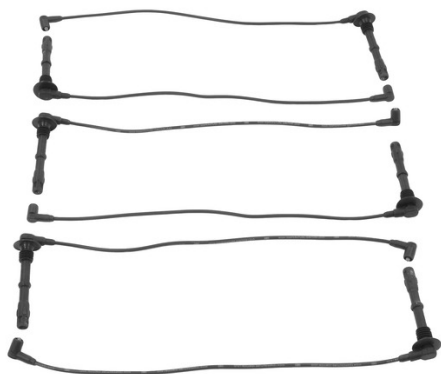

| | |
|----|---|
| mm | |
| ∅ | |
| | 6 |
| | |
| | |
| | |

CLS088



| | |
|----|---|
| mm | |
| ∅ | |
| | 4 |
| | |
| | |
| | |

CLS089

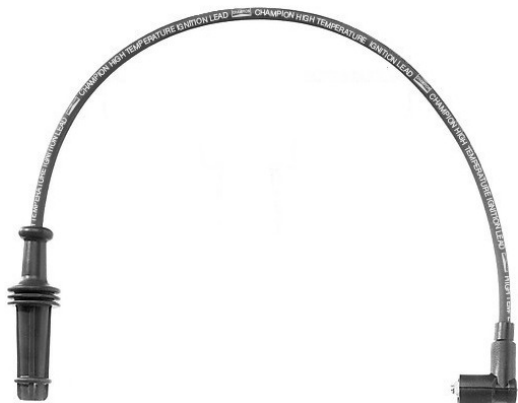

| | |
|--------------------------|-----|
| mm | |
| 380 320 190 140 | |
| ∅ | 8mm |
| | 4 |
| | |
| | |
| | |

CLS090



| | |
|----|---|
| mm | |
| ∅ | |
| | 4 |
| | |
| | |
| | |



CLS091



| | |
|-----|---|
| mm | |
| 200 | |
| 330 | |
| 370 | |
| 420 | |
| ∅ | |
| | 4 |
| | |
| | |
| | |
| | |

CLS092



| | |
|-----|---|
| mm | |
| 200 | |
| 330 | |
| 440 | |
| 460 | |
| ∅ | |
| | 4 |
| | |
| | |
| | |
| | |

CLS093



| | |
|-----|---|
| mm | |
| 280 | |
| 280 | |
| 380 | |
| 460 | |
| ∅ | |
| | 4 |
| | |
| | |
| | |
| | |

CLS094



| | |
|-----|---|
| mm | |
| 240 | |
| 330 | |
| 420 | |
| 540 | |
| ∅ | |
| | 4 |
| | |
| | |
| | |
| | |

CLS095



| | |
|-----|---|
| mm | |
| 460 | |
| 310 | |
| 340 | |
| 440 | |
| 510 | |
| ∅ | |
| | 5 |
| | |
| | |
| | |
| | |

CLS096



| | |
|-----|-----|
| mm | |
| 240 | |
| 290 | |
| 360 | |
| 460 | |
| ∅ | 5mm |
| | 4 |
| | |
| | |
| | |
| | |

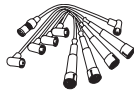

CLS097



CLS098



CLS099



CLS100



CLS101

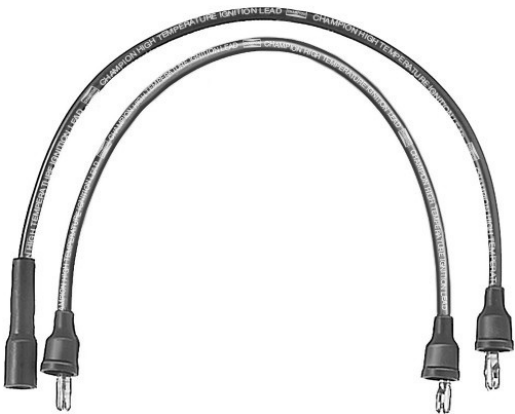

CLS102





CLS103



CLS104

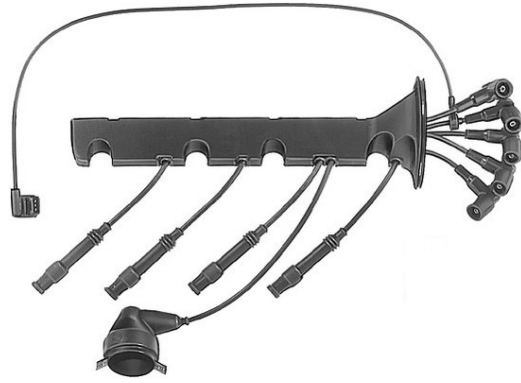

CLS105

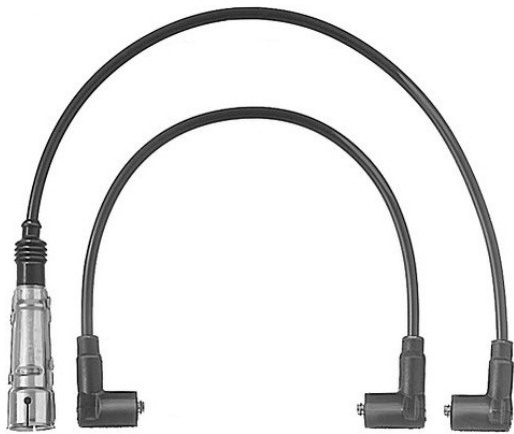

CLS106



CLS107



CLS108



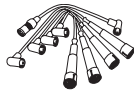

CLS109



| | |
|----|---|
| mm | |
| ∅ | |
| | 5 |
| | |
| | |
| | |

CLS110



| | |
|----|---|
| mm | |
| ∅ | |
| | 5 |
| | |
| | |
| | |

CLS111



| | |
|----|---|
| mm | |
| ∅ | |
| | 4 |
| | |
| | |
| | |

CLS112



| | |
|----|---|
| mm | |
| ∅ | |
| | 4 |
| | |
| | |
| | |

CLS113



| | |
|----|---|
| mm | |
| ∅ | |
| | 5 |
| | |
| | |
| | |

CLS114

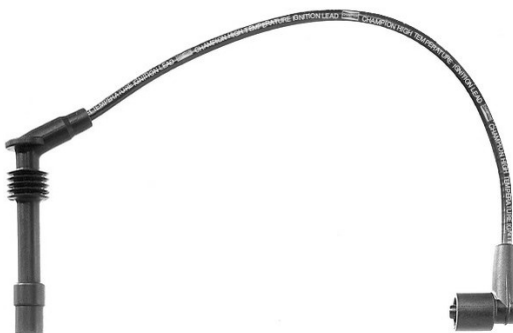

| | |
|----|---|
| mm | |
| ∅ | |
| | 4 |
| | |
| | |
| | |



CLS115

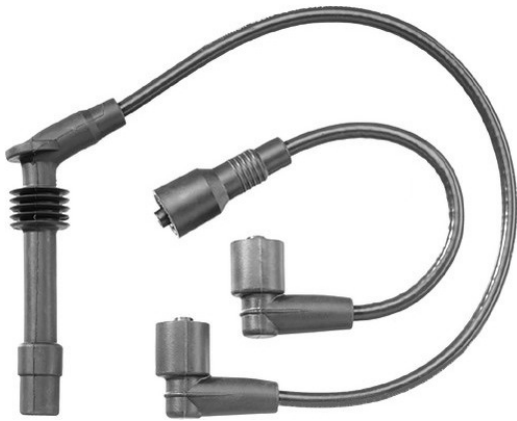

| | |
|----|---|
| mm | |
| ∅ | |
| | 5 |
| | |
| | |
| | |

CLS116



| | |
|----|---|
| mm | |
| ∅ | |
| | 5 |
| | |
| | |
| | |

CLS117



| | |
|----|---|
| mm | |
| ∅ | |
| | 5 |
| | |
| | |
| | |

CLS118



| | |
|----|---|
| mm | |
| ∅ | |
| | 5 |
| | |
| | |
| | |

CLS119



| | |
|----|---|
| mm | |
| ∅ | |
| | 5 |
| | |
| | |
| | |

CLS120



| | |
|----|---|
| mm | |
| ∅ | |
| | 4 |
| | |
| | |
| | |



CLS121

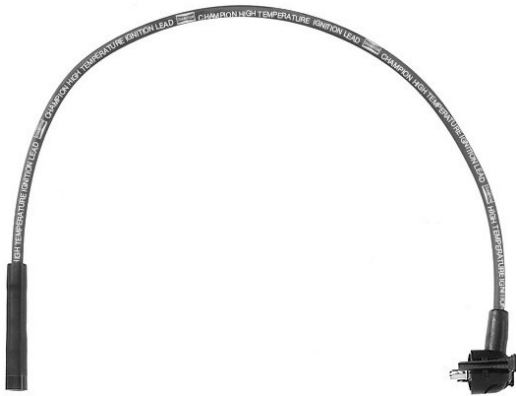

CLS122

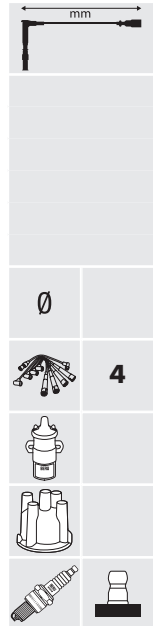

CLS123



CLS124

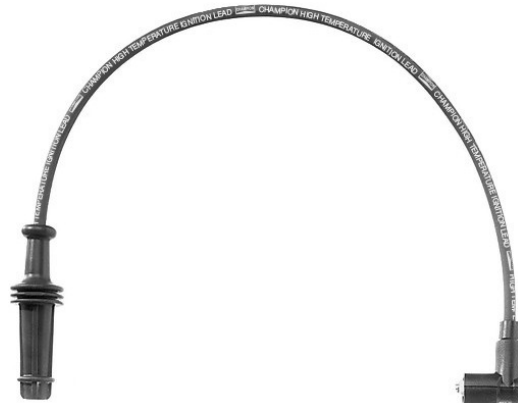

CLS125



CLS126

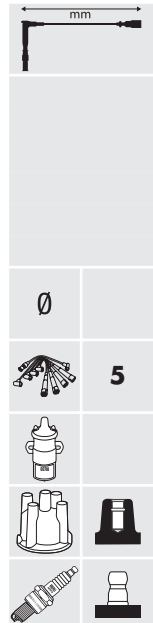



CLS127



CLS128



CLS129



CLS130



CLS131

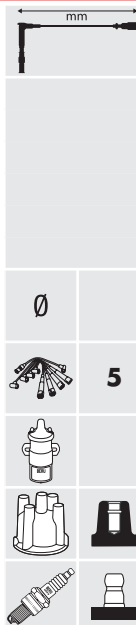

CLS132





CLS133



CLS134

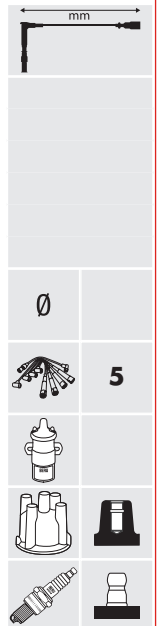

CLS135



CLS136



CLS137



CLS138

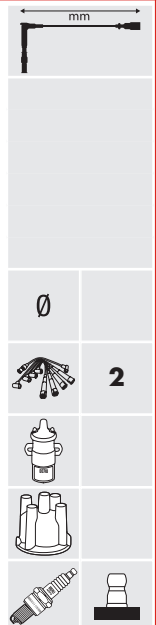
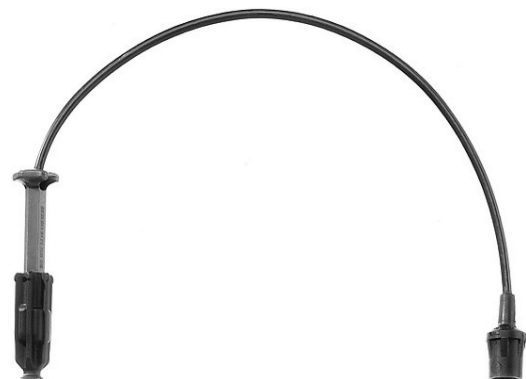



CLS139



| | |
|----|---|
| mm | |
| ∅ | |
| | 4 |
| | |
| | |
| | |

CLS140



| | |
|----|---|
| mm | |
| ∅ | |
| | 4 |
| | |
| | |
| | |

CLS141



| | |
|----|---|
| mm | |
| ∅ | |
| | 5 |
| | |
| | |
| | |

CLS144

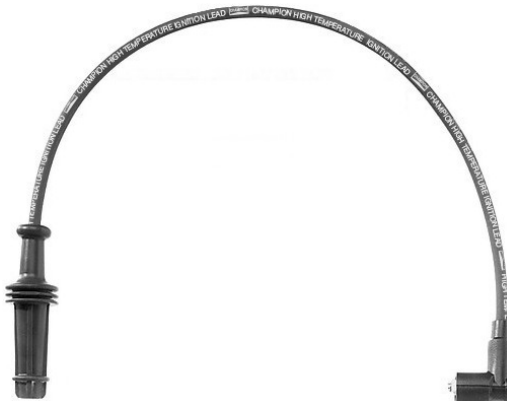

| | |
|----|-----|
| mm | |
| | 330 |
| | 390 |
| | 450 |
| | 230 |
| ∅ | |
| | 4 |
| | |
| | |
| | |

CLS147

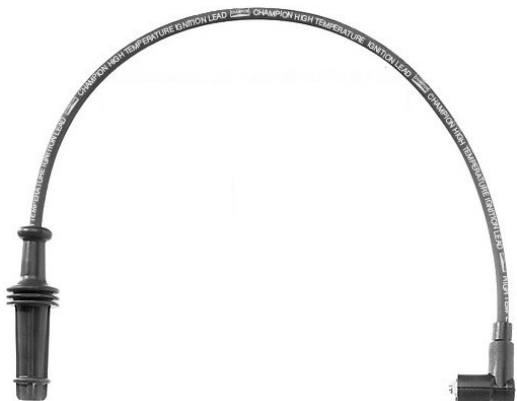

| | |
|----|-----|
| mm | |
| | 390 |
| | 290 |
| | 350 |
| | 380 |
| ∅ | |
| | 4 |
| | |
| | |
| | |

CLS148

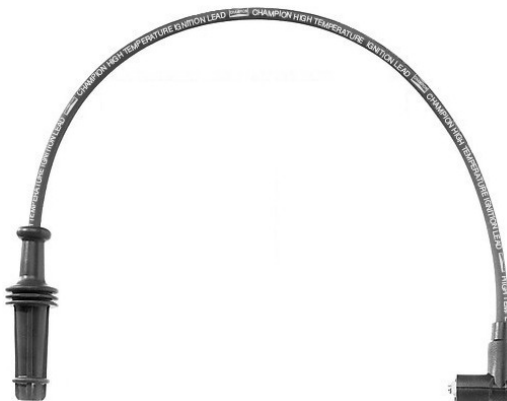

| | |
|----|-----|
| mm | |
| | 475 |
| | 475 |
| | 665 |
| | 705 |
| | 505 |
| ∅ | |
| | 5 |
| | |
| | |
| | |

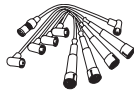

CLS149

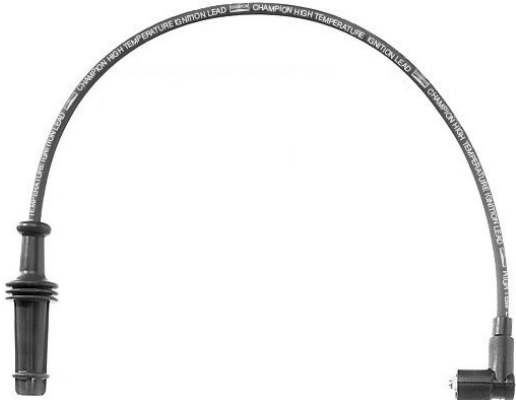

| | |
|-----|---|
| mm | |
| 340 | |
| 340 | |
| 380 | |
| 420 | |
| ∅ | |
| | 4 |
| | |
| | |
| | |
| | |

CLS150

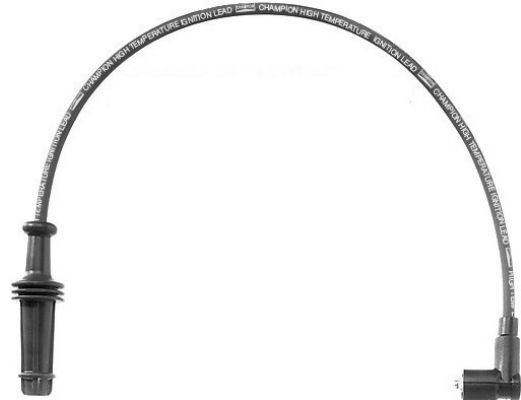

| | |
|-----|---|
| mm | |
| 665 | |
| 595 | |
| 455 | |
| 385 | |
| 305 | |
| ∅ | |
| | 5 |
| | |
| | |
| | |
| | |

CLS153



| | |
|-----|---|
| mm | |
| 425 | |
| 465 | |
| 605 | |
| 645 | |
| 885 | |
| ∅ | |
| | 5 |
| | |
| | |
| | |
| | |

CLS155

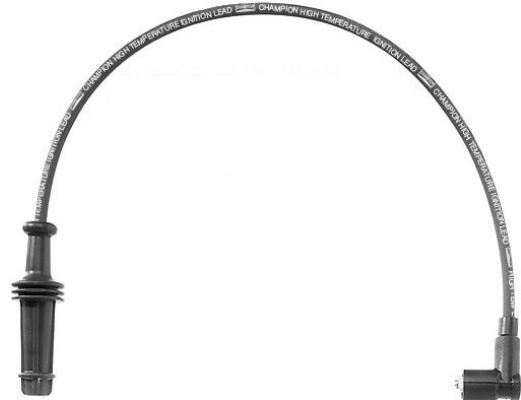

| | |
|-----|---|
| mm | |
| 600 | |
| 530 | |
| 430 | |
| 400 | |
| 210 | |
| ∅ | |
| | 5 |
| | |
| | |
| | |
| | |

CLS156



| | |
|------|---|
| mm | |
| 440 | |
| 400 | |
| 470 | |
| 900 | |
| 1035 | |
| 1100 | |
| ∅ | |
| | 6 |
| | |
| | |
| | |
| | |

CLS157

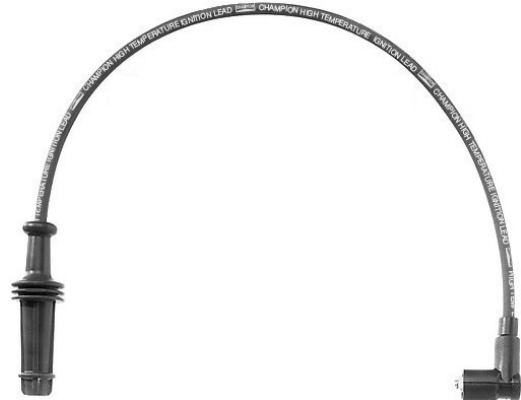

| | |
|-----|---|
| mm | |
| 335 | |
| 190 | |
| ∅ | |
| | 2 |
| | |
| | |
| | |
| | |



CLS159

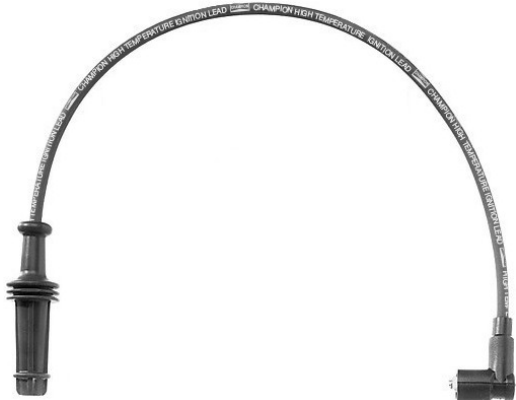

| | |
|-----|---|
| mm | |
| 180 | |
| 560 | |
| ∅ | |
| | 2 |
| | |
| | |
| | |

CLS161

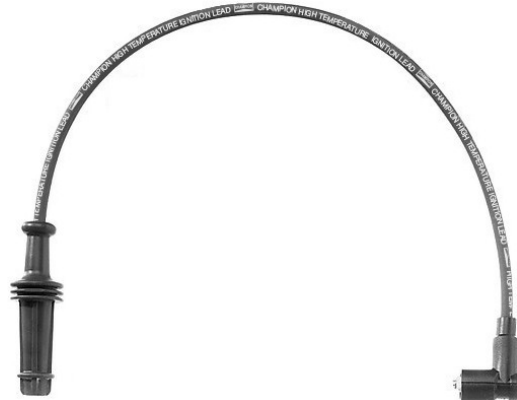

| | |
|-----|---|
| mm | |
| 390 | |
| 430 | |
| 530 | |
| 600 | |
| 795 | |
| ∅ | |
| | 5 |
| | |
| | |
| | |

CLS163

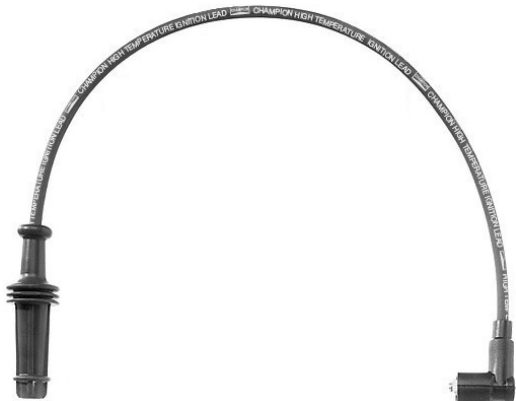

| | |
|-----|---|
| mm | |
| 400 | |
| 300 | |
| 300 | |
| 400 | |
| ∅ | |
| | 4 |
| | |
| | |
| | |

CLS166



| | |
|----|---|
| mm | |
| | |
| | |
| | |
| | |
| ∅ | |
| | 5 |
| | |
| | |
| | |

CLS167



| | |
|----|---|
| mm | |
| 90 | |
| 28 | |
| ∅ | |
| | 2 |
| | |
| | |
| | |

CLS168



| | |
|----|---|
| mm | |
| | |
| | |
| | |
| | |
| ∅ | |
| | 4 |
| | |
| | |
| | |

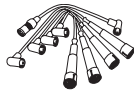

CLS169



| | |
|----|---|
| mm | |
| ∅ | |
| | 4 |
| | |
| | |
| | |

CLS170



| | |
|----|---|
| mm | |
| ∅ | |
| | 4 |
| | |
| | |
| | |

CLS171



| | |
|----|---|
| mm | |
| ∅ | |
| | 4 |
| | |
| | |
| | |

CLS172



| | |
|----|---|
| mm | |
| ∅ | |
| | 6 |
| | |
| | |
| | |

CLS173



| | |
|----|---|
| mm | |
| ∅ | |
| | 2 |
| | |
| | |
| | |

CLS174



| | |
|----|---|
| mm | |
| ∅ | |
| | 5 |
| | |
| | |
| | |



CLS175



CLS176

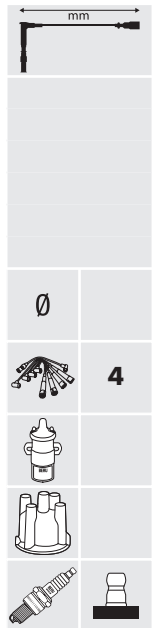

CLS177



CLS178

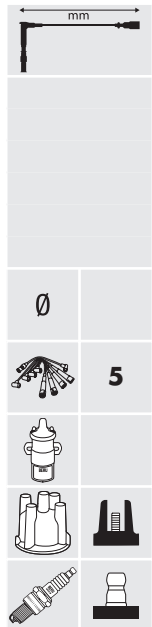
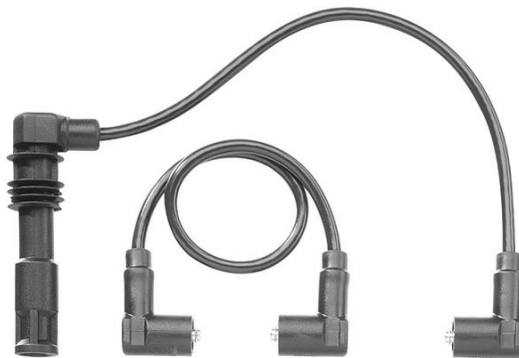

CLS179



CLS180

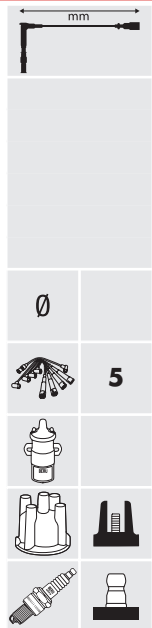
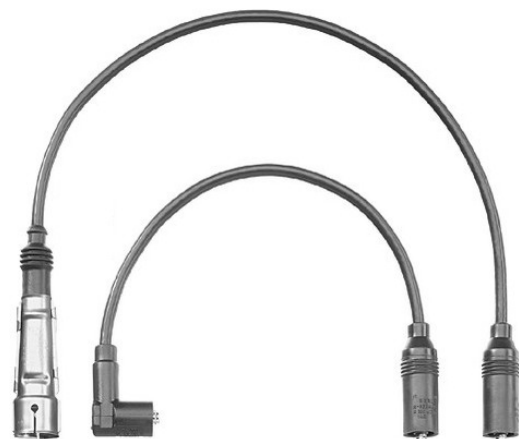



CLS181



CLS182

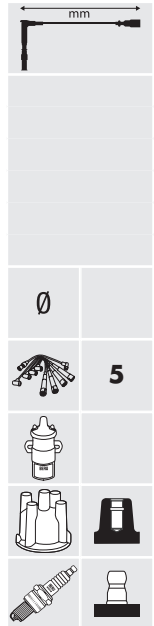

CLS183



CLS184

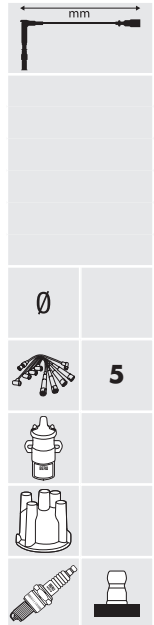

CLS185



CLS186





CLS187



| | |
|----|---|
| mm | |
| ∅ | |
| | 2 |
| | |
| | |
| | |

CLS188



| | |
|----|---|
| mm | |
| ∅ | |
| | 5 |
| | |
| | |
| | |

CLS189



| | |
|----|---|
| mm | |
| ∅ | |
| | 6 |
| | |
| | |
| | |

CLS190



| | |
|----|---|
| mm | |
| ∅ | |
| | 5 |
| | |
| | |
| | |

CLS191



| | |
|-----|---|
| mm | |
| 260 | |
| 360 | |
| 450 | |
| 560 | |
| 810 | |
| ∅ | |
| | 5 |
| | |
| | |
| | |

CLS192



| | |
|----|---|
| mm | |
| ∅ | |
| | 4 |
| | |
| | |
| | |



CLS193



| | |
|----|---|
| mm | |
| ∅ | |
| | 6 |
| | |
| | |
| | |

CLS194



| | |
|----|---|
| mm | |
| ∅ | |
| | 4 |
| | |
| | |
| | |

CLS195



| | |
|-----|-----|
| mm | |
| 360 | |
| 360 | |
| ∅ | 7mm |
| | 2 |
| | |
| | |
| | |

CLS196



| | |
|-----|---|
| mm | |
| 270 | |
| 410 | |
| 470 | |
| 530 | |
| ∅ | |
| | 4 |
| | |
| | |
| | |

CLS197



| | |
|-----|---|
| mm | |
| 230 | |
| 310 | |
| 410 | |
| 460 | |
| ∅ | |
| | 4 |
| | |
| | |
| | |

CLS198



| | |
|-----|-----|
| mm | |
| 250 | |
| 620 | |
| ∅ | 5mm |
| | 2 |
| | |
| | |
| | |



CLS199



CLS200

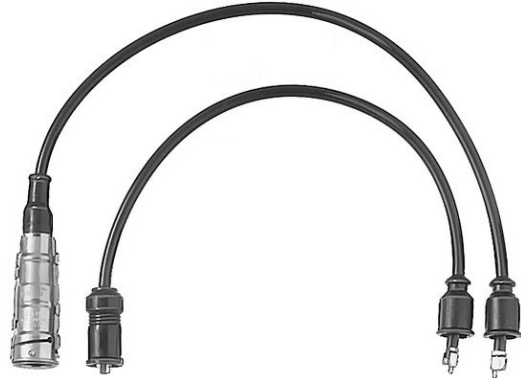

CLS201

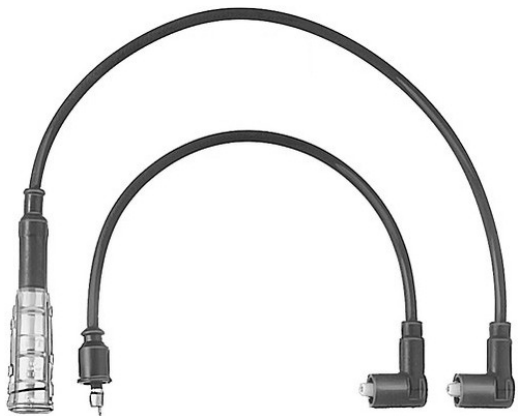

CLS202

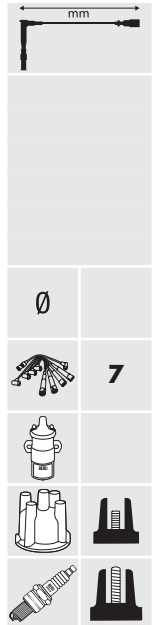

CLS203

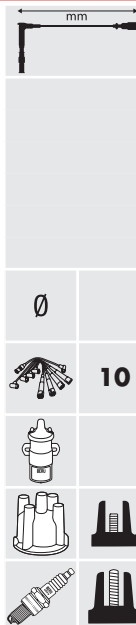
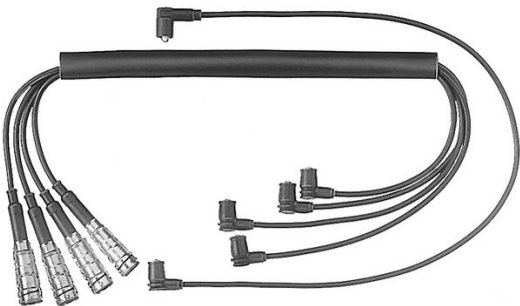

CLS204



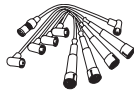

CLS205



CLS206



CLS207

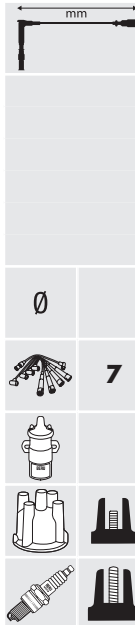
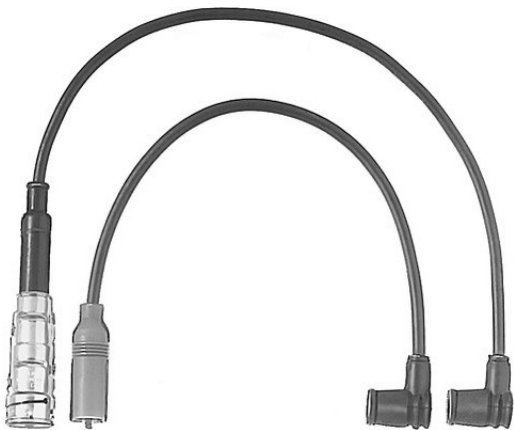

CLS208

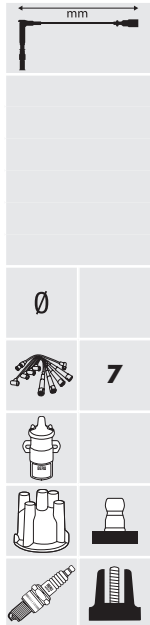

CLS210

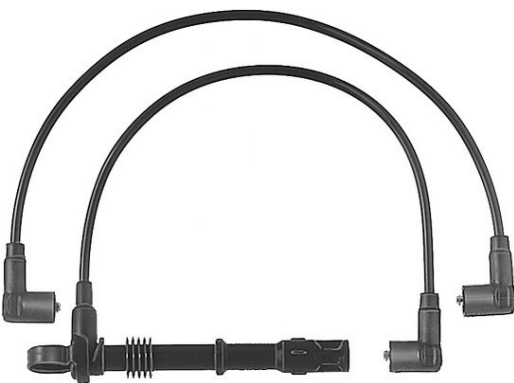

CLS211





CLS212



CLS213

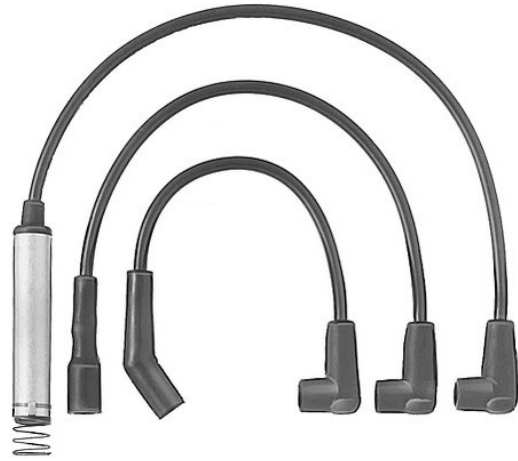

CLS214



CLS215

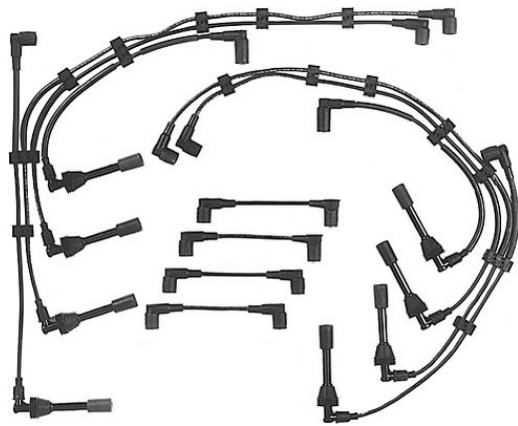

CLS216



CLS217



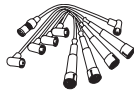

CLS218



CLS219

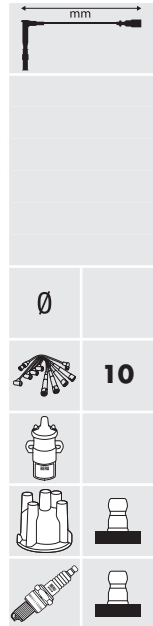

CLS220



CLS221

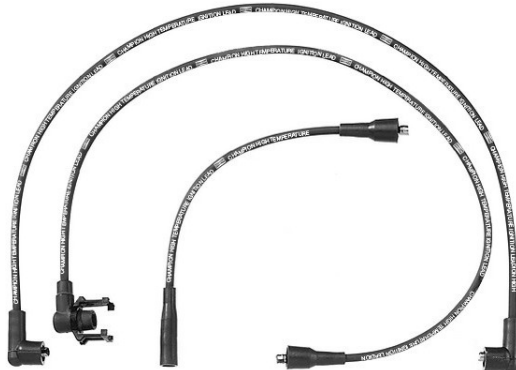

CLS222



CLS223

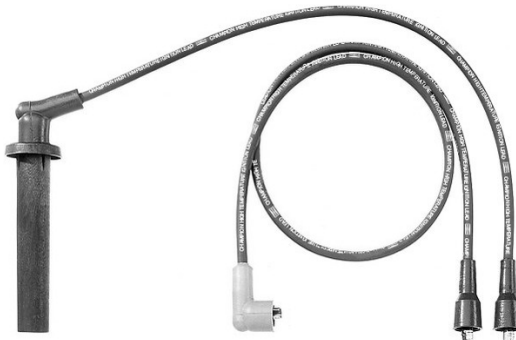



CLS224



| | |
|----|---|
| mm | |
| ∅ | |
| | 5 |
| | |
| | |
| | |

CLS225

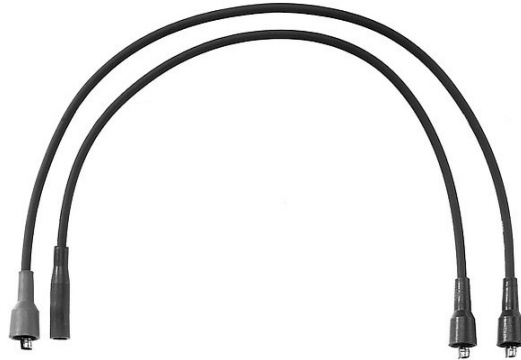

| | |
|----|---|
| mm | |
| ∅ | |
| | 5 |
| | |
| | |
| | |

CLS226

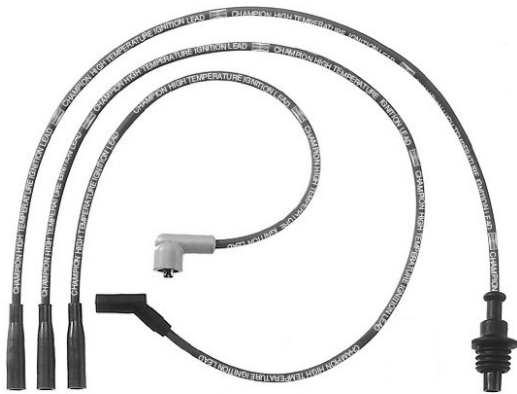

| | |
|----|---|
| mm | |
| ∅ | |
| | 6 |
| | |
| | |
| | |

CLS227



| | |
|----|---|
| mm | |
| ∅ | |
| | 5 |
| | |
| | |
| | |

CLS228



| | |
|----|---|
| mm | |
| ∅ | |
| | 5 |
| | |
| | |
| | |

CLS229



| | |
|----|---|
| mm | |
| ∅ | |
| | 4 |
| | |
| | |
| | |



CLS230



CLS231



CLS232



CLS233



CLS234

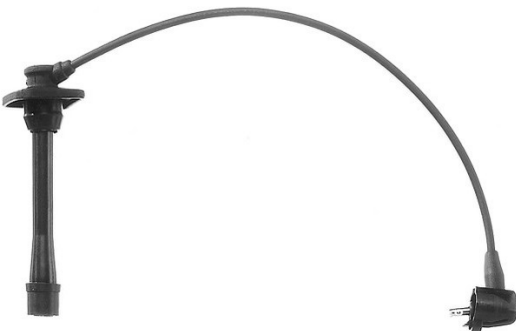

CLS235





CLS236



CLS237

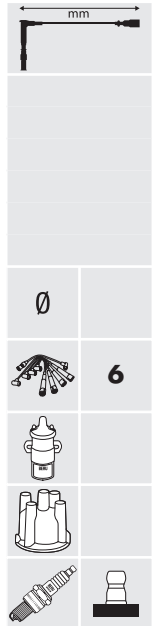

CLS238



CLS239

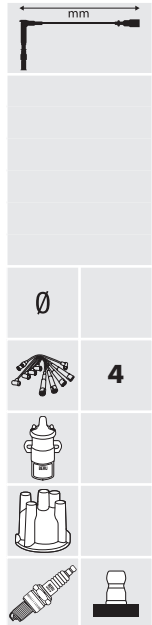
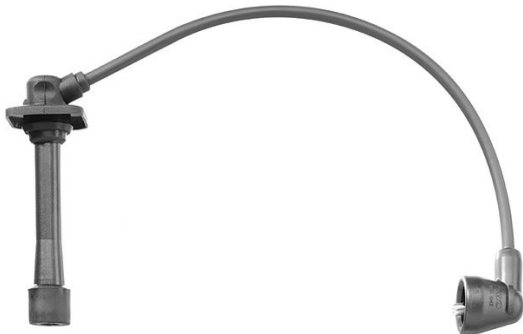

CLS240

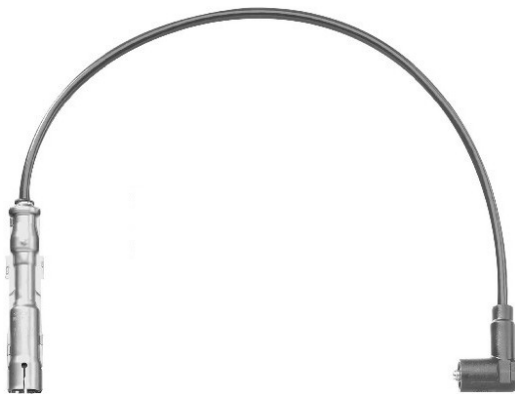

CLS241





CLS242

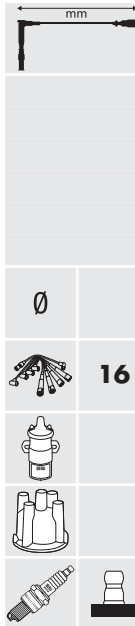

CLS243



CLS244

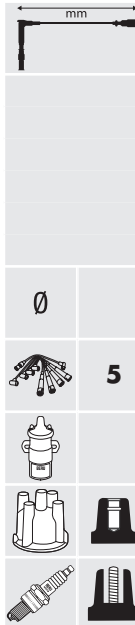

CLS245

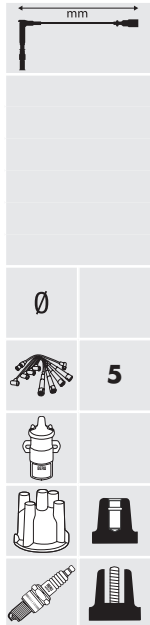

CLS246

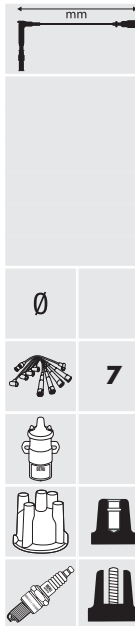
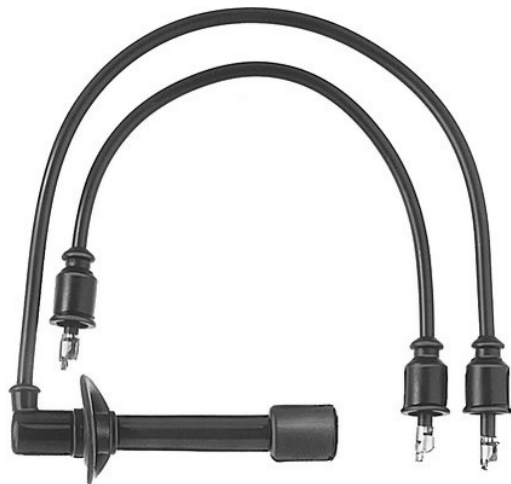

CLS247





CLS248

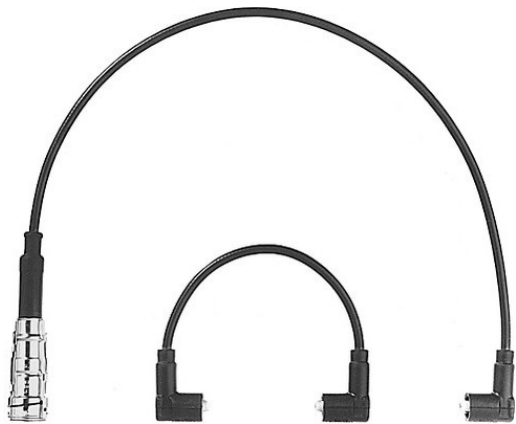

CLS249

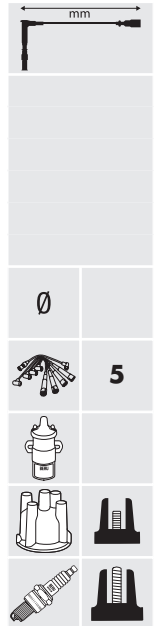
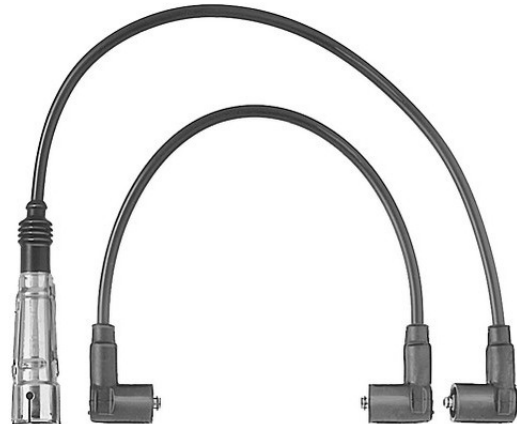

CLS250



CLS251

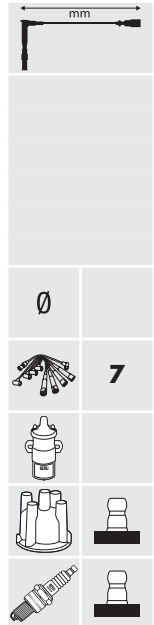

CLS252



CLS253

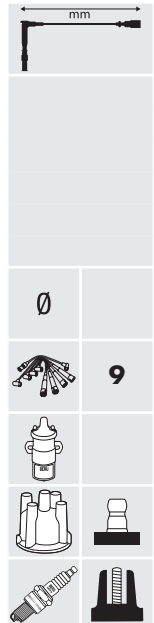

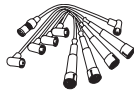

CLS254

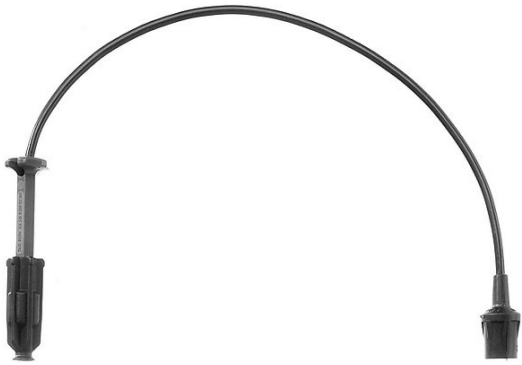

| | |
|----|---|
| mm | |
| ∅ | |
| | 3 |
| | |
| | |
| | |
| | |

CLS255



| | |
|----|---|
| mm | |
| ∅ | |
| | 5 |
| | |
| | |
| | |
| | |

CLS256



| | |
|-----|---|
| mm | |
| 150 | |
| 250 | |
| 330 | |
| 390 | |
| ∅ | |
| | 4 |
| | |
| | |
| | |
| | |

CLS257



| | |
|-----|---|
| mm | |
| 370 | |
| 410 | |
| ∅ | |
| | 2 |
| | |
| | |
| | |
| | |

CLS258



| | |
|----|---|
| mm | |
| ∅ | |
| | 5 |
| | |
| | |
| | |
| | |

CLS259



| | |
|----|---|
| mm | |
| ∅ | |
| | 4 |
| | |
| | |
| | |
| | |



CLS260



CLS261

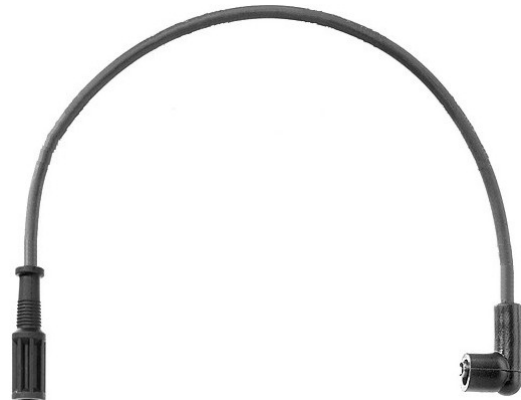

CLS262

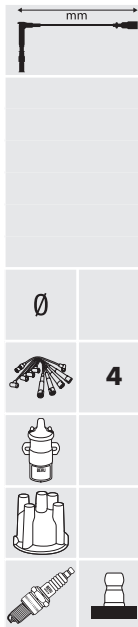
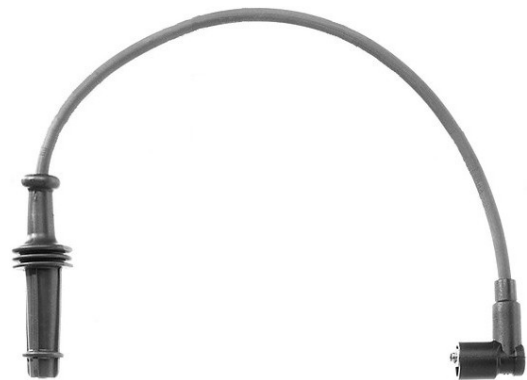

EN

| | | |
|---|--|--|
| [1] Braking / Drive Dynamics: for vehicles with ABS | [50] For manufacturer exhaust norm: CEE 19-5;US 87 | [108] For OE number: 224488J11C |
| [2] Catalytic Converter Type: for vehicles with catalyst | [51] For manufacturer exhaust norm: CEE 95 | [109] For OE number: 22448ED800 |
| [3] Catalytic Converter Type: for vehicles with catalyst arrangement;for vehicles with catalyst | [52] For manufacturer exhaust norm: CEE Fase 2 | [110] For OE number: 25182496;96253555 |
| [4] Catalytic Converter Type: for vehicles without catalytic convertor | [53] For manufacturer exhaust norm: CEE Phase 4 | [111] For OE number: 27301 02100 |
| [5] Catalytic Converter Type: with 3 way catalyst | [54] For manufacturer exhaust norm: CEE Phase 5 | [112] For OE number: 27301 02600 |
| [6] Climate Zones: for cold climates | [55] For manufacturer exhaust norm: CF2 | [113] For OE number: 27301 02700 |
| [7] Colour: Black | [56] For manufacturer exhaust norm: CF2;CF3 | [114] For OE number: 27301 03000 |
| [8] Colour: Blue | [57] For manufacturer exhaust norm: CF3 | [115] For OE number: 27301 03010 |
| [9] Colour: blue;green | [58] For manufacturer exhaust norm: CF3;CF4 | [116] For OE number: 27301 04000 |
| [10] Colour: Grey | [59] For manufacturer exhaust norm: CF4 | [117] For OE number: 27301 22600 |
| [11] Colour: Light Grey | [60] For manufacturer exhaust norm: Euro 5 | [118] For OE number: 27301 23700 |
| [12] Colour: Orange | [61] For manufacturer exhaust norm: US 87 | [119] For OE number: 27301 26600 |
| [13] Colour: Red | [62] For OE number: 000 158 62 03 | [120] For OE number: 27301 28000 |
| [14] Colour: white | [63] For OE number: 000 158 64 03 | [121] For OE number: 27301 28010 |
| [15] Colour: yellow | [64] For OE number: 032 905 106 B | [122] For OE number: 27301 700 |
| [16] Distributor Number: 525352A;525352B;525352C;525352D | [65] For OE number: 036 905 715 F | [123] For OE number: 2S6Q-6M090-AB |
| [17] Exhaust Emission Norm: D3 | [66] For OE number: 03F 905 409 B | [124] For OE number: 2S6Q-6M090-BB |
| [18] Exhaust Emission Norm: D4 | [67] For OE number: 03L 905 061 G | [125] For OE number: 30520-RRA-007 |
| [19] Exhaust Emission Norm: Euro 3 (D3) | [68] For OE number: 04606869AC;04606869AB | [126] For OE number: 30713416;9125601 |
| [20] Exhaust Emission Norm: Euro 3 (D3);Euro 4 (D4) | [69] For OE number: 058 905 101 A | [127] For OE number: 357911253 |
| [21] Exhaust Emission Norm: Euro 4 (D4) | [70] For OE number: 059 905 061 H | [128] For OE number: 36710 2A100 |
| [22] Exhaust Emission Norm: Euro 5 | [71] For OE number: 059 963 319 T | [129] For OE number: 36710 3A000 |
| [23] Exhaust Emission Norm: Euro 5 PLUS | [72] For OE number: 06A 905 097 | [130] For OE number: 36710 4A000 |
| [24] Exhaust Emission Norm: Euro 6 | [73] For OE number: 06A 905 115 D | [131] For OE number: 46 777 288 |
| [25] Exhaust Emission Norm: Euro 6 PLUS | [74] For OE number: 06B 905 115 E | [132] For OE number: 46796050 |
| [26] Exhaust Emission Norm: ULEV2 | [75] For OE number: 06E 905 115 E | [133] For OE number: 55210051 |
| [27] Fitting Position: Exhaust Manifold | [76] For OE number: 07K 905 715 F | [134] For OE number: 5960 66 |
| [28] Fitting Position: Intake Manifold | [77] For OE number: 100630 | [135] For OE number: 5960 66;5960 F5 |
| [29] Fitting Position: Lateral Installation;to cylinder 5;to cylinder 6;to cylinder 7;to cylinder 8 | [78] For OE number: 1106500Q0H;1106500Q0L | [136] For OE number: 5960 F4 |
| [30] Fitting Position: Left | [79] For OE number: 110651492R | [137] For OE number: 70863020 |
| [31] Fitting Position: Right | [80] For OE number: 110651749R | [138] For OE number: 70863021 |
| [32] Fitting Position: to cylinder 1;to cylinder 2;to cylinder 3 | [81] For OE number: 110655X00A | [139] For OE number: 7648797 |
| [33] Fitting Position: to cylinder 1;to cylinder 2;to cylinder 3;to cylinder 4 | [82] For OE number: 11067BN700 | [140] For OE number: 7700100589 |
| [34] Fitting Position: to cylinder 1;to cylinder 2;to cylinder 4 | [83] For OE number: 12 13 1 703 228 | [141] For OE number: 7700100643 |
| [35] Fitting Position: to cylinder 1;to cylinder 3 | [84] For OE number: 12 13 7 172 219 | [142] For OE number: 7700273226 |
| [36] Fitting Position: to cylinder 1;to cylinder 3;to cylinder 5 | [85] For OE number: 12 13 7 510 738 | [143] For OE number: 7700273826 |
| [37] Fitting Position: to cylinder 1;to cylinder 4 | [86] For OE number: 12 13 7 548 553 | [144] For OE number: 7700274008;224336134R |
| [38] Fitting Position: to cylinder 2 | [87] For OE number: 12 13 7 594 937 | [145] For OE number: 7701041607 |
| [39] Fitting Position: to cylinder 2;to cylinder 3 | [88] For OE number: 12 13 7 638 477 | [146] For OE number: 7701041608 |
| [40] Fitting Position: to cylinder 2;to cylinder 3;to cylinder 4 | [89] For OE number: 12 13 8 616 153 | [147] For OE number: 7746152 |
| [41] Fitting Position: to cylinder 2;to cylinder 4 | [90] For OE number: 12 21 7 800 156 | [148] For OE number: 7746153 |
| [42] Fitting Position: to cylinder 2;to cylinder 4;to cylinder 6 | [91] For OE number: 12 21 7 801 200 | [149] For OE number: 8200051128 |
| [43] Fitting Position: to cylinder 2;to cylinder 5 | [92] For OE number: 12 23 0 038 490 | [150] For OE number: 8200084401;8200025256 |
| [44] Fitting Position: to cylinder 3 | [93] For OE number: 12 23 2 248 059 | [151] For OE number: 8200360911;8200702693 |
| [45] Fitting Position: to cylinder 5;to cylinder 6;to cylinder 7;to cylinder 8 | [94] For OE number: 12 23 7 786 869 | [152] For OE number: 8200486877 |
| [46] Fitting Position: Upper;to cylinder 1;to cylinder 2;to cylinder 3;to cylinder 4 | [95] For OE number: 12 23 7 798 001 | [153] For OE number: 8200506297 |
| [47] for facelift: No | [96] For OE number: 12611424 | [154] For OE number: 8200561251 |
| [48] for facelift: Yes | [97] For OE number: 1275971 | [155] For OE number: 8200682592 |
| [49] For manufacturer exhaust norm: CEE 19-5 | [98] For OE number: 1306696 | [156] For OE number: 8200702693 |
| | [99] For OE number: 171 905 115 | [157] For OE number: 8200943801 |
| | [100] For OE number: 18550-80KAO | [158] For OE number: 8973065193 |
| | [101] For OE number: 22 43 361 34R | [159] For OE number: 90543253 |
| | [102] For OE number: 2240100Q0G, 2240100Q0K | [160] For OE number: 90919-01218 |
| | [103] For OE number: 2240100Q0K | [161] For OE number: 90919-02230 |
| | [104] For OE number: 22401CK81B | [162] For OE number: 90919-02234 |
| | [105] For OE number: 224332428R | [163] For OE number: 90919-02234;90919-02207 |
| | [106] For OE number: 224481KTOA | [164] For OE number: 90919-02238 |
| | [107] For OE number: 224488H315 | [165] For OE number: 90919-02243 |

EN

[166] For OE number: 90919-02248
[167] For OE number: 90919-02262
[168] For OE number: 90919-02265
[169] For OE number: 90919-02266
[170] For OE number: 93177212
[171] For OE number: 93198468
[172] For OE number: 9638985980
[173] For OE number: 9651583680
[174] For OE number: A 000 158 78 03
[175] For OE number: A 001 159 15 01;A 001 159 16 01
[176] For OE number: A 001 159 20 01;A 001 159 21 01
[177] For OE number: A 001 159 26 01
[178] For OE number: A 001 159 50 01;A 001 159 71 01
[179] For OE number: A 272 906 00 60
[180] For OE number: A 642 900 58 01
[181] For OE number: N 105 916 02;N 105 916 03
[182] For OE number: N 105 916 03
[183] For OE number: N 105 916 04
[184] For OE number: N 105 916 08
[185] For OE number: NEC100630
[186] For OE number: S210-18-140;S210-18-140 A
[187] For OE number: XM34-12A342-BA
[188] For PR number: OGG
[189] For PR number: OK0 + TS8 + 7MJ, 7MU, 7MR
[190] For PR number: OK3, OK4 +TS8, T7V
[191] For PR number: 7CF
[192] For PR number: 7CF, 7MM
[193] For PR number: 7MM
[194] For PR number: 7MM, 7MJ
[195] For PR number: 7MM, 7MJ, 7CP
[196] For PR number: 7MM;7MJ;7MW
[197] For PR number: 7MU
[198] For PR number: D3E
[199] For PR number: D7N
[200] For PR number: GP1
[201] For PR number: GP2+TD1
[202] For PR number: GP2+TF1
[203] For PR number: GP2+TH1
[204] For PR number: TON;T11
[205] For PR number: T41
[206] For PR number: T41;TF1
[207] For PR number: T7V
[208] For PR number: T7V +7CP, 7CS, 7MV
[209] For PR number: TD1
[210] For PR number: TD1+7MM, 7MJ, 7MW
[211] For PR number: TD1+7MM, 7MJ, 7MW, 7CP
[212] For PR number: TE1
[213] For PR number: TF1
[214] For PR number: TG1
[215] For PR number: TH1
[216] For PR number: TH1+7GB
[217] For PR number: TH1+7MK
[218] For PR number: TK8, TH8
[219] For PR number: TK8, TL1
[220] For PR number: TK8, TL1, TM5
[221] For PR number: TL1, TK8

[222] For PR number: TL1, TK8, TM5, TH8
[223] For PR number: TL1, TP1
[224] For PR number: TL4
[225] For PR number: TM4
[226] For PR number: TP1
[227] For PR number: TS8
[228] For PR number: TS8 + 7MJ
[229] for SA code: 021
[230] for SA code: 022
[231] for SA code: 494
[232] for SA code: 700
[233] for SA code: 803;804;805;806
[234] for SA code: 940K;939K;802
[235] for SA code: MC1;MC2;MC3;MP1;MP2;MP3
[236] for SA code: MC2+MS9
[237] for SA code: MQ3;MQ4;MQ5
[238] for SA code: MQ6;MCO
[239] for SA code: U43;U83
[240] Manufacturer Restriction: BERU
[241] Manufacturer Restriction: BORGWARNER
[242] Manufacturer Restriction: Bosch
[243] Manufacturer Restriction: BOSCH; DUCELLIER
[244] Manufacturer Restriction: Bosch;Beru
[245] Manufacturer Restriction: Bremi
[246] Manufacturer Restriction: DELCO REMY
[247] Manufacturer Restriction: DELPHI
[248] Manufacturer Restriction: Ducellier
[249] Manufacturer Restriction: ELDOR
[250] Manufacturer Restriction: ELECTRICFIL
[251] Manufacturer Restriction: Electronic
[252] Manufacturer Restriction: Vehicle with diagnosis
[253] Manufacturer Restriction: HITACHI
[254] Manufacturer Restriction: ILKAR7A7
[255] Manufacturer Restriction: LUCAS
[256] Manufacturer Restriction: MARELLI
[257] Manufacturer Restriction: MARELLI;DUCELLIER
[258] Manufacturer Restriction: NGK
[259] Manufacturer Restriction: SAE
[260] Manufacturer Restriction: SAGEM
[261] Manufacturer Restriction: System BOSCH
[262] Manufacturer Restriction: System BOSCH / TEMIC
[263] Manufacturer Restriction: SYSTEM DUCELLIER
[264] Manufacturer Restriction: System HITACHI
[265] Manufacturer Restriction: System VALEO
[266] Manufacturer Restriction: Recommendation
[267] Not for exhaust-emission standard: Euro 5
[268] not for SA Code: 494
[269] not for SA Code: 803;804;805;806
[270] not for SA Code: 808
[271] not for SA Code: 928
[272] not for SA Code: 940K;939K
[273] not for SA Code: U43;U83
[274] Note: Changing the ignition coil to satisfy the manufacturer's requirements, install the ignition coil only together with the original heat shield (FORD 1315753, 2S6G 12A376AE). Make sure that the catalytic converter is operating properly.
[275] Note: Product installed must be determined on vehicle or engine.

[276] Note: Recommendation - When changing the spark plugs on vehicles with connector ignition coils, please replace the connector and use spark plug connector grease (ZKF 01 - Order No. 0 890 300 029) to fit the connector.
[277] Note: Recommendation: ZKF 01 - see accessories list
[278] Recommended replace interval (km): 20000
[279] Recommended replace interval (km): 30000
[280] Regional availability: Exclude USA
[281] Regional availability: Exclude USA;Exclude Japan
[282] Regional availability: Include Canada
[283] Regional availability: Include USA
[284] Regional availability: Include USA;Include Japan
[285] Transmission Type: Automatic Transmission
[286] Transmission Type: CVT (Stepless)
[287] Transmission Type: Manual Transmission
[288] Transmission Type: Manual Transmission, 5-speed
[289] Transmission Type: Manual Transmission, 6-speed
[290] Transmission Type: Semi-automatic
[291] Vehicle Equipment: for vehicles with air conditioning
[292] Vehicle Equipment: For vehicles with distributor
[293] Vehicle Equipment: for vehicles with immobilizer
[294] Vehicle Equipment: for vehicles with start-stop function
[295] Vehicle Equipment: for vehicles without diesel soot filter
[296] Vehicle Equipment: For vehicles without distributor
[297] Vehicle Equipment: for vehicles without immobilizer
[298] Vehicle Equipment: for vehicles without start-stop function
[299] Vehicle Main Current: for vehicles with 12V main current
[300] Version: 0221504030
[301] Version: 03L.L
[302] Version: 04E.A, 04E.B
[303] Version: 04E.A, 04E.D
[304] Version: 04E.A, 04E.D, 04E.G, 04E.C
[305] Version: 04E.B
[306] Version: 04E.D, 04E.A
[307] Version: 04E.D, 04E.A, 04E.G
[308] Version: 04E.D, 04E.C
[309] Version: 04L.D;04L.J
[310] Version: 1P
[311] Version: 2U
[312] Version: 55kW
[313] Version: 56kW
[314] Version: Exhaust Emission Norm CEE2000
[315] Version: Exhaust Emission Norm CEE95
[316] Version: Body: LB
[317] Version: Body: LB (USA)
[318] Version: CEE2000, without EOBD
[319] Version: D4123
[320] Version: DOHC
[321] Version: DSL
[322] Version: Duratorq / SID 206
[323] Version: EA17 041
[324] Version: for FSI-Engines

EN

| |
|--|
| [325] Version: FORMEL E |
| [326] Version: GAMMA |
| [327] Version: JBO;JB1;JB2;JB3 |
| [328] Version: JPN |
| [329] Version: KK13 |
| [330] Version: LCI |
| [331] Version: LDK |
| [332] Version: LDK, LHU |
| [333] Version: M47 |
| [334] Version: M47N |
| [335] Version: M47N2 |
| [336] Version: M57N |
| [337] Version: MA13 |
| [338] Version: MD13 NAGARES |
| [339] Version: MD13 NAGARES;Transmission PF1 |
| [340] Version: MJ |
| [341] Version: MM |
| [342] Version: MPI |
| [343] Version: N47 |
| [344] Version: N47N |
| [345] Version: N57 |
| [346] Version: N57N |
| [347] Version: N57S |
| [348] Version: N57Z |
| [349] Version: NA13 |
| [350] Version: Transmission JR5 |
| [351] Version: NA13;Transmission JR5, TL4 |
| [352] Version: ND13 |
| [353] Version: not for exhaust norm EURO 5 |
| [354] Version: not B37A |
| [355] Version: not B37B |
| [356] Version: not for FSI-Engines |
| [357] Version: not N57N |
| [358] Version: NTK #6 |
| [359] Version: without EOBD |
| [360] Version: OP13 |
| [361] Version: alternative for ZS522 |
| [362] Version: Puma |
| [363] Version: Relais #3/103 |
| [364] Version: Relais #4/103 |
| [365] Version: Relais #8/103 |
| [366] Version: RUSSIA PLANT |
| [367] Version: SOHC |
| [368] Version: Transmission JB3 |
| [369] Version: Transmission JC5 |
| [370] Version: Transmission PK5 |
| [371] Version: UK |
| [372] Version: XT17 LINDE |
| [373] Version: Y-115T1 |
| [374] Version: ZH13 |
| [375] Version: ZP17 |

IT

| | |
|------|---|
| [1] | Frenata/guida: per veicoli con ABS |
| [2] | Tipo catalizzatore: per veicoli con catalizzatore;per veicoli con predisposizione catalizzatore |
| [3] | Tipo catalizzatore: per veicoli con sistema catalitico;per veicoli con motore catalitico |
| [4] | Tipo catalizzatore: per veicoli senza catalizzatore |
| [5] | Tipo catalizzatore: con catalizzatore a tre vie |
| [6] | Zone climatiche: per climi freddi |
| [7] | Colore: Nero |
| [8] | Colore: Blu |
| [9] | Colore: Blu; Verde |
| [10] | Colore: Grigio |
| [11] | Colore: grigio chiaro |
| [12] | Colore: Arancione |
| [13] | Colore: Rosso |
| [14] | Colore: Bianco |
| [15] | Colore: Giallo |
| [16] | N° distributore accensione: 525352A;525352B;525352C;525352D |
| [17] | Norma sui gas di scarico: D3 |
| [18] | Norma sui gas di scarico: D4 |
| [19] | Norma sui gas di scarico: Euro 3 (D3) |
| [20] | Norma sui gas di scarico: Euro 3 (D3);Euro 4 (D4) |
| [21] | Norma sui gas di scarico: Euro 4 (D4) |
| [22] | Norma sui gas di scarico: Euro 5 |
| [23] | Norma sui gas di scarico: Euro 5 PLUS |
| [24] | Norma sui gas di scarico: Euro 6 |
| [25] | Norma sui gas di scarico: Euro 6 PLUS |
| [26] | Norma sui gas di scarico: ULEV2 |
| [27] | Lato montaggio: Collettore gas scarico |
| [28] | Lato montaggio: Collettore d'aspirazione |
| [29] | Lato montaggio: Installazione laterale;a cilindro 5;a cilindro 6;a cilindro 7;a cilindro 8 |
| [30] | Lato montaggio: Sinistra |
| [31] | Lato montaggio: Destra |
| [32] | Lato montaggio: a cilindro 1;a cilindro 2;a cilindro 3 |
| [33] | Lato montaggio: a cilindro 1;a cilindro 2;a cilindro 3;a cilindro 4 |
| [34] | Lato montaggio: to cylinder 1;to cylinder 2;to cylinder 4 |
| [35] | Lato montaggio: a cilindro 1; a cilindro 3 |
| [36] | Lato montaggio: a cilindro 1;a cilindro 3;a cilindro 5 |
| [37] | Lato montaggio: su cilindri 1, 4 |
| [38] | Lato montaggio: su cilindro 2 |
| [39] | Lato montaggio: su cilindri 2, 3 |
| [40] | Lato montaggio: a cilindro 2;a cilindro 3;a cilindro 4 |
| [41] | Lato montaggio: su cilindri 2, 4 |
| [42] | Lato montaggio: a cilindro 2;a cilindro 4;a cilindro 6 |
| [43] | Lato montaggio: to cylinder 2;to cylinder 5 |
| [44] | Lato montaggio: Al cilindro 3 |
| [45] | Lato montaggio: a cilindro 5;a cilindro 6;a cilindro 7;a cilindro 8 |
| [46] | Lato montaggio: Superiore; a cilindro 1;a cilindro 2;a cilindro 3;a cilindro 4 |
| [47] | per Facelift: No |
| [48] | per Facelift: Si |
| [49] | per norma sui gas di scarico-Costruttore: CEE 19-5 |

| | |
|-------|--|
| [50] | per norma sui gas di scarico-Costruttore: CEE 19-5;US 87 |
| [51] | per norma sui gas di scarico-Costruttore: CEE 95 |
| [52] | per norma sui gas di scarico-Costruttore: CEE Fase 2 |
| [53] | per norma sui gas di scarico-Costruttore: CEE Phase 4 |
| [54] | per norma sui gas di scarico-Costruttore: CEE Phase 5 |
| [55] | per norma sui gas di scarico-Costruttore: CF2 |
| [56] | per norma sui gas di scarico-Costruttore: CF2;CF3 |
| [57] | per norma sui gas di scarico-Costruttore: CF3 |
| [58] | per norma sui gas di scarico-Costruttore: CF3;CF4 |
| [59] | per norma sui gas di scarico-Costruttore: CF4 |
| [60] | per norma sui gas di scarico-Costruttore: Euro 5 |
| [61] | per norma sui gas di scarico-Costruttore: US 87 |
| [62] | per N° OE: 000 158 62 03 |
| [63] | per N° OE: 000 158 64 03 |
| [64] | per N° OE: 032 905 106 B |
| [65] | per N° OE: 036 905 715 F |
| [66] | per N° OE: 03F 905 409 B |
| [67] | per N° OE: 03L 905 061 G |
| [68] | per N° OE: 04606869AC;04606869AB |
| [69] | per N° OE: 058 905 101 A |
| [70] | per N° OE: 059 905 061 H |
| [71] | per N° OE: 059 963 319 T |
| [72] | per N° OE: 06A 905 097 |
| [73] | per N° OE: 06A 905 115 D |
| [74] | per N° OE: 06B 905 115 E |
| [75] | per N° OE: 06E 905 115 E |
| [76] | per N° OE: 07K 905 715 F |
| [77] | per N° OE: 100630 |
| [78] | per N° OE: 1106500Q0H;1106500Q0L |
| [79] | per N° OE: 110651492R |
| [80] | per N° OE: 110651749R |
| [81] | per N° OE: 110655X00A |
| [82] | per N° OE: 11067BN700 |
| [83] | per N° OE: 12 13 1 703 228 |
| [84] | per N° OE: 12 13 1 712 219 |
| [85] | per N° OE: 12 13 7 510 738 |
| [86] | per N° OE: 12 13 7 548 553 |
| [87] | per N° OE: 12 13 7 594 937 |
| [88] | per N° OE: 12 13 7 638 477 |
| [89] | per N° OE: 12 13 8 616 153 |
| [90] | per N° OE: 12 21 7 800 156 |
| [91] | per N° OE: 12 21 7 801 200 |
| [92] | per N° OE: 12 23 0 038 490 |
| [93] | per N° OE: 12 23 2 248 059 |
| [94] | per N° OE: 12 23 7 786 869 |
| [95] | per N° OE: 12 23 7 798 001 |
| [96] | per N° OE: 12611424 |
| [97] | per N° OE: 1275971 |
| [98] | per N° OE: 1306696 |
| [99] | per N° OE: 171 905 115 |
| [100] | per N° OE: 18550-80KA0 |
| [101] | per N° OE: 22 43 361 34R |
| [102] | per N° OE: 2240100Q0G, 2240100Q0K |
| [103] | per N° OE: 2240100Q0K |

| | |
|-------|----------------------------------|
| [104] | per N° OE: 22401CK81B |
| [105] | per N° OE: 224332428R |
| [106] | per N° OE: 224481KTOA |
| [107] | per N° OE: 224488H315 |
| [108] | per N° OE: 224488J11C |
| [109] | per N° OE: 22448ED800 |
| [110] | per N° OE: 25182496;96253555 |
| [111] | per N° OE: 27301 02100 |
| [112] | per N° OE: 27301 02600 |
| [113] | per N° OE: 27301 02700 |
| [114] | per N° OE: 27301 03000 |
| [115] | per N° OE: 27301 03010 |
| [116] | per N° OE: 27301 04000 |
| [117] | per N° OE: 27301 22600 |
| [118] | per N° OE: 27301 23700 |
| [119] | per N° OE: 27301 26600 |
| [120] | per N° OE: 27301 2B000 |
| [121] | per N° OE: 27301 2B010 |
| [122] | per N° OE: 27301 700 |
| [123] | per N° OE: 2S6Q-6M090-AB |
| [124] | per N° OE: 2S6Q-6M090-BB |
| [125] | per N° OE: 30520-RRA-007 |
| [126] | per N° OE: 30713416;9125601 |
| [127] | per N° OE: 357911253 |
| [128] | per N° OE: 36710 2A100 |
| [129] | per N° OE: 36710 3A000 |
| [130] | per N° OE: 36710 4A000 |
| [131] | per N° OE: 46 777 288 |
| [132] | per N° OE: 46796050 |
| [133] | per N° OE: 55210051 |
| [134] | per N° OE: 5960 66 |
| [135] | per N° OE: 5960 66;5960 F5 |
| [136] | per N° OE: 5960 F4 |
| [137] | per N° OE: 70863020 |
| [138] | per N° OE: 70863021 |
| [139] | per N° OE: 7648797 |
| [140] | per N° OE: 7700100589 |
| [141] | per N° OE: 7700100643 |
| [142] | per N° OE: 7700273226 |
| [143] | per N° OE: 7700273826 |
| [144] | per N° OE: 7700274008;224336134R |
| [145] | per N° OE: 7701041607 |
| [146] | per N° OE: 7701041608 |
| [147] | per N° OE: 7746152 |
| [148] | per N° OE: 7746153 |
| [149] | per N° OE: 8200051128 |
| [150] | per N° OE: 8200084401;8200025256 |
| [151] | per N° OE: 8200360911;8200702693 |
| [152] | per N° OE: 8200486877 |
| [153] | per N° OE: 8200506297 |
| [154] | per N° OE: 8200561251 |
| [155] | per N° OE: 8200682592 |
| [156] | per N° OE: 8200702693 |
| [157] | per N° OE: 8200943801 |
| [158] | per N° OE: 8973065193 |
| [159] | per N° OE: 90543253 |
| [160] | per N° OE: 90919-01218 |
| [161] | per N° OE: 90919-02230 |

IT

[162] per N° OE: 90919-02234
[163] per N° OE: 90919-02234;90919-02207
[164] per N° OE: 90919-02238
[165] per N° OE: 90919-02243
[166] per N° OE: 90919-02248
[167] per N° OE: 90919-02262
[168] per N° OE: 90919-02265
[169] per N° OE: 90919-02266
[170] per N° OE: 93177212
[171] per N° OE: 93198468
[172] per N° OE: 9638985980
[173] per N° OE: 9651583680
[174] per N° OE: A 000 158 78 03
[175] per N° OE: A 001 159 15 01;A 001 159 16 01
[176] per N° OE: A 001 159 20 01;A 001 159 21 01
[177] per N° OE: A 001 159 26 01
[178] per N° OE: A 001 159 50 01;A 001 159 71 01
[179] per N° OE: A 272 906 00 60
[180] per N° OE: A 642 900 58 01
[181] per N° OE: N 105 916 02;N 105 916 03
[182] per N° OE: N 105 916 03
[183] per N° OE: N 105 916 04
[184] per N° OE: N 105 916 08
[185] per N° OE: NEC100630
[186] per N° OE: S210-18-140;S210-18-140 A
[187] per N° OE: XM34-12A342-BA
[188] per N° PR: OGG
[189] per N° PR: OK0 + TS8 + 7MJ, 7MU, 7MR
[190] per N° PR: OK3, OK4 +TS8, T7V
[191] per N° PR: 7CF
[192] per N° PR: 7CF, 7MM
[193] per N° PR: 7MM
[194] per N° PR: 7MM, 7MJ
[195] per N° PR: 7MM, 7MJ, 7CP
[196] per N° PR: 7MM;7MJ;7MW
[197] per N° PR: 7MU
[198] per N° PR: D3E
[199] per N° PR: D7N
[200] per N° PR: GP1
[201] per N° PR: GP2+TD1
[202] per N° PR: GP2+TF1
[203] per N° PR: GP2+TH1
[204] per N° PR: TON;T11
[205] per N° PR: T41
[206] per N° PR: T41;TF1
[207] per N° PR: T7V
[208] per N° PR: T7V +7CP, 7CS, 7MV
[209] per N° PR: TD1
[210] per N° PR: TD1+7MM, 7MJ, 7MW
[211] per N° PR: TD1+7MM, 7MJ, 7MW, 7CP
[212] per N° PR: TE1
[213] per N° PR: TF1
[214] per N° PR: TG1
[215] per N° PR: TH1
[216] per N° PR: TH1+7GB
[217] per N° PR: TH1+7MK
[218] per N° PR: TK8, TH8
[219] per N° PR: TK8, TL1

[220] per N° PR: TK8, TL1, TM5
[221] per N° PR: TL1, TK8
[222] per N° PR: TL1, TK8, TM5, TH8
[223] per N° PR: TL1, TP1
[224] per N° PR: TL4
[225] per N° PR: TM4
[226] per N° PR: TP1
[227] per N° PR: TS8
[228] per N° PR: TS8 + 7MJ
[229] per codice SA: 021
[230] per codice SA: 022
[231] per codice SA: 494
[232] per codice SA: 700
[233] per codice SA: 803;804;805;806
[234] per codice SA: 940K;939K;802
[235] per codice SA: MC1;MC2;MC3;MP1;MP2;MP3
[236] per codice SA: MC2+MS9
[237] per codice SA: MQ3;MQ4;MQ5
[238] per codice SA: MQ6;MCO
[239] per codice SA: U43;U83
[240] Limitazione costruttore: BERU
[241] Limitazione costruttore: BORGWARNER
[242] Limitazione costruttore: Bosch
[243] Limitazione costruttore: BOSCH; DUCELLIER
[244] Limitazione costruttore: Bosch;Beru
[245] Limitazione costruttore: Bremi
[246] Limitazione costruttore: DELCO REMY
[247] Limitazione costruttore: DELPHI
[248] Limitazione costruttore: Ducellier
[249] Limitazione costruttore: ELDOR
[250] Limitazione costruttore: ELECTRICFIL
[251] Limitazione costruttore: elettronica
[252] Limitazione costruttore: Auto con diagnosi
[253] Limitazione costruttore: HITACHI
[254] Limitazione costruttore: ILKAR7A7
[255] Limitazione costruttore: LUCAS
[256] Limitazione costruttore: MARELLI
[257] Limitazione costruttore: MARELLI;DUCELLIER
[258] Limitazione costruttore: NGK
[259] Limitazione costruttore: SAE
[260] Limitazione costruttore: SAGEM
[261] Limitazione costruttore: Sistema Bosch
[262] Limitazione costruttore: Sistema BOSCH / TEMIC
[263] Limitazione costruttore: Sistema DUCELLIER
[264] Limitazione costruttore: Sistema HITACHI
[265] Limitazione costruttore: Sistema VALEO
[266] Limitazione costruttore: Raccomandazione non vincolante
[267] Non per norma sui gas di scarico: Euro 5
[268] non per codice SA: 494
[269] non per codice SA: 803;804;805;806
[270] non per codice SA: 808
[271] non per codice SA: 928
[272] non per codice SA: 940K;939K
[273] non per codice SA: U43;U83
[274] Nota: Sostituzione della bobina di accensione per soddisfare le esigenze del costruttore, installare la bobina di accensione solo con lo scudo termico originale (FORD 1315753, 2S6G 12A376AE). Assicurarsi che il catalizzatore funzioni correttamente.

[275] Nota: Il prodotto installato deve essere definito sul veicolo o sul motore.
[276] Nota: Attenzione! Nel caso di sostituzione delle candele in veicoli con bobine d'accensione, sostituire gli spinottie utilizzare il grasso per candele per il montaggio.
[277] Nota: Raccomandazione ZKF 01 - vedere la lista degli accessori
[278] Intervallo di sostituzione consigliato (km): 20000
[279] Intervallo di sostituzione consigliato (km): 30000
[280] Restrizione_Vendite: esclusi Stati Uniti d'America
[281] Restrizione_Vendite: esclusi Stati Uniti d'America; escluso il Giappone
[282] Restrizione_Vendite: Inclusi Canada
[283] Restrizione_Vendite: Inclusi Stati Uniti d'America
[284] Restrizione_Vendite: Inclusi Stati Uniti d'America; Incluso Giappone
[285] Tipo trasmissione: Cambio Automatico
[286] Tipo trasmissione: CVT-Cambio automatico (a variazione continua)
[287] Tipo trasmissione: Cambio velocità manuale
[288] Tipo trasmissione: Cambio Manuale 5 marce
[289] Tipo trasmissione: Cambio Manuale 6 marce
[290] Tipo trasmissione: Semiautomatico
[291] Equipaggiamento veicolo: per veicoli con aria condizionata
[292] Equipaggiamento veicolo: per veicoli con distributore d'accensione
[293] Equipaggiamento veicolo: per veicoli con immobilizzatore
[294] Equipaggiamento veicolo: Per veicoli con la funzione Start-Stop
[295] Equipaggiamento veicolo: Per veicoli Diesel senza filtro antiparticolato
[296] Equipaggiamento veicolo: per veicoli senza distributore d'accensione
[297] Equipaggiamento veicolo: per veicoli senza immobilizzatore
[298] Equipaggiamento veicolo: Per veicoli senza la funzione Start-Stop
[299] Tipo imp. elettrico di bordo: per veicoli con impianto elettrico di bordo a 12 Volt
[300] Versione: 0221504030
[301] Versione: 03L.L
[302] Versione: 04E.A, 04E.B
[303] Versione: 04E.A, 04E.D
[304] Versione: 04E.A, 04E.D, 04E.G, 04E.C
[305] Versione: 04E.B
[306] Versione: 04E.D, 04E.A
[307] Versione: 04E.D, 04E.A, 04E.G
[308] Versione: 04E.D, 04E.C
[309] Versione: 04L.D;04L.J
[310] Versione: 1P
[311] Versione: 2U
[312] Versione: 55kW
[313] Versione: 56kW
[314] Versione: Normativa emissioni CEE2000
[315] Versione: Normativa emissioni CEE95
[316] Versione: Corpo: LB
[317] Versione: Corpo: LB (USA)
[318] Versione: CEE2000, senza EOBD
[319] Versione: D4123
[320] Versione: DOHC
[321] Versione: DSL

IT

| |
|--|
| [322] Versione: Duratorq / SID 206 |
| [323] Versione: EA17 041 |
| [324] Versione: per motori FSI |
| [325] Versione: FORMEL E |
| [326] Versione: GAMMA |
| [327] Versione: JB0;JB1;JB2;JB3 |
| [328] Versione: JPN |
| [329] Versione: KK13 |
| [330] Versione: LCI |
| [331] Versione: LDK |
| [332] Versione: LDK, LHU |
| [333] Versione: M47 |
| [334] Versione: M47N |
| [335] Versione: M47N2 |
| [336] Versione: M57N |
| [337] Versione: MA13 |
| [338] Versione: MD13 NAGARES |
| [339] Versione: MD13 NAGARES;Trasmissione PF1 |
| [340] Versione: MJ |
| [341] Versione: MM |
| [342] Versione: Iniezione multipoint |
| [343] Versione: N47 |
| [344] Versione: N47N |
| [345] Versione: N57 |
| [346] Versione: N57N |
| [347] Versione: N57S |
| [348] Versione: N57Z |
| [349] Versione: NA13 |
| [350] Versione: Trasmissione JR5 |
| [351] Versione: NA13;Trasmissione JR5, TL4 |
| [352] Versione: ND13 |
| [353] Versione: Non per normativa emissioni Euro 5 |
| [354] Versione: non B37A |
| [355] Versione: non B37B |
| [356] Versione: non per motori FSI |
| [357] Versione: non N57N |
| [358] Versione: NTK #6 |
| [359] Versione: Senza EOBD |
| [360] Versione: OP13 |
| [361] Versione: in alternativa per ZS522 |
| [362] Versione: Puma |
| [363] Versione: Relais #3/103 |
| [364] Versione: Relais #4/103 |
| [365] Versione: Relais #8/103 |
| [366] Versione: STABILIMENTO RUSSIA |
| [367] Versione: SOHC |
| [368] Versione: Trasmissione JB3 |
| [369] Versione: Trasmissione JC5 |
| [370] Versione: Trasmissione PK5 |
| [371] Versione: UK |
| [372] Versione: XT17 LINDE |
| [373] Versione: Y-115T1 |
| [374] Versione: ZH13 |
| [375] Versione: ZP17 |

FR

| | | |
|---|--|--|
| [1] Freinage: pour véhicules avec système antibloccage | [49] pour norme des gaz d'échappement des fabricants: CEE 19-5 | [98] pour numéro OE: 1306696 |
| [2] Type de catalyseur: pour les véhicules avec catalyseur, pour les véhicules avec dispositif catalyseur | [50] pour norme des gaz d'échappement des fabricants: CEE 19-5;US 87 | [99] pour numéro OE: 171 905 115 |
| [3] Type de catalyseur: pour les véhicules avec dispositif catalyseur, pour les véhicules avec catalyseur | [51] pour norme des gaz d'échappement des fabricants: CEE 95 | [100] pour numéro OE: 18550-80KA0 |
| [4] Type de catalyseur: pour les véhicules sans catalyseur | [52] pour norme des gaz d'échappement des fabricants: CEE Fase 2 | [101] pour numéro OE: 22 43 361 34R |
| [5] Type de catalyseur: avec catalyseur | [53] pour norme des gaz d'échappement des fabricants: CEE Phase 4 | [102] pour numéro OE: 2240100Q0G, 2240100Q0K |
| [6] Type de climat: pour les climats froids | [54] pour norme des gaz d'échappement des fabricants: CEE Phase 5 | [103] pour numéro OE: 2240100Q0K |
| [7] Couleur: noir | [55] pour norme des gaz d'échappement des fabricants: CF2 | [104] pour numéro OE: 22401CK81B |
| [8] Couleur: bleu | [56] pour norme des gaz d'échappement des fabricants: CF2;CF3 | [105] pour numéro OE: 224332428R |
| [9] Couleur: Bleu; Vert | [57] pour norme des gaz d'échappement des fabricants: CF3 | [106] pour numéro OE: 224481KT0A |
| [10] Couleur: gris | [58] pour norme des gaz d'échappement des fabricants: CF3;CF4 | [107] pour numéro OE: 224488H315 |
| [11] Couleur: gris clair | [59] pour norme des gaz d'échappement des fabricants: CF4 | [108] pour numéro OE: 224488J11C |
| [12] Couleur: orange | [60] pour norme des gaz d'échappement des fabricants: Euro 5 | [109] pour numéro OE: 22448ED800 |
| [13] Couleur: rouge | [61] pour norme des gaz d'échappement des fabricants: US 87 | [110] pour numéro OE: 25182496;96253555 |
| [14] Couleur: Blanc | [62] pour numéro OE: 000 158 62 03 | [111] pour numéro OE: 27301 02100 |
| [15] Couleur: Jaune | [63] pour numéro OE: 000 158 64 03 | [112] pour numéro OE: 27301 02600 |
| [16] Numéro de distributeur: 525352A;525352B;525352C;525352D | [64] pour numéro OE: 032 905 106 B | [113] pour numéro OE: 27301 02700 |
| [17] Norme de pollution: D3 | [65] pour numéro OE: 036 905 715 F | [114] pour numéro OE: 27301 03000 |
| [18] Norme de pollution: D4 | [66] pour numéro OE: 03F 905 409 B | [115] pour numéro OE: 27301 03010 |
| [19] Norme de pollution: Euro 3 (D3) | [67] pour numéro OE: 03L 905 061 G | [116] pour numéro OE: 27301 04000 |
| [20] Norme de pollution: Euro 3 (D3);Euro 4 (D4) | [68] pour numéro OE: 04606869AC;04606869AB | [117] pour numéro OE: 27301 22600 |
| [21] Norme de pollution: Euro 4 (D4) | [69] pour numéro OE: 058 905 101 A | [118] pour numéro OE: 27301 23700 |
| [22] Norme de pollution: Euro 5 | [70] pour numéro OE: 059 905 061 H | [119] pour numéro OE: 27301 26600 |
| [23] Norme de pollution: Euro 5 PLUS | [71] pour numéro OE: 059 963 319 T | [120] pour numéro OE: 27301 2B000 |
| [24] Norme de pollution: Euro 6 | [72] pour numéro OE: 06A 905 097 | [121] pour numéro OE: 27301 2B010 |
| [25] Norme de pollution: Euro 6 PLUS | [73] pour numéro OE: 06A 905 115 D | [122] pour numéro OE: 27301 700 |
| [26] Norme de pollution: ULEV2 | [74] pour numéro OE: 06B 905 115 E | [123] pour numéro OE: 2S6Q-6M090-AB |
| [27] Position: Collecteur des gaz d'échappement | [75] pour numéro OE: 06E 905 115 E | [124] pour numéro OE: 2S6Q-6M090-BB |
| [28] Position: Collecteur d'admission | [76] pour numéro OE: 07K 905 715 F | [125] pour numéro OE: 30520-RRA-007 |
| [29] Position: Montage latéral, sur cylindre 5, sur cylindre 6, sur cylindre 7, sur cylindre 8 | [77] pour numéro OE: 100630 | [126] pour numéro OE: 30713416;9125601 |
| [30] Position: gauche | [78] pour numéro OE: 1106500Q0H;1106500Q0L | [127] pour numéro OE: 357911253 |
| [31] Position: droite | [79] pour numéro OE: 110651492R | [128] pour numéro OE: 36710 2A100 |
| [32] Position: sur cylindre 1, sur cylindre 2, sur cylindre 3 | [80] pour numéro OE: 110651749R | [129] pour numéro OE: 36710 3A000 |
| [33] Position: sur cylindre 1, sur cylindre 2, sur cylindre 3, sur cylindre 4 | [81] pour numéro OE: 110655X00A | [130] pour numéro OE: 36710 4A000 |
| [34] Position: to cylinder 1;to cylinder 2;to cylinder 4 | [82] pour numéro OE: 11067BN700 | [131] pour numéro OE: 46 777 288 |
| [35] Position: sur cylindre 1, sur cylindre 3 | [83] pour numéro OE: 12 13 1 703 228 | [132] pour numéro OE: 46796050 |
| [36] Position: sur cylindre 1, sur cylindre 3, sur cylindre 5 | [84] pour numéro OE: 12 13 1 712 219 | [133] pour numéro OE: 55210051 |
| [37] Position: sur cylindre 1, 4 | [85] pour numéro OE: 12 13 7 510 738 | [134] pour numéro OE: 5960 66 |
| [38] Position: sur cylindre 2 | [86] pour numéro OE: 12 13 7 548 553 | [135] pour numéro OE: 5960 66;5960 F5 |
| [39] Position: sur cylindre 2, 3 | [87] pour numéro OE: 12 13 7 594 937 | [136] pour numéro OE: 5960 F4 |
| [40] Position: sur cylindre 2;sur cylindre 3;sur cylindre 4 | [88] pour numéro OE: 12 13 7 638 477 | [137] pour numéro OE: 70863020 |
| [41] Position: sur cylindre 2, 4 | [89] pour numéro OE: 12 13 8 616 153 | [138] pour numéro OE: 70863021 |
| [42] Position: sur cylindre 2, sur cylindre 4, sur cylindre 6 | [90] pour numéro OE: 12 21 7 800 156 | [139] pour numéro OE: 7648797 |
| [43] Position: to cylinder 2;to cylinder 5 | [91] pour numéro OE: 12 21 7 801 200 | [140] pour numéro OE: 7700100589 |
| [44] Position: dans cylindre 3 | [92] pour numéro OE: 12 23 0 038 490 | [141] pour numéro OE: 7700100643 |
| [45] Position: sur cylindre 5, sur cylindre 6, sur cylindre 7, sur cylindre 8 | [93] pour numéro OE: 12 23 2 248 059 | [142] pour numéro OE: 7700273226 |
| [46] Position: Supérieur sur cylindre 1, sur cylindre 2, sur cylindre 3, sur cylindre 4 | [94] pour numéro OE: 12 23 7 786 869 | [143] pour numéro OE: 7700273826 |
| [47] pour facelift: No | [95] pour numéro OE: 12 23 7 798 001 | [144] pour numéro OE: 7700274008;224336134R |
| [48] pour facelift: Oui | [96] pour numéro OE: 12611424 | [145] pour numéro OE: 7701041607 |
| | [97] pour numéro OE: 1275971 | [146] pour numéro OE: 7701041608 |
| | | [147] pour numéro OE: 7746152 |
| | | [148] pour numéro OE: 7746153 |
| | | [149] pour numéro OE: 8200051128 |
| | | [150] pour numéro OE: 8200084401;8200025256 |
| | | [151] pour numéro OE: 8200360911;8200702693 |
| | | [152] pour numéro OE: 8200486877 |
| | | [153] pour numéro OE: 8200506297 |
| | | [154] pour numéro OE: 8200561251 |
| | | [155] pour numéro OE: 8200682592 |

FR

[156] pour numéro OE: 8200702693
[157] pour numéro OE: 8200943801
[158] pour numéro OE: 8973065193
[159] pour numéro OE: 90543253
[160] pour numéro OE: 90919-01218
[161] pour numéro OE: 90919-02230
[162] pour numéro OE: 90919-02234
[163] pour numéro OE: 90919-02234;90919-02207
[164] pour numéro OE: 90919-02238
[165] pour numéro OE: 90919-02243
[166] pour numéro OE: 90919-02248
[167] pour numéro OE: 90919-02262
[168] pour numéro OE: 90919-02265
[169] pour numéro OE: 90919-02266
[170] pour numéro OE: 93177212
[171] pour numéro OE: 93198468
[172] pour numéro OE: 9638985980
[173] pour numéro OE: 9651583680
[174] pour numéro OE: A 000 158 78 03
[175] pour numéro OE: A 001 159 15 01;A 001 159 16 01
[176] pour numéro OE: A 001 159 20 01;A 001 159 21 01
[177] pour numéro OE: A 001 159 26 01
[178] pour numéro OE: A 001 159 50 01;A 001 159 71 01
[179] pour numéro OE: A 272 906 00 60
[180] pour numéro OE: A 642 900 58 01
[181] pour numéro OE: N 105 916 02;N 105 916 03
[182] pour numéro OE: N 105 916 03
[183] pour numéro OE: N 105 916 04
[184] pour numéro OE: N 105 916 08
[185] pour numéro OE: NEC100630
[186] pour numéro OE: S210-18-140;S210-18-140 A
[187] pour numéro OE: XM34-12A342-BA
[188] pour numéro PR: OGG
[189] pour numéro PR: OK0 + TS8 + 7MJ, 7MU, 7MR
[190] pour numéro PR: OK3, OK4 +TS8, T7V
[191] pour numéro PR: 7CF
[192] pour numéro PR: 7CF, 7MM
[193] pour numéro PR: 7MM
[194] pour numéro PR: 7MM, 7MJ
[195] pour numéro PR: 7MM, 7MJ, 7CP
[196] pour numéro PR: 7MM;7MJ;7MW
[197] pour numéro PR: 7MU
[198] pour numéro PR: D3E
[199] pour numéro PR: D7N
[200] pour numéro PR: GP1
[201] pour numéro PR: GP2+TD1
[202] pour numéro PR: GP2+TF1
[203] pour numéro PR: GP2+TH1
[204] pour numéro PR: TON;T1I
[205] pour numéro PR: T41
[206] pour numéro PR: T41;TF1
[207] pour numéro PR: T7V
[208] pour numéro PR: T7V +7CP, 7CS, 7MW
[209] pour numéro PR: TD1
[210] pour numéro PR: TD1+7MM, 7MJ, 7MW
[211] pour numéro PR: TD1+7MM, 7MJ, 7MW, 7CP

[212] pour numéro PR: TE1
[213] pour numéro PR: TF1
[214] pour numéro PR: TG1
[215] pour numéro PR: TH1
[216] pour numéro PR: TH1+7GB
[217] pour numéro PR: TH1+7MK
[218] pour numéro PR: TK8, TH8
[219] pour numéro PR: TK8, TL1
[220] pour numéro PR: TK8, TL1, TM5
[221] pour numéro PR: TL1, TK8
[222] pour numéro PR: TL1, TK8, TM5, TH8
[223] pour numéro PR: TL1, TP1
[224] pour numéro PR: TL4
[225] pour numéro PR: TM4
[226] pour numéro PR: TP1
[227] pour numéro PR: TS8
[228] pour numéro PR: TS8 + 7MJ
[229] pour SA code: 021
[230] pour SA code: 022
[231] pour SA code: 494
[232] pour SA code: 700
[233] pour SA code: 803;804;805;806
[234] pour SA code: 940K;939K;802
[235] pour SA code: MC1;MC2;MC3;MP1;MP2;MP3
[236] pour SA code: MC2+MS9
[237] pour SA code: MQ3;MQ4;MQ5
[238] pour SA code: MQ6;MCO
[239] pour SA code: U43;U83
[240] Montage d'origine: BERU
[241] Montage d'origine: BORGWARNER
[242] Montage d'origine: Bosch
[243] Montage d'origine: BOSCH; DUCELLIER
[244] Montage d'origine: Bosch;Beru
[245] Montage d'origine: Bremi
[246] Montage d'origine: DELCO REMY
[247] Montage d'origine: DELPHI
[248] Montage d'origine: Ducellier
[249] Montage d'origine: ELDOR
[250] Montage d'origine: ELECTRICFIL
[251] Montage d'origine: électronique
[252] Montage d'origine: Véhicule avec diagnostic
[253] Montage d'origine: HITACHI
[254] Montage d'origine: ILKAR7A7
[255] Montage d'origine: LUCAS
[256] Montage d'origine: MARELLI
[257] Montage d'origine: MARELLI;DUCELLIER
[258] Montage d'origine: NGK
[259] Montage d'origine: SAE
[260] Montage d'origine: SAGEM
[261] Montage d'origine: Système BOSCH
[262] Montage d'origine: Système BOSCH/TEMIC
[263] Montage d'origine: Système DUCELLIER
[264] Montage d'origine: Système HITACHI
[265] Montage d'origine: Système VALEO
[266] Montage d'origine: Recommandation non contraignante
[267] pas pour norme de dépollution: Euro 5
[268] pas pour SA code: 494
[269] pas pour SA code: 803;804;805;806

[270] pas pour SA code: 808
[271] pas pour SA code: 928
[272] pas pour SA code: 940K;939K
[273] pas pour SA code: U43;U83
[274] Remarque: Pour respecter les préconisations constructeur, changer la bobine d'allumage uniquement avec un pare-chaleur première monte (FORD 1315753, 2S6G 12A376AE). S'assurer du bon fonctionnement du catalyseur.
[275] Remarque: Le produit installé doit être déterminé sur le véhicule ou le moteur.
[276] Remarque: Recommandation - lors du changement des bougies d'allumage sur des véhicules à bobines d'allumage avec embout, veuillezchanger l'embout et utiliser la graisse de montage pour embouts de bougies d'allumage(ZKF 01 - n° de réf. 0 890 300 029).
[277] Remarque: Recommandation : ZKF 01 - voir la liste des accessoires
[278] Intervalle de changement recommandé (km): 20000
[279] Intervalle de changement recommandé (km): 30000
[280] Restriction des ventes: Hors Etats Unis
[281] Restriction des ventes: Hors Etats Unis, hors Japon
[282] Restriction des ventes: Canada inclus
[283] Restriction des ventes: Etats Unis inclus
[284] Restriction des ventes: Etats Unis inclus, Japon inclus
[285] Boîte de vitesses: Transmission automatique
[286] Boîte de vitesses: Boîte de vitesses à variateur classique (CVT)
[287] Boîte de vitesses: boîte manuelle
[288] Boîte de vitesses: Spécifique aux boîtes de vitesses 5 rapports
[289] Boîte de vitesses: Spécifique aux boîtes de vitesses 6 rapports
[290] Boîte de vitesses: semi-automatique
[291] Équipement véhicule: pour véhicules avec système de climatisation
[292] Équipement véhicule: pour véhicules avec distributeur d'allumage
[293] Équipement véhicule: pour véhicules avec immobilisateur antivol
[294] Équipement véhicule: Pour véhicules équipé du start & stop
[295] Équipement véhicule: Pour véhicules sans filtre à particules
[296] Équipement véhicule: pour véh. sans distributeur d'allumage
[297] Équipement véhicule: pour véhicules sans immobilisateur antivol
[298] Équipement véhicule: Pour véhicules non équipé du start & stop
[299] Réseau électrique: pour véhicules avec réseau de bord de 12V
[300] Version: 0221504030
[301] Version: 03LL
[302] Version: 04E.A, 04E.B
[303] Version: 04E.A, 04E.D
[304] Version: 04E.A, 04E.D, 04E.G, 04E.C
[305] Version: 04E.B
[306] Version: 04E.D, 04E.A
[307] Version: 04E.D, 04E.A, 04E.G
[308] Version: 04E.D, 04E.C

FR

[309] Version: 04L.D;04L.J
[310] Version: 1P
[311] Version: 2U
[312] Version: 55kW
[313] Version: 56kW
[314] Version: Norme d'émission CEE2000
[315] Version: Norme d'émission CEE95
[316] Version: Corps: LB
[317] Version: Corps: LB (USA)
[318] Version: CEE2000, sans EOBD
[319] Version: D4123
[320] Version: DOHC
[321] Version: DSL
[322] Version: Duratorq / SID 206
[323] Version: EA17 041
[324] Version: pour moteurs FSI
[325] Version: FORMEL E
[326] Version: GAMMA
[327] Version: JB0;JB1;JB2;JB3
[328] Version: JPN
[329] Version: KK13
[330] Version: LCI
[331] Version: LDK
[332] Version: LDK, LHU
[333] Version: M47
[334] Version: M47N
[335] Version: M47N2
[336] Version: M57N
[337] Version: MA13
[338] Version: MD13 NAGARES
[339] Version: MD13 NAGARES;Boîte de vitesses PF1
[340] Version: MJ
[341] Version: MM
[342] Version: Injection multipoint
[343] Version: N47
[344] Version: N47N
[345] Version: N57
[346] Version: N57N
[347] Version: N57S
[348] Version: N57Z
[349] Version: NA13
[350] Version: Boîte de vitesses JR5
[351] Version: NA13;Boîte de vitesses JR5, TL4
[352] Version: ND13
[353] Version: Pas pour norme d'émission Euro 5
[354] Version: pas B37A
[355] Version: pas B37B
[356] Version: pas pour moteurs FSI
[357] Version: pas N57N
[358] Version: NTK #6
[359] Version: Sans EOBD
[360] Version: OP13
[361] Version: alternative pour ZS522
[362] Version: Puma
[363] Version: Relais #3/103
[364] Version: Relais #4/103
[365] Version: Relais #8/103
[366] Version: SITE DE RUSSIE

[367] Version: SOHC
[368] Version: Boîte de vitesses JB3
[369] Version: Boîte de vitesses JC5
[370] Version: Boîte de vitesses PK5
[371] Version: UK
[372] Version: XT17 LINDE
[373] Version: Y-115T1
[374] Version: ZH13
[375] Version: ZP17

DE

| | | |
|--|---|--|
| [1] Brems-/Fahrtdynamik: für Fahrzeuge mit ABS | [50] für Hersteller-Abgasnorm: CEE 19-5;US 87 | [108] für OE-Nummer: 224488J11C |
| [2] Katalysatorart: für Fahrzeuge mit Katalysator;für Fahrzeuge mit Katalysatoranordnung | [51] für Hersteller-Abgasnorm: CEE 95 | [109] für OE-Nummer: 22448ED800 |
| [3] Katalysatorart: für Fahrzeuge mit Katalysatorgruppe;für Fahrzeuge mit Katalysator | [52] für Hersteller-Abgasnorm: CEE Fase 2 | [110] für OE-Nummer: 25182496;96253555 |
| [4] Katalysatorart: für Fahrzeuge ohne Katalysator | [53] für Hersteller-Abgasnorm: CEE Phase 4 | [111] für OE-Nummer: 27301 02100 |
| [5] Katalysatorart: mit geregeltem (3-Wege) Katalysator | [54] für Hersteller-Abgasnorm: CEE Phase 5 | [112] für OE-Nummer: 27301 02600 |
| [6] Klimazonen: für kalte Klimazonen | [55] für Hersteller-Abgasnorm: CF2 | [113] für OE-Nummer: 27301 02700 |
| [7] Farbe: schwarz | [56] für Hersteller-Abgasnorm: CF2;CF3 | [114] für OE-Nummer: 27301 03000 |
| [8] Farbe: blau | [57] für Hersteller-Abgasnorm: CF3 | [115] für OE-Nummer: 27301 03010 |
| [9] Farbe: Blau; Grün | [58] für Hersteller-Abgasnorm: CF3;CF4 | [116] für OE-Nummer: 27301 04000 |
| [10] Farbe: grau | [59] für Hersteller-Abgasnorm: CF4 | [117] für OE-Nummer: 27301 22600 |
| [11] Farbe: Hellgrau | [60] für Hersteller-Abgasnorm: Euro 5 | [118] für OE-Nummer: 27301 23700 |
| [12] Farbe: orange | [61] für Hersteller-Abgasnorm: US 87 | [119] für OE-Nummer: 27301 26600 |
| [13] Farbe: rot | [62] für OE-Nummer: 000 158 62 03 | [120] für OE-Nummer: 27301 28000 |
| [14] Farbe: weiß | [63] für OE-Nummer: 000 158 64 03 | [121] für OE-Nummer: 27301 28010 |
| [15] Farbe: gelb | [64] für OE-Nummer: 032 905 106 B | [122] für OE-Nummer: 27301 700 |
| [16] Zündverteilernummer: 525352A;525352B;525352C;525352D | [65] für OE-Nummer: 036 905 715 F | [123] für OE-Nummer: 2S6Q-6M090-AB |
| [17] Abgasnorm: D3 | [66] für OE-Nummer: 03F 905 409 B | [124] für OE-Nummer: 2S6Q-6M090-BB |
| [18] Abgasnorm: D4 | [67] für OE-Nummer: 03L 905 061 G | [125] für OE-Nummer: 30520-RRA-007 |
| [19] Abgasnorm: Euro 3 (D3) | [68] für OE-Nummer: 04606869AC;04606869AB | [126] für OE-Nummer: 30713416;9125601 |
| [20] Abgasnorm: Euro 3 (D3);Euro 4 (D4) | [69] für OE-Nummer: 058 905 101 A | [127] für OE-Nummer: 357911253 |
| [21] Abgasnorm: Euro 4 (D4) | [70] für OE-Nummer: 059 905 061 H | [128] für OE-Nummer: 36710 2A100 |
| [22] Abgasnorm: Euro 5 | [71] für OE-Nummer: 059 963 319 T | [129] für OE-Nummer: 36710 3A000 |
| [23] Abgasnorm: Euro 5 PLUS | [72] für OE-Nummer: 06A 905 097 | [130] für OE-Nummer: 36710 4A000 |
| [24] Abgasnorm: Euro 6 | [73] für OE-Nummer: 06A 905 115 D | [131] für OE-Nummer: 46 777 288 |
| [25] Abgasnorm: Euro 6 PLUS | [74] für OE-Nummer: 06B 905 115 E | [132] für OE-Nummer: 46796050 |
| [26] Abgasnorm: ULEV2 | [75] für OE-Nummer: 06E 905 115 E | [133] für OE-Nummer: 55210051 |
| [27] Einbauseite: Abgaskrümmer | [76] für OE-Nummer: 07K 905 715 F | [134] für OE-Nummer: 5960 66 |
| [28] Einbauseite: Ansaugkrümmer | [77] für OE-Nummer: 100630 | [135] für OE-Nummer: 5960 66;5960 F5 |
| [29] Einbauseite: Seitlicher Einbau;an Zylinder 5;an Zylinder 6;an Zylinder 7;an Zylinder 8; | [78] für OE-Nummer: 1106500Q0H;1106500Q0L | [136] für OE-Nummer: 5960 F4 |
| [30] Einbauseite: links | [79] für OE-Nummer: 110651492R | [137] für OE-Nummer: 70863020 |
| [31] Einbauseite: rechts | [80] für OE-Nummer: 110651749R | [138] für OE-Nummer: 70863021 |
| [32] Einbauseite: an Zylinder 1;an Zylinder 2;an Zylinder 3 | [81] für OE-Nummer: 110655X00A | [139] für OE-Nummer: 7648797 |
| [33] Einbauseite: an Zylinder 1;an Zylinder 2;an Zylinder 3;an Zylinder 4 | [82] für OE-Nummer: 11067BN700 | [140] für OE-Nummer: 7700100589 |
| [34] Einbauseite: to cylinder 1;to cylinder 2;to cylinder 4 | [83] für OE-Nummer: 12 13 1 703 228 | [141] für OE-Nummer: 7700100643 |
| [35] Einbauseite: an Zylinder 1;an Zylinder 3 | [84] für OE-Nummer: 12 13 1 712 219 | [142] für OE-Nummer: 7700273226 |
| [36] Einbauseite: an Zylinder 1;an Zylinder 3;an Zylinder 5 | [85] für OE-Nummer: 12 13 7 510 738 | [143] für OE-Nummer: 7700273826 |
| [37] Einbauseite: an Zylinder 1, 4 | [86] für OE-Nummer: 12 13 7 548 553 | [144] für OE-Nummer: 7700274008;224336134R |
| [38] Einbauseite: an Zylinder 2 | [87] für OE-Nummer: 12 13 7 594 937 | [145] für OE-Nummer: 7701041607 |
| [39] Einbauseite: an Zylinder 2, 3 | [88] für OE-Nummer: 12 13 7 638 477 | [146] für OE-Nummer: 7701041608 |
| [40] Einbauseite: an Zylinder 2;an Zylinder 3;an Zylinder 4 | [89] für OE-Nummer: 12 13 8 616 153 | [147] für OE-Nummer: 7746152 |
| [41] Einbauseite: an Zylinder 2, 4 | [90] für OE-Nummer: 12 21 7 800 156 | [148] für OE-Nummer: 7746153 |
| [42] Einbauseite: an Zylinder 2;an Zylinder 4;an Zylinder 6 | [91] für OE-Nummer: 12 21 7 801 200 | [149] für OE-Nummer: 8200051128 |
| [43] Einbauseite: to cylinder 2;to cylinder 5 | [92] für OE-Nummer: 12 23 0 038 490 | [150] für OE-Nummer: 8200084401;8200025256 |
| [44] Einbauseite: zum Zylinder 3 | [93] für OE-Nummer: 12 23 2 248 059 | [151] für OE-Nummer: 8200360911;8200702693 |
| [45] Einbauseite: an Zylinder 5;an Zylinder 6;an Zylinder 7;an Zylinder 8 | [94] für OE-Nummer: 12 23 7 786 869 | [152] für OE-Nummer: 8200486877 |
| [46] Einbauseite: Oben;an Zylinder 1;an Zylinder 2;an Zylinder 3;an Zylinder 4 | [95] für OE-Nummer: 12 23 7 798 001 | [153] für OE-Nummer: 8200506297 |
| [47] für Facelift: Nein | [96] für OE-Nummer: 12611424 | [154] für OE-Nummer: 8200561251 |
| [48] für Facelift: Ja | [97] für OE-Nummer: 1275971 | [155] für OE-Nummer: 8200682592 |
| [49] für Hersteller-Abgasnorm: CEE 19-5 | [98] für OE-Nummer: 1306696 | [156] für OE-Nummer: 8200702693 |
| | [99] für OE-Nummer: 171 905 115 | [157] für OE-Nummer: 8200943801 |
| | [100] für OE-Nummer: 18550-80KAO | [158] für OE-Nummer: 8973065193 |
| | [101] für OE-Nummer: 22 43 361 34R | [159] für OE-Nummer: 90543253 |
| | [102] für OE-Nummer: 2240100Q0G, 2240100Q0K | [160] für OE-Nummer: 90919-01218 |
| | [103] für OE-Nummer: 2240100Q0K | [161] für OE-Nummer: 90919-02230 |
| | [104] für OE-Nummer: 22401CK81B | [162] für OE-Nummer: 90919-02234 |
| | [105] für OE-Nummer: 224332428R | [163] für OE-Nummer: 90919-02234;90919-02207 |
| | [106] für OE-Nummer: 224481KTOA | [164] für OE-Nummer: 90919-02238 |
| | [107] für OE-Nummer: 224488H315 | [165] für OE-Nummer: 90919-02243 |

DE

[166] für OE-Nummer: 90919-02248
[167] für OE-Nummer: 90919-02262
[168] für OE-Nummer: 90919-02265
[169] für OE-Nummer: 90919-02266
[170] für OE-Nummer: 93177212
[171] für OE-Nummer: 93198468
[172] für OE-Nummer: 9638985980
[173] für OE-Nummer: 9651583680
[174] für OE-Nummer: A 000 158 78 03
[175] für OE-Nummer: A 001 159 15 01;A 001 159 16 01
[176] für OE-Nummer: A 001 159 20 01;A 001 159 21 01
[177] für OE-Nummer: A 001 159 26 01
[178] für OE-Nummer: A 001 159 50 01;A 001 159 71 01
[179] für OE-Nummer: A 272 906 00 60
[180] für OE-Nummer: A 642 900 58 01
[181] für OE-Nummer: N 105 916 02;N 105 916 03
[182] für OE-Nummer: N 105 916 03
[183] für OE-Nummer: N 105 916 04
[184] für OE-Nummer: N 105 916 08
[185] für OE-Nummer: NEC100630
[186] für OE-Nummer: S210-18-140;S210-18-140 A
[187] für OE-Nummer: XM34-12A342-BA
[188] für PR-Nummer: OGG
[189] für PR-Nummer: OK0 + TS8 + 7MJ, 7MU, 7MR
[190] für PR-Nummer: OK3, OK4 +TS8, T7V
[191] für PR-Nummer: 7CF
[192] für PR-Nummer: 7CF, 7MM
[193] für PR-Nummer: 7MM
[194] für PR-Nummer: 7MM, 7MJ
[195] für PR-Nummer: 7MM, 7MJ, 7CP
[196] für PR-Nummer: 7MM;7MJ;7MW
[197] für PR-Nummer: 7MU
[198] für PR-Nummer: D3E
[199] für PR-Nummer: D7N
[200] für PR-Nummer: GP1
[201] für PR-Nummer: GP2+TD1
[202] für PR-Nummer: GP2+TF1
[203] für PR-Nummer: GP2+TH1
[204] für PR-Nummer: TON;T1I
[205] für PR-Nummer: T41
[206] für PR-Nummer: T41;TF1
[207] für PR-Nummer: T7V
[208] für PR-Nummer: T7V +7CP, 7CS, 7MV
[209] für PR-Nummer: TD1
[210] für PR-Nummer: TD1+7MM, 7MJ, 7MW
[211] für PR-Nummer: TD1+7MM, 7MJ, 7MW, 7CP
[212] für PR-Nummer: TE1
[213] für PR-Nummer: TF1
[214] für PR-Nummer: TG1
[215] für PR-Nummer: TH1
[216] für PR-Nummer: TH1+7GB
[217] für PR-Nummer: TH1+7MK
[218] für PR-Nummer: TK8, TH8
[219] für PR-Nummer: TK8, TL1
[220] für PR-Nummer: TK8, TL1, TM5
[221] für PR-Nummer: TL1, TK8

[222] für PR-Nummer: TL1, TK8, TM5, TH8
[223] für PR-Nummer: TL1, TP1
[224] für PR-Nummer: TL4
[225] für PR-Nummer: TM4
[226] für PR-Nummer: TP1
[227] für PR-Nummer: TS8
[228] für PR-Nummer: TS8 + 7MJ
[229] für SA Code: 021
[230] für SA Code: 022
[231] für SA Code: 494
[232] für SA Code: 700
[233] für SA Code: 803;804;805;806
[234] für SA Code: 940K;939K;802
[235] für SA Code: MC1;MC2;MC3;MP1;MP2;MP3
[236] für SA Code: MC2+MS9
[237] für SA Code: MQ3;MQ4;MQ5
[238] für SA Code: MQ6;MCO
[239] für SA Code: U43;U83
[240] Herstellereinschränkung: BERU
[241] Herstellereinschränkung: BORGWARNER
[242] Herstellereinschränkung: Bosch
[243] Herstellereinschränkung: BOSCH; DUCELLIER
[244] Herstellereinschränkung: Bosch;Beru
[245] Herstellereinschränkung: Bremi
[246] Herstellereinschränkung: DELCO REMY
[247] Herstellereinschränkung: DELPHI
[248] Herstellereinschränkung: Ducellier
[249] Herstellereinschränkung: ELDOR
[250] Herstellereinschränkung: ELECTRICFIL
[251] Herstellereinschränkung: elektronisch
[252] Herstellereinschränkung: Fahrzeug mit Diagnose
[253] Herstellereinschränkung: HITACHI
[254] Herstellereinschränkung: ILKAR7A7
[255] Herstellereinschränkung: LUCAS
[256] Herstellereinschränkung: MARELLI
[257] Herstellereinschränkung: MARELLI;DUCELLIER
[258] Herstellereinschränkung: NGK
[259] Herstellereinschränkung: SAE
[260] Herstellereinschränkung: SAGEM
[261] Herstellereinschränkung: System BOSCH
[262] Herstellereinschränkung: System BOSCH/TEMIC
[263] Herstellereinschränkung: SYSTEM DUCELLIER
[264] Herstellereinschränkung: System HITACHI
[265] Herstellereinschränkung: System VALEO
[266] Herstellereinschränkung: UNVERB.EMPFEHLUNG
[267] nicht für Abgasnorm: Euro 5
[268] nicht für SA Code: 494
[269] nicht für SA Code: 803;804;805;806
[270] nicht für SA Code: 808
[271] nicht für SA Code: 928
[272] nicht für SA Code: 940K;939K
[273] nicht für SA Code: U43;U83
[274] Bemerkung: Zündspule zusätzlich wechseln, um die Anforderungen des Herstellers zu erfüllen. Die Zündspule nur zusammen mit dem original Hitzeschild (FORD 1315753, 2S6G 12A376AE) verbauen. Stellen Sie sicher, dass der Katalysator ordnungsgemäß funktioniert.
[275] Bemerkung: Eingebautes Produkt muss am Fahrzeug oder Motor bestimmt werden.

[276] Bemerkung: ZÜNDKERZENWECHSEL
Empfehlung: Bei Zündkerzenwechsel an Fahrzeugen mitSteckerzündspulen, bitte gleichzeitig Stecker erneuern undZündkerzen-Steckerfett verwenden.
[277] Bemerkung: Bemerkung: Empfehlung: ZKF 01 – siehe Zubehörliste
[278] Empfohlenes Wechselintervall (km): 20000
[279] Empfohlenes Wechselintervall (km): 30000
[280] Verkaufsbeschränkung: Außer USA
[281] Verkaufsbeschränkung: Außer USA und Japan
[282] Verkaufsbeschränkung: Canada
[283] Verkaufsbeschränkung: USA
[284] Verkaufsbeschränkung: USA und Japan
[285] Getriebeart: Automatikgetriebe
[286] Getriebeart: CVT-Automatikgetriebe (Stufenlos)
[287] Getriebeart: Schaltgetriebe
[288] Getriebeart: 5-Gang Getriebe
[289] Getriebeart: 6-Gang Getriebe
[290] Getriebeart: Halbautomatik
[291] Fahrzeugausstattung: für Fahrzeuge mit Klimaanlage
[292] Fahrzeugausstattung: für Fahrzeuge mit Zündverteiler
[293] Fahrzeugausstattung: für Fahrzeuge mit Wegfahrsperr
[294] Fahrzeugausstattung: Für Fahrzeuge mit StartStop Funktion
[295] Fahrzeugausstattung: Für Fahrzeuge ohne Partikelfilter
[296] Fahrzeugausstattung: für Fahrzeuge ohne Zündverteiler
[297] Fahrzeugausstattung: für Fahrzeuge ohne Wegfahrsperr
[298] Fahrzeugausstattung: Für Fahrzeuge ohne StartStop Funktion
[299] Bordnetzausführung: für Fahrzeuge mit 12V Bordnetz
[300] Version: 0221504030
[301] Version: 03L.L
[302] Version: 04E.A, 04E.B
[303] Version: 04E.A, 04E.D
[304] Version: 04E.A, 04E.D, 04E.G, 04E.C
[305] Version: 04E.B
[306] Version: 04E.D, 04E.A
[307] Version: 04E.D, 04E.A, 04E.G
[308] Version: 04E.D, 04E.C
[309] Version: 04L.D;04L.J
[310] Version: 1P
[311] Version: 2U
[312] Version: 55kW
[313] Version: 56kW
[314] Version: Abgasnorm CEE2000
[315] Version: Abgasnorm CEE95
[316] Version: Fahrwerk: LB
[317] Version: Fahrwerk: LB (USA)
[318] Version: CEE2000, ohne EOBD
[319] Version: D4123
[320] Version: DOHC
[321] Version: DSL
[322] Version: Duratorq / SID 206
[323] Version: EA17 041
[324] Version: für FSI-Motoren

DE

| |
|---|
| [325] Version: FORMEL E |
| [326] Version: GAMMA |
| [327] Version: JB0;JB1;JB2;JB3 |
| [328] Version: JPN |
| [329] Version: KK13 |
| [330] Version: LCI |
| [331] Version: LDK |
| [332] Version: LDK, LHU |
| [333] Version: M47 |
| [334] Version: M47N |
| [335] Version: M47N2 |
| [336] Version: M57N |
| [337] Version: MA13 |
| [338] Version: MD13 NAGARES |
| [339] Version: MD13 NAGARES;Getriebe PF1 |
| [340] Version: MJ |
| [341] Version: MM |
| [342] Version: MPI |
| [343] Version: N47 |
| [344] Version: N47N |
| [345] Version: N57 |
| [346] Version: N57N |
| [347] Version: N57S |
| [348] Version: N57Z |
| [349] Version: NA13 |
| [350] Version: Getriebe JR5 |
| [351] Version: NA13;Getriebe JR5, TL4 |
| [352] Version: ND13 |
| [353] Version: Nicht für Abgasnorm Euro 5 |
| [354] Version: nicht B37A |
| [355] Version: nicht B37B |
| [356] Version: nicht für FSI-Motoren |
| [357] Version: nicht N57N |
| [358] Version: NTK #6 |
| [359] Version: ohne EOBD |
| [360] Version: OP13 |
| [361] Version: Alternative für ZS522 |
| [362] Version: Puma |
| [363] Version: Relais #3/103 |
| [364] Version: Relais #4/103 |
| [365] Version: Relais #8/103 |
| [366] Version: RUSSISCHES WERK |
| [367] Version: SOHC |
| [368] Version: Getriebe JB3 |
| [369] Version: Getriebe JC5 |
| [370] Version: Getriebe PK5 |
| [371] Version: UK |
| [372] Version: XT17 LINDE |
| [373] Version: Y-115T1 |
| [374] Version: ZH13 |
| [375] Version: ZP17 |

ES

| | | |
|---|---|---|
| [1] Frenado / conducción: para vehículos con ABS | [48] para facelift: Sí | [106] para OE N°: 224481KTOA |
| [2] Tipo de catalizador: para vehículos con convertidor catalítico; para vehículos con disposición catalítica | [49] para norma de emisión/fabricante: CEE 19-5 | [107] para OE N°: 224488H315 |
| [3] Tipo de catalizador: para vehículos con disposición de catalizador; para vehículos con catalizador | [50] para norma de emisión/fabricante: CEE 19-5;US 87 | [108] para OE N°: 224488J11C |
| [4] Tipo de catalizador: para vehículos sin convertidor catalítico | [51] para norma de emisión/fabricante: CEE 95 | [109] para OE N°: 22448ED800 |
| [5] Tipo de catalizador: con catalizador regulado (3 vías) | [52] para norma de emisión/fabricante: CEE Fase 2 | [110] para OE N°: 25182496;96253555 |
| [6] Zonas climáticas: para climas fríos | [53] para norma de emisión/fabricante: CEE Phase 4 | [111] para OE N°: 27301 02100 |
| [7] Pintura: negro | [54] para norma de emisión/fabricante: CEE Phase 5 | [112] para OE N°: 27301 02600 |
| [8] Pintura: azul | [55] para norma de emisión/fabricante: CF2 | [113] para OE N°: 27301 02700 |
| [9] Pintura: Azul; Verde | [56] para norma de emisión/fabricante: CF2;CF3 | [114] para OE N°: 27301 03000 |
| [10] Pintura: gris | [57] para norma de emisión/fabricante: CF3 | [115] para OE N°: 27301 03010 |
| [11] Pintura: Gris claro | [58] para norma de emisión/fabricante: CF3;CF4 | [116] para OE N°: 27301 04000 |
| [12] Pintura: naranja | [59] para norma de emisión/fabricante: CF4 | [117] para OE N°: 27301 22600 |
| [13] Pintura: rojo | [60] para norma de emisión/fabricante: Euro 5 | [118] para OE N°: 27301 23700 |
| [14] Pintura: Blanco | [61] para norma de emisión/fabricante: US 87 | [119] para OE N°: 27301 26600 |
| [15] Pintura: Amarillo | [62] para OE N°: 000 158 62 03 | [120] para OE N°: 27301 2B000 |
| [16] Número de distribuidor de encendido: 525352A;525352B;525352C;525352D | [63] para OE N°: 000 158 64 03 | [121] para OE N°: 27301 28010 |
| [17] Norma de emisiones: D3 | [64] para OE N°: 032 905 106 B | [122] para OE N°: 27301 700 |
| [18] Norma de emisiones: D4 | [65] para OE N°: 036 905 715 F | [123] para OE N°: 2S6Q-6M090-AB |
| [19] Norma de emisiones: Euro 3 (D3) | [66] para OE N°: 03F 905 409 B | [124] para OE N°: 2S6Q-6M090-BB |
| [20] Norma de emisiones: Euro 3 (D3);Euro 4 (D4) | [67] para OE N°: 03L 905 061 G | [125] para OE N°: 30520-RRA-007 |
| [21] Norma de emisiones: Euro 4 (D4) | [68] para OE N°: 04606869AC;04606869AB | [126] para OE N°: 30713416;9125601 |
| [22] Norma de emisiones: Euro 5 | [69] para OE N°: 058 905 101 A | [127] para OE N°: 357911253 |
| [23] Norma de emisiones: Euro 5 PLUS | [70] para OE N°: 059 905 061 H | [128] para OE N°: 36710 2A100 |
| [24] Norma de emisiones: Euro 6 | [71] para OE N°: 059 963 319 T | [129] para OE N°: 36710 3A000 |
| [25] Norma de emisiones: Euro 6 PLUS | [72] para OE N°: 06A 905 097 | [130] para OE N°: 36710 4A000 |
| [26] Norma de emisiones: ULEV2 | [73] para OE N°: 06A 905 115 D | [131] para OE N°: 46 777 288 |
| [27] Lado de montaje: Colector de escape | [74] para OE N°: 06B 905 115 E | [132] para OE N°: 46796050 |
| [28] Lado de montaje: Colector de admisión | [75] para OE N°: 06E 905 115 E | [133] para OE N°: 55210051 |
| [29] Lado de montaje: Instalación lateral; en el cilindro 5; en el cilindro 6; en el cilindro 7; en el cilindro 8 | [76] para OE N°: 07K 905 715 F | [134] para OE N°: 5960 66 |
| [30] Lado de montaje: izquierda | [77] para OE N°: 100630 | [135] para OE N°: 5960 66;5960 F5 |
| [31] Lado de montaje: derecha | [78] para OE N°: 1106500Q0H;1106500Q0L | [136] para OE N°: 5960 F4 |
| [32] Lado de montaje: en el cilindro 1; en el cilindro 2; en el cilindro 3 | [79] para OE N°: 110651492R | [137] para OE N°: 70863020 |
| [33] Lado de montaje: en el cilindro 1; en el cilindro 2; en el cilindro 3; en el cilindro 4 | [80] para OE N°: 110651749R | [138] para OE N°: 70863021 |
| [34] Lado de montaje: to cylinder 1; to cylinder 2; to cylinder 4 | [81] para OE N°: 110655X00A | [139] para OE N°: 7648797 |
| [35] Lado de montaje: en el cilindro 1; en el cilindro 3 | [82] para OE N°: 11067BN700 | [140] para OE N°: 7700100589 |
| [36] Lado de montaje: en el cilindro 1; en el cilindro 3; en el cilindro 5 | [83] para OE N°: 12 13 1 703 228 | [141] para OE N°: 7700100643 |
| [37] Lado de montaje: del cilindro 1, 4 | [84] para OE N°: 12 13 1 712 219 | [142] para OE N°: 7700273226 |
| [38] Lado de montaje: del cilindro 2 | [85] para OE N°: 12 13 7 510 738 | [143] para OE N°: 7700273826 |
| [39] Lado de montaje: del cilindro 2, 3 | [86] para OE N°: 12 13 7 548 553 | [144] para OE N°: 7700274008;224336134R |
| [40] Lado de montaje: en el cilindro 2; en el cilindro 3; en el cilindro 4 | [87] para OE N°: 12 13 7 594 937 | [145] para OE N°: 7701041607 |
| [41] Lado de montaje: del cilindro 2, 4 | [88] para OE N°: 12 13 7 638 477 | [146] para OE N°: 7701041608 |
| [42] Lado de montaje: en el cilindro 2; en el cilindro 4; en el cilindro 6 | [89] para OE N°: 12 13 8 616 153 | [147] para OE N°: 7746152 |
| [43] Lado de montaje: to cylinder 2; to cylinder 5 | [90] para OE N°: 12 21 7 800 156 | [148] para OE N°: 7746153 |
| [44] Lado de montaje: al cilindro 3 | [91] para OE N°: 12 21 7 801 200 | [149] para OE N°: 8200051128 |
| [45] Lado de montaje: en el cilindro 5; en el cilindro 6; en el cilindro 7; en el cilindro 8 | [92] para OE N°: 12 23 0 038 490 | [150] para OE N°: 8200084401;8200025256 |
| [46] Lado de montaje: Superior; en el cilindro 1; en el cilindro 2; en el cilindro 3; en el cilindro 4 | [93] para OE N°: 12 23 2 248 059 | [151] para OE N°: 8200360911;8200702693 |
| [47] para facelift: No | [94] para OE N°: 12 23 7 786 869 | [152] para OE N°: 8200486877 |
| | [95] para OE N°: 12 23 7 798 001 | [153] para OE N°: 8200506297 |
| | [96] para OE N°: 12611424 | [154] para OE N°: 8200561251 |
| | [97] para OE N°: 1275971 | [155] para OE N°: 8200682592 |
| | [98] para OE N°: 1306696 | [156] para OE N°: 8200702693 |
| | [99] para OE N°: 171 905 115 | [157] para OE N°: 8200943801 |
| | [100] para OE N°: 18550-80KAO | [158] para OE N°: 8973065193 |
| | [101] para OE N°: 22 43 361 34R | [159] para OE N°: 90543253 |
| | [102] para OE N°: 2240100Q0G, 2240100Q0K | [160] para OE N°: 90919-01218 |
| | [103] para OE N°: 2240100Q0K | [161] para OE N°: 90919-02230 |
| | [104] para OE N°: 22401CK81B | [162] para OE N°: 90919-02234 |
| | [105] para OE N°: 224332428R | [163] para OE N°: 90919-02234;90919-02207 |

ES

[164] para OE N°: 90919-02238
[165] para OE N°: 90919-02243
[166] para OE N°: 90919-02248
[167] para OE N°: 90919-02262
[168] para OE N°: 90919-02265
[169] para OE N°: 90919-02266
[170] para OE N°: 93177212
[171] para OE N°: 93198468
[172] para OE N°: 9638985980
[173] para OE N°: 9651583680
[174] para OE N°: A 000 158 78 03
[175] para OE N°: A 001 159 15 01;A 001 159 16 01
[176] para OE N°: A 001 159 20 01;A 001 159 21 01
[177] para OE N°: A 001 159 26 01
[178] para OE N°: A 001 159 50 01;A 001 159 71 01
[179] para OE N°: A 272 906 00 60
[180] para OE N°: A 642 900 58 01
[181] para OE N°: N 105 916 02;N 105 916 03
[182] para OE N°: N 105 916 03
[183] para OE N°: N 105 916 04
[184] para OE N°: N 105 916 08
[185] para OE N°: NEC100630
[186] para OE N°: S210-18-140;S210-18-140 A
[187] para OE N°: XM34-12A342-BA
[188] Número de PR: OGG
[189] Número de PR: OK0 + TS8 + 7MJ, 7MU, 7MR
[190] Número de PR: OK3, OK4 +TS8, T7V
[191] Número de PR: 7CF
[192] Número de PR: 7CF, 7MM
[193] Número de PR: 7MM
[194] Número de PR: 7MM, 7MJ
[195] Número de PR: 7MM, 7MJ, 7CP
[196] Número de PR: 7MM;7MJ;7MW
[197] Número de PR: 7MU
[198] Número de PR: D3E
[199] Número de PR: D7N
[200] Número de PR: GP1
[201] Número de PR: GP2+TD1
[202] Número de PR: GP2+TF1
[203] Número de PR: GP2+TH1
[204] Número de PR: TON;T11
[205] Número de PR: T41
[206] Número de PR: T41;TF1
[207] Número de PR: T7V
[208] Número de PR: T7V +7CP, 7CS, 7MV
[209] Número de PR: TD1
[210] Número de PR: TD1+7MM, 7MJ, 7MW
[211] Número de PR: TD1+7MM, 7MJ, 7MW, 7CP
[212] Número de PR: TE1
[213] Número de PR: TF1
[214] Número de PR: TG1
[215] Número de PR: TH1
[216] Número de PR: TH1+7GB
[217] Número de PR: TH1+7MK
[218] Número de PR: TK8, TH8
[219] Número de PR: TK8, TL1
[220] Número de PR: TK8, TL1, TM5
[221] Número de PR: TL1, TK8

[222] Número de PR: TL1, TK8, TM5, TH8
[223] Número de PR: TL1, TP1
[224] Número de PR: TL4
[225] Número de PR: TM4
[226] Número de PR: TP1
[227] Número de PR: TS8
[228] Número de PR: TS8 + 7MJ
[229] para código SA: 021
[230] para código SA: 022
[231] para código SA: 494
[232] para código SA: 700
[233] para código SA: 803;804;805;806
[234] para código SA: 940K;939K;802
[235] para código SA: MC1;MC2;MC3;MP1;MP2;MP3
[236] para código SA: MC2+MS9
[237] para código SA: MQ3;MQ4;MQ5
[238] para código SA: MQ6;MC0
[239] para código SA: U43;U83
[240] Restricción de fabricante: BERU
[241] Restricción de fabricante: BORGWARNER
[242] Restricción de fabricante: Bosch
[243] Restricción de fabricante: BOSCH; DUCELLIER
[244] Restricción de fabricante: Bosch;Beru
[245] Restricción de fabricante: Bremi
[246] Restricción de fabricante: DELCO REMY
[247] Restricción de fabricante: DELPHI
[248] Restricción de fabricante: Ducellier
[249] Restricción de fabricante: ELDOR
[250] Restricción de fabricante: ELECTRICFIL
[251] Restricción de fabricante: electrónico
[252] Restricción de fabricante: Vehículo con diagnóstico
[253] Restricción de fabricante: HITACHI
[254] Restricción de fabricante: ILKAR7A7
[255] Restricción de fabricante: LUCAS
[256] Restricción de fabricante: MARELLI
[257] Restricción de fabricante: MARELLI;DUCELLIER
[258] Restricción de fabricante: NGK
[259] Restricción de fabricante: SAE
[260] Restricción de fabricante: SAGEM
[261] Restricción de fabricante: Système BOSCH
[262] Restricción de fabricante: Sistema BOSCH / TEMIC
[263] Restricción de fabricante: SISTEMA DUCELLIER
[264] Restricción de fabricante: Sistema HITACHI
[265] Restricción de fabricante: Sistema VALEO
[266] Restricción de fabricante: Recomendación sin garantía
[267] no para norma emisión: Euro 5
[268] no para código SA: 494
[269] no para código SA: 803;804;805;806
[270] no para código SA: 808
[271] no para código SA: 928
[272] no para código SA: 940K;939K
[273] no para código SA: U43;U83
[274] Anotación: Cambio de la bobina de encendido según los requisitos del fabricante, instala la bobina de encendido solamente junto con la protección térmica original (FORD 1315753, 2S6G 12A376AE). Asegúrate de que el convertidor catalítico esté funcionando correctamente

[275] Anotación: El producto instalado se debe determinar en el vehículo o el motor.
[276] Anotación: Recomendación - Para el cambio de las bujías de encendido en vehículos con bobinas de encendido con conector, renovarelconector y utilizar, para el montaje, grasa para conectoresde las bujías de encendido.
[277] Anotación: Recomendación: ZKF 01 ver lista de accesorios
[278] intervalo de cambio recomendado (km): 20000
[279] intervalo de cambio recomendado (km): 30000
[280] Restricción_Ventas: Excluye Estados Unidos de América
[281] Restricción_Ventas: Excluye Estados Unidos de América, excluye Japón
[282] Restricción_Ventas: Incluido Canada
[283] Restricción_Ventas: Incluido Estados Unidos de América
[284] Restricción_Ventas: Incluido Estados Unidos de América, incluido Japón
[285] Clase de caja de cambios: Transmisión automática
[286] Clase de caja de cambios: Transmisión automática CVT (continua)
[287] Clase de caja de cambios: Caja de cambios manual
[288] Clase de caja de cambios: Transmisión 5 velocidades
[289] Clase de caja de cambios: Transmisión 6 velocidades
[290] Clase de caja de cambios: semiautomática
[291] Equipamiento de vehículo: para vehículos con climatizador
[292] Equipamiento de vehículo: para vehículos con distribuidor de encendido
[293] Equipamiento de vehículo: para vehículos con sistema de inmovilización
[294] Equipamiento de vehículo: para vehículos con función start-stop
[295] Equipamiento de vehículo: para vehículos sin filtro diésel
[296] Equipamiento de vehículo: para vehículos sin distribuidor de encendido
[297] Equipamiento de vehículo: para vehículos sin sistema de inmovilización
[298] Equipamiento de vehículo: para vehículos sin función start-stop
[299] Modelo red de a bordo: para vehículos con red de a bordo 12V
[300] Versión: 0221504030
[301] Versión: 03L.L
[302] Versión: 04E.A, 04E.B
[303] Versión: 04E.A, 04E.D
[304] Versión: 04E.A, 04E.D, 04E.G, 04E.C
[305] Versión: 04E.B
[306] Versión: 04E.D, 04E.A
[307] Versión: 04E.D, 04E.A, 04E.G
[308] Versión: 04E.D, 04E.C
[309] Versión: 04L.D;04L.J
[310] Versión: 1P
[311] Versión: 2U
[312] Versión: 55KW
[313] Versión: 56KW
[314] Versión: La norma de escape CEE2000
[315] Versión: La norma de escape CEE95
[316] Versión: Carrocería: LB

ES

[317] Versión: Carrocería: LB (USA)
[318] Versión: CEE2000, sin EOB
[319] Versión: D4123
[320] Versión: DOHC
[321] Versión: DSL
[322] Versión: Duratorq / SID 206
[323] Versión: EA17 041
[324] Versión: para motores FSI
[325] Versión: FORMEL E
[326] Versión: GAMMA
[327] Versión: JBO;JB1;JB2;JB3
[328] Versión: JPN
[329] Versión: KK13
[330] Versión: LCI
[331] Versión: LDK
[332] Versión: LDK, LHU
[333] Versión: M47
[334] Versión: M47N
[335] Versión: M47N2
[336] Versión: M57N
[337] Versión: MA13
[338] Versión: MD13 NAGARES
[339] Versión: MD13 NAGARES;Transmisión PF1
[340] Versión: MJ
[341] Versión: MM
[342] Versión: Inyección multipoint
[343] Versión: N47
[344] Versión: N47N
[345] Versión: N57
[346] Versión: N57N
[347] Versión: N57S
[348] Versión: N57Z
[349] Versión: NA13
[350] Versión: Transmisión JR5
[351] Versión: NA13;Transmisión JR5, TL4
[352] Versión: ND13
[353] Versión: No para la norma de escape Euro 5
[354] Versión: no B37A
[355] Versión: no B37B
[356] Versión: no para motores FSI
[357] Versión: no N57N
[358] Versión: NTK #6
[359] Versión: Sin EOB
[360] Versión: OP13
[361] Versión: alternativa para ZS522
[362] Versión: Puma
[363] Versión: Relés #3/103
[364] Versión: Relés #4/103
[365] Versión: Relés #8/103
[366] Versión: PLANTA RUSA
[367] Versión: SOHC
[368] Versión: Transmisión JB3
[369] Versión: Transmisión JC5
[370] Versión: Transmisión PK5
[371] Versión: UK
[372] Versión: XT17 LINDE
[373] Versión: Y-115T1
[374] Versión: ZH13

[375] Versión: ZP17

NL

| | | |
|---|--|---|
| [1] Rem- / Rijndynamiek: voor voertuigen met ABS | [50] Voor uitlaatgasnorm: CEE 19-5;US 87 | [108] voor OE nummer: 224488J11C |
| [2] katalysator type: voor auto's met katalytische omvormer; voor auto's met katalysator-inrichting | [51] Voor uitlaatgasnorm: CEE 95 | [109] voor OE nummer: 22448ED800 |
| [3] katalysator type: voor auto's met katalytische omvormer; voor auto's met katalysator | [52] Voor uitlaatgasnorm: CEE Fase 2 | [110] voor OE nummer: 25182496;96253555 |
| [4] katalysator type: voor auto's zonder katalytische omvormer | [53] Voor uitlaatgasnorm: CEE Phase 4 | [111] voor OE nummer: 27301 02100 |
| [5] katalysator type: met geregelde (3-weg) katalysator | [54] Voor uitlaatgasnorm: CEE Phase 5 | [112] voor OE nummer: 27301 02600 |
| [6] klimaatzones: voor koude klimaten | [55] Voor uitlaatgasnorm: CF2 | [113] voor OE nummer: 27301 02700 |
| [7] kleur: zwart | [56] Voor uitlaatgasnorm: CF2;CF3 | [114] voor OE nummer: 27301 03000 |
| [8] kleur: blauw | [57] Voor uitlaatgasnorm: CF3 | [115] voor OE nummer: 27301 03010 |
| [9] kleur: Blauw;Groen | [58] Voor uitlaatgasnorm: CF3;CF4 | [116] voor OE nummer: 27301 04000 |
| [10] kleur: grijs | [59] Voor uitlaatgasnorm: CF4 | [117] voor OE nummer: 27301 22600 |
| [11] kleur: Lichtgrijs | [60] Voor uitlaatgasnorm: Euro 5 | [118] voor OE nummer: 27301 23700 |
| [12] kleur: oranje | [61] Voor uitlaatgasnorm: US 87 | [119] voor OE nummer: 27301 26600 |
| [13] kleur: rood | [62] voor OE nummer: 000 158 62 03 | [120] voor OE nummer: 27301 2B000 |
| [14] kleur: Wit | [63] voor OE nummer: 000 158 64 03 | [121] voor OE nummer: 27301 2B010 |
| [15] kleur: Geel | [64] voor OE nummer: 032 905 106 B | [122] voor OE nummer: 27301 700 |
| [16] Nummer stroomverdelers: 525352A;525352B;525352C;525352D | [65] voor OE nummer: 036 905 715 F | [123] voor OE nummer: 2S6Q-6M090-AB |
| [17] emissienorm: D3 | [66] voor OE nummer: 03F 905 409 B | [124] voor OE nummer: 2S6Q-6M090-BB |
| [18] emissienorm: D4 | [67] voor OE nummer: 03L 905 061 G | [125] voor OE nummer: 30520-RRA-007 |
| [19] emissienorm: Euro 3 (D3) | [68] voor OE nummer: 04606869AC;04606869AB | [126] voor OE nummer: 30713416;9125601 |
| [20] emissienorm: Euro 3 (D3);Euro 4 (D4) | [69] voor OE nummer: 058 905 101 A | [127] voor OE nummer: 357911253 |
| [21] emissienorm: Euro 4 (D4) | [70] voor OE nummer: 059 905 061 H | [128] voor OE nummer: 36710 2A100 |
| [22] emissienorm: Euro 5 | [71] voor OE nummer: 059 963 319 T | [129] voor OE nummer: 36710 3A000 |
| [23] emissienorm: Euro 5 PLUS | [72] voor OE nummer: 06A 905 097 | [130] voor OE nummer: 36710 4A000 |
| [24] emissienorm: Euro 6 | [73] voor OE nummer: 06A 905 115 D | [131] voor OE nummer: 46 777 288 |
| [25] emissienorm: Euro 6 PLUS | [74] voor OE nummer: 06B 905 115 E | [132] voor OE nummer: 46796050 |
| [26] emissienorm: ULEV2 | [75] voor OE nummer: 06E 905 115 E | [133] voor OE nummer: 55210051 |
| [27] Plaats: Uitlaatbocht | [76] voor OE nummer: 07K 905 715 F | [134] voor OE nummer: 5960 66 |
| [28] Plaats: Inlaatspruitstuk | [77] voor OE nummer: 100630 | [135] voor OE nummer: 5960 66;5960 F5 |
| [29] Plaats: Parallele montage: naar cilinder 5; naar cilinder 6; naar cilinder 7; naar cilinder 8 | [78] voor OE nummer: 1106500Q0H;1106500Q0L | [136] voor OE nummer: 5960 F4 |
| [30] Plaats: links | [79] voor OE nummer: 110651492R | [137] voor OE nummer: 70863020 |
| [31] Plaats: rechts | [80] voor OE nummer: 110651749R | [138] voor OE nummer: 70863021 |
| [32] Plaats: naar cilinder 1; naar cilinder 2; naar cilinder 3 | [81] voor OE nummer: 110655X00A | [139] voor OE nummer: 7648797 |
| [33] Plaats: naar cilinder 1; naar cilinder 2; naar cilinder 3; naar cilinder 4 | [82] voor OE nummer: 11067BN700 | [140] voor OE nummer: 7700100589 |
| [34] Plaats: to cilinder 1;to cilinder 2;to cilinder 4 | [83] voor OE nummer: 12 13 1 703 228 | [141] voor OE nummer: 7700100643 |
| [35] Plaats: naar cilinder 1; naar cilinder 3 | [84] voor OE nummer: 12 13 1 712 219 | [142] voor OE nummer: 7700273226 |
| [36] Plaats: naar cilinder 1; naar cilinder 3; naar cilinder 5 | [85] voor OE nummer: 12 13 7 510 738 | [143] voor OE nummer: 7700273826 |
| [37] Plaats: op cilinder 1;4 | [86] voor OE nummer: 12 13 7 548 553 | [144] voor OE nummer: 7700274008;224336134R |
| [38] Plaats: op cilinder 2 | [87] voor OE nummer: 12 13 7 594 937 | [145] voor OE nummer: 7701041607 |
| [39] Plaats: op cilinder 2;3 | [88] voor OE nummer: 12 13 7 638 477 | [146] voor OE nummer: 7701041608 |
| [40] Plaats: naar cilinder 2;naar cilinder 3;naar cilinder 4 | [89] voor OE nummer: 12 13 8 616 153 | [147] voor OE nummer: 7746152 |
| [41] Plaats: op cilinder 2;4 | [90] voor OE nummer: 12 21 7 800 156 | [148] voor OE nummer: 7746153 |
| [42] Plaats: naar cilinder 2; naar cilinder 4; naar cilinder 6 | [91] voor OE nummer: 12 21 7 801 200 | [149] voor OE nummer: 8200051128 |
| [43] Plaats: to cilinder 2;to cilinder 5 | [92] voor OE nummer: 12 23 0 038 490 | [150] voor OE nummer: 8200084401;8200025256 |
| [44] Plaats: naar cilinder 3 | [93] voor OE nummer: 12 23 2 248 059 | [151] voor OE nummer: 8200360911;8200702693 |
| [45] Plaats: naar cilinder 5; naar cilinder 6; naar cilinder 7; naar cilinder 8 | [94] voor OE nummer: 12 23 7 786 869 | [152] voor OE nummer: 8200486877 |
| [46] Plaats: Bovenste; naar cilinder 1; naar cilinder 2; naar cilinder 3; naar cilinder 4 | [95] voor OE nummer: 12 23 7 798 001 | [153] voor OE nummer: 8200506297 |
| [47] voor facelift: geen | [96] voor OE nummer: 12611424 | [154] voor OE nummer: 8200561251 |
| [48] voor facelift: Ja | [97] voor OE nummer: 1275971 | [155] voor OE nummer: 8200682592 |
| [49] Voor uitlaatgasnorm: CEE 19-5 | [98] voor OE nummer: 1306696 | [156] voor OE nummer: 8200702693 |
| | [99] voor OE nummer: 171 905 115 | [157] voor OE nummer: 8200943801 |
| | [100] voor OE nummer: 18550-80KA0 | [158] voor OE nummer: 8973065193 |
| | [101] voor OE nummer: 22 43 361 34R | [159] voor OE nummer: 90543253 |
| | [102] voor OE nummer: 2240100Q0G, 2240100Q0K | [160] voor OE nummer: 90919-01218 |
| | [103] voor OE nummer: 2240100Q0K | [161] voor OE nummer: 90919-02230 |
| | [104] voor OE nummer: 22401CK81B | [162] voor OE nummer: 90919-02234 |
| | [105] voor OE nummer: 224332428R | [163] voor OE nummer: 90919-02234;90919-02207 |
| | [106] voor OE nummer: 224481KTOA | [164] voor OE nummer: 90919-02238 |
| | [107] voor OE nummer: 224488H315 | [165] voor OE nummer: 90919-02243 |

NL

[166] voor OE nummer: 90919-02248
[167] voor OE nummer: 90919-02262
[168] voor OE nummer: 90919-02265
[169] voor OE nummer: 90919-02266
[170] voor OE nummer: 93177212
[171] voor OE nummer: 93198468
[172] voor OE nummer: 9638985980
[173] voor OE nummer: 9651583680
[174] voor OE nummer: A 000 158 78 03
[175] voor OE nummer: A 001 159 15 01;A 001 159 16 01
[176] voor OE nummer: A 001 159 20 01;A 001 159 21 01
[177] voor OE nummer: A 001 159 26 01
[178] voor OE nummer: A 001 159 50 01;A 001 159 71 01
[179] voor OE nummer: A 272 906 00 60
[180] voor OE nummer: A 642 900 58 01
[181] voor OE nummer: N 105 916 02;N 105 916 03
[182] voor OE nummer: N 105 916 03
[183] voor OE nummer: N 105 916 04
[184] voor OE nummer: N 105 916 08
[185] voor OE nummer: NEC100630
[186] voor OE nummer: S210-18-140;S210-18-140 A
[187] voor OE nummer: XM34-12A342-BA
[188] voor PR nummer: OGG
[189] voor PR nummer: OK0 + TS8 + 7MJ, 7MU, 7MR
[190] voor PR nummer: OK3, OK4 +TS8, T7V
[191] voor PR nummer: 7CF
[192] voor PR nummer: 7CF, 7MM
[193] voor PR nummer: 7MM
[194] voor PR nummer: 7MM, 7MJ
[195] voor PR nummer: 7MM, 7MJ, 7CP
[196] voor PR nummer: 7MM;7MJ;7MW
[197] voor PR nummer: 7MU
[198] voor PR nummer: D3E
[199] voor PR nummer: D7N
[200] voor PR nummer: GP1
[201] voor PR nummer: GP2+TD1
[202] voor PR nummer: GP2+TF1
[203] voor PR nummer: GP2+TH1
[204] voor PR nummer: TON;T11
[205] voor PR nummer: T41
[206] voor PR nummer: T41;TF1
[207] voor PR nummer: T7V
[208] voor PR nummer: T7V +7CP, 7CS, 7MV
[209] voor PR nummer: TD1
[210] voor PR nummer: TD1+7MM, 7MJ, 7MW
[211] voor PR nummer: TD1+7MM, 7MJ, 7MW, 7CP
[212] voor PR nummer: TE1
[213] voor PR nummer: TF1
[214] voor PR nummer: TG1
[215] voor PR nummer: TH1
[216] voor PR nummer: TH1+7GB
[217] voor PR nummer: TH1+7MK
[218] voor PR nummer: TK8, TH8
[219] voor PR nummer: TK8, TL1
[220] voor PR nummer: TK8, TL1, TM5
[221] voor PR nummer: TL1, TK8

[222] voor PR nummer: TL1, TK8, TM5, TH8
[223] voor PR nummer: TL1, TP1
[224] voor PR nummer: TL4
[225] voor PR nummer: TM4
[226] voor PR nummer: TP1
[227] voor PR nummer: TS8
[228] voor PR nummer: TS8 + 7MJ
[229] voor SA code: 021
[230] voor SA code: 022
[231] voor SA code: 494
[232] voor SA code: 700
[233] voor SA code: 803;804;805;806
[234] voor SA code: 940K;939K;802
[235] voor SA code: MC1;MC2;MC3;MP1;MP2;MP3
[236] voor SA code: MC2+MS9
[237] voor SA code: MQ3;MQ4;MQ5
[238] voor SA code: MQ6;MCO
[239] voor SA code: U43;U83
[240] voor fabrikant: BERU
[241] voor fabrikant: BORGWARNER
[242] voor fabrikant: Bosch
[243] voor fabrikant: BOSCH; DUCELLIER
[244] voor fabrikant: Bosch;Beru
[245] voor fabrikant: Bremi
[246] voor fabrikant: DELCO REMY
[247] voor fabrikant: DELPHI
[248] voor fabrikant: Ducellier
[249] voor fabrikant: ELDOR
[250] voor fabrikant: ELECTRICFIL
[251] voor fabrikant: electronic
[252] voor fabrikant: Auto met diagnose
[253] voor fabrikant: HITACHI
[254] voor fabrikant: ILKAR7A7
[255] voor fabrikant: LUCAS
[256] voor fabrikant: MARELLI
[257] voor fabrikant: MARELLI;DUCELLIER
[258] voor fabrikant: NGK
[259] voor fabrikant: SAE
[260] voor fabrikant: SAGEM
[261] voor fabrikant: Systeem BOSCH
[262] voor fabrikant: Systeem BOSCH / TEMIC
[263] voor fabrikant: SYSTEEM DUCELLIER
[264] voor fabrikant: Systeem HITACHI
[265] voor fabrikant: Systeem VALEO
[266] voor fabrikant: Niet-bindende aanbeveling
[267] niet voor uitlaastgasnorm: Euro 5
[268] niet voor SA code: 494
[269] niet voor SA code: 803;804;805;806
[270] niet voor SA code: 808
[271] niet voor SA code: 928
[272] niet voor SA code: 940K;939K
[273] niet voor SA code: U43;U83
[274] opmerkingen: Om de bobine te wisselen volgens de vereisten van de producent, moet men de bobine met het originele hittescherm monteren (FORD 1315753, 2S6G 12A376AE). Zorg ervoor dat de catalic converter goed werkt.
[275] opmerkingen: Het geïnstalleerde product moet worden afgestemd op de auto of de motor.

[276] opmerkingen: Aanbeveling - Bij het vervangen van bougies bij auto's met bougiestekkers, a.u.b. nieuwe stekkers en bougiestekkerket (ZKF 01 - Best.-nr. 0 890 300 029) gebruiken.
[277] opmerkingen: Aanbeveling: ZKF 01 - zie de accessoireslijst
[278] Aanbevolen vervangingsinterval (km): 20000
[279] Aanbevolen vervangingsinterval (km): 30000
[280] Verkoopbeperking: Exclusief Verenigde Staten van Amerika
[281] Verkoopbeperking: Exclusief Verenigde Staten van Amerika, exclusief Japan
[282] Verkoopbeperking: Inclusief Canada
[283] Verkoopbeperking: Inclusief Verenigde Staten van Amerika
[284] Verkoopbeperking: Inclusief Verenigde Staten van Amerika, inclusief Japan
[285] aandrijving: Automatische transmissie
[286] aandrijving: CTV automaat (trappenloos)
[287] aandrijving: handgeschakeld
[288] aandrijving: Transmissie met 5 versnellingen
[289] aandrijving: Transmissie met 6 versnellingen
[290] aandrijving: semi-automatisch
[291] uitvoering: voor voertuigen met airco
[292] uitvoering: voor voertuigen met stroomverdeler
[293] uitvoering: voor voertuigen met startblokkering
[294] uitvoering: Voor voertuigen met start-stop functie
[295] uitvoering: Voor voertuigen met een diesel filter
[296] uitvoering: voor voertuigen zonder ontstekingsverdeler
[297] uitvoering: voor voertuigen zonder startonderbreking
[298] uitvoering: Voor voertuigen zonder start-stop functie
[299] uitvoering boordleiding: voor voertuigen met 12V boordspanning
[300] versie: 0221504030
[301] versie: 03LL
[302] versie: 04E.A, 04E.B
[303] versie: 04E.A, 04E.D
[304] versie: 04E.A, 04E.D, 04E.G, 04E.C
[305] versie: 04E.B
[306] versie: 04E.D, 04E.A
[307] versie: 04E.D, 04E.A, 04E.G
[308] versie: 04E.D, 04E.C
[309] versie: 04L.D;04L.J
[310] versie: 1P
[311] versie: 2U
[312] versie: 55kW
[313] versie: 56kW
[314] versie: Uitlaat norm CEE2000
[315] versie: Uitlaat norm CEE95
[316] versie: Carrosserie: LB
[317] versie: Carrosserie: LB (USA)
[318] versie: CEE2000, zonder EOBD
[319] versie: D4123
[320] versie: DOHC
[321] versie: DSL
[322] versie: Duratorq / SID 206
[323] versie: EA17 041
[324] versie: voor FSI-motoren
[325] versie: FORMEL E

NL

| |
|---|
| [326] versie: GAMMA |
| [327] versie: JB0;JB1;JB2;JB3 |
| [328] versie: JPN |
| [329] versie: KK13 |
| [330] versie: LCI |
| [331] versie: LDK |
| [332] versie: LDK, LHU |
| [333] versie: M47 |
| [334] versie: M47N |
| [335] versie: M47N2 |
| [336] versie: M57N |
| [337] versie: MA13 |
| [338] versie: MD13 NAGARES |
| [339] versie: MD13 NAGARES;Transmissie PF1 |
| [340] versie: MJ |
| [341] versie: MM |
| [342] versie: MPI |
| [343] versie: N47 |
| [344] versie: N47N |
| [345] versie: N57 |
| [346] versie: N57N |
| [347] versie: N57S |
| [348] versie: N57Z |
| [349] versie: NA13 |
| [350] versie: Transmissie JR5 |
| [351] versie: NA13;Transmissie JR5, TL4 |
| [352] versie: ND13 |
| [353] versie: Niet voor uitlaat norm Euro 5 |
| [354] versie: B37A uitgezonderd |
| [355] versie: B37B uitgezonderd |
| [356] versie: niet voor FSI-motoren |
| [357] versie: N57N uitgezonderd |
| [358] versie: NTK #6 |
| [359] versie: Zonder EOBD |
| [360] versie: OP13 |
| [361] versie: alternatief voor ZS522 |
| [362] versie: Puma |
| [363] versie: Relais #3/103 |
| [364] versie: Relais #4/103 |
| [365] versie: Relais #8/103 |
| [366] versie: RUSSIA-FABRIEK |
| [367] versie: SOHC |
| [368] versie: Transmissie JB3 |
| [369] versie: Transmissie JC5 |
| [370] versie: Transmissie PK5 |
| [371] versie: UK |
| [372] versie: XT17 LINDE |
| [373] versie: Y-115T1 |
| [374] versie: ZH13 |
| [375] versie: ZP17 |

CZ

| | |
|------|--|
| [1] | Brzdná/jízdní dynamika: pro vozidla s ABS |
| [2] | druh katalyzátoru: pro vozidla s katalyzátorem; pro vozidla s úpravou pro katalyzátoru |
| [3] | druh katalyzátoru: pro vozidla se systémem katalyzátoru; pro vozidla s katalyzátorem |
| [4] | druh katalyzátoru: pro vozidla bez katalyzátoru |
| [5] | druh katalyzátoru: s řízeným katalyzátorem (třícestný) |
| [6] | klimatická pásma: do nízkých teplot |
| [7] | Barva: černá |
| [8] | Barva: modrá |
| [9] | Barva: Modrý;Zelená |
| [10] | Barva: Seda |
| [11] | Barva: světle šedá |
| [12] | Barva: oranžova |
| [13] | Barva: červená |
| [14] | Barva: Bílý |
| [15] | Barva: Žlutý |
| [16] | číslo rozdělovače: 525352A;525352B;525352C;525352D |
| [17] | Emisní norma: D3 |
| [18] | Emisní norma: D4 |
| [19] | Emisní norma: Euro 3 (D3) |
| [20] | Emisní norma: Euro 3 (D3);Euro 4 (D4) |
| [21] | Emisní norma: Euro 4 (D4) |
| [22] | Emisní norma: Euro 5 |
| [23] | Emisní norma: Euro 5 PLUS |
| [24] | Emisní norma: Euro 6 |
| [25] | Emisní norma: Euro 6 PLUS |
| [26] | Emisní norma: ULEV2 |
| [27] | montovací strana: Sberac výfukových plynů |
| [28] | montovací strana: Koleny sacího potrubí |
| [29] | montovací strana: Příčná montáž;do válce 5;do válce 6;do válce 7;do válce 8 |
| [30] | montovací strana: levá |
| [31] | montovací strana: pravá |
| [32] | montovací strana: do válce 1;do válce 2;do válce 3 |
| [33] | montovací strana: do válce 1;do válce 2;do válce 3;do válce 4 |
| [34] | montovací strana: to cylinder 1;to cylinder 2;to cylinder 4 |
| [35] | montovací strana: do válce 1;do válce 3 |
| [36] | montovací strana: do válce 1;do válce 3;do válce 5 |
| [37] | montovací strana: do válce 1, 4 |
| [38] | montovací strana: do válce 2 |
| [39] | montovací strana: do válce 2, 3 |
| [40] | montovací strana: do válce 2;do válce 3;do válce 4 |
| [41] | montovací strana: do válce 2, 4 |
| [42] | montovací strana: do válce 2;do válce 4;do válce 6 |
| [43] | montovací strana: to cylinder 2;to cylinder 5 |
| [44] | montovací strana: do válce 3 |
| [45] | montovací strana: do válce 5;do válce 6;do válce 7;do válce 8 |
| [46] | montovací strana: Horní;do válce 1;do válce 2;do válce 3;do válce 4 |
| [47] | pro facelift: Ne |
| [48] | pro facelift: Ano |
| [49] | pro výrobce-norma vyfukových plynů: CEE 19-5 |

| | |
|-------|--|
| [50] | pro výrobce-norma vyfukových plynů: CEE 19-5;US 87 |
| [51] | pro výrobce-norma vyfukových plynů: CEE 95 |
| [52] | pro výrobce-norma vyfukových plynů: CEE Fase 2 |
| [53] | pro výrobce-norma vyfukových plynů: CEE Phase 4 |
| [54] | pro výrobce-norma vyfukových plynů: CEE Phase 5 |
| [55] | pro výrobce-norma vyfukových plynů: CF2 |
| [56] | pro výrobce-norma vyfukových plynů: CF2;CF3 |
| [57] | pro výrobce-norma vyfukových plynů: CF3 |
| [58] | pro výrobce-norma vyfukových plynů: CF3;CF4 |
| [59] | pro výrobce-norma vyfukových plynů: CF4 |
| [60] | pro výrobce-norma vyfukových plynů: Euro 5 |
| [61] | pro výrobce-norma vyfukových plynů: US 87 |
| [62] | pro OE číslo: 000 158 62 03 |
| [63] | pro OE číslo: 000 158 64 03 |
| [64] | pro OE číslo: 032 905 106 B |
| [65] | pro OE číslo: 036 905 715 F |
| [66] | pro OE číslo: 03F 905 409 B |
| [67] | pro OE číslo: 03L 905 061 G |
| [68] | pro OE číslo: 04606869AC;04606869AB |
| [69] | pro OE číslo: 058 905 101 A |
| [70] | pro OE číslo: 059 905 061 H |
| [71] | pro OE číslo: 059 963 319 T |
| [72] | pro OE číslo: 06A 905 097 |
| [73] | pro OE číslo: 06A 905 115 D |
| [74] | pro OE číslo: 06B 905 115 E |
| [75] | pro OE číslo: 06E 905 115 E |
| [76] | pro OE číslo: 07K 905 715 F |
| [77] | pro OE číslo: 100630 |
| [78] | pro OE číslo: 1106500Q0H;1106500Q0L |
| [79] | pro OE číslo: 110651492R |
| [80] | pro OE číslo: 110651749R |
| [81] | pro OE číslo: 110655X00A |
| [82] | pro OE číslo: 11067BN700 |
| [83] | pro OE číslo: 12 13 1 703 228 |
| [84] | pro OE číslo: 12 13 1 712 219 |
| [85] | pro OE číslo: 12 13 7 510 738 |
| [86] | pro OE číslo: 12 13 7 548 553 |
| [87] | pro OE číslo: 12 13 7 594 937 |
| [88] | pro OE číslo: 12 13 7 638 477 |
| [89] | pro OE číslo: 12 13 8 616 153 |
| [90] | pro OE číslo: 12 21 7 800 156 |
| [91] | pro OE číslo: 12 21 7 801 200 |
| [92] | pro OE číslo: 12 23 0 038 490 |
| [93] | pro OE číslo: 12 23 2 248 059 |
| [94] | pro OE číslo: 12 23 7 786 869 |
| [95] | pro OE číslo: 12 23 7 798 001 |
| [96] | pro OE číslo: 12611424 |
| [97] | pro OE číslo: 1275971 |
| [98] | pro OE číslo: 1306696 |
| [99] | pro OE číslo: 171 905 115 |
| [100] | pro OE číslo: 18550-80KAO |
| [101] | pro OE číslo: 22 43 361 34R |
| [102] | pro OE číslo: 2240100Q0G, 2240100Q0K |
| [103] | pro OE číslo: 2240100Q0K |
| [104] | pro OE číslo: 22401CK81B |
| [105] | pro OE číslo: 224332428R |

| | |
|-------|---------------------------------------|
| [106] | pro OE číslo: 224481KTOA |
| [107] | pro OE číslo: 224488H315 |
| [108] | pro OE číslo: 224488J11C |
| [109] | pro OE číslo: 22448ED800 |
| [110] | pro OE číslo: 25182496;96253555 |
| [111] | pro OE číslo: 27301 02100 |
| [112] | pro OE číslo: 27301 02600 |
| [113] | pro OE číslo: 27301 02700 |
| [114] | pro OE číslo: 27301 03000 |
| [115] | pro OE číslo: 27301 03010 |
| [116] | pro OE číslo: 27301 04000 |
| [117] | pro OE číslo: 27301 22600 |
| [118] | pro OE číslo: 27301 23700 |
| [119] | pro OE číslo: 27301 26600 |
| [120] | pro OE číslo: 27301 2B000 |
| [121] | pro OE číslo: 27301 2B010 |
| [122] | pro OE číslo: 27301 700 |
| [123] | pro OE číslo: 2S6Q-6M090-AB |
| [124] | pro OE číslo: 2S6Q-6M090-BB |
| [125] | pro OE číslo: 30520-RRA-007 |
| [126] | pro OE číslo: 30713416;9125601 |
| [127] | pro OE číslo: 357911253 |
| [128] | pro OE číslo: 36710 2A100 |
| [129] | pro OE číslo: 36710 3A000 |
| [130] | pro OE číslo: 36710 4A000 |
| [131] | pro OE číslo: 46 777 288 |
| [132] | pro OE číslo: 46796050 |
| [133] | pro OE číslo: 55210051 |
| [134] | pro OE číslo: 5960 66 |
| [135] | pro OE číslo: 5960 66;5960 F5 |
| [136] | pro OE číslo: 5960 F4 |
| [137] | pro OE číslo: 70863020 |
| [138] | pro OE číslo: 70863021 |
| [139] | pro OE číslo: 7648797 |
| [140] | pro OE číslo: 7700100589 |
| [141] | pro OE číslo: 7700100643 |
| [142] | pro OE číslo: 7700273226 |
| [143] | pro OE číslo: 7700273826 |
| [144] | pro OE číslo: 7700274008;224336134R |
| [145] | pro OE číslo: 7701041607 |
| [146] | pro OE číslo: 7701041608 |
| [147] | pro OE číslo: 7746152 |
| [148] | pro OE číslo: 7746153 |
| [149] | pro OE číslo: 8200051128 |
| [150] | pro OE číslo: 8200084401;8200025256 |
| [151] | pro OE číslo: 8200360911;8200702693 |
| [152] | pro OE číslo: 8200486877 |
| [153] | pro OE číslo: 8200506297 |
| [154] | pro OE číslo: 8200561251 |
| [155] | pro OE číslo: 8200682592 |
| [156] | pro OE číslo: 8200702693 |
| [157] | pro OE číslo: 8200943801 |
| [158] | pro OE číslo: 8973065193 |
| [159] | pro OE číslo: 90543253 |
| [160] | pro OE číslo: 90919-01218 |
| [161] | pro OE číslo: 90919-02230 |
| [162] | pro OE číslo: 90919-02234 |
| [163] | pro OE číslo: 90919-02234;90919-02207 |

CZ

[164] pro OE číslo: 90919-02238
[165] pro OE číslo: 90919-02243
[166] pro OE číslo: 90919-02248
[167] pro OE číslo: 90919-02262
[168] pro OE číslo: 90919-02265
[169] pro OE číslo: 90919-02266
[170] pro OE číslo: 93177212
[171] pro OE číslo: 93198468
[172] pro OE číslo: 9638985980
[173] pro OE číslo: 9651583680
[174] pro OE číslo: A 000 158 78 03
[175] pro OE číslo: A 001 159 15 01;A 001 159 16 01
[176] pro OE číslo: A 001 159 20 01;A 001 159 21 01
[177] pro OE číslo: A 001 159 26 01
[178] pro OE číslo: A 001 159 50 01;A 001 159 71 01
[179] pro OE číslo: A 272 906 00 60
[180] pro OE číslo: A 642 900 58 01
[181] pro OE číslo: N 105 916 02;N 105 916 03
[182] pro OE číslo: N 105 916 03
[183] pro OE číslo: N 105 916 04
[184] pro OE číslo: N 105 916 08
[185] pro OE číslo: NEC100630
[186] pro OE číslo: S210-18-140;S210-18-140 A
[187] pro OE číslo: XM34-12A342-BA
[188] pro PR-číslo: OGG
[189] pro PR-číslo: OK0 + TS8 + 7MJ, 7MU, 7MR
[190] pro PR-číslo: OK3, OK4 +TS8, T7V
[191] pro PR-číslo: 7CF
[192] pro PR-číslo: 7CF, 7MM
[193] pro PR-číslo: 7MM
[194] pro PR-číslo: 7MM, 7MJ
[195] pro PR-číslo: 7MM, 7MJ, 7CP
[196] pro PR-číslo: 7MM;7MJ;7MW
[197] pro PR-číslo: 7MU
[198] pro PR-číslo: D3E
[199] pro PR-číslo: D7N
[200] pro PR-číslo: GP1
[201] pro PR-číslo: GP2+TD1
[202] pro PR-číslo: GP2+TF1
[203] pro PR-číslo: GP2+TH1
[204] pro PR-číslo: TON;T1I
[205] pro PR-číslo: T41
[206] pro PR-číslo: T41;TF1
[207] pro PR-číslo: T7V
[208] pro PR-číslo: T7V +7CP, 7CS, 7MV
[209] pro PR-číslo: TD1
[210] pro PR-číslo: TD1+7MM, 7MJ, 7MW
[211] pro PR-číslo: TD1+7MM, 7MJ, 7MW, 7CP
[212] pro PR-číslo: TE1
[213] pro PR-číslo: TF1
[214] pro PR-číslo: TG1
[215] pro PR-číslo: TH1
[216] pro PR-číslo: TH1+7GB
[217] pro PR-číslo: TH1+7MK
[218] pro PR-číslo: TK8, TH8
[219] pro PR-číslo: TK8, TL1
[220] pro PR-číslo: TK8, TL1, TM5
[221] pro PR-číslo: TL1, TK8

[222] pro PR-číslo: TL1, TK8, TM5, TH8
[223] pro PR-číslo: TL1, TP1
[224] pro PR-číslo: TL4
[225] pro PR-číslo: TM4
[226] pro PR-číslo: TP1
[227] pro PR-číslo: TS8
[228] pro PR-číslo: TS8 + 7MJ
[229] pro SA Kod: 021
[230] pro SA Kod: 022
[231] pro SA Kod: 494
[232] pro SA Kod: 700
[233] pro SA Kod: 803;804;805;806
[234] pro SA Kod: 940K;939K;802
[235] pro SA Kod: MC1;MC2;MC3;MP1;MP2;MP3
[236] pro SA Kod: MC2+MS9
[237] pro SA Kod: MQ3;MQ4;MQ5
[238] pro SA Kod: MQ6;MC0
[239] pro SA Kod: U43;U83
[240] omezení výrobce: BERU
[241] omezení výrobce: BORGWARNER
[242] omezení výrobce: Bosch
[243] omezení výrobce: BOSCH; DUCELLIER
[244] omezení výrobce: Bosch;Beru
[245] omezení výrobce: Bremi
[246] omezení výrobce: DELCO REMY
[247] omezení výrobce: DELPHI
[248] omezení výrobce: Ducellier
[249] omezení výrobce: ELDOR
[250] omezení výrobce: ELECTRICFIL
[251] omezení výrobce: elektronický
[252] omezení výrobce: Fzg. s diagnostikou
[253] omezení výrobce: HITACHI
[254] omezení výrobce: ILKAR7A7
[255] omezení výrobce: LUCAS
[256] omezení výrobce: MARELLI
[257] omezení výrobce: MARELLI;DUCELLIER
[258] omezení výrobce: NGK
[259] omezení výrobce: SAE
[260] omezení výrobce: SAGEM
[261] omezení výrobce: Systém BOSCH
[262] omezení výrobce: Systém BOSCH / TEMIC
[263] omezení výrobce: SYSTÉM DUCELLIER
[264] omezení výrobce: Systém HITACHI
[265] omezení výrobce: Systém VALEO
[266] omezení výrobce: nezávazné doporučení
[267] není pro emisní normu: Euro 5
[268] není pro SA Kod: 494
[269] není pro SA Kod: 803;804;805;806
[270] není pro SA Kod: 808
[271] není pro SA Kod: 928
[272] není pro SA Kod: 940K;939K
[273] není pro SA Kod: U43;U83
[274] Poznámka: Výměna zapalovací svíčky musí být provedena tak, aby vyhovovala nařízení výrobce, nainstalujte zapalovací svíčku pouze společně s originálním tepelným štítem (FORD 1315753, 2S6G 12A376AE). Ujistěte se, že katalyzátor pracuje správně.
[275] Poznámka: Instalovaný výrobek musí být určen pro vozidlo nebo motor.

[276] Poznámka: Doporučení - p*í vým*n* zapalovacích svíček u vozidel se nástr*kovými zapalovacími svíčkami obnovte prosímnástr*ku a k montáži použijte tuk pro nástr*ky zapalovacíchsvíček
[277] Poznámka: Doporučení: ZKF 01 – viz seznam příslušenství
[278] Doporučený interval výměny (km): 20000
[279] Doporučený interval výměny (km): 30000
[280] Omezení_ prodeje: Kromě - Spojené státy americké
[281] Omezení_ prodeje: Kromě - Spojené státy americké a Japonsko
[282] Omezení_ prodeje: Včetně Canada
[283] Omezení_ prodeje: Včetně - Spojené státy americké
[284] Omezení_ prodeje: Včetně - Spojené státy americké a Japonsko
[285] převodovka typ: Automatická převodovka
[286] převodovka typ: Převodovka-CVT (plynulá)
[287] převodovka typ: převodovka
[288] převodovka typ: 5-rychlostní převodovka
[289] převodovka typ: 6-rychlostní převodovka
[290] převodovka typ: poloautomatický
[291] vybavení vozidla: pro vozidla s klimatizací
[292] vybavení vozidla: pro vozidla s rozdelovacem
[293] vybavení vozidla: pro vozidla se zabezpečením proti neoprávněnému odjetí
[294] vybavení vozidla: pro vozidla s stop-start systémem
[295] vybavení vozidla: pro dieselová vozidla s filtrem pevných částic
[296] vybavení vozidla: pro vozidla bez rozdelovace
[297] vybavení vozidla: pro vozidla bez imobilizéru
[298] vybavení vozidla: pro vozidla bez stop-start systému
[299] Provedení palubní sítě: pro vozidla s 12 V palubní sítí
[300] verze: 0221504030
[301] verze: 03L.L
[302] verze: 04E.A, 04E.B
[303] verze: 04E.A, 04E.D
[304] verze: 04E.A, 04E.D, 04E.G, 04E.C
[305] verze: 04E.B
[306] verze: 04E.D, 04E.A
[307] verze: 04E.D, 04E.A, 04E.G
[308] verze: 04E.D, 04E.C
[309] verze: 04L.D;04L.J
[310] verze: 1P
[311] verze: 2U
[312] verze: 55kW
[313] verze: 56kW
[314] verze: Emisní normu CEE2000
[315] verze: Emisní normu CEE95
[316] verze: Těleso: LB
[317] verze: Těleso: LB (USA)
[318] verze: CEE2000, bez EOBD
[319] verze: D4123
[320] verze: DOHC
[321] verze: DSL
[322] verze: Duratorq / SID 206
[323] verze: EA17 041
[324] verze: pro motory FSI

CZ

| |
|--|
| [325] verze: FORMEL E |
| [326] verze: GAMMA |
| [327] verze: JB0;JB1;JB2;JB3 |
| [328] verze: JPN |
| [329] verze: KK13 |
| [330] verze: LCI |
| [331] verze: LDK |
| [332] verze: LDK, LHU |
| [333] verze: M47 |
| [334] verze: M47N |
| [335] verze: M47N2 |
| [336] verze: M57N |
| [337] verze: MA13 |
| [338] verze: MD13 NAGARES |
| [339] verze: MD13 NAGARES;Převodovka PF1 |
| [340] verze: MJ |
| [341] verze: MM |
| [342] verze: vícenásobné zapalování |
| [343] verze: N47 |
| [344] verze: N47N |
| [345] verze: N57 |
| [346] verze: N57N |
| [347] verze: N57S |
| [348] verze: N57Z |
| [349] verze: NA13 |
| [350] verze: Převodovka JR5 |
| [351] verze: NA13;Převodovka JR5, TL4 |
| [352] verze: ND13 |
| [353] verze: Pro emisní normu Euro 5 |
| [354] verze: ne B37A |
| [355] verze: ne B37B |
| [356] verze: není pro motory FSI |
| [357] verze: ne N57N |
| [358] verze: NTK #6 |
| [359] verze: Bez EOBD |
| [360] verze: OP13 |
| [361] verze: alternativa pro ZS522 |
| [362] verze: Puma |
| [363] verze: Relé #3/103 |
| [364] verze: Relé #4/103 |
| [365] verze: Relé #8/103 |
| [366] verze: VÝROBNÍ ZÁVOD V RUSKU |
| [367] verze: SOHC |
| [368] verze: Převodovka JB3 |
| [369] verze: Převodovka JC5 |
| [370] verze: Převodovka PK5 |
| [371] verze: UK |
| [372] verze: XT17 LINDE |
| [373] verze: Y-115T1 |
| [374] verze: ZH13 |
| [375] verze: ZP17 |

GR

| | | |
|--|--|--|
| [1] Δυναμική φρεναρίσματος/κίνησης: για οχήματα με ABS | [46] Πλευρά τοποθέτησης: Άνω;προς κύλινδρο 1;προς κύλινδρο 2;προς κύλινδρο 3;προς κύλινδρο 4 | [85] για κωδικό γνήσιου ανταλλακτικού: 12 13 7 510 738 |
| [2] Τύπος καταλύτη: για οχήματα με καταλυτικό μετατροπέα, για οχήματα με διάταξη για καταλύτη | [47] για Facelift: χι | [86] για κωδικό γνήσιου ανταλλακτικού: 12 13 7 548 553 |
| [3] Τύπος καταλύτη: για οχήματα με διάταξη για καταλύτη;για οχήματα με καταλύτη | [48] για Facelift: Ναι | [87] για κωδικό γνήσιου ανταλλακτικού: 12 13 7 594 937 |
| [4] Τύπος καταλύτη: για οχήματα χωρίς καταλυτικό μετατροπέα | [49] για προδιαγραφή καυσαερίων κατασκευαστή: CEE 19-5 | [88] για κωδικό γνήσιου ανταλλακτικού: 12 13 7 638 477 |
| [5] Τύπος καταλύτη: με ρυθμιζ. καταλύτη (3 δρόμων) | [50] για προδιαγραφή καυσαερίων κατασκευαστή: CEE 19-5;US 87 | [89] για κωδικό γνήσιου ανταλλακτικού: 12 13 8 616 153 |
| [6] Κλιματολογικές ζώνες: για κρύα κλίματα | [51] για προδιαγραφή καυσαερίων κατασκευαστή: CEE 95 | [90] για κωδικό γνήσιου ανταλλακτικού: 12 21 7 800 156 |
| [7] Χρώμα: μαύρο | [52] για προδιαγραφή καυσαερίων κατασκευαστή: CEE Fase 2 | [91] για κωδικό γνήσιου ανταλλακτικού: 12 21 7 801 200 |
| [8] Χρώμα: μπλε | [53] για προδιαγραφή καυσαερίων κατασκευαστή: CEE Phase 4 | [92] για κωδικό γνήσιου ανταλλακτικού: 12 23 0 038 490 |
| [9] Χρώμα: μπλε;πράσινο | [54] για προδιαγραφή καυσαερίων κατασκευαστή: CEE Phase 5 | [93] για κωδικό γνήσιου ανταλλακτικού: 12 23 2 248 059 |
| [10] Χρώμα: γκρι | [55] για προδιαγραφή καυσαερίων κατασκευαστή: CF2 | [94] για κωδικό γνήσιου ανταλλακτικού: 12 23 7 786 869 |
| [11] Χρώμα: Ανοιχτό γκρι | [56] για προδιαγραφή καυσαερίων κατασκευαστή: CF2;CF3 | [95] για κωδικό γνήσιου ανταλλακτικού: 12 23 7 798 001 |
| [12] Χρώμα: πορτοκαλί | [57] για προδιαγραφή καυσαερίων κατασκευαστή: CF3 | [96] για κωδικό γνήσιου ανταλλακτικού: 12611424 |
| [13] Χρώμα: κόκκινο | [58] για προδιαγραφή καυσαερίων κατασκευαστή: CF3;CF4 | [97] για κωδικό γνήσιου ανταλλακτικού: 1275971 |
| [14] Χρώμα: Λευκό | [59] για προδιαγραφή καυσαερίων κατασκευαστή: CF4 | [98] για κωδικό γνήσιου ανταλλακτικού: 1306696 |
| [15] Χρώμα: Κίτρινο | [60] για προδιαγραφή καυσαερίων κατασκευαστή: Euro 5 | [99] για κωδικό γνήσιου ανταλλακτικού: 171 905 115 |
| [16] Αριθμός διανομέα: 525352A;525352B;525352C;525352D | [61] για προδιαγραφή καυσαερίων κατασκευαστή: US 87 | [100] για κωδικό γνήσιου ανταλλακτικού: 18550-80KA0 |
| [17] προδ. καυσαερίων: D3 | [62] για κωδικό γνήσιου ανταλλακτικού: 000 158 62 03 | [101] για κωδικό γνήσιου ανταλλακτικού: 22 43 361 34R |
| [18] προδ. καυσαερίων: D4 | [63] για κωδικό γνήσιου ανταλλακτικού: 000 158 64 03 | [102] για κωδικό γνήσιου ανταλλακτικού: 2240100Q0G, 2240100Q0K |
| [19] προδ. καυσαερίων: Euro 3 (D3) | [64] για κωδικό γνήσιου ανταλλακτικού: 032 905 106 B | [103] για κωδικό γνήσιου ανταλλακτικού: 2240100Q0K |
| [20] προδ. καυσαερίων: Euro 3 (D3);Euro 4 (D4) | [65] για κωδικό γνήσιου ανταλλακτικού: 036 905 715 F | [104] για κωδικό γνήσιου ανταλλακτικού: 22401CK81B |
| [21] προδ. καυσαερίων: Euro 4 (D4) | [66] για κωδικό γνήσιου ανταλλακτικού: 03F 905 409 B | [105] για κωδικό γνήσιου ανταλλακτικού: 224332428R |
| [22] προδ. καυσαερίων: Euro 5 | [67] για κωδικό γνήσιου ανταλλακτικού: 03L 905 061 G | [106] για κωδικό γνήσιου ανταλλακτικού: 224481KT0A |
| [23] προδ. καυσαερίων: Euro 5 PLUS | [68] για κωδικό γνήσιου ανταλλακτικού: 04606869AC;04606869AB | [107] για κωδικό γνήσιου ανταλλακτικού: 224488H315 |
| [24] προδ. καυσαερίων: Euro 6 | [69] για κωδικό γνήσιου ανταλλακτικού: 058 905 101 A | [108] για κωδικό γνήσιου ανταλλακτικού: 224488J11C |
| [25] προδ. καυσαερίων: Euro 6 PLUS | [70] για κωδικό γνήσιου ανταλλακτικού: 059 905 061 H | [109] για κωδικό γνήσιου ανταλλακτικού: 22448ED800 |
| [26] προδ. καυσαερίων: ULEV2 | [71] για κωδικό γνήσιου ανταλλακτικού: 059 963 319 T | [110] για κωδικό γνήσιου ανταλλακτικού: 25182496;96253555 |
| [27] Πλευρά τοποθέτησης: Πολλαπλή εξαγωγή | [72] για κωδικό γνήσιου ανταλλακτικού: 06A 905 097 | [111] για κωδικό γνήσιου ανταλλακτικού: 27301 02100 |
| [28] Πλευρά τοποθέτησης: Πολλαπλή εισαγωγής | [73] για κωδικό γνήσιου ανταλλακτικού: 06A 905 115 D | [112] για κωδικό γνήσιου ανταλλακτικού: 27301 02600 |
| [29] Πλευρά τοποθέτησης: Πλευρική τοποθέτηση;προς κύλινδρο 5;προς κύλινδρο 6;προς κύλινδρο 7;προς κύλινδρο 8 | [74] για κωδικό γνήσιου ανταλλακτικού: 06B 905 115 E | [113] για κωδικό γνήσιου ανταλλακτικού: 27301 02700 |
| [30] Πλευρά τοποθέτησης: αριστερά | [75] για κωδικό γνήσιου ανταλλακτικού: 06E 905 115 E | [114] για κωδικό γνήσιου ανταλλακτικού: 27301 03000 |
| [31] Πλευρά τοποθέτησης: δεξιά | [76] για κωδικό γνήσιου ανταλλακτικού: 07K 905 715 F | [115] για κωδικό γνήσιου ανταλλακτικού: 27301 03010 |
| [32] Πλευρά τοποθέτησης: προς κύλινδρο 1;προς κύλινδρο 2;προς κύλινδρο 3 | [77] για κωδικό γνήσιου ανταλλακτικού: 100630 | [116] για κωδικό γνήσιου ανταλλακτικού: 27301 04000 |
| [33] Πλευρά τοποθέτησης: προς κύλινδρο 1;προς κύλινδρο 2;προς κύλινδρο 3;προς κύλινδρο 4 | [78] για κωδικό γνήσιου ανταλλακτικού: 1106500Q0H;1106500Q0L | [117] για κωδικό γνήσιου ανταλλακτικού: 27301 22600 |
| [34] Πλευρά τοποθέτησης: to cylinder 1;to cylinder 2;to cylinder 4 | [79] για κωδικό γνήσιου ανταλλακτικού: 110651492R | [118] για κωδικό γνήσιου ανταλλακτικού: 27301 23700 |
| [35] Πλευρά τοποθέτησης: προς κύλινδρο 1;προς κύλινδρο 3 | [80] για κωδικό γνήσιου ανταλλακτικού: 110651749R | [119] για κωδικό γνήσιου ανταλλακτικού: 27301 26600 |
| [36] Πλευρά τοποθέτησης: προς κύλινδρο 1;προς κύλινδρο 3;προς κύλινδρο 5 | [81] για κωδικό γνήσιου ανταλλακτικού: 110655X00A | [120] για κωδικό γνήσιου ανταλλακτικού: 27301 2B000 |
| [37] Πλευρά τοποθέτησης: Θέση τοποθέτησης στον κύλινδρο 1, 4 | [82] για κωδικό γνήσιου ανταλλακτικού: 11067BN700 | [121] για κωδικό γνήσιου ανταλλακτικού: 27301 2B010 |
| [38] Πλευρά τοποθέτησης: Θέση τοποθέτησης στον κύλινδρο 2 | [83] για κωδικό γνήσιου ανταλλακτικού: 12 13 1 703 228 | [122] για κωδικό γνήσιου ανταλλακτικού: 27301 700 |
| [39] Πλευρά τοποθέτησης: Θέση τοποθέτησης στον κύλινδρο 2, 3 | [84] για κωδικό γνήσιου ανταλλακτικού: 12 13 1 712 219 | [123] για κωδικό γνήσιου ανταλλακτικού: 2S6Q-6M090-AB |
| [40] Πλευρά τοποθέτησης: προς κύλινδρο 2;προς κύλινδρο 3;προς κύλινδρο 4 | | [124] για κωδικό γνήσιου ανταλλακτικού: 2S6Q-6M090-BB |
| [41] Πλευρά τοποθέτησης: Θέση τοποθέτησης στον κύλινδρο 2, 4 | | [125] για κωδικό γνήσιου ανταλλακτικού: 30520-RRR-007 |
| [42] Πλευρά τοποθέτησης: προς κύλινδρο 2;προς κύλινδρο 4;προς κύλινδρο 6 | | [126] για κωδικό γνήσιου ανταλλακτικού: 30713416;9125601 |
| [43] Πλευρά τοποθέτησης: to cylinder 2;to cylinder 5 | | [127] για κωδικό γνήσιου ανταλλακτικού: 357911253 |
| [44] Πλευρά τοποθέτησης: στον κύλινδρο 3 | | [128] για κωδικό γνήσιου ανταλλακτικού: 36710 2A100 |
| [45] Πλευρά τοποθέτησης: προς κύλινδρο 5;προς κύλινδρο 6;προς κύλινδρο 7;προς κύλινδρο 8 | | [129] για κωδικό γνήσιου ανταλλακτικού: 36710 3A000 |
| | | [130] για κωδικό γνήσιου ανταλλακτικού: 36710 4A000 |

GR

- [131] για κωδικό γνήσιου ανταλλακτικού: 46 777 288
- [132] για κωδικό γνήσιου ανταλλακτικού: 46796050
- [133] για κωδικό γνήσιου ανταλλακτικού: 55210051
- [134] για κωδικό γνήσιου ανταλλακτικού: 5960 66
- [135] για κωδικό γνήσιου ανταλλακτικού: 5960 66;5960 F5
- [136] για κωδικό γνήσιου ανταλλακτικού: 5960 F4
- [137] για κωδικό γνήσιου ανταλλακτικού: 70863020
- [138] για κωδικό γνήσιου ανταλλακτικού: 70863021
- [139] για κωδικό γνήσιου ανταλλακτικού: 7648797
- [140] για κωδικό γνήσιου ανταλλακτικού: 7700100589
- [141] για κωδικό γνήσιου ανταλλακτικού: 7700100643
- [142] για κωδικό γνήσιου ανταλλακτικού: 7700273226
- [143] για κωδικό γνήσιου ανταλλακτικού: 7700273826
- [144] για κωδικό γνήσιου ανταλλακτικού: 7700274008;224336134R
- [145] για κωδικό γνήσιου ανταλλακτικού: 7701041607
- [146] για κωδικό γνήσιου ανταλλακτικού: 7701041608
- [147] για κωδικό γνήσιου ανταλλακτικού: 7746152
- [148] για κωδικό γνήσιου ανταλλακτικού: 7746153
- [149] για κωδικό γνήσιου ανταλλακτικού: 8200051128
- [150] για κωδικό γνήσιου ανταλλακτικού: 8200084401;8200025256
- [151] για κωδικό γνήσιου ανταλλακτικού: 8200360911;8200702693
- [152] για κωδικό γνήσιου ανταλλακτικού: 8200486877
- [153] για κωδικό γνήσιου ανταλλακτικού: 8200506297
- [154] για κωδικό γνήσιου ανταλλακτικού: 8200561251
- [155] για κωδικό γνήσιου ανταλλακτικού: 8200682592
- [156] για κωδικό γνήσιου ανταλλακτικού: 8200702693
- [157] για κωδικό γνήσιου ανταλλακτικού: 8200943801
- [158] για κωδικό γνήσιου ανταλλακτικού: 8973065193
- [159] για κωδικό γνήσιου ανταλλακτικού: 90543253
- [160] για κωδικό γνήσιου ανταλλακτικού: 90919-01218
- [161] για κωδικό γνήσιου ανταλλακτικού: 90919-02230
- [162] για κωδικό γνήσιου ανταλλακτικού: 90919-02234
- [163] για κωδικό γνήσιου ανταλλακτικού: 90919-02234;90919-02207
- [164] για κωδικό γνήσιου ανταλλακτικού: 90919-02238
- [165] για κωδικό γνήσιου ανταλλακτικού: 90919-02243
- [166] για κωδικό γνήσιου ανταλλακτικού: 90919-02248
- [167] για κωδικό γνήσιου ανταλλακτικού: 90919-02262
- [168] για κωδικό γνήσιου ανταλλακτικού: 90919-02265
- [169] για κωδικό γνήσιου ανταλλακτικού: 90919-02266
- [170] για κωδικό γνήσιου ανταλλακτικού: 93177212
- [171] για κωδικό γνήσιου ανταλλακτικού: 93198468
- [172] για κωδικό γνήσιου ανταλλακτικού: 9638985980
- [173] για κωδικό γνήσιου ανταλλακτικού: 9651583680
- [174] για κωδικό γνήσιου ανταλλακτικού: A 000 158 78 03
- [175] για κωδικό γνήσιου ανταλλακτικού: A 001 159 15 01;A 001 159 16 01
- [176] για κωδικό γνήσιου ανταλλακτικού: A 001 159 20 01;A 001 159 21 01
- [177] για κωδικό γνήσιου ανταλλακτικού: A 001 159 26 01
- [178] για κωδικό γνήσιου ανταλλακτικού: A 001 159 50 01;A 001 159 71 01
- [179] για κωδικό γνήσιου ανταλλακτικού: A 272 906 00 60
- [180] για κωδικό γνήσιου ανταλλακτικού: A 642 900 58 01

- [181] για κωδικό γνήσιου ανταλλακτικού: N 105 916 02;N 105 916 03
- [182] για κωδικό γνήσιου ανταλλακτικού: N 105 916 03
- [183] για κωδικό γνήσιου ανταλλακτικού: N 105 916 04
- [184] για κωδικό γνήσιου ανταλλακτικού: N 105 916 08
- [185] για κωδικό γνήσιου ανταλλακτικού: NEC100630
- [186] για κωδικό γνήσιου ανταλλακτικού: S210-18-140;S210-18-140 A
- [187] για κωδικό γνήσιου ανταλλακτικού: XM34-12A342-BA
- [188] για αριθμό παραγωγής: OGG
- [189] για αριθμό παραγωγής: OK0 + TS8 + 7MJ, 7MU, 7MR
- [190] για αριθμό παραγωγής: OK3, OK4 +TS8, T7V
- [191] για αριθμό παραγωγής: 7CF
- [192] για αριθμό παραγωγής: 7CF, 7MM
- [193] για αριθμό παραγωγής: 7MM
- [194] για αριθμό παραγωγής: 7MM, 7MJ
- [195] για αριθμό παραγωγής: 7MM, 7MJ, 7CP
- [196] για αριθμό παραγωγής: 7MM;7MJ;7MW
- [197] για αριθμό παραγωγής: 7MU
- [198] για αριθμό παραγωγής: D3E
- [199] για αριθμό παραγωγής: D7N
- [200] για αριθμό παραγωγής: GP1
- [201] για αριθμό παραγωγής: GP2+TD1
- [202] για αριθμό παραγωγής: GP2+TF1
- [203] για αριθμό παραγωγής: GP2+TH1
- [204] για αριθμό παραγωγής: TON,T11
- [205] για αριθμό παραγωγής: T41
- [206] για αριθμό παραγωγής: T41;TF1
- [207] για αριθμό παραγωγής: T7V
- [208] για αριθμό παραγωγής: T7V +7CP, 7CS, 7MV
- [209] για αριθμό παραγωγής: TD1
- [210] για αριθμό παραγωγής: TD1+7MM, 7MJ, 7MW
- [211] για αριθμό παραγωγής: TD1+7MM, 7MJ, 7MW, 7CP
- [212] για αριθμό παραγωγής: TE1
- [213] για αριθμό παραγωγής: TF1
- [214] για αριθμό παραγωγής: TG1
- [215] για αριθμό παραγωγής: TH1
- [216] για αριθμό παραγωγής: TH1+7GB
- [217] για αριθμό παραγωγής: TH1+7MK
- [218] για αριθμό παραγωγής: TK8, TH8
- [219] για αριθμό παραγωγής: TK8, TL1
- [220] για αριθμό παραγωγής: TK8, TL1, TM5
- [221] για αριθμό παραγωγής: TL1, TK8
- [222] για αριθμό παραγωγής: TL1, TK8, TM5, TH8
- [223] για αριθμό παραγωγής: TL1, TP1
- [224] για αριθμό παραγωγής: TL4
- [225] για αριθμό παραγωγής: TM4
- [226] για αριθμό παραγωγής: TP1
- [227] για αριθμό παραγωγής: TS8
- [228] για αριθμό παραγωγής: TS8 + 7MJ
- [229] για SA Code: 021
- [230] για SA Code: 022
- [231] για SA Code: 494
- [232] για SA Code: 700
- [233] για SA Code: 803;804;805;806
- [234] για SA Code: 940K;939K;802
- [235] για SA Code: MC1;MC2;MC3;MP1;MP2;MP3

- [236] για SA Code: MC2+MS9
- [237] για SA Code: MQ3;MQ4;MQ5
- [238] για SA Code: MQ6;MCO
- [239] για SA Code: U43;U83
- [240] Περιορισμός κατασκευαστή: BERU
- [241] Περιορισμός κατασκευαστή: BORGWARNER
- [242] Περιορισμός κατασκευαστή: Bosch
- [243] Περιορισμός κατασκευαστή: BOSCH; DUCELLIER
- [244] Περιορισμός κατασκευαστή: Bosch;Beru
- [245] Περιορισμός κατασκευαστή: Bremi
- [246] Περιορισμός κατασκευαστή: DELCO REMY
- [247] Περιορισμός κατασκευαστή: DELPHI
- [248] Περιορισμός κατασκευαστή: Ducellier
- [249] Περιορισμός κατασκευαστή: ELDOR
- [250] Περιορισμός κατασκευαστή: ELECTRICFIL
- [251] Περιορισμός κατασκευαστή: ηλεκτρονικό
- [252] Περιορισμός κατασκευαστή: χημα με διάγνωση
- [253] Περιορισμός κατασκευαστή: HITACHI
- [254] Περιορισμός κατασκευαστή: ILKAR7A7
- [255] Περιορισμός κατασκευαστή: LUCAS
- [256] Περιορισμός κατασκευαστή: MARELLI
- [257] Περιορισμός κατασκευαστή: MARELLI;DUCELLIER
- [258] Περιορισμός κατασκευαστή: NGK
- [259] Περιορισμός κατασκευαστή: SAE
- [260] Περιορισμός κατασκευαστή: SAGEM
- [261] Περιορισμός κατασκευαστή: Σύστημα BOSCH
- [262] Περιορισμός κατασκευαστή: Σύστημα BOSCH / TEMIC
- [263] Περιορισμός κατασκευαστή: σύστημα DUCELLIER
- [264] Περιορισμός κατασκευαστή: Σύστημα HITACHI
- [265] Περιορισμός κατασκευαστή: Σύστημα VALEO
- [266] Περιορισμός κατασκευαστή: δεν είναι δεσμευτικές σύσταση
- [267] όχι για προδ. καυσαερίων: Euro 5
- [268] όχι για SA Code: 494
- [269] όχι για SA Code: 803;804;805;806
- [270] όχι για SA Code: 808
- [271] όχι για SA Code: 928
- [272] όχι για SA Code: 940K;939K
- [273] όχι για SA Code: U43;U83
- [274] Σημείωση: Αντικαταστήστε τα πηνία ανάφλεξης και τους πολλαπλασιαστές σύμφωνα με τις απαιτήσεις του κατασκευαστή. Εγκαταστήστε το πηνίο ανάφλεξης ή τον πολλαπλασιαστή μόνο μαζί με το αρχικό προστατευτικό θερμότητας (FORD 1315753, 2S6G 12A376AE). Βεβαιωθείτε ότι ο κα
- [275] Σημείωση: Το προϊόν που εγκαθίσταται πρέπει να καθορίζεται βάσει του οχήματος ή του κινητήρα.
- [276] Σημείωση: Σύσταση - Κατά την αντικατάσταση των μπουζί σε οχήματα με πολλαπλασιαστή συνδέσμου, αντικαταστήστε τον σύνδεσμο και χρησιμοποιήστε γράσο για συνδέσμους (ZKF 01 - Αρ. παραγωγής 0 890 300 029) για την τοποθέτηση του συνδέσμου.
- [277] Σημείωση: Recommendation: ZKF 01 - see accessories list
- [278] Συνιστώμενο διάστημα αντικατάστασης (km): 20000
- [279] Συνιστώμενο διάστημα αντικατάστασης (km): 30000
- [280] Περιορισμός πωλήσεων: Αποκλείει τις Ηνωμένες Πολιτείες Αμερικής
- [281] Περιορισμός πωλήσεων: Αποκλείει τις Ηνωμένες Πολιτείες Αμερικής και την Ιαπωνία

GR

| |
|--|
| [282] Περιορισμός πωλήσεων: Περιορισμός πωλήσεων: Περιλαμβάνει τις Καναδάς |
| [283] Περιορισμός πωλήσεων: Περιλαμβάνει τις Ηνωμένες Πολιτείες Αμερικής |
| [284] Περιορισμός πωλήσεων: Περιλαμβάνει τις Ηνωμένες Πολιτείες Αμερικής και την Ιαπωνία |
| [285] Είδος κιβωτίου ταχυτήτων: Αυτόματο κιβώτιο ταχυτήτων |
| [286] Είδος κιβωτίου ταχυτήτων: CVT- αυτόμ. κιβ. ταχ. (αβαθμίδ.) |
| [287] Είδος κιβωτίου ταχυτήτων: Μηχανικό κιβώτιο ταχυτήτων |
| [288] Είδος κιβωτίου ταχυτήτων: 5-ταχυτο Κιβώτιο Ταχυτήτων |
| [289] Είδος κιβωτίου ταχυτήτων: 6-ταχυτο Κιβώτιο Ταχυτήτων |
| [290] Είδος κιβωτίου ταχυτήτων: Ημιαυτόματο |
| [291] Εξοπισμός οχήματος: για οχήμ. με σύστ. κλιματισμού |
| [292] Εξοπισμός οχήματος: για οχήματα με ντιστριμπιτέρ |
| [293] Εξοπισμός οχήματος: για οχήματα με φραγή εκκίνησης |
| [294] Εξοπισμός οχήματος: Για οχήματα με λειτουργία start-stop |
| [295] Εξοπισμός οχήματος: Για οχήματα πετρελαίου χωρίς φίλτρο αιθάλης |
| [296] Εξοπισμός οχήματος: Για οχήματα χωρίς ντιστριμπιτέρ |
| [297] Εξοπισμός οχήματος: για οχήμ. χωρίς σύστ. ακινητοπ. |
| [298] Εξοπισμός οχήματος: Για οχήματα χωρίς λειτουργία start-stop |
| [299] Παραλλαγή ηλεκτρικού δικτύου: για οχήματα με ρεύμα 12V |
| [300] Έκδοση: 0221504030 |
| [301] Έκδοση: 03L.L |
| [302] Έκδοση: 04E.A, 04E.B |
| [303] Έκδοση: 04E.A, 04E.D |
| [304] Έκδοση: 04E.A, 04E.D, 04E.G, 04E.C |
| [305] Έκδοση: 04E.B |
| [306] Έκδοση: 04E.D, 04E.A |
| [307] Έκδοση: 04E.D, 04E.A, 04E.G |
| [308] Έκδοση: 04E.D, 04E.C |
| [309] Έκδοση: 04L.D;04L.J |
| [310] Έκδοση: 1P |
| [311] Έκδοση: 2U |
| [312] Έκδοση: 55kW |
| [313] Έκδοση: 56kW |
| [314] Έκδοση: Νόρμα καυσαερίων CEE2000 |
| [315] Έκδοση: Νόρμα καυσαερίων CEE95 |
| [316] Έκδοση: Σώμα : LB |
| [317] Έκδοση: Σώμα : LB (USA) |
| [318] Έκδοση: CEE2000, χωρίς EOBD |
| [319] Έκδοση: D4123 |
| [320] Έκδοση: DOHC |
| [321] Έκδοση: DSL |
| [322] Έκδοση: Duratorq / SID 206 |
| [323] Έκδοση: EA17 041 |
| [324] Έκδοση: για κινητήρες FSI |
| [325] Έκδοση: FORMEL E |
| [326] Έκδοση: GAMMA |
| [327] Έκδοση: JBO;JB1;JB2;JB3 |
| [328] Έκδοση: JPN |

| |
|--|
| [329] Έκδοση: KK13 |
| [330] Έκδοση: LCI |
| [331] Έκδοση: LDK |
| [332] Έκδοση: LDK, LHU |
| [333] Έκδοση: M47 |
| [334] Έκδοση: M47N |
| [335] Έκδοση: M47N2 |
| [336] Έκδοση: M57N |
| [337] Έκδοση: MA13 |
| [338] Έκδοση: MD13 NAGARES |
| [339] Έκδοση: MD13 NAGARES;κιβώτιο ταχυτήτων PF1 |
| [340] Έκδοση: MJ |
| [341] Έκδοση: MM |
| [342] Έκδοση: MPI |
| [343] Έκδοση: N47 |
| [344] Έκδοση: N47N |
| [345] Έκδοση: N57 |
| [346] Έκδοση: N57N |
| [347] Έκδοση: N57S |
| [348] Έκδοση: N57Z |
| [349] Έκδοση: NA13 |
| [350] Έκδοση: Κιβώτιο ταχυτήτων JR5 |
| [351] Έκδοση: NA13;κιβώτιο ταχυτήτων JR5, TL4 |
| [352] Έκδοση: ND13 |
| [353] Έκδοση: ` χι για νόρμα καυσαερίων Euro 5 |
| [354] Έκδοση: όχι για B37A |
| [355] Έκδοση: όχι για B37B |
| [356] Έκδοση: όχι για κινητήρες FSI |
| [357] Έκδοση: όχι για N57N |
| [358] Έκδοση: NTK #6 |
| [359] Έκδοση: Χωρίς EOBD |
| [360] Έκδοση: OP13 |
| [361] Έκδοση: εναλλακτική για το ZS522 |
| [362] Έκδοση: Puma |
| [363] Έκδοση: Ρελέ #3/103 |
| [364] Έκδοση: Ρελέ #4/103 |
| [365] Έκδοση: Ρελέ #8/103 |
| [366] Έκδοση: ΕΡΓΟΣΤΑΣΙΟ ΡΩΣΙΑΣ |
| [367] Έκδοση: SOHC |
| [368] Έκδοση: κιβώτιο ταχυτήτων JB3 |
| [369] Έκδοση: Κιβώτιο ταχυτήτων JC5 |
| [370] Έκδοση: κιβώτιο ταχυτήτων PK5 |
| [371] Έκδοση: UK |
| [372] Έκδοση: XT17 LINDE |
| [373] Έκδοση: Y-115T1 |
| [374] Έκδοση: ZH13 |
| [375] Έκδοση: ZP17 |

HU

| | | |
|---|--|---|
| [1] Fék-/menetdinamika: ABS-sel szerelt járművekhez | [48] facelift-hez: Igen | [106] OE-számhoz: 224481KTOA |
| [2] Katalizátor fajtá: katalizátoros gépjárművekhez;katalizátoros elrendezésű gépjárművekhez | [49] Gyártói kipufogógáz-szabványhoz: CEE 19-5 | [107] OE-számhoz: 224488H315 |
| [3] Katalizátor fajtá: katalizátoros elrendezésű gépjárművekhez;katalizátoros gépjárművekhez | [50] Gyártói kipufogógáz-szabványhoz: CEE 19-5;US 87 | [108] OE-számhoz: 224488J11C |
| [4] Katalizátor fajtá: katalizátor nélküli gépjárművekhez | [51] Gyártói kipufogógáz-szabványhoz: CEE 95 | [109] OE-számhoz: 22448ED800 |
| [5] Katalizátor fajtá: hármas hatású katalizátorral | [52] Gyártói kipufogógáz-szabványhoz: CEE Fase 2 | [110] OE-számhoz: 25182496;96253555 |
| [6] Klímazónák: hideg környezetben | [53] Gyártói kipufogógáz-szabványhoz: CEE Phase 4 | [111] OE-számhoz: 27301 02100 |
| [7] Szín: fekete | [54] Gyártói kipufogógáz-szabványhoz: CEE Phase 5 | [112] OE-számhoz: 27301 02600 |
| [8] Szín: kék | [55] Gyártói kipufogógáz-szabványhoz: CF2 | [113] OE-számhoz: 27301 02700 |
| [9] Szín: Kék;zöld | [56] Gyártói kipufogógáz-szabványhoz: CF2;CF3 | [114] OE-számhoz: 27301 03000 |
| [10] Szín: szürke | [57] Gyártói kipufogógáz-szabványhoz: CF3 | [115] OE-számhoz: 27301 03010 |
| [11] Szín: világosszürke | [58] Gyártói kipufogógáz-szabványhoz: CF3;CF4 | [116] OE-számhoz: 27301 04000 |
| [12] Szín: narancs | [59] Gyártói kipufogógáz-szabványhoz: CF4 | [117] OE-számhoz: 27301 22600 |
| [13] Szín: piros | [60] Gyártói kipufogógáz-szabványhoz: Euro 5 | [118] OE-számhoz: 27301 23700 |
| [14] Szín: Fehér | [61] Gyártói kipufogógáz-szabványhoz: US 87 | [119] OE-számhoz: 27301 26600 |
| [15] Szín: Sárga | [62] OE-számhoz: 000 158 62 03 | [120] OE-számhoz: 27301 2B000 |
| [16] Gyújtáselosztó szám: 525352A;525352B;525352C;525352D | [63] OE-számhoz: 000 158 64 03 | [121] OE-számhoz: 27301 2B010 |
| [17] Emissziós norma: D3 | [64] OE-számhoz: 032 905 106 B | [122] OE-számhoz: 27301 700 |
| [18] Emissziós norma: D4 | [65] OE-számhoz: 036 905 715 F | [123] OE-számhoz: 2S6Q-6M090-AB |
| [19] Emissziós norma: Euro 3 (D3) | [66] OE-számhoz: 03F 905 409 B | [124] OE-számhoz: 2S6Q-6M090-BB |
| [20] Emissziós norma: Euro 3 (D3);Euro 4 (D4) | [67] OE-számhoz: 03L 905 061 G | [125] OE-számhoz: 30520-RRR-007 |
| [21] Emissziós norma: Euro 4 (D4) | [68] OE-számhoz: 04606869AC;04606869AB | [126] OE-számhoz: 30713416;9125601 |
| [22] Emissziós norma: Euro5 | [69] OE-számhoz: 058 905 101 A | [127] OE-számhoz: 357911253 |
| [23] Emissziós norma: Euro 5 PLUS | [70] OE-számhoz: 059 905 061 H | [128] OE-számhoz: 36710 2A100 |
| [24] Emissziós norma: Euro 6 | [71] OE-számhoz: 059 963 319 T | [129] OE-számhoz: 36710 3A000 |
| [25] Emissziós norma: Euro 6 PLUS | [72] OE-számhoz: 06A 905 097 | [130] OE-számhoz: 36710 4A000 |
| [26] Emissziós norma: ULEV2 | [73] OE-számhoz: 06A 905 115 D | [131] OE-számhoz: 46 777 288 |
| [27] Beépítési oldal: kipufogó könyök | [74] OE-számhoz: 06B 905 115 E | [132] OE-számhoz: 46796050 |
| [28] Beépítési oldal: Szívókönyök | [75] OE-számhoz: 06E 905 115 E | [133] OE-számhoz: 55210051 |
| [29] Beépítési oldal: Hosszirányú beépítés;az 5. hengerhez;a 6. hengerhez;a 7. hengerhez;a 8. hengerhez | [76] OE-számhoz: 07K 905 715 F | [134] OE-számhoz: 5960 66 |
| [30] Beépítési oldal: bal | [77] OE-számhoz: 100630 | [135] OE-számhoz: 5960 66;5960 F5 |
| [31] Beépítési oldal: jobb | [78] OE-számhoz: 1106500Q0H;1106500Q0L | [136] OE-számhoz: 5960 F4 |
| [32] Beépítési oldal: az 1. hengerhez;a 2. hengerhez;a 3. hengerhez | [79] OE-számhoz: 110651492R | [137] OE-számhoz: 70863020 |
| [33] Beépítési oldal: az 1. hengerhez;a 2. hengerhez;a 3. hengerhez;a 4. hengerhez | [80] OE-számhoz: 110651749R | [138] OE-számhoz: 70863021 |
| [34] Beépítési oldal: to cylinder 1;to cylinder 2;to cylinder 4 | [81] OE-számhoz: 110655X00A | [139] OE-számhoz: 7648797 |
| [35] Beépítési oldal: az 1. hengerhez;a 3. hengerhez | [82] OE-számhoz: 11067BN700 | [140] OE-számhoz: 7700100589 |
| [36] Beépítési oldal: az 1. hengerhez;a 3. hengerhez;az 5. hengerhez | [83] OE-számhoz: 12 13 1 703 228 | [141] OE-számhoz: 7700100643 |
| [37] Beépítési oldal: hengerszám 1;hengerszám 4 | [84] OE-számhoz: 12 13 1 712 219 | [142] OE-számhoz: 7700273226 |
| [38] Beépítési oldal: hengerszám 2 | [85] OE-számhoz: 12 13 7 510 738 | [143] OE-számhoz: 7700273826 |
| [39] Beépítési oldal: hengerszám 2;hengerszám 3 | [86] OE-számhoz: 12 13 7 548 553 | [144] OE-számhoz: 7700274008;224336134R |
| [40] Beépítési oldal: az 2. hengerhez;az 3. hengerhez;az 4. hengerhez | [87] OE-számhoz: 12 13 7 594 937 | [145] OE-számhoz: 7701041607 |
| [41] Beépítési oldal: hengerszám 2;hengerszám 4 | [88] OE-számhoz: 12 13 7 638 477 | [146] OE-számhoz: 7701041608 |
| [42] Beépítési oldal: a 2. hengerhez;a 4. hengerhez;a 6. hengerhez | [89] OE-számhoz: 12 13 8 616 153 | [147] OE-számhoz: 7746152 |
| [43] Beépítési oldal: to cylinder 2;to cylinder 5 | [90] OE-számhoz: 12 21 7 800 156 | [148] OE-számhoz: 7746153 |
| [44] Beépítési oldal: 3-as hengerhez | [91] OE-számhoz: 12 21 7 801 200 | [149] OE-számhoz: 8200051128 |
| [45] Beépítési oldal: az 5. hengerhez;a 6. hengerhez;a 7. hengerhez;a 8. hengerhez | [92] OE-számhoz: 12 23 0 038 490 | [150] OE-számhoz: 8200084401;8200025256 |
| [46] Beépítési oldal: Felső;az 1. hengerhez;a 2. hengerhez;a 3. hengerhez;a 4. hengerhez | [93] OE-számhoz: 12 23 2 248 059 | [151] OE-számhoz: 8200360911;8200702693 |
| [47] facelift-hez: Nem | [94] OE-számhoz: 12 23 7 786 869 | [152] OE-számhoz: 8200486877 |
| | [95] OE-számhoz: 12 23 7 798 001 | [153] OE-számhoz: 8200506297 |
| | [96] OE-számhoz: 12611424 | [154] OE-számhoz: 8200561251 |
| | [97] OE-számhoz: 1275971 | [155] OE-számhoz: 8200682592 |
| | [98] OE-számhoz: 1306696 | [156] OE-számhoz: 8200702693 |
| | [99] OE-számhoz: 171 905 115 | [157] OE-számhoz: 8200943801 |
| | [100] OE-számhoz: 18550-80KAO | [158] OE-számhoz: 8973065193 |
| | [101] OE-számhoz: 22 43 361 34R | [159] OE-számhoz: 90543253 |
| | [102] OE-számhoz: 2240100Q0G, 2240100Q0K | [160] OE-számhoz: 90919-01218 |
| | [103] OE-számhoz: 2240100Q0K | [161] OE-számhoz: 90919-02230 |
| | [104] OE-számhoz: 22401CK81B | [162] OE-számhoz: 90919-02234 |
| | [105] OE-számhoz: 224332428R | [163] OE-számhoz: 90919-02234;90919-02207 |

HU

[164] OE-számhoz: 90919-02238
[165] OE-számhoz: 90919-02243
[166] OE-számhoz: 90919-02248
[167] OE-számhoz: 90919-02262
[168] OE-számhoz: 90919-02265
[169] OE-számhoz: 90919-02266
[170] OE-számhoz: 93177212
[171] OE-számhoz: 93198468
[172] OE-számhoz: 9638985980
[173] OE-számhoz: 9651583680
[174] OE-számhoz: A 000 158 78 03
[175] OE-számhoz: A 001 159 15 01;A 001 159 16 01
[176] OE-számhoz: A 001 159 20 01;A 001 159 21 01
[177] OE-számhoz: A 001 159 26 01
[178] OE-számhoz: A 001 159 50 01;A 001 159 71 01
[179] OE-számhoz: A 272 906 00 60
[180] OE-számhoz: A 642 900 58 01
[181] OE-számhoz: N 105 916 02;N 105 916 03
[182] OE-számhoz: N 105 916 03
[183] OE-számhoz: N 105 916 04
[184] OE-számhoz: N 105 916 08
[185] OE-számhoz: NEC100630
[186] OE-számhoz: S210-18-140;S210-18-140 A
[187] OE-számhoz: XM34-12A342-BA
[188] PR-számhoz: OGG
[189] PR-számhoz: OK0 + TS8 + 7MJ, 7MU, 7MR
[190] PR-számhoz: OK3, OK4 +TS8, T7V
[191] PR-számhoz: 7CF
[192] PR-számhoz: 7CF, 7MM
[193] PR-számhoz: 7MM
[194] PR-számhoz: 7MM, 7MJ
[195] PR-számhoz: 7MM, 7MJ, 7CP
[196] PR-számhoz: 7MM;7MJ;7MW
[197] PR-számhoz: 7MU
[198] PR-számhoz: D3E
[199] PR-számhoz: D7N
[200] PR-számhoz: GP1
[201] PR-számhoz: GP2+TD1
[202] PR-számhoz: GP2+TF1
[203] PR-számhoz: GP2+TH1
[204] PR-számhoz: TON;T1I
[205] PR-számhoz: T41
[206] PR-számhoz: T41;TF1
[207] PR-számhoz: T7V
[208] PR-számhoz: T7V +7CP, 7CS, 7MV
[209] PR-számhoz: TD1
[210] PR-számhoz: TD1+7MM, 7MJ, 7MW
[211] PR-számhoz: TD1+7MM, 7MJ, 7MW, 7CP
[212] PR-számhoz: TE1
[213] PR-számhoz: TF1
[214] PR-számhoz: TG1
[215] PR-számhoz: TH1
[216] PR-számhoz: TH1+7GB
[217] PR-számhoz: TH1+7MK
[218] PR-számhoz: TK8, TH8
[219] PR-számhoz: TK8, TL1
[220] PR-számhoz: TK8, TL1, TM5
[221] PR-számhoz: TL1, TK8

[222] PR-számhoz: TL1, TK8, TM5, TH8
[223] PR-számhoz: TL1, TP1
[224] PR-számhoz: TL4
[225] PR-számhoz: TM4
[226] PR-számhoz: TP1
[227] PR-számhoz: TS8
[228] PR-számhoz: TS8 + 7MJ
[229] SA kódhoz: 021
[230] SA kódhoz: 022
[231] SA kódhoz: 494
[232] SA kódhoz: 700
[233] SA kódhoz: 803;804;805;806
[234] SA kódhoz: 940K;939K;802
[235] SA kódhoz: MC1;MC2;MC3;MP1;MP2;MP3
[236] SA kódhoz: MC2+MS9
[237] SA kódhoz: MQ3;MQ4;MQ5
[238] SA kódhoz: MQ6;MC0
[239] SA kódhoz: U43;U83
[240] Gyártó korlátozás: BERU
[241] Gyártó korlátozás: BORGWARNER
[242] Gyártó korlátozás: Bosch
[243] Gyártó korlátozás: BOSCH; DUCELLIER
[244] Gyártó korlátozás: Bosch;Beru
[245] Gyártó korlátozás: Bremi
[246] Gyártó korlátozás: DELCO REMY
[247] Gyártó korlátozás: DELPHI
[248] Gyártó korlátozás: Ducellier
[249] Gyártó korlátozás: ELDOR
[250] Gyártó korlátozás: ELECTRICFIL
[251] Gyártó korlátozás: elektromos
[252] Gyártó korlátozás: jármű diagnosztikával
[253] Gyártó korlátozás: HITACHI
[254] Gyártó korlátozás: ILKAR7A7
[255] Gyártó korlátozás: LUCAS
[256] Gyártó korlátozás: MARELLI
[257] Gyártó korlátozás: MARELLI;DUCELLIER
[258] Gyártó korlátozás: NGK
[259] Gyártó korlátozás: SAE
[260] Gyártó korlátozás: SAGEM
[261] Gyártó korlátozás: BOSCH rendszer
[262] Gyártó korlátozás: BOSCH/TEMIC rendszer
[263] Gyártó korlátozás: Rendszer DUCELLIER
[264] Gyártó korlátozás: HITACHI rendszer
[265] Gyártó korlátozás: VALEO rendszer
[266] Gyártó korlátozás: nem kötelező ajánlás
[267] kipufogógáz szabványhoz nem: Euro5
[268] SA kódhoz nem: 494
[269] SA kódhoz nem: 803;804;805;806
[270] SA kódhoz nem: 808
[271] SA kódhoz nem: 928
[272] SA kódhoz nem: 940K;939K
[273] SA kódhoz nem: U43;U83
[274] Megjegyzés: Cserélje ki a gyújtótrafót a gyártó elvárásainak megfelelően, a trafót csak az eredeti hűvédőpajzzsal együtt szerelje be (FORD 1315753, 2S6G 12A376AE) Győződjön meg arról, hogy a katalizátor megfelelően működik.
[275] Megjegyzés: A beszerelendő terméket a gépjármű vagy a motor alapján kell meghatározni.

[276] Megjegyzés: Ajánlás- Gyújtótekerccsel ellátott gépjárművek gyújtógyertyájának cseréjékor kérjük, használjon új dugaszt, az összeszereléshez pediggyújtógyertya-dugaszszírt(ZKF 01 - rendelési sz. 0 890 300 029)
[277] Megjegyzés: Ajánlás: ZKF 01 - lásd a tartozéklistát
[278] Javasolt csereperiódus (km): 20000
[279] Javasolt csereperiódus (km): 30000
[280] Sales_Restriction: Egyesült Államok
[281] Sales_Restriction: Egyesült Államok, kivéve Japán
[282] Sales_Restriction: Include Canada
[283] Sales_Restriction: Egyesült Államokban is
[284] Sales_Restriction: Egyesült Államokban és Japánban is
[285] Sebességváltó fajta: Automata sebességváltó
[286] Sebességváltó fajta: CVT (fokozatmentes) automata váltóhoz
[287] Sebességváltó fajta: Kézikapcsolású váltó
[288] Sebességváltó fajta: 5 sebességes váltó
[289] Sebességváltó fajta: 6 sebességes váltó
[290] Sebességváltó fajta: Félautomata
[291] Jármű felszerelés: klímával szerelt járművekhez
[292] Jármű felszerelés: gyújtáselosztóval szerelt járművekhez
[293] Jármű felszerelés: indításgátlóval szerelt járművekhez
[294] Jármű felszerelés: Start-Stop rendszerrel szerelt járművekhez
[295] Jármű felszerelés: Részecskeszűrővel szerelt járművekhez
[296] Jármű felszerelés: gyújtáselosztó nélküli járművekhez
[297] Jármű felszerelés: indításgátlóval szerelt járművekhez nem
[298] Jármű felszerelés: Start-Stop rendszer nélküli járművekhez
[299] Jármű hálózat kivétel: 12 V-os hálózatú járművekhez
[300] Verzió: 0221504030
[301] Verzió: 03L.L
[302] Verzió: 04E.A, 04E.B
[303] Verzió: 04E.A, 04E.D
[304] Verzió: 04E.A, 04E.D, 04E.G, 04E.C
[305] Verzió: 04E.B
[306] Verzió: 04E.D, 04E.A
[307] Verzió: 04E.D, 04E.A, 04E.G
[308] Verzió: 04E.D, 04E.C
[309] Verzió: 04L.D;04L.J
[310] Verzió: 1P
[311] Verzió: 2U
[312] Verzió: 55kW
[313] Verzió: 56kW
[314] Verzió: Kibocsátási norma CEE2000
[315] Verzió: Kibocsátási norma CEE95
[316] Verzió: Karosszéria: LB
[317] Verzió: Karosszéria: LB (USA)
[318] Verzió: CEE2000, EOBD nélküli
[319] Verzió: D4123
[320] Verzió: DOHC
[321] Verzió: DSL
[322] Verzió: Duratorq / SID 206

HU

| |
|--|
| [323] Verzió: EA17 041 |
| [324] Verzió: FSI-motorok esetén |
| [325] Verzió: FORMEL E |
| [326] Verzió: GAMMA |
| [327] Verzió: JB0;JB1;JB2;JB3 |
| [328] Verzió: JPN |
| [329] Verzió: KK13 |
| [330] Verzió: LCI |
| [331] Verzió: LDK |
| [332] Verzió: LDK, LHU |
| [333] Verzió: M47 |
| [334] Verzió: M47N |
| [335] Verzió: M47N2 |
| [336] Verzió: M57N |
| [337] Verzió: MA13 |
| [338] Verzió: MD13 NAGARES |
| [339] Verzió: MD13 NAGARES;Sebességváltó PF1 |
| [340] Verzió: MJ |
| [341] Verzió: MM |
| [342] Verzió: MPI |
| [343] Verzió: N47 |
| [344] Verzió: N47N |
| [345] Verzió: N57 |
| [346] Verzió: N57N |
| [347] Verzió: N57S |
| [348] Verzió: N57Z |
| [349] Verzió: NA13 |
| [350] Verzió: Sebességváltó JR5 |
| [351] Verzió: NA13;Sebességváltó JR5, TL4 |
| [352] Verzió: ND13 |
| [353] Verzió: Euro 5 |
| [354] Verzió: nem B37A |
| [355] Verzió: nem B37B |
| [356] Verzió: FSI-motorok esetén nem |
| [357] Verzió: nem N57N |
| [358] Verzió: NTK #6 |
| [359] Verzió: EOBD nélkül |
| [360] Verzió: OP13 |
| [361] Verzió: a ZS522 alternatívája |
| [362] Verzió: Puma |
| [363] Verzió: Relék #3/103 |
| [364] Verzió: Relék #4/103 |
| [365] Verzió: Relék #8/103 |
| [366] Verzió: OROSZORSZÁGI ÜZEM |
| [367] Verzió: SOHC |
| [368] Verzió: Sebességváltó JB3 |
| [369] Verzió: Sebességváltó JC5 |
| [370] Verzió: Sebességváltó PK5 |
| [371] Verzió: UK |
| [372] Verzió: XT17 LINDE |
| [373] Verzió: Y-115T1 |
| [374] Verzió: ZH13 |
| [375] Verzió: ZP17 |

PL

| | | |
|--|---|--|
| [1] Układ hamulcowy: dla pojazdów z ABS | [49] dla normy emisji spalin producenta: CEE 19-5 | [107] dla numeru OE: 224488H315 |
| [2] Typ katalizatora: dla pojazdów z katalizatorami; dla pojazdów z układem katalitycznym | [50] dla normy emisji spalin producenta: CEE 19-5;US 87 | [108] dla numeru OE: 224488J11C |
| [3] Typ katalizatora: do pojazdów z katalizatorami; do pojazdów z układem katalitycznym | [51] dla normy emisji spalin producenta: CEE 95 | [109] dla numeru OE: 22448ED800 |
| [4] Typ katalizatora: dla pojazdów bez katalizatora | [52] dla normy emisji spalin producenta: CEE Fase 2 | [110] dla numeru OE: 25182496;96253555 |
| [5] Typ katalizatora: z katalizatorem 3-drożnym | [53] dla normy emisji spalin producenta: CEE Phase 4 | [111] dla numeru OE: 27301 02100 |
| [6] Strefy klimatyczne: w przypadku chłodnych klimatów | [54] dla normy emisji spalin producenta: CEE Phase 5 | [112] dla numeru OE: 27301 02600 |
| [7] Kolor: czarny | [55] dla normy emisji spalin producenta: CF2 | [113] dla numeru OE: 27301 02700 |
| [8] Kolor: niebieski | [56] dla normy emisji spalin producenta: CF2;CF3 | [114] dla numeru OE: 27301 03000 |
| [9] Kolor: Niebieski;Zielony | [57] dla normy emisji spalin producenta: CF3 | [115] dla numeru OE: 27301 03010 |
| [10] Kolor: szary | [58] dla normy emisji spalin producenta: CF3;CF4 | [116] dla numeru OE: 27301 04000 |
| [11] Kolor: jasnoszary | [59] dla normy emisji spalin producenta: CF4 | [117] dla numeru OE: 27301 22600 |
| [12] Kolor: pomarańczowy | [60] dla normy emisji spalin producenta: Euro 5 | [118] dla numeru OE: 27301 23700 |
| [13] Kolor: czerwony | [61] dla normy emisji spalin producenta: US 87 | [119] dla numeru OE: 27301 26600 |
| [14] Kolor: Biały | [62] dla numeru OE: 000 158 62 03 | [120] dla numeru OE: 27301 2B000 |
| [15] Kolor: Żółty | [63] dla numeru OE: 000 158 64 03 | [121] dla numeru OE: 27301 2B010 |
| [16] Nr aparatu zapłonowego: 525352A;525352B;525352C;525352D | [64] dla numeru OE: 032 905 106 B | [122] dla numeru OE: 27301 700 |
| [17] Norma emisji spalin: D3 | [65] dla numeru OE: 036 905 715 F | [123] dla numeru OE: 2S6Q-6M090-AB |
| [18] Norma emisji spalin: D4 | [66] dla numeru OE: 03F 905 409 B | [124] dla numeru OE: 2S6Q-6M090-BB |
| [19] Norma emisji spalin: Euro 3 (D3) | [67] dla numeru OE: 03L 905 061 G | [125] dla numeru OE: 30520-RRA-007 |
| [20] Norma emisji spalin: Euro 3 (D3);Euro 4 (D4) | [68] dla numeru OE: 04606869AC;04606869AB | [126] dla numeru OE: 30713416;9125601 |
| [21] Norma emisji spalin: Euro 4 (D4) | [69] dla numeru OE: 058 905 101 A | [127] dla numeru OE: 357911253 |
| [22] Norma emisji spalin: Euro 5 | [70] dla numeru OE: 059 905 061 H | [128] dla numeru OE: 36710 2A100 |
| [23] Norma emisji spalin: Euro 5 PLUS | [71] dla numeru OE: 059 963 319 T | [129] dla numeru OE: 36710 3A000 |
| [24] Norma emisji spalin: Euro 6 | [72] dla numeru OE: 06A 905 097 | [130] dla numeru OE: 36710 4A000 |
| [25] Norma emisji spalin: Euro 6 PLUS | [73] dla numeru OE: 06A 905 115 D | [131] dla numeru OE: 46 777 288 |
| [26] Norma emisji spalin: ULEV2 | [74] dla numeru OE: 06B 905 115 E | [132] dla numeru OE: 46796050 |
| [27] Miejsce zabudowy: Kolektor wydechowy | [75] dla numeru OE: 06E 905 115 E | [133] dla numeru OE: 55210051 |
| [28] Miejsce zabudowy: Kolektor dolotowy | [76] dla numeru OE: 07K 905 715 F | [134] dla numeru OE: 5960 66 |
| [29] Miejsce zabudowy: Montaż boczny;do cylindra nr 5; do cylindra nr 6; do cylindra nr 7;do cylindra nr 8 | [77] dla numeru OE: 100630 | [135] dla numeru OE: 5960 66;5960 F5 |
| [30] Miejsce zabudowy: z lewej | [78] dla numeru OE: 1106500Q0H;1106500Q0L | [136] dla numeru OE: 5960 F4 |
| [31] Miejsce zabudowy: z prawej | [79] dla numeru OE: 110651492R | [137] dla numeru OE: 70863020 |
| [32] Miejsce zabudowy: do cylindra nr 1; do cylindra nr 2; do cylindra nr 3 | [80] dla numeru OE: 110651749R | [138] dla numeru OE: 70863021 |
| [33] Miejsce zabudowy: do cylindra nr 1; do cylindra nr 2; do cylindra nr 3;do cylindra nr 4 | [81] dla numeru OE: 110655X00A | [139] dla numeru OE: 7648797 |
| [34] Miejsce zabudowy: to cylinder 1;to cylinder 2;to cylinder 4 | [82] dla numeru OE: 11067BN700 | [140] dla numeru OE: 7700100589 |
| [35] Miejsce zabudowy: do cylindra nr 1; do cylindra nr 3 | [83] dla numeru OE: 12 13 1 703 228 | [141] dla numeru OE: 7700100643 |
| [36] Miejsce zabudowy: do cylindra nr 1; do cylindra nr 3; do cylindra nr 5 | [84] dla numeru OE: 12 13 1 712 219 | [142] dla numeru OE: 7700273226 |
| [37] Miejsce zabudowy: w cylindrze 1, 4 | [85] dla numeru OE: 12 13 7 510 738 | [143] dla numeru OE: 7700273826 |
| [38] Miejsce zabudowy: w cylindrze 2 | [86] dla numeru OE: 12 13 7 548 553 | [144] dla numeru OE: 7700274008;224336134R |
| [39] Miejsce zabudowy: w cylindrze 2, 3 | [87] dla numeru OE: 12 13 7 594 937 | [145] dla numeru OE: 7701041607 |
| [40] Miejsce zabudowy: do cylindra nr 2;do cylindra nr 3;do cylindra nr 4 | [88] dla numeru OE: 12 13 7 638 477 | [146] dla numeru OE: 7701041608 |
| [41] Miejsce zabudowy: w cylindrze 2, 4 | [89] dla numeru OE: 12 13 8 616 153 | [147] dla numeru OE: 7746152 |
| [42] Miejsce zabudowy: do cylindra nr 2; do cylindra nr 4; do cylindra nr 6 | [90] dla numeru OE: 12 21 7 800 156 | [148] dla numeru OE: 7746153 |
| [43] Miejsce zabudowy: to cylinder 2;to cylinder 5 | [91] dla numeru OE: 12 21 7 801 200 | [149] dla numeru OE: 8200051128 |
| [44] Miejsce zabudowy: do 3 cylindra | [92] dla numeru OE: 12 23 0 038 490 | [150] dla numeru OE: 8200084401;8200025256 |
| [45] Miejsce zabudowy: do cylindra nr 5; do cylindra nr 6; do cylindra nr 7;do cylindra nr 8 | [93] dla numeru OE: 12 23 2 248 059 | [151] dla numeru OE: 8200360911;8200702693 |
| [46] Miejsce zabudowy: Góra;do cylindra nr 1; do cylindra nr 2; do cylindra nr 3;do cylindra nr 4 | [94] dla numeru OE: 12 23 7 786 869 | [152] dla numeru OE: 8200486877 |
| [47] do modernizacji: Nie | [95] dla numeru OE: 12 23 7 798 001 | [153] dla numeru OE: 8200506297 |
| [48] do modernizacji: Tak | [96] dla numeru OE: 12611424 | [154] dla numeru OE: 8200561251 |
| | [97] dla numeru OE: 1275971 | [155] dla numeru OE: 8200682592 |
| | [98] dla numeru OE: 1306696 | [156] dla numeru OE: 8200702693 |
| | [99] dla numeru OE: 171 905 115 | [157] dla numeru OE: 8200943801 |
| | [100] dla numeru OE: 18550-80KA0 | [158] dla numeru OE: 8973065193 |
| | [101] dla numeru OE: 22 43 361 34R | [159] dla numeru OE: 90543253 |
| | [102] dla numeru OE: 2240100Q0G, 2240100Q0K | [160] dla numeru OE: 90919-01218 |
| | [103] dla numeru OE: 2240100Q0K | [161] dla numeru OE: 90919-02230 |
| | [104] dla numeru OE: 22401CK81B | [162] dla numeru OE: 90919-02234 |
| | [105] dla numeru OE: 224332428R | [163] dla numeru OE: 90919-02234;90919-02207 |
| | [106] dla numeru OE: 224481KT0A | [164] dla numeru OE: 90919-02238 |

PL

[165] dla numeru OE: 90919-02243
[166] dla numeru OE: 90919-02248
[167] dla numeru OE: 90919-02262
[168] dla numeru OE: 90919-02265
[169] dla numeru OE: 90919-02266
[170] dla numeru OE: 93177212
[171] dla numeru OE: 93198468
[172] dla numeru OE: 9638985980
[173] dla numeru OE: 9651583680
[174] dla numeru OE: A 000 158 78 03
[175] dla numeru OE: A 001 159 15 01;A 001 159 16 01
[176] dla numeru OE: A 001 159 20 01;A 001 159 21 01
[177] dla numeru OE: A 001 159 26 01
[178] dla numeru OE: A 001 159 50 01;A 001 159 71 01
[179] dla numeru OE: A 272 906 00 60
[180] dla numeru OE: A 642 900 58 01
[181] dla numeru OE: N 105 916 02;N 105 916 03
[182] dla numeru OE: N 105 916 03
[183] dla numeru OE: N 105 916 04
[184] dla numeru OE: N 105 916 08
[185] dla numeru OE: NEC100630
[186] dla numeru OE: S210-18-140;S210-18-140 A
[187] dla numeru OE: XM34-12A342-BA
[188] dla numeru PR: OGG
[189] dla numeru PR: OK0 + TS8 + 7MJ, 7MU, 7MR
[190] dla numeru PR: OK3, OK4 +TS8, T7V
[191] dla numeru PR: 7CF
[192] dla numeru PR: 7CF, 7MM
[193] dla numeru PR: 7MM
[194] dla numeru PR: 7MM, 7MJ
[195] dla numeru PR: 7MM, 7MJ, 7CP
[196] dla numeru PR: 7MM;7MJ;7MW
[197] dla numeru PR: 7MU
[198] dla numeru PR: D3E
[199] dla numeru PR: D7N
[200] dla numeru PR: GP1
[201] dla numeru PR: GP2+TD1
[202] dla numeru PR: GP2+TF1
[203] dla numeru PR: GP2+TH1
[204] dla numeru PR: TON;T11
[205] dla numeru PR: T41
[206] dla numeru PR: T41;TF1
[207] dla numeru PR: T7V
[208] dla numeru PR: T7V +7CP, 7CS, 7MV
[209] dla numeru PR: TD1
[210] dla numeru PR: TD1+7MM, 7MJ, 7MW
[211] dla numeru PR: TD1+7MM, 7MJ, 7MW, 7CP
[212] dla numeru PR: TE1
[213] dla numeru PR: TF1
[214] dla numeru PR: TG1
[215] dla numeru PR: TH1
[216] dla numeru PR: TH1+7GB
[217] dla numeru PR: TH1+7MK
[218] dla numeru PR: TK8, TH8
[219] dla numeru PR: TK8, TL1
[220] dla numeru PR: TK8, TL1, TM5

[221] dla numeru PR: TL1, TK8
[222] dla numeru PR: TL1, TK8, TM5, TH8
[223] dla numeru PR: TL1, TP1
[224] dla numeru PR: TL4
[225] dla numeru PR: TM4
[226] dla numeru PR: TP1
[227] dla numeru PR: TS8
[228] dla numeru PR: TS8 + 7MJ
[229] dla kodu SA: 021
[230] dla kodu SA: 022
[231] dla kodu SA: 494
[232] dla kodu SA: 700
[233] dla kodu SA: 803;804;805;806
[234] dla kodu SA: 940K;939K;802
[235] dla kodu SA: MC1;MC2;MC3;MP1;MP2;MP3
[236] dla kodu SA: MC2+MS9
[237] dla kodu SA: MQ3;MQ4;MQ5
[238] dla kodu SA: MQ6;MCO
[239] dla kodu SA: U43;U83
[240] Ograniczenia producenta: BERU
[241] Ograniczenia producenta: BORGWARNER
[242] Ograniczenia producenta: Bosch
[243] Ograniczenia producenta: BOSCH; DUCELLIER
[244] Ograniczenia producenta: Bosch;Beru
[245] Ograniczenia producenta: Bremi
[246] Ograniczenia producenta: DELCO REMY
[247] Ograniczenia producenta: DELPHI
[248] Ograniczenia producenta: Ducellier
[249] Ograniczenia producenta: ELDOR
[250] Ograniczenia producenta: ELECTRICFIL
[251] Ograniczenia producenta: energia elektryczna
[252] Ograniczenia producenta: Pojazd z diagnozą
[253] Ograniczenia producenta: HITACHI
[254] Ograniczenia producenta: ILKAR7A7
[255] Ograniczenia producenta: LUCAS
[256] Ograniczenia producenta: MARELLI
[257] Ograniczenia producenta: MARELLI;DUCELLIER
[258] Ograniczenia producenta: NGK
[259] Ograniczenia producenta: SAE
[260] Ograniczenia producenta: SAGEM
[261] Ograniczenia producenta: System BOSCH
[262] Ograniczenia producenta: System BOSCH / TEMIC
[263] Ograniczenia producenta: SYSTEM DUCELLIER
[264] Ograniczenia producenta: System HITACHI
[265] Ograniczenia producenta: System VALEO
[266] Ograniczenia producenta: niewiążące zalecenie
[267] nie dla normy czystości spalin: Euro 5
[268] nie dla kodu SA: 494
[269] nie dla kodu SA: 803;804;805;806
[270] nie dla kodu SA: 808
[271] nie dla kodu SA: 928
[272] nie dla kodu SA: 940K;939K
[273] nie dla kodu SA: U43;U83
[274] Uwaga: Podczas wymiany cewki zapłonowej postępuj zgodnie z zaleceniami producenta, zainstaluj cewkę zapłonową tylko w połączeniu z oryginalną osłoną termiczną (FORD 1315753, 2S6G 12A376AE). Upewnij się, że katalizator spalin działa poprawnie.

[275] Uwaga: Zamontowany produkt musi być określony na podstawie samochodu lub silnika.
[276] Uwaga: Uwaga!!! Przy wymianie *wiece zap*onowych u*ywa* tylko nowych wtyków oraz smaru do wtyków *wiece zap*onowych(ZKF 01 nr kat. 0 890 300 029).
[277] Uwaga: Zalecenie: ZKF 01 - patrz lista akcesoriów
[278] Zalecana częstotliwość wymiany (km): 20000
[279] Zalecana częstotliwość wymiany (km): 30000
[280] Ograniczenia dot. sprzedaży: Z wykluczeniem Stanów Zjednoczonych
[281] Ograniczenia dot. sprzedaży: Z wykluczeniem Stanów Zjednoczonych, z wykluczeniem Japonii
[282] Ograniczenia dot. sprzedaży: Z uwzględnieniem Canada
[283] Ograniczenia dot. sprzedaży: Z uwzględnieniem Stanów Zjednoczonych
[284] Ograniczenia dot. sprzedaży: Z uwzględnieniem Stanów Zjednoczonych, z uwzględnieniem
[285] Rodzaj skrzyni biegów: Automatyczna skrzynia biegów
[286] Rodzaj skrzyni biegów: skrzynia automat. bezstopniowa (CVT)
[287] Rodzaj skrzyni biegów: przekładnia mechaniczna
[288] Rodzaj skrzyni biegów: 5-biegowa skrzynia biegów
[289] Rodzaj skrzyni biegów: 6-biegowa skrzynia biegów
[290] Rodzaj skrzyni biegów: półautomatyczny
[291] Wyposażenie pojazdu: dla pojazdów z klimatyzacją
[292] Wyposażenie pojazdu: dla pojazdów z rozdzielaczem zapłonu
[293] Wyposażenie pojazdu: dla pojazdów z immobilizerem
[294] Wyposażenie pojazdu: dla pojazdów z systemem start-stop
[295] Wyposażenie pojazdu: dla pojazdów z filtrem cząstek stałych
[296] Wyposażenie pojazdu: dla pojazdów bez rozdzielacza zapłonu
[297] Wyposażenie pojazdu: dla pojazdów bez immobilizera
[298] Wyposażenie pojazdu: dla pojazdów bez systemu start-stop
[299] Wykonanie sieci pokładowej: dla pojazdów z 12V instalacją elektryczną
[300] Wersja: 0221504030
[301] Wersja: 03L.L
[302] Wersja: 04E.A, 04E.B
[303] Wersja: 04E.A, 04E.D
[304] Wersja: 04E.A, 04E.D, 04E.G, 04E.C
[305] Wersja: 04E.B
[306] Wersja: 04E.D, 04E.A
[307] Wersja: 04E.D, 04E.A, 04E.G
[308] Wersja: 04E.D, 04E.C
[309] Wersja: 04L.D;04L.J
[310] Wersja: 1P
[311] Wersja: 2U
[312] Wersja: 55kW
[313] Wersja: 56kW
[314] Wersja: Normy spalin CEE2000
[315] Wersja: Normy spalin CEE95
[316] Wersja: Nadwozie: LB

PL

[317] Wersja: Nadwozie: LB (USA)
[318] Wersja: CEE2000, bez EOBD
[319] Wersja: D4123
[320] Wersja: DOHC
[321] Wersja: DSL
[322] Wersja: Duratorq / SID 206
[323] Wersja: EA17 041
[324] Wersja: do silników FSI
[325] Wersja: FORMEL E
[326] Wersja: GAMMA
[327] Wersja: JB0;JB1;JB2;JB3
[328] Wersja: JPN
[329] Wersja: KK13
[330] Wersja: LCI
[331] Wersja: LDK
[332] Wersja: LDK, LHU
[333] Wersja: M47
[334] Wersja: M47N
[335] Wersja: M47N2
[336] Wersja: M57N
[337] Wersja: MA13
[338] Wersja: MD13 NAGARES
[339] Wersja: MD13 NAGARES;Skrzynia biegów PF1
[340] Wersja: MJ
[341] Wersja: MM
[342] Wersja: Wtrysk wielopunktowy (MPI)
[343] Wersja: N47
[344] Wersja: N47N
[345] Wersja: N57
[346] Wersja: N57N
[347] Wersja: N57S
[348] Wersja: N57Z
[349] Wersja: NA13
[350] Wersja: Skrzynia biegów JR5
[351] Wersja: NA13;Skrzynia biegów JR5, TL4
[352] Wersja: ND13
[353] Wersja: Dla normy spalin Euro 5
[354] Wersja: nie B37A
[355] Wersja: nie B37B
[356] Wersja: nie do silników FSI
[357] Wersja: nie N57N
[358] Wersja: NTK #6
[359] Wersja: Bez EOBD
[360] Wersja: OP13
[361] Wersja: alternatywa dla ZS522
[362] Wersja: Puma
[363] Wersja: Przekładnik #3/103
[364] Wersja: Przekładnik #4/103
[365] Wersja: Przekładnik #8/103
[366] Wersja: FABRYKA W ROSJI
[367] Wersja: SOHC
[368] Wersja: Skrzynia biegów JB3
[369] Wersja: Skrzynia biegów JC5
[370] Wersja: Skrzynia biegów PK5
[371] Wersja: UK
[372] Wersja: XT17 LINDE
[373] Wersja: Y-115T1
[374] Wersja: ZH13

[375] Wersja: ZP17

PT

| | | |
|---|---|--|
| [1] Dinâmica de travagem/condução: para veículos com ABS | [50] para norma dos gases de escape do fabricante: CEE 19-5;US 87 | [100] para número OE: 18550-80KA0 |
| [2] Tipo de catalisador: para veículos com conversor catalítico;para veículos com configuração para catalisador | [51] para norma dos gases de escape do fabricante: CEE 95 | [101] para número OE: 22 43 361 34R |
| [3] Tipo de catalisador: para veículos com disposição de catalisador;para veículos com catalisador | [52] para norma dos gases de escape do fabricante: CEE Fase 2 | [102] para número OE: 2240100Q0G, 2240100Q0K |
| [4] Tipo de catalisador: para veículos sem conversor catalítico | [53] para norma dos gases de escape do fabricante: CEE Phase 4 | [103] para número OE: 2240100Q0K |
| [5] Tipo de catalisador: com catalisador regulado (3 vias) | [54] para norma dos gases de escape do fabricante: CEE Phase 5 | [104] para número OE: 22401CK81B |
| [6] Zonas de climatização: para climas frios | [55] para norma dos gases de escape do fabricante: CF2 | [105] para número OE: 224332428R |
| [7] Cor: preto | [56] para norma dos gases de escape do fabricante: CF2;CF3 | [106] para número OE: 224481KT0A |
| [8] Cor: azul | [57] para norma dos gases de escape do fabricante: CF3 | [107] para número OE: 224488H315 |
| [9] Cor: Azul;Verde | [58] para norma dos gases de escape do fabricante: CF3;CF4 | [108] para número OE: 224488J11C |
| [10] Cor: cinzento | [59] para norma dos gases de escape do fabricante: CF4 | [109] para número OE: 22448ED800 |
| [11] Cor: Cinzento claro | [60] para norma dos gases de escape do fabricante: Euro 5 | [110] para número OE: 25182496;96253555 |
| [12] Cor: cor de laranja | [61] para norma dos gases de escape do fabricante: US 87 | [111] para número OE: 27301 02100 |
| [13] Cor: vermelho | [62] para número OE: 000 158 62 03 | [112] para número OE: 27301 02600 |
| [14] Cor: Branco | [63] para número OE: 000 158 64 03 | [113] para número OE: 27301 02700 |
| [15] Cor: Amarelo | [64] para número OE: 032 905 106 B | [114] para número OE: 27301 03000 |
| [16] Número do distribuidor: 525352A;525352B;525352C;525352D | [65] para número OE: 036 905 715 F | [115] para número OE: 27301 03010 |
| [17] Norma sobre os gases de escape: D3 | [66] para número OE: 03F 905 409 B | [116] para número OE: 27301 04000 |
| [18] Norma sobre os gases de escape: D4 | [67] para número OE: 03L 905 061 G | [117] para número OE: 27301 22600 |
| [19] Norma sobre os gases de escape: Euro 3 (D3) | [68] para número OE: 04606869AC;04606869AB | [118] para número OE: 27301 23700 |
| [20] Norma sobre os gases de escape: Euro 3 (D3);Euro 4 (D4) | [69] para número OE: 058 905 101 A | [119] para número OE: 27301 26600 |
| [21] Norma sobre os gases de escape: Euro 4 (D4) | [70] para número OE: 059 905 061 H | [120] para número OE: 27301 2B000 |
| [22] Norma sobre os gases de escape: Euro 5 | [71] para número OE: 059 963 319 T | [121] para número OE: 27301 2B010 |
| [23] Norma sobre os gases de escape: Euro 5 PLUS | [72] para número OE: 06A 905 097 | [122] para número OE: 27301 700 |
| [24] Norma sobre os gases de escape: Euro 6 | [73] para número OE: 06A 905 115 D | [123] para número OE: 2S6Q-6M090-AB |
| [25] Norma sobre os gases de escape: Euro 6 PLUS | [74] para número OE: 06B 905 115 E | [124] para número OE: 2S6Q-6M090-BB |
| [26] Norma sobre os gases de escape: ULEV2 | [75] para número OE: 06E 905 115 E | [125] para número OE: 30520-RRA-007 |
| [27] Posição: Colector de escape | [76] para número OE: 07K 905 715 F | [126] para número OE: 30713416;9125601 |
| [28] Posição: Colector de admissão | [77] para número OE: 100630 | [127] para número OE: 357911253 |
| [29] Posição: Instalação lateral;no cilindro 5;no cilindro 6;no cilindro 7;no cilindro 8 | [78] para número OE: 1106500Q0H;1106500Q0L | [128] para número OE: 36710 2A100 |
| [30] Posição: esquerda | [79] para número OE: 110651492R | [129] para número OE: 36710 3A000 |
| [31] Posição: à direita | [80] para número OE: 110651749R | [130] para número OE: 36710 4A000 |
| [32] Posição: no cilindro 1;no cilindro 2;no cilindro 3 | [81] para número OE: 110655X00A | [131] para número OE: 46 777 288 |
| [33] Posição: no cilindro 1;no cilindro 2;no cilindro 3;no cilindro 4 | [82] para número OE: 11067BN700 | [132] para número OE: 46796050 |
| [34] Posição: to cylinder 1;to cylinder 2;to cylinder 4 | [83] para número OE: 12 13 1 703 228 | [133] para número OE: 55210051 |
| [35] Posição: no cilindro 1;no cilindro 3 | [84] para número OE: 12 13 1 712 219 | [134] para número OE: 5960 66 |
| [36] Posição: no cilindro 1;no cilindro 3;no cilindro 5 | [85] para número OE: 12 13 7 510 738 | [135] para número OE: 5960 66;5960 F5 |
| [37] Posição: ao cilindro 1, 4 | [86] para número OE: 12 13 7 548 553 | [136] para número OE: 5960 F4 |
| [38] Posição: ao cilindro 2 | [87] para número OE: 12 13 7 594 937 | [137] para número OE: 70863020 |
| [39] Posição: ao cilindro 2, 3 | [88] para número OE: 12 13 7 638 477 | [138] para número OE: 70863021 |
| [40] Posição: no cilindro 2;no cilindro 3;no cilindro 4 | [89] para número OE: 12 13 8 616 153 | [139] para número OE: 7648797 |
| [41] Posição: ao cilindro 2, 4 | [90] para número OE: 12 21 7 800 156 | [140] para número OE: 7700100589 |
| [42] Posição: no cilindro 2;no cilindro 4;no cilindro 6 | [91] para número OE: 12 21 7 801 200 | [141] para número OE: 7700100643 |
| [43] Posição: to cylinder 2;to cylinder 5 | [92] para número OE: 12 23 0 038 490 | [142] para número OE: 7700273226 |
| [44] Posição: para o cilindro 3 | [93] para número OE: 12 23 2 248 059 | [143] para número OE: 7700273826 |
| [45] Posição: no cilindro 5;no cilindro 6;no cilindro 7;no cilindro 8 | [94] para número OE: 12 23 7 786 869 | [144] para número OE: 7700274008;224336134R |
| [46] Posição: Superior;no cilindro 1;no cilindro 2;no cilindro 3;no cilindro 4 | [95] para número OE: 12 23 7 798 001 | [145] para número OE: 7701041607 |
| [47] "para ""facelift""": Nr | [96] para número OE: 12611424 | [146] para número OE: 7701041608 |
| [48] "para ""facelift""": Sim | [97] para número OE: 1275971 | [147] para número OE: 7746152 |
| [49] para norma dos gases de escape do fabricante: CEE 19-5 | [98] para número OE: 1306696 | [148] para número OE: 7746153 |
| | [99] para número OE: 171 905 115 | [149] para número OE: 8200051128 |
| | | [150] para número OE: 8200084401;8200025256 |
| | | [151] para número OE: 8200360911;8200702693 |
| | | [152] para número OE: 8200486877 |
| | | [153] para número OE: 8200506297 |
| | | [154] para número OE: 8200561251 |
| | | [155] para número OE: 8200682592 |
| | | [156] para número OE: 8200702693 |
| | | [157] para número OE: 8200943801 |

PT

[158] para número OE: 8973065193
[159] para número OE: 90543253
[160] para número OE: 90919-01218
[161] para número OE: 90919-02230
[162] para número OE: 90919-02234
[163] para número OE: 90919-02234;90919-02207
[164] para número OE: 90919-02238
[165] para número OE: 90919-02243
[166] para número OE: 90919-02248
[167] para número OE: 90919-02262
[168] para número OE: 90919-02265
[169] para número OE: 90919-02266
[170] para número OE: 93177212
[171] para número OE: 93198468
[172] para número OE: 9638985980
[173] para número OE: 9651583680
[174] para número OE: A 000 158 78 03
[175] para número OE: A 001 159 15 01;A 001 159 16 01
[176] para número OE: A 001 159 20 01;A 001 159 21 01
[177] para número OE: A 001 159 26 01
[178] para número OE: A 001 159 50 01;A 001 159 71 01
[179] para número OE: A 272 906 00 60
[180] para número OE: A 642 900 58 01
[181] para número OE: N 105 916 02;N 105 916 03
[182] para número OE: N 105 916 03
[183] para número OE: N 105 916 04
[184] para número OE: N 105 916 08
[185] para número OE: NEC100630
[186] para número OE: S210-18-140;S210-18-140 A
[187] para número OE: XM34-12A342-BA
[188] para número PR: OGG
[189] para número PR: OK0 + TS8 + 7MJ, 7MU, 7MR
[190] para número PR: OK3, OK4 +TS8, T7V
[191] para número PR: 7CF
[192] para número PR: 7CF, 7MM
[193] para número PR: 7MM
[194] para número PR: 7MM, 7MJ
[195] para número PR: 7MM, 7MJ, 7CP
[196] para número PR: 7MM;7MJ;7MW
[197] para número PR: 7MU
[198] para número PR: D3E
[199] para número PR: D7N
[200] para número PR: GP1
[201] para número PR: GP2+TD1
[202] para número PR: GP2+TF1
[203] para número PR: GP2+TH1
[204] para número PR: T0N;T1I
[205] para número PR: T41
[206] para número PR: T41;TF1
[207] para número PR: T7V
[208] para número PR: T7V +7CP, 7CS, 7MV
[209] para número PR: TD1
[210] para número PR: TD1+7MM, 7MJ, 7MW
[211] para número PR: TD1+7MM, 7MJ, 7MW, 7CP
[212] para número PR: TE1
[213] para número PR: TF1

[214] para número PR: TG1
[215] para número PR: TH1
[216] para número PR: TH1+7GB
[217] para número PR: TH1+7MK
[218] para número PR: TK8, TH8
[219] para número PR: TK8, TL1
[220] para número PR: TK8, TL1, TM5
[221] para número PR: TL1, TK8
[222] para número PR: TL1, TK8, TM5, TH8
[223] para número PR: TL1, TP1
[224] para número PR: TL4
[225] para número PR: TM4
[226] para número PR: TP1
[227] para número PR: TS8
[228] para número PR: TS8 + 7MJ
[229] para código SA: 021
[230] para código SA: 022
[231] para código SA: 494
[232] para código SA: 700
[233] para código SA: 803;804;805;806
[234] para código SA: 940K;939K;802
[235] para código SA: MC1;MC2;MC3;MP1;MP2;MP3
[236] para código SA: MC2+MS9
[237] para código SA: MQ3;MQ4;MQ5
[238] para código SA: MQ6;MCO
[239] para código SA: U43;U83
[240] Restrição do fabricante: BERU
[241] Restrição do fabricante: BORGWARNER
[242] Restrição do fabricante: Bosch
[243] Restrição do fabricante: BOSCH; DUCCELLIER
[244] Restrição do fabricante: Bosch;Beru
[245] Restrição do fabricante: Bremi
[246] Restrição do fabricante: DELCO REMY
[247] Restrição do fabricante: DELPHI
[248] Restrição do fabricante: Ducellier
[249] Restrição do fabricante: ELDOR
[250] Restrição do fabricante: ELECTRICFIL
[251] Restrição do fabricante: electrónico
[252] Restrição do fabricante: Diagnóstico do veículo
[253] Restrição do fabricante: HITACHI
[254] Restrição do fabricante: ILKAR7A7
[255] Restrição do fabricante: LUCAS
[256] Restrição do fabricante: MARELLI
[257] Restrição do fabricante: MARELLI;DUCCELLIER
[258] Restrição do fabricante: NGK
[259] Restrição do fabricante: SAE
[260] Restrição do fabricante: SAGEM
[261] Restrição do fabricante: Sistema BOSCH
[262] Restrição do fabricante: Sistema BOSCH / TEMIC
[263] Restrição do fabricante: SISTEMA DUCCELLIER
[264] Restrição do fabricante: Sistema HITACHI
[265] Restrição do fabricante: Sistema VALEO
[266] Restrição do fabricante: recomendação não vinculativa
[267] não para a norma de gases de escape: Euro 5
[268] não para código SA: 494
[269] não para código SA: 803;804;805;806
[270] não para código SA: 808
[271] não para código SA: 928

[272] não para código SA: 940K;939K
[273] não para código SA: U43;U83
[274] Observação: Alterando a bobina de ignição para satisfazer as especificações do fabricante, instale a bobina de ignição somente em conjunto com o escudo térmico original (FORD 1315753, 2S6G 12A376AE). Certifique-se de que o catalisador está a funcionar adequadamente.
[275] Observação: O produto instalado tem de ser determinado no veículo ou motor.
[276] Observação: Recomendação! Quando substituir as velas de ignição em veículos com bobinas de ignição de conector, devesubstituir igualmente os conectores e usar massaprópria para montagem de conectores de velas deignição (ZKF 01 - N.º de encomenda 0 890 300 029).
[277] Observação: Recomendação: ZKF 01 - ver lista de acessórios
[278] Intervalo de substituição recomendado (km): 20000
[279] Intervalo de substituição recomendado (km): 30000
[280] Restrição_Vendas: Excluindo Estados Unidos da América
[281] Restrição_Vendas: Excluindo Estados Unidos da América;Excluindo japão
[282] Restrição_Vendas: Inclui Canada
[283] Restrição_Vendas: Inclui EUA.
[284] Restrição_Vendas: Inclui EUA, inclui Japão
[285] Tipo de caixa de velocidades: Transmissão Automática
[286] Tipo de caixa de velocidades: Caixa de velocidades automática CVT (de variação contínua)
[287] Tipo de caixa de velocidades: Caixa de velocidades manual
[288] Tipo de caixa de velocidades: caixa de 5 velocidades
[289] Tipo de caixa de velocidades: caixa de 6 velocidades
[290] Tipo de caixa de velocidades: Semi-automático
[291] Equipamento do veículo: para veículos com climatização
[292] Equipamento do veículo: para veículos com distribuidor de ignição
[293] Equipamento do veículo: para veículos com imobilizador
[294] Equipamento do veículo: Para veículos com a função start-stop
[295] Equipamento do veículo: Para veículos sem filtro diesel de carbono
[296] Equipamento do veículo: para veículos sem distribuidor de ignição
[297] Equipamento do veículo: para veículos sem imobilizador
[298] Equipamento do veículo: Para veículos sem a função start-stop
[299] Tipo de instalação eléctrica de bordo: para veículos com rede de bordo de 12V
[300] Versão: 0221504030
[301] Versão: 03L.L
[302] Versão: 04E.A, 04E.B
[303] Versão: 04E.A, 04E.D
[304] Versão: 04E.A, 04E.D, 04E.G, 04E.C
[305] Versão: 04E.B
[306] Versão: 04E.D, 04E.A
[307] Versão: 04E.D, 04E.A, 04E.G
[308] Versão: 04E.D, 04E.C

PT

[309] Versão: 04L.D;04L.J
[310] Versão: 1P
[311] Versão: 2U
[312] Versão: 55kW
[313] Versão: 56kW
[314] Versão: Norma de escape CEE2000
[315] Versão: Norma de escape CEE95
[316] Versão: Carroçaria: LB
[317] Versão: Carroçaria: LB (USA)
[318] Versão: CEE2000, sem EOBD
[319] Versão: D4123
[320] Versão: DOHC
[321] Versão: DSL
[322] Versão: Duratorq / SID 206
[323] Versão: EA17 041
[324] Versão: para motores FSI
[325] Versão: FORMEL E
[326] Versão: GAMMA
[327] Versão: JB0;JB1;JB2;JB3
[328] Versão: JPN
[329] Versão: KK13
[330] Versão: LCI
[331] Versão: LDK
[332] Versão: LDK, LHU
[333] Versão: M47
[334] Versão: M47N
[335] Versão: M47N2
[336] Versão: M57N
[337] Versão: MA13
[338] Versão: MD13 NAGARES
[339] Versão: MD13 NAGARES;Transmissão PF1
[340] Versão: MJ
[341] Versão: MM
[342] Versão: Injeção multiponto
[343] Versão: N47
[344] Versão: N47N
[345] Versão: N57
[346] Versão: N57N
[347] Versão: N57S
[348] Versão: N57Z
[349] Versão: NA13
[350] Versão: Transmissão JR5
[351] Versão: NA13;Transmissão JR5, TL4
[352] Versão: ND13
[353] Versão: Não para norma de escape Euro 5
[354] Versão: não B37A
[355] Versão: não B37B
[356] Versão: não para motores FSI
[357] Versão: não N57N
[358] Versão: NTK #6
[359] Versão: Sem EOBD
[360] Versão: OP13
[361] Versão: alternativa para ZS522
[362] Versão: Puma
[363] Versão: Relé #3/103
[364] Versão: Relé #4/103
[365] Versão: Relé #8/103
[366] Versão: PLANTA RÚSSIA

[367] Versão: SOHC
[368] Versão: Transmissão JB3
[369] Versão: Transmissão JC5
[370] Versão: Transmissão PK5
[371] Versão: UK
[372] Versão: XT17 LINDE
[373] Versão: Y-115T1
[374] Versão: ZH13
[375] Versão: ZP17

RU

- [1] Тормозная динамика / динамика движения: для автомобилей с ABS
- [2] Тип катализатора: для автомобилей с каталитическим нейтрализатором; для автомобилей с системой катализаторов
- [3] Тип катализатора: для автомобилей с каталитическим нейтрализатором
- [4] Тип катализатора: для автомобилей без каталитического нейтрализатора
- [5] Тип катализатора: с регулируемым катализатором (3-х ступенчатый)
- [6] Зоны кондиционирования: Для холодного климата
- [7] Цвет: черный
- [8] Цвет: синий
- [9] Цвет: синий;зеленый
- [10] Цвет: серый
- [11] Цвет: Светло-серый
- [12] Цвет: оранжевый
- [13] Цвет: красный
- [14] Цвет: Белый
- [15] Цвет: Желтый
- [16] Номер распределителя зажигания: 525352A;525352B;525352C;525352D
- [17] Выхлопная система: D3
- [18] Выхлопная система: D4
- [19] Выхлопная система: Euro 3 (D3)
- [20] Выхлопная система: Euro 3 (D3);Euro 4 (D4)
- [21] Выхлопная система: Euro 4 (D4)
- [22] Выхлопная система: Euro 5
- [23] Выхлопная система: Euro 5 PLUS
- [24] Выхлопная система: Euro 6
- [25] Выхлопная система: Euro 6 PLUS
- [26] Выхлопная система: ULEV2
- [27] Сторона установки: Выпускной коллектор
- [28] Сторона установки: Впускной коллектор
- [29] Сторона установки: Боковая установка на цилиндр 5, на цилиндр 6, на цилиндр 7, на цилиндр 8
- [30] Сторона установки: слева
- [31] Сторона установки: справа
- [32] Сторона установки: к цилиндру 1, к цилиндру 2, к цилиндру 3
- [33] Сторона установки: к цилиндру 1, к цилиндру 2, к цилиндру 3, к цилиндру 4
- [34] Сторона установки: to cylinder 1;to cylinder 2;to cylinder 4
- [35] Сторона установки: к цилиндру 1, к цилиндру 3
- [36] Сторона установки: к цилиндру 1, к цилиндру 3, к цилиндру 5
- [37] Сторона установки: цилиндры 1, 4
- [38] Сторона установки: цилиндр 2
- [39] Сторона установки: цилиндры 2, 3
- [40] Сторона установки: к цилиндру 2;к цилиндру 3;к цилиндру 4
- [41] Сторона установки: цилиндры 2, 4
- [42] Сторона установки: к цилиндру 2, к цилиндру 4, к цилиндру 6
- [43] Сторона установки: to cylinder 2;to cylinder 5
- [44] Сторона установки: к цилиндру 3
- [45] Сторона установки: к цилиндру 5, к цилиндру 6, к цилиндру 7, к цилиндру 8
- [46] Сторона установки: Верх: к цилиндру 1, к цилиндру 2, к цилиндру 3, к цилиндру 4

- [47] для модернизации дизайна: Нет
- [48] для модернизации дизайна: Да
- [49] для производителя выхлопной системы: CEE 19-5
- [50] для производителя выхлопной системы: CEE 19-5;US 87
- [51] для производителя выхлопной системы: CEE 95
- [52] для производителя выхлопной системы: CEE Fase 2
- [53] для производителя выхлопной системы: CEE Phase 4
- [54] для производителя выхлопной системы: CEE Phase 5
- [55] для производителя выхлопной системы: CF2
- [56] для производителя выхлопной системы: CF2;CF3
- [57] для производителя выхлопной системы: CF3
- [58] для производителя выхлопной системы: CF3;CF4
- [59] для производителя выхлопной системы: CF4
- [60] для производителя выхлопной системы: Euro 5
- [61] для производителя выхлопной системы: US 87
- [62] для оригинального номера: 000 158 62 03
- [63] для оригинального номера: 000 158 64 03
- [64] для оригинального номера: 032 905 106 B
- [65] для оригинального номера: 036 905 715 F
- [66] для оригинального номера: 03F 905 409 B
- [67] для оригинального номера: 03L 905 061 G
- [68] для оригинального номера: 04606869AC;04606869AB
- [69] для оригинального номера: 058 905 101 A
- [70] для оригинального номера: 059 905 061 H
- [71] для оригинального номера: 059 963 319 T
- [72] для оригинального номера: 06A 905 097
- [73] для оригинального номера: 06A 905 115 D
- [74] для оригинального номера: 06B 905 115 E
- [75] для оригинального номера: 06E 905 115 E
- [76] для оригинального номера: 07K 905 715 F
- [77] для оригинального номера: 100630
- [78] для оригинального номера: 1106500QH;1106500QL
- [79] для оригинального номера: 110651492R
- [80] для оригинального номера: 110651749R
- [81] для оригинального номера: 110655X00A
- [82] для оригинального номера: 11067BN700
- [83] для оригинального номера: 12 13 1 703 228
- [84] для оригинального номера: 12 13 1 712 219
- [85] для оригинального номера: 12 13 7 510 738
- [86] для оригинального номера: 12 13 7 548 553
- [87] для оригинального номера: 12 13 7 594 937
- [88] для оригинального номера: 12 13 7 638 477
- [89] для оригинального номера: 12 13 8 616 153
- [90] для оригинального номера: 12 21 7 800 156
- [91] для оригинального номера: 12 21 7 801 200
- [92] для оригинального номера: 12 23 0 038 490
- [93] для оригинального номера: 12 23 2 248 059
- [94] для оригинального номера: 12 23 7 786 869
- [95] для оригинального номера: 12 23 7 798 001
- [96] для оригинального номера: 12611424
- [97] для оригинального номера: 1275971

- [98] для оригинального номера: 1306696
- [99] для оригинального номера: 171 905 115
- [100] для оригинального номера: 18550-80KA0
- [101] для оригинального номера: 22 43 361 34R
- [102] для оригинального номера: 2240100Q0G, 2240100Q0K
- [103] для оригинального номера: 2240100Q0K
- [104] для оригинального номера: 22401CK81B
- [105] для оригинального номера: 224332428R
- [106] для оригинального номера: 224481KTOA
- [107] для оригинального номера: 224488H315
- [108] для оригинального номера: 224488J11C
- [109] для оригинального номера: 22448ED800
- [110] для оригинального номера: 25182496;96253555
- [111] для оригинального номера: 27301 02100
- [112] для оригинального номера: 27301 02600
- [113] для оригинального номера: 27301 02700
- [114] для оригинального номера: 27301 03000
- [115] для оригинального номера: 27301 03010
- [116] для оригинального номера: 27301 04000
- [117] для оригинального номера: 27301 22600
- [118] для оригинального номера: 27301 23700
- [119] для оригинального номера: 27301 26600
- [120] для оригинального номера: 27301 2B000
- [121] для оригинального номера: 27301 2B010
- [122] для оригинального номера: 27301 700
- [123] для оригинального номера: 2S6Q-6M090-AB
- [124] для оригинального номера: 2S6Q-6M090-BB
- [125] для оригинального номера: 30520-RRA-007
- [126] для оригинального номера: 30713416;9125601
- [127] для оригинального номера: 357911253
- [128] для оригинального номера: 36710 2A100
- [129] для оригинального номера: 36710 3A000
- [130] для оригинального номера: 36710 4A000
- [131] для оригинального номера: 46 777 288
- [132] для оригинального номера: 46796050
- [133] для оригинального номера: 55210051
- [134] для оригинального номера: 5960 66
- [135] для оригинального номера: 5960 66;5960 F5
- [136] для оригинального номера: 5960 F4
- [137] для оригинального номера: 70863020
- [138] для оригинального номера: 70863021
- [139] для оригинального номера: 7648797
- [140] для оригинального номера: 7700100589
- [141] для оригинального номера: 7700100643
- [142] для оригинального номера: 7700273226
- [143] для оригинального номера: 7700273826
- [144] для оригинального номера: 7700274008;224336134R
- [145] для оригинального номера: 7701041607
- [146] для оригинального номера: 7701041608
- [147] для оригинального номера: 7746152
- [148] для оригинального номера: 7746153
- [149] для оригинального номера: 8200051128
- [150] для оригинального номера: 8200084401;8200025256
- [151] для оригинального номера: 8200360911;8200702693



RU

[152] для оригинального номера: 8200486877
[153] для оригинального номера: 8200506297
[154] для оригинального номера: 8200561251
[155] для оригинального номера: 8200682592
[156] для оригинального номера: 8200702693
[157] для оригинального номера: 8200943801
[158] для оригинального номера: 8973065193
[159] для оригинального номера: 90543253
[160] для оригинального номера: 90919-01218
[161] для оригинального номера: 90919-02230
[162] для оригинального номера: 90919-02234
[163] для оригинального номера: 90919-02234;90919-02207
[164] для оригинального номера: 90919-02238
[165] для оригинального номера: 90919-02243
[166] для оригинального номера: 90919-02248
[167] для оригинального номера: 90919-02262
[168] для оригинального номера: 90919-02265
[169] для оригинального номера: 90919-02266
[170] для оригинального номера: 93177212
[171] для оригинального номера: 93198468
[172] для оригинального номера: 9638985980
[173] для оригинального номера: 9651583680
[174] для оригинального номера: A 000 158 78 03
[175] для оригинального номера: A 001 159 15 01;A 001 159 16 01
[176] для оригинального номера: A 001 159 20 01;A 001 159 21 01
[177] для оригинального номера: A 001 159 26 01
[178] для оригинального номера: A 001 159 50 01;A 001 159 71 01
[179] для оригинального номера: A 272 906 00 60
[180] для оригинального номера: A 642 900 58 01
[181] для оригинального номера: N 105 916 02;N 105 916 03
[182] для оригинального номера: N 105 916 03
[183] для оригинального номера: N 105 916 04
[184] для оригинального номера: N 105 916 08
[185] для оригинального номера: NEC100630
[186] для оригинального номера: S210-18-140;S210-18-140 A
[187] для оригинального номера: XM34-12A342-BA
[188] для заменяемого номера: OGG
[189] для заменяемого номера: OK0 + TS8 + 7MJ, 7MU, 7MR
[190] для заменяемого номера: OK3, OK4 +TS8, TV
[191] для заменяемого номера: 7CF
[192] для заменяемого номера: 7CF, 7MM
[193] для заменяемого номера: 7MM
[194] для заменяемого номера: 7MM, 7MJ
[195] для заменяемого номера: 7MM, 7MJ, 7CP
[196] для заменяемого номера: 7MM;7MJ;7MW
[197] для заменяемого номера: 7MU
[198] для заменяемого номера: D3E
[199] для заменяемого номера: D7N
[200] для заменяемого номера: GP1
[201] для заменяемого номера: GP2+TD1
[202] для заменяемого номера: GP2+TF1
[203] для заменяемого номера: GP2+TH1
[204] для заменяемого номера: TON;T11
[205] для заменяемого номера: T41

[206] для заменяемого номера: T41;TF1
[207] для заменяемого номера: TVV
[208] для заменяемого номера: TVV +7CP, 7CS, 7MV
[209] для заменяемого номера: TD1
[210] для заменяемого номера: TD1+7MM, 7MJ, 7MW
[211] для заменяемого номера: TD1+7MM, 7MJ, 7MW, 7CP
[212] для заменяемого номера: TE1
[213] для заменяемого номера: TF1
[214] для заменяемого номера: TG1
[215] для заменяемого номера: TH1
[216] для заменяемого номера: TH1+7GB
[217] для заменяемого номера: TH1+7MK
[218] для заменяемого номера: TK8, TH8
[219] для заменяемого номера: TK8, TL1
[220] для заменяемого номера: TK8, TL1, TM5
[221] для заменяемого номера: TL1, TK8
[222] для заменяемого номера: TL1, TK8, TM5, TH8
[223] для заменяемого номера: TL1, TP1
[224] для заменяемого номера: TL4
[225] для заменяемого номера: TM4
[226] для заменяемого номера: TP1
[227] для заменяемого номера: TS8
[228] для заменяемого номера: TS8 + 7MJ
[229] для SA Code: 021
[230] для SA Code: 022
[231] для SA Code: 494
[232] для SA Code: 700
[233] для SA Code: 803;804;805;806
[234] для SA Code: 940K;939K;802
[235] для SA Code: MC1;MC2;MC3;MP1;MP2;MP3
[236] для SA Code: MC2+MS9
[237] для SA Code: MQ3;MQ4;MQ5
[238] для SA Code: MQ6;MCO
[239] для SA Code: U43;U83
[240] ограничение производителя: BERU
[241] ограничение производителя: BORGWARNER
[242] ограничение производителя: Bosch
[243] ограничение производителя: BOSCH; DUCELLIER
[244] ограничение производителя: Bosch;Beru
[245] ограничение производителя: Bremi
[246] ограничение производителя: DELCO REMY
[247] ограничение производителя: DELPHI
[248] ограничение производителя: Ducellier
[249] ограничение производителя: ELDOR
[250] ограничение производителя: ELECTRICFIL
[251] ограничение производителя: электронный
[252] ограничение производителя: С диагнозом
[253] ограничение производителя: HITACHI
[254] ограничение производителя: ILKAR7A7
[255] ограничение производителя: LUCAS
[256] ограничение производителя: MARELLI
[257] ограничение производителя: MARELLI;DUCELLIER
[258] ограничение производителя: NGK
[259] ограничение производителя: SAE
[260] ограничение производителя: SAGEM
[261] ограничение производителя: BOSCH

[262] ограничение производителя: BOSCH / TEMIC
[263] ограничение производителя: система DUCELLIER
[264] ограничение производителя: HITACHI
[265] ограничение производителя: VALEO
[266] ограничение производителя: не обязывающая рекомендация
[267] кроме выхлопной системы: Euro 5
[268] кроме SA Code: 494
[269] кроме SA Code: 803;804;805;806
[270] кроме SA Code: 808
[271] кроме SA Code: 928
[272] кроме SA Code: 940K;939K
[273] кроме SA Code: U43;U83
[274] замечание: Замена катушки зажигания. В соответствии с требованиями производителя катушка зажигания должна устанавливаться только совместно с оригинальным тепловым экраном (FORD 1315753, 2S6G 12A376AE). Убедитесь в исправности каталитического нейтрализатора.
[275] замечание: Установленный продукт должен соответствовать автомобилю или двигателю.
[276] замечание: Recommendation - When changing the spark plugs on vehicles with connector ignition coils, please replace the connector and use spark plug connector grease (ZKF 01 - Order No. 0 890 300 029) to fit the connector.
[277] замечание: Рекомендация: ZKF 01 - см. перечень принадлежностей
[278] Рекомендуемая периодичность замены (км): 20000
[279] Рекомендуемая периодичность замены (км): 30000
[280] Ограничение продаж: исключая Соединенные Штаты Америки
[281] Ограничение продаж: исключая Соединенные Штаты Америки, Японию
[282] Ограничение продаж: включая Канада
[283] Ограничение продаж: включая Соединенные Штаты Америки
[284] Ограничение продаж: включая Соединенные Штаты Америки, Японию
[285] Вид коробки передач: Автоматическая коробка передач
[286] Вид коробки передач: CVT-автоматическая коробка передач(без ступеней)
[287] Вид коробки передач: механическая коробка передач
[288] Вид коробки передач: 5-ступенчатая коробка передач
[289] Вид коробки передач: 6-ступенчатая коробка передач
[290] Вид коробки передач: полуавтоматическая коробка передач
[291] Оснащение / оборудование: для автомобилей с кондиционером
[292] Оснащение / оборудование: для автомобилей с распределителем зажигания
[293] Оснащение / оборудование: для автомобилей с противоголоном устройством
[294] Оснащение / оборудование: для автомобилей с системой start-stop
[295] Оснащение / оборудование: для автомобилей с дизельным двигателем без сажевого фильтра
[296] Оснащение / оборудование: для автомобилей без дополнительного охлаждения масла

RU

[297] Оснащение / оборудование: для автомобилей без противоугонного устройства

[298] Оснащение / оборудование: для автомобилей без системы start-stop

[299] Модель бортовой сети: для транспортного средства с 12В бортовой сетью

[300] Версия: 0221504030

[301] Версия: 03L.L

[302] Версия: 04E.A, 04E.B

[303] Версия: 04E.A, 04E.D

[304] Версия: 04E.A, 04E.D, 04E.G, 04E.C

[305] Версия: 04E.B

[306] Версия: 04E.D, 04E.A

[307] Версия: 04E.D, 04E.A, 04E.G

[308] Версия: 04E.D, 04E.C

[309] Версия: 04L.D;04L.J

[310] Версия: 1P

[311] Версия: 2U

[312] Версия: 55kW

[313] Версия: 56kW

[314] Версия: экологического стандарта CEE2000

[315] Версия: экологического стандарта CEE95

[316] Версия: Кузов: LB

[317] Версия: Кузов: LB (USA)

[318] Версия: CEE2000, без EOBD

[319] Версия: D4123

[320] Версия: DOHC

[321] Версия: DSL

[322] Версия: Duratorq / SID 206

[323] Версия: EA17 041

[324] Версия: для двигателей FSI

[325] Версия: FORMEL E

[326] Версия: GAMMA

[327] Версия: JBO;JB1;JB2;JB3

[328] Версия: JPN

[329] Версия: KK13

[330] Версия: LCI

[331] Версия: LDK

[332] Версия: LDK, LHU

[333] Версия: M47

[334] Версия: M47N

[335] Версия: M47N2

[336] Версия: M57N

[337] Версия: MA13

[338] Версия: MD13 NAGARES

[339] Версия: MD13 NAGARES;Трансмиссия PF1

[340] Версия: MJ

[341] Версия: MM

[342] Версия: Многоточечный впрыск

[343] Версия: N47

[344] Версия: N47N

[345] Версия: N57

[346] Версия: N57N

[347] Версия: N57S

[348] Версия: N57Z

[349] Версия: NA13

[350] Версия: Трансмиссия JR5

[351] Версия: NA13;Трансмиссия JR5, TL4

[352] Версия: ND13

[353] Версия: Не для экологического стандарта Евро 5

[354] Версия: не B37A

[355] Версия: не B37B

[356] Версия: не для двигателей FSI

[357] Версия: не N57N

[358] Версия: NTK #6

[359] Версия: Без EOBD

[360] Версия: OP13

[361] Версия: альтернатива ZS522

[362] Версия: Puma

[363] Версия: Реле #3/103

[364] Версия: Реле #4/103

[365] Версия: Реле #8/103

[366] Версия: РОССИЙСКИЙ ЗАВОД

[367] Версия: SONC

[368] Версия: Трансмиссия JB3

[369] Версия: Трансмиссия JC5

[370] Версия: Трансмиссия PK5

[371] Версия: UK

[372] Версия: XT17 LINDE

[373] Версия: Y-115T1

[374] Версия: ZH13

[375] Версия: ZP17

Federal-Mogul Global Aftermarket EMEA bvba

Prins Boudewijnlaan 5 • 2550 Kontich • Belgium

Central Distribution Centre

Schoondonkweg 17 • 2830 Willebroek • Belgium

Phone +32 (0) 3450 83 10 • Fax +32 (0) 3450 83 38

Federal-Mogul Italy Srl • Aftermarket Division

Via Enrico Fermi 8 • 37135 Verona • Italy

Phone +39 045 828 13 11 • Fax +39 045 828 14 00

Federal-Mogul Aftermarket GmbH

Albert-Ruprecht-Strasse 2 • 71636 Ludwigsburg • Germany

Phone +49 (0) 7141-64865-8230 • Fax +49 (0) 7141-64865-8390

Federal-Mogul Aftermarket UK Limited

Greyhound Drive • Bradford • BD7 1NQ • U.K.

Phone +44 (0) 800 970 0203 • Fax +44 (0) 1274 848282

Federal-Mogul Aftermarket España S.A.

Calle Alcarria, nº 2 • 28823 Coslada • Madrid • Spain

Phone + 34 91 746 1900 • Fax + 34 91 746 18 90

Federal-Mogul Aftermarket France SAS

60-62, rue Danjou • 92517 Boulogne-Billancourt Cedex • France

Phone +33 (0) 1 46 94 27 00 • Fax +33 (0) 1 46 94 27 01

Service Commande de stock :

Phone +33 (0) 810 000 029 • Fax +32 (0) 34 50 80 26

Service Commande express :

Phone +33 (0) 810 000 029 • Fax +32 (0) 34 50 80 26

Federal-Mogul Motorparts Serbia*

Spanskih Boraca 22 • 11070 Novi Beograd • Serbia

Phone +381 11 31 31 918 • Fax +381 11 31 31 848

Federal-Mogul Aftermarket Southern Africa (PTY) Ltd

33 Western Boulevard • 2092 City West Johannesburg • South Africa

Phone +27 (0) 11 630 3000 • Fax +27 (0) 11 630 3106

Federal Mogul Powertrain Otomotiv A.S. (Aftermarket Division)

Meclis-i Mebusan Cad. No: 53 Dereli İş Merkezi 34427 • Fındıklı / İstanbul • Türkiye

Phone +90 212 292 6313 • Fax +90 212 292 6260

Federal-Mogul VCS 000

Smolnaya street 24D, 13th floor • 125445 Moscow • Russia

Phone +7 495 221 50 60 • Fax +7 495 221 50 64

Federal-Mogul Aftermarket Egypt Ltd.

3 El Yemen St., Giza • 12311 Egypt • P.O. Box: 391 Dokki • Egypt

Phone +202 333 85 725 • Fax +202 374 84 147

Federal-Mogul Motorparts Sharjah*

Sharjah Airport International Free Zone (Saif-Zone)

Building X3 • Phone 20, 21, 22 • P.O.Box. 120548 • Sharjah • UAE

Phone +971 6 557 8870 • Fax +971 6 557 8941

* Branch office of Federal-Mogul Global Aftermarket EMEA, bvba



BERU® is a Registered Trademark of Borg Warner

Short code → Tech code

| Short Code | Technical Code |
|------------|----------------|
| CCH306C | L86C |
| CCH425 | X |
| CJ6 | CJ6 |
| CJ7Y | CJ7Y |
| CJ8 | CJ8 |
| D16 | D16 |
| DJ8J | DJ8J |
| J17LM | J17LM |
| J19LM | J19LM |
| J8C | J8C |
| L77JC4 | L77JC4 |
| L78C | L78C |
| L82C | L82C |
| OE001 | N9YC |
| OE002 | RC9YCC |
| OE003 | C9YC |
| OE004 | RN9YCC |
| OE005 | RC9YC |
| OE006 | RN9YC |
| OE007 | L87YC |
| OE008 | RN7YCC |
| OE009 | S9YC |
| OE010 | N7YC |
| OE011 | RS9YC |
| OE012 | N7BYC |
| OE013 | RC12YC |
| OE014 | RC7YCC |
| OE015 | N12YC |
| OE016 | RC10YCC |
| OE018 | RN7YC |
| OE019 | RC10DMC |
| OE025 | RN8VTYC4 |
| OE026 | RC8DMC |
| OE027 | RN10VTYC4 |
| OE029 | RES9PYP4 |
| OE030 | RC8BYC |
| OE031 | RES9YCC4 |
| OE032 | RC8VTYC4 |
| OE033 | RC87YCL |
| OE034 | RC8YCL |
| OE035 | REC9YCL |
| OE037 | L86C |
| OE038 | L82YC |
| OE039 | RC9YC4 |
| OE041 | RC12LYC |
| OE042 | RN12YC |
| OE044 | N9BYC |
| OE048 | RN9YC4 |
| OE049 | RN11YC4 |
| OE051 | RN11YC |
| OE052 | RA4HCX |
| OE054 | RF7YC |
| OE057 | C11YCC |
| OE059 | L92YC |
| OE063 | RC10YC4 |
| OE064 | RL82YC |
| OE065 | N11YC |
| OE068 | N3C |
| OE073 | RA4HC |
| OE074 | N5C |
| OE077 | RC7BYC4 |
| OE078 | N3G |
| OE079 | N4C |
| OE083 | RA6HC |
| OE086 | RL82C |

| Short Code | Technical Code |
|------------|----------------|
| OE087 | N6YC |
| OE089 | RC9MCC4 |
| OE091 | RN2C |
| OE093 | RC89YCC |
| OE094 | RC6YCC |
| OE098 | RN4C |
| OE099 | S12YC |
| OE105 | RN14PMP5 |
| OE108 | RN3C |
| OE112 | A6GC |
| OE114 | RC11LCC4 |
| OE120 | RC89TMC |
| OE122 | RG4PHP |
| OE123 | RC8TYC |
| OE128 | RC12LC4 |
| OE130 | REA8MX |
| OE131 | RS9PYP4 |
| OE136 | RC8PYP |
| OE138 | RC11PYPB4 |
| OE145 | RC89PYC |
| OE146 | RC8PYPB4 |
| OE148 | REC10YC4 |
| OE154 | RC12MCC4 |
| OE175 | REC10PYC4 |
| OE176 | KC8ZPYPB4 |
| OE177 | KC8ZMCC |
| OE178 | REC9MCLX |
| OE179 | RC8WYPB4 |
| OE180 | RC10WYPB4 |
| OE181 | KC8WYPB4 |
| OE182 | RC89WYPB4 |
| OE183 | RS8WYPB5 |
| OE184 | RC10WMPB2 |
| OE186 | RA8YCX4 |
| OE187 | RA7WHPB |
| OE188 | RC8WMPB4 |
| OE189 | RES9WYPB5 |
| OE190 | REC10WYPB4 |
| OE191 | KC10PYPB4 |
| OE192 | RN10PYP4 |
| OE193 | RC12WYPB4 |
| OE194 | RC12WMPB4 |
| OE195 | RN8WYPB |
| OE196 | RA8MCX4 |
| OE197 | RER8YC |
| OE198 | RC10MCC |
| OE199 | RA7YC |
| OE201 | RER8MC |
| OE203 | RERX8PMPB4 |
| OE204 | RERX6PMC4 |
| OE205 | RERX4PMPB |
| OE206 | REC8PYB |
| OE207 | REA8PMPB5 |
| OE208 | RA2PYPB |
| OE209 | KC7PYPB4 |
| OE210 | KEC4PYPB |
| OE211 | RER6DMC |
| OE212 | RER6YC |
| OE213 | KC7ZPYPB4 |
| OE214 | KC6PYPB |
| OE215 | KA4ZPYPB4 |
| OE216 | RC7BMC |
| OE217 | RC7DYC |
| OE218 | RC8QMC |
| OE219 | KEC4PYPBF |

| Short Code | Technical Code |
|------------|----------------|
| OE220 | KEC4PYPBF-1 |
| OE222 | KC6PYPB4 |
| OE223 | RC9QMP |
| OE224 | REC8PYPB |
| OE225 | REA6PYPB |
| OE226 | RA7PYPB4 |
| OE227 | RC8PMPB |
| OE228 | KC8PYP4 |
| OE229 | KER4PYPB |
| OE230 | RA4YC |
| OE231 | REA6YC |
| OE232 | RER2PYPB |
| OE233 | REA4PMPB4 |
| OE234 | KC7ZPMPB4 |
| OE235 | KC7ZTMC4 |
| OE236 | REC6TMC |
| OE237 | RC7BYC |
| OE238 | REC7PMPB4 |
| OE239 | RC8ZPYPB4 |
| OE240 | REA12WMB4 |
| OE241 | RG4HCX |
| OE242 | RERX5PMPB |
| OE243 | RERX5ZPYPB |
| OE244 | KA6ZPHPB-1 |
| OE245 | RERX4ZWYPB |
| OE246 | KEC6WYPB-1 |
| OE247 | KA8ZYCC-1 |
| OE248 | RER3WYPB |
| OE249 | RER8WMPB |
| OE250 | RER8WYPB |
| OE253 | REA8WYPB4 |
| OE254 | RC7BYC |
| OE255 | RES10TMC4 |
| OE256 | REA8WYPB |
| OE257 | RC7QMC |
| OE258 | RET4WYPB4 |
| OE260 | KC6ZWYPB |
| OE261 | REA10WYPB |
| OE262 | REC7QMC |
| OE263 | RER12WMPB |
| OE264 | RC6WYPB4 |
| P-RA7HC | P-RA7HC |
| P-RG4HCC | P-RG4HCC |
| P-RG6HCC | P-RG6HCC |
| P-RG7C | P-RG7C |
| P-RZ7HC | P-RZ7HC |
| P-RZ9HC | P-RZ9HC |
| QCJ6Y | QCJ6Y |
| QCJ8Y | QCJ8Y |
| QL77JC4 | QL77JC4 |
| RCJ8 | RCJ8 |
| RG6YC | RG6YC |
| RG6YCA | RG6YCA |
| RJ17LM | RJ17LM |
| RJ19LM | RJ19LM |
| RJ19LMC | RJ19LMC |
| RL78C | RL78C |
| RN1C | RN1C |
| RV15YC4 | RV15YC4 |
| RV8C | RV8C |
| RX12ZYC | RX12ZYC |
| RY4C | RY4C |
| RZ7C | RZ7C |
| Z9Y | Z9Y |

INTRODUCING AN EXTENDED RANGE OF

PARTS FOR PASSIONATE PEOPLE



What could Champion® car parts offer you?

Champion delivers the dependable and performant quality automotive parts you crave. Our range of ignition, braking, filters, wipers and lighting are all under starter's orders for you.

You want parts that give you a quick start, a safe stop and clean air when driving? And the finest visibility no matter whether it's pouring with rain or the middle of the night? Choose Champion and drive with pleasure and passion.

Ask for Champion parts at your professional workshop



PARTS FOR PASSIONATE PEOPLE

IGNITION

- Spark Plugs
- Ignition Coils
- Wire Sets
- Glow Plugs
- Glow Control Units

FILTERS

- Diesel Filters
- Petrol Filters
- Oil Filters
- Cabin Filters
- Air Filters

BRAKES

- Brake Pads
- Brake Discs
- Brake Shoe Kits
- Wear Indicators

WIPERS

- Aerovantage
- Easyvision
- Rainy Day

LIGHTING

- Xenon
- Halogen
- Miniature

BATTERIES

- AGM batteries
- EFB batteries
- SLI batteries

Your Champion specialist

Learn more about quality products and latest technologies on www.championautoparts.eu



Federal Mogul Global Aftermarket EMEA bvba
Prins Boudewijnlaan 5
2550 Kontich - Belgium
info@fmmotorparts.eu

