

HemoSphere
Advanced Monitor

Operator's manual



Edwards

Edwards HemoSphere Advanced Monitor Operator's Manual

Because of continuing product improvement, prices and specifications are subject to change without notice. Changes to this manual, either in response to user input or to continuing product improvements, are accomplished through reissue. If, in the normal use of this manual, errors, omissions, or incorrect data are noted, please contact Edwards Technical Support or your local Edwards representative.

Edwards Technical Support

United States and Canada (24 hours) 800.822.9837 or tech_support@edwards.com
Outside the U.S. and Canada (24 hours) 949.250.2222
Europe +8001.8001.801 or techserv_europe@edwards.com
In the UK 0870 606 2040 - Option 4
In Ireland 01 8211012 Option 4

CAUTION Federal (USA) law restricts this device to sale by or on the order of a physician.

Manufactured by Edwards Lifesciences LLC
One Edwards Way
Irvine, CA 92614
Made in USA

Trademarks Edwards, Edwards Lifesciences, the stylized E logo, Acumen, Acumen HPI, Acumen IQ, CCombo, CCombo V, ClearSight, CO-Set, CO-Set+, FloTrac, ForeSight, FORE-SIGHT, ForeSight Elite, FORE-SIGHT ELITE, HemoSphere, HemoSphere ClearSight, HemoSphere Swan-Ganz, Hypotension Prediction Index, HPI, PediaSat, Physiocal, Swan, Swan-Ganz, Time-In-Target, and TruWave are trademarks of Edwards Lifesciences Corporation or its affiliates. All other trademarks are the property of their respective owners.

This product is manufactured and distributed under one or more of the following U.S. Patents: 7,220,230; 7,422,562; 7,452,333; 7,785,263; and 7,967,757 and corresponding foreign patents.

© 2020 Edwards Lifesciences Corporation. All rights reserved.

Version 4.1 Manual Release Date: SEPTEMBER 2020; Software Version: 2.1

Original Release Date: 9/30/2016



Intertek



Edwards Lifesciences Services GmbH

Edisonstrasse 6
85716 Unterschleissheim, Germany

Users and/or patients should report any serious incidents to the manufacturer and the Competent Authority of the Member State in which the user and/or patient is established.

Using This Manual

The Edwards HemoSphere advanced monitor operator’s manual is comprised of fifteen chapters, eight appendices, and an index. Figures in this manual are intended for reference only and may not be an exact replication of the screens as a result of continuous software improvements.

Carefully read these instructions for use, which address the warnings, precautions, and residual risks for this medical device.

WARNING Read this operator’s manual carefully before attempting to use the Edwards HemoSphere advanced monitor.

Refer to the instructions for use provided with each compatible accessory before using it with the HemoSphere advanced monitor.

CAUTION Inspect the HemoSphere advanced monitor and all accessories and equipment used with the monitor for damage prior to use. Damage may include cracks, scratches, dents, exposed electrical contacts, or any signs that the housing may be compromised.

WARNING To prevent injury to patient or user, damage to platform, or inaccurate measurements, do not use any damaged or non-compatible platform accessories, components or cables.

Chapter	Description
1	Introduction: Provides an overview of the HemoSphere advanced monitor
2	Safety and Symbols: Includes WARNINGS, CAUTIONS, and NOTES that are found in the manual, as well as illustrations of labels found on the HemoSphere advanced monitor and accessories
3	Installation and Setup: Provides information about setting up the HemoSphere advanced monitor and connections for the first time
4	HemoSphere Advanced Monitor Quick Start: Provides experienced clinicians and users of bedside monitors instructions for immediate monitor use
5	Navigating the HemoSphere Advanced Monitor: Provides information on monitoring screen views
6	User Interface Settings: Provides information about the various display settings including patient information, language and international units, alarm volume, system time, and system date. It also provides instructions for selecting the screen appearance
7	Advanced Settings: Provides information on advanced settings including alarm targets, graphical scales, serial port setup, and Demo Mode
8	Data Export and Connectivity: Provides information on monitor connectivity for transferring patient and clinical data
9	HemoSphere Invasive Swan-Ganz Module Monitoring: Describes procedures for setup and operation of continuous cardiac output, intermittent cardiac output, and right ventricular end diastolic volume monitoring using the Swan-Ganz module

Chapter	Description
10	HemoSphere Minimally-Invasive Pressure Cable Monitoring: Describes procedures for setup and operation of vascular pressure monitoring
11	HemoSphere Noninvasive ClearSight Module Monitoring: Describes the methodology behind ClearSight technology and gives instructions for setup and application of patient monitoring equipment as well as how to measure noninvasive blood pressure, cardiac output, stroke volume, stroke volume variation, and systemic vascular resistance
12	Venous Oximetry Monitoring: Describes procedures for calibration and operation of oximetry (oxygen saturation) measurement
13	Tissue Oximetry Monitoring: Describes procedures for setup and operation of ForeSight Elite tissue oximetry monitoring
14	Advanced Features: Describes the advanced monitoring features that are currently available for upgrade with the HemoSphere advanced monitoring platform
15	Help and Troubleshooting: Describes the Help menu and provides a list of faults, alerts, and messages, with causes and suggested actions

Appendix	Description
A	Specifications
B	Accessories
C	Equations for Calculated Patient Parameters
D	Monitor Settings and Defaults
E	Thermodilution Computation Constants
F	Monitor Care, Service and Support
G	Guidance and Manufacturer's Declaration
H	Glossary
Index	

Contents

1 Introduction

- 1.1 Intended Purpose of this Manual 21
- 1.2 Indications For Use 21
 - 1.2.1 HemoSphere Advanced Monitor with HemoSphere Swan-Ganz Module 21
 - 1.2.2 HemoSphere Advanced Monitor with HemoSphere Oximetry Cable . . . 22
 - 1.2.3 HemoSphere Advanced Monitor with HemoSphere Pressure Cable . . . 22
 - 1.2.4 HemoSphere Advanced Monitor with HemoSphere Tissue Oximetry Module and ForeSight Elite Tissue Oximeter Module 22
 - 1.2.5 HemoSphere Advanced Monitor with HemoSphere ClearSight Module . 22
- 1.3 Contraindications For Use 23
 - 1.3.1 HemoSphere Advanced Monitor with HemoSphere Tissue Oximetry Module 23
 - 1.3.2 HemoSphere Advanced Monitor with HemoSphere ClearSight Module . 23
- 1.4 Intended Use Statement 23
- 1.5 Expected Clinical Benefit 29
- 1.6 HemoSphere Advanced Monitor Hemodynamic Technology Connections . . 29
 - 1.6.1 HemoSphere Swan-Ganz Module 30
 - 1.6.2 HemoSphere Pressure Cable 31
 - 1.6.3 HemoSphere Oximetry Cable 32
 - 1.6.4 HemoSphere Tissue Oximetry Module 33
 - 1.6.5 HemoSphere ClearSight Module 33
 - 1.6.6 Documentation and Training 35
- 1.7 Manual style conventions 35
- 1.8 Abbreviations Found in This Manual 36

2 Safety and Symbols

- 2.1 Safety Signal Words Definitions 38
 - 2.1.1 Warning 38
 - 2.1.2 Caution 38
 - 2.1.3 Note 38
- 2.2 Warnings 39
- 2.3 Cautions 46
- 2.4 User Interface Symbols 52
- 2.5 Symbols on Product Labels 54
- 2.6 Applicable Standards 56
- 2.7 HemoSphere Advanced Monitor Essential Performance 56

3 Installation and Setup

- 3.1 Unpacking 57
 - 3.1.1 Packaging Contents 57
 - 3.1.2 Required Accessories for Platform Modules and Cables 58



3.2 HemoSphere Advanced Monitor Connection Ports	60
3.2.1 Monitor Front	60
3.2.2 Monitor Rear	61
3.2.3 Monitor Right Panel	62
3.2.4 Monitor Left Panel	62
3.3 HemoSphere Advanced Monitor Installation	63
3.3.1 Mounting Options and Recommendations	63
3.3.2 Battery Installation	64
3.3.3 Connecting Power Cord	64
3.3.3.1 Equipotential Connection	65
3.3.4 Connecting and Disconnecting a Hemodynamic Monitoring Module	65
3.3.5 Connecting and Disconnecting a Hemodynamic Monitoring Cable	66
3.3.6 Connecting Cables from External Devices	66
3.4 Initial Start Up	67
3.4.1 Start Up Procedure	67
3.4.2 Select Language	67
4 HemoSphere Advanced Monitor Quick Start	
4.1 HemoSphere Swan-Ganz Module Cardiac Output Monitoring	70
4.1.1 Continuous Cardiac Output Monitoring	71
4.1.2 Intermittent Cardiac Output Monitoring	71
4.1.3 Continuous End Diastolic Volume Monitoring	72
4.2 Monitoring with the HemoSphere Pressure Cable	73
4.2.1 Pressure Cable Setup	73
4.2.2 Zero Pressure Cable	73
4.3 HemoSphere Oximetry Cable Monitoring	75
4.3.1 In Vitro Calibration	75
4.3.2 In vivo Calibration	76
4.4 HemoSphere Tissue Oximetry Module Monitoring	78
4.4.1 Connecting the HemoSphere Tissue Oximetry Module	78
4.5 HemoSphere ClearSight Module Monitoring	80
4.5.1 Connecting the HemoSphere Noninvasive System	80
5 Navigating the HemoSphere Advanced Monitor	
5.1 HemoSphere Advanced Monitor Screen Appearance	82
5.2 Navigation Bar	84
5.3 Monitor Views	87
5.3.1 Parameter Tiles	88
5.3.1.1 Change Parameters	88
5.3.1.2 Change Alarm/Target	89
5.3.1.3 Status Indicators	90
5.3.2 Main Monitoring View	91
5.3.3 Graphical Trend Monitoring View	91
5.3.3.1 Graphical Trend Scroll Mode	92
5.3.3.2 Intervention Events	93
5.3.3.3 Live Blood Pressure Waveform Display	95

5.3.4	Tabular Trends	96
5.3.4.1	Tabular Trend Scroll Mode	96
5.3.5	Graphical/Tabular Trends Split	97
5.3.6	Physiology Screen	98
5.3.6.1	SVV Slope Indicator	99
5.3.7	Cockpit Screen	99
5.3.8	Physio Relationship	100
5.3.8.1	Continuous and Historical Modes	100
5.3.8.2	Parameter Boxes	102
5.3.8.3	Setting Targets and Entering Parameter Values	102
5.3.9	Goal Positioning Screen	103
5.4	Focused Monitoring Format	103
5.4.1	Select Monitoring View	103
5.4.2	Blood Pressure Waveform Tile	104
5.4.3	Focused Parameter Tile	104
5.4.4	Change Parameters	105
5.4.5	Change Alarms /Targets	105
5.4.6	Focused Main Screen	105
5.4.7	Focused Graphical Trend Screen	106
5.4.8	Focused Charting Screen	106
5.5	Clinical Tools	107
5.5.1	Select Monitoring Mode	107
5.5.2	CVP Entry	108
5.5.3	Derived Value Calculator	108
5.5.4	Event Review	109
5.6	Information Bar	112
5.6.1	Battery	113
5.6.2	Screen Brightness	114
5.6.3	Alarm Volume	114
5.6.4	Screen Capture	114
5.6.5	Lock Screen	114
5.7	Status Bar	115
5.8	Monitor Screen Navigation	115
5.8.1	Vertical Scrolling	115
5.8.2	Navigation Icons	116
6 User Interface Settings		
6.1	Password Protection	118
6.1.1	Changing passwords	119
6.2	Patient Data	120
6.2.1	New Patient	120
6.2.2	Continue Monitoring Patient	121
6.2.3	View Patient Data	122
6.3	General Monitor Settings	122
6.3.1	Change Language	122
6.3.2	Change Date and Time Display	123

6.3.2.1	Adjust Date or Time	123
6.3.3	Monitoring Screens Settings	124
6.3.4	Time Intervals / Averaging	124
6.3.4.1	Display Parameter Value Change	124
6.3.4.2	CO/Pressure Averaging Time	125
6.3.5	Analog Pressure Signal Input	126
6.3.5.1	Calibration	128
7	Advanced Settings	
7.1	Alarms/Targets	130
7.1.1	Silence Alarms	131
7.1.1.1	Physiological Alarms	131
7.1.1.2	Technical Alarms	132
7.1.2	Set Alarm Volume	132
7.1.3	Set Targets	132
7.1.4	Alarms/Targets Setup Screen	133
7.1.5	Configure All Targets	134
7.1.6	Configure Targets and Alarms for One Parameter	135
7.2	Adjust Scales	136
7.3	Physiology and Physio Relationship Screen SVV/PPV Parameter Settings	138
7.4	20-Second Flow Parameter Settings	138
7.5	Demo Mode	139
8	Data Export and Connectivity Settings	
8.1	Export Data	140
8.1.1	Data Download	140
8.1.2	Diagnostic Export	142
8.2	Wireless Settings	142
8.3	HIS Connectivity	143
8.3.1	Patient Demographic Data	144
8.3.2	Patient Physiological Data	145
8.3.3	Physiological Alarms and Device Faults	145
8.4	Cyber Security	145
8.4.1	HIPAA	145
9	HemoSphere Swan-Ganz Module Monitoring	
9.1	Connecting the HemoSphere Swan-Ganz Module	146
9.1.1	Patient CCO Cable Test	148
9.1.2	Parameter Selection Menu	149
9.2	Continuous Cardiac Output	150
9.2.1	Connecting the Patient Cables	150
9.2.2	Initiating Monitoring	151
9.2.3	Thermal Signal Conditions	152
9.2.4	CO Countdown Timer	152
9.2.5	STAT CO	153
9.2.6	20-Second Flow Parameters	153
9.2.6.1	PAP Waveform Troubleshooting	153

9.3 Intermittent Cardiac Output	153
9.3.1 Connecting Patient Cables	154
9.3.1.1 Probe Selection	154
9.3.2 Configuration Settings	155
9.3.2.1 Select Injectate Volume	155
9.3.2.2 Select Catheter Size	156
9.3.2.3 Select Computation Constant	156
9.3.2.4 Select Mode	156
9.3.3 Instructions for Bolus Measurement Modes	156
9.3.4 Thermodilution Summary Screen	158
9.4 EDV/RVEF Monitoring	159
9.4.1 Connecting Patient Cables	159
9.4.2 Connecting the ECG Interface Cable	160
9.4.3 Initiating Measurement	161
9.4.4 Active EDV Monitoring	162
9.4.5 STAT EDV and RVEF	163
9.5 SVR	163
10 Monitoring with the HemoSphere Pressure Cable	
10.1 Pressure Cable Overview	164
10.2 Monitoring Mode Selection	166
10.3 FloTrac Sensor Monitoring	166
10.3.1 Connect FloTrac or Acumen IQ Sensor	168
10.3.2 Set Averaging Time	168
10.3.3 Zero Arterial Pressure	169
10.3.4 SVR monitoring	170
10.4 Pressure Cable Monitoring with a TruWave DPT	170
10.4.1 Connect TruWave DPT	170
10.4.2 Zero Intravascular Pressure	171
10.5 Pressure Cable Monitoring in Swan-Ganz Module Monitoring Mode	172
10.6 Zero & Waveform Screen	173
10.6.1 Select Pressure and Zero Sensor	173
10.6.2 Pressure-Out	173
10.6.3 Waveform Confirmation	174
11 HemoSphere ClearSight Module Noninvasive Monitoring	
11.1 HemoSphere Noninvasive System Methodology	175
11.1.1 Volume Clamp Method	175
11.1.2 Physiological Method	176
11.1.3 Waveform Reconstruction and Hemodynamic Analysis (ClearSight Algorithm)	176
11.1.4 Heart Reference Sensor	176
11.1.5 Discoloration, Numbness, or Tingling of the Fingertip	176
11.1.6 Single Cuff Monitoring	176
11.1.7 Double Cuff Monitoring	177
11.1.8 Methodology References	177

11.2	Connecting the HemoSphere Noninvasive System	177
11.2.1	Apply the Pressure Controller	180
11.2.2	Select Finger Cuff Size	181
11.2.3	Apply Finger Cuff(s)	181
11.2.4	Zero and Apply the Heart Reference Sensor	182
11.2.5	General Troubleshooting of HemoSphere Noninvasive System Monitoring	182
11.3	Optional HRS	184
11.3.1	Patient Sedated and Stationary	184
11.3.2	Update Offset Value During Monitoring	186
11.3.3	Change Patient Positioning Mode	186
11.4	SQI	187
11.5	Physiocal Display	187
11.6	ClearSight Settings and Cuff Options	187
11.6.1	Cuff Pressure Release Mode	188
11.7	Blood Pressure Calibration	189
11.8	Output Signal to Patient Monitor	190
12	Venous Oximetry Monitoring	
12.1	Oximetry Cable Overview	191
12.2	Venous Oximetry Setup	191
12.3	In Vitro Calibration	193
12.3.1	In Vitro Calibration Error	194
12.4	In Vivo Calibration	194
12.5	Signal Quality Indicator	195
12.6	Recall Venous Oximetry Data	196
12.7	HGB Update	197
12.8	HemoSphere Oximetry Cable Reset	198
12.9	New Catheter	198
13	HemoSphere Tissue Oximetry Module Monitoring	
13.1	HemoSphere Tissue Oximetry Module Monitoring	199
13.2	ForeSight Elite Tissue Oximeter Overview	200
13.2.1	ForeSight Elite Module Mounting Solutions	200
13.2.2	Installing the Mounting Clip	201
13.2.3	Removing the Mounting Clip	203
13.3	Connecting the HemoSphere Tissue Oximetry Module and ForeSight Elite Module	205
13.3.1	Attaching Sensors to the Patient	209
13.3.1.1	Selecting a Sensor Site	209
13.3.1.2	Preparing the Sensor Site	210
13.3.1.3	Applying Sensors	211
13.3.1.4	Connecting Sensors to Cables	213
13.3.2	Disconnecting Sensors After Monitoring	214
13.3.3	Monitoring Considerations	214

13.3.3.1	Module Use During Defibrillation	214
13.3.3.2	Interference	215
13.3.3.3	Interpreting StO2 Values	215
13.3.4	Skin Check Timer	216
13.3.5	Set Averaging Time	217
13.3.6	Signal Quality Indicator	217
13.3.7	Tissue Oximetry Physiology Screen	217
14	Advanced Features	
14.1	Acumen™ Hypotension Prediction Index (HPI) Software Feature	218
14.1.1	Acumen Hypotension Prediction Index (HPI)	220
14.1.2	HPI as a Key Parameter	221
14.1.3	HPI Alarm	223
14.1.4	HPI on Information Bar	224
14.1.5	Disable HPI Information Bar Indicator	224
14.1.6	HPI High Alert Popup	225
14.1.7	HPI Secondary Screen	225
14.1.8	Clinical Application	227
14.1.9	Additional Parameters	228
14.1.10	Clinical Validation	230
14.1.10.1	Surgical Patients	230
14.1.10.2	Non-Surgical Patients	231
14.1.11	References	237
14.2	Enhanced Parameter Tracking	239
14.2.1	GDT Tracking	239
14.2.1.1	Key Parameter and Target Selection	239
14.2.1.2	Active GDT Tracking	240
14.2.1.3	Historical GDT	241
14.2.2	SV Optimization	241
14.2.3	GDT Report Download	241
14.3	Fluid Responsiveness Test	242
14.3.1	Passive Leg Raise Test	242
14.3.2	Fluid Bolus Test	244
14.3.3	Historical Test Results	245
15	Troubleshooting	
15.1	On Screen Help	246
15.2	Monitor Status Lights	247
15.3	Pressure Cable Communication	248
15.4	ForeSight Elite Module Sensor Communication	249
15.5	Pressure Controller Communication	250
15.6	HemoSphere Advanced Monitor Error Messages	251
15.6.1	System/Monitoring Faults/Alerts	251
15.6.2	System/Monitoring Warnings	254
15.6.3	Numeric Keypad Errors	254
15.7	HemoSphere Swan-Ganz Module Error Messages	255

15.7.1 CO Faults/Alerts	255
15.7.2 EDV and SV Faults/Alerts	256
15.7.3 iCO Faults/Alerts	257
15.7.4 SVR Faults/Alerts	258
15.7.5 20-Second Parameters Faults/Alerts	259
15.7.6 General Troubleshooting	259
15.8 Pressure Cable Error Messages	261
15.8.1 General Pressure Cable Faults/Alerts	261
15.8.2 CO Faults/Alerts	262
15.8.3 SVR Faults/Alert	264
15.8.4 MAP Faults/Alert	264
15.8.5 General Troubleshooting	265
15.9 HemoSphere ClearSight Module Error Messages	266
15.9.1 Faults/Alerts	266
15.10 Venous Oximetry Error Messages	272
15.10.1 Venous Oximetry Faults/Alerts	272
15.10.2 Venous Oximetry Warnings	273
15.10.3 Venous Oximetry General Troubleshooting	274
15.11 Tissue Oximetry Error Messages	275
15.11.1 Tissue Oximetry Faults/Alerts	275
15.11.2 Tissue Oximetry General Troubleshooting	277
Appendix A: Specifications	
A.1 Essential Performance Characteristics	278
A.2 HemoSphere Advanced Monitor Specifications	281
A.3 HemoSphere Battery Pack Specifications	283
A.4 HemoSphere Swan-Ganz Module Specifications	284
A.5 HemoSphere Pressure Cable Specifications	286
A.6 HemoSphere Oximetry Cable Specifications	287
A.7 HemoSphere Tissue Oximetry Specifications	287
A.8 HemoSphere ClearSight Module Specifications	289
Appendix B: Accessories	
B.1 Accessories List	291
B.2 Additional Accessories Description	292
B.2.1 Roll Stand	292
B.2.2 Oximetry Cradle	292
Appendix C: Equations for Calculated Patient Parameters	
Appendix D: Monitor Settings and Defaults	
D.1 Patient Data Input Range	299
D.2 Trend Scale Default Limits	299
D.3 Parameter Display and Configurable Alarm/Target Ranges	300
D.4 Alarm and Target Defaults	302
D.5 Alarm Priorities	303
D.6 Language Default Settings	304

Appendix E: Computation Constants	
E.1 Computation Constant Values	305
Appendix F: System Care, Service and Support	
F.1 General Maintenance	307
F.2 Cleaning the Monitor and Modules	308
F.3 Cleaning the Platform Cables	308
F.3.1 Cleaning the HemoSphere Oximetry Cable	309
F.3.2 Cleaning the Patient CCO Cable and Connector	309
F.3.3 Cleaning the HemoSphere Pressure Cable	310
F.3.4 Cleaning the ForeSight Elite Tissue Oximeter Module	310
F.3.5 Cleaning the Heart Reference Sensor and Pressure Controller	311
F.4 Service and Support	311
F.5 Edwards Lifesciences Regional Headquarters	312
F.6 Monitor Disposal	313
F.6.1 Battery Recycling	313
F.7 Preventive Maintenance	313
F.7.1 Battery Maintenance	313
F.7.1.1 Battery Conditioning	313
F.7.1.2 Battery Storage	313
F.7.2 HemoSphere ClearSight Module Maintenance	314
F.8 Testing of Alarm Signals	314
F.9 Warranty	314
Appendix G: Guidance and Manufacturer’s Declaration	
G.1 Electromagnetic Compatibility	315
G.2 Instructions for Use	315
G.3 Wireless Technology Information	322
G.3.1 Quality of Service for Wireless Technology	324
G.3.2 Wireless Security Measures	325
G.3.3 Troubleshooting Wireless Coexistence Issues	325
G.3.4 Federal Communication Commission (FCC) Interference Statements	325
G.3.5 Industry Canada Statements	326
G.3.6 European Union R&TTE Statements	326
Appendix H: Glossary	

List of Figures

- Figure 1-1 HemoSphere advanced monitor hemodynamic technology connections 29
- Figure 3-1 HemoSphere advanced monitor front view 60
- Figure 3-2 HemoSphere advanced monitor rear view (shown with HemoSphere Swan-Ganz module) 61
- Figure 3-3 HemoSphere advanced monitor right panel 62
- Figure 3-4 HemoSphere advanced monitor left panel (shown with no modules) 62
- Figure 3-5 HemoSphere advanced monitor power entry cover - screw locations 65
- Figure 3-6 Startup screen 67
- Figure 3-7 Language selection screen 68
- Figure 4-1 HemoSphere Swan-Ganz module monitoring connection overview 70
- Figure 4-2 Pressure cable connection overview 73
- Figure 4-3 Oximetry connection overview 75
- Figure 4-4 HemoSphere tissue oximetry module connection overview 78
- Figure 4-5 HemoSphere noninvasive system connection overview 80
- Figure 5-1 HemoSphere advanced monitor screen features 83
- Figure 5-2 Navigation bar and icons
¹invasive monitoring, ²minimally-invasive monitoring, ³noninvasive monitoring, ⁴graphical trend screens 84
- Figure 5-3 Example of monitoring screen selection window 87
- Figure 5-4 Example of key parameter selection tile configuration menu 89
- Figure 5-5 Parameter tile 90
- Figure 5-6 Main monitoring view 91
- Figure 5-7 Graphical trend screen 92
- Figure 5-8 Graphical trend- intervention window 93
- Figure 5-9 Graphical trend screen - intervention information balloon 95
- Figure 5-10 Tabular trend screen 96
- Figure 5-11 Tabular increment popup 96
- Figure 5-12 Physiology screen while monitoring with HemoSphere Swan-Ganz module 98
- Figure 5-13 Cockpit monitoring screen 99
- Figure 5-14 Physio relationship screen while monitoring with HemoSphere Swan-Ganz module 100
- Figure 5-15 Historic physio relationship data screen 101
- Figure 5-16 Physio relationship parameter boxes 102
- Figure 5-17 Physio relationship target/enter popup 102
- Figure 5-18 Goal positioning screen 103
- Figure 5-19 Focused parameter tile 104

Figure 5-20 Focused parameter tile – parameter and alarm/target selection	105
Figure 5-21 Focused main screen	105
Figure 5-22 Focused Graphical Trend Screen	106
Figure 5-23 Focused Charting Screen	107
Figure 5-24 Focused Charting View – Configure Columns	107
Figure 5-25 Information bar	113
Figure 5-26 Lock screen popup	115
Figure 5-27 Status bar	115
Figure 6-1 New or continuing patient screen	120
Figure 6-2 New Patient Data screen	121
Figure 6-3 General Monitor Settings	123
Figure 7-1 Alarms/Targets configuration	134
Figure 7-2 Set individual parameter alarms and targets	135
Figure 7-3 Graphical trend screen	136
Figure 7-4 Adjust scales	137
Figure 7-5 Tabular increment popup	138
Figure 8-1 HIS- Patient query screen	143
Figure 8-2 HIS- New patient data screen	144
Figure 9-1 HemoSphere Swan-Ganz module connection overview	147
Figure 9-2 Patient CCO cable test connections	149
Figure 9-3 HemoSphere Swan-Ganz module key parameter selection window	150
Figure 9-4 CO connection overview	151
Figure 9-5 iCO connection overview	154
Figure 9-6 iCO new set configuration screen	155
Figure 9-7 Thermodilution summary screen	158
Figure 9-8 EDV/RVEF connection overview	160
Figure 10-1 HemoSphere pressure cable	165
Figure 10-2 Zero & Waveform screens – Zero sensor and Pressure-Out	173
Figure 11-1 HemoSphere noninvasive system connection overview	178
Figure 11-2 Pressure controller application	180
Figure 11-3 Cuff size selection	181
Figure 11-4 Heart reference sensor application	182
Figure 11-5 Patient Positioning Mode Selection – Optional HRS	184
Figure 11-6 Zero & Waveform screen – Vertical Offset Entry	185
Figure 11-7 BP Calibration Screen	189
Figure 11-8 Transmit arterial pressure waveform to patient monitor	190
Figure 12-1 Venous oximetry connection overview	192
Figure 13-1 ForeSight Elite tissue oximeter front view	200
Figure 13-2 ForeSight Elite tissue oximeter rear view	200
Figure 13-3 Mounting clip – module slide attachment points	201

Figure 13-4 Module case – mounting clip attachment points	201
Figure 13-5 Attaching the mounting clip vertically	202
Figure 13-6 Attaching the mounting clip horizontally	203
Figure 13-7 Removing the mounting clip	204
Figure 13-8 HemoSphere tissue oximetry module connection overview	205
Figure 13-9 ForeSight Elite module status LED	207
Figure 13-10 Removing protective liner from sensor	211
Figure 13-11 Sensor placement (cerebral)	211
Figure 13-12 Sensor placement (non-cerebral)	212
Figure 13-13 Connecting a sensor to the sensor cable connector	213
Figure 13-14 Connecting a sensor to the ForeSight module – channel status LED	214
Figure 13-15 Tissue Oximetry Physiology Screens	217
Figure 14-1 HPI key parameter tile	222
Figure 14-2 HPI key parameter on cockpit screen	223
Figure 14-3 Information bar with HPI	224
Figure 14-4 Parameter settings - Hypotension Prediction Index	224
Figure 14-5 HPI high alert popup	225
Figure 14-6 HPI secondary screen	226
Figure 14-7 HPI secondary screen – graphical trend value display	227
Figure 14-8 GDT Menu Screen - Key Parameter Selection	239
Figure 14-9 GDT Menu Screen - Target Selection	239
Figure 14-10 GDT Active Tracking	240
Figure 14-11 Fluid Responsiveness Test – New Test Screen	242
Figure 14-12 Fluid Responsiveness Test – Results Screen	244
Figure 15-1 HemoSphere advanced monitor LED indicators	247
Figure 15-2 Pressure cable LED indicator	248
Figure 15-3 ForeSight Elite tissue oximeter module LED indicators	249
Figure 15-4 Pressure Controller LED Indicators	250
Figure A-1 Spectral Irradiance and location of light emission aperture	290

List of Tables

Table 1-1 HemoSphere Swan-Ganz module available parameters list	24
Table 1-2 HemoSphere oximetry cable available parameters list	24
Table 1-3 HemoSphere Swan-Ganz module with oximetry cable available parameters list	25
Table 1-4 HemoSphere Swan-Ganz module with pressure cable available parameters list*	25
Table 1-5 HemoSphere pressure cable available parameters list	26
Table 1-6 HemoSphere pressure cable with oximetry cable available parameters list	27
Table 1-7 HemoSphere tissue oximetry module with ForeSight Elite tissue oximeter module available parameters list	27
Table 1-8 HemoSphere ClearSight module available parameters list	28
Table 1-9 HemoSphere ClearSight module with oximetry cable available parameters list	28
Table 1-10 HemoSphere Swan-Ganz module parameters description	30
Table 1-11 HemoSphere pressure cable key parameters description	31
Table 1-12 HemoSphere oximetry cable parameters description	32
Table 1-13 HemoSphere tissue oximetry module with ForeSight Elite tissue oximeter module parameters description	33
Table 1-14 HemoSphere ClearSight module key parameters description	34
Table 1-15 Operator’s manual style conventions	35
Table 1-16 Acronyms, Abbreviations	36
Table 2-1 Monitor display symbols	52
Table 2-2 Symbols on product labels	54
Table 2-3 Applicable standards	56
Table 3-1 HemoSphere advanced monitoring components	57
Table 3-2 Cables and catheters required for monitoring parameters with HemoSphere Swan-Ganz module	58
Table 3-3 Sensor options for monitoring parameters with HemoSphere pressure cable	58
Table 3-4 Finger cuff options for monitoring parameters with HemoSphere ClearSight module	59
Table 3-5 Catheters required for monitoring parameters with HemoSphere oximetry cable	59
Table 3-6 Accessories required for monitoring parameters with HemoSphere tissue oximetry module	59
Table 5-1 Graphical trend scroll rates	92
Table 5-2 Intervention events	94
Table 5-3 Tabular trend scroll rates	97
Table 5-4 Reviewed events	109
Table 5-5 Battery status	113
Table 6-1 HemoSphere advanced monitor password levels	118
Table 6-2 Advanced setup menu navigation and password protection	118

Table 6-3 Export data menu navigation and password protection	119
Table 6-4 CO/pressure averaging time and display update rates –minimally-invasive monitoring mode	125
Table 6-5 Analog input parameter ranges	127
Table 7-1 Visual alarm indicator colors	130
Table 7-2 Target status indicator colors	133
Table 7-3 Target defaults	133
Table 8-1 Wi-Fi connection status	142
Table 8-2 HIS connectivity status	143
Table 9-1 Available HemoSphere Swan-Ganz module parameters and required connections	148
Table 9-2 Unstable thermal signal time lapse for CO alert and fault messages	152
Table 10-1 HemoSphere pressure cable configurations and available key parameters	165
Table 11-1 Arterial waveform SQI levels	187
Table 11-2 PhysioCal Interval Status	187
Table 12-1 In vitro calibration options	194
Table 12-2 In vivo calibration options	195
Table 12-3 Signal quality indicator levels	195
Table 13-1 Tissue oximetry sensor locations	208
Table 13-2 Sensor selection matrix	209
Table 13-3 StO ₂ validation methodology	216
Table 14-1 HPI display configurations	220
Table 14-2 HPI value graphical and audible display elements	221
Table 14-3 HPI versus other key parameters: similarities and differences	222
Table 14-4 Parameter status colors for HPI	223
Table 14-5 Patient Demographics (surgical patients)	230
Table 14-6 Surgical Characteristics for NIBP Surgical Patients (N=252)	230
Table 14-7 Patient Demographics (Non-Surgical Patients)	231
Table 14-8 Non-Surgical Patient Characteristics (N=298)	232
Table 14-9 Non-Surgical Patient Characteristics (N=228)	232
Table 14-10 Characteristics for NIBP non-surgical patients (N=175)	232
Table 14-11 Clinical Validation Studies* (surgical patients)	233
Table 14-12 Clinical Validation Studies* (non-surgical patients)	234
Table 14-13 Clinical Validation (surgical patients, minimally-invasive radial arterial line monitoring [N=52])	235
Table 14-14 Clinical Validation (surgical patients, noninvasive monitoring [N=252])	235
Table 14-15 Clinical Validation (non-surgical patients, minimally-invasive radial arterial line monitoring [N=298])	236
Table 14-16 Clinical Validation (non-surgical patients, noninvasive monitoring [N=175]) ...	237
Table 14-17 GDT Target Status Indicator Colors	240
Table 15-1 HemoSphere advanced monitor visual alarm indicator	247

Table 15-2 HemoSphere advanced monitor power light	248
Table 15-3 Pressure cable communication light	248
Table 15-4 ForeSight Elite module LED communication lights	249
Table 15-5 Pressure controller communication lights*	250
Table 15-6 System faults/alerts	251
Table 15-7 HemoSphere advanced monitor warnings	254
Table 15-8 Numeric keypad errors	254
Table 15-9 HemoSphere Swan-Ganz module CO faults/alerts	255
Table 15-10 HemoSphere Swan-Ganz module EDV and SV faults/alerts	256
Table 15-11 HemoSphere Swan-Ganz module iCO faults/alerts	257
Table 15-12 HemoSphere Swan-Ganz module SVR faults/alerts	258
Table 15-13 HemoSphere Swan-Ganz module 20s parameters faults/alerts	259
Table 15-14 HemoSphere Swan-Ganz module general troubleshooting	259
Table 15-15 HemoSphere pressure cable general faults/alerts	261
Table 15-16 HemoSphere pressure cable CO faults/alerts	262
Table 15-17 HemoSphere pressure cable SVR faults/alerts	264
Table 15-18 HemoSphere pressure cable MAP faults/alerts	264
Table 15-19 HemoSphere pressure cable general troubleshooting	265
Table 15-20 HemoSphere ClearSight module faults/alerts	266
Table 15-21 HemoSphere ClearSight warnings	270
Table 15-22 HemoSphere ClearSight general troubleshooting	272
Table 15-23 Venous oximetry faults/alerts	272
Table 15-24 Venous oximetry warnings	273
Table 15-25 Venous oximetry general troubleshooting	274
Table 15-26 Tissue oximetry faults/alerts	275
Table 15-27 Tissue oximetry general troubleshooting	277
Table A-1 HemoSphere advanced monitor essential performance – transient and non-transient electromagnetic phenomena	279
Table A-2 HemoSphere advanced monitor physical and mechanical specifications	281
Table A-3 HemoSphere advanced monitor environmental specifications	281
Table A-4 HemoSphere advanced monitor transportation environmental specifications	282
Table A-5 HemoSphere advanced monitor technical specifications	282
Table A-6 HemoSphere battery pack physical specifications	283
Table A-7 HemoSphere battery pack environmental specifications	283
Table A-8 HemoSphere battery pack technical specifications	283
Table A-9 HemoSphere Swan-Ganz module physical specifications	284
Table A-10 HemoSphere Swan-Ganz module parameter measurement specifications	284
Table A-11 HemoSphere Swan-Ganz module 20-second flow parameter measurement specifications ¹	285
Table A-12 HemoSphere pressure cable physical specifications	286

Table A-13 HemoSphere pressure cable parameter measurement specifications	286
Table A-14 HemoSphere oximetry cable physical specifications	287
Table A-15 HemoSphere oximetry cable parameter measurement specifications	287
Table A-16 HemoSphere tissue oximetry module physical specifications	287
Table A-17 ForeSight Elite tissue oximeter module physical specifications	288
Table A-18 HemoSphere tissue oximetry module with ForeSight Elite tissue oximeter module parameter measurement specifications	288
Table A-19 HemoSphere ClearSight module physical specifications	289
Table A-20 HemoSphere ClearSight module environmental specifications	289
Table A-21 HemoSphere ClearSight module parameter measurement specifications	289
Table A-22 Edwards finger cuff specifications*	289
Table B-1 HemoSphere advanced monitor components	291
Table C-1 Cardiac and oxygenation profile equations	293
Table D-1 Patient information	299
Table D-2 Graphical trend parameter scale defaults	299
Table D-3 Configurable parameter alarm and display ranges	300
Table D-4 Parameter alarm red zone and target defaults	302
Table D-5 Parameter alarms, faults, and alerts priorities	303
Table D-6 Language default settings	304
Table E-1 Computation constants for bath temperature probe	305
Table E-2 Computation constants for in-line temperature probe	306
Table G-1 Electromagnetic emissions	316
Table G-2 Guidance and Manufacturer's Declaration - Immunity to RF wireless communications equipment	317
Table G-3 Recommended Separation Distances between Portable and Mobile RF Communications Equipment and the HemoSphere advanced monitor	318
Table G-4 In band wireless coexistence – Threshold of Interference (ToI) and Threshold of Communication (ToC) between HemoSphere advanced monitor (EUT) in Invasive mode and external devices	318
Table G-5 In band wireless coexistence – Threshold of Interference (ToI) and Threshold of Communication (ToC) between HemoSphere advanced monitor (EUT) in Noninvasive mode and external devices	319
Table G-6 Electromagnetic Immunity (ESD, EFT, Surge, Dips and Magnetic Field)	320
Table G-7 Electromagnetic Immunity (RF Radiated and Conducted)	321
Table G-8 HemoSphere advanced monitor wireless information	322

Introduction

Contents

Intended Purpose of this Manual	21
Indications For Use	21
Contraindications For Use	23
Intended Use Statement	23
Expected Clinical Benefit	29
HemoSphere Advanced Monitor Hemodynamic Technology Connections	29
Manual style conventions	35
Abbreviations Found in This Manual	36

1.1 Intended Purpose of this Manual

This manual describes the features and monitoring options of the Edwards HemoSphere advanced monitor. The HemoSphere advanced monitor is a modular device that displays monitored data obtained through Edwards hemodynamic technologies.

This manual has been prepared for use with the Edwards HemoSphere advanced monitor by trained critical care clinicians, nurses, and physicians in any hospital environment where critical care is administered.

This manual provides the operator of the HemoSphere advanced monitor with setup and operating instructions, device interfacing procedures, and limitations.

1.2 Indications For Use

1.2.1 HemoSphere Advanced Monitor with HemoSphere Swan-Ganz Module

The HemoSphere advanced monitor when used with the HemoSphere Swan-Ganz module and Edwards Swan-Ganz catheters is indicated for use in adult and pediatric critical care patients requiring monitoring of cardiac output (continuous [CO] and intermittent [iCO]) and derived hemodynamic parameters in a hospital environment. It may be used for monitoring hemodynamic parameters in conjunction with a perioperative goal directed therapy protocol in a hospital environment. Refer to the Edwards Swan-Ganz catheter indications for use statement for information on target patient population specific to the catheter being used.

Refer to the Intended Use statement for a complete list of measured and derived parameters available for each patient population.

1.2.2 HemoSphere Advanced Monitor with HemoSphere Oximetry Cable

The HemoSphere advanced monitor when used with the HemoSphere oximetry cable and Edwards oximetry catheters is indicated for use in adult and pediatric critical care patients requiring monitoring of venous oxygen saturation (SvO₂ and ScvO₂) and derived hemodynamic parameters in a hospital environment. Refer to the Edwards oximetry catheter indications for use statement for information on target patient population specific to the catheter being used.

Refer to the Intended Use statement for a complete list of measured and derived parameters available for each patient population.

1.2.3 HemoSphere Advanced Monitor with HemoSphere Pressure Cable

The HemoSphere advanced monitor when used with the HemoSphere pressure cable is indicated for use in critical care patients in which the balance between cardiac function, fluid status, vascular resistance and pressure needs continuous assessment. It may be used for monitoring of hemodynamic parameters in conjunction with a perioperative goal directed therapy protocol in a hospital environment. Refer to the Edwards FloTrac sensor, Acumen IQ sensor, and TruWave DPT indications for use statements for information on target patient populations specific to the sensor/transducer being used.

The Edwards Acumen Hypotension Prediction Index feature provides the clinician with physiological insight into a patient's likelihood of future hypotensive events (defined as mean arterial pressure < 65 mmHg for at least one minute in duration) and the associated hemodynamics. The Acumen HPI™ feature is intended for use in surgical or non-surgical patients receiving advanced hemodynamic monitoring. The Acumen HPI™ feature is considered to be additional quantitative information regarding the patient's physiological condition for reference only and no therapeutic decisions should be made based solely on the Acumen Hypotension Prediction Index (HPI) parameter.

Refer to the Intended Use statement for a complete list of measured and derived parameters available for each patient population.

1.2.4 HemoSphere Advanced Monitor with HemoSphere Tissue Oximetry Module and ForeSight Elite Tissue Oximeter Module

The noninvasive ForeSight Elite tissue oximeter module is intended for use as an adjunct monitor of absolute regional hemoglobin oxygen saturation of blood under the sensors in individuals at risk for reduced-flow or no-flow ischemic states. The ForeSight Elite tissue oximeter module is intended to allow for the display of StO₂ on the HemoSphere advanced monitor.

- When used with large sensors, the ForeSight Elite tissue oximeter module is indicated for use on adults and transitional adolescents ≥40 kg.
- When used with medium sensors, the ForeSight Elite tissue oximeter module is indicated for use on pediatric subjects ≥3 kg.
- When used with small sensors, the ForeSight Elite tissue oximeter module is indicated for cerebral use on pediatric subjects <8 kg and non-cerebral use on pediatric subjects <5kg.

Refer to the Intended Use statement for a complete list of measured and derived parameters available for each patient population.

1.2.5 HemoSphere Advanced Monitor with HemoSphere ClearSight Module

The HemoSphere advanced monitor when used with the HemoSphere ClearSight module, pressure controller and a compatible Edwards finger cuff are indicated for patients over 18 years of age in which the balance between cardiac function, fluid status and vascular resistance needs continuous assessment. It may

be used for monitoring hemodynamic parameters in conjunction with a perioperative goal directed therapy protocol in a hospital environment. In addition, the noninvasive system is indicated for use in patients with co-morbidities for which hemodynamic optimization is desired and invasive measurements are difficult. The HemoSphere advanced monitor and compatible Edwards finger cuffs noninvasively measures blood pressure and associated hemodynamic parameters. Refer to the ClearSight finger cuff and Acumen IQ finger cuff indications for use statements for information on target patient population specific to the finger cuff being used.

The Edwards Acumen™ Hypotension Prediction Index (HPI) feature provides the clinician with physiological insight into a patient's likelihood of future hypotensive events (defined as mean arterial pressure < 65 mmHg for at least one minute in duration) and the associated hemodynamics. The Acumen HPI™ feature is intended for use in surgical and non-surgical patients receiving advanced hemodynamic monitoring. The Acumen HPI feature is considered to be additional quantitative information regarding the patient's physiological condition for reference only and no therapeutic decisions should be made based solely on the Acumen Hypotension Prediction Index (HPI) parameter.

Refer to the Intended Use statement for a complete list of measured and derived parameters available for each patient population.

1.3 Contraindications For Use

The HemoSphere advanced monitor while used with the HemoSphere Swan-Ganz module, oximetry cable or pressure cable has no contraindications for use.

1.3.1 HemoSphere Advanced Monitor with HemoSphere Tissue Oximetry Module

The ForeSight Elite sensor is contraindicated for use on patients:

- with a physical site area too limited for proper sensor placement
- with allergic reactions to sensor adhesive
- undergoing an MRI scan because of associate risk of injury

1.3.2 HemoSphere Advanced Monitor with HemoSphere ClearSight Module

The HemoSphere advanced monitor while used with the HemoSphere ClearSight module and compatible finger cuff(s) is contraindicated in some patients with extreme contraction of the smooth muscle in the arteries and arterioles in the lower arm and hand, such as may be present in patients with Raynaud's disease. In these patients, blood pressure measurement can become impossible.

No other contraindications were known at the time this operator's manual was published.

1.4 Intended Use Statement

The HemoSphere advanced monitoring platform is intended to be used by qualified personnel or trained clinicians in a critical care environment in a hospital setting.

The HemoSphere advanced monitoring platform is intended for use with compatible Edwards Swan-Ganz and oximetry catheters, FloTrac sensors, Acumen IQ sensors, TruWave DPTs, ForeSight Elite sensors, ClearSight finger cuffs, and Acumen IQ finger cuffs.

A comprehensive list of parameters available while monitoring with the HemoSphere advanced monitor and a connected HemoSphere Swan-Ganz module are listed below in table 1-1. Only iCO, iCI, iSVR, and iSVRI are available to the pediatric patient population.

Table 1-1 HemoSphere Swan-Ganz module available parameters list

Abbreviation	Definition	Sub-system technology used	Patient population	Hospital environment
CO	continuous cardiac output	HemoSphere Swan-Ganz module	adult only	operating room, intensive care unit, emergency room
sCO	STAT cardiac output			
CI	continuous cardiac index			
sCI	STAT cardiac index			
EDV	right ventricular end diastolic volume			
sEDV	STAT right ventricular end diastolic volume			
EDVI	right ventricular end diastolic volume index			
sEDVI	STAT right ventricular end diastolic volume index			
HR _{avg}	averaged heart rate			
LVSWI	left ventricular stroke work index			
PVR	pulmonary vascular resistance			
PVRI	pulmonary vascular resistance index			
RVEF	right ventricular ejection fraction			
sRVEF	STAT right ventricular ejection fraction			
RVSWI	right ventricular stroke work index			
SV	stroke volume			
SVI	stroke volume index			
SVR	systemic vascular resistance			
SVRI	systemic vascular resistance index			
iCO	intermittent cardiac output		adult and pediatric	
iCI	intermittent cardiac index			
iSVR	intermittent systemic vascular resistance			
iSVRI	intermittent systemic vascular resistance index			

A comprehensive list of parameters available for adult and pediatric patient populations while monitoring with the HemoSphere advanced monitor and a connected HemoSphere oximetry cable are listed below in table 1-2.

Table 1-2 HemoSphere oximetry cable available parameters list

Abbreviation	Definition	Sub-system technology used	Patient population	Hospital environment
SvO ₂	mixed venous oxygen saturation	HemoSphere oximetry cable	adult and pediatric	operating room, intensive care unit, emergency room
ScvO ₂	central venous oxygen saturation			

A comprehensive list of parameters available for adult and pediatric patient populations while monitoring with the HemoSphere advanced monitor and both a connected HemoSphere Swan-Ganz module and oximetry cable are listed below in table 1-3.

Table 1-3 HemoSphere Swan-Ganz module with oximetry cable available parameters list

Abbreviation	Definition	Sub-system technology used	Patient population	Hospital environment
DO ₂	oxygen delivery	HemoSphere Swan-Ganz module and HemoSphere oximetry cable	adult and pediatric	operating room, intensive care unit, emergency room
DO ₂ l	oxygen delivery index			
VO ₂	oxygen consumption			
VO ₂ e	estimated oxygen consumption when ScvO ₂ is being monitored			
VO ₂ l	oxygen consumption index			
VO ₂ le	estimated oxygen consumption index when ScvO ₂ is being monitored			

A comprehensive list of parameters available while monitoring with the HemoSphere advanced monitor and both a connected HemoSphere Swan-Ganz module and pressure cable are listed below in table 1-4.

Table 1-4 HemoSphere Swan-Ganz module with pressure cable available parameters list*

Abbreviation	Definition	Sub-system technology used	Patient population	Hospital environment
CO _{20s}	20-second cardiac output	HemoSphere Swan-Ganz module and HemoSphere pressure cable	adult only	operating room, intensive care unit, emergency room
CI _{20s}	20-second cardiac index			
SV _{20s}	20-second stroke volume			
SVI _{20s}	20-second stroke volume index			
*20-second flow parameters are only available if the 20s flow parameter feature is enabled. Please contact your local Edwards representative for more information on enabling this advanced feature.				

A comprehensive list of parameters available while monitoring with the HemoSphere advanced monitor and a connected HemoSphere pressure cable are listed below in table 1-5.

Table 1-5 HemoSphere pressure cable available parameters list

Abbreviation	Definition	Sub-system technology used	Patient population	Hospital environment
CO	continuous cardiac output ¹	HemoSphere pressure cable	adult only	operating room, intensive care unit, emergency room
CI	continuous cardiac index ¹			
CVP	central venous pressure			
DIA _{ART}	systemic arterial diastolic blood pressure			
DIA _{PAP}	pulmonary artery diastolic blood pressure			
dP/dt	systolic slope ²			
Ea _{dyn}	dynamic arterial elastance ²			
MAP	mean arterial blood pressure			
MPAP	mean pulmonary artery blood pressure			
PPV	pulse pressure variation ¹			
PR	pulse rate			
SV	stroke volume ¹			
SVI	stroke volume index ¹			
SVR	systemic vascular resistance ¹			
SVRI	systemic vascular resistance index ¹			
SVV	stroke volume variation ¹			
SYS _{ART}	systemic arterial systolic blood pressure			
SYS _{PAP}	pulmonary artery systolic blood pressure			
HPI	Acumen Hypotension Prediction Index ²			
<p>¹FloTrac parameters are available when using a FloTrac/Acumen IQ sensor and if the FloTrac feature is enabled.</p> <p>²HPI parameters are available when using an Acumen IQ sensor and if the HPI feature is activated. Activation is only available in certain areas. Please contact your local Edwards representative for more information on enabling this advanced feature.</p>				

A comprehensive list of parameters available for adult and pediatric patient populations while monitoring with the HemoSphere advanced monitor and both a connected HemoSphere pressure cable and oximetry cable are listed below in table 1-6.

Table 1-6 HemoSphere pressure cable with oximetry cable available parameters list

Abbreviation	Definition	Sub-system technology used	Patient population	Hospital environment
DO ₂	oxygen delivery	HemoSphere pressure cable and HemoSphere oximetry cable	adult only	operating room, intensive care unit, emergency room
DO ₂ l	oxygen delivery index			
VO ₂	oxygen consumption			
VO ₂ e	estimated oxygen consumption when ScvO ₂ is being monitored			
VO ₂ l	oxygen consumption index			
VO ₂ le	estimated oxygen consumption index when ScvO ₂ is being monitored			

Tissue oxygen saturation, StO₂, can be monitored with the HemoSphere advanced monitor, a connected HemoSphere tissue oximetry module, and the ForeSight Elite tissue oximeter module as listed below in table 1-7.

Table 1-7 HemoSphere tissue oximetry module with ForeSight Elite tissue oximeter module available parameters list

Abbreviation	Definition	Sub-system technology used	Patient population	Hospital environment
StO ₂	tissue oxygen saturation	HemoSphere tissue oximetry module	adult and pediatric	operating room, intensive care unit, emergency room

NOTE Tissue oximetry parameters are available when using a ForeSight Elite module and sensor, and if the tissue oximetry feature is activated. Activation is only available in certain areas. Please contact your local Edwards representative for more information on enabling this advanced feature.

A comprehensive list of parameters available while monitoring with the HemoSphere advanced monitor and a connected HemoSphere ClearSight module are listed below in table 1-8.

Table 1-8 HemoSphere ClearSight module available parameters list

Abbreviation	Definition	Sub-system technology used	Patient population	Hospital environment
CO	continuous cardiac output	HemoSphere ClearSight module	adult only	operating room and intensive care unit
CI	continuous cardiac index			
DIA _{ART}	noninvasive arterial diastolic blood pressure			
dP/dt	systolic slope ¹			
Ea _{dyn}	dynamic arterial elastance ¹			
MAP	noninvasive mean arterial blood pressure			
PPV	pulse pressure variation			
PR	noninvasive pulse rate			
SV	stroke volume			
SVI	stroke volume index			
SVR	systemic vascular resistance			
SVRI	systemic vascular resistance index			
SVV	stroke volume variation			
SYS _{ART}	noninvasive arterial systolic blood pressure			
HPI	Acumen Hypotension Prediction Index ¹			
¹ HPI parameters are available when using an Acumen IQ finger cuff, heart reference sensor (HRS) and if the HPI feature is activated. Activation is only available in certain areas. Please contact your local Edwards representative for more information on enabling this advanced feature.				

A comprehensive list of parameters available for adult patient populations while monitoring with the HemoSphere advanced monitor and both a connected HemoSphere ClearSight module and oximetry cable are listed below in table 1-9.

Table 1-9 HemoSphere ClearSight module with oximetry cable available parameters list

Abbreviation	Definition	Sub-system technology used	Patient population	Hospital environment
DO ₂	oxygen delivery	HemoSphere ClearSight module and HemoSphere oximetry cable	adult only	operating room and intensive care unit
DO ₂ l	oxygen delivery index			
VO ₂	oxygen consumption			
VO ₂ e	estimated oxygen consumption when ScvO ₂ is being monitored			
VO ₂ l	oxygen consumption index			
VO ₂ le	estimated oxygen consumption index when ScvO ₂ is being monitored			

WARNING Improper use of the HemoSphere advanced monitor could present a hazard to the patient. Carefully read the “warnings” section of this manual, located in chapter 2, before using the platform.

The HemoSphere advanced monitor is intended for use only in patient assessment. This instrument must be used in conjunction with a bedside physiological monitor and/or patient clinical signs and symptoms. If hemodynamic values obtained from the device are not consistent with the clinical presentation of the patient, consider troubleshooting before initiating treatment options.

ECG signal input and all parameters derived from heart rate measurements have not been evaluated for pediatric patients and are therefore not available for that patient population.

1.5 Expected Clinical Benefit

The HemoSphere advanced monitoring platform allows you to see and interact with patient hemodynamic parameters. In conjunction with the compatible sensors and predictive decision support software, the modular HemoSphere platform facilitates proactive clinical decision-making and insight for individualized patient care.

1.6 HemoSphere Advanced Monitor Hemodynamic Technology Connections

The HemoSphere advanced monitor is equipped with three technology expansion module slots (two standard size and one large [L-Tech] size) and two cable ports. Module and cable connection points are located on the left side panel. See figure 1-1.

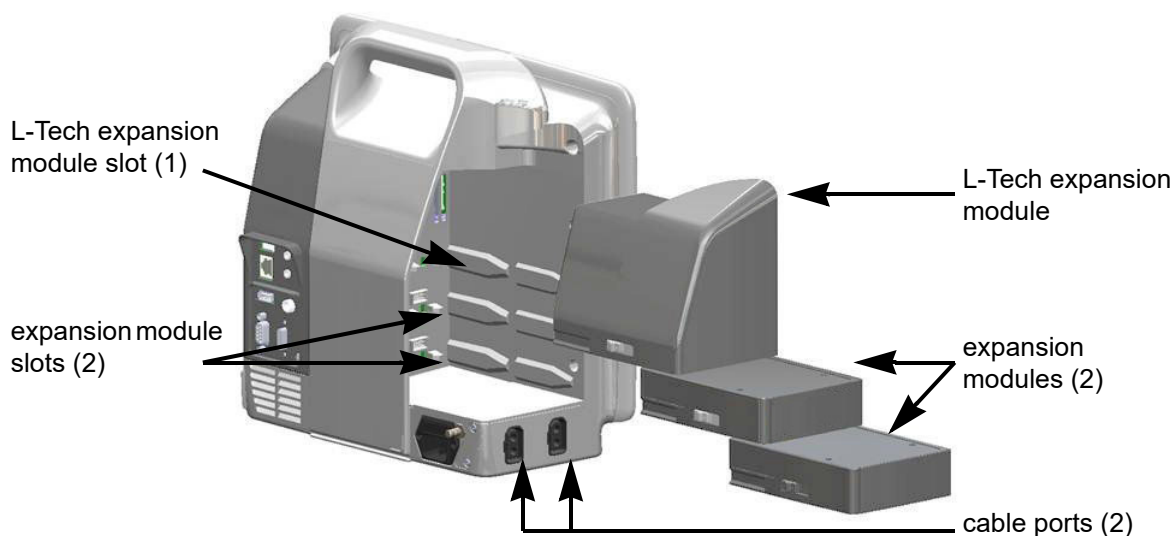

Figure 1-1 HemoSphere advanced monitor hemodynamic technology connections

Each module/cable is associated with a specific Edwards hemodynamic monitoring technology. Currently available modules include the HemoSphere Swan-Ganz module, introduced below and in detail in chapter 9, *HemoSphere Swan-Ganz Module Monitoring*, and the HemoSphere tissue oximetry module, an advanced

feature technology, introduced below and described in detail in chapter 13, *HemoSphere Tissue Oximetry Module Monitoring*. Currently available large technology (L-Tech) modules include the HemoSphere ClearSight module, introduced below and in detail in chapter 11, *HemoSphere ClearSight Module Noninvasive Monitoring*. Currently available cables include the HemoSphere pressure cable, introduced below and described in detail in chapter 10, *Monitoring with the HemoSphere Pressure Cable*, and the HemoSphere oximetry cable, introduced below and described in detail in chapter 12, *Venous Oximetry Monitoring*.

1.6.1 HemoSphere Swan-Ganz Module

The HemoSphere Swan-Ganz module enables continuous cardiac output (CO) and intermittent cardiac output (iCO) monitoring with an Edwards patient CCO cable and compatible Swan-Ganz catheter. Right ventricular end diastolic volume (EDV) monitoring is available with slaved in heart rate (HR_{avg}) data from a bedside patient monitor. The HemoSphere Swan-Ganz module fits into a standard module slot. For more information, see chapter 9, *HemoSphere Swan-Ganz Module Monitoring*. Table 1-10 lists the parameters available while using the HemoSphere Swan-Ganz module.

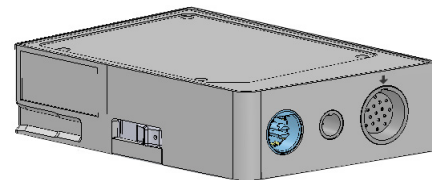

Table 1-10 HemoSphere Swan-Ganz module parameters description

Parameter	Description	Technology
continuous cardiac output (CO)	continuous assessment through advanced thermodilution technology of the volume of blood pumped by the heart measured in liters per minute	Swan-Ganz CCO and CCombo catheters
continuous cardiac index (CI)	continuous cardiac output relative to body surface area (BSA)	Swan-Ganz CCO and CCombo catheters
intermittent cardiac output (iCO)	intermittent assessment through the bolus thermodilution method of the volume of blood pumped by the heart measured in liters per minute	Swan-Ganz thermodilution catheters
intermittent cardiac index (iCI)	intermittent cardiac output relative to body surface area (BSA)	Swan-Ganz thermodilution catheters
right ventricular ejection fraction (RVEF)	continuous assessment through advanced thermodilution technology and algorithm analysis of the percentage of blood volume ejected from the right ventricle during systole	Swan-Ganz CCombo V catheters with ECG signal input
right ventricular end diastolic volume (EDV)	continuous assessment of the volume of blood in the right ventricle at the end of diastole calculated by dividing stroke volume (mL/beat) by RVEF(%)	Swan-Ganz CCombo V catheters with ECG signal input
stroke volume (SV)	amount of blood ejected from the ventricles with each contraction derived from CO assessment and heart rate ($SV = CO/HR \times 1000$)	Swan-Ganz CCO, CCombo, and CCombo V catheters with ECG signal input
stroke volume index (SVI)	stroke volume relative to body surface area (BSA)	Swan-Ganz CCO, CCombo, and CCombo V catheters with ECG signal input

Table 1-10 HemoSphere Swan-Ganz module parameters description (continued)

Parameter	Description	Technology
systemic vascular resistance (SVR)	a derived measure of impedance to blood flow from left ventricle (afterload)	Swan-Ganz CCO and CCOmbo catheters with MAP and CVP analog pressure signal input
systemic vascular resistance index (SVRI)	systemic vascular resistance relative to body surface area (BSA)	Swan-Ganz CCO and CCOmbo catheters with MAP and CVP analog pressure signal input

1.6.2 HemoSphere Pressure Cable

The HemoSphere pressure cable enables vascular pressure monitoring with a compatible Edwards pressure transducer/sensor and catheter. A connected FloTrac or Acumen IQ sensor provides continuous cardiac output (CO) and associated hemodynamic parameters. A connected TruWave transducer provides location based intravascular pressure. The HemoSphere pressure cable plugs into a monitoring cable port. For more information, see chapter 10, *Monitoring with the HemoSphere Pressure Cable*. Table 1-11 lists the parameters available while using the HemoSphere pressure cable.

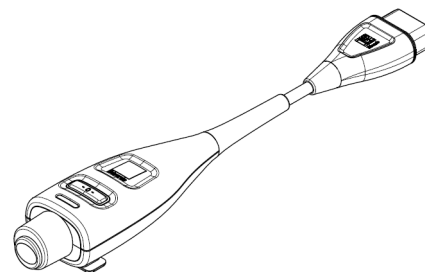
**Table 1-11 HemoSphere pressure cable key parameters description**

Parameter	Description	Technology
continuous cardiac output (CO)	continuous assessment of the volume of blood pumped by the heart measured in liters per minute using the existing arterial pressure waveform and FloTrac system algorithm	FloTrac or Acumen IQ sensor
continuous cardiac index (CI)	continuous cardiac output relative to body surface area (BSA)	FloTrac or Acumen IQ sensor
central venous pressure (CVP)	central venous blood pressure	TruWave pressure transducer at central venous catheter line
diastolic blood pressure (DIA _{ART} /DIA _{PAP})	diastolic blood pressure measured at the pulmonary artery (PAP) or a systemic artery (ART)	FloTrac sensor, Acumen IQ sensor, or TruWave pressure transducer
systolic slope (dP/dt)*	maximum upslope of the arterial pressure waveform measured from a peripheral artery *	Acumen IQ sensor
dynamic arterial elastance (Ea _{dyn})*	measure of afterload to the left ventricle by the arterial system (arterial elastance) relative to the left ventricular elastance*	Acumen IQ sensor
Acumen Hypotension Prediction Index (HPI)*	index representing the likelihood that the patient may be trending toward a hypotensive event (MAP<65 mmHg for at least one minute in duration)*	Acumen IQ sensor
mean arterial pressure (MAP)	averaged systemic blood pressure over one cardiac cycle	FloTrac sensor, Acumen IQ sensor, or TruWave pressure transducer
mean pulmonary artery pressure (MPAP)	averaged pulmonary artery blood pressure over one cardiac cycle	TruWave pressure transducer at pulmonary artery catheter line

Table 1-11 HemoSphere pressure cable key parameters description (continued)

Parameter	Description	Technology
pulse pressure variation (PPV)	the percent difference between PPmin and PPmax relative to PPmean where $PP = SYS - DIA$	FloTrac or Acumen IQ sensor
pulse rate (PR)	number of arterial blood pressure pulses per minute	FloTrac sensor, Acumen IQ sensor, or TruWave pressure transducer
stroke volume (SV)	volume of blood pumped with each heart beat	FloTrac or Acumen IQ sensor
stroke volume index (SVI)	stroke volume relative to body surface area (BSA)	FloTrac or Acumen IQ sensor
systemic vascular resistance (SVR)	a derived measure of impedance to blood flow from left ventricle (afterload)	FloTrac or Acumen IQ sensor
systemic vascular resistance index (SVRI)	systemic vascular resistance relative to body surface area (BSA)	FloTrac or Acumen IQ sensor
stroke volume variation (SVV)	the percent difference between SVmin and SVmax relative to SVmean	FloTrac or Acumen IQ sensor
systolic pressure (SYS _{ART} /SYS _{PAP})	systolic blood pressure measured at the pulmonary artery (PAP) or a systemic artery (ART)	FloTrac sensor, Acumen IQ sensor, or TruWave pressure transducer
*HPI parameters are available when using an Acumen IQ sensor and if the HPI feature is activated. Activation is only available in certain areas. Please contact your local Edwards representative for more information on enabling this advanced feature.		

NOTE Cardiac output calculated with the HemoSphere pressure cable may differ from that calculated with the HemoSphere Swan-Ganz module due to methodological and algorithmic differences.

1.6.3 HemoSphere Oximetry Cable

The HemoSphere oximetry cable enables mixed venous oxygen saturation (SvO₂) or central venous oxygen saturation (ScvO₂) monitoring with a compatible Edwards oximetry catheter. The HemoSphere oximetry cable plugs into a monitoring cable port and can be used in combination with other hemodynamic monitoring technologies. For more information on oximetry monitoring, see chapter 12, *Venous Oximetry Monitoring*. Table 1-12 lists the parameters available while using the HemoSphere oximetry cable.

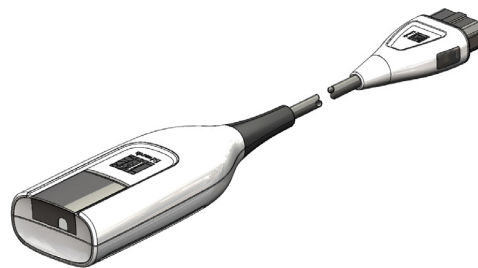
**Table 1-12 HemoSphere oximetry cable parameters description**

Parameter	Description
central venous oximetry (ScvO ₂)	venous oxygen saturation as measured in the superior vena cava
mixed venous oximetry (SvO ₂)	venous oxygen saturation as measured in the pulmonary artery
oxygen consumption (VO ₂)	the amount of oxygen used by the body per minute
estimated oxygen consumption (VO ₂ e)	an estimate of the amount of oxygen used by the body per minute (ScvO ₂ monitoring only)

Table 1-12 HemoSphere oximetry cable parameters description (continued)

Parameter	Description
oxygen consumption index (VO_2l)	the amount of oxygen used by the body per minute indexed against body surface area (BSA)
estimated oxygen consumption index (VO_2le)	an estimate of the amount of oxygen used by the body per minute indexed against body surface area (BSA)

1.6.4 HemoSphere Tissue Oximetry Module

The HemoSphere tissue oximetry module enables tissue oximetry (StO_2) monitoring with a ForeSight Elite tissue oximeter module and compatible tissue oximetry sensors. The HemoSphere tissue oximetry module fits into a standard module slot. Monitoring with the HemoSphere tissue oximetry module is an advanced feature. Activation is only available in certain areas. Please contact your local Edwards representative for more information on enabling this advanced feature. For more information, see chapter 13, *HemoSphere Tissue Oximetry Module Monitoring*. Table 1-13 lists the parameters available while using the HemoSphere tissue oximetry module.

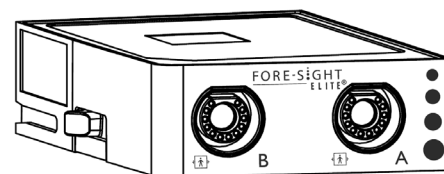
**Table 1-13 HemoSphere tissue oximetry module with ForeSight Elite tissue oximeter module parameters description**

Parameter	Description	Technology
tissue oximetry (StO_2)	absolute tissue oxygen saturation as measured at anatomical surface below sensor location	ForeSight Elite sensor detection of near-infrared light reflection

1.6.5 HemoSphere ClearSight Module

The HemoSphere ClearSight module with a connected compatible pressure controller and finger cuff(s) enables noninvasive measurement of a patient's arterial pressure waveform and calculation of continuous cardiac output (CO) and associated hemodynamic parameters. The HemoSphere ClearSight module fits into the large technology (L-Tech) slot. For more information, see chapter 11, *HemoSphere ClearSight Module Noninvasive Monitoring*.

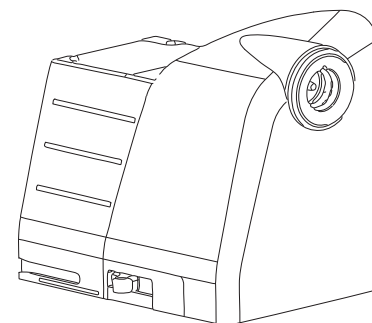

Table 1-14 HemoSphere ClearSight module key parameters description

Parameter	Description	Technology
continuous cardiac output (CO)	continuous assessment of the volume of blood pumped by the heart measured in liters per minute using the monitored arterial pressure waveform and ClearSight algorithm	ClearSight or Acumen IQ cuff
continuous cardiac index (CI)	continuous cardiac output relative to body surface area (BSA)	ClearSight or Acumen IQ cuff
noninvasive diastolic blood pressure (DIA _{ART})	diastolic blood pressure	ClearSight or Acumen IQ cuff
systolic slope (dP/dt)*	maximum upslope of the arterial pressure waveform measured from a peripheral artery*	Acumen IQ cuff
dynamic elastance (Ea _{dyn})*	measure of afterload to the left ventricle by the arterial system (arterial elastance) relative to the left ventricular elastance*	Acumen IQ cuff
Acumen Hypotension Prediction Index (HPI)*	index representing the likelihood that the patient may be trending toward a hypotensive event (MAP<65 mmHg for at least one minute in duration)*	Acumen IQ cuff
noninvasive mean arterial pressure (MAP)	averaged systemic blood pressure over one cardiac cycle	ClearSight or Acumen IQ cuff
pulse pressure variation (PPV)	the percent difference between PPmin and PPmax relative to PPmean where PP = SYS-DIA	ClearSight or Acumen IQ cuff
noninvasive pulse rate (PR)	number of arterial blood pressure pulses per minute	ClearSight or Acumen IQ cuff
stroke volume (SV)	volume of blood pumped with each heart beat	ClearSight or Acumen IQ cuff
stroke volume index (SVI)	stroke volume relative to body surface area (BSA)	ClearSight or Acumen IQ cuff
systemic vascular resistance (SVR)	a derived measure of impedance to blood flow from left ventricle (afterload)	ClearSight or Acumen IQ cuff
systemic vascular resistance index (SVRI)	systemic vascular resistance relative to body surface area (BSA)	ClearSight or Acumen IQ cuff
stroke volume variation (SVV)	the percent difference between SVmin and SVmax relative to SVmean	ClearSight or Acumen IQ cuff
noninvasive systolic pressure (SYS _{ART})	systolic blood pressure	ClearSight or Acumen IQ cuff
*HPI parameters are available when using an Acumen IQ finger cuff, heart reference sensor, and if the HPI feature is activated. Activation is only available in certain areas. Please contact your local Edwards representative for more information on enabling this advanced feature.		

1.6.6 Documentation and Training

Available documentation and training for the HemoSphere advanced monitor includes:



- HemoSphere Advanced Monitor Operator’s Manual
- HemoSphere Advanced Monitor Quick Start Guide
- HemoSphere Pressure-Out Cable Instructions for Use
- Edwards Heart Reference Sensor Instructions for Use
- Edwards Pressure Controller Instructions for Use
- HemoSphere Battery Instructions for Use
- HemoSphere Roll Stand Instructions for Use
- HemoSphere Oximetry Cradle Instructions for Use

Instructions for Use are included with HemoSphere Advanced Monitor components. See table B-1, “HemoSphere advanced monitor components,” on page 291. For more information on how you can receive training or available documentation for the HemoSphere advanced monitor, contact your local Edwards representative or Edwards Technical Support. See appendix F, *System Care, Service and Support*.

1.7 Manual style conventions

Table 1-15 lists the style conventions used in this manual.

Table 1-15 Operator’s manual style conventions

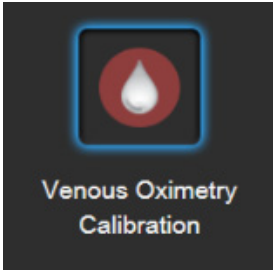
Convention	Description
Bold	Bold text indicates a software term. This word or phrase will appear on the screen as shown.
Bold button	A button is a touch screen access point for the option appearing in bold. For example, the Review button appears on-screen as: 
→	An arrow is shown between two on-screen menu options that are selected consecutively by the operator.
	An icon is a touch screen access point for the menu or navigation graphic shown. See table 2-1 on page 52 for full list of menu icons shown on the HemoSphere advanced monitor.
Venous Oximetry Calibration icon 	Bold text with a menu icon indicates an icon that is paired with a software term or phrase appearing on the screen. For example, the Venous Oximetry Calibration icon appears on-screen as: 

1.8 Abbreviations Found in This Manual

Table 1-16 Acronyms, Abbreviations

Abbreviation	Definition
A/D	analog/digital
ART	systemic arterial blood pressure
BSA	body surface area
BT	blood temperature
CaO ₂	arterial oxygen content
CI	cardiac index
CI _{20s}	20-second cardiac index
CO	cardiac output
CO _{20s}	20-second cardiac output
CCO	continuous cardiac output (used when describing certain Swan-Ganz catheters and patient CCO cable)
CPI	cardiac power index
CPO	cardiac power output
CVP	central venous pressure
DIA _{ART}	systemic arterial diastolic blood pressure
DIA _{PAP}	pulmonary artery diastolic blood pressure
DO ₂	oxygen delivery
DO ₂ I	oxygen delivery index
dP/dt	systolic slope (maximum upslope of the arterial pressure waveform)
DPT	disposable pressure transducer
Ea _{dyn}	dynamic arterial elastance
EDV	end diastolic volume
EDVI	end diastolic volume index
ESV	end systolic volume
ESVI	end systolic volume index
efu	ejection fraction unit
FRT	Fluid Responsiveness Test
FT-CO	FloTrac arterial pressure auto calibrated cardiac output
GDT	goal directed therapy
Hct	hematocrit
HIS	hospital information systems
HGB	hemoglobin
HPI	Acumen Hypotension Prediction Index
HR	heart rate
HR _{avg}	average heart rate
HRS	heart reference sensor
IA	Intervention Analysis
iCI	intermittent cardiac index
iCO	intermittent cardiac output

Table 1-16 Acronyms, Abbreviations (continued)

Abbreviation	Definition
IEC	International Electrotechnical Commission
IT	injectate temperature
LED	light emitting diode
LVSWI	left ventricular stroke work index
MAP	mean arterial pressure
MPAP	mean pulmonary artery pressure
NIBP	noninvasive blood pressure
OR	operating room
PA	pulmonary artery
PAP	pulmonary artery blood pressure
PaO ₂	partial pressure of arterial oxygen
PAWP	pulmonary artery wedge pressure
PC2	pressure controller
PPV	pulse pressure variation
POST	power-on self test
PR	pulse rate
PvO ₂	partial pressure of venous oxygen
PVR	pulmonary vascular resistance
PVRI	pulmonary vascular resistance index
RV	right ventricular
RVEF	right ventricular ejection fraction
RVSWI	right ventricular stroke work index
sCI	STAT cardiac index
sCO	STAT cardiac output
ScvO ₂	central venous oximetry
sEDV	STAT end diastolic volume
sEDVI	STAT end diastolic volume index
SpO ₂	pulse oximetry saturation
SQI	signal quality indicator
sRVEF	STAT right ventricular ejection fraction
ST	surface temperature
STAT	fast estimate of parameter value
StO ₂	tissue oxygen saturation
SV	stroke volume
SV _{20s}	20-second stroke volume
SVI	stroke volume index
SVI _{20s}	20-second stroke volume index
SvO ₂	mixed venous oxygen saturation
SVR	systemic vascular resistance
SVRI	systemic vascular resistance index
SVV	stroke volume variation

Table 1-16 Acronyms, Abbreviations (continued)

Abbreviation	Definition
SYS _{ART}	systemic arterial systolic blood pressure
SYS _{PAP}	pulmonary artery systolic blood pressure
Touch	Interact with the HemoSphere advanced monitor by touching the screen.
TD	thermodilution
USB	Universal Serial Bus
VO ₂	oxygen consumption
VO ₂ l	oxygen consumption index
VO ₂ e	estimation of oxygen consumption
VO ₂ le	estimated oxygen consumption index

Safety and Symbols

Contents

Safety Signal Words Definitions	38
Warnings	39
Cautions	46
User Interface Symbols	52
Symbols on Product Labels	54
Applicable Standards	56
HemoSphere Advanced Monitor Essential Performance	56

2.1 Safety Signal Words Definitions

2.1.1 Warning

A warning advises against certain actions or situations that could result in personal injury or death.

WARNING This is how warnings appear throughout the text of this manual.

2.1.2 Caution

A caution advises against actions or situations that could damage equipment, produce inaccurate data, or invalidate a procedure.

CAUTION This is how cautions appear throughout the text of this manual.

2.1.3 Note

A note draws attention to useful information regarding a function or procedure.

NOTE This is how notes appear throughout the text of this manual.

2.2 Warnings

The following are warnings that are used in the HemoSphere advanced monitor operator's manual. They are introduced in the manual where relevant to the function or procedure being described.

-
- Read this operator's manual carefully before attempting to use the Edwards HemoSphere advanced monitor.
 - Refer to the instructions for use provided with each compatible accessory before using it with the HemoSphere advanced monitor.
 - To prevent injury to patient or user, damage to platform, or inaccurate measurements, do not use any damaged or non-compatible platform accessories, components or cables.
 - Improper use of the HemoSphere advanced monitor could present a hazard to the patient. Carefully read the "warnings" section of this manual, located in chapter 2, before using the platform. (chapter 1)
 - The HemoSphere advanced monitor is intended for use only in patient assessment. This instrument must be used in conjunction with a bedside physiological monitor and/or patient clinical signs and symptoms. If hemodynamic values obtained from the device are not consistent with the clinical presentation of the patient, consider troubleshooting before initiating treatment options. (chapter 1)
 - ECG signal input and all parameters derived from heart rate measurements have not been evaluated for pediatric patients and are therefore not available for that patient population. (chapter 1)
 - Shock hazard! Do not attempt to connect/disconnect system cables while hands are wet. Ensure that hands are dry prior to disconnecting system cables. (chapter 3)
 - Explosion Hazard! Do not use the HemoSphere advanced monitor in the presence of flammable anesthetic mixture with air or with oxygen or nitrous oxide. (chapter 3)
 - This product contains metallic components. Do NOT use in a Magnetic Resonance (MR) environment. (chapter 3)
 - Make sure the HemoSphere advanced monitor is securely positioned or mounted and that all cords and accessory cables are appropriately arranged to minimize the risk of injury to patients, users or the equipment. (chapter 3)
 - Do not stack additional equipment or items on top of the HemoSphere advanced monitor. (chapter 3)
 - The HemoSphere advanced monitor must be positioned in an upright position to ensure IPX1 ingress protection. (chapter 3)
 - Do not allow any liquids to splash onto the monitoring screen. Liquid buildup may disable the touchscreen functionality. (chapter 3)
 - Do not position the monitor so that it is difficult to access rear panel ports or power cord. (chapter 3)
 - Equipment is rated for use with high-frequency surgical equipment. Inaccurate parameter measurements can be caused by interference from high-frequency surgical equipment. To reduce hazards that can arise from the use of high-frequency surgical equipment, only use undamaged patient cables and accessories connected as specified in this operator's manual. (chapter 3)
-

-
- This system is rated for use with defibrillators. To ensure proper defibrillator-proof operation, only use undamaged patient cables and accessories connected as specified in this operators manual. (chapter 3)
 - All IEC/EN 60950 equipment, including printers, to be positioned no closer than 1.5 meters to the patient's bed. (chapter 3)
 - Make sure the battery is fully inserted and the battery door is properly latched. Falling batteries could seriously injure patients or clinicians. (chapter 3)
 - Only use Edwards approved batteries with the HemoSphere advanced monitor. Do not charge the battery pack outside of the monitor. Doing so can damage the battery or injure the user. (chapter 3)
 - To prevent any interruptions to monitoring during power loss, it is recommended to use the HemoSphere advanced monitor with the battery inserted. (chapter 3)
 - In cases of power failure and battery depletion, the monitor will go through a controlled shut off procedure. (chapter 3)
 - Do not use the HemoSphere advanced monitoring platform without an installed power cord entry cover. Failure to do so may result in fluid ingress. (chapter 3)
 - Do not use extension cords or multiple socket devices to connect the power cord. Do not use detachable power cords other than the power cord provided. (chapter 3)
 - To avoid the risk of electric shock, the HemoSphere advanced monitor can only be connected to a supply mains with grounding (protective earth). Do not use three prong to two prong power adaptors. (chapter 3)
 - Grounding reliability can only be achieved when the instrument is connected to a receptacle marked "hospital only", "hospital grade", or its equivalent. (chapter 3)
 - Disconnect the monitor from the AC source by unplugging mains power cable from the AC Mains. The On/Off button on the monitor does not disconnect the system from the AC mains supply. (chapter 3)
 - Only use HemoSphere advanced monitor accessories, cables and or components that have been supplied and labeled by Edwards. Using other unlabeled accessories, cables and or components may affect patient safety and measurement accuracy. (chapter 3)
 - Upon initiation of a new patient session, the default high/low physiological alarm ranges should be checked to ensure that they are appropriate for the given patient. (chapter 6)
 - Perform New Patient or clear the patient data profile whenever a new patient is connected to the HemoSphere advanced monitor. Failure to do so may result in previous patient data in the historical displays. (chapter 6)
 - The analog communication ports of the HemoSphere advanced monitor share a common ground that is isolated from the catheter interface electronics. When connecting multiple devices to the HemoSphere advanced monitor, all devices should be provided with isolated power to avoid compromising the electrical isolation of any of the connected devices. (chapter 6)
 - Risk and Leakage current of the final system configuration must comply with IEC 60601-1:2005/A1:2012. It is the responsibility of the user to ensure compliance. (chapter 6)
-

-
- Accessory equipment connected to the monitor must be certified according to IEC/EN 60950 for data-processing equipment or IEC 60601-1:2005/A1:2012 for electromedical equipment. All combinations of equipment must be in compliance with IEC 60601-1:2005/A1:2012 systems requirements. (chapter 6)
 - When switching to a different bedside monitor, always check that the default values listed are still valid. If necessary, reconfigure the voltage range and corresponding parameter range or calibrate. (chapter 6)
 - Do not turn off the audible alarms in situations in which patient safety could be compromised. (chapter 7)
 - Do not lower the alarm volume to a level that prohibits alarms from being adequately monitored. Failure to do so could result in a situation where patient safety is compromised. (chapter 7)
 - Visual and audible physiological alarms are activated only if the parameter is configured on the screens as a key parameter (1-8 parameters displayed in parameter tiles). If a parameter is not selected and displayed as a key parameter, the audible and visual physiological alarms are not triggered for that parameter. (chapter 7)
 - Make sure that Demo Mode is not activated in a clinical setting to ensure that simulated data is not mistaken for clinical data. (chapter 7)
 - Do not use the HemoSphere advanced monitor as part of a Distributed Alarm System. The HemoSphere advanced monitor does not support remote alarm monitoring/management systems. Data is logged and transmitted for charting purposes only. (chapter 8)
 - Compliance to IEC 60601-1 is only maintained when the HemoSphere Swan-Ganz module (applied part connection, defibrillation proof) is connected to a compatible monitoring platform. Connecting external equipment or configuring the system in a way not described in these instructions will not meet this standard. Failure to use the device as instructed may increase the risk of electrical shock to the patient/operator. (chapter 9)
 - Do not modify, service or alter the product in any way. Servicing, alteration or modification may affect patient/operator safety and/or product performance. (chapter 9)
 - CO monitoring should always be discontinued when blood flow around the thermal filament is stopped. Clinical situations where CO monitoring should be discontinued include, but are not limited to: • Time periods when a patient is on cardiopulmonary bypass • Partial withdrawal of the catheter so that the thermistor is not in the pulmonary artery • Removal of the catheter from the patient (chapter 9)
 - PACEMAKER PATIENTS – Rate meters may continue to count the pacemaker rate during occurrences of cardiac arrest or some arrhythmias. Do not rely entirely upon displayed heart rate. Keep pacemaker patients under close surveillance. See table A-5 on page 282 for disclosure of the pacemaker pulse rejection capability of this instrument. (chapter 9)
 - For patients requiring internal or external pacing support, the HemoSphere advanced monitoring platform should not be used to obtain heart rate and heart rate derived parameters under the following conditions: • pacer pulse synch output from bedside monitor includes the pacer pulse, however, the characteristics are outside of the pacemaker pulse rejection capabilities specifications as listed in table A-5 • pacer pulse synch output characteristics from bedside monitor cannot be determined (chapter 9)
-

-
- Note any discrepancies in heart rate (HRavg) with the patient monitor HR and ECG waveform display when interpreting derived parameters such as SV, EDV, RVEF, and associated index parameters. (chapter 9)
 - Do not resterilize or reuse any FloTrac sensor, Acumen IQ sensor, TruWave transducer, or catheter; refer to the catheter's "directions for use". (chapter 10)
 - Do not use a FloTrac sensor, Acumen IQ sensor, TruWave transducer, or catheter that is wet, damaged, or that has exposed electrical contacts. (chapter 10)
 - Refer to the directions provided with each accessory for specific instructions on placement and use, and for relevant WARNINGS, CAUTIONS, and specifications. (chapter 10)
 - When the pressure cable is not in use, protect the exposed cable connector from fluid. Moisture within the connector may result in the cable malfunctioning or in inaccurate pressure readings. (chapter 10)
 - Compliance to IEC 60601-1 is only maintained when the HemoSphere pressure cable (applied part accessory, defibrillation proof) is connected to a compatible monitoring platform. Connecting external equipment or configuring the system in a way not described in these instructions will not meet this standard. Failure to use the device as instructed may increase the risk of electrical shock to the patient/operator. (chapter 10)
 - Do not use the HemoSphere advanced monitoring platform as a pulse rate or blood pressure monitor. (chapter 10)
 - Components that are not indicated as APPLIED PARTS should not be placed in a location where the patient may come into contact with the component. (chapter 11)
 - Compliance to IEC 60601-1 is only maintained when the HemoSphere ClearSight module (applied part connection) is connected to a compatible monitoring platform. Connecting external equipment or configuring the system in a way not described in these instructions will not meet this standard. Failure to use the device as instructed may increase the risk of electrical shock to the patient/operator. (chapter 11)
 - Do not sterilize any components of the HemoSphere noninvasive system. The HemoSphere noninvasive system is provided non sterile. (chapter 11)
 - Refer to cleaning instructions. Do not disinfect the instrument by autoclave or gas sterilization. (chapter 11)
 - Refer to the directions provided with each accessory for specific instructions on placement and use, and for relevant WARNINGS, CAUTIONS, and specifications. (chapter 11)
 - Do not use damaged components/sensors or components/sensors with exposed electrical contacts to prevent patient or user shocks. (chapter 11)
 - The HemoSphere noninvasive system monitoring components are not defibrillation proof. Disconnect the system before defibrillating. (chapter 11)
 - Only use compatible Edwards finger cuffs, heart reference sensor and other HemoSphere noninvasive system accessories, cables and or components that have been supplied and labeled by Edwards. Using other unlabeled accessories, cables and or components may affect patient safety and measurement accuracy. (chapter 11)
-

-
- Always remove HemoSphere noninvasive system sensors and components from the patient and completely disconnect the patient from the instrument before bathing the patient. (chapter 11)
 - Do not overtighten the pressure controller band or finger cuff(s). (chapter 11)
 - Do not apply pressure controller band on injured skin as this can cause further injury. (chapter 11)
 - Improper finger cuff placement or sizing can lead to inaccurate monitoring. (chapter 11)
 - Do not use the HemoSphere noninvasive system as a heart rate monitor. (chapter 11)
 - If using the instrument during full body irradiation, keep all HemoSphere noninvasive system monitoring components out of the irradiation field. If a monitoring component is exposed to the irradiation, the readings may be affected. (chapter 11)
 - Strong magnetic fields may cause malfunction of the instrument and burn wounds to the patient. Do not use the instrument during magnetic resonance imaging (MRI) scanning. Induced current could potentially cause burns. The device may affect the MR image, and the MRI unit may affect the accuracy of the measurements. (chapter 11)
 - Compliance to IEC 60601-1 is only maintained when the HemoSphere oximetry cable (applied part accessory, defibrillation proof) is connected to a compatible monitoring platform. Connecting external equipment or configuring the system in a way not described in these instructions will not meet this standard. Failure to use the device as instructed may increase the risk of electrical shock to the patient/operator. (chapter 12)
 - Do not wrap the main body of the oximetry cable in fabric or place directly on the patient's skin. The surface does get warm (up to 45 °C) and needs to dissipate heat to maintain its internal temperature level. A software fault will trigger if the internal temperature exceeds its limits. (chapter 12)
 - Before touching Yes to recall oximetry data, confirm that the displayed data matches the current patient. Recalling incorrect oximetry calibration data and patient demographics will result in inaccurate measurements. (chapter 12)
 - Compliance to IEC 60601-1 is only maintained when the HemoSphere tissue oximetry module (applied part connection, defibrillation proof) is connected to a compatible monitoring platform. Connecting external equipment or configuring the system in a way not described in these instructions will not meet this standard. Failure to use the device as instructed may increase the risk of electrical shock to the patient/operator. (chapter 13)
 - Inspect all of the ForeSight Elite module cable for damage prior to installation. If any damage is noted, the module must not be used until it has been serviced or replaced. Contact Edwards Technical support. There is a risk that damaged parts could reduce the performance of the module or present a safety hazard. (chapter 13)
 - To remove any chance of contamination between patients, the ForeSight Elite module and cables should be cleaned after each case. (chapter 13)
 - To reduce the risk of contamination and cross infection, if the module or cables are grossly contaminated, with blood or other bodily fluids, it should be disinfected. If the ForeSight Elite module or cables cannot be disinfected, it should be serviced, replaced or discarded. Contact Edwards Technical support. (chapter 13)
-

-
- To reduce the risk of damaging internal elements of the cables assemblies, within the ForeSight Elite module, avoid excessive pulling, bending or other types of stress on the module's cables. (chapter 13)
 - Do not modify, service or alter the product in any way. Servicing, alteration or modification may affect patient/operator safety and/or product performance (chapter 13)
 - Sensors are not sterile and therefore should not be applied on abraded, cracked, or lacerated skin. Exercise caution when applying sensors to a site with delicate skin. Applying sensors, tape or pressure to such a site may reduce circulation and/or cause skin deterioration. (chapter 13)
 - Do not place sensor over poorly perfused tissues. Avoid uneven skin surfaces for best adhesion. Do not place sensor over sites with ascites, cellulitis, pneumoencephalus, or edema. (chapter 13)
 - If electrocautery procedures will be performed, sensors and electrocautery electrodes should be placed as far apart as possible to prevent unwanted skin burns; a distance of at least 15 cm (6 in) is recommended. (chapter 13)
 - Use only Edwards supplied accessories with the ForeSight Elite module. Edwards accessories ensure patient safety and preserve the integrity, accuracy, and electromagnetic compatibility of the ForeSight Elite module. Connecting a non-Edwards sensor will cause an appropriate alert on that channel and no StO₂ values will be recorded. (chapter 13)
 - Sensors are designed for single-patient use, and are not to be reprocessed – re-used sensors present a risk of cross-contamination or infection. (chapter 13)
 - Use a new sensor for each patient and discard it after use. Disposal should follow in accordance with local hospital and institution policies. (chapter 13)
 - If a sensor seems damaged in any way, it must not be used. (chapter 13)
 - Always read the sensor packaging. (chapter 13)
 - Exercise extreme care when applying sensors. Sensor circuits are conductive and must not come into contact with other grounded, conductive parts other than EEG or entropy monitors. Such contact would bridge the patient's isolation and cancel the protection provided by the sensor. (chapter 13)
 - Failure to apply sensors properly may cause incorrect measurements. Misapplied sensors or sensors that become partially dislodged may cause either over- or under-reading of oxygen saturation. (chapter 13)
 - Do not position a sensor under the weight of the patient. Prolonged periods of pressure (such as taping over the sensor or the patient lying on a sensor) transfers weight from the sensor to the skin, which can injure skin and reduce sensor performance. (chapter 13)
 - The sensor site must be inspected at least every 12 hours to reduce the risk of inadequate adhesion, circulation, and skin integrity. If the circulatory condition or skin integrity has deteriorated, the sensor should be applied to a different site. (chapter 13)
 - Do not connect more than one patient to the ForeSight Elite module, this may compromise the patient's isolation and cancel the protection provided by the sensor. (chapter 13)
-

-
- The ForeSight Elite oximeter module has been designed to promote patient safety. All module parts are “Type BF Defibrillation Proof” and are protected against the effects of the defibrillator discharge and may remain attached to the patient. Module readings may be inaccurate during defibrillator use and up to twenty (20) seconds thereafter. (chapter 13)
 - No separate actions are required when using this equipment with a defibrillator, but only Edwards-supplied sensors must be used for proper protection against the effects of a cardiac defibrillator. (chapter 13)
 - Do not come into contact with patients during defibrillation, or serious injury or death could result. (chapter 13)
 - If the accuracy of any value displayed on the monitor is questionable, determine the patient’s vital signs by alternative means. The functions of the alarm system for patient monitoring must be verified at regular intervals and whenever the integrity of the product is in doubt. (chapter 13)
 - Testing of the ForeSight Elite module operation should be done at least once every 6 months, as described in HemoSphere service manual. Failure to comply may lead to injury. If the module fails to respond, it must not be used until it has been inspected and serviced or replaced. See technical support contact information on inside cover. (chapter 13)
 - The Acumen Hypotension Prediction Index, HPI, should not be used exclusively to treat patients. A review of the patient’s hemodynamics is recommended prior to initiating treatment. (chapter 14)
 - Only use approved HemoSphere advanced monitor accessories, cables and or components that have been supplied and labeled by Edwards. Using unapproved accessories, cables and or components may affect patient safety and measurement accuracy. (appendix B)
 - The HemoSphere advanced monitor contains no user-serviceable parts. Removing the cover or any other disassembly will expose you to hazardous voltages. (appendix F)
 - Shock or fire hazard! Do not immerse the HemoSphere advanced monitor, modules, or platform cables in any liquid solution. Do not allow any fluids to enter the instrument. (appendix F)
 - Do not, under any circumstances, perform any cleaning or maintenance of the ForeSight Elite module while the module is being used to monitor a patient. The module must be turned off and the HemoSphere advanced monitor power cord disconnected, or the module must be disconnected from the monitor and the sensors removed from the patient. (appendix F)
 - Before starting cleaning or maintenance of any sort, check the ForeSight Elite module, cables, sensors, and other accessories for damage. Check the cables for bent or broken prongs, cracks, or fraying. If any damage is noted, the module must not be used until it has been inspected and serviced or replaced. Contact Edwards Technical Support. (appendix F)
 - There is a risk of serious injury or death if this procedure is not followed. (appendix F)
 - Explosion Hazard! Do not open battery, dispose of in fire, store at high temperature or short circuit. It may ignite, explode, leak or get hot, causing serious personal injury or death. (appendix F)
 - Use of accessories, sensors, and cables other than those specified may result in increased electromagnetic emissions or decreased electromagnetic immunity. (appendix G)
 - No modification of the HemoSphere advanced monitor is allowed. (appendix G)
-

-
- Portable and mobile RF communication equipment and other sources of electromagnetic disturbance such as diathermy, lithotripsy, RFID, electromagnetic ant-theft systems and metal detectors can potentially affect all electronic medical equipment, including the HemoSphere advanced monitor. Guidance on maintaining appropriate separation between communications equipment and the HemoSphere advanced monitor is provided in table G-3. The effects of other RF emitters are unknown and may interfere with the function and safety of the HemoSphere monitoring platform. (appendix G)
-

2.3 Cautions

The following are cautions that are used in the HemoSphere advanced monitor operator's manual. They are introduced in the manual where relevant to the function or procedure being described.

-
- Federal (USA) law restricts this device to sale by or on the order of a physician.
 - Inspect the HemoSphere advanced monitor and all accessories and equipment used with the monitor for damage prior to use. Damage may include cracks, scratches, dents, exposed electrical contacts, or any signs that the housing may be compromised.
 - Always grasp the connector, not the cable, when connecting or disconnecting cables. Do not twist or bend the connectors. Confirm that all sensors and cables are connected correctly and completely before use. (chapter 3)
 - To avoid corruption of data on the HemoSphere advanced monitor, always disconnect the patient CCO cable and oximetry cable from the monitor before using a defibrillator. (chapter 3)
 - Do not expose the HemoSphere advanced monitor to extreme temperatures. Refer to environmental specifications in appendix A. (chapter 3)
 - Do not expose the HemoSphere advanced monitor to dirty or dusty environments. (chapter 3)
 - Do not obstruct the HemoSphere advanced monitor ventilation openings. (chapter 3)
 - Do not use the HemoSphere advanced monitor in environments where strong lighting makes the LCD screen difficult to view. (chapter 3)
 - Do not use the monitor as a handheld device. (chapter 3)
 - When moving the instrument, be sure to turn off the power and remove the connected power cord. (chapter 3)
 - Make sure that the HRS is correctly applied so that it can be leveled to the phlebostatic axis. (chapter 4)
 - When connecting the HemoSphere advanced monitor to external devices, refer to the external device's instruction manual for complete instructions. Verify proper operation of the system before clinical use. (chapter 6)
 - Only properly trained personnel should calibrate the HemoSphere advanced monitor analog ports. (chapter 6)
-

-
- The accuracy of continuous SVR while monitoring with the HemoSphere Swan-Ganz module depends upon the quality and accuracy of the MAP and CVP data transmitted from the external monitors. Since MAP and CVP analog signal quality from the external monitor cannot be validated by the HemoSphere advanced monitor, actual values and the values (including all derived parameters) displayed by the HemoSphere advanced monitor may not be consistent. The accuracy of continuous SVR measurement, therefore, cannot be guaranteed. To aid in determining the quality of the analog signals, regularly compare the MAP and CVP values displayed on the external monitor to the values displayed on the physio relationship screen of the HemoSphere advanced monitor. Refer to the external input device operator's manual for detailed information regarding accuracy, calibration, and other variables which may impact the analog output signal from the external monitor. (chapter 6)
 - Use a virus scan on any USB stick before inserting to prevent a virus or malware infection. (chapter 8)
 - Do not force the module into the slot. Apply even pressure to slide and click the module into place. (chapter 9)
 - Inaccurate cardiac output measurements may be caused by:
 - Incorrect placement or position of the catheter
 - Excessive variations in pulmonary artery blood temperature. Some examples that cause BT variations include, but are not limited to: * status post cardiopulmonary bypass surgery * centrally administered cooled or warmed solutions of blood products * use of sequential compression devices
 - Clot formation on the thermistor
 - Anatomical abnormalities (for example, cardiac shunts)
 - Excessive patient movement
 - Electrocautery or electrosurgical unit interference
 - Rapid changes in cardiac output (chapter 9)
 - Inaccurate 20-second flow parameter measurements may be caused by: Incorrect placement or position of the catheter • Improperly zeroed and/or leveled transducer • Over- or under-damped pressure line • Adjustments to the PAP line made after start of monitoring (chapter 9)
 - Refer to Appendix E to ensure computation constant is the same as specified in the catheter package insert. If the computation constant differs, enter the desired computation constant manually. (chapter 9)
 - Sudden changes in PA blood temperature, such as those caused by patient movement or bolus drug administration, may cause an iCO or iCI value to be computed. To avoid falsely triggered curves, inject as soon as possible after the Inject message appears. (chapter 9)
 - Do not use any FloTrac sensor or TruWave transducer past its labeled "Use By Date." Products used beyond this date may have compromised transducer or tubing performance, or compromised sterility. (chapter 10)
 - Excessive dropping of the HemoSphere pressure cable may result in cable damage and/or malfunction. (chapter 10)
 - The effectiveness of FT-CO measurements in pediatric patients has not been evaluated. (chapter 10)
-

-
- Inaccurate FT-CO measurements can be caused by factors such as: • Improperly zeroed and/or leveled sensor/transducer • Over- or under-damped pressure lines • Excessive variations in blood pressure. Some conditions that cause BP variations include, but are not limited to: * Intra-aortic balloon pumps • Any clinical situation where the arterial pressure is deemed inaccurate or not representative of aortic pressure, including but not limited to: * Extreme peripheral vasoconstriction which results in a compromised radial arterial pressure waveform * Hyperdynamic conditions as seen in post liver transplant • Excessive patient movement • Electrocautery or electrosurgical unit interference Aortic valve regurgitation may cause an over estimation of Stroke Volume / Cardiac Output calculated depending on the amount of valvular disease and the volume lost back into the left ventricle. (chapter 10)
 - Always grasp the connector, not the cable, when connecting or disconnecting the cable. (chapter 10)
 - Do not twist or bend the connectors. (chapter 10)
 - To prevent cable damage, do not apply excessive force to the pressure cable zero button. (chapter 10)
 - The effectiveness of HemoSphere noninvasive system has not been evaluated in patients under 18 years of age. (chapter 11)
 - Always grasp the connector, not the cable, when connecting or disconnecting cables. Do not twist or bend the connectors. Confirm that all sensors and cables are connected correctly and completely before use. (chapter 11)
 - Make sure that the HRS is correctly applied so that it can be leveled to the phlebostatic axis. (chapter 11)
 - The HemoSphere noninvasive system is not intended for use as an apnea monitor. (chapter 11)
 - In patients with extreme contraction of the smooth muscle in the arteries and arterioles in the lower arm and hand, such as may be present in patients with Raynaud's disease, blood pressure measurement can become impossible. (chapter 11)
 - Inaccurate noninvasive measurements can be caused by factors such as: • Improperly zeroed and/or leveled HRS • Excessive variations in blood pressure. Some conditions that cause BP variations include, but are not limited to: * Intra-aortic balloon pumps • Any clinical situation where the arterial pressure is deemed inaccurate or not representative of aortic pressure. • Poor blood circulation to the fingers. • A bent or flattened finger cuff. • Excessive patient movement of fingers or hands. • Artifacts and poor signal quality. • Incorrect placement of finger cuff, position of finger cuff, or finger cuff too loose. • Electrocautery or electrosurgical unit interference. (chapter 11)
 - Always disconnect the finger cuff when it is not wrapped around a finger, to prevent damage by accidental over-inflation. (chapter 11)
 - The effectiveness of Edwards compatible finger cuffs has not been established in pre-eclamptic patients. (chapter 11)
 - The pulsations from intra-aortic balloon support can be additive to the pulse rate on the instrument pulse rate display. Verify patient's pulse rate against the ECG heart rate. (chapter 11)
 - The pulse rate measurement is based on the optical detection of a peripheral flow pulse and therefore may not detect certain arrhythmias. The pulse rate should not be used as a replacement or substitute for ECG based arrhythmia analysis. (chapter 11)
-

-
- Monitoring without an HRS may lead to measurement inaccuracies. Ensure patient remains still with accurately measured finger to heart height difference. (chapter 11)
 - Do not place the patient in a non-supine position while monitoring without an HRS. This may lead to an inaccurate vertical offset entry for the HRS and measurement inaccuracies. (chapter 11)
 - Do not perform a BP calibration during monitoring periods when blood pressure appears unstable. This may result in inaccurate blood pressure measurements. (chapter 11)
 - Make sure that the oximetry cable is securely stabilized to prevent unnecessary movement of the attached catheter. (chapter 12)
 - The catheter tip or calibration cup must not get wet before an in vitro calibration is performed. The catheter and the calibration cup must be dry for an accurate oximetry in vitro calibration. Flush the catheter lumen only after the in vitro calibration has been completed. (chapter 12)
 - Performing an in vitro calibration after the oximetry catheter has been inserted into the patient will yield an inaccurate calibration. (chapter 12)
 - The SQI signal is sometimes affected by the use of electro-surgical units. Attempt to distance electrocautery equipment and cables from the HemoSphere advanced monitor and plug the power cords into separate AC circuits if possible. If signal quality problems persist, call your local Edwards representative for assistance. (chapter 12)
 - Do not disconnect the oximetry cable while calibration or data recall are in process. (chapter 12)
 - If the oximetry cable is being transferred from a HemoSphere advanced monitor to another HemoSphere advanced monitor, check that the patient height, weight, and BSA are correct prior to beginning monitoring. Re-enter patient data, if necessary. (chapter 12)
 - Avoid placing the ForeSight Elite module where the status LED cannot be easily seen. (chapter 13)
 - Applying too much pressure may break the retaining tab, which may present a risk of the module falling on the patient, bystander, or operator. (chapter 13)
 - Do not lift or pull the ForeSight Elite module by any cable, or place the module in any position that might present a risk that the module may fall on the patient, bystander or operator. (chapter 13)
 - Avoid placing the ForeSight Elite module under sheets, or blanket that could restrict air flow around the module that may increase the module's case temperature and present an injury. (chapter 13)
 - Do not force the module into the slot. Apply even pressure to slide and click the module into place. (chapter 13)
 - Sensors should not be placed on high density hair areas. (chapter 13)
 - The sensor must be able to rest flush with clean, dry skin. Any debris, lotion, oil, powder, perspiration, or hair that prevents good contact between the sensor and the skin will affect the validity of the data collected and may result in an alarm message. (chapter 13)
 - When used in settings with LED lighting, sensors may need to be covered with a light blocker prior to connection to the sensor cable, as some high intensity systems can interfere with the sensor's near infrared light detection. (chapter 13)
 - Do not lift or pull the ForeSight Elite module by any cable, or place the ForeSight Elite module in any position that might present a risk that the module may fall on the patient, bystander or operator. (chapter 13)
-

-
- Once patient monitoring has started, do not replace the sensor or disconnect the sensor for more than 10 minutes to avoid restarting the initial StO₂ calculation. (chapter 13)
 - Measurements may be affected in the presence of strong electromagnetic sources such as electro-surgery equipment, and measurements may be inaccurate during use of such equipment. (chapter 13)
 - Elevated levels of carboxyhemoglobin (COHb) or methemoglobin (MetHb) may lead to inaccurate or erroneous measurements, as may intravascular dyes or any substance containing dyes that change usual blood pigmentation. Other factors that may affect measurement accuracy include: myoglobin, hemoglobinopathies, anemia, pooled blood under the skin, interference from foreign objects in the Sensor path, Bilirubinemia, externally applied coloring (tattoos), high levels of Hgb or Hct and birthmarks. (chapter 13)
 - The effectiveness of the HPI parameter has been established using radial arterial pressure waveform data. The effectiveness of the HPI parameter using arterial pressure from other sites (e.g., femoral) has not been evaluated. (chapter 14)
 - The HPI parameter may not provide advanced notice of a trend towards a hypotensive event in situations where a clinical intervention results in a sudden non-physiological hypotensive event. If this occurs, the HPI feature will provide the following without delay: a high alert popup, a high priority alarm, and an HPI value of 100 will be displayed indicating that the patient is undergoing a hypotensive event. (chapter 14)
 - Exercise caution when using dP/dt in patients with severe aortic stenosis, since the stenosis may reduce the coupling between the left ventricle and the afterload. (chapter 14)
 - The dP/dt parameter, although predominantly determined by changes in LV contractility, may be impacted by afterload during periods of vasoplegic states (venoarterial decoupling). During these periods, dP/dt may not reflect changes in LV contractility. (chapter 14)
 - The HPI parameter information provided in table 14-13, table 14-14, table 14-15, and table 14-16 are presented as general guidance and may not be representative of individual experience. A review of the patient's hemodynamics is recommended prior to initiating treatment. See Clinical Application on page 227. (chapter 14)
 - If any of the ForeSight Elite module LEDs fail to turn on, the module must not be used until it has been serviced or replaced. Contact Edwards Technical Support. There is a risk that damaged parts could reduce the performance of the module. (chapter 15)
 - Clean and store the instrument and accessories after each use. (appendix F)
 - The HemoSphere advanced monitor modules and platform cables are electrostatic discharge (ESD) sensitive. Do not attempt to open cable or module housing or use if the housing has been damaged. (appendix F)
 - Do not pour or spray liquid on any portion of the HemoSphere advanced monitor, accessories, modules, or cables. (appendix F)
 - Do not use any disinfecting solution other than the types specified. (appendix F)
-

-
- DO NOT: Allow any liquid to come in contact with the power connector. Allow any liquid to penetrate connectors or openings in the monitor case or modules. If any liquid does come in contact with any of the above mentioned items, DO NOT attempt to operate the monitor. Disconnect power immediately and call your Biomedical Department or local Edwards representative. (appendix F)
 - Conduct periodic inspections of all cables for defects. Do not coil cables tightly when storing. (appendix F)
 - Do not use any other cleaning agents, spray, or pour cleaning solution directly on platform cables. Do not steam, radiate, or EO sterilize platform cables. Do not immerse platform cables. (appendix F)
 - Do not steam, radiate, or EO sterilize the HemoSphere oximetry cable. Do not immerse the HemoSphere oximetry cable. (appendix F)
 - If any electrolytic solution, for example Ringer's lactate solution, is introduced into the cable connectors while they are connected to the monitor, and the monitor is turned on, the excitation voltage can cause electrolytic corrosion and rapid degradation of the electrical contacts. (appendix F)
 - Do not immerse any cable connectors in detergent, isopropyl alcohol or glutaraldehyde. (appendix F)
 - Do not use a hot air gun to dry cable connectors. (appendix F)
 - Device contains electronics. Handle with care. (appendix F)
 - Do not disinfect the heart reference sensor or pressure controller by autoclave or gas sterilization. (appendix F)
 - Do not immerse any cable connectors in fluid. (appendix F)
 - Clean and store the heart reference sensor after each use. (appendix F)
 - Recycle or dispose of the lithium-ion battery in accordance to all federal, state, and local laws. (appendix F)
 - The instrument has been tested and complies with the limits of IEC 60601-1-2. These limits are designed to provide reasonable protection against harmful interference in a typical medical installation. This equipment generates, uses and can radiate radio frequency energy and, if not installed and used in accordance with the instructions, may cause harmful interference to other devices in the vicinity. However, there is no guarantee that interference will not occur in a particular installation. If this equipment does cause harmful interference to other devices which can be determined by turning the equipment off and on, the user is encouraged to try to correct the interference by one or more of the following measures:
 - Reorient or relocate the receiving device.
 - Increase the separation between the equipment.
 - Consult the manufacturer for help.(appendix G)
-

2.4 User Interface Symbols

The following are icons that appear on the HemoSphere advanced monitor screen. For more information about screen appearance and navigation, see chapter 5, *Navigating the HemoSphere Advanced Monitor*. Certain icons will only appear while monitoring with a specific hemodynamic technology module or cable, as specified.

Table 2-1 Monitor display symbols













Symbol	Description
Navigation Bar Icons	
	Select Monitoring Mode
	Begin CO monitoring (HemoSphere Swan-Ganz module)
	Stop CO monitoring with CO countdown timer (see <i>CO Countdown Timer</i> on page 152) (HemoSphere Swan-Ganz module)
	Start noninvasive monitoring (HemoSphere ClearSight module)
	Stop noninvasive monitoring (HemoSphere ClearSight module)
	Resume noninvasive monitoring after cuff pressure release (HemoSphere ClearSight module)
	Zero & Waveform
	GDT Tracking
	Settings menu
	Home (return to main monitoring screen)
	Display pressure waveform
	Hide pressure waveform
	Silence audible alarms

Table 2-1 Monitor display symbols (continued)













Symbol	Description
	Alarms paused (silenced) with countdown timer (See <i>Silence Audible Alarms</i> on page 86)
	Resume monitoring with elapsed time from monitoring pause
Clinical Tools Menu Icons	
	Select Monitoring Mode
	iCO (intermittent cardiac output) (HemoSphere Swan-Ganz module)
	Venous Oximetry Calibration (HemoSphere oximetry cable)
	Enter CVP
	Derived Value Calculator
	Event Review
	Zero & Waveform
	Patient CCO Cable Test (HemoSphere Swan-Ganz module)
	HPI Secondary Screen (advanced feature)
	Fluid Responsiveness Test (advanced feature)
	Calibration (ClearSight BP) (HemoSphere ClearSight module)

Table 2-1 Monitor display symbols (continued)



















Symbol	Description
	Patient Data
Menu Navigation Icons	
	Return to main monitoring screen
	Return to previous menu
	Cancel
	Scroll to select item on vertical list
	Vertical page scroll
	Horizontal scroll
	Enter
	Keypad enter key
	Keypad backspace key
	Move cursor left by 1 character
	Move cursor right by 1 character
	Keypad cancel key
	Item enabled
	Item not enabled
	Clock/waveform - allows user to view historical data or intermittent data
Parameter Tile Icons	
	Alarms / Targets menu: parameter audible alarm indicator enabled
	Alarms / Targets menu: parameter audible alarm indicator disabled

Table 2-1 Monitor display symbols (continued)



















Symbol	Description
	Signal quality indicator bar See <i>Signal Quality Indicator</i> on page 195 (HemoSphere oximetry cable) See <i>SQL</i> on page 187 (HemoSphere ClearSight module)
	SVV Filtering Exceeded Indicator: High degree of pulse rate variability may be impacting SVV values
	Venous Oximetry Calibration (not calibrated) (HemoSphere oximetry cable)
	Venous Oximetry Calibration (calibrated) (HemoSphere oximetry cable)
Information Bar Icons	
	HIS enabled icon on information bar See table 8-2 on page 143
	Snapshot (screen capture)
	Battery life indicator icons on information bar See table 5-5 on page 113
	Screen Brightness
	Alarm Volume
	Lock Screen
	Help menu shortcut
	Event Review
	Beat-to-beat heart rate (HemoSphere Swan-Ganz module with ECG input)
	Wi-Fi signal See table 8-1 on page 142
	Time until cuff pressure release mode (HemoSphere ClearSight module, see <i>Cuff Pressure Release Mode</i> on page 188)
	Time until conclusion of cuff pressure release mode (HemoSphere ClearSight module, see <i>Cuff Pressure Release Mode</i> on page 188)
Intervention Analysis Icons	
	Intervention analysis button
	Intervention analysis type indicator for custom event (gray)

Table 2-1 Monitor display symbols (continued)













Symbol	Description
	Intervention analysis type indicator for positional challenge (purple)
	Intervention analysis type indicator for a fluid challenge (blue)
	Intervention analysis type indicator for intervention (green)
	Intervention analysis type indicator for oximetry (red)
	Intervention analysis type indicator for event (yellow)
	Edit icon on intervention information balloon
	Keyboard icon for entering notes on intervention edit screen

Table 2-1 Monitor display symbols (continued)

Symbol	Description
GDT Tracking Icons	
	Add Target button on GDT Tracking Screen
	Target Value button on GDT Tracking Screen
	Exit Target Selection button on GDT Tracking Screen
	Edit Target button on GDT Tracking Screen
	Time-In-Target symbol on GDT Tracking Screen
HPI Icons	
	HPI Secondary Screen shortcut key

2.5 Symbols on Product Labels

This section provides the symbols that are on the HemoSphere advanced monitor and other available HemoSphere advanced monitoring platform accessories.

Table 2-2 Symbols on product labels





Symbol	Description
	Manufacturer
	Date of manufacture
Rx only	Caution: Federal (USA) law restricts this device to sale by, or on the order of a physician.
IPX1	Provides protection against vertically falling water to IPX1 standard
IPX4	Provides protection against water splashing in any direction to IPX4 standard
	Separate collection for electrical and electronic equipment in accordance with EC directive 2012/19/EU.
	Restriction of Hazardous Substances (RoHS) compliance - China only
	Federal Communications Commission (FCC) compliance - USA only

Table 2-2 Symbols on product labels (continued)







Symbol	Description
	This device contains a non-ionizing radiation transmitter, which can cause RF interference with other devices near this device.
 eifu.edwards.com + 1 888 570 4016	Follow instructions for use on the website
	Instructions for use in electronic form is available by phone or website address.
	Intertek ETL
	Catalogue number
	Serial number
	Authorized representative in the European Community

Table 2-2 Symbols on product labels (continued)













Symbol	Description
	MR unsafe
	Conformité Européenne (CE Mark) of TÜV SÜD Product Service GmbH (notified body)
	Conformité Européenne (CE Mark)
	Batch code
	Part number
	Quantity
	Lead-free
	Underwriters Laboratories product certification mark
	Recyclable Lithium-Ion
	Technical conformity mark (Japan)
	Do not disassemble
	Do not incinerate
	Medical device
	Importer
Connector Identification Labels	
	Equipotential terminal stud
	USB 2.0
	USB 3.0

Table 2-2 Symbols on product labels (continued)











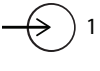
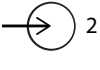



Symbol	Description
	Ethernet connection
	Analog input 1
	Analog input 2
	Pressure (DPT) output
	Defibrillation proof type CF applied part or connection
	Defibrillation proof type BF applied part or connection
	Type BF applied part or connection
	Continuous noninvasive arterial blood pressure
	ECG input from external monitor
	High-Definition Multimedia Interface output
	Connector: serial COM output (RS232)
Additional Packaging Labels	
	Keep dry
	Fragile, handle with care
	This end up
	Do not use if package is damaged
	Box made from recyclable cardboard
	Keep away from sunlight

Table 2-2 Symbols on product labels (continued)

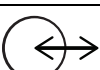

Symbol	Description
	Temperature limit (X = lower limit, Y = upper limit)

Table 2-2 Symbols on product labels (continued)

Symbol	Description
	Humidity limitation (X = lower limit, Y = upper limit)

NOTE For all accessory product labels, refer to symbol table contained in accessory instructions for use.

2.6 Applicable Standards

Table 2-3 Applicable standards

Standard	Title
IEC 60601-1:2005 / A1:2012	Medical electrical equipment — Part 1: General requirements for basic safety and essential performance + amendment 1 (2012)
IEC 60601-1-2: 2014	Medical electrical equipment — Part 1-2: General requirements for basic safety and essential performance — Collateral standard: Electromagnetic compatibility - Requirements and tests
IEC 60601-2-34: 2011	Medical electrical equipment — Part 2-34: Particular requirements for the basic safety and essential performance of invasive blood pressure monitoring equipment
IEC 60601-2-49:2011/ IEC 80601-2-49:2018	Medical electrical equipment — Part 2-49: Particular requirements for the basic safety and essential performance of multifunction patient monitoring equipment/monitors
IEEE 802.11 b/g/n	Telecommunications and information exchange between systems Local and metropolitan area networks — Specific requirements Part 11: Wireless LAN Medium Access Control (MAC) and Physical Layer (PHY) Specifications

2.7 HemoSphere Advanced Monitor Essential Performance

The platform shall provide display of continuous CO and intermittent CO with a compatible Swan-Ganz catheter according to the specifications provided in appendix A. The platform shall provide display of intravascular blood pressure with a compatible FloTrac or Acumen IQ sensor or compatible TruWave DPT according to the specifications provided in appendix A. The platform shall provide display of SvO₂/ScvO₂ with a compatible oximetry catheter according to the specifications provided in appendix A. The platform shall provide noninvasive measurement of arterial blood pressure with a compatible Edwards finger cuff according to the specifications provided in appendix A. The platform shall provide display of StO₂ with a compatible oximetry module and sensor according to the specifications provided in appendix A. The platform shall provide alarm, alert, indicator, and/or system status when unable to provide accurate measurement of the applicable hemodynamic parameter. For more information, see *Essential Performance Characteristics* on page 278.

Device performance, including functional characteristics, have been verified in a comprehensive series of testing to support the safety and performance of the device for its intended use when used in accordance with the established Instructions For Use.

Installation and Setup

Contents

Unpacking	57
HemoSphere Advanced Monitor Connection Ports	60
HemoSphere Advanced Monitor Installation	63
Initial Start Up	67

3.1 Unpacking

Examine the shipping container for any signs of damage that may have occurred during transit. If any damage is detected, photograph the package and contact Edwards technical support for assistance. Do not use if the package or contents are damaged. Perform a visual inspection of the packaging contents for damage. Damage may include cracks, scratches, dents or any signs that the monitor, modules or cable housing may be compromised. Report any evidence of external damage.

3.1.1 Packaging Contents

The HemoSphere advanced monitoring platform is modular and therefore packaging configurations will vary depending upon the kit ordered. The HemoSphere advanced monitoring system, which is the base kit configuration, contains the HemoSphere advanced monitor, mains power cord, power entry cover, HemoSphere battery pack, two expansion modules, one L-Tech expansion module, a quick start guide and a USB stick containing this operator's manual. See table 3-1. Additional items that may be included and shipped with other kit configurations include the HemoSphere Swan-Ganz module, patient CCO cable, and HemoSphere oximetry cable. Disposable and accessory items may be delivered separately. It is recommended that the user confirm the receipt of all ordered equipment. Refer to appendix B: *Accessories*, for a full list of available accessories.

Table 3-1 HemoSphere advanced monitoring components

HemoSphere advanced monitoring system (base kit)
<ul style="list-style-type: none"> • HemoSphere advanced monitor • HemoSphere battery pack • mains power cord • power entry cover • L-Tech expansion module • expansion module (2) • quick start guide • operator's manual (on USB stick)

3.1.2 Required Accessories for Platform Modules and Cables

The following tables identify accessories required to display specific monitored and calculated parameters for the specified hemodynamic technology module or cable:

Table 3-2 Cables and catheters required for monitoring parameters with HemoSphere Swan-Ganz module

Required cable/catheter	Monitored and calculated parameters							
	CO	CO _{20s}	EDV	RVEF	SVR	iCO	SV	SV _{20s}
patient CCO cable	•	•	•	•	•	•	•	•
ECG cable			•	•			•	•
analog pressure input cable(s)					•			
injectate temperature probe						•		
Swan-Ganz thermodilution catheter						•		
Swan-Ganz CCO catheter or Swan-Ganz CCombo catheter	•				•	•	•	
Swan-Ganz CCombo V catheter	•	•	•	•	•	•	•	•
TruWave transducer*		•						•

* 20 second flow parameters are only available while monitoring with a CCombo V catheter (models 777F8 and 774F75) and require a pulmonary artery pressure signal through a HemoSphere pressure cable connection. See 20-Second Flow Parameters on page 153.

NOTE Not all parameters can be monitored or calculated in pediatric patients. See table 1-1 on page 24 for available parameters.

Table 3-3 Sensor options for monitoring parameters with HemoSphere pressure cable

Pressure sensor/transducer options	Monitored and calculated parameters								
	CO	SV	SVV/PPV	SVR	PR	SYS/DIA/MAP	MPAP	CVP	HPI/dP/dt / E _a dyn
FloTrac sensor	•	•	•	*	•	•			
TruWave transducer					•	•	•	•	
Acumen IQ sensor	•	•	•	*	•	•			•

***NOTE** A CVP analog input signal, CVP monitoring, or CVP manual entry is needed to calculate SVR.

Table 3-4 Finger cuff options for monitoring parameters with HemoSphere ClearSight module

Finger cuff options (one required)	Monitored and calculated parameters						
	CO	SV	SVV/ PPV	SVR	PR	SYS/ DIA/ MAP	HPI/ dP/dt / Ea _{dyn}
ClearSight finger cuff	•	•	•	*	•	•	
Acumen IQ finger cuff	•	•	•	*	•	•	•

***NOTE** A CVP analog input signal, CVP monitoring, or CVP manual entry is needed to calculate SVR

Table 3-5 Catheters required for monitoring parameters with HemoSphere oximetry cable

Required catheter	Monitored and calculated parameters	
	ScvO ₂	SvO ₂
PediaSat oximetry catheter or compatible central venous oximetry catheter	•	
Swan-Ganz oximetry catheter		•

Table 3-6 Accessories required for monitoring parameters with HemoSphere tissue oximetry module

Required accessory	Tissue oximetry (StO ₂)
ForeSight Elite module	•
ForeSight Elite sensor	•

WARNING **Shock hazard!** Do not attempt to connect/disconnect system cables while hands are wet. Ensure that hands are dry prior to disconnecting system cables.

CAUTION Always grasp the connector, not the cable, when connecting or disconnecting cables. Do not twist or bend the connectors. Confirm that all sensors and cables are connected correctly and completely before use.

To avoid corruption of data on the HemoSphere advanced monitor, always disconnect the patient CCO cable and oximetry cable from the monitor before using a defibrillator.

3.2 HemoSphere Advanced Monitor Connection Ports

The following monitor views illustrate the connection ports and other key features of the front, rear, and side panels of the HemoSphere advanced monitor.

3.2.1 Monitor Front

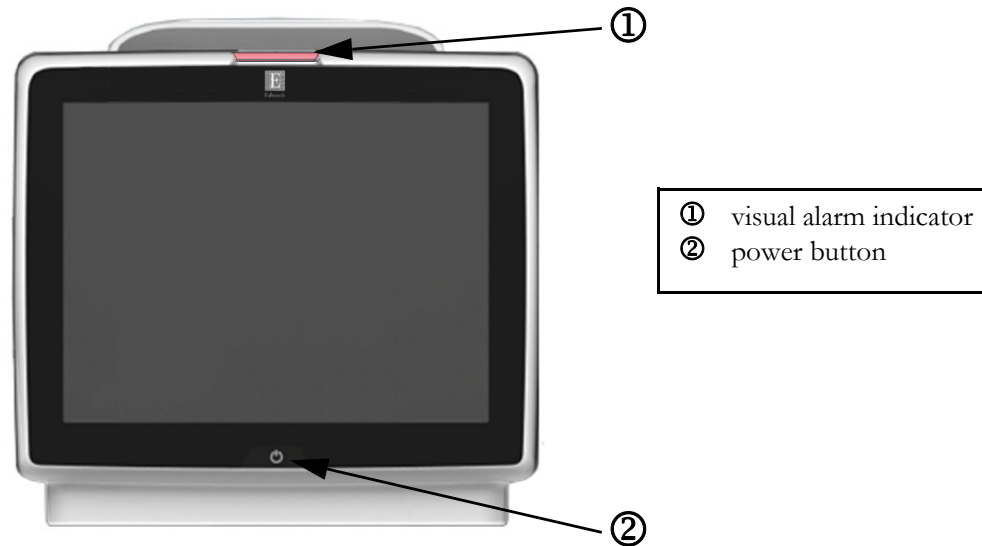

Figure 3-1 HemoSphere advanced monitor front view

3.2.2 Monitor Rear

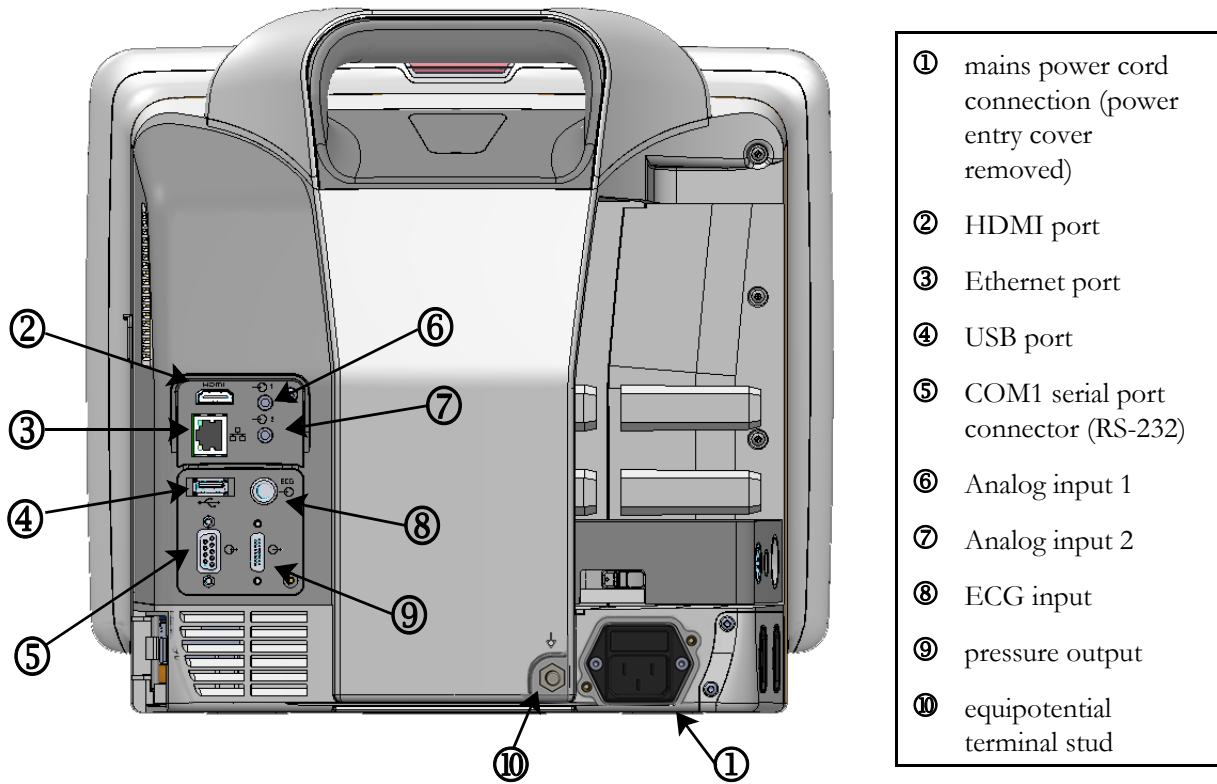

Figure 3-2 HemoSphere advanced monitor rear view (shown with HemoSphere Swan-Ganz module)

3.2.3 Monitor Right Panel

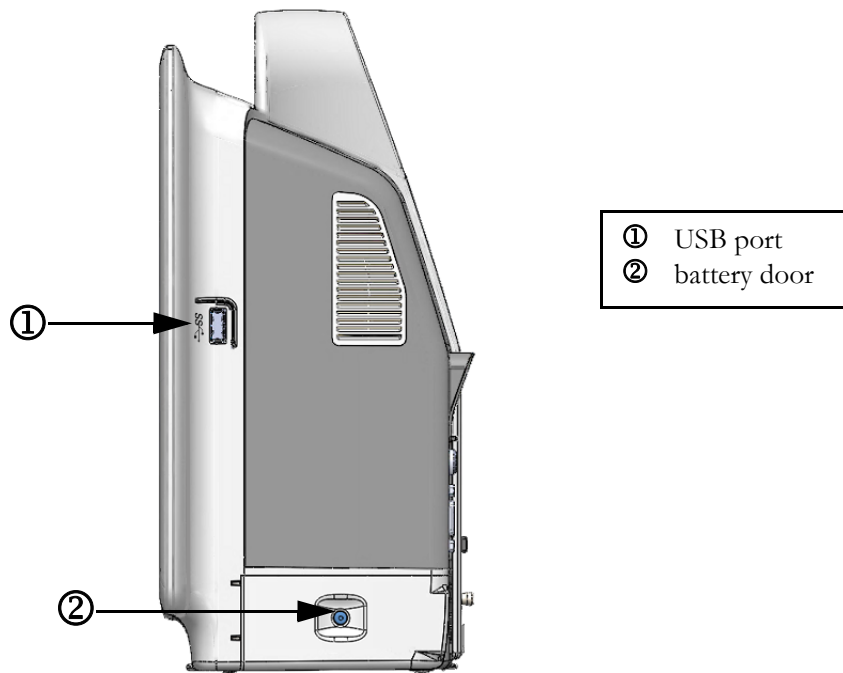

Figure 3-3 HemoSphere advanced monitor right panel

3.2.4 Monitor Left Panel

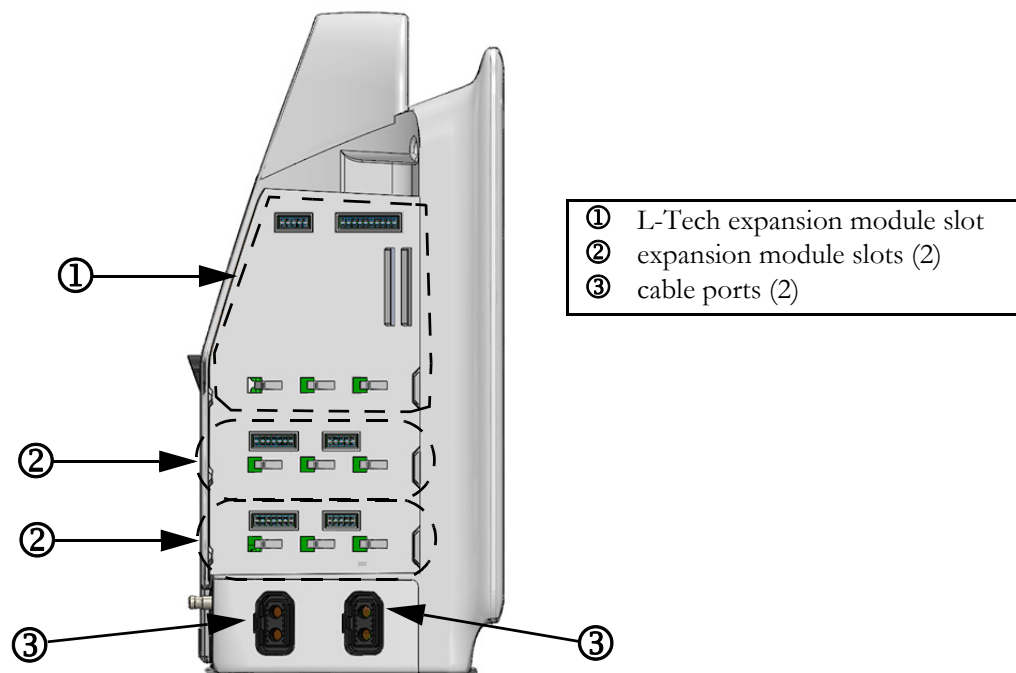

Figure 3-4 HemoSphere advanced monitor left panel (shown with no modules)

3.3 HemoSphere Advanced Monitor Installation

3.3.1 Mounting Options and Recommendations

The HemoSphere advanced monitor should be placed on a stable flat surface or securely mounted on a compatible stand, according to your institution's practices. The operator should be positioned in front of the monitor and at close proximity during use. The device is intended to be used by only one user at a time. A roll stand for the HemoSphere advanced monitor is available as an optional accessory. See *Additional Accessories Description* on page 292 more information. Contact your local Edwards representative for recommendations on additional mounting options.

WARNING **Explosion Hazard!** Do not use the HemoSphere advanced monitor in the presence of flammable anesthetic mixture with air or with oxygen or nitrous oxide.

This product contains metallic components. Do NOT use in a Magnetic Resonance (MR) environment.

Make sure the HemoSphere advanced monitor is securely positioned or mounted and that all cords and accessory cables are appropriately arranged to minimize the risk of injury to patients, users or the equipment.

Do not stack additional equipment or items on top of the HemoSphere advanced monitor.

The HemoSphere advanced monitor must be positioned in an upright position to ensure IPX1 ingress protection.

Do not allow any liquids to splash onto the monitoring screen. Liquid buildup may disable the touchscreen functionality.

Do not position the monitor so that it is difficult to access rear panel ports or power cord.

Equipment is rated for use with high-frequency surgical equipment. Inaccurate parameter measurements can be caused by interference from high-frequency surgical equipment. To reduce hazards that can arise from the use of high-frequency surgical equipment, only use undamaged patient cables and accessories connected as specified in this operator's manual.

This system is rated for use with defibrillators. To ensure proper defibrillator-proof operation, only use undamaged patient cables and accessories connected as specified in this operators manual.

All IEC/EN 60950 equipment, including printers, to be positioned no closer than 1.5 meters to the patient's bed.

CAUTION Do not expose the HemoSphere advanced monitor to extreme temperatures. Refer to environmental specifications in appendix A.

Do not expose the HemoSphere advanced monitor to dirty or dusty environments.

CAUTION Do not obstruct the HemoSphere advanced monitor ventilation openings.

Do not use the HemoSphere advanced monitor in environments where strong lighting makes the LCD screen difficult to view.

Do not use the monitor as a handheld device.

3.3.2 Battery Installation

Open the battery door (figure 3-3) and insert the battery into the battery bay, ensuring pack is fully inserted and seated. Close the battery door and ensure that the latch is securely fastened. Follow instructions below to connect the power cord and then fully charge the battery. Do not use a new battery pack as a power source until it has been fully charged.

NOTE To ensure that the battery charge level displayed on the monitor is accurate, please condition the battery before first use. For information on battery maintenance and conditioning, see *Battery Maintenance* on page 313.

The HemoSphere battery pack is intended as a backup power source during power-loss and can only support monitoring for a limited time period.

WARNING Make sure the battery is fully inserted and the battery door is properly latched. Falling batteries could seriously injure patients or clinicians.

Only use Edwards approved batteries with the HemoSphere advanced monitor. Do not charge the battery pack outside of the monitor. Doing so can damage the battery or injure the user.

To prevent any interruptions to monitoring during power loss, it is recommended to use the HemoSphere advanced monitor with the battery inserted.

In cases of power failure and battery depletion, the monitor will go through a controlled shut off procedure.

3.3.3 Connecting Power Cord

Before connecting the power cord to the rear panel of the monitor, ensure that the power entry cover is installed:

- 1 If the power entry cover is already installed, remove the two screws (figure 3-5) that attach the power entry cover to the rear panel of the monitor.
- 2 Connect the detachable power supply cord. Ensure that the plug is seated securely.
- 3 Attach the power cord entry cover over the plug by routing the power cord through the cover opening and then pressing the cover and gasket up against the rear panel of the monitor, aligning the two screw holes.
- 4 Reinsert the screws to fasten the cover onto the monitor.

- 5 Plug power cord into a hospital grade outlet.

WARNING Do not use the HemoSphere advanced monitoring platform without an installed power cord entry cover. Failure to do so may result in fluid ingress.

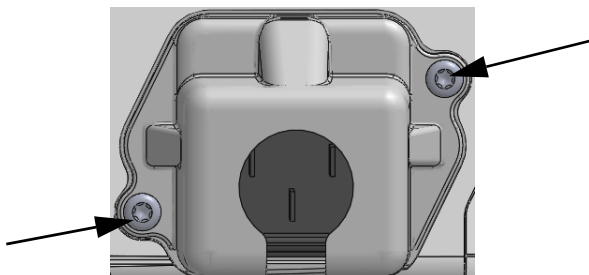

Figure 3-5 HemoSphere advanced monitor power entry cover - screw locations

3.3.3.1 Equipotential Connection

This monitor **MUST** be grounded during operation (Class I equipment according to IEC 60601-1). If a hospital grade or three-prong receptacle is not available, a hospital electrician must be consulted to ensure proper grounding. An equipotential terminal is provided on the rear panel of the monitor (figure 3-2) to be connected to an equipotential grounding system (equipotential cable).

WARNING Do not use extension cords or multiple socket devices to connect the power cord. Do not use detachable power cords other than the power cord provided.

To avoid the risk of electric shock, the HemoSphere advanced monitor can only be connected to a supply mains with grounding (protective earth). Do not use three prong to two prong power adaptors.

Grounding reliability can only be achieved when the instrument is connected to a receptacle marked “hospital only”, “hospital grade”, or its equivalent.

Disconnect the monitor from the AC source by unplugging mains power cable from the AC Mains. The On/Off button on the monitor does not disconnect the system from the AC mains supply.

CAUTION When moving the instrument, be sure to turn off the power and remove the connected power cord.

3.3.4 Connecting and Disconnecting a Hemodynamic Monitoring Module

The HemoSphere advanced monitor is shipped with two standard expansion modules and one L-Tech expansion module. Before inserting a new monitoring technology module, remove the expansion module by pressing the release button to unlatch and slide the blank module out.

Inspect the new module for external damage before installation. Insert the desired monitoring module into the open slot by applying even pressure to slide and click the module into place.

3.3.5 Connecting and Disconnecting a Hemodynamic Monitoring Cable

Both monitoring cable ports are equipped with a magnetic latch mechanism. Inspect the cable for damage before connecting. A monitoring cable will snap into place when it is properly seated in the port. To disconnect a cable, hold at the plug to pull it away from the monitor.

3.3.6 Connecting Cables from External Devices

The HemoSphere advanced monitor utilizes slaved-in monitored data to calculate certain hemodynamic parameters. This includes data from the pressure input data ports and ECG monitor input port. All slaved-in cable connections are located on the rear panel of the monitor (figure 3-2). See *Required Accessories for Platform Modules and Cables* on page 58 for a list of calculated parameters available with certain cable connections. For more information on configuring the analog pressure ports, see *Analog Pressure Signal Input* on page 126.

IMPORTANT NOTE

The HemoSphere advanced monitor is compatible with pressure and ECG analog slave inputs from any external patient monitor that has analog slave output ports which meet the signal input specifications identified in appendix A, table A-5 of this operator's manual. These provide a convenient means to utilize information from a patient monitor to calculate additional hemodynamic parameters for display. This is an optional feature that does not impact the HemoSphere advanced monitor's primary function of monitoring cardiac output (with the HemoSphere Swan-Ganz module) or venous oxygen saturation (with the HemoSphere oximetry cable).

WARNING

Only use HemoSphere advanced monitor accessories, cables and or components that have been supplied and labeled by Edwards. Using other unlabeled accessories, cables and or components may affect patient safety and measurement accuracy.

3.4 Initial Start Up

3.4.1 Start Up Procedure

To turn on and off the monitor, press the power button located on the front panel. After turning on the monitor, the Edwards screen is displayed followed by the Power-On Self Test (POST) screen. The POST verifies the monitor meets basic operating requirements by exercising critical hardware components and is performed each time the system is turned on. POST status message is displayed on the startup screen along with system information such as serial numbers and software version numbers.

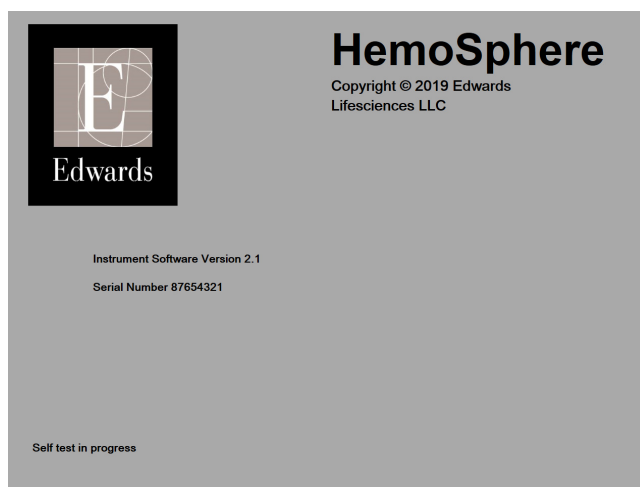

Figure 3-6 Startup screen

NOTE If the diagnostic tests detect an error condition, a system error screen will replace the startup screen. See chapter 15: *Troubleshooting* or appendix F: *System Care, Service and Support*. Otherwise, call your Edwards Lifesciences representative for assistance.

3.4.2 Select Language

Upon initial HemoSphere advanced monitor startup, language options are offered which affect the displayed language, time and date formats, and units of measurement. The language selection screen appears after the software has initialized and POST is complete. Selecting the language also sets the display units and the time and date format to the default settings for that language (see appendix D: *Monitor Settings and Defaults*).

Each of the language-related settings can be changed later in the **Date/Time** screen of the **General Settings** screen and in the language option through **Settings** → **General**.

When the language selection screen appears, touch the desired language for use.



Figure 3-7 Language selection screen

NOTE Figure 3-6 and figure 3-7 are examples of startup and language selection screens.

HemoSphere Advanced Monitor Quick Start

Contents

HemoSphere Swan-Ganz Module Cardiac Output Monitoring	70
Monitoring with the HemoSphere Pressure Cable	73
HemoSphere Oximetry Cable Monitoring	75
HemoSphere Tissue Oximetry Module Monitoring	78
HemoSphere ClearSight Module Monitoring	80

NOTE This chapter is intended for experienced clinicians. It provides brief instructions for using the HemoSphere advanced monitor. Refer to the manual chapters for more detailed information, warnings, and cautions.

4.1 HemoSphere Swan-Ganz Module Cardiac Output Monitoring

Refer to figure 4-1 for HemoSphere Swan-Ganz module monitoring connections.

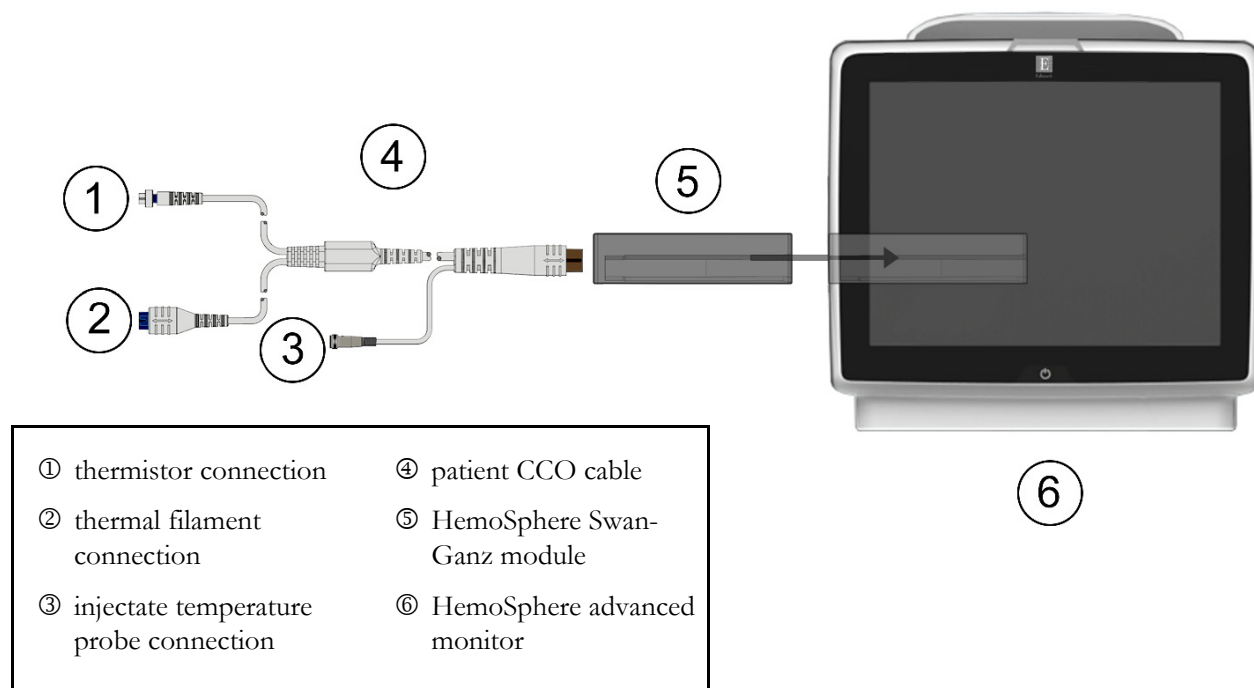

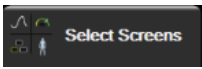





Figure 4-1 HemoSphere Swan-Ganz module monitoring connection overview

- 1 Insert the HemoSphere Swan-Ganz module into the monitor. The module will click when properly engaged.
- 2 Press the power button to turn on the HemoSphere advanced monitor. All functions are accessed through the touch screen.
- 3 Select **Continue Same Patient** button or **New Patient** button and enter new patient data.
- 4 Connect the patient CCO cable to the HemoSphere Swan-Ganz module.
- 5 Select the **Invasive** monitoring mode button on the **Monitoring Mode Selection** window.
- 6 Touch **Start Monitoring** to begin monitoring.
- 7 Touch the settings icon  → **Select Screens** tab  to select the desired monitoring screen view.
- 8 Touch inside of a parameter tile to select the desired key parameter from the parameter tile configuration menu.
- 9 Touch within a parameter tile to adjust **Alarms / Targets**.
- 10 Depending on catheter type, continue to step 1 in one of the following sections:
 - section 4.1.1 for CO monitoring
 - section 4.1.2 for iCO monitoring
 - section 4.1.3 for EDV monitoring



4.1.1 Continuous Cardiac Output Monitoring

Follow steps 1-10 at the start of section 4.1 before proceeding.



- 1 Attach the thermistor ① and thermal filament ② Swan-Ganz CCO catheter connections (figure 4-1) to the patient CCO cable.
- 2 Verify that the catheter is properly inserted into the patient.
- 3 Touch the start monitoring icon . A countdown clock will appear on the stop monitoring icon  to indicate the time until the first CO value. After approximately 5 to 12 minutes, when sufficient data has been obtained, a CO value will appear in the parameter tile.
- 4 The time until the next CO measurement is displayed below the stop monitoring icon . For shorter time spans between calculations, select STAT CO (sCO) as a key parameter. sCO is a fast estimate of the CO value. 20-second flow parameters (CO_{20s}/CI_{20s} and SV_{20s}/SVI_{20s}) are available when monitoring pulmonary artery pressure with a connected HemoSphere pressure cable and TruWave DPI.
- 5 Touch the stop monitoring icon  to stop CO monitoring.

4.1.2 Intermittent Cardiac Output Monitoring

Follow steps 1-10 at the start of section 4.1 before proceeding.

- 1 Attach the Swan-Ganz catheter thermistor connection (①, figure 4-1) to the patient CCO cable.
- 2 Connect the injectate temperature probe to the injectate temperature probe connector ③ on the patient CCO cable. The injectate system type (in-line or bath) is automatically detected.
- 3 Touch settings icon  → **Clinical Tools** tab  **Clinical Tools** → iCO icon .
- 4 Select the following settings on the new set configuration screen:
 - **Injectate Volume:** 10 mL, 5 mL, or 3 mL (bath type probe only)
 - **Catheter Size:** 5.5F, 6F, 7F, 7.5F, or 8F
 - **Comp Constant:** Auto, or keypad appears for manual entry when selected

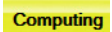

NOTE The computation constant is automatically calculated according to injectate system type, injectate volume and catheter size. If the computation constant is manually entered, the injectate volume and catheter size selections are set to **Auto**.

- **Bolus Mode:** Auto or Manual
- 5 Touch the **Start Set** button.
 - 6 If in automatic bolus mode, **Wait** appears highlighted () until the thermal baseline is achieved. If in manual bolus mode, **Ready** () will appear highlighted when the thermal baseline is achieved. Touch the **Inject** button first to start the bolus procedure.

- 7 When **Inject** becomes highlighted (), use a rapid, smooth, continuous method to inject the bolus with the volume amount previously selected.
- 8 **Computing** is highlighted () and then the resultant iCO measurement is displayed.
- 9 Repeat steps 6-8 up to six times as desired.
- 10 Touch the **Review** button and if necessary, edit the bolus series.
- 11 Touch the **Accept** button.

4.1.3 Continuous End Diastolic Volume Monitoring

Follow steps 1-10 at the start of section 4.1 before proceeding. To acquire EDV/RVEF parameters, a Swan-Ganz CCO catheter with RVEDV must be used.

- 1 Attach the thermistor ① and thermal filament ② Swan-Ganz volumetric catheter connections (figure 4-1) to the patient CCO cable.
- 2 Verify that the catheter is properly inserted into the patient.
- 3 Connect one end of the ECG interface cable to the rear panel of the HemoSphere advanced monitor and the other end to the bedside monitor's ECG signal output.
- 4 Touch the start monitoring icon  to begin CO/EDV monitoring.
- 5 A countdown clock will appear on the stop monitoring icon  to indicate the time until the first CO/EDV value. After approximately 5 to 12 minutes, when sufficient data has been obtained, an EDV and/or RVEF value will appear in the configured parameter tile(s).
- 6 The time until the next CO measurement is displayed on the information bar. For longer time spans between calculations, select STAT parameters (sCO, sEDV, and sRVEF) as key parameters. sCO, sEDV, and sRVEF are fast estimates of CO, EDV, and RVEF.
- 7 Touch the stop monitoring icon  to stop CO/EDV monitoring.

4.2 Monitoring with the HemoSphere Pressure Cable

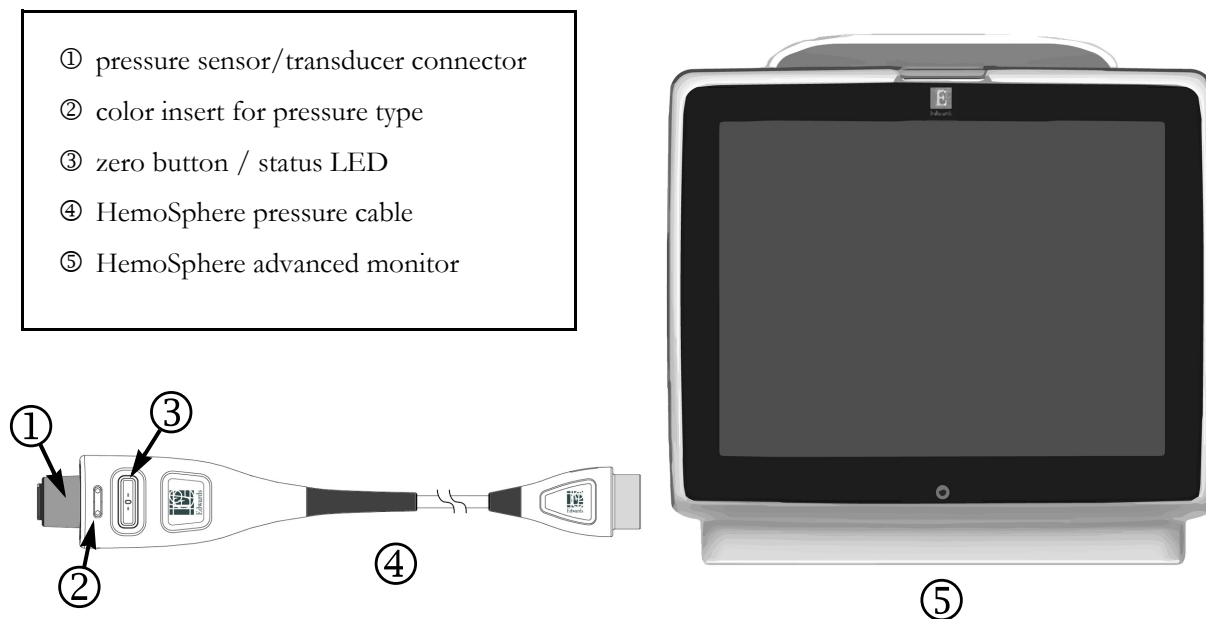



Figure 4-2 Pressure cable connection overview

4.2.1 Pressure Cable Setup

- 1 Connect monitor connection end of the pressure cable to the HemoSphere advanced monitor.
- 2 Press the power button to turn on the HemoSphere advanced monitor. All functions are accessed through the touch screen.
- 3 Select **Continue Same Patient** button or **New Patient** button and enter new patient data.
- 4 Select the **Minimally-Invasive** monitoring mode button on the **Monitoring Mode Selection** window and touch **Start Monitoring**. The **Zero & Waveform** screen will appear.
- 5 Connect the primed pressure sensor to the pressure cable. The pressure cable LED that surrounds the zero button at ③ will flash green indicating that the pressure sensor is detected.
- 6 Follow all instructions found in pressure monitoring catheter IFU for catheter preparation and insertion procedures.

The HemoSphere pressure cable must be zeroed before each monitoring session.





4.2.2 Zero Pressure Cable

- 1 Touch the **Zero & Waveform** icon  located on the navigation bar or through the Clinical Tools menu.

OR

Press the physical zero button  directly on the pressure cable and hold for three seconds (see figure 4-2).

- 2 Select the type/location of pressure sensor being used next to the displayed **port** of the connected HemoSphere pressure cable. The choices are:
 - **ART**
 - **CVP**
 - **PAP**

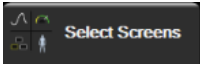
This step can be skipped while monitoring with a FloTrac or Acumen IQ sensor. If a FloTrac or Acumen IQ sensor is connected **ART** is the only available pressure option and is automatically selected.
- 3 Level the stopcock valve to the patient's phlebostatic axis position according to the instructions for use.
- 4 Open the stopcock valve to measure atmospheric pressure.
- 5 Press and hold the physical zero button  directly on the pressure cable, or touch the zero button  located on the screen. When zeroing is complete, a tone sounds, and the message "Zeroed" appears with the time and date. The zero button LED will stop blinking and turn off once zeroing is completed successfully.
- 6 Confirm stable zero pressure and turn stopcock such that sensor is reading patient intravascular pressure.
- 7 Touch the home icon  to begin monitoring.
- 8 Touch the settings icon  → **Select Screens** tab  to select the desired monitoring screen view.
- 9 Touch inside of a parameter tile to select the desired key parameter from the parameter tile configuration menu.
- 10 Touch within a parameter tile to adjust **Alarms / Targets**.

NOTE The alarms limits for the Hypotension Prediction Index parameter (HPI) are not adjustable.

4.3 HemoSphere Oximetry Cable Monitoring

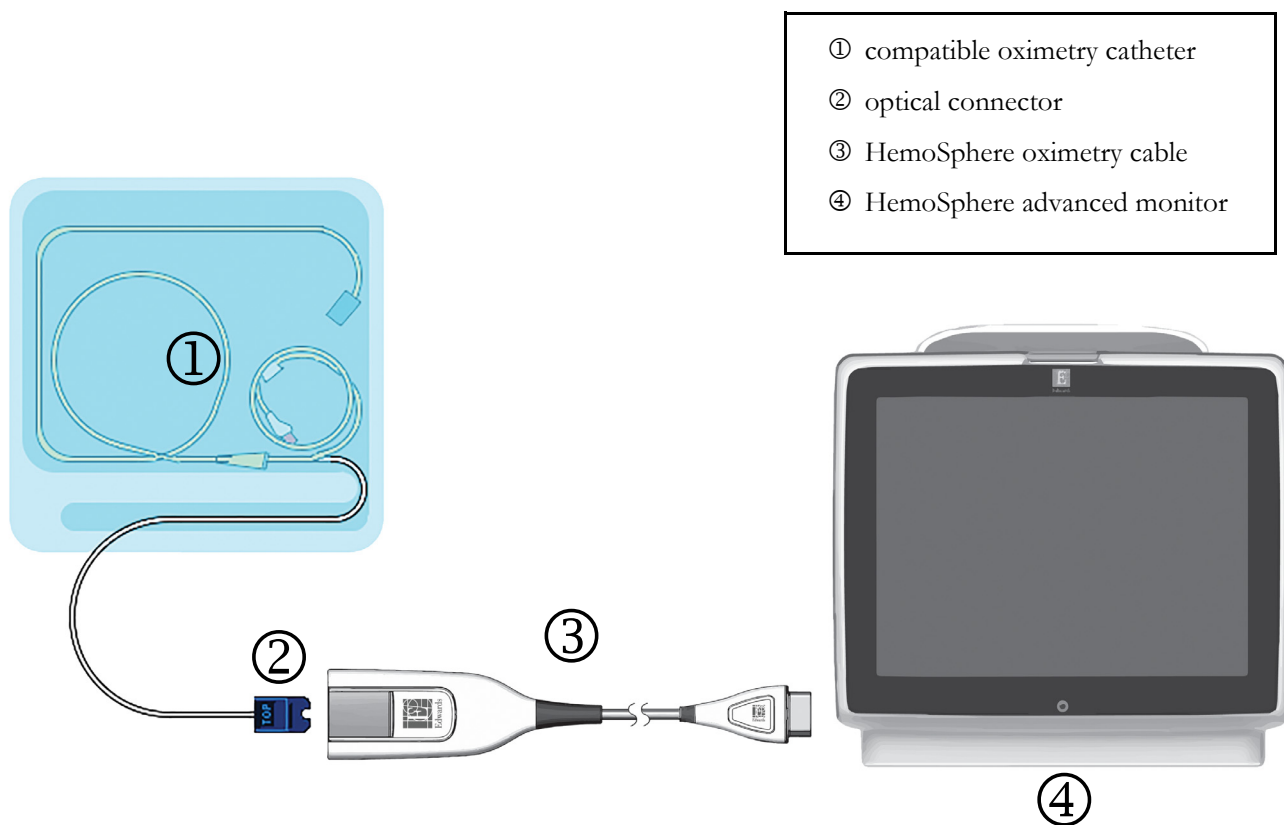

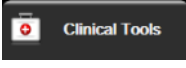



Figure 4-3 Oximetry connection overview





- 1 Connect the HemoSphere oximetry cable to the left side of the HemoSphere advanced monitor. See figure 4-3.
- 2 Press the power button to turn on the HemoSphere advanced monitor. All functions are accessed through the touch screen.
- 3 Select **Continue Same Patient** button or **New Patient** button and enter new patient data.
- 4 Select the **Noninvasive**, **Invasive** or **Minimally-Invasive** monitoring mode button on the Monitoring Mode Selection window as applicable.
- 5 Touch **Start Monitoring**.
- 6 The HemoSphere oximetry cable must be calibrated before each monitoring session. Continue to section 4.3.1 for in vitro calibration instructions and section 4.3.2 for in vivo calibration instructions.

4.3.1 In Vitro Calibration

- 1 Remove a section of the catheter tray lid to expose the optical connector.
- 2 Insert the optical connector of the catheter “TOP” side up into the oximetry cable and snap the enclosure shut.

- 3 Touch the oximetry calibration icon  on the **ScvO₂/SvO₂** parameter tile or, touch the settings icon  → **Clinical Tools** tab  → **Venous Oximetry Calibration** icon .
- 4 Select **Oximetry Type: ScvO₂ or SvO₂**.
- 5 Touch **In vitro Calibration** button.
- 6 Enter either the patient's hemoglobin (**HGB**) or hematocrit (**Hct**) value. A default value may be used until the patient's HGB or Hct is available.
- 7 Touch **Calibrate** button.
- 8 When the calibration successfully completes, the following message appears:
In vitro Calibration OK, insert catheter
- 9 Insert the catheter as described in the catheter directions for use.
- 10 Touch **Start** button.
- 11 If **ScvO₂/SvO₂** are not current key parameters, touch the displayed parameter label located inside of any parameter tile to select **ScvO₂/SvO₂** as a key parameter from the parameter tile configuration menu.
- 12 Touch within the **ScvO₂/SvO₂** parameter tile to adjust **Alarms / Targets**.

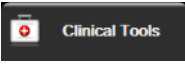
4.3.2 In vivo Calibration

- 1 Insert the catheter as described in the catheter directions for use.
- 2 Insert the optical connector of the catheter “TOP” side up into the oximetry cable and snap the enclosure shut.
- 3 Touch the oximetry calibration icon  on the **ScvO₂/SvO₂** parameter tile or, touch settings icon  → **Clinical Tools** tab  → **Venous Oximetry Calibration** icon .
- 4 Select **Oximetry Type: ScvO₂ or SvO₂**.
- 5 Touch **In vivo Calibration** button.

If setup is unsuccessful, one of the following messages will be displayed:

Warning: Wall Artifact or Wedge Detected. Reposition catheter.

OR

Warning: Unstable Signal.

- 6 If a “Wall Artifact or Wedge Detected,” or “Unstable Signal” message appears, attempt to troubleshoot the problem as instructed in *Chapter 10: Help and Troubleshooting* and touch

Recalibrate button to restart the baseline setup.

OR

Touch **Continue** button to proceed to the Draw operation.

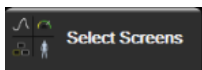
- 7 When baseline calibration is successful, touch **Draw** button and then draw the blood sample and send the blood sample to the lab for measured analysis by co-oximeter.
- 8 Enter **HGB** or **Hct** and **ScvO₂/SvO₂** when lab values are received.
- 9 Touch **Calibrate** button.
- 10 Touch the settings icon  → **Select Screens** tab  to select the desired monitoring screen view.
- 11 Touch the displayed parameter label located inside of any parameter tile to select **ScvO₂/SvO₂** as a key parameter from the parameter tile configuration menu.
- 12 Touch within the **ScvO₂/SvO₂** parameter tile to adjust **Alarms / Targets**.

4.4 HemoSphere Tissue Oximetry Module Monitoring

The HemoSphere tissue oximetry module is compatible with a ForeSight Elite tissue oximeter module and ForeSight Elite tissue oximetry sensors. The HemoSphere tissue oximetry module fits into a standard module slot.

4.4.1 Connecting the HemoSphere Tissue Oximetry Module

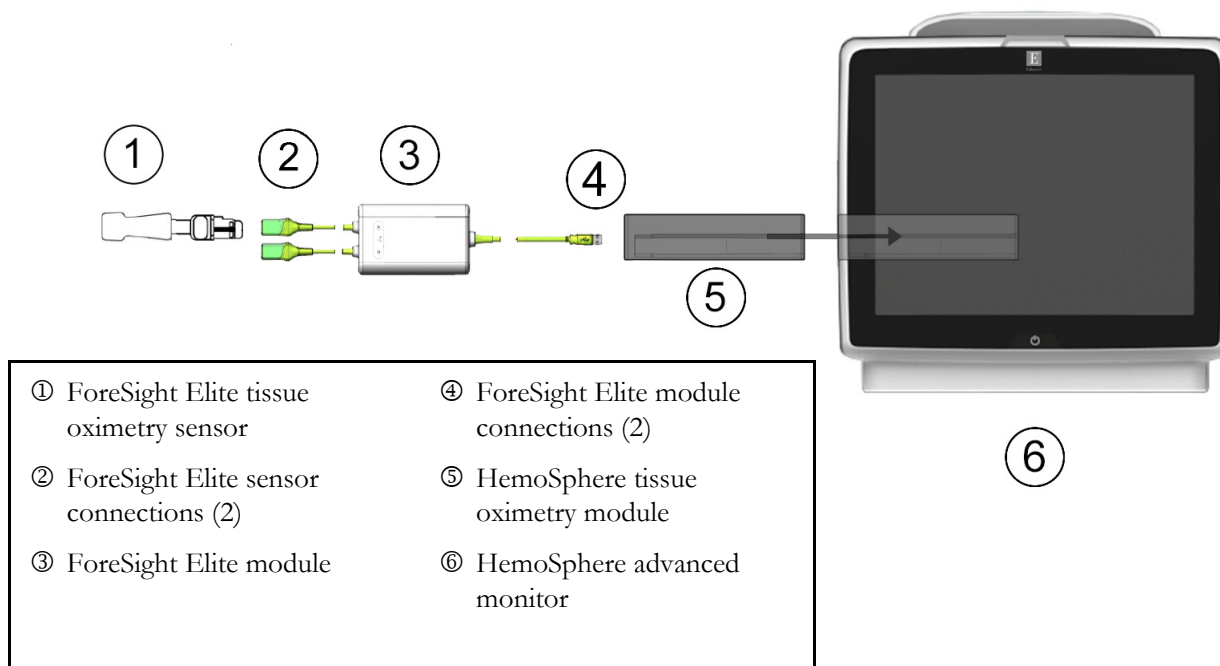

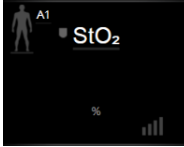



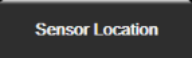
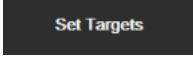

Figure 4-4 HemoSphere tissue oximetry module connection overview

- 1 Insert the HemoSphere tissue oximetry module into the monitor. The module will click when properly engaged.
- 2 Press the power button to turn on the HemoSphere advanced monitor. All functions are accessed through the touch screen.
- 3 Select **Continue Same Patient** button or **New Patient** button and enter new patient data.
- 4 Ensure proper orientation, then plug the ForeSight Elite module host cable into the tissue oximetry module. Up to two ForeSight Elite modules can be connected to each tissue oximetry module.
- 5 Connect the compatible ForeSight Elite sensor(s) to the ForeSight Elite module. Up to two sensors can be connected to each ForeSight Elite module. See *Attaching Sensors to the Patient* on page 209 and refer to the ForeSight Elite sensor instructions for use for proper application directions.
- 6 Select the **Noninvasive**, **Invasive** or **Minimally-Invasive** monitoring mode button on the **Monitoring Mode Selection** window as applicable.
- 7 Touch **Start Monitoring**.

- 8 If **StO₂** is not a current key parameter, touch the displayed parameter label located inside of any parameter tile to select **StO₂ <Ch>** as a key parameter from the **Select Parameter** tab of the tile configuration menu, where **<Ch>** is the sensor channel. The channel options are **A1** and **A2** for ForeSight Elite module A and **B1** and **B2** for ForeSight Elite module B.
- 9 The channel will appear in the upper left corner of the parameter tile. Touch the patient figure  on the parameter tile to access the **Sensor Location** tab of the tile configuration menu. 
- 10 Select the Patient monitoring mode: adult  or pediatric 
- 11 Select the anatomical location of the sensor. See table 13-1 on page 208 for a list of available sensor locations.
- 12 Touch the home icon  to return to the monitoring window.
- 13 Touch anywhere in the **StO₂** parameter tile → **Sensor Location** tab  to adjust **Skin Check Reminder** or **Averaging** for that sensor.
- 14 Touch anywhere in the **StO₂** parameter tile → **Set Targets** tab  to adjust **Alarms/Targets** for **StO₂**.

4.5 HemoSphere ClearSight Module Monitoring

4.5.1 Connecting the HemoSphere Noninvasive System

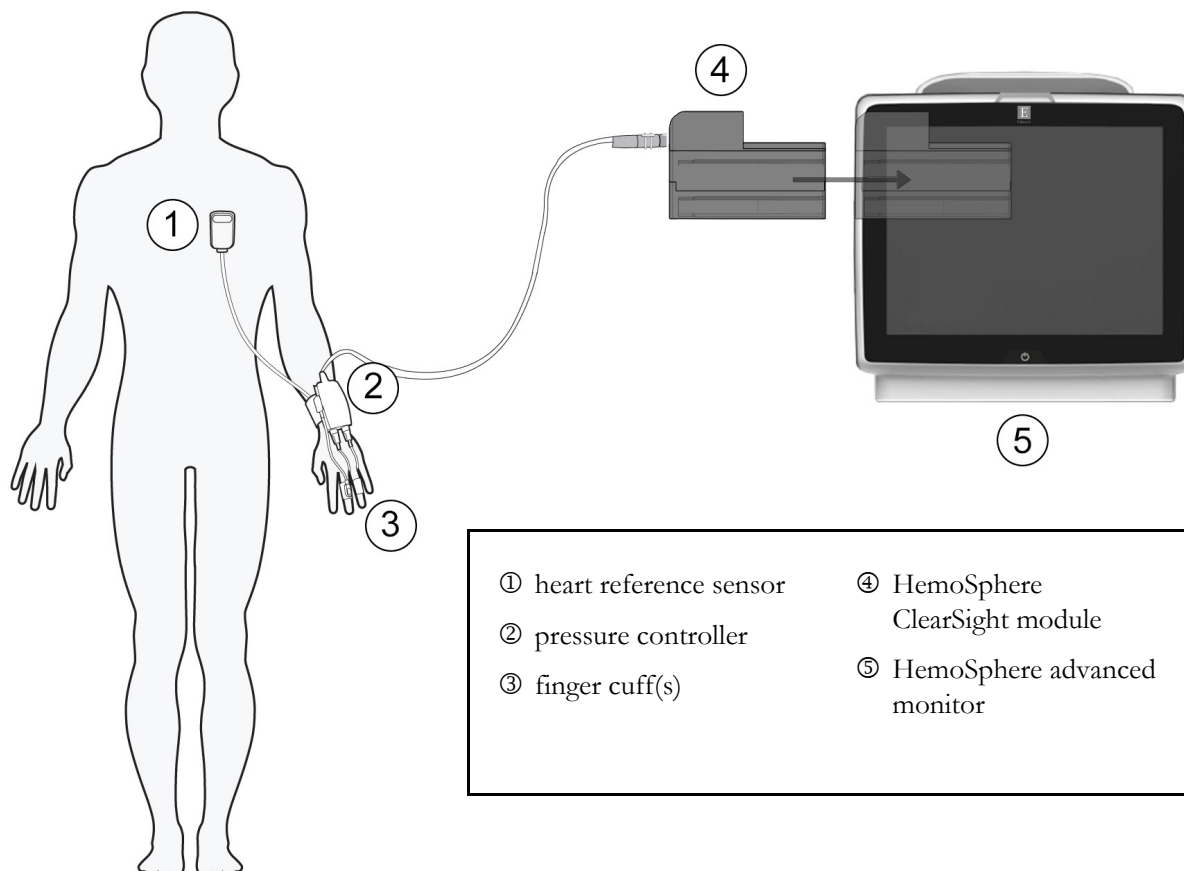

Figure 4-5 HemoSphere noninvasive system connection overview

- 1 Insert the HemoSphere ClearSight module into the large technology (L-Tech) slot of monitor. The module will click when properly engaged.
- 2 Press the power button to turn on the HemoSphere advanced monitor. All functions are accessed through the touch screen.
- 3 Select **Continue Same Patient** button or **New Patient** button and enter new patient data.
- 4 Select the **Noninvasive** monitoring mode button on the **Monitoring Mode Selection** window.
- 5 Connect the pressure controller to the HemoSphere ClearSight module.
- 6 Wrap the pressure controller band around the patient's wrist and attach the compatible pressure controller to the band. Either wrist can be used however the non-dominant arm is preferred.
- 7 Select the proper size finger cuff by using the finger cuff sizing aid.
- 8 Place the finger cuff on the patient's finger. Refer to the product IFU for detailed instructions on proper finger cuff placement and actual device illustrations.
- 9 Connect finger cuff to pressure controller.

NOTE After 8 hours of accumulated monitoring on the same finger, the HemoSphere noninvasive system will stop monitoring and display a warning to place the cuff on another finger if continued monitoring is desired.

10 Connect heart reference sensor to the pressure controller.

NOTE Monitoring without an HRS is available as an advanced feature in sedated and stationary patients only. To enable the Acumen Hypotension Prediction Index (HPI) feature, an Acumen IQ finger cuff and HRS are both required. See *Optional HRS* on page 184.

11 Vertically align both ends of the HRS and touch the on-screen zero button.

12 Wait for indication that the HRS has been zeroed.

13 Apply the heart end of the HRS to the patient at phlebostatic axis level by using an HRS clip.

CAUTION Make sure that the HRS is correctly applied so that it can be leveled to the phlebostatic axis.

14 Attach the other end of the HRS to the finger cuff.

15 Touch the start monitoring icon  on the navigation bar or on setup help screen to begin monitoring.

16 Touch the stop monitoring icon  on the navigation bar to end monitoring at any time.

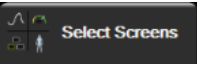
17 Touch the settings icon  → **Select Screens** tab  to select the desired monitoring screen view.

18 Touch inside of a parameter tile to select the desired key parameter from the parameter tile configuration menu.

19 Touch within a parameter tile to adjust **Alarms / Targets**.

NOTE The alarms limits for the Hypotension Prediction Index parameter (HPI) are not adjustable.

Navigating the HemoSphere Advanced Monitor

Contents

HemoSphere Advanced Monitor Screen Appearance	82
Navigation Bar	84
Monitor Views	87
Focused Monitoring Format	103
Clinical Tools	107
Information Bar	112
Status Bar	115
Monitor Screen Navigation	115

5.1 HemoSphere Advanced Monitor Screen Appearance

All monitoring functions are initiated by touching the appropriate area on the touch screen. The navigation bar, located on the left side of the screen, includes various controls for stopping and starting monitoring, scrolling and selecting screens, performing clinical actions, adjusting system settings, capturing screen shots, and silencing alarms. The main components of the HemoSphere advanced monitor screen are shown below in figure 5-1. The main window displays the current monitoring view or menu screen. For details on monitoring view types, see *Monitor Views* on page 87. For details on other screen features, see the referenced sections in figure 5-1.

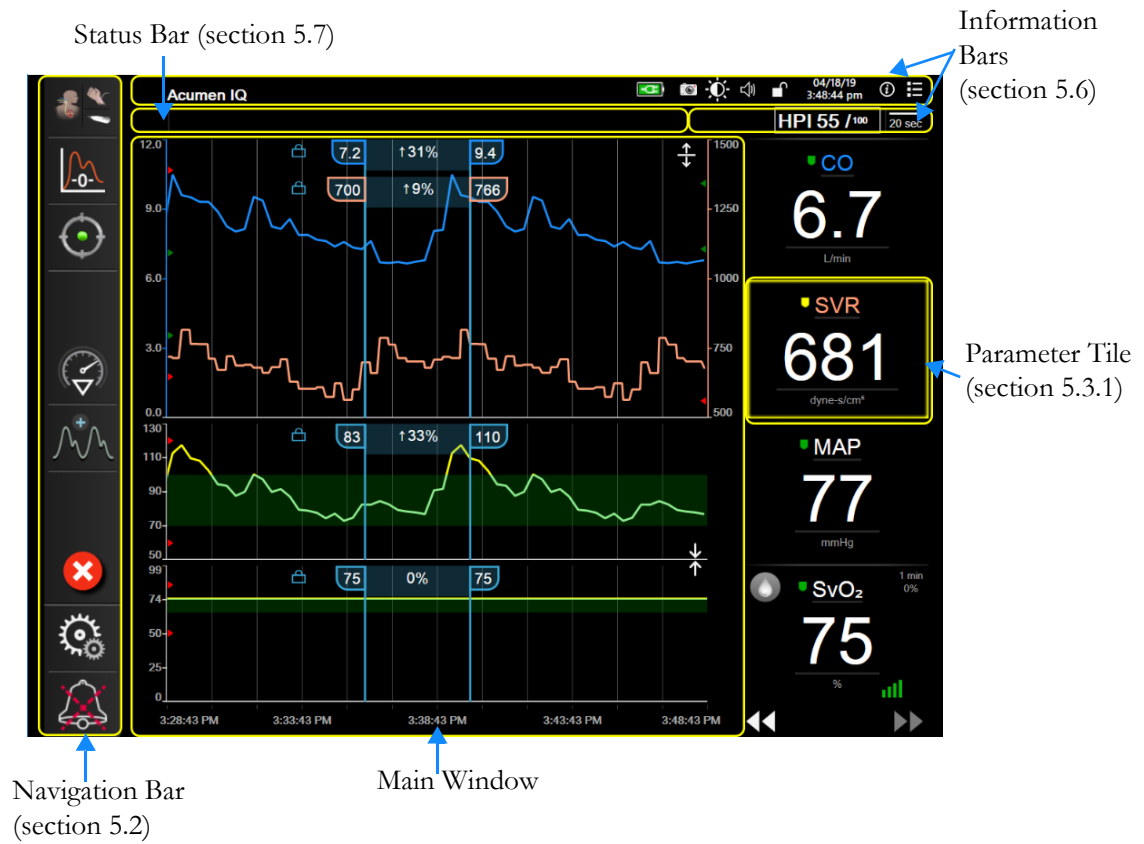

Figure 5-1 HemoSphere advanced monitor screen features

5.2 Navigation Bar

The navigation bar is present on most screens. Exceptions are the startup screen and screens indicating the HemoSphere advanced monitor has stopped monitoring. The example shown below for figure 5-1 is during invasive monitoring on a graphical trend monitoring screen. All available icons are described in detail below.

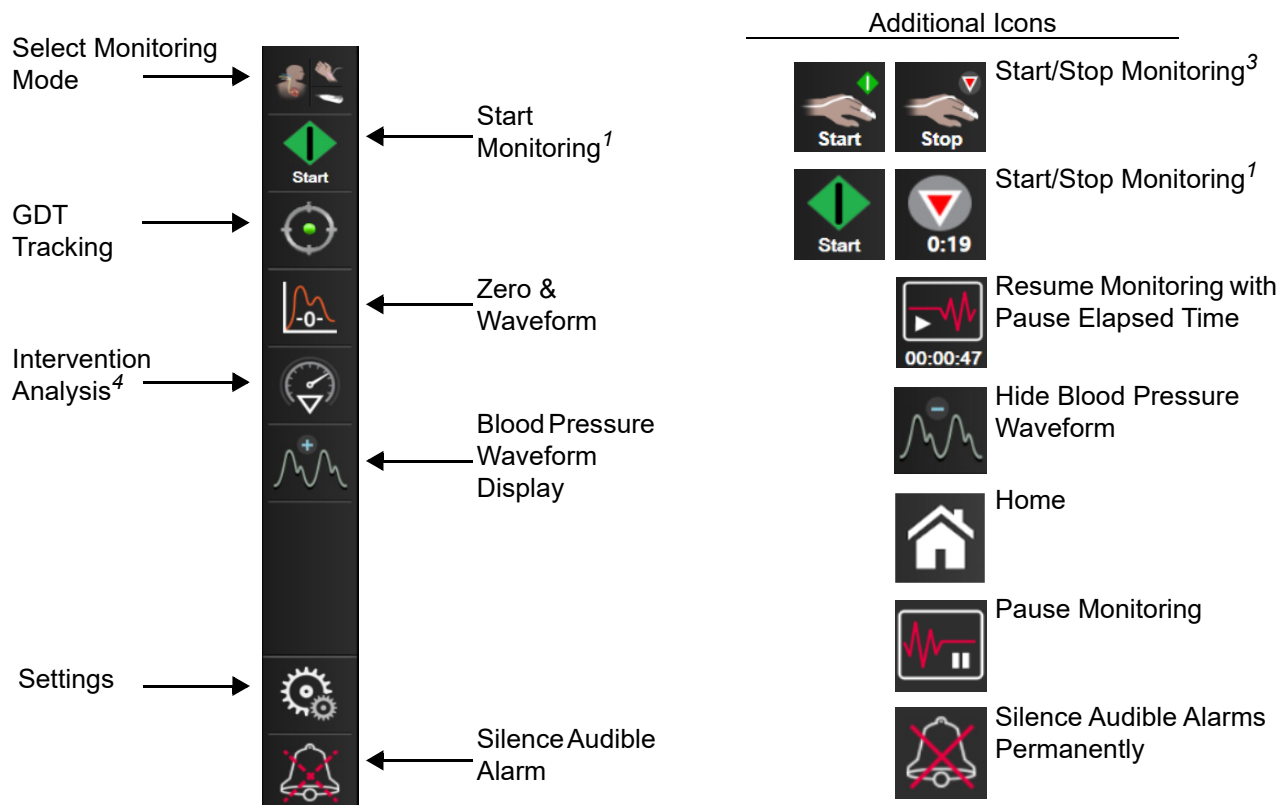
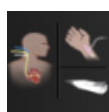
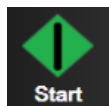

Figure 5-2 Navigation bar and icons

¹*invasive monitoring*, ²*minimally-invasive monitoring*, ³*noninvasive monitoring*, ⁴*graphical trend screens*



Select Monitoring Mode. Touch here to switch between monitoring modes. See *Select Monitoring Mode* on page 107.



Start CO Monitoring. While monitoring with the HemoSphere Swan-Ganz module, the start CO monitoring icon allows the user to initiate CO monitoring directly from the navigation bar. See *Continuous Cardiac Output* on page 150.

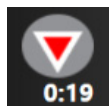

Stop CO Monitoring. The stop monitoring icon indicates that CO monitoring using the HemoSphere Swan-Ganz module is underway. The user can immediately stop monitoring by touching this icon and then **OK** on the confirmation popup.

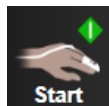

Start Noninvasive Monitoring. While monitoring with the HemoSphere ClearSight module, the start monitoring icon allows the user to initiate noninvasive blood pressure and CO monitoring directly from the navigation bar. See *General Troubleshooting of HemoSphere Noninvasive System Monitoring* on page 182.

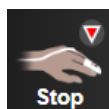

Stop Noninvasive Monitoring. The stop noninvasive monitoring icon indicates that noninvasive blood pressure and hemodynamic parameter monitoring using the HemoSphere ClearSight module is underway.



Zero & Waveform. This icon allows the user to access the Zero & Waveform screen directly from the navigation bar. See *Zero & Waveform Screen* on page 173.



Intervention Analysis. This icon allows the user to access the Intervention Analysis menu. From here clinical interventions can be logged. See *Intervention Events* on page 93.



Display Blood Pressure Waveform. This icon allows the user to display the blood pressure waveform when a HemoSphere pressure cable and compatible sensor is connected or during noninvasive monitoring. See *Live Blood Pressure Waveform Display* on page 95.



Hide Blood Pressure Waveform. This icon allows the user to hide the blood pressure waveform.

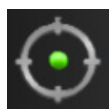

GDT Tracking. This icon displays the GDT Tracking Menu. Enhanced parameter tracking allows a user to manage key parameters in the optimal range. See *Enhanced Parameter Tracking* on page 239.



Home. This icon returns the user to the main monitoring screen.



Settings. The settings icon provides access to four configuration screens which include:

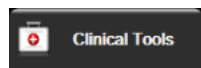

Clinical Tools. The clinical actions screen provides access to the following clinical tools:

- **Select Monitoring Mode**
- **iCO** (HemoSphere Swan-Ganz module)
- **Zero & Waveform**
- **Venous Oximetry Calibration** (HemoSphere oximetry cable)
- **Enter CVP**
- **Derived Value Calculator**
- **Event Review**
- **Patient CCO Cable Test** (HemoSphere Swan-Ganz module)
- **Fluid Responsiveness Test** (advanced feature – see *Fluid Responsiveness Test* on page 242)
- **Patient Data** (see *Patient Data* on page 120)

- **HPI Secondary Screen** (HemoSphere pressure cable – advanced feature)
- **Calibration** (HemoSphere ClearSight module)

NOTE **HPI Secondary Screen** is available if the Acumen HPI™ feature is activated. Activation is only available in certain areas. See *Acumen™ Hypotension Prediction Index (HPI) Software Feature* on page 218. Please contact your local Edwards representative for more information on enabling this advanced feature.

A description of **Select Monitoring Mode**, **CVP Entry**, **Derived Value Calculator**, **Event Review**, and **CVP Entry** can be found in this chapter (see *Clinical Tools* on page 107). For the remaining clinical actions, refer to the specified module or cable chapter for more information.

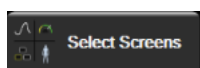

Select Screens. The select screens tab allows the user to select the desired number of monitored parameters displayed and the type of monitoring view used to display them, which is highlighted in color (see figure 5-3, “Example of monitoring screen selection window,” on page 87). When a monitoring view screen is selected, that monitoring mode is immediately displayed.

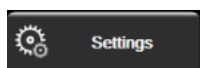

Settings. The settings icon provides access to configuration screens which include:

- **General Monitor Settings:** See chapter 6: *User Interface Settings*
- **Advanced Setup:** See chapter 7: *Alarms/Targets*, chapter 7: *Adjust Scales*, and chapter 8: *Data Export and Connectivity Settings*
- **Export Data:** See chapter 8: *Data Export and Connectivity Settings*
- **Demo Mode:** See chapter 7: *Demo Mode*
- **ClearSight:** See chapter 11: *ClearSight Settings and Cuff Options*

Advanced Setup and **Export Data** are password protected menu options. See *Password Protection* on page 118.

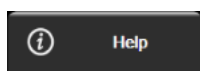

Help. See chapter 15: *On Screen Help*

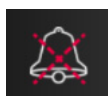

Silence Audible Alarms. This icon silences all audio and visual indicator alarms for up to five minutes. The alarm pause interval options are 1, 2, 3, 4 and 5 minutes. New physiological alarms are silenced during the pause period. Alarms will resume sounding after the pause period has elapsed. Faults are silenced until the fault is cleared and re-occurs. If a new fault occurs, the alarm sound will resume.



Audible Alarms Silenced. Indicates that alarms are temporarily silenced. A countdown timer and “**Alarms Paused**” appear. An alarm paused indicator  will appear on any parameter tile that is currently alarming.

Touch the silence audible alarms icon continuously for five seconds to show additional alarm silencing options (below).

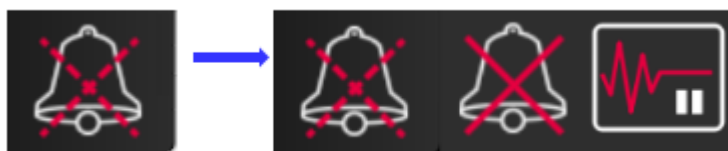



Silence All Alarms Permanently. Touch this icon on the alarm expansion menu to silence all alarms indefinitely. Selecting this alarm silence option requires a **Super User** password. See *Password Protection* on page 118.



Monitoring Pause. Touch this icon to pause monitoring. A monitoring pause confirmation banner will appear to confirm suspension of monitoring operations.

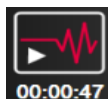

Resume Monitoring. After monitoring pause confirmation, a resume monitoring icon and elapsed time will appear on the navigation bar. A “**Monitoring Pause**” banner will be displayed. To return to monitoring, touch the resume monitoring icon.

5.3 Monitor Views

There are eight classic monitoring views: graphical trend, tabular trend, graphical/tabular trend split screen, physiology, cockpit, physio relationship, goal positioning, and the main monitoring view which is a split between the graphical and cockpit view. Depending on the monitoring view selected, up to eight monitored parameters can be displayed.

In addition to these classic monitoring view formats, three additional focused monitoring views are available. These allow the user to see arterial blood pressure values along with three parameters in a streamlined and focused screen layout. See *Focused Main Screen* on page 105, *Focused Graphical Trend Screen* on page 106, and *Focused Charting Screen* on page 106.

To switch between monitoring views, swipe across the screen with three fingers. Or, to select a monitoring view:

- 1 Touch the settings icon  → **Select Screens** tab . The monitor screen selection menu contains icons that are based upon the look of the monitoring screens.



Figure 5-3 Example of monitoring screen selection window

- 2 Touch the circled number, **1**, **2**, **3**, or **4**, that represents the number of key parameters to be displayed on parameter tiles on monitoring screens. Focused screens, shown on the bottom of the selection window, always display 3 key parameters.
- 3 Select and touch a monitor view button to display the key parameters in that screen format.

5.3.1 Parameter Tiles

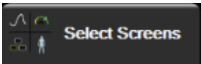
Parameter tiles are located on the right side of most monitoring screens. The cockpit monitoring view is composed of larger format parameter globes which function identically as described below.

5.3.1.1 Change Parameters

- 1 Touch the displayed parameter label located inside the parameter tile to change it to a different parameter.
- 2 The tile configuration menu will show the selected parameter highlighted in color and other parameters currently being displayed outlined in color. Available parameters appear on the screen without highlights. Figure 5-4 shows the parameter selection tab of the tile configuration menu that will appear while selecting continuous parameters and monitoring with the HemoSphere Swan-Ganz module. The appearance of this window while monitoring with other HemoSphere modules or cables varies from what is shown in figure 5-4.
Parameters are organized into categories. The categories available are based on the current monitoring mode. Categories, listed below, are grouped together on the parameter selection configuration menu. See figure 5-4.

FLOW. Flow parameters measure blood flow from the left heart and include CO, CI, SV, SVI, and SVV.

RESISTANCE. Resistance parameters SVR and SVRI are related to systemic resistance to blood flow.

RV FUNCTION. These parameters which include EDV, EDVI, and RVEF are volumetric indicators of the right ventricle (RV).

ACUMEN. Parameters listed here are only available with a connected Acumen IQ sensor and enabled HPI feature. This includes HPI, $E_{a_{dyn}}$, and dp/dt .

PRESSURE. These blood pressure parameters include SYS_{ART} , DIA_{ART} , MAP, SYS_{PAP} , DIA_{PAP} , MPAP, PR, CVP, and PPV.

OXIMETRY. Oximetry parameters include venous oximetry (SvO₂/ScvO₂) and tissue oximetry (StO₂) when enabled.

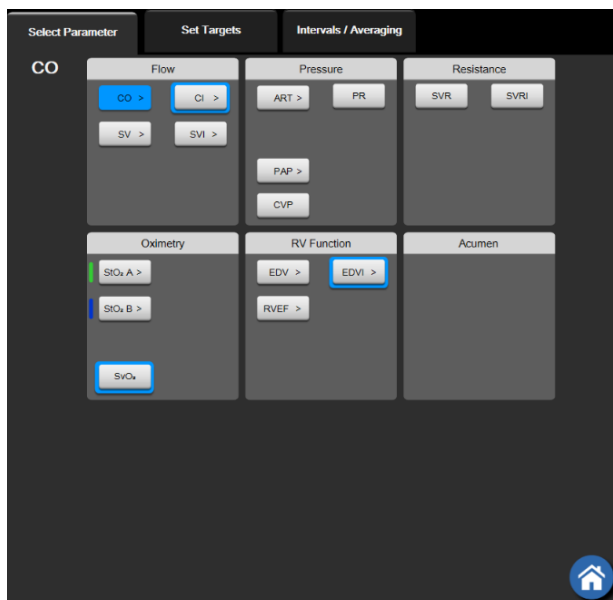

Figure 5-4 Example of key parameter selection tile configuration menu

- 3 Touch an available parameter to select the replacement parameter.
- 4 To change the order of any key parameter, touch and hold the parameter tile until the tile appears with a blue outline. Drag and drop the parameter tile to the new desired location to update the order of key parameters.

5.3.1.2 Change Alarm/Target

The **Alarms / Targets** screen lets the user view and set up alarm and target values for the selected parameter or enable/disable the audible alarm and target settings. Additionally, the target settings can be adjusted with a numbered key pad or with the scroll buttons when a minor adjustment is needed. This screen is accessed by touching the parameter value on a parameter tile or through the parameter settings screen. For more information, see *Alarms/Targets* on page 130.

NOTE There is a two minute inactivity timer associated with this menu screen.

The alarms limits and target ranges for the Acumen Hypotension Prediction Index parameter, HPI, are not adjustable.

5.3.1.3 Status Indicators

A parameter tile is outlined in color to indicate the patient’s current status. The color changes as the patient’s status changes. Items on the tile that appear underlined can be touched to access a configuration menu. The tiles may display additional information:

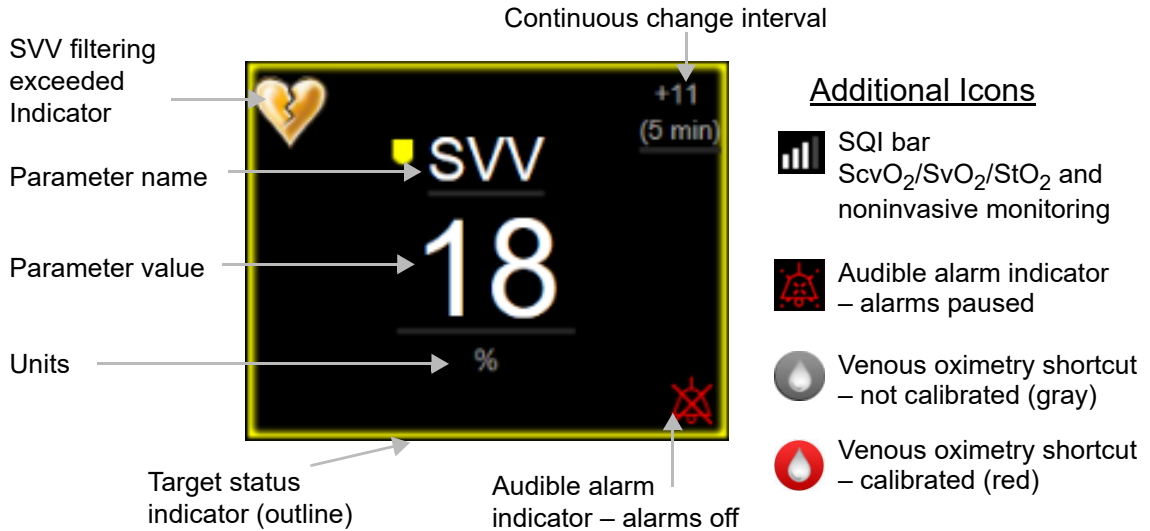



Figure 5-5 Parameter tile

Status Bar Messages. When a fault, alert, or alarm condition occurs, the message(s) will be displayed on the status bar until the condition is cleared. When there is more than one fault, alert or alarm, the message is cycled every two seconds.

When a fault condition occurs, parameter calculations are stopped, and each affected parameter tile displays the last value, time, and date at which the parameter was measured.

Continuous Change Interval. This indicator displays the percentage of change or absolute value of change, followed by the time period over which it changed. See *Time Intervals / Averaging* on page 124 for configuration options.



SVV Filtering Exceeded Indicator. The SVV filtering exceeded indicator symbol  appears on the SVV parameter tile if a high degree of pulse rate variability is detected that could affect the SVV value.

SQI Bar. The SQI bar  is a reflection of the signal quality during oximetry or noninvasive monitoring. Signal quality is based on the catheter condition and positioning within the vessel for intra-vascular oximetry or the near-infrared light tissue perfusion index for tissue oximetry. For oximetry indicator levels, see table 12-3, “Signal quality indicator levels,” on page 195. For noninvasive finger cuff monitoring, SQI is based on the quality of the pressure waveform signal from the plethysmograph sensor of the finger cuff. For noninvasive SQI levels, see table 11-1, “Arterial waveform SQI levels,” on page 187.

Target Status Indicators. The colored indicator outlining each monitoring tile indicates the patient's clinical status. For indicator colors and their clinical indications, see table 7-2, "Target status indicator colors," on page 133.

NOTE When using the Acumen™ Hypotension Prediction Index parameter, HPI, the patient status indicators differ from those described. Refer to *Acumen™ Hypotension Prediction Index (HPI) Software Feature* on page 218 for the patient status indicators available when using the Acumen™ Hypotension Prediction Index feature.

5.3.2 Main Monitoring View

The main monitoring view displays a combination of the graphical trend monitoring view (see *Graphical Trend Monitoring View* on page 91) and a semicircular variation of the cockpit monitoring view (see *Cockpit Screen* on page 99). The cockpit gauge that appears on the bottom of the main monitoring view utilizes a semicircular gauge area. See figure 5-6. Key parameters displayed on parameter gauges on the bottom of the main monitoring view can be an additional four key parameters beyond those monitored on the graphical trends and parameter tiles displayed on the screen. Up to eight key parameters can be viewed on the main monitoring view. The position of any key parameter on the screen can be moved by holding down the parameter tile or parameter gauge then dragging and dropping it to the new desired position.



Figure 5-6 Main monitoring view

5.3.3 Graphical Trend Monitoring View

The graphical trend screen displays the current status and history of monitored parameters. The amount of history shown for monitored parameters can be configured by adjusting the time scale.

When the target range for the parameter is enabled, the graph color codes the plot line, green indicating within the target range, yellow indicating the value is outside the target range but within the physiological alarm range, and red indicating the value is outside the alarm range. When the target range is disabled for the parameter the plot line is white. Color plotting can be disabled through general settings. The colors match those of the clinical target indicator (parameter tile outline) on the key parameter tiles in the graphical trend graph when targets are enabled for the parameter. The alarm limits for each parameter are displayed as colored arrows on the graph y-axis.

NOTE The graphical trend for the Acumen Hypotension Prediction Index parameter, HPI, displays as a white trend line when not in alarm range and a red trend line when in alarm range.

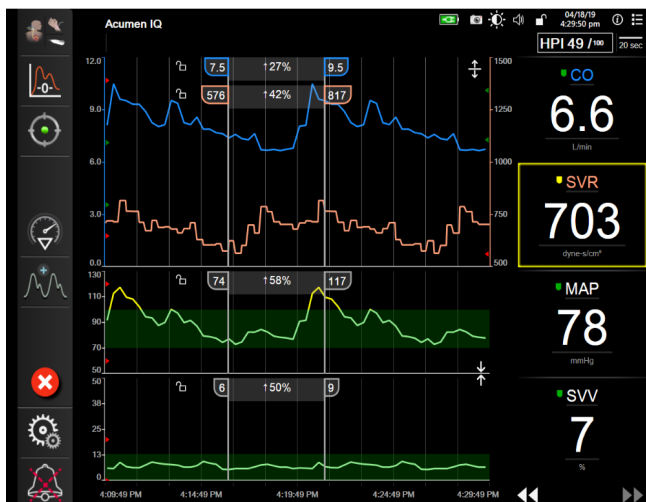



Figure 5-7 Graphical trend screen

To change the time scale of the displayed parameters, touch outside of the plot area along the x or y-axis, and a scale popup menu will appear. Touch the value side of the **Graphical Trend Time** button to select a different time period. To move the order of a trend plot, hold the plot down and drag and drop it to a new location. To combine plots, drop the parameter plot onto another graphical trend plot, or touch the combine icon  located between plots. The y-axis values for the second parameter will appear on the right side of the plot. To return to separate graphical trend plots, touch the expand icon .

5.3.3.1 Graphical Trend Scroll Mode







Up to 72 hours of monitored parameter data can be viewed by scrolling back. To start scrolling, swipe to the right/left or touch the appropriate scroll mode button as shown above. Keep touching the scroll mode button to increase the scroll speed. The screen will return to live mode two minutes after the scroll button has been touched, or if the cancel icon  is touched. The scroll rate will appear between the scroll buttons.

Table 5-1 Graphical trend scroll rates

Scroll setting	Description
	Scrolls at two times the current time scale
	Scrolls at the current time scale (one graph width)
	Scrolls at half the current time scale (one-half graph width)

While in scroll mode the user can scroll to data older than the current time scale displays.

NOTE It is not possible to touch past the most recent data or before the oldest data. The graph will scroll only as far as data is available.

5.3.3.2 Intervention Events

While in the graphical trend screen or other monitoring views that display graphical trend plots such as the main monitoring view, selecting the intervention icon  provides a menu of intervention types, details and a notes section.

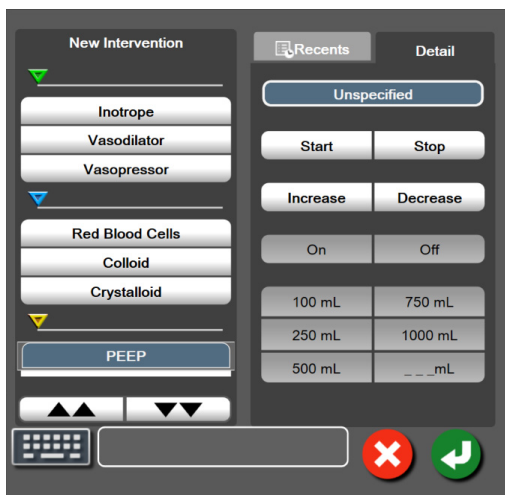



Figure 5-8 Graphical trend- intervention window

To enter a **New Intervention**:

- 1 Select the **Intervention** type from the **New Intervention** menu on left. Use the vertical scroll arrows to view all available **Intervention** types.
- 2 Select **Detail** from right menu tab. **Unspecified** is set as a default.
- 3 Select the keyboard icon  to enter notes (optional).
- 4 Touch the enter icon .

To enter a previously used **Intervention**:









- 1 Select the **Intervention** from the **Recents** list tab.
- 2 To add, edit, or remove a note, touch the keyboard icon .
- 3 Touch the enter icon .

Table 5-2 Intervention events



Intervention	Indicator	Type
Intervention	 (green)	Inotrope Vasodilator Vasopressor
Positional	 (purple)	Passive Leg Raise Trendelenburg
Fluids	 (blue)	Red Blood Cells Colloid Crystalloid Fluid Bolus*
Oximetry	 (red)	In-vitro Calibration* Draw Blood* In-vivo Calibration* HGB Update* Recall Oximetry Data*
Event	 (yellow)	PEEP Induction Cannulation CPB Cross Clamp Cardioplegia Pump Flow Circulatory Arrest Warming Cooling Selective Cerebral Perfusion
Custom	 (gray)	Custom Event BP Calibration*
<i>*System generated markers</i>		

NOTE Interventions initiated through the clinical tools menu, such as oximetry, BP calibration, or fluid responsiveness tests, are system generated and cannot be entered through the intervention analysis menu.

After selection of the intervention type, markers indicating the intervention are visually displayed on all graphs. These markers can be selected for more information. Upon touching the marker, an information balloon will appear. See figure 5-9: "Graphical trend screen - intervention information balloon". The information balloon displays the specific intervention, date, time, and notes pertaining to the intervention. Touching the edit button allows the user to edit intervention time, date, and note. Touching the exit button closes the balloon.

NOTE The intervention information balloon has a 2 minute time out.

Intervention Editing. The time, date, and associated note for each intervention can be edited after initial entry:

- 1 Touch the intervention event indicator  associated with the intervention to be edited.
- 2 Touch the edit icon  located on the information balloon.
- 3 To change the time of the selected intervention, touch on **Time Adjust**, and enter the updated time on keypad.
- 4 To change the date, touch on **Date Adjust**, and enter the updated date on keypad.

NOTE The date or time of system generated intervention markers cannot be edited.

- 5 Touch the keyboard icon  to enter or edit notes.
- 6 Touch the enter icon .

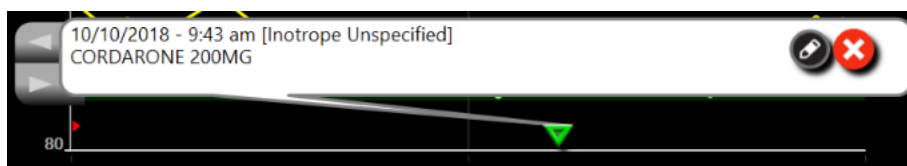



Figure 5-9 Graphical trend screen - intervention information balloon

5.3.3.3 Live Blood Pressure Waveform Display

To display the real-time blood pressure waveform while in minimally-invasive or noninvasive monitoring modes, touch the display pressure waveform icon . The display waveform icon appears on the navigation bar while monitoring with the graphical trend or main monitoring screens. A live pressure waveform graph panel will be displayed above the first monitored parameter graph. A numeric reading of the beat to beat systolic, diastolic and mean arterial pressure will be displayed above the first monitored parameter tile. To change the sweep speed (x-axis scale) of the graph, touch the scale area and a popup menu will appear to allow input of a new sweep speed. If multiple pressure monitoring technologies are connected, touch the parameter name on the waveform parameter tile to switch between monitored pressure waveforms.

To stop display of live blood pressure waveform, touch the hide pressure waveform icon .

NOTE If there are 4 key parameters being displayed when the display pressure waveform button is touched, display of the 4th key parameter is temporarily removed and the blood pressure waveform graph is placed at the top of the remaining 3 Key Parameter trend graphs.

5.3.4 Tabular Trends

The tabular trends screen displays selected key parameters and their history in a tabular format.

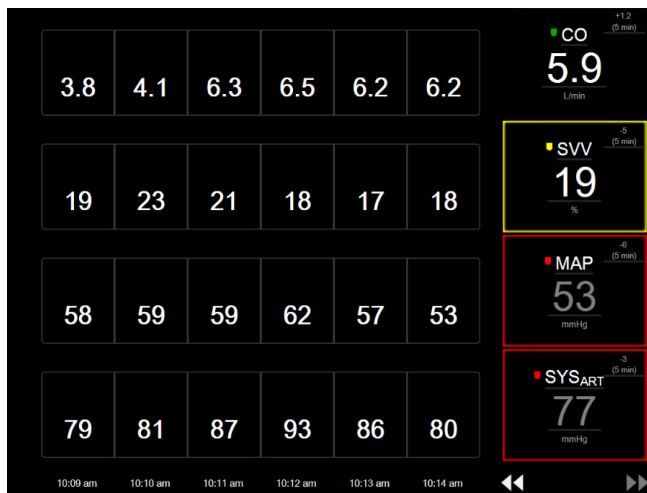

Figure 5-10 Tabular trend screen

- 1 To change the interval between values, touch inside the table.
- 2 Select a value on the **Tabular Increment** popup.

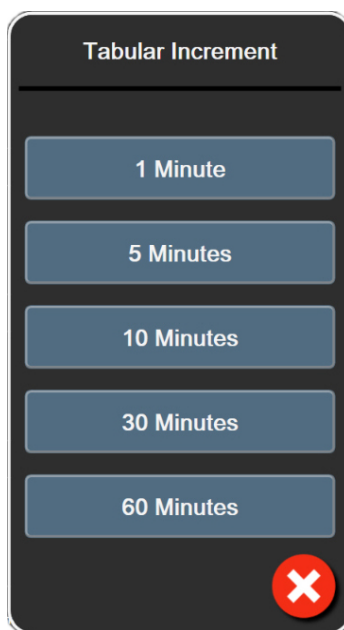

Figure 5-11 Tabular increment popup

5.3.4.1 Tabular Trend Scroll Mode







Up to 72 hours of data can be viewed by scrolling back. The scroll mode is based on the number of cells. Three scroll speeds are available: 1x, 6x, and 40x.

While the screen scrolls, the date appears above the table. If the time period overlaps two days, both dates will appear on the screen.

- 1 To start scrolling, touch and hold one of the double arrows below the parameter tiles. The scroll rate will appear between the scroll icons.

Table 5-3 Tabular trend scroll rates

Setting	Time	Speed
	one cell	Slow
	six cells	Moderate
	forty cells	Fast

- 2 To exit scroll mode, stop touching the scrolling arrow or touch the cancel icon .

NOTE The screen will return to live mode two minutes after the last touch of the scroll arrow icon or if the cancel icon is touched.

5.3.5 Graphical/Tabular Trends Split

The graphical/tabular trends split screen displays a combination of the graphical trend and tabular trend monitoring views. This display is useful for viewing the current status and history of selected monitored parameters in graphical format and other selected monitored parameters in tabular format at the same time.

If two key parameters are selected, the first key parameter is displayed in graphical trend format, and the second in tabular trend format. Key parameters can be changed by touching the parameter label located on the parameter tile. If more than two key parameters are selected, the first two parameters are displayed in graphical trend format, and the third and fourth — if a fourth is selected — are displayed in tabular trend format. The time scale for data displayed on any key parameter graphical trend view(s) is independent of the time scale displayed on the tabular trend view(s). For more information on the graphical trend view see *Graphical Trend Monitoring View* on page 91. For more on tabular trend view, see *Tabular Trends* on page 96.

5.3.6 Physiology Screen

The Physiology screen is an animation depicting the interaction between the heart, blood, and vascular system. The appearance of this screen varies based on the monitoring technology being used. For example, if the tissue oximetry feature is enabled three additional animations are used to display available tissue oximetry measurement sites along with hemodynamic parameters. See *Tissue Oximetry Physiology Screen* on page 217. Continuous parameter values are displayed in association with the animation.

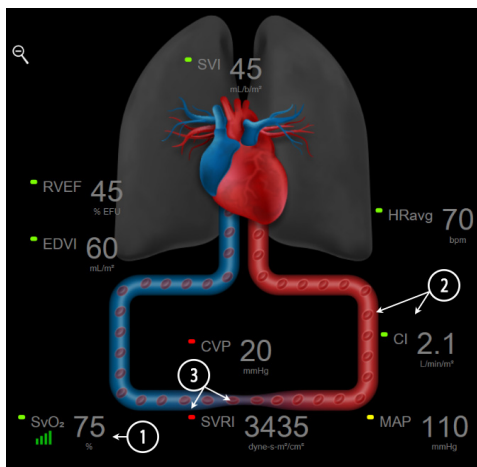

Figure 5-12 Physiology screen while monitoring with HemoSphere Swan-Ganz module

In the physiology screen the image of the beating heart is a visual representation of the heart rate and is not an exact representation of beats per minute. Key features of this screen are numbered shown in figure 5-12. This example is of the continuous physiology screen during active monitoring with the HemoSphere Swan-Ganz module and slaved-in ECG, MAP, and CVP signals.

- 1 ScvO₂/SvO₂ parameter data and signal quality indicator (SQI) are displayed here while the HemoSphere oximetry cable is connected and actively monitoring venous oxygen saturation.
- 2 Cardiac output (CO/CI) is indicated on the arterial side of the vascular system animation. The blood flow animation rate will adjust based on the CO/CI value and the low/high target ranges selected for that parameter.
- 3 Systemic Vascular Resistance, indicated in the center of the vascular system animation, is available while monitoring CO/CI and utilizing MAP and CVP analog pressure signal inputs from a connected patient monitor or two HemoSphere pressure cables, as $SVR = [(MAP - CVP) / CO] * 80$. While in minimally-invasive or noninvasive monitoring mode, only CVP is required using the CVP entry screen, CVP monitoring through a HemoSphere pressure cable or through analog input. The level of constriction shown in the vessel will adjust based on the derived SVR value, and the low/high target ranges selected for that parameter.

NOTE

The alarms/targets settings can be adjusted through the Alarms / Targets setting screen (see *Alarms/Targets Setup Screen* on page 133) or by selecting the desired parameter as a key parameter, and accessing the tile configuration menu by touching inside of the parameter tile.

The example shown in figure 5-12 is while monitoring with a HemoSphere Swan-Ganz module. Differences in appearance and parameters will occur with other monitoring

modes. For example, while monitoring within FloTrac sensor monitoring mode, HR_{avg} is replaced by PR, PPV and SVV appear (if configured), and EDV and RVEF are not shown.

5.3.6.1 SVV Slope Indicator

The SVV slope indicator is a visual representation of the Frank-Starling curve used when assessing the stroke volume variation (SVV) value. This appears on the physiology screen while in minimally-invasive and noninvasive monitoring modes. The color of the lantern changes based upon set target ranges. An SVV value of 13% is displayed approximately at the inflection point of the curve. The indicator is displayed on the physiology and historic physiology screens.



The user has the ability to enable or disable the display of the SVV lantern, parameter value, and the SVV filtering exceeded indicator from the monitor settings – monitoring screens settings menu. The default setting is enabled. The system will not show the SVV lantern on the SVV indicator curve when the SVV filtering exceeded indicator is on.

5.3.7 Cockpit Screen

This monitoring screen, shown in figure 5-13, displays large parameter globes with the values of the parameter being monitored. Cockpit parameter globes graphically indicate alarm/target ranges and values, and utilize needle indicators to show where the current parameter value falls. Similar to standard parameter tiles, the value within the globe will flash when the parameter is alarming.

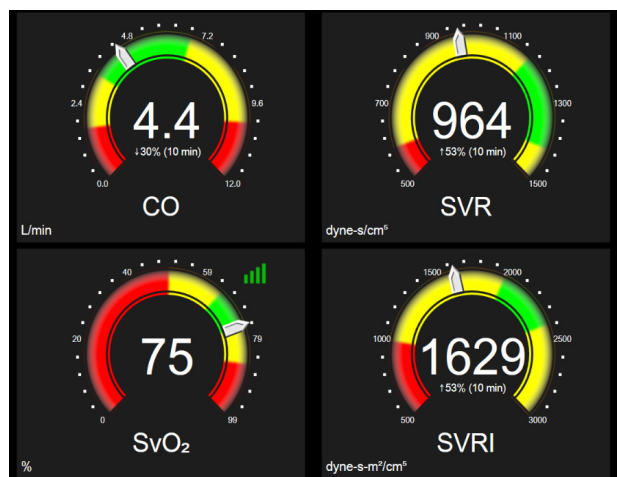

Figure 5-13 Cockpit monitoring screen

The key parameter globes shown on the cockpit screen display a more complex target and alarm indicator than the standard parameter tile. The full display range of the parameter is used to create a gauge from the graphical trends minimum to maximum settings. A needle is used to indicate the current value on the circular gauge scale. When target ranges are enabled, red (alarm zone), yellow (warning target zone), and green (acceptable target zone) are used to indicate the target and alarm regions within the circular gauge. When target ranges are not enabled, the circular gauge area is all gray in color and target or alarm indicators are removed. The value indicator arrow changes to indicate when the values are out of the gauge scale limits.

5.3.8 Physio Relationship

The physio relationship screen depicts the balance between oxygen delivery (DO_2) and oxygen consumption (VO_2). It automatically updates as parameter values change so the values are always current. The connecting lines highlight the relationship of the parameters to each other.

5.3.8.1 Continuous and Historical Modes

The physio relationship screen has two modes: continuous and historical. When in continuous mode, the intermittent and derived values are always displayed as unavailable. HGB is the exception and is displayed as in intermittent parameter in continuous mode with a time stamp of last calculated/entered value.

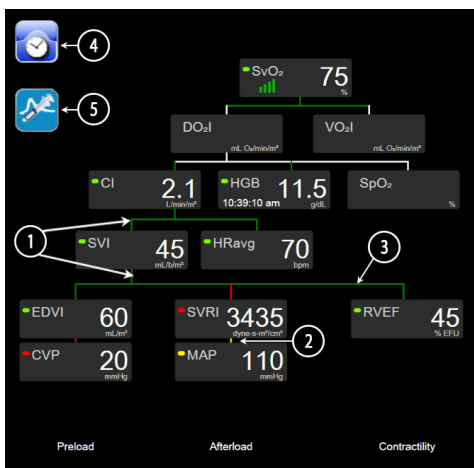

Figure 5-14 Physio relationship screen while monitoring with HemoSphere Swan-Ganz module

- 1 The vertical lines above and below the parameters appear in the same color as the parameter lantern.
- 2 Vertical lines that directly connect two parameters will appear in the same color as the parameter lantern below (for example, between SVRI and MAP in figure 5-14).
- 3 The horizontal lines are the same color as the line above them.
- 4 The left bar appears after a bolus set is performed. Touch the clock/waveform icon to display historical data when available (see figure 5-14).
- 5 Touch the iCO icon, when available, to open the thermodilution new set configuration screen.

NOTE

The example shown in figure 5-14 is while monitoring with a HemoSphere Swan-Ganz module. Differences in appearance and parameters will occur with other monitoring modes. For example, while monitoring within minimally-invasive monitoring mode, HR_{avg} is replaced by PR, PPV and SVV appear (if configured), and EDV and RVEF are not shown.

NOTE Before a thermodilution set is performed and before any values are entered (see 5.3.8.2 *Parameter Boxes* below) the clock/waveform and iCO icons do not appear. Only the available continuous parameters are displayed.

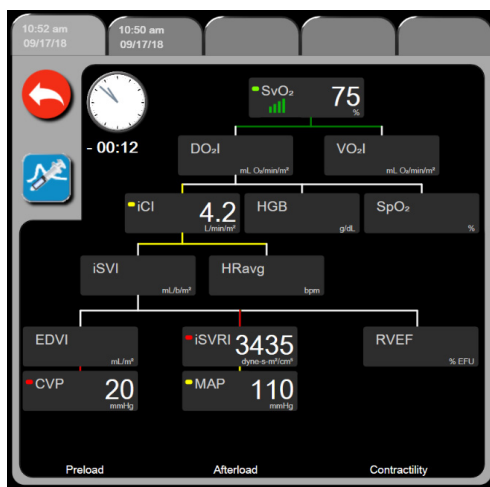



Figure 5-15 Historic physio relationship data screen

NOTE The historic physio relationship screen displays most of the parameters available on the system at a point in time. The screen displays lines connecting the parameters, highlighting the relationship of the parameters to each other. The historic physio relationship screen displays the configured key parameters (up to eight) on the right hand side of the screen. There is a horizontal tab composite at the top that allows the user to navigate through the database of historic records. The record times correspond to thermodilution bolus sets and derived value calculations.

The historic physio relationship screen allows the user to enter parameters used to calculate derived parameters **DO₂** and **VO₂**, on only the most recent record. The values entered are for the time of the record and not the current time.

The historic physio relationship screen is accessed through the clock/waveform icon on the continuous physio relationship screen. Touch the return icon  to return to the continuous physio relationship screen. There is no 2 minute time-out for this screen.

To calculate **DO₂** and **VO₂**, the partial pressure of arterial (PaO₂) and venous (PvO₂) oxygen is required. For the historic physio relationship screen, a PaO₂ and PvO₂ value of zero (0) is used. To calculate DO₂ and VO₂ using values other than zero (0) for PaO₂ and PvO₂, use the **Derived Value Calculator** (see section 5.5.3 on page 108).

5.3.8.2 Parameter Boxes

Each small parameter box displays:

- Parameter name
- Parameter units
- Parameter value (if available)
- Clinical target status indicator (if a value is available)
- SVV indicator (when applicable)
- Parameter time stamp (for HGB)

If the parameter is in a fault state, the value is blank, indicating it is or was unavailable at the time of the display.

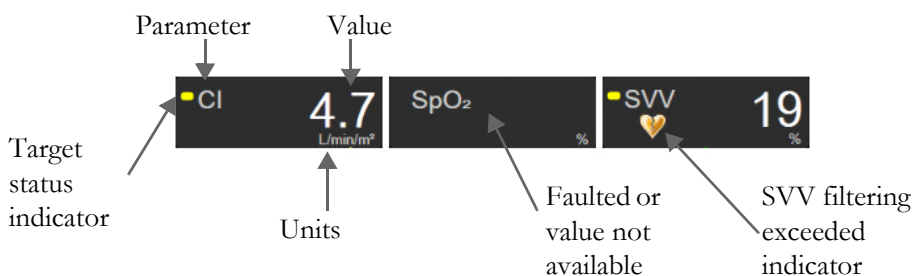

Figure 5-16 Physio relationship parameter boxes

5.3.8.3 Setting Targets and Entering Parameter Values

To change the target settings or enter a value, touch a parameter to bring up the target/enter popup. The physio relationship target/enter popup will be displayed when the following physio relationship small parameter boxes are touched:

- **HGB**
- **SpO₂**
- **SvO₂/ScvO₂** (when no HemoSphere oximetry cable measurement is available)

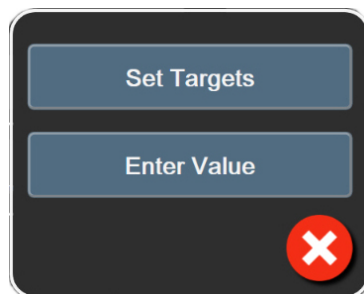

Figure 5-17 Physio relationship target/enter popup

When the value is accepted, a new time-stamped historic physio relationship record is created. It includes:

- Current continuous parameter data
- The entered value and any derived calculated values.

The historic physio relationship screen is shown with the newly created record; you can then enter the rest of the manually entered values to calculate any derived values.

5.3.9 Goal Positioning Screen

The Goal Positioning Screen allows the user to monitor and track the relationship of two key parameters by plotting them against each other on an XY plane.

A single, pulsating blue dot represents the intersection of the two parameters and moves in real time as parameter values change. The additional circles represent the historical parameter trend with the smaller circles indicating older data.

The green target box represents the intersection of the green parameter target zone. The red arrows on the X and Y axis represent the parameter alarm limits.

The first two key parameters selected represent the parameter values plotted on the y and x-axis respectively, as shown in figure 5-18.

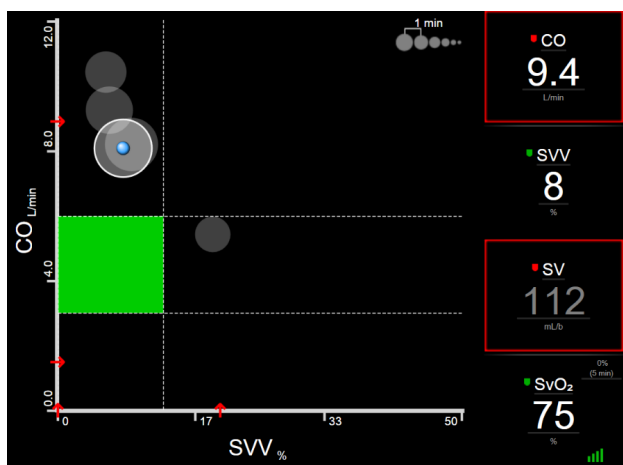



Figure 5-18 Goal positioning screen

The following adjustments can be made on this screen:

- To adjust the time interval between the historical trend circles, touch the trend interval icon  displayed on the screen.
- Continue touching the trend interval icon until **Off** appears to turn off historical trend circles.
- To adjust the scale of the X or Y axis, touch along the corresponding axis.
- If the current intersection of parameters moves outside the scale of the X/Y plane, a message will appear indicating this to the user.

5.4 Focused Monitoring Format



The focused monitoring format allows the user to see arterial blood pressure values along with monitored data for up to three key parameters in a streamlined screen layout.

5.4.1 Select Monitoring View

To select a monitoring view in the focused monitoring format, touch settings icon  → **Select Screens**

tab . See figure 5-3 on page 87.

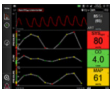
The focused monitoring view has three available monitoring views:

- 
1 Focused Main (see *Focused Main Screen* on page 105)
- 
2 Focused Graphical Trend (see *Focused Graphical Trend Screen* on page 106)
- 
3 Focused Charting (see *Focused Charting Screen* on page 106)

The three focused monitoring formats are displayed across the bottom of the monitoring selection menu, with buttons that are based upon the monitoring screen appearance. Touch a monitor view button to display the key parameters in that screen format.

NOTE If four parameters are selected while monitoring using the formats outlined in *Monitor Views* on page 87 and monitoring is switched to focused monitoring format, only the first three selected parameters are displayed.

5.4.2 Blood Pressure Waveform Tile

All focused monitoring views contain the blood pressure waveform display. See *Live Blood Pressure Waveform Display* on page 95. The focused pressure waveform display uses a format similar to the focused parameter tile, which is described below, to display blood pressure numeric values.

5.4.3 Focused Parameter Tile

The key element in the focused monitoring view is a focused parameter tile. The focused parameter tile displays information similar to the classic parameter tile described in *Parameter Tiles* on page 88. In the focused view, the entire color of the tile changes to match the target status color. For example, the background color of the tile shown figure 5-19 is green; the value is within target range. If monitoring is disabled or paused, the background is black.

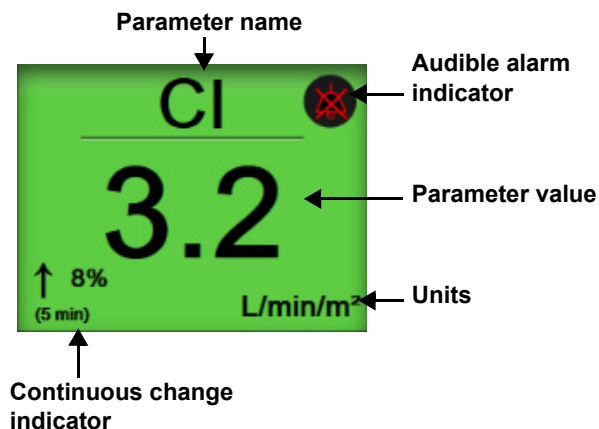

Figure 5-19 Focused parameter tile

5.4.4 Change Parameters

To change parameters while in focused monitoring view, touch anywhere above the central line of the parameter tile, where the parameter name is displayed. See figure 5-20.

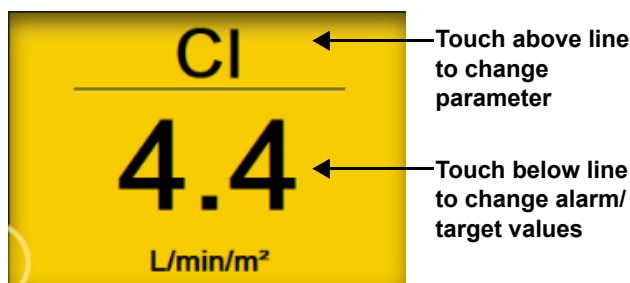

Figure 5-20 Focused parameter tile – parameter and alarm/target selection

The parameter selection menu will appear. See figure 5-4. On the parameter selection menu, parameters are organized into categories. See *Change Parameters* on page 88 for a description of these categories. Currently selected parameters are highlighted in blue. Other monitored parameters are outlined in blue. Select any available parameter – one that is not highlighted – to actively monitor that parameter.

5.4.5 Change Alarms /Targets

To change the alarms or targets for a key parameter while in focused monitoring view, touch anywhere below the central line of the parameter tile, where the parameter value and units are displayed. The **Alarms / Targets** menu will appear for that parameter. For more information on this menu, see *Alarms/Targets* on page 130.

5.4.6 Focused Main Screen

Within the focused main screen, up to three parameters are displayed in columns and the arterial waveform is displayed across the top of the screen. Each column is titled as the parameter category (for example: **Flow**, **Resistance**, or **Pressure**) and displays a centered parameter tile, the continuous % change or reference value (if enabled), and a vertical target meter on the left side of the column. See figure 5-21.

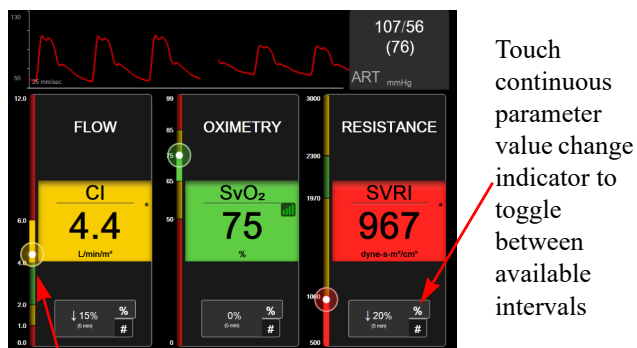

Vertical target meter on side displays the patient's current parameter value and highlights zone

Figure 5-21 Focused main screen

The vertical meter highlights the target zone of the current value. This will match the color of the parameter tile. To change the parameter value change interval – displayed as a percentage or value – touch the displayed value at the bottom of the parameter column to toggle between interval options (0, 5, 10, 15, 20, 30 mins, or from a reference value when displaying a value change). See *Time Intervals / Averaging* on page 124.

5.4.7 Focused Graphical Trend Screen

The focused graphical trend screen displays a graphical plot of the parameter view over time. The elements of this view match that of the graphical trends view in described in *Graphical Trend Monitoring View* on page 91. See that section for information on Intervention Events and Graphical Trend Scroll Mode.

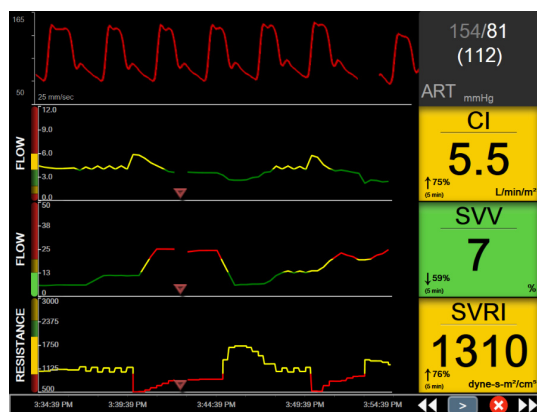

Figure 5-22 Focused Graphical Trend Screen

The focused graphical trend view is displayed in row format with the parameter category and vertical meter on the left side, the trend plot centered, and the parameter tile on the right side. See figure 5-22. Adjust the time scale or upper/lower display limit of the parameter value by touching anywhere on the x- or y-axis of the parameter trend plot. See *Adjust Scales* on page 136 for information on setting the display ranges for all parameters. Menu options selected through the parameter settings menu affect views in all graphical trend formats – the focused graphical screen and the graphical trend view described in *Graphical Trend Monitoring View* on page 91.

5.4.8 Focused Charting Screen

The focused charting screen displays all available parameters for up to three parameter categories described in *Change Parameters* on page 88. Only the top parameter, which is displayed as a parameter tile, can be configured as a key parameter and display/sound alarms (alarm-able). To change the key parameter, touch the parameter name above the parameter tile line. The parameter selection menu for focused charting view only displays those parameters available within the selected parameter category. The font color of parameter

values displayed below the top parameter tile indicate the color of the current target range. The targets for these unconfigured parameters can be adjusted by touching anywhere on the smaller parameter tile and accessing the **Alarms / Targets** configuration menu for that parameter.

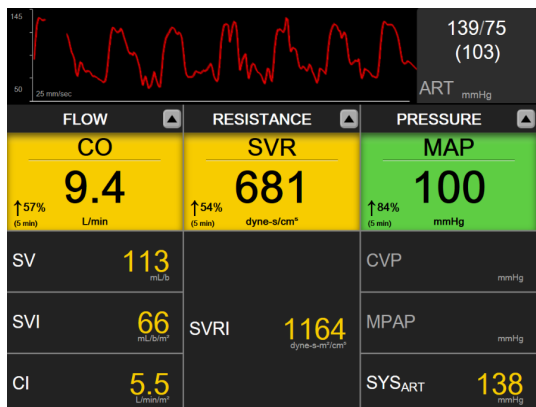

Figure 5-23 Focused Charting Screen

To change the displayed parameter category, touch the currently configured parameter category displayed at the top of the column. A popup menu will appear (figure 5-24). Touch the replacement parameter category.



Figure 5-24 Focused Charting View – Configure Columns

5.5 Clinical Tools

Most options on the clinical actions menu are related to the current monitoring mode (e.g., while monitoring with the HemoSphere Swan-Ganz module). The following clinical actions are available across all monitoring modes.



5.5.1 Select Monitoring Mode

The **Select Monitoring Mode** page allows the user to switch between monitoring modes. This screen will appear before a new monitoring session is started. This screen can also be accessed by:

- a touching the select monitoring mode icon at the top of the navigation bar

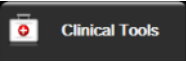

OR

- b touching the settings icon  → **Clinical Tools** tab  → **Select Monitoring Mode** icon 

From this screen, the user can select from connected monitoring technologies. Oximetry monitoring is available across all monitoring modes.

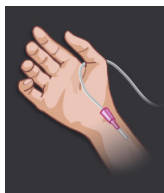

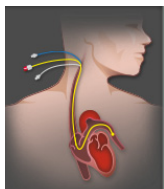

Minimally-Invasive Monitoring Mode Button. The user can select this button for minimally-invasive hemodynamic monitoring using the HemoSphere pressure cable. Monitoring with a TruWave DPT is also available while in this mode.



Invasive Monitoring Mode Button. The user can select this button for invasive hemodynamic monitoring using a HemoSphere Swan-Ganz module.





Non-invasive Monitoring Mode Button. The user can select this button for noninvasive hemodynamic monitoring using a HemoSphere ClearSight module.

Touch the home icon  to continue with the selected monitoring mode. The letter “S” () will appear on the x-axis of the graphical trends monitoring view at the point in time when the monitoring mode switch occurred.

5.5.2 CVP Entry

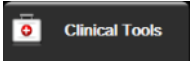
The CVP Entry screen allows the user to input a patient’s CVP value to derive continuous SVR/SVRI calculation when MAP data is also available.



- 1 Touch the settings icon  → **Clinical Tools** tab  → **Enter CVP** icon 
- 2 Enter the CVP value.
- 3 Touch the home icon  to return to the main monitoring screen.

NOTE CVP entry is not available when an analog input signal is used to display CVP data (see *Analog Pressure Signal Input* on page 126) or when the HemoSphere pressure cable and a TruWave transducer are monitoring CVP (see *Pressure Cable Monitoring with a TruWave DPT* on page 170).

5.5.3 Derived Value Calculator



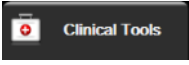

The **Derived Value Calculator** allows the user to compute certain hemodynamic parameters and provides a convenient way to display these parameters for one-time calculation.

Calculated parameters are based on monitoring mode and may include: CPO/CPI, DO₂/DO₂I, ESV/ESVI, SVI/SV, VO₂/VO₂I, VO₂c/VO₂Ie, SVR/SVRI, LVSWI, RVSWI, and PVR.

- 1 Touch the settings icon  → **Clinical Tools** tab  → **Derived Value Calculator** icon .
- 2 Enter the required values and the derived calculations will automatically display.
- 3 Touch the home icon  to return to the monitoring screen.

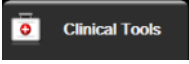
5.5.4 Event Review

Use **Event Review** to view parameter-related and system events that occurred during monitoring. This includes the start and end time of any faults, alerts, physiological alarms, or system messages. Up to 72 hours of events and alarm messages are recorded in order with the most recent event at the top.

- 1 Touch the settings icon  → **Clinical Tools** tab  → **Event Review** icon .
- OR
- touching the **Event Review** shortcut on the information bar .
- 2 To view system logged events (see table 5-4) select the **Events** tab. To view system generated messages, touch the **Alarms** tab. To scroll up or down on either screen, touch the arrow keys.
 - 3 Touch the home icon  to return to the monitoring screen.

The following events are included in the **Events** tab of the event review log.

Table 5-4 Reviewed events

Event	When time logged
Arterial Pressure Zeroed	A TruWave pressure transducer is zeroed and the label is ART
Averaging Time – 5 seconds	The CO/pressure averaging time changes to 5 seconds
Averaging Time – 20 seconds	The CO/pressure averaging time changes to 20 seconds
Averaging Time – 5 minutes	The CO/pressure averaging time changes to 5 minutes
BP Calibration Cleared	The existing BP calibration is cleared
BP Calibration Failed REFERENCE: SYS <X>, DIA <Y>	Blood pressure calibration has failed where <X> is the user-entered reference value for SYS and <Y> is the user-entered value for DIA
BP Calibration Successful REFERENCE: SYS <X>, DIA <Y>	Blood pressure calibration is successfully completed where <X> is the user-entered reference value for SYS and <Y> is the user-entered value for DIA
BSA Change	The BSA value changes from the previous BSA value (including when BSA goes to/from blank)
Central Venous Pressure Zeroed	A TruWave pressure transducer is zeroed and the label is CVP
CO Cable Test Passed	When the Patient CCO Cable Test was performed and passed
CO Monitoring Started	When invasive (Swan-Ganz module) CO monitoring is started
CO Monitoring Stopped	When the user or system stops invasive (Swan-Ganz module) CO monitoring
ClearSight Monitoring Started	The user begins noninvasive system monitoring

Table 5-4 Reviewed events (continued)

Event	When time logged
ClearSight Monitoring Started (No HRS; Finger <position>)	The user begins noninvasive system monitoring without an HRS where <position> is the verified height offset between the monitored finger and heart.
ClearSight Monitoring Stopped	The user or system stops noninvasive system monitoring
ClearSight Monitoring Resumed	When monitoring resumes after a cuff pressure release
Continuous monitoring has reached the 72 hour limit	Noninvasive system monitoring has stopped due to 72 hour limit
Cuff 1 Monitoring	Cuff 1 monitoring begins
Cuff 2 Monitoring	Cuff 2 monitoring begins
Cuff Pressure Released	A cuff pressure release has occurred
Cuff Pressure Released Acknowledged	The Acknowledge button is touched on Pressure Release notification popup
CVP Cleared	The user has cleared the manually entered CVP value
CVP Entered <value><units>	A CVP value has been manually entered with the shown value and units
[IA#N]Draw Blood	The Draw option is selected in the In vivo Calibration Draw screen. This is logged as an intervention analysis where #N is the enumeration of interventions for this patient.
FloTrac Sensor Zeroed	The FloTrac or Acumen IQ sensor is zeroed
FRT Start Baseline	An FRT baseline measurement is started
FRT End Baseline	An FRT baseline measurement is completed with a valid measurement
FRT Cancel Baseline	An FRT baseline measurement is canceled
FRT Unstable Baseline	An FRT baseline measurement is stopped with a valid measurement however the measurement is unstable
FRT Start Challenge	An FRT challenge measurement is started.
FRT End Challenge	An FRT challenge measurement is stopped with a valid measurement. This occurs at the end of the challenge duration or when the user touches END NOW .
FRT Cancel Challenge	An FRT measurement is canceled
FRT Insufficient Data	An FRT measurement is stopped and invalid
GDT Session Started: #nn	A GDT Tracking Session is started. 'nn' is the GDT tracking session number for the current patient
GDT Session Stopped: #nn	A GDT Tracking Session is stopped. 'nn' is the tracking session number for the current patient
GDT Session Paused: #nn	A GDT Tracking Session is paused. 'nn' is the tracking session number for the current patient
GDT Session Resumed: #nn	A GDT Tracking Session is resumed. 'nn' is the tracking session number for the current patient
GDT Session Targets Updated: #nn; <pppp>:<qqq><uuu>,<...>	GDT Tracking Session targets are updated. 'nn' is the tracking session number for the current patient, <pppp> is the parameter whose target range <qqq> with units <uuu> was updated. <...> additional targets were updated
[IA#N] HGB Update	Oximetry cable update completes following the HGB update process
HPI Alert	Acumen Hypotension Prediction Index, HPI, alert becomes active. [HPI only]
HPI Alert Acknowledged*	Acumen Hypotension Prediction Index, HPI, alert is acknowledged*. [HPI only]

Table 5-4 Reviewed events (continued)

Event	When time logged
HPI Alert Cleared (Acknowledged*)	Acumen Hypotension Prediction Index, HPI, alert is cleared as the HPI value was lower than 75 for the last two consecutive 20-second updates. The HPI high alert popup was acknowledged* prior to the alert clearing. [HPI only]
HPI Alert Cleared (Not Acknowledged*)	Acumen Hypotension Prediction Index, HPI, alert is cleared as the HPI value was lower than 75 for the last two consecutive 20-second updates. The HPI high alert popup was not acknowledged* prior to the alert clearing. [HPI only]
HRS Zeroed	HRS is zeroed by the user
iCO Bolus Performed	When an iCO bolus is performed
In vitro Calibration	When oximetry cable update completes following the In vitro calibration process
In vivo Calibration	When oximetry cable update completes following In vivo calibration process
[IA#N] <sub-type> <detail> <note>	An intervention analysis is performed where #N is the enumeration of interventions for this patient <sub-type> is the intervention sub-type selected (for general Intervention: Inotrope, Vasodilator, or Vasopressor; for Fluid analysis: Red Blood Cells, Colloid, or Crystalloid; for Position Challenge: Passive Leg Raise or Trendelenburg; for Event: PEEP, Induction, Cannulation, CPB, Cross Clamp, Cardioplegia, Pump Flow, Circulatory Arrest, Warming, Cooling, Selective Cerebral Perfusion) <detail> is the selected detail <note> is note added by user
[IA#N] Custom <detail> <note>	A Custom intervention analysis is performed where #N is the enumeration of interventions for this patient <detail> is the selected detail <note> is note added by user
[IA#N Updated] Note: <updated note>	The note associated with the Nth intervention was edited but the time and date were not edited. Logged when the Accept button on Edit Intervention Popup is enabled and touched. N is the enumeration of the original intervention.
[IA#N Updated] Time: <Updated date> - <Updated Time>	The date or time associated with the Nth intervention was edited but the note was not edited. Logged when the Accept button on Edit Intervention Popup is enabled and touched. N is the enumeration of the original intervention.
[IA#N Updated] Time: <Updated date> - <Updated Time>; Note: <updated note>	The (time OR date) AND note associated with the Nth intervention were edited. Logged when the Accept button on Edit Intervention Popup is enabled and touched. N is the enumeration of the original intervention.
Light Out of Range	When the Oximetry Light Range Fault occurs
Monitoring Mode Switched from Minimally-Invasive to Invasive	The user switches monitoring modes from minimally-invasive mode (with FloTrac/Acumen IQ sensor or TruWave DPT) to invasive mode (with Swan-Ganz catheter)
Monitoring Mode Switched from Invasive to Minimally-Invasive	The user switches monitoring modes from invasive mode (with Swan-Ganz catheter) minimally-invasive mode (with FloTrac/Acumen IQ sensor or TruWave DPT)
Monitoring Paused	Active monitoring paused to prevent audible alarms and parameter monitoring
Monitoring Resumed	Normal monitoring resumed. Audible alarms and parameter monitoring are active
Monitoring Stopped as Single Cuff Use Has Exceeded 8 Hours	Monitoring for 8 continuous hours on a single cuff has occurred
Oximetry Disconnected	An oximetry cable disconnection is detected

Table 5-4 Reviewed events (continued)

Event	When time logged
Positioning Mode: <mode>	The user has started noninvasive system monitoring and the positioning mode is selected as < Patient Sedated and Stationary > or < Variable Patient Positioning >
Postpone Pressure Release	Monitoring is extended to delay a finger cuff pressure release
Pulmonary Artery Pressure Zeroed	A TruWave pressure transducer is zeroed and the label is PAP
[IA#N] Recall Oximetry Data	When recalled oximetry calibration data is accepted by the user
System Restart Recovery	When the system has resumed monitoring without being prompted following a power cycle
Monitoring Mode Switch Occurred	The monitoring mode is changed from one technology to another
Time Change	The system clock is updated
Vertical Offset Updated: Finger <position>	The finger to height offset is updated by the user during Patient Sedated and Stationary positioning mode where <position> is the verified height offset between the monitored finger and heart.
* Acknowledgment is logged when the user touches either button on the HPI Hight Alert popup.	

5.6 Information Bar

The information bar appears on all active monitoring screens and most clinical tools screens. It displays the current time, date, battery status, screen brightness menu shortcut, alarm volume menu shortcut, help screen shortcut, event review shortcut, and the lock screen symbol. For information on switching the monitoring mode, see *Select Monitoring Mode* on page 107. While monitoring with the HemoSphere Swan-Ganz module, the parameter information bar may display blood temperature and slaved in heart rate. While monitoring with the HemoSphere pressure cable, in minimally-invasive monitoring mode, the parameter information bar may display CO/pressure averaging time and HPI parameter values. For more information on the Acumen Hypotension Prediction Index feature (HPI), which is an advanced feature, see *Acumen™ Hypotension Prediction Index (HPI) Software Feature* on page 218. While monitoring in noninvasive monitoring mode, the information bar may display HPI parameter values and a cuff pressure release countdown clock. See *Cuff Pressure Release Mode* on page 188. When the monitor has an activated HIS or Wi-Fi connection, the status will be displayed. See table 8-1 on page 142 for Wi-Fi status symbols and table 8-2 on page 143 for HIS connectivity status symbols. Figure 5-25 shows an example of an information bar while monitoring with the HemoSphere Swan-Ganz module with a slaved in ECG heart rate.

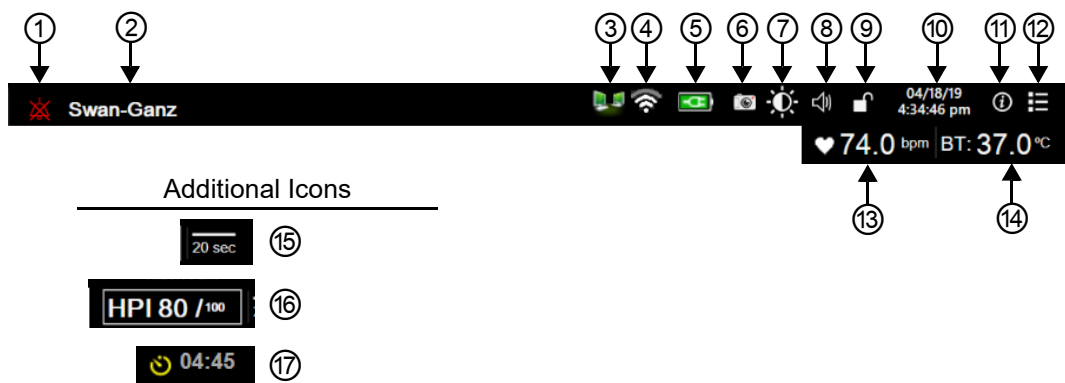

Figure 5-25 Information bar

- ① alarms silenced
- ② sensor technology
- ③ HIS status
- ④ Wi-Fi status
- ⑤ battery status
- ⑥ snapshot
- ⑦ screen brightness
- ⑧ alarm volume
- ⑨ lock screen
- ⑩ date/time
- ⑪ help menu
- ⑫ event review
- ⑬ heart rate¹
- ⑭ blood temperature¹
- ⑮ averaging time²
- ⑯ HPI parameter^{2,3}
- ⑰ cuff release countdown³

¹ *invasive HemoSphere Swan-Ganz module monitoring*
² *minimally-invasive HemoSphere pressure cable monitoring*
³ *noninvasive HemoSphere ClearSight module monitoring*

NOTE Figure 5-25 is an example of an information bar with U.S. standard defaults. To see the defaults for all languages, see table D-6, “Language default settings,” on page 304.



5.6.1 Battery

The HemoSphere advanced monitor allows for uninterrupted monitoring during power loss when the HemoSphere battery pack is installed. Battery life is indicated on the information bar by the symbols shown in table 5-5. For more information on battery installation, see *Battery Installation* on page 64. To ensure that the battery charge status displayed on the monitor is correct, it is recommended to perform periodic checks of battery health through battery conditioning. For information on battery maintenance and conditioning, see *Battery Maintenance* on page 313.

Table 5-5 Battery status

Battery symbol	Indication
	The battery has greater than 50% charge remaining.
	The battery has less than 50% charge remaining.
	The battery has less than 20% charge remaining.

Table 5-5 Battery status (continued)

Battery symbol	Indication
	The battery is charging and connected to mains power.
	The battery is fully charged and connected to mains power.
	The battery is not installed.

WARNING To prevent any interruptions to monitoring during power loss, always use the HemoSphere advanced monitor with the battery inserted.

In cases of power failure and battery depletion, the monitor will go through a controlled shut off procedure.

5.6.2 Screen Brightness

To adjust the screen brightness, touch the shortcut located on the information bar .

5.6.3 Alarm Volume

To adjust the alarm volume, touch the shortcut located on the information bar .

5.6.4 Screen Capture

The snapshot icon captures an image of the screen at the current time. A USB stick attached to one of the two USB ports (rear and right panels) of the HemoSphere advanced monitor is required to save the image. Touch the snapshot icon located on the information bar .

5.6.5 Lock Screen

If the monitor is being cleaned or moved, lock the screen. For cleaning instructions refer to *Cleaning the Monitor and Modules* on page 308. The screen will automatically unlock once the internal timer has counted down.

- 1 Touch the lock screen icon .

- 2 Touch the time that the screen will remain locked on the **Lock Screen** popup.

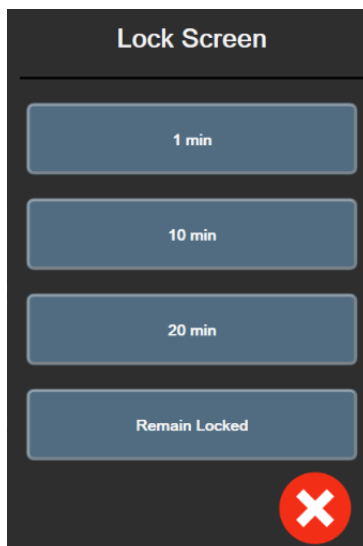

Figure 5-26 Lock screen popup

- 3 A red lock icon will appear on the information bar.
- 4 To unlock the screen, touch the red lock icon  and touch **Unlock Screen** on the **Lock Screen** menu.

5.7 Status Bar

The status bar appears at the top of all active monitoring screens below the information bar. It displays faults, alarms, alerts, some warnings and notifications. When there is more than one fault, alert or alarm, the message is cycled every two seconds. The message number out of total messages is displayed on the left. Touch this to toggle through the current messages. Touch the question icon to access the help screen for non-physiological alarm messages.



Figure 5-27 Status bar

5.8 Monitor Screen Navigation

There are several standard navigational procedures on the screen.

5.8.1 Vertical Scrolling

Some screens will have more information than fits on the screen at one time. If vertical arrows appear on a review list, touch the up or down arrow to see the next set of items.



If selecting from a list, the vertical scroll arrows move up or down one item at a time.



5.8.2 Navigation Icons

There are some buttons that always perform the same function:



Home. The home icon takes you to the most recently viewed monitoring screen and stores any modification made to data on the screen.



Return. The return icon takes you to the previous menu screen and stores any modification made to data on the screen.



Enter. The enter icon stores any modification made to data on the screen and returns to the monitoring screen or brings up the next menu screen.



Cancel. The cancel icon causes any entries to be discarded.

On some screens, for example Patient Data, there is no cancel button. As soon as a patient's data is entered, it is stored by the system.

List buttons. Some of the screens have buttons that appear next to menu text.

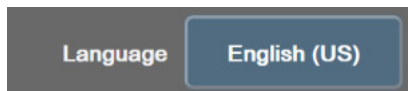

In these cases, touching anywhere on the button reveals a list of selectable items associated with the menu text. The button displays the current selection.

Value button. Some screens have square buttons as shown below. Touch the button to display a keypad.



Toggle button. When an option exists between two choices, such as on/off, a toggle button appears.



Touch on the opposite side of the button to switch the choice.

Keypad. Touch the keys on the keypad to enter numeric data.

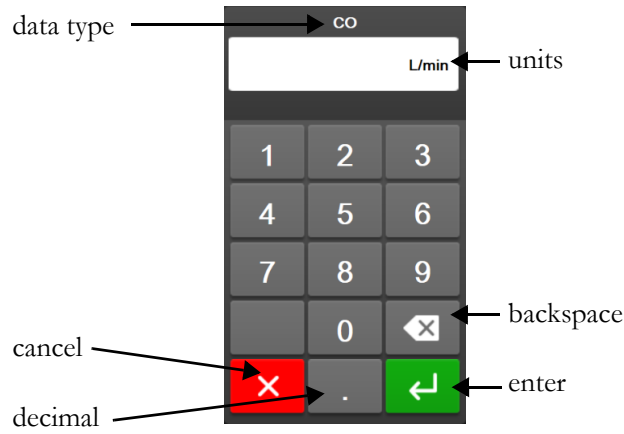

Keyboard. Touch the keys on the keyboard to enter alphanumeric data.

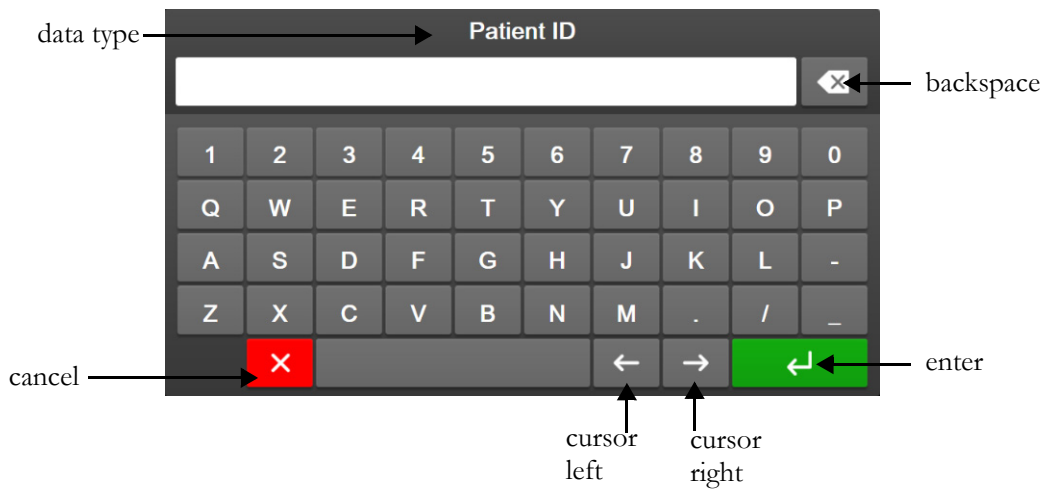

User Interface Settings

Contents

Password Protection	118
Patient Data	120
General Monitor Settings	122

6.1 Password Protection

The HemoSphere advanced monitor has three levels of password protection.

Table 6-1 HemoSphere advanced monitor password levels

Level	Digits required	User description
Super User	four	Clinicians
Secure User	eight	Hospital authorized personnel
Edwards User	rolling password	internal Edwards use only

Any settings or features described in this manual that require a password are **Super User** features. The **Super User** and **Secure User** passwords require a reset during system initialization the first time a password screen is accessed. Contact your hospital administrator or IT department for passwords. If a password is entered incorrectly ten times, the password keypad will become locked for a certain time period. Monitoring will remain active. In the event of forgotten passwords, contact your local Edwards representative.

Two settings menu options are password protected: **Advanced Setup** and **Export Data**.

To access the **Advanced Setup** features described below in table 6-2,

touch settings icon  → Settings tab  → **Advanced Setup** button.

Table 6-2 Advanced setup menu navigation and password protection

Advanced setup menu selection	Sub-menu selection	Super User	Secure User	Edwards User
Parameter Settings	Alarms / Targets	✓	✓	✓
	Alarms / Targets → Configure All	no access	✓	✓
	Adjust Scales	✓	✓	✓
	HPI Settings	✓	✓	✓
	SVV/PPV	✓	✓	✓
	20-Second Flow Settings	✓	✓	✓
GDT Settings		✓	✓	✓

Table 6-2 Advanced setup menu navigation and password protection (continued)

Advanced setup menu selection	Sub-menu selection	Super User	Secure User	Edwards User
Analog Input		✓	✓	✓
Setting Profile		no access	✓	✓
System Reset	Restore Factory Defaults	no access	✓	✓
	Data Wipe	no access	✓	✓
	Decommission Monitor	no access	no access	✓
Connectivity	Wireless	no access	✓(if enabled)	✓
	Serial Port Setup	no access	✓	✓
	HL7 Setup	no access	✓(if enabled)	✓
Manage Features		no access	✓	✓
System Status		no access	✓	✓
Change Passwords		no access	✓	✓
Engineering	Alarm Settings	no access	✓	✓
	Tissue Oximetry	no access	✓	✓

To access the **Export Data** features described below in table 6-3,

touch settings icon  → **Settings** tab  → **Export Data** button.

Table 6-3 Export data menu navigation and password protection

Export data menu selection	Super User	Secure User	Edwards User
Diagnostics Export	✓	✓	✓
Data Download	✓	✓	✓
Manage Clinical Data	no access	✓(if enabled)	✓
Export Service Data	no access	✓	✓

6.1.1 Changing passwords

Changing passwords requires **secure user** access. Contact your hospital administrator or IT department for password. To change passwords:

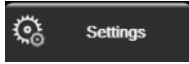
- 1 Touch settings icon  → **Settings** tab  → **Advanced Setup** button.
- 2 Enter the **Secure User** password.
- 3 Touch **Change Passwords** button.
- 4 Enter the new **Super User** and/or **Secure User** password digits in both value boxes until the green check mark appears. A check mark confirms that the minimum digit requirement has been met and both entries of the desired password are identical.
- 5 Touch the **Confirm** button.

6.2 Patient Data

After the system is turned on, the user has the option to either continue monitoring the last patient or to start monitoring a new patient. See figure 6-1 below.

NOTE If data for the last patient monitored is 12 hours or older, the only option is to start a new patient.

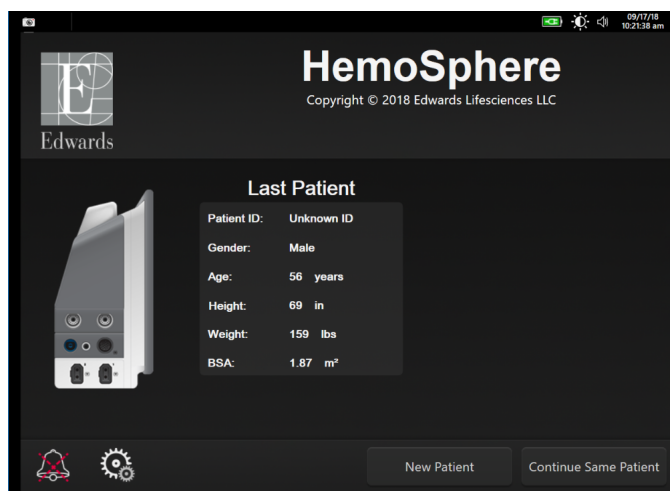

Figure 6-1 New or continuing patient screen

6.2.1 New Patient

Starting a new patient clears all previous patient data. The alarm limits and continuous parameters are set to their default values.

WARNING Upon initiation of a new patient session, the default high/low physiological alarm ranges should be checked to ensure that they are appropriate for the given patient.

The user has the option of entering a new patient upon initial startup of the system or while the system is running.

WARNING Perform **New Patient** or clear the patient data profile whenever a new patient is connected to the HemoSphere advanced monitor. Failure to do so may result in previous patient data in the historical displays.

- 1 After turning on the monitor, the new or continuing patient screen appears (figure 6-1). Touch **New Patient** and continue to step 6.

OR

If the monitor is already on, touch the settings icon  → **Clinical Tools** tab

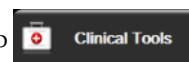

and continue to step 2.

- 2 Touch **Patient Data** icon .

- 3 Touch **New Patient** button.
- 4 The **New Patient Data** screen appears. See figure 6-2.

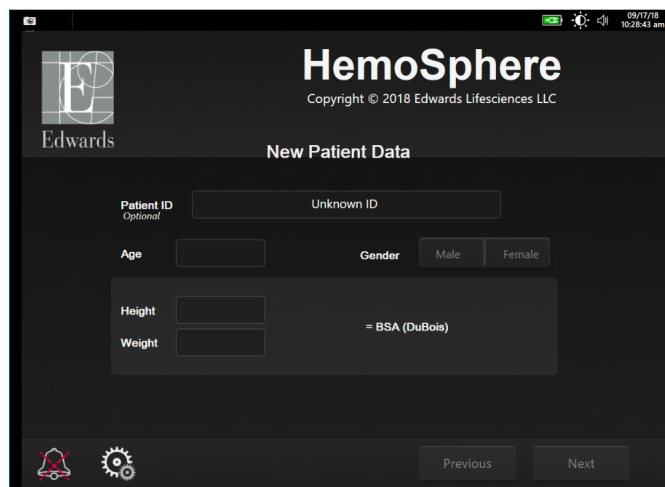



Figure 6-2 New Patient Data screen

- 5 Touch the enter key  on the keypad/keyboard to save each patient demographic selection value and return to the patient data screen.
- 6 Touch **Patient ID** button and use the keyboard to enter the patient's hospital ID.
- 7 Touch **Height** button and use the keypad to enter the patient's height. The unit default for your language is at the upper right of the keypad. Touch it to change the unit of measurement.
- 8 Touch **Age** and use the keypad to enter the patient's age.
- 9 Touch **Weight** and use the keypad to enter the patient's weight. The unit default for your language is at the upper right of the keypad. Touch it to change the unit of measurement.
- 10 Touch **Gender** and select **Male** or **Female**.
- 11 The **BSA** is calculated from the height and weight using the DuBois formula.
- 12 Touch the **Next** button.



NOTE The **Next** button is disabled until all patient data is entered.

- 13 Select the appropriate monitoring mode on the **Monitoring Mode Selection** window. See *Select Monitoring Mode* on page 107. Refer to instructions for starting monitoring with the desired hemodynamic monitoring technology.

6.2.2 Continue Monitoring Patient

If the last patient's data is less than 12 hours old, the patient's demographics and patient ID will be displayed when the system is turned on. When monitoring of the last patient is continued, the patient's data is loaded and the trend data is retrieved. The most recently viewed monitoring screen is displayed. Touch **Continue Patient**.

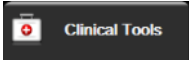
6.2.3 View Patient Data

- 1 Touch settings icon  → **Clinical Tools** tab .
- 2 Touch **Patient Data** icon  to see patient data. The screen will also include a **New Patient** button.
- 3 Touch the return icon  to return to the settings screen. The patient demographic popup screen will appear. If returning to the same patient, review the patient demographics and press **Yes** if they are correct.

6.3 General Monitor Settings

The General Monitor Settings are those that affect every screen. These are the display language, units used, alarm volume, snapshot sound, date/time settings, screen brightness, and monitoring screen display settings.

The HemoSphere advanced monitor interface is available in several languages. A language selection screen appears the first time the HemoSphere advanced monitor is started. See figure 3-7, “Language selection screen,” on page 68. The language screen will not appear again, but the display language can be changed at any time.

The selected language determines the default time and date format. These can also be changed independently of the language selected.

NOTE If power is lost and restored to the HemoSphere advanced monitor, the system settings prior to the power loss, including alarm settings, alarm volume, target settings, monitoring screen, parameter configuration, language and unit selection, are automatically restored to last configured settings.

6.3.1 Change Language

- 1 Touch the settings icon  → **Settings** tab .

- 2 Touch the **General** button.

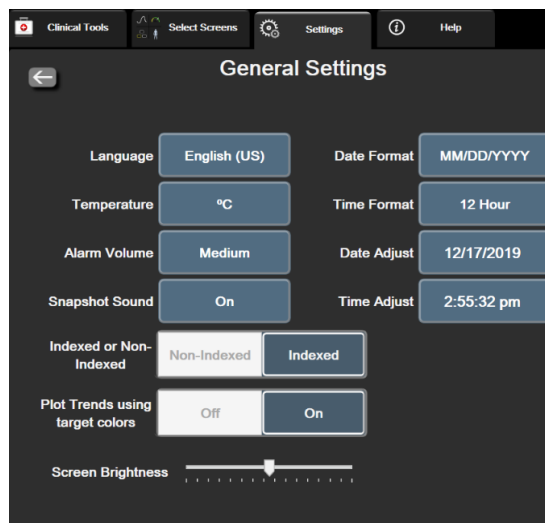



Figure 6-3 General Monitor Settings



- 3 Touch the value section of the **Language** button and select the desired display language.
- 4 Touch the home icon  to return to the monitoring screen.

NOTE See appendix D for all language default settings.

6.3.2 Change Date and Time Display

English (US) dates default to **MM/DD/YYYY**, and the time defaults to a **12 Hour** clock.

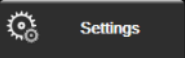
When an international language is selected, the date defaults to the format found in appendix D: *Monitor Settings and Defaults*, and the time defaults to a 24 hour clock.

- 1 Touch the settings icon  → **Settings** tab .
- 2 Touch **General** button.
- 3 Touch the value section of the **Date Format** button and touch the desired format.
- 4 Touch the value section of the **Time Format** button and touch the desired format.
- 5 Touch the home icon  to return to the monitoring screen.

6.3.2.1 Adjust Date or Time

The system time can be reset if necessary. When the time or date is changed, trended data is updated to reflect the change. Any retained data is updated to reflect the time change.

NOTE The time clock of the HemoSphere advanced monitor does not automatically adjust for daylight saving time (DST). This adjustment needs to be made using the following instructions.

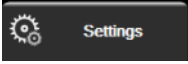
- 1 Touch the settings icon  → **Settings** tab .
- 2 Touch **General** button.
- 3 To change the date, touch the value section of the **Date Adjust** button and enter the date on the keypad.
- 4 To change the time, touch the value section of the **Time Adjust** button and enter the time.

NOTE The time and date can also be adjusted by touching the date/time directly on the information bar.

- 5 Touch the home icon  to return to the monitoring screen.

6.3.3 Monitoring Screens Settings

From the **General Settings** screen, the user can also set physiology and physio relationship monitoring screen and graphical trend monitoring screen options.

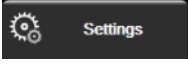
- 1 Touch the settings icon  → **Settings** tab .
- 2 Touch the **General** button.
- 3 Select the **Indexed or Non-Indexed** toggle for parameters in the physiology and physio relationship screens.
- 4 Next to **Plot trends using target colors** select **On** or **Off** to display target colors on graphical trend monitoring screens.

6.3.4 Time Intervals / Averaging

The **Time Intervals / Averaging** screen lets the user select the continuous change % or value interval. During FloTrac sensor monitoring mode, the user can also change the CO/pressure averaging time.

NOTE The screen will return to the monitoring view after two minutes of inactivity.

The **CO/Pressure Averaging Time** value button is only available in FloTrac sensor monitoring mode.

- 1 Touch within a parameter tile to access the parameter configuration menu.
- 2 Touch the **Intervals / Averaging** tab.

6.3.4.1 Display Parameter Value Change

The change in value or percent change in value of a key parameter over a selected time interval can be displayed on a parameter tile.

- 1 Touch the **Change Display** menu button to select the format for which the change interval is displayed: **% Changed** or **Value Difference**.

2 Touch the **Change Interval** value button and select one of the following time interval options:

- None
- Reference
- 1 min
- 3 min
- 5 min
- 10 min
- 15 min
- 20 min
- 30 min

If **Reference** is selected, the change interval will be calculated from the start of monitoring. The **Reference Value** can be adjusted on the **Intervals/Averaging** tab of the tile configuration menu.

6.3.4.2 CO/Pressure Averaging Time

Touch the right side of the **CO/Pressure Averaging Time** value button and touch one of the following interval options:

- 5 sec
- 20 sec (default and recommended time interval)
- 5 min

The **CO/Pressure Averaging Time** selection affects the averaging time and display update rate of CO and other additional parameters while in minimally-invasive monitoring mode. See table 6-4 below for details of which parameter averaging and update rates are affected based on menu selection.

Table 6-4 CO/pressure averaging time and display update rates –minimally-invasive monitoring mode

CO/Pressure Averaging Time menu selection	Parameter update rate		
	5 sec	20 sec	5 min
Cardiac Output (CO)	2 sec	20 sec	20 sec
Stroke Volume (SV)	2 sec	20 sec	20 sec
Systolic Pressure (SYS)	2 sec	20 sec [^]	20 sec [^]
Diastolic Pressure (DIA)	2 sec	20 sec [^]	20 sec [^]
Mean Arterial Pressure (MAP)	2 sec	20 sec [^]	20 sec [^]
Pulse Rate (PR)	2 sec	20 sec [^]	20 sec [^]
Central Venous Pressure (CVP)	2 sec	2 sec [†]	2 sec [†]
Mean Pulmonary Artery Pressure (MPAP)	2 sec	2 sec [†]	2 sec [†]
Stroke Volume Variation (SVV)	20 sec [*]	20 sec [*]	20 sec
Pulse Pressure Variation (PPV)	20 sec [*]	20 sec [*]	20 sec
<p>*5 and 20 second parameter averaging time is not available for SVV and PPV. If 5 or 20 seconds is selected, SVV and PPV will have a 1 minute averaging time.</p> <p>†Parameter averaging time is always 5 seconds with an update rate of 2 seconds for CVP and MPAP.</p> <p>[^]When using a TruWave transducer, averaging is only available at 5 seconds with an update rate of 2 seconds.</p>			

NOTE For real-time blood pressure waveform displayed on the blood pressure waveform display (see *Live Blood Pressure Waveform Display* on page 95) or on the Zero & Waveform screen (see *Zero & Waveform Screen* on page 173), the update rate is always 2 seconds.

Touch home icon  to return to the monitoring screen.

6.3.5 Analog Pressure Signal Input

While performing CO monitoring, the HemoSphere advanced monitor can also calculate SVR by utilizing analog pressure signal input from a connected patient monitor.

NOTE Connecting to external input devices allows additional information to be displayed. For example, while monitoring with the HemoSphere Swan-Ganz module and when MAP and CVP are available continuously from a bedside monitor, SVR is displayed if configured in a parameter tile. MAP and CVP are displayed on the physio relationship and physiology monitoring screens.

WARNING The analog communication ports of the HemoSphere advanced monitor share a common ground that is isolated from the catheter interface electronics. When connecting multiple devices to the HemoSphere advanced monitor, all devices should be provided with isolated power to avoid compromising the electrical isolation of any of the connected devices.

Risk and Leakage current of the final system configuration must comply with IEC 60601-1:2005/A1:2012. It is the responsibility of the user to ensure compliance.

Accessory equipment connected to the monitor must be certified according to IEC/EN 60950 for data-processing equipment or IEC 60601-1:2005/A1:2012 for electro-medical equipment. All combinations of equipment must be in compliance with IEC 60601-1:2005/A1:2012 systems requirements.

CAUTION When connecting the HemoSphere advanced monitor to external devices, refer to the external device's instruction manual for complete instructions. Verify proper operation of the system before clinical use.

Once the bedside monitor has been configured for the desired parameter output, connect the monitor via an interface cable to the selected analog input port on the HemoSphere advanced monitor.

NOTE A compatible bedside monitor must provide an analog output signal.

Please contact your local Edwards representative to obtain the correct HemoSphere advanced monitor analog input interface cable for your bedside monitor.

The following procedure describes how to configure the analog input ports of the HemoSphere advanced monitor.

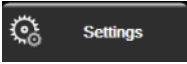
- 1 Touch the settings icon  → **Settings** tab .
- 2 Touch **Advanced Setup** button and enter the required password. All passwords are set during system initialization. Contact your hospital administrator or IT department for password.
- 3 Touch **Analog Input** button.
- 4 If monitoring with the HemoSphere Swan-Ganz module, select **MAP** from the **Parameter** list button for the numbered analog port where MAP is connected (**1** or **2**). The default setting values for MAP will be displayed.

NOTE While in FloTrac sensor monitoring mode, MAP data through analog input is not available.

If an analog signal is not detected on the selected port, “**Not Connected**” will be displayed below the **Port** list button.

When an analog input connection or disconnection is first detected, a brief notification message will be displayed on the status bar.

-
- 5 Select **CVP** in the **Parameter** list button for the numbered analog port where CVP is connected. The default setting values for CVP will be displayed.

NOTE The same parameter may not be configured on more than one analog input at the same time.

While in FloTrac sensor monitoring mode, and a TruWave DPT monitoring CVP is connected, CVP data through analog input is not available.

-
- 6 If the default values are correct for the bedside monitor being used, touch the home icon .

If the default values are not correct for the bedside monitor being used (refer to the bedside monitor operator’s manual), the user can modify the voltage range, full scale range, or perform the calibration option described in section 6.3.5.1 of this chapter.

Touch the **Full Scale Range** value button to change the displayed full scale signal value. Table 6-5 below shows the allowable input values for full scale range based on the selected parameter.

Table 6-5 Analog input parameter ranges

Parameter	Full Scale Range
MAP	0 to 510 mmHg (0 kPa to 68 kPa)
CVP	0 to 110 mmHg (0 kPa to 14.6 kPa)

NOTE A voltage reading of zero is automatically set to a minimum pressure reading of 0 mmHg (0 kPa). The **Full Scale Range** represents the full scale signal or maximum pressure reading for the selected **Voltage Range**.

Touch the **Voltage Range** list button to change the displayed voltage range. The selectable voltage ranges available for all of the parameters are:

- 0 - 1 volts
- 0 - 5 volts
- 0 - 10 volts
- Custom (see *6.3.5.1: Calibration*)

WARNING When switching to a different bedside monitor, always check that the default values listed are still valid. If necessary, reconfigure the voltage range and corresponding parameter range or calibrate.

6.3.5.1 Calibration

The calibration option is required when default values are incorrect, or the voltage range is not known. The calibration process configures the HemoSphere advanced monitor with the analog signal received from the bedside monitor.

NOTE If the default values are correct, do not calibrate.

CAUTION Only properly trained personnel should calibrate the HemoSphere advanced monitor analog ports.

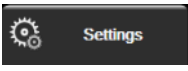
- 1 Touch the settings icon  → **Settings** tab .
- 2 Touch **Advanced Setup** button and enter the required password. All passwords are set during system initialization. Contact your hospital administrator or IT department for password.
- 3 Touch **Analog Input** button.
- 4 Select the desired port number (1 or 2) from the **Port** list button and corresponding parameter (**MAP** or **CVP**) from the **Parameter** list button.
- 5 Select **Custom** from the voltage value popup screen. The **Analog Input Custom Settings** screen will appear.
- 6 Simulate a full scale signal from the bedside monitor to the selected analog input port on the HemoSphere advanced monitor.
- 7 Set the maximum parameter value equal to the full-scale signal value.
- 8 Touch **Calibrate Maximum** button. The **Maximum A/D** value will appear on the **Analog Input Custom Settings** screen.

NOTE If an analog connection is not detected, the **Calibrate Maximum** and **Calibrate Minimum** buttons will be disabled and the Maximum A/D value will be displayed as **Not Connected**.

- 9 Repeat the process to calibrate the minimum parameter value.
- 10 Touch the **Accept** button to accept the displayed custom settings and return to the Analog Input Screen.
- 11 Repeat steps 4-10 to calibrate another port if needed, or touch the home icon  to return to the monitoring screen.

CAUTION The accuracy of continuous SVR while monitoring with the HemoSphere Swan-Ganz module depends upon the quality and accuracy of the MAP and CVP data transmitted from the external monitors. Since MAP and CVP analog signal quality from the external monitor cannot be validated by the HemoSphere advanced monitor, actual values and the values (including all derived parameters) displayed by the HemoSphere advanced monitor may not be consistent. The accuracy of continuous SVR measurement, therefore, cannot be guaranteed. To aid in determining the quality of the analog signals, regularly compare the MAP and CVP values displayed on the external monitor to the values displayed on the physio relationship screen of the HemoSphere advanced monitor. Refer to the external input device operator's manual for detailed information regarding accuracy, calibration, and other variables which may impact the analog output signal from the external monitor.

Advanced Settings

Contents

Alarms/Targets.....	130
Adjust Scales.....	136
Physiology and Physio Relationship Screen SVV/PPV Parameter Settings.....	138
20-Second Flow Parameter Settings.....	138
Demo Mode.....	139

7.1 Alarms/Targets

There are two types of alarms on the HemoSphere advanced monitor intelligent alarm system:

- 1 Physiological alarms: These are set by the clinician and signify the upper and/or lower alarm ranges for configured key continuous parameters.
- 2 Technical alarms: This alarm signifies a device fault or alert.

Physiological alarms occur with either Medium or High priority. Only parameters that are displayed on tiles (key parameters) will have active visual and audible alarms.

Among technical alarms, faults are of medium or high priority, and will halt operation of the related monitoring activity. Alerts are of low priority and will not halt any monitoring activity.

All alarms have an associated text displayed on the status bar. The intelligent alarm system will actively cycle through every active alarm text on the status bar. In addition, alarms will generate the visual alarm indicator shown in table 7-1 below. For additional information, see table 15-1 on page 247.

Table 7-1 Visual alarm indicator colors

Alarm priority	Color	Light pattern
High	red	Flashing ON/OFF
Medium	yellow	Flashing ON/OFF
Low	yellow	Solid ON

The visual alarm indicator will indicate the highest active alarm priority. Alarm messages displayed on the status bar are outlined in the alarm priority color indicated in table 7-1. The audible tone associated with the highest priority active alarm will be played. Where the priority levels are the same, physiological alarms take priority over faults and alerts. All technical alarms are generated once detected by the system; there is no inherent delay in alarms from the point of detection. For physiological alarms, the delay is the amount of time it takes to calculate the next physiological parameter after the parameter is out of range continuously for five or more seconds:

- HemoSphere Swan-Ganz module continuous CO and associated parameters: varies, but is typically around 57 seconds (see *CO Countdown Timer* on page 152)
- HemoSphere pressure cable continuous CO and associated FloTrac sensor measured parameters: varies based on CO/pressure averaging time menu selection and associated update rate (see table 6-4, “CO/pressure averaging time and display update rates –minimally-invasive monitoring mode,” on page 125)
- HemoSphere pressure cable arterial blood pressure parameters (SYS/DIA/MAP) while arterial waveform is displayed: 2 seconds
- HemoSphere pressure cable with TruWave DPT measured parameters: 2 seconds
- HemoSphere ClearSight module continuous CO and associated hemodynamic parameters: 20 seconds
- HemoSphere ClearSight module arterial blood pressure parameters (SYS/DIA/MAP) while arterial waveform is displayed: 5 heartbeats
- Oximetry: 2 seconds

All alarms are logged and stored for the given patient and can be accessed via the Data Download function (see *Data Download* on page 140). The Data Download log is cleared when initiating a new patient (see *New Patient* on page 120). The current patient can be accessed from up to 12 hours following a system power-off.

WARNING Do not use alarm settings/presets that differ from the same or similar equipment in any single area, e.g. an intensive care unit or cardiac operating theater. Conflicting alarms can affect patient safety.

7.1.1 Silence Alarms

7.1.1.1 Physiological Alarms

Physiological alarms can be silenced directly from the monitoring screen by touching the silence audible alarms icon . The physiological alarm audio tone is silenced for a user selected alarm pause time period.

No audio tone for any physiological alarm will be emitted during this alarm pause period, including new physiological alarms triggered during this time. If a technical alarm is generated during this alarm pause time period, the audio silence will be cleared, allowing alarm audio tones to resume. The user can also manually clear the alarm pause period by pressing the alarm silence button again. Once the alarm pause period has elapsed, active physiological alarms will resume audio sound.

If the physiological alarm is a medium priority, the visual alarm indicator (blinking yellow) is also disabled for the alarm pause period. A high priority visual alarm indicator (blinking red) cannot be disabled. For information on physiological alarm priorities, see *Alarm Priorities* on page 303.

NOTE Physiological parameters can be configured to have no alarms. See sections 7.1.5 and 7.1.6.



WARNING Do not turn off the audible alarms in situations in which patient safety could be compromised.

7.1.1.2 Technical Alarms

During an active technical alarm, the user can silence the alarm and clear the visual alarm indicator (medium and low priority) by touching the silence audible alarms icon . The visual alarm indicator and audio tone will remain inactive unless another technical or physiological alarm condition triggers, or the original technical alarm resolves and re-triggers.

7.1.2 Set Alarm Volume

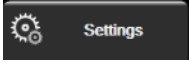
The alarm volume ranges from low to high with a default of medium. It applies to physiological alarms, technical faults, and alerts. Alarm volume can be changed at any time.

- 1 Touch the settings icon  → **Settings** tab .
- 2 Touch **General** button.
- 3 Touch the right side of the **Alarm Volume** list button to select the desired volume.
- 4 Touch the home icon  to return to the monitoring screen.

WARNING Do not lower the alarm volume to a level that prohibits alarms from being adequately monitored. Failure to do so could result in a situation where patient safety is compromised.

7.1.3 Set Targets

Targets are visual indicators set by the clinician to indicate if the patient is in the ideal target zone (green), warning target zone (yellow), or alarm zone (red). Target colors are displayed as a shaded outline around parameter tiles (see figure 5-5). The use of target zone ranges can be enabled or disabled by the clinician. Alarms (high/low) differ from target zones in that the alarm parameter value flashes and has an audible alarm.

Parameters that can “Alarm” are indicated by a bell icon  in the **Alarms/Targets** settings screen. High/low alarms by default also become the ranges for the red caution zone for that parameter. Parameters which DO NOT have the ability to set a high/low alarm will not have a bell icon in the **Alarms/Targets** settings screen for that parameter but can still have target ranges set.

Target behavior and range of HPI are described in *HPI on Information Bar* on page 224.

Table 7-2 Target status indicator colors

Color	Indication
Green	Acceptable – Green target zone is considered an ideal range for parameter as set by the clinician.
Yellow	Yellow target zone is considered a warning range and visually indicates that the patient has exited the ideal range but has not entered the alarm or caution range as set by the clinician.
Red	Red alarm and/or target zones can be considered “Alarm” parameters indicated by a bell icon in the Alarms /Targets settings screen. High/low alarms by default also become the range for the red caution zone for that parameter. Parameters which DO NOT have the ability to set a high/low alarm will not have a bell icon in the Alarms /Targets settings screen for that parameter but can still have target ranges set. Ranges for the alarm and/or target zone are to be set by the clinician.
Gray	If a target is not set, the status indicator appears as gray.

7.1.4 Alarms/Targets Setup Screen

The **Alarms/Targets** Setup Screen allows the clinician to view and set up alarms and targets for each key parameter. From the **Alarms/Targets** screen, located within the **Advanced Setup** settings menu, the user can adjust targets and enable/disable audible alarms. Any features accessed through the **Advanced Setup** settings menu are password protected and should only be altered by experienced clinicians. The settings for each key parameter are displayed in a parameter box. The currently configured key parameters are the first set of key parameters displayed. The remaining key parameters are displayed in a defined order. The parameters also indicate what the target ranges are based on: Custom Default, Edwards Default, and Modified.

Table 7-3 Target defaults

Default name	Description
Custom Default	A custom default target range was set for the parameter and the parameter target range has not been modified from that default.
Edwards Default	The parameter target range has not been changed from the original settings.
Modified	Parameter target range was changed for this patient.

NOTE Visual and audible alarm settings are only applicable to parameters being displayed.

To modify **Alarms/Targets**:

- 1 Touch the settings icon  → **Settings** tab .
- 2 Touch **Advanced Setup** button and enter the required password.
- 3 Touch **Parameter Settings** button → **Alarms/Targets** button.

- 4 Touch anywhere in a parameter box to display the **Alarms/Targets** menu for the parameter.

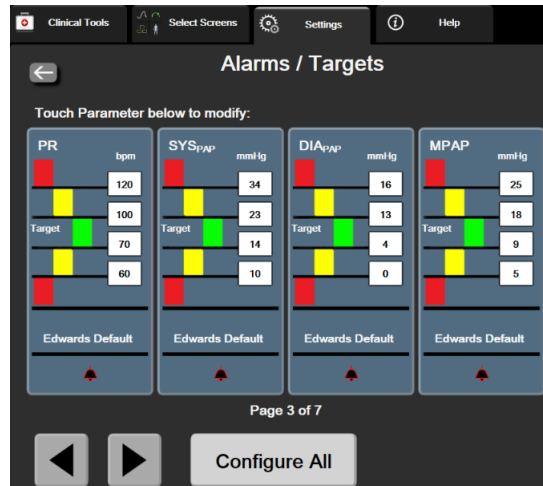

Figure 7-1 Alarms/Targets configuration

NOTE There is a 2 minute inactivity timer associated with this screen.

The red, yellow and green rectangles are fixed shapes, and don't change size/shape.

7.1.5 Configure All Targets

Alarms/Targets can easily be configured or changed all at the same time. From the **Configure All** screen, the user can:

- Restore all parameter alarm and target settings to Custom Defaults.
- Restore all parameter alarm and target settings to Edwards Defaults.
- Enable or disable audible physiological alarms for all applicable parameters.
- Enable or disable all audible alarms.

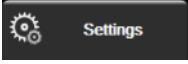
- 1 Touch the settings icon  → **Settings** tab .
- 2 Touch **Advanced Setup** button and enter the required **Secure User** password.
- 3 Touch **Parameter Settings** button → **Alarms/Targets** button.
- 4 Touch the **Configure All** button.
 - To enable or disable all audible physiological alarms for all parameters, touch the **Disable/Enable** toggle button for **Targets** within the **Audible Alarm** box.
 - To enable or disable all audible technical alarms for all parameters, touch the **Disable/Enable** toggle button for **All Alarms** within the **Audible Alarm** box.
 - To restore all settings to the custom defaults, touch **Restore All to Custom Defaults**. The message, “**This action will restore ALL Alarms and Targets to the Custom Defaults.**” appears. Touch **Continue** button on the confirmation popup to confirm the restore.
 - To restore all settings to the Edwards defaults, touch **Restore All to Edwards Defaults**. The message, “**This action will restore ALL Alarms and Targets to the Edwards’**

Defaults.” appears. Touch **Continue** button on the confirmation popup to confirm the restore.

7.1.6 Configure Targets and Alarms for One Parameter

The **Alarms/Targets** menu lets the user set up alarm and target values for the selected parameter. The user can also enable or disable the audible alarm. Adjust the target settings by using the numbered keypad or by using the scroll buttons when a minor adjustment is needed.

- 1 Touch inside a tile to open the alarms/targets menu for that parameter. The alarms/targets menu is also available on the physio relationship screen by touching a parameter box.
- 2 To disable the audible alarm for the parameter, touch the **Audible Alarm** icon  at the top right of the menu.

NOTE Parameters that DO NOT have the ability to set a high/low alarm will not have an **Audible Alarm** icon  on the **Alarms/Targets** menu.

The alarms limits for the Acumen Hypotension Prediction Index, HPI, are not adjustable. Target behavior and range of HPI are described in *HPI Alarm* on page 223.

- 3 To disable visual targets for the parameter, touch the **Target** enabled icon  at the top left of the menu. The target indicator for that parameter will appear gray.
- 4 Use the arrows to adjust the zone settings or touch the value button to open a numeric keypad.

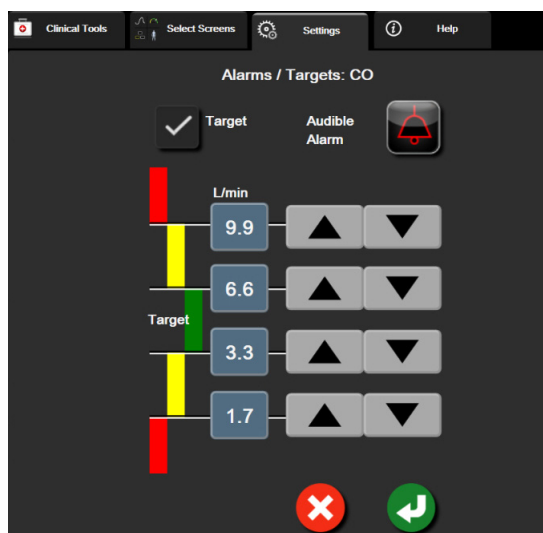



Figure 7-2 Set individual parameter alarms and targets

- 5 When the values are correct, touch the enter icon .
- 6 To cancel, touch the cancel icon .

WARNING Visual and audible physiological alarms are activated only if the parameter is configured on the screens as a key parameter (1-8 parameters displayed in parameter tiles). If a parameter is not selected and displayed as a key parameter, the audible and visual physiological alarms are not triggered for that parameter.

7.2 Adjust Scales

The graphical trend data fills the graph from left to right with the most recent data at the right. The parameter scale is on the vertical axis with the time scale on the horizontal.

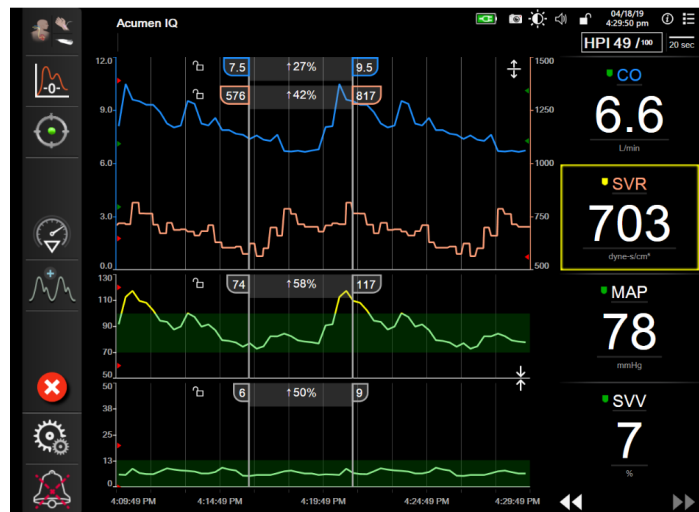

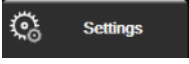

Figure 7-3 Graphical trend screen

The scales setup screen allows the user to set up both the parameter and time scales. The key parameters are at the top of the list. Use the horizontal scroll buttons to see additional parameters.

- 1 Touch the settings icon  → **Settings** tab .
- 2 Touch **Advanced Setup** button and enter the required password.

- 3 Touch **Parameter Settings** button → **Adjust Scales** button.

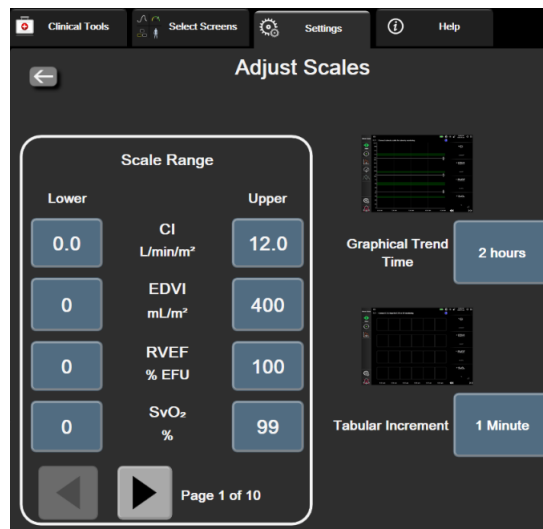



Figure 7-4 Adjust scales

NOTE The screen will return to the monitoring view after two minutes of inactivity.

- 4 For each parameter, touch the **Lower** button to enter the minimum value to appear the vertical axis. Touch the **Upper** button to enter the maximum value. Use the horizontal scroll icons   to view additional parameters.
- 5 Touch the right side of the **Graphical Trend Time** value button to set the total amount of time displayed on the graph. The options are:
- 3 minutes
 - 5 minutes
 - 10 minutes
 - 15 minutes
 - 30 minutes
 - 1 hour
 - 2 hours (default)
 - 4 hours
 - 6 hours
 - 12 hours
 - 18 hours
 - 24 hours
 - 48 hours
- 6 Touch the right side of the **Tabular Increment** value icons to set the amount of time to each tabbed value. The options are:
- 1 Minute (default)
 - 5 Minutes
 - 10 Minutes
 - 30 Minutes
 - 60 Minutes

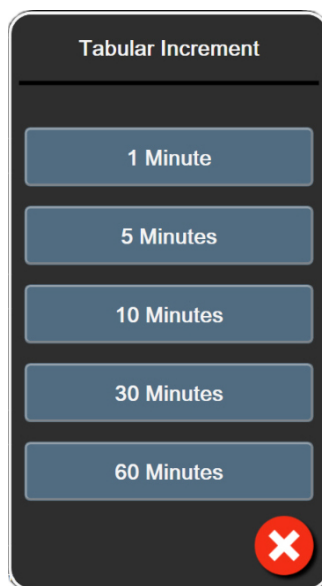

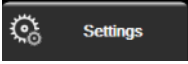

Figure 7-5 Tabular increment popup

- 7 To advance to the next set of parameters, touch the arrow at the bottom left.
- 8 Touch the home icon  to return to the monitoring screen.

7.3 Physiology and Physio Relationship Screen SVV/PPV Parameter Settings

- 1 Touch the settings icon  → **Settings** tab .
- 2 Touch the **Advanced Setup** button and enter the required password.
- 3 Touch **Parameter Settings** button → **SVV/PPV** button.
- 4 To turn the SVV indicator **On** or **Off**, touch the **SVV: Physiology and Physio Relationship Screens** toggle button.
- 5 To turn PPV data **On** or **Off**, touch the **PPV: Physiology and Physio Relationship Screens** toggle button.

7.4 20-Second Flow Parameter Settings

This parameter setting automatically switches the display of 20-second flow parameters (CO_{20s} , CI_{20s} , SV_{20s} , SVI_{20s}) to the standard averaged equivalent (CO , CI , SV , and SVI) when the PA pressure signal is poor. For more information on the 20-second flow parameters, see *20-Second Flow Parameters* on page 153.

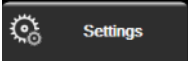
- 1 Touch the settings icon  → **Settings** tab .
- 2 Touch **Advanced Setup** button and enter the required password.
- 3 Touch **Parameter Settings** button → **20-Second Flow Settings** button.
- 4 Touch the toggle button to switch the setting to **On** or **Off**.

NOTE 20-second flow parameters are available when monitoring with the HemoSphere Swan-Ganz module and a PA (pulmonary artery) pressure signal is also monitored through a connected HemoSphere pressure cable, TruWave DPT, and CCombo V catheter (models 777F8 and 774F75). In addition, the 20-second flow parameter feature must be activated. Please contact your local Edwards representative for more information on enabling this advanced feature.

7.5 Demo Mode

Demonstration Mode is used to display simulated patient data to assist in training and demonstration.

Demonstration mode displays data from a stored set and continually loops through a predefined data set. During **Demo Mode**, the HemoSphere advanced monitoring platform user interface retains the same functionality as a fully operational platform. Simulated patient demographics must be entered to demonstrate the selected monitoring mode functions. The user can touch the controls as if a patient was being monitored.

When **Demo Mode** is entered, trended data and events are cleared from being displayed and saved for return to patient monitoring.

- 1 Touch settings icon  → Settings tab 
- 2 Touch the **Demo Mode** button.

NOTE When the HemoSphere advanced monitoring platform runs in **Demo Mode**, all audible alarms are disabled

- 3 Select the demonstration monitoring mode:

Invasive: See chapter 9: *HemoSphere Swan-Ganz Module Monitoring* for details on monitoring with the HemoSphere Swan-Ganz module and **Invasive** monitoring mode.

Minimally-Invasive: See chapter 10: *Monitoring with the HemoSphere Pressure Cable* for details on monitoring with the HemoSphere pressure cable and **Minimally-Invasive** monitoring mode.

Non-Invasive: See chapter 11: *HemoSphere ClearSight Module Noninvasive Monitoring* for details on monitoring with the HemoSphere ClearSight module and **Non-Invasive** monitoring mode.

NOTE Selecting Minimally-Invasive demo mode simulates using an Acumen IQ sensor when the HPI feature has been activated.

- 4 Touch **Yes** on the **Demo Mode** confirmation screen.
 - 5 The HemoSphere advanced monitoring platform must be restarted prior to monitoring a patient.
-

WARNING Make sure that Demo Mode is not activated in a clinical setting to ensure that simulated data is not mistaken for clinical data.

Data Export and Connectivity Settings

Contents

Export Data	140
Wireless Settings	142
HIS Connectivity	143
Cyber Security	145

8.1 Export Data

The **Export Data** screen lists a number of data export features of the HemoSphere advanced monitor. This screen is password protected. From this screen clinicians can export diagnostic reports, delete monitoring sessions, or export monitoring data reports. For more on exporting monitoring data reports, see below.

8.1.1 Data Download

The **Data Download** screen allows the user to export monitored patient data to a USB device in Windows Excel XML 2003 format.

NOTE The screen will return to the monitoring view after two minutes of inactivity.

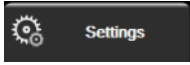
- 1 Touch the settings icon  → **Settings** tab .
- 2 Touch the **Export Data** button.
- 3 Enter password when prompted in **Export Data Password** popup window. All passwords are set during system initialization. Contact your hospital administrator or IT department for password.
- 4 Ensure a USB device has been inserted.

NOTE When exceeding 4GB of data the USB storage device should not use FAT32 formatting.

CAUTION Use a virus scan on any USB stick before inserting to prevent a virus or malware infection.

- 5 Touch the **Data Download** button.

Monitoring Data. To generate a spreadsheet of monitored patient data:

- 1 Touch the value side of the Interval button and select the frequency of the data to download. The shorter the frequency, the greater the amount of data. Options are:
 - 20 seconds (default)
 - 1 minute
 - 5 minutes
- 2 Touch the **Start Download** button.

NOTE All alarms are logged and stored for the given patient and can be accessed via the **Monitoring Data** download. Alarm data logging discards older data when the log becomes full. The **Monitoring Data** log is cleared when initiating a new patient. The current patient can be accessed from up to 12 hours following a system power-off. This log also contains timestamped alarm conditions and the system power-off time.

Case Report. To generate a report of key parameters:

- 1 Touch the **Case Report** button.
- 2 Select desired parameters from the case report popup menu. A maximum of three parameters can be selected.
- 3 Check **De-identify** to exclude patient demographic data.
- 4 Touch the enter icon  to export PDF.

GDT Report. To generate a report of GDT tracking sessions:

- 1 Touch the **GDT Report** button.
- 2 Select desired GDT tracking session(s) from the GDT Report popup menu. Use the scroll buttons to select older tracking sessions.
- 3 Check **De-identify** to exclude patient demographic data.
- 4 Touch the enter icon  to export PDF.

NOTE Do not disconnect the USB device until the “**Download complete. Remove the USB drive.**” message appears.

If a message appears stating that the USB device is out of space, insert a different USB device and restart the download.

All monitored patient data may be cleared by the user. Touch the **Clear All** button and confirm to clear.

8.1.2 Diagnostic Export

The capturing of all events, alerts, alarms and monitoring activity is logged if investigations or detailed troubleshooting is needed. A **Diagnostics Export** option within the **Export Data** settings menu is provided where this information can be downloaded for diagnostic purposes. This information may be requested by Edwards service personnel to help troubleshoot issues. In addition, this engineering section provides detailed software revision information of connected platform components.

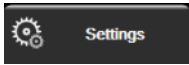
- 1 Touch the settings icon  → **Settings** tab .
- 2 Touch the **Export Data** button.
- 3 Enter the **Super User** password. All passwords are set during system initialization. Contact your hospital administrator or IT department for password.
- 4 Touch **Diagnostics Export** button.
- 5 Insert an Edwards approved USB flash drive into one of the available monitor USB ports.
- 6 Allow the diagnostic export to complete as indicated on the screen.







The diagnostic data will be located in a folder labeled with the monitor serial number on the USB flash drive.

8.2 Wireless Settings

The HemoSphere advanced monitor can connect to available wireless networks. For information on connecting to a wireless network contact your local Edwards representative.

Wi-Fi connection status is indicated on the information bar by the symbols shown in table 8-1.

Table 8-1 Wi-Fi connection status

Wi-Fi Symbol	Indication
	very high signal strength
	medium signal strength
	low signal strength
	very low signal strength
	no signal strength
	no connection

8.3 HIS Connectivity



The HemoSphere advanced monitor has the ability to interface with the Hospital Information Systems (HIS) to send and receive patient demographics and physiological data. The HemoSphere advanced monitor supports Health Level 7 (HL7) messaging standard and implements Integrating Healthcare Enterprise (IHE) profiles. HL7's version 2.6 messaging standard is the most commonly used means for electronic data exchange in the clinical domain. Use a compatible interface to access this feature. The HemoSphere advanced monitor HL7 communication protocol, also referred to as HIS Connectivity, facilitates the following types of data exchanges between the HemoSphere advanced monitor and external applications and devices:

- Sending of physiological data from the HemoSphere advanced monitor to the HIS and/or medical devices
- Sending of physiological alarms and device faults from the HemoSphere advanced monitor to the HIS
- HemoSphere advanced monitor retrieval of patient data from the HIS.

HIS Connection Status should only be queried through the Monitor Settings menu after the HL7 connectivity feature has been configured and tested by the facility network administrator. If HIS Connection Status is queried while the feature setup is incomplete, the Connection Status Screen will remain open for 2 minutes before timing out.

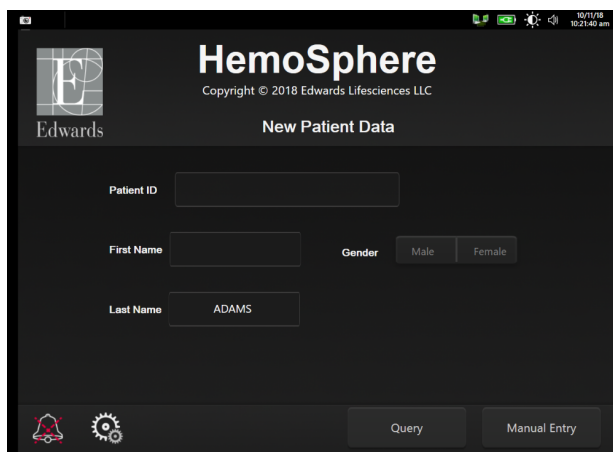



Figure 8-1 HIS- Patient query screen

HIS connectivity status is indicated on the information bar by the symbols shown in Table 8-2.

Table 8-2 HIS connectivity status

HIS symbol	Indication
	Connection to all configured HIS actors are good.
	Unable to establish communication with configured HIS actors.
	Patient ID is set to "Unknown" in all outbound HIS messages.

Table 8-2 HIS connectivity status

HIS symbol	Indication
	Intermittent errors are occurring in communications with configured HIS actors.
	Persistent errors are occurring in communications with configured HIS actors.

8.3.1 Patient Demographic Data

The HemoSphere advanced monitor with HIS Connectivity enabled, can retrieve patient demographics data from enterprise application. Once the HIS Connectivity feature is enabled, touch the **Query** button. The **Patient Query** screen allows the user to search for a patient based on name, patient ID or room and bed information. The **Patient Query** screen can be used to retrieve patient demographics data when starting a new patient or to associate the patient physiological data being monitored on the HemoSphere advanced monitor with a patient record retrieved from HIS.

NOTE Stopping an incomplete patient query may result in a connection error. If encountered, close error window and restart the query.

Once a patient is selected from the query results, patient demographics data is displayed in the **New Patient Data** screen.

To complete the query, the configured HIS must have patient gender values of either ‘Male,’ ‘Female,’ or blank. If the query exceeds the maximum duration defined in HIS configuration file, an error message will be displayed to prompt manual entry of patient data.

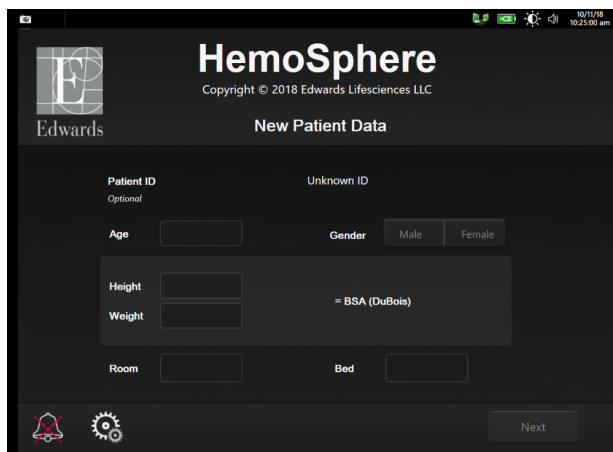



Figure 8-2 HIS- New patient data screen

The user can enter or edit patient height, weight, age, gender, room and bed information on this screen. The selected or updated patient data can be saved by touching the home icon . Once patient data is saved, the HemoSphere advanced monitor generates unique identifiers for the selected patient and sends out this information in outbound messages with physiological data to the enterprise applications.

8.3.2 Patient Physiological Data

The HemoSphere advanced monitor can send monitored and calculated physiological parameters in outbound messages. Outbound messages can be sent to one or more configured enterprise applications. Continuously monitored and calculated parameters with the HemoSphere advanced monitor can be sent to the enterprise application.

8.3.3 Physiological Alarms and Device Faults

The HemoSphere advanced monitor can send physiological alarms and device faults to configure HIS. Alarms and faults can be sent to one or more configured HIS. Statuses of individual alarms including change in states are sent out to the enterprise application.

For more information on how to receive access to HIS Connectivity, contact your local Edwards representative or Edwards Technical Support.

WARNING Do not use the HemoSphere advanced monitor as part of a Distributed Alarm System. The HemoSphere advanced monitor does not support remote alarm monitoring/management systems. Data is logged and transmitted for charting purposes only.

8.4 Cyber Security

This chapter outlines ways in which patient data can be transferred to and from the HemoSphere advanced monitor. It is important to note that any facility using the HemoSphere advanced monitor must take measures to protect the privacy of a patient's personal information in accordance with country-specific regulations, and consistent with the facility's policies for managing this information. Steps that can be taken to safeguard this information and the general security of the HemoSphere advanced monitor include:

- **Physical Access:** Limit use of the HemoSphere advanced monitor to authorized users. The HemoSphere advanced monitor has password protection for certain configuration screens. Passwords should be protected. See *Password Protection* on page 118 for more information.
- **Active Use:** Users of the monitor should take measures to limit patient data storage. Patient data should be removed from the monitor after a patient is discharged and patient monitoring has ended.
- **Network Security:** The facility must take measures to ensure the security of any shared network to which the monitor may be connected to.
- **Device Security:** Users should only use Edwards approved accessories. In addition, ensure that any connected device is free of malware.

The use of any HemoSphere advanced monitor interface outside of its intended purpose could pose cyber security risks. No HemoSphere advanced monitor connections are meant to control the operations of another device. All available interfaces are shown in *HemoSphere Advanced Monitor Connection Ports* on page 60 and specifications for these interfaces are listed in table A-5, "HemoSphere advanced monitor technical specifications," on page 282.

8.4.1 HIPAA

The Health Insurance Portability and Accountability Act of 1996 (HIPAA), introduced by the U.S. Department of Health and Human Services, outlines important standards to protect individually identifiable health information. If applicable, these standards should be followed during monitor use.

HemoSphere Swan-Ganz Module Monitoring

Contents

Connecting the HemoSphere Swan-Ganz Module.....	146
Continuous Cardiac Output.....	150
Intermittent Cardiac Output.....	153
EDV/RVEF Monitoring.....	159
SVR.....	163

9.1 Connecting the HemoSphere Swan-Ganz Module

The HemoSphere Swan-Ganz module is compatible with all approved Edwards Swan-Ganz pulmonary artery catheters. The HemoSphere Swan-Ganz module acquires and processes signals to and from a compatible Edwards Swan-Ganz catheter for CO, iCO and EDV/RVEF monitoring. This section provides an overview of the HemoSphere Swan-Ganz module connections. See figure 9-1.

WARNING Compliance to IEC 60601-1 is only maintained when the HemoSphere Swan-Ganz module (applied part connection, defibrillation proof) is connected to a compatible monitoring platform. Connecting external equipment or configuring the system in a way not described in these instructions will not meet this standard. Failure to use the device as instructed may increase the risk of electrical shock to the patient/operator.

Do not modify, service or alter the product in any way. Servicing, alteration or modification may affect patient/operator safety and/or product performance.

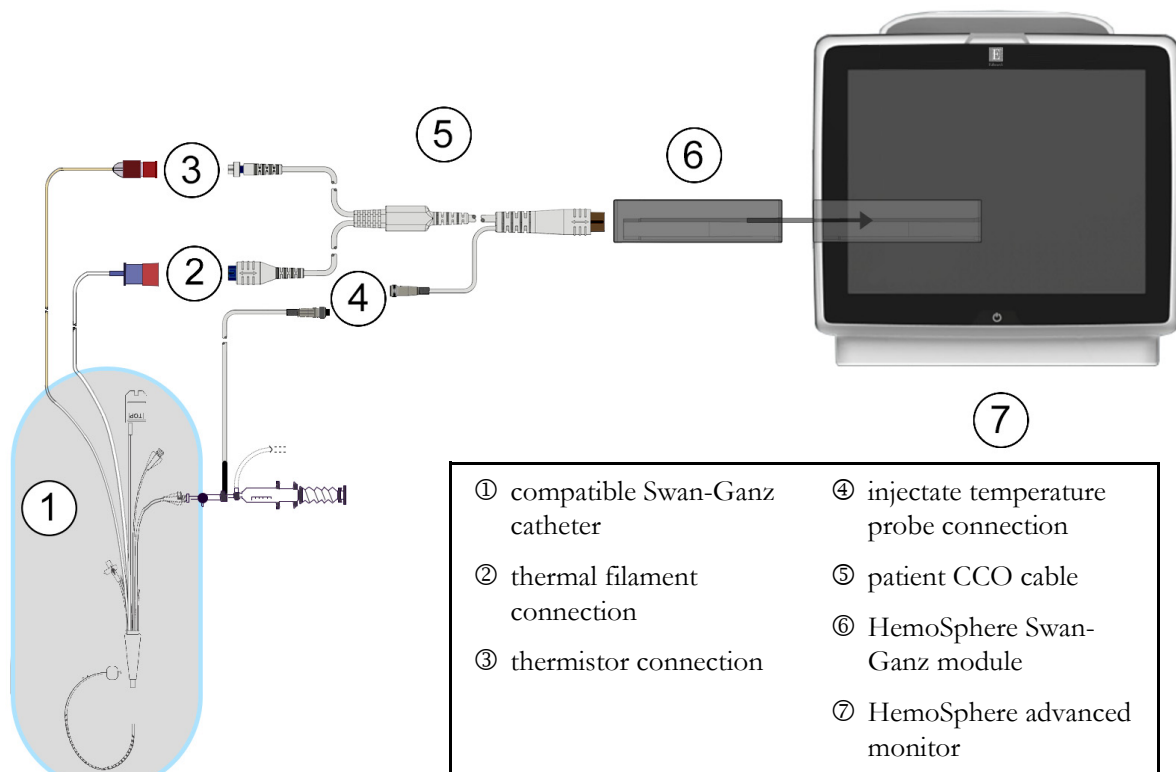

Figure 9-1 HemoSphere Swan-Ganz module connection overview

NOTE Appearance of catheters and injectate systems shown in this chapter are for example only. Actual appearance may vary depending on catheter and injectate system models.

Pulmonary artery catheters are TYPE CF defibrillation proof APPLIED PARTS. Patient cables that attach to the catheter, such as the patient CCO cable, are not intended to be applied parts but may come into contact with the patient and meet the relevant applied part requirements per IEC 60601-1.

- 1 Insert the HemoSphere Swan-Ganz module into the HemoSphere advanced monitor. The module will click when properly engaged.

CAUTION Do not force the module into the slot. Apply even pressure to slide and click the module into place.

- 2 Press the power button to turn on the HemoSphere advanced monitor and follow steps for entering patient data. See *Patient Data* on page 120. Connect the patient CCO cable to the HemoSphere Swan-Ganz module.

- 3 Connect the compatible Swan-Ganz catheter to the patient CCO cable. See table 9-1 below for available parameters and required connections.

Table 9-1 Available HemoSphere Swan-Ganz module parameters and required connections

Parameter	Required connection	See
CO	thermistor and thermal filament connection	<i>Continuous Cardiac Output</i> on page 150
CO _{20s} , Cl _{20s} , SV _{20s} , SVI _{20s}	thermistor and thermal filament connection PAP signal from HemoSphere pressure cable	<i>20-Second Flow Parameters</i> on page 153
iCO	thermistor and injectate (bath or in-line) probe	<i>Intermittent Cardiac Output</i> on page 153
EDV/RVEF (SV)	thermistor and thermal filament connection *HR slaved-in by HemoSphere advanced monitor	<i>EDV/RVEF Monitoring</i> on page 159
SVR	thermistor and thermal filament connection *MAP and CVP slaved-in by HemoSphere advanced monitor	<i>SVR</i> on page 163

NOTE Pulmonary artery pressure data is available with a HemoSphere pressure cable connection. See *Pressure Cable Monitoring in Swan-Ganz Module Monitoring Mode* on page 172 for more information.

- 4 Follow the necessary directions for monitoring. See *Continuous Cardiac Output* on page 150, *Intermittent Cardiac Output* on page 153 or *EDV/RVEF Monitoring* on page 159.

9.1.1 Patient CCO Cable Test

To test the integrity of the Edwards patient CCO cable, perform a cable integrity test. It is recommended to test the integrity of the cable as part of a troubleshooting process. This does not test the injectate temperature probe connection of the cable.

To access the patient CCO cable test window, touch the settings icon  → **Clinical Tools** tab

 → **Patient CCO Cable Test** icon . Refer to figure 9-2 for numbered connections.

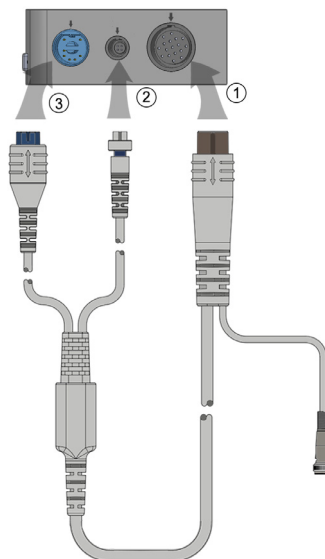





Figure 9-2 Patient CCO cable test connections

- 1 Attach the patient CCO cable to the inserted HemoSphere Swan-Ganz module ①.
- 2 Attach the patient CCO cable thermal filament connector ③ and thermistor connector ② to their mating test ports on the HemoSphere Swan-Ganz module.
- 3 Touch the **Start** button to begin the cable test. A progress bar will appear.
- 4 If the patient CCO cable fails, reconnect and perform the patient CCO cable test again. Replace the patient CCO cable if it fails the cable test repeatedly.
- 5 Touch the enter icon  when the cable has passed. Disconnect the patient cable thermal filament connector and thermistor connector from the HemoSphere Swan-Ganz module.

9.1.2 Parameter Selection Menu

Parameter categories while monitoring with a Swan-Ganz module are **Flow** (see *Continuous Cardiac Output* on page 150), **Resistance** (see *SVR* on page 163), and **RV Function** (*EDV/RVEF Monitoring* on page 159). **Oximetry** is also available if an oximetry cable or tissue oximetry module is connected (see *Venous Oximetry Monitoring* on page 191). Touch parameter buttons that display an arrow () to view additional monitoring

options for that parameter based on the display update rate and averaging time. See *STAT CO* on page 153, *STAT EDV* and *RVEF* on page 163, and *20-Second Flow Parameters* on page 153. Touch the blue arrow () to see definitions of these monitoring options or the help icon () for more information.

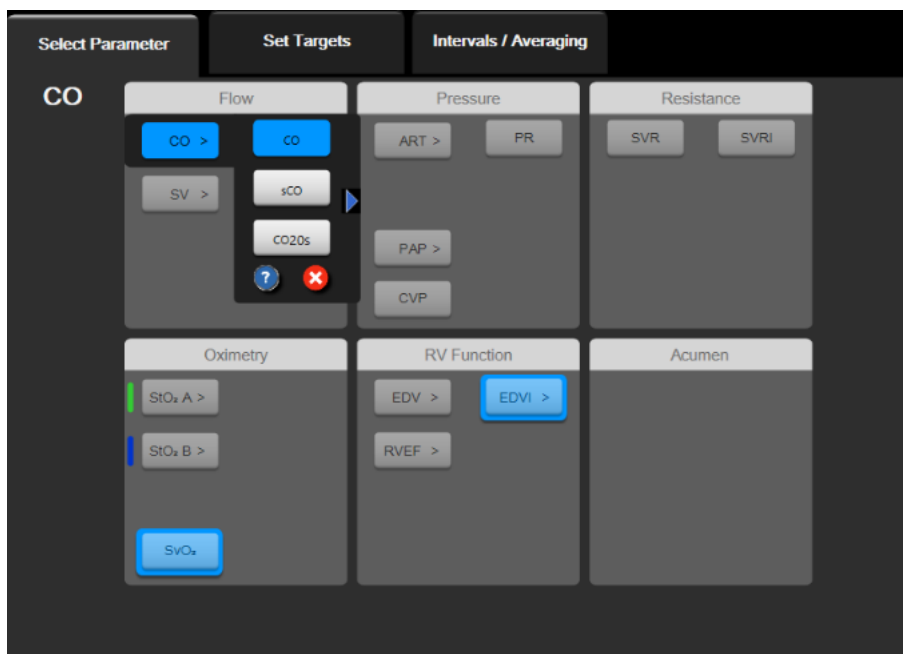

Figure 9-3 HemoSphere Swan-Ganz module key parameter selection window

9.2 Continuous Cardiac Output

The HemoSphere advanced monitor measures cardiac output continuously by introducing small pulses of energy into the blood stream and measuring blood temperature via a pulmonary artery catheter. The maximum surface temperature of the thermal filament used to release these pulses of energy within the blood is 48 °C. Cardiac output is computed using proven algorithms derived from the conservation of heat principles, and indicator dilution curves that are obtained by cross-correlation of energy input and blood temperature waveforms. After initialization, the HemoSphere advanced monitor continuously measures and displays the cardiac output in liters per minute without operator calibration or intervention.

9.2.1 Connecting the Patient Cables

- 1 Connect the patient CCO cable to the inserted HemoSphere Swan-Ganz module as previously described in section 9.1.
- 2 Attach the catheter end of the patient cable to the thermistor and thermal filament connectors on the Swan-Ganz CCO catheter. These connections are emphasized as numbers ② and ③ in figure 9-4 on page 151.

3 Verify that the CCO catheter is properly inserted into the patient.

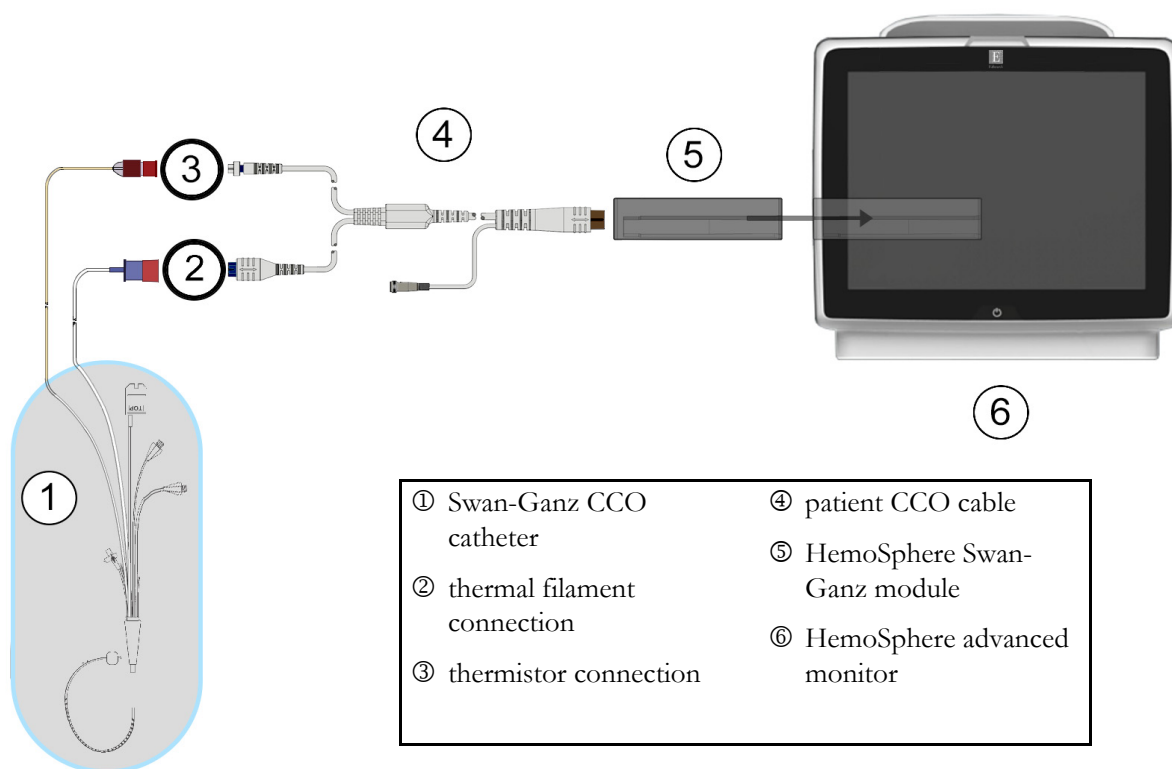



Figure 9-4 CO connection overview

9.2.2 Initiating Monitoring

WARNING CO monitoring should always be discontinued when blood flow around the thermal filament is stopped. Clinical situations where CO monitoring should be discontinued include, but are not limited to:

- Time periods when a patient is on cardiopulmonary bypass
- Partial withdrawal of the catheter so that the thermistor is not in the pulmonary artery
- Removal of the catheter from the patient

When the system is properly connected, touch the start monitoring icon  to begin CO monitoring. The CO countdown timer will appear on the stop monitoring icon. After approximately 5 to 12 minutes, when sufficient data has been obtained, a CO value will appear in the parameter tile. The CO value displayed on the screen will be updated approximately every 60 seconds.

NOTE No CO value will be displayed until sufficient time-averaged data is available.

9.2.3 Thermal Signal Conditions

In some situations where patient conditions create large changes in pulmonary artery blood temperature over several minutes, the monitor may take longer than 6 minutes to obtain an initial CO measurement. When CO monitoring is in progress, updating of the CO measurement may also be delayed by unstable pulmonary artery blood temperature. The last CO value and measurement time will be displayed in place of an updated CO value. Table 9-2 shows the alert/fault messages that appear on the screen at different time points while the signal stabilizes. Refer to table 15-9, “HemoSphere Swan-Ganz module CO faults/alerts,” on page 255 for more information on CO faults and alerts.

Table 9-2 Unstable thermal signal time lapse for CO alert and fault messages

Condition	Notification	Alert CO		Fault CO
	Cardiac Output calculation in progress	Signal Adapting — Continuing	Unstable Blood Temp. — Continuing	Thermal Signal Loss
Monitoring Commencing: time from commencement without CO measurement	3 ½ minutes	6 minutes	15 minutes	30 minutes
Monitoring in Progress: time from last CO update	5 seconds from expiry of CO countdown timer	na	6 minutes	20 minutes

A fault condition terminates monitoring. A fault condition could result from migration of the catheter tip into a small vessel preventing the thermistor from accurately sensing the thermal signal. Check catheter position and reposition the catheter, if necessary. After verifying patient status and catheter position, CO monitoring may be resumed by touching the start monitoring icon .

- CAUTION** Inaccurate cardiac output measurements may be caused by:
- Incorrect placement or position of the catheter
 - Excessive variations in pulmonary artery blood temperature. Some examples that cause BT variations include, but are not limited to:
 - * status post cardiopulmonary bypass surgery
 - * centrally administered cooled or warmed solutions of blood products
 - * use of sequential compression devices
 - Clot formation on the thermistor
 - Anatomical abnormalities (for example, cardiac shunts)
 - Excessive patient movement
 - Electrocautery or electrosurgical unit interference
 - Rapid changes in cardiac output

9.2.4 CO Countdown Timer

The CO countdown timer is located on the stop monitoring icon . This timer alerts the user as to when the next CO measurement will take place. The time to the next CO measurement varies from 60 seconds to 3 minutes or longer. A hemodynamically unstable thermal signal may delay CO calculations.

9.2.5 STAT CO

For longer time spans between CO measurements, the STAT CO is available. The STAT CO (sCO) is a fast estimate of the CO value and is updated every 60 seconds. Select sCO as a key parameter to view STAT CO values. Select CO and sCO as key parameters while viewing the graphical/tabular trends split screen and CO monitored data is graphically plotted alongside tabular/numerical data for STAT values of sCO. See *Graphical/Tabular Trends Split* on page 97.

9.2.6 20-Second Flow Parameters

The 20-second flow parameters are available when monitoring with the HemoSphere Swan-Ganz module and a PA (pulmonary artery) pressure signal is also monitored through a connected HemoSphere pressure cable, TruWave DPT, and CCOMbo V catheter (models 777F8 and 774F75). A pulse contour analysis of the pulmonary artery pressure signal is used in combination with the CCO thermodilution algorithm to obtain a faster parameter calculation for CO, CI, SV and SVI. The 20-second flow parameters are labeled with “20s” (CO_{20s}, CI_{20s}, SV_{20s}, SVI_{20s}). These parameters are only available if the 20s flow parameter feature is enabled. Please contact your local Edwards representative for more information on enabling this advanced feature. For more information on PA monitoring, see *Pressure Cable Monitoring in Swan-Ganz Module Monitoring Mode* on page 156.

CAUTION Inaccurate 20-second flow parameter measurements may be caused by:

- Incorrect placement or position of the catheter
 - Improperly zeroed and/or leveled transducer
 - Over- or under-damped pressure line
 - Adjustments to the PAP line made after start of monitoring

9.2.6.1 PAP Waveform Troubleshooting

The calculation of 20-second flow parameters is highly dependent on a good pulmonary artery pressure waveform. Use the **Zero & Waveform**  screen to view and evaluate the PAP waveform. The features of a good waveform include:

- Dicrotic notch with minimal dip between systole and diastole
- Clean signal without noise or high-frequency artifacts
- Minimal “whip” artifacts caused by catheter tip movement in the right ventricle
- Sharp waveform morphology and minimal over-damping due to bubbles or kinking in tubing

PAP waveforms that do not display the above listed features have not been validated. These waveforms may result in a loss of 20-second flow parameter calculation.

9.3 Intermittent Cardiac Output

The HemoSphere Swan-Ganz module measures cardiac output intermittently using the bolus thermodilution technique. With this technique, a small amount of sterile physiological solution (e.g., saline or dextrose) at a known volume and temperature — cooler than blood temperature — is injected through the catheter injectate port, and the resultant decrease in blood temperature is measured by the thermistor in the pulmonary artery (PA). Up to six bolus injections can be completed in one series. The average value of

the injections in the series is displayed. The results of any series may be reviewed, and the user can remove individual iCO (bolus) measurements that may have been compromised (e.g., patient movement, diathermia, or operator error).

9.3.1 Connecting Patient Cables

- 1 Connect the patient CCO cable to the inserted HemoSphere Swan-Ganz module as previously described in section 9.1.
- 2 Attach the catheter end of the patient CCO cable to the thermistor connector on the Swan-Ganz iCO catheter as shown by ② in figure 9-5.
- 3 Verify that the catheter is properly inserted into the patient.

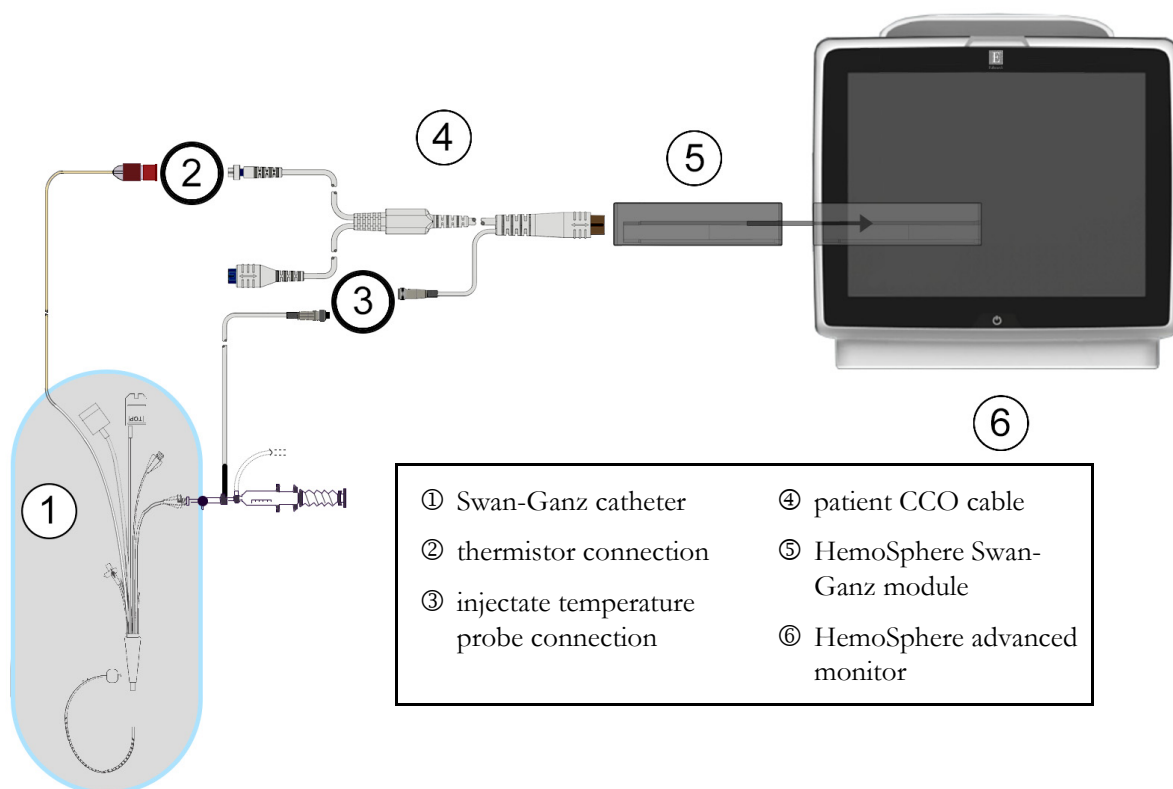

Figure 9-5 iCO connection overview

9.3.1.1 Probe Selection

An injectate temperature probe senses injectate temperature. The selected probe is connected to the patient CCO cable (figure 9-5). Either of two probes may be used:

- An in-line probe is connected to the flow-thru housing on the CO-Set/CO-Set+ injectate delivery system.
- A bath probe measures the temperature of the injectate solution. Bath probes are intended to measure the temperature of a sample solution that is kept at the same temperature as the sterile solution used for injectate when calculating bolus cardiac output.

Connect the injectate temperature probe (in-line or bath) to the injectate temperature probe connector on the patient CCO cable illustrated by ③ in figure 9-5.

9.3.2 Configuration Settings

The HemoSphere advanced monitor provides the operator with the choice of entering a specific computation constant, or configuring the HemoSphere Swan-Ganz module to allow it to automatically determine the computation constant by selecting the injectate volume and catheter size. The operator can also select the parameter display type and bolus mode.

Touch settings icon  → **Clinical Tools** tab  → **iCO** icon .

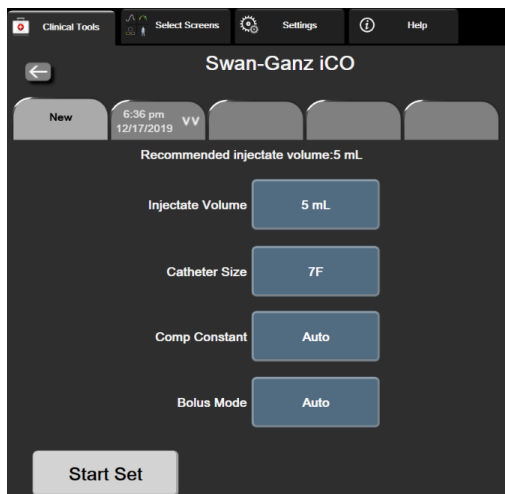

Figure 9-6 iCO new set configuration screen

CAUTION Refer to Appendix E to ensure computation constant is the same as specified in the catheter package insert. If the computation constant differs, enter the desired computation constant manually.

NOTE The HemoSphere Swan-Ganz module will automatically sense the type of temperature probe in use (ice bath or in-line). The module will use this information to determine the computation constant.

If an injectate temperature (IT) probe is not detected by the monitor, the message “**Connect injectate probe for iCO monitoring**” is displayed.

9.3.2.1 Select Injectate Volume

Select a value from the **Injectate Volume** list button. The available choices are:

- 10 mL
- 5 mL
- 3 mL (bath type probe only)

When a value is chosen, the computation constant is automatically set.

9.3.2.2 **Select Catheter Size**

Select a catheter size from the **Catheter Size** list button. The available choices are:

- 5.5F
- 6F
- 7F
- 7.5F
- 8F

When a value is chosen, the computation constant is automatically set.

9.3.2.3 **Select Computation Constant**

To manually enter a computation constant, touch the **Comp Constant** value button and enter a value on the keypad. If a computation constant is manually entered, injectate volume and catheter size are automatically set, and value entry is set to **Auto**.

9.3.2.4 **Select Mode**

Select **Auto** or **Manual** from the **Mode** list button. The default mode is **Auto**. In the **Auto** mode, the HemoSphere advanced monitor automatically highlights an **Inject** message upon achieving a baseline blood temperature. The **Manual** mode operation is similar to the **Automatic** mode except that the user must touch the **Inject** button prior to each injection. The following section provides instructions for both of these bolus modes.

9.3.3 **Instructions for Bolus Measurement Modes**

The HemoSphere Swan-Ganz module factory default setting for bolus measurement is **Auto** mode. In this mode, the HemoSphere advanced monitor highlights an **Inject** message upon achieving a baseline blood temperature. During **Manual** mode, the operator will initiate when to inject by touching the **Inject** button. When an injection is complete, the module computes a value and is ready to process another bolus injection. Up to six bolus injections can be completed in one series.

The following provides step-by-step instructions for performing bolus cardiac measurements starting from the iCO new set configuration screen.



- 1 Touch the **Start Set** button at the bottom of the iCO new set configuration screen after selecting thermodilution configuration settings.

The button is disabled if:

- The injectate volume is invalid or not selected
- Injectate temperature (Ti) is not connected
- Blood temperature (Tb) is not connected
- An iCO fault is active

If continuous CO measurements are active, a popup window will appear to confirm the suspension of CO monitoring. Touch the **Yes** button.

NOTE During bolus CO measurements, any parameters calculated using an ECG input signal (HR_{avg}) are unavailable.

- 2 The iCO new set screen appears with **Wait** highlighted ().
- 3 When in auto mode and the thermal baseline is established **Inject** becomes highlighted on the screen (), signifying when to begin the bolus injection series.

OR

If in manual mode, **Ready** () will appear highlighted on the screen when the thermal baseline is established. Touch the **Inject** button when ready to inject and then **Inject** becomes highlighted on the screen.

- 4 Use a rapid, smooth, continuous method to inject the bolus with the volume amount previously selected.

CAUTION Sudden changes in PA blood temperature, such as those caused by patient movement or bolus drug administration, may cause an iCO or iCI value to be computed. To avoid falsely triggered curves, inject as soon as possible after the **Inject** message appears.

Once a bolus is injected, the thermodilution washout curve appears on the screen, **Computing** is highlighted () and the resultant iCO measurement is displayed.

- 5 When the thermal washout curve is complete the HemoSphere advanced monitor will highlight **Wait** and then **Inject** – or **Ready** during manual mode – when a stable thermal baseline is reached again. Repeat steps 2 through 4 up to six times as desired. The highlighted messages are repeated as follows:

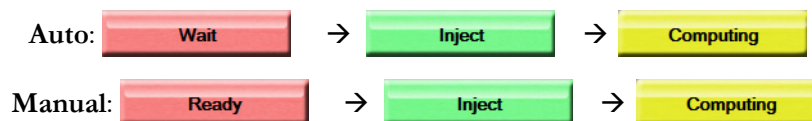

NOTE When the bolus mode is set to **Auto**, the maximum time allowed between the appearance of the **Inject** message and injection of the bolus is four minutes. If no injection is detected within this time interval, the **Inject** message will disappear and the **Wait** message will reappear.

While in **Manual** bolus mode, the operator has a maximum of 30 seconds in which to make a bolus injection after touching the **Inject** button. If no injection is detected within the time interval, the **Inject** button is enabled again and the Inject message disappears.



If a bolus measurement is compromised, as indicated by an alert message, an  will

appear in place of the CO/CI value displayed on screen.

To discontinue iCO (bolus) measurements, touch the cancel icon .

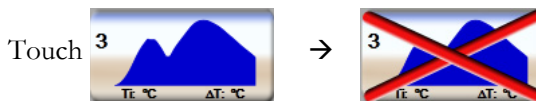
- 6 After the desired number of bolus injections has been performed, review the set of washout curves by touching the **Review** button.
- 7 Remove any of the six injections in the set by touching on it on the review screen.





A red “X” appears over the waveform removing it from the averaged CO/CI value. Waveforms that are irregular or questionable will have an  next to the waveform data set. If desired, touch the cancel icon  to delete the bolus set. Touch the **Yes** button to confirm.

- 8 Touch the **Accept** button after completing the review of bolus injections to use the averaged CO/CI value or touch the return icon  to resume the series and add additional bolus injections (up to six) for averaging.

9.3.4 Thermodilution Summary Screen

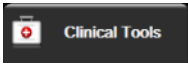
After the set has been accepted, the set summary will be displayed as a time stamped tab on the thermodilution summary screen. This screen can be accessed anytime by touching the historical thermodilution icon  from certain monitoring screens or by touching

the settings icon  → **Clinical Tools** tab  → **iCO** icon .

The following actions are available to the operator on the thermodilution summary screen:

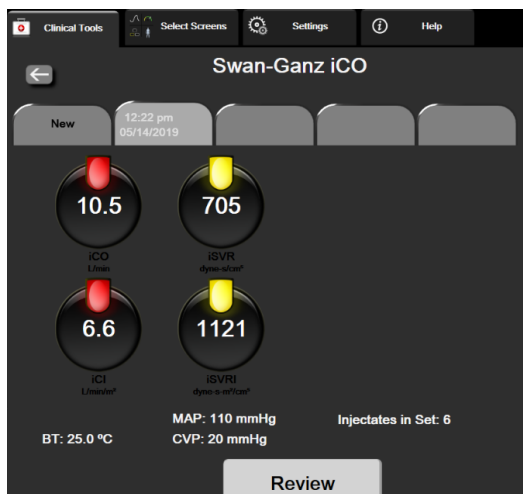



Figure 9-7 Thermodilution summary screen

New Set. Touch the return icon  or the **New** tab to perform another thermodilution set. The previous CO/CI average value and associated washout curves will be saved as a tab in the thermodilution summary screen.

Review. Review the thermal washout curves from the bolus set. Touch any tab to review the thermal washout curves from other bolus sets.

CO Monitoring. If the system is properly connected for continuous CO monitoring, touch the start monitoring icon  to begin CO monitoring at any time.

9.4 EDV/RVEF Monitoring

Right ventricular end diastolic volume (EDV) monitoring is available in conjunction with CO monitoring mode when using a Swan-Ganz CCombo V catheter and ECG signal input. During EDV monitoring, the HemoSphere advanced monitor continuously displays EDV and right ventricular ejection fraction (RVEF) measurements. EDV and RVEF are time-averaged values that can be numerically displayed in parameter tiles, and graphically trended over time in the graphical trend view.

In addition, estimates of EDV and RVEF values at approximately 60 second intervals are calculated and displayed by selecting sEDV and sRVEF as key parameters.

9.4.1 Connecting Patient Cables

- 1 Connect the patient CCO cable to the inserted HemoSphere Swan-Ganz module as previously described in section 9.1.
- 2 Attach the catheter end of the patient cable to the thermistor and thermal filament connectors on the Swan-Ganz CCombo V catheter. These connections are emphasized by ② and ③ in figure 9-8.

- 3 Verify that the catheter is properly inserted into the patient.

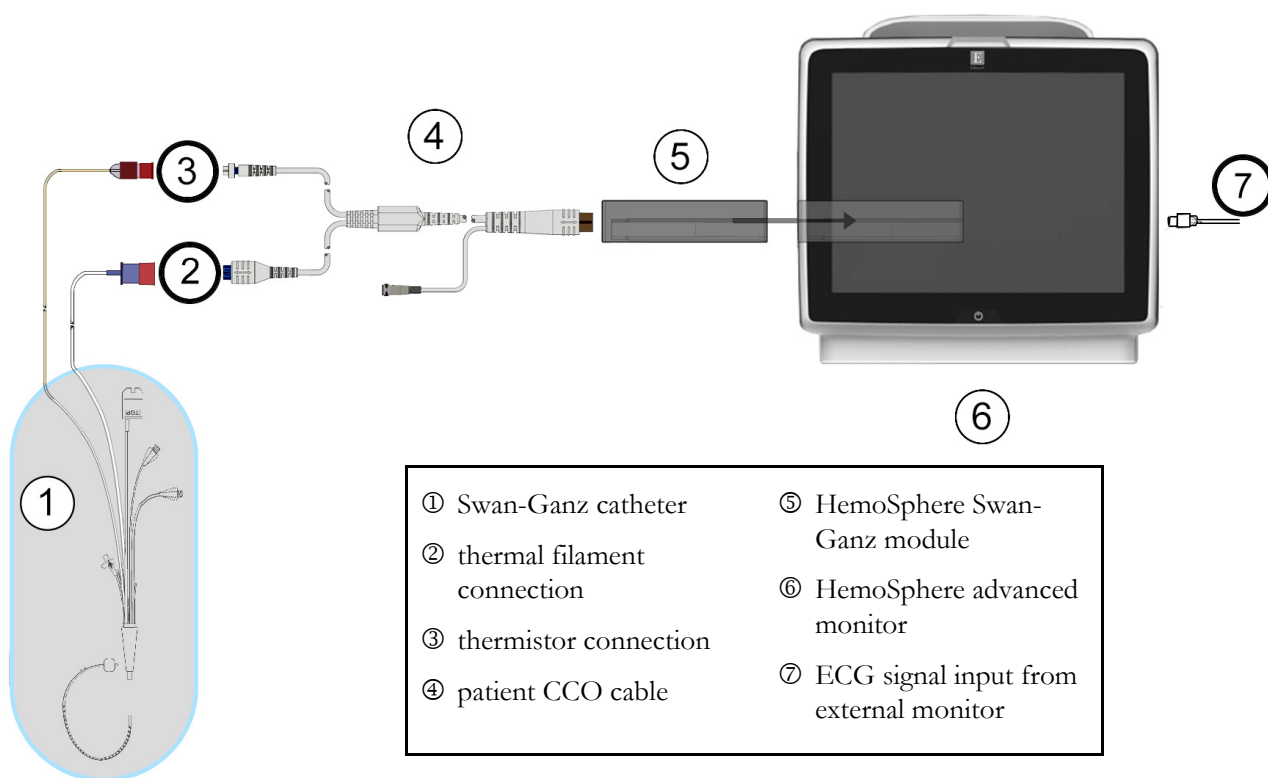

Figure 9-8 EDV/RVEF connection overview

9.4.2 Connecting the ECG Interface Cable

Connect the ECG interface cable's 1/4 inch miniature phone plug to the ECG monitor input on the rear panel of the HemoSphere advanced monitor.



Connect the other end of the interface cable to the bedside monitor's ECG signal output. This will provide an average heart rate (HR_{avg}) measure to the HemoSphere advanced monitor for EDV and RVEF measurements. For compatible ECG cables, contact your local Edwards representative.

IMPORTANT NOTE

The HemoSphere advanced monitor is compatible with an ECG analog slave input from any external patient monitor that has an analog slave output port which meets the ECG signal input specifications identified in appendix A, table A-5 of this operator's manual. The ECG signal is used to derive heart rate which is then used to calculate additional hemodynamic parameters for display. This is an optional feature that does not impact the HemoSphere advanced monitor's primary function of monitoring cardiac output (with the HemoSphere Swan-Ganz module) and venous oxygen saturation (with the HemoSphere oximetry cable). Device performance testing was conducted using ECG input signals.

WARNING PACEMAKER PATIENTS – Rate meters may continue to count the pacemaker rate during occurrences of cardiac arrest or some arrhythmias. Do not rely entirely upon displayed heart rate. Keep pacemaker patients under close surveillance. See table A-5 on page 282 for disclosure of the pacemaker pulse rejection capability of this instrument.

For patients requiring internal or external pacing support, the HemoSphere advanced monitoring platform should not be used to obtain heart rate and heart rate derived parameters under the following conditions:

- pacer pulse synch output from bedside monitor includes the pacer pulse, however, the characteristics are outside of the pacemaker pulse rejection capabilities specifications as listed in table A-5
- pacer pulse synch output characteristics from bedside monitor cannot be determined

Note any discrepancies in heart rate (HRavg) with the patient monitor HR and ECG waveform display when interpreting derived parameters such as SV, EDV, RVEF, and associated index parameters.

ECG signal input and all parameters derived from heart rate measurements have not been evaluated for pediatric patients and are therefore not available for that patient population.

NOTE When an ECG input connection or disconnection is first detected, a brief notification message will be displayed on the status bar.

SV is available with any compatible Swan-Ganz catheter and an ECG signal input. For EDV/RVEF monitoring, a Swan-Ganz CCombo V catheter is required.

9.4.3 Initiating Measurement

WARNING CO monitoring should always be discontinued when blood flow around the thermal filament is stopped. Clinical situations where CO monitoring should be discontinued include, but are not limited to:

- Time periods when a patient is on cardiopulmonary bypass
- Partial withdrawal of the catheter so that the thermistor is not in the pulmonary artery
- Removal of the catheter from the patient

When the system is properly connected, touch the start monitoring icon  to begin CO

monitoring. The CO countdown timer will appear on the stop monitoring icon. After approximately 5 to 12 minutes, when sufficient data has been obtained, an EDV and/or RVEF value will appear in the configured parameter tiles. The EDV and RVEF values displayed on the screen will be updated approximately every 60 seconds.

NOTE No EDV or RVEF value will be displayed until sufficient time-averaged data is available.

In some situations where patient conditions create large changes in pulmonary artery blood temperature over several minutes, the monitor may take longer than 9 minutes to obtain an initial EDV or RVEF measurement. In these cases, the following alert message will appear 9 minutes after monitoring has commenced:

Alert: EDV – Signal Adapting — Continuing

The monitor will continue to function and no user action is required. When continuous EDV and RVEF measurements are obtained, the alert message will be removed and the current values will be displayed and plotted.

NOTE CO values may still be available even when EDV and RVEF are not.

9.4.4 Active EDV Monitoring

When EDV monitoring is in progress, updating of the continuous EDV and RVEF measurement may be delayed by unstable pulmonary artery blood temperature. If the values are not updated for 8 minutes, the following message will appear:

Alert: EDV – Signal Adapting — Continuing

In cases when the average heart rate goes out of range (i.e., less than 30 bpm or greater than 200 bpm) or when no heart rate is detected, the following message will appear:

Alert: EDV – Heart Rate Signal Missing

Continuous EDV and RVEF monitoring values will no longer be displayed. This condition could result from physiologic changes in the patient's status or the loss of the ECG slave signal. Check the ECG interface cable connections and reconnect if necessary. After verifying patient status and cable connections, EDV and RVEF monitoring will automatically be resumed.

NOTE SV, EDV, and RVEF values are dependent on accurate heart rate calculations. Care should be taken that accurate heart rate values are being displayed, and that double counting should be avoided, especially in case of AV pacing.

If the patient has an atrial or atrial-ventricular (AV) pacemaker, the user should assess for the presence of double sensing (for accurate HR determinations, only one pacemaker spike or one contraction per cardiac cycle should be sensed). In the event of double sensing, the user should:

- Reposition the reference lead to minimize atrial spike sensing
- Select appropriate lead configuration to maximize HR triggers and minimize atrial spike sensing, and
- Assess appropriateness of milliamperage (mA) pacing levels.

The accuracy of continuous EDV and RVEF determinations is dependent upon a consistent ECG signal from the bedside monitor. For additional troubleshooting, see table 15-10, “HemoSphere Swan-Ganz module EDV and SV faults/alerts,” on page 256 and table 15-14, “HemoSphere Swan-Ganz module general troubleshooting,” on page 259.

If EDV monitoring is stopped, by touching the stop monitoring icon , the parameter tile target indicator for EDV and/or RVEF will become gray, and a time stamp will be placed below the value indicating the time that the last value was measured.

NOTE Pressing the stop monitoring icon  will stop EDV, RVEF and CO monitoring.

If EDV monitoring is resumed, a gap will appear in the plotted line of the trend graph indicating the time period when continuous monitoring was interrupted.

9.4.5 STAT EDV and RVEF

A hemodynamically unstable thermal signal may delay the HemoSphere advanced monitor from displaying an EDV, EDVI and/or RVEF value after monitoring has been initiated. The clinician may use the STAT values, which presents estimates of EDV or EDVI, and RVEF values updated approximately 60 seconds. Select sEDV, sEDVI, or sRVEF as a key parameter to view STAT values. EDV, EDVI, and RVEF values can be graphically trended over time alongside numerical values of sEDV, sEDVI, and sRVEF using the graphical/tabular trends split screen monitoring view. Up to two parameters can be viewed in tabular format on this screen. See *Graphical/Tabular Trends Split* on page 97.

9.5 SVR

While performing CO monitoring, the HemoSphere advanced monitor can also calculate SVR by utilizing MAP and CVP analog pressure signal inputs from a connected patient monitor. See *Analog Pressure Signal Input* on page 126.

Monitoring with the HemoSphere Pressure Cable

Contents

Pressure Cable Overview	164
Monitoring Mode Selection	166
FloTrac Sensor Monitoring	166
Pressure Cable Monitoring with a TruWave DPT	170
Pressure Cable Monitoring in Swan-Ganz Module Monitoring Mode	172
Zero & Waveform Screen	173

10.1 Pressure Cable Overview

The HemoSphere pressure cable is a reusable device that connects with the HemoSphere monitor on one end ④ and any approved single Edwards disposable pressure transducer (DPT) or sensor on the other end ①. See figure 10-1 on page 165. The HemoSphere pressure cable acquires and processes a single pressure signal from a compatible Edwards DPT, such as the TruWave DPT, or a FloTrac sensor. A FloTrac or Acumen IQ sensor connects to an existing arterial catheter to provide minimally invasive hemodynamic parameters. A TruWave transducer can connect to any compatible pressure monitoring catheter to provide location based intravascular pressure. Refer to the directions for use provided with each catheter for specific instructions on catheter placement and use, and for relevant warnings, cautions and notes. The HemoSphere pressure cable can be monitored through two technology monitoring modes based on the paired sensor/transducer: **FloTrac** or **Acumen IQ** sensor monitoring mode or **Swan-Ganz** catheter monitoring mode. The monitoring mode appears on the top of the navigation bar (see figure 5-2 on page 84). The appearance and connection points for the HemoSphere pressure cable are shown in figure 10-1.

Pressure Type Color Insert. If desired, the appropriate color insert can be used on the pressure cable to indicate the monitored pressure type. See ③ in figure 10-1 below. The colors are as follows:

- Red for arterial pressure (AP)
- Blue for central venous pressure (CVP)
- Yellow for pulmonary artery pressure (PAP)
- Green for cardiac output (CO)

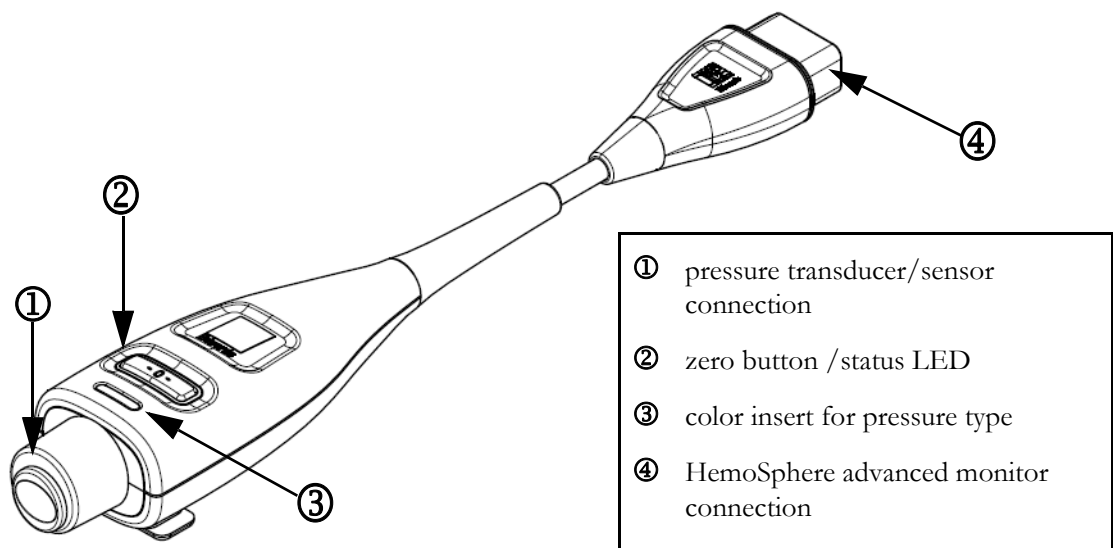

Figure 10-1 HemoSphere pressure cable

Table 10-1 HemoSphere pressure cable configurations and available key parameters

Available key parameters	Pressure cable configuration					
	FloTrac/ Acumen IQ sensor	FloTrac/ Acumen IQ sensor with CVP entry or slaved-in CVP signal	FloTrac/ Acumen IQ sensor with CVP entry or slaved-in CVP signal and oximetry cable	TruWave DPT connected to arterial line	TruWave DPT connected to central line	TruWave DPT connected to pulmonary artery catheter
CO/CI	•	•	•			
SV/SVI	•	•	•			
SVV/PPV	•	•	•			
SVR/SVRI		•	•			
SvO ₂ /ScvO ₂			•			
PR	•	•	•	•		
SYS _{ART}	•	•	•	•		
DIA _{ART}	•	•	•	•		
MAP	•	•	•	•		
MPAP						•
SYS _{PAP}						•
DIA _{PAP}						•
CVP		•	•		•	
HPI*	•	•	•			
dP/dt*	•	•	•			
E _{adyn} *	•	•	•			

***NOTE** The Acumen Hypotension Prediction Index parameter, HPI, is an advanced feature that must be activated using a Acumen IQ sensor connected to a radial arterial catheter. See *Acumen™ Hypotension Prediction Index (HPI) Software Feature* on page 218 for more information.

WARNING Do not resterilize or reuse any FloTrac sensor, Acumen IQ sensor, TruWave transducer, or catheter; refer to the catheter’s “directions for use”.

Do not use a FloTrac sensor, Acumen IQ sensor, TruWave transducer, or catheter that is wet, damaged, or that has exposed electrical contacts.

Do not modify, service or alter the product in any way. Servicing, alteration or modification may affect patient/operator safety and/or product performance.

Refer to the directions provided with each accessory for specific instructions on placement and use, and for relevant WARNINGS, CAUTIONS, and specifications.

When the pressure cable is not in use, protect the exposed cable connector from fluid. Moisture within the connector may result in the cable malfunctioning or in inaccurate pressure readings.

Compliance to IEC 60601-1 is only maintained when the HemoSphere pressure cable (applied part accessory, defibrillation proof) is connected to a compatible monitoring platform. Connecting external equipment or configuring the system in a way not described in these instructions will not meet this standard. Failure to use the device as instructed may increase the risk of electrical shock to the patient/operator.

CAUTION Do not use any FloTrac sensor or TruWave transducer past its labeled “Use By Date.” Products used beyond this date may have compromised transducer or tubing performance, or compromised sterility.

Excessive dropping of the HemoSphere pressure cable may result in cable damage and/or malfunction.

10.2 Monitoring Mode Selection

The primary monitoring mode for the HemoSphere pressure cable is minimally-invasive monitoring mode. The pressure cable can also be used to collect pulmonary artery pressure (PAP) data while in invasive monitoring mode using a Swan-Ganz module. See *Select Monitoring Mode* on page 107 for more information on switching between monitoring modes.

10.3 FloTrac Sensor Monitoring

The HemoSphere pressure cable serves as an Edwards FloTrac sensor connecting cable for the HemoSphere advanced monitoring platform. The HemoSphere pressure cable with a connected FloTrac or Acumen IQ sensor uses the patient’s existing arterial pressure waveform to continuously measure cardiac output (FloTrac

arterial pressure autocalibrated cardiac output [FT-CO]). With the input of patient height, weight, age, and gender, a specific vascular compliance is determined. The FloTrac algorithm's automatic vascular tone adjustment recognizes and adjusts for changes in vascular resistance and compliance. Cardiac output is displayed on a continuous basis by multiplying the pulse rate and calculated stroke volume as determined from the pressure waveform. The FloTrac or Acumen IQ sensor measures variations of arterial pressure proportional to stroke volume.

The HemoSphere pressure cable and FloTrac or Acumen IQ sensor, use the patient's existing arterial pressure waveform to continuously measure stroke volume variation (SVV). SVV is a sensitive indicator of the patient's preload responsiveness when the patient is 100% mechanically ventilated with a fixed rate and tidal volume, and no spontaneous breaths. SVV is always used best in conjunction with stroke volume or cardiac output assessment.

When using the Acumen IQ sensor, the patient's existing arterial pressure waveform is used to continuously measure, the systolic slope (dP/dt), and dynamic arterial elastance (Ea_{dyn}). Ea_{dyn} is a measure of the afterload to the left ventricle by the arterial system (arterial elastance) relative to left ventricular elastance (dynamic arterial elastance). See *Acumen™ Hypotension Prediction Index (HPI) Software Feature* on page 218 for more information on the Acumen IQ sensor and the Acumen Hypotension Prediction Index (HPI) feature. Activation of the Acumen HPI feature is only available in certain areas. Please contact your local Edwards representative for more information on enabling this advanced feature.

Available parameters using FloTrac technology include cardiac output (CO), cardiac index (CI), stroke volume (SV), stroke volume index (SVI), stroke volume variation (SVV), systolic pressure (SYS), diastolic pressure (DIA), mean arterial pressure (MAP), and pulse rate (PR). When using a Acumen IQ sensor and the Acumen HPI feature is activated, additional available parameters include dynamic arterial elastance (Ea_{dyn}), systolic slope (dP/dt), pulse pressure variation (PPV), and Acumen Hypotension Prediction Index parameter (HPI). When the FloTrac or Acumen IQ sensor is paired with the patient's central venous pressure (CVP), systemic vascular resistance (SVR) and systemic vascular resistance index (SVRI) are also available.

CAUTION The effectiveness of FT-CO measurements in pediatric patients has not been evaluated.

Inaccurate FT-CO measurements can be caused by factors such as:

- Improperly zeroed and/or leveled sensor/transducer
- Over- or under-damped pressure lines
- Excessive variations in blood pressure. Some conditions that cause BP variations include, but are not limited to:
 - * Intra-aortic balloon pumps
- Any clinical situation where the arterial pressure is deemed inaccurate or not representative of aortic pressure, including but not limited to:
 - * Extreme peripheral vasoconstriction which results in a compromised radial arterial pressure waveform
 - * Hyperdynamic conditions as seen in post liver transplant
- Excessive patient movement
- Electrocautery or electrosurgical unit interference

Aortic valve regurgitation may cause an over estimation of Stroke Volume / Cardiac Output calculated depending on the amount of valvular disease and the volume lost back into the left ventricle.

10.3.1 Connect FloTrac or Acumen IQ Sensor

- 1 Connect one end of the pressure cable to the HemoSphere advanced monitor.
- 2 To de-air and prime I.V. bag and FloTrac or Acumen IQ sensor: Invert normal saline I.V. bag (anticoagulation per institution policy). Spike I.V. bag with fluid administration set, keeping drip chamber upright. While keeping I.V. bag inverted, gently squeeze air out of bag with one hand while pulling flush tab (Snap-tab) with the other hand until air is emptied from I.V. bag and drip chamber is filled half-way.
- 3 Insert I.V. bag into the Pressure Bag and hang on I.V. pole (DO NOT INFLATE).
- 4 With gravity only (no pressure in Pressure Bag), flush FloTrac sensor holding pressure tubing in upright position as the column of fluid raises through the tubing, pushing air out of the pressure tubing until the fluid reaches the end of the tubing.
- 5 Pressurize the Pressure Bag until it reaches 300 mmHg.
- 6 Fast-flush the FloTrac sensor and tap on tubing and stopcocks to remove any residual bubbles.
- 7 Use a straight in or out motion to connect the green connector of the primed FloTrac sensor. The pressure cable LED that surrounds the zero button (see ② in figure 10-1) will flash green indicating that the pressure sensor is detected. A yellow light indicates a fault condition. If this occurs refer to the status bar for specific fault condition details.
- 8 Connect tubing to arterial catheter, then aspirate and flush system to assure no residual bubbles remain.
- 9 Use routine transducer calibration procedures (according to institutional policy) to ensure proper pressure signals are being transmitted. Refer to the FloTrac or Acumen IQ sensor's instructions for use.
- 10 Follow steps for entering patient data. See *Patient Data* on page 120.
- 11 Follow the instructions below for zeroing the FloTrac or Acumen IQ sensor.

CAUTION Always grasp the connector, not the cable, when connecting or disconnecting the cable.

Do not twist or bend the connectors.

10.3.2 Set Averaging Time

- 1 Touch within a parameter tile to access the tile configuration menu.
- 2 Touch the **Intervals / Averaging** tab
- 3 Touch the **CO/Pressure Averaging Time** value button and select one of the following interval options:
 - 5 sec
 - 20 sec (default and recommended time interval)
 - 5 minFor more information on **CO/Pressure Averaging Time** menu choices, see *Time Intervals / Averaging* on page 124.
- 4 Touch the return icon .

10.3.3 Zero Arterial Pressure

The FloTrac or Acumen IQ sensor must be zeroed to atmospheric pressure to ensure accurate monitoring.

- 1 Touch the Zero & Waveform icon  located on the navigation bar or through the Clinical Tools menu.



OR

- Press the physical zero button  directly on the pressure cable and hold for three seconds (see figure 10-1).

CAUTION To prevent cable damage, do not apply excessive force to the pressure cable zero button.

- 2 The current arterial pressure waveform is displayed and continually updated on the screen. This is to confirm the zero operation is successful.
- 3 Select **ART** (arterial) next to the listed port for which the active pressure cable is connected. Up to two pressure cables can be connected at once.
- 4 Make sure the sensor is leveled to the patient's phlebostatic axis position according to the instructions for use.

NOTE It is important to keep the FloTrac or Acumen IQ sensor level to the phlebostatic axis at all times to ensure accuracy of cardiac output.

- 5 Open the FloTrac sensor stopcock valve to measure atmospheric air. The pressure should display as a flat line.
- 6 Press the physical zero button  directly on the pressure cable and hold for three seconds, or touch the zero button  located on the screen. When zeroing is complete, a tone sounds, and "**Zeroed**" appears along with the current time and date above the waveform plot for the connected pressure cable port.
- 7 Confirm stable zero pressure value and turn stopcocks such that sensors are reading patient intravascular pressure.
- 8 If desired, output the pressure signal to a connected patient monitor. See *Pressure-Out* on page 173 for more information on this option.
- 9 Touch the home icon  to begin CO monitoring. When the next CO value is calculated, it is displayed and updates will continue as determined by the **CO/Pressure Averaging Time**.

Once CO monitoring is initiated, the blood pressure waveform can also be viewed using the blood pressure waveform display. See *Live Blood Pressure Waveform Display* on page 95. When unplugging the HemoSphere pressure cable from a compatible monitor or sensors from the pressure cable, always pull at the connection site. Do not pull from cables or use tools to disconnect.

10.3.4 SVR monitoring

When paired with the FloTrac or Acumen IQ sensor, the HemoSphere pressure cable can monitor systemic vascular resistance (SVR) and systemic vascular resistance index (SVRI) with a slaved-in CVP pressure signal or if the user manually enters the patient's CVP value. For information on utilizing the analog signal from a compatible bedside monitor, see *Analog Pressure Signal Input* on page 126. To manually input the patient's CVP:

- 1 Touch the settings icon  → **Clinical Tools** tab  → **Enter CVP** icon .
- 2 Enter a CVP value.
- 3 Touch the home icon .

When using the Acumen Hypotension Prediction Index (HPI) feature, SVR is available on the **HPI Secondary Screen**.

10.4 Pressure Cable Monitoring with a TruWave DPT

The HemoSphere pressure cable connects to a single TruWave pressure transducer to provide location based intravascular pressure. Available pressures measured by a TruWave DPT include central venous pressure (CVP) when monitored from a central venous line, diastolic pressure (DIA), systolic pressure (SYS), mean arterial pressure (MAP), and pulse rate (PR) when monitored from an arterial line, and mean pulmonary arterial pressure (MPAP) when monitored from a pulmonary arterial line. See table 10-1.

10.4.1 Connect TruWave DPT

- 1 Connect one end of the pressure cable to the HemoSphere advanced monitor.
- 2 To de-air and prime I.V. flush bag and TruWave transducer: Invert normal saline bag (anticoagulation per institution policy). Spike I.V. bag with fluid administration set, keeping drip chamber upright. While keeping I.V. bag inverted, gently squeeze air out of bag with one hand while pulling flush tab (Snap-tab) with the other hand until air is emptied from I.V. bag and drip chamber is filled to desired level (½ or full).
- 3 Insert flush bag into pressure infuser bag (DO NOT INFLATE) and hang on IV pole at least 2 feet (60 cm) above the transducer.
- 4 With gravity only (no pressure in Pressure Bag), flush TruWave transducer holding pressure tubing in upright position as the column of fluid raises through the tubing, pushing air out of the pressure tubing until the fluid reaches the end of the tubing (flushing under pressure creates turbulence and increased occurrence of bubbles).
- 5 Pressurize the pressure bag until it reaches 300 mmHg.
- 6 Fast-flush transducer tubing while tapping on tubing and stopcocks to remove any residual bubbles.
- 7 Use a straight in or out motion to connect the TruWave DPT to the HemoSphere pressure cable. The pressure cable LED that surrounds the zero button (see ② in figure 10-1) will flash green indicating that the pressure sensor is detected. A yellow light indicates a fault condition. If this occurs refer to the status bar for specific fault condition details.
- 8 Connect tubing to catheter, and then aspirate and flush system to assure catheter is intra-vascular and remove residual bubbles.

- 9 Use routine transducer calibration procedures (according to institutional policy) to ensure proper pressure signals are being transmitted. Refer to the TruWave pressure transducer's instructions for use.
- 10 Follow steps for entering patient data. See *Patient Data* on page 120.
- 11 Follow the instructions below for zeroing the transducer.

10.4.2 Zero Intravascular Pressure



The TruWave DPT must be zeroed to atmospheric pressure to ensure accurate monitoring.

- 1 Touch the Zero & Waveform icon  located on the navigation bar.

OR

Press the physical zero button  directly on the pressure cable and hold for three seconds (see figure 10-1).

CAUTION To prevent cable damage, do not apply excessive force to the pressure cable zero button.

- 2 The current intravascular pressure waveform is displayed and continually updated on the screen. This is to confirm the zero operation is successful.
- 3 Use the pressure type button for the connected pressure cable port (1 or 2) to select the type/ location of pressure sensor being used. The waveform color will match the pressure type selected. The choices for **Pressure Transducer** are:
 - **ART** (red)
 - **CVP** (blue)
 - **PAP** (yellow)
- 4 Level the stopcock valve (vent port) just above the TruWave transducer to the patient's phlebostatic axis position according to the instructions for use.
- 5 Open the stopcock valve to measure atmospheric conditions. The pressure should display as a flat line.
- 6 Press the physical zero button  directly on the pressure cable and hold for three seconds, or touch the zero button  located on the screen. When zeroing is complete, a tone sounds, and the message "**Zeroed**" appears along with the current time and date above the waveform plot for the connected pressure cable port.
- 7 Confirm stable zero pressure value and turn stopcocks such that sensors are reading patient intravascular pressure.
- 8 If desired, output the pressure signal to a connected patient monitor. See *Pressure-Out* on page 173 for more information on this option.
- 9 Touch the home icon  to begin monitoring. See table 10-1 for which key parameters are available based on the type of configuration.

Once pressure cable monitoring is initiated, the blood pressure waveform can also be viewed using the blood pressure waveform display. See *Live Blood Pressure Waveform Display* on page 95.

Parameter values monitored using the TruWave DPT are averaged over a 5 second interval, and displayed every 2 seconds. See table 6-4 on page 125.

10.5 Pressure Cable Monitoring in Swan-Ganz Module Monitoring Mode

The HemoSphere pressure cable connects to a single Swan-Ganz pulmonary artery pressure port to provide pulmonary artery pressure (PAP).

While in HemoSphere Swan-Ganz module monitoring mode, the pressure cable can be connected to a TruWave DPT on a pulmonary artery line. Monitoring of PAP while monitoring with a HemoSphere Swan- Ganz module also enables monitoring of 20-Second parameter values. See *20-Second Flow Parameters* on page 153.

- 1 Connect one end of the pressure cable to the HemoSphere advanced monitor.
- 2 Use a straight in or out motion to connect or disconnect the TruWave DPT. Refer to the TruWave pressure transducer's instructions for use and to steps 2-6 in section 10.4.1 above for instructions on flushing air from the system.
- 3 Use routine transducer calibration procedures (according to institutional policy) to ensure proper pressure signals are being transmitted.



- 4 Touch settings icon  → **Clinical Tools** tab 

→ **Zero & Waveform** icon  .

OR

Press the physical zero button  directly on the pressure cable and hold for three seconds (see figure 10-1).

CAUTION To prevent cable damage, do not apply excessive force to the pressure cable zero button.

- 5 **PAP** will be automatically selected on the pressure type button.
- 6 Level the stopcock valve (vent port) just above the TruWave transducer to the patient's phlebostatic axis position according to the instructions for use.
- 7 Open the stopcock valve to measure atmospheric conditions. The pressure should display as a flat line.
- 8 Press the physical zero button  directly on the pressure cable and hold for three seconds, or touch the zero button  located on the screen. When zeroing is complete, a tone sounds, and the message "**Zeroed**" appears along with the current time and date above the waveform plot for the connected pressure cable port.

- 9 Confirm stable zero pressure value and turn stopcocks such that sensors are reading patient pulmonary artery pressure.
- 10 To assist with correct placement of the catheter tip in the pulmonary artery, touch the **Reference** button. The current pressure waveform along with a graphic aid of example waveforms for various catheter tip positions is displayed.
- 11 Touch the home icon  to return to Swan-Ganz module monitoring. Return to the Zero & Waveform screen at any time to view PAP data.

10.6 Zero & Waveform Screen

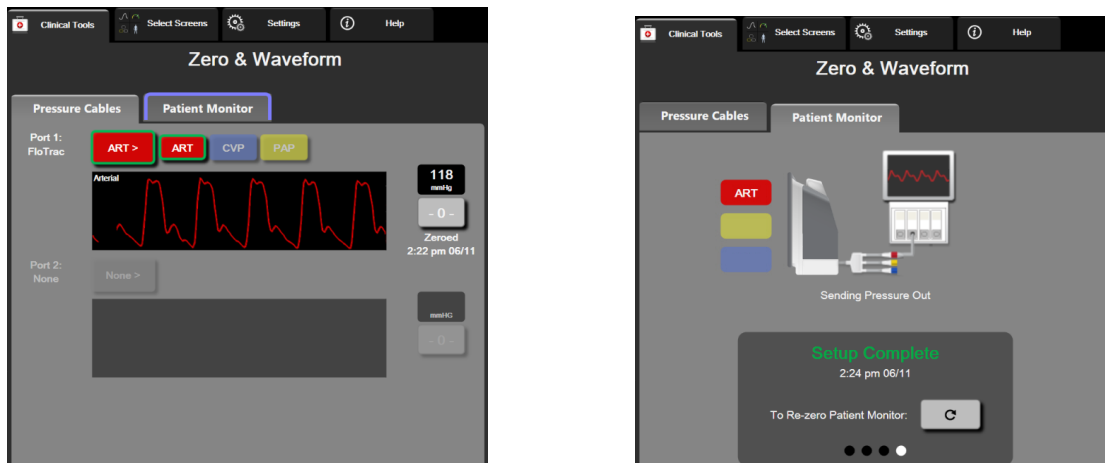

Figure 10-2 Zero & Waveform screens – Zero sensor and Pressure-Out

This screen is accessed through the clinical actions menu and provides three primary functions:

- 1 Select pressure and zero the sensor
- 2 Output pressure signal
- 3 Check waveform

10.6.1 Select Pressure and Zero Sensor

As previously described, the primary function of the **Zero & Waveform** screen is to allow the user to zero the attached pressure sensor/transducer. The user is required to zero the sensor before monitoring is initiated with the pressure cable.

10.6.2 Pressure-Out

The **Zero & Waveform** screen allows the user to output the pressure waveform to a connected patient monitor.

- 1 Plug the HemoSphere pressure-out cable into the rear panel of the monitor at the pressure out port. See ③ in figure 3-2 on page 61.
- 2 Connect the desired pressure signal plug into a compatible patient monitor:
 - arterial pressure (AP, red)
 - pulmonary artery pressure (PAP, yellow)

- central venous pressure (CVP, blue)
- Ensure that the selected connector is fully engaged. Refer to the patient monitor instructions for use.
- 3 Zero the patient monitor.
 - 4 Confirm that a value of 0 mmHg is displayed on the patient monitor and touch the **Confirm** button on the **Patient Monitor** tab of the **Zero & Waveform** screen.
 - 5 Touch the **Transmit Waveform** icon  to begin pressure signal output to the patient monitor. A “**Setup Complete**” message will be displayed when the live waveform is being transmitted to the connected patient monitor. See right screen shown in figure 10-2 on page 173.

10.6.3 Waveform Confirmation

The Zero & Waveform screen displays the blood pressure waveform. Use this screen or the continuous, real-time blood pressure waveform display (see *Live Blood Pressure Waveform Display* on page 95) to assess the quality of the arterial waveform in response to “Fault: CO – Check Arterial Waveform”. This fault is generated when the arterial pressure signal quality has been poor for too long.

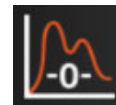

The vertical axis is auto-scaled to the Average BP value \pm 50 mmHg.

Monitoring PAP in Invasive Monitoring Mode. The Zero & Waveform is also utilized to monitor the pulmonary artery pressure (PAP) when using the HemoSphere Swan-Ganz module in combination with the pressure cable. While monitoring PAP, touch the **Reference** button to view a waveform screen displaying example waveforms of various catheter tip positions and confirm correct placement in the pulmonary artery.

WARNING Do not use the HemoSphere advanced monitoring platform as a pulse rate or blood pressure monitor.

HemoSphere ClearSight Module Noninvasive Monitoring

Contents

HemoSphere Noninvasive System Methodology	175
Connecting the HemoSphere Noninvasive System	177
Optional HRS	184
SQI	187
Physiocal Display	187
ClearSight Settings and Cuff Options	187
Blood Pressure Calibration	189
Output Signal to Patient Monitor	190

11.1 HemoSphere Noninvasive System Methodology

The HemoSphere noninvasive system is composed of the HemoSphere advanced monitor with ClearSight module and connected pressure controller, heart reference sensor, and compatible Edwards finger cuff(s). See system connections in figure 11-1 on page 178. Accurate measurement of the patient's blood pressure and key hemodynamic parameters is based on the Volume Clamp method, Physiocal method and ClearSight algorithm.

11.1.1 Volume Clamp Method

The ClearSight and Acumen IQ finger cuffs use the Volume Clamp method developed by Czech physiologist J. Peñáz (Penaz J 1973)¹. The finger cuff is equipped with a plethysmograph sensor, which is a combination of a light source and light receiver, to continuously monitor changes in finger arterial blood volume. An inflatable bladder within the cuff rapidly adjusts to this change in volume to equilibrate the pressure of the cuff with the pressure inside of the artery. The artery is therefore clamped at its “un-stretched” volume and the pressure of the cuff is equal to that of the finger arterial pressure at all times.

11.1.2 Physioical Method

The Physioical method, developed by K.H. Wesseling (K.H. Wesseling et al. 1995)², is short for physiological calibration.

Physioical adjusts for changes in the “un-stretched” volume during a normal measurement period. Cuff pressure is kept constant for one or more heart beats and blood pressure measurement is momentarily interrupted to observe the physiological properties of the finger artery. Early in the measurement period, these interruptions occur regularly. If the properties of the artery are sufficiently constant over time, the interval between Physioical adjustments will be increased up to 70 heart beats, with higher intervals representing increased measurement stability.

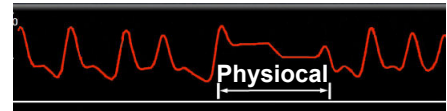

11.1.3 Waveform Reconstruction and Hemodynamic Analysis (ClearSight Algorithm)

The arterial blood pressure waveform is known to gradually change between the brachial and finger arteries due to physiological reasons. The ClearSight algorithm uses advanced processing methods to reconstruct the brachial arterial pressure waveform (P. Gizdulich et al. 1997)³. Waveform reconstruction yields beat-to-beat values of systolic (SYS), diastolic (DIA) and mean arterial (MAP) noninvasive pressures. Arterial pulse pressure variation (PPV) is also available. Waveform hemodynamic analysis yields values for cardiac output (CO), cardiac index (CI), stroke volume (SV), stroke volume index (SVI), and pulse rate (PR) using an advanced pulse contour method. Advanced algorithms are used to compute stroke volume variation (SVV) to evaluate dynamic fluid responsiveness. Systemic vascular resistance (SVR), and systemic vascular resistance index (SVRI) are available when a central venous pressure (CVP) value is entered or monitored.

If an Acumen IQ finger cuff and HRS are connected and the Acumen Hypotension Prediction Index feature is activated, the Hypotension Prediction Index, HPI, systolic slope (dP/dt), and dynamic elastance (Eadyn) can be monitored as key parameters. For more information on setup and usage, see *Acumen™ Hypotension Prediction Index (HPI) Software Feature* on page 218.

11.1.4 Heart Reference Sensor

The heart reference sensor (HRS) takes into account differences in pressure between the finger and heart. The hydrostatic pressure changes due to difference in height between the finger and heart are compensated by the HRS. One end of the HRS is placed on the finger at the cuff level, and the other end is placed at heart level.

11.1.5 Discoloration, Numbness, or Tingling of the Fingertip

The Volume Clamp methodology places a continual pressure on the finger which never fully occludes the arteries, but inhibits venous return and causes some venous congestion in the fingertip distal to the cuff. As a result, the patient’s fingertip may often experience discoloration (blue or red coloring) after a few minutes of monitoring. After longer periods of monitoring (approximately 30 minutes - 2 hours), some patients may experience some tactile sensations (tingling or numbness) in the fingertip. Immediately after removing the cuff, the middle phalanx often shows a slightly decreased volume and may show some reactive hyperemia or swelling. All of these phenomena generally subside within a few minutes of relieving the cuff pressure. Keeping the fingers and hand warm during the measurement improves the arterialization of the fingertip, which can improve coloration and reduce the rate of occurrence of tactile numbing.

11.1.6 Single Cuff Monitoring

A single compatible Edwards finger cuff can be used for accumulated monitoring of the same patient for up to 8 hours on a single finger. During single cuff monitoring, the HemoSphere noninvasive system will automatically release the pressure in the cuff at regular intervals. See *Cuff Pressure Release Mode* on page 188.

NOTE After 8 hours of accumulated monitoring on the same finger, the HemoSphere non-invasive system will stop monitoring and display a warning to place the cuff on another finger if continued monitoring is desired.

11.1.7 Double Cuff Monitoring

For monitoring periods lasting longer than 8 hours, the HemoSphere noninvasive system enables two compatible Edwards finger cuffs to be connected simultaneously on separate fingers. In this configuration, the system switches active monitoring between the two cuffs at a user selected interval to allow for minimally interrupted continuous monitoring. During cuff switching, there may be up to a minute pause in monitoring. See *ClearSight Settings and Cuff Options* on page 187.

NOTE When using the double cuff configuration, ensure that each finger is sized separately. It is not uncommon for patients to have two different sized fingers requiring two different sized compatible Edwards finger cuffs. Failure to select the correct finger cuff can result in measurement inaccuracy.

If an Acumen IQ finger cuff and HRS are connected and the Acumen Hypotension Prediction Index feature is activated, the Hypotension Prediction Index, HPI, arterial pulse pressure variation (PPV), systolic slope (dP/dt), and dynamic arterial elastance ($E_{a_{dyn}}$) can be monitored as key parameters.

For more information on setup and usage, see *Acumen™ Hypotension Prediction Index (HPI) Software Feature* on page 218.

When using the double cuff configuration, both finger cuffs must be an Acumen IQ finger cuff to enable HPI.

Upon starting a measurement, the finger cuff will expire after 72 hours for a single patient.

11.1.8 Methodology References

- 1 Penaz J (1973), "Photoelectric measurement of blood pressure, volume and flow in the finger" *Digest of the 10th Int Conf Med Biol Engng, Dresden*, p. 104.
- 2 Wesseling KH, et al. (1995), "Physiocal, calibration finger vascular physiology for Finapres" *Homeostasis* **36** (2-3), pp. 67-82.
- 3 Gizdulich P, Prentza A, Wesseling KH (1997), "Models of brachial to finger pulse wave distortion and pressure decrement" *Cardiovascular Research* **33** (3), pp. 698-705.

11.2 Connecting the HemoSphere Noninvasive System

The HemoSphere ClearSight module is compatible with all approved Edwards finger cuffs. See figure 11-1 for an overview of the HemoSphere noninvasive system connections.

- 1 Align and insert the HemoSphere ClearSight module into an large technology (L-Tech) module slot on the left panel of the HemoSphere advanced monitor. The module will click in place when properly engaged.

CAUTION Do not force the module into the slot. Apply even pressure to slide and click the module into place.

- 2 Press the power button to turn on the HemoSphere advanced monitor and follow steps for entering patient data. See *Patient Data* on page 120.
- 3 Follow instructions below on how to apply the pressure controller, select finger cuff size and apply the finger cuff(s) to the patient.

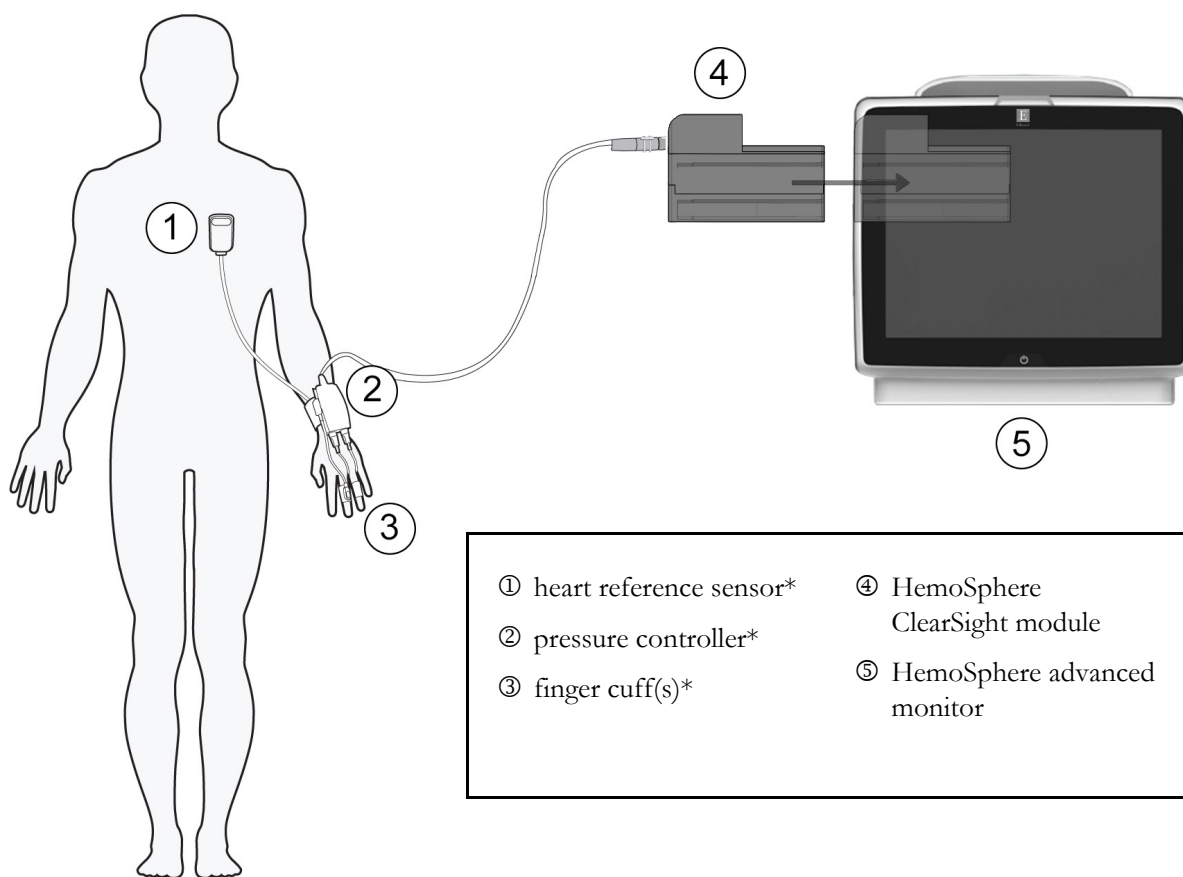

Figure 11-1 HemoSphere noninvasive system connection overview

NOTE Components indicated by * figure 11-1 legend are APPLIED PARTS as defined in IEC 60601-1 that in normal use necessarily come into physical contact with the patient for the HemoSphere noninvasive system to perform its function.

WARNING Components that are not indicated as APPLIED PARTS should not be placed in a location where the patient may come into contact with the component.

Compliance to IEC 60601-1 is only maintained when the HemoSphere ClearSight module (applied part connection) is connected to a compatible monitoring platform. Connecting external equipment or configuring the system in a way not described in these instructions will not meet this standard. Failure to use the device as instructed may increase the risk of electrical shock to the patient/operator.

Do not modify, service or alter the product in any way. Servicing, alteration or modification may affect patient/operator safety and/or product performance.

Do not sterilize any components of the HemoSphere noninvasive system. The HemoSphere noninvasive system is provided non sterile.

Refer to cleaning instructions. Do not disinfect the instrument by autoclave or gas sterilization.

Refer to the directions provided with each accessory for specific instructions on placement and use, and for relevant WARNINGS, CAUTIONS, and specifications.

Do not use damaged components/sensors or components/sensors with exposed electrical contacts to prevent patient or user shocks.

The HemoSphere noninvasive system monitoring components are not defibrillation proof. Disconnect the system before defibrillating.

Only use compatible Edwards finger cuffs, heart reference sensor and other HemoSphere noninvasive system accessories, cables and or components that have been supplied and labeled by Edwards. Using other unlabeled accessories, cables and or components may affect patient safety and measurement accuracy.

Always remove HemoSphere noninvasive system sensors and components from the patient and completely disconnect the patient from the instrument before bathing the patient.

CAUTION The effectiveness of HemoSphere noninvasive system has not been evaluated in patients under 18 years of age.

Always grasp the connector, not the cable, when connecting or disconnecting cables. Do not twist or bend the connectors. Confirm that all sensors and cables are connected correctly and completely before use.

11.2.1 Apply the Pressure Controller

The pressure controller is worn on the patient's wrist and connects to the HemoSphere ClearSight module, HRS and finger cuff(s). See figure 11-2.

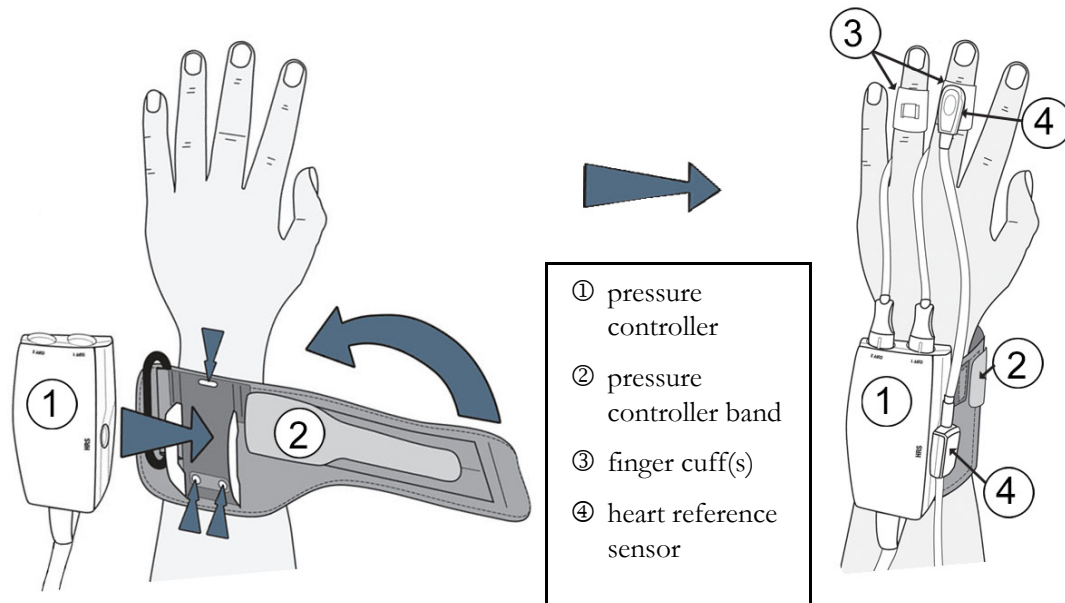

Figure 11-2 Pressure controller application

- 1 Wrap the pressure controller band around the patient's wrist. The non dominant hand is preferred for monitoring in awake patients. (figure 11-2, left)
- 2 Snap the pressure controller into the plastic sleeve of the band, making sure that the cuff connectors are facing towards the fingers.
- 3 Attach the pressure controller cable to the HemoSphere ClearSight module. (figure 11-1)

WARNING Do not overtighten the pressure controller band or finger cuff(s).

Do not apply pressure controller band on injured skin as this can cause further injury.

11.2.2 Select Finger Cuff Size

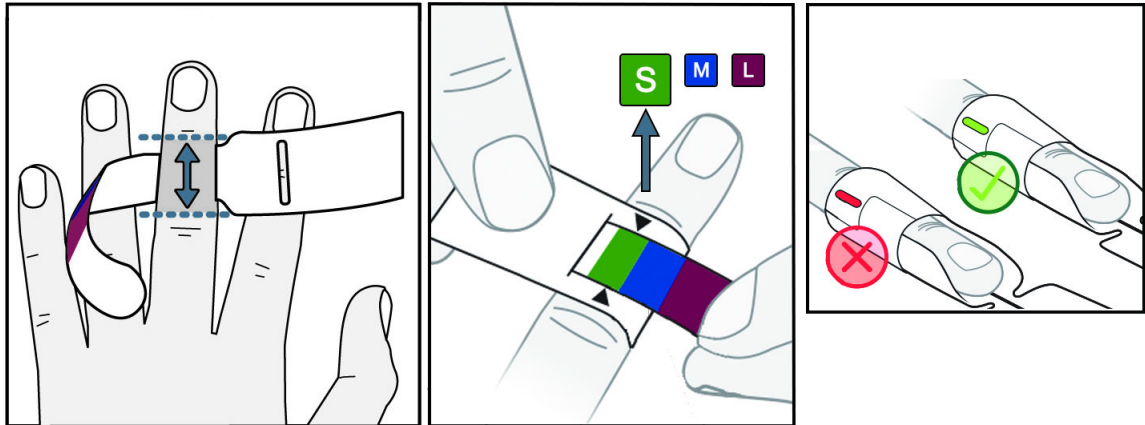

Figure 11-3 Cuff size selection

- 1 Size the finger(s) that will be used for monitoring by using the finger cuff sizing aid. Best results are obtained from the middle, ring or index finger. The cuff is not intended to be placed on the thumb or previously fractured fingers.
- 2 Wrap the sizing aid around the middle phalanx of the finger by pulling the color coded smaller end through the slot to create a snug fit.
- 3 The black arrows indicate suitable cuff size. Match the indicated color with the correct finger cuff size.
- 4 In certain cuffs, a window will indicate that the correct cuff size has been selected.

WARNING Improper finger cuff placement or sizing can lead to inaccurate monitoring.

11.2.3 Apply Finger Cuff(s)

Refer to the product IFU for detailed instructions on proper compatible Edwards finger cuff placement and actual device illustrations.

Single Patient Use. The ClearSight and Acumen IQ finger cuffs are designed for single patient use. Upon starting a measurement, the finger cuff will expire after 72 hours for a single patient.

Double Cuff Monitoring. The HemoSphere noninvasive system allows two compatible Edwards finger cuffs to be connected simultaneously to alternate the measurement between two fingers. This feature allows for minimum interruptions to monitoring for durations of up to 72 hours and is required for measurements that take longer than 8 hours. This feature can also be used to increase patient comfort.

11.2.4 Zero and Apply the Heart Reference Sensor

The Heart Reference Sensor (HRS) should always be used in conscious patients, freely moving patients or those patients that will be frequently re-positioned during the case. Follow the on-screen prompts or the steps below to connect and zero the HRS.

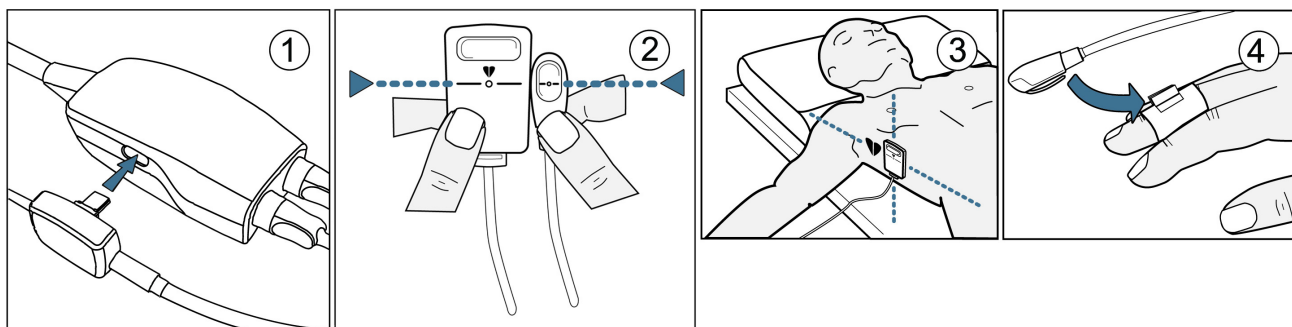



Figure 11-4 Heart reference sensor application

CAUTION Make sure that the HRS is correctly applied so that it can be leveled to the phlebostatic axis.

- 1 Connect the HRS to the pressure controller. See ① in figure 11-4.
- 2 Vertically align both ends of the HRS and touch the zero button. See ② in figure 11-4.
- 3 Wait for indication that the HRS has been zeroed.
- 4 Apply the heart end of the HRS to the patient at phlebostatic axis level by using an HRS clip. See ③ in figure 11-4.

NOTE If the patient is rotated or moved, the phlebostatic axis will rotate or move with the patient. If necessary, be sure to reapply the heart end of the HRS to ensure that it is still at the same vertical level as the heart in the patient's new position.

- 5 Attach the other end of the HRS to the finger cuff. See ④ in figure 11-4
- 6 Touch the start monitoring icon  on the navigation bar or on setup help screen to begin monitoring.
- 7 Touch the stop monitoring icon  on the navigation bar to end monitoring at any time.

11.2.5 General Troubleshooting of HemoSphere Noninvasive System Monitoring

Listed below are common issues that may occur during normal monitoring and some troubleshooting steps.

- If waveform does not appear within minutes after monitoring is initiated, check the status bar for any faults or alerts that may indicate there is a problem. Touch the question icon for more information on a displayed message or see table 15-20, “HemoSphere ClearSight module faults/alerts,” on page 266.

- During measurement, the tip of the finger being monitored by the cuff may show some coloring. This is normal and will disappear within a few minutes of cuff removal.
- During measurement, a conscious patient may notice slight pulsations in the finger to which the cuff is applied. These pulsations will stop momentarily during Physiocal. The patient should be made aware that these irregularities are normal and not caused by the patient's heart.
- If the patient is responsive, instruct the patient to keep the hand relaxed and not tense the muscles or overstretch the hand.
- Make sure that the blood flow to the hand is not (partially) obstructed, e.g. because the wrist is pressing on a hard surface.
- Some situations, such as cold hands, may make it difficult to start monitoring. If the patient has cold hands, try to warm the hand.

WARNING Do not use the HemoSphere noninvasive system as a heart rate monitor.

If using the instrument during full body irradiation, keep all HemoSphere noninvasive system monitoring components out of the irradiation field. If a monitoring component is exposed to the irradiation, the readings may be affected.

Strong magnetic fields may cause malfunction of the instrument and burn wounds to the patient. Do not use the instrument during magnetic resonance imaging (MRI) scanning. Induced current could potentially cause burns. The device may affect the MR image, and the MRI unit may affect the accuracy of the measurements.

CAUTION The HemoSphere noninvasive system is not intended for use as an apnea monitor.

In patients with extreme contraction of the smooth muscle in the arteries and arterioles in the lower arm and hand, such as may be present in patients with Raynaud's disease, blood pressure measurement can become impossible.

Inaccurate noninvasive measurements can be caused by factors such as:

- Improperly zeroed and/or leveled HRS
- Excessive variations in blood pressure. Some conditions that cause BP variations include, but are not limited to:
 - * Intra-aortic balloon pumps
- Any clinical situation where the arterial pressure is deemed inaccurate or not representative of aortic pressure.
- Poor blood circulation to the fingers.
- A bent or flattened finger cuff.
- Excessive patient movement of fingers or hands.
- Artifacts and poor signal quality.
- Incorrect placement of finger cuff, position of finger cuff, or finger cuff too loose.
- Electrocautery or electrosurgical unit interference.

Always disconnect the finger cuff when it is not wrapped around a finger, to prevent damage by accidental over-inflation.

CAUTION The effectiveness of Edwards compatible finger cuffs has not been established in pre-eclamptic patients.

The pulsations from intra-aortic balloon support can be additive to the pulse rate on the instrument pulse rate display. Verify patient's pulse rate against the ECG heart rate.

The pulse rate measurement is based on the optical detection of a peripheral flow pulse and therefore may not detect certain arrhythmias. The pulse rate should not be used as a replacement or substitute for ECG based arrhythmia analysis.

11.3 Optional HRS

Optional HRS is an advanced feature that must be enabled. If this feature is enabled, steps vary from how described previously in *Heart Reference Sensor* on page 176. The HemoSphere noninvasive system finger cuff algorithm must account for differences in pressure due to the change in vertical level of the monitored finger relative to the heart. This can be performed in one of two ways on the **Patient Positioning Mode Selection** window (see figure 11-5):

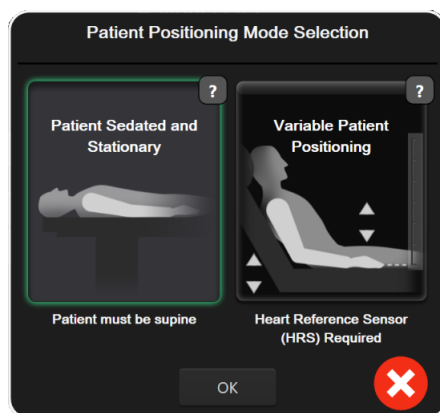
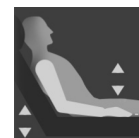

Figure 11-5 Patient Positioning Mode Selection – Optional HRS

Manually enter height differences. Use this method to account for height differences only in stationary and sedated patients. After entering patient data, touch on the **Patient Sedated and Stationary** icon and proceed with steps outlined below in *Patient Sedated and Stationary* on page 184.



Use Heart Reference Sensor (HRS). The HRS must be used in patients where the vertical level of the finger relative to the heart may change at any time during monitoring. After entering patient data, touch the **Variable Patient Positioning** button and proceed with steps outlined in the *Heart Reference Sensor* on page 176.



11.3.1 Patient Sedated and Stationary

This mode could be chosen for those patients under general anesthesia with limited or no re-positioning needs anticipated. The HRS can be used during this mode, but is not required.

- 1 Touch **Patient Sedated and Stationary** button to highlight and select this mode.
- 2 Touch **OK**.

CAUTION Monitoring without an HRS may lead to measurement inaccuracies. Ensure patient remains still with accurately measured finger to heart height difference.

Do not place the patient in a non-supine position while monitoring without an HRS. This may lead to an inaccurate vertical offset entry for the HRS and measurement inaccuracies.

NOTE If the Acumen Hypotension Prediction Index feature is enabled, the alert “**HRS and Acumen IQ Cuff(s) are required for HPI features**” will be displayed. Touch **Acknowledge** button if the Acumen HPI feature is not desired for the current monitoring session.

To enable HPI, an Acumen IQ finger cuff and HRS is required.

If an HRS is connected a popup screen with the message **Alert: HRS Detected** will be displayed. To start monitoring with the HRS, touch **Yes** and proceed to step 2 under *Zero and Apply the Heart Reference Sensor* on page 182. To monitor without an HRS, disconnect the HRS and touch **No** and proceed with the steps below.

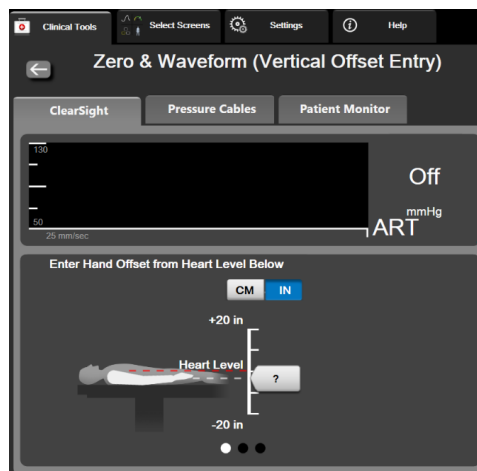



Figure 11-6 Zero & Waveform screen – Vertical Offset Entry



- 3 The **Zero & Waveform** screen in this mode (shown in figure 11-6) will depict a vertical scale bar to represent the offset of the hand relative to the heart; the heart level is set at zero. A positive offset signifies a patient position where the hand is above the heart. Select the units of the scale bar: **CM** or **IN**.
- 4 Use the slider to move the vertical level of the hand and set the offset between the hand and heart.
- 5 Touch the next arrow .
- 6 A confirmation screen will appear. If the displayed offset is correct for the current patient position, touch **Start Monitoring** to begin monitoring. If the displayed offset value is incorrect, touch **Cancel** and adjust the offset value as needed.

- 7 Touch the stop monitoring icon  on the navigation bar to end monitoring at any time.

Two alerts will cycle through on the information bar with the texts “**Alert: No HRS Connected – Verify Patient Positioning**” and “**Alert Current Offset: Finger <position>**” where <position> is the verified height offset between the monitored finger and heart. The offset value must be updated each time a patient is re-positioned in this mode. In addition, if monitoring is stopped for more than one minute, the vertical offset must be verified again upon restarting monitoring.



11.3.2 Update Offset Value During Monitoring

To update the finger to heart vertical offset value:

- 1 Touch the Zero & Waveform icon  located on the navigation bar or through the Clinical Tools menu.
- 2 Touch the **Update Offset** button on the **Zero & Waveform (Vertical Offset Entry)** screen.
- 3 Use the slider to move the vertical level of the hand to set the offset value to match the new patient position.
- 4 Touch the next arrow .
- 5 A confirmation screen will appear. If the displayed offset is correct for the current patient position, touch **Confirm Offset** to begin monitoring. If the displayed offset value is incorrect, touch **Cancel** and adjust the offset value as needed.

11.3.3 Change Patient Positioning Mode

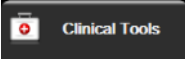
To change the patient position mode between **Patient Sedated and Stationary** and **Variable Patient Positioning**:





- 1 Touch settings icon  → **Clinical Tools** tab .
- 2 Touch **Patient Data** icon .
- 3 Touch the **Positioning Mode** list button to access the **Patient Positioning Mode Selection** screen.
- 4 Touch and highlight the desired patient positioning mode: **Patient Sedated and Stationary** or **Variable Patient Positioning**.
- 5 Touch the OK button and follow steps outlined in *Patient Sedated and Stationary* on page 184 for **Patient Sedated and Stationary** or *Heart Reference Sensor* on page 176 for **Variable Patient Positioning**.

NOTE While monitoring with an HRS and switching to **Variable Patient Positioning** from **Patient Sedated and Stationary**, monitoring will stop. Touch the start monitoring icon  to restart monitoring after touching the enter icon.

11.4 SQI

A signal quality indicator (SQI) is present on all noninvasive parameter tiles during HemoSphere noninvasive system monitoring. SQI level is calculated with each parameter update every 20 seconds. See table 11-1 below for a description of arterial waveform SQI levels. SQI levels of one and two are typically associated with alert conditions. An SQI level of zero is shown when monitoring is initializing (starting or resuming). A zero SQI value can also be associated with a fault condition. See table 15-20 on page 266 for a list of finger cuff faults and alerts.



Table 11-1 Arterial waveform SQI levels

Appearance	Level	Indication
	4	Normal
	3	Intermediate (moderately compromised)
	2	Poor (possible alert status causing limited signal)
	1	Unacceptable (possible alert status causing extremely limited or no signal; see table 15-20 on page 266 for a list of finger cuff alerts)
	0	Pressure waveform unavailable See table 15-20 on page 266 for a list of finger cuff faults

11.5 Physioical Display

Physioical is an automatic calibration of the arterial waveform which occurs at regular intervals during noninvasive monitoring. Physioical can be observed on the live pressure waveform display as a stepwise increase in pressure upon startup and as brief interruptions throughout monitoring. The interval between Physioicals is displayed on the arterial waveform graph in parenthesis next to the Physioical interval icon (see table 11-2). To accurately account for changes in the finger artery characteristics throughout monitoring, Physioical is performed at regular intervals resulting in momentary interruptions to the arterial waveform.

Table 11-2 Physioical Interval Status

Appearance	Physioical beats interval	Indication
	≥30	Normal measurement stability
	<30	Frequent Physioical interruptions; variable physiological artery properties and decreased measurement stability
	--	Physioical being performed or status not available

11.6 ClearSight Settings and Cuff Options

The ClearSight settings screen allows the user to select the time interval between cuff pressure release and the switching time interval for double cuff monitoring. This screen also displays sensor status and information for connected finger cuff(s) and HRS.

NOTE Allow for at least 10 minutes of monitoring before reviewing sensor status information.

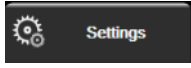
- 1 Touch settings icon  → **Settings** tab  → **ClearSight** button.
- 2 Touch the **Options** tab to view monitoring settings. All selection options on this settings screen are not available during active monitoring or during cuff pressure release mode.

Single Cuff. For single cuff monitoring, select a cuff pressure release time interval from the available option list. At the end of the cuff pressure time release interval, the pressure will be released from the cuff for a duration indicated by the countdown timer on the information bar. See *Cuff Pressure Release Mode* on page 188.

Double Cuff. For double cuff monitoring, select a switching time interval from the available option list.

Optional HRS. The optional heart reference sensor (HRS) feature can be **enabled** or **disabled** from this toggle button. This menu option is an advanced feature and must be enabled. If the **Optional HRS** feature is enabled, the user has the option of manually entering a vertical offset value between the hand and heart instead of using an HRS. See *Optional HRS* on page 184.

- 3 Touch the **Finger Cuff** tab to view connected finger cuff(s) status and information.
- 4 Touch the **HRS** tab to view connected HRS status and information.

11.6.1 Cuff Pressure Release Mode

During single cuff monitoring, the HemoSphere noninvasive system will automatically release pressure from the finger cuff at regular intervals.

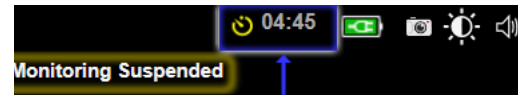

 When ≤ 5 minutes remain until **Cuff Pressure Release Mode**, a white countdown timer icon will appear on the information bar along with the time remaining until pressure release. A notification pop up will indicate that the countdown clock has been initiated. The user has the option to extend the countdown time until cuff pressure release by touching **Postpone** on the notification popup. Continuous monitoring will not be extended beyond the 8 hour continuous monitoring limit on a single finger. Refer to *Single Cuff Monitoring* on page 176 and *Double Cuff Monitoring* on page 177.

 At the end of the cuff pressure time release interval, pressure will be released from the cuff and monitoring will be temporarily suspended. A notification will appear on the screen to indicate that finger cuff pressure has been released. The cuff pressure release icon will appear yellow and the timer will indicate time until monitoring is automatically resumed.

 During **Cuff Pressure Release Mode**, a countdown clock appears on the navigation bar. A **Pressure Release Active** popup menu will appear on the screen. This menu can also be accessed by touching the navigation or information bar countdown clocks. Menu options on this popup include: **Postpone Release** and **Stop Monitoring**.

NOTE Cuff pressure release intervals can only be changed when monitoring is stopped. Avoid frequent changes to cuff release intervals during a patient monitoring session.



11.7 Blood Pressure Calibration

The **BP Calibration** screen allows the user to calibrate ClearSight finger cuff monitored blood pressure values with reference blood pressure monitored values.

NOTE Do not perform a BP Calibration until at least one minute of monitoring has been completed.

BP Calibration is not available during double cuff monitoring.

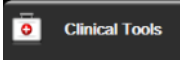
CAUTION Do not perform a BP calibration during monitoring periods when blood pressure appears unstable. This may result in inaccurate blood pressure measurements.

- 1 Touch the settings icon  → **Clinical Tools** tab  → **Calibration** icon .
- 2 Touch **Add Measurement** to enter the reference BP values.

NOTE Once the **Add Measurement** button is touched, the current ClearSight BP values are displayed and the user has five minutes to enter reference BP values. If more than five minutes are needed, the **Add Measurement** button can be touched again to reset the five minute timer.

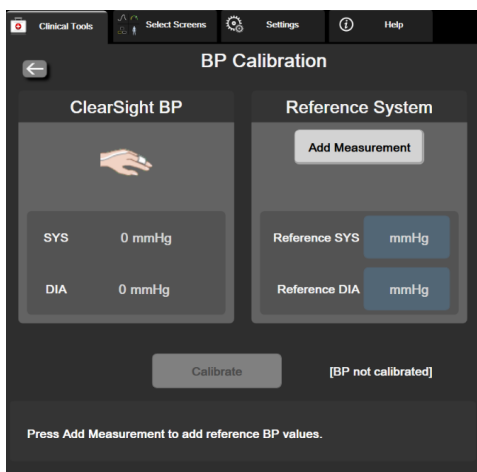



Figure 11-7 BP Calibration Screen

- 3 Enter a **Reference SYS** and **Reference DIA** value.
- 4 Touch **Calibrate** to complete the calibration process. The abbreviation of calibration (**CAL**) will appear above the parameter name on the BP tile to indicate that ClearSight BP has been calibrated.
- 5 To clear the last entered BP reference values, touch **Clear BP Calibration**.

NOTE The current **BP calibration** will be cleared if monitoring is paused for more than 10 minutes.

11.8 Output Signal to Patient Monitor

The **Zero & Waveform** screen provides the user with the option to send the arterial waveform signal to a bedside patient monitor.

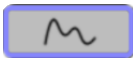
- 1 Touch the **Zero & Waveform** icon  located on the navigation bar or through the Clinical Tools menu.
- 2 Plug the HemoSphere pressure-out cable into the rear panel of the monitor at the pressure out port. See ③ in figure 3-2 on page 61.
- 3 Connect the arterial pressure (AP, red) pressure signal plug into a compatible patient monitor. Ensure that the selected connector is fully engaged. Refer to the patient monitor instructions for use.
- 4 Touch the **Patient Monitor** tab on the **Zero & Waveform** screen.
- 5 Zero patient monitor and confirm 0 mmHg is displayed. Touch **Confirm**. See ① in figure 11-8.
- 6 Touch the **Transmit Waveform** icon  to begin pressure signal output to the patient monitor. See ② in figure 11-8.
- 7 A “**Setup Complete**” message will be displayed when the live waveform is being transmitted to the connected patient monitor. See ③ in figure 11-8.

NOTE Normal interruptions to arterial waveform monitoring, such as during PhysioCal, cuff switching, or cuff pressure release mode, can trigger an alert on the patient monitor.

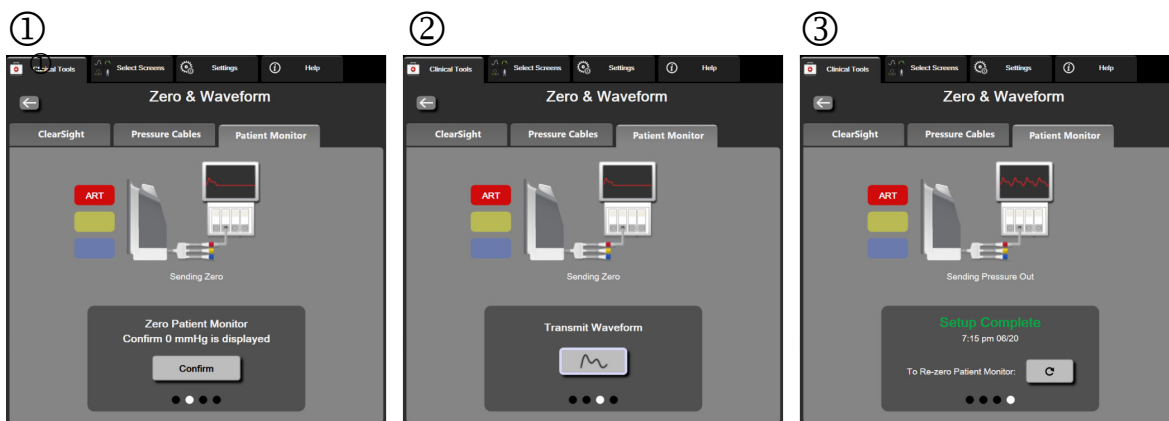

Figure 11-8 Transmit arterial pressure waveform to patient monitor

Venous Oximetry Monitoring

Contents

Oximetry Cable Overview	191
Venous Oximetry Setup	191
In Vitro Calibration	193
In Vivo Calibration	194
Signal Quality Indicator	195
Recall Venous Oximetry Data	196
HGB Update	197
HemoSphere Oximetry Cable Reset	198
New Catheter	198

12.1 Oximetry Cable Overview

The HemoSphere oximetry cable is a reusable device that connects with HemoSphere advanced monitor on one end and any approved Edwards oximetry catheter on the other end. The HemoSphere oximetry cable is a non-contact device and should not touch the patient during normal use. The oximetry cable continuously measures venous oxygen saturation by reflectance spectrophotometry. LEDs within the oximetry cable transmit light fiber optically to the distal end of the catheter. The amount of light absorbed, refracted, and reflected depends on the relative amounts of oxygenated and deoxygenated hemoglobin in the blood. This optical intensity data is gathered by the oximetry catheter, processed by the HemoSphere oximetry cable and displayed on a compatible monitoring platform. Parameter output is mixed venous oxygen saturation (SvO₂) or central venous oxygen saturation (ScvO₂).

12.2 Venous Oximetry Setup

Refer to the directions for use provided with each catheter for specific instructions on catheter placement and use, and for relevant warnings, cautions and notes.

Precaution. Unwind the cable carefully while removing it from its packed configuration. Do not pull at the cable to uncoil it. Check that the enclosure door at catheter connection point of the oximetry cable moves freely and latches properly. Do not use the oximetry cable if the door is damaged, open, or missing. If the door becomes damaged, contact Edwards technical support.

The HemoSphere oximetry cable must be calibrated before monitoring. For information on tissue oximetry monitoring, see *HemoSphere Tissue Oximetry Module Monitoring* on page 199.

- 1 Connect the HemoSphere oximetry cable to the HemoSphere advanced monitor. The following message will appear:
Oximetry Cable Initializing, Please Wait
- 2 If the HemoSphere advanced monitor is not on, turn on the power switch and follow steps for entering patient data. See *Patient Data* on page 120.
- 3 Remove a section of the catheter tray lid to expose the optical connector.
- 4 Insert the optical connector of the catheter “TOP” side up into the oximetry cable and snap the enclosure shut.

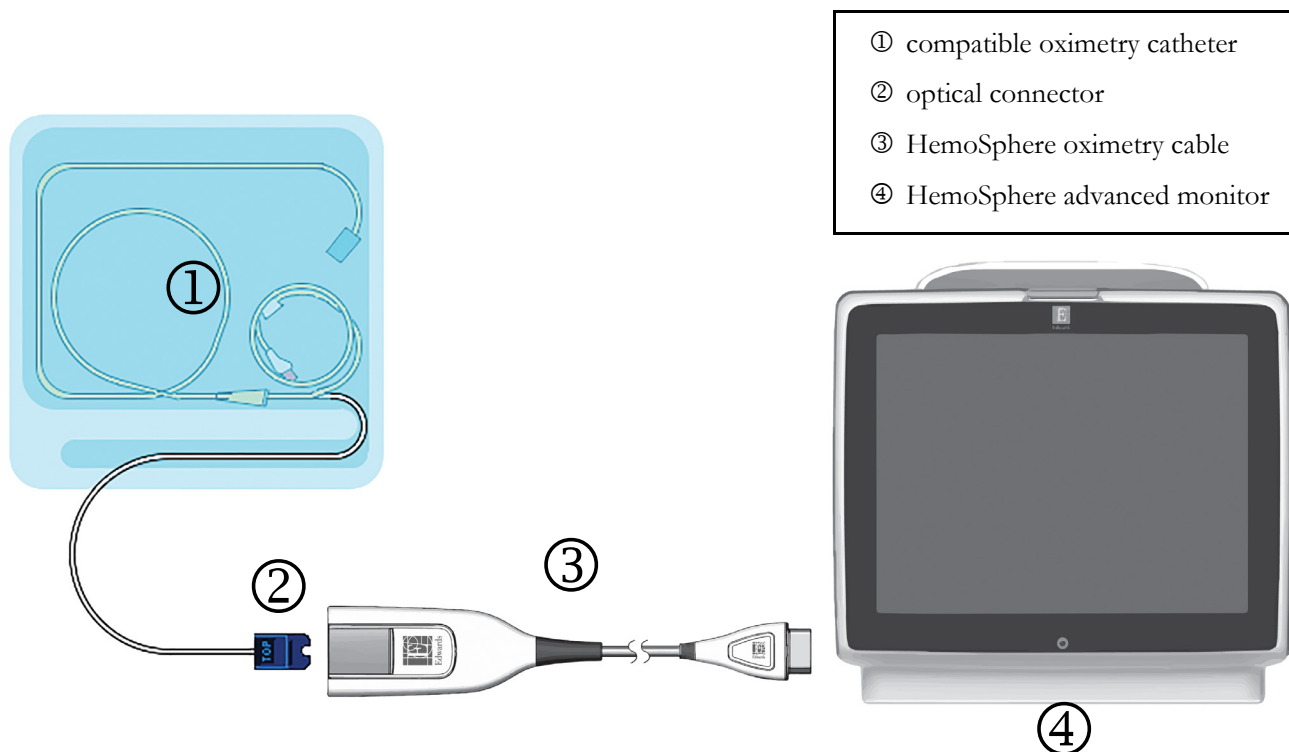

Figure 12-1 Venous oximetry connection overview

NOTE Appearance of catheter shown in figure 12-1 is for example only. Actual appearance may vary depending on catheter model.

When unplugging the HemoSphere oximetry cable from the HemoSphere advanced monitor or catheters from the oximetry cable, always pull at the connection site. Do not pull from cables or use tools to disconnect.

Pulmonary artery and central venous catheters are TYPE CF defibrillation proof APPLIED PARTS. Patient cables that attach to the catheter, such as the HemoSphere oximetry cable, are not intended to be applied parts but may come into contact with the patient and meet the relevant applied part requirements per IEC 60601-1.

CAUTION Make sure that the oximetry cable is securely stabilized to prevent unnecessary movement of the attached catheter.

WARNING Compliance to IEC 60601-1 is only maintained when the HemoSphere oximetry cable (applied part accessory, defibrillation proof) is connected to a compatible monitoring platform. Connecting external equipment or configuring the system in a way not described in these instructions will not meet this standard. Failure to use the device as instructed may increase the risk of electrical shock to the patient/operator.

Do not wrap the main body of the oximetry cable in fabric or place directly on the patient's skin. The surface does get warm (up to 45 °C) and needs to dissipate heat to maintain its internal temperature level. A software fault will trigger if the internal temperature exceeds its limits.

Do not modify, service or alter the product in any way. Servicing, alteration or modification may affect patient/operator safety and/or product performance.





12.3 In Vitro Calibration

In vitro calibration is performed before the catheter is inserted into the patient, using the calibration cup provided in the catheter packaging.

NOTE Once an oximetry cable has been in vitro or in vivo calibrated, faults or alerts can be generated if monitoring venous oximetry without a connected patient catheter.

CAUTION The catheter tip or calibration cup must not get wet before an in vitro calibration is performed. The catheter and the calibration cup must be dry for an accurate oximetry in vitro calibration. Flush the catheter lumen only after the in vitro calibration has been completed.

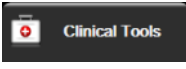
Performing an in vitro calibration after the oximetry catheter has been inserted into the patient will yield an inaccurate calibration.

- 1 Touch the oximetry calibration icon  on the **ScvO₂/SvO₂** parameter tile or, touch the settings icon  → **Clinical Tools** tab  → **Venous Oximetry Calibration** icon .
- 2 At the top of the **Oximetry Calibration** screen, select oximetry type: **ScvO₂** or **SvO₂**.
- 3 Touch **In vitro Calibration** button.

- 4 On the **In vitro Calibration** screen, enter either the patient's hemoglobin (**HGB**) or hematocrit (**Hct**). Hemoglobin may be entered in either g/dL or mmol/L on the keypad. See table 12-1 for acceptable ranges.

Table 12-1 In vitro calibration options

Option	Description	Selection range
HGB (g/dL)	Hemoglobin	4.0 to 20.0
HGB (mmol/L)		2.5 to 12.4
Hct (%)	Hematocrit	12 to 60

- 5 Touch **Calibrate** button to start the calibration process.
- 6 When the calibration successfully completes, the following message appears:
In vitro Calibration OK, insert catheter
- 7 Insert the catheter as described in the catheter instructions for use.
- 8 Touch **Start** button. The oximetry calibration icon  appears gray after successful calibration.

12.3.1 In Vitro Calibration Error

If the HemoSphere advanced monitor is unable to perform an in vitro calibration, an error popup screen appears.

Touch **In vitro Calibration** button to repeat the oximetry calibration process.

OR

Touch **Cancel** button to return to the **Venous Oximetry Calibration** menu.





12.4 In Vivo Calibration

Use in vivo calibration to perform a calibration after the catheter has been inserted into the patient.

NOTE This process requires approved personnel to draw waste blood (clearing volume) and a blood sample for laboratory processing. A measured oximetry value must be obtained from a co-oximeter.

For optimal accuracy, in vivo calibration should be performed at least every 24 hours.

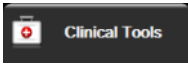
Signal quality is displayed during in vivo calibration. It is recommended that calibration be performed only when the SQI level is 1 or 2. See *Signal Quality Indicator* on page 195.

- 1 Touch the oximetry calibration icon  on the **ScvO₂/SvO₂** parameter tile or, touch the settings icon  → **Clinical Tools** tab 
→ **Venous Oximetry Calibration** icon .
- 2 At the top of the **Oximetry Calibration** screen, select oximetry type: **ScvO₂** or **SvO₂**.

3 Touch **In vivo Calibration** button.

If setup is unsuccessful, one of the following messages will be displayed:

Warning: Wall Artifact or Wedge Detected. Reposition catheter.

OR

Warning: Unstable Signal.

4 If a “Wall Artifact or Wedge Detected,” or “Unstable Signal” message appears, attempt to troubleshoot the problem as instructed in table 15-24, “Venous oximetry warnings,” on page 273 and touch **Recalibrate** button to restart the baseline setup.

OR

Touch **Continue** button to proceed to the draw operation.

- 5 When baseline calibration is successful, touch **Draw** button and then draw the blood sample.
- 6 Draw the blood sample slowly (2 mL or 2 cc over 30 seconds) and send the blood sample to the lab for measured analysis by co-oximeter.
- 7 When lab values are received, touch **HGB** button to enter the patient’s hemoglobin and touch g/dL or mmol/L or **Hct** button to enter the patient’s hematocrit. See table 12-2 for acceptable ranges.

Table 12-2 In vivo calibration options

Option	Description	Selection range
HGB (g/dL)	Hemoglobin	4.0 to 20.0
HGB (mmol/L)		2.5 to 12.4
Hct (%)	Hematocrit	12 to 60

NOTE When an HGB or Hct value is entered, the system automatically calculates the other value. If both values are selected, the last value entered is accepted.

- 8 Enter the lab oximetry value (**ScvO₂** or **SvO₂**).
- 9 Touch **Calibrate** button. The oximetry calibration icon  appears gray after successful calibration.

12.5 Signal Quality Indicator



Signal quality indicator (SQI) is a reflection of the signal quality based on the catheter condition and position within the vessel. While measuring tissue oximetry, the signal quality is based on the amount of near-infrared light tissue perfusion. The SQI bar boxes fill based on the level of oximetry signal quality. The SQI level is updated every two seconds after oximetry calibration is complete and will display one of four signal levels as described in table 12-3.

Table 12-3 Signal quality indicator levels

Level	Bars filled	Description
4 - Normal	four	All aspects of the signal are optimal
3 - Intermediate	three	Indicates a moderately compromised signal

Table 12-3 Signal quality indicator levels (continued)

Level	Bars filled	Description
2 - Poor	two	Indicates poor signal quality
1 - Unacceptable	one	Indicates a severe problem with one or more aspects of signal quality

Signal quality may be compromised by the following during intravascular oximetry:

- Pulsatility (for example, the catheter tip is wedged)
- Signal Intensity (for example, the catheter is kinked, a blood clot, hemodilution)
- Intermittent vessel wall contact by the catheter





Signal quality is displayed during in vivo calibration and HGB update functions. It is recommended that calibration be performed only when the SQI level is 3 or 4. When SQI is 1 or 2, see *Venous Oximetry Error Messages* on page 272 to determine and resolve the issue.

CAUTION The SQI signal is sometimes affected by the use of electrosurgical units. Attempt to distance electrocautery equipment and cables from the HemoSphere advanced monitor and plug the power cords into separate AC circuits if possible. If signal quality problems persist, call your local Edwards representative for assistance.

12.6 Recall Venous Oximetry Data

Recall Venous Oximetry Data can be used to recall data from the oximetry cable after a patient has been transported away from the HemoSphere advanced monitor. This allows the patients last calibration to be recalled along with the patients demographic data for immediate oximetry monitoring. Calibration data within the oximetry cable must be less than 24 hours old to use this function.

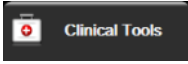
NOTE If patient data has already been entered into the HemoSphere advanced monitor, only system calibration information is recalled. The HemoSphere oximetry cable is updated with current patient data.



- 1 With the catheter connected to the HemoSphere oximetry cable, unplug the cable from the HemoSphere advanced monitor and transport it with the patient. The catheter should not be disconnected from the oximetry cable.
- 2 If the oximetry cable is being connected to another HemoSphere advanced monitor, make sure that previous patient data is cleared.
- 3 Once the patient has been transferred, reconnect the oximetry cable to the HemoSphere advanced monitor and turn it on.
- 4 Touch the gray oximetry calibration icon  on the **ScvO₂/SvO₂** parameter tile or, touch the settings icon  → **Clinical Tools** tab  → **Venous Oximetry Calibration** icon .

- 5 Touch **Recall Venous Oximetry Data** button.
- 6 If the oximetry cable data is less than 24 hours old, touch **Yes** button to start oximetry monitoring using the recalled calibration information.
OR
Touch **No** button and perform an in vivo calibration.

WARNING Before touching **Yes** to recall oximetry data, confirm that the displayed data matches the current patient. Recalling incorrect oximetry calibration data and patient demographics will result in inaccurate measurements.

CAUTION Do not disconnect the oximetry cable while calibration or data recall are in process.

- 7 From the oximetry calibration menu, touch **In vivo Calibration** button to recalibrate the cable. To review patient data that was transported with the oximetry cable, touch the settings icon 

→ **Clinical Tools** tab  **Clinical Tools** → **Patient Data** icon 

CAUTION If the oximetry cable is being transferred from a HemoSphere advanced monitor to another HemoSphere advanced monitor, check that the patient height, weight, and BSA are correct prior to beginning monitoring. Re-enter patient data, if necessary.





NOTE Keep the time and date of all HemoSphere advanced monitors current. If the date and/or time of the HemoSphere advanced monitor being transported “from” differs from the HemoSphere advanced monitor being transported “to” the following message may appear:

“Patient data in oximetry cable more than 24 hours old - Recalibrate.”

If the system needs to be recalibrated, a 10 minute warm up period for the oximetry cable may be required.

12.7 HGB Update

Use the **HGB Update** option to adjust the HGB or Hct value of a previous calibration. The update function can be used only if a previous calibration has been performed, or if the calibration data has been recalled from the oximetry cable.

- 1 Touch the gray oximetry calibration icon  on the **ScvO₂/SvO₂** parameter tile or, touch settings icon  → **Clinical Tools** tab  **Clinical Tools**
→ **Venous Oximetry Calibration** icon 
- 2 Touch **HGB Update** button.





- 3 You can use the displayed HGB and Hct values or touch **HGB** or **Hct** buttons to enter a new value.
- 4 Touch **Calibrate** button.
- 5 To stop the calibration process, touch the cancel icon .

NOTE To achieve optimal accuracy, we recommended you update the HGB and Hct values when there is a change of 6% or greater in Hct or of 1.8 g/dL (1.1 mmol/L) or greater in HGB. A change in hemoglobin may also affect SQI. Use **HGB Update** to resolve signal quality problems.

12.8 HemoSphere Oximetry Cable Reset



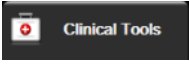

Use HemoSphere oximetry cable reset when the SQI level is continuously low. An oximetry cable reset may stabilize the signal quality. It should be performed only after attempting other actions to resolve the high SQI as defined in Troubleshooting.

NOTE The HemoSphere advanced monitor will not permit an oximetry cable reset before performing a calibration or recalling calibration from the oximetry cable.

- 1 Touch the gray oximetry calibration icon  on the **ScvO₂/SvO₂** parameter tile or, touch settings icon  → **Clinical Tools** tab  → **Venous Oximetry Calibration** icon .
- 2 Touch **Oximetry Cable Reset** button.
- 3 A progress bar will appear. Do not disconnect the oximetry cable.

12.9 New Catheter

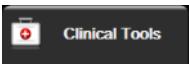
Use the **New Catheter** option any time a new catheter is used for a patient. After **New Catheter** is confirmed, oximetry must be re-calibrated. Refer to the directions for use provided with each catheter for specific instructions on catheter placement, calibration type, and use, and for relevant warnings, cautions and notes.

- 1 Touch the gray oximetry calibration icon  on the **ScvO₂/SvO₂** parameter tile or, touch settings icon  → **Clinical Tools** tab  → **Venous Oximetry Calibration** icon .
- 2 Touch **New Catheter** button.
- 3 Touch **Yes** button.

HemoSphere Tissue Oximetry Module Monitoring

Contents

HemoSphere Tissue Oximetry Module Monitoring	199
ForeSight Elite Tissue Oximeter Overview	200
Connecting the HemoSphere Tissue Oximetry Module and ForeSight Elite Module	205

13.1 HemoSphere Tissue Oximetry Module Monitoring

The HemoSphere tissue oximetry module is an interface module intended to be used with the ForeSight Elite tissue oximeter module to display continuous monitoring of blood oxygen saturation in the tissue (StO₂). The ForeSight Elite tissue oximeter module is a noninvasive device that measures absolute tissue oxygen saturation. It operates on the principle that blood contains hemoglobin in two primary forms – oxygenated hemoglobin (HbO₂) and de-oxygenated hemoglobin (Hb) – which absorb near-infrared light in different, measurable ways.

Tissue oxygen saturation (StO₂) levels are determined by the ratio of oxygenated hemoglobin to total hemoglobin at the microvascular level (arterioles, venules, and capillaries) in the region to which the sensor is applied:

$$\%StO_2 = \frac{\text{Oxygenated Hemoglobin}}{\text{Total Hemoglobin}} = \frac{HbO_2}{HbO_2 + Hb} \times 100$$

The ForeSight Elite module incorporates Edwards technology to project harmless near-infrared light (in five precise wavelengths) through the overlying tissue (e.g. scalp and skull) and into the underlying tissue (e.g. brain) via a disposable sensor on the patient's skin. Reflected light is captured by detectors positioned on the sensor for optimal signal collection. After analyzing the reflected light, the module provides the tissue oxygen saturation level to the HemoSphere tissue oximetry module and advanced monitor as an absolute number and provides a graphical representation of historical values.

A pulse oximeter only reflects arterial blood oxygen saturation (SpO₂) and requires pulsations to operate; whereas the ForeSight Elite module measures even in pulseless conditions and displays the balance of oxygen supply and demand in a target tissue (StO₂), e.g., brain, abdomen, limb muscle. Thus, HemoSphere advanced monitor StO₂ values indicate overall tissue oxygenation state, which provides direct feedback for guiding care interventions.

13.2 ForeSight Elite Tissue Oximeter Overview

The following diagrams provide an overview of the ForeSight Elite module’s physical features.

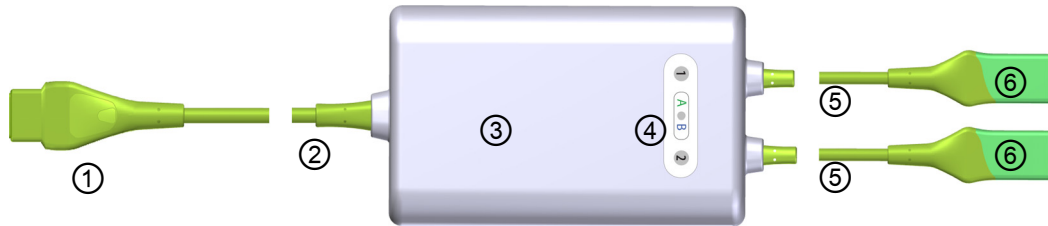

Figure 13-1 ForeSight Elite tissue oximeter front view

- | | | |
|------------------|---------------|---------------------|
| ① host connector | ③ module case | ⑤ sensor cables |
| ② host cable | ④ LED display | ⑥ sensor connectors |

NOTE The tissue oximetry module and sensor cables are shown cut; see table A-17 on page 288. For a description of LED status indicators, see *ForeSight Elite Module Sensor Communication* on page 249.

CAUTION Avoid placing the ForeSight Elite module where the status LED cannot be easily seen.

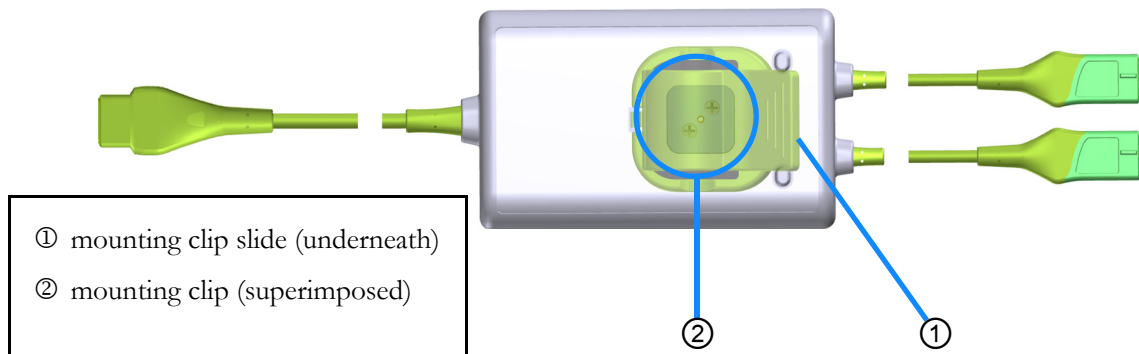

Figure 13-2 ForeSight Elite tissue oximeter rear view

NOTE Images of case rear view in this manual are shown without labeling for clarity.

13.2.1 ForeSight Elite Module Mounting Solutions

The ForeSight Elite tissue oximeter module is packaged with a mounting clip.

Figure 13-3 and figure 13-4 identify attachment points on the mounting clip and module case.

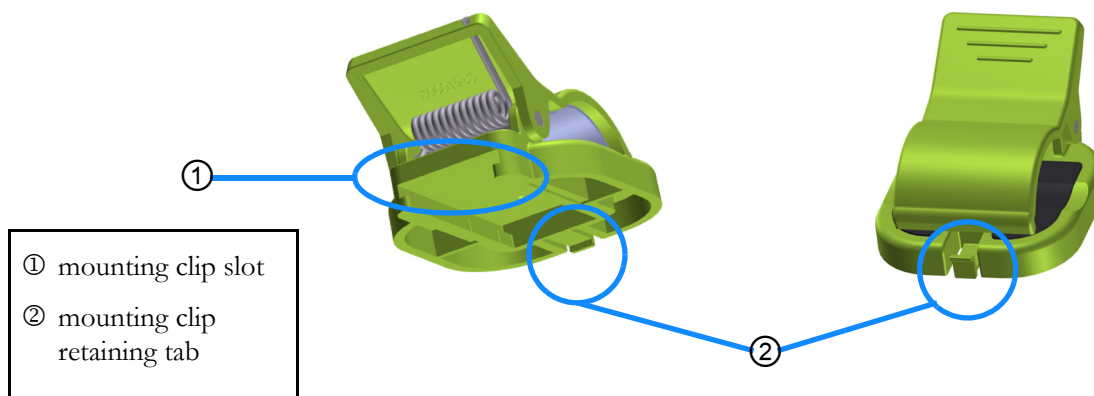

Figure 13-3 Mounting clip – module slide attachment points

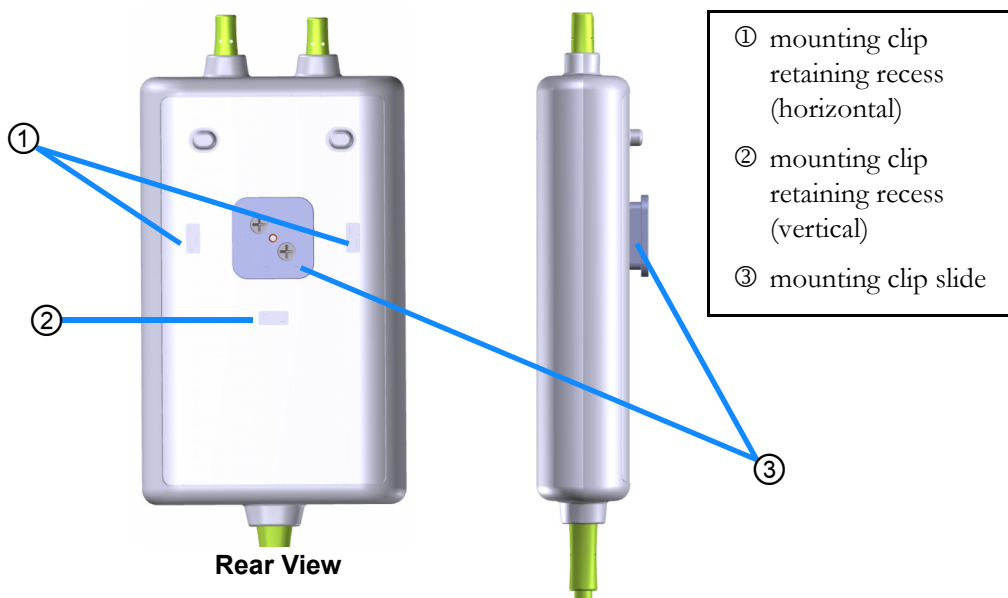

Figure 13-4 Module case – mounting clip attachment points

13.2.2 Installing the Mounting Clip

The mounting clip can be attached to the ForeSight Elite module either vertically (typical for a bed rail – see figure 13-5) or horizontally (typical for a pole mount – see figure 13-6).

To attach the mounting clip vertically:

- 1 On the rear of the module, position the mounting clip with the slot facing the mounting clip slide.
- 2 Slide the mounting clip towards the top of the module, until the mounting clip retaining tab locks in to the vertical mounting clip retaining recess.

NOTE The mounting clip is not designed to be attached with the opening facing up.

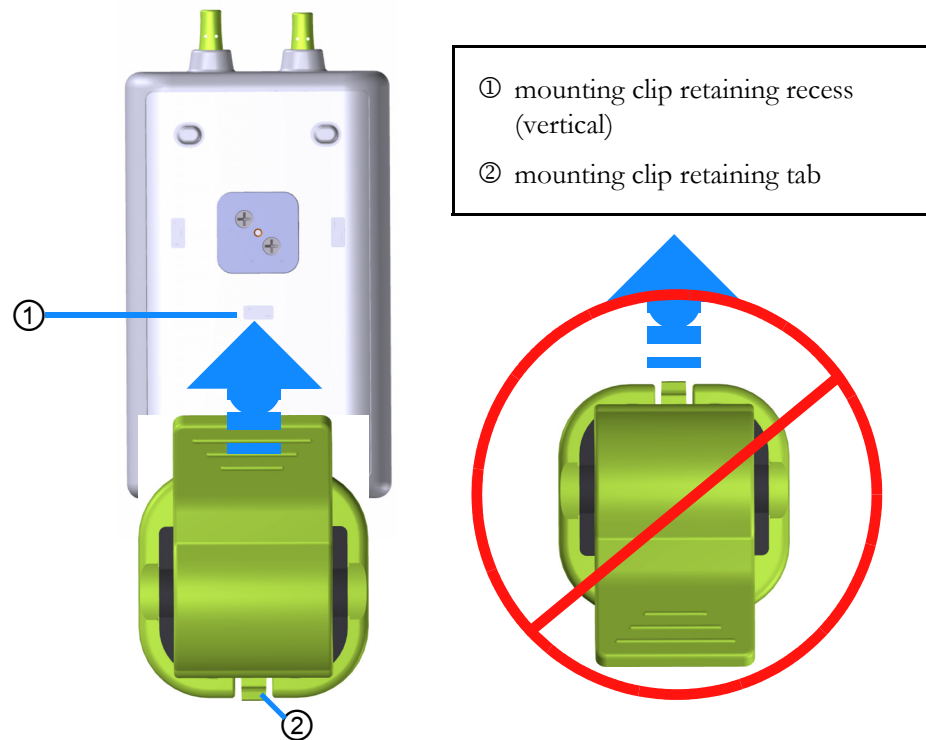

Figure 13-5 Attaching the mounting clip vertically

To attach the mounting clip horizontally:

- 1** Position the mounting clip with the mounting clip retaining tab facing away from the module, from either the left or right.
- 2** Slide the mounting clip across the rear of the module, until the mounting clip retaining tab locks in to the one of horizontal mounting clip retaining recesses.

NOTE You may attach the mounting clip with the opening facing the left or right side.

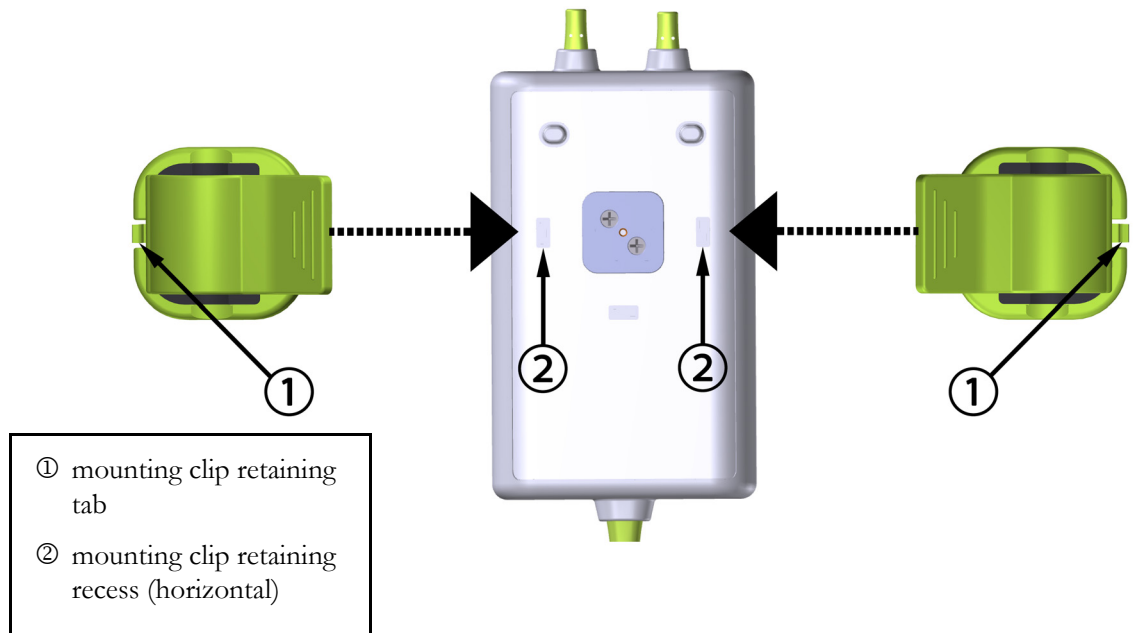

Figure 13-6 Attaching the mounting clip horizontally

13.2.3 Removing the Mounting Clip

To remove the mounting clip from the rear of the module (see figure 13-7 on page 204):

- 1 Gently lift the mounting clip retaining tab until it disengages from its recess.

CAUTION Applying too much pressure may break the retaining tab, which may present a risk of the module falling on the patient, bystander, or operator.

NOTE For information on replacement parts, technical support numbers are located on inside cover. See table B-1 on page 291 for approved parts and accessories.

- 2 Slide the mounting clip in the direction of the mounting clip retaining tab until the mounting clip is free from the mounting clip slide.

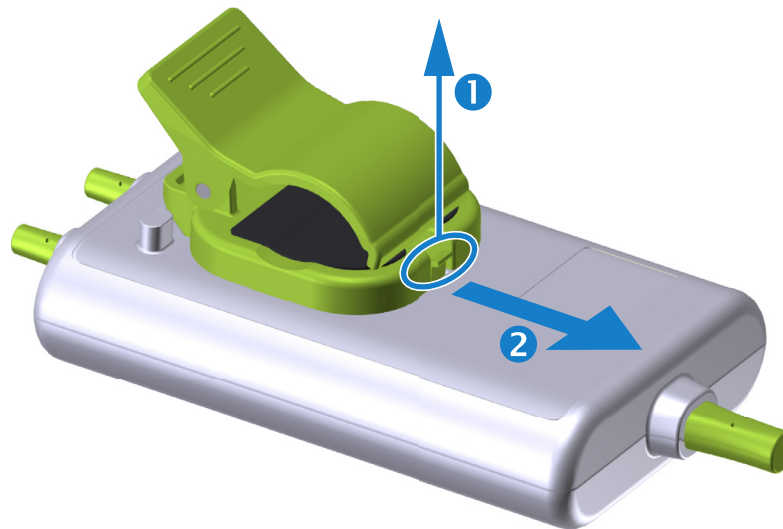

Figure 13-7 Removing the mounting clip

- 3 Remove the mounting clip from the rear of the module.

CAUTION Do not lift or pull the ForeSight Elite module by any cable, or place the module in any position that might present a risk that the module may fall on the patient, bystander or operator.

Avoid placing the ForeSight Elite module under sheets, or blanket that could restrict air flow around the module that may increase the module's case temperature and present an injury.

13.3 Connecting the HemoSphere Tissue Oximetry Module and ForeSight Elite Module

The HemoSphere tissue oximetry module is compatible with a ForeSight Elite tissue oximeter module and ForeSight Elite tissue oximetry sensors. The HemoSphere tissue oximetry module fits into a standard module slot.

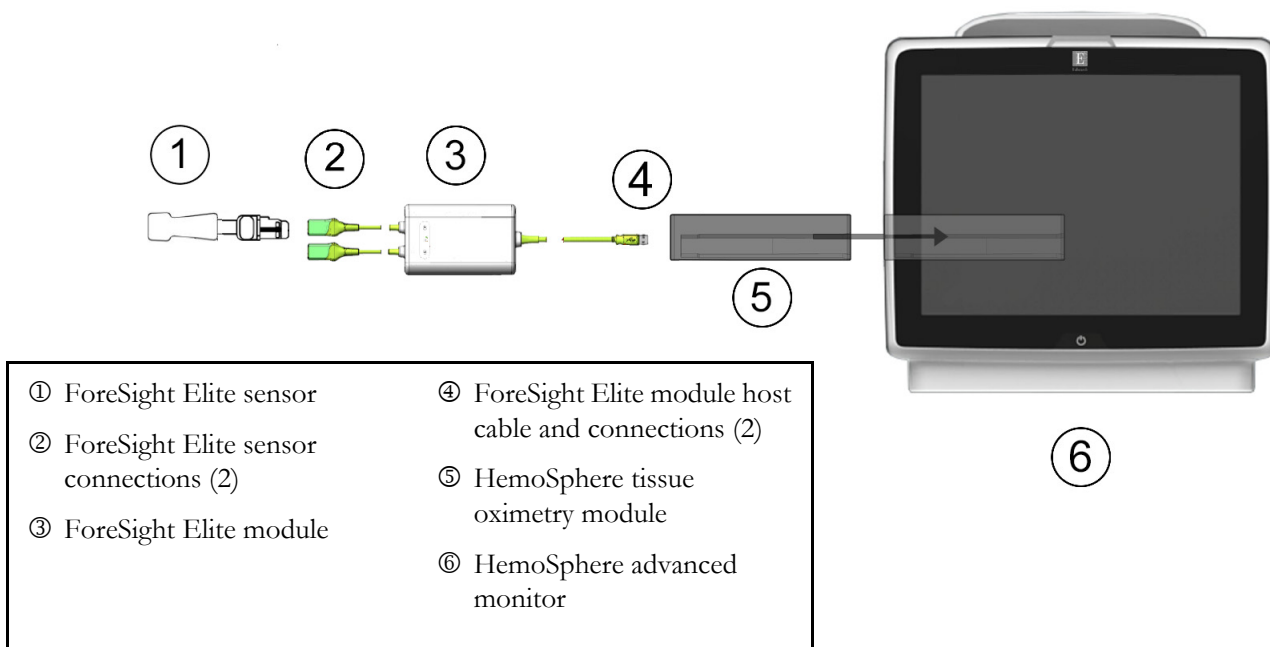

Figure 13-8 HemoSphere tissue oximetry module connection overview

NOTE ForeSight Elite sensors are TYPE BF defibrillation proof APPLIED PARTS. Patient cables that attach to the sensors, such as the ForeSight Elite module, are not intended to be applied parts but may come into contact with the patient and meet the relevant applied part requirements per IEC 60601-1.

The ForeSight Elite module can remain connected to the patient during cardiac defibrillation.

The tissue oximetry module is shipped with ESD covers for the ForeSight Elite module connection ports. After removing them when using the system for the first time, it is recommended that they be kept and used to protect the electrical connection points when the ports are not in use.

WARNING Compliance to IEC 60601-1 is only maintained when the HemoSphere tissue oximetry module (applied part connection, defibrillation proof) is connected to a compatible monitoring platform. Connecting external equipment or configuring the system in a way not described in these instructions will not meet this standard. Failure to use the device as instructed may increase the risk of electrical shock to the patient/operator.

Inspect all of the ForeSight Elite module cable for damage prior to installation. If any damage is noted, the module must not be used until it has been serviced or replaced. Contact Edwards Technical support. There is a risk that damaged parts could reduce the performance of the module or present a safety hazard.

To remove any chance of contamination between patients, the ForeSight Elite module and cables should be cleaned after each case.

To reduce the risk of contamination and cross infection, if the module or cables are grossly contaminated, with blood or other bodily fluids, it should be disinfected. If the ForeSight Elite module or cables cannot be disinfected, it should be serviced, replaced or discarded. Contact Edwards Technical support.

To reduce the risk of damaging internal elements of the cables assemblies, within the ForeSight Elite module, avoid excessive pulling, bending or other types of stress on the module's cables.

Do not modify, service or alter the product in any way. Servicing, alteration or modification may affect patient/operator safety and/or product performance

CAUTION Do not force the module into the slot. Apply even pressure to slide and click the module into place.

- 1 Press the power button to turn on the HemoSphere advanced monitor. All functions are accessed through the touch screen.
- 2 Ensure proper orientation, then plug the ForeSight Elite module host cable into the tissue oximetry module. Up to two ForeSight Elite modules can be connected to each tissue oximetry module.

NOTE The host cable only connects one way. If at first the connection does not go in, rotate the connector and try inserting it again.

Do not pull on the ForeSight Elite module host communication cable when unplugging it from the HemoSphere tissue oximetry module. If it is necessary to remove the HemoSphere tissue oximetry module from the monitor, press the release button to unlatch and slide module out.

Once the host cable connection has been made, the channel 1 and channel 2 status LEDs should turn on. The group status LED will also turn on, indicating the module channels are group A (connected to port A on inserted tissue oximetry module) or group B (connected to port B on inserted tissue oximetry module).

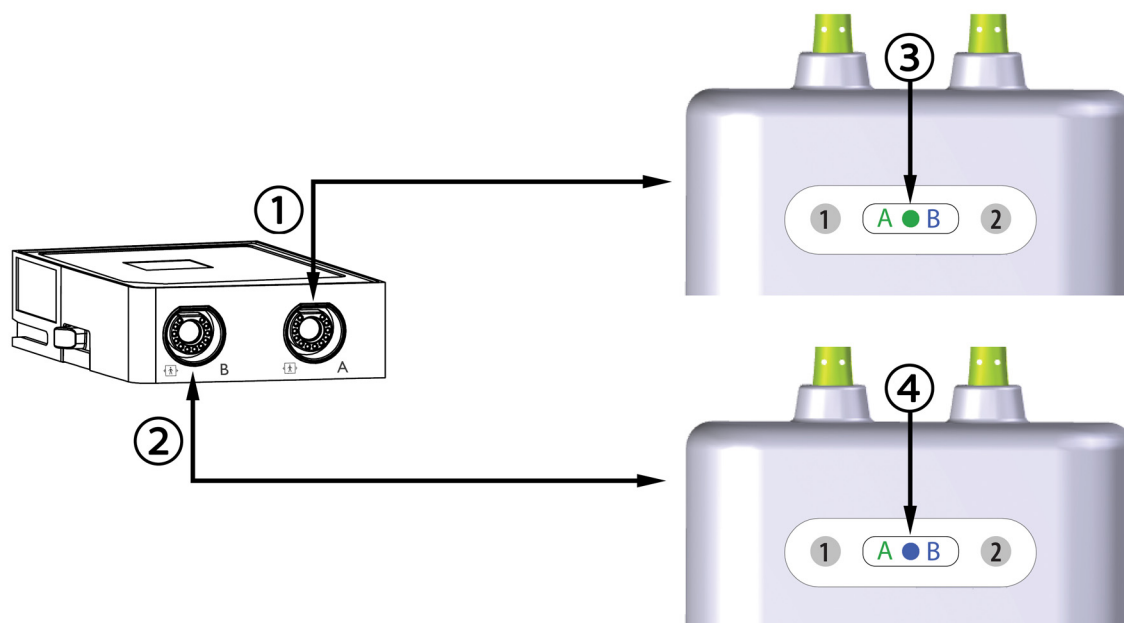















- | | |
|--|---|
| ① HemoSphere tissue oximetry module port A | ④ Blue module group status LED: Channels associated with port B on tissue oximetry module |
| ② HemoSphere tissue oximetry module port B | |
| ③ Green module group status LED: Channels associated with port A on tissue oximetry module | |

Figure 13-9 ForeSight Elite module status LED

- 3** Select **Continue Same Patient** button or **New Patient** button and enter new patient data.
- 4** Connect the compatible ForeSight Elite sensor(s) to the ForeSight Elite module. Up to two ForeSight Elite sensors can be connected to each ForeSight Elite module. Available sensor locations are listed in table 13-1. See *Attaching Sensors to the Patient* on page 209 and refer to the ForeSight Elite sensor instructions for use for proper sensor application directions.
- 5** Select the **Noninvasive**, **Invasive** or **Minimally-Invasive** monitoring mode button on the **Monitoring Mode Selection** window as applicable.

6 Touch **Start Monitoring**.



Table 13-1 Tissue oximetry sensor locations

Symbol (right)*	Symbol (left)*	Adult (≥40 kg) anatomical location* (sensor size) 	Pediatric (<40 kg) anatomical location* (sensor size) 
		brain (large)	brain (medium/small)
		shoulder (large)	n/a
		arm (large)	n/a
		flank/abdomen (large)	flank/abdomen (medium/small)
		n/a	abdomen (medium/small)
		leg – quadriceps (large)	leg – quadriceps (medium)
		leg – calf (gastrocnemius or tibialis, large)	leg – calf (gastrocnemius or tibialis, medium)
*Symbols are color coded based on ForeSight Elite module group channel: green for channel A and blue (shown) for channel B			

7 If **StO₂** is not a current key parameter, touch the displayed parameter label located inside of any parameter tile to select **StO₂ <Ch>** as a key parameter from the tile configuration menu, where <Ch> is the sensor channel. The channel options are **A1** and **A2** for ForeSight Elite module A and **B1** and **B2** for ForeSight Elite module B.

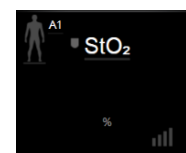
8 The channel will appear in the upper left corner of the parameter tile. Touch the patient figure  on the parameter tile to access the **Sensor Location** window.



9 Select the Patient monitoring mode: adult  or pediatric .

NOTE The sensor mode selection is automatically selected based on the patient’s entered body weight. Adult sensor mode is configured for any body weight ≥40 kg.

10 Select the anatomical location of the sensor. See table 13-1 for a list of available sensor locations. The sensor locations are color coded based on the HemoSphere tissue oximetry connection port:

- **Green:** Sensor locations for an ForeSight Elite module connected to port A on HemoSphere tissue oximetry module
- **Blue:** Sensor locations for an ForeSight Elite module connected to port B on HemoSphere tissue oximetry module

11 Touch the home icon  to return to the monitoring screen.

13.3.1 Attaching Sensors to the Patient

The following sections describe how to prepare the patient for monitoring. For additional information on how to apply a sensor to the patient, see the instructions included in the ForeSight Elite sensor packaging.

13.3.1.1 Selecting a Sensor Site

To ensure patient safety and proper data collection, consider the following items when selecting a sensor site.

WARNING Sensors are not sterile and therefore should not be applied on abraded, cracked, or lacerated skin. Exercise caution when applying sensors to a site with delicate skin. Applying sensors, tape or pressure to such a site may reduce circulation and/or cause skin deterioration.

Do not place sensor over poorly perfused tissues. Avoid uneven skin surfaces for best adhesion. Do not place sensor over sites with ascites, cellulitis, pneumoencephalus, or edema.

If electrocautery procedures will be performed, sensors and electrocautery electrodes should be placed as far apart as possible to prevent unwanted skin burns; a distance of at least 15 cm (6 in) is recommended.

CAUTION Sensors should not be placed on high density hair areas.

The sensor must be able to rest flush with clean, dry skin. Any debris, lotion, oil, powder, perspiration, or hair that prevents good contact between the sensor and the skin will affect the validity of the data collected and may result in an alarm message.

NOTE Skin pigmentation does not affect the validity of collected data. The ForeSight Elite module compensates automatically for skin pigmentation.

In the event that the location of the selected tissues cannot be palpated or visualized, confirmation by ultrasound or X-ray is recommended.

Table 13-2 provides sensor selection guidelines based on patient monitoring mode, patient weight, and body location.

Table 13-2 Sensor selection matrix

Patient Mode	Sensor	Weight	Body Location				
			Brain	Flank	Abdomen	Legs	Arms/ Deltoids
Adult	Large	≥ 40 kg	✓	✓		✓	✓
Pediatric	Medium	≥ 3 kg	✓	✓	✓	✓	

Table 13-2 Sensor selection matrix (continued)

Patient Mode	Sensor	Weight	Body Location				
			Brain	Flank	Abdomen	Legs	Arms/ Deltoids
Pediatric neonatal	Small	< 8 kg	✓				
		< 5 kg	✓	✓	✓		
Pediatric neonatal	Small, non-adhesive	< 8 kg	✓				
		< 5 kg	✓	✓	✓		

NOTE If you connect a sensor that is sized inappropriately for the current patient monitoring mode, that channel displays an alert on the status bar. If this is the only sensor connected, you may be prompted to switch modes (adult or pediatric).

If you connect a sensor that is sized inappropriately for the selected body location, that channel displays an alert on the status bar. If this is the only sensor connected, you may be prompted to select a different body location or use a different sensor size.

WARNING Use only Edwards supplied accessories with the ForeSight Elite module. Edwards accessories ensure patient safety and preserve the integrity, accuracy, and electromagnetic compatibility of the ForeSight Elite module. Connecting a non-Edwards sensor will cause an appropriate alert on that channel and no StO₂ values will be recorded.

Sensors are designed for single-patient use, and are not to be reprocessed – re-used sensors present a risk of cross-contamination or infection.

Use a new sensor for each patient and discard it after use. Disposal should follow in accordance with local hospital and institution policies.

If a sensor seems damaged in any way, it must not be used.

Always read the sensor packaging.

13.3.1.2 Preparing the Sensor Site

To prepare the patient's skin for sensor placement:

- 1 Verify that the skin area where the sensor is to be placed is clean, dry, intact, and free of powder, oil, or lotion.
- 2 If necessary, shave hair from skin at the chosen site.
- 3 Use an appropriate cleanser to gently clean the intended sensor site.
The large and medium sensor packages include an alcohol pad. Do not use the alcohol pad on newborn or fragile skin.
You may use Tegaderm or Mepitel under the sensor in patients with delicate skin or edema.
- 4 Allow the skin to dry completely before applying the sensors.

13.3.1.3 Applying Sensors

- 1 Select the appropriate sensor (see table 13-2 on page 209) and remove it from the package.
- 2 Remove and discard the protective liner from the sensor (figure 13-10).

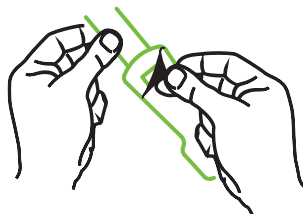

Figure 13-10 Removing protective liner from sensor

NOTE

When using the non-adhesive small sensor, you must size and cut the sensor band length to fit the patient.

- Shorten the sensor band away from the patient. Do not cut the sensor band while on the patient, and do not cut any other part of the sensor.
- Attach the sensor band to the patient with the print facing out.
- Do not over-tighten the sensor band, as pressure can be transferred to the baby.

- 3 Affix the sensor to the patient in the chosen location.

Cerebral Use (figure 13-11): Select the site on the forehead above the eyebrow and just below the hairline where the sensors will be linearly aligned.

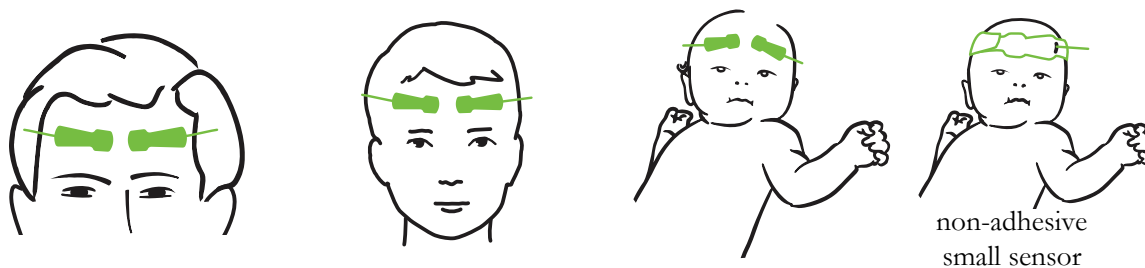

Figure 13-11 Sensor placement (cerebral)

Non-Cerebral Use (figure 13-12): Select the site that provides the ideal access to the desired skeletal muscle tissue (if muscle cannot be palpated, too much adipose or edema may be present).

- Arm: Position sensor over the deltoid (shoulder), biceps (upper arm), or brachioradialis muscle.
- Leg: Position sensor over the quadriceps (upper leg), gastrocnemius (calf), or tibialis (calf) muscle. Apply the sensor with the connector towards the feet.

- Flank/Abdomen: Position sensor over the Latissimus dorsi (flank) or external oblique (abdomen) muscle.

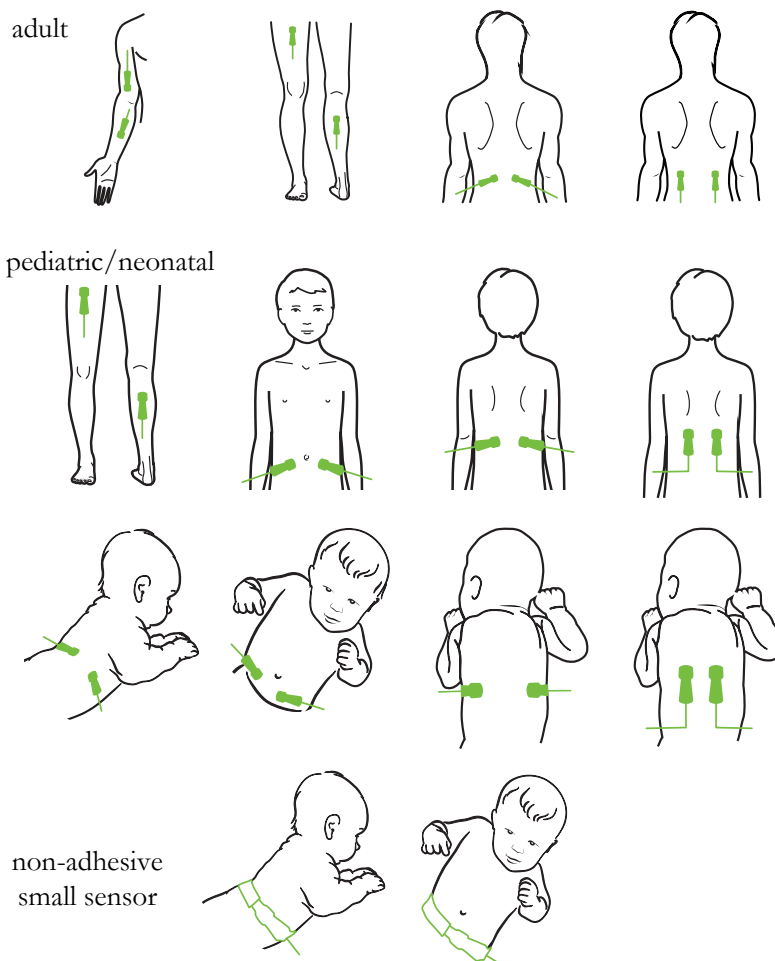

Figure 13-12 Sensor placement (non-cerebral)

NOTE When monitoring muscle tissue, place the sensor centrally over the selected muscle bed (e.g., middle of upper half of the lower leg as diagrammed).

A muscle bed with significant atrophy may not provide enough tissue for monitoring.

When monitoring for the effects of vascular obstruction in a limb, place a sensor on both the limb of concern and in the same location on the opposing limb.

WARNING Exercise extreme care when applying sensors. Sensor circuits are conductive and must not come into contact with other grounded, conductive parts other than EEG or entropy monitors. Such contact would bridge the patient’s isolation and cancel the protection provided by the sensor.

WARNING Failure to apply sensors properly may cause incorrect measurements. Misapplied sensors or sensors that become partially dislodged may cause either over- or under-reading of oxygen saturation.

Do not position a sensor under the weight of the patient. Prolonged periods of pressure (such as taping over the sensor or the patient lying on a sensor) transfers weight from the sensor to the skin, which can injure skin and reduce sensor performance.

The sensor site must be inspected at least every 12 hours to reduce the risk of inadequate adhesion, circulation, and skin integrity. If the circulatory condition or skin integrity has deteriorated, the sensor should be applied to a different site.

13.3.1.4 Connecting Sensors to Cables

- 1 Be sure that ForeSight Elite module is connected to the tissue oximetry module and that sensors are placed correctly on the patient's skin.
- 2 Use the clips on the sensor cable to secure and prevent the cable from being pulled away from the patient.

WARNING Do not connect more than one patient to the ForeSight Elite module, this may compromise the patient's isolation and cancel the protection provided by the sensor.

CAUTION When used in settings with LED lighting, sensors may need to be covered with a light blocker prior to connection to the sensor cable, as some high intensity systems can interfere with the sensor's near infrared light detection.

Do not lift or pull the ForeSight Elite module by any cable, or place the ForeSight Elite module in any position that might present a risk that the module may fall on the patient, bystander or operator.

- 3 Position the sensor connector in front of the sensor cable connector and align the marks on each (figure 13-13).

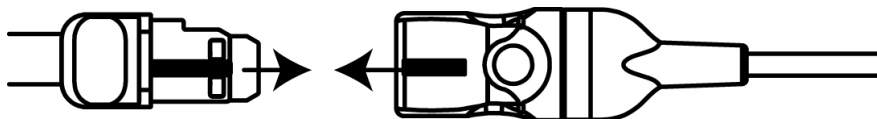

Figure 13-13 Connecting a sensor to the sensor cable connector

- 4 Gently push the sensor connector straight into the sensor cable connector until it snaps into place.
- 5 Gently pull back on the sensor to verify the sensor is fully inserted into the connector.

- Verify that the channel status LED indicator on the ForeSight Elite module changes from white to green when the sensor is fully connected. See figure 13-14.

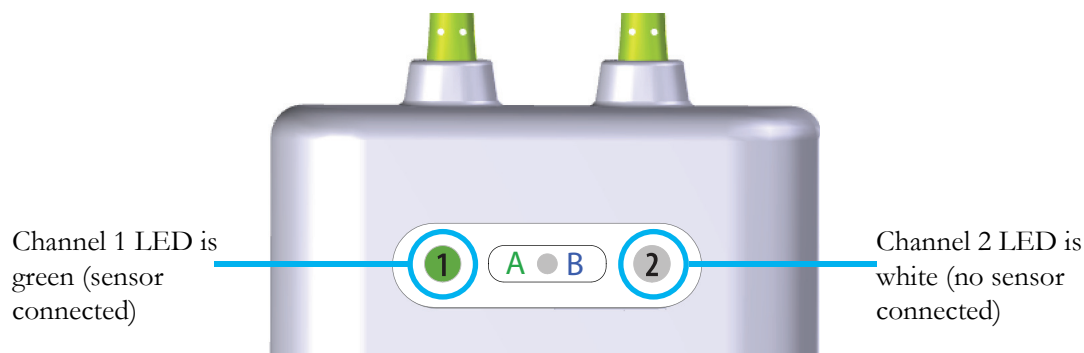

Figure 13-14 Connecting a sensor to the ForeSight module – channel status LED

CAUTION Once patient monitoring has started, do not replace the sensor or disconnect the sensor for more than 10 minutes to avoid restarting the initial StO₂ calculation.

NOTE If the ForeSight Elite module cannot read sensor data properly after starting a new patient, a message to verify the sensors are properly applied to the patient may be displayed on the status bar.

Confirm that sensors are properly adhered to the patient and dismiss the message and begin monitoring.

13.3.2 Disconnecting Sensors After Monitoring

Once you are done monitoring a patient, you need to remove the sensors from the patient and disconnect the sensors from the sensor cable as described in the instructions included in the ForeSight Elite sensor packaging.

13.3.3 Monitoring Considerations

13.3.3.1 Module Use During Defibrillation

WARNING The ForeSight Elite oximeter module has been designed to promote patient safety. All module parts are “Type BF Defibrillation Proof” and are protected against the effects of the defibrillator discharge and may remain attached to the patient. Module readings may be inaccurate during defibrillator use and up to twenty (20) seconds thereafter.

No separate actions are required when using this equipment with a defibrillator, but only Edwards-supplied sensors must be used for proper protection against the effects of a cardiac defibrillator.

WARNING Do not come into contact with patients during defibrillation, or serious injury or death could result.

13.3.3.2 Interference

CAUTION Measurements may be affected in the presence of strong electromagnetic sources such as electro-surgery equipment, and measurements may be inaccurate during use of such equipment.

Elevated levels of carboxyhemoglobin (COHb) or methemoglobin (MetHb) may lead to inaccurate or erroneous measurements, as may intravascular dyes or any substance containing dyes that change usual blood pigmentation. Other factors that may affect measurement accuracy include: myoglobin, hemoglobinopathies, anemia, pooled blood under the skin, interference from foreign objects in the Sensor path, Bilirubinemia, externally applied coloring (tattoos), high levels of Hgb or Hct and birthmarks.

When used in settings with LED lighting, sensors may need to be covered with a light blocker prior to connection to the sensor cable, as some high intensity systems can interfere with the sensor's near infrared light detection.

13.3.3.3 Interpreting StO₂ Values

WARNING If the accuracy of any value displayed on the monitor is questionable, determine the patient's vital signs by alternative means. The functions of the alarm system for patient monitoring must be verified at regular intervals and whenever the integrity of the product is in doubt.

Testing of the ForeSight Elite module operation should be done at least once every 6 months, as described in HemoSphere service manual. Failure to comply may lead to injury. If the module fails to respond, it must not be used until it has been inspected and serviced or replaced. See technical support contact information on inside cover.

NOTE For patients experiencing complete bilateral external carotid artery (ECA) occlusion, measurements may be lower than expected.

Table 13-3 summarizes the validation methodology associated with the ForeSight Elite module.

Table 13-3 StO₂ validation methodology

Patient population	ForeSight sensor	Cerebral reference	Non-cerebral reference	Type measurement	Subject weight range
Adult	Large	Co-oximetry of jugular bulb and arterial blood samples	Co-oximetry of central venous and arterial blood samples	Single point	≥ 40 kg
Pediatric – adolescents, children, infants, and neonates	Medium	Co-oximetry of internal jugular vein and arterial blood samples	Co-oximetry of central venous and arterial blood samples	Single point	≥ 3 kg
Pediatric – adolescents, children, infants, and neonates	Small	Co-oximetry of internal jugular vein and arterial blood samples	Co-oximetry of central venous and arterial blood samples	Single point	3 to 8 kg
Pediatric – neonates (term, premature, low birth weight, very low birth weight)	Small	FORE-SIGHT MC3010 ¹	Co-oximetry of umbilical venous and pulse oximetry samples	StO ₂ data averaged in two-minute windows ²	< 5 kg

¹ Unlike the other ForeSight Elite validation studies, this cerebral validation study did not include invasive measurements because of the challenge for medical centers to obtain consent to insert an internal jugular venous catheter in very small subjects.

² StO₂ data was averaged in two-minute windows for term, premature low birth weight (LBW), and very low birth weight (VLBW) neonates for the following reasons: 1) to reduce the influence of acute changes in StO₂ due to changes in body position or touch as the hemodynamics in premature LBW and VLBW neonates are not as stable compared to normal birth weight neonates, and 2) to enable measurements for both FORE-SIGHT MC3010 and ForeSight Elite sensors or across multiple abdominal locations at nominally the same time for the smallest neonates for which only one sensor can be fitted on the head or specific abdominal location at a time.

13.3.4 Skin Check Timer

Tissue oximetry sensor sites must be inspected at least every 12 hours to reduce the risk of inadequate adhesion, circulation, and skin integrity. The **Skin Check Reminder** displays a reminder every 12 hours, by default. The time interval for this reminder can be modified:

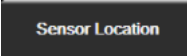
- 1 Touch anywhere in the **StO₂** parameter tile → **Sensor Location** tab 
- 2 Touch the value button for **Skin Check Reminder** to select a time interval between skin check notifications. The options are: **2 Hours**, **4 Hours**, **6 Hours**, **8 Hours** or **12 Hours** (default).
- 3 To reset the timer, select **Reset** from the **Skin Check Reminder** value button.

13.3.5 Set Averaging Time

The averaging time used to smooth monitored data points can be adjusted. Faster averaging times will limit the filter of irregular or noisy data points.

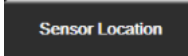
- 1 Touch anywhere in the **StO₂** parameter tile → **Sensor Location** tab 
- 2 Touch the value button for **Averaging** to select a time interval between skin check notifications. The options are: **Slow**, **Normal** (default), and **Fast**.

13.3.6 Signal Quality Indicator

The signal quality indicator (SQI), displayed on parameter tiles configured for tissue oximetry is a reflection of the signal quality based on the amount of near-infrared light tissue perfusion. See *Signal Quality Indicator* on page 195. 

13.3.7 Tissue Oximetry Physiology Screen

While monitoring with the HemoSphere tissue oximetry module three additional physiology screens are available to display the interaction between location specific tissue oximetry values and the cardiovascular system. These three views are shown below in figure 13-15. The default physiology screen while monitoring with the tissue oximetry module is the tissue oximetry view, which is shown first in figure 13-15. Touch the heart to view the main physiology screen described in *Physiology Screen* on page 98. To return to the tissue oximetry view, touch the magnifying glass.

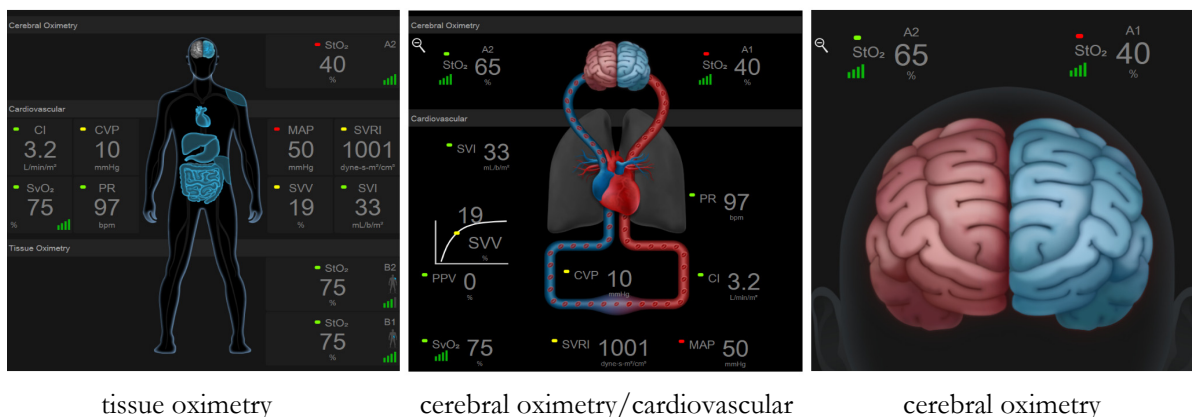

Figure 13-15 Tissue Oximetry Physiology Screens

Tissue Oximetry. This view displays monitored tissue oximetry values, including cerebral sensor sites, and any of the monitored cardiovascular parameters displayed on the main physiology screen described in *Physiology Screen* on page 98. Touch on the magnifying glass to return to this screen when viewing other physiology screens.

Cerebral Oximetry/Cardiovascular. This view is similar to the main physiology screen with the addition of monitored cerebral oximetry values, if available. Touch between the heart and brain on the tissue oximetry physiology screen to display this view.

Cerebral Oximetry. The cerebral oximetry view displays tissue oximetry values for cerebral configured sensors. Touch on the brain on the tissue oximetry physiology screen to display this view.

Advanced Features

Contents

Acumen™ Hypotension Prediction Index (HPI) Software Feature	218
Enhanced Parameter Tracking.....	239
Fluid Responsiveness Test	242

14.1 Acumen™ Hypotension Prediction Index (HPI) Software Feature

Acumen™ Hypotension Prediction Index (HPI) software, when activated and using an Acumen IQ™ sensor connected to a radial arterial catheter (minimally-invasive monitoring) or Acumen IQ finger cuff and HRS (noninvasive mode), provides the clinician with information regarding the likelihood of a patient trending towards a hypotensive event and the associated hemodynamics. A hypotensive event is defined as mean arterial pressure (MAP) < 65 mmHg for at least one minute. During minimally-invasive monitoring, the accuracy of the presented measurements is based upon several factors: the arterial line is reliable (not damped), the connected arterial line pressure sensor is well aligned and properly zeroed, and patient demographics (age, gender, height, and weight) have been accurately entered into the device. During noninvasive monitoring, the accuracy of the presented measurements is based upon several factors: the finger cuff has been properly sized and placed, the HRS has been properly zeroed and positioned, and patient demographics (age, gender, height, and weight) have been accurately entered into the device.

CAUTION The effectiveness of the HPI parameter has been established using radial arterial pressure waveform data. The effectiveness of the HPI parameter using arterial pressure from other sites (e.g., femoral) has not been evaluated.

The Acumen HPI™ feature is intended for use in surgical and non-surgical patients receiving advanced hemodynamic monitoring. The additional quantitative information provided by using the Acumen HPI feature is for reference only and no therapeutic decisions should be made based solely on the Acumen Hypotension Prediction Index (HPI) parameter.

Precaution. If in the clinician's judgment, a mean arterial pressure (MAP) value of < 65 mmHg would not be meaningful for an individual patient, the clinician may choose to disable the HPI feature completely from the parameter settings menu, or if the information available on the secondary screen is useful, may choose to silence the HPI alarm from the Alarms / Targets screen.

CAUTION Inaccurate FT-CO measurements can be caused by factors such as:

- Improperly zeroed and/or leveled sensor/transducer
- Over- or under-damped pressure lines

- Excessive variations in blood pressure. Some conditions that cause BP variations include, but are not limited to:
 - * Intra-aortic balloon pumps
- Any clinical situation where the arterial pressure is deemed inaccurate or not representative of aortic pressure, including but not limited to:
 - * Extreme peripheral vasoconstriction which results in a compromised radial arterial pressure waveform
 - * Hyperdynamic conditions as seen in post liver transplant
- Excessive patient movement
- Electrocautery or electrosurgical unit interference

Aortic valve regurgitation may cause an over estimation of Stroke Volume / Cardiac Output calculated depending on the amount of valvular disease and the volume lost back into the left ventricle.

Inaccurate noninvasive measurements can be caused by factors such as:

- Improperly zeroed and/or leveled HRS
- Excessive variations in blood pressure. Some conditions that cause BP variations include, but are not limited to:
 - * Intra-aortic balloon pumps
- Any clinical situation where the arterial pressure is deemed inaccurate or not representative of aortic pressure.
- Poor blood circulation to the fingers.
- A bent or flattened finger cuff.
- Excessive patient movement of fingers or hands.
- Artifacts and poor signal quality.
- Incorrect placement or position of the finger cuff.
- Electrocautery or electrosurgical unit interference

The Acumen Hypotension Prediction Index parameter, HPI, which can be configured as a key parameter on all monitoring screens, displays as an integer value ranging from 0 to 100, with higher values indicating a higher likelihood of a hypotensive event. In addition, the Acumen Hypotension Prediction Index (HPI) software provides three additional configurable parameters, dP/dt , Ea_{dyn} , and PPV, which together with SVV, provide decision support based upon preload responsiveness [SVV or PPV], contractility [dP/dt], and afterload [Ea_{dyn}]. Refer to *Acumen Hypotension Prediction Index (HPI)* on page 220, *HPI Secondary Screen* on page 225, and *Clinical Application* on page 227, for additional information regarding SVV, dP/dt and Ea_{dyn} .

To activate the Acumen HPI™ software, the platform requires entry of a password to access the Manage Features screen, where an activation key must be entered. Please contact your local Edwards Representative for more information on enabling this Advanced Feature.

Like other monitored parameters, the HPI value updates every 20 seconds. When the HPI value exceeds 85, a high priority alarm is initiated. If the HPI value exceeds 85 for two consecutive readings (total of 40 seconds), an HPI High Alert popup appears on the screen recommending a review of the patient hemodynamics. Hemodynamic information associated with hypotension is available for the user on the HPI Secondary Screen. That information includes several key parameters (MAP, CO, SVR, PR, and SV), as well as more advanced indicators of preload, contractility, and afterload (SVV or PPV, dP/dt , Ea_{dyn}). Additionally, the patient hemodynamics may also be assessed by review of currently configured key parameters, as for example, SVV, PPV, CO and SVR.

Once the Acumen HPI feature is activated, the user can choose to configure Acumen Hypotension Prediction Index (HPI) as a key parameter, display it on the Information Bar, or choose not to display it. dP/dt , Ea_{dyn} , and PPV can also be configured as key parameters.

Refer to the HPI as a Key Parameter and HPI in the Information Bar sections for information about configuring the parameter. See *HPI as a Key Parameter* on page 221 and *HPI on Information Bar* on page 224.

The alarm and alert functions for HPI will differ with the chosen display option for HPI as described in table 14-1.

Table 14-1 HPI display configurations

Display option	Audible and visual alarm	Alert popup
Key Parameter	Yes	Yes
Information Bar	No	Yes
Not displayed	No	No

Unlike other monitored parameters, the HPI alarm limits are not adjustable, as HPI is not a physiologic parameter with a selectable target range (as with cardiac output, for example), but rather a likelihood of physiological state. The alarm limits are displayed to the user in the software, but the controls to change the alarm limits are disabled. The alarm limit for the HPI parameter (>85 for red alarm range) is a fixed value that may not be modified.

The visual and audible cues available to the user when the HPI value is >85 (red alarm range) result from the analysis of multiple variables from an arterial pressure waveform and patient demographic information, and application of a data-driven model developed from retrospectively annotating hypotensive and non-hypotensive episodes. The HPI alarm limit is provided in table 14-2 on page 221 and in table D-4 on page 302. The algorithm performance characteristics for the alarm threshold of 85 are provided in table 14-11, included in the clinical validation section.

The parameters dP/dt , Ea_{dyn} , and PPV can be configured as key parameters. PPV and dP/dt behave as other monitored parameters, however Ea_{dyn} is not an alarmable parameter. Alarm/target ranges are unavailable for Ea_{dyn} and target status indicators appear white at all times. A dashed line appears at a value of 0.8 on the Ea_{dyn} graphical trend plot for reference.

14.1.1 Acumen Hypotension Prediction Index (HPI)

The HPI value will update every 20 seconds and displays as a value equating to the likelihood that a hypotensive event may occur on a scale from 0 to 100. The higher the value, the higher the likelihood that a hypotensive event ($MAP < 65$ mmHg for at least one minute) will occur.

The HPI parameter uses data from the first ten minutes of monitoring to establish a ‘base value.’ Device performance during these first ten minutes may differ as a result. Table 14-2 provides a detailed explanation and interpretation of HPI graphical display elements (trendline, dial segment [cockpit display], audible alarms, and parameter value [tile display]) and recommended user action when HPI is configured as a key parameter.

WARNING The Acumen Hypotension Prediction Index, HPI, should not be used exclusively to treat patients. A review of the patient's hemodynamics is recommended prior to initiating treatment.

Table 14-2 HPI value graphical and audible display elements

HPI value	Graphical display elements	Audible	General interpretation	Recommended user action
HPI ≤85	White	None	Patient hemodynamics indicate that there is a low to moderate likelihood of a hypotensive event occurring. A low HPI value does not exclude a hypotensive event from occurring for surgical patients in the next 5-15 minutes or non-surgical patients in the next 20-30 minutes (minimally-invasive radial arterial line monitoring only) regardless of MAP value.	Continue monitoring patient hemodynamics. Remain vigilant with respect to changing patient hemodynamics using the primary monitoring screen, HPI Secondary Screen, HPI, and trends in parameters and vital signs.
HPI >85	Red (flashing)	High priority alarm tone	Surgical patient has a high likelihood of experiencing a hypotensive event within 15 minutes Non-surgical patient has a high likelihood of experiencing a hypotensive event within 20 minutes (minimally-invasive radial arterial line monitoring only)	Check patient hemodynamics using the secondary screen and other primary screen parameters in order to investigate the potential cause of the high likelihood of hypotension in order to inform a potential course of action
HPI >85 and persists for two continuous readings (40 seconds)	Red (flashing) Popup	High priority alarm tone	Surgical patient has a high likelihood of experiencing a hypotensive event within 15 minutes Non-surgical patient has a high likelihood of experiencing a hypotensive event within 20 minutes (minimally-invasive radial arterial line monitoring only)	Acknowledge popup by chosen method Check patient hemodynamics using the secondary screen and other primary screen parameters in order to investigate the potential cause of the high likelihood of hypotension in order to inform a potential course of action
HPI =100	Red (flashing) Popup	High priority alarm tone	Patient is hypotensive	Acknowledge popup by chosen method Check patient hemodynamics using the secondary screen and other primary screen parameters in order to investigate the potential cause of the hypotension in order to inform a potential course of action

NOTE If HPI is displayed on the Information Bar the graphical display element changes will not change color nor alarm. Instead the user will only be notified when HPI exceeds 85 for consecutive updates by displaying the HPI High Alert popup.

14.1.2 HPI as a Key Parameter

Once the Acumen HPI feature is activated, the user can configure HPI as a key parameter using the steps described in *Change Parameters* on page 88.

The display of HPI differs in several ways from other key parameters. Display of other key parameters is described in *Status Indicators* on page 90.

Table 14-3 describe the similarities and differences between HPI and other key parameters.

Table 14-3 HPI versus other key parameters: similarities and differences

Similarities	Differences
<ul style="list-style-type: none"> • Values update every 20 seconds • Audible alarm when > alarm limit • Visual alarm when > alarm limit • Can display % change, if configured • Audible alarm can be disabled 	<ul style="list-style-type: none"> • HPI key parameter tile does not have target color in colored font, depending on clinical/alarm indicator status • HPI key parameter tile has shortcut key in top-right corner to provide direct access to HPI Secondary Screen • HPI will display Alert popup when HPI exceeds high alarm limit for two consecutive updates or HPI value is 100 • HPI only available as key parameter if activation key entered • HPI alarm limit is not adjustable • HPI does not have a target, green-shaded region with red arrows at the upper and lower limits when displayed as a trend on the main monitoring screen because it is not a physiologic parameter with a target range. Instead HPI is a quantitative indication of physiological status used to inform users of patient likelihood of trending toward a hypotensive event. Specifically: <ul style="list-style-type: none"> * When HPI is less than or equal to 85, the graphic elements (displayed number trend line or dial segment) are white and clinician should continue monitoring patient hemodynamics using the primary monitoring screen, HPI secondary screen, HPI, and trends in parameters and vital signs. * When HPI exceeds 85, the graphical elements (displayed number, trend line, or dial segment) appear red indicating the user should check patient hemodynamics using the secondary screen and other monitoring screen parameters in order to investigate the potential cause of the high likelihood of hypotension (or hypotension if HPI = 100) in order to inform a potential course of action • HPI has three parameter status colors: gray, white, and red. See table 14-4.

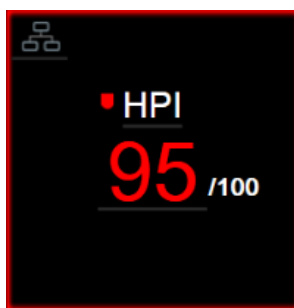

Figure 14-1 HPI key parameter tile

HPI will be displayed as shown in figure 14-1 when configured as a key parameter in all screens except the cockpit screen (figure 14-2). For more information about the cockpit screen, see *Cockpit Screen* on page 99.

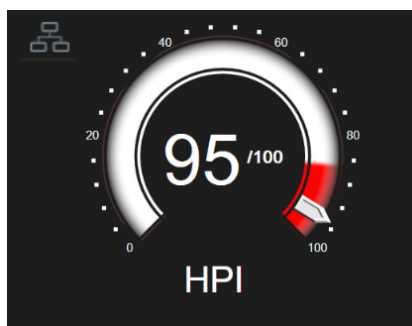

Figure 14-2 HPI key parameter on cockpit screen

On all monitoring screens, there is a shortcut icon  in the top-left corner of the HPI key parameter tile. If touched, this shortcut button will display the HPI Secondary Screen shown on page 226.

On all monitoring screens except the cockpit screen, the font color of the parameter value denotes parameter status as shown in table 14-4. On the cockpit screen, HPI has the same alarm and target ranges, but it is displayed as shown in figure 14-2.

Table 14-4 Parameter status colors for HPI

Parameter status color	Lower limit	Upper limit
Gray	Fault condition	
White	10	85
Red/Gray Flashing	86	100

14.1.3 HPI Alarm

When HPI is configured as a key parameter and exceeds the upper threshold of 85, a high priority alarm will activate which indicates to the user that the patient may be trending towards a hypotensive event. This includes an alarm tone, red parameter status color, and flashing parameter value. The alarm limit of HPI shown in table 14-4 divides the display range into areas of lower and higher likelihood of hypotension. HPI uses features extracted from Acumen IQ measurements, some compared to an initial base value determined over the first 10 minutes of the patient monitoring session, to a data-driven model developed from retrospective analysis of an arterial waveform database collected from ICU and OR patients containing annotated hypotensive (defined as MAP < 65 mmHg for at least 1 minute) and non-hypotensive events. HPI is displayed as an integer value between 0 and 100. The assessment of hypotension likelihood using HPI should consider both the displayed value along the range from 0 to 100 and the associated parameter color (white/red). As with other available alarms on the HemoSphere advanced monitoring platform, the volume of the HPI available alarm is adjustable. See *Alarms/Targets* on page 130 for information about silencing the alarm and configuring the alarm volume. Occurrence of HPI alarm will be logged in the data download file following an update with HPI exceeding the alarm limit.

CAUTION The HPI parameter may not provide advanced notice of a trend towards a hypotensive event in situations where a clinical intervention results in a sudden non-physiological hypotensive event. If this occurs, the HPI feature will provide the following without delay: a high alert popup, a high priority alarm, and an HPI value of 100 will be displayed indicating that the patient is undergoing a hypotensive event.

14.1.4 HPI on Information Bar

When HPI is not configured as a key parameter, the parameter value is still computed and displayed on the information bar as shown in figure 14-3.



Figure 14-3 Information bar with HPI

14.1.5 Disable HPI Information Bar Indicator

To disable the HPI information bar indicator:

- 1 Touch the settings icon  → **Settings** tab .
- 2 Touch **Advanced Setup** button and enter the required password.
- 3 Touch the **Parameter Settings** button.
- 4 Touch the **HPI Settings** button.
- 5 Touch the **Always alert when HPI is high** toggle button to switch to **Disabled**. See figure 14-4

To re-enable the HPI information bar indicator, repeat steps 1-4 and switch the toggle button to **Enabled** in step 5.

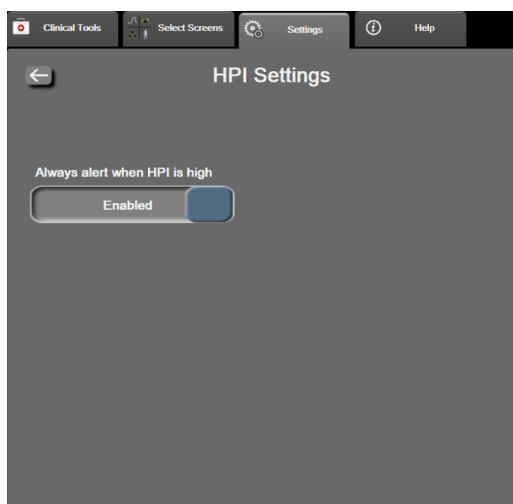

Figure 14-4 Parameter settings - Hypotension Prediction Index

The HPI feature remains available even when HPI is not displayed on the screen. If HPI is configured as a key parameter, the parameter will alarm and alert as described in *HPI Alarm* on page 223.

14.1.6 HPI High Alert Popup

When HPI exceeds 85 for two consecutive 20-second updates or reaches 100 at any time, the HPI high alert popup becomes active. See figure 14-5. This popup recommends a review of patient hemodynamics and displays either when HPI is configured as a key parameter or appears on the information bar.

WARNING The Acumen Hypotension Prediction Index, HPI, should not be used exclusively to treat patients. A review of the patient's hemodynamics is recommended prior to initiating treatment.

To review patient hemodynamics on the HPI secondary screen (see *HPI Secondary Screen* on page 225) and acknowledge the HPI high alert popup, touch the **More Information** button. To acknowledge the HPI high alert popup without reviewing patient hemodynamics on the HPI secondary screen, touch the **Acknowledge** button.

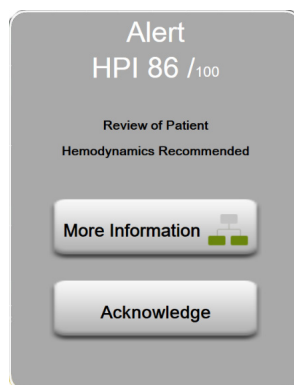

Figure 14-5 HPI high alert popup

Upon acknowledgment of the popup, the following will occur:

- The popup will be removed from the display.
- The HPI alarm tone will be silenced for as long as the alert is active.
- The HPI high alert is acknowledged.

The **More Information** button is enabled when any monitoring screen is displayed. If the **More Information** button on the HPI high alert popup is touched, the HPI secondary screen is displayed. When the **More Information** button is disabled, the HPI secondary screen can still be accessed as described in *HPI Secondary Screen* on page 225.

To disable the HPI alert popup, see *Disable HPI Information Bar Indicator* on page 224.

14.1.7 HPI Secondary Screen

The HPI secondary screen provides hemodynamic information about the patient. It may be a useful tool to quickly review the patient hemodynamics related to hypotension. This screen may be accessed at any time during hemodynamic monitoring with a Acumen IQ sensor.

The HPI secondary screen, along with other key parameters on the monitoring screen, can be used to provide potential insight into the cause of a high hypotension likelihood or hypotension when such an event occurs. The parameters displayed on the HPI secondary screen include the following key parameters:

- cardiac output (CO)
- pulse rate (PR)
- mean arterial pressure (MAP)
- stroke volume (SV)
- systemic vascular resistance (SVR)

Additional advanced parameters are arranged visually on the screen by preload, contractility, and afterload. These advanced parameters are:

- stroke volume variation (SVV) or pulse pressure variation (PPV)
- systolic slope (dP/dt)
- dynamic arterial elastance ($E_{a_{dyn}}$)

To toggle between display of PPV or SVV, touch the currently displayed parameter name (PPV or SVV) on the HPI Secondary Screen. For all of the parameters on the HPI Secondary Screen, the percent change and direction of change (via up/down arrow) over a user-selectable time interval and small graphical trend plots are displayed. The arterial blood pressure waveform is also displayed. All parameter boxes are outlined in the current target status color, matching visual indicator functionality of parameter tiles.

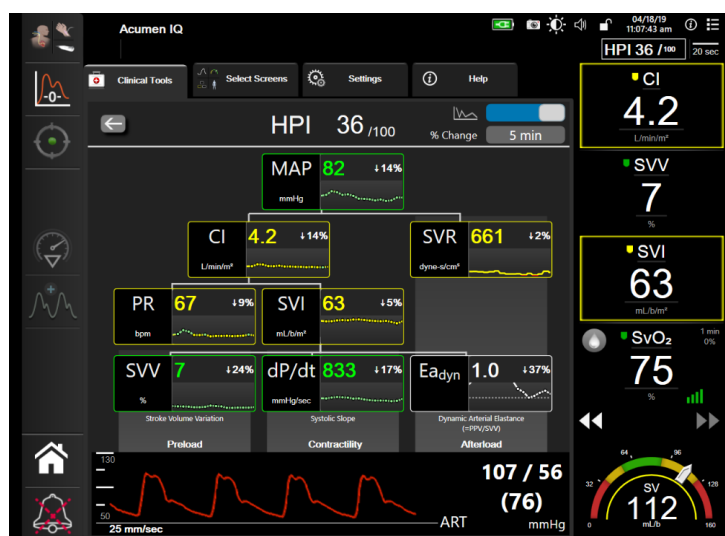





Figure 14-6 HPI secondary screen

To access the HPI secondary screen, choose one of the following:

- Touch the More Information button  on the HPI high alert popup.
- Touch the HPI information bar indicator button .
- Touch the HPI key parameter shortcut icon .

- Touch the **Settings** icon  → **Clinical Tools** tab  **Clinical Tools**
- **HPI Secondary Screen** icon .

NOTE The HPI secondary screen is also accessible if the HPI feature is activated and an Acumen IQ sensor is not connected.

The displayed trend graph parameter value scales match the currently configured scales on the graphical trend monitoring screen. See *Adjust Scales* on page 136. The time scale matches the currently selected **% Change** value. The current change interval value is displayed at the top of the HPI Secondary Screen. Configure the change interval directly on the HPI secondary screen by touching the displayed interval.

The displayed trend graphs can be turned off by touching the trend graph toggle button. When turned off, the parameter values appear larger and replace the trend plots. See figure 14-7.



Touch any parameter graph to view a larger graphical trend plot. The selected parameter graphical trend plot will appear in place of the blood pressure waveform plot. See figure 14-7. Touch anywhere on the HPI Secondary Screen to exit the enlarged trend graph plot. The graphical trend plot has a thirty second timeout.

For parameter derivations, see table C-1 in appendix C, *Equations for Calculated Patient Parameters*.

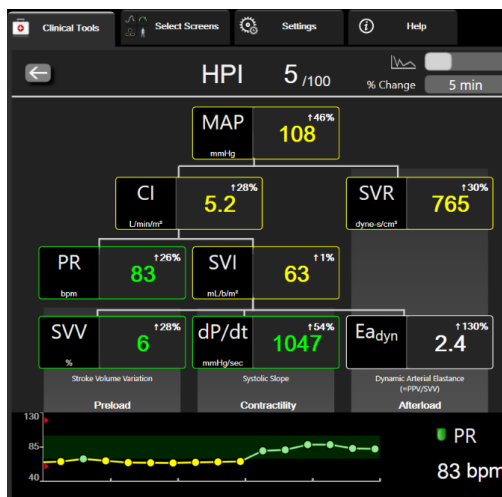

Figure 14-7 HPI secondary screen – graphical trend value display

14.1.8 Clinical Application

The Acumen Hypotension Prediction Index parameter, HPI, can be configured as a key parameter on the monitoring screen, or it can be displayed only in the Information Bar at the bottom right of the monitoring screen, as described in *Acumen™ Hypotension Prediction Index (HPI) Software Feature* on page 218.

- When HPI is displayed in the Information Bar:
- After a second consecutive HPI value exceeds 85, High Alert popup appears
- Check patient hemodynamics using the HPI secondary screen and other primary screen parameters in order to investigate the potential cause of the high likelihood of hypotension in order to inform a potential course of action.

When HPI is configured as a key parameter, HPI and trend graph appear on the monitoring screen:

- Alarm occurs when HPI exceeds 85.
- When HPI is less than or equal to 85:
 - * The trend line and value appear white.
 - * Continue monitoring patient hemodynamics. Remain vigilant with respect to changing patient hemodynamics using the primary monitoring screen, HPI Secondary Screen, HPI, and trends in parameters and vital signs.
- When HPI exceeds 85, check patient hemodynamics using the HPI Secondary Screen and other primary screen parameters in order to investigate the potential cause of the high likelihood of hypotension in order to inform a potential course of action.
- Once mean arterial pressure remains below 65 mmHg for three consecutive readings, indicating the occurrence of a hypotensive event:
 - * HPI displays 100.
 - * Check patient hemodynamics using the HPI secondary screen and other primary screen parameters in order to investigate the potential cause of the hypotension in order to inform a potential course of action.

14.1.9 Additional Parameters

- Stroke Volume Variation (SVV) and Pulse Pressure Variation (PPV) – sensitive dynamic measures of fluid responsiveness, which predict whether the preload is increased – by giving more fluid or by reducing the venous unstressed volume via compensatory control mechanisms or drugs – the heart will respond with an increase in stroke volume [1]. Low values of SVV or PPV are an indicator that a patient is not fluid responsive; high values are an indicator that a patient is fluid responsive; and there is a gray zone in between [6].
- Systolic slope (dP/dt) – The maximum upslope of the arterial pressure waveform from a peripheral artery. The arterial pressure dP/dt (by nature of its computation during outflow) will have absolute values lower than the isovolumic LV pressure dP/dt-max, but their changes correlate strongly [1, 2].

NOTE dP/dt measured from the peripheral artery has not been studied as a measure of left ventricular contractility in all patient populations.

- Dynamic arterial elastance ($E_{a_{dyn}}$) – a measure of the afterload to the left ventricle by the arterial system (arterial elastance), relative to the left ventricular elastance, computed as the ratio between PPV and SVV [8]. The arterial elastance is an integrative arterial load parameter that incorporates systemic vascular resistance (SVR), total arterial compliance (C) and systolic and diastolic time intervals [9, 10].

The correlation of these parameters to physiological status and their relationship to clinical outcome has been well-studied with a large body of clinical literature.

Most interventions to treat SV (or SVI) and MAP, impact primarily SV and its determinants preload, contractility, afterload. Decision support for treatment decisions should integrally provide information on all three aspects, since they often inter-relate.



SVV is limited as preload measure to patients that are mechanically ventilated with stable ventilation frequency and tidal volumes and that do not have intra-abdominal insufflation [6, 7]. SVV is best used in conjunction with stroke volume or cardiac output assessment.

dP/dt is best used in conjunction with stroke volume variation and stroke volume or cardiac output assessment.

CAUTION Exercise caution when using dP/dt in patients with severe aortic stenosis, since the stenosis may reduce the coupling between the left ventricle and the afterload.

The dP/dt parameter, although predominantly determined by changes in LV contractility, may be impacted by afterload during periods of vasoplegic states (venoarterial decoupling). During these periods, dP/dt may not reflect changes in LV contractility.

By normalizing the arterial elastance by the ventricular elastance, their ratio becomes an index of the matching between the LV and the arterial system. When matching there is an optimal transfer of blood from the LV to the arterial system without loss of energy and with optimal stroke work [3, 8, 9].

$E_{a_{dyn}}$ has been shown to provide an indication of potential afterload responsiveness to increase MAP by giving volume in preload volume responsive mechanically ventilated patients [4] and spontaneously breathing patients [5]. Afterload responsiveness to increase MAP is greater potentially at values of $E_{a_{dyn}} > 0.8$ [4, 5, 8].

$E_{a_{dyn}}$ is not limited to patients that are mechanically ventilated because it is a computation of presented as the ratio of PPV/SVV [5, 8]. $E_{a_{dyn}}$ is best used in conjunction with stroke volume variation (in ventilated patients) and stroke volume or cardiac output assessment.

SVV or PPV, dP/dt, and $E_{a_{dyn}}$ share the property that one is seldom independent of one or the other. Giving volume to increase the preload and increase the stroke volume leads to an increase in cardiac output and arterial pressure; therefore, the afterload on the ventricle increases. Increasing afterload (increasing aortic pressure) by increasing systemic vascular resistance, will reduce the stroke volume. The resulting increased end-systolic volume, however, leads to a secondary increase in end-diastolic volume because more blood is left inside the ventricle following ejection and this extra blood is added to the venous return, thereby increasing ventricular filling, which increases contractility (Frank-Starling mechanism) and partially offsets the reduction in stroke volume caused by the initial increase in afterload.

SVV or PPV, dP/dt, and $E_{a_{dyn}}$ are intended as integrative decision support parameters to guide an interventional treatment of SV or SV and MAP.

14.1.10 Clinical Validation

Retrospective clinical validation studies were undertaken to assess the diagnostic performance of HPI to predict hypotensive and non-hypotensive events in surgical and non-surgical patients.

14.1.10.1 Surgical Patients

There are three studies that assessed the diagnostic performance of HPI in surgical patients. The first retrospective clinical validation study, to assess the diagnostic performance of HPI to predict hypotensive and non-hypotensive events, included 52 surgical patients. Table 14-5 provides the patient demographics. The number of hypotensive event segments included in the analysis was 1058 and the total number of non-hypotensive event segments included in the analysis was 521.

The second retrospective clinical validation study, included 204 patients, and provides further evidence regarding the diagnostic performance of HPI to predict hypotensive and non-hypotensive events. Table 14-5 provides the patient demographics. The number of hypotensive event segments included in the analysis was 1923 and the total number of non-hypotensive event segments included in the analysis was 3731.

A third retrospective clinical validation study, included 252 patients, provides further evidence regarding the diagnostic performance of HPI to predict hypotensive and non-hypotensive events. Table 14-5 provides the patient demographics. The number of hypotensive event segments included in the analysis was 317 and the total number of non-hypotensive event segments included in the analysis was 2845.

Table 14-5 Patient Demographics (surgical patients)

Description	Clinical Validation Study, Radial Arterial Line (N=52)	Clinical Validation Study, Radial Arterial Line (N=204)	Clinical Validation Study, Noninvasive Blood Pressure (N=252)
# of Patients	52	204	252
Gender (Male)	29	100	112
Age	58.3±11.3	56.7±14.4	54±16
BSA	1.8±0.2	1.9±0.3	1.9±0.2

The 52 radial arterial line monitored surgical patients can be further stratified in two groups – those who underwent high risk non-cardiac surgery (n=25, 48.1%) and those who underwent liver surgery (n=27, 51.9%).

The 204 radial arterial line monitored surgical patients can be further stratified – those who underwent neurological surgery (n=73, 35.8%), abdominal surgery (n=58, 28.4%), general thoracic surgery (n=8, 3.9%), cardiac surgery (n=6, 3.0%), and other surgery (n=59, 28.9%).

The 252 noninvasive blood pressure (NIBP) surgical patients can be further stratified by surgery type as provided in table 14-6.

Table 14-6 Surgical Characteristics for NIBP Surgical Patients (N=252)

Diagnosis	Number of Patients	% of Total
Bladder	4	1.6
Cardiac	2	0.8
Cranial	7	2.8
Eye	34	13.5
Facial	36	14.3
Gastro-intestinal	49	19.4
Gynecological	30	11.9

Table 14-6 Surgical Characteristics for NIBP Surgical Patients (N=252) (continued)

Diagnosis	Number of Patients	% of Total
Liver	5	2.0
Esophageal	5	2.0
Orthopedic	16	6.3
Pancreas	4	1.6
Plastic	2	0.8
Rectal	2	0.8
Renal	28	11.1
Thoracic	4	1.6
Unknown	23	9.1
Vascular	1	0.4

Table 14-11 on page 233 provides the results of these clinical validation studies.

14.1.10.2 Non-Surgical Patients

There are three studies that assessed the diagnostic performance of HPI in non-surgical patients. The first, a retrospective clinical validation study, assessed the diagnostic performance of HPI to predict hypotensive and non-hypotensive events and included 298 non-surgical patients. Table 14-7 provides the patient demographics. The number of hypotensive event segments included in the analysis was 13911 and the total number of non-hypotensive event segments included in the analysis was 48490.

The 298 radial arterial line monitored non-surgical patients can be further stratified as described in table 14-8 below.

The second retrospective clinical validation study included 228 patients, and provides further evidence regarding the diagnostic performance of HPI to predict hypotensive and non-hypotensive events. Table 14-7 provides the patient demographics. The number of hypotensive event segments included in the analysis was 23205 and the total number of non-hypotensive event segments included in the analysis was 82461.

The 228 radial arterial line monitored non-surgical patients can be further stratified as described in table 14-9 below.

A third retrospective clinical validation study included 175 patients and provides further evidence regarding the diagnostic performance of HPI to predict hypotensive and non-hypotensive events. Table 14-7 provides the patient demographics. The number of hypotensive event segments included in the analysis was 1384 and the total number of non-hypotensive event segments included in the analysis was 6723.

The 175 noninvasive blood pressure (NIBP) non-surgical patients can be further stratified as described in table 14-10 below.

Table 14-7 Patient Demographics (Non-Surgical Patients)

Description	Clinical Validation Study, Radial Arterial Line(N=298)	Clinical Validation Study, Radial Arterial Line (N=228)	Clinical Validation Study, Noninvasive Blood Pressure (N=175)
# of Patients	298	228	175
Gender (Male)	191	128	109
Age	62.6±15.1	63.9±15.6	60.7±14.6
BSA	1.9±0.3	1.9±0.2	2.0±0.3

Table 14-8 Non-Surgical Patient Characteristics (N=298)

Diagnosis	Number of Patients	% of Total
Diabetes	1	0.3
Infectious disease	1	0.3
Liver	1	0.3
Aneurysm	2	0.7
Poison	2	0.7
Renal failure	2	0.7
Stroke	2	0.7
Hemorrhage	4	1.3
Unknown	4	1.3
Other	5	1.7
Cardiogenic shock	7	2.3
Infarction	8	2.7
Respiratory/pulmonary	8	2.7
Severe hypovolemia	8	2.7
Cardiac	12	4.0
Post-liver surgery	25	8.4
Septic shock	25	8.4
Post-surgery (non-cardiac/liver)	46	15.4
Sepsis	65	21.8
Post-cardiac surgery	70	23.5

Table 14-9 Non-Surgical Patient Characteristics (N=228)

Diagnosis	Number of Patients	% of Total
Cardiovascular	67	29.5
Bleeding	24	10.5
Sepsis	19	8.3
Other	60	26.2
Cancer	20	8.7
Respiratory	13	5.7
Orthopedic	10	4.4
Neuro	3	1.3
GI or Hepatic	12	5.4

Table 14-10 Characteristics for NIBP non-surgical patients (N=175)

Diagnosis	Number of Patients	% of Total
Cardiac	65	37.1
Cerebral	2	1.1
Liver	2	1.1
Neurological	43	24.6
Other	6	3.4
Post-surgical	5	2.9
Pulmonary	1	0.6

Table 14-10 Characteristics for NIBP non-surgical patients (N=175) (continued)

Diagnosis	Number of Patients	% of Total
Renal	1	0.6
Respiratory	17	9.7
Sepsis	9	5.1
Septic shock	5	2.9
Trauma	4	2.3
Vascular	15	8.6

Table 14-12 provides the results of these clinical validation studies.

A hypotensive event, as described in table 14-11 and table 14-12, is calculated by identifying a segment of at least 1 minute in length such that all data points in the section have a MAP < 65 mmHg. An event (positive) data point is chosen as the sample 5 minutes prior to the hypotensive event. If consecutive hypotension events are less than 5 minutes apart then a positive sample is defined as the first sample immediately following the preceding hypotension event.

A non-hypotensive event, as described in table 14-11 and table 14-12, is calculated by identifying segments of data points such that the segment is at least 20 minutes away from any hypotensive events and all data points in that segment have MAP > 75 mmHg. One non-event (negative) data point is taken for each of the non-hypotensive event segments.

A true positive, as described in table 14-11 and table 14-12, is any event (positive) data point with HPI value greater than or equal to a chosen threshold. Sensitivity is the ratio of true positives to total number of events (positives) with a positive defined as a data point that is at most 5 minutes prior to a hypotensive event. A false negative is any positive data point with HPI value less than the threshold.

A true negative, as described in table 14-11 and table 14-12, is any negative (non-event) data point with HPI value less than a chosen threshold. Specificity is the ratio of true negatives to total number of non-events (negatives) with a negative defined as a data point that is at least 20 minutes away from any hypotensive event. A false positive is any negative data point with HPI value greater than or equal to the threshold.

Table 14-11 Clinical Validation Studies* (surgical patients)

Clinical Validation Study	HPI Threshold	PPV [confidence interval]	NPV [confidence interval]	Specificity (%) [95% confidence interval]	# True negative/ # nonevents	Sensitivity (%) [95% confidence interval]	# True positive/ # events	AUC
(N=52) Radial arterial line	85	99.9 (=886/887) [99.7, 100.0]	75.1 (=520/692) [71.9, 78.4]	99.8 [99.4, 100.0]	520/521	83.7 [81.5, 86.0]	886/1058	0.95
(N=204) Radial arterial line	85	98.3 (=1265/1287) [97.6, 99.0]	84.9 (=3709/4367) [83.9, 86.0]	99.4 [99.2, 99.7]	3709/3731	65.8 [63.7, 67.9]	1265/1923	0.88
(N=252) NIBP	85	99.5 (=940/945) [99.0, 99.9]	88.3 (=2840/3217) [87.2, 89.4]	99.8 [99.7, 100.0]	2840/2845	71.4 [68.9, 73.8]	940/1317	0.89

*Data on File at Edwards Lifesciences

Table 14-12 Clinical Validation Studies* (non-surgical patients)

Data Set	HPI Threshold	PPV (%) [95% confidence interval]	NPV (%) [95% confidence interval]	Specificity (%) [95% confidence interval]	# True negative/ # nonevents	Sensitivity (%) [95% confidence interval]	# True positive/ # events	AUC
(N=298) Radial arterial line	85	93.1 (=11683/ 12550) [92.6, 93.5]	95.5 (=47623/ 49851) [95.3, 95.7]	98.2 [98.1, 98.3]	47623/ 48490	84.0 [83.4, 84.6]	11683/ 13911	0.94
(N=228) Radial arterial line	85	86.2 (=19932/ 23116) [85.8, 86.7]	96.0 (=79277/ 82550) [95.9, 96.2]	96.1 [96.0, 96.3]	79277/ 82461	85.9 [85.4, 86.3]	19932/ 23205	0.94
(N=175) NIBP	85	100.0 (=1150/1150) [100.0, 100.0]	96.6 (=6723/6957) [96.2, 97.1]	100.0 [100.0, 100.0]	6723/6723	83.1 [81.1, 85.1]	1150/1384	0.93

*Data on File at Edwards Lifesciences

Table 14-13 and table 14-14 provide the hypotensive event occurrence percentage and time-to-event data for a given HPI range for surgical patients in the clinical validation studies (radial arterial line [N=52] and NIBP [N=252]). These data are presented using time windows that have been selected based upon how fast hypotensive events developed on average in surgical patients. Therefore based upon the clinical validation studies (radial arterial line [N=52] and NIBP [N=252]) data, table 14-13 and table 14-14 present data for surgical patients for a time-window of 15 minutes. These analyses are performed by taking samples in each patient from the validation dataset and looking forward in time for a hypotensive event within a 15-minute search window. Once a hypotensive event is found for a given sample then the time-to-event is noted, which is the time duration between the sample and the hypotensive event. The time-to-event statistic is the average event time of all samples that have an event within the search window.

Table 14-15 and table 14-16 provide the hypotensive event occurrence percentage and time-to-event data for a given HPI range for non-surgical patients (in the clinical validation studies (radial arterial line [N=298] and NIBP [N=175])). These data are presented using time windows that have been selected based upon how fast hypotensive events developed on average in non-surgical patients. Therefore based upon the clinical validation studies (radial arterial line [N=298] and NIBP [N=175]) data, table 14-15 and table 14-16 present data for non-surgical patients for a time-window of 120 minutes. This analysis is performed by taking samples in each patient from the validation dataset and looking forward in time for a hypotensive event within a 120-minute search window. Once a hypotensive event is found for a given sample then the time-to-event is noted, which is the time duration between the sample and the hypotensive event. The time-to-event statistic is the average event time of all samples that have an event within the search window.

The event rates, included in table 14-13, table 14-14, table 14-15, and table 14-16, are the ratio of the number of samples that have an event within the search window to the total number of samples. This is done for samples in each of the individual HPI ranges between 10 to 99 as shown in table 14-13, through table 14-16.

The proportion of HPI alarms followed by a hypotensive event in radial arterial line monitored non-surgical patients using a 30 minute time window was determined to be 86.3% [81.6%, 90.8%] for the first validation data set (N=298) and 85.5% [80.8%, 90.6%] for the second validation data set (N=228). This Positive Predictive Value is defined as the ratio of true alarms (that were followed by a hypotensive event within 30 minutes) to the total number of alarms within 30 minutes.

CAUTION The HPI parameter information provided in table 14-13, table 14-14, table 14-15, and table 14-16 are presented as general guidance and may not be representative of individual experience. A review of the patient's hemodynamics is recommended prior to initiating treatment. See *Clinical Application* on page 227.

Table 14-13 Clinical Validation (surgical patients, minimally-invasive radial arterial line monitoring [N=52])

HPI range	Event rate (%)	Time-to-Event in minutes: Median [10 th percentile, 90 th percentile]
10-14	14.2	8.0 [4.7, 12.7]
15-19	16.6	6.7 [3.3, 12.6]
20-24	15.4	7.0 [3.3, 14.0]
25-29	16.9	7.8 [3.7, 13.4]
30-34	22.5	9.0 [3.7, 14.0]
35-39	27.4	8.0 [3.3, 13.3]
40-44	31.8	8.3 [3.0, 13.7]
45-49	40.4	8.3 [3.3, 13.7]
50-54	43.4	7.7 [2.7, 13.3]
55-59	44.3	7.3 [3.0, 13.1]
60-64	57.0	6.7 [2.7, 12.8]
65-69	56.8	5.7 [2.3, 12.3]
70-74	67.2	5.7 [2.0, 11.7]
75-79	81.0	4.7 [2.0, 11.0]
80-84	84.2	5.0 [1.7, 12.3]
85-89	92.9	4.0 [1.7, 10.3]
90-94	95.8	3.7 [1.3, 10.0]
95-99	97.6	1.3 [0.3, 8.0]

Table 14-14 Clinical Validation (surgical patients, noninvasive monitoring [N=252])

HPI Range	Event Rate (%)	Time-to-Event in minutes: Median [10 th percentile, 90 th percentile]
10-14	16.7	8.0 [3.3, 13.3]
15-19	18.5	7.7 [3.3, 13.7]
20-24	18.3	7.7 [3.0, 13.3]

Table 14-14 Clinical Validation (surgical patients, noninvasive monitoring [N=252]) (continued)

25-29	20.6	7.3 [3.0, 13.0]
30-34	22.2	7.3 [2.3, 12.8]
35-39	26.4	7.7 [2.7, 13.3]
40-44	29.3	7.0 [2.3, 13.0]
45-49	35.3	6.3 [2.0, 13.3]
50-54	39.0	5.7 [2.0, 13.3]
55-59	43.8	6.0 [2.0, 12.7]
60-64	47.6	5.8 [1.7, 13.3]
65-69	55.4	5.7 [1.7, 12.3]
70-74	65.4	5.0 [1.3, 12.0]
75-79	74.5	5.3 [1.7, 11.7]
80-84	79.5	4.7 [1.3, 11.3]
85-89	82.6	3.8 [1.0, 11.7]
90-94	89.4	2.7 [1.0, 10.3]
95-99	90.0	1.3 [0.3, 8.0]

Table 14-15 Clinical Validation (non-surgical patients, minimally-invasive radial arterial line monitoring [N=298])

HPI Range	Event Rate (%)	Time-to-Event in minutes: Median [10th percentile, 90th percentile]
10-14	13.8	51.0 [10, 104.0]
15-19	17.2	48.7 [10, 102.3]
20-24	20.8	51.0 [9.9, 105.3]
25-29	25.1	48.5 [9.3, 104.0]
30-34	29.6	48.2 [9.3, 102.3]
35-39	35.2	45.0 [8.3, 102.0]
40-44	38.0	43.7 [7.0, 101.7]
45-49	41.3	39.3 [6.3, 100.0]
50-54	43.7	38.7 [5.7, 99.3]
55-59	46.1	35.3 [5.3, 96.7]
60-64	53.0	28.7 [4.0, 93.7]
65-69	60.2	16.0 [2.7, 88.0]
70-74	67.8	9.0 [1.7, 70.7]

Table 14-15 Clinical Validation (non-surgical patients, minimally-invasive radial arterial line monitoring [N=298]) (continued)

HPI Range	Event Rate (%)	Time-to-Event in minutes: Median [10 th percentile, 90 th percentile]
75-79	76.3	7.0 [1.4, 44.7]
80-84	85.3	5.7 [1.3, 19.0]
85-89	89.9	5.0 [1.0, 16.7]
90-94	94.9	3.6 [1.0, 13.7]
95-99	99.6	1.3 [0.3, 8.3]

Table 14-16 Clinical Validation (non-surgical patients, noninvasive monitoring [N=175])

HPI Range	Event Rate (%)	Time-to-Event in minutes: Median [10 th percentile, 90 th percentile]
10-14	11.7	47.3 [12.3, 102.3]
15-19	14.1	50.3 [12.3, 102.0]
20-24	18.0	46.3 [10.7, 101.7]
25-29	20.7	45.0 [10.0, 102.7]
30-34	22.9	42.7 [9.0, 104.3]
35-39	28.2	40.3 [8.3, 104]
40-44	33.7	37.7 [7.7, 98.6]
45-49	37.7	33.9 [6.7, 93.3]
50-54	40.6	31.7 [5.7, 89.3]
55-59	42.9	27.0 [5.0, 88.0]
60-64	46.8	20.0 [4.0, 90.0]
65-69	60.0	13.7 [3.3, 65.0]
70-74	74.7	8.0 [2.0, 30.7]
75-79	87.4	6.3 [1.7, 16.7]
80-84	95.9	5.0 [1.3, 15.2]
85-89	99.0	4.7 [1.3, 13.7]
90-94	99.5	3.7 [1.0, 12.3]
95-99	99.9	1.3 [0.3, 8.3]

14.1.11 References

- 1 De Hert et al, Evaluation of Left Ventricular Function in Anesthetized Patients Using Femoral Artery dP/dtmax. Journal of Cardiothoracic and Vascular Anesthesia 2006; 20(3): 325-330.

- 2 Tartiere et al, Non-invasive radial pulse wave assessment for the evaluation of left ventricular systolic performance in heart failure. *Eur Journal of Heart Failure* 2007; 9: 477-483.
- 3 Monge Garcia MI, Orduna PS, Cecconi M. Understanding arterial load. *Intensive Care Med* 2016; 42: 1625-1627.
- 4 Monge Garcia MI, Manuel Gracia Romero MG, Cano AG, Aya HD, Rhodes A, Grounds RM, Cecconi M. Dynamic arterial elastance as a predictor of arterial pressure response to fluid administration: a validation study. *Critical Care* 2014; 18: 626-637.
- 5 Cecconi M, Monge Garcia MI, Romero MG, Mellinshof J, Caliandro F, Grounds RM, Rhodes A. 2015. The Use of Pulse Pressure Variation and Stroke Volume Variation in Spontaneously Breathing Patients to Assess Dynamic Arterial Elastance and to Predict Arterial Pressure Response to Fluid Administration. *Anesth Analg* 2015; 120: 76-84.
- 6 Cannesson M, Le Manach Y, Hofer CK, Goarin JP, Lehot JJ, Vallet B, Tavernier B. Assessing the diagnostic accuracy of pulse pressure variations for the prediction of fluid responsiveness. A “gray zone” approach. *Anesthesiology* 2011; 115: 231-241.
- 7 Cannesson M, Musard H, Desebbe O, Boucau C, Simon R, Henaine R, Lehot JJ. The Ability of Stroke Volume Variations Obtained with Vigileo/FloTrac System to Monitor Fluid Responsiveness in Mechanically Ventilated. *Anesth Analg* 2009; 108: 513-517.
- 8 Pinsky MR. Protocolized Cardiovascular Management Based on Ventricular-arterial Coupling. In: *Functional Hemodynamic Monitoring. Update in Intensive Care and Emergency Medicine* (44). Springer-Verlag, Berlin, 2004, pp. 381-395.
- 9 Sunagawa K, Maughan WL, Burkhoff D, Sagawa K. Left ventricular interaction with arterial load studied in isolated canine ventricle. *Am J Physiol, Heart Circ Physiol* 1983; 245: H773-H780.
- 10 Chantler PD, Lakatta EG, Najjar S. Arterial-ventricular coupling: mechanistic insights into cardiovascular performance at rest and during exercise. *J Appl Physiol* 2008; 105: 1342-1351.

14.2 Enhanced Parameter Tracking

The HemoSphere advanced monitoring platform provides tools for performing **Goal Directed Therapy (GDT)**, enabling a user to track and manage key parameters in the optimal range. With enhanced parameter tracking, clinicians have the ability to create and monitor customized protocols.

14.2.1 GDT Tracking

14.2.1.1 Key Parameter and Target Selection

- 1 Touch the GDT tracking icon  on the navigation bar to access the GDT menu screen.



Figure 14-8 GDT Menu Screen - Key Parameter Selection



- 2 Touch the upper half of a **Parameter/Target** selection icon  and choose the desired parameter from the parameter panel. Up to four key parameters can be tracked.
- 3 Touch the lower half of the **Parameter/Target** selection icon  to enter a range value on the keypad. The selected operator (<, ≤, > or ≥) and value represent the upper or lower boundary during parameter tracking. Touch the enter key .



Figure 14-9 GDT Menu Screen - Target Selection

- 4 Touch any selected parameter to change it to a different available parameter or touch **None** on the parameter selection panel to remove it from tracking.
- 5 To view and select parameter/target settings from a previous GDT tracking session, touch the **Recents** tab.
- 6 Touch **OK** to begin GDT tracking.

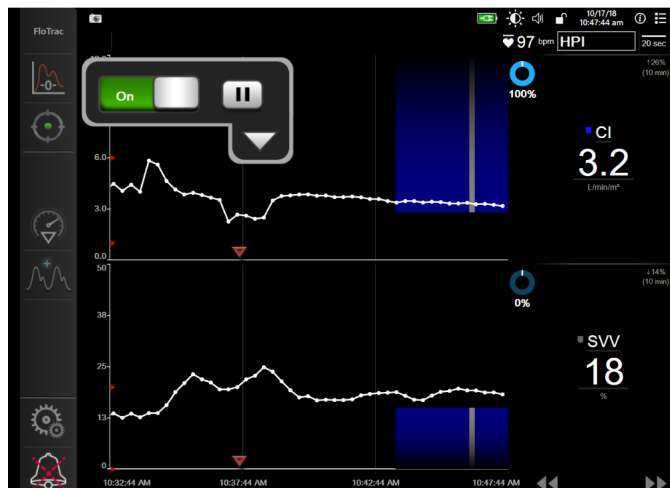

Figure 14-10 GDT Active Tracking

14.2.1.2 Active GDT Tracking

During active GDT tracking, the plot area of the parameter trend graph within targeted range appears shaded in blue. See figure 14-10, “GDT Active Tracking,” on page 240.



GDT Tracking Control Panel. Touch the GDT Tracking button to pause or stop during active tracking. While tracking is paused, the plot area within target range on the parameter graph appears shaded in gray.



Time-In-Target™ Value. This is the primary output of enhanced parameter tracking. It is displayed below the **Time-In-Target** icon on the upper right corner of the parameter’s graphical trend plot. This value represents the accumulated percentage of time a parameter has been within target during an active tracking session.

Parameter Tile Target Indicator Colors. Table 14-17 defines clinical target indicator colors during GDT tracking.

Table 14-17 GDT Target Status Indicator Colors

Color	Indication
Blue	Tracked parameter is currently within the configured target range.
Black	Tracked parameter is currently outside of the configured target range.
Red	Tracked parameter is currently below the low alarm limit or above the high alarm limit.
Gray	Tracked parameter is unavailable, in a fault state, GDT tracking is paused, or a target has not been selected.

Auto Scale Trend Time. Upon initiating active GDT tracking, the graphical trend time is automatically scaled to fit all tracked data for the current session within the plot. The initial Graphical Trend time scale value is set to 15 minutes and increases as tracking time expands beyond 15 minutes. **Auto Scale Trend Time** can be disabled through the set scales popup menu while in GDT mode.

NOTE While viewing active GDT tracking on the Graphical Trend Screen, parameter selection menus are disabled.







14.2.1.3 Historical GDT

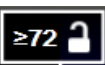

Touch the historical data icon to display recent GDT tracking sessions. A blue “**Viewing Historical GDT Session**” banner will appear at the top of the screen. Current parameter values are displayed on key parameter tiles while viewing a historical GDT session. Touch the scroll buttons to view different historical GDT sessions. Percent change measurements displayed on the trend screen represent percent changes between two historical values.

14.2.2 SV Optimization

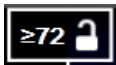
During SV Optimization mode, the SV/SVI target range for GDT tracking is selected based on recent SV trends. This allows the user to identify the optimal SV value during active monitoring of fluid management.

- 1 Touch the GDT tracking icon  on the navigation bar.
- 2 Select **SV** or **SVI** as a key parameter.
- 3 Do NOT specify a target value in the lower half of the **Parameter/Target** selection icon  instead, touch **OK** to begin target selection on the trend graph.
- 4 Observe the SV trend while administering necessary fluid management to achieve an optimal value.
- 5 Touch the add target icon  on the right side of the SV/SVI trend graph. The trend line will turn blue.
- 6 Touch within the plot area to view a trend line value. A target value icon will appear along with an unlocked icon. A horizontal white dashed line will be displayed at 10% below the target cursor value. The area extending from this line to the top of the Y-axis will be shaded blue. 
- 7 If desired, touch the Exit Target Selection button  to return to monitoring of fluid management.
- 8 Touch the target value icon  to accept the displayed target range and initiate GDT tracking.
- 9 The edit target icon  can be touched at anytime after target selection to adjust the SV/SVI target value.
- 10 The GDT tracking icon  can be touched at anytime when GDT mode is active to end the GDT tracking session.



14.2.3 GDT Report Download

The Data Download screen allows a user to export GDT reports to a USB drive. See *Data Download* on page 140.

14.3 Fluid Responsiveness Test

With the **Fluid Responsiveness Test (FRT)**, clinicians have the ability to assess preload responsiveness. Preload responsiveness is assessed by tracking the changes in **SV**, **SVI**, **CO** or **CI** in response to a fluid challenge (**Passive Leg Raise** or **Fluid Bolus**).

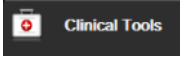
To begin the test:

- 1 Touch the settings icon  → **Clinical Tools** tab .
- 2 Touch **Fluid Responsiveness Test** .

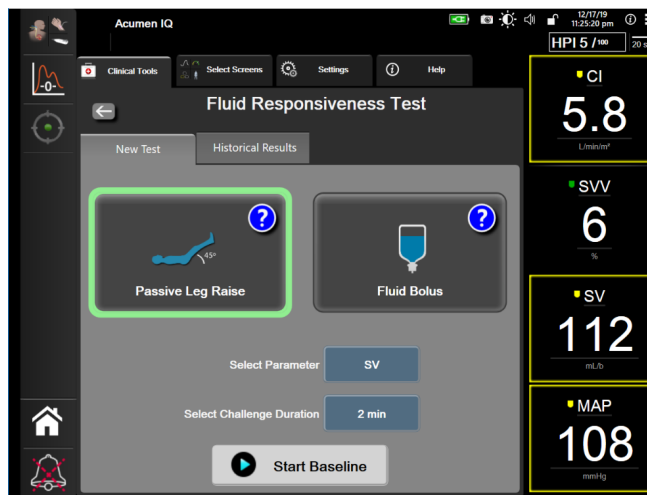

Figure 14-11 Fluid Responsiveness Test – New Test Screen

- 3 On the **New Test** tab (see Figure 14-11), touch the desired test type: **Passive Leg Raise** or **Fluid Bolus**.

Touch the question mark symbol for brief instructions on starting each test. For more detailed instructions, follow the steps below.

NOTE Interpretation of the Fluid Responsiveness Test (FRT) is directly correlated with the response time of the parameter being monitored. Response times of monitored parameters can vary depending on the monitoring mode and are dictated by the connected technology. Update rates for FRT selected parameters while in minimally-invasive mode are based on CO averaging time (see table 6-4 on page 125). For information on response times while in invasive monitoring mode, see table A-11 on page 285.

14.3.1 Passive Leg Raise Test

The **Passive Leg Raise** is a sensitive noninvasive method for assessing a patient's fluid responsiveness. During this test, venous blood transferred from the lower body to the heart simulates a fluid challenge.



- 1 Touch and highlight **Passive Leg Raise** under the **New Test** tab. The **New Test** tab displays test configuration menu options.

- 2 Select the **Parameter** to be analyzed:
 - **SV, SVI, CO, or CI** (**Minimally-Invasive** and **Noninvasive** monitoring modes)
 - **SV_{20s}, SVI_{20s}, CO_{20s}, or CI_{20s}** (**Invasive** monitoring mode with PAP signal; see *20-Second Flow Parameters* on page 153)
- 3 Select the **Challenge Duration**: **1 minute, 1 minute 30 sec, or 2 minutes** (**Minimally-Invasive** and **Noninvasive** monitoring modes) or 3 minutes (**Invasive** monitoring mode).
- 4 Place the patient in a semi-recumbent position. Touch the **Start Baseline** button to begin the baseline measurement.

NOTE The baseline value is averaged from multiple readings. Ensure that the patient remains still and stays in the same position during this measurement period.

- 5 The **Baseline Measurement** screen will appear with a trend graph of the selected parameter and a countdown timer displaying the amount of time remaining for the baseline measurement.

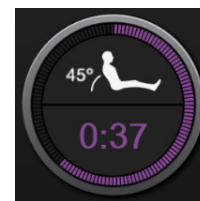

NOTE To abort the baseline measurement, touch the **CANCEL** button and return to the **New Test** screen.

- 6 At the conclusion of the baseline measurement, the baseline value will appear below the trend graph. To remeasure the baseline value, touch **RESTART**.
- 7 To continue to the **Passive Leg Raise Measurement**, place the patient in supine position and touch the **START** button. Passively raise the patient's legs to a 45 degree angle within five seconds. A five second countdown clock will appear to indicate time remaining until the start of the challenge measurement.
- 8 A new countdown timer will appear starting at the selected **Challenge Duration** time. Ensure that the patient remains still during the measurement period.

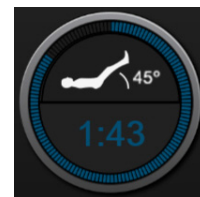

NOTE Before sufficient measurements have been taken, the **CANCEL** button can be touched to abort the test. A confirmation popup window will appear. Touch **Cancel Test** to return to the test configuration screen (**New Test** tab).

After sufficient measurements have been taken, the **CANCEL** button is no longer available. To stop the test and analyze measured data before the full time of the test has been reached touch **END NOW**.

- At the conclusion of the test, the change in the selected **Parameter** value as a response to the fluid challenge will be displayed. See Figure 14-12. Touch the return icon to perform another test, or the home icon to return to the main monitoring screen.



Figure 14-12 Fluid Responsiveness Test – Results Screen

14.3.2 Fluid Bolus Test

The **Fluid Bolus** test is a sensitive method for assessing a patient's fluid responsiveness. During this test, a fluid bolus is administered to the patient and preload responsiveness may be assessed by tracking the value of SV, SVI, CO, or CI.



- Touch and highlight **Fluid Bolus** under the **New Test** tab. The **New Test** tab displays test configuration menu options.
- Select the **Parameter** to be analyzed:
 - SV, SVI, CO, or CI (Minimally-Invasive and Noninvasive monitoring modes)**
 - SV_{20s}, SVI_{20s}, CO_{20s}, or CI_{20s} (Invasive monitoring mode with PAP signal; see *20-Second Flow Parameters* on page 153)**
- Select the **Challenge Duration: 5 minutes, 10 minutes, or 15 minutes.**
- Touch the **Start Baseline** button to begin the baseline measurement.

NOTE The baseline value is averaged from multiple readings. Ensure that the patient remains still and stays in the same position during this measurement period.

- The **Baseline Measurement** screen will appear with a trend graph of the selected parameter and a countdown timer displaying the amount of time remaining for the baseline measurement.

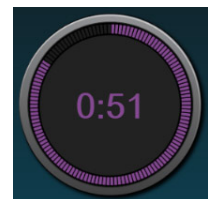

NOTE To abort the baseline measurement, touch the **CANCEL** button and return to the **New Test** screen.

- 6 At the conclusion of the baseline measurement, the baseline value will appear below the trend graph. To remeasure the baseline value, touch **RESTART**.
- 7 To continue to the **Fluid Bolus Measurement**, administer the fluid bolus and touch **START** when the bolus begins.
- 8 A new countdown timer will appear starting at the selected **Challenge Duration** time. Ensure that the patient remains still during the measurement period.

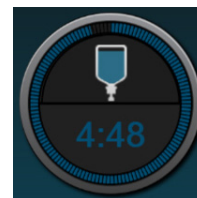

NOTE Before sufficient measurements have been taken, the **CANCEL** button can be touched to abort the test. A confirmation popup window will appear. Touch **Cancel Test** to return to the test configuration screen (**New Test** tab).

After sufficient measurements have been taken, the **CANCEL** button is no longer available. To stop the test and analyze measured data before the full time of the test has been reached touch **END NOW**.

- 9 At the conclusion of the test, change in the selected **Parameter** value as a response to the fluid challenge will be displayed. See Figure 14-12. Touch the return icon to perform another test, or the home icon to return to the main monitoring screen.

14.3.3 Historical Test Results

The user can view previous test results on the **Historical Results** tab. A list of all fluid responsiveness tests for the current patient is shown. Use the scroll buttons to highlight a specific test and touch the **Select** button to view a test summary. A popup window will appear listing the test configurations, key timestamped points and measured **Parameter** values.

Troubleshooting

Contents

On Screen Help246
Monitor Status Lights247
Pressure Cable Communication248
ForeSight Elite Module Sensor Communication249
Pressure Controller Communication250
HemoSphere Advanced Monitor Error Messages251
HemoSphere Swan-Ganz Module Error Messages255
Pressure Cable Error Messages261
HemoSphere ClearSight Module Error Messages266
Venous Oximetry Error Messages272
Tissue Oximetry Error Messages275

The help topics outlined in this chapter and displayed on monitor help screens are associated with common error conditions. In addition to these error conditions, a list of unresolved anomalies and troubleshooting steps are available at eifu.edwards.com. This list is associated with the HemoSphere advanced monitor model number (HEM1) and software version indicated on the startup page (see *Start Up Procedure* on page 67). These issues are continually updated and compiled as a result of ongoing product improvements.

15.1 On Screen Help

The main help screen allows the user navigate to specific help for HemoSphere advanced monitoring platform issues. Faults, alerts and warnings notify the user of error conditions affecting parameter measurements. Faults are technical alarm conditions that suspend parameter measurement. The category help screen provides specific assistance for faults, warnings, alerts, and troubleshooting.

- 1 Touch the settings icon .
- 2 Touch the **Help** button to access the main help screen.
- 3 Touch the **Versions** button to display software versions and serial numbers for the monitor and connected technology module(s)/cable(s).

OR

Touch the category help button corresponding to the technology for which help is needed:

Monitoring, Swan-Ganz Module, Pressure Cable, Oximetry, 20-Second Flow, ClearSight module, or **Tissue Oximetry**.

- 4 Touch the type of help needed based on the message type: **Faults**, **Alerts**, **Warnings**, or **Troubleshooting**.

NOTE The help screens for **20-Second Flow** do not list help categories for system messages. **20-Second Flow** help screens contain information on how to monitor with 20-second parameters and how they are calculated.

- 5 A new screen appears with a list of the selected messages.
- 6 Touch a message or troubleshooting item from the list and touch **Select** to access information for that message or troubleshooting item. To view the full list, use the arrow buttons to move the selection highlight up or down the list. The next screen displays the message along with possible causes and suggested actions.

15.2 Monitor Status Lights

The HemoSphere advanced monitor has a visual alarm indicator to alert the user to alarm conditions. See *Alarm Priorities* on page 303 for more information on medium and high priority physiological alarm conditions. The monitor power button has an integrated LED to indicate the power status at all times.

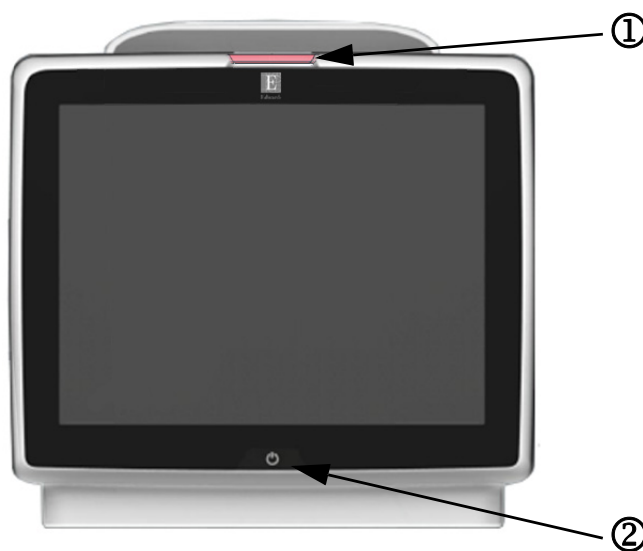

Figure 15-1 HemoSphere advanced monitor LED indicators

① visual alarm indicator

② monitor power status

Table 15-1 HemoSphere advanced monitor visual alarm indicator

Alarm status	Color	Light pattern	Suggested action
High-priority physiological alarm	Red	Flashing ON/OFF	This physiological alarm condition needs immediate attention Refer to the status bar for specific alarm condition
High-priority technical faults and alerts	Red	Flashing ON/OFF	This alarm condition requires immediate attention If a particular technical alarm condition is unrecoverable, restart system If problem persists, contact Edwards Technical Support

Table 15-1 HemoSphere advanced monitor visual alarm indicator

Alarm status	Color	Light pattern	Suggested action
Medium-priority technical faults and alerts	Yellow	Flashing ON/OFF	This alarm condition needs prompt attention Refer to the status bar for specific alarm condition
Medium-priority physiological alarm	Yellow	Flashing ON/OFF	This alarm condition needs prompt attention Refer to the status bar for specific alarm condition
Low-priority technical alert	Yellow	Solid ON	This alarm condition requires non-urgent attention Refer to the status bar for specific alarm condition

Table 15-2 HemoSphere advanced monitor power light

Monitor status	Color	Light pattern	Suggested action
Monitor power ON	Green	Solid ON	None
Monitor power OFF Monitor connected to AC mains Battery charging	Yellow	Flashing ON/OFF	Wait for battery to be charged before unplugging from AC mains.
Monitor power OFF Monitor connected to AC mains Battery not charging	Yellow	Solid ON	None
Monitor power OFF	No light	Solid OFF	None

15.3 Pressure Cable Communication

The pressure cable LED indicates the status of the pressure sensor or transducer.

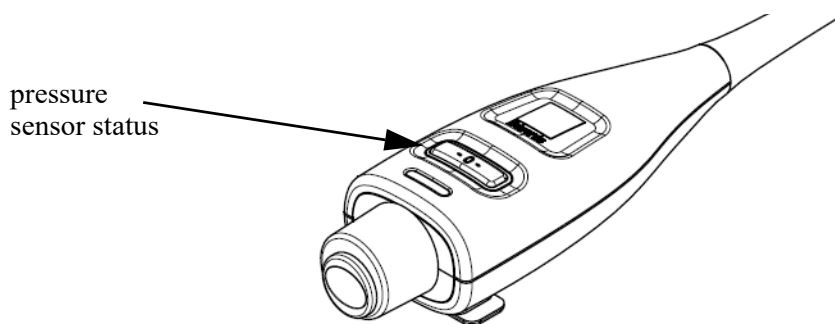

Figure 15-2 Pressure cable LED indicator

Table 15-3 Pressure cable communication light

Condition	Color	Light Pattern	Suggested Action
No pressure sensor/transducer connected	No light	Solid OFF	None
Pressure sensor/transducer connected but not yet zeroed	Green	Flashing ON/OFF	Zero the pressure sensor to begin monitoring
Pressure sensor/transducer zeroed	No light	Solid OFF	None. The connected pressure sensor can actively monitor pressure signal
Pressure sensor/transducer medium priority technical alarm	Yellow	Flashing ON/OFF	Refer to the screen to ascertain the type of technical fault. Use the help menu or tables below for the appropriate suggested action

15.4 ForeSight Elite Module Sensor Communication

The ForeSight Elite tissue oximeter module LED indicates the status of the tissue oximetry sensor channels.

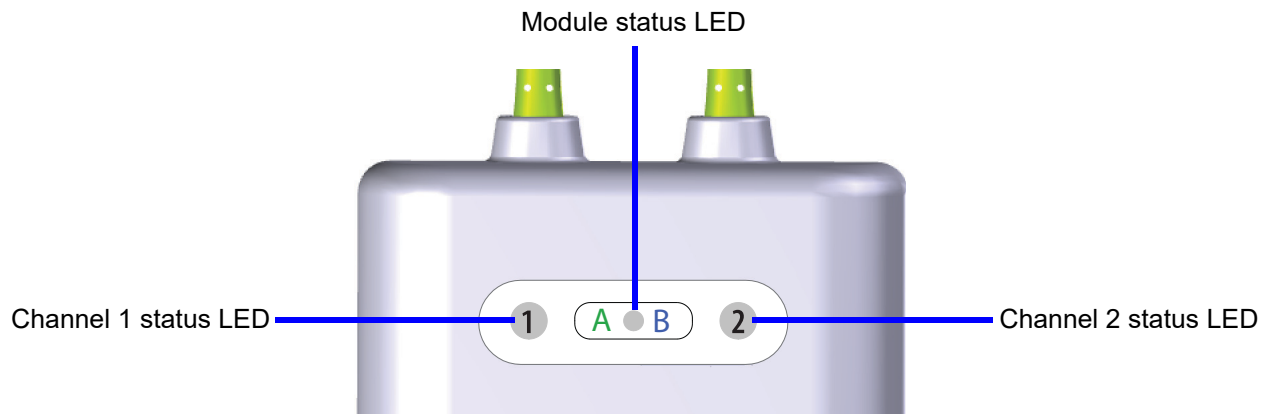

Figure 15-3 ForeSight Elite tissue oximeter module LED indicators

Table 15-4 ForeSight Elite module LED communication lights

LED indicator	Color	Indication
Channel 1 status	White	No sensor connected
	Green	Sensor connected
Channel 2 status	White	No sensor connected
	Green	Sensor connected
Module status	Green	Channels are associated with port A on HemoSphere tissue oximetry module
	Blue	Channels are associated with port B on HemoSphere tissue oximetry module

CAUTION If any of the ForeSight Elite module LEDs fail to turn on, the module must not be used until it has been serviced or replaced. Contact Edwards Technical Support. There is a risk that damaged parts could reduce the performance of the module.

15.5 Pressure Controller Communication

The pressure controller lights indicate the status of the finger cuff(s) and heart reference sensor.

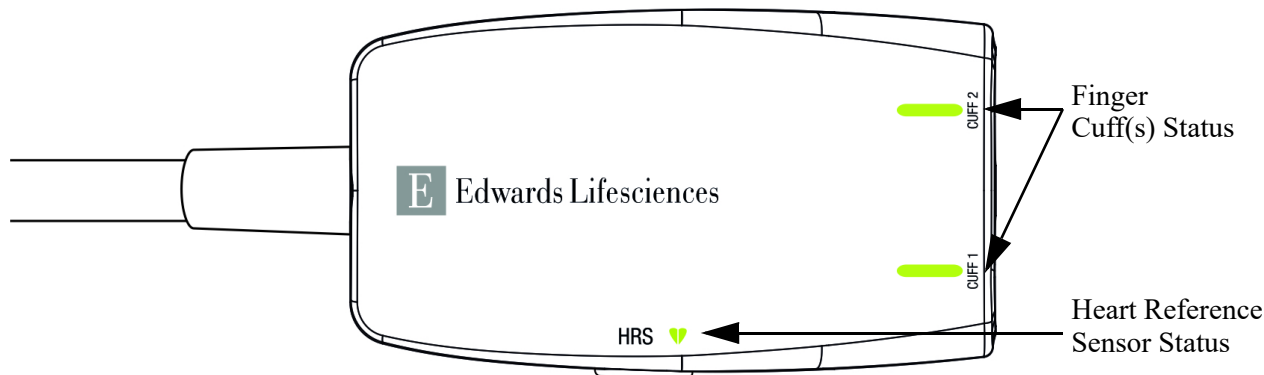

Figure 15-4 Pressure Controller LED Indicators

Table 15-5 Pressure controller communication lights*

Condition	Color	Light Pattern	Suggested Action
<i>CUFF STATUS LIGHT</i>			
No finger cuff connected	No light	Solid OFF	None
Finger cuff connected	Green	Solid ON	None. The connected cuff is detected, authenticated, and not expired.
Active monitoring	Green	Flashing ON/OFF	None. The connected finger cuff is actively monitoring.
Defective finger cuff connected Expired finger cuff connected Non-compatible Edwards finger cuff connected	Amber	Flashing ON/OFF	Verify that a compatible Edwards finger cuff has been used. Disconnect and reconnect the finger cuff. Replace the finger cuff with a compatible Edwards finger cuff. Restart the measurement. If the problem persists, contact Edwards Technical Support.
<i>HEART REFERENCE SENSOR STATUS LIGHT</i>			
No Heart Reference Sensor connected	No light	Solid OFF	None
Heart Reference Sensor connected	Green	Solid ON	None. The system is ready to start a measurement.
Defective Heart Reference Sensor connected Non Edwards Heart Reference Sensor detected	Amber	Flashing ON/OFF	Verify that an Edwards heart reference sensor has been used. Disconnect and reconnect the heart reference sensor. Replace the heart reference sensor with a genuine heart reference sensor. Restart the measurement. If the problem persists, contact Edwards Technical Support.

*Finger cuff error may also be indicated by software. See table 15-20 on page 266.

15.6 HemoSphere Advanced Monitor Error Messages

15.6.1 System/Monitoring Faults/Alerts

Table 15-6 System faults/alerts

Message	Possible causes	Suggested actions
Fault: Module Slot 1 – Hardware Failure	Module 1 is not inserted properly Connection points on slot or module are damaged	Reinsert the module Check for bent or broken pins Try switching to module slot 2 If problem persists, contact Edwards Technical Support
Fault: Module Slot 2 – Hardware Failure	Module 2 is not inserted properly Connection points on slot or module are damaged	Reinsert the module Check for bent or broken pins Try switching to module slot 1 If problem persists, contact Edwards Technical Support
Fault: L-Tech Module Slot – Hardware Failure	Large technology module is not inserted properly Connection points on slot or module are damaged	Reinsert the module Check for bent or broken pins If problem persists, contact Edwards Technical Support
Fault: Cable Port 1 – Hardware Failure	Cable is not inserted properly Connection points on cable or port are damaged	Reinsert the cable Check for bent or broken pins Try switching to cable port 2 If problem persists, contact Edwards Technical Support
Fault: Cable Port 2 – Hardware Failure	Cable is not inserted properly Connection points on cable or port are damaged	Re-insert the cable Check for bent or broken pins Try switching to cable port 1 If problem persists, contact Edwards Technical Support
Fault: Module Slot 1 – Software Failure	There is a software error with the module inserted in module slot 1	Contact Edwards Technical Support
Fault: Module Slot 2 – Software Failure	There is a software error with the module inserted in module slot 2	Contact Edwards Technical Support
Fault: L-Tech Module Slot – Software Failure	There is a software error with the module inserted in the large technology module slot	Contact Edwards Technical Support
Fault: Cable Port 1 – Software Failure	There is a software error with the cable inserted in cable port 1	Contact Edwards Technical Support
Fault: Cable Port 2 – Software Failure	There is a software error with the cable inserted in cable port 2	Contact Edwards Technical Support
Fault: Module Slot 1 – Communication Error	Module 1 is not inserted properly Connection points on slot or module are damaged	Reinsert the module Check for bent or broken pins Try switching to module slot 2 If problem persists, contact Edwards Technical Support
Fault: Module Slot 2 – Communication Error	Module 2 is not inserted properly Connection points on slot or module are damaged	Reinsert the module Check for bent or broken pins Try switching to module slot 1 If problem persists, contact Edwards Technical Support
Fault: L-Tech Module Slot – Communication Error	Large technology module is not inserted properly Connection points on slot or module are damaged	Reinsert the module Check for bent or broken pins If problem persists, contact Edwards Technical Support

Table 15-6 System faults/alerts (continued)

Message	Possible causes	Suggested actions
Fault: Cable Port 1 – Communication Error	Cable is not inserted properly Connection points on cable or port are damaged	Reinsert the cable Check for bent or broken pins Try switching to cable port 2 If problem persists, contact Edwards Technical Support
Fault: Cable Port 2 – Communication Error	Cable is not inserted properly Connection points on cable or port are damaged	Reinsert the cable Check for bent or broken pins Try switching to cable port 1 If problem persists, contact Edwards Technical Support
Fault: Monitor – Incompatible Software Version	Unsuccessful software upgrade or incompatible software version detected	Contact Edwards Technical Support
Fault: Module Slot 1 – Incompatible Software Version	Unsuccessful software upgrade or incompatible software version detected	Contact Edwards Technical Support
Fault: Module Slot 2 – Incompatible Software Version	Unsuccessful software upgrade or incompatible software version detected	Contact Edwards Technical Support
Fault: L-Tech Module Slot – Incompatible Software Version	Unsuccessful software upgrade or incompatible software version detected	Contact Edwards Technical Support
Fault: Cable Port 1 – Incompatible Software Version	Unsuccessful software upgrade or incompatible software version detected	Contact Edwards Technical Support
Fault: Cable Port 2 – Incompatible Software Version	Unsuccessful software upgrade or incompatible software version detected	Contact Edwards Technical Support
Fault: Second Swan-Ganz Module Detected	Multiple Swan-Ganz module connections detected	Disconnect one of the Swan-Ganz modules
Fault: Swan-Ganz Module Disconnected	HemoSphere Swan-Ganz module removed during monitoring HemoSphere Swan-Ganz module not detected Connection points on slot or module are damaged	Confirm that module is properly inserted Remove and re-insert the module Check module for bent or broken pins Try switching to other module slot If problem persists, contact Edwards Technical Support
Fault: Cable Port <#>* – Pressure Cable Disconnected	Pressure cable disconnected during monitoring Pressure cable not detected Bent or missing pressure cable connector pins	Confirm that pressure cable is connected Verify that connection between pressure cable and sensor/transducer is secure Check pressure cable connector for bent/missing pins Disconnect and reconnect pressure cable Try switching to other cable port If problem persists, contact Edwards Technical Support
Fault: Second Oximetry Cable Detected	Multiple oximetry cable connections detected	Disconnect one of the oximetry cables
Fault: Oximetry Cable Disconnected	Oximetry cable connection at HemoSphere advanced monitor not detected Bent or missing oximetry cable connector pins	Verify secure oximetry cable /catheter connection Check oximetry cable connector for bent/missing pins
Fault: HemoSphere ClearSight Module	Defective HemoSphere ClearSight module	Power cycle the system Replace HemoSphere ClearSight module If problem persists, contact Edwards Technical Support
Fault: HemoSphere ClearSight Module Disconnected	HemoSphere ClearSight module removed during monitoring HemoSphere ClearSight module not detected Connection points on slot or module are damaged	Confirm that module is properly inserted Remove and re-insert the module Check module for bent or broken pins If problem persists, contact Edwards Technical Support
Fault: Internal System Failure	Internal system malfunction	Power cycle the system If problem persists, contact Edwards Technical Support

Table 15-6 System faults/alerts (continued)

Message	Possible causes	Suggested actions
Fault: Battery Depleted	The battery is depleted and the system will shut down in 1 minute if not plugged in	Connect the HemoSphere advanced monitor to an alternate source of power to avoid loss of power and resume monitoring
Fault: System Temperature Too High - Shutdown Imminent	The internal temperature of the monitor is at a critically high level Monitor ventilation openings are obstructed	Reposition the monitor away from any heat sources Ensure that the monitor ventilation openings are unobstructed and clear of dust If problem persists, contact Edwards Technical Support
Fault: Pressure-Out – Hardware Failure	Pressure-out cable is not properly connected Connection points on cable or port are damaged	Reinsert the pressure-out cable Check for bent or broken pins If problem persists, contact Edwards Technical Support
Fault: HIS Connectivity Loss	There was a loss in HL7 communication Poor Ethernet connection Poor Wi-Fi connection	Check Ethernet connection Check Wi-Fi connection If problem persists, contact Edwards Technical Support
Fault: Second CO Pressure Sensor Detected	Multiple pressure cables with CO sensor connections detected	Disconnect one of the pressure cable CO sensors
Fault: Wireless Module Failure	There was an internal hardware failure in the wireless module	Disable and re-enable wireless connection.
Alert: System Temperature Too High	The internal temperature of the monitor is reaching a critically high level Monitor ventilation openings are obstructed	Reposition the monitor away from any heat sources Ensure that the monitor ventilation openings are unobstructed and clear of dust If problem persists, contact Edwards Technical Support
Alert: System LED Indicators Inoperable	Visual alarm indicator hardware or communication error Visual alarm indicator malfunction	Power cycle the system If problem persists, contact Edwards Technical Support
Alert: System Buzzer Inoperable	Speaker hardware or software communication error Mainboard speaker malfunction	Power cycle the system If problem persists, contact Edwards Technical Support
Alert: Low Battery	The battery has less than 20% charge remaining or will be depleted within 8 minutes	Connect the HemoSphere advanced monitor to an alternate source of power to avoid loss of power and continue monitoring
Alert: Battery Disconnected	Previously inserted battery not detected Poor battery connection	Confirm battery is properly seated in the battery bay Remove and re-insert the battery pack Change HemoSphere battery pack If problem persists, contact Edwards Technical Support
Alert: Service Battery	Internal battery fault occurred Battery can no longer sustain the system adequately on a full charge	Power cycle the system If condition persists, replace the battery pack
Alert: Transmit Pressure Not Active	Connection of new patient monitor pressure channel detected	Navigate to Zero & Waveform screen, and touch transmit pressure button (waveform icon) after zeroing patient monitor Disconnect pressure-out cable
<i>*Note: <#> is the port number: 1 or 2.</i>		

15.6.2 System/Monitoring Warnings

Table 15-7 HemoSphere advanced monitor warnings

Message	Possible causes	Suggested actions
Battery Needs Conditioning	Gas gauge is not synched to actual battery capacity status	<p>To ensure uninterrupted measurement, make certain the HemoSphere advanced monitor is connected to electrical outlet</p> <p>Condition the battery (ensure a measurement is not active):</p> <ul style="list-style-type: none"> • Connect monitor to an electrical outlet to fully charge battery • Allow the battery to rest in fully charged state for at least two hours • Disconnect the monitor from electrical outlet and continue to run the system on battery power • The HemoSphere advanced monitor will power down automatically when the battery is fully depleted • Allow the battery to rest in fully depleted state for five hours or more • Connect monitor to an electrical outlet to fully charge battery <p>If the condition battery message persists, replace battery pack</p>
Service Battery	Internal battery fault occurred	<p>Power cycle the system</p> <p>If condition persists, replace the battery pack</p>

15.6.3 Numeric Keypad Errors

Table 15-8 Numeric keypad errors

Message	Possible causes	Suggested actions
Value out of range (xx-yy)	The entered value is either higher or lower than the allowed range.	Displayed when the user enters a value that is out of range. The range is displayed as part of the notification replacing the xx and yy.
Value must be \leq xx	The entered value is in range, but is higher than the high value setting such as the high scale setting. xx is the associated value.	Enter a lower value.
Value must be \geq xx	The entered value is in range, but is lower than the low value setting such as the low scale setting. xx is the associated value.	Enter a higher value.
Incorrect password entered	The password entered is incorrect.	Enter the correct password.
Please enter valid time	The time entered is invalid, i.e. 25:70.	Enter the correct time in 12- or 24-hour format.
Please enter valid date	The date entered is invalid, i.e. 33.13.009.	Enter the correct date.

15.7 HemoSphere Swan-Ganz Module Error Messages

15.7.1 CO Faults/Alerts

Table 15-9 HemoSphere Swan-Ganz module CO faults/alerts

Message	Possible causes	Suggested actions
Fault: CO – Blood Temp Out of Range (<31 °C or >41 °C)*	Monitored blood temperature is <31 °C or >41 °C	Verify proper catheter position in the pulmonary artery: <ul style="list-style-type: none"> confirm wedge pressure balloon inflation volume of 1.25 - 1.50 mL confirm appropriate catheter placement for patient's height, weight, and insertion site consider chest x-ray for evaluation of proper placement Resume CO monitoring when blood temperature is within range
Fault: CO – Cardiac Output < 1.0 L/min*	Measured CO < 1.0 L/min	Follow hospital protocol to increase CO Resume CO monitoring
Fault: CO – Catheter Memory, Use Bolus Mode	Poor catheter thermal filament connection Patient CCO cable malfunction Catheter CO error Patient CCO cable is connected to cable test ports	Verify secure thermal filament connection. Check catheter/ patient CCO cable thermal filament connections for bent/missing pins Perform patient CCO cable test Change patient CCO cable Use Bolus CO mode Replace catheter for CO measurement
Fault: CO – Catheter Verification, Use Bolus Mode	Patient CCO cable malfunction Catheter CO error Catheter connected is not an Edwards CCO catheter	Perform patient CCO cable test Change patient CCO cable Use Bolus CO mode Verify catheter is an Edwards CCO catheter
Fault: CO – Check Catheter and Cable Connections	Catheter thermal filament and thermistor connections not detected Patient CCO cable malfunction	Verify patient CCO cable and catheter connections Disconnect thermistor and thermal filament connections and check for bent/missing pins Perform patient CCO cable test Change patient CCO cable
Fault: CO – Check Thermal Filament Connection	Catheter thermal filament connection not detected Patient CCO cable malfunction Catheter connected is not an Edwards CCO catheter	Verify that catheter thermal filament is connected securely to patient CCO cable Disconnect thermal filament connection and check for bent/missing pins Perform patient CCO cable test Change patient CCO cable Verify catheter is an Edwards CCO catheter Use Bolus CO mode
Fault: CO – Check Thermal Filament Position*	Flow around thermal filament may be reduced Thermal filament may be against vessel wall Catheter not in patient	Flush catheter lumens Verify proper catheter positions in the pulmonary artery: <ul style="list-style-type: none"> confirm wedge pressure balloon inflation volume of 1.25 - 1.50 mL confirm appropriate catheter placement for patient's height, weight, and insertion site consider chest x-ray for evaluation of proper placement Resume CO monitoring

Table 15-9 HemoSphere Swan-Ganz module CO faults/alerts (continued)

Message	Possible causes	Suggested actions
Fault: CO – Check Thermistor Connection	Catheter thermistor connection not detected Monitored blood temperature is <15 °C or >45 °C Patient CCO cable malfunction	Verify that catheter thermistor is connected securely to patient CCO cable Verify that blood temperature is between 15 - 45 °C Disconnect thermistor connection and check for bent/missing pins Perform patient CCO cable test Change patient CCO cable
Fault: CO – Signal Processor, Use Bolus Mode	Data processing error	Resume CO monitoring Power monitor off and on to restore system Use Bolus CO mode
Fault: CO – Thermal Signal Loss*	Thermal signal detected by monitor is too small to process Sequential compression device interference	Verify proper catheter position in the pulmonary artery: <ul style="list-style-type: none"> confirm wedge pressure balloon inflation volume of 1.25 - 1.50 mL confirm appropriate catheter placement for patient's height, weight, and insertion site consider chest x-ray for evaluation of proper placement Temporarily turn off sequential compression device per hospital procedure Resume CO monitoring
Fault: Swan-Ganz Module	Electrocautery interference Internal system malfunction	Disconnect patient CCO cable during electrocautery use Remove and reinsert module to reset If problem persists, contact Edwards Technical Support
Alert: CO – Signal Adapting - Continuing	Large pulmonary artery blood temperature variations detected Sequential compression device interference Catheter thermal filament not properly positioned	Allow more time for monitor to measure and display CO Verify proper catheter position in the pulmonary artery: <ul style="list-style-type: none"> confirm wedge pressure balloon inflation volume of 1.25 - 1.50 mL confirm appropriate catheter placement for patient's height, weight, and insertion site consider chest x-ray for evaluation of proper placement Minimizing patient discomfort may reduce temperature variations Temporarily turn off sequential compression device per hospital procedure
Alert: CO – Unstable Blood Temp. - Continuing	Large pulmonary artery blood temperature variations detected Sequential compression device interference	Wait for CO measurement to be updated Minimizing patient discomfort may reduce temperature variations Temporarily turn off sequential compression device per hospital procedure

* These are latching faults. Touch the silence icon to silence. To clear, restart monitoring.

15.7.2 EDV and SV Faults/Alerts

Table 15-10 HemoSphere Swan-Ganz module EDV and SV faults/alerts

Message	Possible causes	Suggested actions
Alert: EDV – Heart Rate Signal Missing	Patient's time-averaged heart rate out of range (HR_{avg} <30 or >200 bpm) No heart rate detected ECG interface cable connection not detected	Wait until average heart rate is within range Select appropriate lead configuration to maximize heart rate triggers Verify cable connection between the HemoSphere advanced monitor and bedside monitor is secure Change ECG interface cable

Table 15-10 HemoSphere Swan-Ganz module EDV and SV faults/alerts (continued)

Message	Possible causes	Suggested actions
Alert: EDV – Exceeding HR Threshold Limit	Patient's time-averaged heart rate out of range ($HR_{avg} < 30$ or > 200 bpm)	Wait until average heart rate is within range Select appropriate lead configuration to maximize heart rate triggers Verify cable connection between the HemoSphere advanced monitor and bedside monitor is secure Change ECG interface cable
Alert: EDV – Signal Adapting - Continuing	Patient's respiratory pattern may have changed Sequential compression device interference Catheter thermal filament not properly positioned	Allow more time for monitor to measure and display EDV Temporarily turn off sequential compression device per hospital procedure Verify proper catheter position in the pulmonary artery: <ul style="list-style-type: none"> confirm wedge pressure balloon inflation volume of 1.25 - 1.50 mL confirm appropriate catheter placement for patient's height, weight, and insertion site consider chest x-ray for evaluation of proper placement
Alert: SV – Heart Rate Signal Missing	Patient's time-averaged heart rate out of range ($HR_{avg} < 30$ or > 200 bpm) No heart rate detected ECG interface cable connection not detected	Wait until average heart rate is within range Select appropriate lead configuration to maximize heart rate triggers Verify cable connection between HemoSphere advanced monitor and bedside monitor is secure Change ECG interface cable

15.7.3 iCO Faults/Alerts

Table 15-11 HemoSphere Swan-Ganz module iCO faults/alerts

Message	Possible causes	Suggested actions
Fault: iCO – Check Injectate Probe Connection	Injectate temperature probe not detected Injectate temperature probe malfunction Patient CCO cable malfunction	Verify connection between patient CCO cable and injectate temperature probe Change injectate temperature probe Change patient CCO cable
Fault: iCO – Check Thermistor Connection	Catheter thermistor connection not detected Monitored blood temperature is < 15 °C or > 45 °C Patient CCO cable malfunction	Verify that catheter thermistor is connected securely to patient CCO cable Verify that blood temperature is between 15 – 45 °C Disconnect thermistor connection and check for bent/missing pins Change patient CCO cable
Fault: iCO – Injectate Volume Not Valid	In-line probe injectate volume must be 5 mL or 10 mL	Change injectate volume to 5 mL or 10 mL Use a bath type probe for an injectate volume of 3 mL
Fault: iCO – Injectate Temperature Out of Range, Check Probe	Injectate temperature < 0 °C, > 30 °C or $> BT$ Injectate temperature probe malfunction Patient CCO cable malfunction	Verify injectate fluid temperature Check injectate probe connections for bent/missing pins Change injectate temperature probe Change patient CCO cable
Fault: iCO – Blood Temperature Out of Range	Monitored blood temperature is < 31 °C or > 41 °C	Verify proper catheter position in the pulmonary artery: <ul style="list-style-type: none"> confirm wedge pressure balloon inflation volume of 1.25 - 1.50 mL confirm appropriate catheter placement for patient's height, weight, and insertion site consider chest x-ray for evaluation of proper placement Resume bolus injections when blood temperature is within range

Table 15-11 HemoSphere Swan-Ganz module iCO faults/alerts (continued)

Message	Possible causes	Suggested actions
Alert: iCO – Unstable Baseline	Large pulmonary artery blood temperature variations detected	Allow more time for blood temperature baseline to stabilize Use Manual mode
Alert: iCO – Curve Not Detected	No bolus injection detected for >4 minutes (Automatic mode) or 30 seconds (Manual mode)	Restart Bolus CO monitoring and proceed with injections
Alert: iCO – Extended Curve	Thermodilution curve slow to return to baseline Injectate port in introducer sheath Possible cardiac shunt	Verify correct injection technique Verify proper catheter position in the pulmonary artery: <ul style="list-style-type: none"> confirm wedge pressure balloon inflation volume of 1.25 - 1.50 mL confirm appropriate catheter placement for patient's height, weight and insertion site consider chest x-ray for evaluation of proper placement Ensure injectate port location is outside of the introducer sheath Use "iced" injectate and/or 10 mL injectate volume to create a large thermal signal
Alert: iCO – Irregular Curve	Thermodilution curve has multiple peaks	Verify correct injection technique Verify proper catheter position in the pulmonary artery: <ul style="list-style-type: none"> confirm wedge pressure balloon inflation volume of 1.25 - 1.50 mL confirm appropriate catheter placement for patient's height, weight, and insertion site consider chest x-ray for evaluation of proper placement Use "iced" injectate and/or 10 mL injectate volume to create a large thermal signal
Alert: iCO – Warm Injectate	Injectate temperature within 8 °C of blood temperature Injectate temperature probe malfunction Patient CCO cable malfunction	Use cooler injectate fluid Change injectate temperature probe Change patient CCO cable

15.7.4 SVR Faults/Alerts

Table 15-12 HemoSphere Swan-Ganz module SVR faults/alerts

Message	Possible causes	Suggested actions
Alert: SVR – Slaved-In Pressures Signal Loss	HemoSphere advanced monitor analog input port not configured to accept MAP and CVP Analog input interface cable connections not detected Inaccurate input signal External monitor malfunction	Verify correct voltage range and low/high voltage values on the HemoSphere advanced monitor for external monitor Verify cable connection between the monitoring platform and bedside monitor is secure Verify correct height/weight entries and units of measure for patient's BSA Check for signal at external monitor's analog output device Change external device module, if used
Alert: SVR – Configure Analog Inputs for SVR Monitoring	HemoSphere advanced monitor analog input ports not configured to accept MAP and CVP signals	Use the analog input settings screen to configure analog input ports 1 and 2 for external monitor MAP and CVP signal output

15.7.5 20-Second Parameters Faults/Alerts

Table 15-13 HemoSphere Swan-Ganz module 20s parameters faults/alerts

Message	Possible causes	Suggested actions
Fault: 20s Parameters – Poor PA Signal Quality	<p>Pulmonary artery pressure waveform is inadequate to measure 20s parameters accurately</p> <p>Poor pressure waveform over extended period of time</p> <p>Integrity of pressure monitoring line is compromised</p> <p>Pressure waveform has shifted or is measuring negative signals due to change in phlebostatic axis or other related movement impacting pressure signal</p>	<p>Verify proper catheter position in the pulmonary artery:</p> <ul style="list-style-type: none"> confirm wedge pressure balloon inflation volume of 1.25 - 1.50 mL confirm appropriate catheter placement for patient's height, weight, and insertion site consider chest x-ray for evaluation of proper placement <p>Make sure the pulmonary artery pressure line is not kinked</p> <p>Make sure there are no loose connections</p> <p>Perform Square Wave Test to assess the frequency response of the system</p> <p>Re-zero pulmonary artery pressure transducer</p>
Fault: 20s Parameters – Software Failure	There is a software error with the 20s parameters	<p>Power cycle the system</p> <p>Re-zero pulmonary artery pressure transducer</p> <p>If problem persists, contact Edwards Technical Support</p>
Alert 20s Parameters – Negative PA Pressure Detected	<p>Pulmonary artery pressure waveform is inadequate to measure 20s parameters accurately</p> <p>Pressure transducer is not aligned with the patient's phlebostatic axis</p> <p>Integrity of pressure monitoring line is compromised</p>	<p>Verify proper catheter position in the pulmonary artery:</p> <ul style="list-style-type: none"> confirm wedge pressure balloon inflation volume of 1.25 - 1.50 mL confirm appropriate catheter placement for patient's height, weight, and insertion site consider chest x-ray for evaluation of proper placement <p>Confirm the pressure transducer is aligned with the patient's phlebostatic axis</p> <p>Zero the pressure transducer on the HemoSphere advanced monitor to re-zero the transducer and confirm pressure cable connection</p>

15.7.6 General Troubleshooting

Table 15-14 HemoSphere Swan-Ganz module general troubleshooting

Message	Possible causes	Suggested actions
Connect HemoSphere Swan-Ganz module for CO monitoring	Connection to the HemoSphere Swan-Ganz module has not been detected	<p>Insert the HemoSphere Swan-Ganz module into slot 1 or slot 2 of the monitor</p> <p>Remove and re-insert module</p>
Connect patient CCO cable for CO monitoring	Connection between the HemoSphere Swan-Ganz module and patient CCO cable has not been detected	<p>Verify connection between patient CCO cable and the inserted HemoSphere Swan-Ganz module</p> <p>Disconnect patient CCO cable and check for bent/missing pins</p> <p>Change patient CCO cable</p>
Connect thermistor for CO monitoring	<p>Connection between patient CCO cable and catheter thermistor has not been detected</p> <p>Patient CCO cable malfunction</p>	<p>Verify that catheter thermistor is connected securely to patient CCO cable</p> <p>Disconnect thermistor connection and check for bent/missing pins</p> <p>Perform patient CCO cable test</p> <p>Change patient CCO cable</p>

Table 15-14 HemoSphere Swan-Ganz module general troubleshooting (continued)

Message	Possible causes	Suggested actions
Connect thermal filament for CO monitoring	Connection between patient CCO cable and catheter thermal filament has not been detected Patient CCO cable malfunction Catheter connected is not an Edwards CCO catheter	Verify that catheter thermal filament is connected securely to patient CCO cable Disconnect thermal filament connection and check for bent/missing pins Perform patient CCO cable test Change patient CCO cable Verify catheter is an Edwards CCO catheter
Connect injectate probe for iCO monitoring	Connection between patient CCO cable and injectate temperature probe not detected Injectate temperature probe malfunction Patient CCO cable malfunction	Verify connection between patient CCO cable and injectate temperature probe Change injectate temperature probe Change patient CCO cable
Connect analog inputs for SVR monitoring	Analog input interface cable connections not detected	Verify cable connection between the monitoring platform and bedside monitor is secure Check for signal at external monitor's analog output device
Configure analog inputs for SVR monitoring	HemoSphere advanced monitor analog input ports not configured to accept MAP and CVP signals	Use the analog input settings screen to configure analog input ports 1 and 2 for external monitor MAP and CVP signal output
Connect ECG Input for EDV or SV monitoring	ECG interface cable connection not detected	Verify cable connection between the HemoSphere advanced monitor and bedside monitor is secure Change ECG interface cable
Connect pressure cable for 20s parameter monitoring	Connection between the HemoSphere advanced monitor and pressure cable has not been detected	Verify connection between pressure cable and monitor Disconnect pressure cable and check for bent/missing pins Change pressure cable
Connect pulmonary artery pressure sensor for 20s parameter monitoring	CO _{20s} , CI _{20s} , SV _{20s} or SVI _{20s} is configured as a key parameter Connection between the pressure cable and a pulmonary artery pressure sensor has not been detected	Verify connection between pressure cable and monitor Disconnect pressure cable and check for bent/missing pins Change pressure cable
Zero pulmonary artery pressure for 20s parameter monitoring	The pulmonary artery pressure signal was not zeroed prior to monitoring	Touch the "Zero & Waveform" icon on the navigation bar
CI > CO	Incorrect patient BSA BSA <1	Verify units of measure and values for patient's height and weight.
CO ≠ iCO	Incorrectly configured bolus information Faulty thermistor or injectate probe Unstable baseline temperature affecting bolus CO measurements	Verify that computation constant, injectate volume, and catheter size have been correctly selected Use "iced" injectate and/or 10 mL injectate volume to create a large thermal signal Verify correct injection technique Change injectate temperature probe
SVR > SVRI	Incorrect patient BSA BSA <1	Verify units of measure and values for patient's height and weight
HemoSphere Advanced Monitor HRavg ≠ External Monitor HR	External monitor not optimally configured for ECG signal output External monitor malfunction ECG interface cable malfunction Elevated patient heart rate HemoSphere advanced monitor uses up to 3 minutes of HR data to calculate HRavg	Stop CO monitoring and verify heart rate is the same for the HemoSphere advanced monitor and external monitor Select appropriate lead configuration to maximize heart rate triggers and minimize atrial spike sensing Verify signal output from external monitoring device Wait for patient's HR to stabilize Change ECG interface cable

Table 15-14 HemoSphere Swan-Ganz module general troubleshooting (continued)

Message	Possible causes	Suggested actions
HemoSphere Advanced Monitor Display of MAP and CVP ≠ External Monitor	HemoSphere advanced monitoring platform configured incorrectly Inaccurate input signal External monitor malfunction	Verify correct voltage range and low/high voltage values on monitoring platform for external monitor Confirm correct units of measure for analog input port voltage values (mmHg or kPa) Verify correct height/weight entries and units of measure for patient's BSA Check for signal at external monitor's analog output device Change analog input interface cable

15.8 Pressure Cable Error Messages

15.8.1 General Pressure Cable Faults/Alerts

Table 15-15 HemoSphere pressure cable general faults/alerts

Message	Possible causes	Suggested actions
Fault: Cable Port <#>* – Pressure Cable	Internal system malfunction	Disconnect and reconnect pressure cable Reposition the cable away from any heat sources or insulating surfaces If the cable body feels warm, allow it to cool before operating again Power monitor off and on to restore platform If problem persists, contact Edwards Technical Support
Fault: Cable Port <#>* – Pressure Sensor	Cable or sensor malfunction Damaged or defective sensor	Disconnect sensor and check for bent/missing contacts Change pressure sensor Change pressure cable If problem persists, contact Edwards Technical Support
Fault: Cable Port <#>* – Pressure Sensor Disconnected	Pressure sensor disconnected during monitoring Cable connections not detected Edwards pressure cable or sensor malfunction Internal system malfunction	Verify catheter connection Verify pressure cable and sensor and check for missing pins Change Edwards pressure cable Change Edwards CO/pressure sensor If problem persists, contact Edwards Technical Support
Fault: Cable Port <#>* – Incompatible Pressure Sensor	A non-Edwards sensor has been detected Cable or sensor malfunction Internal system malfunction	Verify that an Edwards pressure sensor has been used Disconnect sensor and check for bent/missing contacts Change pressure sensor Change pressure cable If problem persists, contact Edwards Technical Support
Fault: Cable Port <#>* – Signal Processing Malfunction	Pressure cable malfunction Data processing error	Disconnect and reconnect pressure cable Power monitor off and on to restore system If problem persists, contact Edwards Technical Support
Alert: Cable Port <#>* – Release Pressure Cable Zero Button	The pressure cable zero button has been depressed for more than 10 seconds Pressure cable malfunction	Release the pressure cable zero button Check that the button releases properly Replace the pressure cable
*note: <#> is the port number: 1 or 2.		

15.8.2 CO Faults/Alerts

Table 15-16 HemoSphere pressure cable CO faults/alerts

Message	Possible causes	Suggested actions
Fault: CO – Check Arterial Waveform	<p>Arterial waveform is inadequate to measure CO accurately</p> <p>Poor pressure waveform over extended period of time</p> <p>Integrity of pressure monitoring line is compromised</p> <p>Systolic pressure too high or diastolic pressure too low</p>	<p>Assess Edwards continuous CO system starting from patient leading to pressure bag</p> <p>Check the arterial waveform for severe hypotension, severe hypertension, and motion artifact</p> <p>Make sure the arterial catheter is not kinked or clotted</p> <p>Make sure all arterial pressure lines are patent and stopcocks are properly positioned</p> <p>Make sure Edwards CO sensor is aligned with the patient's phlebostatic axis</p> <p>Zero the Edwards CO sensor on HemoSphere advanced monitor to zero transducer and confirm pressure cable connection</p> <p>Make sure the pressure bag is inflated and flush bag is at least ¼ full</p> <p>Perform Square Wave Test to assess the Edwards continuous CO system frequency response</p>
Fault: CO – Arterial Waveform Compromised	<p>Edwards pressure cable or sensor malfunction</p> <p>Internal system malfunction</p> <p>Patient condition results in a low pulse pressure</p> <p>Integrity of pressure monitoring line is compromised</p> <p>CO sensor not aligned with the patient's phlebostatic axis</p>	<p>Assess Edwards CO system starting from patient leading to pressure bag</p> <p>Check the arterial waveform for severe hypotension, severe hypertension, and motion artifact</p> <p>Make sure the arterial catheter is not kinked or clotted</p> <p>Make sure all arterial pressure lines are patent and stopcocks are properly positioned</p> <p>Make sure Edwards CO sensor is aligned with the patient's phlebostatic axis</p> <p>Zero the Edwards CO sensor on HemoSphere advanced monitor to zero transducer and confirm pressure cable connection</p> <p>Make sure the pressure bag is inflated and flush bag is at least ¼ full</p> <p>Perform Square Wave Test to assess Edwards CO system frequency response</p> <p>Verify Edwards pressure cable and sensor and check for missing pins</p> <p>Change Edwards pressure cable</p> <p>Change Edwards CO sensor</p> <p>If problem persists, contact Edwards Technical Support</p>
Fault: CO – Arterial Pressure Disconnected	<p>Arterial pressure low and non-pulsatile</p> <p>Arterial catheter disconnected</p> <p>Cable connections not detected</p> <p>Edwards pressure cable or CO sensor malfunction</p> <p>Internal system malfunction</p>	<p>Verify arterial catheter connection</p> <p>Verify Edwards pressure cable and CO sensor and check for missing pins</p> <p>Change Edwards pressure cable</p> <p>Change Edwards CO sensor</p> <p>If problem persists, contact Edwards Technical Support</p>

Table 15-16 HemoSphere pressure cable CO faults/alerts

Message	Possible causes	Suggested actions
Alert: CO – Unstable Arterial Pressure Signal	<p>Arterial waveform inadequate to measure CO accurately</p> <p>Integrity of arterial pressure monitoring line is compromised</p> <p>Systolic pressure too high or diastolic pressure too low</p>	<p>Assess Edwards continuous CO system starting from patient leading to pressure bag</p> <p>Check the arterial waveform for severe hypotension, severe hypertension, and motion artifact</p> <p>Make sure the arterial catheter is not kinked or clotted</p> <p>Make sure all arterial pressure lines are patent and stopcocks are properly positioned</p> <p>Make sure Edwards CO sensor is aligned with the patient's phlebostatic axis</p> <p>Zero the Edwards CO sensor on HemoSphere advanced monitor to zero transducer and confirm pressure cable connection</p> <p>Make sure the pressure bag is inflated and flush bag is at least ¼ full</p> <p>Perform Square Wave Test to assess Edwards continuous CO system frequency response</p>
Alert: CO – Pulse Pressure Low	<p>Integrity of pressure monitoring line is compromised</p> <p>Patient condition results in a low pulse pressure</p>	<p>Assess Edwards CO system starting from patient leading to pressure bag</p> <p>Check the arterial waveform for severe hypotension, severe hypertension, and motion artifact</p> <p>Make sure the arterial catheter is not kinked or clotted</p> <p>Make sure all arterial pressure lines are patent and stopcocks are properly positioned</p> <p>Make sure the Edwards CO sensor is aligned with the patient's phlebostatic axis</p> <p>Zero the Edwards CO sensor on HemoSphere advanced monitor to zero transducer and confirm pressure cable connection</p> <p>Make sure the pressure bag is inflated and flush bag is at least ¼ full</p> <p>Perform Square Wave Test to assess Edwards CO system frequency response</p>
Alert: CO – Pressure Waveform Not Stable	<p>Arterial waveform is inadequate to measure CO accurately</p> <p>Integrity of pressure monitoring line is compromised</p> <p>Systolic pressure too high or diastolic pressure too low</p> <p>Fluid line is being flushed</p>	<p>Assess Edwards continuous CO system starting from patient leading to pressure bag</p> <p>Check the arterial waveform for severe hypotension, severe hypertension, and motion artifact</p> <p>Make sure the arterial catheter is not kinked or clotted</p> <p>Make sure all arterial pressure lines are patent and stopcocks are properly positioned</p> <p>Make sure Edwards CO sensor is aligned with the patient's phlebostatic axis</p> <p>Zero the Edwards CO sensor on HemoSphere advanced monitor to zero transducer and confirm pressure cable connection</p> <p>Make sure the pressure bag is inflated and flush bag is at least ¼ full</p> <p>Perform Square Wave Test to assess the Edwards continuous CO system frequency response</p>

15.8.3 SVR Faults/Alert

Table 15-17 HemoSphere pressure cable SVR faults/alerts

Message	Possible causes	Suggested actions
Alert: SVR – Slaved-In CVP Pressure Signal Loss	HemoSphere advanced monitor analog input port not configured to accept CVP Analog input interface cable connection not detected Inaccurate input signal External monitor malfunction	Verify correct voltage range and low/high voltage values on the HemoSphere advanced monitor for external monitor Verify cable connection between the monitoring platform and bedside monitor is secure Verify correct height/weight entries and units of measure for patient's BSA Check for signal at external monitor's analog output device Change external device module, if used
Alert: SVR – Configure Analog Input or Enter CVP for SVR Monitoring	HemoSphere advanced monitor analog input port not configured to accept CVP signal No CVP value entered	Use the analog input settings screen to configure analog input ports 1 or 2 for external monitor CVP signal output Enter CVP value

15.8.4 MAP Faults/Alert

Table 15-18 HemoSphere pressure cable MAP faults/alerts

Message	Possible causes	Suggested actions
Fault: MAP – Arterial Pressure Disconnected	Arterial pressure low and non-pulsatile Arterial catheter disconnected Cable connections not detected Edwards pressure cable or TruWave sensor malfunction Internal system malfunction	Verify arterial catheter connection Verify connection between pressure cable and sensor and check for missing pins Change pressure cable Change pressure sensor If problem persists, contact Edwards Technical Support
Fault: MAP – Waveform Compromised	Edwards pressure cable or sensor malfunction Internal system malfunction Patient condition results in a low pulse pressure Integrity of pressure monitoring line is compromised CO sensor is not aligned with the patient's phlebostatic axis	Assess Edwards CO system starting from patient leading to pressure bag Check the arterial waveform for severe hypotension, severe hypertension, and motion artifact Make sure the arterial catheter is not kinked or clotted Make sure all arterial pressure lines are patent and stopcocks are properly positioned Make sure Edwards CO sensor is aligned with the patient's phlebostatic axis Zero the Edwards CO sensor on HemoSphere advanced monitor to zero transducer and confirm pressure cable connection Make sure the pressure bag is inflated and flush bag is at least ¼ full Perform Square Wave Test to assess Edwards CO system frequency response Verify Edwards pressure cable and sensor and check for missing pins Change Edwards pressure cable Change Edwards CO sensor If problem persists, contact Edwards Technical Support

Table 15-18 HemoSphere pressure cable MAP faults/alerts (continued)

Message	Possible causes	Suggested actions
Alert: MAP – Pressure Waveform Not Stable	<p>Arterial waveform is inadequate to measure blood pressure accurately</p> <p>Integrity of pressure monitoring line is compromised</p> <p>Systolic pressure too high or diastolic pressure too low</p> <p>Fluid line is being flushed</p>	<p>Assess Edwards pressure monitoring system starting from patient leading to pressure bag</p> <p>Check the arterial waveform for severe hypotension, severe hypertension, and motion artifact</p> <p>Make sure the arterial catheter is not kinked or clotted</p> <p>Make sure all arterial pressure lines are patent and stopcocks are properly positioned</p> <p>Make sure Edwards pressure sensor/transducer is aligned with the patient's phlebostatic axis</p> <p>Zero the Edwards pressure sensor/transducer on HemoSphere advanced monitor and confirm pressure cable connection</p> <p>Make sure the pressure bag is inflated and flush bag is at least ¼ full</p> <p>Perform Square Wave Test to assess the Edwards pressure monitoring system frequency response</p>

15.8.5 General Troubleshooting

Table 15-19 HemoSphere pressure cable general troubleshooting

Message	Possible causes	Suggested actions
Connect pressure cable for CO or pressure monitoring	Connection between the HemoSphere advanced monitor and pressure cable has not been detected	<p>Verify connection between pressure cable and monitor</p> <p>Disconnect pressure cable and check for bent/missing pins</p> <p>Change pressure cable</p>
Connect CO pressure sensor for CO monitoring	<p>A CO-dependent key parameter is configured</p> <p>Connection between the pressure cable and CO pressure sensor has not been detected</p> <p>The incorrect pressure sensor type is connected</p>	<p>Verify connection between pressure cable and catheter</p> <p>Verify that the pressure sensor connected is for CO monitoring</p> <p>Disconnect pressure cable and check for missing pins</p> <p>Change Edwards CO sensor</p> <p>Change pressure cable</p>
Connect pressure sensor for arterial pressure monitoring	<p>An arterial pressure-dependent key parameter is configured</p> <p>Connection between the pressure cable and an arterial pressure sensor has not been detected</p>	<p>Verify connection between pressure cable and catheter</p> <p>Disconnect pressure cable and check for missing pins</p> <p>Change Edwards pressure sensor</p> <p>Change pressure cable</p>
Connect pressure sensor for pulmonary artery monitoring	<p>MPAP is configured as a key parameter</p> <p>Connection between the pressure cable and a pulmonary artery pressure sensor has not been detected</p>	<p>Verify connection between pressure cable and catheter</p> <p>Disconnect pressure cable and check for missing pins</p> <p>Change Edwards pressure sensor</p> <p>Change pressure cable</p>
Connect pressure sensor for CVP monitoring	<p>CVP is configured as a key parameter</p> <p>Connection between the pressure cable and a central venous pressure sensor has not been detected</p>	<p>Verify connection between pressure cable and catheter</p> <p>Disconnect pressure cable and check for missing pins</p> <p>Change Edwards pressure sensor</p> <p>Change pressure cable</p>
Zero arterial pressure for CO monitoring	The arterial pressure signal was not zeroed prior to CO monitoring	Touch the "Zero & Waveform" icon on the navigation bar or from the Clinical Actions Menu to zero pressure
Zero pressure for arterial pressure monitoring	The arterial pressure signal was not zeroed prior to monitoring	Touch the "Zero & Waveform" icon on the navigation bar or from the Clinical Actions Menu to zero pressure
Zero pressure for pulmonary artery monitoring	The pulmonary artery pressure signal was not zeroed prior to monitoring	Touch the "Zero & Waveform" icon on the navigation bar or from the Clinical Actions Menu to zero pressure
Zero pressure for CVP monitoring	The central venous pressure signal was not zeroed prior to monitoring	Touch the "Zero & Waveform" icon on the navigation bar or from the Clinical Actions Menu to zero pressure

Table 15-19 HemoSphere pressure cable general troubleshooting (continued)

Message	Possible causes	Suggested actions
Connect CVP analog input or enter CVP value for SVR monitoring	CVP cable connection not detected No CVP value entered	Verify cable connection between the HemoSphere advanced monitor and bedside monitor is secure Change CVP cable Enter CVP value
Configure CVP analog input or enter CVP for SVR monitoring	HemoSphere advanced monitor analog input port not configured to accept CVP signal No CVP value entered	Use the analog input settings screen to configure analog input ports 1 or 2 for external monitor CVP signal output Enter CVP value
CI > CO	Incorrect patient BSA BSA <1	Verify units of measure and values for patient's height and weight.
SVR > SVRI	Incorrect patient BSA BSA <1	Verify units of measure and values for patient's height and weight

15.9 HemoSphere ClearSight Module Error Messages

15.9.1 Faults/Alerts

Table 15-20 HemoSphere ClearSight module faults/alerts

Message	Possible causes	Suggested actions
Fault: Finger Cuff <#>* – BP Measurement Error	Blood pressure measurement failed due to movement or poor measurement conditions	Apply finger cuff to a different finger Resize finger cuff and replace finger cuff with different size Restart measurement
Fault: Finger Cuff <#>* – Sensor Light Out of Range	Light signal too high	Warm the hand Apply finger cuff to a different finger Resize finger cuff and replace finger cuff with different size Restart measurement
Fault: Finger Cuff <#>* – No Signal Detected – Low Perfusion	No measurable Plethysmogram detected on startup Possibly contracted arteries	Warm the hand Apply finger cuff to a different finger Restart measurement
Fault: Finger Cuff <#>* – No Pressure Waveforms Detected	The system failed to detect pressure waveforms Pressure pulsations in finger diminished due to pressure applied to the upper arm, elbow or wrist	Check if the blood flow in the arm of the patient is free of obstructions Check the blood pressure waveforms Reapply finger cuff(s) Restart measurement
Fault: Insufficient Pressure Build Up in Cuff <#>*	Finger cuff tube kinked Finger cuff leaking Cable between HemoSphere ClearSight module and pressure controller kinked or leaking Defective pressure controller Defective HemoSphere ClearSight module	Check finger cuff Check cable between HemoSphere ClearSight module and pressure controller Replace finger cuff Replace pressure controller Replace HemoSphere ClearSight module Restart measurement
Fault: Finger Cuff Disconnected	Previously connected finger cuff(s) not detected	Disconnect and reconnect Edwards finger cuff(s). Replace finger cuff(s) Restart measurement

Table 15-20 HemoSphere ClearSight module faults/alerts

Message	Possible causes	Suggested actions
Fault: Accumulated Single Cuff Monitoring Has Reached The Duration Limit	Cumulative measurement on the same finger exceeded maximum duration of 8 hours	Remove cuff from finger Place the cuff on another finger and press 'Continue' on the Popup Restart measurement
Fault: Finger Cuff <#>* Has Expired – Replace Cuff	Finger Cuff <#>* has exceeded maximum use time	Replace Finger Cuff <#>* Restart measurement
Fault: Invalid Finger Cuff <#>* Connected	Non Edwards finger cuff <#>* detected Defective finger cuff <#>* connected	Verify that an Edwards finger cuff has been used Disconnect and reconnect Edwards finger cuff <#>* Replace finger cuff <#>* with a genuine Edwards cuff Restart measurement If problem persists, contact Edwards Technical Support
Fault: Finger Cuff <#>* or Finger Cuff Connector Error	Finger cuff <#>* is defective Cuff connector on pressure controller is damaged or defective	Disconnect and reconnect Edwards finger cuff <#>* Replace finger cuff <#>* Replace pressure controller Restart measurement If problem persists, contact Edwards Technical Support
Fault: HRS Value Out of Physiological Range	Heart end of HRS is loose and may no longer be at heart level HRS detached from finger cuff HRS incorrectly zeroed HRS is defective	Verify HRS placement. Finger end should be attached to finger cuff and heart end should be placed at phlebostatic axis Vertically align the two ends of HRS and re-zero Replace HRS Restart Measurement If problem persists, contact Edwards Technical Support
Fault: HRS Disconnected	Heart Reference Sensor (HRS) disconnected during monitoring HRS connection not detected	Verify HRS connection Disconnect and reconnect Edwards HRS Replace HRS If problem persists, contact Edwards Technical Support
Fault: HRS Detected	Measurement without HRS chosen but HRS is connected	Disconnect HRS Select to measure with HRS
Fault: Invalid HRS Connected	Non Edwards HRS detected HRS is defective	Verify that an Edwards HRS has been used Disconnect and reconnect Edwards HRS Replace HRS with a genuine Edwards HRS Restart Measurement If problem persists, contact Edwards Technical Support
Fault: HRS or HRS Connector Error	HRS is defective HRS connector on pressure controller is damaged	Disconnect and reconnect Edwards HRS Replace HRS Replace pressure controller Restart measurement If problem persists, contact Edwards Technical Support
Fault: HRS Has Expired. Replace HRS	HRS has expired as it is past useful life	Disconnect and reconnect Edwards HRS Replace HRS Restart Measurement If problem persists, contact Edwards Technical Support
Fault: Pressure Controller Disconnected	Pressure controller connection not detected	Disconnect and reconnect Edwards pressure controller Replace pressure controller If problem persists, contact Edwards Technical Support

Table 15-20 HemoSphere ClearSight module faults/alerts

Message	Possible causes	Suggested actions
Fault: Invalid Pressure Controller Connected	Incompatible pressure controller detected Non Edwards pressure controller detected Defective pressure controller connected	Verify that an Edwards pressure controller has been used Disconnect and re-connect Edwards pressure controller Replace pressure controller with a genuine Edwards pressure controller If problem persists, contact Edwards Technical Support
Fault: Pressure Controller Communication Error	Unresponsive pressure controller Poor connection between pressure controller and HemoSphere ClearSight module Pressure controller authentication failure Defective pressure controller Defective HemoSphere ClearSight module	Disconnect and reconnect Edwards pressure controller Power cycle the system Replace pressure controller Replace HemoSphere ClearSight module If Problem Persists, contact Edwards Technical Support
Fault: Pressure Controller Error	Defective pressure controller Poor connection between Edwards pressure controller and HemoSphere ClearSight module	Disconnect and reconnect Edwards pressure controller Replace pressure controller If problem persists, contact Edwards Technical Support
Fault: Pressure Controller Power Failure	Defective HemoSphere ClearSight module Defective pressure controller	Disconnect and reconnect Edwards pressure controller Replace pressure controller Replace HemoSphere ClearSight module If Problem Persists, contact Edwards Technical Support
Fault: Incompatible Pressure Controller Software	Unsuccessful software upgrade or incompatible software version detected	Replace pressure controller with a genuine Edwards pressure controller If problem persists, contact Edwards Technical Support
Fault: Continuous Monitoring Has Reached the 72 Hour Limit	Continuous measurement on the same hand exceeded maximum duration of 72 hours	Place the cuffs on fingers of opposite hand and resume monitoring
Fault: Air Supply Error	Kinked or damaged pressure controller cable Damaged finger cuff System malfunction Defective HemoSphere ClearSight module Defective pressure controller	Verify that connection between pressure controller and HemoSphere ClearSight module is not kinked or damaged Power cycle the system Replace pressure controller Replace HemoSphere ClearSight module Replace finger cuff If problem persists, contact Edwards Technical Support
Fault: CO – Check Arterial Waveform	Arterial waveform is inadequate to measure CO accurately Poor pressure waveform over extended period of time Systolic pressure too high or diastolic pressure too low	Assess noninvasive system starting from patient leading to finger cuff and HemoSphere ClearSight module Check the arterial waveform for severe hypotension, severe hypertension, and motion artifact Make sure the heart end of Edwards HRS is aligned with the patient's phlebostatic axis Confirm electrical connections of cables Apply finger cuff to a different finger Resize finger cuff and replace finger cuff with different size If problem persists, contact Edwards Technical Support
Fault: CO – Arterial Waveform Compromised	The system failed to detect pressure waveforms Pressure pulsations in finger diminished due to pressure applied to the upper arm, elbow, or wrist	Check if the blood flow in the arm of the patient is free of obstructions Make sure the heart end of Edwards HRS is aligned with the patient's phlebostatic axis Check the blood pressure waveforms Reapply finger cuff(s) Restart measurement If problem persists, contact Edwards Technical Support

Table 15-20 HemoSphere ClearSight module faults/alerts

Message	Possible causes	Suggested actions
Fault: Cuff Disconnected During Double Cuff Monitoring	Previously connected finger cuff(s) not detected	Disconnect and reconnect Edwards finger cuff(s) Replace finger cuff(s) Restart measurement
Fault: Second Cuff Connected During Single Cuff Monitoring	A second finger cuff connection is detected	Disconnect one of the finger cuffs and restart measurement Restart measurement in double cuff monitoring mode
Alert: CO – Pulse Pressure Low	Poor pressure waveform over extended period of time Patient condition results in a low pulse pressure	Assess noninvasive system starting from patient leading to finger cuff and HemoSphere ClearSight module Check the arterial waveform for severe hypotension, severe hypertension, and motion artifact Make sure the heart end of Edwards HRS is aligned with the patient's phlebostatic axis Apply finger cuff to a different finger Resize finger cuff and replace finger cuff with different size If problem persists, contact Edwards Technical Support
Alert: CO – Pressure Waveform Not Stable	Arterial waveform is inadequate to measure CO accurately Poor pressure waveform over extended period of time Systolic pressure too high or diastolic pressure too low	Assess noninvasive system starting from patient leading to finger cuff and HemoSphere ClearSight module Check the arterial waveform for severe hypotension, severe hypertension, and motion artifact Make sure the heart end of Edwards HRS is aligned with the patient's phlebostatic axis Confirm electrical connections of cables Apply finger cuff to a different finger Resize finger cuff and replace finger cuff with different size If problem persists, contact Edwards Technical Support
Alert: Cuff Pressure Release Mode – Monitoring Suspended	Finger cuff pressure has been released	Monitoring will automatically resume when the countdown clock on the status bar reaches 00:00 To resume monitoring, touch the countdown clock and select "Postpone Release"
Alert: SVV – Check Blood Pressure Waveform	Arterial waveform is inadequate to measure SVV accurately Poor pressure waveform over extended period of time Frequent Physiocals within waveform Systolic pressure too high or diastolic pressure too low	Assess noninvasive system starting from patient leading to finger cuff and HemoSphere ClearSight module Check the arterial waveform for severe hypotension, severe hypertension, and motion artifact Make sure the heart end of Edwards HRS is aligned with the patient's phlebostatic axis Confirm electrical connections of cables Apply finger cuff to a different finger Resize finger cuff and replace finger cuff with different size
Alert: Finger Cuff <#>* – BP Measurement Error – Restarting	Blood pressure measurement failed due to movement or poor measurement conditions	Allow system to automatically resolve issue Apply finger cuff to a different finger Resize finger cuff and replace finger cuff with different size
Alert: Finger Cuff <#>* – No Pressure Waveforms Detected	The system failed to detect pressure waveforms Pressure pulsations in finger diminished due to pressure applied to the upper arm, elbow or wrist	Allow System to automatically resolve issue Check if the blood flow in the arm of the patient is free of obstructions Check the blood pressure waveforms Reapply finger cuff(s)

Table 15-20 HemoSphere ClearSight module faults/alerts

Message	Possible causes	Suggested actions
Alert: HRS Value Out of Physiological Range	Heart end of HRS is loose and may no longer be at heart level HRS detached from finger cuff HRS incorrectly zeroed HRS is defective	Verify HRS placement. Finger end should be attached to finger cuff and heart end should be placed at phlebostatic axis Vertically align the two ends of HRS and re-zero Replace HRS If problem persists, contact Edwards Technical Support
Alert: No HRS Connected – Verify Patient Positioning Alert: Current Offset: Finger <offset amount> Above Heart Alert: Current Offset: Finger at Heart Level Alert: Current Offset: Finger <offset amount> Below Heart	The patient positioning mode is “Patient Sedated and Stationary” and an HRS is not connected	Verify that the displayed offset is still accurate If the patient has been re-positioned, update the offset value on the “Zero & Waveform” screen
Alert: HemoSphere ClearSight Module Service Required	HemoSphere ClearSight module service time is overdue	Replace HemoSphere ClearSight module Contact Edwards Technical Support
<i>*note: <#> is the CUFF port number: 1 or 2</i>		

Table 15-21 HemoSphere ClearSight warnings

Message	Possible causes	Suggested actions
HRS Out of Range	HRS pressure offset exceeded limit during the zeroing process HRS is defective	Vertically align the two ends of HRS Zero HRS Replace HRS
HRS Zero Unsuccessful – No Movement Detected	Prior to zero, no HRS movement detected Defective HRS Defective pressure controller	Move heart end of HRS up and down. Next, keep both ends at same level, wait 1-2 seconds, and then re-zero while keeping both ends steady Replace HRS and re-zero HRS If problem persists, contact Edwards Technical Support
HRS Zero Unsuccessful – Excessive Movement Detected	During zero, HRS movement detected Defective pressure controller	Move heart end of HRS up and down. Next, keep both ends at same level, wait 1-2 seconds, and then re-zero while keeping both ends steady Replace HRS and re-zero HRS If problem persists, contact Edwards Technical Support
Unstable Arterial Pressure	System detecting large variability in the arterial pressure due to physiological or artificial noise	Ensure no external or artificial noise is interfering with arterial pressure measurements Stabilize arterial pressure
BP Calibration Unavailable	Insufficient monitoring data has been collected Blood pressure values from past 1 minute are too variable for a reliable calibration Non-physiological noise or artifacts are detected in the pressure signal	Allow for additional monitoring time and try again Stabilize arterial pressure Ensure no external or artificial noise is interfering with arterial pressure measurements
Finger Cuff <#>* – No Signal Detected – Low Perfusion – Restarting	No measurable Plethysmogram detected on startup Possibly contracted arteries	Allow system to automatically resolve issue Warm the hand Apply finger cuff to a different finger
ClearSight Cuff Use Not Recommended For Patient Age < 18 yrs	Non invasive BP measurement technology not validated for patients under 18 years of age	Measurement with an alternate BP / Cardiac Output technology recommended
Connect HemoSphere ClearSight module for CO or pressure monitoring	Connection to the HemoSphere ClearSight module has not been detected	Insert HemoSphere ClearSight module into the large technology module slot of the monitor Remove and re-insert module

Table 15-21 HemoSphere ClearSight warnings (continued)

Message	Possible causes	Suggested actions
Finger Cuff <#>* – Sensor Light out of Range – Restarting	Light signal too high	Allow system to automatically resolve issue Warm the hand Apply finger cuff to a different finger Resize finger cuff and replace finger cuff with different size
Insufficient Pressure Build Up in Cuff <#>* – Restarting	Finger cuff air tube kinked Finger cuff leaking Cable between HemoSphere ClearSight module and pressure controller kinked or leaking Defective pressure controller Defective HemoSphere ClearSight module	Check finger cuff Check cable between HemoSphere ClearSight module and pressure controller Replace finger cuff Replace pressure controller Replace HemoSphere ClearSight module Restart measurement
Severe Vasoconstriction	Very small arterial volume pulsations detected, possibly contracted arteries	Allow System to automatically resolve issue Warm the hand Apply finger cuff to a different finger Resize finger cuff and replace finger cuff with different size
Moderate Vasoconstriction	Very small arterial volume pulsations detected, possibly contracted arteries	Allow system to automatically resolve issue Warm the hand Apply finger cuff to a different finger Resize finger cuff and replace finger cuff with different size
Finger Cuff <#>* – Pressure Waveform Oscillations Detected	Possibly contracted arteries Finger cuff too loose	Allow system to automatically resolve issue Warm the hand Apply finger cuff to a different finger Resize finger cuff and replace finger cuff with different size
Connect Pressure Controller	Pressure Controller not connected. Defective Pressure Controller connected.	Connect pressure controller. Replace pressure controller. If problem persists, contact Edwards Technical Support.
Finger Cuff <#>* Expiration in < 5 minutes	Finger cuff <#>* approaching maximum use time	Replace finger cuff <#>* to ensure uninterrupted measurement
Finger Cuff <#>* Has Expired	Finger cuff <#>* has exceeded maximum use time	Replace finger cuff <#>* Restart measurement
Connect Finger Cuff	No Finger Cuff(s) detected. Defective Finger Cuff(s) connected.	Connect finger cuff(s) Replace finger cuff(s)
Finger Cuff <#>* Approaching Maximum Use Time	Finger cuff <#>* approaching maximum use time	Replace finger cuff <#>* to ensure uninterrupted measurement
Switched Cuff – Restarting	Monitoring has stopped on one finger cuff and is switching to other connected finger cuff	Wait for monitoring to automatically resume using second finger cuff
Connect HRS	HRS connection not detected	Connect HRS Replace HRS
Zero HRS	HRS not zeroed	Ensure HRS connected and zero HRS to start measurement
HRS Expires in <2 weeks	HRS will expire in less than 2 weeks	Replace HRS to prevent delay in start of monitoring
HRS Expires in <4 weeks	HRS will expire in less than 4 weeks	Replace HRS to prevent delay in start of monitoring
HemoSphere ClearSight Module Service Required	HemoSphere ClearSight module service time is approaching	Replace HemoSphere ClearSight module Contact Edwards Technical Support

Table 15-22 HemoSphere ClearSight general troubleshooting

Message	Possible causes	Suggested actions
Pressure Difference: ClearSight BP vs. Other BP	HRS detached from Finger Cuff or phlebostatic axis HRS not properly zeroed Possibly contracted arteries (due to cold fingers) Finger Cuff too loose Other BP measurement device not zeroed Other BP measurement sensor incorrectly applied	Verify HRS placement - The finger end should be attached to Finger Cuff and heart end should be placed at phlebostatic axis In case of invasive BP reference, HRS heart end and the transducer should be at the same level Rezero HRS Warm the hand Reapply Finger Cuff (to a different finger) or replace Finger Cuff with proper size Re-zero other BP measurement device Remove and reapply other BP measurement sensor
Connect Acumen IQ Cuff for HPI	Acumen IQ Cuff is not detected and HPI or HPI key parameter is configured	Connect Acumen IQ cuff Replace Acumen IQ cuff
Connect Acumen IQ Cuff In CUFF 1 for HPI	CUFF 1 connection is not an Acumen IQ Cuff and HPI or HPI key parameter is configured	Replace ClearSight cuff for Acumen IQ cuff in CUFF 1
Connect Acumen IQ Cuff in CUFF 2 for HPI	CUFF 2 connection is not an Acumen IQ Cuff and HPI or HPI key parameter is configured	Replace ClearSight cuff for Acumen IQ cuff in CUFF 2
Connect HRS for HPI	HRS is not detected and HPI or HPI key parameter is configured	Connect HRS Replace HRS

15.10 Venous Oximetry Error Messages

15.10.1 Venous Oximetry Faults/Alerts

Table 15-23 Venous oximetry faults/alerts

Message	Possible causes	Suggested actions
Fault: Venous Oximetry – Light Range	Poor oximetry cable/catheter connection Debris or film obstructing oximetry cable/catheter connector lens Oximetry cable malfunction Catheter kinked or damaged	Verify secure oximetry cable /catheter connection Clean oximetry cable /catheter connectors with 70% isopropyl alcohol and swab, let air-dry and recalibrate Change oximetry cable and recalibrate Replace catheter if damage is suspected and recalibrate
Fault: Venous Oximetry – Red/IR Transmit	Debris or film obstructing oximetry cable / catheter connector lens Oximetry cable malfunction	Clean oximetry cable / catheter connectors with 70% isopropyl alcohol and swab, let air dry and recalibrate Power monitor off and on to restore platform Change oximetry cable and recalibrate
Fault: Venous Oximetry – Value Out of Range	Incorrectly entered ScvO ₂ /SvO ₂ , HGB or Hct values Incorrect HGB units of measure Calculated ScvO ₂ /SvO ₂ value is outside of the 0-99% range	Verify correctly entered ScvO ₂ /SvO ₂ , HGB, and Hct values Verify correct HGB units of measure Obtain updated ScvO ₂ /SvO ₂ lab values and recalibrate
Fault: Venous Oximetry – Input Signal Unstable	Poor oximetry cable/catheter connection Debris or film obstructing oximetry cable/catheter connector lens Oximetry cable malfunction Catheter kinked or damaged	Verify secure oximetry cable /catheter connection Clean oximetry cable /catheter connectors with 70% isopropyl alcohol and swab, let air-dry and recalibrate Change oximetry cable and recalibrate Replace catheter if damage is suspected and recalibrate
Fault: Venous Oximetry – Signal Processing Malfunction	Oximetry cable malfunction	Power monitor off and on to restore platform Change oximetry cable and recalibrate If problem persists, contact Edwards Technical Support

Table 15-23 Venous oximetry faults/alerts (continued)

Message	Possible causes	Suggested actions
Fault: Oximetry Cable Memory	Oximetry cable memory malfunction	Disconnect and then reconnect the cable Change oximetry cable and recalibrate
Fault: Oximetry Cable Temperature	Oximetry cable malfunction	Power monitor off and on to restore platform Change oximetry cable and recalibrate If the cable is wrapped in fabric or sitting on an insulating surface such as a pillow, place it on a smooth surface that allows it to readily dissipate heat If the cable body feels warm, allow it to cool before operating again If problem persists, contact Edwards Technical Support
Fault: Oximetry Cable Malfunction	Internal system malfunction	Power monitor off and on to restore platform If problem persists, contact Edwards Technical Support
Alert: Venous Oximetry – Poor Signal Quality	Low blood flow at catheter tip or catheter tip against vessel wall Significant change in HGB/Hct values Catheter tip clotted Catheter kinked or damaged Catheter is not connected to oximetry cable	If the cable is wrapped in fabric or sitting on an insulating surface such as a pillow, place it on a smooth surface that allows it to readily dissipate heat If the cable body feels warm, allow it to cool before operating again Verify proper catheter position (for SvO ₂ , verify proper catheter position in the pulmonary artery): <ul style="list-style-type: none"> • Confirm wedge pressure balloon inflation volume of 1.25-1.50 ml (for SvO₂ only) • Confirm appropriate catheter placement for patient's height, weight, and insertion site • Consider chest x-ray evaluation of proper placement Aspirate then flush distal lumen per hospital protocol Update HGB/Hct values using update function Check catheter for kinking and recalibrate Replace catheter if damage is suspected and recalibrate Ensure catheter is connected to oximetry cable

15.10.2 Venous Oximetry Warnings

Table 15-24 Venous oximetry warnings

Message	Possible causes	Suggested actions
In vitro Calibration Error	Poor oximetry cable and catheter ScvO ₂ /SvO ₂ connection Calibration cup wet Catheter kinked or damaged Oximetry cable malfunction Catheter tip is not in catheter calibration cup	Verify secure oximetry cable /catheter connection Straighten any visible kinks; replace catheter if damage is suspected Change oximetry cable and recalibrate Verify catheter tip is securely seated in calibration cup Perform in vivo calibration
Warning: Unstable Signal	Changing ScvO ₂ /SvO ₂ , HGB/Hct, or unusual hemodynamic values	Stabilize patient per hospital protocol and perform in vivo calibration

Table 15-24 Venous oximetry warnings

Message	Possible causes	Suggested actions
Warning: Wall Artifact or Wedge Detected	<p>Low blood flow at catheter tip</p> <p>Catheter tip clotted</p> <p>Catheter tip wedged in vessel or against vessel wall</p>	<p>Aspirate then flush distal lumen per hospital protocol.</p> <p>Verify proper catheter position (for SvO₂, verify proper catheter position in the pulmonary artery):</p> <ul style="list-style-type: none"> confirm wedge pressure balloon inflation volume of 1.25-1.50 ml (For SvO₂ only) confirm appropriate catheter placement for patient's height, weight, and insertion site consider chest x-ray for evaluation of proper placement <p>Perform in vivo calibration.</p>

15.10.3 Venous Oximetry General Troubleshooting

Table 15-25 Venous oximetry general troubleshooting

Message	Possible causes	Suggested actions
Oximetry Cable Not Calibrated — Select Venous Oximetry to Calibrate	<p>Oximetry cable has not been calibrated (in vivo or in vitro)</p> <p>Recall venous oximetry data function has not been performed</p> <p>Oximetry cable malfunction</p>	<p>Run in-vitro calibration</p> <p>Run in-vivo calibration</p> <p>Recall calibration values</p>
Patient data in oximetry cable more than 24 hours old — Recalibrate	<p>Last oximetry cable calibration >24 hours old</p> <p>Date and time on Edwards' monitors at facility differ</p>	<p>Perform in vivo calibration</p> <p>Synchronize date and time on all Edwards' monitors at facility</p>
Connect oximetry cable for venous oximetry monitoring	<p>Oximetry cable connection at HemoSphere monitoring platform not detected</p> <p>Bent or missing oximetry cable connector pins</p>	<p>Verify secure oximetry cable connection</p> <p>Check oximetry cable connector for bent/missing pins</p>

15.11 Tissue Oximetry Error Messages

15.11.1 Tissue Oximetry Faults/Alerts

Table 15-26 Tissue oximetry faults/alerts

Message	Possible causes	Suggested actions
Fault: Second Tissue Oximetry Module Detected	Multiple tissue oximetry module connections detected	Remove one of the tissue oximetry modules from the monitor slots
Fault: StO ₂ – Tissue Oximetry Module Disconnected	HemoSphere tissue oximetry module removed during monitoring HemoSphere tissue oximetry module not detected Connection points on slot or module are damaged	Confirm that module is properly inserted Remove and re-insert the module Check module for bent or broken pins Try switching to other module slot If problem persists, contact Edwards Technical Support
Fault: StO ₂ – ForeSight Elite Module A Disconnected	ForeSight Elite module A has become disconnected	Connect ForeSight Elite module to port A of the inserted HemoSphere tissue oximetry module
Fault: StO ₂ – ForeSight Elite Module B Disconnected	ForeSight Elite module B has become disconnected	Connect ForeSight Elite module to port B of the inserted HemoSphere tissue oximetry module
Fault: StO ₂ <Ch>* – Sensor Disconnected	ForeSight Elite sensor on the indicated channel has become disconnected	Connect Sensor to ForeSight Elite module
Fault: StO ₂ – Tissue Oximetry Module	Internal system malfunction	Remove and reinsert module to reset If problem persists, contact Edwards Technical Support
Fault: StO ₂ – ForeSight Elite Module A	ForeSight Elite module A is defective	If condition persists, contact Edwards to replace the ForeSight Elite module
Fault: StO ₂ – ForeSight Elite Module B	ForeSight Elite module B is defective	If condition persists, contact Edwards to replace the ForeSight Elite module
Fault: StO ₂ – ForeSight Elite Module A Communication Error	The tissue oximetry module has lost communication with the indicated ForeSight Elite module	Reconnect the module Check for bent or broken pins Try switching ForeSight Elite module to other port of tissue oximetry module If problem persists, contact Edwards Technical Support
Fault: StO ₂ – ForeSight Elite Module B Communication Error	The tissue oximetry module has lost communication with the indicated ForeSight Elite module	Reconnect the module Check for bent or broken pins Try switching ForeSight Elite module to other port of tissue oximetry module If problem persists, contact Edwards Technical Support
Fault: StO ₂ – ForeSight Elite Module A Incompatible Software Version	Unsuccessful software upgrade or incompatible software version detected	Contact Edwards Technical Support
Fault: StO ₂ – ForeSight Elite Module B Incompatible Software Version	Unsuccessful software upgrade or incompatible software version detected	Contact Edwards Technical Support
Fault: StO ₂ <Ch>* – Faulty Sensor	Sensor is defective or Non-ForeSight Elite sensor in use	Replace with ForeSight Elite sensor
Fault: StO ₂ <Ch>* – Ambient Light Too High	Sensor is not in correct contact with patient	Check that Sensor is in direct contact with skin Apply a light blocker or drape over the Sensor to limit exposure to light
Fault: StO ₂ <Ch>* – Sensor Temperature High	Temperature under Sensor is > 45 °C (Adult Mode) or > 43 °C (Pediatric/ Neonatal Mode)	Cooling of patient or environment may be required

Table 15-26 Tissue oximetry faults/alerts (continued)

Message	Possible causes	Suggested actions
Fault: StO ₂ <Ch>* – Signal Level Too Low	Insufficient light detected from patient Tissue under the sensors may have conditions such as excessive skin pigmentation, elevated hematocrit, birth marks, hematoma, or scar tissue A large (adult) sensor is being used on a pediatric patient (<18 years of age)	Verify that sensor is well adhered to patient's skin Move sensor to a location where SQI is 3 or 4 In the case of edema, remove the sensor until tissue condition returns to normal Replace large sensor with medium or small sensor in pediatric patients (<18 years of age)
Fault: StO ₂ <Ch>* – Signal Level Too High	Very unusual condition that is likely caused by optical shunting, where most of the light emitted is directed to the detectors Certain non-physiological materials, anatomical characteristics or scalp edema may trigger this message	Check that sensor is in direct contact with skin and that the clear liner has been removed
Fault: StO ₂ <Ch>* – Check Tissue Under Sensor	Tissue under sensor may have fluid accumulation/edema	Check patient for edema under Sensor When tissue condition returns to normal range (e.g., patient is no longer edematous) the Sensor may be reapplied
Fault: StO ₂ <Ch>* – Stool Interference High	The Sensor is interrogating primarily stool versus perfused tissue and StO ₂ cannot be measured	Move the Sensor to a location where the relative amount of intestinal tissue is less, such as the flank
Fault: StO ₂ <Ch>* – Sensor Off	Computed StO ₂ not in valid range or sensor placed on an inappropriate object	Sensor may need to be repositioned
Fault: StO ₂ <Ch>* – Not Physiological	The measured value is out of physiological range Sensor malfunction	Verify correct placement of Sensor Check Sensor connection
Fault: StO ₂ <Ch>* – Incorrect Sensor Size	The sensor size is incompatible with either the Patient Mode or body location	Use a different sensor size (Refer to Sensor Instructions for Use for sensor size table) Change the Patient Mode or body location on the tile configuration menu accordingly
Fault: StO ₂ <Ch>* – Algorithm Fault	A processing error has occurred in the calculation of StO ₂ for the indicated channel	Disconnect and reconnect the indicated Sensor channel Replace the ForeSight Elite module Replace the tissue oximetry module If problem persists, contact Edwards Technical Support
Alert: StO ₂ <Ch>* – Unstable Signal	Interference from outside source	Move Sensor away from interfering source
Alert: StO ₂ <Ch>* – Reduce Ambient Light	Ambient light approaching maximum value	Check that Sensor is in direct contact with skin Apply a light blocker or drape over the Sensor to limit exposure to light
Alert: StO ₂ <Ch>* – Stool Interference	Stool Interference is approaching maximum acceptable level The Sensor is interrogating some perfused tissue to make a StO ₂ measurement, but there is also a high concentration of stool in the Sensor's interrogation path	Consider moving the Sensor to a different abdominal location with less stool interference
Alert: StO ₂ <Ch>* – Sensor Temperature Low	Temperature under Sensor < -10 °C	Warming of patient or environment may be required
Alert: StO ₂ <Ch>* – Configure location for tissue oximetry sensor	An anatomical location on the patient has not been configured for the connected sensor	Use the tissue oximetry configuration menu to select a body location for the indicated sensor channel
<i>*note: <Ch> is the sensor channel. The channel options are A1 and A2 for ForeSight Elite module A and B1 and B2 for ForeSight Elite module B.</i>		

15.11.2 Tissue Oximetry General Troubleshooting

Table 15-27 Tissue oximetry general troubleshooting

Message	Possible causes	Suggested actions
Connect tissue oximetry module for StO ₂ monitoring	Connection between the HemoSphere advanced monitor and tissue oximetry module has not been detected	Insert the HemoSphere tissue oximetry module into slot 1 or slot 2 of the monitor Remove and re-insert module
Connect ForeSight Elite module <A or B> for StO ₂ monitoring	Connection between the HemoSphere tissue oximetry module and ForeSight Elite module at the indicated port has not been detected	Connect a ForeSight Elite module to the indicated port of the HemoSphere tissue oximetry module Reconnect the ForeSight Elite module
Connect tissue oximetry sensor for StO ₂ monitoring – <Ch>*	Connection between the ForeSight Elite module and tissue oximetry sensor has not been detected on the channel for which StO ₂ has been configured	Connect a tissue oximetry sensor to the indicated channel Reconnect the tissue oximetry sensor on the indicated channel
*note: <Ch> is the sensor channel. The channel options are A1 and A2 for ForeSight Elite module A and B1 and B2 for ForeSight Elite module B.		

Appendix A

Specifications

Contents

Essential Performance Characteristics278
HemoSphere Advanced Monitor Specifications281
HemoSphere Battery Pack Specifications283
HemoSphere Swan-Ganz Module Specifications284
HemoSphere Pressure Cable Specifications286
HemoSphere Oximetry Cable Specifications287
HemoSphere Tissue Oximetry Specifications287
HemoSphere ClearSight Module Specifications289

A.1 Essential Performance Characteristics

Under normal and single fault conditions either the essential performance listed in table A-1 below is provided or failure to provide this performance is readily identifiable by the user (e.g., no display of parameter values, technical alarm, distorted waveforms or delay in parameter value update, complete failure of the monitor, etc.).

Table A-1 represents the minimum performance when operating under non-transient electromagnetic phenomena, such as radiated and conducted RF, according to IEC 60601-1-2. Table A-1 also identifies the minimum performance for transient electromagnetic phenomena, such as electrical fast transients and surges, according to IEC 60601-1-2.

Table A-1 HemoSphere advanced monitor essential performance – transient and non-transient electromagnetic phenomena

Module or cable	Parameter	Essential Performance
General: all monitoring modes and parameters		<p>No interruption of current monitoring mode. No unexpected reboots or halting of operation. No spontaneous triggering of events that require user interaction to initiate.</p> <p>Patient connections provide defibrillator protection. Following exposure to defibrillation voltages, the system shall return to an operational state within 10 seconds.</p> <p>After the transient electromagnetic phenomena, the system shall return to an operational state within 10 seconds. If Swan-Ganz continuous cardiac output (CO) was active during the event, the system will automatically re-initiate monitoring. The system shall exhibit no loss of any stored data following the transient electromagnetic phenomena.</p> <p>When used with HF Surgical Equipment, the monitor shall return to operational mode within 10 seconds without loss of stored data after exposure to the field produced by the HF Surgical Equipment.</p>
HemoSphere Swan-Ganz module	Continuous Cardiac Output (CO), and associated parameters, both indexed and non-indexed (SV, SVR, RVEF, EDV)	<p>Monitors the filament surface temperature and time at temperature. If a time and temperature threshold is exceeded (above 45 °C), monitoring halts and alarm triggered.</p> <p>Measurement of blood temperature within specified accuracy (± 0.3 °C). Alarm if blood temperature outside of monitoring range.</p> <p>Alarm if CO and related parameters outside of alarm ranges. Alarm delay based on a variable averaging time. Typical averaging time is 57 seconds.</p>
	intermittent cardiac output (iCO) and associated parameters, both indexed and non-indexed (SV, SVR)	Measurement of blood temperature within specified accuracy (± 0.3 °C). Alarm if blood temperature outside monitoring range.
HemoSphere Swan-Ganz module and pressure cable	20-second flow parameters (CO _{20s} , CI _{20s} , SV _{20s} , SVI _{20s})	Alarm if 20-second parameters outside of alarm ranges. Alarm delay based on a 20 second averaging time.
HemoSphere pressure cable	arterial blood pressure (SYS, DIA, MAP), central venous blood pressure (CVP), pulmonary artery blood pressure (MPAP)	<p>Measurement of blood pressure within specified accuracy ($\pm 4\%$ or ± 4 mmHg, whichever is greater).</p> <p>Alarm if blood pressure outside of alarm ranges. Alarm delay of 7 seconds based on averaging time of 2 seconds and 5 consecutive seconds outside of alarm ranges.</p> <p>The device supports detection of invasive pressure transducer and transducer cable fault.</p> <p>The device supports detection of disconnected catheter.</p>

Table A-1 HemoSphere advanced monitor essential performance – transient and non-transient electromagnetic phenomena (continued)

Module or cable	Parameter	Essential Performance
HemoSphere ClearSight module	noninvasive blood pressure (SYS, DIA, MAP)	<p>Measurement of blood pressure within specified accuracy ($\pm 1\%$ of full scale with a maximum of ± 3 mmHg).</p> <p>Alarm if blood pressure outside alarm ranges. Alarm delay of approximately 10 seconds based on averaging window of 5 heartbeats (at 60 bpm this would be 5 seconds but will vary based on heart rate) and 5 consecutive seconds outside of alarm ranges.</p>
HemoSphere oximetry cable	oxygen saturation (mixed venous SvO ₂ or central venous ScvO ₂)	<p>Measurement of oxygen saturation within specified accuracy ($\pm 2\%$ oxygen saturation).</p> <p>Alarm if oxygen saturation outside of alarm ranges. Alarm delay of 7 seconds based on averaging time of 2 seconds and 5 consecutive seconds outside of alarm ranges.</p>
HemoSphere tissue oximetry module with ForeSight Elite oximeter module	tissue oxygen saturation (StO ₂)	<p>The ForeSight Elite module shall recognize attached sensor and issue an appropriate equipment status if inoperable or disconnected. When a sensor is properly positioned on the patient and connected to the ForeSight Elite module, the ForeSight Elite module shall measure StO₂ values within system specifications (refer to table A-18 on page 288) and correctly output values to HemoSphere tissue oximetry module.</p> <p>In response to a defibrillation event, the ForeSight Elite module shall not be electrically damaged.</p> <p>In response to an external noise event, the values may continue to report as pre-event values or may be reported as indeterminate value (dashed). The ForeSight Elite module shall automatically recover and resume reporting appropriate values within 20 seconds after the noise event.</p>

A.2 HemoSphere Advanced Monitor Specifications

Table A-2 HemoSphere advanced monitor physical and mechanical specifications

HemoSphere advanced monitor		
Weight	10 ±0.2 lbs (4.5 ±0.1 kg)	
Dimensions	Height	11.7 in (297 mm)
	Width	12.4 in (315 mm)
	Depth	5.56 in (141 mm)
Footprint	Width	10.6 in (269 mm)
	Depth	4.8 in (122 mm)
Ingress protection	IPX1	
Display	Active Area	12.1 in (307 mm)
	Resolution	1024 × 768 LCD
Operating system	Windows 7 embedded	
Speaker count	1	

Table A-3 HemoSphere advanced monitor environmental specifications

Environmental specification		Value
Temperature	Operational	10 to 32.5 °C
	Non-operational/storage*	-18 to 45 °C
Relative humidity	Operational	20 to 90% non-condensing
	Non-operational/storage	90% non-condensing at 45 °C
Altitude	Operational	0 to 10,000 feet (3048 m)
	Non-operational/storage	0 to 20,000 feet (6096 m)

***NOTE** Battery capacity starts to degrade with extended exposure above 35 °C.

Table A-4 HemoSphere advanced monitor transportation environmental specifications

Environmental specification	Value
Temperature*	-18 to 45 °C
Relative humidity*	20 to 90% RH non-condensing
Altitude	maximum of 20,000 feet (6096 m) for up to 8 hours
Standard	ASTM D4169, DC13
*Note: Pre-conditioning temperature and humidity	

MRI Information. Do not use the HemoSphere advanced monitor or platform modules and cables in an MR environment. The HemoSphere advanced monitoring platform, including all modules and cables, is MR unsafe since the device contains metallic components, which can experience RF-induced heating in the MRI environment.



Table A-5 HemoSphere advanced monitor technical specifications

Input/Output	
Touch screen	Projective capacitive touch
RS-232 serial port (1)	Edwards proprietary protocol; Maximum data rate = 57.6 kilo baud
USB ports (2)	one USB 2.0 (rear) and one USB 3.0 (side)
RJ-45 Ethernet port	One
HDMI port	One
Analog inputs (2)	Input voltage range: 0 to 10V; Selectable full-scale: 0 to 1V, 0 to 5V, 0 to 10V; >100 kΩ input impedance; 1/8 in. stereo jack; Bandwidth: 0 to 5.2 Hz; Resolution: 12 bits ±1 LSB of full scale
Pressure output (1)	DPT pressure out signal is compatible with monitors and accessories intended to interface with Edwards minimally invasive pressure transducers Post-zero minimum patient monitor display range:-20 mmHg to 270 mmHg
ECG monitor input	ECG sync line conversion from ECG signal: 1V/mV; Input voltage range ±10V full scale; Resolution = ±1 BPM; Accuracy = ±10% or 5 BPM of the input, whichever is greater; Range = 30 to 200 BPM; 1/4 in. stereo jack, tip at positive polarity; analog cable Pacemaker pulse rejection capabilities. Instrument rejects all pacemaker pulses having amplitudes from ±2 mV to ±5 mV (assumes 1V/mV ECG sync line conversion) and pulse widths from 0.1 ms to 5.0 ms, both with normal and ineffective pacing. Pacemaker pulses with overshoot of ≤7% of pulse amplitude (Method A of EN 60601-2-27:2014, subclause 201.12.1.101.13) and overshoot time constants from 4 ms to 100 ms are rejected. Maximum T-wave rejection capability. Maximum T-wave amplitude that can be rejected by instrument: 1.0 mV (assumes 1V/ mV ECG sync line conversion). Irregular Rhythm. Figure 201.101 of EN 60601-2-27:2014. <ul style="list-style-type: none"> * Complex A1: Ventricular bigeminy, system displays 80 BPM * Complex A2: Slow alternating ventricular bigeminy, system displays 60 BPM * Complex A3: Rapid alternating ventricular bigeminy, system displays 60 BPM * Complex A4: Bidirectional systoles, system displays 104 BPM

Table A-5 HemoSphere advanced monitor technical specifications (continued)

Input/Output (continued)	
HRavg display	<p>CO Monitoring Off. Averaging time: 57 seconds; Update rate: Per beat; Response time: 40 seconds for step increase from 80 to 120 BPM, 29 seconds for step decrease from 80 to 40 BPM.</p> <p>CO Monitoring On. Averaging time: Time between CO measurements (3 to 21 minutes); Update rate: Approximately 1 minute; Response time: 175 seconds for step increase from 80 to 120 BPM, 176 seconds for step decrease from 80 to 40 BPM.</p>
Electrical	
Rated supply voltage	100 to 240 Vac; 50/60 Hz
Rated input	1.5 to 2.0 Amps
Fuses	T 2.5AH, 250V; High breaking capacity; Ceramic
Alarm	
Sound pressure level	45 to 85 dB(A)
Wireless	
Type	connection to Wi-Fi networks that are compliant to 802.11b/g/n, minimum

A.3 HemoSphere Battery Pack Specifications

Table A-6 HemoSphere battery pack physical specifications

HemoSphere battery pack		
Weight	0.9 lbs (0.4 kg)	
Dimensions	Height	1.38 in (35 mm)
	Width	3.15 in (80 mm)
	Depth	5.0 in (126 mm)

Table A-7 HemoSphere battery pack environmental specifications

Environmental specification		Value
Temperature	Operational	10 to 37 °C
	Recommended storage	21 °C
	Maximum long term storage	35 °C
	Minimum long term storage	0 °C
Relative humidity	Operational	5 to 95% non-condensing at 40 °C

Table A-8 HemoSphere battery pack technical specifications

Specification	Value
Output voltage (nominal)	12.8 V
Maximum discharge current	5 A
Cells	4 x LiFePO ₄ (lithium iron phosphate)
Capacity	3150 mAh

A.4 HemoSphere Swan-Ganz Module Specifications

Table A-9 HemoSphere Swan-Ganz module physical specifications

HemoSphere Swan-Ganz module		
Weight	approximately 1.0 lbs (0.45 kg)	
Dimensions	Height	1.36 in (3.45 cm)
	Width	3.53 in (8.96 cm)
	Depth	5.36 in (13.6 cm)
Ingress protection	IPX1	
Applied part classification	Type CF defibrillation proof	

NOTE For HemoSphere Swan-Ganz module environmental specifications, see table A-3, *HemoSphere advanced monitor environmental specifications*, on page 281.

Table A-10 HemoSphere Swan-Ganz module parameter measurement specifications

Parameter	Specification	
Continuous Cardiac Output (CO)	Range	1 to 20 L/min
	Reproducibility ¹	±6% or 0.1 L/min, whichever is greater
	Average response time ²	<10 mins (for CCO catheters) <14 mins (for CCO volumetric catheters)
	Maximum thermal filament surface temperature	48 °C
Intermittent (Bolus) Cardiac Output (iCO)	Range	1 to 20 L/min
	Reproducibility ¹	±3% or 0.1 L/min, whichever is greater
Blood Temperature (BT)	Range	15 to 45 °C (59 to 113 °F)
	Accuracy	±0.3 °C
Injectate Temperature (IT)	Range	0 to 30 °C (32 to 86 °F)
	Accuracy	±1 °C
Average Heart Rate for EDV/ RVEF Determination (HRavg)	Acceptable input range	30 to 200 bpm
Continuous Right Ventricular Ejection Fraction (RVEF)	Range	10 to 60%
	Reproducibility ¹	±6% or 3 efu, whichever is greater
¹ Coefficient of variation — measured using electronically generated data		
² 10 to 90% change under conditions of stable blood temperature		

NOTE The expected useful life of the HemoSphere Swan-Ganz module is 5 years from date of purchase. If your equipment experiences a malfunction, please contact Technical Support or your local Edwards representative for further assistance.

Table A-11 HemoSphere Swan-Ganz module 20-second flow parameter measurement specifications¹

Parameter	Specification	
CO _{20s}	Range	1 to 20 L/min
	Update rate	20 ±1 seconds
	Response time ²	20 seconds
CI _{20s}	Range	0 to 20 L/min/m ²
	Update rate	20 ±1 seconds
	Response time ²	20 seconds
SV _{20s}	Range	0 to 300 mL/b
	Update rate	20 ±1 seconds
	Response time ²	20 seconds
SVI _{20s}	Range	0 to 200 mL/b/m ²
	Update rate	20 ±1 seconds
	Response time ²	20 seconds

¹20-second flow parameters only available when monitoring pulmonary artery pressure with a connected HemoSphere pressure cable and TruWave DPT.

² A 20 second response time is only available after initial CCO thermodilution algorithm based parameter calculation has been obtained which can take up to 14 minutes. See Table A-10 on page 284.

A.5 HemoSphere Pressure Cable Specifications

Table A-12 HemoSphere pressure cable physical specifications

HemoSphere pressure cable		
Weight	approximately 0.64 lbs (0.29 kg)	
Dimensions	Length	10 ft (3.0 m)
Ingress protection	IPX4	
Applied part classification	Type CF defibrillation proof	

NOTE For HemoSphere pressure cable environmental specifications, see table A-3, *HemoSphere advanced monitor environmental specifications*, on page 281.

Table A-13 HemoSphere pressure cable parameter measurement specifications

Parameter	Specification	
FloTrac cardiac output (CO)	Display range	1.0 to 20 L/min
	Reproducibility ¹	±6% or 0.1 L/min, whichever is greater
Blood pressure ²	Live pressure display range	-34 to 312 mmHg
	MAP/DIA/SYS display range	0 to 300 mmHg
	CVP display range	0 to 50 mmHg
	MPAP display range	0 to 99 mmHg
	Accuracy	±4% or ±4 mmHg, whichever is greater, from -30 to 300 mmHg
	Bandwidth	1-10Hz
Pulse rate (PR)	Accuracy ³	$A_{rms} \leq 3$ bpm
¹ Coefficient of variation - measured using electronically generated data. ² Parameter specifications compliant with IEC 60601-2-34 standards. Testing performed under laboratory conditions. ³ Accuracy tested under laboratory conditions.		

NOTE The expected useful life of the HemoSphere pressure cable is 5 years from date of purchase. If your equipment experiences a malfunction, please contact Technical Support or your local Edwards representative for further assistance.

A.6 HemoSphere Oximetry Cable Specifications

Table A-14 HemoSphere oximetry cable physical specifications

HemoSphere oximetry cable		
Weight	approximately 0.54 lbs (0.24 kg)	
Dimensions	Length	9.6 ft (2.9 m)
Ingress protection	IPX4	
Applied part classification	Type CF defibrillation proof	

NOTE For HemoSphere oximetry cable environmental specifications, see table A-3, *HemoSphere advanced monitor environmental specifications*, on page 281.

Table A-15 HemoSphere oximetry cable parameter measurement specifications

Parameter	Specification	
ScvO ₂ /SvO ₂ Oximetry (Oxygen Saturation)	Range	0 to 99%
	Precision ¹	±2% at 30 to 99%
	Update rate	2 seconds
¹ Precision tested under laboratory conditions.		

NOTE The expected useful life of the HemoSphere oximetry cable is 1.5 years from date of purchase. If your equipment experiences a malfunction, please contact Technical Support or your local Edwards representative for further assistance.

A.7 HemoSphere Tissue Oximetry Specifications

Table A-16 HemoSphere tissue oximetry module physical specifications

HemoSphere tissue oximetry module		
Weight	approximately 1.0 lbs (0.4 kg)	
Dimensions	Height	1.4 in (3.5 cm)
	Width	3.5 in (9.0 cm)
	Depth	5.4 in (13.6 cm)
Ingress protection	IPX1	
Applied part classification	Type BF defibrillation proof	

NOTE For HemoSphere tissue oximetry module and ForeSight Elite tissue oximeter module environmental specifications, see table A-3, *HemoSphere advanced monitor environmental specifications*, on page 281.

Table A-17 ForeSight Elite tissue oximeter module physical specifications

ForeSight Elite tissue oximeter module specifications		
Weight	mounting clip	0.1 lbs (0.05 kg)
	case, cables, and clip	2.3 lbs (1.0 kg)
Dimensions	tissue oximetry module cable length	15 ft (4.6 m) ¹
	sensor cable length (2)	4.9 ft (1.5 m) ¹
	module case (H × W × D)	6.0 in (15.24 cm) × 3.75 in (9.52 cm) × 2.75 in (6.00 cm)
	mounting clip (H × W × D)	2.4 in (6.2 cm) × 1.75 in (4.47 cm) × 3.2 in (8.14 cm)
Ingress protection	IPX4	
Applied part classification	Type BF defibrillation proof	
¹ The length of the tissue oximetry module and sensor cables are nominal lengths		

Table A-18 HemoSphere tissue oximetry module with ForeSight Elite tissue oximeter module parameter measurement specifications

Parameter	Specification		
Cerebral StO ₂ (tissue oxygen saturation)	Range	1 to 99%	
	Accuracy ¹	large sensors	46% to 88%: -0.06 ± 3.25% at 1 SD
			46% to 88%: -0.06 ± 3.28% at 1 SD ¹
		medium sensors	44% to 91%: 0.97 ± 5.43% at 1 SD
			44% to 91%: 1.21 ± 5.63% at 1 SD ¹
small sensors	44% to 90%: -0.74 ± 5.98% at 1 SD		
Non-cerebral StO ₂ (tissue oxygen saturation)	Range	1 to 99%	
	Accuracy ¹	large sensors	51% to 92%: -0.12 ± 4.15% at 1 SD
			51% to 92%: -0.12 ± 4.17% at 1 SD ¹
		medium sensors	52% to 88%: -0.14 ± 5.75% at 1 SD
small sensors	66% to 96%: 2.35 ± 5.25% at 1 SD		
¹ Dependent Data Bland-Altman			
² Brain StO ₂ values averaged vs. REF CX bias and precision			

NOTE The expected useful life of the HemoSphere tissue oximetry module and ForeSight Elite tissue oximeter module is 5 years from date of purchase. If your equipment experiences a malfunction, please contact Technical Support or your local Edwards representative for further assistance.

A.8 HemoSphere ClearSight Module Specifications

Table A-19 HemoSphere ClearSight module physical specifications

HemoSphere ClearSight module		
Weight	approximately 2 lbs (0.9 kg)	
Dimensions	Height	5.1 in (13 cm)
	Width	5.6 in (14 cm)
	Depth	3.9 in (10 cm)
Ingress protection	IPX1	
Applied part classification	Type BF	

Table A-20 HemoSphere ClearSight module environmental specifications

Environmental specification		Value
Temperature	Operational	10 to 32.5 °C
	Non-operational/storage*	-18 to 45 °C
Relative humidity	Operational	20 to 85% non-condensing
	Non-operational/storage	20 to 90% non-condensing at 45 °C
Altitude	Operational	0 to 9,483 feet (3000 m)
	Non-operational/storage	0 to 19,685 feet (6000 m)

Table A-21 HemoSphere ClearSight module parameter measurement specifications

Parameter	Specification	
arterial blood pressure	display range	0 to 300 mmHg
	accuracy ¹	Bias systolic pressure (SYS) $\leq \pm 5.0$ mmHg Bias diastolic pressure (DIA) $\leq \pm 5.0$ mmHg Precision (1 σ) systolic pressure (SYS) $\leq \pm 8.0$ mmHg Precision (1 σ) diastolic pressure (DIA) $\leq \pm 8.0$ mmHg
finger cuff pressure	range	0 to 300 mmHg
	accuracy	1% of full scale (max 3 mmHg), zeroing automatically
cardiac output (CO)	display range	1.0 to 20.0 L/min
	accuracy	Bias $\leq \pm 0.6$ L/min or $\leq 10\%$ (whichever is greater) Precision (1 σ) $\leq \pm 20\%$ over the range of cardiac output from 2 to 20 L/min
	reproducibility ²	$\pm 6\%$
	update rate	20 seconds
¹ Accuracy tested under laboratory conditions compared to a calibrated pressure gauge		
² Coefficient of variation – measured using electronically generated data		

Table A-22 Edwards finger cuff specifications*

Finger cuff	
Maximum weight	11 g (0.02 lbs)
LED spectral irradiance	See figure A-1
Max optical output	0.013 mWatts
Max variation of output over treatment area	50%

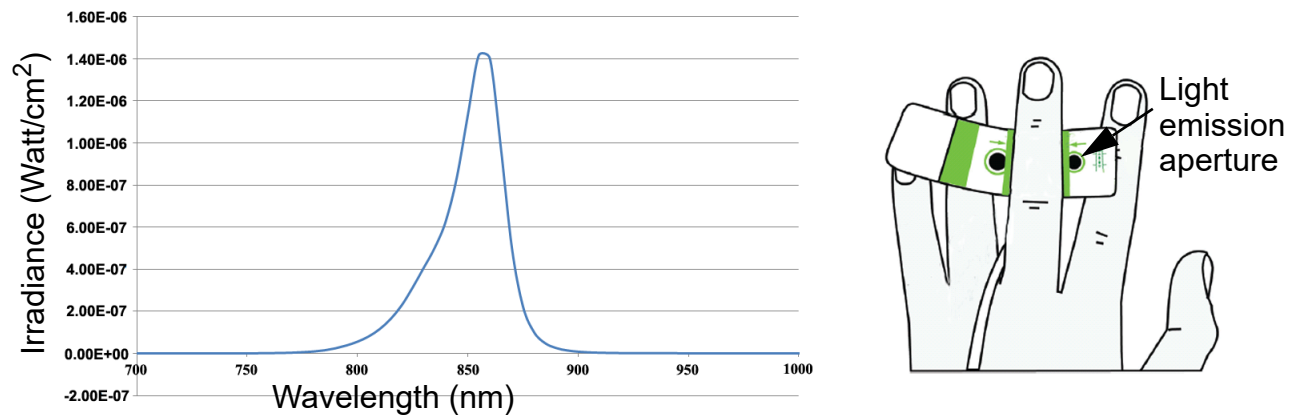

Figure A-1 Spectral Irradiance and location of light emission aperture

NOTE

The expected useful life of the HemoSphere ClearSight module is 5 years from date of purchase. If your equipment experiences a malfunction, please contact Technical Support or your local Edwards representative for further assistance.

Appendix B

Accessories

Contents

Accessories List	291
Additional Accessories Description	292

B.1 Accessories List

WARNING Only use approved HemoSphere advanced monitor accessories, cables and or components that have been supplied and labeled by Edwards. Using unapproved accessories, cables and or components may affect patient safety and measurement accuracy.

Table B-1 HemoSphere advanced monitor components

Description	Model number
HemoSphere advanced monitor	
HemoSphere advanced monitor	HEM1
HemoSphere battery pack	HEMBAT10
HemoSphere expansion module	HEMEXPM10
HemoSphere L-tech expansion Module	HEMLTECHM10
HemoSphere advanced monitor roll stand	HEMRLSTD1000
HemoSphere Swan-Ganz monitoring	
HemoSphere Swan-Ganz module	HEMSGM10
Patient CCO cable	70CC2
Edwards Swan-Ganz catheters	*
In-line temperature probe (CO-SET+ closed injectate delivery system)	93522
Bath temperature injectate probe	9850A
HemoSphere pressure cable monitoring	
HemoSphere pressure cable	HEMPSC100
Edwards FloTrac or Acumen IQ sensor	*
Edwards TruWave pressure monitoring transducer	*

Table B-1 HemoSphere advanced monitor components

Description	Model number
HemoSphere venous oximetry monitoring	
HemoSphere oximetry cable	HEMOXSC100
HemoSphere oximetry cradle	HEMOXCR1000
Edwards oximetry catheter	*
HemoSphere tissue oximetry monitoring	
HemoSphere tissue oximetry module	HEMTOM10
ForeSight Elite tissue oximeter module	HEMFSM10
ForeSight Elite oximeter module mounting clip	FSEMC 01-06-1100
ForeSight Elite tissue oximetry sensors (sizes: non-adhesive small, small, medium, and large)	*
HemoSphere ClearSight module monitoring	
HemoSphere ClearSight module	HEMCSM10
Pressure controller kit	PC2K
Pressure controller	PC2
Pressure controller band multi pack	PC2B
Pressure controller cuff connector cap multi pack	PC2CCC
Pressure controller cover	PCCVR
Heart reference sensor	HRS

Table B-1 HemoSphere advanced monitor components

Description	Model number
HemoSphere ClearSight module upgrade (HEMCSM10, PC2K, HRS, and ClearSight software)	HEMCSMUPG
ClearSight and Acumen IQ finger cuff	*
HemoSphere advanced monitor cables	
Mains power cord	*
Pressure slave cable	**
ECG monitor slave cables	**
Pressure-out cable	HEMDPT1000
Additional HemoSphere Accessories	
HemoSphere advanced monitor operator's manual	***

Table B-1 HemoSphere advanced monitor components

Description	Model number
HemoSphere advanced monitor service manual	***
HemoSphere advanced monitor quick start guide <i>contains HemoSphere advanced monitor operator's manual</i>	HEMQG1000
<p>* Please contact your Edwards representative for model and ordering information.</p> <p>** Edwards Lifesciences slave cables are bedside monitor specific; they are available for a family of bedside monitor companies such as Philips (Agilent), GE (Marquette) and Spacelabs (OSI Systems). Please contact your Edwards representative for specific model and ordering information.</p> <p>*** Please contact your Edwards representative for the most current version.</p>	

B.2 Additional Accessories Description

B.2.1 Roll Stand

The HemoSphere advanced monitor roll stand is intended for use with the HemoSphere advanced monitor. Follow included instructions for roll stand assembly and warnings. Place the assembled roll stand on the floor, ensuring that all wheels are in contact with the floor, and securely mount the monitor to the roll stand plate as indicated in the directions.

B.2.2 Oximetry Cradle

The HemoSphere oximetry cradle is a reusable accessory intended to properly secure the HemoSphere oximetry cable while monitoring with the HemoSphere advanced monitoring platform. Follow included instructions for proper cradle mounting directions.

Appendix C

Equations for Calculated Patient Parameters

This section describes the equations used to calculate continuous and intermittent patient parameters displayed on the HemoSphere advanced monitor.

NOTE Patient parameters are calculated to more decimal places than are displayed on the screen. For example, a screen CO value of 2.4 may actually be a CO of 2.4492. Consequently, attempts to verify the accuracy of the monitor's display using the following equations may produce results that are slightly different from the data computed by the monitor.

For all calculations that include SvO₂, ScvO₂ will be substituted when the user selects the ScvO₂.

Subscript SI = Standard International Units

Table C-1 Cardiac and oxygenation profile equations

Parameter	Description and formula	Units
BSA	Body Surface Area (DuBois formula) $BSA = 71.84 \times (WT^{0.425}) \times (HT^{0.725}) / 10,000$ where: WT – Patient Weight, kg HT – Patient Height, cm	m ²
CaO ₂	Arterial Oxygen Content $CaO_2 = (0.0138 \times HGB \times SpO_2) + (0.0031 \times PaO_2) \text{ (mL/dL)}$ $CaO_2 = [0.0138 \times (HGB_{SI} \times 1.611) \times SpO_2] + [0.0031 \times (PaO_{2SI} \times 7.5)] \text{ (mL/dL)}$ where: HGB – Total Hemoglobin, g/dL HGB _{SI} – Total Hemoglobin, mmol/L SpO ₂ – Arterial O ₂ Saturation, % PaO ₂ – Partial Pressure of Arterial Oxygen, mmHg PaO _{2SI} – Partial Pressure of Arterial Oxygen, kPa	mL/dL

Table C-1 Cardiac and oxygenation profile equations (continued)

Parameter	Description and formula	Units
CvO ₂	Venous Oxygen Content $CvO_2 = (0.0138 \times HGB \times SvO_2) + (0.0031 \times PvO_2) \text{ (mL/dL)}$ $CvO_2 = [0.0138 \times (HGB_{SI} \times 1.611) \times SvO_2] + [0.0031 \times (PvO_{2SI} \times 7.5)] \text{ (mL/dL)}$ where: HGB – Total Hemoglobin, g/dL HGB _{SI} – Total Hemoglobin, mmol/L SvO ₂ – Venous O ₂ Saturation, % PvO ₂ – Partial Pressure of Venous Oxygen, mmHg PvO _{2SI} – Partial Pressure of Venous Oxygen, kPa and PvO ₂ can be entered by the user in Invasive monitoring mode and is assumed to be 0 during all other monitoring modes	mL/dL
Ca-vO ₂	Arteriovenous Oxygen Content Difference $Ca-vO_2 = CaO_2 - CvO_2 \text{ (mL/dL)}$ where: CaO ₂ – Arterial Oxygen Content (mL/dL) CvO ₂ – Venous Oxygen Content (mL/dL)	mL/dL
CI	Cardiac Index $CI = CO/BSA$ where: CO – Cardiac Output, L/min BSA – Body Surface Area, m ²	L/min/m ²
CPI	Cardiac Power Index $CPI = MAP \times CI \times 0.0022$	W/m ²
CPO	Cardiac Power Output $CPO = CO \times MAP \times K$ where: cardiac power output (CPO) (W) was calculated as $MAP \times CO/451$ K is the conversion factor (2.22×10^{-3}) into watts MAP in mmHg CO L/min	W
DO ₂	Oxygen Delivery $DO_2 = CaO_2 \times CO \times 10$ where: CaO ₂ – Arterial Oxygen Content, mL/dL CO – Cardiac Output, L/min	mL O ₂ /min
DO ₂ l	Oxygen Delivery Index $DO_2l = CaO_2 \times CI \times 10$ where: CaO ₂ – Arterial Oxygen Content, ml/dl CI – Cardiac Output, L/min/m ²	mL O ₂ /min/m ²
dP/dt	Systolic slope calculated as maximal first derivative of arterial pressure waveform with respect to time $dP/dt = \max(P[n+1]-P[n])/ts, \text{ for } n=0 \text{ to } N=1$ where: P[n] – current sample of the arterial pressure signal, mmHg ts – sampling time interval, second N – total number of samples in a given cardiac cycle	mmHg/sec

Table C-1 Cardiac and oxygenation profile equations (continued)

Parameter	Description and formula	Units
Ea _{dyn}	Dynamic Arterial Elastance $Ea_{dyn} = PPV/SVV$ where: SVV – Stroke Volume Variation, % PPV – Pulse Pressure Variation, %	none
EDV	End Diastolic Volume $EDV = SV/EF$ where: SV – Stroke Volume (mL) EF – Ejection Fraction, % (efu)	mL
EDVI	End Diastolic Volume Index $EDVI = SVI/EF$ where: SVI – Stroke Volume Index (mL/m ²) EF – Ejection Fraction, % (efu)	mL/m ²
ESV	End Systolic Volume $ESV = EDV - SV$ where: EDV – End Diastolic Volume (mL) SV – Stroke Volume (mL)	mL
ESVI	End Systolic Volume Index $ESVI = EDVI - SVI$ where: EDVI – End Diastolic Volume Index (mL/m ²) SVI – Stroke Volume Index (mL/m ²)	mL/m ²
LVSWI	Left Ventricular Stroke Work Index $LVSWI = SVI \times (MAP - PAWP) \times 0.0136$ $LVSWI = SVI \times (MAP_{SI} - PAWP_{SI}) \times 0.0136 \times 7.5$ where: SVI – Stroke Volume Index, ml/beat/m ² MAP – Mean Arterial Pressure, mmHg MAP _{SI} – Mean Arterial Pressure, kPa PAWP – Pulmonary Artery Wedge Pressure, mmHg PAWP _{SI} – Pulmonary Artery Wedge Pressure, kPa	g-m/m ² /beat
O ₂ EI	Oxygen Extraction Index $O_2EI = \{(SaO_2 - SvO_2) / SaO_2\} \times 100 (\%)$ where: SaO ₂ – Arterial O ₂ Saturation, % SvO ₂ – Mixed Venous O ₂ Saturation, %	%
O ₂ ER	Oxygen Extraction Ratio $O_2ER = (Ca-vO_2 / CaO_2) \times 100 (\%)$ where: CaO ₂ – Arterial Oxygen Content, mL/dL Ca-vO ₂ – Arteriovenous Oxygen Content Difference, mL/dL	%

Table C-1 Cardiac and oxygenation profile equations (continued)

Parameter	Description and formula	Units
PPV	Pulse Pressure Variation $PPV = 100 \times (PP_{max} - PP_{min}) / \text{mean}(PP)$ where: PP – Pulse Pressure, mmHg calculated as: $PP = \text{SYS} - \text{DIA}$ SYS – systolic pressure DIA – diastolic pressure	%
PVR	Pulmonary Vascular Resistance $PVR = \{(MPAP - PAWP) \times 80\} / CO$ $PVR = \{(MPAP_{SI} - PAWP_{SI}) \times 60\} / CO$ where: MPAP – Mean Pulmonary Artery Pressure, mmHg MPAP _{SI} – Mean Pulmonary Artery Pressure, kPa PAWP – Pulmonary Artery Wedge Pressure, mmHg PAWP _{SI} – Pulmonary Artery Wedge Pressure, kPa CO – Cardiac Output, l/min	dyne-s/cm ⁵ kPa-s/L
PVRI	Pulmonary Vascular Resistance Index $PVRI = \{(MPAP - PAWP) \times 80\} / CI$ $PVRI = \{(MPAP_{SI} - PAWP_{SI}) \times 60\} / CI$ where: MPAP – Mean Pulmonary Artery Pressure, mmHg MPAP _{SI} – Mean Pulmonary Artery Pressure, kPa PAWP – Pulmonary Artery Wedge Pressure, mmHg PAWP _{SI} – Pulmonary Artery Wedge Pressure, kPa CI – Cardiac Index, L/min/m ²	dyne-s-m ² /cm ⁵ kPa-s-m ² /L
RVSWI	Right Ventricular Stroke Work Index $RVSWI = SVI \times (MPAP - CVP) \times 0.0136$ $RVSWI = SVI \times (MPAP_{SI} - CVP_{SI}) \times 0.0136 \times 7.5$ where: SVI – Stroke Volume Index, ml/beat/m ² MPAP – Mean Pulmonary Artery Pressure, mmHg MPAP _{SI} – Mean Pulmonary Artery Pressure, kPa CVP – Central Venous Pressure, mmHg CVP _{SI} – Central Venous Pressure, kPa	g-m/m ² /beat
StO ₂	Tissue oxygen saturation $StO_2 = [HbO_2 / (HbO_2 + Hb)] \times 100$ where: HbO ₂ – Oxygenated Hemoglobin Hb – De-Oxygenated Hemoglobin	%
SV	Stroke Volume $SV = (CO / PR) \times 1000$ where: CO – Cardiac Output, L/min PR – Pulse rate, beats/min	mL/beat

Table C-1 Cardiac and oxygenation profile equations (continued)

Parameter	Description and formula	Units
SVI	Stroke Volume Index $SVI = (CI/PR) \times 1000$ where: CI – Cardiac Index, L/min/m ² PR – Pulse rate, beats/min	mL/beat/m ²
SVR	Systemic Vascular Resistance $SVR = \{(MAP - CVP) \times 80\} / CO$ (dyne-sec/cm ⁵) $SVR = \{(MAP_{SI} - CVP_{SI}) \times 60\} / CO$ where: MAP – Mean Arterial Pressure, mmHg MAP _{SI} – Mean Arterial Pressure, kPa CVP – Central Venous Pressure, mmHg CVP _{SI} – Central Venous Pressure, kPa CO – Cardiac Output, L/min	dyne-s/cm ⁵ (kPa-s/L) _{SI}
SVRI	Systemic Vascular Resistance Index $SVRI = \{(MAP - CVP) \times 80\} / CI$ $SVRI = \{(MAP_{SI} - CVP_{SI}) \times 60\} / CI$ where: MAP – Mean Arterial Pressure, mmHg MAP _{SI} – Mean Arterial Pressure, kPa CVP – Central Venous Pressure, mmHg CVP _{SI} – Central Venous Pressure, kPa CI – Cardiac Index, L/min/m ²	dyne-s-m ² /cm ⁵ (kPa-s-m ² /L) _{SI}
SVV	Stroke Volume Variation $SVV = 100 \times (SV_{max} - SV_{min}) / \text{mean}(SV)$	%
VO ₂	Oxygen Consumption $VO_2 = Ca-vO_2 \times CO \times 10$ (mL O ₂ /min) where: Ca-vO ₂ – Arteriovenous Oxygen Content Difference, mL/dL CO – Cardiac Output, L/min	mL O ₂ /min
VO _{2e}	Estimated Oxygen Consumption Index when ScvO ₂ is being monitored $VO_{2e} = Ca-vO_2 \times CO \times 10$ (mL O ₂ /min) where: Ca-vO ₂ – Arteriovenous Oxygen Content Difference, mL/dL CO – Cardiac Output, L/min	mL O ₂ /min
VO _{2l}	Oxygen Consumption Index VO_2 / BSA	mL O ₂ /min/m ²

Table C-1 Cardiac and oxygenation profile equations (continued)

Parameter	Description and formula	Units
VO ₂ le	Estimated Oxygen Consumption Index VO ₂ e/ BSA	mL O ₂ /min/m ²
VQI	<p>Ventilation Perfusion Index</p> $VQI = \frac{\{1.38 \times HGB \times (1.0 - (SaO_2/100)) + (0.0031 \times PAO_2)\}}{\{1.38 \times HGB \times (1.0 - (SvO_2/100)) + (0.0031 \times PAO_2)\}} \times 100$ $VQI = \frac{\{1.38 \times HGB_{SI} \times 1.611344 \times (1.0 - (SaO_2/100)) + (0.0031 \times PAO_2)\}}{\{1.38 \times HGB_{SI} \times 1.611344 \times (1.0 - (SvO_2/100)) + (0.0031 \times PAO_2)\}} \times 100$ <p>where:</p> <p>HGB – Total Hemoglobin, g/dl HGB_{SI} – Total Hemoglobin, mmol/l SaO₂ – Arterial O₂ Saturation, % SvO₂ – Mixed Venous O₂ Saturation, % PAO₂ – Alveolar O₂ Tension, mmHg</p> <p>and:</p> $PAO_2 = ((PBAR - PH_2O) \times FiO_2) - PaCO_2 \times (FiO_2 + (1.0 - FiO_2)/0.8)$ <p>where:</p> <p>FiO₂ – Fraction of Inspired Oxygen PBAR – 760 mmHg PH₂O – 47 mmHg PaCO₂ – 40 mmHg</p>	%

Appendix D

Monitor Settings and Defaults

D.1 Patient Data Input Range

Table D-1 Patient information

Parameter	Minimum	Maximum	Available units
Gender	M (Male) / F (Female)	N/A	N/A
Age	2	120	years
Height	12 in / 30 cm	98 in / 250 cm	inches (in) or cm
Weight	2 lbs / 1.0 kg	881 lbs / 400.0 kg	lbs or kg
BSA	0.08	5.02	m ²
ID	0 digits	40 characters	None

D.2 Trend Scale Default Limits

Table D-2 Graphical trend parameter scale defaults

Parameter	Units	Minimum default value	Maximum default value	Setting increment
CO/iCO/sCO	L/min	0.0	12.0	1.0
CI/iCI/sCI	L/min/m ²	0.0	12.0	1.0
SV	mL/b	0	160	20
SVI	mL/b/m ²	0	80	20
SVV	%	0	50	10
ScvO ₂ /SvO ₂	%	0	99	10
StO ₂	%	1	99	10
SVR/iSVR	dyne-s/cm ⁵	500	1500	100
SVRI/iSVRI	dyne-s-m ² /cm ⁵	500	3000	200
EDV/sEDV	mL	0	800	25
EDVI/sEDVI	mL/m ²	0	400	25
RVEF/sRVEF	%	0	100	10
SYS _{ART}	mmHg	80	160	5

Table D-2 Graphical trend parameter scale defaults

Parameter	Units	Minimum default value	Maximum default value	Setting increment
SYS _{PAP}	mmHg	0	55	5
DIA _{ART}	mmHg	50	110	5
DIA _{PAP}	mmHg	0	35	5
MAP	mmHg	50	130	5
MPAP	mmHg	0	45	5
PPV	%	0	50	10
PR	bpm	40	130	5
dP/dt	mmHg/sec	0	2000	100
Ea _{dyn}	none	0.2	1.5	0.1
HPI	none	0	100	10

NOTE The HemoSphere advanced monitor will not accept a setting of an upper scale setting that is less than the lower scale setting. Nor will it accept a lower scale setting that is higher than the upper scale setting.

D.3 Parameter Display and Configurable Alarm/Target Ranges

Table D-3 Configurable parameter alarm and display ranges

Parameter	Units	Display Range	Configurable Range
CO	L/min	1.0 to 20.0	1.0 to 20.0
iCO	L/min	0.0 to 20.0	0.0 to 20.0
sCO	L/min	1.0 to 20.0	1.0 to 20.0
CO _{20s}	L/min	1.0 to 20.0	1.0 to 20.0
CI	L/min/m ²	0.0 to 20.0	0.0 to 20.0
iCI	L/min/m ²	0.0 to 20.0	0.0 to 20.0
sCI	L/min/m ²	0.0 to 20.0	0.0 to 20.0
CI _{20s}	L/min/m ²	0.0 to 20.0	0.0 to 20.0
SV	mL/b	0 to 300	0 to 300
SV _{20s}	mL/b	0 to 300	0 to 300
SVI	mL/b/m ²	0 to 200	0 to 200
SVI _{20s}	mL/b/m ²	0 to 200	0 to 200
SVR	dyne-s/cm ⁵	0 to 5000	0 to 5000
SVRI	dyne-s-m ² /cm ⁵	0 to 9950	0 to 9950
iSVR	dyne-s/cm ⁵	0 to 5000	0 to 5000

Table D-3 Configurable parameter alarm and display ranges (continued)

Parameter	Units	Display Range	Configurable Range
iSVRI	dyne-s-m ² /cm ⁵	0 to 9950	0 to 9950
SVV	%	0 to 99	0 to 99
Oximetry (ScvO ₂ /SvO ₂ /StO ₂)	%	0 to 99	0 to 99
EDV	mL	0 to 800	0 to 800
sEDV	mL	0 to 800	0 to 800
EDVI	mL/m ²	0 to 400	0 to 400
sEDVI	mL/m ²	0 to 400	0 to 400
RVEF	%	0 to 100	0 to 100
sRVEF	%	0 to 100	0 to 100
CVP	mmHg	0 to 50	0 to 50
MAP	mmHg	0 to 300	0 to 300
MAP (live arterial waveform display)	mmHg	-34 to 312	0 to 300
MPAP	mmHg	0 to 99	0 to 99
SYS _{ART}	mmHg	0 to 300	10 to 300
SYS _{PAP}	mmHg	0 to 99	0 to 99
DIA _{ART}	mmHg	0 to 300	10 to 300
DIA _{PAP}	mmHg	0 to 99	0 to 99
PPV	%	0 to 99	0 to 99
PR	bpm	0 to 220	0 to 220
HPI	none	0 to 100	N/A ¹
dP/dt	mmHg/sec	0 to 3000	0 to 3000
Ea _{dyn}	none	0.0 to 3.0	N/A ²
HRavg	bpm	0 to 220	0 to 220
<p>¹Parameter alarm range for HPI is non-configurable.</p> <p>²Ea_{dyn} is a non alarming parameter. Range shown here is for display only.</p>			

D.4 Alarm and Target Defaults

Table D-4 Parameter alarm red zone and target defaults

Parameter	Units	EW default lower alarm (red zone) setting	EW default lower target setting	EW default upper target setting	EW default upper alarm (red zone) setting
CI/iCI/sCI/CI _{20s}	L/min/m ²	1.0	2.0	4.0	6.0
SVI/SVI _{20s}	mL/b/m ²	20	30	50	70
SVRI/iSVRI	dyne-s-m ² /cm ⁵	1000	1970	2390	3000
SVV	%	0	0	13	20
ScvO ₂ /SvO ₂	%	50	65	75	85
StO ₂	%	50	60	90	100
EDVI/sEDVI	mL/m ²	40	60	100	200
RVEF/sRVEF	%	20	40	60	60
DO ₂ I	mL O ₂ /min/m ²	300	500	600	800
VO ₂ I/VO ₂ Ie	mL O ₂ /min/m ²	80	120	160	250
CVP	mmHg	2	2	8	10
SYS _{ART}	mmHg	90	100	130	150
SYS _{PAP}	mmHg	10	14	23	34
DIA _{ART}	mmHg	60	70	90	100
DIA _{PAP}	mmHg	0	4	13	16
MAP	mmHg	60	70	100	120
MPAP	mmHg	5	9	18	25
HRavg	bpm	60	70	100	120
HGB	g/dL	7.0	11.0	17.0	19.0
	mmol/L	4.3	6.8	10.6	11.8
SpO ₂	%	90	94	100	100
PPV	%	0	0	13	20
PR	bmp	60	70	100	120
HPI	none	0	N/A	N/A	85
dP/dt	mmHg/sec	380	480	1300	1800

NOTE Non-indexed ranges are based on indexed ranges and entered BSA values.

D.5 Alarm Priorities

Table D-5 Parameter alarms, faults, and alerts priorities

Physiologic parameter (alarms)/ message type	Lower physiological alarm (red zone) priority	Upper physiological alarm (red zone) priority	Message type priority
CO/CI/sCO/sCI/CO _{20s} /CI _{20s}	High	Medium	
SV/SVI/SV _{20s} /SVI _{20s}	High	Medium	
SVR/SVRI	Medium	Medium	
SVV	Medium	Medium	
ScvO ₂ /SvO ₂	High	Medium	
StO ₂	High	N/A	
EDV/EDVI/sEDV/sEDVI	Medium	Medium	
RVEF/sRVEF	Medium	Medium	
SYS _{ART} /SYS _{PAP}	High	High	
DIA _{ART} /DIA _{PAP}	High	High	
MAP	High	High	
PR	High	High	
MPAP	Medium	Medium	
CVP	Medium	Medium	
PPV	Medium	Medium	
Fault			Medium/High
Alert			Low

NOTE

The alarm signal generation delay is parameter dependent. For oximetry associated parameters, the delay is less than 2 seconds after the parameter is out of range continuously for 5 or more seconds. For HemoSphere Swan-Ganz module continuous CO and associated parameters, the delay is less than 360 seconds, although typical delay due to parameter calculation is 57 seconds. For HemoSphere pressure cable continuous CO and associated FloTrac system parameters, the delay is 2 seconds for 5 second parameter averaging (after the parameter is out of range continuously for 5 or more seconds for a total of 7 seconds), and 20 seconds for 20 second and 5 minute parameter averaging (see table 6-4 on page 125). For HemoSphere pressure cable with TruWave DPT measured parameters, the delay is 2 seconds, after the parameter is out of range continuously for 5 or more seconds (total of 7 seconds). For HemoSphere ClearSight module noninvasive monitoring, the delay is 5 heartbeats after the parameter is out of range continuously for 5 or more seconds.

The parameter value will flash at a higher frequency for a high priority physiological alarm as compared to a medium physiological alarm. If medium and high priority alarms are sounding at the same time, the physiological high priority alarm tone will be

heard. If a low priority alarm is active and a medium or higher priority alarms is generated, the low priority alarm visual indicator will be replaced by the higher priority alarm visual indicator.

Most technical faults are medium priority. Alerts and other system messages are low priority.

D.6 Language Default Settings

Table D-6 Language default settings

Language	Default display units				Time format	Date format	CO trend averaging time
	PaO ₂	HGB	Height	Weight			
English (US)	mmHg	g/dL	in	lbs	12 hour	MM/DD/YYYY	20 seconds
English (UK)	kPa	mmol/L	cm	kg	24 hour	DD.MM.YYYY	20 seconds
Français	kPa	mmol/L	cm	kg	24 hour	DD.MM.YYYY	20 seconds
Deutsch	kPa	mmol/L	cm	kg	24 hour	DD.MM.YYYY	20 seconds
Italiano	kPa	mmol/L	cm	kg	24 hour	DD.MM.YYYY	20 seconds
Español	kPa	mmol/L	cm	kg	24 hour	DD.MM.YYYY	20 seconds
Svenska	kPa	mmol/L	cm	kg	24 hour	DD.MM.YYYY	20 seconds
Nederlands	kPa	mmol/L	cm	kg	24 hour	DD.MM.YYYY	20 seconds
Ελληνικά	kPa	mmol/L	cm	kg	24 hour	DD.MM.YYYY	20 seconds
Português	kPa	mmol/L	cm	kg	24 hour	DD.MM.YYYY	20 seconds
日本語	mmHg	g/dL	cm	kg	24 hour	MM/DD/YYYY	20 seconds
中文	kPa	mmol/L	cm	kg	24 hour	DD.MM.YYYY	20 seconds
Čeština	kPa	mmol/l	cm	kg	24 hour	DD.MM.YYYY	20 seconds
Polski	kPa	mmol/l	cm	kg	24 hour	DD.MM.YYYY	20 seconds
Suomi	kPa	mmol/l	cm	kg	24 hour	DD.MM.YYYY	20 seconds
Norsk	kPa	mmol/L	cm	kg	24 hour	DD.MM.YYYY	20 seconds
Dansk	kPa	mmol/L	cm	kg	24 hour	DD.MM.YYYY	20 seconds
Eesti	mmHg	mmol/L	cm	kg	24 hour	DD.MM.YYYY	20 seconds
Lietuvių	mmHg	g/dl	cm	kg	24 hour	DD.MM.YYYY	20 seconds
Latviešu	kPa	mmol/L	cm	kg	24 hour	DD.MM.YYYY	20 seconds

Note: Temperature defaults to Celsius for all languages.

NOTE Languages listed above are for reference only and may not be available for selection.

Appendix E

Computation Constants

E.1 Computation Constant Values

In iCO mode, the HemoSphere Swan-Ganz module computes cardiac output employing either a bath probe setup or an in-line temperature probe using the computation constants listed in the following tables. The HemoSphere Swan-Ganz module automatically senses the type of injectate temperature probe being used, and the corresponding injectate temperature, catheter size, and injectate volume define the computation constant to be used.

NOTE The computation constants given below are nominal and generally applicable to the specified catheter sizes. For computation constants specific to the catheter being used, refer to the catheter directions for use.

Model-specific computation constants are entered manually in the setup menu for the iCO mode.

Table E-1 Computation constants for bath temperature probe

Injectate temperature range* (°C)	Injectate volume (mL)	Catheter size (French)				
		8	7.5	7	6	5.5
Room temp. 22.5–27 °C	10	0.612	0.594	0.595	0.607	0.616
	5	0.301	0.283	0.287	0.304	0.304
	3	0.177	0.159	0.165	0.180	0.180
Room temp. 18–22.5 °C	10	0.588	0.582	0.578	0.597	0.606
	5	0.283	0.277	0.274	0.297	0.298
	3	0.158	0.156	0.154	0.174	0.175
Cold (iced) 5–18 °C	10	0.563	0.575	0.562	0.573	0.581
	5	0.267	0.267	0.262	0.278	0.281
	3	0.148	0.150	0.144	0.159	0.161
Cold (iced) 0–5 °C	10	0.564	0.564	0.542	0.547	0.555
	5	0.262	0.257	0.247	0.259	0.264
	3	0.139	0.143	0.132	0.144	0.148

* To optimize cardiac measurement, it is recommended that the temperature of the injectate correspond to one of the temperature ranges listed in the catheter's directions for use.

Table E-2 Computation constants for in-line temperature probe

Injectate temperature range* (°C)	Injectate volume (mL)	Catheter size (French)				
		8	7.5	7	6	5.5
Room temp. 22.5–27 °C	10	0.601	0.599	0.616	0.616	0.624
	5	0.294	0.301	0.311	0.307	0.310
Room temp. 18–22.5 °C	10	0.593	0.593	0.603	0.602	0.612
	5	0.288	0.297	0.295	0.298	0.304
Cold (iced) 5–18 °C	10	0.578	0.578	0.570	0.568	0.581
	5	0.272	0.286	0.257	0.276	0.288
Cold (iced) 0–5 °C	10	0.562	0.563	0.537	0.533	0.549
	5	0.267	0.276	0.217	0.253	0.272

* To optimize cardiac measurement, it is recommended that the temperature of the injectate correspond to one of the temperature ranges listed in the catheter's directions for use.

Appendix F

System Care, Service and Support

Contents

General Maintenance307
Cleaning the Monitor and Modules308
Cleaning the Platform Cables308
Service and Support311
Edwards Lifesciences Regional Headquarters312
Monitor Disposal313
Preventive Maintenance313
Testing of Alarm Signals314
Warranty314

F.1 General Maintenance

The HemoSphere advanced monitor contains no user-serviceable parts, and should be repaired only by qualified service representatives. Hospital biomedics or service technicians can refer to the HemoSphere advanced monitor service manual for information on maintenance and recurrent testing. This appendix provides instructions for cleaning the monitor and monitor accessories and contains information on how to contact your local Edwards representative for support and information on repair and/or replacement.

WARNING The HemoSphere advanced monitor contains no user-serviceable parts. Removing the cover or any other disassembly will expose you to hazardous voltages.

CAUTION Clean and store the instrument and accessories after each use.

CAUTION The HemoSphere advanced monitor modules and platform cables are electrostatic discharge (ESD) sensitive. Do not attempt to open cable or module housing or use if the housing has been damaged.

F.2 Cleaning the Monitor and Modules

WARNING **Shock or fire hazard!** Do not immerse the HemoSphere advanced monitor, modules, or platform cables in any liquid solution. Do not allow any fluids to enter the instrument.

The HemoSphere advanced monitor and modules can be cleaned using a lint-free cloth dampened with cleaning agents that are based on the following chemical content:

- 70% isopropyl alcohol
- 2% glutaraldehyde
- 10% bleach solution (sodium hypochlorite)
- quaternary ammonium solution

Do not use any other cleaning agents. Unless otherwise stated, these cleaning agents are approved for all HemoSphere advanced monitoring accessories, cables and modules.

NOTE Once inserted, modules do not need to be removed unless maintenance or cleaning is necessary. If it is necessary to remove platform modules, store them in a cool, dry place in original packaging to prevent damage.

CAUTION Do not pour or spray liquid on any portion of the HemoSphere advanced monitor, accessories, modules, or cables.

Do not use any disinfecting solution other than the types specified.

DO NOT:

Allow any liquid to come in contact with the power connector

Allow any liquid to penetrate connectors or openings in the monitor case or modules

If any liquid does come in contact with any of the above mentioned items, DO NOT attempt to operate the monitor. Disconnect power immediately and call your Biomedical Department or local Edwards representative.

F.3 Cleaning the Platform Cables

Platform cables, such as the pressure-out cable, can be cleaned using the cleaning agents listed above in section F.2 and the following methods.

CAUTION Conduct periodic inspections of all cables for defects. Do not coil cables tightly when storing.

- 1 Moisten a lint-free cloth with disinfectant and wipe the surfaces.
- 2 Follow the disinfectant wipe with rinsing wipes using cotton gauze moistened with sterile water. Use sufficient rinsing wipes to remove all residual disinfectant.
- 3 Dry the surface with a clean dry cloth.

Store platform cables in a cool, dry place in original packaging to prevent damage. Additional instructions specific to certain cables are listed in the following sub-sections.

CAUTION Do not use any other cleaning agents, spray, or pour cleaning solution directly on platform cables.
Do not steam, radiate, or EO sterilize platform cables.
Do not immerse platform cables.

F.3.1 Cleaning the HemoSphere Oximetry Cable

Use the cleaning agents listed above in section F.2 to clean the oximetry cable housing and the connecting cable. The fiber-optic interface of the oximetry cable must be kept clean. The optical fibers within the oximetry catheter fiber optic connector mate with the optical fibers in the oximetry cable. Moisten a lint-free cotton-tipped applicator with sterile alcohol and apply gentle pressure to clean the optical fibers recessed within the front of the oximetry cable housing.

CAUTION Do not steam, radiate, or EO sterilize the HemoSphere oximetry cable.
Do not immerse the HemoSphere oximetry cable.

F.3.2 Cleaning the Patient CCO Cable and Connector

The patient CCO cable contains electrical and mechanical components and is therefore subject to normal use wear and tear. Visually inspect the cable insulation jacket, strain relief and connectors before each use. If any of the following conditions are present, discontinue use of the cable.

- Broken insulation
 - Frays
 - Connector pins are recessed or bent
 - Connector is chipped and/or cracked
- 1 The patient CCO cable is not protected against fluid ingress. Wipe the cable with a damp, soft cloth using 10% bleach and 90% water solution as needed.
 - 2 Air dry the connector.

CAUTION If any electrolytic solution, for example Ringer's lactate solution, is introduced into the cable connectors while they are connected to the monitor, and the monitor is turned on, the excitation voltage can cause electrolytic corrosion and rapid degradation of the electrical contacts.

Do not immerse any cable connectors in detergent, isopropyl alcohol or glutaraldehyde.

Do not use a hot air gun to dry cable connectors.

- 3 Please contact Technical Support or your local Edwards representative for further assistance.

F.3.3 Cleaning the HemoSphere Pressure Cable

The HemoSphere pressure cable can be cleaned using the cleaning agents listed in section F.2 and methods specified for platform cables at the start of this section (section F.3). Disconnect the pressure cable from the monitor to air dry the transducer connector. To blow dry the transducer connector, use clean, dry wall air, canned air, or CO₂ aerosol for at least two minutes. If left to dry under room conditions, allow the connector to dry for two days before using.

CAUTION If any electrolytic solution, for example Ringer's lactate solution, is introduced into the cable connectors while they are connected to the monitor, and the monitor is turned on, the excitation voltage can cause electrolytic corrosion and rapid degradation of the electrical contacts.

Do not immerse any cable connectors in detergent, isopropyl alcohol or glutaraldehyde.

Do not use a hot air gun to dry cable connectors.

Device contains electronics. Handle with care.

F.3.4 Cleaning the ForeSight Elite Tissue Oximeter Module

Regular cleaning and preventive maintenance of the ForeSight Elite module is an important function that should be performed routinely to ensure safe and efficient module operation. The module does not require calibration, but following maintenance intervals are recommended:

The module should be tested upon installation and every six (6) months thereafter. Please contact Edwards Technical Support for more information.

WARNING Do not, under any circumstances, perform any cleaning or maintenance of the ForeSight Elite module while the module is being used to monitor a patient. The module must be turned off and the HemoSphere advanced monitor power cord disconnected, or the module must be disconnected from the monitor and the sensors removed from the patient.

Before starting cleaning or maintenance of any sort, check the ForeSight Elite module, cables, sensors, and other accessories for damage. Check the cables for bent or broken prongs, cracks, or fraying. If any damage is noted, the module must not be used until it has been inspected and serviced or replaced. Contact Edwards Technical Support.

WARNING There is a risk of serious injury or death if this procedure is not followed.

The following cleaning agents are recommended to clean the ForeSight Elite module:

- Aspeti-Wipe
- 3M Quat #25
- Metrix CaviCide
- Phenolic germicidal detergent solution (per manufacturer's recommendations)
- Quaternary ammonium germicidal detergent solution (per manufacturer's recommendations)

See the product directions for use and labeling for detailed information on active ingredients and any disinfecting claims.

The ForeSight Elite module is designed to be cleaned using wipes or towelettes designed for that purpose. When all surfaces have been cleaned, wipe the entire surface of the module using a soft cloth dampened with fresh water to remove any trace residue.

The sensor cables may be cleaned using wipes or towelettes designed for that purpose. They may be cleaned by wiping from the ForeSight Elite module end towards the sensor connections.

F.3.5 Cleaning the Heart Reference Sensor and Pressure Controller

The heart reference sensor (HRS) and pressure controller can be cleaned using the following disinfectants:

- 70% isopropyl alcohol solution
 - 10% sodium hypochlorite water solution
- 1 Moisten a clean cloth with disinfectant and wipe the surfaces.
 - 2 Dry the surface with a clean, dry cloth.

CAUTION Do not disinfect the heart reference sensor or pressure controller by autoclave or gas sterilization.

Do not immerse any cable connectors in fluid.

Clean and store the heart reference sensor after each use.

F.4 Service and Support

See chapter 15: *Troubleshooting* for diagnosis and remedies. If this information does not solve the problem, contact Edwards Lifesciences.

Edwards provides HemoSphere advanced monitor operations support:

- Within the United States and Canada, call 1.800.822.9837.
- Outside the United States and Canada, contact your local Edwards Lifesciences representative.
- E-mail operational support questions to tech_support@edwards.com.

Have the following information before you call:

- The HemoSphere advanced monitor's serial number, located on the rear panel;

- The text of any error message and detailed information as to the nature of the problem.

F.5 Edwards Lifesciences Regional Headquarters

USA: Edwards Lifesciences LLC
One Edwards Way
Irvine, CA 92614 USA
949.250.2500
800.424.3278
www.edwards.com

China: Edwards (Shanghai) Medical
Products Co., Ltd.
Unit 2602-2608, 2 Grand Gateway,
3 Hong Qiao Road, Xu Hui
District
Shanghai, 200030
Republic of China
Phone 86.21.5389.1888

Switzerland: Edwards Lifesciences S.A.
Route de l'Etraz 70
1260 Nyon, Switzerland
Phone 41.22.787.4300

India: Edwards Lifesciences (India) Pvt.
Ltd.
Techniplex II, 7th floor,
Unit no 1 & 2, off. S.V.Road
Goregaon west-Mumbai
400062
India
Phone +91.022.66935701 04

Japan: Edwards Lifesciences Ltd.
Nittochi Nishi-Shinjuku Bldg.
6-10-1, Nishi-Shinjuku, Shinjuku-ku,
Tokyo 160-0023 Japan
Phone 81.3.6894.0500

Australia: Edwards Lifesciences Pty Ltd
Unit 2 40 Talavera Road
North Ryde
NSW 2113
PO Box 137, North Ryde BC
NSW 1670
Australia
Phone +61(2)8899 6300

Brazil: Edwards Lifesciences
Avenida das Nações Unidas, 14.401 –
Parque da Cidade
Torre Sucupira – 17º. Andar – cj. 171
Chácara Santo Antonio – São Paulo/SP
CEP: 04794-000
Brazil
Phone 55.11.5567.5200

F.6 Monitor Disposal

To avoid contaminating or infecting personnel, the environment or other equipment, make sure the HemoSphere advanced monitor and/or cables are disinfected and decontaminated appropriately in accordance with your country's laws for equipment containing electrical and electronic parts prior to disposal.

For single use parts and accessories, where not otherwise specified, follow local regulations regarding disposal of hospital waste.

F.6.1 Battery Recycling

Replace the HemoSphere battery pack when it no longer holds a charge. After removal, follow your local recycling guidelines.

CAUTION Recycle or dispose of the lithium-ion battery in accordance to all federal, state, and local laws.

F.7 Preventive Maintenance

Periodically examine the HemoSphere advanced monitor exterior for general physical condition. Make sure the housing is not cracked, broken or dented, and that everything is present. Make sure there is no sign of spilled liquids or signs of abuse.

Routinely inspect cords and cables for fraying and cracks, and make sure there are no exposed conductors. In addition, check that the enclosure door at catheter connection point of the oximetry cable moves freely and latches properly.

F.7.1 Battery Maintenance

F.7.1.1 Battery Conditioning

The battery pack may require periodic conditioning. This feature should only be performed by trained hospital staff or technicians. Refer to the HemoSphere advanced monitor service manual for conditioning instructions.

WARNING **Explosion Hazard!** Do not open battery, dispose of in fire, store at high temperature or short circuit. It may ignite, explode, leak or get hot, causing serious personal injury or death.

F.7.1.2 Battery Storage

The battery pack can remain stored in the HemoSphere advanced monitor. Refer to “HemoSphere Advanced Monitor Specifications” on page 281 for environmental specifications for storage.

NOTE Long term storage at high temperatures may decrease life of battery pack.

F.7.2 HemoSphere ClearSight Module Maintenance

Do not pull on the pressure controller cable when unplugging it from the HemoSphere ClearSight module. If it is necessary to remove the module from the HemoSphere advanced monitor, press the release button to unlatch and slide module out. It is recommended to send the HemoSphere ClearSight module to a qualified Edwards Service Center for routine service and preventive maintenance checks every two years. Additional testing includes a visual inspection, a software inspection, safety testing and functional testing. For more information on the testing contact your local Edwards Lifesciences representative.

F.8 Testing of Alarm Signals

Each time the HemoSphere advanced monitor is powered on, a self test is automatically performed. As a part of the self test, an alarm tone will sound. This indicates that the audible alarm indicators are functioning correctly. For further testing of individual measurement alarms, periodically adjust alarm limits and check that the appropriate alarm behavior is observed.

F.9 Warranty

Edwards Lifesciences (Edwards) warrants that the HemoSphere advanced monitor is fit for the purposes and indications described in the labeling for a period of one (1) year from the date of purchase when used in accordance with the directions for use. Unless equipment is used in accordance with such instructions, this warranty is void and of no effect. No other express or implied warranty exists, including any warranty of merchantability or fitness for a particular purpose. This warranty does not include cables, batteries, probes, or oximetry cables used with the HemoSphere advanced monitor. Edwards' sole obligation and purchaser's exclusive remedy for breach of any warranty shall be limited to repair or replacement of the HemoSphere advanced monitor at Edwards' option.

Edwards shall not be liable for proximate, incidental, or consequential damages. Edwards shall not be obligated under this warranty to repair or replace a damaged or malfunctioning HemoSphere advanced monitor if such damage or malfunction is caused by the customer's use of catheters other than those manufactured by Edwards.

Guidance and Manufacturer's Declaration

Contents

Electromagnetic Compatibility.....	315
Instructions for Use.....	315
Wireless Technology Information.....	322

G.1 Electromagnetic Compatibility

*Reference: IEC/EN 60601-1-2:2007 and IEC 60601-2-49:2011-02
IEC/EN 60601-1-2:2014-02 and IEC 60601-2-49:2011-02*

The HemoSphere advanced monitor is intended for use in the electromagnetic environment specified in this appendix. The customer or the user of the HemoSphere advanced monitor should assure that it is used in such an environment. When connected to the HemoSphere advanced monitor, all accessory cables listed in table B-1 on page 291 comply with the EMC standards listed above.

G.2 Instructions for Use

Medical electrical equipment needs special precautions regarding EMC and needs to be installed and put into service according to the EMC information provided in the following information and tables.

WARNING Use of accessories, sensors, and cables other than those specified may result in increased electromagnetic emissions or decreased electromagnetic immunity.

No modification of the HemoSphere advanced monitor is allowed.

Portable and mobile RF communication equipment and other sources of electromagnetic disturbance such as diathermy, lithotripsy, RFID, electromagnetic ant-theft systems and metal detectors can potentially affect all electronic medical equipment, including the HemoSphere advanced monitor.

Guidance on maintaining appropriate separation between communications equipment

and the HemoSphere advanced monitor is provided in table G-3. The effects of other RF emitters are unknown and may interfere with the function and safety of the HemoSphere monitoring platform.

CAUTION The instrument has been tested and complies with the limits of IEC 60601-1-2. These limits are designed to provide reasonable protection against harmful interference in a typical medical installation. This equipment generates, uses and can radiate radio frequency energy and, if not installed and used in accordance with the instructions, may cause harmful interference to other devices in the vicinity. However, there is no guarantee that interference will not occur in a particular installation. If this equipment does cause harmful interference to other devices which can be determined by turning the equipment off and on, the user is encouraged to try to correct the interference by one or more of the following measures:

- Reorient or relocate the receiving device.
- Increase the separation between the equipment.
- Consult the manufacturer for help.

Table G-1 Electromagnetic emissions

Guidance and Manufacturer's Declaration - Electromagnetic Emissions		
The HemoSphere advanced monitor is intended for use in the electromagnetic environment specified below. The customer or user of the HemoSphere advanced monitor should assure that it is used in such an environment.		
Emissions	Compliance	Description
RF emissions CISPR 11	Group 1	The HemoSphere advanced monitor uses RF energy only for its internal function. Therefore, its RF emissions are very low and are not likely to cause any interference with nearby electronic equipment.
RF emissions CISPR 11	Class A	The HemoSphere advanced monitor is suitable for use in all establishments other than domestic and those directly connected to the public low-voltage power supply network that supplies buildings used for domestic purposes.
Harmonic emissions IEC 61000-3-2	Class A	
Voltage fluctuation/ Flicker emissions IEC 61000-3-3	Complies	

Table G-2 Guidance and Manufacturer's Declaration - Immunity to RF wireless communications equipment

Test Frequency	Band ¹	Service ¹	Modulation ²	Maximum Power	Distance	Immunity Test Level
MHz	MHz			W	Meters	(V/m)
The HemoSphere advanced monitor is intended for use in the electromagnetic environment specified below. The customer or user of the HemoSphere advanced monitor should ensure that it is used in such an environment.						
385	380 - 390	TETRA 400	Pulse modulation ² 18 Hz	1.8	0.3	27
450	430 - 470	GMRS 460, FRS 460	FM ³ ± 5 kHz deviation 1 kHz sine	2	0.3	28
710 745 780	704 - 787	LTE Band 13, 17	Pulse modulation ² 217 Hz	0.2	0.3	9
810 870 930	800 - 960	GSM 800/900, TETRA 800, iDEN 820, CDMA 850, LTE Band 5	Pulse modulation ² 18 Hz	2	0.3	28
1720 1845 1970	1700 - 1900	GSM 1800; CDMA 1900; GSM 1900; DECT; LTE Band 1, 3, 4, 25; UMTS	Pulse modulation ² 217 Hz	2	0.3	28
2450	2400 - 2570	Bluetooth, WLAN, 802.11 b/g/n, RFID 2450, LTE Band 7	Pulse modulation ² 217 Hz	2	0.3	28
5240 5500 5785	5100 - 5800	WLAN 802.11a/n	Pulse modulation ² 217 Hz	0.2	0.3	9
NOTE If necessary to achieve the IMMUNITY TEST LEVEL, the distance between the transmitting antenna and the ME EQUIPMENT or ME SYSTEM may be reduced to 1 m. The 1 m test distance is permitted by IEC 61000-4-3.						
¹ For some services, only the uplink frequencies are included.						
² The carrier shall be modulated using a 50 % duty cycle square wave signal.						
³ As an alternative to FM modulation, 50 % pulse modulation at 18 Hz may be used because while it does not represent actual modulation, it would be worst case.						

Table G-3 Recommended Separation Distances between Portable and Mobile RF Communications Equipment and the HemoSphere advanced monitor

The HemoSphere advanced monitor is intended for use in an electromagnetic environment in which radiated RF disturbances are controlled. To help prevent electromagnetic interference, maintain a minimum distance between portable and mobile RF communications equipment (transmitters) and the HemoSphere advanced monitor as recommended below, according to the maximum output power of the communications equipment.

Transmitter Frequency	150 kHz to 80 MHz	80 to 800 MHz	800 to 2500 MHz	2.5 to 5.0 GHz
Equation	$d = 1.2 \sqrt{P}$	$d = 1.2 \sqrt{P}$	$d = 2.3 \sqrt{P}$	$d = 2.3 \sqrt{P}$
Rated Maximum Output Transmitter Power (watts)	Separation Distance (meters)	Separation Distance (meters)	Separation Distance (meters)	Separation Distance (meters)
0.01	0.12	0.12	0.24	0.24
0.1	0.37	0.37	0.74	0.74
1	1.2	1.2	2.3	2.3
10	3.7	3.8	7.4	7.4
100	12	12	23	23

For transmitters rated at a maximum output power not listed above, the recommended separation distance d can be estimated using the equation in the corresponding column, where P is the maximum output power rating of the transmitter in watts according to the transmitter manufacturer.

NOTE 1: At 80 MHz and 800 MHz, the separation distance for the higher frequency range applies.

NOTE 2: These guidelines may not apply in all situations. Electromagnetic propagation is affected by absorption and reflection from structures, objects, and people.

Table G-4 In band wireless coexistence – Threshold of Interference (ToI) and Threshold of Communication (ToC) between HemoSphere advanced monitor (EUT) in Invasive mode and external devices

Test Specifications ¹	Threshold of interference (ToI) or Threshold of Communication (ToC) Results					Extrapolated Interference Thresholds based upon the Intended Signal located 3m away from the HemoSphere advanced monitor							
	Unintended Type and min level	EUT Intended Frequency (EUT)	Frequency of Unintended Signal (MHz)	Unintended Signal Level at EUT (dBm)	I/U Ratio (ToI or ToC)	EIRP (W)	Distance (m)	EIRP (W)	Distance (m)	EIRP (W)	Distance (m)	EIRP (W)	Distance (m)
A (ToI)	Tier 3 / 802.11n 64 qam	2437	2412	25.57	3.85	10	15.80	1	5.00	0.1	1.58	0.01	0.50
A (ToC)				47.56	-18.14	10	1.26	1	0.40	0.1	0.13	0.01	0.04
B (ToI)	20MHz Adj Channel 20dBm	5200	5180	32.19	-15.81	10	7.37	1	2.33	0.1	0.74	0.01	0.23
B (ToC)				38.53	-22.15	10	3.55	1	1.12	0.1	0.36	0.01	0.11
C (ToI)	(TRP/ EIRP)	5765	5745	28.17	-12.15	10	11.70	1	3.70	0.1	1.17	0.01	0.37
C (ToC)				30.21	-14.19	10	9.25	1	2.93	0.1	0.93	0.01	0.29

¹Test Specifications [Threshold of interference (ToI) or Threshold of Communication (ToC) results]:

- A. 2.4 GHz; Ch 6, 2437 MHz – Invasive Mode
- B. 5 GHz, 20 MHz; Ch 40, (5190-5210 MHz) – Invasive Mode
- C. 5 GHz, 20 MHz; Ch 153, (5755-5775 MHz) – Invasive Mode

Table G-5 In band wireless coexistence – Threshold of Interference (ToI) and Threshold of Communication (ToC) between HemoSphere advanced monitor (EUT) in Noninvasive mode and external devices

Test Specifications ¹	Threshold of interference (ToI) or Threshold of Communication (ToC) Results					Extrapolated Interference Thresholds based upon the Intended Signal located 3m away from the HemoSphere advanced monitor							
	Unintended Type and min level	EUT Intended Frequency (EUT)	Frequency of Unintended Signal (MHz)	Unintended Signal Level at EUT (dBm)	I/U Ratio (ToI or ToC)	EIRP (W)	Distance (m)	EIRP (W)	Distance (m)	EIRP (W)	Distance (m)	EIRP (W)	Distance (m)
A (ToI)	Tier 3 / 802.11n 64 qam 20MHz Adj Channel 20dBm (TRP/ EIRP)	2437	2412	24.06	3.05	10	18.80	1	5.94	0.1	1.88	0.01	0.59
A (ToC)		2437	2412	47.96	-20.85	10	1.20	1	0.38	0.1	0.12	0.01	0.04
B (ToI)		5200	5180	36.19	-18.7	10	4.65	1	1.47	0.1	0.47	0.01	0.15
B (ToC)		5200	5180	36.19	-18.7	10	4.65	1	1.47	0.1	0.47	0.01	0.15
C (ToI)		5765	5745	28.18	-12.1	10	11.69	1	3.70	0.1	1.17	0.01	0.37
C (ToC)		5765	5745	32.34	-16.26	10	7.24	1	2.29	0.1	0.72	0.01	0.23

¹Test Specifications [Threshold of interference (ToI) or Threshold of Communication (ToC) results]:

- A. 2.4 Ghz; Ch 6, 2437 MHz – Noninvasive Mode
- B. 5 GHz, 20 MHz; Ch 40, (5190-5210 MHz) – Noninvasive Mode
- C. 5 GHz, 20 MHz; Ch 153, (5755-5775 MHz) – Noninvasive Mode

Table G-6 Electromagnetic Immunity (ESD, EFT, Surge, Dips and Magnetic Field)

Immunity Test	IEC 60601-1-2 Test Level	Compliance Level	Electromagnetic Environment - Guidance
<p>The HemoSphere advanced monitor is intended for use in the electromagnetic environment specified below. The customer or user of the HemoSphere advanced monitor should assure that it is used in such an environment.</p>			
Electrostatic discharge (ESD) IEC 61000-4-2	±8 kV contact	±8 kV	Floors should be wood, concrete, or ceramic tile. If floors are covered with synthetic material, the relative humidity should be at least 30%.
	±15 kV air	±15 kV	
Electrical fast transient/burst IEC 61000-4-4	±2 kV for power supply lines ±1 kV for 1 kV for input/output lines > 3 meters	±2 kV for power supply lines ±1 kV for 1 kV for input/output lines > 3 meters	Mains power quality should be that of a typical commercial and/or hospital environment.
Surge IEC 61000-4-5	±1 kV line(s) to line(s)	±1 kV line(s) to line(s)	
	±2 kV line(s) to earth	±2 kV line(s) to earth	
Voltage dips, short interruptions and voltage variations on power supply AC input lines IEC 61000-4-11	0% U_T (100% dip in U_T) for 0.5 cycle (0°, 45°, 90°, 135°, 180°, 225°, 270°, and 315°)	0% U_T	Mains power quality should be that of a typical commercial or hospital environment. If the HemoSphere advanced monitor user requires continued operation during power mains interruptions, it is recommended that the HemoSphere advanced monitor be powered by an uninterruptible power supply or battery.
	0% U_T (100% dip in U_T) for 1 cycle (single phase at 0°)	0% U_T	
	70% U_T (30% dip in U_T) for 25/30 cycles (single phase at 0°)	70% U_T	
	Interrupt: 0% U_T (100% drop in U_T) for 250/300 cycles	0% U_T	
Power frequency (50/60 Hz) magnetic field IEC 61000-4-8	30 A(rms)/m	30 A/m	Power frequency magnetic fields should be at levels characteristic of a typical location in a typical commercial or hospital environment.
NOTE: U_T is the AC mains voltage prior to application of the test level.			

Table G-7 Electromagnetic Immunity (RF Radiated and Conducted)

Immunity Test	IEC 60601-1-2 Test Level	Compliance Level	Electromagnetic Environment - Guidance
<p>The HemoSphere advanced monitor is intended for use in the electromagnetic environment specified below. The customer or user of the HemoSphere advanced monitor should assure that it is used in such an environment.</p>			
<p>Conducted RF IEC 61000-4-6</p>	<p>3 Vrms 150 kHz to 80 MHz</p>	<p>3 Vrms</p>	<p>Portable and mobile RF communication equipment should be used no closer to any part of the HemoSphere advanced monitor, including cables, than the recommended separation distance calculated from the equation applicable to the frequency of the transmitter.</p> <p>Recommended Separation Distance</p> $d = [1.2] \times \sqrt{P} ; 150 \text{ kHz to } 80 \text{ MHz}$
<p>Conducted RF IEC 61000-4-6</p>	<p>6 Vrms (ISM band) 150 kHz to 80 MHz</p>	<p>6 Vrms</p>	$d = [1.2] \times \sqrt{P} ; 80 \text{ MHz to } 800 \text{ MHz}$
<p>Radiated RF IEC 61000-4-3</p>	<p>3 V/m 80 to 2700 MHz</p>	<p>3 V/m</p>	$d = [2.3] \times \sqrt{P} ; 800 \text{ MHz to } 2500 \text{ MHz}$ <p>Where P is the maximum output power rating of the transmitter in watts (W) according to the transmitter manufacturer and d is the recommended separation distance in meters (m).</p> <p>Field strengths from fixed RF transmitters, as determined by an electromagnetic site survey,^a should be less than the compliance level in each frequency range.^b</p> <p>Interference may occur in the vicinity of equipment with the following symbol:</p> 
<p>^a Field strengths from fixed transmitters, such as base stations for radio (cellular/cordless) telephones and land mobile radios, amateur radio, AM and FM radio broadcast, and TV broadcast cannot be predicted theoretically with accuracy. To assess the electromagnetic environment due to fixed RF transmitters, an electromagnetic site survey should be considered. If the measured field strength in the location in which the HemoSphere advanced monitor is used exceeds the applicable RF compliance level above, the HemoSphere advanced monitor should be observed to verify normal operation. If abnormal performance is observed, additional measures may be necessary, such as re-orienting or relocating the HemoSphere advanced monitor.</p> <p>^b Over the frequency range 150 kHz to 80 MHz, field strengths should be less than 3 V/m.</p> <p>NOTE 1: At 80 MHz and 800 MHz, the higher frequency range applies.</p> <p>NOTE 2: These guidelines may not apply in all situations. Electromagnetic propagation is affected by absorption and reflection from structures, objects and people.</p>			

G.3 Wireless Technology Information

The HemoSphere advanced monitor contains wireless communication technology that provides enterprise-class Wi-Fi connectivity. HemoSphere advanced monitor wireless technology supports IEEE 802.11a/b/g/n with a fully integrated security supplicant providing 802.11i/WPA2 Enterprise authentication, data encryption.

Technical details of the wireless technology implemented in the HemoSphere advanced monitor are provided in the following table.



Table G-8 HemoSphere advanced monitor wireless information

Feature	Description
Wi-Fi standards	IEEE 802.11a, 802.11b, 802.11g, 802.11n
Wi-Fi media	Direct Sequence-Spread Spectrum (DSSS) Complementary Code Keying (CCK) Orthogonal Frequency Divisional Multiplexing (OFDM)
Wi-Fi Media Access Protocol	Carrier sense multiple access with collision avoidance (CSMA/CA)
Wi-Fi Data Rates Supported	802.11a (OFDM): 6, 9, 12, 18, 24, 36, 48, 54 Mbps 802.11b (DSSS, CCK): 1, 2, 5.5, 11 Mbps 802.11g (OFDM): 6, 9, 12, 18, 24, 36, 48, 54 Mbps 802.11n (OFDM, HT20, MCS 0-7): 6.5, 13, 19.5, 26, 39, 52, 58.5, 72.2 Mbps 7.2, 14.4, 21.7, 28.9, 43.3, 57.8, 65 Mbps
Modulation	BPSK at 1, 6, 6.5, 7.2 and 9 Mbps QPSK at 2, 12, 13, 14.4, 18, 19.5 and 21.7 Mbps CCK at 5.5 and 11 Mbps 16-QAM at 24, 26, 28.9, 36, 39 and 43.3 Mbps 64-QAM at 48, 52, 54, 57.8, 58.5, 65, and 72.2 Mbps
802.11n Spatial Streams	1X1 SISO (Single Input, Single Output)
Regulatory Domain Support	FCC (Americas, Parts of Asia, and Middle East) ETSI (Europe, Middle East, Africa, and Parts of Asia) MIC (Japan) (formerly TELEC) KC (Korea) (formerly KCC) NCC (Taiwan)
2.4 GHz Frequency Bands	ETSI: 2.4 GHz to 2.483 GHz MIC: 2.4 GHz to 2.495 GHz FCC: 2.4 GHz to 2.483 GHz KC: 2.4 GHz to 2.483 GHz
2.4 GHz Operating Channels	ETSI: 13 (3 non-overlapping) MIC: 14 (4 non-overlapping) FCC: 11 (3 non-overlapping) KC: 13 (3 non-overlapping)
5 GHz Frequency Bands	ETSI: 5.15 GHz to 5.35 GHz 5.47 GHz to 5.725 GHz FCC: 5.15 GHz to 5.35 GHz 5.47 GHz to 5.725 GHz 5.725 GHz to 5.825 GHz MIC: 5.15 GHz to 5.35 GHz 5.47 GHz to 5.725 GHz KC: 5.15 GHz to 5.25 GHz 5.725 GHz to 5.825 GHz
5 GHz Operating Channels	ETSI: 19 non-overlapping MIC: 19 non-overlapping FCC: 24 non-overlapping KC: 19 non-overlapping

Table G-8 HemoSphere advanced monitor wireless information (continued)

Feature	Description
<p>Maximum Transmit Power</p> <p>Note: <i>Maximum transmits power varies according to individual country regulations. All values nominal, ±2 dBm. At 2.4 GHz, a single spatial stream and 20 MHz channel bandwidth is supported.</i></p>	<p>802.11a 6 Mbps 15 dBm (31.623 mW) 54 Mbps 12 dBm (19.953 mW)</p> <p>802.11b 1 Mbps 16 dBm (39.81 mW) 11 Mbps 16 dBm (39.81mW)</p> <p>802.11g 6 Mbps 16 dBm (39.81 mW) 54 Mbps 12 dBm (25.12 mW)</p> <p>802.11n (2.4 GHz) 6.5 Mbps (MCS0) 16 dBm (39.81 mW) 65 Mbps (MCS7) 12 dBm (15.85 mW)</p> <p>802.11n (5 GHz HT20) 6.5 Mbps (MCS0) 15 dBm (31.62mW) 65 Mbps (MCS7) 12 dBm (15.85mW)</p>
<p>Typical Receiver Sensitivity</p> <p>Note: <i>All values nominal, +/-3 dBm. Variant by channels.</i></p>	<p>802.11a 6 Mbps -90 dBm 54 Mbps -73 dBm (PER <= 10%)</p> <p>802.11b 1 Mbps -89 dBm 11 Mbps -82 dBm (PER <= 8%)</p> <p>802.11g 6 Mbps -85 dBm 54 Mbps -68 dBm (PER <= 10%)</p> <p>802.11n (2.4 GHz) MCS0 Mbps -86 dBm MCS7 Mbps -65 dBm</p> <p>802.11n (5 GHz HT20) MCS0 Mbps -90 dBm MCS7 Mbps -70 dBm</p>
<p>Security</p>	<p>Standards IEEE 802.11i (WPA2)</p> <p>Encryption Advanced Encryption Standard (AES, Rijndael Algorithm)</p> <p>Encryption Key Provisioning Pre-Shared (PSK) Dynamic</p> <p>802.1X Extensible Authentication Protocol Types EAP-FAST, EAP-TLS, EAP-TTLS PEAP-GTC, PEAP-MSCHAPv2, PEAP-TLS LEAP</p> <p>FIPS 140-2 Mode Operation restricted to WPA2-AES with EAP-TLS, and WPA2-PSK/AES</p>

Table G-8 HemoSphere advanced monitor wireless information (continued)

Feature	Description
Compliance	<p>ETSI Regulatory Domain</p> <p>EN 300 328 EN 55022:2006 Class B</p> <p>EN 300 328 v1.8.1 (BT 2.1) EN 55024:1998 +A1:2001, A2:2003</p> <p>EN 301 489-1 EN 61000-3-2:2006</p> <p>EN 301 489-17 EN 61000-3-3:1995 +A1:2001, A2:2005</p> <p>EN 301 893 EU 2002/95/EC (RoHS)</p> <p>EN 60950-1</p> <p>FCC Regulatory Domain (Certification ID: SQG-WB45NBT)</p> <p>FCC 15.247 DTS – 802.11b/g (Wi-Fi): 2.4 GHz & 5.8 GHz</p> <p>FCC 15.407 UNII – 802.11a (Wi-Fi): 2.4 GHz & 5.4 GHz</p> <p>FCC Part 15 Class B UL 60950</p> <p>Industry Canada (Certification ID: 3147A-WB45NBT)</p> <p>RSS-210 – 802.11a/b/g/n (Wi-Fi) – 2.4 GHz, 5.8 GHz, 5.2 GHz, and 5.4 GHz</p> <p>ICES-003, Class B</p> <p>MIC (Japan) (Certification ID:   201-140137)</p> <p>STD-T71 Article 2 Item 19, Category WW (2.4GHz Channels 1-13)</p> <p>Article 2 Item 19-2, Category GZ (2.4GHz Channel 14)</p> <p>Article 2 Item 19-3 Category XW (5150-5250 W52 & 5250-5350 W53)</p> <p>KC (Korea) (Certification ID: MSIP-CRM-LAI-WB45NBT)</p> <p>NCC (Taiwan) (Certification ID: CCAM18LP0760T)</p>
Certifications	<p>Wi-Fi Alliance</p> <p>802.11a, 802.11b, 802.11g, 802.11n</p> <p>WPA Enterprise</p> <p>WPA2 Enterprise</p> <p>Cisco Compatible Extensions (Version 4)</p> <p>FIPS 140-2 Level 1</p> <p>Linux 3.8 running on 45 Series Wi-Fi Module with ARM926 (ARMv5TEJ) - OpenSSL FIPS Object Module v2.0 (validation certificate #1747)</p>
Antenna Type	PCB Dipole
Antenna Dimensions	36 mm x 12 mm x 0.1 mm

G.3.1 Quality of Service for Wireless Technology

The HemoSphere advanced monitor wireless technology enables transmission of physiologic data, alarms, and device notifications to supported Hospital Information Systems (HIS) for electronic charting and archival purposes only. Wirelessly transmitted data is not intended for remote alarm management or real-time, remote data visualization systems. Quality of service (QoS) is specified in terms of total data loss for a normal connection where the HemoSphere advanced monitor is operating at medium wireless signal strength or higher (table 8-1), with good HIS connection (table 8-2). HemoSphere advanced monitor wireless data transmission has been validated to have less than 5% total data loss under these conditions. HemoSphere advanced monitor wireless technology has an effective range of 150 feet, line of sight and 75 feet, non-line of sight. The effective range might be affected due to the presence of other wireless emitters.

The HemoSphere advanced monitor supports data transmission using Health Level 7 (HL7) messaging standard. All data transmitted is expected to be acknowledged by the receiving system. Data is resent if not sent successfully. The HemoSphere advanced monitor automatically tries to re-establish any HIS connections that are interrupted. If pre-existing HIS connection(s) cannot be reestablished, the HemoSphere advanced monitor alerts the user with an audible alert and message (**Alert: HIS Connectivity Loss**, see table 15-6).

G.3.2 Wireless Security Measures

The wireless signals are secured using industry standard wireless security protocols (table G-8). Wireless security standards WEP and WPA have been shown to be vulnerable to intrusions and are not recommended. Edwards recommends securing wireless data transmission by enabling IEEE 802.11i (WPA2) security and FIPS mode. Edwards also recommends implementing network security measures like virtual LANs with firewalls to further secure HemoSphere advanced monitoring platform data in transit to the HIS.

G.3.3 Troubleshooting Wireless Coexistence Issues

The instrument has been tested and complies with the limits of IEC 60601-1-2. If you experience communication issues with HemoSphere advanced monitor wireless technology, ensure a minimum distance between portable and mobile RF communications equipment (transmitters) and the HemoSphere advanced monitor are maintained. Refer to table G-3 for additional details on separation distances.

G.3.4 Federal Communication Commission (FCC) Interference Statements

IMPORTANT NOTE To comply with FCC RF exposure compliance requirements, the antenna used for this transmitter must be installed to provide a separation distance of at least 20 cm from all persons and must not be co-located or operating in conjunction with any other antenna or transmitter.

Federal Communication Commission Interference Statement

This equipment has been tested and found to comply with the limits for a Class B digital device, pursuant to Part 15 of the FCC Rules. These limits are designed to provide reasonable protection against harmful interference in a residential installation. This equipment generates, uses, and can radiate radio frequency energy and, if not installed and used in accordance with the instructions, may cause harmful interference to radio communications. However, there is no guarantee that interference will not occur in a particular installation. If this equipment does cause harmful interference to radio or television reception, which can be determined by turning the equipment off and on, the user is encouraged to try to correct the interference by one of the following measures:

- 1 Reorient or relocate the receiving antenna.
- 2 Increase the separation between the equipment and receiver.
- 3 Connect the equipment into an outlet on a circuit different from that to which the receiver is connected.
- 4 Consult the dealer or an experienced radio/TV technician for help.

FCC CAUTION Any changes or modifications not expressly approved by the party responsible for compliance could void the user's authority to operate this equipment.

This device complies with Part 15 of the FCC Rules. Operation is subject to the following two conditions: (1) This device may not cause harmful interference, and (2) this device must accept any interference received, including interference that may cause undesired operation.

This device is restricted to *indoor* use when operated in the 5.15 to 5.25 GHz frequency range.

FCC requires this product to be used indoors for the frequency range 5.15 to 5.25 GHz to reduce the potential for harmful interference to co-channel Mobile Satellite systems.

This device does not permit operations on channels 116-128 (5580 – 5640 MHz) for 11na and 120-128 (5600-5640 MHz) for 11a which overlap the 5600 -5650 MHz band.

IMPORTANT NOTE FCC Radiation Exposure Statement:
This equipment complies with FCC radiation exposure limits set forth for an uncontrolled environment. This equipment should be installed and operated with minimum distance 20cm between the radiator & your body.

G.3.5 Industry Canada Statements

RF Radiation Hazard Warning

To ensure compliance with FCC and Industry Canada RF exposure requirements, this device must be installed in a location where the antennas of the device will have a minimum distance of at least 20 cm from all persons. Using higher gain antennas and types of antennas not certified for use with this product is not allowed. The device shall not be co-located with another transmitter.

Maximum Antenna Gain – If the integrator configures the device such that the antenna is detectable from the host product.

This radio transmitter (IC ID: 3147A-WB45NBT) has been approved by Industry Canada to operate with the antenna types listed below with the maximum permissible gain and required antenna impedance for each antenna type indicated. Antenna types not included in this list, having a gain greater than the maximum gain indicated for that type, are strictly prohibited for use with this device.

“To reduce potential radio interference to other users, the antenna type and its gain should be so chosen that the equivalent isotropically radiated power (EIRP) is not more than that required for successful communication”

“This device has been designed to operate with an antenna having a maximum gain of [4] dBi. Antenna having a higher gain is strictly prohibited per regulations of Industry Canada. The required antenna impedance is 50 ohms.”

This device complies with Industry Canada licence-exempt RSS standard(s). Operation is subject to the following two conditions: (1) this device may not cause interference, and (2) this device must accept any interference, including interference that may cause undesired operation of the device.

G.3.6 European Union R&TTE Statements

This device complies with the essential requirements of the R&TTE Directive 1999/5/EC. The following test methods have been applied in order to prove presumption of conformity with the essential requirements of the R&TTE Directive 1999/5/EC:

- **EN60950-1:2001 A11:2004**
Safety of Information Technology Equipment
- **EN 300 328 V1.8.1: (2006-10)**
Electromagnetic compatibility and Radio Spectrum Matters (ERM); Wideband Transmission systems; Data transmission equipment operating in the 2,4 GHz ISM band and using spread spectrum modulation techniques; Harmonized EN covering essential requirements under article 3.2 of the R&TTE Directive

- **EN 301 489-1 V1.6.1: (2005-09)**
Electromagnetic compatibility and Radio Spectrum Matters (ERM); ElectroMagnetic Compatibility (EMC) standard for radio equipment and services; Part 1: Common technical requirements
- **EN 301 489-17 V1.2.1 (2002-08)**
Electromagnetic compatibility and Radio spectrum Matters (ERM); ElectroMagnetic Compatibility (EMC) standard for radio equipment and services; Part 17: Specific conditions for 2,4 GHz wideband transmission systems and 5 GHz high performance RLAN equipment
- **EN 301 893 V1.5.1 (2008-12)**
Electromagnetic compatibility and Radio spectrum Matters (ERM); Broadband Radio Access Networks (BRAN); Specific conditions for 5 GHz high performance RLAN equipment
- **EU 2002/95/EC (RoHS)**
Declaration of Compliance – EU Directive 2003/95/EC; Reduction of Hazardous Substances (RoHS)

This device is a 2.4 GHz wideband transmission system (transceiver), intended for use in all EU member states and EFTA countries, except in France and Italy where restrictive use applies.

In Italy the end-user should apply for a license at the national spectrum authorities in order to obtain authorization to use the device for setting up outdoor radio links and/or for supplying public access to telecommunications and/or network services.

This device may not be used for setting up outdoor radio links in France and in some areas the RF output power may be limited to 10 mW EIRP in the frequency range of 2454 – 2483.5 MHz. For detailed information the end-user should contact the national spectrum authority in France.

Hereby, Edwards Lifesciences, declares that this monitor is in compliance with the essential requirements and other relevant provisions of Directive 1999/5/EC.

Glossary

Acumen™ Hypotension Prediction Index (HPI)

The likelihood that the patient may be trending toward a hypotensive event (MAP < 65 mmHg for at least one minute).

Alarms

Audible and visual indicators that notify operator that a measured patient parameter is outside the alarm limits.

Alarm Limits

Maximum and minimum values for monitored patient parameters.

Baseline Blood Temperature

Blood temperature that serves as the basis for cardiac output measurements.

Blood Pressure (BP)

Blood pressure measured with HemoSphere pressure cable.

Blood Temperature (BT)

Temperature of the blood in the pulmonary artery when the catheter is properly positioned.

Body Surface Area (BSA)

The calculated surface area of a human body.

Bolus (iCO) Mode

Functional state of the HemoSphere Swan-Ganz module in which cardiac output is measured by the bolus thermodilution method.

Bolus Injection

A known volume of iced or room temperature fluid, which is injected into a port on the pulmonary artery catheter and serves as the indicator for measuring cardiac output.

Button

A screen image with text that, when touched, initiates an action or provides access to a menu.

Cardiac Index (CI)

Cardiac output adjusted for body size.

Cardiac Output (CO)

Volume of blood ejected per minute from the heart into the systemic circulation measured in liters per minute.

Central Venous Oxygen Saturation (ScvO₂)

Percentage of hemoglobin saturated with oxygen in the venous blood as measured in the superior vena cava (SVC). Displayed as ScvO₂.

Central Venous Pressure (CVP)

The average pressure in the superior vena cava (right atrium) as measured by an external monitor. Indicates venous return to the right side of the heart.

Computation Constant

A constant used in the cardiac output equation that accounts for density of blood and injectate, injectate volume, and indicator loss in the catheter

Default Settings

Initial operating conditions assumed by the system.

Dynamic Arterial Elastance (E_a_{dyn})

Dynamic arterial elastance is the ratio of pulse pressure variation and stroke volume variation (PPV/SVV). It is an estimate of arterial elastance.

End-Diastolic Volume (EDV)

The volume of blood in the right ventricle at the end of diastole.

End-Diastolic Volume Index (EDVI)

Right heart end diastolic volume adjusted for body size.

Estimated Oxygen Consumption (VO_{2e})

An expression of the estimated rate at which oxygen is used by tissues, usually given in mL./min of oxygen consumed in 1 hour by 1 milligram dry weight of tissue. Calculated with ScvO₂.

FloTrac Arterial Pressure Autocalibrated Cardiac Output (FT-CO)

CO continuously calculated from the arterial blood pressure waveform.

Heart Rate (HR)

Number of ventricular contractions per minute. HR data slaved in from an external monitor is averaged over time and displayed as HRavg.

Hematocrit (Hct)

Percentage of blood volume that contain red blood cells.

Hemoglobin (HGB)

Oxygen carrying component of red blood cells. Volume of red blood cells measured in grams per deciliter.

Icon

A screen image that represents a specific screen, platform status, or menu item. When enabled and touched, icons initiate an action or provide access to a menu.

Injectate

Fluid used for iCO (bolus thermodilution cardiac output) measurement.

Intermittent Cardiac Index (iCI)

Intermittent cardiac output adjusted according to body size.

Intervention

Steps taken to change a patient's condition.

Intermittent Cardiac Output (iCO)

Intermittent measurement of blood ejected per minute from the heart into the systemic circulation measured through thermodilution.

Mean Arterial Pressure (MAP)

Average systemic arterial blood pressure as measured by an external monitor.

Mixed Venous Oxygen Saturation (SvO₂)

Percentage of hemoglobin saturated with oxygen in the venous blood as measured in the pulmonary artery. Displayed as SvO₂.

Oxygen Consumption (VO₂)

An expression of the rate at which oxygen is used by tissues, usually given in mL./min of oxygen consumed in 1 hour by 1 milligram dry weight of tissue. Calculated with SvO₂.

Oxygen Delivery (DO₂)

Amount of oxygen in milliliters per minute (mL./min) delivered to the tissues.

Oxygen Delivery Index (DO₂I)

Amount of oxygen in milliliters per minute (mL./min/m²) delivered to the tissues, adjusted for body size.

Oximetry (Oxygen Saturation, ScvO₂/SvO₂)

Percentage of hemoglobin saturated with oxygen in the blood.

Patient CCO Cable Test

Test to verify the integrity of the patient CCO cable.

Phlebostatic Axis

Reference axis in the patient that passes through the patient's right atrium in any anatomical plane.

Physiocal

A physiological calibration procedure used to obtain accurate blood pressure readings from the artery of the finger.

Plethysmograph Sensor

A device built into the finger cuff that measures fluctuations of volume within the finger artery.

Pressure Controller (PC2)

The unit worn on the patient's wrist that connects the Heart Reference Sensor and compatible Edwards finger cuffs to the HemoSphere ClearSight module.

Pulse Rate (PR)

Number of arterial blood pressure pulses per minute.

Right Ventricular Ejection Fraction (RVEF)

Percentage of blood volume ejected from the right ventricle during systole.

Sensitivity

The ability of a test to correctly identify those with the condition (true positive rate).

Mathematically defined as:

$(\text{number of true positives} / [\text{number of true positives} + \text{number of false negatives}]) \times 100$

Signal Quality Indicator (SQI)

The oximetry signal quality based on the catheter condition and positioning in the vessel.

Specificity

The ability of a test to correctly identify those without the condition (true negative rate).

Mathematically defined as:

$(\text{number of true negatives} / [\text{number of true negatives} + \text{number of false positives}]) \times 100$

Slave Cable

Cable that transfers data to the HemoSphere advanced monitor from another monitor.

STAT Value

A fast estimate of CO/CI, EDV/EDVI, and RVEF values.

Stroke Volume (SV)

Amount of blood ejected from the ventricles with each contraction.

Stroke Volume Index (SVI)

Stroke volume adjusted for body size.

Stroke Volume Variation (SVV)

Stroke volume variation is the percent difference between maximum and minimum stroke volume.

Systemic Vascular Resistance (SVR)

A derived measure of impedance to blood flow from left ventricle (afterload).

Systemic Vascular Resistance Index (SVRI)

Systemic vascular resistance adjusted for body size.

Systolic Slope (dP/dt)

The maximum upslope of the arterial pressure waveform measured from a peripheral artery.

Thermal Filament

Area on the CCO thermodilution catheter that transfers small amounts of energy into the blood to serve as indicator for trending cardiac output continuously.

Thermistor

Temperature sensor near the tip of the pulmonary artery catheter.

Thermodilution (TD)

A variant of the indicator dilution technique using temperature change as the indicator.

USB

Universal Serial Bus.

Volume Clamp Method

Arterial blood volume is kept constant using the signal from the photo-plethysmograph and a rapidly changing pressure in the air bladder.

Washout Curve

Indicator dilution curve produced by a bolus injection. Cardiac output is inversely related to the area under this curve.

Index

Numerics

20-second parameters
troubleshooting 153

A

A/D
def. 36
abbreviations 36
accessories list 291
acronyms 36
adjust scales 136
Alarm/Target
change 89
defaults 302
alarms
configure for one parameter 135
def. 130
priorities 303
set 132
signal testing 314
silence 86
volume 132
Alert Oximetry, alerts listed 273
altitude
environmental specifications 281,
289
analog input 126

B

Battery
installation 64
battery
maintenance 313
status on information bar 113
storage 313
bedside monitor
ECG input 160
Bold
def. 35
bolus
washout curve 158
bolus (iCO) monitoring 153
BSA
equation 293
BSA, calculated 121
BT 36
def. 36
button
list 116

C

cable accessories 58
cable integrity test 148
cable length
oximetry 286, 287, 289
cables
cleaning 308

cancel icon 116
CaO₂
def. 36
equation 293
Cardiac profile equations 293
caution
def. 38
cautions, list of 46
Ca-vO₂
equation 294
CCO
def. 36
change Alarm/Target 89
change parameters 88
CI
def. 36
equation 294
CI20s
def. 36
how to monitor 153
CISPR 11 316
Class A Harmonic Emissions 316
Class A RF Emissions 316
cleaning
cable and connectors 309
cables 308
monitor 308
oximetry cable 309
clinical actions button 85, 86
CO 36
countdown timer 152
monitoring with HemoSphere Swan-
Ganz module 150
required accessories 58, 59
CO20s
def. 36
how to monitor 153
Cockpit monitoring screen 99
computation constant
selection 156
computation constants
bath temperature probe 305
in-line temperature probe 306
tables 305
conducted RF
IEC 61000-4-6 321
Connection ports 60
connector identification labels 55
connectors
cleaning 309
continue monitoring patient 121
Continue Same Patient 121
continuous % change
set 124
continuous change interval
indicator 90
continuous mode, physio relationship
100
CPI

equation 294
CPO
equation 294
CvO₂
equation 294
CVP
def. 36

D

data
download 140
export 140
security 145
date
change 123
date format 123
def. 36
depth
HemoSphere Swan-Ganz module
284
monitor 281
Derived Value Calculator 108
dimensions
battery 283
HemoSphere Swan-Ganz module
284
monitor 281
display output, HDMI 282
display size 281
display specifications
monitor 281
disposal, monitor 313
distances
recommended for equipment 318
DO₂
def. 36
equation 294
DO₂I
def. 36
equation 294
Download Data 241
dP/dt
equation 294
DPT
def. 36
Draw Blood 110

E

ECG cable 160
EDV
def. 36
monitoring with HemoSphere Swan-
Ganz module 159
required accessories 58, 59
EDVI
def. 36
Edwards Lifesciences Regional Head-
quarters 312

- efu
 - def. 36
- electrical fast transient/ burst 320
- electromagnetic
 - compatibility 315
 - emissions 316, 317
- electrostatic discharge 320
- enter value 116
- environmental specifications 281, 283, 289
- Equations
 - cardiac profile 293
- error messages 251
- essential performance 56
- expansion module 29
- export data 140
- F**
- Fault Oximetry, faults listed 272
- Fluid Challenge 94
- G**
- GDT Session
 - Paused 110
 - Resumed 110
 - Targets Updated 110
- gender, enter 121
- general, monitor settings 132
- graphical trend monitoring screen 91
- graphical trend scroll rates 92
- graphical trend time 137
- gray
 - target status indicator 133
- Green
 - Pressure Controller Cuff status light 248, 250
 - Pressure Controller HRS status light 250
- green
 - target status indicator 133
- Group 1 RF Emissions 316
- H**
- harmonic emissions
 - IEC 61000-3-2 316
- Hct
 - def. 36
- HDMI port 282
- height
 - HemoSphere Swan-Ganz module 284
 - monitor 281
- height, patient data 121
- hemodynamic monitoring technologies 29
- HemoSphere advanced monitor
 - base kit 57
 - connection ports 60
 - documentation and training 35
 - environmental specifications 281, 283, 289
 - essential performance 56
 - labels 54
 - required accessories 58
 - specifications 281, 283, 289
 - status lights 247
- HemoSphere oximetry cable
 - available parameters 32
 - cleaning 309
 - error messages 272
 - quick start instructions 73, 75
 - recall data 196
 - reset 198
 - setup 191
 - specifications 287
- HemoSphere Swan-Ganz Module
 - overview 30
- HemoSphere Swan-Ganz module
 - available parameters 30, 31, 33, 34
 - CO algorithm 150
 - CO monitoring 150
 - connections overview 78, 80, 147, 178, 205
 - error messages 255
 - iCO monitoring 153
 - quick start instructions 70
 - specifications 284
 - thermal signal conditions 152
- HGB
 - def. 36
- HGB Update 110
- HIS
 - def. 36
- HIS connectivity 143
- historic mode 100
- historical mode, physio relationship 100
- HL7 messaging 143
- Home button 108
- home icon 116
- Hospital Information Systems 143
- HR
 - def. 36
- HRavg
 - def. 36
- I**
- iCO
 - def. 36
 - monitoring with HemoSphere Swan-Ganz module 153
 - required accessories 58, 59
- IEC
 - def. 36
- IEC 60601-1
 - 2005 / A1 2012 56
- IEC 60601-1-2
 - 2007 315
 - 2014 56
- IEC 60601-2-34
 - 2011 56
- IEC 60601-2-49
 - 2011 56
- IEC 61000-3-2
 - harmonic emissions 316
- IEC 61000-3-3 316
- IEC 61000-4-11 320
- IEC 61000-4-2 320
- IEC 61000-4-3 321
- IEC 61000-4-4 320
- IEC 61000-4-5 320
- IEC 61000-4-6 321
- IEC 61000-4-8 320
- IEC/EN 60601-1-2
 - 2007 315
- IEEE 802.11 56
- In vitro calibration 193
- In vitro Calibration Error 273
- In vivo calibration 194
- Indications For Use 21
- information bar 112, 117
 - CO countdown timer 152
- injectate volume 155
- installation
 - power entry cover 65
- IT
 - def. 36
- K**
- key parameter
 - change 88
- keyboard, using 117
- keypad, using 117
- L**
- labels
 - packaging 55
 - ports 55
 - product 54
- Language
 - change 122
- language
 - default settings 304
- LED lights 247
- Lights
 - Pressure Controller 248, 249, 250
- lights
 - monitor 247
- list button 116
- LVSWI
 - def. 36
- M**
- maintenance 313
- MAP
 - def. 36
- mechanical specifications 281
- message area 115
- model numbers 291
- Module accessories 58
- module slot 29
- monitor
 - cleaning 308
 - dimensions 281
 - display specifications 281
 - disposal 313
 - environmental specifications 281, 283, 289
 - power and communication lights 247
 - screen selection icon 85
 - using 82
 - weight 281
- monitor LEDs 247
- monitor screen navigation 115
- monitor settings 122

- monitor settings, general 132
- Monitoring Pause 111
- monitoring pause 87
- Monitoring Resumed 111
- MPAP
 - def. 36
- N**
- navigation 82, 115
- navigation bar 84
- New Patient 120
- O**
- OM Disconnected 111
- operating system 281
- oximetry
 - setup 191
 - SQI 195
 - troubleshooting 274, 277
 - Warnings 273
- P**
- PA
 - def. 36
- packaging labels 55
- PaO₂
 - def. 36
- PAP waveform
 - troubleshooting 153
- parameter tile 90
- parameter tiles 88
- parameters
 - change 88
 - display and alarm ranges 300
- Passcodes 118
- Passwords 118
- patient
 - continue monitoring 121
 - data 120
 - data parameters 299
 - ID 121
 - new 120
- Patient CCO cable test 148
- patient data
 - age 121
 - enter 120
- Patient Data in oximetry cable more than 24 hours old - Recalibrate 274
- patient data, view 122
- pause, monitoring 87
- PAWP
 - def. 36
- physical specifications 281
- physio relationship 100
 - continuous mode 100
 - set alarms and targets 102
- physio relationship monitoring screen 100
- physiological alarm priorities 303
- Physiology monitoring screen 98
- Please enter valid date 254
- Please enter valid time 254
- POST
 - def. 36
 - see also* Power-On Self Test
- power entry cover 65
- power frequency immunity test 320
- Power-On Self Test 67
- Pressure Controller
 - communication lights 248, 249, 250
- preventive maintenance 313
- PvO₂
 - def. 36
- PVPI
 - equation 296
- PVPI equation 296
- PVR
 - def. 36
- PVRI
 - def. 36
- R**
- radiated RF
 - IEC 61000-4-3 321
- Rear panel 60
 - connection ports 61
- red
 - target status indicator 133
- relative humidity
 - environmental specifications 281, 289
- return icon 116
- Reviewed events 109
- RF emissions 316
- RJ-45 Ethernet connector (monitor) 282
- roll stand 292
- RS-232 Serial Port 282
- RVEF
 - def. 36
 - required accessories 58, 59
- RVEF monitoring 159
- RVSWI
 - def. 36
- S**
- scales
 - adjust 136
- sCI
 - def. 36
- sCO
 - def. 36
- screen navigation 115
- screen size 281
- scroll 115
- scroll rates
 - graphical trend 92
 - tabular trend 97, 187
- ScvO₂
 - def. 36
 - required accessories 59
- security 145
- sEDV
 - def. 36
- separation distances 318
- service 311
- settings 142
 - overview 85, 86
- settings icon 85
- Settings Screen 222, 223, 224, 225, 226, 227, 239, 240
- Signal quality indicator (SQI) 195
- silence audible alarms 86
- Snapshot button 85
- specifications
 - mechanical 281
 - physical 281
- SpO₂
 - def. 36
- SQI
 - def. 36
- sRVEF
 - def. 36
- ST
 - def. 36
- start CO monitoring button 84
- STAT
 - CO 153
 - def. 36
- status bar 115
- stop CO monitoring icon 84, 85
- Stop Monitoring Button 188
- support, technical 311
- surge IEC 61000-4-5 320
- SV
 - def. 36
 - equation 296
 - required accessories 58, 59
- SV equation 296
- SV20s
 - def. 36
 - how to monitor 153
- SVI
 - def. 36
 - equation 297
- SVI equation 297
- SVI20s
 - def. 36
 - how to monitor 153
- SvO₂
 - def. 36
 - required accessories 59
- SVR
 - def. 36
 - equation 297
 - monitoring with HemoSphere Swan-Ganz module 163
 - required accessories 58, 59
- SVR equation 297
- SVRI
 - def. 36
 - equation 297
- SVRI equation 297
- SVV
 - equation 297
- symbols
 - packaging 54
 - screen 52
- T**
- tabular increment 137
- tabular trend monitoring screen 96
- tabular trend scroll rates 97, 187
- targets
 - change 89

- configure for one parameter 135
- set 132
- status indicators 91
- TD
 - def. 37
- technical support 311
- temperature
 - environmental specifications 281, 289
- thermal signal conditions
 - CO monitoring 152
- time
 - change 123
- Time Change 112
- time format 123
- Touch
 - def. 37
- touch screen, specifications 282
- trend scale
 - default limits 299
- troubleshooting
 - oximetry 274, 277
- U**
- USB
 - def. 37
- USB Ports, specifications 282
- user interface symbols 52
- user profile(s) 23
- using monitor 82
- V**
- Value must be greater than 254
- Value must be less than 254
- Value out of range 254
- value, enter 116
- vertical scrolling 115
- view patient data 122
- VO2
 - def. 37
 - equation 297
- VO2e
 - def. 37
 - equation 297
- VO2I
 - def. 37
 - equation 297
- VO2Ie
 - def. 37
 - equation 298
- voltage
 - monitor 283
- voltage fluctuation/ flicker emissions 316
- W**
- Warning
 - Unstable Signal 273
 - Wall Artifact or Wedge Detected 274
- warning
 - def. 38
- Warnings
 - oximetry 273
- warnings, list of 39
- warranty 314
- washout curve 158
- weight
 - HemoSphere Swan-Ganz module 284
 - monitor 281
- weight, patient data 121
- width
 - HemoSphere Swan-Ganz module 284
 - monitor 281
- Windows 7 embedded 281
- wireless 142
 - setup 142
 - specifications 283
- Y**
- yellow
 - target status indicator 133
- Z**
- Zero & Waveform 174

Caution: Federal (USA) law restricts this device to sale by or on the order of a physician. See instructions for use for full prescribing information.

Edwards Lifesciences devices placed on the European market meeting the essential requirements referred to in Article 3 of the Medical Device Directive 93/42/EEC bear the CE marking of conformity.

Edwards, Edwards Lifesciences, the stylized E logo, Acumen, Acumen HPI, Acumen IQ, CCOMbo, CCOMbo V, ClearSight, CO-Set, CO-Set+, FloTrac, ForeSight, FORE-SIGHT, ForeSight Elite, FORE-SIGHT ELITE, HemoSphere, HemoSphere ClearSight, HemoSphere Swan-Ganz, Hypotension Prediction Index, HPI, PediaSat, PhysioCal, Swan, Swan-Ganz, Time-In-Target, and TruWave are trademarks of Edwards Lifesciences Corporation or its affiliates. All other trademarks are the property of their respective owners.

© 2020 Edwards Lifesciences Corporation. All rights reserved. A/W Part No 10034022003/A

Edwards Lifesciences • One Edwards Way, Irvine CA 92614 USA • edwards.com



Edwards