

## Research Article

# Potential Assessment and Performance Evaluation of a Floating Solar Photovoltaic on the Great Ethiopian Renaissance Dam

**Elias Mandefro Getie  and Yosef Berhan Jember**

*Bahir Dar University, Bahir Dar Institute of Technology, Bahir Dar, Ethiopia*

Correspondence should be addressed to Elias Mandefro Getie; [eliasmandefro01@gmail.com](mailto:eliasmandefro01@gmail.com)

Received 26 February 2022; Revised 22 April 2022; Accepted 20 May 2022; Published 2 June 2022

Academic Editor: Manuel Fuentes Conde

Copyright © 2022 Elias Mandefro Getie and Yosef Berhan Jember. This is an open access article distributed under the Creative Commons Attribution License, which permits unrestricted use, distribution, and reproduction in any medium, provided the original work is properly cited.

The demand for electricity has increased rapidly in Ethiopia. Renewable energy sources such as solar PV are being used to respond to the power demand and cover a small percentage of the country's energy need. However, in Ethiopia, where the majority of the land is utilized for agriculture, the land required to generate solar PV power in a large scale is a significant barrier. Big dams, such as Great Ethiopia's Renaissance Dam, can be used for a solar floating system to eliminate the need for land and transmission infrastructure. Due to its wider area covered by the reservoir, which is about 1,874,000,000 m<sup>2</sup>, the potential of the renaissance dam needs to be investigated for solar PV floating installation to meet the electricity demand in residential, commercial, and industrial sectors in Ethiopia. In addition, the cooling action of the water on the PV floating allows it to keep its efficiency and increase the power output from the panels. In this study, the performance of grid-connected floating PV systems was evaluated in terms of power generation potential, performance ratio, capacity utilization factor, greenhouse gas emissions, and water conservation. The power consumption of peoples living in the GERD generation site is nearly 1 MW. Though they get electricity through the grid, this study considers performance assessment of a 1 MW solar FPV with the intention of covering the energy need of the hydropower station itself and near rural communities. Modeling and simulation of the proposed FPV plant is done with the help of PVsyst software tool. Finally, the analysis reveals that the GERD has the FPV capability to generate 18,740 MW of maximum power, and its performance was assessed for a 1 MW grid-connected FPV system. The benefits of employing FPV in energy production, water conservation, CO<sub>2</sub> emission reduction, and economic benefit are demonstrated in this study. Furthermore, the installation of 1 MW FPV saves 54.4 million liters of GERD water from evaporation per year, which benefits the Blue Nile's downstream countries to conserve their share of water.

## 1. Introduction

Energy is a critical factor for a country's economic, social, and political development [1]. As the world is suffering from global warming, green energy sources are getting more attention to be the main sources of electricity [2]. Ethiopia has a large renewable energy potential that is scattered throughout the country, making it a desirable location for renewable energy development and investment. The Ethiopian Electric Power Company is also working to increase the penetration of renewable sources into the electricity grid. Among the common renewable sources, the solar photovoltaic is mostly expanding in different areas of the country [3].

Due to high temperatures and dust, ground-mounted PVs were inefficient and took up a lot of area on the land [4]. As a result, for large solar parks, the area needed for PV installation increased. As the globe swings towards clean energy, floating PV systems are becoming a hot topic of study in enhancing PV power output efficiency. Land is no longer required while using floating PV technology. In floating photovoltaic (FPV), the solar panels have been designed to float on the surface of water. Floating PV technology can be implemented on dam reservoirs, ponds, lakes, and other water bodies, and it can be used as a hybrid floating solar plant. Additionally, an FPV contributes to the reduction of evaporated water and it plays a significant role for limiting carbon emission [2, 5, 6].

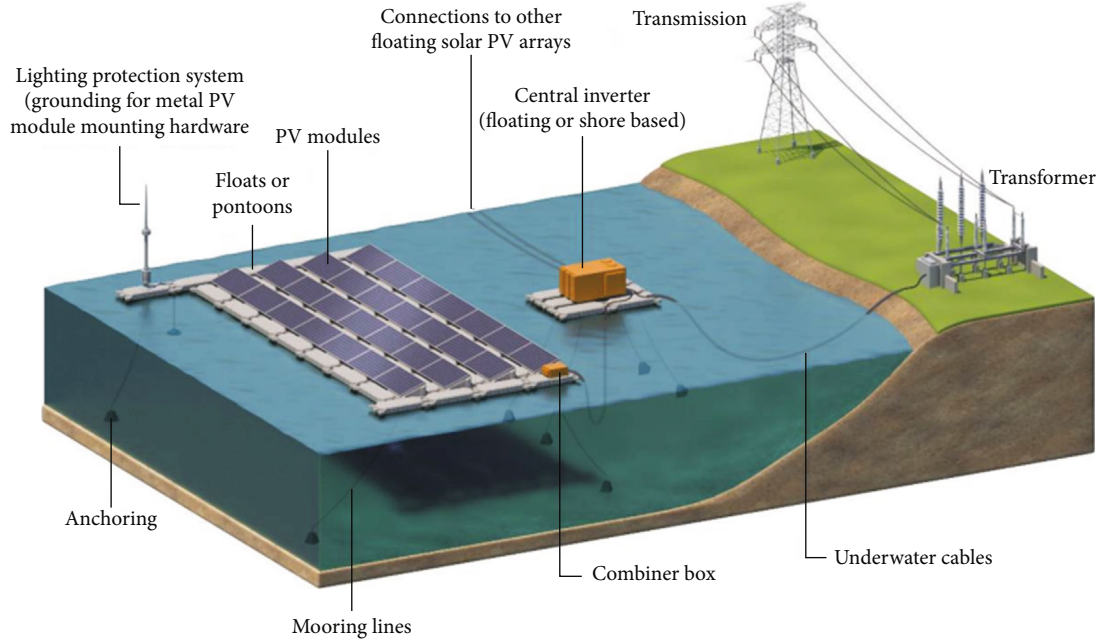

FIGURE 1: Schematic diagram of a typical large-scale FPV power plant [5]

A floating photovoltaic system is the installation of a PV module on the surface of a body of water, mounted on a supporting bed that is connected to a heavy-weight concrete structure sunk beneath the water [7]. FPV solar power has several advantages over the conventional earth mounted PV system, such as (a) provision of panel ventilation by the water, which in turn can increase the output energy; (b) regardless of its initial investment, FPV has low transmission costs because it is installed either on hydroelectric dams where there is an existing power system facility, or any water body where people usually prefer to live around, so the load center will be near to the FPV plant. This can also make it have fewer transmission and distribution losses [7].

Solar FPV can also hybridize with other energy sources. A hybrid energy system is designed to capture energy from multiple sources, including both renewable and conventional power plants, at the same time and place. To improve system performance and energy supply balance, a hybrid renewable energy system (HRES) is linked to the same system. In some cases, combining floating solar with other variable renewables increases the device's energy density to a level higher than that of other renewable power systems, which in some cases can compete with fossil fuels [7]. A crucial aspect in the development of a hybrid solar floating system is the intermittent nature of solar PV, which varies in energy production and in the availability of more sunlight on the sea surface than on land [8]. The hybrid solar floating system with hydropower is proposed as a promising energy production method to effectively utilize the energy resource potential of FPV [7].

The major components found in the FPV are as follows: (i) a PV module, (ii) a floating structure, (iii) an anchoring and mooring system, and (iv) cables and connecting wires [9]. Figure 1 illustrates the different parts of a typical FPV power plant.

Unfortunately, Africa has been hardly working on FPV technology while the continent has huge potential for it. A recent study indicates Africa's current energy capacity can be doubled if 1% of the area in each reservoir of hydroelectric dam is used to install FPV power generation. Ethiopia, in particular, gets more than 90% of its energy from hydroelectric dams [10]. According to a World Bank Collection of Development study report [11], only around 46% of the Ethiopian population has access to electricity in 2019. Hence, further feasibility studies and detailed techno-economic analysis need to be done continuously to exploit the FPV energy resource potential of hydroelectric dams in Ethiopia.

In this research, the Great Ethiopian Renaissance Dam has been chosen for the design and potential analysis of a new grid-connected FPV power generation. In designing FPV, the maximum water surface area to be covered is recommended to be not more than 10% of the total water area in the reservoir [12]. It is one of the reasons why the GERD is preferred since it has a relatively large catchment area, resulting in a large energy yield to the national grid. Due to the high irradiance in the area, a significant volume of water will evaporate each year from the GERD's huge reservoir. The large solar array floating on the reservoir surface can save a significant amount of water from evaporation.

## 2. Literature Survey

Since 2007, researchers have been studying FPV technology [13]. Most scholars have designed and developed FPV systems in levels of research laboratories. This review summarizes some recent works in FPV and hybrid FPV system to demonstrate the state-of-the-art FPV technology as indicated in Table 1.

TABLE 1: Summary of related works on FPV technology.

FPV site and its capacity	Findings
Two units with 50 Wp each, at Bangka Belitung Island, Indonesia. One unit is FPV and the other on the ground [14]	Geraldo et al. perform an experiment and conduct a comparative study on the performance of the FPV with respect to the ground mounted PV system. The FPV exhibits an exceeding over the conventional PV by 1.04%, 1.08%, 1.12%, and 1.29% of average voltage, current, real power, and efficiency, respectively.
A data from 146 large hydroelectric dam reservoirs in African countries is analyzed for FPV potential. An estimated annual energy of 46,04 TWh is generated in total.	In [10], the FPV potential of big hydroelectric dams in Africa is comprehensively assessed. They covered a gross of 29,222 km <sup>2</sup> water area. By employing only 1% in each of the dam's reservoir for FPV, the power generation capability of those hydroelectric plants get doubled and 58% increase in electricity output. In addition to that, 743 million m <sup>3</sup> of water is saved from evaporation annually, which means a gain of extra 170.64 GWh is achieved by conserving the reservoir water.
Study and simulation shows 5 MW FPV can be generated at each of the two dams in Egypt, namely High dam and Aswan Reservoir [15].	While adding the FPV, the high dam and Aswan reservoir, respectively, can have an annual increment of up to 11.9 GWh and 11.3 GWh by operating them as a hybrid hydro PV plant. The new hybrid system is estimated to save about 0.1 MCM of water from the two dams. Polycrystalline FPV are found convenient to be used at Egypt. For fixing and mounting the FPV, the single axis tracking type results in the higher energy rate of 4.96%. The proposed hybrid FPV hydro plant can also contribute by limiting the emission of 44,270.61 tons of carbon dioxide.
An annual capacity of 188 MWh is estimated to be extracted from FPV installed on an irrigation dam. The location is at the cooperative of irrigators in Valencia region, Spain.	The FPV plant is proved to have better yield of energy than the roof top mounted conventional PV of its equivalent. However, the total cost of the FPV reaches 119,100 €, which shows a relatively higher cost of installation. It has a payback period of 15 years which is long time as compared with 7-10 years of money return period for PV systems in Spain. This grid connected FPV system is proved to save around 13.55% of the annual energy formerly supplied from the grid [16].
Sizing and assessment of 1 MWp FPV plant at Gouvães dam. It is one of the three dams constructed along the Tâmega River, Portugal [17].	FPV potential of Portugal is comprehensively explained. Design and analysis of an FPV is performed as a case study on a newly constructing dam, Gouvães dam. The 1 MWp floating PV plant alone will generate an annual revenue of 65000 €. Its payback period will be about 15 years if the whole energy is for sale. This period will be minimized if the energy is exploited for recycling systems in the country like the pumped hydro.
A design and simulation of 294.8 kW floating solar power is done on Debremariam Island, Lake Tana, Ethiopia.	Taye et al. [18] propose an FPV-based power source to electrify a small community in one of the islands at Lake Tana. A comparison is made with the ground erected PV, and the FPV results in greater output of 4.9 KW.
In [19], 15 MW FPV is planned and analyzed with the help of simulation. The site is at Kaptai, Rangamati, Bangladesh.	The Kaptai reservoir has water area of 777 Km <sup>2</sup> . However, the 15 MW floating PV will only cover about 11% of the total area of the Kaptai reservoir. Implementation of this FPV system is recommended for better exploitation of solar energy which minimizes environmental pollution, avoid the occupation of fertile land surfaces by PV, and improve the reliability of power in Bangladesh.
In annual basis, an 835,820 MWh is shown to be generated from FPV as the simulation result shows. The site is in the tropical Gaviao reservoir, Northeast Brazil.	The FPV generated energy can supply around 19% of Fortaleza city's demand, whose population is nearly 2,600,000 people. The floating PV panels laid on 81% of the reservoir's total area. Consequently, 2,595,000 m <sup>3</sup> of water is saved from loss due to evaporation. This amount of water is estimated to cover about 1.5% consumption of the Fortaleza city. US\$755 million will be needed for investment cost of the proposed power plant [20].

TABLE 1: Continued.

FPV site and its capacity	Findings
In [21], an FPV plant which can support 16% of European need of electricity is studied to be erected at lake Nasser, Egypt.	The world's second largest and man-made lake Nasser has water surface area of 5000 square km. Only about 20% of it, means 1000 Km <sup>2</sup> needs to be covered by FPV for generating 16% of Europeans electric power need. It can be green and low cost energy option and completely substitute coal and fossil fuel-based electricity in Europe upon finishing all phases of this project. 3 billion m <sup>3</sup> of freshwater will be saved from evaporation, which is equivalent to 20-25% of Egyptians yearly water usage.
6513 MWp is estimated to be yield from an FPV on Rajghat dam in Uttar Pradesh, India.	In [22], 25% of the reservoirs area is used to get the 10,623,501 MWh annually. In measure of water conservation from evaporation, 1395 cubic meter of water per MWp can be saved annually. That can cut tariff from Rs 0.12 to Rs 0.14 per kWh. As well 9.08 million cubic meter of water could be saved, which can generate additional 482.86 MWh from hydropower. Levelized cost of energy (LCOE) is calculated \$ 0.036/kWh (INR 2.61/kWh) having 8.55% internal rate of return (IRR). This has a good indication to widely implement FPV, which can also play a role in protecting possession of fertile lands by PV power plant.
A comprehensive review is conducted about hybrid floating solar photovoltaic (HFPV) power generation [7].	Energy can be generated by hybridizing FPV plant with other sources of power and known as HFPV. Some of the possible sources to combine with FPV are hydro, pumped hydro, tidal, solar tree, tracking PV, conventional power, and hydrogen. Among those options, HFPV is found efficient when an FPV is implemented with the hydropower system. The hybrid floating PV has tremendous benefits. It can increase the reliability of hydropower plants by backing energy production when there is a drop in water level of the reservoir in the dry seasons. The other advantage is getting higher flexibility for the grid to dispatch the power with the variation of load demand. HFPV also assist to have more energy storage when it is used with pumped storage, more water can be pumped by FPV followed by extra energy generation to the peak hours. However, further studies needed to tackle shortcomings associated with FPV and HFPV systems. The high cost, stability of the floating structure, impact of the weather, and policy issues can be listed as some the challenges.
In [23], a literature survey is performed to indicate the significance of hybrid FPV-hydropower systems by focusing on the case of Australian hydroelectric generation sites.	Countries including Australia are heading to achieve a 100% renewable source of energy. Solar PV is dependent on irradiation and a hydropower needs continuous rainfall to avoid interruption of power supply. With fewer than 20% exploitation of the reservoir surface, an FPV can yield equal or more power of the hydro. By connecting FPV plants and hydropower, a hybrid system can be formed with better reliability if properly controlled. To date, only two hybrid FPV-hydro plants are found in Brazil and Portugal. These FPVs alone have a contribution of 1 MW and 218 kW, respectively. The FPV potential for four biggest hydropower reservoirs in Australia are analyzed to consider hybrid FPV-hydro systems. Deploying an FPV in the four locations estimated that a power equal to the capacity of the hydro plant can be produced at each of the sites. This is attained by utilizing less than 15% area in the reservoirs.

TABLE 1: Continued.

FPV site and its capacity	Findings
A solar FPV plant is considered, and its integration with a small hydropower station in Pakistan is assessed.	<p>In [24], basic principles and distinguishing features of hybrid FPV-hydro plant are presented based on relevant literatures. A 217.1 MW floating solar PV is designed lying at the reservoir of Ghazi Barotha Hydroelectric power plant. The integration of this FPV with the existing 1450 MW hydro plant is evaluated at 500 kV and 132 kV points in the grid. Connecting it at the 132 kV is found to be optimal.</p> <p>A linear optimization model is developed for a coordinated operation between the two power sources which linked together. The proposed hybrid FPV-hydro model is simulated in MATLAB with the new power system architecture and the existing load profile. The optimization algorithm is found efficient because the generated power tends to follow the load condition at every time of the day. The capacity of the existing hydroelectric power plant is enhanced by 3.3% when the FPV is integrated to it.</p>
The worldwide energy potential from a hybrid hydro-FPV is estimated using a novel geospatial approach in [8].	<p>Theories and different classifications of hybrid hydro-FPV are explored by evidencing a lot of scientific studies. Publicly available datasets are used to predict the approximate hybrid hydro-FPV potential in the globe. The result shows the potential of many areas of the world in a regional basis. For instance, 135 GW capacity is observed in the Eastern Africa, and the maximum of all others is in Northern America, having 1785 GW. It is unveiled that the world has a total of 3.0 TW to 7.6 TW potential from hybrid hydro-FPV. The huge capital cost, need of expert personnel, and the impact on the ecosystem are mentioned as some of the constraints related to the wide practical application of FPVs as well as hybrid FPVs.</p>

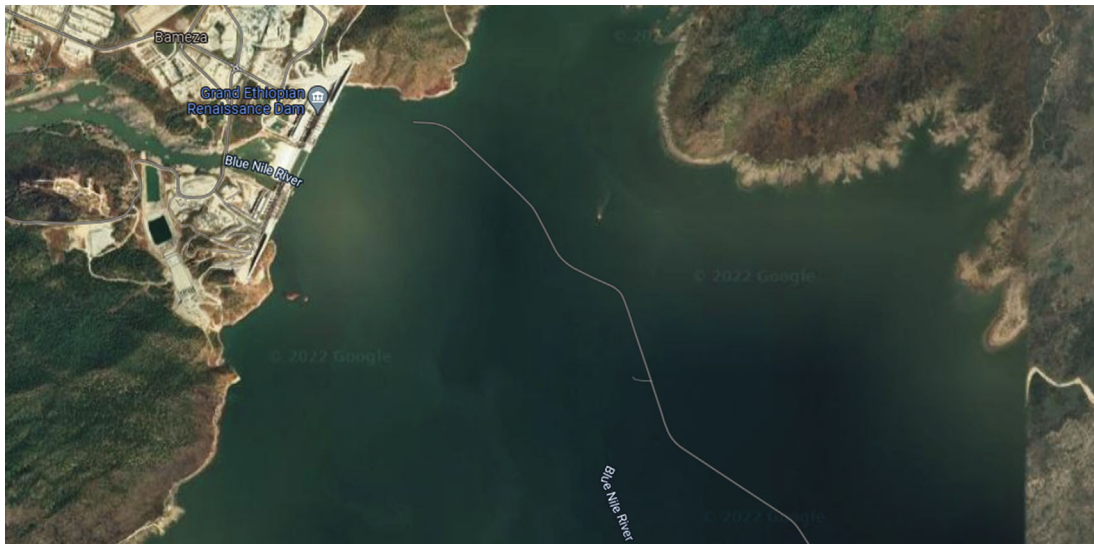

FIGURE 2: Geographical map location of GERD from satellite image.

Apart from the literature, this research work focused on the potential assessment of the largest dam in East Africa and evaluating its performance. There is no floating PV system in Ethiopia, and this research indicates and initiates the government and electric power company to think about the implementation of floating solar PV plant in the Great Renaissance Dam of Ethiopia. For instance, at the beginning of 2022, Ethiopian Electric Power (EEP) signed an agreement with the UAE-based power producer company called Masdar to build 500 MW of grid-connected PV power in

the Afar and Somali regions of the country. In addition to the misuse of precious land surface, one can imagine the cost of building new transmission infrastructure to connect it into the grid, the problem of access roads to the new remote sites, and other shortcomings that can be faced, whereas the GERD could easily handle this 500 MW of hydroelectric power as a hybrid FPV-Hydro plant. There is also sufficiently high solar irradiation at the GERD site. Although the initial cost of the FPV can be higher than the ground PV, there are other reasons that make them have an

TABLE 2: Metrological data of Great Ethiopian Renaissance Dam (GERD).

Months	Global horizontal irradiation (KWh/m <sup>2</sup> /day)	Wind speed (m/s)	Temperature (°C)
January	6.04	3.81	26.94
February	6.5	3.86	28.41
March	6.78	3.82	28.67
April	6.88	3.78	26.53
May	6.22	3.72	24.22
June	5.52	4.3	23.45
July	5.02	3.84	22.5
August	5.16	3.33	22.27
September	5.63	2.73	22.77
October	5.57	2.84	23.55
November	6.09	3.53	25.03
December	5.95	3.83	26.22
Annual average	5.95	3.62	25.05

TABLE 3: PV panel characteristics.

Model	SR-M672400HL
Peak power (P <sub>peak</sub> )	400 W
Open circuit voltage (V <sub>oc</sub> )	49.89
Short circuit current (I <sub>sc</sub> )	10.27 A
Max. power point volt (V <sub>mpp</sub> )	41.73 V
Max. power point current (I <sub>mp</sub> )	9.59 A
Efficiency	19.89%
Coeff. of tem P <sub>max</sub> (%), °C	-0.387%
Coeff. of tem V <sub>oc</sub> (%), °C	-0.282%
Coeff. of tem I <sub>sc</sub> (%), °C	+0.041%

equivalent overall cost. The presence of an established access road to the hydro site and the sharing of machineries as well as consumables will be an advantage. The running cost of the FPV will be lower because the same skilled personnel from the hydro plant can work on the FPV, making it easy to maintain and inspect. The effect of temperature on the power output of the FPV can be minimal. When power loss is less, it means a reduction in the number of solar panels and all other accessories. The cost of designing and constructing a new transmission line will be eliminated since the existing line to the hydropower plant will be used. This will also avoid power loss in the transmission line between two distant points of power generation. On the other hand, Ethiopia is in high security tension with Egypt and Sudan due to the water politics of the Blue Nile. Those downstream countries have been claiming Ethiopia's amount of water flowing to them will be decreased because of the building of the GERD. Thus, implementing the solar floating on that dam will mitigate water loss to some extent. That is, meeting many targets with a single decision. Hence, the various data and results presented in this study can help as an input to

policymakers to consider whether this FPV technology works in Ethiopia's context.

### 3. Methods and Materials

**3.1. Methodology.** Firstly, the Great Ethiopian Renaissance Dam was chosen as a case study area, collects the electric consumption of the camp, which is 1 MW. Then, we start to collect the solar irradiance, ambient temperature, and wind speed data from NASA through PVsyst software. The design and mathematical modeling of the 1 MW FPV system continues. Then, modeling of a 1 MW FPV system and analysis of the performance parameters of FPV, such as performance ratio, capacity utilization factor, greenhouse gas emission, water evaporation, and energy production potential, were performed. Finally, we conclude by indicating the benefits, constraints, and future work of FPV technology in the country.

**3.2. Study Area.** The Great Ethiopian Renaissance Dam (GERD), located in Ethiopia's Benishangul Gumuz area, is one of the largest dams in East Africa, and its construction reached around 85% for completion. In terms of latitude and longitude, the GERD is located at 11.17°N and 35.23°E, respectively. The grand renaissance dam of Ethiopia is depicted in Figure 2 which covers 1,874 km<sup>2</sup> reservoir area.

The average GHI is 5.95 kwh/m<sup>2</sup>/day, with an average wind speed of 3.62 m/s and an ambient temperature of 25.05 degrees Celsius. Table 2 illustrates the solar irradiance, temperature, and wind speed of the GERD during the last ten years, as obtained from NASA (2011 to 2021).

### 4. Solar Photovoltaic Design

The selection of the type and capacity of each PV panel is the first step in the design of the 1 MW FPV system. To generate 1 MW of power from FPV, 2,500 PV panels with a capacity of 400 W each are required, and to connect with the grid, nine inverters with a 100 kW capacity are required. Equation (1) is used to determine the number of PV panels of FPV system.

$$N = \frac{P_{\max}}{P_{\text{panel}}}, \quad (1)$$

where  $N$  is number of PV panels,  $P_{\max}$  is the maximum output power of FPV, and  $P_{\text{panel}}$  is the maximum output power of a single PV panel.

Table 3 indicates the PV panel characteristics used for FPV design and performance analysis.

The performance of the PV module evaluated is shown in Figure 3. The current versus voltage characteristics of the PV module at different incident irradiance is indicated in Figure 3.

Figure 4 shows the FPV model that was used to assess the performance ratio, electricity generation, grid contribution, capacity utilization factor, greenhouse gas emission reduction, and water conservation at the GERD reservoir. The proposed model in the simulation software can access

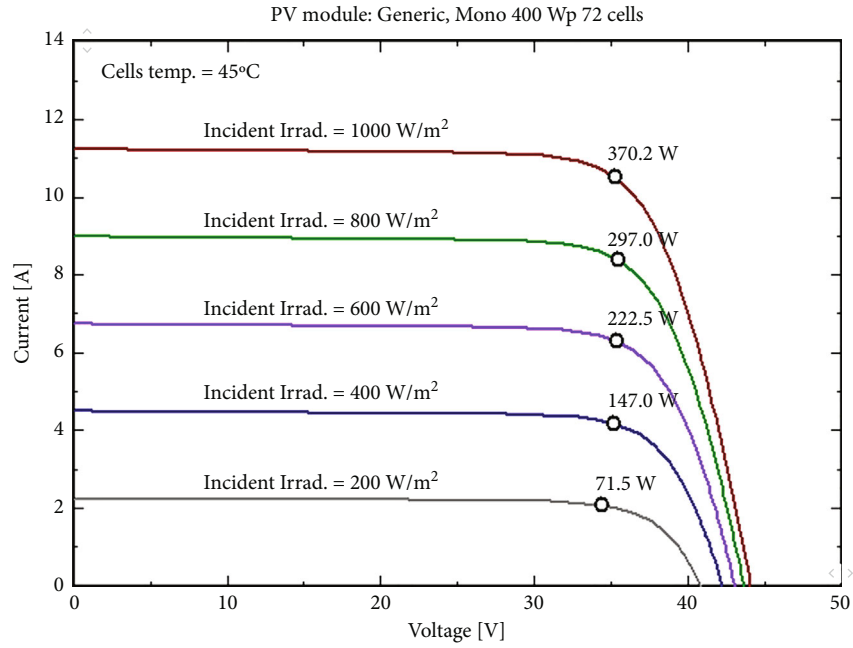

FIGURE 3: Current versus voltage characteristics of 400 W PV module.

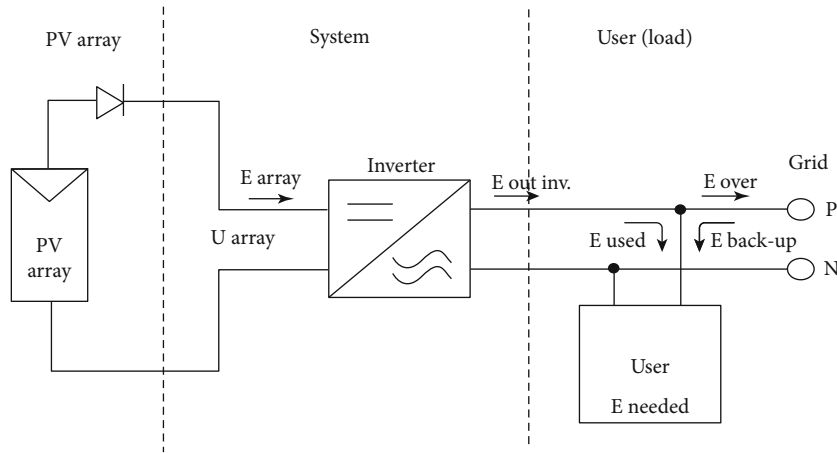

FIGURE 4: Grid connected PV system model.

TABLE 4: Inverter specification.

Model	INGECON SUN 100TL
Rated power DC	101.2-145 kw
Imax	240 A
Isc	185 A
Vmax DC	1100 V
Efficiency	98.9%
Rated power AC	100 kw
Output	50/60 Hz, 400 Vac

4.1. Mathematical Model of FPV System. The mathematical relationship in [4] was used to calculate the amount of electrical energy produced, greenhouse gas emissions, water evaporation, and performance ratio.

4.1.1. Solar PV Array Calculation. The solar radiation on tilted surface is given in equation (2) as proposed in [4]:

$$I_T = I_b * r_b + I_d * r_d + (I_b + I_d)r_r, \quad (2)$$

solar irradiance, wind speed, and ambient temperature data from the NASA weather database.

The inverter used to convert the DC power output of FPV plant to connect with the grid is indicated in Table 4.

where  $I_b$  is the beam flux on a tilted surface,  $I_d$  is the diffused flux on a tilted surface,  $r_b$  is the beam radiation tilt factor,  $r_d$  is the diffused radiation tilt factor, and  $r_r$  is the reflected radiation tilt factor.

TABLE 5: Monthly based different parameters estimation using PVsyst.

Months	GlobHor (KWh/m <sup>2</sup> )	DiffHor (KWh/m <sup>2</sup> )	T_Amb (°C)	GlobInc (KWh/m <sup>2</sup> )	GlobEff (KWh/m <sup>2</sup> )	E <sub>FPV</sub> (KWh)	E_Grid (KWh)	PR ratio
January	189.9	43.38	23.68	227.1	223.8	979.2	961.9	0.815
February	179.6	51.71	28.34	201.2	198	848.2	833.3	0.797
March	223.9	61.05	29.32	231.6	228	966.6	948.9	0.788
April	207.5	70.73	29.64	198.2	194.2	840.5	825.4	0.801
May	204	71.95	29.02	183	178.8	782.7	768.4	0.807
June	150.4	70.96	25.43	133.5	130.2	590.6	579.3	0.834
July	153.2	70.27	24.7	137.1	133.8	607.7	595.6	0.836
August	164.9	77.62	24.06	154.9	151.8	688.1	675.1	0.838
September	162.4	70	23.42	162.7	160	716.8	703	0.831
October	175.1	62.61	24.42	188.2	185.3	821.4	806	0.824
November	179	50.67	25.35	209.2	206.2	902.6	886.6	0.815
December	188.1	44.01	25.34	229.6	226.6	983.5	966	0.809
Year	2178	748.98	26.04	2256.4	2216.8	9728.2	9549.5	0.814

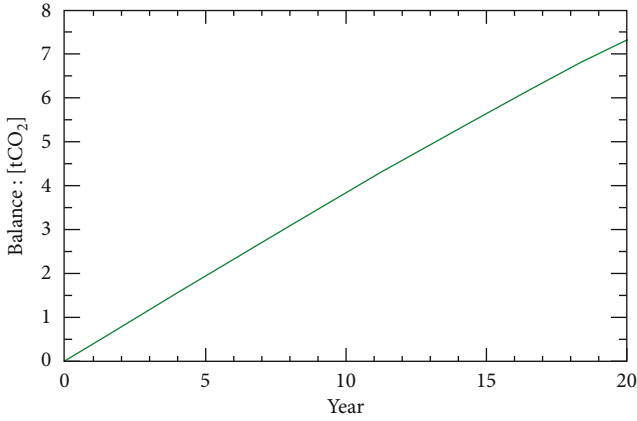
FIGURE 5: Saved CO<sub>2</sub> emission vs time.

The water to air temperature which is very important to determine the cell temperature of floating PV is given in

$$T_w = 5 + 0.75T_a. \quad (3)$$

The wind velocity on water surface is higher than on ground and calculated by using the following

$$V_w = 1.62 + (1.62 * V_{land}). \quad (4)$$

The temperature of PV cell in solar floating system can be found using

$$T_{FPV} = 0.943T_w + 0.0195G - 1.52V_w + 0.3529, \quad (5)$$

where  $T_{FPV}$  is the temperature of the FPV cell in degrees Celsius,  $T_w$  is the temperature of the water in degrees Celsius,  $G$  is the average daily irradiance (W/m<sup>2</sup>), and  $V_w$  is the wind velocity over the water's surface (m/s).

4.1.2. *Electrical Energy Produced by PV Array.* Equation (7) gives the monthly DC energy production by multiplying

daily output by the number of days in the month [4].

$$E_{dc}/day = (I_{tr}/1000) * (P_{dc}) * (1 + \gamma(T_{cell} - T_{ref})), \quad (6)$$

$$E_{dc}/Month = E_{dc}/day * \text{Number of days in Month}, \quad (7)$$

where  $E_{dc}$  = specified DC capacity,  $I_{tr}$  = transmitted irradiance,  $T_{cell}$  = cell temperature,  $r$  = temperature coefficient which is  $-0.0047/^\circ\text{C}$ , and  $T_{ref}$  = reference cell temperature =  $25^\circ\text{C}$ .

The AC energy is converted from the DC energy of the FPV utilizing a 98.9 percent efficient inverter with monthly PV module losses of 6.7 percent [4, 25].

$$E_{FPV} = E_{dc} [(1 - \text{operating losses in array}(\%))], \quad (8)$$

$$E_{grid} = E_{FPV} [1 - (\text{losses at inverter}(\%) + \text{losses in ac cable}(\%))]. \quad (9)$$

4.1.3. *Annual Performance Ratio and Capacity Utilization Factor.* The annual performance ratio (PR) is the ratio of energy delivered to the grid to rated power and tilted irradiation to standard irradiation (1000 W/m<sup>2</sup>). The performance of the floating power plant is determined by this factor, which is provided in equation (10) [4]. The annual capacity utilization factor (CUF) is the ratio of actual energy produced to a power plant's theoretical maximum energy production and its formula is given in equation (11) [4].

$$PR = \frac{E_{grid}/P_o}{I_{tr}/I_o}, \quad (10)$$

$$CUF = \frac{E_{grid}}{24 * 365 * FPV\text{capacity}}, \quad (11)$$

where  $E_{grid}$  is the energy supplied to the grid from floating solar power plant,  $P_o$  is the rated capacity of the power plant,  $I_{tr}$  is the transmitted irradiance,  $I_o$  is the standard irradiance, and FPVcapacity is the FPV plant installed capacity.



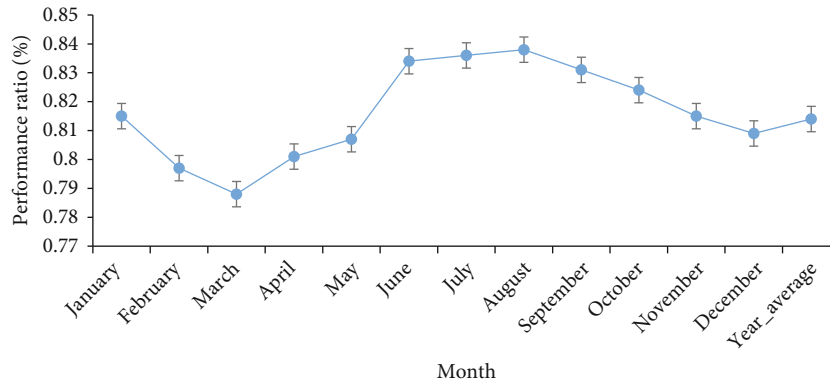

FIGURE 6: Monthly performance ratio of FPV.

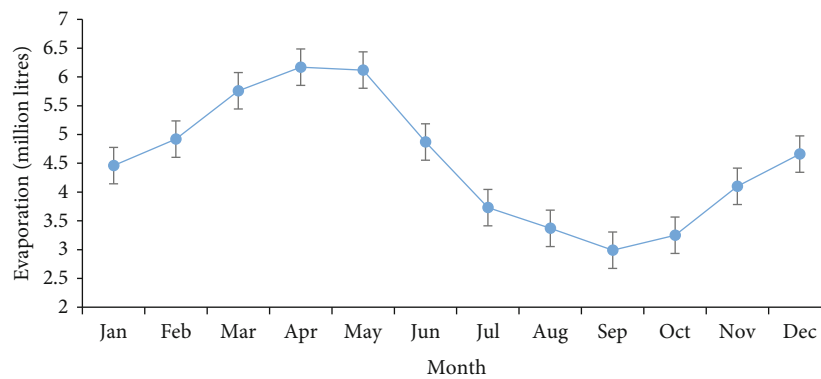

FIGURE 7: Monthly water from evaporation due to FPV.

TABLE 6: FPV power generation capacity of GERD at different area of coverage.

Dam	Total surface area (m <sup>2</sup> )	FPV power generation capacity for seven cases of area coverage (MW)						
		1%	5%	10%	15%	20%	30%	50%
GERD	1,874,000,000	1,874	9,370	18,740	28,110	37,480	56,220	93,700

4.1.4. *Reduction of Greenhouse Gas Emissions.* Equation (12) is used to calculate the reduction in GHG emissions [4, 26].

$$G_t = E_s * G * (1 + \beta), \quad (12)$$

where  $G_t$  is the amount of GHG reduced annually in tCO<sub>2</sub>/year,  $E_s$  is annual electricity production,  $G$  is GHG emissions in tCO<sub>2</sub>/year, and  $\beta$  is the average loss rate of power distribution and transmission.

4.1.5. *Evaporation Modeling.* Equation (13) is used to estimate the amount of water saved from evaporation [4].

$$\text{Evaporation} = 15.24 * (E_s - E_a) * (1 + (0.13 * V_s)), \quad (13)$$

$$E_a = 6.11 * 0.1 * 0.750062 * 10^{7.5 * T_d / 237.3 + T_d}, \quad (14)$$

where  $E_s$  is saturated vapor pressure in cm of mercury,  $E_a$  is actual vapor pressure in cm of mercury,  $V_s$  is the velocity of

air over water surface in km/h, and  $T_d$  is dew point temperature in degree Celsius.

## 5. Result and Analysis

For a 1 MW grid-connected FPV, all other factors, such as energy produced from the FPV, energy fed to the grid, capacity utilization factor, and performance ratio, are calculated. The monthly air temperature, monthly energy generated from an FPV, monthly energy delivered to the grid, and PR are all listed in Table 5. Annually, 9,549 MWh of energy can be sent into the grid, with an annual performance ratio of 81.4 percent. The annual capacity utilization factor is 22.12%, which proves that the FPV is productive enough throughout 365 days of the year, which indicates better energy production potential. The GERD is a suitable site for grid-connected floating PV installations based on the yearly performance ratio of FPV, which is 81.4 percent.

Figure 5 shows the substituted greenhouse gas emissions due to FPV installation at the GERD, as projected using the

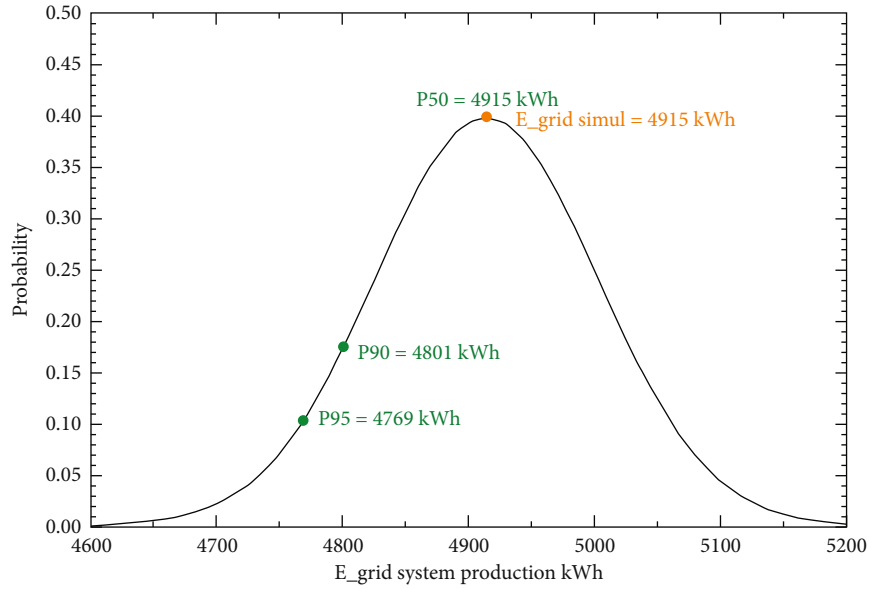

FIGURE 8: Annual energy production probability.

TABLE 7: Total cost of equipment for FPV.

No.	Item	Quantity (number)	Cost per item (USD)	Total cost (USD)
1	PV module	2,500	105.3	263,250
2	Module support (anchor and mooring)	2,500	17.238	43,095
3	Inverter	9	6,500	58,500
4	Installation and commissioning	—	—	60,400
Total investment cost for 1 MW FPV = 425,245 USD				
Module degradation				1% annually
Depreciation rate				5%
Discount rate				7%
Life span of the FPV				20

software. By taking a grid lifespan emission of 82 g CO<sub>2</sub>/kwh, the FPV has a 20-year life cycle and can save 7.81 tCO<sub>2</sub> emissions while producing energy of 9728.2 kwh/yr.

The FPV performance ratio, as shown in Figure 6, indicates that the Great Ethiopian Renaissance Dam has good potential for installing a floating PV system in tandem with the 6 GW hydropower generating project. In addition, the installation of FPV at the GERD dam, as shown in Figure 7, allowed for the saving of 54.4 million liters of water losses due to evaporation. After the dam, this will boost the storage capacity for hydropower generation and water supply for people in Egypt and Sudan. The maximum performance ratio obtained in August was 83.8%, whereas 78.8% was the minimum recorded in March.

Reservoir water evaporates, which is a major issue in maintaining water levels in ponds, lakes, and reservoirs. The 1 MW FPV system covers 10,000 m<sup>2</sup> of the GERD and saves 54.4 million liters of water per year. Installing FPV at GERD is able to maintain the water level for the hydropower producing unit by saving 54.4 million liters of water and improve the output of FPV due to cooling effect of water

in nature. From January through May, there is a lot of water evaporation, as seen in Figure 7.

**5.1. FPV Power Generation Capacity of GERD.** The energy production of the GERD FPV plant at various percentages of the usable area of the dam, i.e., 1%, 5%, 10%, 20%, 30%, and 50% of the entire area of 1,874,000,000m<sup>2</sup>, is shown in Table 6, using 10 m<sup>2</sup> for 1 kw FPV installation.

By utilizing 50% of the reservoir's surface area, the dam at GERD has the ability to generate 93,700 MW from FPV. Several publications, however, claim that the optimal FPV potential is a maximum of 10%, generating 18,740 MW of power from FPV. 1,874 MW of power can be generated using 1% of the GERD reservoir. Even if the cost is quite expensive, the GERD reservoir has the potential to produce more electricity than the hydropower it generates. After determining its FPV capability, a 1 MW FPV design was chosen and analyzed in this study to support the grid and cover the load of the camp at the GERD. The likelihood of electricity contributed to the grid from a 1 MW FPV is shown in Figure 8.

5.2. *Economic Analysis.* The FPV system parameter design and analysis at GERD is to generate 1 MW of power which can have 20 years' operation lifetime. The whole project cost includes solar panels, module support, inverters, installation, and land. The cost of land will not be considered because the FPV facility is located on a body of water. The operating and maintenance expenditures are expected to be 1% of the capital investment cost. The cost of operation and maintenance is expected to increase by 5% per year. As the number of FPV projects installed increases, the cost of operation and maintenance reduces. Table 7 shows the total cost of a 1 MW FPV system at GERD.

## 6. Conclusion

The abundant solar irradiation at the GERD reservoir site, as well as the ambient temperature and wind speed, makes FPV analysis more practical. The potential assessment of FPV at the Great Ethiopia Renaissance Dam was designed and investigated using PVsyst software. The performance ratio of the GERD, which is 81.3%, indicates that Ethiopia has the potential to produce more electric energy using FPV technology from the dam than the hydropower capacity of the GERD. It has the FPV potential of producing 18,740 MW from a total area of  $1874 \times 10^6 \text{ m}^2$  if 10% of the GERD reservoir area is used. PVsyst simulation tool was used to build and analyze a 1 MW FPV covering  $10,000 \text{ m}^2$  of the GERD. The proposed design is evaluated in terms of performance ratio, energy production potential, greenhouse gas emissions, capacity utilization factor, and water evaporation reduction. In general, 7.81 tCO<sub>2</sub> emissions are reduced, and 54.4 million liters of water are saved from evaporation. Furthermore, developing FPV at the GERD increases the volume of water discharged into downstream Blue Nile countries such as Egypt and Sudan by reducing evaporation and allowing year-round water flow in addition to responding to the energy demand of the community. This research did not address the impact of integrating FPV to the grid which can be the limitation in this study and may be considered by future researchers.

## 7. Future Works

Researchers can consider the impact of water level variation, the velocity of the water current, the behavior of the waves in the reservoir, and the quality of the water in relation to causing corrosion on FPV panel and power output capacity. This research can also be made ready for implementation by designing and specifying the overall floating structure with the mooring and anchorage bodies. To reduce energy poverty, the government must develop a policy that takes this research into account, as well as initiate the development of FPV at GERD.

## Data Availability

All the data used for this research analysis is included in this manuscript.

## Conflicts of Interest

There is no conflict of interest regarding the publication of this manuscript.

## References

- [1] J. P. Murenzi and T. S. Ustun, "The case for microgrids in electrifying sub-Saharan Africa," in *IREC2015 The Sixth International Renewable Energy Congress*, pp. 1–6, IEEE, 2015.
- [2] L. Abdallah and T. El-shennawy, "Reducing carbon dioxide emissions from electricity sector using smart electric grid applications," *Journal of Engineering*, vol. 2013, Article ID 845051, 8 pages, 2013.
- [3] Y. Singh, B. Singh, and S. Mishra, "A high-performance solar PV array-wind and battery integrated microgrid for rural electrification," in *2020 IEEE International Conference on Power Electronics, Drives and Energy Systems (PEDES)*, pp. 1–6, Jaipur, India, 2020.
- [4] H. Bala and S. Pakyala, "Floating solar potential assessment," in *2021 13th IEEE PES Asia Pacific Power & Energy Engineering Conference (APPEEC)*, pp. 9–14, Thiruvananthapuram, India, 2021.
- [5] S. Gadzanku, H. Mirlitz, N. Lee, J. Daw, and A. Warren, "Benefits and critical knowledge gaps in determining the role of floating photovoltaics in the energy-water-food nexus," *Sustainability*, vol. 13, no. 8, p. 4317, 2021.
- [6] A. El, A. Chalh, A. Allouhi, S. Motahhir, A. El, and A. Derouich, "Design and construction of a test bench to investigate the potential of floating PV systems," *Journal of Cleaner Production*, vol. 278, article 123917, 2021.
- [7] E. Solomin, E. Sirotkin, E. Cuce, S. P. Selvanathan, and S. Kumarasamy, "Hybrid floating solar plant designs: a review," *Energies*, vol. 14, no. 10, p. 2751, 2021.
- [8] N. Lee, U. Grunwald, E. Rosenlieb et al., "Hybrid floating solar photovoltaics-hydropower systems: benefits and global assessment of technical potential," *Renewable Energy*, vol. 162, pp. 1415–1427, 2020.
- [9] D. Mittal, B. K. Saxena, and K. V. S. Rao, "Comparison of floating photovoltaic plant with solar photovoltaic plant for energy generation at Jodhpur in India," in *2017 International Conference on Technological Advancements in Power and Energy (TAP Energy)*, pp. 1–6, Kollam, India, 2017.
- [10] R. G. Sanchez, I. Kougiyas, M. Moner-girona, and F. Fahl, "Assessment of floating solar photovoltaics potential in existing hydropower reservoirs in Africa," *Renew. Energy*, vol. 169, 2021.
- [11] E. M. Getie, "Poverty of energy and its impact on living standards in Ethiopia," *Journal of Electrical and Computer Engineering*, vol. 2020, Article ID 7502583, 2020.
- [12] S. Kim, M. Oh, and H. Park, "Applied sciences analysis and prioritization of the floating photovoltaic system potential for reservoirs in Korea," *Applied Sciences*, vol. 9, 2019.
- [13] D. Mittal, B. K. Saxena, and K. V. S. Rao, "Floating solar photovoltaic systems : an overview and their feasibility at Kota in Rajasthan," in *2017 international conference on circuit, power and computing technologies (ICCPCT)*, pp. 1–7, Kollam, India, 2017.
- [14] G. V. Hemastra, R. F. Gusa, and W. Sunanda, "Preliminary study of floating photovoltaic in Bangka Belitung Island," in *2021 International Conference on Technology and Policy in*

- Energy and Electric Power (ICT-PEP)*, pp. 192–195, Jakarta, Indonesia, 2021.
- [15] N. Ravichandran, H. H. Fayek, and E. Rusu, “Emerging floating photovoltaic system — case studies high dam and Aswan reservoir in Egypt,” *Processes*, vol. 9, no. 6, p. 1005, 2021.
- [16] C. Vargas-salgado and M. Alcazar-ortega, “Floating PV solar-powered systems : design applied to an irrigators community in the Valencia region–Spain,” in *2020 Global Congress on Electrical Engineering (GC-ElecEng)*, pp. 88–95, Valencia, Spain, 2020.
- [17] J. Baptista and P. Vargas, “Portuguese national potential for floating photovoltaic systems : a case study,” in *2020 IEEE International Conference on Environment and Electrical Engineering and 2020 IEEE Industrial and Commercial Power Systems Europe (EEEIC/I&CPS Europe)*, pp. 1–5, Madrid, Spain, 2020.
- [18] B. Z. Taye, A. H. Nebey, and T. G. Workineh, “Design of floating solar PV system for typical household on Debre Mariam Island Design of Floating Solar PV System for Typical Household on Debre Mariam Island,” *Cogent Engineering*, vol. 7, 2020.
- [19] R. Chowdhury, “Floating solar photovoltaic system : an overview and their feasibility at Kaptai in Rangamati,” in *2020 IEEE International Power and Renewable Energy Conference*, pp. 1–5, Karunagappally, India, 2020.
- [20] I. S. Rodrigues, G. Luis, B. Ramalho, and P. Henrique, “Potential of floating photovoltaic plant in a tropical reservoir in Brazil,” *Journal of Environmental Planning and Management*, vol. 63, no. 13, pp. 2334–2356, 2020.
- [21] M. Elshafei, A. Ibrahim, A. Helmy et al., “Study of massive floating solar panels over lake Nasser,” *Journal of Energy*, vol. 2021, Article ID 6674091, 17 pages, 2021.
- [22] K. Kumar, S. Khanra, R. Kant, and S. Vashishtha, “Assessment of floating solar PV (FSPV) potential and water conservation: case study on Rajghat Dam in Uttar Pradesh, India,” *Energy for Sustainable Development*, vol. 66, pp. 287–295, 2022.
- [23] S. Mahmood, S. Deilami, and S. Taghizadeh, “Floating solar PV and hydropower in Australia: feasibility, future investigations and challenges,” in *2021 31st Australasian Universities Power Engineering Conference (AUPEC)*, pp. 21–25, Perth, Australia, 2021.
- [24] H. Rauf, M. S. Gull, and N. Arshad, “Complementing hydro-electric power with floating solar PV for daytime peak electricity demand,” *Renewable Energy*, vol. 162, pp. 1227–1242, 2020.
- [25] B. A. Chico Hermanu, B. Santoso, W. Suyitno, and F. X. Rian, “Design of 1 MWp floating solar photovoltaic (FSPV) power plant in Indonesia,” *The 4th International Conference on Industrial, Mechanical, Electrical, and Chemical Engineering*, vol. 2097, 2019.
- [26] J. Song and Y. Choi, “Analysis of the potential for use of floating photovoltaic systems on mine pit lakes: case study at the Ssangyong open-pit limestone mine in Korea,” *Energies*, vol. 9, no. 2, pp. 102–113, 2016.