



DEWESoft®

GENERAL CATALOG V23-2



V23-3

7 DEWESoft
YEAR WARRANTY



7 YEAR WARRANTY



We know that quality is not just what we put into the product, but what you get out of it. We know that your work depends on the reliability of your tools. That's why we design and produce to give you a product of high performance and efficiency.

We build our equipment to last. We guarantee you that your hardware will be free from defects and functional. Our warranty covers that the instruments function as promised for a period of 7 years from the day of the delivery. When you buy our data acquisition systems, we make sure they work. Enjoy this unique add-on to Dewesoft quality products and services!



The warranty applies to the following products: SIRIUS®, KRYPTON®, IOLITE®, OBSIDIAN®, DEWE-43A, DSI-ADAPTERS, CAN INTERFACES, EtherCAT® Accessories



THE DEWESOFT 7-YEAR WARRANTY APPLIES TO OUR DATA ACQUISITION SYSTEMS. YOU BUY IT, OWN IT, USE IT, AND OUR WARRANTY KEEPS YOU COVERED. THE 7-YEAR WARRANTY COMES WITH **NO EXTRA CHARGE.**



"The setup and measurement process in the FRF module is really fascinating. Among the systems that I have seen, it is the absolutely most straight forward. Geometry and the measurement setup are available as files. It's a matter of minutes to have the final FRF's and the animation to get an impression of the vibrations. That's great!" - **IABG**

"I wanted to personally write to you and tell you how impressed I am with Dewesoft products. The whole Dewesoft team impressed me as extremely happy, smart, and dedicated." - **IRISENSORS**

"We absolutely enjoy using the Dewesoft data acquisition equipment and its software. I think of it as the Porsche 911 of data acquisition (my dream car/our dream test equipment)." - **AGI**

"We recommend SIRIUS as a great unit to anyone that asks how we like it." - **SPACE X**

"Again, thanks for all of the new features that are being included in DewesoftX. It is already a fantastic product and deserves to become the "Microsoft Word" of data acquisition software." - **Goodrich**

"I think I mentioned in previous emails how Dewesoft has mushroomed here, but even I didn't know how much. I was informed today that the data was being reviewed by up to 50 to 60 different centers, along with NASA personnel as high as the manager of the entire Space Shuttle program." - **NASA KSC**

"Again, thanks for all the efforts on this project! I greatly appreciate everything you guys have provided to us." - **BAYER**





**OUR VISION IS TO DESIGN
TEST EQUIPMENT THAT
SIMPLIFIES THE
ADVANCEMENT OF
HUMANITY.**

We are on a mission to revolutionize the measurement industry by developing innovative solutions that are tailored to our customers needs.

More than 20 years ago, as young engineers we dreamed of creating a revolution in the world of measurement. We dreamed of creating data acquisition software that was versatile and powerful - and yet easy to use - something that didn't exist.

We are who we are because of you - our customers - working in the most advanced labs around the world. You had the same dream: you introduced us to the challenge that drives our passion for constant improvement, keeping our minds sharp and our spirits free.

**IN PARTNERSHIP WITH YOU, WE BUILT SOLUTIONS THAT
EXTENDED FAR BEYOND WHAT WE EVER IMAGINED WAS
POSSIBLE TWO DECADES AGO. THANK YOU!**

Today, we offer a variety of hardware and software solutions made just for you. And you're still our greatest asset. That will never change.
Tell us what you need, and we will continue to push the limits.



Dr. Jure Knez
president and co-founder



**DEWESOFT IS MORE
THAN A COMPANY.
DEWESOFT IS PEOPLE.**

**WE BUILT OUR COMPANY TO LAST,
STRONGLY INVESTING IN PEOPLE,
OUR TECHNOLOGY AND
OUR OWN SALES NETWORK.**





DEWESOFT IS
100%
EMPLOYEE-OWNED

**AND COMPLETELY
SELF-FINANCED,
WITH AAA RATING.**

The best solutions can be made only by a motivated team of people who love their work - those who design and build instruments with a spark in their eyes and those who light up when they have an idea for improvement. Together with you we are the ones creating Dewesoft.

ONE SOFTWARE.
ONE HARDWARE.
YOUR SOLUTION.



CONTENTS

ONE SOFTWARE.

MEASURE
STORE
VISUALIZE
ANALYZE
PUBLISH
DEVELOP
LICENCE SPECS

ONE HARDWARE.

DAQ SYSTEMS

TECHNOLOGY OVERVIEW
SIRIUS® HIGH-END DAQ SYSTEMS
SIRIUS® XHS
XHS-PWR SIRIUS®
SIRIUS® MODULAR
MODULAR SIRIUS® SBOX
SIRIUS® R4 BOXED
PORTABLE INSTRUMENT SIRIUS® R1DB/R2DB
SIRIUS® R8 PORTABLE INSTRUMENT
RACK SYSTEM SIRIUS® R8RT
SIRIUS® R3 19" RACK SYSTEM
COMPACT SYSTEM SOLUTION SIRIUS® MINI
SIRIUS® AMPLIFIERS
SIRIUS® XHS AMPLIFIERS
HYBRID ADC SIRIUS® XHS

DAQ AND CONTROL SYSTEMS

DATA ACQUISITION AND CONTROL DEVICES
IOLITE® AMPLIFIER SPECS
AMPLIFIER SPECS IOLITE®

RUGGED DAQ SYSTEMS

KRYPTON® RUGGED SYSTEMS
RUGGED SYSTEMS SIRIUS® AND SBOX
KRYPTON® WATERPROOF
KRYPTON® WATERPROOF SPECS
KRYPTON® 1 WATERPROOF
KRYPTON® 1 WATERPROOF SPECS
SIRIUS® WATERPROOF
WATERPROOF SBOX®

13

14
15
16
17
18
19
20

23

24
26
28
29
30
31
32
33
34
35
36
37
38
40
41

43

44
46
47

49

50
51
52
53
54
55
56
57

ACCESSORIES, SENSORS & MORE

DEWE-43A
DSI® ADAPTERS
MOUNTING PLATES
DISPLAYS AND BATTERY PACKS
DS-CAM VIDEO CAMERAS
GPS AND IMU DEVICES
CAN BUS AND CAN FD INTERFACES
CLAMPS & TRANSDUCERS
DC-CT 1000I
CURRENT TRANSDUCERS
CURRENT CLAMPS AC/DC
CURRENT CLAMPS AC / ROGOWSKY COILS AC
SENSOR POWER SUPPLY
ACCELEROMETERS
ANGLE SENSORS
MICROPHONES
VIBRATION SHAKERS
DS-WIFI
ETHERCAT® ACCESSORIES

YOUR SOLUTION.

DATA RECORDING & CONTROL

SYNCHRONIZED DATA RECORDING FROM VARIOUS SOURCES
REAL-TIME CONTROL SYSTEM FRONT-END
HIGH CHANNEL COUNT DATA RECORDING
HIGH-SPEED AND TRANSIENT RECORDING

POWER ANALYSIS

POWER ANALYZER
EXTENDABLE MODULAR DESIGN
E-MOBILITY
E-MOBILITY
GRID POWER ANALYZER
GRID POWER ANALYZER
POWER QUALITY ANALYZER
POWER QUALITY ANALYZER
POWER QUALITY ANALYZER
OVERVIEW

VEHICLE ANALYSIS

ROAD LOAD DATA ANALYSIS
DURABILITY TESTBED INTEGRATION
COMBUSTION & HYBRID ANALYSIS
COMBUSTION & HYBRID ANALYSIS
BRAKE NOISE
BRAKE TESTING

59

61
62
63
64
65
66
67
68
69
70
71
72
73
74
75
76
77
78
79

81

81
82
83
84
85

87

88
89
90
92
94
96
97
98
100
101

103

104
105
106
107
108
109

POLYGON AND GPS SOLUTIONS
ADAS TESTING
VEHICLE DYNAMICS
VEHICLE NETWORK SYSTEMS
HARSH ENVIRONMENT TESTING
FATIGUE

DYNAMIC SIGNAL ANALYSIS & NVH

ORBIT ANALYSIS
ORBIT ANALYSIS
FFT ANALYZER
OCTAVE ANALYZER
ORDER ANALYSIS
ROTATIONAL AND TORSIONAL VIBRATIONS
BALANCING
SHOCK RESPONSE SPECTRUM (SRS)
MODAL TEST / ANALYSIS
SINE PROCESSING
SOUND LEVEL METER
SOUND POWER
SOUND INTENSITY
SOUND QUALITY
REVERBERATION TIME RT60
HUMAN BODY VIBRATION
MONITORING
MACHINE CONDITION MONITORING
BRIDGE CONDITION MONITORING

AEROSPACE

TELEMETRY IRIG CHAPTER 4 PCM
IRIG CHAPTER 10 AND INET TELEMETRY

OUR COMPANY.

LIST OF DISTRIBUTORS

110
111
112
113
114
115

117

118
119
120
121
122
123
124
125
126
127
128
129
130
131
132
133
135
136
137

139

140
141

143

148

FREE UPGRADES

PROCESS

ACQUIRE ANY DATA



EXTREMELY DEEP IN FUNCTIONALITY

F R E E A N A L Y S I S

ONE SOFTWARE.



EASY TO LEARN

Intuitive user interface. Free PRO on-line training courses. Free webinars. Large user community. Local support also in your country.

SAVE TIME

Advanced technology aimed at easy setup and rock solid results. Our real-time "live" data visualization means instant data qualification.

SAVE MONEY

No hidden costs! Software is included with all of our instruments. Free lifetime software upgrades. Free data analysis. No maintenance fees. You buy it, you own it.

V I S U A L I Z E

E A S Y T O L E A R N

DEWESoft® X MEASURE



ANALOG CHANNELS

Voltage, Current, Potentiometer, Temperature, Strain, Stress, Force, Displacement, Velocity, Acceleration, Sound pressure, Pressure, Resistance, Torque, Mass and TEDS.

OUTPUTS

Analog out, digital out alarms, CAN, EtherCAT®, Ethernet, RS232 and OPC UA.

VEHICLE BUS SYSTEMS

CAN, CAN FD, XCP, LIN, FlexRay, CCP, OBDII, J1587/J1708, J1939, SENT, Arinc 429, MIL 1553, Chapter 10, iNET and Kiroad.

NAVIGATION

GPS and Inertial platforms.

VIDEO

Video from DirectX, GigE, high-speed Photon™ and Optris infrared cameras.

No other software allows you to connect so many different kinds of data sources and record them all synchronously, see them in real time, and record them to a single data file. That IS the Dewesoft advantage.

DIGITAL

Digital inputs, waveform timing, counters, angle & frequency from encoders, any type of gear tooth sensors and tachos.

DATA BUS SYSTEMS

OPC UA, Ethernet, Modbus TCP/IP, PCM telemetry, RS232 and RS485, Weather station and Siemens S7.

STORE DEWESoft® X

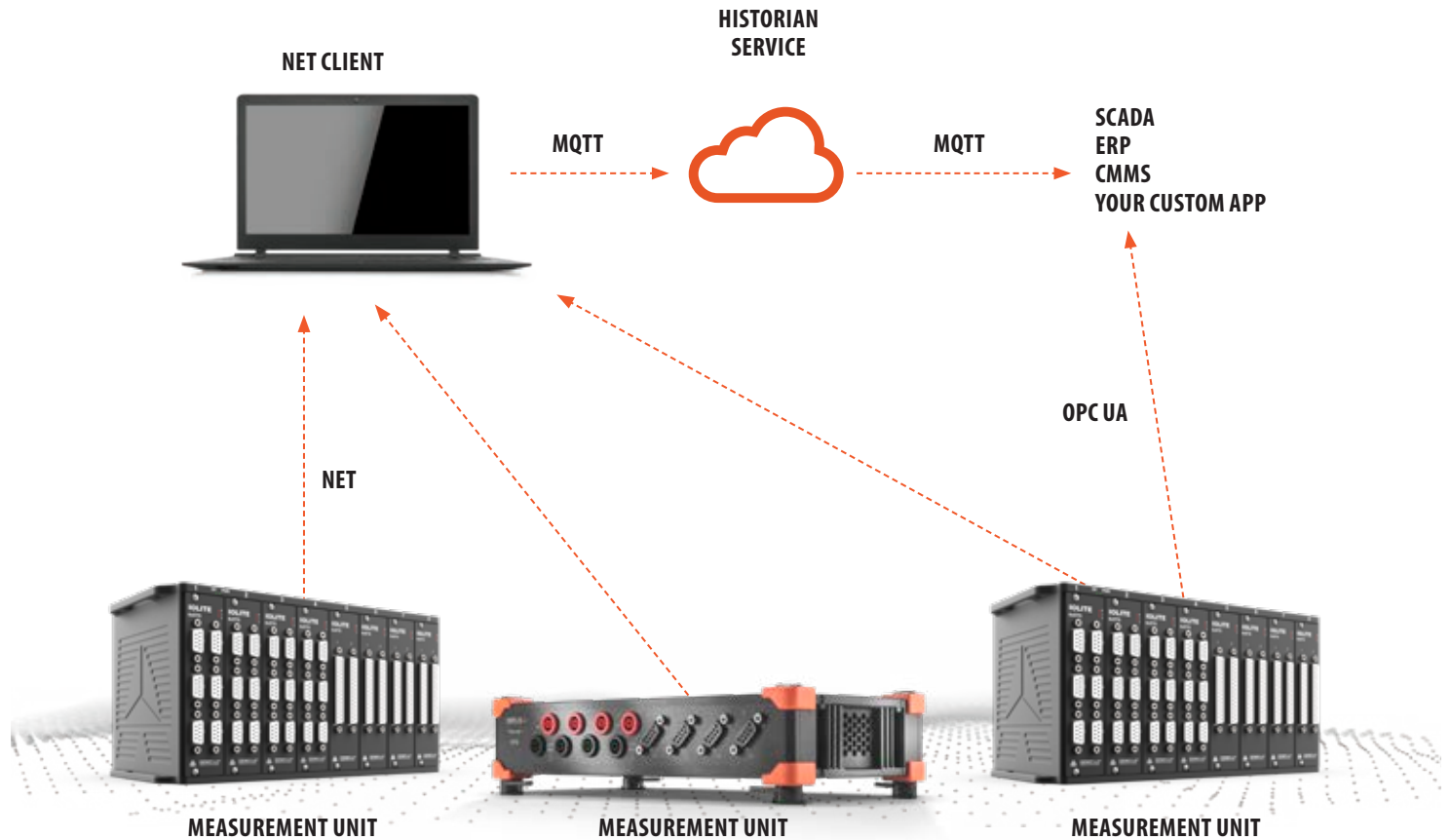

ADVANCED TRIGGERING

Using triggering, only the data you need are stored. Dewesoft supports Pre trigger, Post trigger, Hold off, Post time extension, Simple edge trigger, Filtered edge trigger, Window and Pulsewidth, Slope, Delta amplitude, Relative time trigger, Absolute time trigger and FFT trigger.

MORE THAN 500MB/SEC STORING

High performance engine allowing high data storing write speeds. Advanced data structure allows data files, even GBs long, to be loaded instantly.

BIG DATA

For big data and Industry 4.0 applications, data can be stored to the cloud and reviewed using standard OPC UA interface.

DISTRIBUTED NETWORKED DATA ACQUISITION

Precise synchronization allows flexible configurations of thousands of channels.

High performance storing >500MB/sec, instant file loading, triggering, networked acquisition and cloud storage.

RAW DATA AND MATH CHANNELS

Raw data are always stored from the hardware interface channels and kept untouched. You can easily create new math channels based on the raw data, leaving the original data untouched.

HISTORIAN

Dewesoft historian provides a versatile solution for cloud or local networked data storage in powerful Influx time series database. Standard OPC UA interface allows communication between measurement units and database and between database and clients, so any standard SCADA, MES or mobile solution can be used for data analysis.

DEWESoft® X VISUALIZE

EXTENSIVE LIBRARY OF STANDARD DISPLAYS:

- **Recorders:** horizontal, vertical and XY recorder
- **Oscilloscope:** scope, 3D scope, vectorscope
- **FFT:** FFT, 3D FFT, Harmonic FFT and Octave
- **Meters:** digital, analog, horizontal/vertical bar meters
- **Graphs:** 2D, 3D Graph, Octave, Orbit, Campbell and Contour plot
- **Video:** standard video display and thermal video display with temperature indicators
- **GPS:** positioning display with Satellite and OpenStreetMap layers
- **Control:** button, switch, knob, slider, user input
- **Combustion analysis:** P-V diagram and combustion scope
- **Rotor balancer:** for field balancing
- **Orbit Analysis:** Orbit plot, Polar plot, Bode plot, Full motion graph
- **Automotive:** 3D polygon for displaying moving objects
- **Aerospace:** AHRS, Altimeter, Vertical speed indicator, Horizontal situation indicator, Compass
- **DSA/NVH:** Modal circle
- **Other:** 2D/3D table, image, text box, line, over-load indicator, indicator lamp, legend, marker table, load indicator, indicator lamp, note

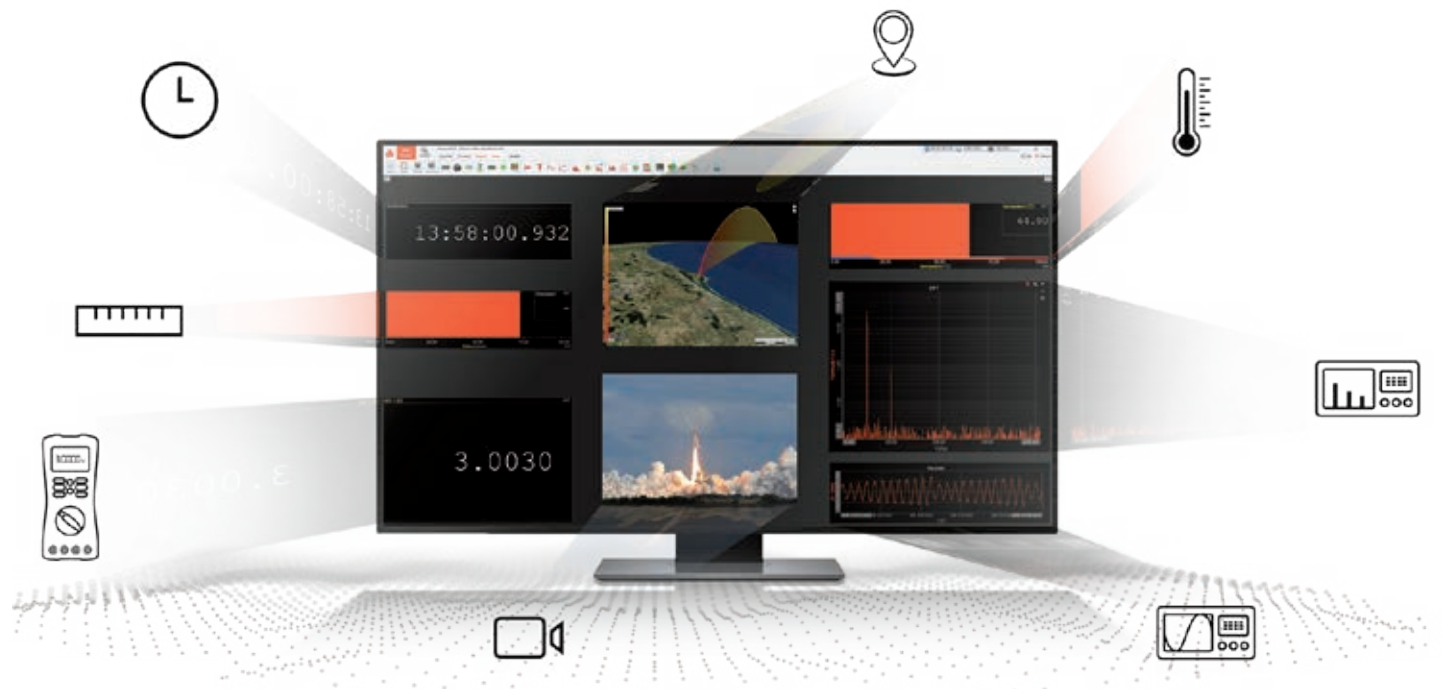

FLEXIBLE VISUALIZATION

Simple drag-drop and assign channel generates your perfect display. Create any number of different displays.

FILE REPLAY

During analysis, data replay looks the same as when it was being recorded. With integrated video you can easily follow the measurement process.

Extensive widget library, flexible displays, optimized graphics.

OPTIMIZED GRAPHICS

Using the latest CPU and GPU technologies, graphics run smoothly even on basic computers.

ANALYZE DEWESoft® X

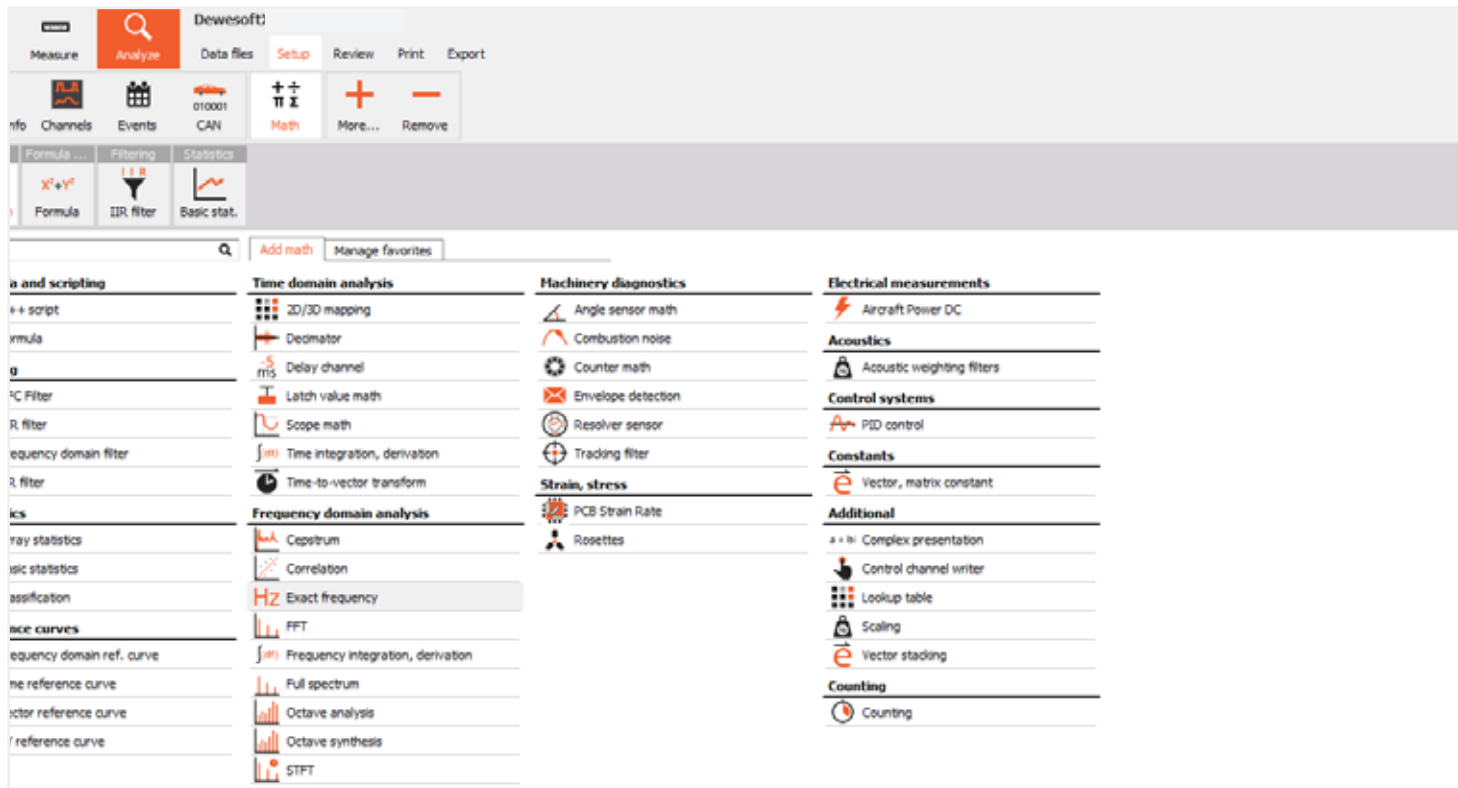

MATH LIBRARY FUNCTIONALITIES:

- **Formula:** Custom formula editor
- **Filtering:** FIR, IIR, FFR, CFC, integration, derivation
- **Statistics:** RMS, Average, Min, Max, Std deviation, variance, classification, counting, array statistics ...
- **Reference curve:** Time and frequency domain, vector and XY reference curves
- **Time domain analysis:** Delay channel, Integral, derivative, Latch value math, Scope math, Time-to-vector transform
- **Frequency domain analysis:** Cepstrum, Correlation, Exact frequency, Fourier transform, Full spectrum, Octave analysis, Short-time Fourier transform
- **Control systems:** PID control
- **Strain, stress:** Strain rosette
- **Constants:** Vectors, Matrix constant

ADVANCED APPLICATION ANALYSIS:

POWER ANALYSIS

Power Analyzer, Power Quality, Hybrid Vehicle Analysis, Inverter Motor Analysis, efficiency measurements.

VEHICLE ANALYSIS

Combustion Analyzer, Combustion Noise, Polygon, Brake Test, Vehicle Dynamics, Brake Noise.

ACOUSTICS

Acoustic Weighting Filters, Octave Analysis, Sound Level Meter, Sound Power, Sound Intensity, Sound Quality, RT60.

MACHINERY DIAGNOSTICS

Modal Test & Analysis, Order Tracking & Analysis, Rotational & Torsional Vibration Analysis, Balancing, Angle Sensor Math, Envelope Detection, Sine Processing (COLA), Tracking Filter.

An extensive and easy-to-use mathematical library for data and signal processing - all developed to match specific applications.

DEWESoft® X PUBLISH

REPORTING

Create and print PDF or printed reports directly from DewesoftX.

DISPLAY COPY

Copy/paste displays to integrate data in standard reports.

VIDEO FILE EXPORT

If a picture is worth a thousand words, imagine the value of video! You can export your choice of live screens with all widgets to a video file.

SEQUENCER

A built-in block diagram sequencer extends the use of Dewesoft to automated testing applications.



EXPORT YOUR DATA TO A VARIETY OF STANDARD FORMATS FOR FURTHER ANALYSIS...

- **MS Excel®**: standard spreadsheet software
- **FlexPro®**: powerful, easy-to-use data analysis software
- **Text/CSV and ASCII**: tab delimited text file
- **DIAdem®**: powerful data analysis software from NI
- **Famos**: signal analysis software
- **NSoft**: NCode file format for Somat software
- **MATLAB®**: MATLAB® file format
- **Sony**: Sony tape recorder compatible format
- **RPC III**: MTS file format used by road simulator testbed
- **Comtrade**: used in power & energy markets
- **UNV**: universal file format
- **WAV**: standard audio file format
- **KML**: GPS export for viewing path in Google Earth
- **BWF**: multichannel wave file format
- **ATI**: native iDeas format for dynamic signal analysis
- **SDF**: used by LMS and Prosig software
- **WFT**: Nicolet file format
- **CSV**: for exporting CAN messages
- **TDF**: file format defined and used by LMS software
- **ASAM ODS and MDF**: Open Data services and Measurement Data format by ASAM organisation (ASAM ODS with supported NVH module)
- **TAFFmat**: TEAC Data Acquisition File Format
- **Winplot [* .sun]**: Data format compatible with Winplot, a powerful desktop graphical analysis tool that allows the user to generate displays of unrestricted amounts of data
- **iFile**: Used for AVL Concerto

You can add DewesoftX on any computer to freely view and analyze files. Export data and create reports in standard formats.

DCOM INTERFACE

Integrate Dewesoft systems as components in custom applications.

REAL TIME EtherCAT® INTERFACE

For control applications, Dewesoft brings together the words of data acquisition and control.

OPEN EXPORT INTERFACE

Create your own unique export format using our open export programming interface.

OPEN DISPLAY INTERFACE

Our built-in displays cover 99% of application requirements, however you can extend our visual displays using the plugin programming interface for special cases.

OPC UA INTERFACE

Exchange data between Industry 4.0 systems with standard OPC UA interface.

NET INTERFACE

Control remotely and exchange data with our simple, but powerful exchange protocol.

DewesoftX offers a wide variety of BUILT-IN functions, but it is also completely open to adapt to various applications.

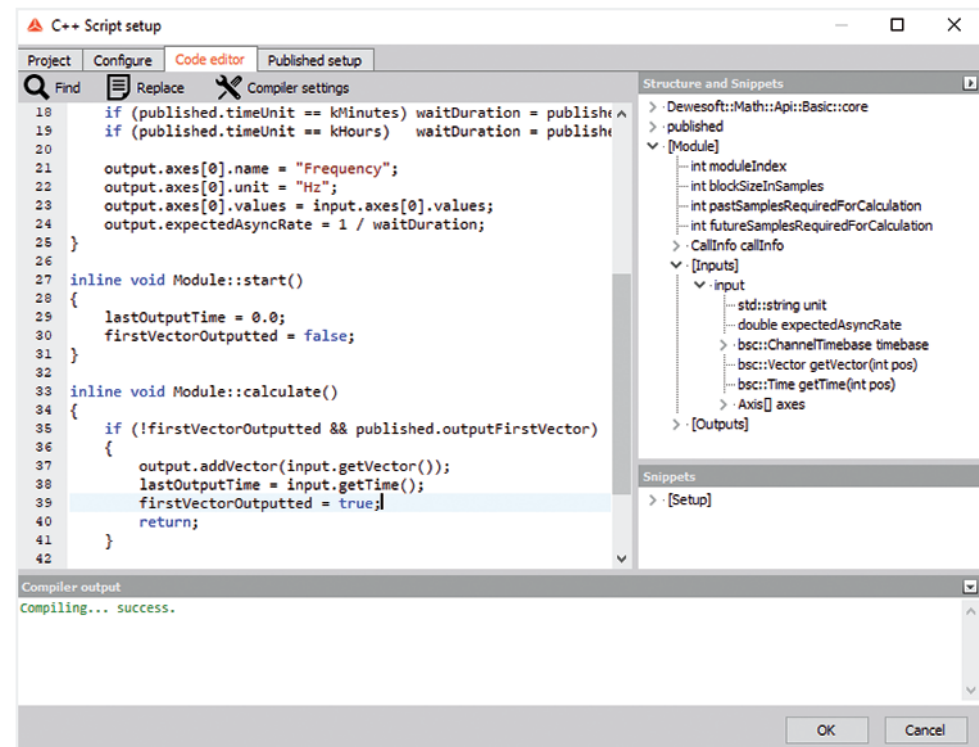

PLUGIN INTERFACE

Using plugins you can add just about any external device to your system. Plugins can be created in virtually any programming language.

BUILT-IN C++ COMPILER

Extend your processing capability with our built-in C++ script editor. No need for external programming tools.

SEQUENCER

Automate test workflow with easy-to-use build-in flowchart programming tool.



DEWESoft® X LICENCE SPECS

	Professional	DSA	Enterprise
Key features			
All applications/interfaces in one software	✓	✓	✓
Synchronized data acquisition	✓	✓	✓
Unlimited number of configurable channels	✓	✓	✓
Live visualization of data	✓	✓	✓
Triggered storing	✓	✓	✓
Distributed acquisition (Dewesoft NET)	Option	Option	✓
Offline analysis (Post-processing)	✓	✓	✓
Reporting	✓	✓	✓
Localization (software translation)	✓	✓	✓
Lifetime free upgrades	✓	✓	✓
Configuration management			
Savable/sharable configuration files	✓	✓	✓
Project definition for different users	✓	✓	✓
Sensor database	✓	✓	✓
Adjustable physical quantities	✓	✓	✓
Modular security, encryption, access restriction	✓	✓	✓
Input/output interfaces			
General			
Dewesoft analog/digital inputs	✓	✓	✓
Dewesoft analog/digital outputs	✓	✓	✓
Analog replay of data	✓	✓	✓
Function generator	Option	Option	✓
TEDS support	✓	✓	✓
Gantner Ethernet devices	Option	Option	✓
Gyro platform - LORD MicroStrain	Option	Option	✓
Barcodes	Option	Option	✓
Scanivalve	Option	Option	✓
Moog	Option	Option	✓

	Professional	DSA	Enterprise
Vehicle interfaces			
Dewesoft CAN/J1939 interfaces	Option	Option	✓
Vector CAN/J1939 interfaces	Option	Option	✓
Vector CAN FD devices	Option	Option	✓
OBDII	Option	Option	✓
XCP/CCP	Option	Option	✓
XCP Slave	Option	Option	✓
FlexRay	Option	Option	✓
LIN	Option	Option	✓
SENT (SAE J2716)	Option	Option	✓
Kistler RoaDyn 2000	Option	Option	✓
Kistler KiRoad	Option	Option	✓
Engine Testbed	Option	Option	✓
Velodyne Lidar	Option	Option	✓
GPS and IMU interfaces			
Dewesoft or third party GPS devices	✓	✓	✓
Dewesoft IMU devices	✓	✓	✓
Navion	✓	✓	✓
OxTS	Option	Option	✓
Gyro platform - GeneSys ADMA-CAN	Option	Option	✓
Gyro platform - GeneSys ADMA-Ethernet	Option	Option	✓
Gyro platform - MicroStrain MIP	Option	Option	✓
Aerospace interfaces			
PCM telemetry	Option	Option	✓
Chapter 7 decoding	Option	Option	✓
Chapter 10	Option	Option	✓
ARINC 429 and MIL-STD-1553 devices	Option	Option	✓
iNET	Option	Option	✓
Video cameras			
Direct X compatible cameras	✓	✓	✓
Dewesoft DS-CAM cameras	✓	✓	✓
GigE cameras	✓	✓	✓
FLIR thermovision cameras	Option	Option	✓
Optris infrared cameras	Option	Option	✓

	Professional	DSA	Enterprise
Photron high-speed cameras	Option	Option	✓
Industrial interfaces			
OPC UA server	Option	Option	✓
OPC UA client	Option	Option	✓
Siemens S7	Option	Option	✓
MODBUS TCP/IP (Client)	Option	Option	✓
MODBUS TCP/IP (Server)	Option	Option	✓
Serial communication	Option	Option	✓
Ethernet	Option	Option	✓
Data post-processing and analysis			
Standard math			
Formula editor	✓	✓	✓
Filters (IIR, FIR, FFT, CFC)	✓	✓	✓
Integration, derivation	✓	✓	✓
FFT analyzer (basic)	✓	✓	✓
Statistics (basic, array, classification)	✓	✓	✓
Reference curves	✓	✓	✓
Latch mathematics	✓	✓	✓
Interactive math cursors	✓	✓	✓
Counting (histogramming)	✓	✓	✓
Exact frequency extraction	✓	✓	✓
Advanced analysis			
Power analysis	Option	✓	✓
Motor analysis	Option	✓	✓
Basic combustion engine analysis	Option	✓	✓
Advanced combustion engine analysis	Option	✓	✓
Combustion noise	Option	Option	✓
Vehicle dynamics (VTS)	Option	Option	✓
Polygon for vehicle analysis	Option	Option	✓
Brake noise	Option	Option	✓
Brake test	Option	Option	✓

	Professional	DSA	Enterprise
FFT analyzer (advanced) - Advanced cursors - Advanced markers - Bearing fault	Option	Option	✓
Octave band analysis	✓	✓	✓
Order tracking	Option	✓	✓
Orbit analysis	Option	Option	✓
Rotational and torsional vibration	Option	✓	✓
Rotor balancer	Option	✓	✓
Human body vibration	Option	✓	✓
Modal test (FRF)	Option	✓	✓
Modal analysis	Option	Option	✓
SRS (offline only)	Option	✓	✓
Angle sensor math	✓	✓	✓
Envelope detection	✓	✓	✓
Sine processing	Option	Option	✓
Harmonic tracking filter	✓	✓	✓
Full spectrum (two-sided Fourier transform)	✓	✓	✓
Cepstrum	✓	✓	✓
Sound level meter	Option	✓	✓
Sound power	Option	✓	✓
Sound intensity	Option	✓	✓
Sound quality	Option	✓	✓
Reverberation Time RT60	Option	✓	✓
Fatigue analysis	Option	✓	✓
Psophometer	Option	✓	✓

	Professional	DSA	Enterprise
Visualization			
Meters (digital, analog, horizontal/vertical bar)	✓	✓	✓
Recorders (horizontal, vertical and XY recorder)	✓	✓	✓
Oscilloscope (scope, scope 3D, vector-scope)	✓	✓	✓
FFT (FFT, 3D FFT, Harmonic FFT and Octave)	✓	✓	✓
Graphs (2D, 3D graph, Octave, Orbit, Campbell plot, Contour plot)	✓	✓	✓
Video	✓	✓	✓
Control (button, switch, knob, slider, user input)	✓	✓	✓
Utilities (table, image, text, line, overload indicator, indicator lamp, note)	✓	✓	✓
Interactive GPS Map and 3D Model	✓	✓	✓
Attitude or artificial horizon indicator	✓	✓	✓
Data management			
Data export			
FlexPro	✓	✓	✓
FlexPro template	✓	✓	✓
Excel	✓	✓	✓
Excel template	✓	✓	✓
Dewesoft (file reduction)	✓	✓	✓
DIAdem	✓	✓	✓
Matlab	✓	✓	✓
Universal file format 58	✓	✓	✓
Famos	✓	✓	✓
NSoft	✓	✓	✓
Text/CSV	✓	✓	✓
Sony	✓	✓	✓
RPCIII	✓	✓	✓
Comtrade	✓	✓	✓
Technical data management	✓	✓	✓
JSON	✓	✓	✓
ASAM MDF4	✓	✓	✓
ASAM ODS	✓	✓	✓
S3	✓	✓	✓

	Professional	DSA	Enterprise
ATI	✓	✓	✓
HDF5	✓	✓	✓
DynaWorks neutral file	✓	✓	✓
Standard data file	✓	✓	✓
WFT	✓	✓	✓
Replay	✓	✓	✓
Wave	✓	✓	✓
Google earth KML	✓	✓	✓
Broadcast wave format	✓	✓	✓
CAN messages	✓	✓	✓
IFile CA	✓	✓	✓
Clipboard	✓	✓	✓
TAFFmat	✓	✓	✓
Winplot	✓	✓	✓
Data import			
Dewesoft data file merge (channel import)	✓	✓	✓
Text	✓	✓	✓
RT data (Logger)	✓	✓	✓
Data exchange			
Data management (FTP file transfer)	Option	Option	✓
Online data export to .csv/SQL/MySQL	Option	Option	✓
Online data writing to Excel	Option	Option	✓
Excel reporting tool (Excel add-in)	✓	✓	✓
Email/SMS alarm notifications	✓	✓	✓
Automation/Development tools			
Sequencer	✓	✓	✓
DCOM	✓	✓	✓
Data reader API	✓	✓	✓
EtherCAT ENI export	Option	Option	✓
C++ Script	Option	Option	✓
Third party extensions	✓	✓	✓

COMPACT FORM FACTOR

We build our equipment to last. We guarantee you that your hardware will be free from defects and functional. Our warranty covers that the instruments function as promised for a period of 7 years from the day of the delivery.

 DEWESoft®

7 YEAR WARRANTY



SYNCHRONIZED

SOFTWARE INCLUDED

NO HIDDEN COST

F L E X I B L E

ONE HARDWARE.

DAQ SYSTEMS

FLEXIBLE DAQs

Ready to be used for any measurement application, more at the same time.

ANY NUMBER OF CHANNELS

Our DAQ systems are modular by design. Expand to 1000's of channels.

PLUG AND PLAY

Our DAQ devices are plug and play. Technologies like smart sensors and TEDS offer automatic sensor detection and configuration.

FULLY SYNCHRONIZED

Data from various sources are aligned: Analog, digital, counter, digital data buses, video, etc.

P L U G A N D P L A Y

E X P A N D A B L E

TECHNOLOGY OVERVIEW

HIGH ISOLATION

SIRIUS instruments come with high galvanic channel-to-channel and channel-to-ground isolation (CAT II 1000 V with ranges up to 2000 V), and even include isolated sensor excitation.

Our high isolation means that you have no problem measuring high voltage potentials or common mode voltages. You are also safe with measurements like vibration, temperature, or any other measurement where non-isolated sensors are placed next to the high voltage potential against the DAQ system ground. In such cases, a non-isolated DAQ system would burn or at least give faulty results. With SIRIUS it is just one thing less to worry about.

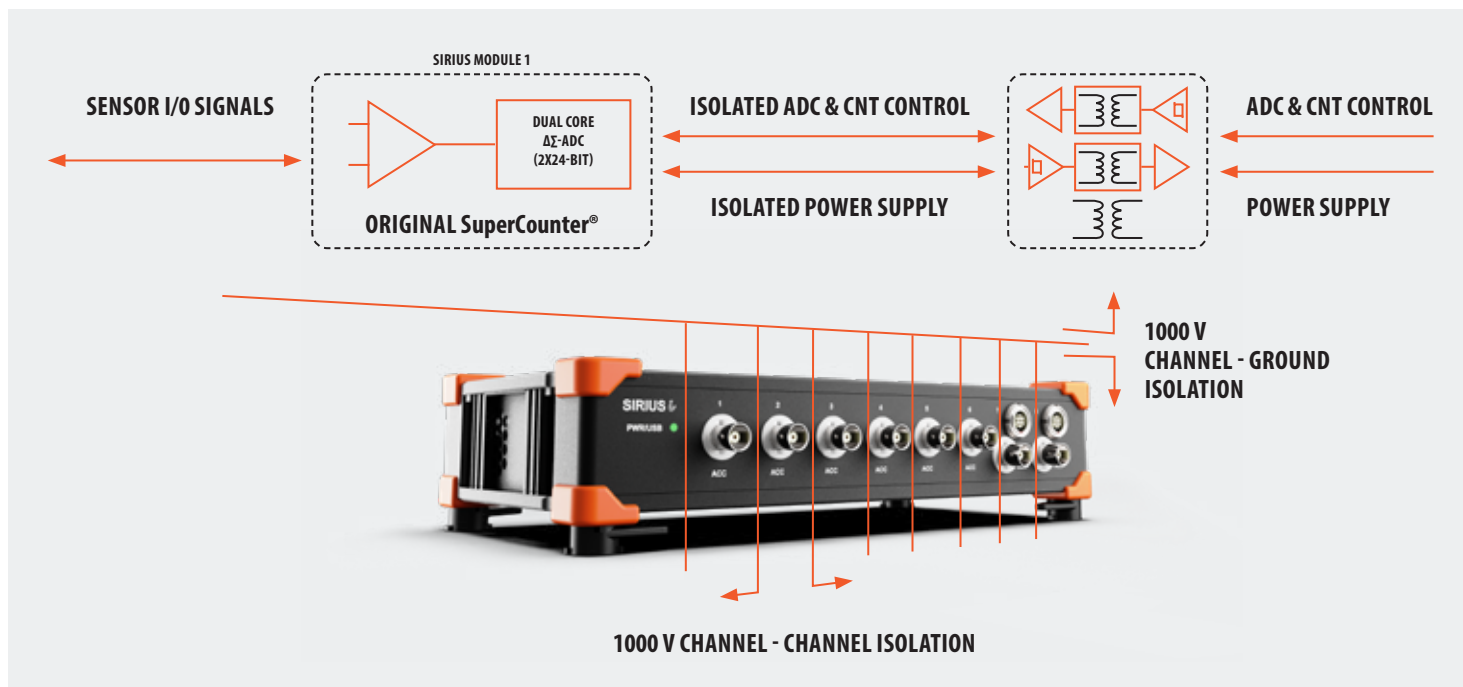

HIGH DYNAMIC RANGE (SIRIUS®)

The most common problems you face when recording data are signal overloads, noise, and false signals recorded into the data due to aliasing. When signal levels are higher than expected, they are clipped by the ADC, resulting in wrong measurements, which means you have to do the test all over again.

DualCoreADC® technology prevents these problems. Each channel amplifier has two ADC's that always measure the high and low gain of the input signal. This results in the full possible measuring range of the sensor and prevents the signal from being clipped.

With DualCoreADC® technology SIRIUS achieves more than 130 dB signal to noise ratio and more than 160 dB in dynamic range. This is 20 times better than 24-bit systems and 20 times less noise.

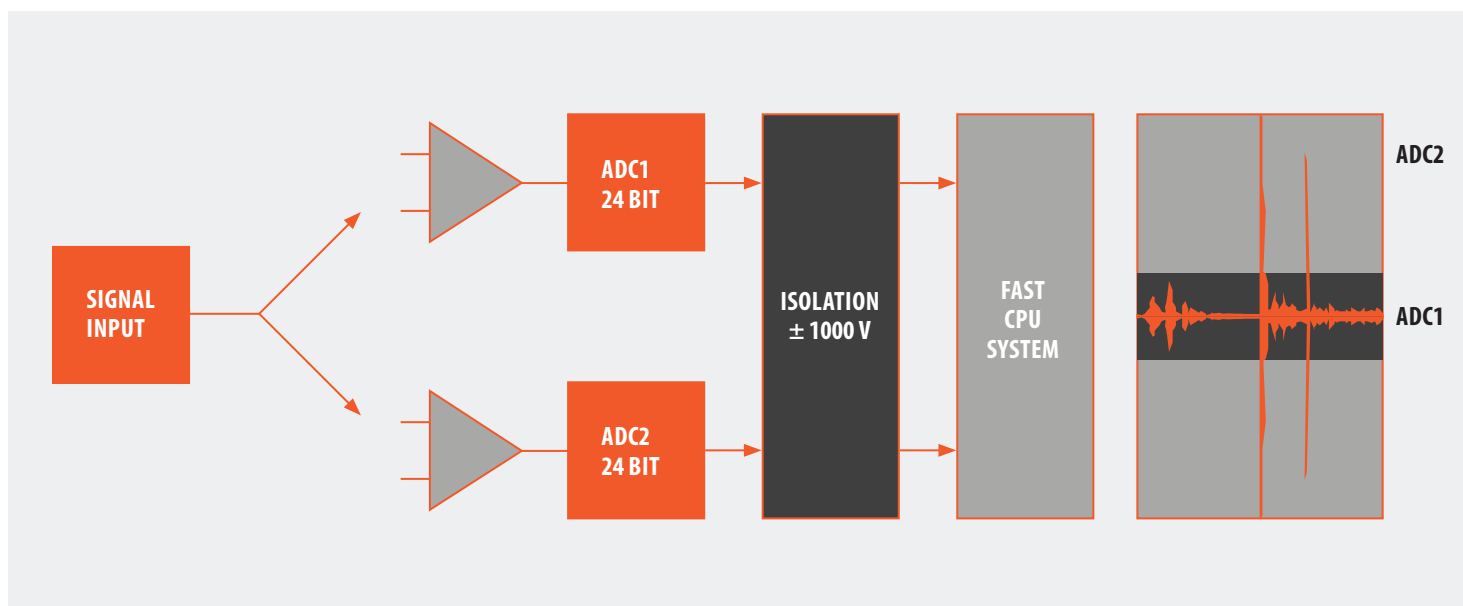

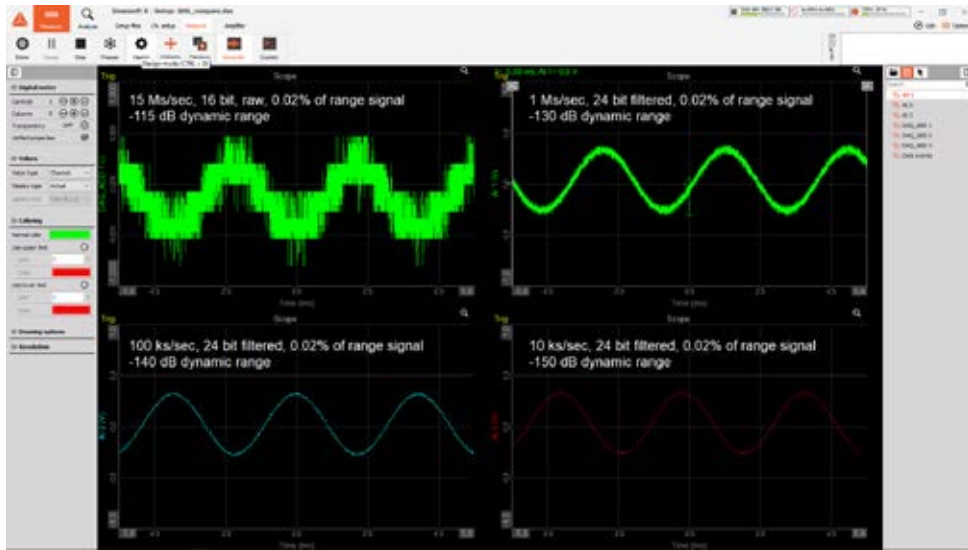

HYBRID ADC TECHNOLOGY

Offers everything you ever wanted out of a high-end data acquisition system. High bandwidth and high dynamic mode available in parallel, software selectable per channel.

High bandwidth mode: with 5 MHz bandwidth and 15 MS/s sampling rate, SIRIUS XHS can perfectly acquire impulse, step, and square signals without any ringing or overshoot. Such a mode is perfect for transient recording and power analysis. Such acquisition mode is typically found in SAR ADCs.

High dynamic alias-free mode: data can be acquired up to 150 dB dynamic range. Up to 2 MS/s alias-free filter with a bandwidth close to the Nyquist criteria is used for frequency domain analysis of the signal like sound and vibration. This behavior is similar to classical Sigma-Delta ADCs.

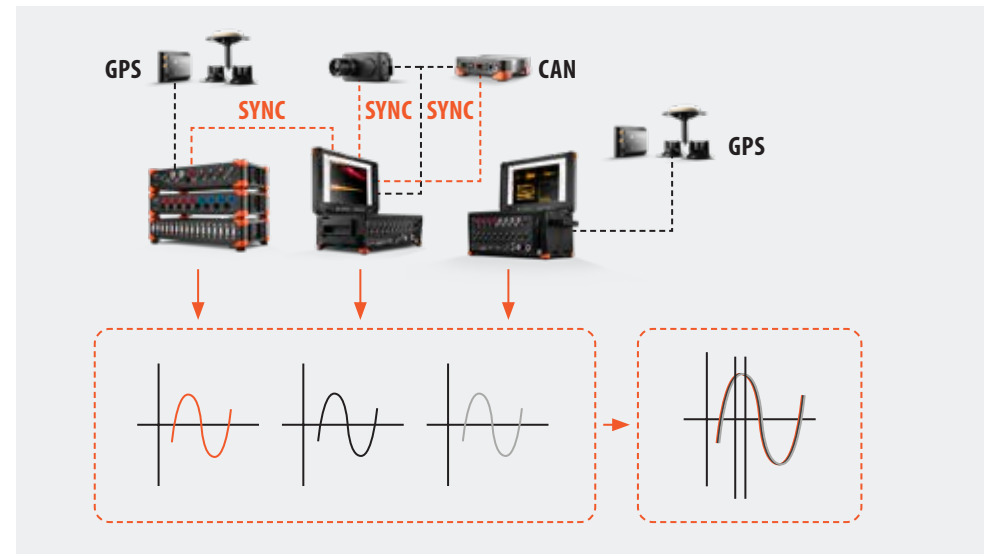

SYNCHRONIZATION

SIRIUS hardware is capable of reading different signals like voltage, strain, ICP/IEPE, charge, CAN, counter, encoder, and digital. Additionally, with the included DewesoftX software, you can easily acquire and combine data from additional interfaces like GPS, Flexray, Ethernet, Serial, PCM telemetry, and many more. Even though each data source have different sampling rates, all your data will be perfectly synchronized down to 50 nanoseconds accuracy. All this thanks to our timing and GPS synchronization technologies.

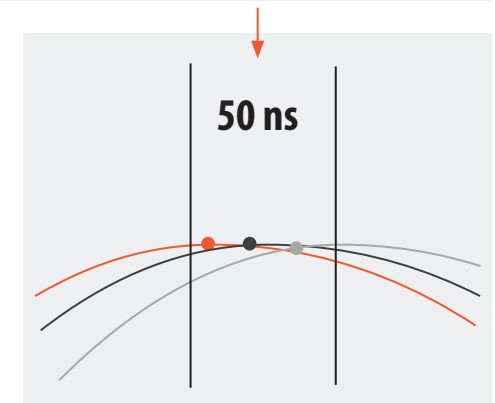

PRECISE COUNTER AND ENCODER MEASUREMENT

SIRIUS® uses a patented technology called SuperCounter® in all of its counter/encoder inputs. Counter inputs can measure RPM and angle when testing rotating machines. Standard counters only provide integer resolution (like 1, 1, 2, 2) and their data is one sample behind the data. However, SuperCounter® can extract floating point values like 1.37, 1.87, 2.37, and time-align them precisely with the

rest of your data. This is done by measuring the exact time of the rising edge of the signal with an additional counter. Our SuperCounter® work on a 102.4 MHz time base, independent from the current sampling rate.

Counter inputs are fully synchronized with analog, CAN bus, and other data sources to enable easy applications like balancing, order tracking, and torsional vibrations.

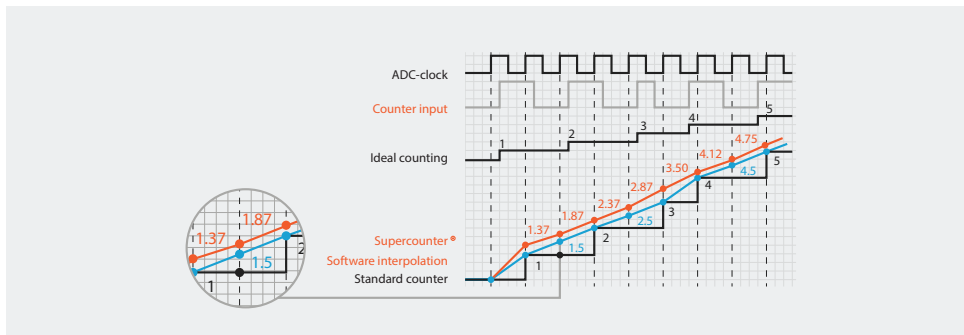

SIRIUS® HIGH-END DAQ SYSTEMS

SIRIUS® MODULAR

Most flexible and distributable single slices with USB and EtherCAT® interface.



SIRIUS® SBOX

Synchronized, highly reliable data logger and powerful data processing computer.



SIRIUS® R4/R4rt/R4-HUB

Integrated solution with 4 SIRIUS slices and powerful SBOX computer or USB hub in one unit with real-time EtherCAT® slave interface.



SIRIUS® XHS

High-speed data acquisition system (15 MS/s) with the new Hybrid ADC technology capable of high bandwidth transient recording and very high dynamic, alias-free data acquisition.



ANALOG OUTPUTS

SIRIUS slices can be configured with 8 analog outputs and function as a multi-channel function generator, can also do real-time signal conditioning, analog replay of data in analysis, and perform manual or automated control output with output voltage levels of up to +/- 10V.

HYBRID ADC TECHNOLOGY

Offers everything you ever wanted out of a high-end data acquisition system. High bandwidth and high dynamic mode available in parallel, software selectable per channel.

ISOLATED CAN BUS INTERFACE

High-speed CAN 2.0b channels with 1 Mbit/s data throughput with additional support for CCP, OBDII, J1939, and CAN output.

Our data acquisition systems are versatile, modular, easy to use and can work with any sensor with the highest precision imaginable. Input channel configurations are flexible and the input channel count can vary from 1 to 1000's of channels. Our measurement systems are flexible and can grow with you at any time in your measurement process.



SIRIUS® R8DB/R8rt

Integrated instrument with 8 SIRIUS slices, powerful SBOX computer, optional 19" display (R8D) and batteries (R8DB) and real-time EtherCAT® slave interface (R8rt).

SIRIUS® R1DB/R2DB

Small-size instrument with embedded computer, 12" display and batteries.

SIRIUS® R3

Up to 3 SIRIUS slices in a rack mounted lab unit with standard easy-to-upgrade computer.



HIGH ISOLATION

High channel-channel and channel-ground isolation prevents ground loops and damage to the system from excessive voltage.

DEWESOFT 7-YEAR WARRANTY

Our warranty covers that the instruments function as promised for a period of 7 years from the day of the delivery.

SENSOR POWER SUPPLY

Amplifiers provide channel-independent, programmable power supply for sensor excitation.

UNIVERSAL ANALOG INPUTS

A wide variety of universal and analog amplifiers that accept voltage and full/half/quarter bridge signals natively as well charge and IEPE accelerometers, thermocouple and RTD temperature sensors, current, resistance, and even LVDT sensors, with the use of DSI adapters.

DIGITAL/COUNTER/ENCODER INPUTS

Each counter channel is capable of 3x digital inputs, 1x event counter, encoder, period, pulse-width, duty-cycle, and precise frequency and angle measurement using patented SuperCounter® technology.

SIRIUS[®] XHS



HYBRID ADC TECHNOLOGY

Offers everything you ever wanted out of a high-end data acquisition system. High bandwidth and high dynamic mode available and software selectable per channel.

VARIETY OF AMPLIFIERS

High voltage amplifiers that can measure 2000 V peak directly. Low voltage amplifiers for connecting almost any current sensor. ACC amplifiers for connecting high-speed accelerometers and pressure sensors. The XHS range of amplifiers available will grow in the future and will also include charge and strain gauge amplifiers.

SMALLEST FORM FACTOR

With the standard SIRIUS sized chassis you can easily carry the SIRIUS XHS in your backpack along with your laptop for field measurements.

HIGH GALVANIC ISOLATION

High channel-to-channel and channel-to-ground isolation prevents damage to the systems from excessive voltage and avoids ground loops.

The future is here - and it is in the form of a single device. 15 MS/s sampling rate. 5 MHz Bandwidth. Up to 150 dB Dynamic Range. Meet our new Hybrid ADC data acquisition technology.

ALIAS FREE MODE

Up to 2 MS/s data can be acquired with an extremely high dynamic range, similar to our SIRIUS DualCoreADC devices. The data is totally alias-free, so all higher frequencies are fully rejected. Such an acquisition mode is typically found in Sigma-delta ADCs, and general data recording applications.

By today's standard, you would need two totally separate data acquisition devices for those measurements and applications. But the new SIRIUS XHS data acquisition system allows you to select per channel, depending on the measurement application, the appropriate mode of ADC operation.

XHS-PWR SIRIUS®



The SIRIUS XHS-PWR is a DAQ device designed for direct in-vehicle measurement of current, voltage, and power. It features an integrated patented DC-CT current transducer for very precise current measurements in the most demanding applications such as very high current peaks as well as leakage current measurement.

DC-CT CURRENT TRANSDUCER

DC-CT represents an innovative principle of isolated measurement of DC and AC currents. This compact-sized patented technology allows you to measure peak currents up to 2000 A and leakage currents - with high bandwidth and ultimate performance.

HIGH BANDWIDTH MODE

This mode offers more than **5 MHz** bandwidth and **15 MS/s** sampling rate, SIRIUS XHS can acquire impulse, step, and square signals without any ringing or overshoot. Such an acquisition mode is perfect for transient recording and power analysis, and would usually be found in SAR ADCs.

RUGGED

IP67 rated chassis operating between -20 °C and 70 °C withstanding tough shock and vibration conditions.

PERFECT SYNCHRONIZATION

Even though you can select some channels to be high bandwidth and some to be alias free, filtering is made in the way that all signals are perfectly time aligned with zero phase shift.

SIRIUS[®] MODULAR



UP TO 8 ISOLATED ANALOG CHANNELS OF SIRIUS DUAL-CORE, HIGH-SPEED OR EXTRA HIGH-SPEED.

UP TO 16 ANALOG CHANNELS WITH HD AMPLIFIERS.

SCALABLE

SIRIUS DAQ systems can grow with needs at any time - from a single channel to a system with thousands of channels.

FLEXIBLE

SIRIUS single slices provide you the most flexible configuration. Slice-based systems can be split or combined at any time, to handle different measurement tasks.

DISTRIBUTABLE

SIRIUS EtherCAT[®] slices can be located up to 100 meters (328 feet) apart from each other, using a single cable that carries data, sync, and power!

Versatile USB and EtherCAT[®] data acquisition systems. Any signal, any sensor - packed with cutting edge technology.

USB / ETHERCAT[®] / ETHERNET INTERFACE

You can connect SIRIUS DAQ systems via USB or EtherCAT[®] to any data acquisition computer, or to one of our high-performance data loggers. SIRIUS XHS offers also Ethernet interface including PTPv2 synchronization

MODULAR SIRIUS® SBOX



EtherCAT® INTERFACE

Built-in EtherCAT® interface port for synchronized data acquisition from Dewesoft EtherCAT® DAQ devices.

6 USB INTERFACES

SBOX includes four USB3.0 ports and two USB2.0 ports. All USB ports feature screw-lock connectors to prevent accidental disconnection.

Highly reliable SBOX data logger with powerful data processing computer. The perfect companion to your SIRIUS data acquisition system.

100 Hz GPS WITH RTK

An optional 10 Hz or 100 Hz GPS receiver with additional RTK support can be built straight into SBOX.

HIGHLY RELIABLE SSD STORAGE

SBOX provides highly reliable data recording with a typical 180 MB per second write speed to the internal fast SSD. This drive is removable so that you can swap and replace it quickly.

3 NETWORK INTERFACES

Two 2.5 Gb LAN ports and a wireless WLAN interface with external antenna ensure maximum connectivity.

HIGH-PERFORMANCE DATA PROCESSING COMPUTER

With an 8-thread Intel Core CPU and 8 GB of memory, SBOX is a powerhouse computer for worry-free, real-time data recording and processing.

SIRIUS® R4 BOXED

POWERFUL AND RELIABLE COMPUTER

R4 DAQ system offers a powerful built-in data processing computer and fast and reliable SSD data logging capabilities for a stand-alone operation or a USB hub for connecting R4 to an external computer.



DUAL MODE

The EtherCAT® slave interface provides real-time data to a 3rd party control system, while the internal bus allows full-speed data to be recorded via DewesoftX in parallel. For the first time, the worlds of data acquisition and control are merged into a single system!

HIGH-END SIGNAL CONDITIONING

R4 data acquisition systems are built around SIRIUS DAQ technology and feature the same versatile and powerful amplifiers for prime signal conditioning.

UP TO 64 ANALOG INPUTS

Systems can be configured with up to 4 SIRIUS DAQ slices for a total of 64 analog inputs for connecting virtually any sensor.

UP TO 4 ISOLATED CAN PORTS

Configure up to 4 high-speed CAN 2.0b channels with 1 Mbit/s data throughput and additional support for CCP, OBDII, J1939, and CAN output.

ALL INTERFACES

Interfaces for wireless LAN, dual GLAN, 4x USB 3.0, GPS, HDMI and 2x synchronization are available.

UP TO 32 COUNTER/ENCODER INPUTS

The system can be configured with up to 32 counter/encoder inputs, or 96 digital inputs - all equipped with our patented SuperCounter® technology.

Compact data acquisition system with up to 64 analog inputs, 32 counter inputs and 32 analog outputs, and a built-in high performance, highly reliable data processing computer and SSD data logger.

EtherCAT® MASTER PORT

R4 DAQ systems include an EtherCAT® master port with built-in synchronization, for easy connection to and extension of any of our EtherCAT® based DAQ systems - including KRYPTON DAQ modules or SIRIUS hardware.

100 Hz GPS WITH RTK

Optional 10 Hz or 100 Hz GPS receiver with additional RTK support can be built straight into the R4 DAQ system.

PORTABLE INSTRUMENT SIRIUS® R1DB/R2DB

ALL INTERFACES

Interfaces for wireless LAN, dual GLAN, 4x USB 3.0, GPS, HDMI, 2x synchronization are available.



EtherCAT® MASTER PORT

R1DB / R2DB DAQ systems include an EtherCAT® master port with built-in synchronization, for easy connection to and extension of any of our EtherCAT® based DAQ systems - including KRYPTON DAQ modules or SIRIUS hardware.

ALL-IN-ONE INSTRUMENT

R1DB/R2DB instruments are stand-alone DAQ systems with the built-in touchscreen LED display, keyboard, a powerful data processing computer, SSD data logging capabilities, and internal Li-Ion batteries (R1DB/R2DB). A version without batteries is also available (R2D).

HIGH-END SIGNAL CONDITIONING

R1DB/R2DB data acquisition systems are built on solid SIRIUS DAQ technology, and feature the same powerful, world-leading signal conditioning amplifiers. See the SIRIUS product page for more details.

Compact, mobile data acquisition system with a built-in data logger, powerful data processing computer, multi-touch display and internal batteries for maximum portability.

UP TO 16 COUNTER/ENCODER INPUTS

Up to 16 counter/encoders or 48 digital input channels, all equipped with our patented SuperCounter® technology.

100 Hz GPS WITH RTK

An optional 10 Hz or 100 Hz GPS receiver with additional RTK support can be built right into R1DB/R2DB DAQ system.

UP TO 32 ANALOG INPUTS

Systems can be configured with one (R1DB) or two (R2DB) SIRIUS DAQ slices for a total of 32 analog inputs capable of connecting virtually any sensor.

UP TO 2 ISOLATED CAN PORTS

Up to 2 high speed CAN 2.0b channels with 1 Mbit/s data throughput with additional support for CCP, OBDII, J1939, and CAN output.

SIRIUS[®] R8 PORTABLE INSTRUMENT

HIGH-END SIGNAL CONDITIONING

R8 data acquisition systems are built around SIRIUS DAQ technology and feature the same versatile and powerful amplifiers for world-leading signal conditioning.



UP TO 128 ANALOG INPUTS

Systems can be configured with up to eight SIRIUS DAQ slices for a total of 128 analog inputs for virtually any sensor.

ALL-IN-ONE INSTRUMENT

R8 instruments are high-channel-count, standalone DAQ systems with a built-in powerful data processing computer, SSD data logging capabilities, touch-screen LED display (R8D and R8DB), and internal Li-Ion batteries (R8B/R8DB) for maximum portability.

UP TO 8 ISOLATED CAN PORTS

Configure up to 8 high-speed CAN 2.0b channels with 1 Mbit/s data throughput with additional support for CCP, OBDII, J1939, and CAN output.

UP TO 64 COUNTER/ENCODER INPUTS

R8 DAQ system can be configured with up to 64 counter/encoder or 192 digital input channels, all equipped with our patented Super-Counter[®] technology.

UP TO 64 ANALOG OUTPUTS

R8/R8B can be configured with up to 64 analog outputs and can function as a multi-channel function generator, analog replay, or control device with the output voltage signal of +/- 10V.

High-channel-count data acquisition system with built-in data logger, a powerful data processing computer, touch screen display (R8D) and internal batteries (R8B, R8DB) for maximum portability.

EtherCAT[®] MASTER PORT

R8 DAQ systems include an EtherCAT[®] master port with built-in synchronization, for easy connection to and extension of any of our EtherCAT[®] based DAQ systems - including KRYPTON DAQ modules or SIRIUS hardware.

ALL INTERFACES

Interfaces for wireless LAN, dual 2.5 Gb LAN, 4x USB 3.0, GPS, HDMI, 2x synchronization are available.

100 Hz GPS WITH RTK

Optional 10 Hz or 100 Hz GPS receiver with additional RTK support can be built straight into R8 DAQ system.

RACK SYSTEM SIRIUS® R8RT



High-channel-count DAQ system with high-end signal conditioning, a powerful computer, data logger, and real-time data output capability to EtherCAT® real-time controller.

UP TO 128 ANALOG INPUTS

Systems can be configured with up to eight SIRIUS DAQ slices for a total of 128 analog inputs for virtually any sensor.

DUAL MODE

The EtherCAT® slave interface can be used to provide real-time data to a 3rd party control system, while the internal bus allows full-speed recording via DewesoftX software in parallel. Finally, the worlds of data acquisition and control have come together in one system!

DAQ AND CONTROL

The R8RT instrument is an upgrade of our R8 DAQ system. It uses the same DAQ technology, and provides the same data logging and data processing capabilities as the R8. However, the R8RT includes an additional EtherCAT® slave port that can send your real-time data to any 3rd party EtherCAT® master controller.

SIRIUS[®] R3 19" RACK SYSTEM



FULLY SYNCHRONIZED

Every single channel - analog, digital, and CAN - is synchronized with microsecond accuracy.

19" RACK MOUNTABLE

The included PC chassis can be mounted in any 19" rack cabinet.

HIGH-END SIGNAL CONDITIONING

The R3 data acquisition system is built upon SIRIUS DAQ technology, and features the same powerful world-class signal conditioning amplifiers. Check out the SIRIUS product page for more details.

UP TO 3 ISOLATED CAN PORTS

Up to 3 high-speed CAN 2.0b channels with 1 Mbit/s data throughput, with additional support for CCP, OBDII, J1939, and CAN output.

DIGITAL/COUNTER/ENCODER INPUTS

Each channel is capable of 3x digital inputs, 1x event counter, encoder, period, pulse-width, duty-cycle. Precise frequency and angle measurement uses patented SuperCounter[®] technology.

Rack mountable DAQ system built into standard PC computer chassis and integrated SIRIUS data acquisition slices. Ready for simple and inexpensive upgrade of PC components.

HIGH PERFORMANCE COMPUTER

The PC computer inside is built with standard, off-the-shelf computer components, allowing for easy upgrades of drive, memory, CPU, and other components.

UP TO 48 ANALOG INPUTS

Systems can be configured with up to eight SIRIUS DAQ slices for a total of 48 analog inputs for virtually any sensor.

UP TO 24 COUNTER/ENCODER INPUTS

Up to 24 counter/encoder or 72 digital input channels, all equipped with our patented SuperCounter[®] technology.

COMPACT SYSTEM SOLUTION SIRIUS[®] MINI



UNMATCHED PRICE

SIRIUS MINI ships off-the-shelf with high-quality signal conditioning, award-winning data acquisition software for the best price on the market.

USB POWERED

SIRIUS MINI does not require any external power supply. It can be powered straight from the USB connection, for example, through a laptop.

Small and highly portable, USB powered data acquisition system ideal for acoustic, vibration, and rotating machinery analysis.

SMALLEST DAQ

SIRIUS MINI is our smallest, 4-channel data acquisition system. Fits almost anywhere, suitable for acoustic, vibration, and angle measurements.

COUNTER/ENCODER/DIGITAL INPUTS

The system includes one counter/encoder input which can be used as 3x digital inputs, 1x event counter, encoder, period, pulse-width, duty-cycle. Precise frequency and angle measurement use patented SuperCounter[®] technology.

4 IEPE/VOLTAGE INPUTS

The system includes four high-dynamic analog inputs, dual sigma-delta ADCs with 200 kS/s/ch sample rate, and up to 160 dB dynamic range.



HIGH-DYNAMIC - DualCoreADC® SIRIUS®

Our DualCoreADC® technology boosts dual 24-bit delta-sigma ADC's with an anti-aliasing filter on each channel, achieving an astonishing 160 dB of dynamic range in the time and frequency domains, with up to 200 kS/s/ch sampling rate per channel. Up to 8 channels per SIRIUS module.

Counter input: Most amplifiers can be also ordered with additional counter input featuring event counting, waveform timing, angle, encoder and speed measurements. Each counter has 3 digital inputs and 1 digital output.

	HIGH-DYNAMIC - DualCoreADC® SIRIUS®								
	UNI	STG	STGM	MULTI	ACC	MIC200	CHG	HV	LV
Connectors	DSUB-9, L2B10f	DSUB-9, L2B7f, L2B10f	DSUB-9, L2B7f, L2B10f	DSUB-15, L2B16f	BNC, TNC	L1B7f	BNC, TNC	BANANA	DSUB-9, BNC, BANANA
Counter version	✓	✓	✓	✓	✓	X	✓	X	✓
Channels per slice	8	8	8	8	8	8	8	8	8
Data rate / channel	200 kS/s USB, 20 kS/s EtherCAT	200 kS/s USB, 20 kS/s EtherCAT	200 kS/s USB, 20 kS/s EtherCAT	200 kS/s USB, 20 kS/s EtherCAT	200 kS/s USB, 20 kS/s EtherCAT	200 kS/s USB, 20 kS/s EtherCAT	200 kS/s USB, 20 kS/s EtherCAT	200 kS/s USB, 20 kS/s EtherCAT	200 kS/s USB, 20 kS/s EtherCAT
Resolution	24-bit DualCoreADC	24-bit DualCore-ADC	24-bit DualCore-ADC	24-bit DualCore-ADC	24-bit DualCore-ADC	24-bit DualCoreADC	24-bit DualCore-ADC	24-bit DualCore-ADC	24-bit DualCoreADC
Bandwidth	70 kHz	70 kHz	70 kHz	70 kHz	70 kHz	70 kHz	70 kHz	70 kHz	70 kHz
Voltage ranges	±100 V, ±10 V, ±1 V, ±100 mV, ±10 mV	±50 V, ±10 V, ±1 V, ±100 mV	±10 V, ±1 V, ±100 mV, ±10 mV	±10 V, ±1 V, ±100 mV, ±50 mV	±10 V, ±500 mV	±10 V, ±500 mV	±10 V, ±500 mV	±1200 V, ±50 V	±200 V, ±10 V, ±1 V, ±100 mV
Input coupling	DC, AC 0.3 Hz / 0.16 Hz (1, 3, 5, 10, 20 Hz SW)	DC, AC 1 Hz (3, 10 Hz SW)	DC	DC	DC, AC 0.1 Hz, 1 Hz	AC 0.35 Hz (3, 10 Hz SW)	DC, AC 0.1 Hz, 1 Hz, 10 Hz, 100 Hz	DC	DC, AC 1 Hz (3, 10 Hz SW)
Sensor excitation	0..20 V max. 0.8 W, 0..60 mA max 0.5 W, IEPE 2..20 mA	0..20 V max. 0.8 W, 0..60 mA max 0.5 W	0..15 V max. 44 mA	0..12 V max. 44 mA	IEPE 2, 4, 8, 12, 16, 20 mA	14 V bipolar, 200 V polarization	IEPE 4, 8, 12 mA	X	2..30 V bipolar, 0..24 V unipolar, max. 0.2 A / 2 W
Bridge connection	Full, ½, ¼ 350 Ω, ¼ 120 Ω 3, 4 wire	Full, ½, ¼ 350 Ω, ¼ 120 Ω 3, 4 wire	Full, ½, ¼ 350 Ω, ¼ 120 Ω 3 wire	Full, ½, ¼ 350 Ω, ¼ 120 Ω 3 wire	X	X	X	X	Full
Programmable shunt	59.88 kΩ, 175 kΩ bipolar	59.88 kΩ, 175 kΩ bipolar	100 kΩ bipolar	59.88 kΩ	X	X	X	X	X
IEPE input	✓	DSI-ACC	DSI-ACC	DSI-ACC	✓	X	✓	X	DSI-ACC
Resistance	✓	✓	X	X	X	X	X	X	X
Temperature (PTx)	✓	✓	DSI-RTD	DSI-RTD	X	X	X	X	DSI-RTD
Thermocouple	DSI-TH	DSI-TH	DSI-TH	DSI-TH	X	X	X	X	DSI-TH
Current	ext. shunt, DSI	ext. shunt, DSI	ext. shunt, DSI	ext. shunt, DSI	ext. shunt	ext. shunt	ext. shunt	X	ext. shunt, DSI
Potentiometer	✓	✓	✓	✓	X	X	X	X	X
LVDT	DSI-LVDT	DSI-LVDT	DSI-LVDT	DSI-LVDT	X	X	X	X	DSI-LVDT
Charge	DSI-CHG	DSI-CHG	DSI-CHG	DSI-CHG	X	X	100 k, 10 k pC	X	DSI-CHG
TEDS	✓	✓	✓	✓	✓	✓	✓	X	✓
Isolation voltage	1000 V	1000 V	1000 V	1000 V	1000 V	1000 V	1000 V	CAT II 1000 V	1000 V
Power consumption per channel	2 W/ch	2 W/ch	1.3 W/ch	1.3 W/ch	1 W/ch	1.1 W/ch	1.2 W/ch	1 W/ch	1.2 W/ch
Advanced functions	Supports all strain types, IEPE sensors and high input range	Supports all strain types and high input range	Low power, sensor and amplifier balance, bipolar shunt	Analog Output, Low power, sensor and amplifier balance	Sensor error detection, high dynamic range	Supports polarized condenser microphones	Sensor error detection in IEPE and CHG mode (injection)	High voltage, high isolation	High sensor power and multi range

HIGH-DENSITY HD SIRIUS®

High-density SIRIUS module with up to 16 channels per SIRIUS slice is the perfect choice for high channel count applications.

HIGH-SPEED HS SIRIUS®

1 MHz 16 bit SAR technology with software selectable alias-free filtering is the perfect choice for transient recording. Up to 8 channels per SIRIUS module.

	HIGH-DENSITY HD SIRIUS®			HIGH-SPEED HS SIRIUS®				
	HD-STGS	HD-LV	HD-ACC	HS-HV	HS-LV	HS-ACC	HS-CHG	HS-STG
Connectors	DSUB-9, L1B10f	DSUB-9, BNC	BNC	BANANA	DSUB-9, BNC, BANANA	BNC	BNC, TNC	DSUB-9
Counter version	X	X	X	✓	✓	✓	✓	✓
Isolated version	✓	✓	✓	✓	✓	✓	✓	✓
Differential version	✓	✓	✓	✓	✓	✓	✓	✓
EtherCAT version	✓	✓	✓	✓	✓	✓	✓	✓
Rack version	✓	✓	✓	✓	✓	✓	✓	✓
Fanless version	X	X	X	✓	✓ (see 1)	X	X	X
Channels per slice	16	16	16	8	8	8	8	8
Data rate / channel	200 kS/s USB, 10 kS/s EtherCAT	200 kS/s USB, 10 kS/s EtherCAT	200 kS/s USB, 10 kS/s EtherCAT	1 MS/s	1 MS/s	1 MS/s	1 MS/s	1 MS/s
Resolution	24-bit	24-bit	24-bit	16-bit	16-bit	16-bit	16-bit	16-bit
Bandwidth	70 kHz	71 kHz	72 kHz	2 MHz	1 MHz	500 kHz	500 kHz	1 MHz
Voltage ranges	±10 V, ±1 V, ±100 mV, ±10 mV	±100 V, ±10 V, ±1 V, ±100 mV	±10 V, ±5 V, ±1 V, ±200 mV	±2000 V ... ±20 V	±100 V ... ±50 mV	±10 V ... ±200 mV	±10 V ... ±100 mV	±50 V ... ±20 mV
Input coupling	DC	DC	DC, AC 0.1 Hz, 1 Hz	DC	DC, AC 1 Hz (3, 10 Hz SW)	DC, AC 1 Hz (3, 10 Hz SW)	DC, AC 0.1 Hz, 1 Hz, 10 Hz, 100 Hz	DC, AC 1 Hz (3, 10 Hz SW)
Sensor excitation	0..12 V max. 44 mA	2...30 V bipolar, 0...24 unipolar, max. 0.2 A / 2 W	IEPE 4,8,12 mA	X	2...30 V bipolar, 0...24 V unipolar, max. 0.2 A / 2 W	IEPE 4 mA, 8 mA	IEPE 4, 8, 12 mA	0...20 V max. 0.8 W, 0..60 mA max 0.5 W
Bridge connection	Full, ½, ¼ 350 Ω, ¼ 120 Ω 3-wire	Full	X	X	Full	X	X	Full, ½, ¼ 350 Ω, ¼ 120 Ω, 3 or 4 wire
Programmable shunt	100 kΩ	X	X	X	X	X	X	59.88 kΩ, 175 kΩ bipolar
IEPE input	DSI-ACC	DSI-ACC	✓	X	DSI-ACC	✓	✓	DSI-ACC
Resistance	X	X	X	X	X	X	X	✓
Temperature (PTx)	DSI-RTD	DSI-RTD	X	X	DSI-RTD	X	X	✓
Thermocouple	DSI-TH	DSI-TH	X	X	DSI-TH	X	X	DSI-TH
Potentiometer	✓	X	X	X	X	X	X	✓
LVDT	DSI-LVDT	DSI-LVDT	X	X	DSI-LVDT	X	X	DSI-LVDT
Charge	DSI-CHG	DSI-CHG	X	X	DSI-CHG	X	1 k ...100 k pC	DSI-CHG
Current	"ext. shunt, DSI"	"ext. shunt, DSI"	ext. shunt	X	ext. shunt, DSI	ext. shunt	ext. shunt	ext. shunt, DSI
TEDS	✓	✓	✓	X	✓	✓	✓	✓
Isolation voltage	500 V in pairs	500 V in pairs	500 V in pairs	CAT II 1000 V	1000 V	1000 V	1000 V	1000 V
Power consumption per channel	1.3 W/pair	1.3 W/pair	1.3 W/pair	1 W/ch	1.2 W/ch	2 W/ch	1.2 W/ch	2 W/ch
Advanced functions	Low power, sensor and amplifier balance	High sensor power and multi range	Sensor error detection	High voltage, high bandwidth, high isolation	High sensor power and multi range	Sensor error detection, high speed	Sensor error detection in IEPE and CHG mode (injection)	High speed, supports all strain types and high input range

(1) Fanless operation only for BNC or Banana version (without excitation)

SIRIUS[®] XHS AMPLIFIERS

EXTRA-HIGH-SPEED XHS SIRIUS[®]

SIRIUS XHS is a high-speed data acquisition system (15 MS/s) with the new Hybrid ADC technology capable of high-bandwidth transient recording and very high-dynamic, alias-free data acquisition.

	EXTRA-HIGH-SPEED XHS SIRIUS [®]		
	XHS-HV	XHS-LV	XHS-ACC
Connectors	BANANA	DB9, BNC	BNC
Channels per slice	8		
Data rate / channel	15 MS/s		
Resolution	16-bit (24-bit @ 1 MS/s)		
Bandwidth	5 MHz		
Voltage ranges	±2000 V ... ±200 V	±100 V ... ±50 mV	±10 V ... ±200 mV
Input coupling	DC	DC, AC 1 Hz	DC, AC 0.1 Hz, AC 1 Hz
Sensor excitation	-	2.5...30 V bipolar, 2...24 V unipolar, max. 0.2 A / 2 W	IEPE 2 mA, 4 mA, 8 mA, 12 mA, 16 mA, 20 mA
Bridge connection	-	Full	-
Programmable shunt	-	-	-
IEPE input	-	DSI-ACC	✓
Resistance	-	-	-
Temperature (PTx)	-	DSI-RTD	-
Thermocouple	-	DSI-TH	-
Potentiometer	-	-	-
LVDT	-	DSI-LVDT	-
Charge	-	DSI-CHG	-
Current	-	ext. shunt DSI20mA, DSI15A	ext. shunt
TEDS	-	✓	✓
Isolation voltage	CATII 1000 V	1000 V	1000 V
Power consumption per channel	1 W/ch	1.2 W/ch	-
Advanced functions	High voltage, high bandwidth, high isolation	High sensor excitation and multi range	Sensor error detection, high speed

EXTRA-HIGH-SPEED XHS-PWR SIRIUS[®]

SIRIUS-XHS-PWR is a DAQ device designed for direct in-vehicle measurement of current, voltage, and power with up to 15 MS/s sampling rate.

EXTRA-HIGH-SPEED XHS-PWR SIRIUS [®]	
SIRIUSi-XHS-PWR specifications	SIRIUSi-XHS-PWR-1xHV-1xDC-CT-1000A-UNI
Input types	Voltage, Current (single phase)
ADC Type	Hybrid ADC - alias free up to 2 MS/s, 16-bit up to 15 MS/s
Sampling Rate	Simultaneous 15 MS/s
Filtering	AAF 1 MHz (6th order)
Voltage Mode	±2000 V, ±1000 V, ±400 V, ±200 V
Analog bandwidth (-3 dB)	5 MHz
Working voltage (continuous)	1000 VDC or 1000 VAC
Measuring voltage (max.)	±2000 V (see 1)
Input Accuracy DC	±0.03 % of reading ±0.02 % of range
Input Coupling	DC
Input Impedance	10 MΩ 1 pF
Current Mode	±2000 A, ±1000 A, ±400 A, ±200 A
Analogue bandwidth (-3 dB)	> 500 kHz
Working current (continuous)	±1000 ADC
Measuring current	±2000 ADC
Maximum withstand peak current	min. -1700 A, max. 2000 A (see 2)
Primary / Secondary Ratio	1 : 1680
Input Accuracy (I _p @ 10 Arms)	±0.1 % of reading ±50 ppm of range ±0.05 A
HV harness	120 mm2 95 mm2 70 mm2 50 mm2 35 mm2
Rated DC current	344 A 292 A 245 A 198 A 158 A
Cable gland	M32 M32 M32 M25 M25
General specifications	
Power	
Power Supply	9 - 48 V DC (see 3), PWR + DATA + SYNC (Lemo 1T 8-pin)
Power consumption	Typ. 13 W (Max. 23 W)
Environmental	
Operating Temperature	-20 °C to 70 °C
IP rating	IP67
Interfaces	
Ethernet	GbE (XCP, OPC UA) incl. IEEE1588v2 synchronization (PTP) (LEMO 1T 8-pin)
CAN	CAN 2.0 (DSUB-9)
Additional Specifications	
Grounding	M6 insert
Dimensions	245 x 151 x 63 mm
Weight (incl. cables and connectors)	4.4 kg (max. 7 kg)

HybridADC SIRIUS® XHS

SIRIUS® XHS HAS TWO WAYS OF TRANSMITTING DATA TO THE PC:

Ethernet interface (GLAN)

is intended for distributed data acquisition

USB 3.0 (type C connector)

is intended for very high-speed transmission.

The system is acquiring the data with a very low CPU load. We are using DMA transfer on the system level to reduce loads. In today's world of open tool chain and intercommunication, devices should be compliant with standard protocols. SIRIUS XHS can serve acquired data via these standard protocols - all in parallel.

ALIAS FREE MODE

Up to **2 MS/s** data can be acquired with an extremely high dynamic range, similar to our dual **24-bit SIRIUS DualCoreADC** devices. The data is alias-free, so all higher frequencies are fully rejected. Such a mode is perfect for sound, vibration, and general data recording applications. such an acquisition mode is typically found in Sigma-delta ADCs.

By today's standard, you would need two totally separate data acquisition devices for the mentioned measurements and applications. But the new SIRIUS XHS data acquisition system allows you to select per channel, depending on the measurement application, the appropriate mode of ADC operation. Both modes are available also in parallel acquiring two channels at different rates per one input slot.

HybridADC TECHNOLOGY

Offers everything you ever wanted out of a high-end data acquisition system. High bandwidth and high dynamic mode available in parallel, software selectable per channel.

HIGH BANDWIDTH MODE

This mode offers more than 5 MHz bandwidth and 15 MS/s sampling rate, SIRIUS XHS can perfectly acquire impulse, step, and square signals without any ringing or overshoot. Such an acquisition mode is perfect for transient recording and power analysis and would usually be found in SAR ADCs.



USB 3.0 (type C) or Ethernet (1 GB GLAN)



Data via XCP to:
ECU calibration software like ETAS INCA or Vector CANape

XCP starting with version 1.4, XCP became a very powerful interface protocol in the automotive industry for data exchange. In the modern age of e-mobility, the required sampling rates are much higher than ever and 1 GBIT XCP interface allows for data transfers up to 1 MS/s.



Data via OPC UA to:
DewesoftX
Time-series DB, Cloud, SCADA

OPC UA is the industry standard. Actually, it is more than a standard, it is a perfect framework where the device can be described and set up in any system, including SCADA, MES, ERP, mobile devices, and others.

in parallel



EVERY APPLICATION

EtherCAT®

DAQ SOFTWARE INCLUDED

We build our equipment to last. We guarantee you that your hardware will be free from defects and functional. Our warranty covers that the instruments function as promised for a period of 7 years from the day of the delivery.

DEWESoft®

YEAR WARRANTY

BUILT TO LAST



HIGH QUALITY DAQ DEVICE

REAL TIME CONTROL

PERFECT SIGNAL CONDITIONING

EXPANDABLE

ONE HARDWARE.

DAQ AND CONTROL SYSTEMS

CAPACITY & COMPATIBILITY

Our devices are capable of storing hundreds of analog and digital channels at full speed while allowing parallel data to be sent out in real-time to any 3rd party EtherCAT® master controller.

RUGGED AND BUILT TO LAST

Made on our own CNC machines, designed by our mechanical engineers. Proven tough.

SOFTWARE INCLUDED WITH FREE LIFETIME UPGRADE

Award winning DewesoftX software is included with every instrument. All upgrades to the software are free forever with no hidden licensing costs.

DUAL MODE

DATA ACQUISITION AND CONTROL DEVICES

OBSIDIAN® R8

Embedded data acquisition system based on a low power ARM processor with Linux-based open architecture. OBSIDIAN device can act as a standalone data logger, real-time control system, and signal conditioning front-end - all at the same time.



REMOTE OVERVIEW

Simple indicating system (LED light) or usage of the advanced mobile application provides an easy overview of health and status of the device.

STAND-ALONE DATA RECORDER

OBSIDIAN can autonomously store analog, digital and positional data from virtually any object for months on either internal storage, removable SDHC card with up to TB capacity or USB-C external disc.

IOLITE® R8/R8r

SIRIUS form chassis with up to eight slots, dual EtherCAT® interface and redundant power supply - also available in rugged chassis.



IOLITE® R12

19" rack version with up to twelve slots, dual EtherCAT® interface and redundant power supply.



REDUNDANT POWER SUPPLY

Together with dual EtherCAT® interface provides maximum system reliability.

GREAT SIGNAL CONDITIONING

High-quality IOLITE amplifiers compatible with IOLITE or OBSIDIAN device, offer great signal quality and up to 20 kHz sampling rate.

DUAL EtherCAT®

IOLITE and OBSIDIAN devices use two EtherCAT® buses in parallel. The EtherCAT® primary bus is used for full speed buffered data acquisition to a computer. The EtherCAT® secondary bus is mainly used for real-time data to any 3rd party control system.

Our data acquisition devices are capable of storing hundreds of analog and digital channels at full speed while allowing parallel data to be sent out in real-time to any 3rd party EtherCAT® master controller. We have brought the worlds of data acquisition and real-time control closer together - this will save you time and money in a big way.

IOLITE®

Standalone, distributed, and cost-effective data acquisition device with high-end signal conditioning for monitoring and industrial applications.

IOLITE®

Distributed, cost-effective single channel data acquisition device with high-end signal conditioning.

**SIRIUS® R8DB/R8rt**

Integrated instrument with up to 8 SIRIUS slices, powerful SBOX computer, optional 19" display (R8D) and batteries (R8DB) and real-time EtherCAT® slave interface (R8rt).

**GREAT PRICE/PERFORMANCE**

IOLITE and OBSIDIAN offer great price/performance ratio and is suitable for test-bed and industrial applications.

**DEWESOFT
7-YEAR WARRANTY**

Our warranty covers that the instruments function as promised for a period of 7 years from the day of the delivery.

**WIDE OPERATING
TEMPERATURE RANGE**

While IOLITE and OBSIDIAN DAQ systems are labelled to run at -10°C.. 50°C, certain configurations can operate in the -40°C .. +85°C temperature range.

MULTIPLE CHASSIS OPTION

IOLITE can be configured in the 19-inch cabinet compatible chassis or in more rugged SIRIUS-like compatible chassis (SIRIUS R8rt, SIRIUS R4rt, SIRIUS R2rt).

DUAL MODE

The EtherCAT® slave interface can be used to provide real-time data to a 3rd party control system, while the internal bus allows full-speed recording via DewesoftX software in parallel. Finally, the worlds of data acquisition and control have come together in one system!

IOLITE® AMPLIFIER SPECS

	6xSTG	8xSTGS	8xLV	8xLVe	16xLV	8xLA	8xACC
Connectors	DSUB-9	Terminal block, DSUB-37	BNC, Terminal block	Terminal block, DSUB-37	Terminal block	BNC, Terminal block	BNC
Channels per module	6x	8x	8x	8x	16x	8x	8x
Data rate per channel IOLITE	20 kS/s	20 kS/s	20 kS/s	20 kS/s	20 kS/s	20 kS/s	40 kS/s
Data rate per channel OBSIDIAN	20 kS/s	20 kS/s	20 kS/s	20 kS/s	10 kS/s	20 kS/s	20 kS/s
Resolution	24-bit	24-bit	24-bit	24-bit	24-bit	24-bit	24-bit
Bandwidth	0.49*fs	0.433*fs	0.49*fs	0.433*fs	0.433*fs	0.49*fs	0.433*fs
Voltage ranges	±50 V, ±10 V, ±1 V, ±100 mV	±1 V, ±100 mV, ±20 mV	±100 V, ±10 V (±10 V, ±1 V on request)	±100 V, ±5 V	±200 V, ±10 V	X	±10 V, ±5 V, ±1 V, ±200 mV
Input coupling	DC, AC 1 Hz	DC	DC	DC	DC	DC	DC, AC 1 Hz, AC 0.1 Hz
Sensor excitation	0..24 V (unipolar), 0..12 V (bipolar), 0..44 mA (current), max. 0.55 W/ch	1 V, 2 V, 5 V		0..24V (unipolar)			2 mA, 4mA, 6 mA
Bridge connection	Full, ½, ¼ 350 Ω, ¼ 120 Ω 3-wire	Full, ½, ¼ 350 Ω, ¼ 120 Ω 3-wire					
Programmable shunt	100 kΩ	100 kΩ					
IEPE input	DSI-ACC						
Resistance	✓						
Temperature (PTx)	DSI-RTD						
Thermocouple	DSI-TH						
Current	20 mA (internal shunt), DSI-5A, DSli-10A, DSli-20A					±20 mA, ±2 mA	
Potentiometer	✓	✓		✓			
LVDT	DSI-LVDT						
Charge	DSI-CHG						
TEDS	✓	✓ (except DB37)		✓			✓
Isolation voltage	Differential	Differential	450 V	250 V	250 V	450 V	250V
Isolation arrangement	None	Isolated common GND	Ch-Ch & Ch-GND	Ch-GND	Isolated common GND	Ch-Ch & Ch-GND	Ch-GND
Power consumption per module	Typ. 5.4 W, Max. 11.1 W	Typ. 2.7 W, Max. 5.1 W	Typ. 2.4 W, Max. 3.5 W	Typ. 3.3 W, Max. 4.2 W	Typ. 3.4 W, Max. 4.2 W	Typ. 2.4 W, Max. 3.5 W	Typ. 4.5 W, Max. 6 W
Advanced functions	Supports all strain types, high input range	Supports all strain types, low power consumption	High isolation, high input range	High isolation, high input range	High isolation, high input range	High isolation, high input range	IEPE, supports TEDS, high channel density

¹ Not supported on the OBSIDIAN

AMPLIFIER SPECS IOLITE®

8xTH	8xTH-HS	8xRTD	8xRTD-HS	32xDI	32xDO ¹	8xDI-4xDO ¹	4xCNT	16xAO
MINI TC	MINI TC	L0B6f, Terminal block	L0B6f, Terminal block	Terminal block	Terminal block	Terminal block	L1B7f	Terminal block
8x	8x	8x	8x	32x	32x	8x digital in, 4x digital out	4x	16x
100 S/s	100 S/s, upgradable to 10 kS/s	100 S/s	100 S/s, upgradable to 10 kS/s	20 kS/s			20 kS/s	20 kS/s
100 S/s	100 S/s	100 S/s	100 S/s,	10 kS/s	not supported	not supported	20 kS/s	20 kS/s
24-bit	24-bit	24-bit	24-bit	digital	digital	digital	100 MHz timebase 5 ppm, 20 ppm max	16-bit
X	0.49*fs (max. 1 kHz)		0.49*fs (max. 1 kHz)				10 MHz	
±1 V, ±100 mV	±1 V, ±100 mV	±1 V, ±100 mV	±1 V, ±100 mV		open collector		TTL (Low: <0.8 V, High > 2 V)	±10 V
DC	DC	DC	DC					
		244 uA / 440 uA	150 uA / 400 uA				5 V, 12 V	
		1 kΩ, 10 kΩ	1 kΩ, 10 kΩ					
		PT100, 200, 500, 1000, 2000	PT100, 200, 500, 1000, 2000					
K, J, T, R, S, N, E, C, B	K, J, T, R, S, N, E, C, B							
1000 V	1000 V	1000 V	1000 V	1000 V	1000 V	1000 V		
Ch-Ch & Ch-GND	Ch-Ch & Ch-GND	Ch-Ch & Ch-GND	Ch-Ch & Ch-GND	Isolated common GND, groups of 8 ch.	Isolated common GND, groups of 8 ch.	Isolated common GND, group of 4/8 ch	Isolated common GND	Isolated common GND
3.2 W	Typ. 2.6 W, Max. 3.4 W	Typ. 2.1 W, Max. 2.7 W	Typ. 3.5 W, Max. 4.3 W	Typ. 1.2 W, Max. 1.9 W	Typ. 1.2 W, Max. 2.0 W	Typ. 1.1 W, Max. 1.8 W	Typ. 1.9 W	Typ. 4.3 W, Max. 7.2 W
High isolation, support of main TC types	High isolation, support of main TC types	High isolation	High isolation	X	Watchdog	High sink current, watchdog	Supercounter technology	X

SOFTWARE INCLUDED

OUTDOOR

EXTREME TEMPERATURES

SHOCK-RESISTANT



DEWESoft®

YEAR WARRANTY



EXTREME VIBRATION

We build our equipment to last. We guarantee you that your hardware will be free from defects and functional. Our warranty covers that the instruments function as promised for a period of 7 years from the day of the delivery.



IP 67

WATERPROOF

CUTTING EDGE SIGNAL CONDITIONING

ONE HARDWARE.

RUGGED DAQ SYSTEMS

RUGGED

Instruments are rugged enough to sustain the harshest environments: water, dust, shock, vibration, and extreme temperature ranges from -40 °C up to 85 °C.

DISTRIBUTABLE

Devices can be distributed close to the source of data - close to the sensors, down to a single measurement node.

STANDARD INTERFACE

The EtherCAT® bus can be connected to 3rd party masters, as well as DewesoftX, thanks to the buffered mode.

SOFTWARE INCLUDED WITH FREE LIFETIME UPGRADE

Award-winning DewesoftX software is included with every instrument. All upgrades to the software are free - FOREVER - and there are never any hidden licensing fees.

H A R S H E N V I R O N M E N T

KRYPTON® RUGGED SYSTEMS

KRYPTON® CPU

Compact, highly portable logger for data recording in harsh environments from -40 to +70 °C operating range.



KRYPTON®

Ultra rugged and distributable data acquisition devices from -40 to +85 °C operating range.

KRYPTON® 1 SERIES

Distribute your measurements down to a single channel.

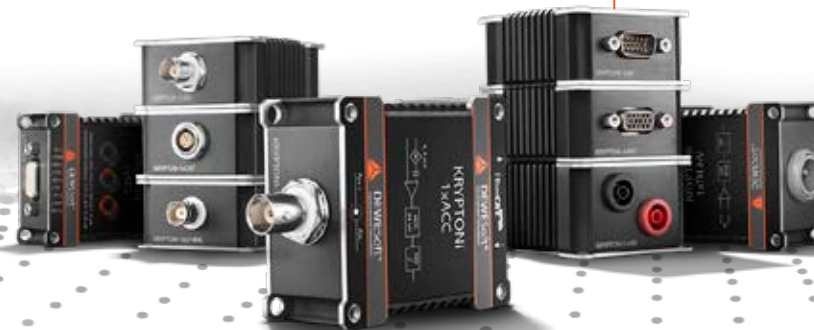

Rugged DAQ system that can be distributed down to a single channel and placed close to sensors. All DAQ systems offer IP67 degree of protection and are thus waterproof, dustproof, shock resistant up to 100 g, and can withstand a temperature range up to -40 °C to 85 °C.

MADE TO BE EXTREME

IP67, dust proof, waterproof, 100 g shock and vibration resistant, wide temperature operating range.

SINGLE CABLE

With up to 100 m between devices for power, data and synchronization.

DISTRIBUTABLE DEVICES

Locate your data acquisition hardware close to the sensors.

RUGGED SYSTEMS SIRIUS® AND SBOX

SBOXwe

Ultra rugged and powerful data logger from -40 to +50 °C.

SIRIUS®iwe

High-end signal conditioning in rugged form factor from -40 to +60 °C.



Extremely rugged (IP67 degree of protection) and fully isolated data acquisition system for the most demanding testing in harsh environments. High-precision, high-dynamic, and high-bandwidth for all types of analog signals from IEPE to strain gages.

DEWESOFT 7-YEAR WARRANTY

Our warranty covers that the instruments function as promised for a period of 7 years from the day of the delivery.

SIRIUS® DAQ TECHNOLOGY

DualCoreADC®, high dynamic range 160 dB, high isolation, SuperCounter®.

MADE TO BE IP67 EXTREME

Dust-proof, water-proof, 100 g shock and vibration resistant, wide temperature operating range.

KRYPTON® WATERPROOF



UP TO 100 m BETWEEN UNITS

KRYPTON units can be distributed over the large area with distances of up to 100 meters (328 feet) between DAQ nodes.

DISTRIBUTED DAQ

Distributed measurement hardware that can be located close to sensors. Compared to traditional DAQ systems, this has many advantages such as shorter cable runs and less potential for signal noise. KRYPTON systems can be distributed down to a single channel.

EtherCAT® DAQ

Protocol with 100Mb/s bus speed is used for data transmission, data synchronization, and power supply. KRYPTONs are connected with a single cable for data, power, and sync.

RUGGED IP67

These modules are built with tough-as-nails IP67 protection - they're ready to go to work in extreme weather and under the harshest conditions.

Rugged and distributable data acquisition modules. EtherCAT® interface for analog and digital I/O and IP67 degree of protection.

UP TO 20 kS/s/CH SAMPLING RATE

Most KRYPTON channels in the EtherCAT® line can achieve sampling rates up to 20 kS/s.

FROM 3 TO 16 CHANNEL UNITS

Modules are available from a 3 channel unit, ranging up to larger 8 and 16 channel modules.

KRYPTON® WATERPROOF SPECS

	STG	TH	TH-HS	RTD	ACC	LV	LA	DIO	CNT
Connectors	DB9, L2B10f	Thermocouple	Thermocouple	L0B6f	BNC	BNC	BNC	DB25	L1T7f
#ch per module	3x, 6x	8x, 16x	8x, 16x	8x	4x, 8x	4x, 8x	8x	16xDI, 16xDO 8xDI, 8xDO	4xCNT
Data rate / channel	20 kS/s	100 S/s	100 S/s, upgradable to 10 kS/s	100 S/s	20 kS/s	20 kS/s	20 kS/s	40 kS/s	20 kS/s
Resolution	24-bit	24-bit	24-bit	24-bit	24-bit	24-bit	24-bit	digital	100 MHz timebase 5 ppm, 20 ppm max
Bandwidth	0.49*fs	X	0.49*fs (max. 1 kHz)	X	0.49*fs	0.49*fs	0.49*fs	X	10 MHz
Voltage ranges	±10 V, ±1 V, ±100 mV, ±10 mV	±1 V, ±100 mV	±1 V, ±100 mV	±1 V, ±100 mV	±10 V, ±5 V, ±1 V, ±200 mV	±50 V	±20 mA	CMOS compatible	TTL (Low: <0.8 V, High > 2 V)
Input coupling	DC	DC	DC	DC	DC, AC 0.1 Hz, 1 Hz	DC	DC	DC	
Sensor excitation	0...15 V max. 0.4 W/ch (45 mA limit)	X	X	X	IEPE 4 mA, 8 mA	-	-	5 V / 300 mA, 12 V / 120 mA, Vsupply / 200 mA*	5 V / 100 mA 12 V / 50 mA
Bridge connection	Full, ½, ¼ 350 Ω, ¼ 120 Ω 3 wire	X	X	X	X	X	X	X	X
Programmable shunt	100 kΩ	X	X	X	X	X	X	X	X
IEPE input	DSI-ACC	X	X	X	✓	X	X	X	X
Resistance	X	X	X	10 kΩ	X	X	X	X	X
Temperature (PTx)	DSI-RTD	X	X	PT100, 200, 500, 1000, 2000	X	X	X	X	X
Thermocouple	DSI-TH	K, J, T, R, S, N, E, C, B	K, J, T, R, S, N, E, C, B	X	X	X	X	X	X
Current	ext. shunt DSI-20mA, DSI-5A	X	X	X	ext. shunt	X	X	X	X
Potentiometer	✓	X	X	X	X	X	X	X	X
LVDT	DSI-LVDT	X	X	X	X	X	X	X	X
Charge	DSI-CHG	X	X	X	X	X	X	X	X
TEDS	✓	X	X	X	✓	X	X	X	X
Isolation voltage	Differential	1000 V	1000 V	1000 V	Differential	1000 V	1000 V	250 V	X
Isolation arrangement	None	Ch-Ch & Ch-GND	Ch-Ch & Ch-GND	Ch-Ch & Ch-GND	None	Ch-Ch & Ch-GND	Ch-Ch & Ch-GND	Isolated common GND	Isolated common GND
Power consumption per module	2.4 W (4 W 120 Ω @ 5 V load) 3xSTG; 5.9 W (8.9 W 120 Ω @ 5 V load) 6xSTG	2.5 W (8xTH) 4 W (16xTH)	2.6 W (8xTH-HS) 4.3 W (16xTH-HS)	2.5 W	4.6 W	3.5 W (4xLV) 6.7 W (8xLV)	6.8 W	2 W	2.3W
Advanced functions	Supports all strain types, TEDS support	High isolation, support of main TC types	High isolation, support of main TC types	X	TEDS support	High isolation, high input range	High isolation, 4-20 mA current loop	X	SuperCounter®

AMPLIFIER SPECS

3xSTG, 6xSTG	Differential universal and strain module
8xTH, 16xTH, 8xTH-HS, 16xTH-HS	Isolated universal thermocouples module
8xRTD	Isolated module for measurements with resistance temperature detectors
4xACC, 8xACC	IEPE accelerometer amplifier
4xLV, 8xLV	Isolated voltage input module

8xLA	Isolated low current amplifier
16xDI, 16xDO, 8xDI-8xDO	Isolated digital input/output module
GPS JUNCTION	Module for synchronization between SIRIUS or KRYPTON EtherCAT® devices to SIRIUS USB device, IRIG-B-DC or GPS
Sync junction	Module used to inject IRIG-B-DC sync signal from USB device to EtherCAT® line
KRYPTON CPU	Rugged data logger

KRYPTON® 1 WATERPROOF



UP TO 40 kS/s SAMPLING RATE

UP TO 40 kS/s SAMPLING RATE

Most devices in the KRYPTON 1 product line can achieve sampling rate up to 40 kS/s.

RUGGED IP67

All KRYPTON modules are rugged with the IP67 degree of protection and ready for testing in extreme weather and harsh environments.

UP TO 100 m BETWEEN UNITS

KRYPTON units can be distributed over the large area with distances of up to 100 meters (328 feet) between DAQ nodes.

DISTRIBUTED TO SINGLE CHANNEL

KRYPTON 1 allows distributing DAQ units down to single channel.

Smallest size single channel rugged and distributable data acquisition modules with EtherCAT® interface.

EtherCAT® DAQ

The EtherCAT® protocol with 100Mb/s bus speed is used for data transmission, data synchronization, and for powering the module. KRYPTON 1 modules are connected with a single cable for data, sync, and power.

KRYPTON® 1 WATERPROOF SPECS

	AO	DI	DO	ACC	STG	LV	HV	TH-HV	CNT
Connector	BNC	DSUB15HD Male	DSUB15HD Female	BNC	DB9	BNC	Banana jack	K-type Thermocouple LEMO REDEL	LEMO T-type 7pin female
Number of channels per module	1	4	4	1	1	1	1	1	1
Data rate per channel	X	40 kS/s	X	40 kS/s	40 kS/s	40 kS/s	40 kS/s	100 S/s	20 kS/s
Resolution	18 bit	Digital	Digital	24-bit	24-bit	24-bit	24-bit	24-bit	100 MHz timebase 5 ppm, 20 ppm max
Bandwidth	X	X	X	0.49 fs	0.49 fs	0.49 fs	0.49 fs	0.49 fs	10 MHz
Voltage ranges	X	Digital (Low: < 1 V, High: > 2 V)	X	±10 V, ±5 V, ±1 V, ±200 mV	±50 V, ±10 V, ±1 V, ±100 mV	±50 V, ±10 V, ±1 V, ±100 mV	±1000 V	Thermocouple	TTL (Low: <0.8 V, High > 2 V)
Input coupling				DC, AC 0.1 Hz, 1 Hz	DC, AC 1 Hz	DC, AC 1 Hz	DC		
Sensor excitation	±10 V	X	X	IEPE 4 mA, 8 mA	Unipolar 0 - 24 V Bipolar 0 - 12 V	X	X	X	5 V (100 mA max.), 12 V (90 mA max.)
Bridge connection	X	X	X	X	Full, ½, ¼ 350 Ω, ¼ 120 Ω 3 wire	X	X	X	X
Programmable shunt	X	X	X	X	100 kΩ	X	X	X	X
IEPE input	X	X	X	✓	DSI-ACC	X	X	X	X
Resistance	X	X	X	X	✓	X	X	X	X
Temperature (PTx)	X	X	X	X	DSI-RTD	X	X	X	X
Thermocouple	X	X	X	X	DSI-TH	X	X	K-type	X
Current	X	X	X	X	20mA (internal shunt), DSI-5A, ext. shunt	ext. shunt	X	X	X
Potentiometer	X	X	X	X	✓	X	X	X	X
LVDT	X	X	X	X	DSI-LVDT	X	X	X	X
Charge	X	X	X	X	DSI-CHG	X	X	X	X
TEDS	X	X	X	✓	✓	X	X	X	X
Isolation	None	Galvanic isolation CH, GND	Galvanic isolation CH, GND	125 Vrms Isolation CH, GND	125 Vrms Isolation CH, GND	125 Vrms Isolation CH, GND	CAT III 600 V CAT II 1000 V	CAT III 600 V CAT II 1000 V	None
Power consumption	2 W	1.5 W	2 W	2 W	3 W	1.5 W	1 W	1.3 W	1.2 W

AMPLIFIER SPECS

4xDI, 4xDO	Four channel digital I/O amplifier
1xAO	Analog output
1xCNT	Single channel SuperCounter® module
1xLV	Isolated low voltage module

1xSTG	Isolated universal and strain amplifier
1xACC	Isolated IEPE accelerometer amplifier
1xHV	Isolated high voltage module
1xTH-HV	Isolated thermocouple module (CATII 1000V)

SIRIUS® WATERPROOF



IP67 DEGREE OF PROTECTION

SIRIUS waterproof is designed for testing in extremely harsh environments. The unit is waterproof, dustproof and can withstand shocks up to 100 g.

160 dB DYNAMIC RANGE

With our DualCoreADC® technology all analog inputs boost dual 24-bit delta-sigma with an anti-aliasing filter, achieving astonishing 160 dB dynamic range in time and frequency domain with 200 kHz sampling rate per channel.

-40 TO 60 °C

Extreme testing means extreme temperatures. SIRIUS waterproof is ready.

FULLY SYNCHRONIZED

Each channel, either analog, digital or CAN is synchronized with microsecond accuracy.

UNIVERSAL ANALOG INPUTS

Universal analog amplifiers can accept voltage and full/half/quarter bridge signals natively as well as IEPE, charge, thermocouples, RTD, current, resistance and LVDT signals with the use of DSI adapters.

Extremely rugged, isolated, IP67 rated, data acquisition system with EtherCAT® and USB interface for testing in harsh environment. Fast, precise and distributable!

Rugged modules configuration examples:

SIRIUSiwe 8xSTGM	8-channel, universal strain gage amplifiers
SIRIUSiwe 6xSTGM, 2xSTGM+	8-channel universal strain gage amplifier with two counter inputs
SIRIUSiwe 16xHD-STGS	16 channel universal strain gage input

DIGITAL/COUNTER/ENCODER INPUTS

Each channel is capable of 3x digital inputs, 1x event counter, encoder, period, pulse-width, duty-cycle. Precise frequency and angle measurement using patented SuperCounter® technology.

SENSOR POWER SUPPLY

Each channel provides power for sensor excitation.

HIGH ISOLATION

High channel-to-channel and channel-to-ground isolation prevents ground loops and damage to the systems from excessive voltage.

WATERPROOF SBOX®



-40 TO 50 °C

Extreme testing means extreme temperatures. SBOX waterproof is ready.

IP67 LEVEL PROTECTION

SBOX waterproof is designed for testing in extremely harsh environments. The unit is waterproof, dustproof, and can withstand shocks up to 100 g.

Extremely rugged, IP67 rated data logger and powerful data processing computer. The perfect companion for your SIRIUS waterproof DAQ system.

100 Hz GPS WITH RTK

Optional 10Hz or 100Hz GPS receiver with additional RTK support can be built straight into SBOX waterproof.

5 USB PORTS

SBOX includes five USB 2.0 ports. All USB ports feature screw-lock connectors.

PERFORMANCE COMPUTER

With built-in Intel Core i7 CPU and 4GB memory, SBOX waterproof is also very capable computer for worry-free, real-time data processing.

EtherCAT® INTERFACE

Built-in EtherCAT® interface port with synchronization for EtherCAT® DAQ devices.

3 NETWORK INTERFACES

Two gigabit LAN ports and wireless WLAN interface with external antenna ensure maximum connectivity.

HIGHLY RELIABLE SSD STORAGE

SBOX waterproof provides highly reliable data recording with typical 180 MB/sec write speeds straight into its fast, reliable solid state drive.

CURRENT SENSORS

MOUNTING PLATES

SIGNAL ADAPTERS

DISPLAYS



ANGLE SENSORS

ACCELEROMETERS

VIDEO CAMERAS

M I C R O P H O N E S

B A T T E R Y P A C K S

V E H I C L E I N T E R F A C E S

ONE HARDWARE.

ACCESSORIES, SENSORS & MORE

DSI ADAPTERS

TEDS equipped adapters that convert our D-SUB9 universal signal conditioners into direct IEPE, charge, thermocouple, shunt, voltage, LVDT or RTD inputs.

DISPLAYS, VIDEO CAMERAS AND BATTERY PACKS

All you need for our data acquisition systems for stand-alone, in-vehicle or remote test and measurement applications.

GPS AND IMU DEVICES

High accuracy 100Hz GPS receivers and Inertial Measurement Units (IMU) with Real-time Kinematics (RTK) support for the most precise position based test and measurement applications.

WIDE VARIETY OF SENSORS

Current clamps, transducers, accelerometers, angle sensors, microphones, and more.

A C T U A T O R S

P R E - B U I L T I N S T R U M E N T S



AFTER MORE
THAN TEN YEARS
CUSTOMERS
STILL
LOVE IT.

TECH BRIEFS

2009

Readers' Choice

Product of the Year

DEWE-43A

TECH BRIEFS MAGAZINE
2009 Readers' Choice -
Product of the Year Award

DEWE-43A 

DEWESOFT 7-YEAR WARRANTY

Our warranty covers that the instruments function as promised for a period of 7 years from the day of the delivery.



SENSOR POWER SUPPLY

Each channel provides power for sensor excitation.

ISOLATED POWER SUPPLY

The DEWE-43A power supply is internally isolated, completely preventing ground loops.

COUNTER/ENCODER/DIGITAL INPUTS

Each of the 8 counter inputs can be used as 3x digital inputs, 1 event counter, encoder, period, pulse-width, duty-cycle. Precise frequency and angle measurement use patented Super-Counter® technology.

Award-winning versatile USB data acquisition system with unmatched price/performance ratio - all in compact small size.

FULLY SYNCHRONIZED

Each channel, either analog, digital or CAN is synchronized with microsecond accuracy.

ISOLATED CAN INPUTS

High speed CAN 2.0b channels with 1 Mbit/sec data throughput with additional support for CCP, OBDII, J1939, and CAN output. All fully isolated.

UNIVERSAL ANALOG INPUTS

The DEWE-43A natively accepts analog voltages and full bridge sensors. With DSI adapters it can even interface with IEP and charge accelerometers, thermocouple and RTD temperature sensors, half and quarter bridge configurations, current, resistance, and LVDT sensors. The sample rate is up to 200 kS/s/ch using sigma-delta 24-bit ADCs.

DSI[®] ADAPTERS



DSI-ACC, DSI-ACC-0.16HZ, DSI-ACC-20MA:

Adapters for connecting IEPE sensors.



DSI-CHG:

Adapter for connecting charge sensors.



DSI-CHG-DC:

DC coupled adapter for connecting charge sensors with high input range and large time constant.



DSI-RTD:

Adapter for connecting DSI RTD temperature sensors (Pt100, Pt200, Pt500, Pt1000, Pt2000).



DSI-TH-K, TH-J, TH-T, TH-C, TH-E, TH-UNI:

Adapter for connecting thermocouples.



DSI-V-200, DSI-V-20:

Adapter for extending voltage range of amplifiers.



DSI-20MA, DSI-5A, DSII-10A, DSII-20A:

Adapters for current measurements.



DSI-LVDT:

Adapter for connecting LVDT sensors.



DEWESOFT 7-YEAR WARRANTY

Our warranty covers that the instruments function as promised for a period of 7 years from the day of the delivery.

TEDS equipped adapters that turn SIRIUS, KRYPTON or IOLITE DSUB9 voltage or strain analog input into a truly universal input supporting a wide variety of signals.

MOUNTING PLATES



DS-MOUNT-19-R8X

19" Mounting Kit for SIRIUS R8 systems.



DS-MOUNT2-K

Top mounting plate for binding KRYPTON DAQ modules to SIRIUS and MINITAURs data acquisition systems, SBOX data loggers and battery packs.



DS-MOUNT-K2, DS-MOUNT-K3

Mounting plate with click mechanism, for the bottom (DS-MOUNT-K2) or top (DS-MOUNT-K3) of the KRYPTON units.



DS-MOUNT-DISP12

Mount that fits DS-DISP-12, our 12" multi-touch LED screen DS-DISP-12, on a SIRIUS or SBOX slice.



VIB-ISO MOUNT

The VIBISO mount provides a vibration-isolated base for SIRIUS waterproof and SBOX waterproof DAQ instruments. Measurement units which are mounted on the VibISO mount are suspended on rubber dampers which isolate instruments from high-frequency vibrations for extreme conditions.



DS-MOUNT19

Mounting plate for fitting SIRIUS and SBOX data loggers into a 19" rack cabinet.



DS-MOUNT2

General top mount for SIRIUS data acquisition systems and/or SBOX data loggers. Mount can be used to fit small instruments, such as DS-CAN2, or any accessory that needs to be firmly fixed to the DAQ system.



DS-MOUNT1

This mount can be used to mount SIRIUS data acquisition systems and SBOX data processing computers to the wall, floor or any other flat surface.

DISPLAYS AND BATTERY PACKS

DS-BP2i, DS-BP4i

Hot-swappable Li-ion battery solutions with the best weight-to-energy ratio (180 Wh for BP2i, and 360 Wh for BP4i).



ISOLATED POWER SUPPLY

For in-vehicle measurements, an isolated power supply on battery packs will guard you against unwanted ground loops.

RUGGED AND RELIABLE

Battery packs are built in rugged aluminum chassis, machined out of a single brick of aluminum for reliable operation on the field. Only high-quality Li-Ion batteries are used.

HOT-SWAP FUNCTIONALITY

Internal Li-Ion batteries are hot-swappable, meaning they can be replaced during the measurement to ensure your data acquisition system never runs out of power.

LARGE CAPACITY

Battery packs have up to 384 Wh capacity. This will ensure 3 hours of operation for SBOX data logger with 32 channel SIRIUS DAQ system without replacing batteries.

DS-DISP12

Rugged, high brightness and high resolution LED display for mobile, in-vehicle test and measurement applications.



RUGGED DISPLAY

DS-DISP-12 is 12" industrial grade LED display built into rugged aluminum chassis for use in mobile applications - can operate from -20°C to 60°C.

MULTI-TOUCH

Display has multi-touch functionality for easy touch-enabled operation. DewesoftX has smart gesture-based supported visual displays that allow easy control of software.

HIGH BRIGHTNESS

With high brightness of 1200 cd/m², display ensures visibility even in harshest testing conditions.

DS-CAM VIDEO CAMERAS

ADDITIONAL CAMERA SUPPORT

DIRECT X CAMERA SUPPORT

Free support for all DirectX compatible cameras. Video from this cameras will be software synced to analog and other sources with ~10ms accuracy.

HIGH SPEED VIDEO CAMERA

Extreme high-speed video cameras from Photron are directly supported and perfectly synchronized to other data.

THERMOVISION CAMERAS

Supports OPTRIS infrared thermal cameras.

VIDEO POST SYNC

Any video file from additional cameras can be synchronized in analysis mode and merged with Dewesoft data files.

GIGE VISION V2 SUPPORT

JPEG compression and support for cameras using GigE v2 standard.



HIGH-SPEED VIDEO

DS-CAM cameras offer high frame rates with continuous storage. Lowering the resolution you can achieve even higher speeds.

IP67 LEVEL PROTECTION

Some camera models are available in IP67 version. Fully waterproof, dustproof and ready for applications in harsh environments.

High-speed and rugged video cameras with full synchronization capability and real-time picture compression.

REAL-TIME COMPRESSION

Dewesoft offers real-time or offline compression and video streaming directly to computer's hard drive.

SYNCHRONIZED TO ANALOG

Cameras offer hardware synchronization link to all analog data acquisition instruments. Video and analog data is synchronized frame by frame.

GPS AND IMU DEVICES

	NAVION i2	DS-IMU1	DS-VGPS-HS/HSC	DS-GYRO3
NAVIGATION				
Standalone/SBAS/RTK (horizontal positioning)	1.2 m	2 m	1.2 m	-
Velocity accuracy	0.015 m/s	0.05 m/s	0.02 m/s	-
Roll & Pitch accuracy (dynamic)	0.03 °	0.1 °	-	0.1 °
Heading accuracy (dynamic with GNSS)	0.08 °	0.2 °	-	0.1 °
Slip angle accuracy	0.08 °	0.3 °	-	-
Output data rate	Up to 100 Hz	Up to 100 Hz	20/100 Hz	up to 1600 Hz
GNSS				
Supported navigation systems	GPS L1, L2, L5; GLONASS L1, L2, L3 BeiDou B1, B2 Galileo E1, AltBOC, E5a, E5b NavIC (IRNSS) L5	GPS L1C/A, GLONASS L1OF, BeiDou B1I	GPS L1, L2* GLONASS L1, L2*	-
Supported SBAS systems	SBAS L1, L5 QZSS L1, L2, L5	-	WAAS, EGNOS, MSAS, GAGAN, QZSS	-
ADDITIONAL FEATURES				
Dual antenna heading	✓	-	-	-
RTK positioning	✓	✓	✓	-
HARDWARE				
Operating voltage	9 to 36 V	5 to 36 V *USB powered	9 to 36 V	5 V *USB powered
Operating temperatures	-40 °C to 71 °C (0.8 °C/min Max)w	-40 °C to 85 °C	0 °C to 60 °C	-40 °C to 85 °C
INERTIAL SENSORS				
Accelerometers	✓	✓	-	✓
Gyroscope	-	-	-	✓
Magnetometer	-	-	-	✓

RTK 1 CM ACCURACY

Optional RTK upgrade of all GPS units, improving positioning accuracy down to 1 cm.

USB, CAN, RS232, ETHERNET

GPS instruments offer a variety of data connection interfaces from USB, CAN, RS232 and Ethernet

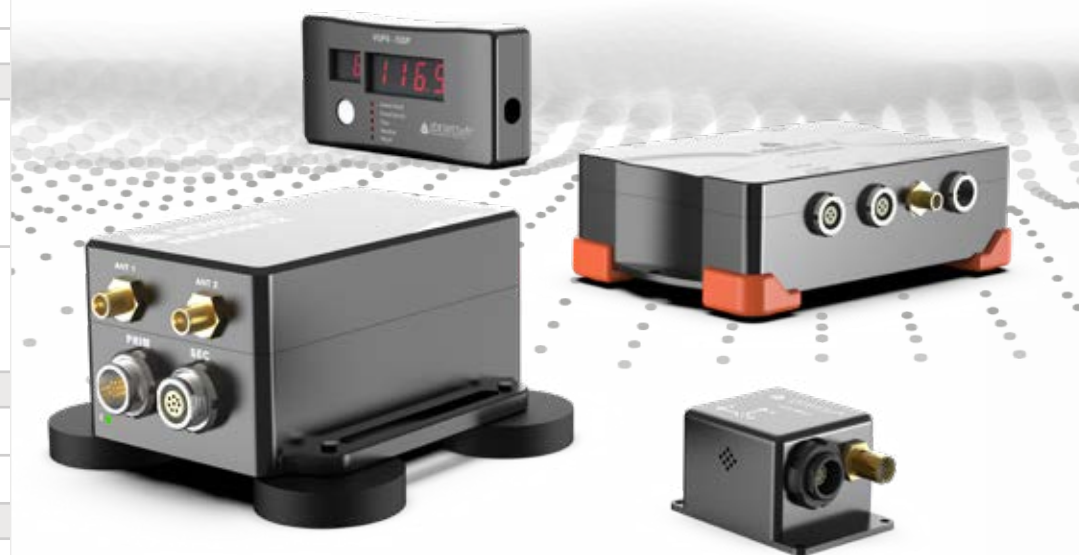

High accuracy 100Hz GPS receivers and Inertial Measurement Units (IMU) with Real-time Kinematics (RTK) support for the most precise position based test and measurement applications.

INERTIAL MEASUREMENT UNITS

Very rugged IMU units - IP67 degree of protection - which in addition to GPS receivers have an integrated 3-axis accelerometer and 3-axis gyroscope to improve dead reckoning.

CAN BUS AND CAN FD INTERFACES



DEWESOFT 7-YEAR WARRANTY

Our warranty covers that the instruments function as promised for a period of 7 years from the day of the delivery.



CAN FD, XCP, FLEXRAY AND LIN

Using third party hardware, additional interfaces are supported.

RAW DATA ANALYZER

Graphical interface for easy CAN decoding and finding signals without a CAN DBC.

OBDII AND J1939 SUPPORT

CAN interfaces have XCP/CCP, OBDII, J1939 and other standard support.

Multichannel USB and single channel EtherCAT® CAN BUS. Software with support for OBDII, J1939, XCP/CCP, CAN transmit, DBC and AUTOSAR XML files.

NATIVE CAN FD SUPPORT

SIRIUS can be ordered with CAN FD or with standard CAN port.

PLUG-AND-PLAY CAN INTERFACES

Robust and easy to use interfaces. Connect your CAN device to the USB port of any laptop or PC, or to any SBOX or KRYPTON CPU computer. The device will be recognized automatically, and be ready to use in a moment.

1, 2, 4 OR 9 CAN PORTS

Multiple CAN devices can be connected together to expand to more CAN ports.

DBC AND ARXML FILE SUPPORT

Included DewesoftX software enables import of DBC or AUTOSAR XML files which will automatically set the CAN channel list.

FANLESS CHASSIS AVAILABLE

1, 2 and 4 port CAN port are fanless by default, and even the 9 port CAN device can also be built into a fanless aluminium chassis with IP50 degree of protection for worry-free CAN acquisition in harsh, dusty environments.

CLAMPS & TRANSDUCERS



-40°C TO +85°C

Dewesoft offers current transducers with wide temperature range - ideal for both winter (-40°C) and summer testing (+85°C).

FLEXIBLE

Dewesoft instruments allow connecting any type of current transducers. There are more than 1000 different current sensors available on the market. If you want to connect your own or other sensors we are happy to help you.

UP TO 30 000 A

Dewesoft offers a very wide range of current measurement ranges up to 30 000 (30 thousand) A.

AC/DC CURRENT MEASUREMENT

Dewesoft offers high-accuracy zero-flux current transducers, Rogowski coils, current clamps and shunts for AC and/or DC current measurement.

High-accuracy sensors for AC/DC current measurement and power analysis. From current clamps, high-precision zero flux current transducers, shunts and Rogowski coils.

HIGH ACCURACY

Highly precise zero flux current transducers or fluxgate compensated clamps are a perfect fit for most demanding power measurements for E-mobility and inverter motors applications.

INTEGRATED SENSOR POWER SUPPLY

Current clamps and zero-flux transducer can be powered straight from the DAQ instrument like R2DB, R8 or with external SIRIUS slice compatible chassis.

ACCURATE MEASUREMENTS - ANYWHERE

A truly accurate sensor that delivers excellent performance across different ambient conditions. It performs equally well at different temperatures, in magnetically harsh environments, and across whole measurement range.

STABLE MEASUREMENTS - TEMPERATURE INDEPENDENT

As compared to the Hall effect sensors that are very temperature sensitive due to the air gap that is needed to insert the sensor. The DC-CT sensor is temperature independent.

WIDE AND FLAT BANDWIDTH - FOR HIGH-SPEED SIGNALS

Be it high-speed transients or higher harmonics of the PWM switching frequency on the emerging GanFET inverters - you can be confident that you will be able to accurately measure the phenomena. This is ensured by a high permeability core that couples the primary and secondary sensor winding.



This current transducer is designed for precise current measurement applications. DC-CT technology represents a Platiše Flux Sensor (PFS) which is used in a closed-loop configuration to offer all the benefits of a zero-flux current transducer but with lower power consumption and in a smaller form factor. Making it your device of choice for all types of current measurement.

SMALL SIZE - EASY TO FIT

DC-CT current sensors deliver up to 1000 amperes of continuous measurement range in one of the smallest form-factors on the market.

LOW POWER CONSUMPTION - SIMPLE SETUP

A single Sirius MCTS2 power supply will easily power four DC-CT sensors without any limitations.

ISOLATION

Galvanic isolation between primary and secondary compliant with IEC 61010-1 CAT II 1000 V.

LOW OFFSET

A compact and gapless core design enables very low magnetic remanence and thus overall very low offset current.

HIGH ACCURACY

High accuracy of current measurements in the whole measurement range up to 1000 A.

SUPERB IMMUNITY

Single gapless core enables immunity to external magnetic fields with highest possible sensitivity.

TEDS SUPPORT

Both the sensor itself and the burden resistor have built-in TEDS compatibility, which makes it plug and play. Connecting the current transducer to the DAQ device will initiate automatic sensor recognition and settings will be configured automatically.

DC-CT 1000I



CURRENT CLAMPS AC/DC

	DS-CLAMP-200DC		DS-CLAMP-500DCS		DS-CLAMP-500DC		DS-CLAMP-1000DC	
Type	Flux gate		Flux gate		Flux gate		Flux gate	
Current Range	200 A DC or AC RMS		500 A DC or AC RMS		500 A DC or AC RMS		1000 A DC or AC RMS	
Sensitivity	10 mV/A		4 mV/A		4 mV/A		2 mV/A	
Bandwidth	DC to 500 kHz		DC to 200 kHz		DC to 100 kHz		DC to 20 kHz	
Bandwidth (upgraded after 2022)	DC to 700 kHz		DC to 500 kHz		DC to 200 kHz		not yet available	
TEDS	Fully supported		Fully supported		Fully supported		Fully supported	
Conductor Position Sensitivity	max. ± 0.1 % of reading		max. ± 0.1 % of reading		max. ± 0.2 % of reading		max. ± 0.2 % of reading	
Zero Offset (+25°C)	max. ± 10 mA		max. ± 250 mA		max. ± 250 mA		max. ± 50 mA	
Error due Earth Magnetic Field	max. ± 50 mA		max. ± 100 mA		max. ± 150 mA		max. ± 150 mA	
Temp. Coefficient	± 0.01 %/°C		± 0.01 %/°C		± 0.01 %/°C		± 0.01 %/°C	
Accuracy	Amplitude	Phase Error	Amplitude	Phase Error	Amplitude	Phase Error	Amplitude	Phase Error
DC	± 0.2 % rdg., ± 40 mA	-	± 0.3 % rdg., ± 100 mA	-	± 0.2 % rdg., ± 100 mA	-	± 0.2 % rdg., ± 200 mA	-
to 100 Hz	± 0.2 % rdg., ± 20 mA	± 0.1 °	± 0.3 % rdg., ± 50 mA	± 0.1 °	± 0.2 % rdg., ± 50 mA	± 0.1 °	± 0.2 % rdg., ± 100 mA	± 0.1 °
100 - 500 Hz	± 0.3 % rdg., ± 40 mA	± 0.2 °	± 0.3 % rdg., ± 100 mA	± 0.2 °	± 0.3 % rdg., ± 100 mA	± 0.2 °	± 0.5 % rdg., ± 200 mA	± 0.2 °
500 Hz - 1 kHz	± 0.5 % rdg., ± 40 mA	± 0.5 °	± 0.5 % rdg., ± 100 mA	± 0.5 °	± 0.5 % rdg., ± 100 mA	± 0.5 °	± 1.0 % rdg., ± 200 mA	± 0.5 °
1 kHz - 5 kHz	± 1.0 % rdg., ± 40 mA	± 1.0 °	± 1.0 % rdg., ± 100 mA	± 1.0 °	± 1.0 % rdg., ± 100 mA	± (0.5 f [kHz]) °	± 2.0 % rdg., ± 200 mA	± (0.7 f [kHz]) °
5 kHz - 10 kHz	± 1.5 % rdg., ± 40 mA	± 1.5 °	± 1.5 % rdg., ± 100 mA	± 1.5 °	± 1.5 % rdg., ± 100 mA	± (0.5 f [kHz]) °	± 5.0 % rdg., ± 200 mA	± (0.7 f [kHz]) °
10 kHz - 20 kHz	± 5 % rdg., ± 40 mA	± (0.5 + 0.1 f [kHz]) °	± 5 % rdg., ± 100 mA	± (0.5 + 0.1 f [kHz]) °	± 5 % rdg., ± 100 mA	± (0.5 f [kHz]) °	± 30 % rdg., ± 200 mA	± (0.7 f [kHz]) °
20 kHz - 50 kHz	± 5 % rdg., ± 40 mA	± (0.5 + 0.1 f [kHz]) °	± 5 % rdg., ± 100 mA	± (0.5 + 0.1 f [kHz]) °	± 10 % rdg., ± 250 mA	± (0.5 f [kHz]) °	± 30 % rdg., ± 200 mA	± (0.7 f [kHz]) °
50 kHz - 100 kHz	± 10 % rdg., ± 100 mA	± (0.5 + 0.1 f [kHz]) °	± 15 % rdg., ± 250 mA	± (0.5 + 0.1 f [kHz]) °	± 30 % rdg., ± 250 mA	± (0.5 f [kHz]) °	/	/
100 kHz - 200 kHz	± 15 % rdg., ± 40 mA	± (0.5 + 0.1 f [kHz]) °	± 30 % rdg., ± 250 mA	± (0.5 + 0.1 f [kHz]) °	/	/	/	/
200 kHz - 300 kHz	± 15 % rdg., ± 40 mA	± (0.5 + 0.1 f [kHz]) °	/	/	/	/	/	/
300 kHz - 500 kHz	± 30 % rdg., ± 100 mA	± (0.5 + 0.1 f [kHz]) °	/	/	/	/	/	/
Dimensions [mm]	153 x 67 x 25		153 x 67 x 25		238 x 114 x 35		238 x 114 x 35	
Max. Conductor Size	20 mm		20 mm		50 mm		50 mm	
Power Supply	± 11 V to ± 15 V		± 11 V to ± 15 V		± 11 V to ± 15 V		± 11 V to ± 15 V	
Current Consumption	max. 6 VA		max. 7 VA		max. 7 VA		max. 7 VA	
Operating Environment	Indoors, Pollution Degree II, altitude up to 2000m		Indoors, Pollution Degree II, altitude up to 2000m		Indoors, Pollution Degree II, altitude up to 2000m		Indoors, Pollution Degree II, altitude up to 2000m	
Operating Temp.	- 40 °C to + 85 °C		- 40 °C to + 85 °C		- 40 °C to + 85 °C		- 40 °C to + 85 °C	
Operating Humidity	up to 80 % (not condensing)		up to 80 % (not condensing)		up to 80 % (not condensing)		up to 80 % (not condensing)	
Safety Standards	EN61010-2-032:2012		EN61010-2-032:2012		EN61010-2-032:2012		EN61010-2-032:2012	
EMC Standards	EN61326-1:2013		EN61326-1:2013		EN61326-1:2013		EN61326-1:2013	
Rohs	EN50581:2012		EN50581:2012		EN50581:2012		/	
PWR-MCTS2 needed	Yes		Yes		Yes		Yes	
Compatible amplifiers	SIRIUS LV / HS-LV / XHS-LV, SIRIUS STG / HS-STG, SIRIUS STGM, DEWE 43		SIRIUS LV / HS-LV / XHS-LV, SIRIUS STG / HS-STG, SIRIUS STGM, DEWE 43		SIRIUS LV / HS-LV / XHS-LV, SIRIUS STG / HS-STG, SIRIUS STGM, DEWE 43		SIRIUS LV / HS-LV / XHS-LV, SIRIUS STG / HS-STG, SIRIUS STGM, DEWE 43	
Cable length	3 m - MCTS to Clamp 0.3 m - Amplifier to MCTS		3 m - MCTS to Clamp 0.3 m - Amplifier to MCTS		3 m - MCTS to Clamp 0.3 m - Amplifier to MCTS		3 m - MCTS to Clamp 0.3 m - Amplifier to MCTS	

CURRENT CLAMPS AC / ROGOWSKY COILS

	DS-CLAMP-5AC	DS-CLAMP-15AC	DS-CLAMP-200AC	DS-CLAMP-1000AC
Type	Iron-Core	Iron-Core	Iron-Core	Iron-Core
Range	5 A AC RMS	15 A AC RMS	200 A AC RMS	1000 A AC RMS
Sensitivity	100 mV/A	100 mV/A	10 mV/A	1 mV/A
Accuracy (+25 °C)	5 mA - 0.5 A ± 2 % of reading 0.5 A - 1 A ± 1 % of reading 1 A - 12 A ± 0.5 % of reading	< 1 A ± 2.5 % of reading 1 A - 15 A ± 1 % of reading	0.5 A - 10 A ± 3.5 % of reading 10 A - 100 A ± 2.5 % of reading 100 A - 240 A ± 1 % of reading	< 1 A ± 2 % of reading 10 A - 100 A ± 0.5 % of reading 100 A - 1200 A ± 0.3 % of reading
Phase Error	5 mA - 0.5 A ± 2° 0.5 A - 1 A ± 1° 1 A - 12 A ± 1°	< 1 A ± 5° 1 A - 15 A ± 3°	0.5 A - 10 A not specified 10 A - 100 A ≤ 5° 100 A - 240 A ≤ 2.5°	< 1 A not specified 10 A - 100 A ≤ 1° 100 A - 1200 A ≤ 0.7°
Bandwidth	2 Hz to 5 kHz	2 Hz to 10 kHz	2 Hz to 10 kHz	2 Hz to 10 kHz
Resolution	0.01 A	0.01 A	0.5 A	0.001 A
TEDS	Fully supported	Fully supported	Fully supported	Fully supported
Overload Capability	1.5 x I nominal	1.3 x I nominal	1.3 x I nominal	1.3 x I nominal
Conductor Position Sensitivity	≤ 0.5 % of reading	≤ 0.5 % of reading	≤ 0.5 % of reading	≤ 0.1 % of reading
Influence of Crest Factor	≤ 1 %	≤ 3 %	≤ 3 %	≤ 1 %
Error due Earth Magnetic Field	/	≤ 15 mV/A @ 50 Hz	≤ 15 mV/A @ 50 Hz	≤ 15 μV/A @ 50 Hz
Temperature Coefficient	± 0.015 % / °C	≤ 0.2 % / 10 °C	≤ 0.2 % / 10 °C	≤ 0.1 % / 10 °C
Influence of Frequency	/	< 5 % of output signal from 20 Hz ... 1 kHz < 10 % of output signal from 1 kHz ... 10 kHz	< 3 % of output signal from 20 Hz ... 1 kHz < 12 % of output signal from 1 kHz ... 10 kHz	< 1 % of output signal from 30 Hz ... 48 Hz < 0.5 % of output signal from 35 Hz ... 1 kHz < 1 % of output signal from 1 kHz ... 5 kHz

The same system can be used to perform simultaneous online analysis of torsional and rotational vibration, order tracking, combustion noise, sound power and more.

Analog inputs with 1 MS/sec sampling rate and sensor supply. Any sensor and signal type
- Charge, IEPE, High voltage, Current, Strain, Torque, Temperature.



	DS-FLEX-3000-17	DS-FLEX-3000-35	DS-FLEX-3000-35-HS	DS-FLEX-3000-80	DS-FLEX-30000-120
Type	Rogowski coil	Rogowski coil	Rogowski coil	Rogowski coil	Rogowski coil
Current Range	3 A, 30 A, 300 A, 3000 A AC RMS	3 A, 30 A, 300 A, 3000 A AC RMS	3000 A AC RMS	3 A, 30 A, 300 A, 3000 A AC RMS	30 A, 300 A, 3000 A AC RMS
Bandwidth	3 A: 10 Hz to 10 kHz	3 A: 10 Hz to 10 kHz Others: 10 Hz to 20 kHz	5 Hz - 1MHz	3 A: 10 Hz to 10 kHz Others: 10 Hz to 20 kHz	3 A: 10 Hz to 5 kHz Others: 10 Hz to 20 kHz
Others: 10 Hz to 20 kHz	3 A: 10 Hz to 10 kHz	≤ 1,5 %	≤ 1,5 %	≤ 1,5 %	≤ 1,5 %
Others: 10 Hz to 20 kHz	5 Hz - 1MHz	3 A: 10 Hz to 10 kHz	350 mm (Ø 100 mm)	800 mm (Ø 250 mm)	1200 mm (Ø 380 mm)
Others: 10 Hz to 20 kHz	30 A: 10 Hz to 5 kHz Others: 10 Hz to 20 kHz	Not Supported	Fully Supported	not supported	Not Supported
Accuracy (+25 °C)	≤ 1.5 %	≤ 1.5 %	≤ 1.0 %	≤ 1.5 %	≤ 1.5 %
Coil Length	170 mm	350 mm	350 mm	800 mm	1200 mm
TEDS	Not supported	Not supported	Fully supported	Not supported	Not supported



	DSII-10A	DSII-20A	DS-SHUNT-05
Type	Current Transducer	Current Transducer	Shunt
Current Range	10A AC/DC	20A AC/DC	5A
Bandwidth	100 kHz	100 kHz	-
Accuracy (+25 °C)	0.3 %	0.3 %	0.1 %
Resistance	-	-	50 mOhm

HIGHLIGHT 3

The system can send combustion analysis results to the testbed via AK-protocol or to ETAS INCA® and similar systems via CAN or XCP.

SENSOR POWER SUPPLY



CONNECTION VIA SIRIUSi-PWR-MCTS2



CONNECTION VIA SIRIUSi-PWR-MCTS2



Most of the current sensors can get power supply directly out of the amplifier (HS-LV or LV) like Rogowski Coils, AC/DC Clamps, DSI-adapters. For current sensors with high-power consumption like AC/DC fluxgate clamps or the zero-flux transducers there is an additional Power supply unit available, which can be fully integrated into All-In-One Instrument (R8D, R2D) or as external SIRIUS box. the most compact power supply solution on the market.

SIRIUSi-PWR-MCTS2 / SIRIUSir-PWR-MCTS	
Power supply	9 - 36 V DC
Max power consumption	85 W
Physical dimensions	265 x 140 x 65 mm
Operating temperature	-20 °C to 50 °C
Storage temperature	-40 °C to 85 °C
Humidity (@60°C)	95 % RH non-condensing
Output	4 x Isolated Power supply (1500 V DC, 60 sec)
Output voltage	±15 V DC
Maximum output per channel	20 W
Short circuit protection	indefinite (automatic recovery)
Over load protection	150 % of lout max. typ

ACCELEROMETERS



	I1T-50G-1	I3TI-50G-1	I1TI-50G-2	C1T-100G-1	I1TI-500G-1	I1AI-500G-1	I3T-50G-1
Number of axis	1	3	1	1	1	1	3
Sensitivity	100 mV/g	100 mV/g	100 mV/g	50 pC/g	10 mV/g	10 mV/g	100 mV/g
Range	50 g	50 g	50 g	100 g	500 g	500 g	50 g
Type	IEPE	IEPE	IEPE	Charge	IEPE	IEPE	IEPE
Frequency range	+/- 5 %: 0.3 to 5000 Hz	+/- 10 %: 2 to 5000 Hz	+/- 10 %: 0.3 to 10 000 Hz	+/- 8 %: up to 5000 Hz	+/- 10 %: 1 to 10 000 Hz	+/- 10 %: 1.1 to 10 000 Hz	+/- 10 %: 0.3 bis 10 000 Hz
TEDS	yes	yes	no	no	yes	yes	yes
Features	Miniature size	Case isolated, triaxial	Case isolated, industrial	High temperature	Case isolated, modal	Ultra-miniature	Low noise, triaxial
Dimensions	10.2 x 10.2 x 10.2 mm	1 5.5 x 15 x 15 mm	17.5 x 42.2 mm	12.7 x 24.4 mm	19.4 x 12.7 x 16.1 mm	9 x 6 mm	12 x 12 x 11 mm
Weight	4.3 g	10 g	44 g	25 g	10 g	2 g	5.6 g
Temperature range	-51 °C ... +85 °C	-51 °C ... +85 °C	-51 °C ... +121 °C	-51 °C ... +191 °C	-40 °C ... +85 °C	-51 °C ... +121 °C	-51 °C ... +82 °C

ANGLE SENSORS



	DS-TACHO2	DS-TACHO3	DS-TACHO4
Light source	LED	Laser (red class 2)	LED
Housing	Stainless steel	Stainless steel	Stainless steel
Cable length	2.5m cable	2.5m cable	5m optical fiber and trigger box
Frequency range	Up to 4kHz	Up to 4kHz	up to 1MHz
Distance to object	Up to 1m	Up to 7.5m	from 1-10 mm
Power supply	3-15VDC, 45mA	3-15VDC, 45mA	10-30VDC
Operating temperature	-10°C to +70°C	-10°C to +70°C	-10°C to +70°C
Dimensions	73mm length, 16mm diameter	73mm length, 16mm diameter	M6 x 20mm with 2.5m cable
Connector	L1B7m connector for SIRIUS and DEWE-43 counter input	L1B7m connector for SIRIUS and DEWE-43 counter input	L1B7m connector for SIRIUS and DEWE-43 counter input
Accessories	30cm reflector band	30 cm reflector band	1m reflector band with 2mm black/white grid

DS-TACHO1- tacho level adapter	
Description	Converts analog tacho signal to digital signal with adjustable trigger level
Trigger/re-trigger level	±10 mV ... ±2 V (adjustable with screwdriver)
Max input voltage	±50 Vdc, ±100 Vac
Power supply output	5VDC (max current depending on used Dewesoft device: e.g. DEWE-43: max 800 mA)

MICROPHONES



	46BC 1/4" CCP Multifield Microphone Set, High Sensitivity	46AE - 1/2" CCP Free-field Standard Microphone Set	146AE - 1/2" CCP Free-field Rugged Microphone Set IP67	46BE 1/4" CCP Free-field Standard Microphone Set w/o cable	46DE 1/8" CCP Pressure Standard Microphone Set
Frequency range (± 1 dB)	10 Hz-10 kHz	5 Hz-10 kHz	5 Hz-10 kHz	10 Hz-40 kHz	10 Hz-25 kHz
Frequency range (± 2 dB)	4 Hz-20kHz	3.15 Hz-20 kHz	3.15 Hz-20 kHz	4 Hz-80 kHz	6.5 Hz-70 kHz
Dynamic range lower limit with GRAS preamplifier	Max 24 dB(A) Typical 23.5 dB(A)	17 dB(A)	18 dB(A)	35 dB(A)	52 dB(A)
Dynamic range upper limit with GRAS CCP preamplifier	142 dB RMS 145 dB Peak	138 dB	138 dB	160 dB(A)	174 dB
Set sensitivity @ 250 Hz (± 2 dB)	20 mV/Pa	50 mv/Pa	50 mV/Pa	3.6 mV/Pa	/
Set sensitivity @ 250 Hz (± 3 dB)	/	/	/	/	0.8 mV/Pa
IEC 61094-4 Compliance	WS3F	WS2F	WS2F	WS3F	manufactured within same tolerances
Temperature range, operation	-20 to 80 °C	-30 to 85 °C	-40 to 125 °C	-30 to 85°C	-30 to 70°C
Temperature range, storage	-40 to 85 °C	-40 to 85 °C	-40 to 85 °C	-40 to 85°C	-40 to 85°C
TEDS	yes	yes	yes	yes	yes
Weight	8 g	33 g	35 g	8 g	7 g



50GI-R CCP Intensity Probe with Remote Control	
Sound-intensity microphone pair 40GK, phase-matched	1/2" Free-field
Preamplifiers 26CB	Phase-matched
Frequency response and phase-matching	IEC 61043 class 1
Frequency range (± 2 dB)	IEC 61043 Class 1
Frequency range with 100 mm spacer	30 Hz – 1 kHz
Frequency range with 50 mm spacer	80 Hz – 1.5 kHz
Frequency range: with 25 mm spacer	120 Hz – 5 kHz
Frequency range: with 12 mm spacer	200 Hz – 10 kHz
TEDS	yes
Weight	400g



IH-440N-1 MODAL HAMMER	
Number of axis	1
Sensitivity	50 mV/lbf (=11,24 mV/N)
Range	100 lbf (=444,82 N)
Type	IEPE
Frequency range	75 kHz resonance frequency
TEDS	yes
Features	modal hammer with TEDS
Dimensions	221 x 71 mm
Weight	100 g (head)
Temperature range	-40 °C ... +65 °C

VIBRATION SHAKERS



Permanent Magnet Shaker				
	DS-PM-20	DS-PM-100	DS-PM-250	DS-PM-440
Output Force (Sinus)	20 N	100 N	250 N	440 N
Frequency range	0 - 12 kHz	0 - 7,5 kHz	0 - 5 kHz	0 - 5 kHz
Displacement (Pk-Pk)	5 mm	10 mm	25 mm	25 mm
Max Acceleration	30 g	45 g	80 g	80 g
Amplifier (Integrated, External)	I	I	E	E

- Embedded power amplifier and sine generator for PM-20 and PM-100
- Lightweight, durable, portable and easy to use
- Adjustable trunnion base provides high degree of flexibility
- Broad frequency range

Modal Shakers				
	DS-MS-20	DS-MS-100	DS-MS-250	DS-MS-440
Output Force (Sinus)	20 N	100 N	250 N	440 N
Frequency range	0 - 12 kHz	0 - 7,5 kHz	0 - 5 kHz	0 - 5 kHz
Displacement (Pk-Pk)	5 mm	10 mm	25 mm	25 mm
Max Acceleration	40 g	60 g	100 g	100 g
Amplifier (Integrated, External)	I	I	E	E

- Embedded power amplifier and sine generator for MS-20 and MS-100
- Modal stinger can be easily adjusted by the through-hole armature
- Lightweight, durable, portable and easy to use
- Adjustable trunnion base provides high flexibility
- Up to 25mm stroke and broad frequency range

Inertial Shaker				
	DS-IS-5	DS-IS-10	DS-IS-20	DS-IS-40
Output Force (Sinus)	5 N	10 N	20 N	40 N
Frequency range	10-1000Hz	10-3000 Hz	10-3000 Hz	10-3000 Hz
Displacement (Pk-Pk)	1 mm	5 mm	8 mm	8 mm
Shaker mass	0,06 kg	0.21 kg	0.28 kg	0.5 kg
Amplifier (Integrated, External)	E	E	E	E

- Compact and lightweight design
- Superior low-frequency performance
- Any angle mounting
- Low friction bearing guided

DS-WIFI

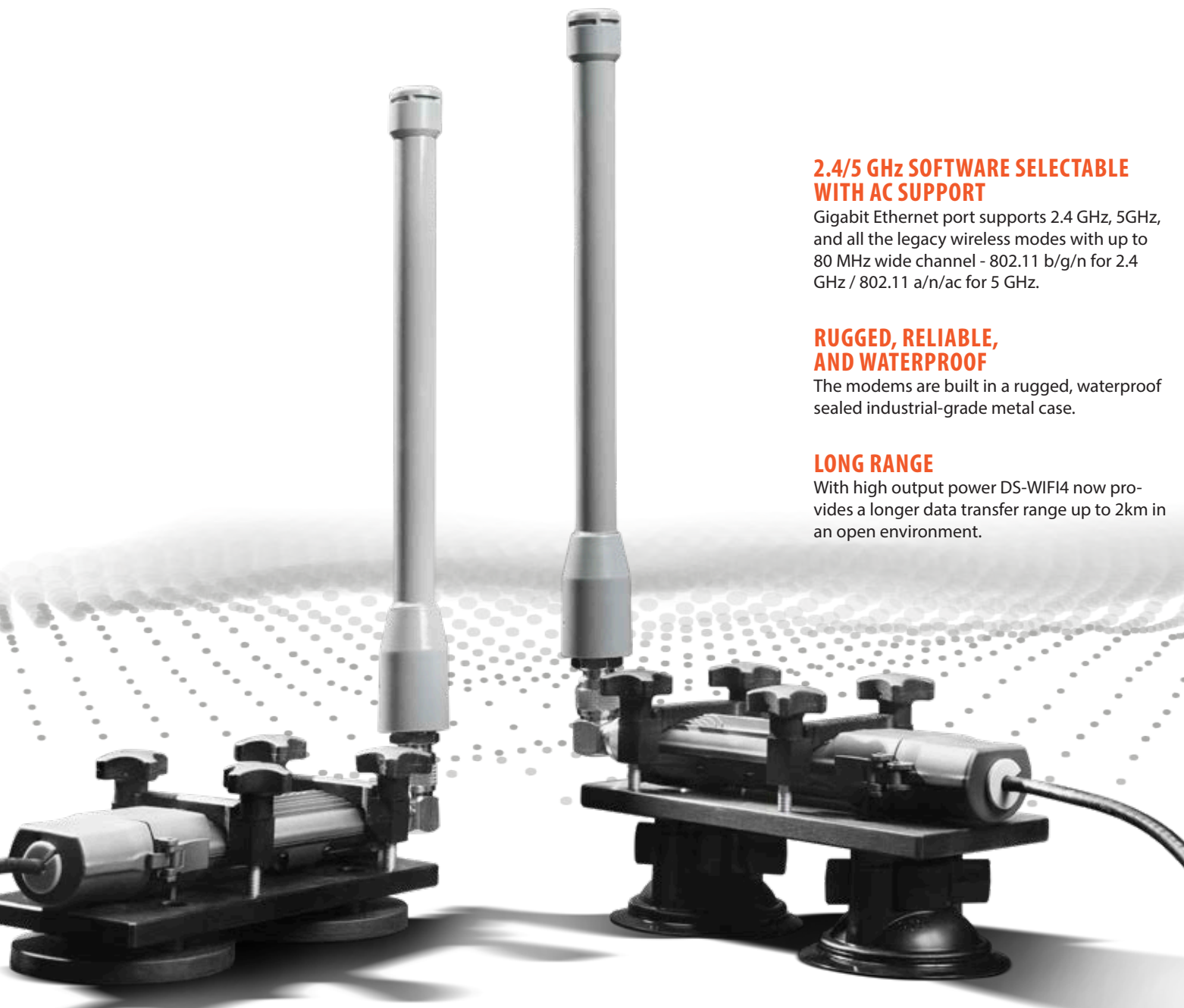

2.4/5 GHz SOFTWARE SELECTABLE WITH AC SUPPORT

Gigabit Ethernet port supports 2.4 GHz, 5GHz, and all the legacy wireless modes with up to 80 MHz wide channel - 802.11 b/g/n for 2.4 GHz / 802.11 a/n/ac for 5 GHz.

RUGGED, RELIABLE, AND WATERPROOF

The modems are built in a rugged, waterproof sealed industrial-grade metal case.

LONG RANGE

With high output power DS-WIFI4 now provides a longer data transfer range up to 2km in an open environment.

SMALL SIZE

Because of the small and compact size of the wireless modems, they can be placed anywhere on the vehicle, motorcycle, or any other object.

MOUNTING ACCESSORIES INCLUDED

The DS-WIFI kit includes all mounting and cabling accessories that you need to connect to your DAQ systems.



DS-WIFI device is a Wi-Fi modem for long-range wireless data transfer between our data acquisition systems. It is perfectly suited for testing moving objects and for remote measurement applications.



DEWESOFT 7-YEAR WARRANTY

Our warranty covers that the instruments function as promised for a period of 7 years from the day of the delivery.

EtherCAT® GPS JUNCTION

Used similarly as ECAT sync junction for synchronization between USB and EtherCAT® based data acquisition devices using GPS as a synchronization time source.

EtherCAT® REPEATER

EtherCAT® repeater is a part of EtherCAT® accessories used for extension of EtherCAT® hybrid cables allowing maximum connection of two 50m long cables.

EtherCAT® HUB

EtherCAT® HUB allows connection and power injection for up to 7 EtherCAT® slave devices (KRYPTON, SIRIUS, IOLITE).



EtherCAT® SYNC JUNCTION

Used to synchronize acquisition from Dewesoft EtherCAT® based data acquisition devices like KRYPTON with USB data acquisition devices like SIRIUS USB and DEWE-43A.

Power and synchronization accessories for KRYPTON and SIRIUS EtherCAT® and USB data acquisition systems.

EtherCAT® POWER INJECTOR

Used to inject additional power into the EtherCAT® measurement chain. It is simply connected into the EtherCAT® chain as any other EtherCAT® DAQ module. ECAT power injector will inject and supply fresh power for all the DAQ nodes.

EtherCAT® POWER JUNCTION

Used to connect any EtherCAT® data acquisition device like KRYPTON or SIRIUS with the power supply and standard PC computer with the RJ45 Ethernet port.

REAL-TIME CONTROL FRONT-END

FULLY SYNCHRONIZED INPUTS

STRAIN
VOLTAGE
TEMPERATURE



DATA ANALYSTS
STORING

YOUR SOLUTION.

DATA RECORDING & CONTROL

SYNCHRONIZED DATA RECORDING FROM A WIDE VARIETY OF SOURCES

All data sources: analog, vehicle interfaces, inertial, video and many others are perfectly synchronized and recorded simultaneously.

PARALLEL REAL-TIME CONTROL INTERFACE

In parallel-to-lossless data acquisitions all signals are available in real time to act as front-end of control systems.

TRIGGERED TRANSIENT RECORDING

Vast variety of trigger conditions can be set for capturing transients.

NETWORKED DATA ACQUISITION

Systems can be easily combined to create large array of channels for largest tests performed in the industry.

ALL APPLICATIONS AND INDUSTRIES

Automotive, aerospace, industrial ... whether it's a few channels or thousands.

C A P T U R E D A T A T O N E T W O R K

E t h e r C A T ® C O N T R O L A N D A C Q U I S I T I O N

S C A L A B L E T O H U N D R E D S O R T H O U S A N D S O F C H A N N E L S

SYNCHRONIZED DATA RECORDING FROM VARIOUS SOURCES



NO HIDDEN COSTS

Free lifetime software upgrades, no maintenance fees, free online training courses.

AWARD-WINNING DewesoftX

One software for all measurement applications. Easy to use, fast learning curve, no programming needed.

PLUG AND PLAY

Any device, sensor or signal.

EASY TO USE AND VERSATILE

Get your measurements in 30 seconds.

FULLY SYNCHRONISED

Data from various sources are perfectly aligned. Analog, digital, counter, vehicle buses, video ...

Testing isn't just analog inputs from one source any more. Today's complex tests can involve outputs from inertial platforms, bus data (CAN, ARINC, etc.), video, and so much more. Only Dewesoft puts it all together, synchronously.

TOTAL SOLUTION

Dewesoft hardware and software forms a total solution for all test and measurement applications.

MODULAR AND EXPANDABLE

Systems can be gradually expanded from one to thousands of channels for any measurement challenge.

REAL-TIME CONTROL SYSTEM FRONT-END

CONTROLLER SOFTWARE

CLEMESSEY SYCLONE
BECKHOFF TWINCAT
ACONTIS
MTS® FLEXTES®
AVL PUMA
INSTRON
....

REAL-TIME DATA
EtherCAT®

CONTROL FEEDBACK
EtherCAT®

< 1 msec

REAL TIME



DAQ DEVICE

SENSORS

ACTUATORS

OPC UA

DEWESOFT FILE

ERP, MES, SCADA

UNIT UNDER TEST



ALL-IN-ONE SYSTEM

Performance testing, vibration, noise, order tracking, balancing, power analysis, thermal and stress testing – these are just a few Dewesoft application areas.

TIME SAVING

By using one system for data acquisition and control, the time required to setup the test bench is reduced typically by 40%.

DATA MONITORING

Test operators can monitor the tests from a safe distance using Dewesoft NET distributed technology.

REAL TIME OUTPUT

Measured data can be transmitted in real-time to test bench control systems (such as the Syclone from Clemessy) with latencies below 1 ms using a second EtherCAT® output, fully parallel with the data acquisition. This greatly reduces system complexity and costs - and improves results.

COST SAVING

Conditioned data are sent digitally, reducing complexity and eliminating conversion and re-conversion errors and inefficiencies.

FLEXIBLE CONFIGURATION

More than 1000 simultaneous channels – and extreme storage speeds.

Data acquisition, control system front-end for rocket and aircraft prototype and production testing.

HIGH CHANNEL COUNT DATA RECORDING

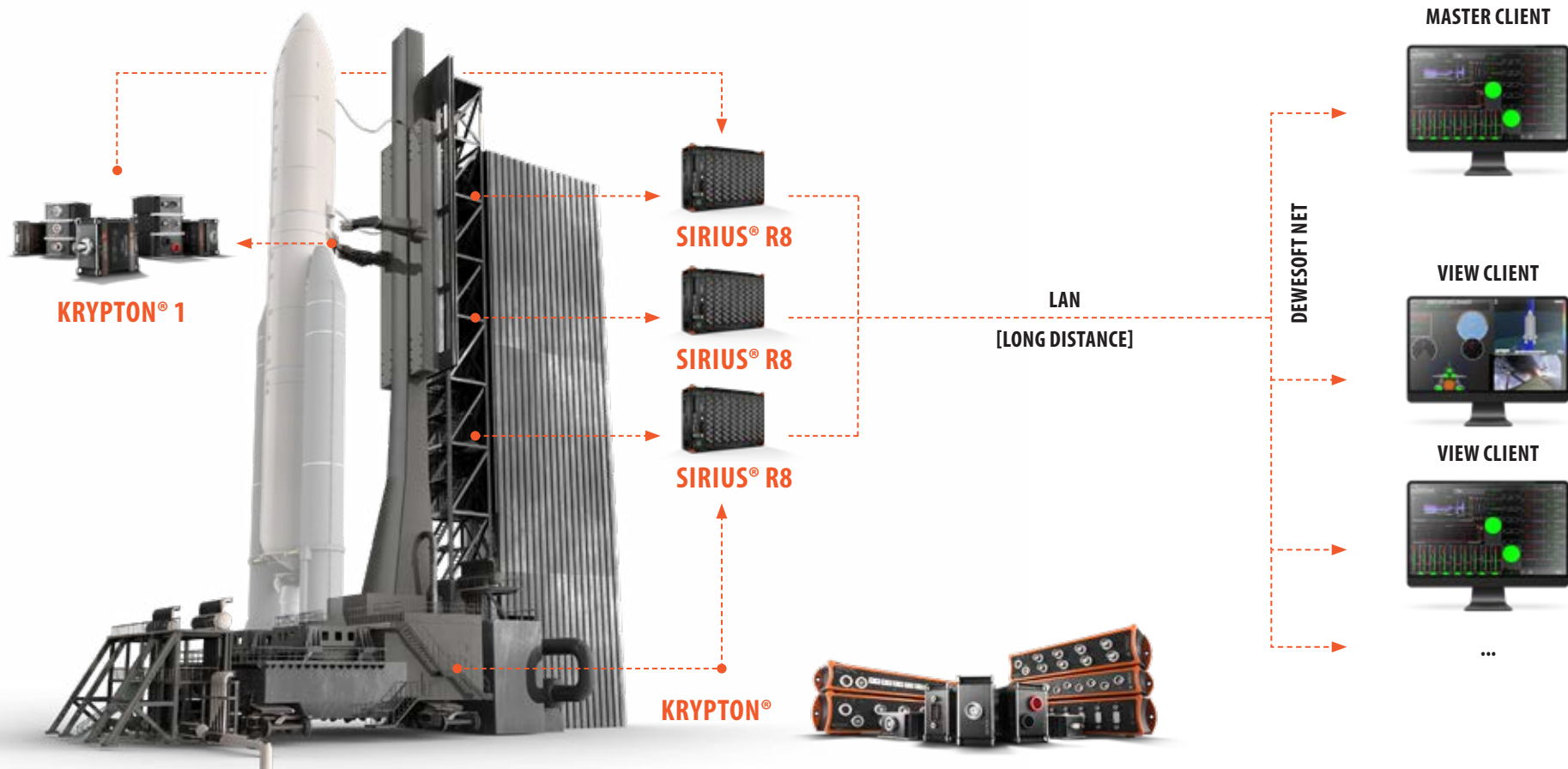

UNLIMITED CHANNEL COUNT

Dewesoft systems can acquire data from thousands of channels from any combination of sensors – even at extremely high sample rates.

RUGGED SYSTEMS

Dewesoft systems are qualified to be used in the most rugged conditions with high temperature, shock and vibration.

REAL TIME VIEW CLIENTS

Data can be observed in real-time by any number of view clients, located anywhere on the network.

Dewesoft system are widely used for data acquisition for launch platforms all around the world.

DISTRIBUTED DATA RECORDING

Virtually unlimited number of channels, synchronized to any external time source. Example: install systems with small or large channel counts at different locations (launch gantry, control room, etc.) and stream data in real-time to a central client. Data are also stored locally in case of network fault, and can be re-synchronized with the central data.

HIGH-SPEED AND TRANSIENT RECORDING

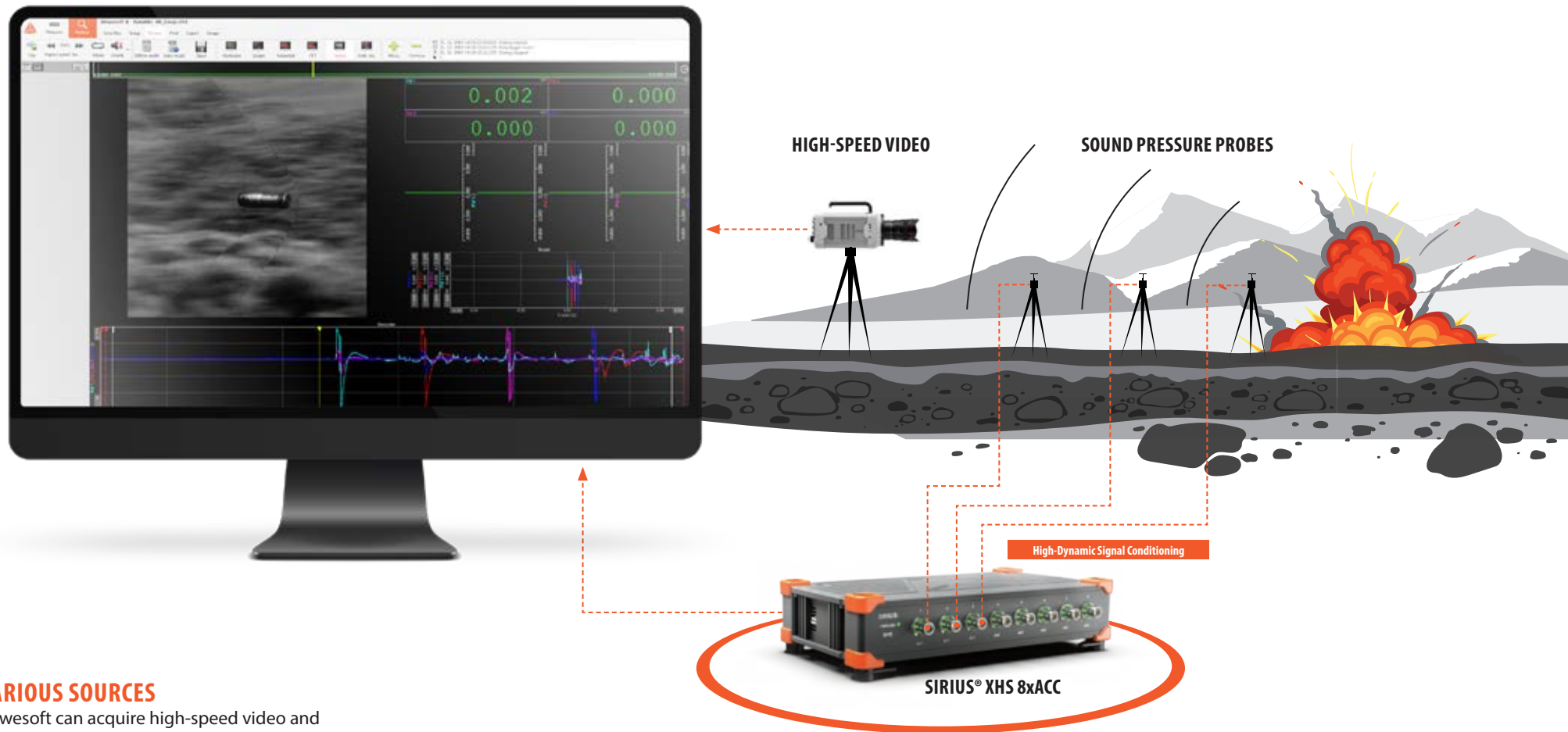

VARIOUS SOURCES

Dewesoft can acquire high-speed video and other data sources with perfect synchronization.

ROBUST, ISOLATED CONDITIONING

Dewesoft signal conditioners acquire voltage, IEPE, charge, strain, high voltage or current signals – and all fully isolated from other channels and ground.

TRANSIENT RECORDING

Advanced triggering capabilities in all Dewesoft systems allow you to capture any event.

STREAMING

When there's no way to predict the trigger event in advance, data can be streamed continuously to disk, at speeds up to and beyond 500 MB/sec! This is also ideal for unrepeatable events like spacecraft launch, or destructive tests.

Dewesoft can acquire high-speed data from transient events including lightning, power supply interruption, blast and explosion testing.

BALLISTICS AND MUNITIONS TESTING

These applications typically require synchronization of a variety of data sources, including pressure sensors, and other sensors distributed at the impact site. Dewesoft can synchronize remote and local measurements, and even integrate high-speed video with the data.

HIGH BANDWIDTH > 5 MHz

HIGH PRECISION: < 0.03 %

HIGH ISOLATION: 1600 V DC

PRECISE

EN50160

SCALABLE

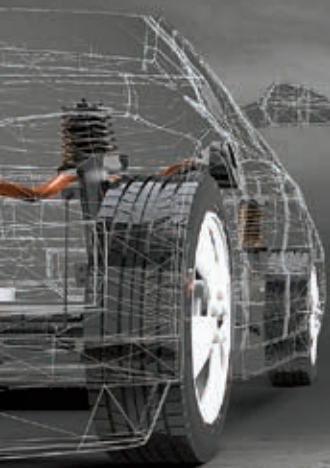

HIGHLY ACCURATE

P O W E R A N A L Y Z E

YOUR SOLUTION.

POWER ANALYSIS

SMALLEST FORM FACTOR

SIRIUS technology allows us to build the smallest Power Analyzer in the world.

HIGHLY ACCURATE

Though extremely small, the Dewesoft Power Analyzer is highly accurate - up to 0.03% accuracy.

FLEXIBLE AND SCALABLE

Dewesoft is much more than just a Power Analyzer. Due to the modular design of the measurement devices the channel count can easily be extended by adding more SIRIUS devices - enabling more applications.

P O W E R Q U A L I T Y T E S T I N

H Y B R I D A N A L Y Z E R

S M A L L E S T F O O T P R I N T

POWER ANALYZER

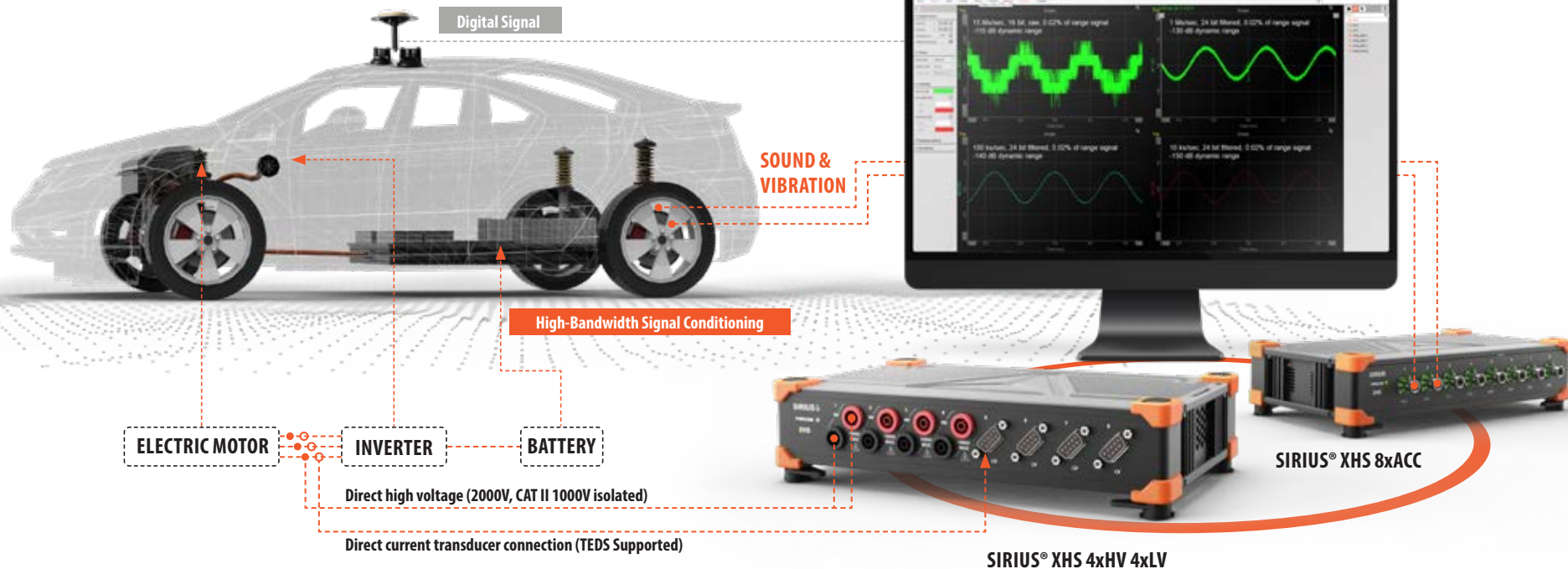

FULLY ISOLATED

Our worry-free solution provides sensor isolation (channel-to-ground), as well as channel-to-channel isolation, and even excitation isolation! Less noise, no ground loops, and the best possible signal quality.

2000 V DC / CAT II 1000 V

Direct input and acquisition of high voltage signals.

0.03 % ACCURACY

We offer high-accuracy amplifiers and sensors for voltage and current measurement with accuracy as high as 0.03 %.

15 MS/s SAMPLING RATE

Dewesoft data acquisition hardware features high sampling rate amplifiers with 15 MS per second sampling rate. Making it ideal for fast transient behavior.

High-sampling rate, high-bandwidth, and high-accuracy hardware for power analysis on electric motors, inverters, transformers, switches and any other electronic equipment. In conjunction sensors can be connected for temperature, vibration, RPM and torque measurement, and more.

CURRENT SENSORS

We offer high-accuracy current sensors such as zero-flux current transducers, flux-gate current transducers, AC/DC current clamps, Rogowsky coils and shunts with the power supply directly from the system.

ADVANCED ONLINE AND OFFLINE MATH PROCESSING

DewesoftX includes an easy-to-use mathematics engine. You can apply math functions during the measurement, as well as during post-processing.

EXTENDABLE MODULAR DESIGN

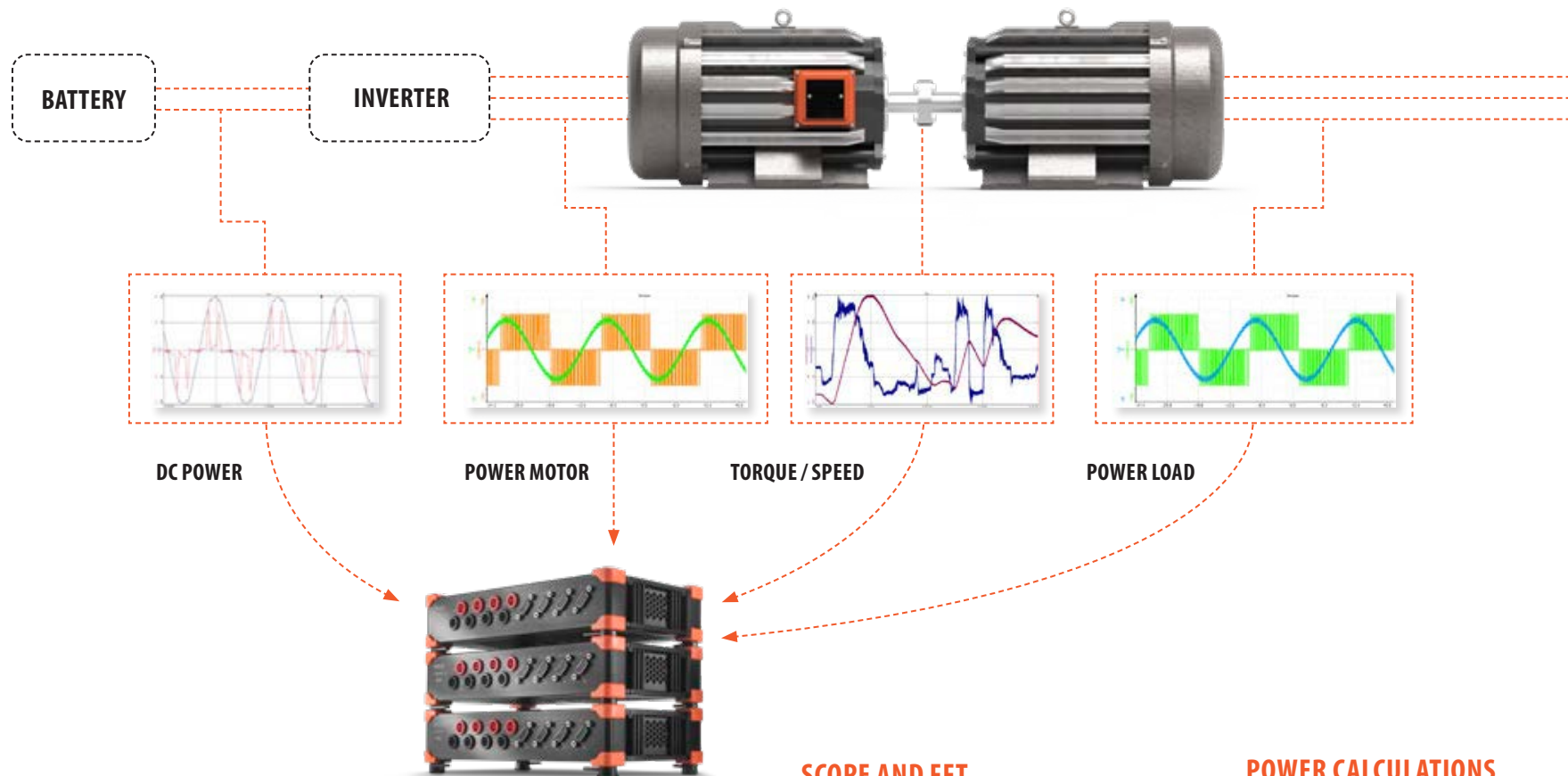

EXTENDIBLE MODULAR DESIGN

Multiple power modules can be stacked to extend channel count - all perfectly synchronized to each other.

DISTRIBUTABLE

Several devices can be over long distances and still be perfectly synchronized for fault location analysis.

HIGH PRECISION POWER ANALYSIS

High-accuracy Dewesoft hardware combined with DewesoftX Power software guarantees reliable measurement results.

Our Power Analyzer isn't just the smallest one in the market - it's also the most capable. Flexible hardware combined with DewesoftX creates a whole new world of testing possibilities for applications across a plethora of industries.

SCOPE AND FFT

In addition to the power analysis other useful tools and visualisations are available such as a Scope, Vector Scope, Harmonic FFT, 2D FFT, and 3D FFT. For example the 3D FFT of a motor run-up will yield valuable information about the behavior of the machine in a single plot.

RAW DATA

Raw data storage is essential for detailed analysis of all measured signals. Transients and Oscillations can be captured continuously or by means of a trigger. Power values in conjunction with raw data allow for immediate anomaly detection.

POWER CALCULATIONS

The system will calculate more than 100 power parameters such as P, Q, S, PF, cos phi and many others. All these calculations can be done during the measurement or in post-processing.

STATIC AND DYNAMIC TESTING

Our sophisticated power calculation algorithms ensure amazing recording results during both static and dynamic recording conditions. Analysis of both low-speed wind turbine power (<10 Hz), and high-speed electric vehicle motors (>5 kHz) is possible. Detailed analysis with period-based values is also included.

E-MOBILITY

ELECTRIC VEHICLE TESTING

ONLINE ANALYSIS OF EFFICIENCY – RECUPERATION – ENERGY BALANCE

The Dewesoft Power Analyzer combining the comprehensive DewesoftX software and the SIRIUS measurement device is the perfect solution for an all-in-one measurement experience for electric vehicles. Measuring any type of motor, be it single phase or multiphase (up to 12 phases), inverter (DC/DC, AC/AC, DC/AC) testing capabilities into the multiple hundred kHz region, as well as measuring battery parameters. Please see the section: Battery testing.

MODULAR HARDWARE DESIGN

The modular hardware design makes it possible to measure power (AC or DC) at multiple measurement points perfectly synchronised. This unique feature provides the flexibility to do a comprehensive analysis of different types of electric drive trains (Single motor, motor-generator, multiple motor configuration from 2 to 4 motors). All the auxiliary loads can be measured and analyzed simultaneously - including heating, air-conditioning, 24 V loads, and 12 V loads to name just a few.

THE HIGH SAMPLING RATE AND BANDWIDTH

The high sampling rate (up to 15 MS/s) and high bandwidth (up to 5 MHz) ensures that the data has the highest quality for the analysis.

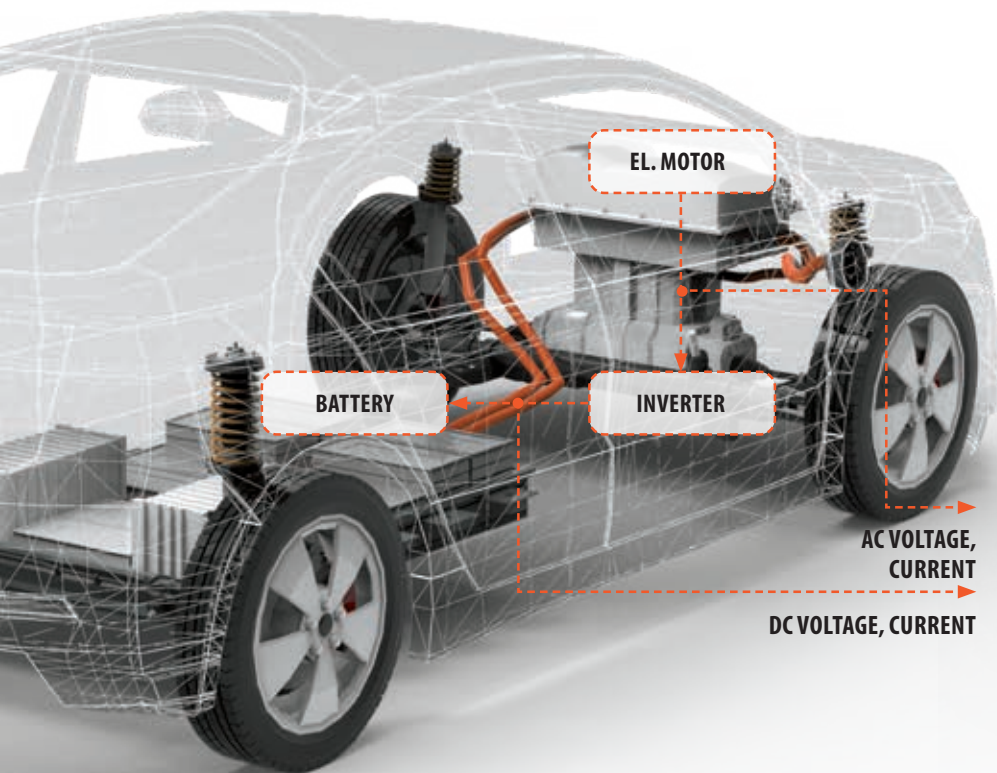

The Dewesoft system is also able to measure various other types of signals such as GPS, vibration, CAN, video, torque, acceleration etc.

The data that is acquired is very versatile, analysis can be done during the measurement as well as in the powerful post processing tool enabling analysis such as energy flow diagrams, influence factors on efficiency, comparison to other vehicles, charging analysis, comparison of different driver behaviour on different drive cycles. By virtue of the small form factor of the Dewesoft devices they can be used in even the smallest electric vehicles.

ANALYZING DIFFERENT DRIVING SITUATIONS

There are various parameters that can influence the energy consumption of an electric vehicle. These could be:

- ambient influences, such as temperature or weather,
- the quality of the road surfaces, or different driving situations (uphill, downhill, city, highway, overland or combined drives), and
- the driver profile, as no two drivers have the exact same driving behavior.

The Dewesoft Power Analyzer is able to do an energy analysis considering all of these parameters during the test drives.

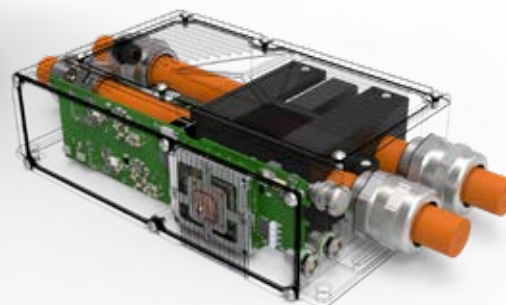

ADDITIONAL AUTOMOTIVE TESTING POSSIBILITIES

The Dewesoft measurement devices can also be used for a variety of other automotive testing procedures see the list of applications. More details can be found in the Vehicle Analysis Solutions brochure.

- Autonomous driving
- Vehicle dynamics
- Ride and handling tests
- Brake testing
- Advanced driver assistance systems
- Pass-by noise
- Combustion analysis
- Torsional and rotational vibration
- Order tracking
- Road load data
- Performance testing
- Component testing
- Modal analysis
- Structural testing
- Crash tests
- Structural testing

On-road testing considering different driving conditions and driver profiles.

SIRIUSi XHS-PWR provides 1000 A calibrated range and up to 2000 A peak current and over 500 kHz bandwidth.

HYBRID & HYDROGEN TESTING

COMBINED POWER AND COMBUSTION ANALYSIS

Combining internal combustion engines and electric motors to propel vehicles can prove to be quite the challenge when measurements of the two propulsion methods need to be compared. This is not the case with the Dewesoft Combustion Analyzer and Power Analyzer.

SYNCHRONISED MEASUREMENT

Due to the modular design of the Dewesoft data acquisition devices these two very different types of propulsion systems can be measured and analyzed perfectly synchronised.

COMBUSTION ANALYZER

The Dewesoft Combustion Analyzer enables the user to display and compare measured parameters using several different diagrams such as, pV-diagrams (pressure over angle) or the CA-Scope (pressure over angle). All CA specific calculations like the mean effec-

tive pressure (IMEP, PMEP), heat release, start/end of combustion (SOC, EOC), start/end of injection (SOI, EOI), indicated power, maximum pressure (Pmax), derivate pressure (dp/da) are presented either as colour diagrams or as data tables. For more detailed analysis, statistical calculations per cylinder or over the complete engine can be performed.

KNOCKING DETECTION AND COMBUSTION NOISE

Dewesoft provides a dedicated knocking detection and combustion noise algorithm. The basis for all of these calculations are precise angle position data and cylinder pressure measurement. Dewesoft provides the ideal hardware for this: the galvanically isolated SIRIUS-Usi charge inputs (with up to 24 Bit resolution) are in perfect sync with the Dewesoft Super-

counters. This allows analysis of hybrid cars during real drive tests.

ELECTRIC VEHICLE TESTING

For more information on the measurements of the electrical parameters please refer to the electric vehicle testing section of this catalog.

HYDROGEN TESTING

Fuel cell vehicles (FCV) use a fuel cell to store hydrogen that is then converted to electrical power by a chemical reaction in the fuel cell that is used to drive the electric. As a FCV has a tank that stores the hydrogen there are a few additional parameters that must be measured. The pressure of the tank needs to be monitored through pressurizing and de-pressurizing tests. The flow velocity of the hydrogen to the fuel cell needs to be monitored. Testing of

pressure relief devices that are temperature dependant for safety reasons in the event of an emergency. These are just a few of the additional parameters that have to be measured. The flexibility and modular design of the Dewesoft data acquisition devices makes it possible to measure all the additional parameters and more - GPS, torque, speed, vibration, CAN, video etc.

High-accuracy combustion analyzer system for engine research, development and optimization as well as testing of ignition systems, exhaust systems, and valve control gear.

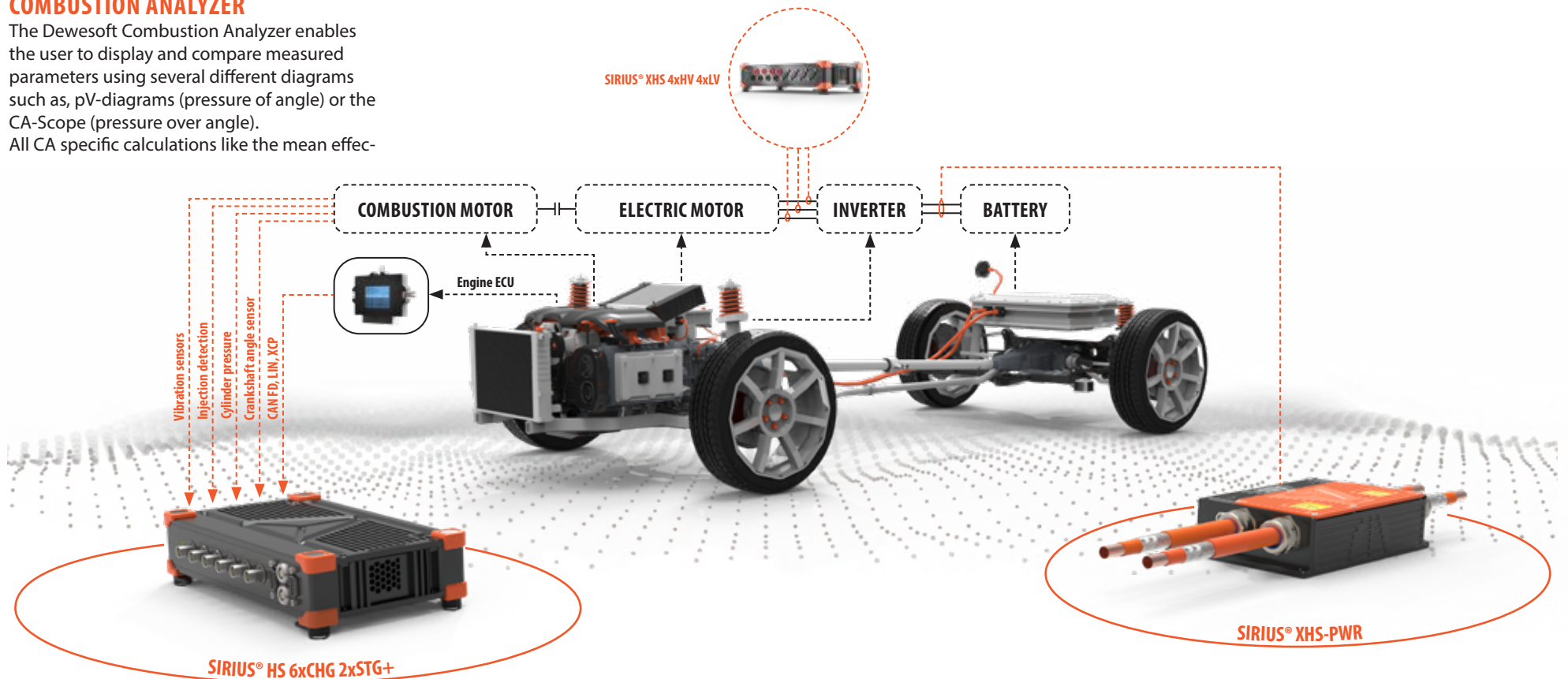

E-MOBILITY

MOTOR/INVERTER TESTING

Combined motor and inverter testing is the Power Analyzers domain. It offers a high number of input channels for both voltage and current measurements, and provides synchronized data acquisition on all channels.

The Dewesoft R8D Power Analyzer can measure 8 x 3-phase systems simultaneously using a single measurement device. This enables the measurement of an entire power system (e.g. electric vehicle, aircraft, ship etc.) completely synchronous.

The analyzer combines the functionalities of motor and inverter testing and analysis as well as the capability to measure other parameters such as speed, torque, temperature, video, GPS, and CAN.

Earlier typical test bed applications required the use of multiple measurement instruments - Power Analyzer, Scope, Data Logger, CAN reader etc. The Dewesoft Power Analyzer facilitates the measurement and analysis of all the data that would have been measured with such devices in a single measurement device.

- Efficiency
- Power & power quality analysis
- Analyzing 1-12 phase motors
- Raw data analysis
- Transient recording
- Data logging
- Scope
- Vectorscope
- Measurements such as speed, torque, temperature, etc...

All the data can be stored at the full-sampling rate and all analysis can be done during the measurement. Furthermore, the unique post-processing functionality enables data manipulation after the measurement (e.g. mathematics, power analysis settings, etc.). For instance if phase voltages were falsely connected this can be rectified, eliminating the need to repeat the measurement.

TYPICAL CONFIGURATION

- 12x Voltage
- 12x Current
- Power Supply for Current transducer
- 1x Torque
- 1x Speed

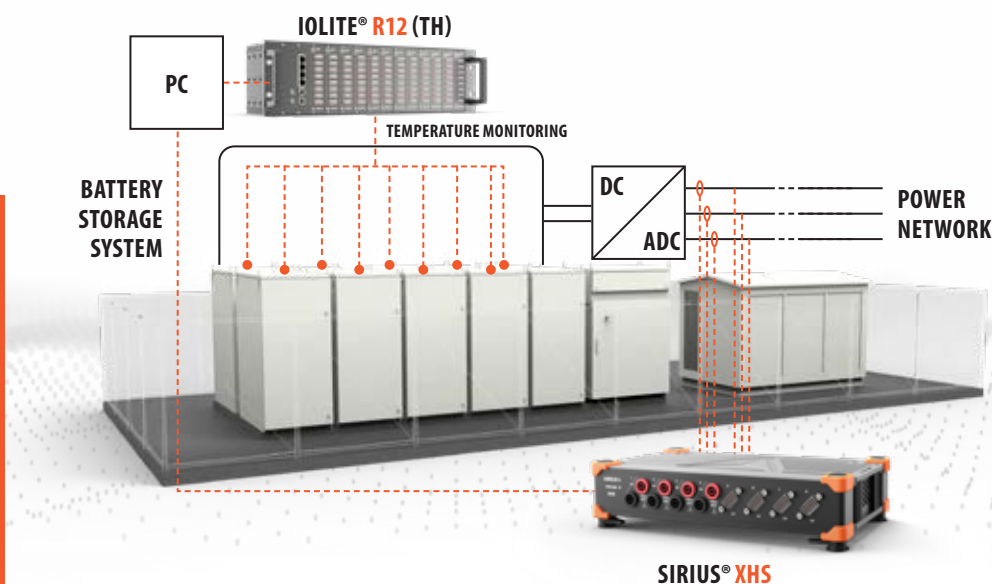

BATTERY TESTING

The batteries in battery electric vehicles (BEVs) are exposed to conditions not optimal for batteries. These include extreme temperatures both hot and cold, humidity, as well as vibrations and shocks. These all have an effect on the stability of power delivery and efficiency of the battery.

EXTENSIVE TESTS

This makes it crucial to do extensive tests on batteries: starting from the cell-characteristics leading up to the complete powertrain of the BEV. Detailed analysis requires temperature and voltage measurement at multiple points e.g. 50x cell voltage and 50x cell temperature measurements.

The flexible and scalable solution from Dewesoft can be configured to encompass over 1000 channels with many different sensors - all synchronised for a detailed analysis.

Battery testing has a broad spectrum of testing requirements, Dewesoft covers them all with ease, whether only one or a combination, the Power Analyzer and Power Quality Analyzer delivers the best results all of the time.

BATTERY DEVELOPMENT

Cell characterisation, endurance and aging tests, shock and vibration, misuse tests such as crash tests, short-circuit tests, overheating-, overloading-, overcharge- tests, forced discharge tests, impact/crush test, thermal misuse,

GENERAL BATTERY TESTING

Voltage and current, power and energy, temperature and humidity, pressure and vibration,

BATTERY CHARGING ANALYSIS

AC/DC charging, charging energy, charge-/discharge efficiency, charging process and time, harmonic analysis as well as inductive and conductive charging.

BATTERY TROUBLE SHOOTING

Such as voltage drops, voltage commutation unbalance and inrush currents.

APPLICATIONS

- Battery monitoring
- Transient recording
- Charge and discharge analysis
- Charging profiles
- Energy delivery
- Efficiency and losses
- State of charge
- Cell voltages and temperatures

EV CHARGING ANALYSIS

CONDUCTIVE AND INDUCTIVE CHARGING

Charging whether conductive (plug-in charging) or inductive (wireless charging) can be analyzed with Dewesoft data acquisition devices, for both alternating current (AC) and direct current (DC).

With higher switching frequencies of the inverter (up to 150 kHz), high sampling rates of up to 15 MS/s ensure that even the fastest transients can be monitored and analyzed.

CHARGING PROFILE AND TIME

This types of tests include analyzing the charging station itself over the different charging levels. Furthermore, they involve analyzing the charging process of the battery starting at the power delivery to the charging station to bulk, as well as the absorption and floating stages of charging.

CHARGE AND DISCHARGE EFFICIENCY

During charging and discharging some energy is lost through heat. The quotient of the amount of energy that is delivered by the battery and the amount of energy that was delivered to the battery, can be measured. Additionally, the efficiency of the drive train from the battery over the inverter to the electrical motor, auxiliary power consumption and finally the actual power that arrives at the wheels, can be measured and analyzed.

TESTBED / ON-ROAD TESTING

Dewesoft data acquisition devices offer the modular design and flexibility that is suited for both testbench testing and in-vehicle testing.

SUPPLY FOR SENSORS

For real-drive tests no auxiliary power is needed from the vehicle. The Dewesoft battery packs - which are hot swappable - can power the Dewesoft system as well as the current transducers and other sensors. With SIRIUSi-PWR-MCTS2 even zero flux transducers that need up to 20 W per unit can be powered. This ensures a true measurement without external influences.

IN-VEHICLE USE

Measurements on BEVs under real-drive conditions require a powerful, mobile, and extra compact measurement system due to the constraints in space. The system also needs to be able to power measurement sensors and other auxiliary systems such as screens directly. Dewesoft Power Analyzers well-suited for this application.

TESTBENCH

Test benches use several important interfaces such as CAN, OPC-UA, DCOM, etc. to receive and relay information. The Dewesoft NET option provides a remote control feature for Dewesoft data acquisition systems, enabling you to control the entire test procedure from a single PC in the control room.

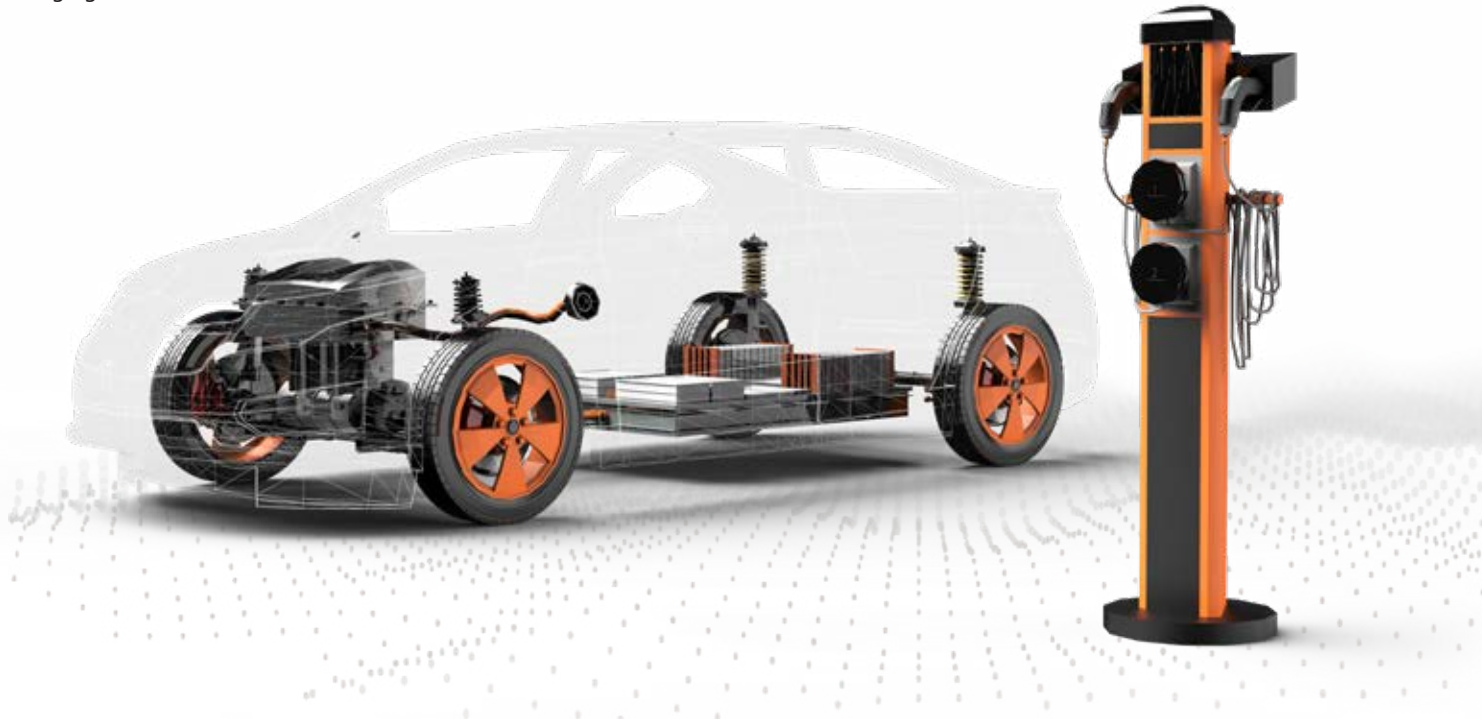

TYPICAL CONFIGURATION

IOLITE® modules
for temperature monitoring
(8x TH, 8x RTD)



SIRIUS® XHS
for inverter monitoring



GRID POWER ANALYZER

GRID ANALYSIS

SMART GRID & ENERGY MANAGEMENT

In conventional power supply systems, the power is produced in big power generation plants (thermal, nuclear, hydro...) and transported via lines to substations, transformers to the customer.

In recent years, the trend toward more renewable energy power plants (wind, solar, etc.) has pushed power supply systems to start moving away from the centralized model. The power grid operators are now facing some inherent challenges.

The systems are designed and built for centralized supply - not for the variable, and intermittent power generation from renewable energy sources, larger loads such as heat pumps and EV charging stations, which are causing transients and voltage quality problems such as dips, swells, or sags.

There is a move toward so-called smart grids, where producers and consumers of energy communicate and interact with each other to avoid problems. They allow for a greater increase in the number of renewable energy

systems entering the power grid. However, the design process and the equipment for such smart grids need comprehensive testing.

With synchronized and distributed measurement capability, the Dewesoft Power Analyzer can measure both power generation and power consumption at multiple points in the grid - a solid foundation for the design and planning of smart grids.

POWER QUALITY ANALYSIS

The power quality can be analyzed and an energy management plan for the operation of both energy production plants and energy consumers, can be compiled. Energy management has the objective of optimizing the energy consumption for the industrial as well as the residential sectors. This includes many activities that will lead to a stable decentralized power grid. These activities include reducing the overall energy consumption, move toward more efficient equipment and technologies and thereby also reducing the costs. The Dewesoft Power Analyzer combined with the ability to measure multiple points in the grid simplifies the identification of numerous

parameters and faults. These include identifying big loads, inefficient equipment, standby consumption, peak loads, harmonic interference, different types of transients, estimation of line parameters, detection of reverse power flows, voltage and frequency behaviour and many more.

TYPICAL CONFIGURATION

SIRIUS R8
4 x Voltage
16 x Current

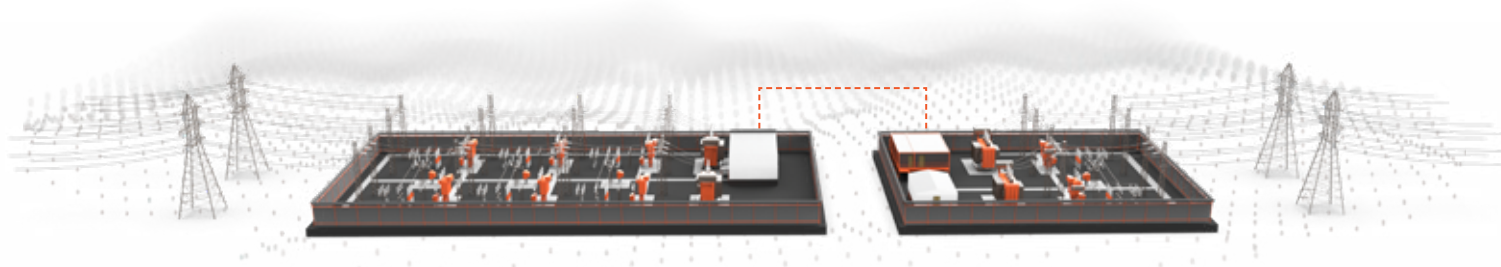

High Voltage Direct Current Cable

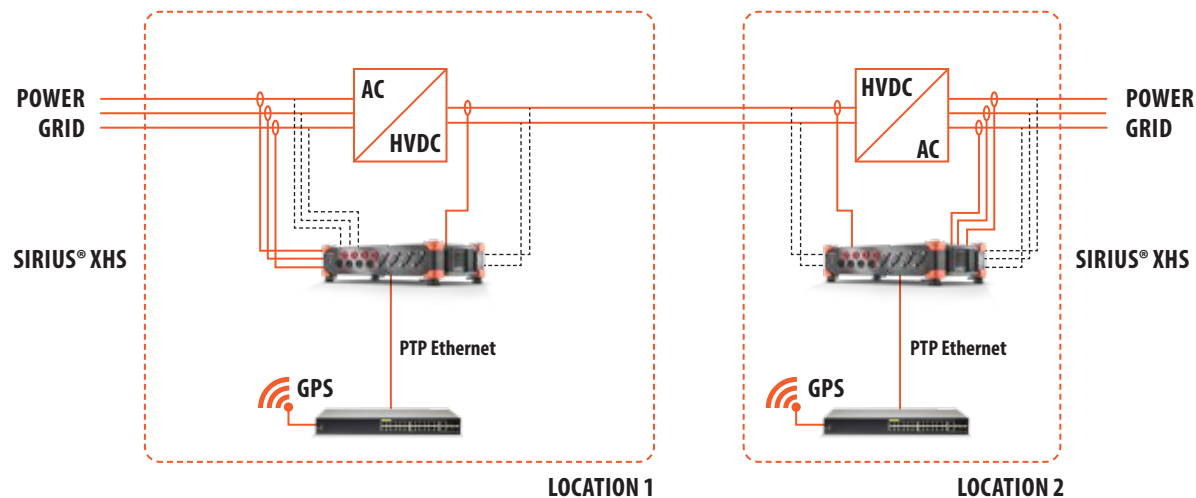

- Power and efficiency analysis
- Multiple power modules analyzed simultaneously
- Synchronous distributed data acquisition
- Interaction between power generation & consumption
- Estimation of line parameters HVDC transmission system analysis

MOTOR TESTING

Motors have to fulfil higher and higher requirements concerning energy efficiency. Dewesoft power analyzer enables comprehensive motor testing.

EFFICIENCY DETERMINATION

There are two ways of determining the efficiency of the motor, the direct and indirect method. The direct method requires a measurement of the input power using a Power Analyzer, and a measurement of the output power by measurement of the rotational speed and the torque that is applied to the motor. Direct method approach is supported within the Power Analysis module with outputs for mechanical power, losses, efficiency and efficiency mapping.

The indirect method is based upon loss segregation and then building a sum of all the losses. There are six measurement points defined in the standard, these are summed together and subtracted from the power input, yielding an output power for efficiency determination.

CLARKE & PARK TRANSFORMATIONS

The Clarke transform can be used to simplify the analysis of three-phase circuits. The difference between the abc reference frame

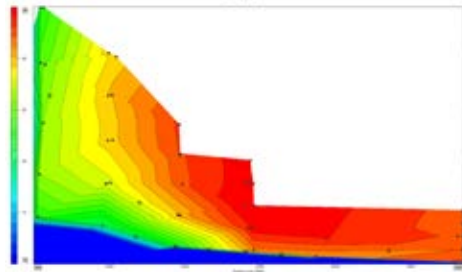

and the $\alpha\beta$ reference frame is that the $\alpha\beta$ domain has projected three balanced phase quantities onto two stationary axes.

The Park transform is conceptually similar to the Clarke transform: Whereas the $\alpha\beta$ (Clarke) transform is the projection of the phase quantities onto a stationary two-axis reference frame, the dq (Park) transform can be thought of as the projection of the phase quantities onto a rotating two-axis reference frame - a rotational transform of the $\alpha\beta$ reference frame.

POWER ANALYZER

The Dewesoft Power Analyzer and the capability of additional software sensor calibration guarantees the highest accuracy measurement results. The modular hardware concept is able to measure multiphase (1 to 12-phase) motors as well as the mechanical parameters such as speed and torque. Furthermore, additional parameters such as vibration, sound level, temperature, etc. can also be measured effortlessly.

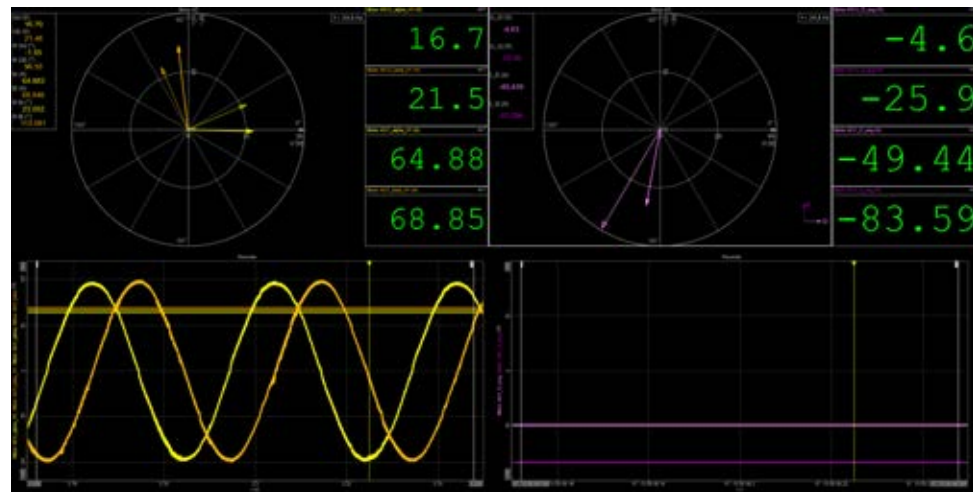

Type of inverter	Input	Output
Industry inverter	1 to 3~AC	3~AC
Electric vehicle inverter	DC	3 to 12~AC
Photovoltaic inverter	DC	1 to 3~AC
Wind power inverter	3~AC	3~AC
Electric two-wheeler	DC	1 to 12~AC

INVERTER TESTING

The Dewesoft Power Analyzer allows for comprehensive and highly accurate analysis of all kinds of inverters. The combination of modular, highly accurate hardware and powerful software can measure any in- and output configuration up to a 7-phase AC system.

Fundamental frequencies from 0.5 Hz up to 3 kHz can be analyzed as well as switching frequencies into the multiple hundred kHz region. The analysis possibilities reach from efficiency determination to a detailed analysis of each switching pulse.

Raw data storing enables detailed analysis and depiction of each individual switching pulse (e.g. transient behavior in the scope). The power quality library automatically calculates THD, harmonics, etc. with the click of a button. A transient recording captures voltage peaks (e.g. with long cable lengths) or captures current peaks which can be any multiple of the nominal current.

POWER TRANSFORMERS

Power transformer testing as described in the international standard IEC 60076, establishes multiple measurement parameters that must be done on the unit. With tools such as the scope and vector scope, voltage ratios and phase displacements of various primary and secondary configurations (e.g. star, delta, and interconnected star) can be analyzed effortlessly.

- Efficiency analysis
- Raw data analysis
- Voltage rise time analysis (dU/dt)
- Transient recording
- Filter analysis

POWER AND POWER QUALITY ANALYSIS

The transient recording functionality with the ability to store all signals at the full sampling rate (up to 15MS/s) ensures a detailed analysis. Combining this with the trigger functionality both failure and transient events (including long-term transformer testing) can be captured and analyzed with ease. The power quality library enables harmonic measurements of voltage and current into the multiple hundred kHz region. The data can be represented as a percentage of the fundamental frequency as required for the no-load current according to IEC 60076.

SYMMETRICAL COMPONENTS

Additionally, the calculation of the zero-sequence impedance is required, this function is built into the DewesoftX power quality library. Power and efficiency analysis of transformers requires the highest measurement accuracy for the phase angles. This is especially important when analyzing units with a low power factor, which is difficult with conventional measurement equipment

TYPICAL CONFIGURATION

- 8x Voltage, 8x Current
- 3x Temperature
- Sound
- Additional Sensor calibration

- Analysis according to IEC 60076
- Correction of power losses depending on temperature
- Additional sensor calibration
- Harmonics
- Symmetrical components

GRID POWER ANALYZER

FAULT/TRANSIENT RECORDING

Power system conditions such as switching operations (capacitor bank connection or disconnection) or some unforeseen system conditions can cause switching transients, voltage interruptions, over-voltages, harmonics, etc. These can affect the function of power system operation, and lead to outages of delivery lines or even cause a complete black-out of the entire power system.

The effects of these unwanted conditions more than often lead to devices seizing to work or even getting completely destroyed, this is especially true for sensitive electronic equipment. The impact of these faults can be very expensive, and time-consuming in the mitigation of these faults.

- High sampling rate up to 15 MS/s
- Storing raw data
- Triggering on different channels (analog, digital, math, power, power quality, etc.)
- Analysis of all line frequencies (16,7 Hz, 50 Hz, 60 Hz, etc.)

DewesoftX SOFTWARE

Being able to store raw data for analysis and the diverse triggering functions offered in the DewesoftX software makes it easy to identify and analyze any kind of fault that may occur. The triggers in DewesoftX can be triggered on any input channel (analog, digital, etc.), as well as being triggered on mathematical channels and standard power channels. Analysis can be done on all line frequencies (16,7 Hz, 50 Hz, 60 HZ, 400 Hz, 800 Hz) as well as variable frequencies for variable frequency

drives (VDF) and inverters. Power quality parameters such as system unbalance, harmonics, THD, flicker, rapid voltage changes etc. can also be acquired and analyzed by the click of a button, all power quality parameters are measured according to international standards.

DewesoftX TRIGGERING

The possibility to acquire the data using the fast-on trigger, slow otherwise option data is stored at a reduced rate (min, max, average and RMS), as soon as an event happens the data is stored at full speed enabling all power parameters for analysis. In addition, it is possible to utilize pre and post times which will store the data at full speed before and after the event for as long as the user-determined pre measurement. This reduces the amount of data that is stored which is handy for long time measurements.

The possibility to use math channels to create combined trigger conditions offers the user the freedom to determine the trigger events for individual events or combinations thereof.

TYPICAL CONFIGURATION

SIRIUS R3
12 x Voltage
12 x Current

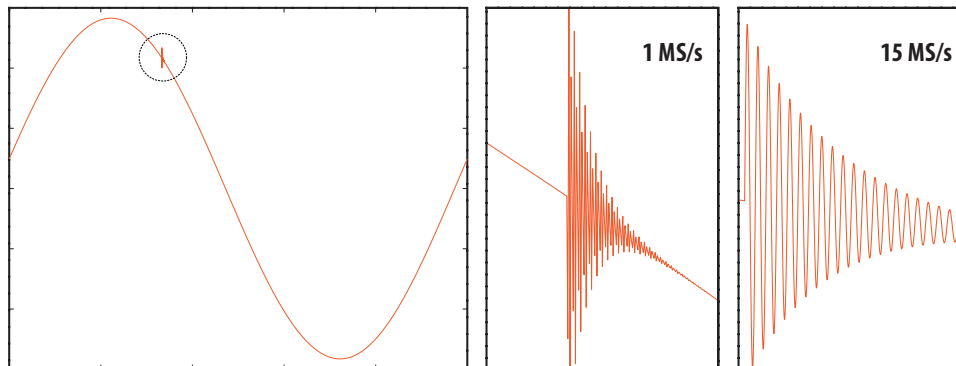

*Comparison of a transient signal captured at 1 MS/s and 15 MS/s.

STANDBY POWER

The IEC 62301, is the internationally recognised standard for the measurement of the standby power consumed by consumer electronic devices. It is estimated that household appliances consume between 5 and 15 % of the entire power requirement of a standard household, while on standby mode. Lowering the level of power consumed by standby power mode can be beneficial for the environment as well as financially.

MEASUREMENT REQUIREMENTS

There are several requirements set for the measurement of the standby power. Measurement devices must be able to measure very low currents (< 1mA) and very low power with specified accuracies depending on the wattage (<0.5 W with an accuracy of 0.01 W, >0.5 W with an accuracy of 2 %). Harmonic analysis up to the 49th order (2.5 kHz @ 50 Hz fundamental) is required and a Data logging capability is strongly recommended. The testing process requires the measurement of the power supply voltage, as well as the THD, temperatures etc. all within the specified limits. With the Dewesoft Power Analyzer all of the required parameters can be measured and analyzed.

DEWESOFT DUAL-CORE TECHNOLOGY

The biggest challenge with measuring standby power is measuring currents with a high crest factor. The high crest factor is caused

by the pulsed current of the power supply units. Furthermore, input filters often produce reactive currents which can be a multiple of the active current. In older DAQ systems these issues forced measurement ranges to be set much higher than required by the pure sinusoidal signal, which decreased the accuracy: The Dewesoft Dual-core technology (incorporates two 24-bit AD converters in parallel: One measuring the full input range and the other measuring 5 % of the range. This ensures high accuracy for both high and low ranges and makes it possible to have a high range and best accuracy simultaneously. This technology is revolutionary for standby power measurements and reaches never-seen accuracies.

TYPICAL CONFIGURATION

1x Voltage, 1x Current
Additional current transducer calibration for 50 or 60Hz

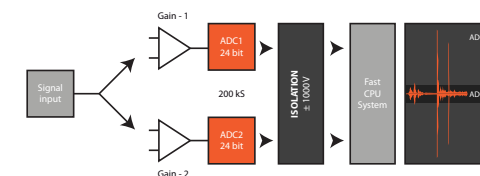

- DUAL-CORE-ADC measurement for low currents with high crest factor
- Harmonics and THD
- Data logging

GRID POWER QUALITY ANALYSIS

The different Power Quality parameters describe the deviation of the voltage from its ideal sinusoidal waveform at a certain frequency. The Dewesoft Power Analyzer is rated to the IEC 61000-4-30 Class A acquisition and measurement devices. When compared to other Power Quality Analyzers Dewesoft offers a more detailed power analysis considering its ability to store raw data, powerful post processing capability, analyzing behavior at faults, and the ability to calculate many additional parameters in the extensive math library. An overview of some of the analyses that can be done at the click of a button is presented below.

HARMONIC ANALYSIS

With the DewesoftX software harmonics for voltage and current as well as active and reactive power can be analyzed up to the 3000th order. All flicker calculations are implemented according to the IEC61000-4-7 standard, and the number of sidebands and halfbands are user-definable. For higher frequency analysis harmonics can be grouped into 200 Hz and 2 kHz bands up 150 kHz. The calculation of THD (Total Harmonic Distortion) for voltage and current up to the 3000th order as well as interharmonics rounds up the harmonic analysis with Dewesoft.

FFT WATERFALL ANALYSIS

In addition to the FFT analysis, the harmonic FFT analysis can also be depicted in either a 2D or 3D FFT Waterfall plot. The visualization is user-definable to be either linear or logarithmic, 2D or 3D, and can also be sorted by harmonic order or frequency. This visualisation is especially useful for the analysis of variable-frequency drives (VFD).

FLICKER AND FLICKER EMISSION

The Dewesoft Power Analyzer measures flicker according to the IEC 61000-4-15 standard.

Flicker emission is calculated according to the IEC 61000-21 and is, therefore, able to evaluate the flicker emission into the grid by wind turbines as well as other power generation units.

RAPID VOLTAGE CHANGES

Rapid Voltage Changes (RVC), describes voltage changes that changes more than 3.3 % in a predefined time interval. This is added as a supplement to the flicker standard. This is a special calculation in DewesoftX, calculating the maximum voltage drop (Dmax), the stationary deviation after the voltage drop (dc) and the specific time where the voltage dropped under 3.3 % of the nominal voltage as specified in the IEC 61000-4-15.

UNBALANCE - SYMMETRICAL COMPONENTS

Normally an electric power system operates in a balanced, symmetrical three-phase sinusoidal steady-state mode. Unbalance in such a system means that the voltages and/or the currents are unsymmetrical. The Dewesoft Power Analyzer has the ability to measure over 50 different parameters for a comprehensive analysis of an unbalanced system (positive, negative and zero sequences). This enables you to calculate multiple parameters for voltage, current, active, reactive, and apparent power. Unbalanced systems can cause the flow of current in the neutral line, heating of conductors and equipment which decreases efficiency, as well as increasing harmonic currents.

FREQUENCY DEVIATION

Frequency deviation is caused by the connection and disconnection of generation units and loads to the grid. These can have severe consequences to the grid stability and even lead to a blackout. The Dewesoft Power Analyzer can be used to monitor the frequency on the grid, as well as for testing the frequency behavior of power generation units when they are in development.

POWER QUALITY ANALYZER

OVERVIEW OF THE POWER QUALITY STANDARDS SUPPORTED BY DEWESOFT

- IEC 61000-4-30, IEC 61000-4-7,
- IEC 61000-4-15, Requirements for Power Quality Analyzers, Calculation of Harmonics, Flicker etc.
- EN50160, EN 50163, IEE519, IEC 61000-2-4, etc. Power Quality limits of public grid, industries and railway applications
- IEC 61400-21, IEC 61400-12, FGW-TR3, VDE-AR4105 etc. Power Quality Analysis of Renewables
- IEC 61000-3-3, IEC 61000-3-11 EMC of voltage changes and Flicker
- IEC 61000-3-2, IEC 61000-3-12 EMC of harmonic current

- Harmonics and THD up the 3000th order
- Interharmonics & higher frequencies
- Flicker, Flicker emission, RVCs
- FFT, harmonic FFT, waterfall-FFT
- Symmetrical components

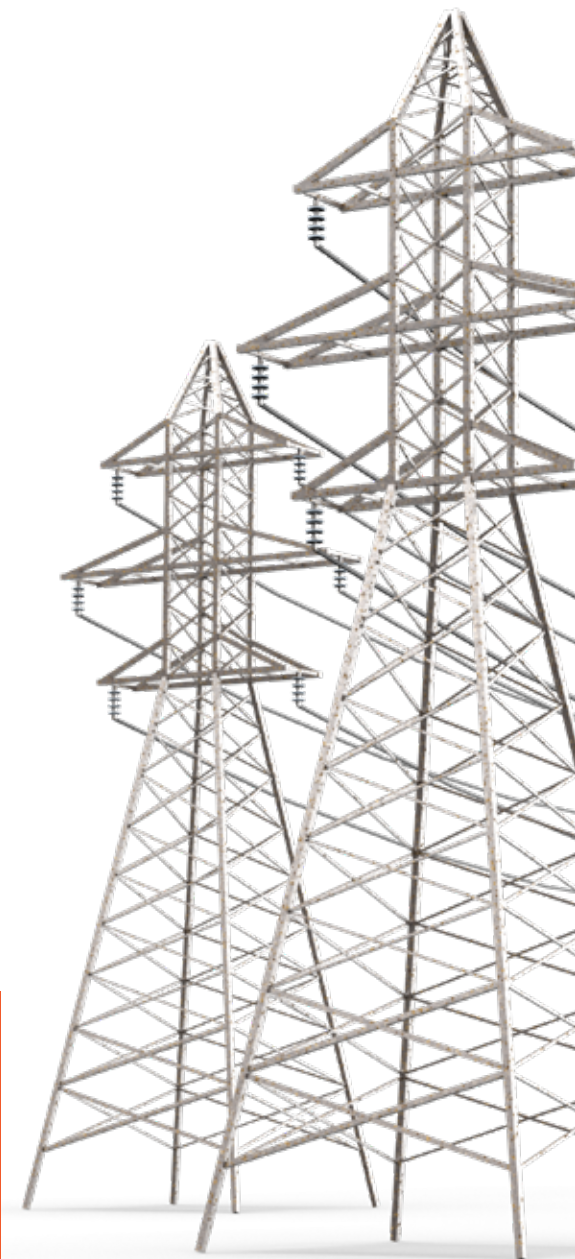

POWER QUALITY ANALYZER

ELECTRICAL EQUIPMENT TESTING & MAINTENANCE - BOTH BIG AND SMALL

ELECTRICAL TESTING

The modular hardware design and the powerful DewesoftX software offer a complete solution for the testing of various types of electrical equipment. The testing of modern electrical equipment in this day and age extends well beyond just fundamental testing. It encompasses so much more ranging from safety, energy requirements, electrical performance, and operation to name just a few. Monitoring In-Rush currents, voltage transients, leakage, load tests, polarity testing, currents, harmonics, and power quality analysis are just a few of the possible applications.

- Electrical stability testing
- Fan and pump testing
- Circuit breaker and switch testing
- Filter analysis
- Castor testing
- Rod-drop testing
- Harmonics analysis according to IEC 61000-3-2/-12
- Voltage changes according to IEC 61000-3-3/-11
- CE conformity of electrical devices (Harmonics/Flicker)

FAULT DETECTION

Testing is the only way that faults in the manufacturing can be identified before the equipment is released into the field. Furthermore, it ensures that the electrical equipment has the ability to be used for its intended function. Tests such as electrical stability testing, fan, and pump testing, circuit breaker and switch testing, filter analysis, castor testing, rod-drop testing, harmonics analysis according to IEC 61000-3-2/-12, voltage changes according to IEC 61000-3-3/-11, and CE conformity of electrical devices (Harmonics/Flicker) to name just a few.

MAINTENANCE AND SAFETY

These tests are done for user safety and liability issues. Handling electrical equipment could pose serious hazards such as electric shock, fires, and even explosions. Furthermore, these tests are done to ensure the quality of the equipment and that they adhere to strict safety standards.

RENEWABLE ENERGY SOLUTION

To maintain a stable and secure power grid operation with a large share of renewable generation, certain standards must be adhered to. DewesoftX provides measurements supported with reporting tools according to FGW-TR3 and VDE-AR4105.

ACTIVE & REACTIVE POWER

The power analysis module provides a comprehensive set of power measurements. Combined with the statistics function the user can apply various statistic operations such as, minimum, maximum, averaged values, etc. to any of the output power measurement channels. This, for instance, allows you to capture maximum power, or check output power deviation, for a specific time interval.

Power plants operate at different setpoints for the injection of active and reactive power. Testing that the regulation controller behaves correctly under changing demand conditions (i.e. if power reduction is within tolerance as the frequency increases if reactive power injection increases as the voltage drops, etc.) is essential for ensuring a reliable network operation with integrated renewables. DewesoftX enables you to perform measurement campaigns storing the data for later in-depth analysis.

POWER QUALITY

Implemented parameters enable you to check equipment compliance to power quality standards such as IEC 61400-21.

Special functionalities are implemented to calculate the flicker parameters (such as flicker coefficient, flicker step factor, voltage change factor, etc.). Switching operations are events that can induce transient behavior, such as oscillations that are not correctly dumped. The power quality analyzer implements period value calculations, for much of the calculations



(P, Q, S, Urms, Irms, ...). Period values enable you to minimize the averaging effect and are ideal for the observation of transients.

The Dewesoft power quality analyzer also provides the classical power quality parameters such as harmonics (up to 3000), interharmonics, and multiple harmonic distortion measurements such as THD.

BEHAVIOUR AT FAULTS

Since our devices enable distributed and synchronous data acquisition, they are ideal for analyzing behavior at faults, such as tripping of a protection relay, recloser, etc. Raw data from multiple points in the grid enables analysis of fault length, type, and specification of short-circuit current.

Particularly in distribution networks, sudden voltage dips can occur, which can lead to unstable operation or even disconnection of certain generator types, the loss of generation causes the voltage to drop even further and this can, in turn, cause a cascading disconnection of other generators on the grid. The generators thus need to be equipped with the so-called Low-Voltage Ride Through (LVRT) capability, which ensures that a generator can withstand certain supply voltage dips. DewesoftX supports the most common standards (IEC 61400-21, FGV TR3) that describe the testing procedures for LVRT capability.

- Power analysis for AC and DC
- Raw data storing (Switching operations, faults)
- Power quality analysis (Harmonics, Interharmonics, ect.)
- Flicker, -emission, -coefficient, -step factor
- Symmetrical components, period values

WIND POWER TESTING

TEST REQUIREMENTS

These tests include electrical measurements such as power performance, power quality, and behavior at faults to name just a few. Additionally, mechanical measurements need to be performed these include testing structural integrity, power generation sound level, and many more.

Power performance analysis according to the IEC 61400-12, in order to determine the power performance of the power plant requires measurements of the voltage and currents but also includes measurements such as wind speed, wind direction, and temperatures. The averaged values from these measurements are classified in BINS, from these BINS indicators such as the performance factor (CP), and the annual energy production (AEP) can be determined.

DewesoftX

The flexible measurement screen visualization setup in the DewesoftX software enables users to analyze graphs such as power factor over wind speed, or tabling the different BINS, wind speed over time, power performance factor, and any other required power parameters round up the complete measurement package.

COMMISSIONING THE POWER PLANT

Before commissioning wind power plants must fulfill the local requirements from local regulators and grid operators. The FGV-TR3 and the IEC 61400-12 are the most popular standards worldwide for testing the power quality behavior and behavior at faults of wind power plants. Parameters such as flicker emission, flicker coefficient, harmonics, interharmonics, and higher frequency emissions are just a few of the test results needed.

These results are handed to the grid operators for confirmation that the wind power plant fulfils all the necessary requirements set by

local and international standards and that all the power quality emissions are within the set limits. Other tests are also possible with the Dewesoft Power Analyzer these include switching operations and low and high voltage ride troughs.

TYPICAL CONFIGURATION

3 x Voltage

3x Current

Additional:

Wind direction, Windspeed, Temperature, pressure, etc.

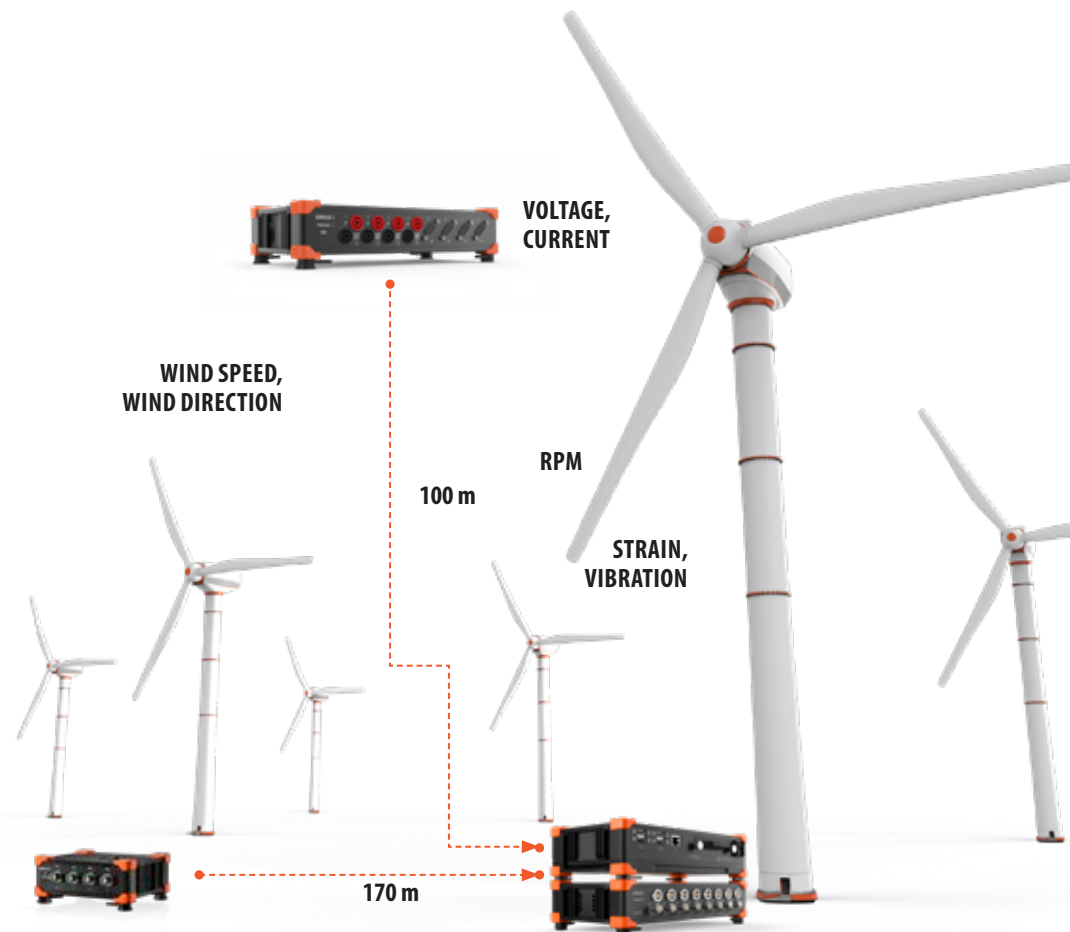

- Power performance
- Transformer testing
- Structural and sound level testing
- Transformer, generator and inverter analysis

POWER QUALITY ANALYZER

AIRCRAFT POWER ANALYZER

The Aircraft Power module calculates the voltage, current and power characteristics of AC 1-phase and 3-phase 400 Hz systems, and for DC supply systems.

STANDARDIZED AIRCRAFT POWER RESULTS

Related standards for aircraft power measurements are listed below:

- MIL-STD-704F
- GJB181x-xxxx
- GJB 5558-2006
- ISO 12384:2010
- ISO 1540:2006

With the compliance to such standards the full set of aircraft power grid parameters can be determined, such as unbalance, modulation amplitude, phase difference, steady-state frequency, distortion factor, ripple amplitude and many more.

LIGHTING DEVICES

The Dewesoft Power Analyzer is able to measure both Efficiency and Power Quality as well as do a full analysis of Lighting systems using a single instrument. This is a new and innovative lighting test experience. The trend towards energy-saving lighting makes fluorescent and LED lights more and more popular. In comparison to incandescent light bulbs, both fluorescent and LED technologies have higher efficiencies.

DIFFERENT CHARACTERISTICS

These technologies have different characteristics that have to be taken into account when doing measurements on them. For instance, fluorescent lighting makes use of ballast units which make use of high switching frequencies of up to 150 kHz.

LEDs are more energy-efficient than incandescent bulbs, but they also have some disadvantages. Using a light-emitting diode that produces a non-linear load can impact the power quality negatively, by introducing noise into the grid. This puts unwanted strain on the AC circuit.

DewesoftX

The high Sample Rate (15 MS/s) of the Dewesoft Power Analyzer guarantees reliable analysis of any kind of lighting system. The power quality library automatically calculates parameters such as Harmonics, THD, Flicker, etc.

The extensive math library is able to calculate efficiency, energy consumption, and many other parameters. For example, the current through a fluorescent lamp can be determined via the math library out of the secondary current and the cathode current.

TYPICAL CONFIGURATION

SIRIUS XHS

3x Voltage

3x Current

1x Low Voltage input for luminance meter

- High switching frequencies
- High bandwidth Harmonics
- THD
- Flicker
- Energy
- Efficiency



OVERVIEW

POWER ANALYSIS

Functionality	Dewesoft Power Analyzer
Power Analysis for DC and AC	✓
Power Analysis	P, Q, S, PF, cos phi, D (Distortion), DH (Harmonic distortion), QH (reactive power of harmonics) (for each phase and total)
Fundamental Power	P_H1, Q_H1, S_H1, cos phi_H1, phi_H1 (for each phase and total)
Voltage and Current	RMS, RM, AVE (star and delta)
Energy Calculation	Total, positive and negative (e.g. Recuperation)
Efficiency	✓
Wiring Schematics	DC, 1-phase, 2-phase, 3-phase delta, 3-phase star, 3-phase V, 3-phase Aron, 6-phase (R2, R4, R8), 7-phase (R2, R4, R8, 12-phase (R4, R8))
Star-Delta Calculation	✓ (waveform and RMS values)
Frequencies	16.7 Hz, 25 Hz, 50 Hz, 60 Hz, 400 Hz, 800 Hz, Variable from 0.5 Hz up to 3 kHz
Frequency Source	Voltage, current, external
Period Values	U, I, P, Q, S, symmetrical components for ½, 1, 2 or 4 periods and selectable Overlap up to 99 %
Number of Cycles for Power Calculation	5 - 12
Power Averaging	Selectable - starting from 1ms , Multiple Averaging (e.g. 20 ms, 60 s, 600 s) possible

POWER QUALITY

Functionality	Dewesoft Power Analyzer
Harmonics (according to IEC61000-4-7)	up to 150 kHz for voltage, current, active-, reactive power, phase angle and impedance
Variable Sidebands and Half Sidebands (according to IEC61000-4-7)	✓
Harmonic Smoothing Filter (according to IEC61000-4-7)	✓
Interharmonics (according to IEC61000-4-7)	✓
Total Harmonic Distortion (THD) (according to IEC61000-4-7)	Voltage and current (Total, odd and even) - selectable up to 150 kHz
Total Interharmonic Distortion (TIHD) and K-factor (according to IEC61000-4-7)	Voltage and current (Total, odd and even) - selectable up to 150 kHz

SOFTWARE FUNCTIONALITY

Functionality	Dewesoft Power Analyzer
Power Analysis	✓
Power Quality Analysis	✓
Database Storing	✓
Post Processing	✓
Math Library	✓
Data logging - Raw data storing	✓ (data Storing at Full Sampling rate of 15 MS/s per channel)
Scope	✓ (up to 8 graphs in one diagram, Zoom In- and Out)
Vector Scope	✓ (1-, 2-, 3-phase systems, Clarke transform, Park transform)
FFT	✓ (up to ½ of Sampling Rate)
Harmonic FFT	✓ (up to ¼ of Sampling Rate)
Transient Recording	✓ (up to 15 MS/s)
Triggering Channels	Analog, Digital, Counter, Math, Power, etc.
Triggering options	Simple edge (rising, falling), Window (two-levels: entering, leaving), Pulsewidth (longer or shorter than duration), Window and Pulsewidth, Slope Trigger (rising or falling slope with steepness)
Functionality	Motor Efficiency Analysis
Dewesoft Power Analyzer	✓ (efficiency mapping)

Higher Frequencies (according to IEC61000-4-7)	up to 150 kHz (grouping in 200 Hz bands, 2 kHz bands optional available)
Flicker (according to IEC61000-4-15)	selectable PST and PLT
Flicker Emission (according to IEC61400-21)	✓
Rapid Voltage Changes (according to IEC61000-4-15)	selectable steady state and hysteresis
Symmetrical Components (according to IEC61000-4-30)	Zero-, positive- & negative system for voltage and current (absolute or relative to fundamental)
Additional Symmetrical Components (according to IEC61400-21)	Active and reactive parts for zero-, positive- & negative system

H A R S H E N V V E H I C L E D Y N A M I C S



R O A D L O A D D A T A

I R O N M E N T T E S T I N G

YOUR SOLUTION.

F A T I G U E

VEHICLE ANALYSIS

WIDE VARIETY OF SOURCES - ALL SYNCHRONIZED

Dewesoft supports wide variety of analog and digital measurements, vehicle bus systems, GPS, inertial platforms, video, ... everything perfectly synchronized.

EXTREMELY DEEP IN FUNCTIONALITY

A single software provides perfect analysis tools for vehicle dynamics, road load data analysis, ADAS, electric, hybrid and combustion analysis, harsh testing, brake test, brake squeal and others.

SOFTWARE INCLUDED WITH FREE LIFETIME UPGRADE

Award winning Dewesoft software is included with every instrument. All upgrades to the software are free forever with no hidden licensing costs.

A D A S

B R A K E T E S

N A N A L Y S I S

H Y B R I D A N A L Y Z E I

ROAD LOAD DATA ANALYSIS

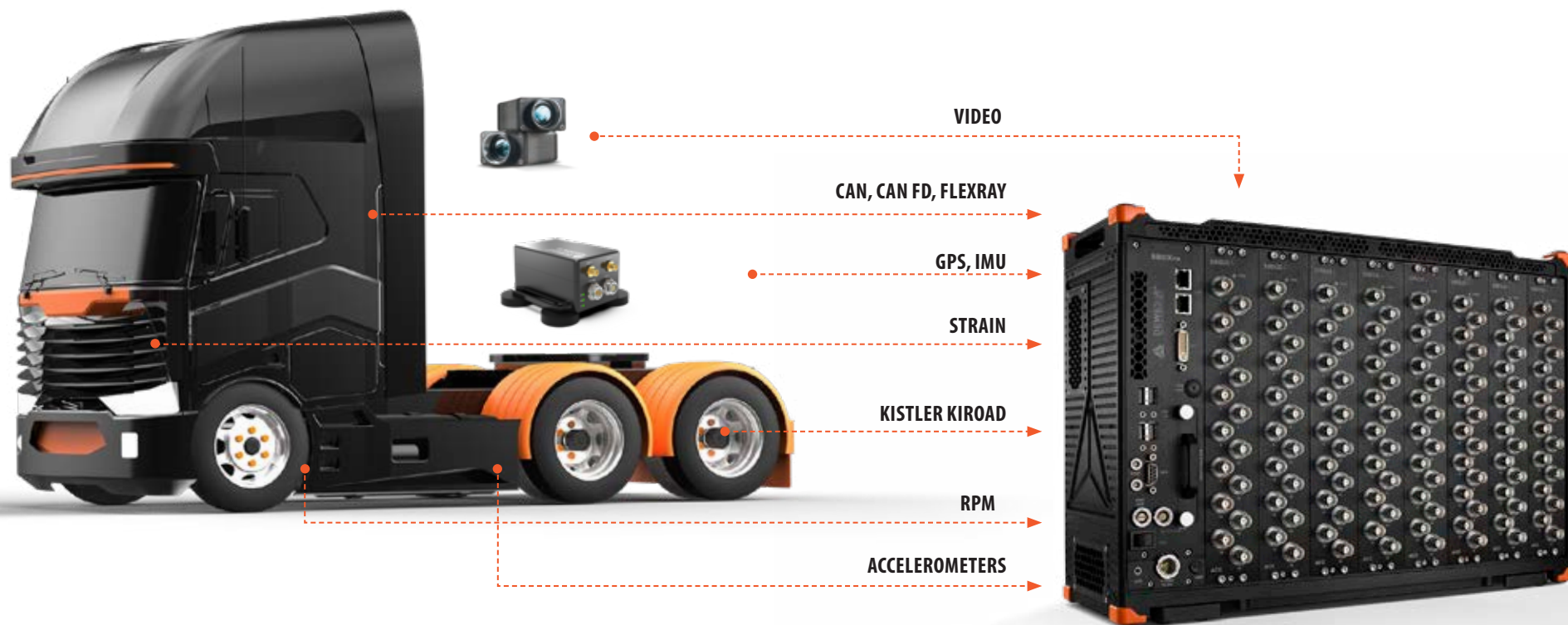

IN VEHICLE DATA COLLECTION

Virtually any analog, counter, and digital sensor can be connected to the system. Measure vibration, strain & stress, acceleration, forces, wheel speed.

OTHER DATA SOURCES

Additional synchronized acquisition of other sources is possible within the same system – Kistler RoaDyn, Kistler Kiroad wheel force transducers, GPS, inertial sensors, CAN, CAN FD, OBDII, J1939, LIN, FlexRay, XCP/CCP, Video, etc.

PERFECT SYNCHRONIZATION

Acquired data from various sources are synchronized with microseconds accuracy.

RPCIII EXPORT

Data analysis and replay data can be directly exported to standard RPCIII format.

Durability measurements during actual test drives or on testbeds, either for entire vehicle or certain components. Various smart technologies eliminate re-testing, and dramatically shorten test time.

ADDITIONAL ANALYSIS

Combine different applications and analysis with the same system. Vehicle dynamics, combustion analysis, vibration, etc. can be combined in one synchronized data file.

DURABILITY TESTBED INTEGRATION

SINGLE MEASUREMENT

Dewesoft system can store synchronized data from SIRIUS devices with data from Kistler KiRoad or Roadyn2000 and other WFTs, along with vehicle CAN FD, Flexray, LIN, SENT, XCP, CCP and other sources.

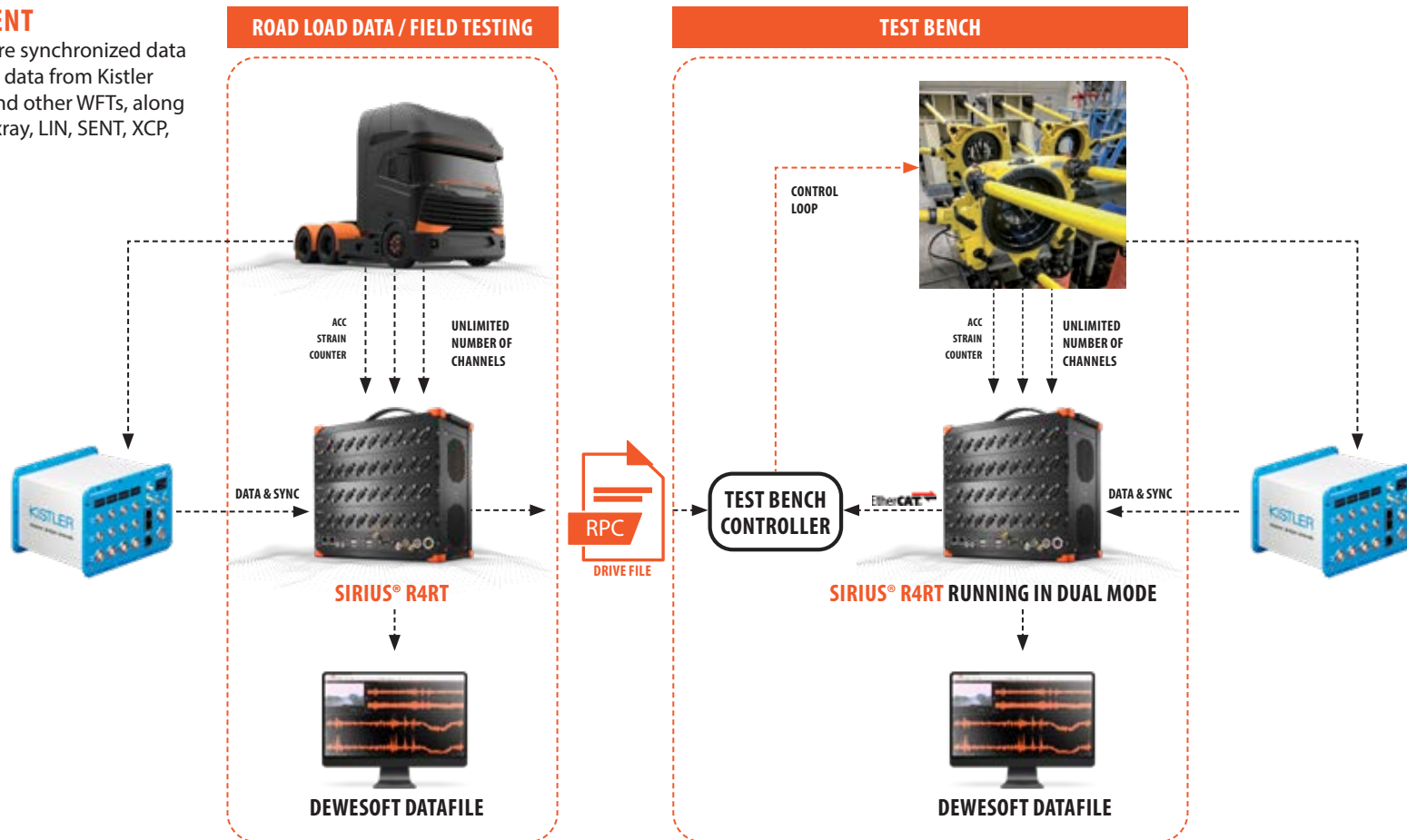

TEST BED INTEGRATION

The EtherCAT® slave port on the R8RT and R4RT can feed the data to any EtherCAT® master controller in real-time. This solution offers easy integration with MTS and Instron road load simulators, with just one cable.

REDUCED COMPLEXITY

Compared to traditional sensor input -> analog out -> analog in the conditioned data is sent digitally and therefore greatly reduces complexity of the system.

Analog signal transfer is a thing of the past with Dewesoft's all-in-one durability test solution. Save time and money by using the same system for acquisition and driving the testbed - using a single EtherCAT® cable.

PORTABLE SETUP FILES

Dewesoft allows easy transfer of the channel setup to MTS testbed reducing setup time and risk of error.

ANALOG OUTPUT

The Dewesoft R8 with optional rear analog outputs is the perfect solution for replaying recorded data, and transmitting analog signals to control the test bed.

ONE SYSTEM FOR ROAD AND LAB TESTING

Save your money! A single Dewesoft system can be used to record data on real or proving ground roads - and also in the lab, to replay the recorded data into the road load simulator.

COMBUSTION & HYBRID ANALYSIS

MULTIPLE DATA INTERFACES

CAN, CAN FD, J1939, XCP, CCP, LIN, SENT, Mod-Bus, OPC UA, Flexray, Ethernet, GPS, Video,...

DIRECT SENSOR SUPPORT

Integrated charge type amplifier for cylinder pressure sensors and direct connection of any RPM sensor (stock - 60-2, encoder, CDM+trig).

NEW KNOCKING ALGORITHM

Knocking can be accurately detected and measured with the updated knocking algorithm with an output of the actual knocking signal curve.

PERFECT INTEGRATION

Interface to testbed via AK-protocol for laboratory use. CAN or XCP compatible with ETAS INCA, Vector CANape, or ATI Vision for mobile use.

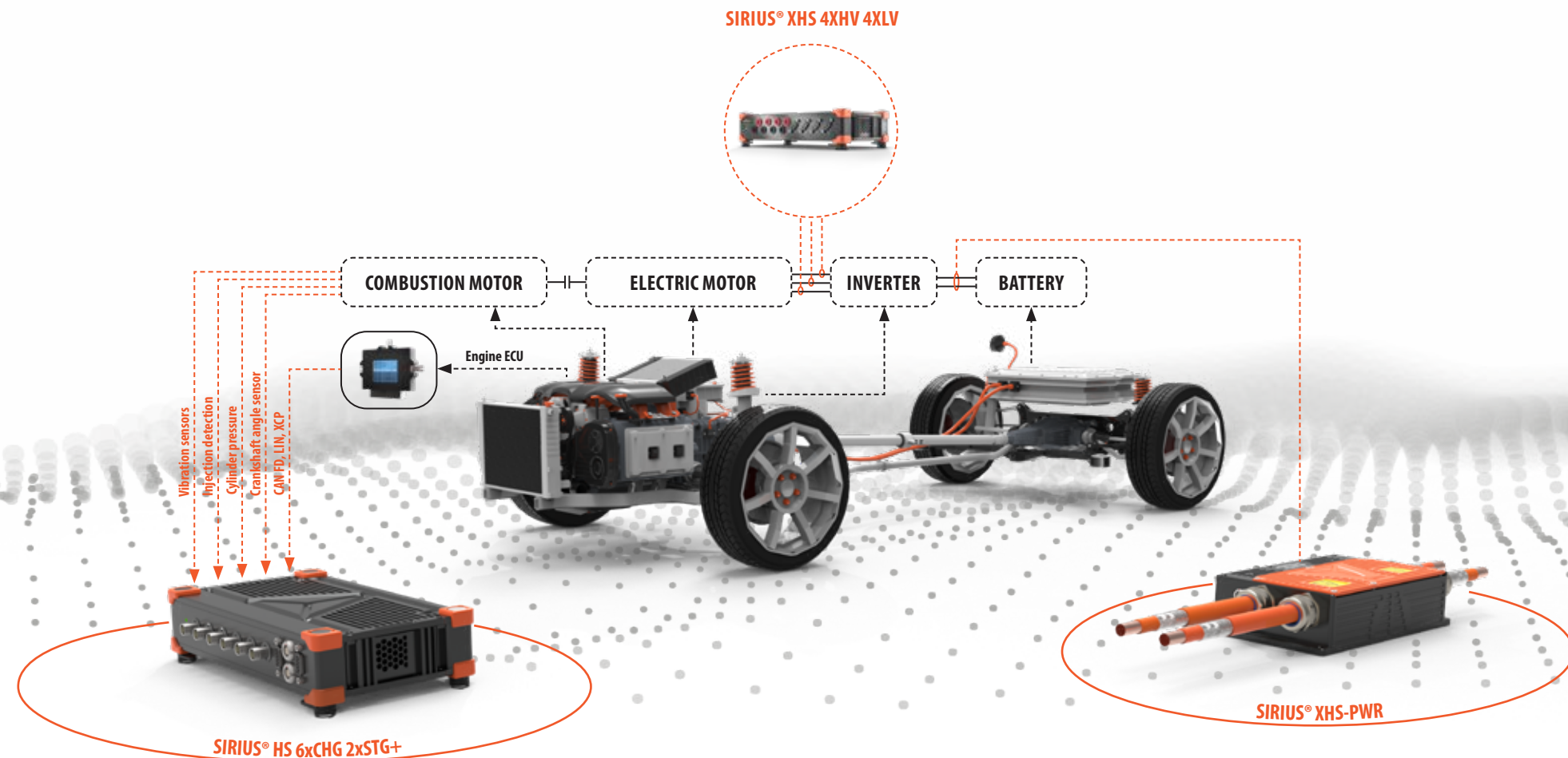

COMBUSTION & HYBRID ANALYSIS

ADVANCED CALCULATIONS

Knock detection, thermodynamics, polytropic coefficient, compression curve...

READY FOR ANY ENGINE

Cylinder deactivation, variable compression ratio, dual polytropic coefficient with automatic detection and input.

STANDARD OUTPUTS

Maximum pressure, MEP, power, work, torque, temperature, average outputs...

HIGHEST ACCURACY

Angle resolution from 2° to 0.025° crank angle.



Complex measurements made easy with our new combustion analyzer. From the smallest single cylinder engines to the largest multi-cylinder ones. Simultaneous use of the combustion analyzer with the power module makes the perfect solution for hybrid engine test!

BRAKE NOISE



VDA 303 AND SAE J2521

Software is developed according to VDA 303 guideline and compatible with SAE J2521.

SQUEAL TRACKING

Each detected squeal is tracked. During the squeal event, statistics on squeal parameters and other DewesoftX channels (temperatures, RPMs, vehicle speed...) can be calculated.

CALCULATION SETTINGS

Squeals are detected from amplitudes of sound and mechanical vibration. Fourier transformation settings are integrated. Only direct time-domain measurements are needed to detect squeal events.

Detect and track brake noise events from microphone and accelerometer measurements.

EASY PAIR DEFINITION

Detects squeal events from paired microphone and accelerometer measurements. Pairs are generated automatically from specified accelerometer and microphone channels.

FLEXIBLE CONFIGURATION

The number of microphone and accelerometer channels is not limited by the software.

BRAKE TESTING

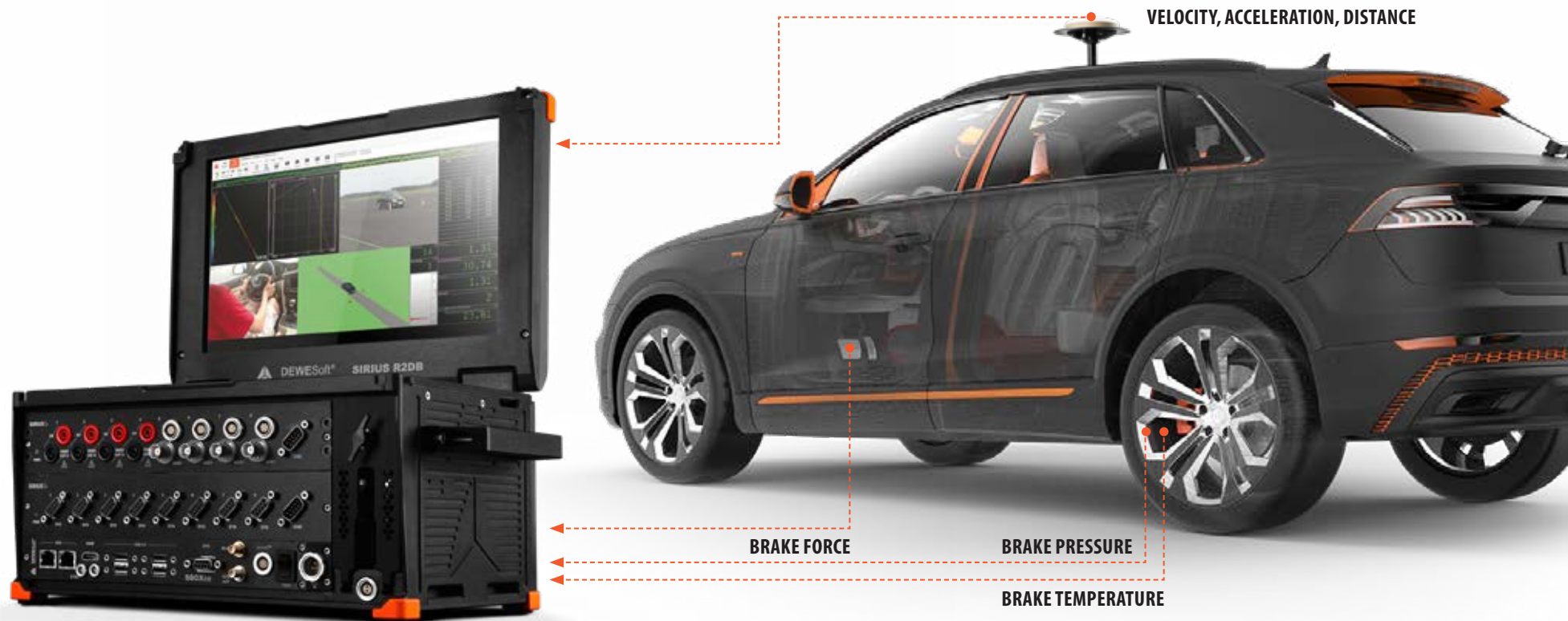

ONLINE CALCULATIONS

Instant calculation of outputs like MFDD, start speed, stopping time, corrected brake distance, brake deceleration, maximum deceleration and custom outputs.

REAL-TIME RESULTS

Results validated and visualized in real-time during the test allow an easy check if the tests are successful.

The brake test system from Dewesoft is very flexible and covers all kind of brake tests, braking comfort and testing vehicles with regenerative braking.

SUPPORTS STANDARDS

Brake tests according to several international standards like ECE13H, FMVSS 135, etc.

BRAKE PEDAL SENSOR

Direct brake pedal force, travel, and pressure sensor inputs via analog or CAN interface.

AUTOMATED WORKFLOW AND REPORTS

Automated testing procedures and reporting.

WIDE RANGE OF APPLICATIONS

Built-in analysis of standard brake tests, plus ABS testing, braking comfort, and brake squeal allow for additional test standards or maneuvers to be performed, such as tire, acceleration, handling, and/or fuel consumption tests.

BRAKE TEMPERATURE

Measures and logs multiple brake temperature and pressure channels.

POLYGON AND GPS SOLUTIONS



3D VISUALIZATION

Freely definable view angles gives a perfect view of the manoeuvre.

ANY GPS DATA SOURCE

GPS data from various sources can be used for measurement, and as inputs for the Polygon module. CAN, Ethernet or RS232 data can be read directly from 3rd party devices.

UNIVERSAL

Suitable for ground, air (high G testing, performance testing) or sea (handling tests, pass by noise, obstacle avoidance test) applications.

EXACT VEHICLE SHAPE

2D shape of the vehicle can be defined for exact front and rear vehicle reference point outputs.

PERFECT HARDWARE

Synchronous acquisition of 2 cm RTK GPS and IMU sensor with additional analog, digital and vehicle bus channels.

The Dewesoft polygon option is the most versatile and widely used tool for performance tests. Along with the new OpenStreetMaps widget, it makes the ideal vehicle testing suite.

PARAMETER OUTPUTS

Each calculated parameter like distance, position, time to collision or overlapping are available as output channels.

NEW MAP WIDGET

Uses a tile server hosted by Dewesoft (OpenStreetMap). Online or offline (pre-downloaded) map usage possible. Multiple tracks can be displayed at once with channel based color tracking.

ADAS TESTING

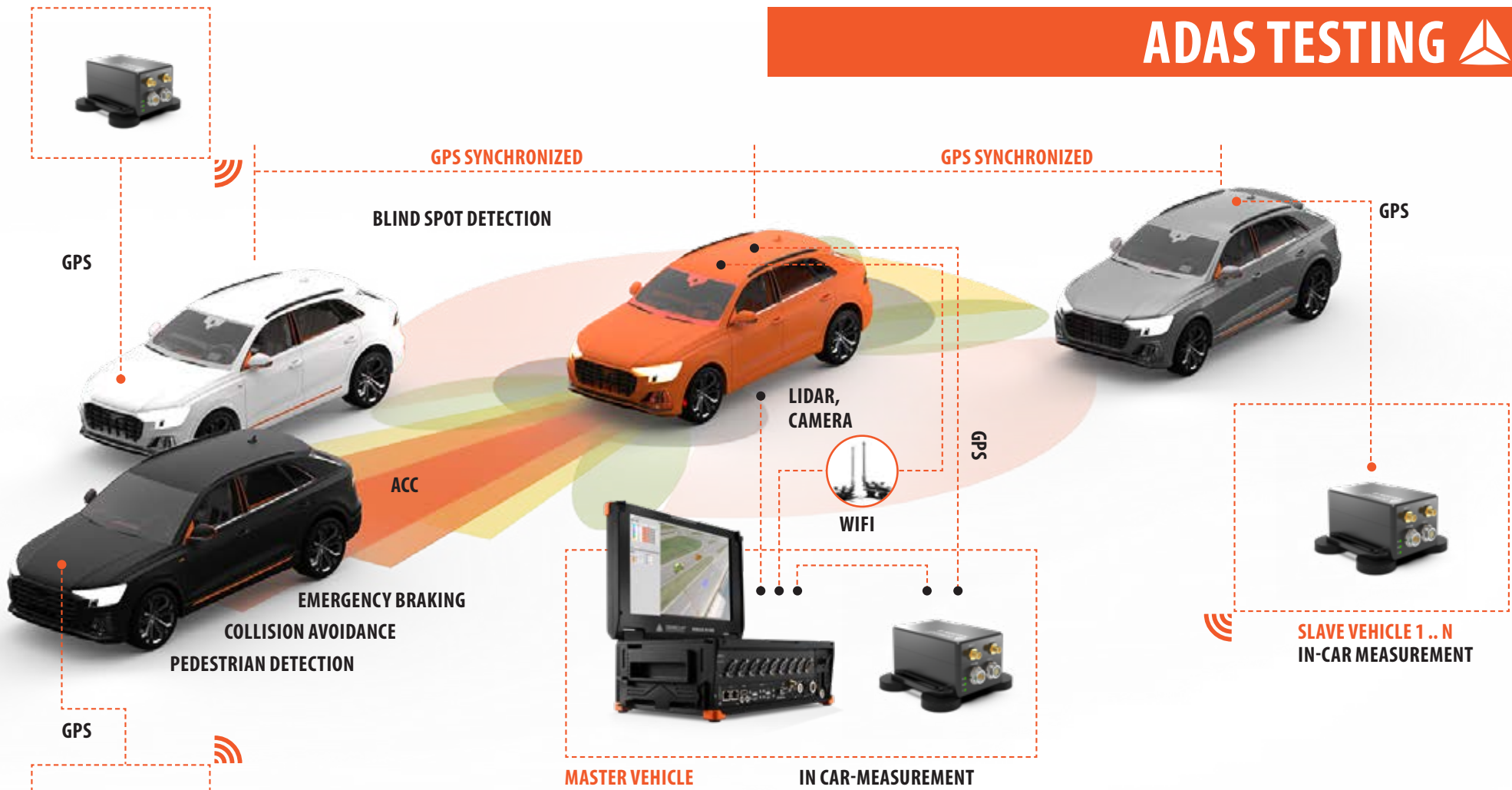

PRECISE GPS AND IMU

Rugged and reliable miniature GPS aided inertial navigation system with high dynamic, 100 Hz update rate and static initialization. High-accuracy GPS or IMU with optional RTK support, offering 2 cm positioning accuracy.

Easy-to-use ADAS validation system with the latest GPS and IMU technologies with 2 cm accuracy. Advanced driver assistance systems are automated, which increase safety and improve the driving experience.

POLYGON WIDGET

Powerful 3D visualization of moving and static objects at any position.

POLYGON MATH

Math functions to place several moving and static objects and calculations of real-time positions, distances and angles from any object to another as well as collision calculations.

3RD PARTY DEVICE INPUT

Direct support for OxTS, Genesys and LORD inertial platforms.

RANGE OF APPLICATIONS

Collision avoidance testing, blind spot detection, adaptive cruise control testing, autonomous vehicles testing, lane departure warning, and lane assist system testing.

VEHICLE DYNAMICS

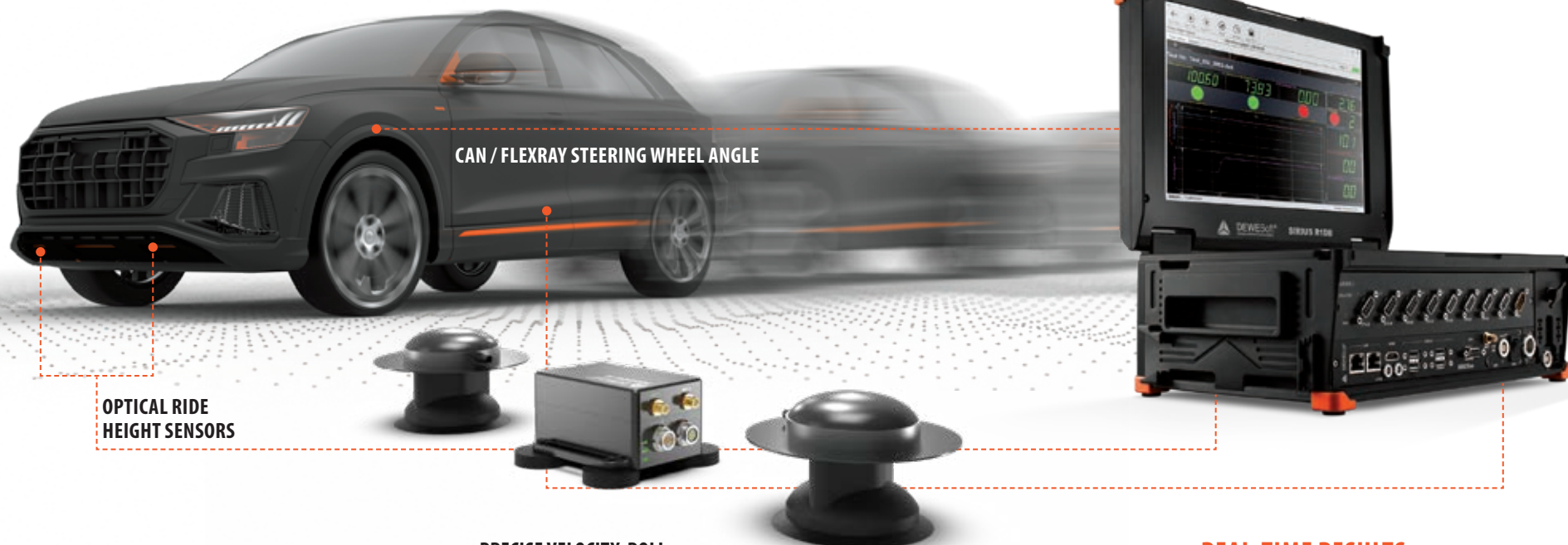

OPTICAL RIDE
HEIGHT SENSORS

CAN / FLEXRAY STEERING WHEEL ANGLE

PRECISE VELOCITY, ROLL,
PITCH, HEADING

The Vehicle Dynamics is a plugin for standard test maneuvers for vehicle dynamics with quick pass/fail evaluation for the driver.

Test type	Ref. standard
Steady-state cornering	ISO 4138
Step steer input	ISO 7401
Step steer non-linear	Based on ISO 7401
On center sinus steer	ISO 13674-1
Pseudo-Random Steer	ISO 7401, ISO TR-8726
Pulse Input Method	ISO 17288-2
Slowly increasing steer	ECE 13H
Sine with dwell	ECE 13H

STANDARD VEHICLE TEST MANEUVERS

Dewesoft Vehicle Test Suite provides easy-to-use automated testing for multiple standard test maneuvers. For every type of test, validation criteria and other objective parameters are calculated and made available as calculated channels in the measurement files.

AUTOMATED RESULTS AND STATISTICS

Summary table with statistics and overlay results from a batch of test runs provides quick analysis of results.

REAL-TIME RESULTS

Results are visualized and validated in real time as the test is running, allowing instant verification of test success or failure.

AUTOMATED WORKFLOW

Pre-defined testing maneuvers and easy-on screen controls for the operator to configure and run the tests.

INS/GNSS FOR AUTOMOTIVE TESTING

DS-IMU1 and Navion i2 with single or dual antenna GPS provide accurate positioning and on-device calculations of slip angle, velocities, distances...

VEHICLE NETWORK SYSTEMS

MASTER OR SLAVE DAQ SYSTEM

Dewesoft can be the master DAQ system and gather synchronized data from multiple sources and buses, or be used as a signal conditioner where measured analog data is sent to other systems over CAN or XCP (Vector Canape, ETAS INCA, ATI Vision,...).

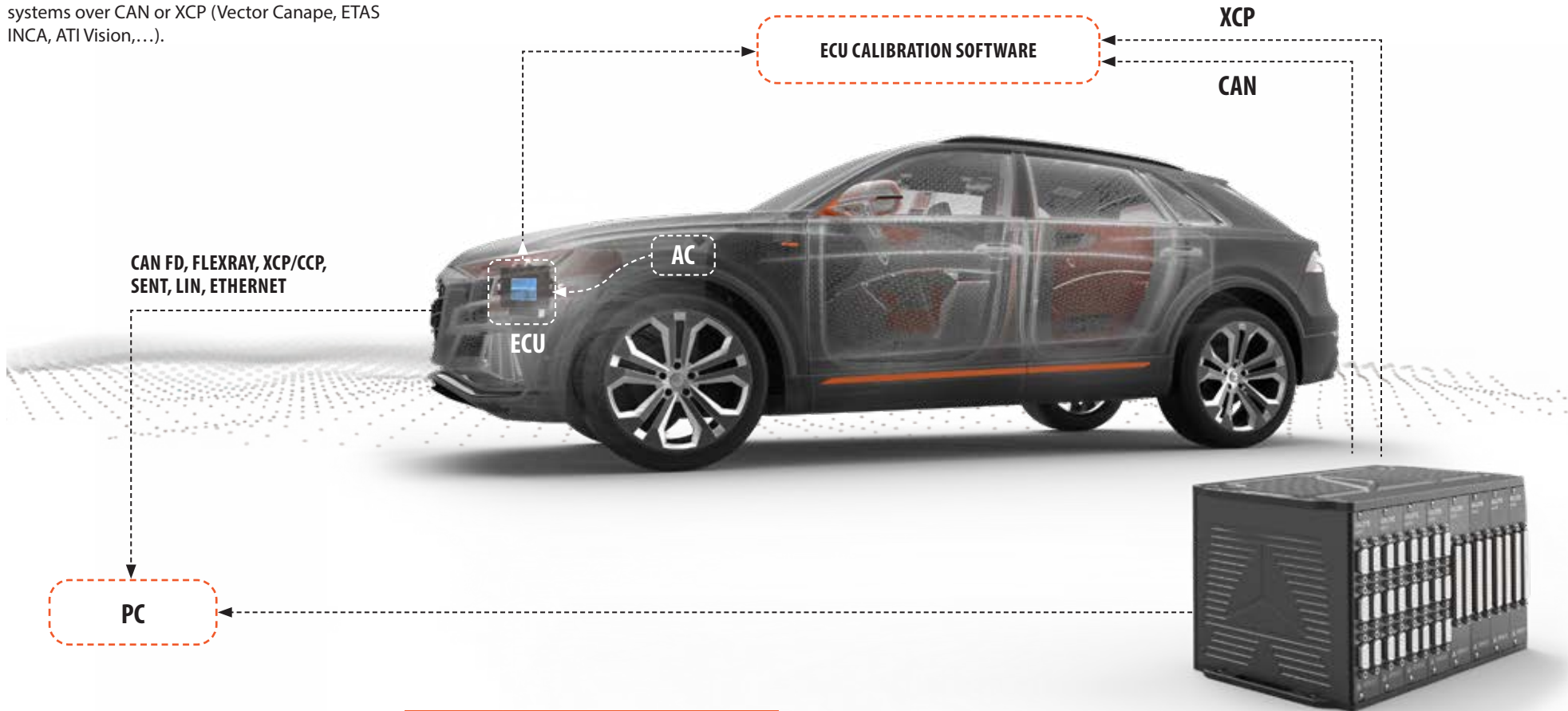

MULTIPLE BUS SUPPORT

Support for CAN, CAN FD, Ethernet, J1939, OBDII, Flexray, CCP, XCP, LIN, SENT, Modbus, OPC UA,...

Forget exporting data from multiples sources and having to use various DAQ systems at once. Dewesoft's support for all major vehicle buses will replace your complete measurement lab with a single system.

XCP MASTER/SLAVE

XCP is available as a software plugin where any channel can be transmitted over XCP. While the native XCP support on XHS and OBSIDIAN is limited to 1 MS/s, XCP Master plugin can read synchronized data from multiple devices at 5 MS/s.

NATIVE CAN FD SUPPORT

Full speed CAN FD is available on SIRIUS devices with read or write functionality. DBC or ARXML configuration import is supported as standard.

HARSH ENVIRONMENT TESTING



-40°C TO 85°C TEMPERATURE RANGE

The SIRIUS waterproof and KRYPTON lines of DAQ system offer a wide temperature range from -40°C up to 85°C suited for the harshest environments on Earth.

SYNCHRONIZED SOURCES

Acquisition of additional data sources like GPS, inertial platforms, gyros, CAN, CAN FD, LIN, XCP/CCP, FlexRay, video, high-speed video with perfect synchronization.

LOW POWER CONSUMPTION

Ideal for air-conditioning testing.

> 100 G SHOCK RATING

Instruments offer high 100G shock rating.

DUST, SHOCK, MUD AND WATER PROOF

IP67 degree of protection from water, dust, mud and high shock. Instruments are tested in highly sophisticated labs to ensure quality and maximum reliability.

Robust DAQ systems with IP67 degree of protection, operating temperature between -40°C and +85°C and high shock protection provide a reliable solution for testing in extreme and harsh environments.

GPS
CAN FD
VOLTAGE
DIGITAL
STRAIN
VIBRATIONS
TEMPERATURE
COUNTER
CAN
FLEXRAY

THOUSANDS OF CHANNELS

Systems can be expanded from 1 to thousands of channels.

DISTRIBUTED

DAQ systems can be distributed down to a single channel - keeping costs of sensor cabling low while ensuring high signal quality.

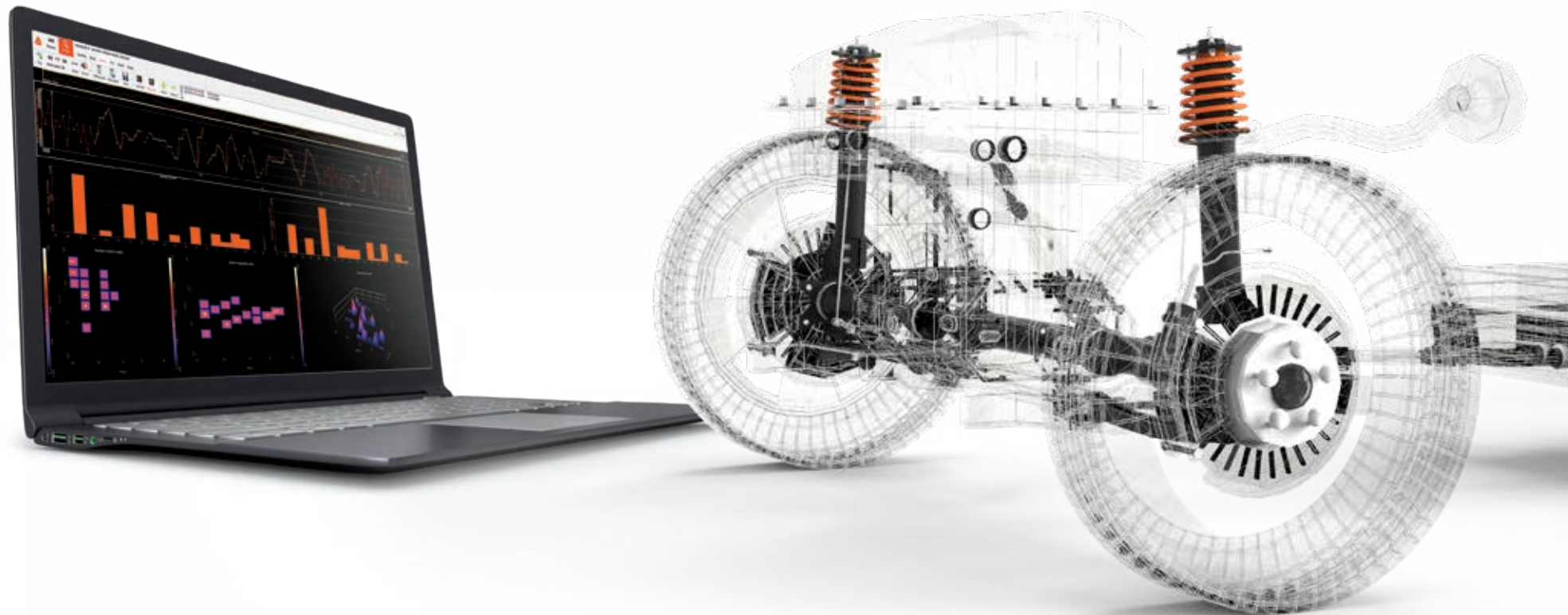

STANDARD COUNTING ALGORITHMS

Standard counting algorithm like Rainflow ASTM and Markov counting are implemented.

INSTANT RESULTS

Temporary fatigue results available online including additional math channels.

Safety is an important aspect in designing automotive components. Fatigue analysis is a DewesoftX software extension for predicting fatigue damages based on measured strain and stress.

SN CURVES AND DAMAGE CALCULATION

Compare calculated results from Fatigue analysis with the SN curve of your material and calculate damage according to the Palmgren Mine rule.

POST PROCESSING MADE EASY

Export to many different file formats and analysis of huge data files is also possible with DewesoftX.

PREPROCESSING

Direct pre-processing or local extreme detection, counting methods with algorithm settings, rainflow filtering, discretization, visualization and analysis software support.

MODAL TEST & ANALYSIS

FEM ANALYZER

SLM
ORBITAL ANALYSIS



SOUND INTENSITY

ORDER TRACKING

SOUND POWER

BALANCING

TORSIONAL VIBRATIONS

YOUR SOLUTION.

DYNAMIC SIGNAL ANALYSIS & NVH

PERFECT HARDWARE

SIRIUS DualCoreADC® with 160 dB dynamic range is perfect for sound and vibration measurements. SuperCounter® technology provides precise data synchronization with angular domain.

EXTREMELY DEEP IN FUNCTIONALITY

One software program provides analysis tools for FFT analysis, octave analysis, sound level meter, sound power, sound intensity, RT60, order tracking, orbit analysis, balancing, modal analysis, human body vibration, SRS and more.

FLEXIBLE AND SCALABLE

Dewesoft is much more than just an NVH & acoustic analyzer. All other capabilities of Dewesoft like mechanical measurements or combustion analysis are just a click away.

SINE PROCESSING

HBV

OCTAVE ANALYZER

RT60

ORBIT ANALYSIS

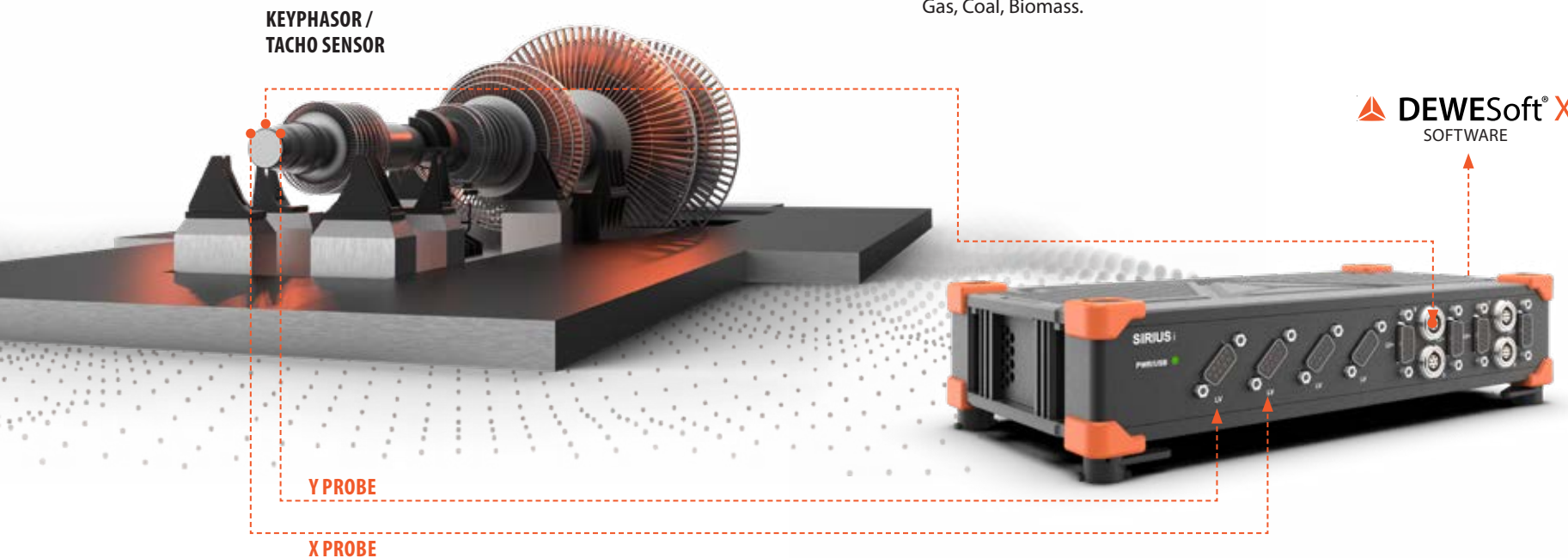

INDUSTRIES

Complete solution that improves the operating efficiency, lower wear, and prevent any potential critical failures of rotating machinery. Applied in a variety of industries, e.g. automotive, chemical, oil and gas, metals, HVAC or mining and in the majority of different power plants: Hydroelectric, Nuclear, Thermal, Gas, Coal, Biomass.

APPLICATIONS

Turbo machinery provides kinetic energy to operations enabling movement - a function that is widely used in industrial processes to move solids, liquids or gases through drivers, driven components and transmissions such as: Compressors, Drills, Generators, Turbines, Engines, Pumps, Blowers, Gearboxes.

SOFTWARE INCLUDED

Award-winning DewesoftX software with powerful math and extensive analysis options included free of charge: mathematical analysis with visualization, sequencing and data export to a multitude of formats.

MULTI FUNCTIONALITY

Maximum measurement capabilities - functions with any Dewesoft DAQ system and sensors can be added to simultaneously capture temperature, vibration, video, strain, etc. in the same SW and perfectly synchronized.

With fully-fledged and wholesome turbo machinery analysis, easy setup, intuitive presentation of measured data and industry leading measurement expandability orbit analysis measurement is reimagined the Dewesoft way.

POWERFUL ANALYSIS

Complete set of functionalities and displays for turbomachinery monitoring: Raw, averaged and harmonic orbits, Time trends and Waveform, Bode plot, Polar plot, Full motion graph, Waterfalls, clearance circle, runout compensation, reference orbit and many more.

DEDICATED ADVANCED PACKAGES

Dewesoft Orbit Analysis can be combined with Order Tracking and Advanced FFT with cursors to cover further analysis needs.

ORBIT ANALYSIS

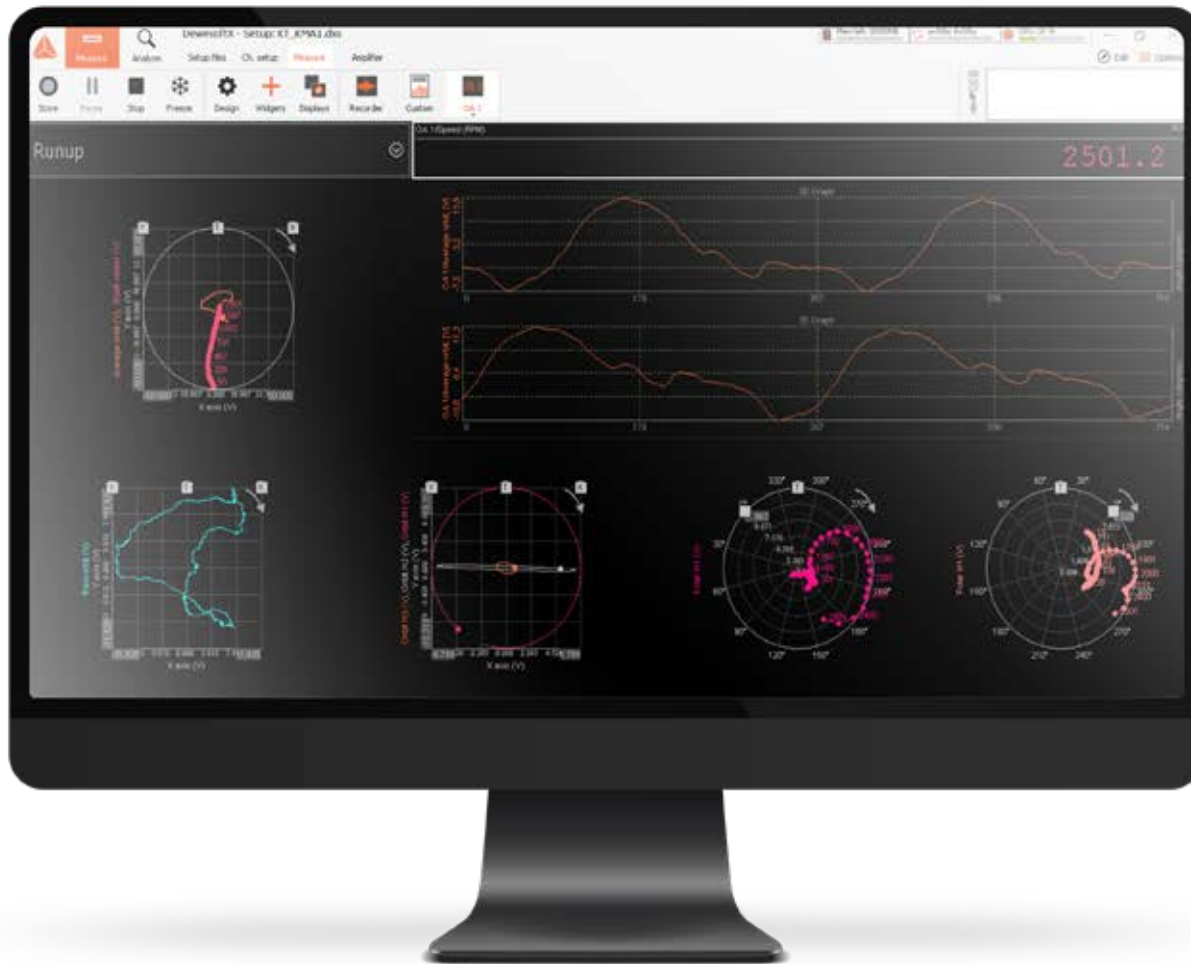

MACHINE TRAIN SUPPORT

Simply add the number of desired bearings to the analysis.

MONITORING CAPABILITIES

Orbits (raw, averaged, 1X, 2X, etc.), FFTs, cascade plots, Bode plots and polar plots can be uploaded to our Historian database for long term condition monitoring.

EASY SETUP

Only a few steps from connecting the sensors to having stored all data. Flexible bearing configuration, supported non-orthogonal probe pair positioning.

HIGH ACQUISITION RATE

200kS/s sample rate enabling analysis of high speed rotors.

UNLIMITED CHANNEL COUNT

Catering any R&D measurement need, regardless of the number of bearings analyzed and/or proximity probes used.

HIGH DYNAMIC CAPABILITIES

Dual ADC converter technology, seamlessly covering 160dB dynamic range out-of-the box.

POST ANALYSIS

Offline calculation using raw signals from proximity probes.

TEDS SUPPORT

Plug-and-play with proximity probes that support TEDs.

MULTI-BRAND PROXIMITY PROBE SUPPORT

Dewesoft LV input on SIRIUS covers the needed ranges and supplies excitation to the majority of proximity probes.

Out of the box, Dewesoft Orbit Analysis packs the entire set of industry-proven analysis metrics, supporting calculation and graphical representation of: Time trends, Raw/Direct orbit, Orbit Waveform, Averaged orbit, Filtered orbit, Subharmonic orbit, maximum orbit dimensions, Polar plot, Bode plot, shaft centerline, full-motion graph, clearance circle, runout compensation, reference orbit, full spectrum, and a complete set of cascade plots and waterfalls.

FFT ANALYZER

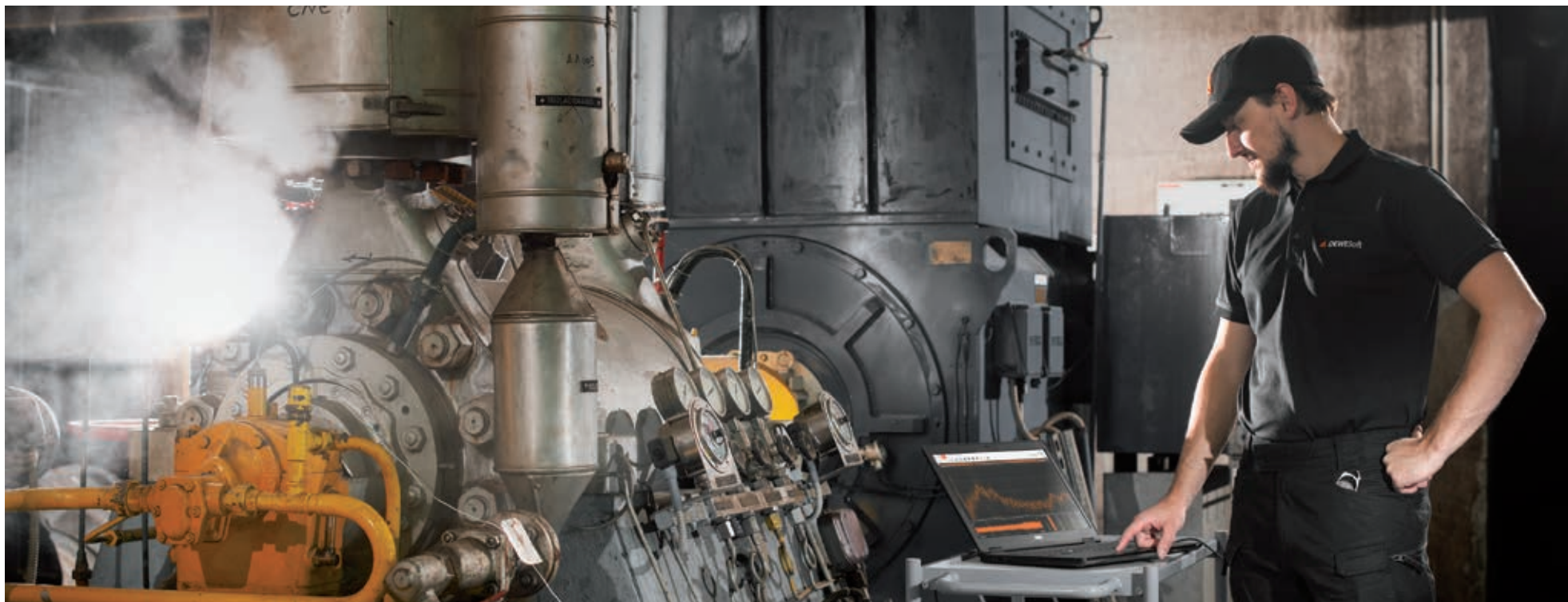

MULTIPLE MARKERS

Maximum marker, free marker, zoom marker, sideband marker, harmonic marker, RMS marker. Linked marker technology enable easy cuts from 3D to 2D graph, export and further analysis. Any edits on each of the graphs automatically applies it to the other as well. Including a dedicated marker table.

AVERAGING

Overall and block history averaged FFT with linear, energy, energy exponential and maximum averaging are available. Including different amplitudes settings: Linear, ASD, PSD, Power, ESD are available in Peak, RMS or Peak-Peak scaling.

ANY LINE RESOLUTION

The frequency resolution can be set freely with no module limitations, or selected to a value from a pre-defined list.



FFT analysis is one of the most used analysis tools across all application domains when it comes to identification and specification of content in measured data.

The FFT analyzer in Dewesoft has it all: top performance, advanced cursor functions, high freely selectable line resolution, flexible averaging as well as advanced functions for in-depth analysis.

CURSOR VALUE ESTIMATE

Innovative window interpolation technique allows precise amplitude and frequency estimation.

ADVANCED MATH

Auto-power spectrum, cross-power spectrum, complex spectrum, waterfall spectrum, cepstrum (for bearing faults, speech processing), full FFT (for rotor whirl analysis), STFT (for non stationary signals), envelope detection (for bearing fault analysis). Including direct integration & derivation of input parameters.

OCTAVE ANALYZER



SEAMLESS ACOUSTIC SUITE INTEGRATION

The Octave analysis module is perfectly integrated with sound level, sound power, sound intensity and other modules for advanced sound analysis.

ACOUSTIC WEIGHTING FILTERS

Acoustic weighting curves (A, B, C, D, and Z) can be applied directly in the module using weighting filters conforming to standards.

AVERAGING

Linear, peak and exponential averaging or block-based calculation.

RESOLUTION UP TO 1/24 OCTAVE

For deep analysis of data very narrow band analysis up to 1/24th octave.

Octave analysis is an indispensable tool for sound measurement as well as predictive monitoring. Dewesoft octave analysis solution meets all of the IEC and ANSI Class I specifications for octave filters.

SYNTHESIZED OCTAVE ANALYSIS

Extremely fast calculation based on the narrow band FFT. Offering the same high level of accuracy with optimal speed - especially useful with high channel count systems where performance is crucial.

TRUE OCTAVE ANALYSIS

True octave filters exactly represent the filter sets defined by the IEC 61260 standards and offer the user a real time response for vivid live visualization of data, crucial for advanced acoustic analysis.

ORDER ANALYSIS



RICH VISUALIZATION

Frequency and order 3D waterfall plots provide a great tool to determine machine condition. Nyquist, Bode and Campbell plots are available for presentation of the data.

TIME, FREQUENCY AND ORDER DOMAIN - AT THE SAME TIME

Due to high sampling rate (support) and advanced alias free resampling mechanism, data are available in all three domains (time, frequency and order), everything at the same time in one screen and data file, perfectly synchronized.

Determine the operation condition of rotating machines (resonances, stable operation points, determining causes of vibrations). Order analysis is even more powerful in combination with other math modules like torsional analysis, combustion or power analysis - the true EKG for machines.

PWM INVERTER ORDERS

Order components caused by inverters using Pulse Width Modulation techniques can be analyzed, using the direct support for demodulation.

ANGLE SENSOR SUPPORT

All angle sensors from tacho, encoder, geartooth, geartooth with missing or double teeth, tape sensors and others are supported to determine angle and rotational speed with 10nsec resolution using SuperCounter® technology.

DIRECT GEARBOX SUPPORT

Use a single speed source and perform extraction on different gear stages of your machine by applying used gear ratios.

ADVANCED MATH

Any order and time-domain harmonics can be easily extracted with amplitude and phase, available versus rotational speed or time in run-up or coast down modes.

ROTATIONAL AND TORSIONAL VIBRATIONS



EASY SENSOR SETUP

Math module supports any type of sensor input and the sensor type can be totally different at each end of the rotor. SuperCounter® technology provides 10ns resolution in determining rotational angle and speed.

ORDER TRACKING INTEGRATION

Closely combined with order tracking, advanced data analysis is available based on the same angle sensors as the source of frequency.

Rotational and torsional vibration module along with order tracking are a strong tool to troubleshoot shafts in automotive, industrial or power-generation applications.

ADVANCED MATH

Different input filters and rotational DC filters are available as well as the option to enter rotational speed ratio for gearbox analysis.

ACCESS TO ALL DATA

All data, such as reference angle, individual sensor rotational angle, speed and acceleration, torsional angle and velocity are readily available for advanced analysis.

BALANCING

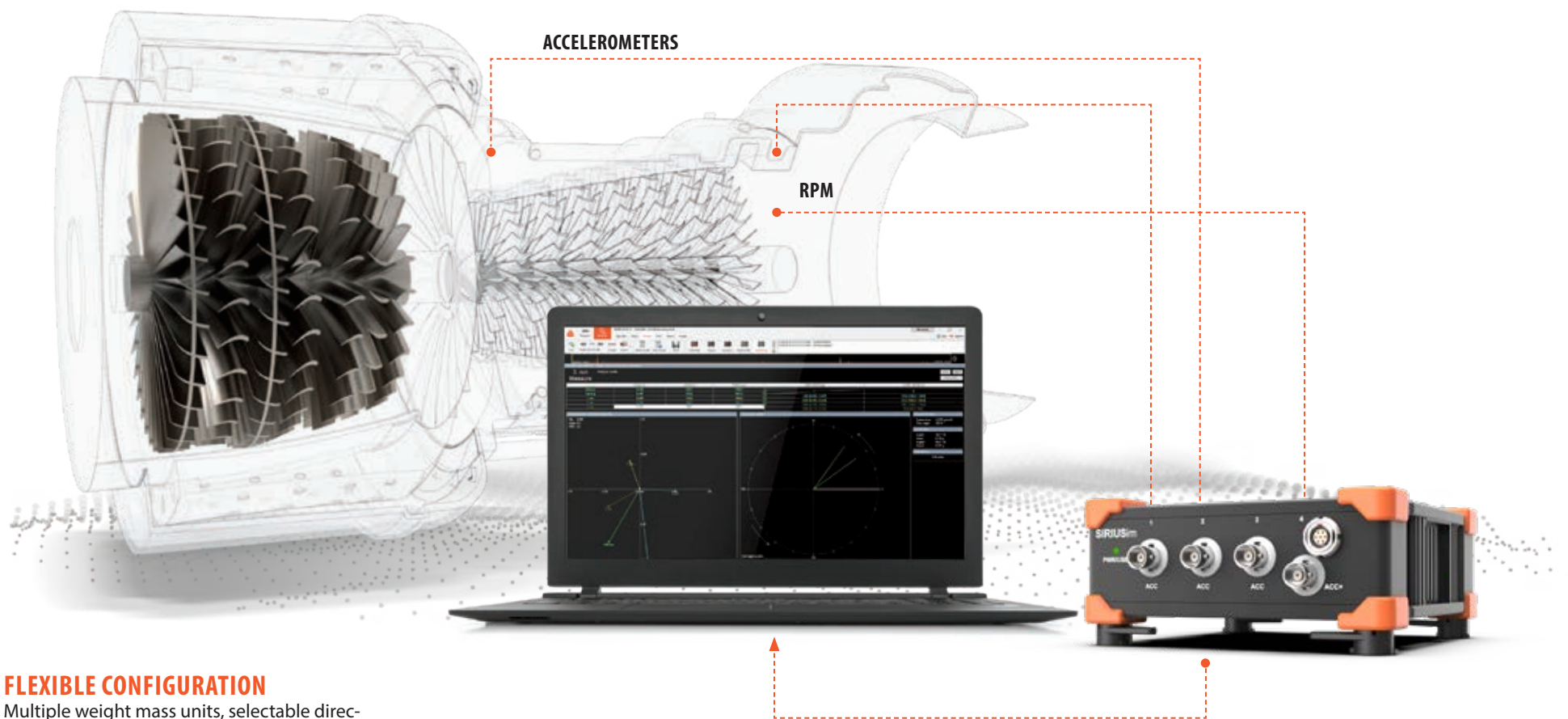

FLEXIBLE CONFIGURATION

Multiple weight mass units, selectable direction of rotation and mass position reference from trial mass or tachometer position.

SINGLE OR DUAL PLANE BALANCING ON SITE

Perform single plane (narrow disc) or dual plane (long shaft) balancing.

WEIGHT SPLITTING

Adds the possibility to split needed balancing weight into equidistantly spaced points, for example holes on the rotor.

SIMPLE STEP-BY-STEP PROCEDURE

You are guided through the balancing steps for flawless operation including setup of angle sensor with live preview. Multiple modules can be combined for multi-axis balancing to save time and improve the quality of balancing.

Balanced rotors are essential for smooth operation of rotating machinery. Imbalance will create high vibrations, reducing machine life, causing material defects and down times. The balancing module is the tool to eliminate imbalance on site.

RICH VISUALIZATION

Results from all runs are displayed in order to ease a decision for the next steps and to evaluate the stability of the measurement. RPM display has color indicator to determine in-out range.

STORAGE OF INFLUENCE VECTOR

Influence vectors can be stored so that additional test runs are not needed for repetitive balancing of the same machine.

SHOCK RESPONSE SPECTRUM (SRS)



SUPPORTED STANDARD

Shock response spectrum calculation according to **ISO 18431-4**.

DATA EXPORT

Data can be exported in virtually any data format used for NVH analysis.

SELECTABLE FREQUENCY SPAN

Freely definable calculation range for the frequency spectrum.

ADVANCED MATH

All relevant mathematics (positive max., negative max., maximax in either primary, residual or composite) are calculated. Results in frequency domain spectrum can be shown as acceleration, velocity or displacement. Support for pseudo-velocity and static acceleration determination.

EASY SETUP & USE

The setup of sensors and the system is fast and simple; automatic shock detection based on the threshold method.

DAMPING/QUALITY FACTOR

The selection of the damping ratio or quality factor is easily updated.

Mechanical shock pulses are often analyzed in terms of the shock response spectrum. The SRS assumes that the shock pulse is applied as a base input to an array of independent single-degree-of-freedom systems.



MODAL TEST / ANALYSIS

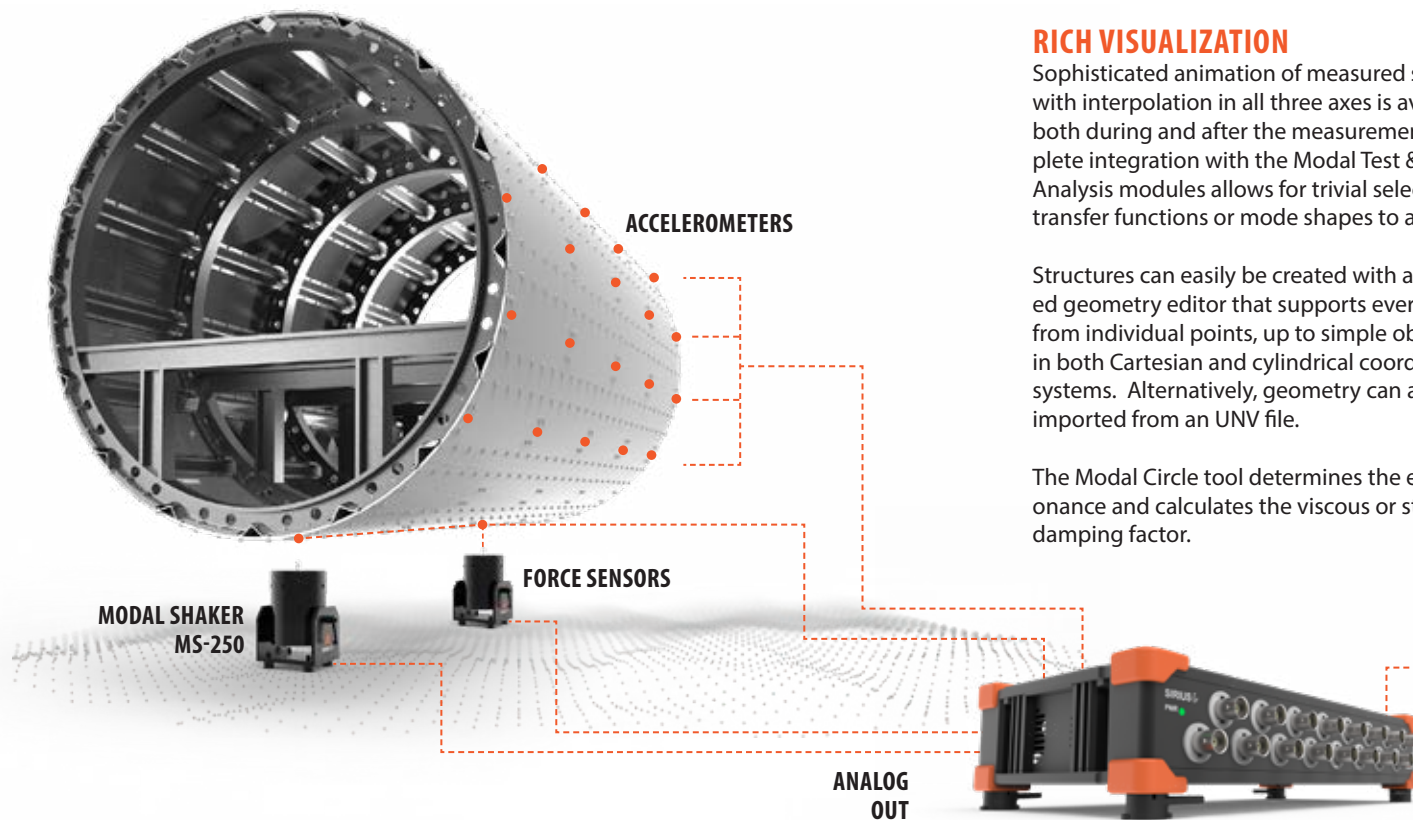

IMPACT HAMMER TEST (SIMO/MISO)

Hammer testing has never been easier than with Dewesoft X. Grouping, rejecting and remeasuring of measurement points is fully supported. Ability to move excitation and/or response points (roving hammer or responses) allows for full flexibility when performing measurements.

In addition to frequency response functions, coherence, (cross) PSD and MIF can also be calculated.

SHAKER TEST (MIMO)

To analyse the most complex structures, Dewesoft X supports tests with any number of shakers. Externally driven shakers are supported, as is controlling the shakers via AO using Dewesoft's function generator (burst random, continuous random, sine sweep, step sine tests).

H1 or H2 estimators are supported for calculating the FRFs. Multiple coherence (MCOH) can be calculated to help with the setup and measurement when using multiple shakers.

ODS

Operating Deflection Shapes (ODS) is a simple way to do dynamic analysis and see how a machine or a structure moves within its operational conditions. ODS tests are fully supported in Dewesoft X.

RICH VISUALIZATION

Sophisticated animation of measured structure with interpolation in all three axes is available - both during and after the measurement. Complete integration with the Modal Test & Modal Analysis modules allows for trivial selection of transfer functions or mode shapes to animate.

Structures can easily be created with a dedicated geometry editor that supports everything from individual points, up to simple objects, in both Cartesian and cylindrical coordinate systems. Alternatively, geometry can also be imported from an UNV file.

The Modal Circle tool determines the exact resonance and calculates the viscous or structural damping factor.

FINE-TUNING OF MEASURED DATA

With its rich displays, Dewesoft X allows for real-time quality control of the measurement, as well as the ability to repeat the measurement of any point, all during acquisition. Additionally, all the time-domain data is stored into a datafile, which allows for offline recalculation with different parameters.

Multiple measurements done on a large structure can easily be combined into a single datafile, to analyze the entire structure at once.

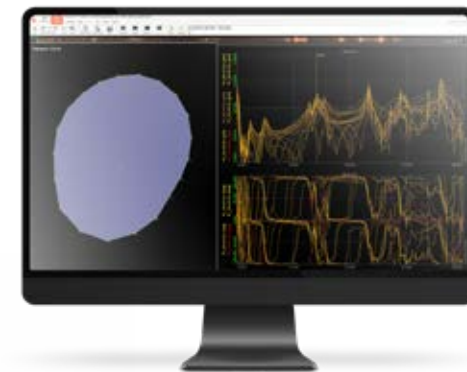

ADVANCED MODAL ANALYSIS

With the help of CMIF (complex mode indicator function) and LSCF curve fitting, finding the modes on the stabilization diagram is easy. Selected modes can be used to calculate mode frequencies, damping ratios, mode shapes, complexity, participation factors, synthesize FRFs, ...

Calculated mode shapes can be animated on a modal geometry widget. AutoMAC matrix can be displayed on a 3D bar graph to ensure the modes are well selected.

UNV EXPORT

All data, from raw time domain signals and FRFs, to all the advanced outputs from Modal analysis, can be exported into a standard UNV file.

Modal test and analysis are an indispensable tool to determine the natural frequencies and mode shapes of any structure - offers easy to use operation with fast setup while providing rich visualization and animation of results.

SINE PROCESSING

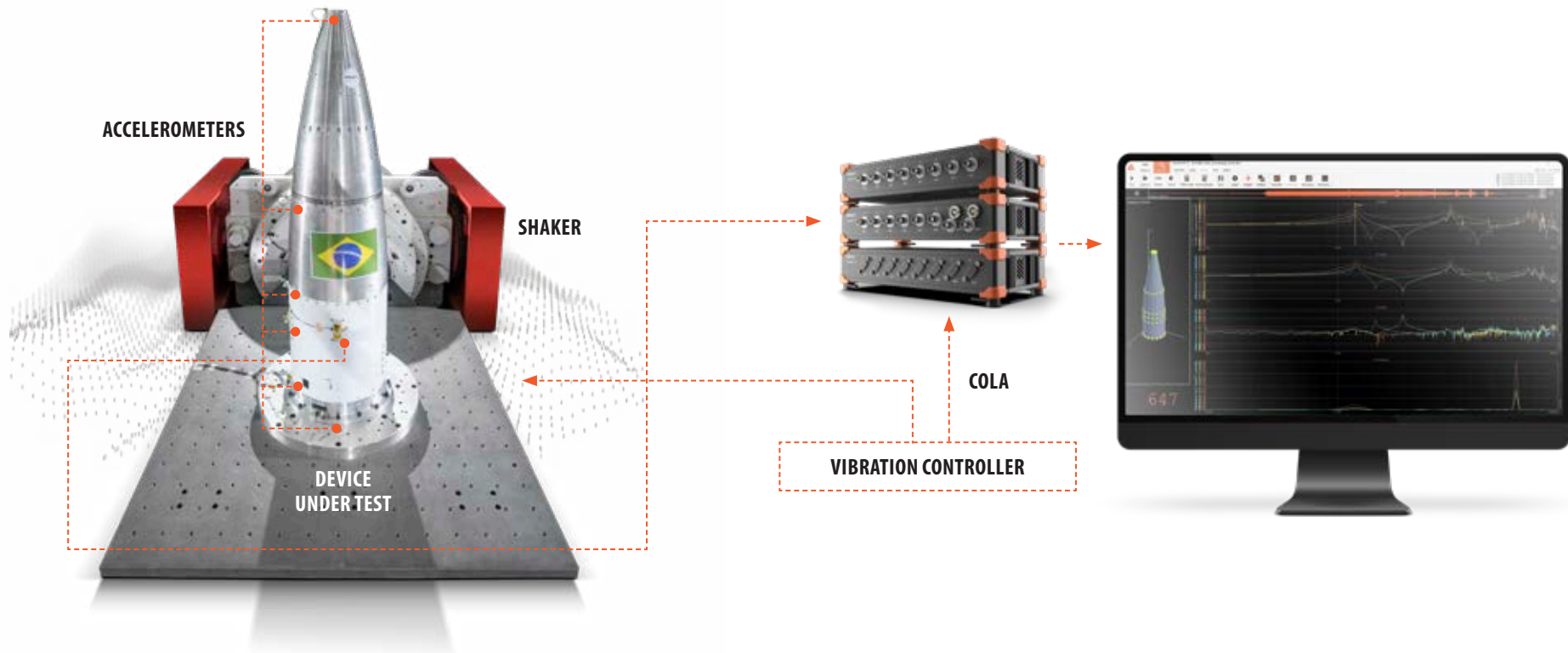

REAL-TIME CALCULATION

Harmonic estimator, Peak, RMS, THD, phase, transfer functions for each available point in real-time and post-analysis.

FUTURE-PROOF APPLICATION

Lifetime free upgrades and support.

STORE AUTOMATICALLY

Automatic storing on desired trigger conditions.

TEDS SUPPORT

Save time by using TEDS accelerometers which are supported by DewesoftX and all Dewesoft hardware.

DATA EXPORT

Data can be exported in virtually any data format used for NVH analysis.

ONLINE AND OFFLINE ANIMATION

Determine the quality of results - animation of structure in all three directions with different projections during (and after) measurement.

Structural dynamics characterization, durability and fatigue testing, design validation and qualification.

UNLIMITED NUMBER OF CHANNELS

Supports real-time calculation of an unlimited number of channels.

COMPLETE SINE PROCESSING TESTS

Directly integrates with your existing shaker and controller, needing only the COLA signal to sync perfectly.

EASY TO SET UP AND USE

Simply connect the accelerometers and COLA signal, assign the correct channels and start measuring.

DIFFERENT MODES OF FREQUENCY DETECTION

Zero crossing and Hilbert transform for detecting the exact frequency of the sweep produced by the shaker controller and driving the shaker through an amplifier.

UNMATCHED POWER OF CALCULATION

Runs octave and FFTs simultaneously on all channels and all in real-time.

DEWESOFT QUALITY AND FLEXIBILITY

Add additional parameters to the same measurement system and expand your measurement chain in seconds.

SOUND LEVEL METER



UNMATCHED FLEXIBILITY

SLM supports sound measurements in both air or water, and can be combined with all other physical measurement parameters, vehicle bus systems, video, GPS and other math to build a thorough image of circumstances.

RICH VISUALIZATION

Flexible displays offering digital meters, analog bars, time domain recorders, narrow band FFT and octave analyzers can be freely combined to show your SLM data in real-time as well as in post-processing.

SUPPORTED STANDARD

IEC 61672 Class 1 sound level meter

ADVANCED MATHEMATICS - ALL AT THE SAME TIME

Standardized acoustic weighting filters (A, B, C, D, and Z), time weighting (Fast, Slow or Impulse), sound pressure level, equivalent, peak, minimum & maximum sound pressure levels, sound energy, impulsivity of sound, statistical noise level (LAF1, 5, 10, 50, 90, 95 and 99 % classes of values) are all available at the same time.

Compliance with international standards. Maximum accuracy and high dynamic range have been re-imagined with the Dewesoft approach. Regardless of the acoustics measurement, SLM plugin is always at the heart of it.

HIGH DYNAMIC RANGE

Our top-class data acquisition hardware with 160 dB dynamic range supports all types of microphones no matter if they require 200 V polarization or constant current (IEPE). If the microphones have TEDS information then it will automatically be used for the measurements. Dewesoft data acquisition systems can be scaled for any number of microphones which can be effortlessly calibrated with a calibrator.



SUPPORTED STANDARDS

Fully compliant with relevant sound power standards **ISO 3741, ISO 3743-1, 3743-2, ISO 3744, ISO 3745, ISO 6393, ISO 6394, ISO 6395 and ISO 6396.**

RAPID REAL-TIME AND OFFLINE CALCULATION

All calculated parameters are available during measurement as well as offline; rapid calculation of correction factors K1 (background noise measurement), K2 (room correction with integrated RT60 module), C1, C2 and C3 (deviations due to meteorological reasons - temperature and barometric pressure); support for raw time domain data storing and offline sound power calculation.

HEAVY MACHINERY

Includes measurement procedures for testing heavy machinery.

PREDEFINED REPORT

After testing, present your results using our pre-defined and yet flexible report templates.

GUIDED STEP-BY-STEP PROCEDURE

You will be guided step by step through the entire measurement procedure, with our clear and comprehensive user interface.

REVERBERATION TIME RT60

Expand your measurement with RT60 and perform room ratings yourself, using the same software interface. Template for absorption coefficient included!

**RT60 plugin sold separately.*

Widely established sound power measurements with familiar, distinctive user interface and industry unmatched flexibility. Rating and comparison of different noise sources with ease and exactness while simultaneously monitoring any number of additional process parameters.

SOUND POWER

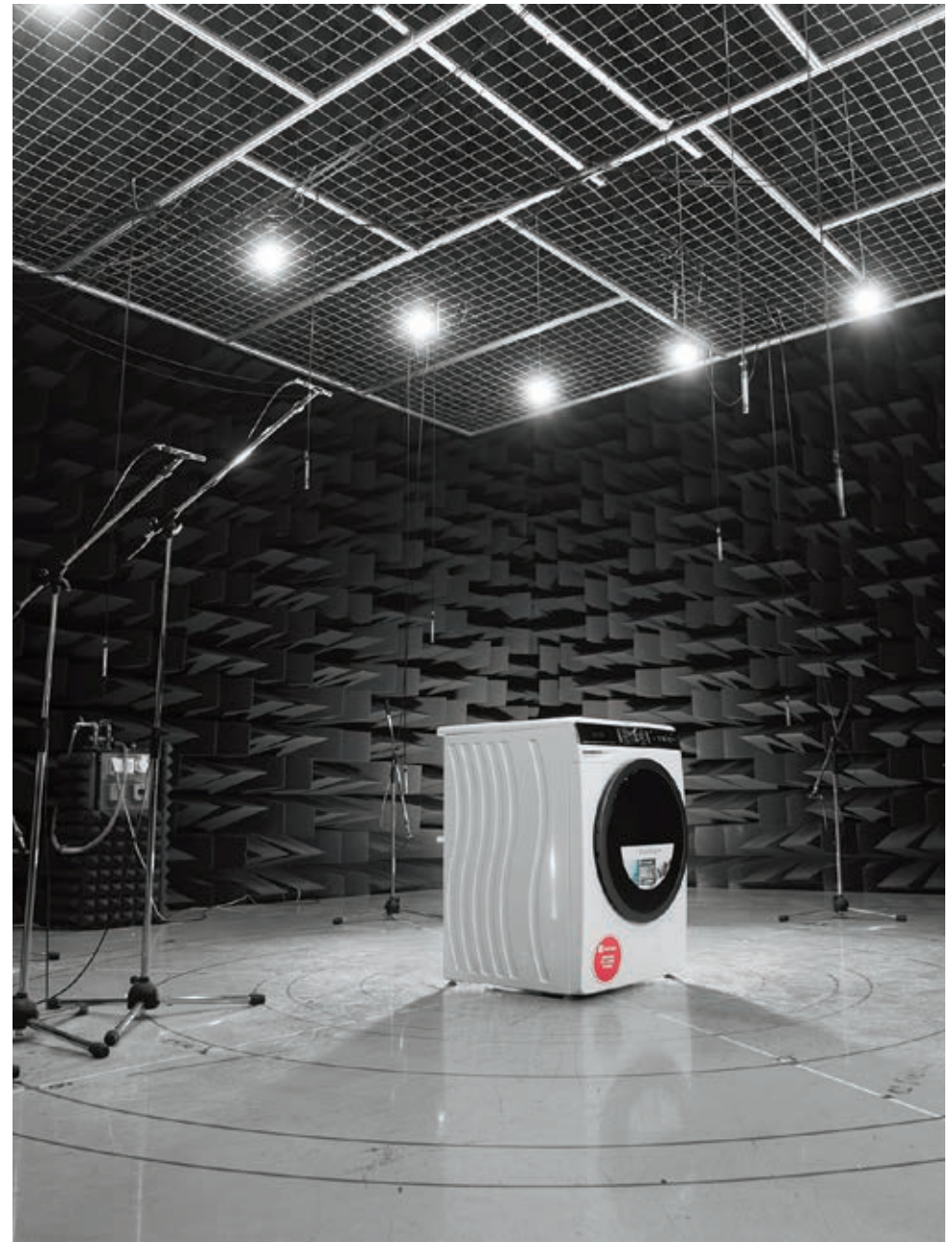

SOUND INTENSITY

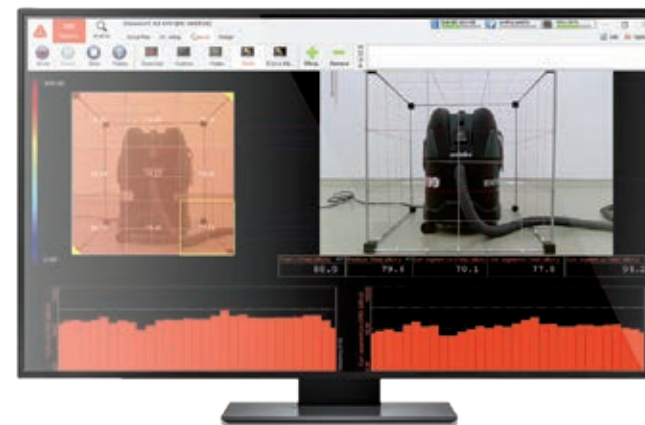

SUPPORTED STANDARDS

Complies to Sound Intensity-based Sound Power calculation - **Discrete points method (ISO 9614-1)** and **Scanning method (ISO 9614-2)**.

IEC 61260 & IEC 61672

Using octave filters in compliance with IEC 61260 and complete measurement chain in compliance with IEC 61672 - worldwide valid calibrations can be ordered together with the system or done in your local calibration lab.

Noise source determination brought to an entirely new level. Sound intensity measurements in a simple and intuitive way with precision and flexibility unmatched in the industry. For example: measuring process parameters and recording video in parallel.

ADAPTED FOR INDUSTRY

No need for a special environment - perfect for measuring on big chillers, transformers and other large-scale industrial applications.

SUPPORTED HARDWARE

Plug and play support for different intensity probes from all major manufacturers, integrating full remote control functionality.

UNMATCHED FLEXIBILITY

Measurement of additional process parameters like vibration, video and others, everything perfectly synchronized. External triggers, selectable probe movement for measurement automation.

PHASE CALIBRATION

Straightforward, automated phase calibration and correction with a single button click. Evaluation of PRI index and all the standard indicators including the dedicated table for output of results and needed actions.

QUICK SOUND SOURCE IDENTIFICATION

Identify noise sources smoothly with an easy-to-use interface, perform rapid investigation with Logged intensity and a camera - automatically synchronized



PROMINENCE RATIO

Calculation according to **ISO 7779**, freely definable frequency range and desired resolution.

LOUDNESS & SHARPNESS

Calculation according to **ISO 532-1** and **ISO 532-2**.

POWERFUL METRICS

Articulation index, speech intelligibility, noise rating and criterion.

MONAURAL AND BINAURAL ANALYSIS

Select desired measurement method before measuring or measure both at the same time.

FUTURE-PROOF APPLICATION

Lifetime free upgrades and support - our solutions are constantly being improved.

REAL-TIME AND POST ANALYSIS

Calculation of metrics is supported in real-time as well as in post-analysis.

TIME-VARYING AND STATIONARY SIGNALS SUPPORT

No limits when it comes to different use cases.

MEASUREMENT EXPANDABILITY

Bundled with award-winning DewesoftX Professional - advanced and easy-to-use data acquisition and analysis software.

POWERFUL DAQ SYSTEM

Bundled with renowned SIRIUS DAQ system supporting sampling rates of 200kHz.

Product sound engineering Analysis and characterization of product sound. The indispensable tool for sound engineering - make your product sound right.

SOUND QUALITY



REVERBERATION TIME RT60

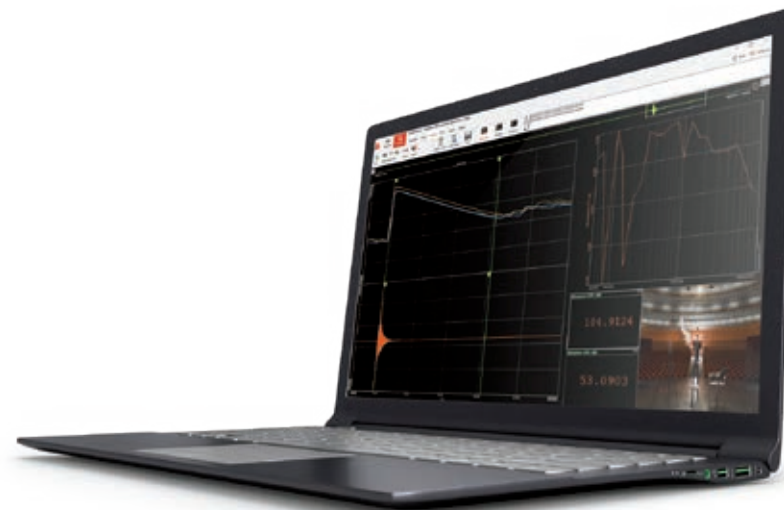

PARAMETER ESTIMATION

Estimation of modal decay parameters from noise measurements of reverberant and resonating systems using **Lundby method**.

When room acoustics properties are the issue, RT60 solution represents an essential tool. Easy setup enables reliable measurement for effective modification of room parameters and achieving desired reverberation time.

ABSORPTION COEFFICIENT CALCULATION

Calculate absorption coefficient and make a report with provided template.

EVALUATION RANGES

Different evaluation ranges for reverberation of time estimation are supported (T10, T15, T20, T30 & T60).

SUPPORTED STANDARDS

Fully complies with the **ISO 354** standard using integrated response method.

DIRECT MICROPHONE INPUT

Our data acquisition hardware with 160 dB dynamic range allows direct input of IEPE compatible microphones with support for TEDS recognition. Data acquisition system can be scaled for any number of microphones.

HUMAN BODY VIBRATION



← HAND VIBRATION

← SEAT VIBRATION

HAND-ARM VIBRATION

Sensors are installed using special adapters for fixing on a handle or between fingers and dedicated hand-arm calculations are available including risk assessment of vascular disorders.

WHOLE-BODY VIBRATION

Applicable to motions transmitted from workplace machines and vehicles to a person's body through a supporting surface.

Measure the effect of vibration on the body of a human being. The extracted parameters allow the judgment of risks for workers exposed to vibration. Whole-body and hand-arm measurement is supported according to international standards.

SUPPORTED STANDARDS

Calculation in accordance with latest revisions of **ISO 5349**, **ISO 8041**, **ISO 2631-1**, **ISO 2631-5** and **ISO/TR 18570**.

ADVANCED MATH

All data like RMS, Peak, Crest, VDV, MSDV, MTVV, Weighted raw, al (ISO 2631-5), al and D (ISO 2631-5) are available.

DATA ANALYSIS

With its deep data analysis functionality, DewesoftX is the basis for R&D work related to the reduction of vibration.

TIME-SERIES DATABASE



OPC UA

HISTORIA



YOUR SOLUTION.

MONITORING

BEST IN CLASS SOFTWARE

Our software meets the requirements of any monitoring user. High-level web-based software provides a remote overview of the monitored machine/infrastructure state and trends over time, relevant for decision-makers. For engineers, DewesoftX software is available with in-depth analysis features, essential to detect failures and root cause identification.

ANY SENSOR

Input amplifiers offer support for almost any sensor used in Structural Health monitoring and Machine Condition Monitoring applications.

AFFORDABLE AND TOTALLY DISTRIBUTED SYSTEM

Dewesoft IOLITE devices are designed to be affordable and distributed under any condition. EtherCAT® technology allows devices to be placed near the sensors and connected with a single cable for power, data, and synchronization. The cable can span up to 100 m between DAQ nodes or virtually unlimited using EtherCAT® to fiber optic converters.

I O T A N D I N D U S T R Y 4 . 0

SIEMENS S7

E t h e r C A T ®

MACHINE CONDITION MONITORING



ACCESS

Data accessible from the local computer, control system or remotely.

PRICE/PERFORMANCE RATIO

Price-effective hardware technologies with the powerful, yet easy to use Dewesoft Machine Condition Monitoring software.

DISTRIBUTED SYSTEM

EtherCAT® technology allows devices to be placed far apart and near the sensors - connected through a single cable for power, data and synchronization.

HIGH-LEVEL WEB-BASED SOFTWARE

Overview of the machinery state via a pre-configured web browser application. Monitoring software built on top of 20 years of experience in high precision test and measurement applications.

CONNECTIVITY

Data can be integrated into any 3rd party control system using OPC UA protocol.

TOTAL SOLUTION

Sensors, DAQ devices, low level software and high level overview including database storage from the same vendor.

UNLIMITED INPUT CHANNELS

DAQ systems with virtually unlimited input channel configurations.

HISTORICAL DATA

Data permanently stored in a database on local or cloud servers for trend tracking as well as in-depth analysis and root cause identification.

ANY SENSOR

Input amplifiers offer support for any type of sensors needed to detect rotating machinery issues.



Space-grade measurement technology brought into machine condition monitoring. Accurate, highly reliable, easy to use, and cost-effective condition monitoring solution.

IN-DEPTH MACHINE CONDITION ANALYSIS

Multiple software features suited for PDM experts.

BRIDGE CONDITION MONITORING



REMOTE OPERATION

The entire system can be remotely operated offering triggered storing, alarms and other monitoring features with capabilities to store data locally or at distant remote locations.

DISTRIBUTED

Dewesoft devices are designed to be distributed under any condition. EtherCAT® technology allows devices to be placed near the sensors and connected with a single cable for power, data, and synchronization. The cable can span up to 100 m between DAQ nodes or virtually unlimited using EtherCAT® to fiber optic converters. We have instrumented world's longest bridge - Hong Kong - Macao, spanning over 50 kilometres.

ANY SENSOR

Input amplifiers offer support for any strain gage sensor, and low-frequency accelerometer sensors for seismic activity monitoring, temperature, and weather factors.

Dewesoft data acquisition systems are used in structural health and seismic bridge monitoring projects ranging from structural mechanics to continuous monitoring of large, complex structures. The systems provide distributed, high-channel-count and remote monitoring for highway overpasses, roads, buildings, and bridges.

OBSIDIAN®

OBSIDIAN is able to serve real-time data via OPC UA interface to database servers while logging the data in parallel to overcome issues with transmission.

IOLITE® di 3xMEMS-ACC

IOLITE di 3xMEMS-ACC is an integrated sensing device. Acceleration is measured by a triaxial MEMS accelerometer inside the device that is tightly attached to the mechanical chassis.

COMMERCIAL

SPACECRAFT

TELEMETRY ENCODER

CHAPTER 10



POWERTELEM

CHAPTER

MILITARY

MIL - STD - 1553

T

YOUR SOLUTION.

AEROSPACE

COMPATIBLE WITH ARINC-429 AND MIL-STD-1553

Dewesoft can directly connect and decode data from these standard aerospace bus systems, either directly from the aircraft or from telemetry stream.

FULLY SYNCHRONIZED WITH THE OTHER DATA

Each channel from these interfaces is synchronized with other data with no less than millisecond accuracy.

USED BY NASA, AIRBUS, RAYTHEON LOCKHEED MARTIN, BOEING...

Dewesoft systems are in use by the biggest and best aerospace facilities and manufacturers all around the world.

E T R Y

4

A R I N C - 4 2 9

I N E T

F R A M E S Y N C

S O F T W A R E D E C O M

TELEMETRY IRIG CHAPTER 4 PCM

DEWESoft® X

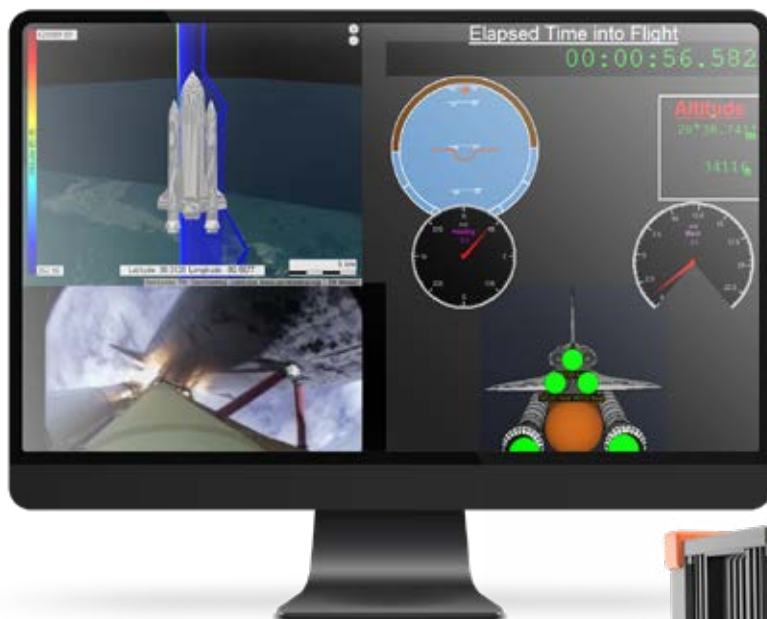

PCM TELEMETRY LINK

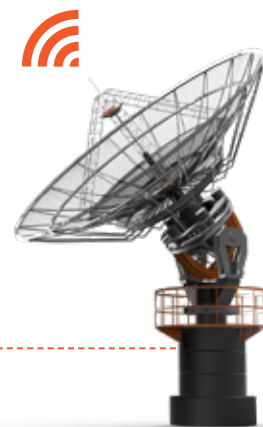

BIT SYNC



INDUSTRY STANDARD

Dewesoft Decom is widely used in most advanced telemetry labs around the world working closely together with major vendors of flight recorders and ground equipment.

PCM TELEMETRY FRAME SYNC

The SIRIUS PCM-FS2 instrument is a dual frame sync IRIG Class II decommutator with up to 40 MBit/s data rates.

SOFTWARE DECOM

Our software decommutator offers full range of decoding for normal commutated, super and sub commutated parameters, embedded frames, and fast switching.

Decode and visualize data from telemetry IRIG Chapter 4 PCM compliant data interfaces.

PCM ENCODER

Dual PCM output up to 40 MBit/s in real time from Dewesoft analog data, Chapter 10, simulated data and other sources.

IRIG CHAPTER 10 AND INET TELEMETRY

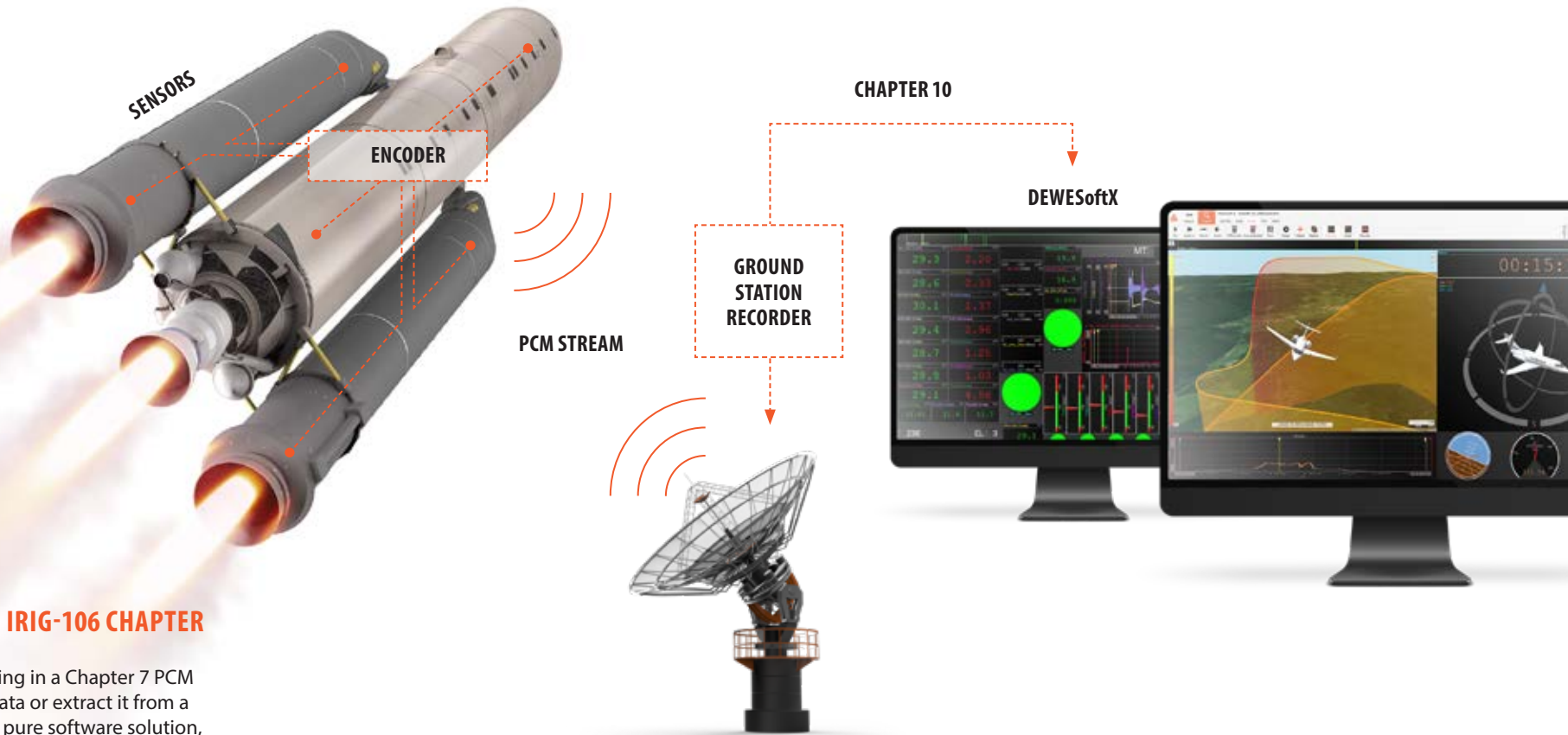

NOW SUPPORTING IRIG-106 CHAPTER 7 STREAMS

DewesoftX can now bring in a Chapter 7 PCM stream via Clock and Data or extract it from a Chapter 10 source. In a pure software solution, the Chapter 7 decoder can extract the Chapter 10 packets from a PCM carrier to be processed in real time by Dewesoft's total telemetry solution.

ONE SYSTEM SOLUTION

A single system solution with integrated digital receiver and PCM processing.

ONLINE AND OFFLINE MODE

DewesoftX can read and process stored CH10 files as well as connect live to an Ethernet CH10 stream during the mission.

Complete IRIG-106 Chapter 10 acquisition and analysis solution for every kind of data source used today.

iNET

Data decoding from up-to-date telemetry standards.

IRIG-106 CHAPTER 10

DewesoftX can fully decode, visualize and analyze Chapter 10 data from PCM, analog, video, MIL-STD-1553, ARINC-429, serial, Ethernet, CAN and GPS streams inside the CH10.

RAW DATA

Raw data are always stored - providing optimal possibilities for offline data processing.

SYNCHRONIZED ACQUISITION

All data sources are synchronized down to microsecond accuracy using GPS or IRIG time.

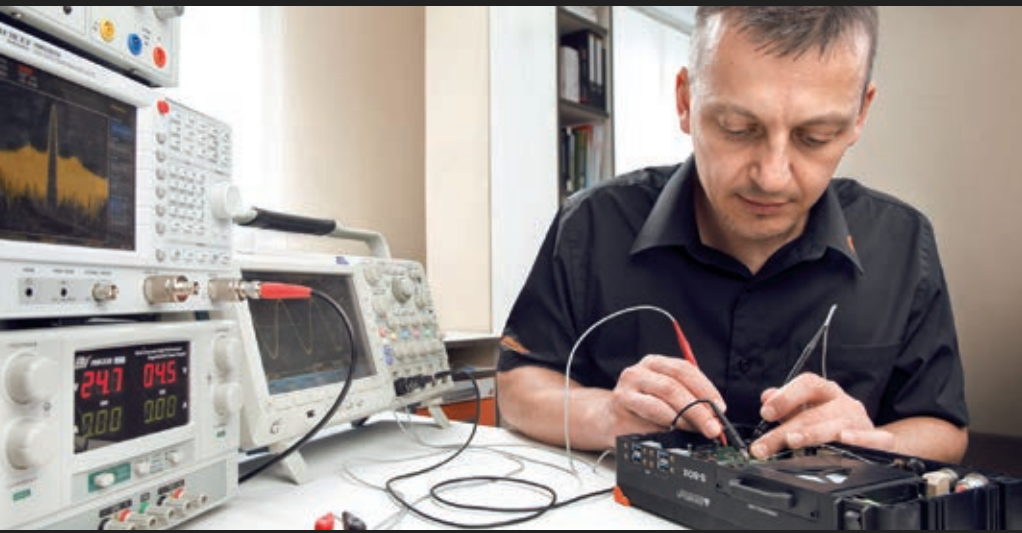

OUR COMPANY.

EVERYTHING IN HOUSE

Slovenia is our operational center which houses all of our development and manufacturing facilities. In this location you'll find our R&D offices, testing facilities, mechanical workshop, production facilities, and a marketing and communications center.

HIGHEST QUALITY

We are fully committed to the highest standards of quality for our development and manufacturing processes as well as to preserving the environment. As such, Dewesoft is a TÜV SÜD certified ISO 9001 and 14001 company.



**IT'S NOT JUST ABOUT
GREAT PRODUCTS**

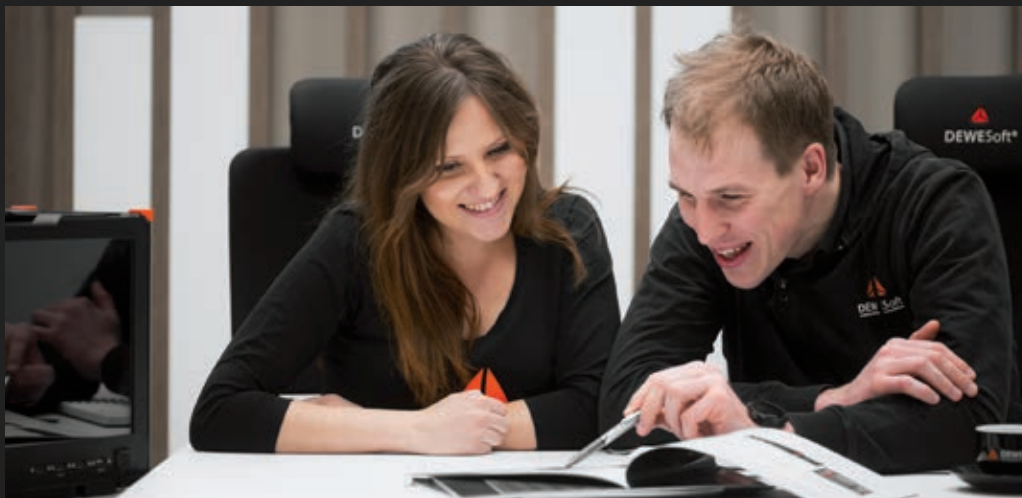

Emotions and values are what makes us human. They shape passionate work, strong products, and long-lasting relationships. Cooperation and mutual trust is important when it comes to business.

That's why we operate worldwide on the base of our core values.



WE ARE
COMMITTED, ACCOUNTABLE,
TRANSPARENT, CARING
AND INNOVATIVE

We care for you - our clients, we care for our co-workers, for society, and the environment. We can only create great and long-lasting business cooperation on the basis of common core values.

IT'S ABOUT
SHARING VALUES



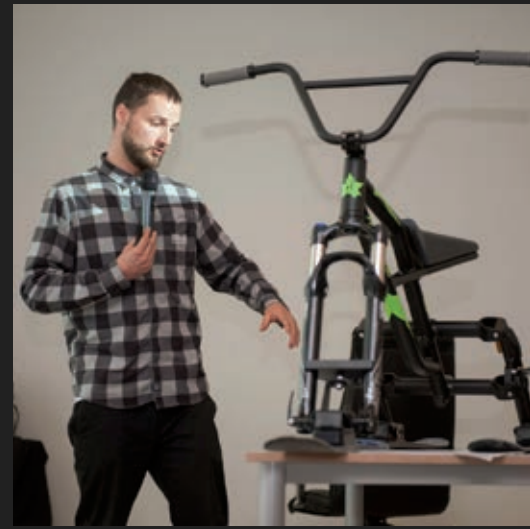

**IT'S NOT
JUST ABOUT US
IT'S ABOUT THE
FUTURE OF THE SOCIETY
WE LIVE IN.**

We feel responsible to improve the world that we all share, and leave it better for the generations that follow. Our kids, your kids, and grandchildren.

The most meaningful thing we can do is help others to achieve their goals. That's why we share our knowledge, equipment, and labs with young entrepreneurs in our own start-up community - now of more than 20 technology innovation companies.

**“BE THE CHANGE YOU
WANT TO SEE IN THE
WORLD”**

-Gandhi

LIST OF DISTRIBUTORS



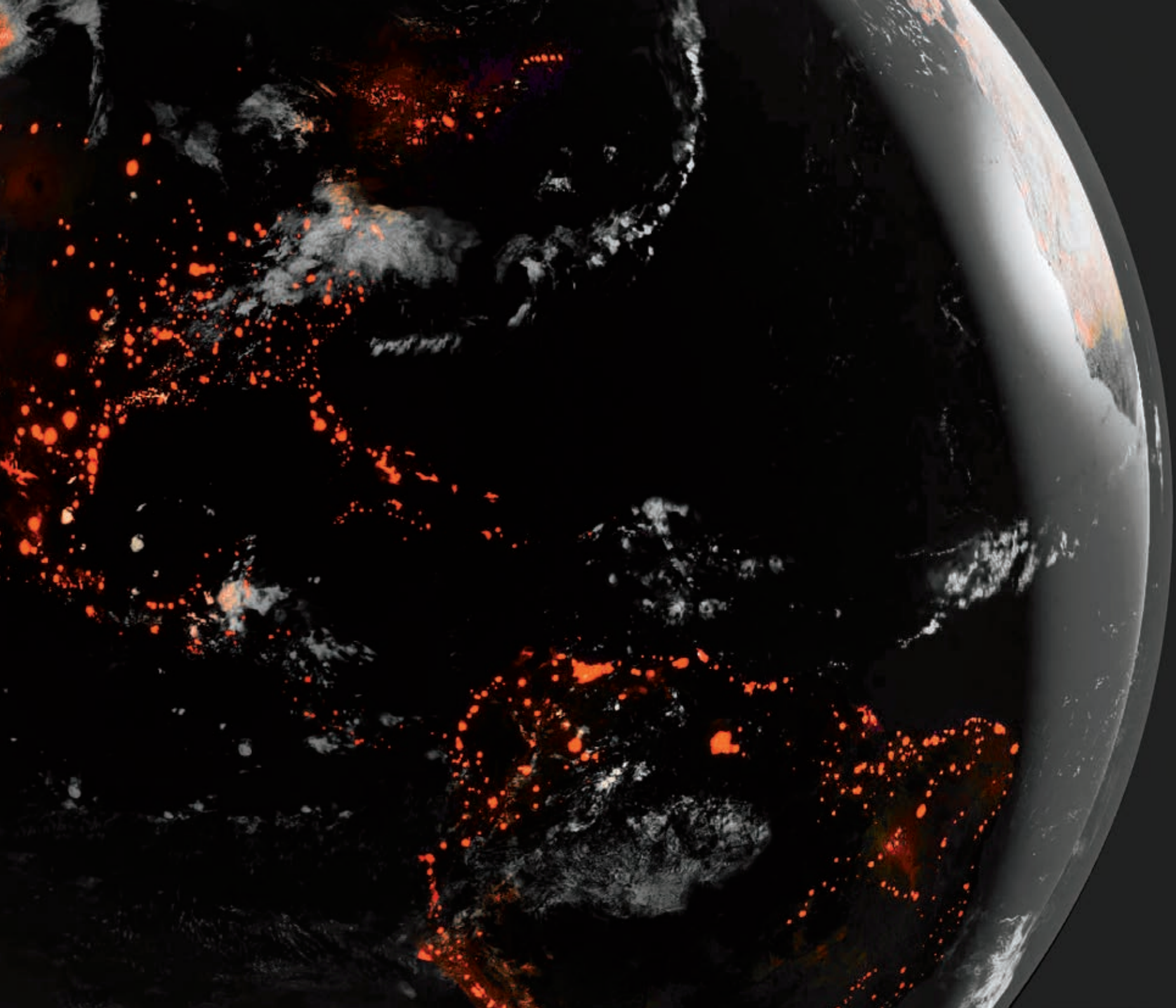

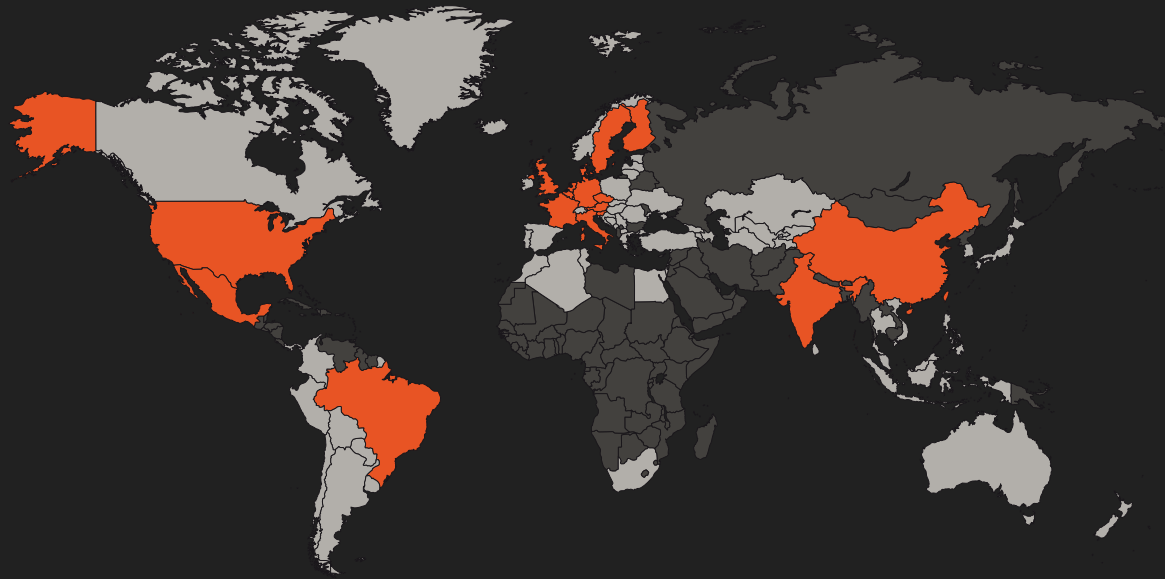

DEWESOFT® WORLDWIDE: SLOVENIA, Austria, Belgium, Brazil, Czech, China, Denmark, Finland, France, Germany, Hong Kong, India, Italy, Mexico, Singapore, Sweden, UK, USA and PARTNERS IN MORE THAN 50 COUNTRIES

HEADQUARTERS

DEWESOFT SLOVENIA

Gabrsko 11A, 1420 Trbovlje, Slovenia

+386 356 25 300

www.dewesoft.com

support@dewesoft.com

sales@dewesoft.com

All trademarks belong to their respective owners.

General Catalog V23-3