

Tektronix

KEITHLEY

A Tektronix Company

automotive

Understanding Power Testing Applications for Today's Automobiles

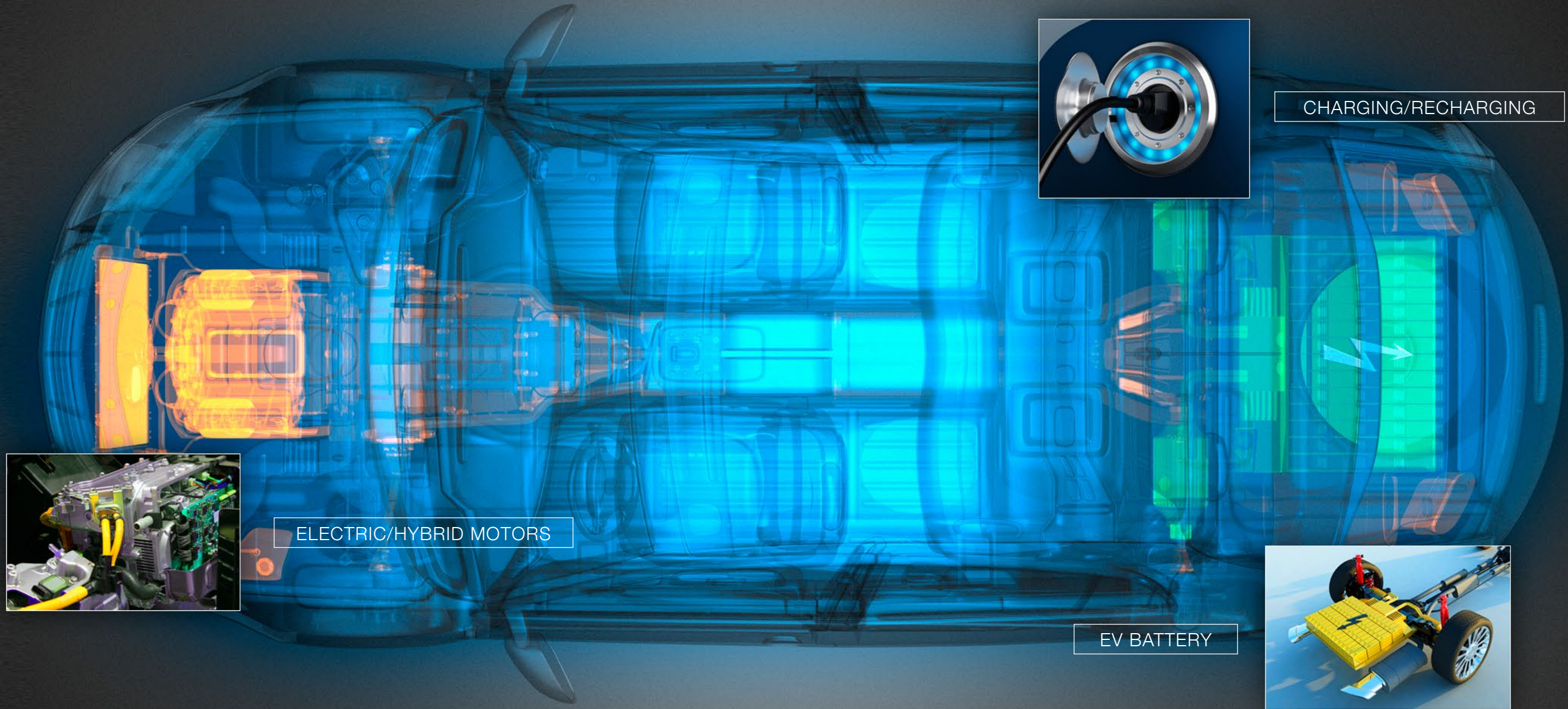

ELECTRIC/HYBRID MOTORS

EV BATTERY

CHARGING/RECHARGING



Introduction

The pursuit of more energy –efficient vehicles such as vehicles that run on alternative fuels, and hybrid and all-electric vehicles is driving technological advances in high power semiconductors, battery technology, battery charging, and drivetrain systems. These technological advances are leading to new components and systems that are being integrated into the automobiles of today and tomorrow. Designing, characterizing, and testing these components and systems requires instrumentation capable of making precise measurements over a wide dynamic range and under a wide range of conditions.

New high power semiconductors must be tested beyond their specifications and under environmental extremes to ensure reliability in any weather condition. For power efficiency, these devices must operate to as near-ideal device performance as possible.

Testing the powertrain of electric and hybrid vehicles to achieve low overall emissions, maximum efficiency, the longest travel distance, and high reliability is critical for gaining consumer acceptance and growing market share in a highly competitive market. Thus, the losses in each power conversion state of the drivetrain – from charger to power electronics inverter – must be minimized. The designers must be capable of fully characterizing their sub-systems and system, and manufacturing must have the complete set of test tools to ensure that they are installing high quality systems into the vehicle. The major systems that require detailed characterization and test are:

- **The battery and its charging and monitoring systems** – AC–DC electrical charging, electromechanical (regenerative braking) charging system, and RF charging system, and inductive coupling. Today’s and future electric and hybrid vehicles may have one or more of these systems. This system also monitors the state of the battery.
- **DC-DC power supplies** for lighting and all other electronic/electromechanical functions.
- **Drivetrain motor control system** – the power inverter sub-system for power delivery, the sensing and torque control system.
- **Electric motor** – Three-phase, permanent magnet, brushless DC motors , switched reluctance motors, and inductance motors.

The following information will help you through the challenges and solutions for characterizing and testing high power semiconductors used in automotive circuits and the major electrical automotive power systems

- Testing New, High Power Semiconductor Devices, Components, and Modules 3**
- Solutions for Power Device Characterization in Automotive Applications 4**
- Device ON- and Off-State: Testing the ON-resistance ($R_{DS(on)}$) 5**
- Characterizing and Testing High Power, High Current Components 6**
- Device ON- and Off-State: Off-State Characterization 7**
- Characterizing and Testing High Voltage Components and Power Semiconductors 8**
- Verifying Battery Performance 9**
- I-V Testing of Batteries 10**
- Verifying External Charging Performance 11**
- Verifying Battery Management System Performance 12**
- Testing Automotive Circuits under Realistic Operating Conditions 13**
- Simulating Power Sources in Automotive Test 14**
- DC-DC Converter Design and Testing 15**
- Testing the Drivetrain Motor Control System 16**
- Determining Motor Output Performance 17**
- Precision, Multi-Channel Power, Energy, and Efficiency Measurements 18**
- Accurate and Versatile Single-Phase Power and Energy Measurements 19**

Get advice for your application.
Send us your question or join the
 discussion in our **application forum**.

Testing New, High Power Semiconductor Devices, Components, and Modules

The onset of advanced electronic technologies and hybrid/electric vehicles has resulted in the design of more efficient semiconductor devices and integrated circuits. Power semiconductor devices are used as switches, control devices, and sources of power in applications such as motor control, voltage regulation, and power conversion. These devices offer lower leakage, lower ON resistance, or both, creating new and increasingly demanding requirements for test and measurements.

Test instrumentation must now be capable of characterizing significantly higher rated voltages, peak currents, and switching frequencies. Breakdown and leakage test are typically performed at 2–3 times the level of the rated or operating voltage. When the devices are in the ON state, they have to pass through tens or hundreds of amps with minimal loss; when they are OFF, they have to block thousands of volts with minimal leakage currents. At the same time, semiconductor technology is being advanced so that it can operate at much higher frequencies to further drive efficiencies.

Diodes & Rectifiers



Forward Voltage (V_f)
Reverse Voltage (V_r)
Reverse Leakage (I_r)

MOSFETS & JFETS

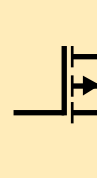

Family of Curves ($V_{ds}-I_d$)
Transfer characteristics ($V_{gs}-I_d$)
On-resistance (R_{dson})
Breakdown voltages (BV_{dss} , BV_{dg})
Leakage Currents (I_{dss} , I_{gss})

Bipolar Transistor & IGBTs

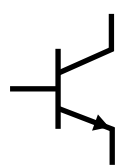

Saturation Voltage (V_{cesat})
Family of Curves ($V_{ce}-I_c$)
Breakdown Voltages (V_{ceo} , V_{ebo} , V_{cbo})
Leakage Currents (I_{ces} , I_{ebo})
DC Current Gain (h_{fe})

Triacs & SCRs etc.



Blocking Voltages (V_{drm} , V_{rrm})
Leakage Currents (I_{drm} , I_{rrm})
Holding Current (I_H)
Latching Current (I_L)

Each type of semiconductor device or component has a set of parameters that must be tested for complete evaluation and characterization.



Download the e-guide [Reinventing High Power Semiconductor Device Characterization](#)

Get advice for your application.
Send us your question or join the discussion in our **application forum**.

Complete Solutions for Power Device Characterization in Automotive Applications

Characterizing and testing today's high power semiconductor devices and components is placing a high demand on test equipment. Device design engineers need equipment that can support them throughout the complete lifecycle of a power device. Today, high power characterization systems are available in two main forms — complete turnkey systems and building blocks that must be configured by the user and completed with good software. Turnkey systems can be set up and running quickly, but they can be quite expensive and limited in the breadth of testing that can be performed.

Keithley's High Power Parametric Curve Tracer (PCT) Configurations and source measure unit (SMU) instruments are ideal for characterizing a variety of power devices in automotive applications:

- Incoming inspection of power MOSFETs and IGBTs
- Failure analysis
- Characterization of new prototype devices
- Testing Gallium Nitride (GaN) and Silicon Carbide (SiC) devices
- Testing LEDs

Keithley's Parametric Curve Tracer configurations are complete solutions configured with a variety of high quality instruments, cables, test fixturing, and software, offering the advantages of easy upgrading or modification to meet changing test needs. Additionally, these instruments and accessories can be used across different test system platforms, such as for reliability or device qualification testing.

Parametric Curve Trace configurations include everything necessary for the characterization engineer to develop a complete test system quickly. The configurations support both parametric and trace test modes, thus including the best of a curve tracer and a parameter analyzer.

Download the Parametric Curve Tracer Configurations Data Sheet.

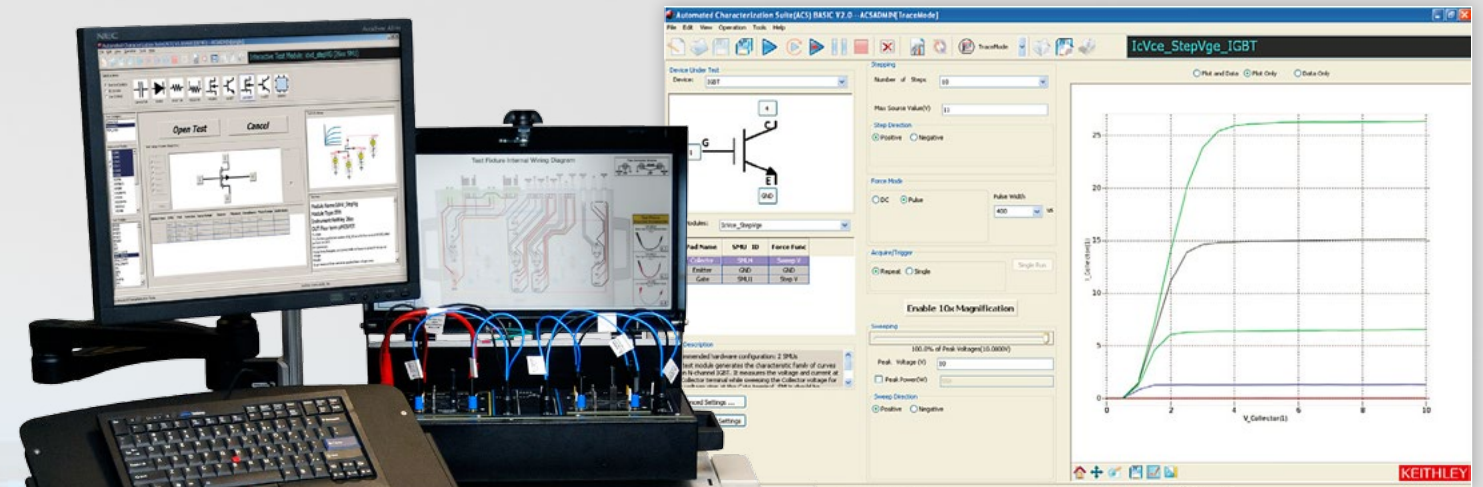

Trace mode quickly captures output characteristics of an IGBT device.

Model 4200-PCT-4 on K420 Cart

**2600-PCT-x
4200-PCT-x**

Parametric Curve Tracer Configurations

High Power Device Characterization

Characterizing and testing today's high power semiconductor devices and components is placing a high demand on test equipment. Device design engineers need equipment that can support them throughout the complete lifecycle of a power device. Today, high power characterization systems are available in two main forms — complete turnkey systems and building blocks that must be configured by the user and completed with good software. Turnkey systems can be set up and running quickly, but they can be quite expensive and limited in the breadth of testing that can be performed.

Keithley's Parametric Curve Tracer configurations are complete solutions configured with a variety of high quality instruments, cables, test fixturing, and software. This building block approach offers the advantages of easy upgrading or modification to meet changing test needs. For example, a low cost 200W/10A system can be purchased initially, and 70A or 100A capability can be easily added later. Additionally, these instruments and accessories can be used across different test system platforms, such as for reliability or device qualification testing.

Keithley's Parametric Curve Tracer configurations include everything necessary for the characterization engineer to develop a complete test system quickly. ACS Basic Edition software provides complete device characterization, including both real-time trace mode for quickly checking fundamental device parameters like breakdown voltage and full parametric mode for extracting precise device parameters. ACS Basic Edition goes beyond traditional curve tracer interfaces by offering a broad range of sample device libraries. More important, users have complete control of all test execution, allowing them to create more advanced tests than previously possible on a curve tracer.

APPLICATIONS

- Power semiconductor device characterization and testing
- Characterization of GaN and SiC, LDMOS, and other devices
- Reliability studies on power devices
- Incoming inspection and device qualification

1.888.KEITHLEY (U.S. only)
www.keithley.com

KEITHLEY
A Tektronix Company

Testing Modern Power Semiconductor Devices Requires a Modern Curve Tracer

David Wyban
Applications Engineer

1. Agenda	00:15
2. Curve Tracer Background	00:20
3. Device Test	00:25
4. What is a Curve Tracer	00:30
5. Basic Block Diagram	00:35
6. What is a Curve Tracer	00:40
7. What is a Curve Tracer	00:45
8. What is a Curve Tracer	00:50
9. What is a Curve Tracer	00:55
10. What is a Curve Tracer	01:00
11. What is a Curve Tracer	01:05
12. What is a Curve Tracer	01:10
13. What is a Curve Tracer	01:15
14. What is a Curve Tracer	01:20
15. What is a Curve Tracer	01:25
16. What is a Curve Tracer	01:30
17. What is a Curve Tracer	01:35
18. What is a Curve Tracer	01:40
19. What is a Curve Tracer	01:45
20. What is a Curve Tracer	01:50
21. What is a Curve Tracer	01:55
22. What is a Curve Tracer	02:00
23. What is a Curve Tracer	02:05
24. What is a Curve Tracer	02:10
25. What is a Curve Tracer	02:15
26. What is a Curve Tracer	02:20
27. What is a Curve Tracer	02:25
28. What is a Curve Tracer	02:30
29. What is a Curve Tracer	02:35
30. What is a Curve Tracer	02:40
31. What is a Curve Tracer	02:45
32. What is a Curve Tracer	02:50
33. What is a Curve Tracer	02:55
34. What is a Curve Tracer	03:00
35. What is a Curve Tracer	03:05
36. What is a Curve Tracer	03:10
37. What is a Curve Tracer	03:15
38. What is a Curve Tracer	03:20
39. What is a Curve Tracer	03:25
40. What is a Curve Tracer	03:30
41. What is a Curve Tracer	03:35
42. What is a Curve Tracer	03:40
43. What is a Curve Tracer	03:45
44. What is a Curve Tracer	03:50
45. What is a Curve Tracer	03:55
46. What is a Curve Tracer	04:00
47. What is a Curve Tracer	04:05
48. What is a Curve Tracer	04:10
49. What is a Curve Tracer	04:15
50. What is a Curve Tracer	04:20
51. What is a Curve Tracer	04:25
52. What is a Curve Tracer	04:30
53. What is a Curve Tracer	04:35
54. What is a Curve Tracer	04:40
55. What is a Curve Tracer	04:45
56. What is a Curve Tracer	04:50
57. What is a Curve Tracer	04:55
58. What is a Curve Tracer	05:00
59. What is a Curve Tracer	05:05
60. What is a Curve Tracer	05:10
61. What is a Curve Tracer	05:15
62. What is a Curve Tracer	05:20
63. What is a Curve Tracer	05:25
64. What is a Curve Tracer	05:30
65. What is a Curve Tracer	05:35
66. What is a Curve Tracer	05:40
67. What is a Curve Tracer	05:45
68. What is a Curve Tracer	05:50
69. What is a Curve Tracer	05:55
70. What is a Curve Tracer	06:00
71. What is a Curve Tracer	06:05
72. What is a Curve Tracer	06:10
73. What is a Curve Tracer	06:15
74. What is a Curve Tracer	06:20
75. What is a Curve Tracer	06:25
76. What is a Curve Tracer	06:30
77. What is a Curve Tracer	06:35
78. What is a Curve Tracer	06:40
79. What is a Curve Tracer	06:45
80. What is a Curve Tracer	06:50
81. What is a Curve Tracer	06:55
82. What is a Curve Tracer	07:00
83. What is a Curve Tracer	07:05
84. What is a Curve Tracer	07:10
85. What is a Curve Tracer	07:15
86. What is a Curve Tracer	07:20
87. What is a Curve Tracer	07:25
88. What is a Curve Tracer	07:30
89. What is a Curve Tracer	07:35
90. What is a Curve Tracer	07:40
91. What is a Curve Tracer	07:45
92. What is a Curve Tracer	07:50
93. What is a Curve Tracer	07:55
94. What is a Curve Tracer	08:00
95. What is a Curve Tracer	08:05
96. What is a Curve Tracer	08:10
97. What is a Curve Tracer	08:15
98. What is a Curve Tracer	08:20
99. What is a Curve Tracer	08:25
100. What is a Curve Tracer	08:30

A GREATER MEASURE OF CONFIDENCE KEITHLEY
A Tektronix Company

View our webinar Testing Modern Power Semiconductor Devices Requires a Modern Curve Tracer.

Get advice for your application.
Send us your question or join the discussion in our **application forum**.

Characterizing Device ON- and OFF-State: Testing the ON-resistance ($R_{DS(on)}$)

A MOSFET in power converters is used as a high speed switch, where the conducting channel between drain and source is either ON (i.e., very low resistance) or OFF (i.e., very low leakage.) The ON and OFF states are controlled by the voltage on the gate contact.

ON-resistance is the key determinant of the conduction loss of the power MOSFET.

Test challenges include:

- Pulse testing capability, including pulse verification
- Precise low voltage measurements
- Kelvin connections
- Low inductance, low resistance cables

Measuring ON-resistance requires the use of two source measure unit (SMU) instruments: one SMU instrument drives the gate into the ON state and a second SMU instrument pulses a defined current at the drain and measures the resulting voltage. On-resistance is calculated using Ohm's Law and the programmed drain current and measured drain voltage. ON-resistance of a power MOSFET is often characterized as a function of drain current or gate voltage. Using software, both SMU instruments can be triggered and swept so that this measurement is performed within a single test.

Shown here are the results for ON-resistance of a power MOSFET as measured as a function of drain current for two gate voltages.

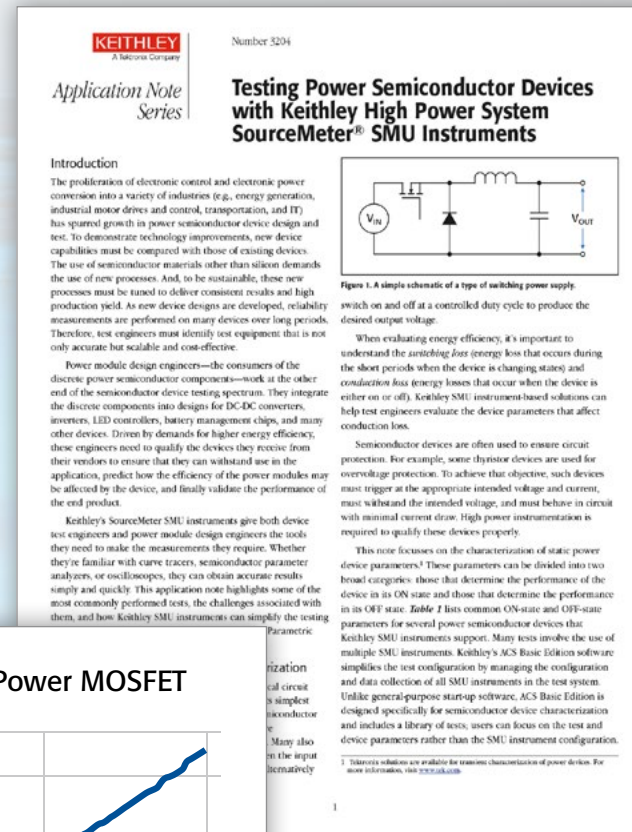
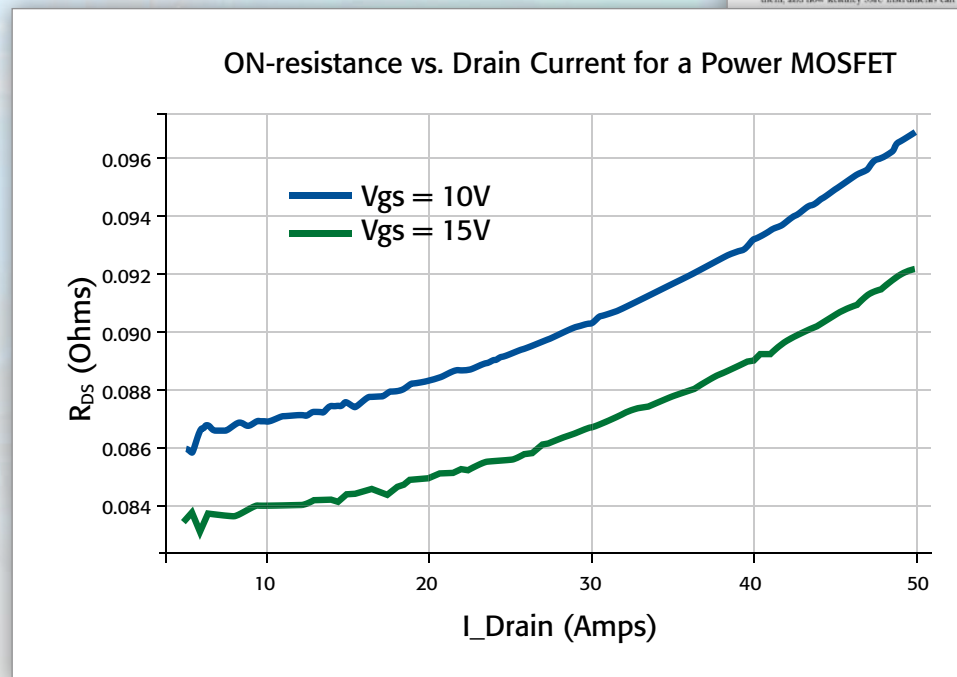

Learn more about measuring ON-resistance. Download the application note Testing Power Semiconductor Devices with Keithley High Power System SourceMeter SMU Instruments.

Get advice for your application.
Send us your question or join the discussion in our **application forum**.

Unmatched Performance for Characterizing and Testing High Power, High Current Components

The Model 2651A High Power/High Current System SourceMeter® Instrument simplifies characterizing today's challenging high power electronics with unprecedented power, precision, speed, flexibility, and ease of use. It combines a highly flexible, four quadrant voltage and current source/load with precision voltage and current meters.

ON-resistance is the key determinant of the conduction loss of the power MOSFET.

Test challenges include:

- Source or sink 2,000W of pulsed power ($\pm 40V$, $\pm 50A$), 200W of DC power ($\pm 10V @ \pm 20A$, $\pm 20V @ \pm 10A$, $\pm 40V @ \pm 5A$)
- Easily connect two units (in series or parallel) to create solutions up to $\pm 100A$ or $\pm 80V$
- 1pA resolution enables precise measurement of very low leakage currents
- 1 μs per point (1MHz), continuous 18-bit sampling, accurately characterizes transient behavior

Choice of Digitizing or Integrating Measurement Modes

With the Model 2651A, you can choose from either digitizing or integrating measurement modes for precise characterization of both transient and steady-state behavior. Two independent ADCs define each mode - one for current and the other for voltage - which run simultaneously for accurate source readback without sacrificing test throughput. The digitizing measurement mode's 18-bit ADCs can support continuous one microsecond-per-point sampling, making it ideal for waveform capture and measuring transient characteristics with high precision. The integrating measurement mode, based on 22-bit ADCs, supports applications that demand the highest possible measurement accuracy and resolution. This ensures precise measurements of the very low currents and voltages common in next-generation devices.

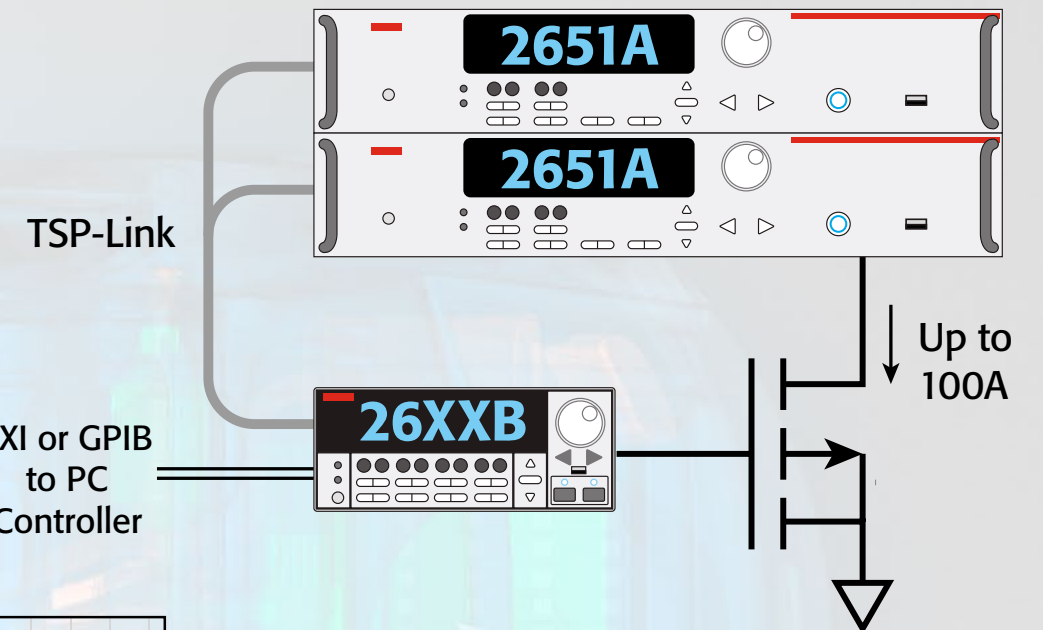
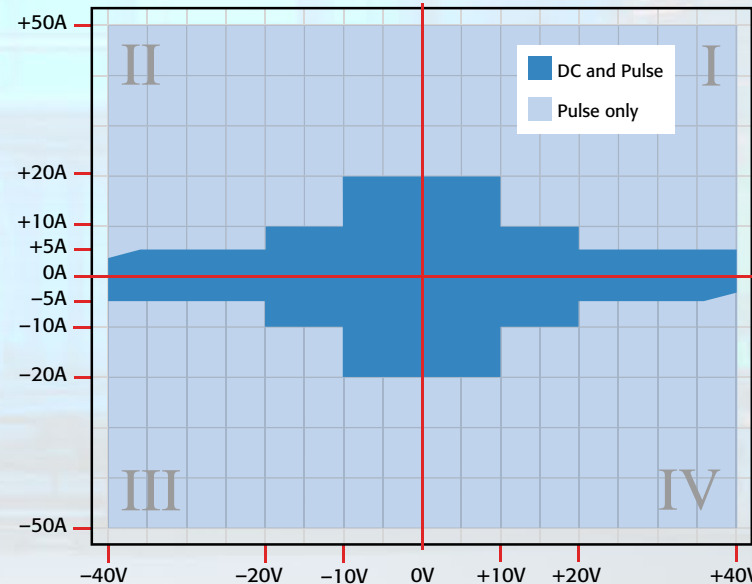

The embedded TSP controller and TSP-Link interface in each System SourceMeter® instrument make it easy to link multiple Model 2651As and other Series 2600B instruments to create an integrated test system with up to 64 channels. Precision timing and tight channel synchronization are guaranteed with built-in 500ns trigger controllers. The fully isolated, independent channels of Series 2600A instruments allow true SMU-per-pin testing without the power and/or channel limitations of mainframe-based systems.

[Download the Model 2651A Data Sheet.](#)

A single Model 2651A unit can source and sink up to $\pm 40V$ and $\pm 50A$. Connect two units in parallel via the built-in TSP-Link® expansion bus to extend the system's current range to 100A or connect them in series to expand the voltage range to 80V. The embedded Test Script Processor (TSP®) included simplifies testing by allowing you to address multiple units as a single instrument so that they act in concert. The built-in trigger controller can synchronize the operation of all linked channels to within 500 nanoseconds.

Get advice for your application.
Send us your question or join the discussion in our [application forum](#).

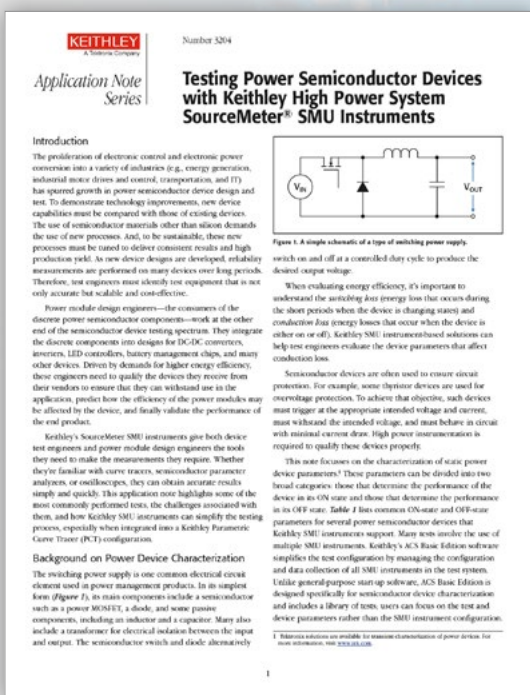

Characterizing Device ON- and OFF-State: Off-State Characterization

For an adequate understanding of all overall product efficiency, the impact of the device on the overall circuit when the device is turned off must be investigated, as well. Two primary DC tests are performed when the device is off: breakdown voltages and leakage currents.

Breakdown Voltages

A device's OFF-state breakdown voltage determines the maximum voltage that can be applied to it. The primary withstand voltage of interest to power management product designers is the breakdown voltage between drain and source of a MOSFET or between the collector and emitter of an IGBT or BJT. For a MOSFET, the gate can be either shorted or forced into a "hard" OFF state, such as by applying a negative voltage to an n-type device or a positive voltage to a p-type device. This is a very simple test that can be performed using one or two SMU instruments. The lower power SMU instrument is connected to the gate and forces the transistor off. It can force 0V for a gate shorted test or force a user-specified bias voltage. A high voltage SMU instrument, such as Keithley's Model 2657A, forces current the drain and measures the resulting drain voltage.

Leakage Currents

Leakage current is the level of current that flows through two terminals of a device even when the device is off. Minimizing leakage current minimizes power loss when the device is off. This power is consumed by the device and is not output to the load and, therefore, contributes to power inefficiency. When using a transistor or diode to switch or rectify, it's important to make a clear distinction between ON and OFF states; a lower leakage current equates with a better switch. While testing a device's OFF state, it is generally desirable to test the gate leakage current and drain, or collector, leakage current. For power devices, these values are typically within the nanoamp or microamp ranges, so they can be measured using the sensitive current measurement capabilities of a SMU instrument, which are greatly beneficial when testing devices made of wide bandgap materials such as silicon carbide (SiC,) gallium nitride (GaN,) and aluminum nitride (AlN,) which typically have higher breakdown voltages and lower leakage currents than do silicon devices.



Watch the product demonstration **How to perform a simple breakdown test on a high power, high voltage IGBT device.**

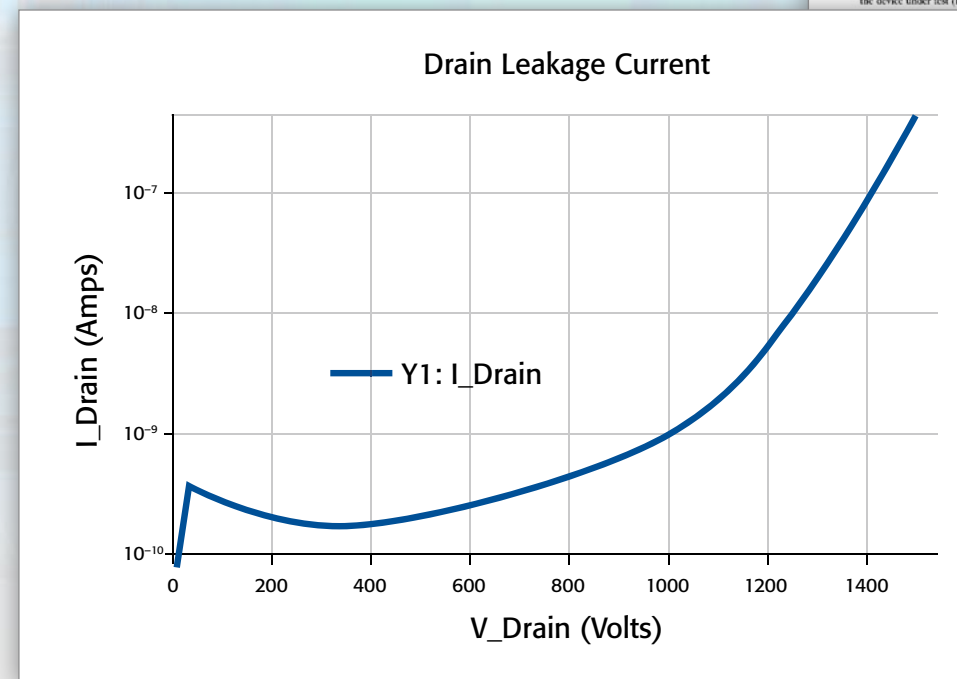

A plot of OFF-state drain voltage vs. drain current results for a commercially available SiC power MOSFET as the drain voltage is swept while the transistor is in the OFF state.



Download the application note **Creating Multi-SMU Systems with High Power System SourceMeter® Instruments**

Get advice for your application. **Send us your question** or join the discussion in our **application forum.**

Characterize and Test High Voltage Components and Power Semiconductors

The Model 2657A High Power/High Voltage System SourceMeter® Instrument adds high voltage to Keithley's SourceMeter SMU instruments family of high speed, precision source measurement units.

- Source or sink up to 3000V @ 20mA or 1500V @ 120mA to capture important parametric data that other equipment can't
- 1fA (femtoamp) current measurement resolution for measuring the low leakage requirements of next-generation devices
- Power semiconductor device characterization and testing
- Characterization of GaN, SiC, and other compound materials and devices
- Breakdown and leakage testing to 3kV
- Characterization of sub-millisecond transients

Like the Model 2651A, the Model 2657A features dual 22-bit precision ADCs and dual 18-bit 1µs per point digitizers for high accuracy and high speed transient capture. It includes TSP® Express characterization software, LabVIEW® driver, and Keithley's Test Script Builder software development environment.



[Download the Model 2657A Data Sheet.](#)

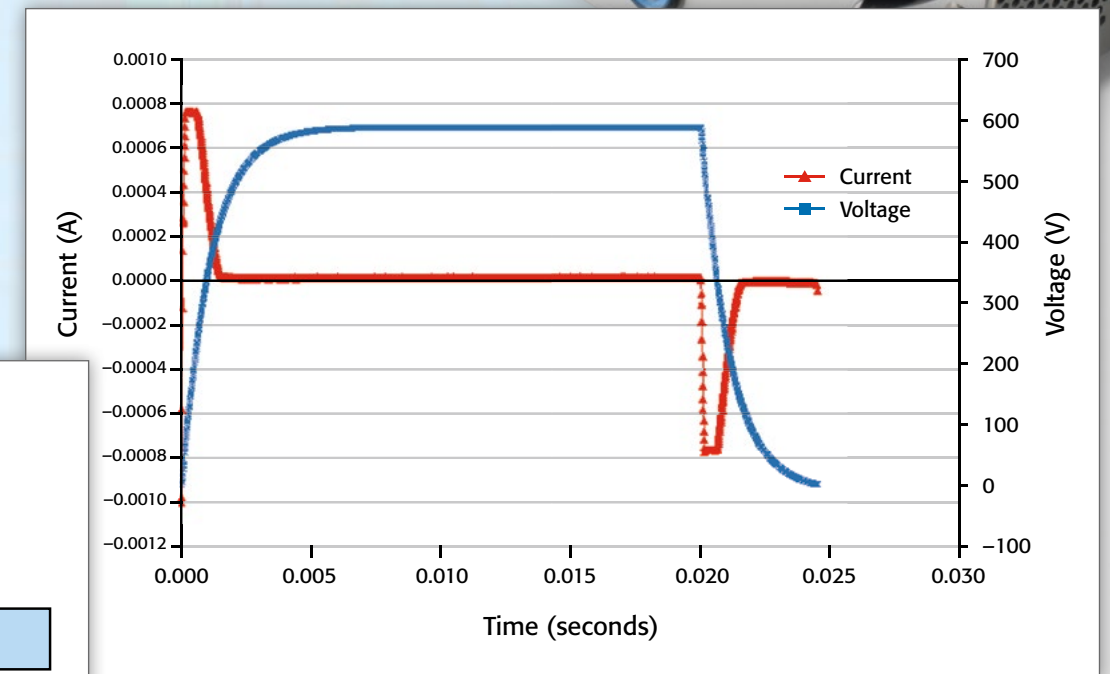
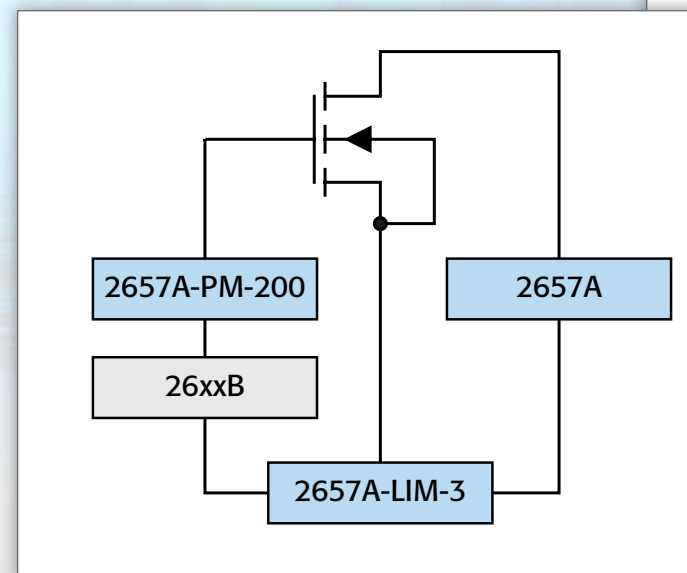

The dual high speed A/D converters sample as fast as 1µs per point, enabling full simultaneous characterization of both voltage and current.

The Model 2657A can be combined with Series 2600B and Model 4200-SCS SMU instruments to support multi-terminal test capability.

Want assistance, a quote, or to place an order? [Contact us online.](#)

Verifying Battery Performance

The heart of the electric vehicle and hybrid system is the battery. Batteries need to have a high energy density, light weight, high capacity to maximize travel distance between charges, reliability, and competitive costs. Today, NiMH and Li-ion batteries are the battery technologies of choice with EV and hybrid automotive manufacturers. Extensive research is going into new battery technologies and battery construction.

Since the battery power also impacts vehicle starting, acceleration, and mileage, battery performance characterization is essential for quantifying vehicle performance. Determining battery performance involves making the following types of measurements:

- Discharge cycling under varying loads
- Charge cycle characterization
- Battery temperature monitoring
- Battery internal resistance measurements

Testing the characteristics of an automotive battery requires DC power, voltage, and current meters, as well as a digital electronic load: and all instruments must have sufficient accuracy to meet demanding test requirements. Using a minimum number of instruments to perform battery testing simplifies test setup, reduces programming time, and saves test system size.

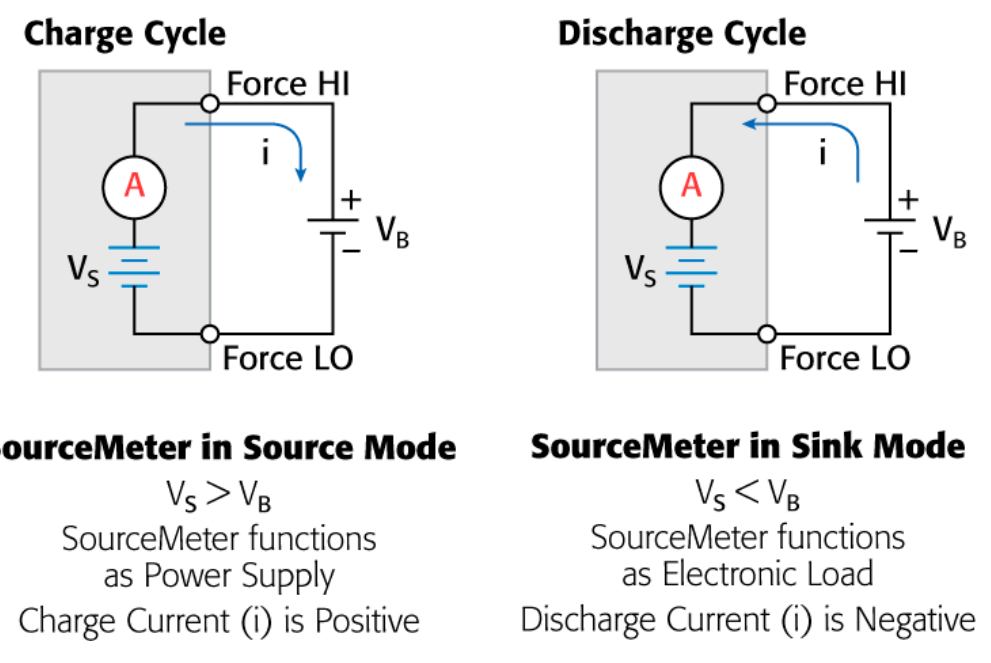
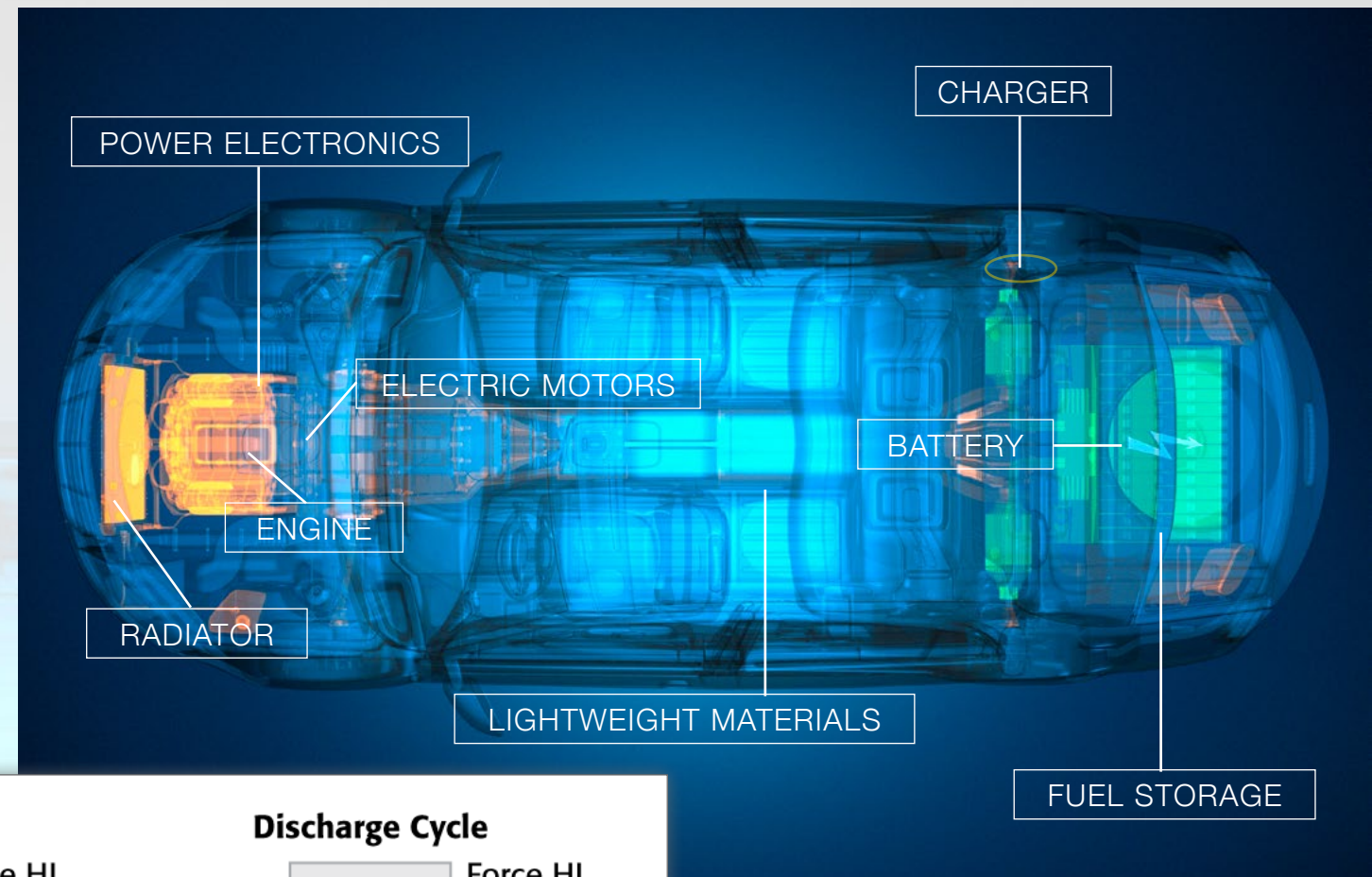

Charge and discharge circuit diagrams.

KEITHLEY
Application Note Series
Number 521

Rechargeable Battery Charge/Discharge Cycling Using the Keithley Model 2450 SourceMeter® SMU Instrument

Introduction

Rechargeable, or secondary, batteries are commonly used in place of disposable batteries in electronic devices such as video game controllers, digital cameras, and remote controls. Common types of rechargeable batteries include Li-ion (lithium ion), Ni-MH (Nickel Metal Hydride), and NiCd (Nickel Cadmium). The characteristics of a secondary battery are commonly tested using discharge and charge cycling. Cycle tests provide information about the battery such as its internal chemistry, capacity, number of useable cycles, and lifetime. In production testing, a discharge/charge cycle is often performed to verify battery specifications and to ensure it is not defective.

Battery Charging/Discharging

Rates for constant current charging and discharging are defined in terms of the battery's capacity, which is the amount of electrical charge that the battery can store. The capacity is expressed in terms of a discharge or load current. The rate at which the discharge current will discharge the entire battery in one hour is known as the C-rate. For example, a battery rated at 1000mAh will charge 1000mA for one hour if discharged at 1C. If a 500mAh cell is discharged at 50mA, then it is discharged at one-tenth the C-rate (0.1C) and therefore can source 50mA for ten hours.

Test Description

For both the charging and discharging cycles, the Model 2450 SourceMeter SMU instrument is configured to source voltage and measure current. A simplified circuit diagram of both the charge and discharge cycles is shown in Figure 2.

Charge Cycle

2450 SourceMeter
SourceMeter in Source Mode
 $V_S > V_B$
SourceMeter Functions as Power Supply
Charge Current (i) is Positive

Discharge Cycle

2450 SourceMeter
SourceMeter in Sink Mode
 $V_S < V_B$
SourceMeter Functions as Electronic Load
Discharge Current (i) is Negative

Figure 2. Charge and discharge circuit diagrams.

A battery is usually charged using a constant current. This is accomplished using the Model 2450 SourceMeter SMU instrument as a voltage source set to the voltage rating of the battery with the desired charging current set as the current limit. At the start of the test, the battery voltage is low (less than the voltage output setting of the Model 2450). As a result, the voltage difference drives a current that is immediately limited to the source-limited current limit. When in current limit, the Model 2450 is acting as a constant current source until it reaches the programmed voltage level. As the battery becomes fully charged, the current will decrease until it reaches zero or near zero. To

Figure 1. Battery test using Model 2450 SourceMeter SMU instrument.

Download this application note for concepts on using an SMU for: **Battery Discharge/Charge Cycling.**

Get advice for your application.
Send us your question or join the discussion in our **application forum.**

SMU Instruments – One, Tightly-Integrated Solution for I-V Testing of Batteries

Keithley's source measure unit (SMU) instruments provide a fully-integrated, four-quadrant, all-in-one solution for testing of batteries. Keithley SMUs are electronic loads for characterizing battery discharge. SMUs can either source current or source voltage for charging batteries and analyzing the batteries charge cycle. Keithley has an extensive range of SMUs with the following range of capabilities:

- Source and measure up to 3kV or 50A pulse, with best-in-class low current resolution
- Up to 2000W pulse or 200W DC power
- Precision 6 ½-digit current, voltage, and resistance measurements
- Waveform and pulse generator
- Source either bipolar voltage or current
- Precision electronic load with constant voltage and constant current sinking

For monitoring temperature, for testing a number of batteries, or for battery test applications that require high throughput, consider Keithley's Series 2700 and Series 3706A integrated digital multimeter/switch/data logger systems. The Series 2700 combines precision measurement, switching, and control in a single, tightly-integrated enclosure for either rack mount or bench-top applications used by data loggers. These products are ideal for data logging and signal routing applications. The Series 2700 offers two- and five-slot models, as well as an Ethernet-based model for high speed and long distance communication. The Series 3706A DMM/Switch System includes a high performance DMM with six slots and can support up to 576 two-wire multiplexer channels for unrivaled density and per-channel costs.



Download the e-guide:
How to Choose and Apply Source Measurement Unit Instruments

Download the e-guide:
High Performance DMMs for single- and multi-channel applications

Want assistance, a quote, or to place an order? **Contact us online.**

Verifying External Charging Performance

Charging stations must convert AC line power to DC voltage and current to charge the battery. To supply sufficient power at the appropriate rate to single or multiple automotive batteries, electric vehicle charging stations are effectively power supplies that operate from single phase or 3-phase AC power sources. These supplies must be as efficient as possible. Testing charging station performance requires analysis of:

- AC power consumption
- Power factor
- Current harmonics compliance with IEC Standard IEC61000-3-2, Electromagnetic Compatibility (EMC)
- Standby or idle power consumption
- DC output power
- Efficiency

Research may lead to contactless charging methods such as inductive power transfer. In this case, power must be measured accurately at frequencies greater than 100kHz.

Charging Controller

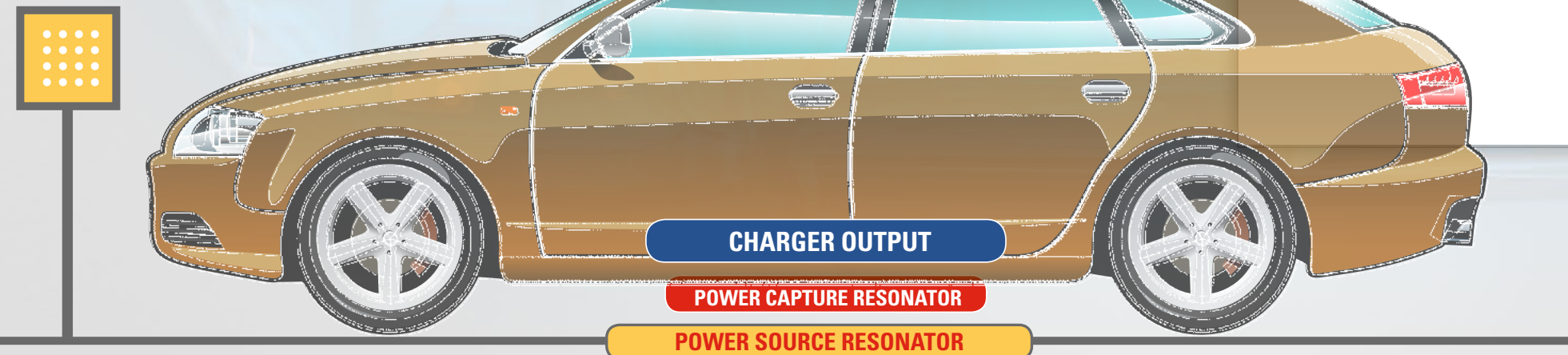

Fundamentals of AC Power Measurements
Application Note

Power analysis involves some measurements, terms and calculations that may be new and possibly confusing to engineers and technicians who are new to this discipline. And today's power-conversion equipment often produces complex voltage and current waveforms that may require different methods than once applied for simpler sine waves. This application note will introduce the basic concepts of power measurements and clarify the definitions of key terms such as:

- Root mean square
- Real power
- Apparent power
- Power factor
- Crest factor
- Harmonic Distortion

By developing a better understanding of these measurement terms and concepts, as well as the relationships between them, you will be better prepared to interpret measurements that you encounter as you test your designs.

PMM OUT		AC INPUT	
Sum	Chg	Chg	
Matt	0.0000 W	Vrms	255.96 V
Vrms	138.95 V	Arms	169.20 mA
Arms	234.04 mA	Matt	23.841 W
VA	56.326 VA	Whr	18.527 Wh
Var	56.326 VA	Hr	779.12 hr
Freq		VA	43.308 VA

Tektronix



Power Supply Measurements

Application Note



Download the application note: **Fundamentals of AC Power Measurements** to learn more about power conversion and power analysis.

Read the application note: **Power Supply Measurements** to learn more.

Get advice for your application. **Send us your question** or join the discussion in our **application forum**.

Verifying Battery Management System Performance

Monitoring of the battery and communicating its condition is critical to ensuring reliable vehicle performance and determining when an electric vehicle battery needs to be re-charged. The battery is monitored by the battery management system which performs the following functions:

- Real time monitoring of battery status
 - o Voltage output, load current, temperature,
 - o State of charge (SOC) and state of health (SOH)
- Cell balancing
- Controlling the charge process
- Communication of the battery status to display systems and vehicle control systems

The battery management system's performance and functionality must be thoroughly tested requiring a full complement of test instrumentation. Of major importance is verifying the quality of the data transferred on the communication bus to other vehicle systems. One protocol used in automobiles is the Controller Area Network (CAN) bus.

Tektronix oscilloscopes have built-in signal and protocol analysis in many of their oscilloscopes for verifying the quality of automotive bus interfaces.

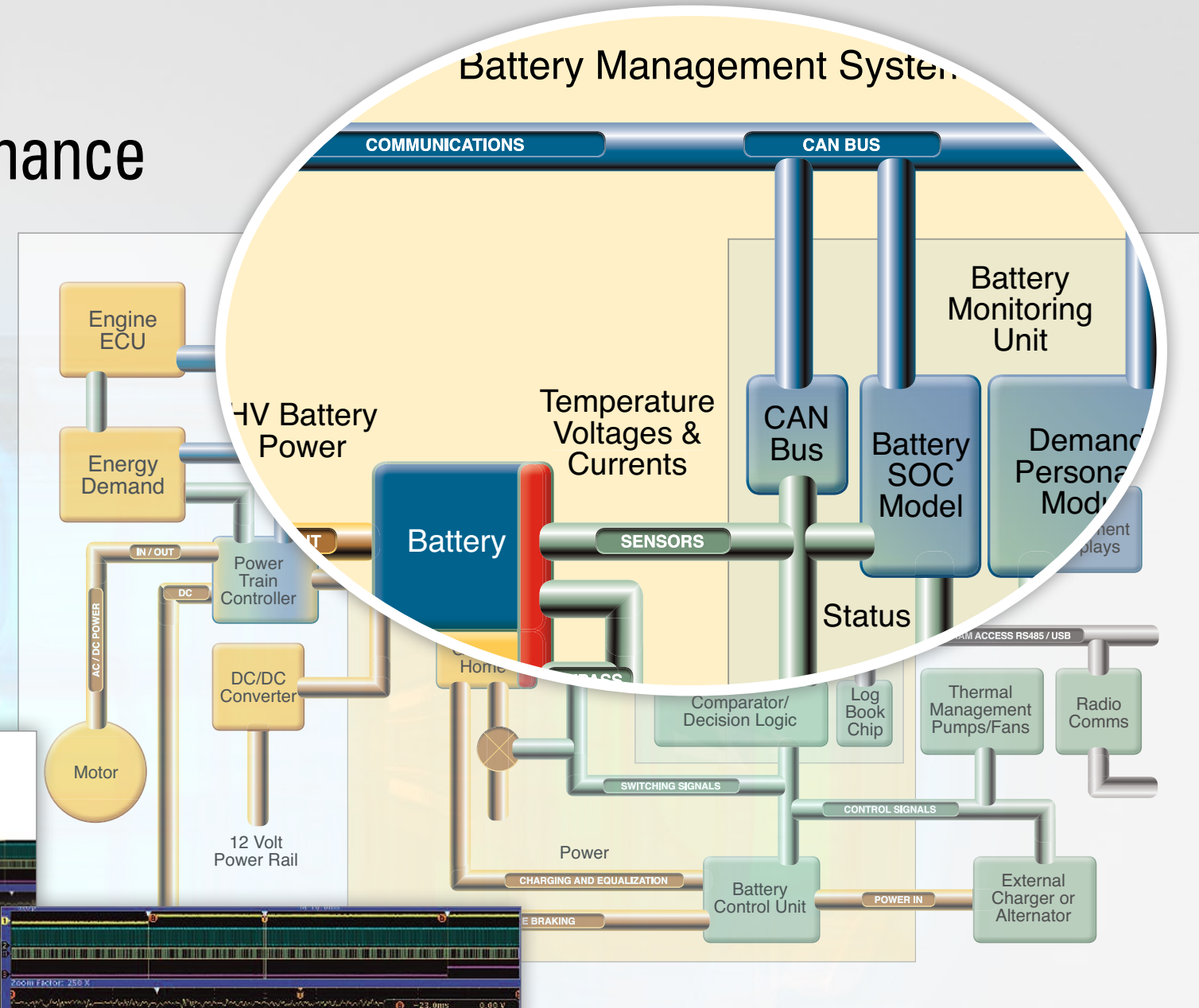

Measurement, Debug and Analysis for Embedded Automotive Designs

Tektronix

Download the application note:
Measurement, Debug, and Analysis for Embedded Automotive Designs

Automatically decode serial bus information in correlation to the live signal in an easy to read format.

Get advice for your application.
Send us your question or join the discussion in our **application forum**.

Testing Automotive Circuits under Realistic Operating Conditions

Circuits in automobiles do not operate with a source that outputs a constant voltage. The power source is a battery that can be simplistically modeled as an ideal voltage source with an internal resistance. The larger the current draw from the battery, the higher the voltage drop across the internal resistance. The actual output voltage is reduced by the voltage drop across the internal resistance.

When motors are energized, high in-rush currents are drawn from the battery resulting in a substantial drop in the battery output voltage. The circuits powered by the battery must be able to continue to operate when the battery voltage drops. Thus these circuits need to be tested with a source that can simulate the response of a battery. A power supply that can emulate the output of a battery under dynamic load changes is needed to test automotive circuits so they can be tested under the most realistic conditions.

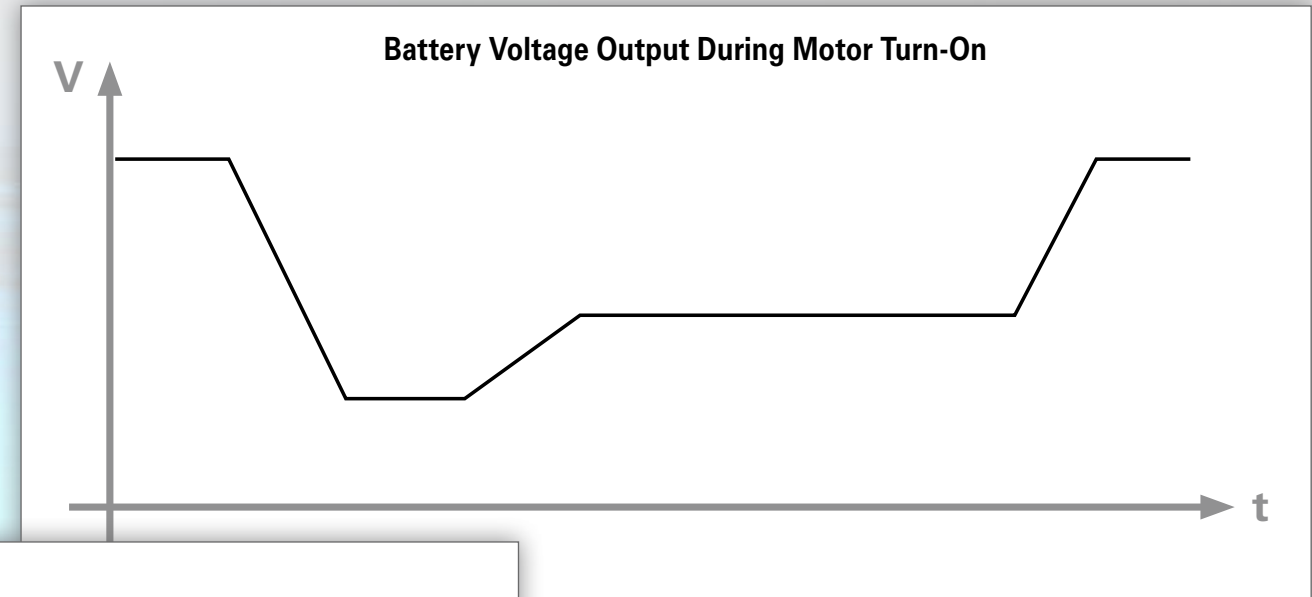

KEITHLEY Number 2191
Application Note Series

Simulating Battery Impedance with the Model 2302 and 2306 Battery Simulator/Chargers

Introduction
The impedance of cells and battery packs varies according to a variety of factors, such as, but not limited to, chemistry, mechanical construction, number of charge/discharge cycles, temperature, and depth of discharge. In applications using batteries with dynamic or pulsed current loads, the voltage across the DUT may vary significantly. If the peak load current is high enough, the voltage drop caused by the impedance of the battery may compromise the performance of the device, including shutdown if the voltage transient is below the operating threshold. This phenomenon is common in TDMA and GSM cellular handsets where the magnitude of the high and low current levels during RF transmission vary by as much as a factor of 20. In the absence of any filtering capacitance between the battery and the RF power amplifier, the handset will shut off if the supply voltage is below the operating threshold for periods as short as several microseconds. The variable impedance output, available exclusively in the Model 2302/2306 battery simulators, enables test and design engineers to simulate the transient voltage response of a battery with pulsed current loads.

Theory
The battery channel in the Models 2302 and 2306 is designed with a variable impedance output to facilitate evaluations of handset performance with a "real" battery, i.e., having a non-zero, variable impedance during the course of operation. Figure 1 shows the transient voltage and current performance of a typical GSM handset with the battery channel and output impedance set to 0.002Ω.

to 0.002Ω. With the exception of the brief transient at the beginning and end of the pulse, the voltage drop at the battery terminals of the handset is nearly zero. The objective is to maintain the programmed voltage across the DUT (or in other words, maintain an effective output impedance of approximately 0.002Ω). In reality, batteries do not have zero impedance and the voltage drop produced by pulsed current loads may have a significant effect on the performance of the device. Figure 2 shows a simple schematic of a battery, represented by an ideal voltage source (V_{oc}), the internal impedance (R_{int}), connected to a DUT with interconnects having a resistance ($R_{interconnect}$).

Figure 1: Transient voltage and current performance of a typical GSM handset with the battery channel and output impedance set to 0.002Ω.

Figure 2: Schematic of a battery represented by an ideal voltage source and a time-varying internal impedance connected to a DUT.

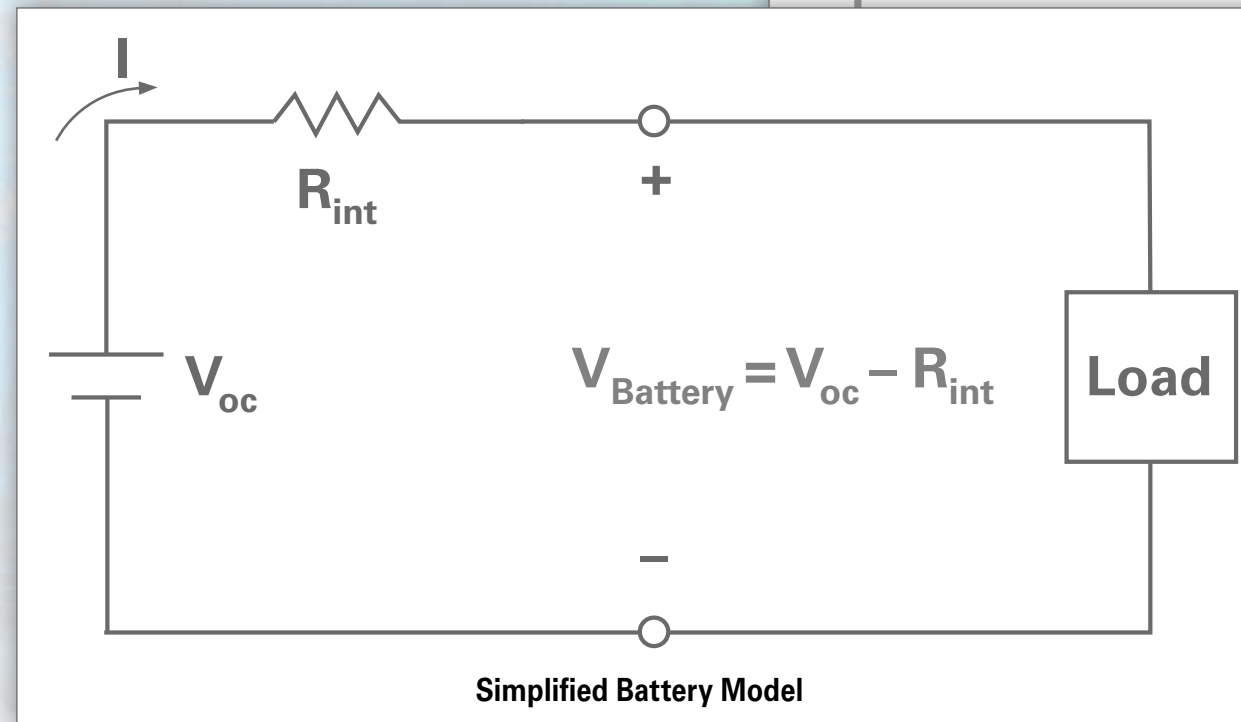

Download the application note: [Simulating Battery Impedance with the Model 2302 and 2306 Battery Simulator/Chargers](#)

Get advice for your application.
Send us your question or join the discussion in our [application forum](#).

Solutions for Simulating Power Sources in Automotive Test

Keithley DC power supplies and source measure unit (SMU) instruments can supply precision voltage levels and specific waveforms to simulate automotive test waveforms.

The Series 2200 Programmable Single-Channel DC Power Supplies includes a list mode feature to create a series of voltage steps and define custom test sequences of up to 80 steps. This makes it easy to perform tests such as analyzing how your circuit- or device-under-test performs at each voltage level within a range of voltages.

Keithley's SMU instruments have programmable source-measure delay sequences that can generate custom waveforms. These instruments can be great alternatives to power supplies for simulating a wide range of battery responses in medium (<100W) and high power (>1kW) I-V testing.

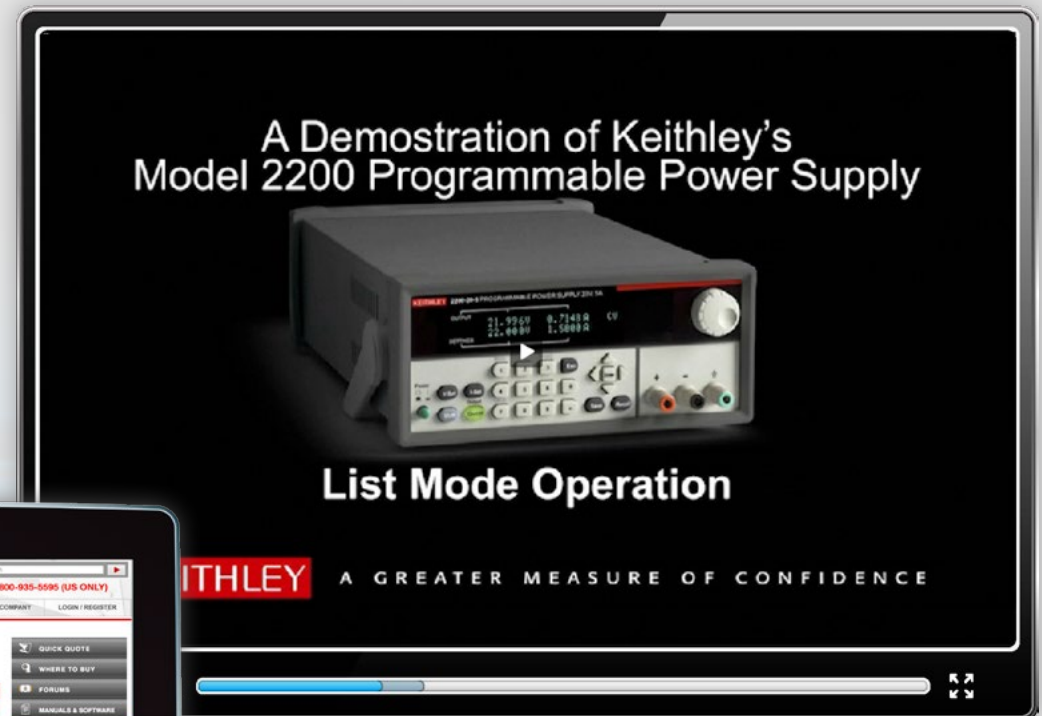

List Mode Operation

KEITHLEY A GREATER MEASURE OF CONFIDENCE

Watch an on-line demonstration of how to create a series of voltage steps with the list mode feature in Keithley's single-channel power supplies.

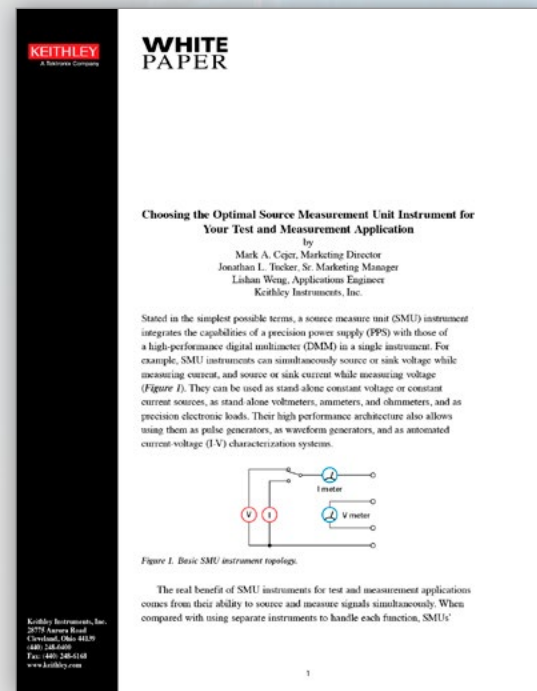

Download the white paper: **Choosing the Optimal Source Measurement Unit Instrument for Your Test and Measurement Application.**

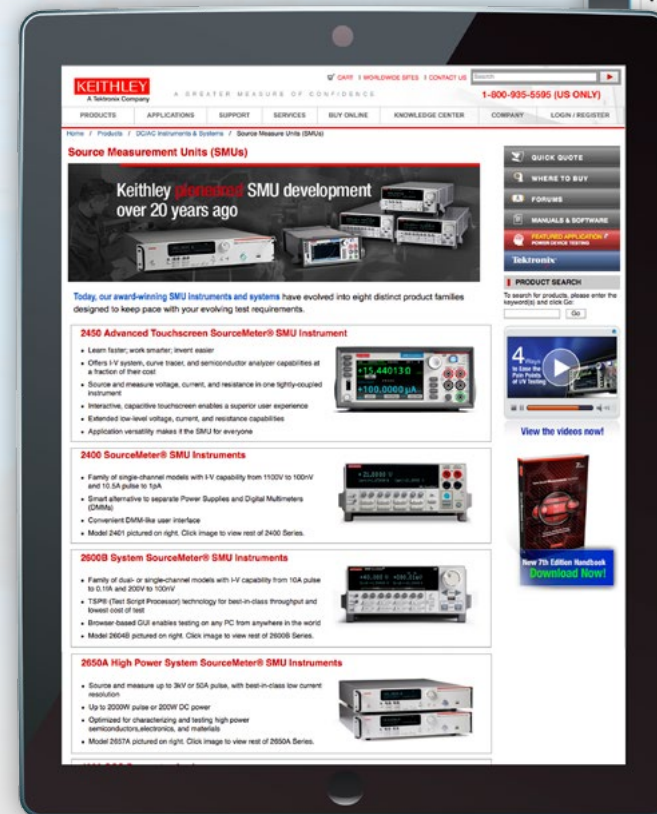

Learn more about Keithley's SMU instruments.

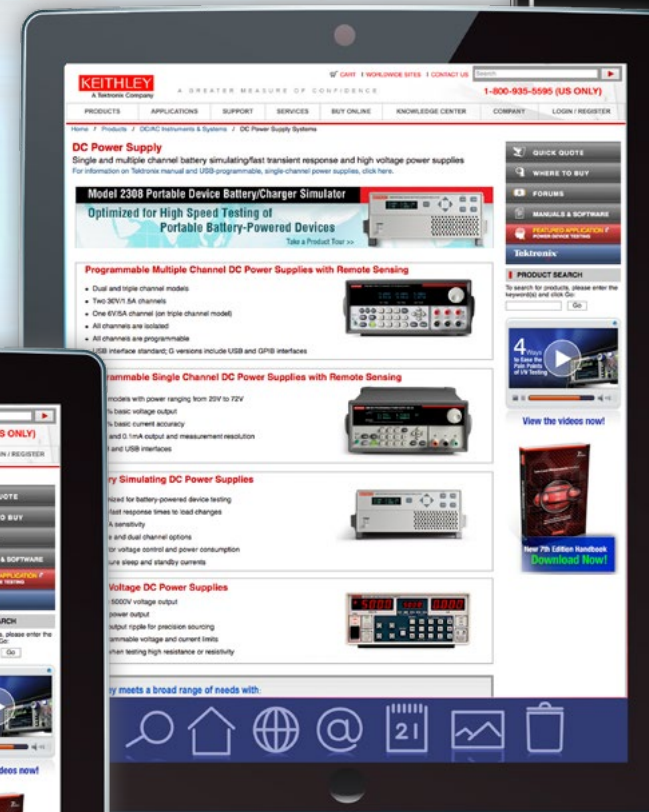

Learn more about Keithley's DC Precision Power Supplies.

Want assistance, a quote, or to place an order? **Contact us online.**

DC-DC Converter Design and Testing

DC-DC converters in hybrid and EV vehicles provide power to the motor drive circuit, the power steering, lighting, and console controls, and the entertainment/infotainment system. These circuits must provide a constant voltage output under all conditions of load current variation and input voltage variation. These DC-DC converters must be designed for high efficiency, electromagnetic susceptibility and interference, high voltage isolation, temperature management, environmental stress, and small size and weight. Much research and development is going into new DC-DC converter designs to meet the challenges of the automotive environment.

Characterizing DC-DC converter performance includes:

- Load and line regulation testing
- Efficiency
- Output noise and ripple
- Turn-on time
- EMI testing
- Thermal testing

A number of important measurements can be done with just two instruments, an oscilloscope and a source measure unit.

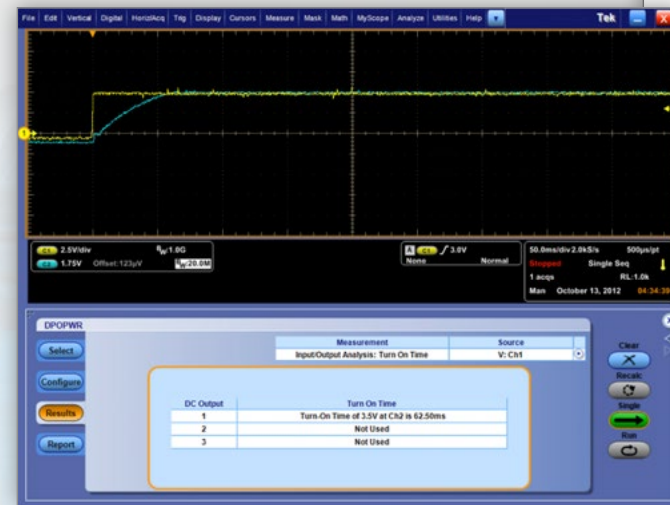

Screenshot of turn-on time test of DPOPOWER software on MSO-5000 scope displaying the measured turn-on time (highlighted in red)

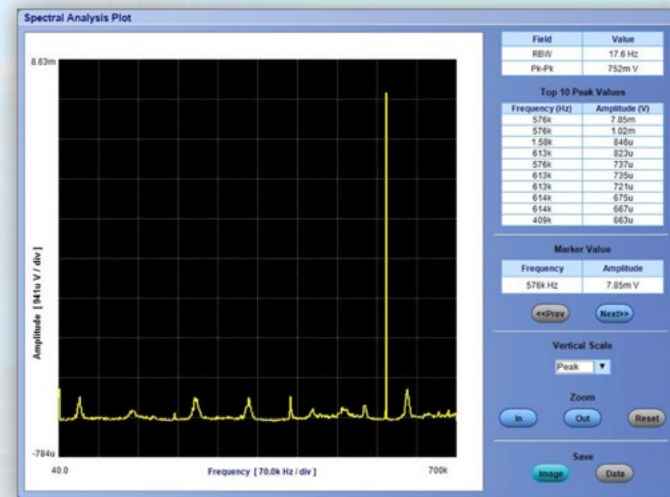

Spectral analysis plot of DC-DC converter

MSO/DPO5000 Series

- Windows 7 Ultimate 64-bit operating system and touchscreen display.
- Over 350 available trigger combinations, including setup/hold serial packet and parallel data.

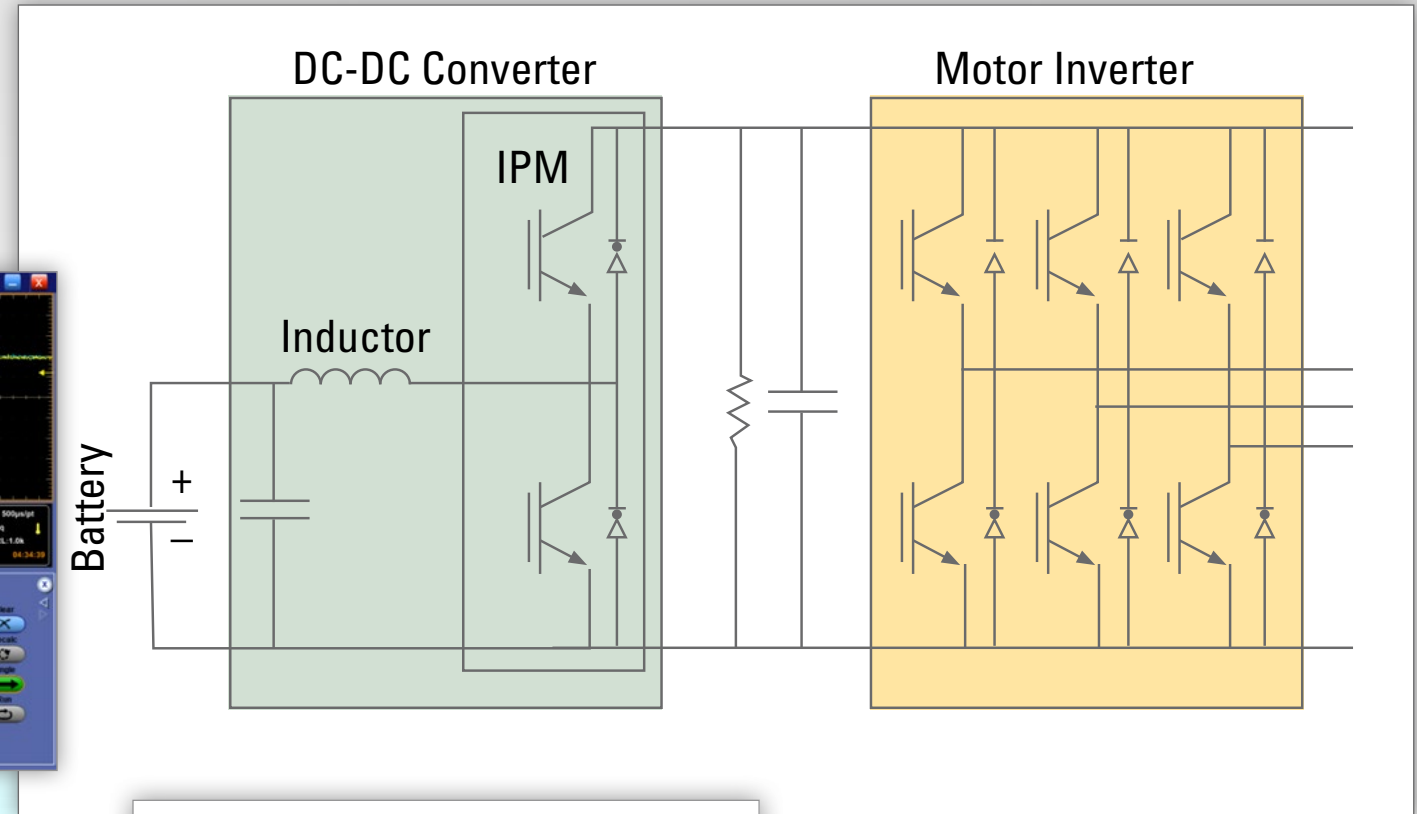

Application Note Series

Number 3203

Simplifying DC-DC Converter Characterization with a Series 2600B System SourceMeter® SMU Instrument and a MSO/DPO-5000 or DPO-7000 Series Scope

Introduction
DC-DC converters are widely used electronic components that convert DC power from one voltage level to another while regulating the output voltage. The output provides a constant voltage to a circuit, regardless of variations in the input voltage or the load current. These power management devices are used in a wide variety of electronic products, including laptops, mobile phones, and instrumentation.

Given the increased pressure to develop products that consume less power and have longer battery life, design engineers need to achieve higher power conversion efficiencies. As a result, numerous measurements are required to characterize the electrical parameters of DC-DC converters. The tests performed include line regulation, load regulation, input and output voltage accuracy, quiescent current, efficiency, turn-on time, ripple, and transient response. Some of these tests require DC test instruments for sourcing and measuring; others require an oscilloscope, and some may require both.

This application note explains how to simplify DC-DC converter testing using a Keithley two-channel Series 2600B System SourceMeter SMU instrument and a Tektronix MSO/DPO-5000 or DPO-7000 Series Oscilloscope. The DPOPOWER Application Software developed for these scopes supports measurement and analysis of common power management device parameters. Figure 1 illustrates a typical configuration for testing DC-DC converters.

The DC-DC Converter
DC-DC converters are useful for generating output voltages that are either higher or lower than the input voltage. A step-down (or buck) converter produces an output voltage lower than the input voltage; a step-up (or boost) converter produces an output voltage higher than the input voltage. Ideally, this conversion should be performed with high efficiency to avoid wasting energy. Figure 2 is a simplified diagram of a DC-DC converter. The V_{in} terminal is the input voltage node of the device, which is referenced to the common GND terminal. The V_{out} terminal is the regulated voltage output with respect to the common terminal.

Using Series 2600B SMUs for DC-DC Converter Parameter Testing
Typically, electrical characterization of DC-DC converters involves sourcing and measuring input voltage (V_{in}), measuring input current (I_{in}), measuring the output voltage (V_{out}), and sinking a load current (I_{out}). From these measurements, the efficiency and other parameters can be determined. The efficiency is important for most designs, especially battery-powered products, because it directly affects the running time of the device. The efficiency of a converter is the output power divided by the input power.

$$\text{Efficiency} = \frac{P_{out}}{P_{in}} = \frac{V_{out} \times I_{out}}{V_{in} \times I_{in}}$$

Traditionally, the DC characterization of these devices required the use of a couple of digital multimeters, a power supply, and an electronic load. However, the DC characterization can be simplified by replacing all of these electronic instruments with a single two-channel Series 2600B System SourceMeter SMU. SMUs are ideal for testing a wide variety of IV parameters of DC-DC converters because they can source and measure both current and voltage, as well as function as an electronic load.

Figure 1. Complete solution: MSO-5000 scope and Model 2610B two-channel SMU for testing DC-DC converter circuits.

Figure 2. Simplified diagram of DC-DC converter.

Download the application note:
Simplifying DC-DC Converter Characterization with a Series 2600B System SourceMeter® SMU Instrument and a MSO/DPO-5000 or DPO-7000 Series Scope

Get advice for your application.

Send us your question or join the discussion in our [application forum](#).

Testing the Drivetrain Motor Control System

The drive train circuit must convert battery voltage to a high DC voltage through a DC-DC conversion and then convert the DC voltage to 3-phase AC output with an inverter circuit. The challenges include creating phase and frequency-stable, AC control waveforms, efficient power conversion, temperature management, and minimally-distorted sinusoidal waveforms.

Key measurements needed to analyze drivetrain motor control electronics are:

- Total output power, voltage, current, and power factor
- Output power, voltage, current, and power factor at the fundamental frequency
- Harmonic power and harmonic component voltage magnitudes
- Output signal frequency
- Efficiency

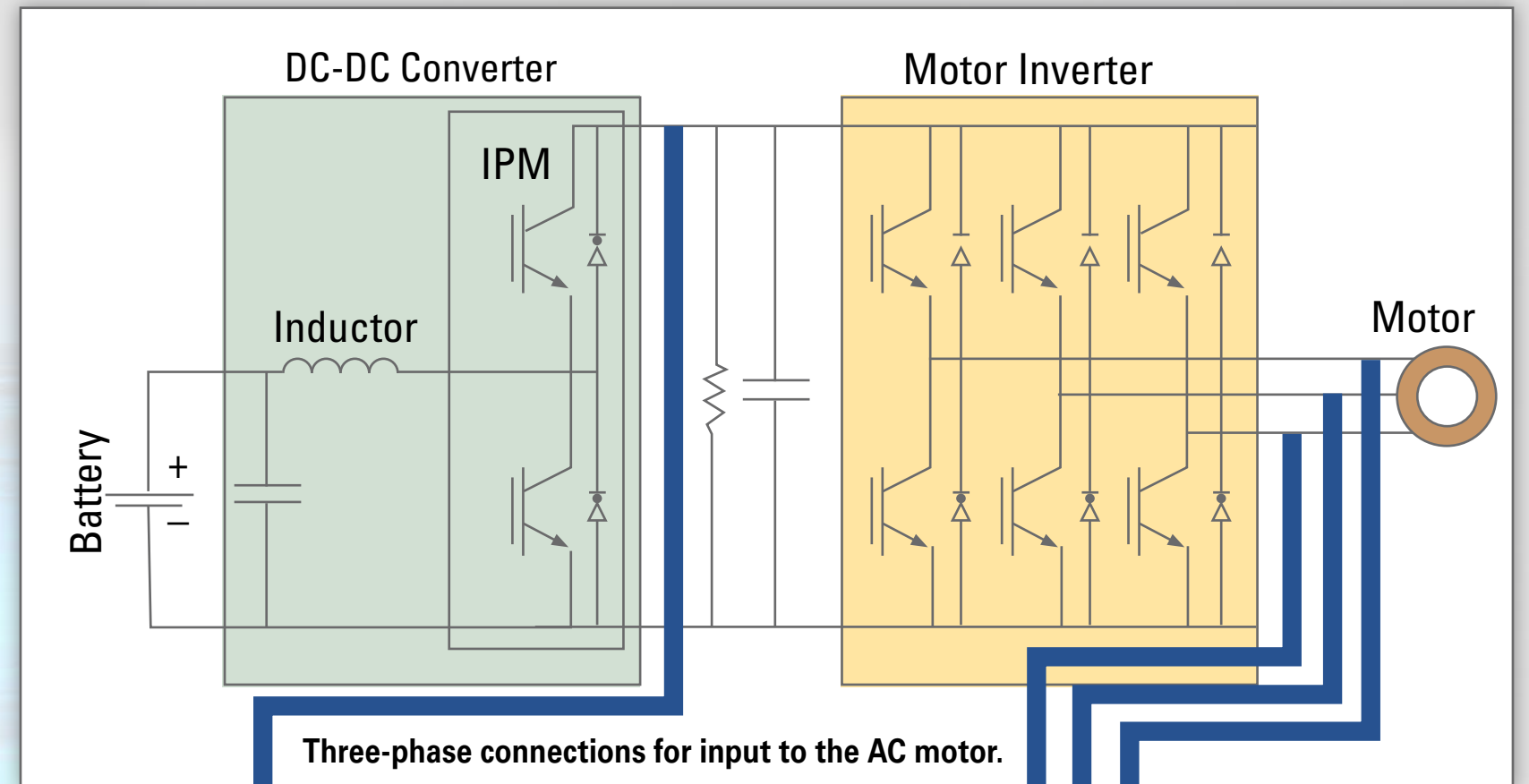

Three-phase connections for input to the AC motor.

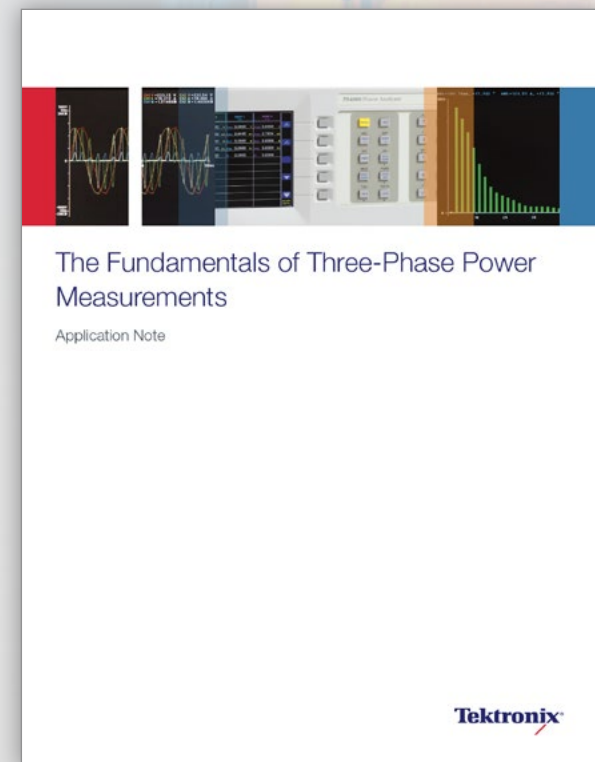

Read the application note: [Fundamentals of Three-Phase Power Measurements](#)

PA4000 Power Analyzer – 0.01% Four-channel Wattmeter

- One-click pulse width modulation mode
- Dynamic frequency tracking
 - o Proprietary technique to avoid the problems of zero-crossing detection
- 30A and 1A inputs
 - o 1A input optimized for transducers to eliminate common-mode errors



Get advice for your application.
 Send us your question or join the discussion in our [application forum](#).

Determining Motor Output Performance

The motor must efficiently convert the electric drive power it receives from the motor control system into mechanical power to propel the vehicle at the desired speed. Torque and speed are the parameters necessary to assess motor functionality. In addition, the efficiency of the complete drive train-motor system needs to be assessed to determine the overall vehicle performance.

Tektronix has an outstanding measurement solution for testing the drivetrain motor control electronics and the motor, and the solution is all in just one instrument, the Model PA4000 Power Analyzer, a 4-channel wattmeter with 0.01% accuracy. This sophisticated instrument measures:

- V, I, VA, VAR, Watts, PF, Phase Angle, Harmonics, W-Hr, and other parameters with outstanding accuracy
- Voltages up to 2000Vpeak and currents up to 200Apeak
- Three-phase or single-phase systems
- Power conversion efficiency
- Up to the 100th harmonic of a voltage or current waveform

The Model PA4000 has the following additional superior functionality for testing the automotive drivetrain:

- Pulse width modulation measurement mode for analyzing PWM drive systems
 - o Includes dynamic frequency detection that ensures stable and accurate measurements on noisy PWM drive waveforms
- 1MHz bandwidth for capturing high frequency harmonics
- Classical discrete Fourier transform, not fast Fourier Transform (FFT) analysis to compute accurate low-level power harmonics for drive and motor optimization
- Auxiliary inputs for acquisition of signals from torque and speed transducers that enable the determination of mechanical power and system efficiency
- Accurate measurements on non-sinusoidal waveforms with crest factors as high as ten
- Accurate measurements in the presence of high common mode voltages

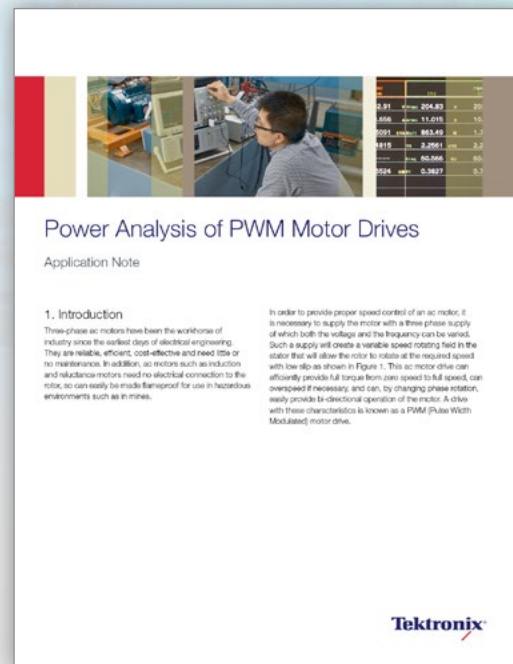
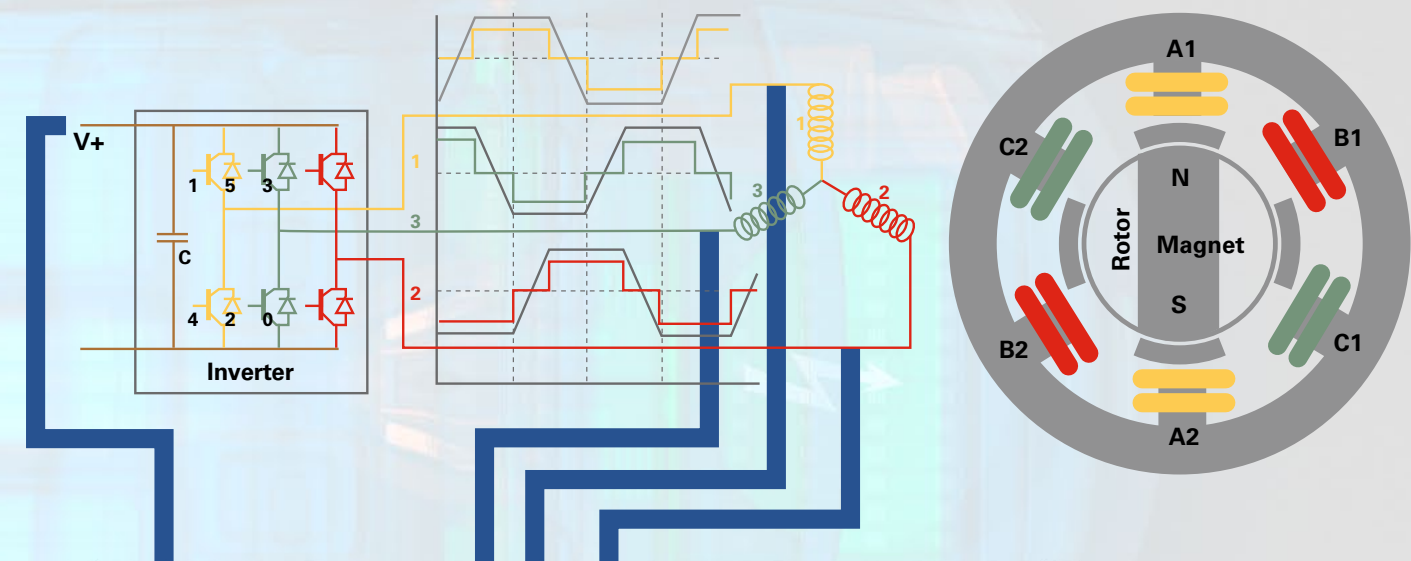
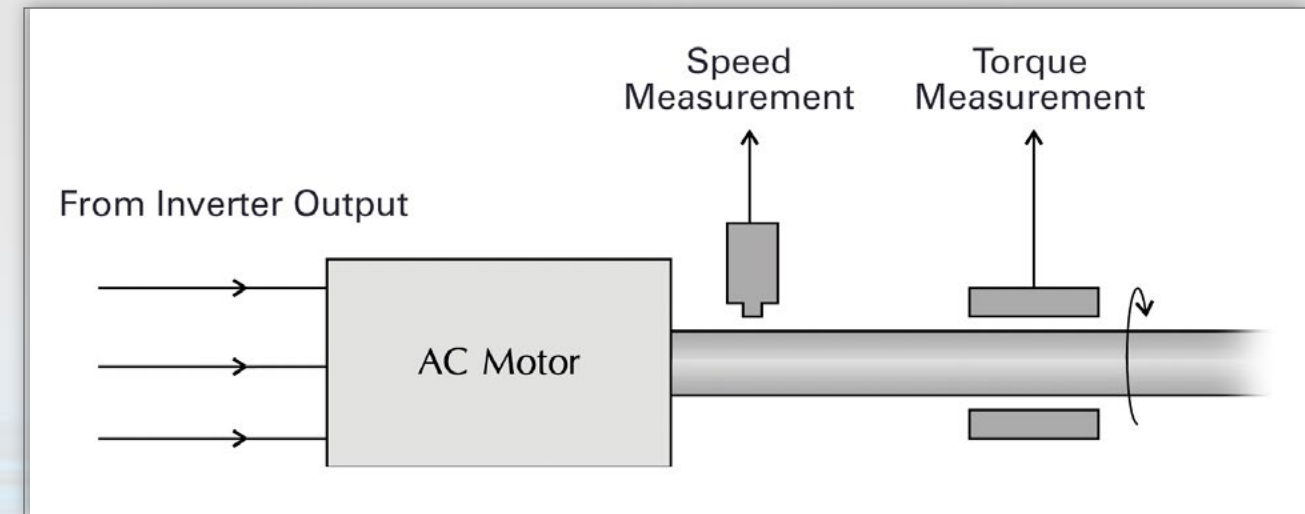

Read the application note **Power Analysis of PWM Motor Drives** to learn more.

Want assistance, a quote, or to place an order? [Contact us online.](#)

Precision, Multi-channel Power, Energy, and Efficiency Measurements

PA4000 Power Analyzers deliver highly accurate, multi-channel power, energy, and efficiency measurements. Precisely-matched inputs, unique Spiral Shunt™ technology, and advanced signal processing deliver high accuracy even with highly modulated waveforms and crest factors as high as 10. The versatile PA4000 offers comprehensive power measurements. Dual current shunts provide optimal resolution from microwatts to kilowatts. Harmonics analysis up to the 100th harmonic, and motor analysis with torque and speed inputs are included in the standard instrument. Every PA4000 comes with multiple PC interfaces, PC software, and USB flash drive support to help you collect and analyze data.

- One to four input modules allow several configurations to match your application
- High measurement accuracy of 0.01% (basic voltage & current accuracy) for demanding test requirements
- Dual internal current shunts for each module maximize accuracy for high- and low-current measurements
- Unique Spiral Shunt™ design maintains stability over variations in current, temperature, etc. (patent applied for)
- Proprietary frequency detection algorithms ensure rock-solid frequency tracking even on noisy waveforms
- Application-specific test modes simplify instrument setup and reduce the likelihood of user error
- Easy data export to USB flash drive or remote PC software, for reporting and/or remote control
- Many standard features such as comm ports and harmonic analysis eliminate costly upgrade options

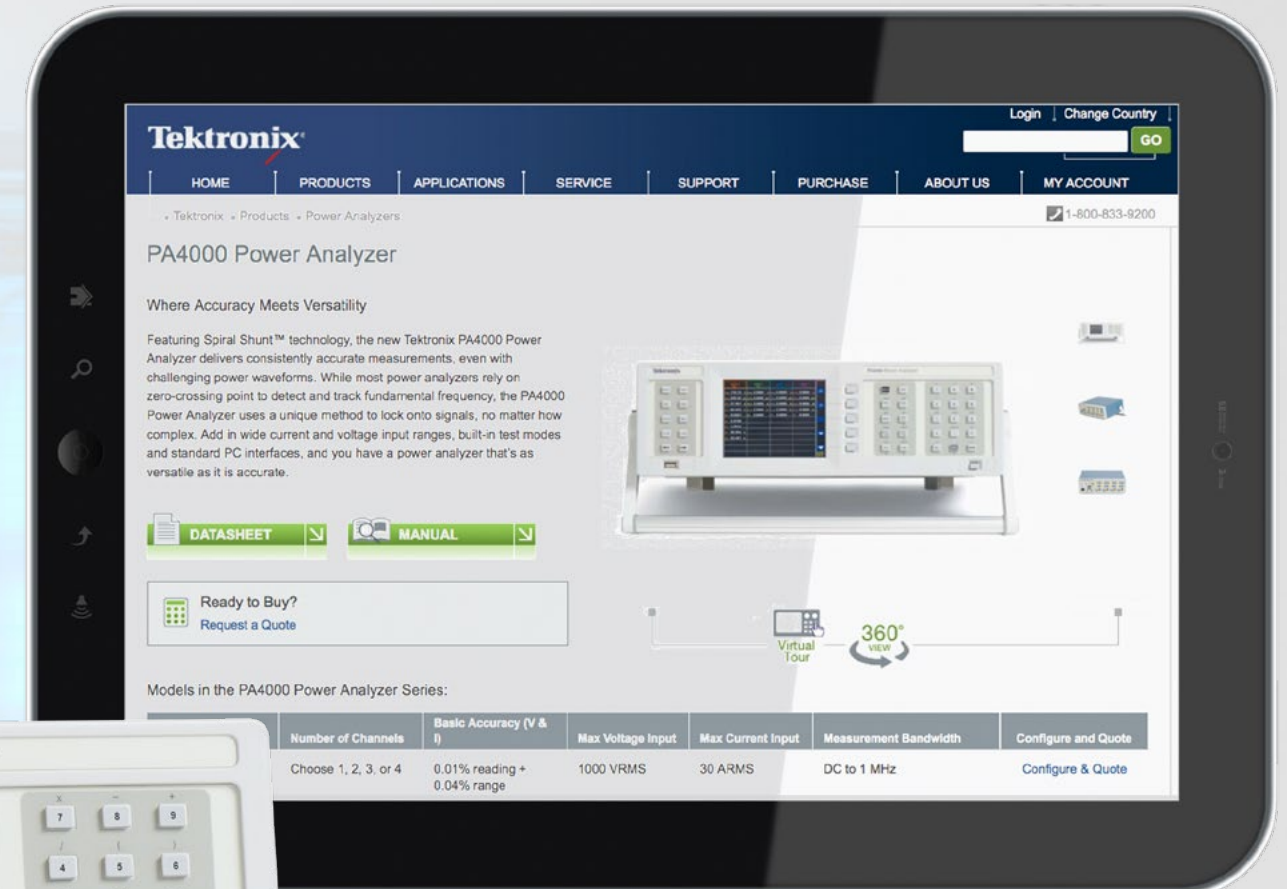

Learn more about the Model PA4000 Power Analyzer.

Get advice for your application.
Send us your question or join the discussion in our **application forum**.

Accurate and Versatile Single-Phase Power and Energy Measurements

The PA1000 Power Analyzer is your best choice for making precision power measurements on single-phase power supplies and all types of products connected to the AC line. Whether you need to test for compliance with energy-usage regulations such as Energy Star™, or simply need to characterize your product's overall power-conversion performance and efficiency, the PA1000 offers the most modern and complete test solution with performance and features unmatched by other single-phase analyzers.

- Bright color graphics display makes instrument setup and data readout easy
- Dual internal current shunts maximize accuracy for high- and low-current measurements
- Application-specific test modes simplify instrument setup and reduce the likelihood of user error
- Easy data export to USB flash drive or remote PC software, for reporting and analysis
- PWRVIEW PC software provides fully-automated compliance testing to IEC 62301 requirements
- Many standard features such as GPIB, USB, Ethernet, and harmonic analysis eliminate costly upgrade options

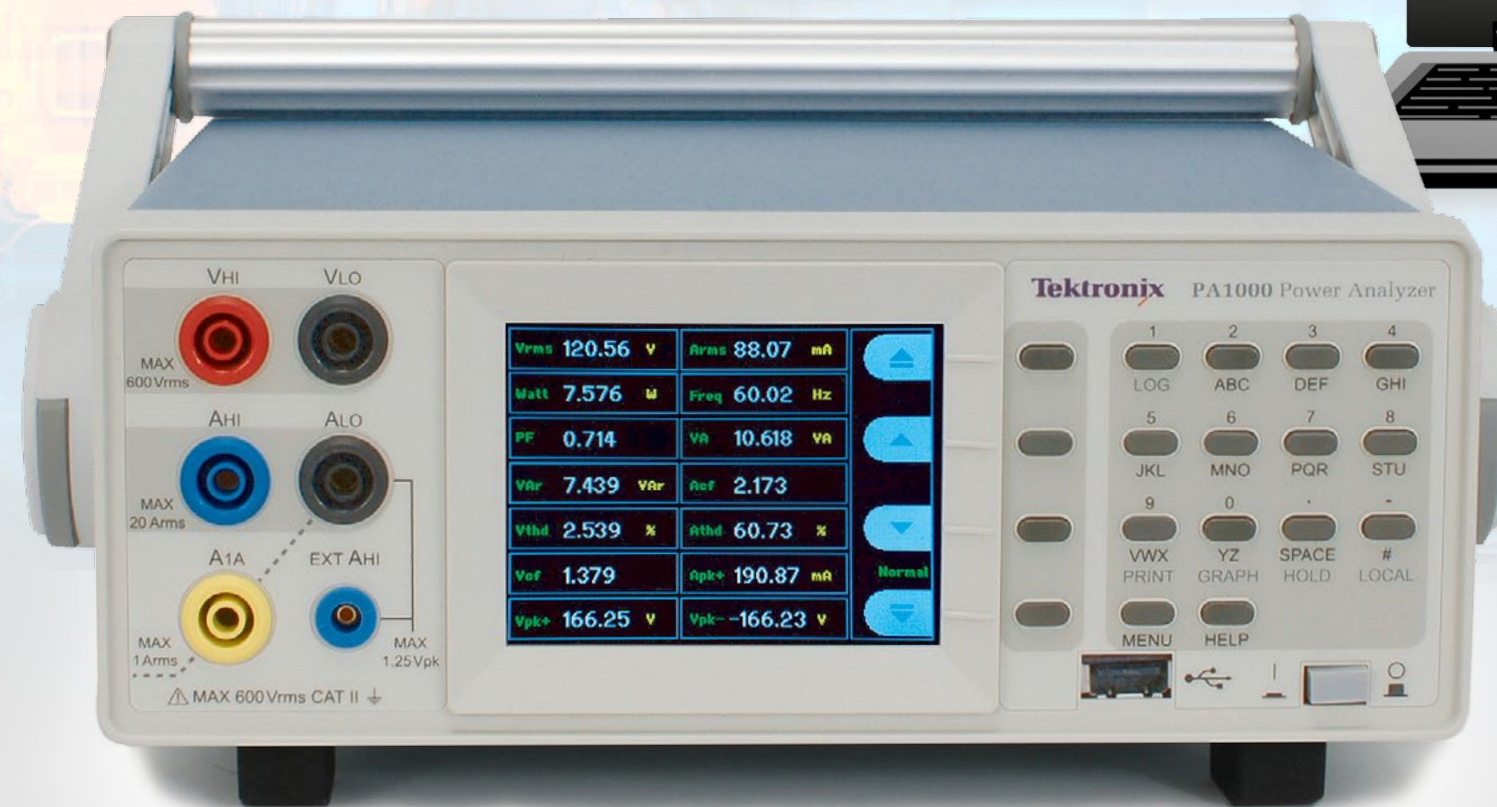

Learn more about the
PA1000 Power Analyzer.

Want assistance, a quote,
or to place an order? [Contact us online.](#)



Tektronix and Keithley maintain a comprehensive, constantly-expanding collection of application notes, technical briefs, and other resources to help engineers stay on the cutting edge of technology. For further information, please visit www.tektronix.com or www.keithley.com.

Copyright © Tektronix, Inc. All rights reserved. Tektronix and Keithley products are covered by U.S. and foreign patents, issued and pending. Information in this publication supersedes that in all previously published material. Specification and price change privileges reserved. TEKTRONIX and TEK are registered trademarks of Tektronix, Inc. All other trade names referenced are the service marks, trademarks, or registered trademarks of their respective companies.