

Feuchtmessgeräte Moisture Meter Humidimètre



AD4A operating instructions



Universal meter type AD4A for measuring moisture in paper, cardboard, wood, building materials, leather, ...
Datalogger for relative air moisture, air temperature, dewpoint and surface temperature.

Universal Moisture Meter type AD4A

normal use:

The electronic moisture meter AD4A is used to determine in a matter of seconds the moisture in materials. Sensors can be connected to measure the air moisture, air temperature, dewpoint temperature and the surface temperature.

materials: mineral building materials, wood, paper, cardboard, leather, ...

measuring ranges:

wood:	0,0 - 99,9 % H ₂ O
paper, cardboard:	0,0 - 50,0 % H ₂ O
building materials:	0,0 - 20,0 % H ₂ O
air humidity:	0,0 - 99,9 % rF
air temperature:	-40,0 - 99,9 °C
surface temperature:	-30,0 - 70,0 °C

At the **material moisture measurement** an average moisture down to a depth of 5 cm is measured.

material temperature range:	5 - 40°C
working temperature range:	5 - 40°C
storage temperature range:	-20 - 70°C

method of operation:

The measuring electrodes of the meter are pressed onto the material during the measuring process, so that a high frequency electrical field is able to pass through the material. A micro processor receives the measured signals and determines from the measured value the percentage water content taking into account the material setting group.

measuring principle:

The meter works in accordance with the principle of an opened plate capacitor. The capacity of the capacitor depends on the material- (dielectric)-constant of the material in between the plates. Compared with air ($\epsilon_r = 1$), for example water has a very high dielectric-constant ($\epsilon_r = 80$). The water content of a wet material can therefore be determined by determining the dielectric constant of this material.

safety tips:

- follow the operating instructions
- only use the meter as directed (see page below)
- keep the meter away from live and current electrical parts
- avoid impacts
- protect the meter from heat
- keep the meter dry and try to prevent dirt from entering the case
- protect the meter from electrostatic discharge
- the meter must only be repaired and serviced by qualified specialists

Damages caused by failure to follow the above safety tips are not covered by the warranty !

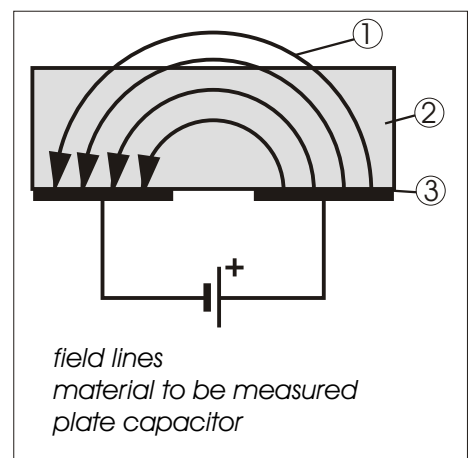
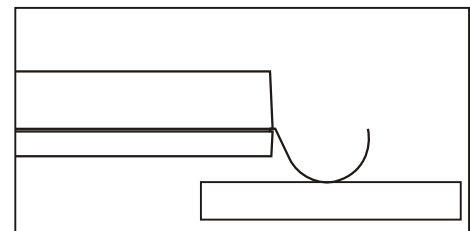
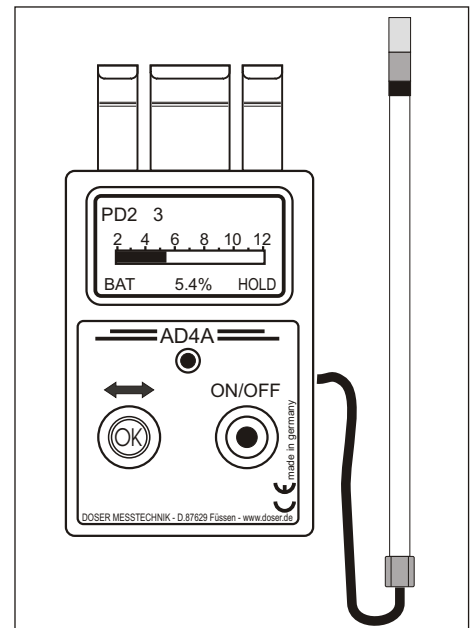

Universal Moisture Meter type AD4A

The **AD4A** has a monochrome graphical display with high resolution (240 x 160 dots). With the integrated backlight, the display is illuminated. The meter operates with a rotating switch, identified with "OK". By turning and pressing you can set different adjustments.

With the "ON/OFF" button the instrument can be switched on and off.

turn on/off the meter::

- push ON/OFF-button, the display shows the time at the bottom of the screen, while the ON/OFF-button is pushed.
- After releasing the ON/OFF-button the meter starts with the settings as it was used before.

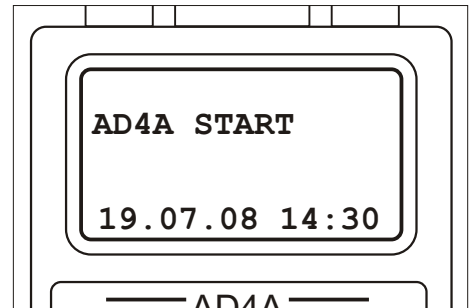

main menu:

In the main menu the symbol ">" points to the selected item. Through turning the rotating switch the menu item will be selected, when selected press "OK"

- >mat.moisture:** start material moisture measurement with the adjusted material setting.
- >adjustments:** select the menu for adjusting different settings
- >calibration:** the capacitive measuring amplifier and the plugged in external sensors can be calibrated
- >storage** data storage for material moisture measurement
 - adjust the storage parameter
 - read out the stored measured values
- >ext. sensors:** external sensors for air moisture, air temperature, dewpoint and surface temperature
 - >sensor values** indicate the sensor values
 - >datalogger** opens the datalogger for up to 16 000 sensor values
- >Info:** indicates the instrument serial number, software version and calibration date. The serial no. has to be identical with the ser. no. on the back of the instrument.

>mat. moisture
adjustments
calibration
storage
ext. sensors
info

main menu

basics for material moisture measurement:

- **if material thickness** ② **< 5 cm** , :
use an appropriate base ①
(e.g.board in styrofoam or foam plastic - **no metal!**)
or better: hold the material to be measured into the air
- **thin materials (< 2 cm)** , :
measure at stack (thickness of the stack at least 2 cm,
avoid air gaps between the several layers)
- **use even, smooth area** ③ for the measurement
(minimum size 4 x 10 cm)
- **minimum distance of the measuring electrode** from the border of the area ③ : >1 cm

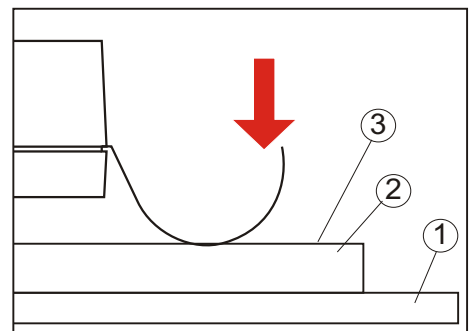

Universal Moisture Meter type AD4A

mat. moisture:

After selecting the menu item "mat.moisture" the capacitive measuring amplifier is activated.

At the same time the meter has to be held in the air, as at the beginning of the material moisture measurement the zero point will be measured and stored for later corrections.

The display shows in the first line the adjusted material setting.

The measurement value is shown with a fast bargraph. The bargraph is updated 100 times per second, therefore quick changes of the measurement values can be recognized.

Below the bargraph the digital moisture value will be displayed and renewed approx. 2 times per second.

material moisture measuring:

1. press the meter with the sensor on the material
(if "automax" is activated, the maximum value is taken and shown automatically. If the meter is pushed again with the sensors on a material, a new measurement starts.)
2. read of the moisture value
3. By pushing the OK-button, the measurement value is hold. The displays shows below on the left side "HOLD". Through pushing again, the hold function will be released. After approx. 10 seconds, the hold function will be released automatically.

main menu

By pushing the OK-button (2 seconds) during the material moisture measurement, the main menu appears.

If this is not possible, the main menu might be locked. In this case look at the locking manual for opening the main menu (page 11)

menu adjustments:

For material setting use either settings from several standard groups (**select instr.**) or choose a specific calibration curve (**mat.group**)

During the material moisture measurement the matched material number or the material in the adjusted group can be selected by turning the rotating switch. Standard material lists are added as stickers, the most appropriate one can be attached to the back of the instrument.

Special calibration curves have to be loaded with the PC into the meter. The material curves can be arranged in groups. The material identification (e.g. "concrete floor") is shown during the material moisture measurement as a text in the first line.

- >**select instr.:** standard calibration curves can be selected
Recommendation: building materials A10/20
wood H24/70
paper, cardboard P12/20
- >**mat.groups:** the required special material group can be selected
- >**input value:** for making comparing measurements to determine customer specific calibration curves
- >**parameter:** measurement parameters can be changed
- >**temperature:** temperature setting °C or °F
- >**auto off sec:** time for automatic switching off
- >**time/date:** time and date can be read and changed
- >**language:** the corresponding menu language can be changed
- >**contrast:** the display contrast can be changed

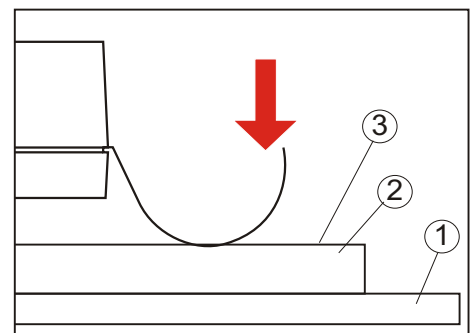
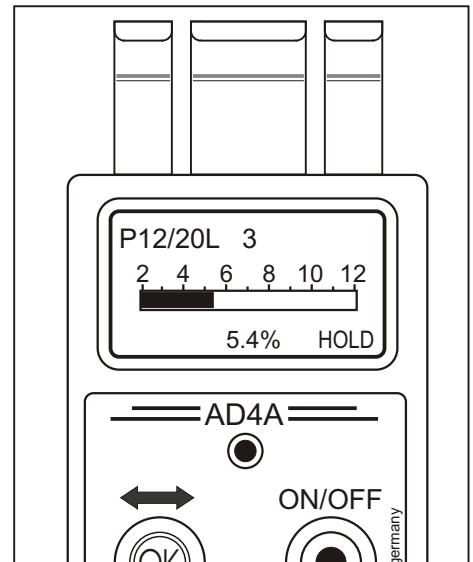

adjustments

```
>mat.group
select instr.
input value
parameter
temperature
auto off sec
time/date
language
contrast
.back
```

Universal Moisture Meter type AD4A

menu parameter: (adjustments for material moisture measurements)

alarm: If the moisture value is higher than the adjusted threshold value an acoustic alarm sounds. At setting 0,0 the alarm is off.

automax: At "ON" at the material moisture measurement the highest value will be shown

Damping: The damping can be adjusted between 0 and 99%. At the material moisture measurement averages will be calculated, therefore display changes are slowed.

parameter

alarm: 0.0

>automax: OFF

damping: 0

back

storage for material moisture measurement values:

Up to 16 storages for up to 128 measurement values are available.

menu storage:

The material measurement storage can be activated and the corresponding settings can be adjusted.

choosing the number of stored values

if an empty rectangle is shown, the storage is empty

if a full rectangle is shown, the storage contains data

OFF <-> ON activate or deactivate selected storage no. for each storage no. 128 values can be stored

single: one value will be stored by pushing OK when **HOLD** is active at material moisture measurements

auto: all values > 0,1% moisture will be stored automatically storage can be stopped by pushing the OK button or it will stop automatically when 128 values are stored.

storage/s: if auto is selected, the number of storages per seconds can be adjusted

The number of stored measurement values will be shown in the right hand corner on the screen.

storage

>storage no 1

storage no 2

storage no 3

storage no 4

storage no 1

>OFF (ON)

back

storage no 1

>ON (OFF)

single (auto)

storage/s ---

back

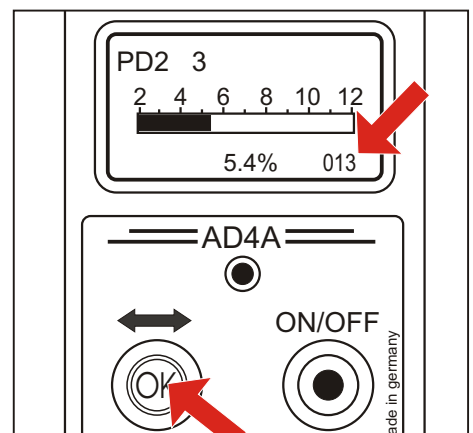

Reading the stored moisture values:

If moisture values are stored, the stored values can be read as follows:

1. open the main menu and select "storage"
2. select the required storage no. and if values are stored the storage reading menu will be shown

OFF: the storage can be switched on again, then the stored values will be deleted

statistic: the statistic analysis of the stored values can be read

values: several stored values can be read

delete: the stored values will be deleted

With the optional PC software **AD4A-S** the stored values can be carried over to a PC, diagrammed and filed.

storage no 1
>OFF (ON)
statistic
values
delete

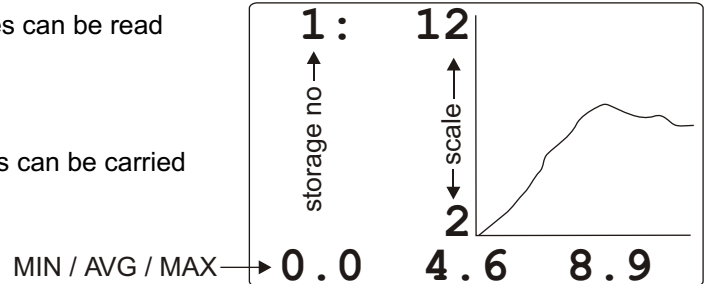

Checking Measuring Quality:

We recommend carrying out regular periodical controlling check measurements, as different local circumstances might need different material adjustments. (recommendation: controlling measurements by oven drying method wood: ISO 3130-1975; building materials: DIN EN 12570; paper: DIN EN 20287 or leather: DIN 53304)

Customer specific calibration curves:

For the exact determination of moisture e. g. at screeds (floorings) we suggest using customer specific calibration curves, they have to be determined for each material with exact test measurements. For building materials a lot of different calibrating curves are available at

DNS-Denzel Natursteinschutz GmbH; Am Wasserturm 5; 73104 Börtlingen; Deutschland
Tel: +49 (0) 7161 959 336; Fax: +49 (0) 7161 959 337; info@dns-denzel.de; www.dns-denzel.de

Even in one room great differences of the moisture in the flooring are possible. Therefore non-damaging measurements are necessary to find out the critical places for an exact time sensitive measurement as e.g. the oven drying method.

The number of such damaging measurements are then minimised.

The result of our capacitive moisture meter depends on differences in density, mixtures and surface roughness. It depends also from the moisture profile. The influence to the moisture gets smaller for higher depth. The measuring result is an average moisture value.

With our moisture meter it is possible to observe the drying process. If at the same place after several days the moisture result does not change, the moisture is in balance with the air humidity. In this case also at high moisture readings an exact comparison measurement e.g. with the oven drying method is recommended.

Oven Drying Method:

The oven drying method is the most accurate way to measure the material moisture in materials.

We recommend this for testing and calibrating of all electronic moisture meters.

Short description:

1. For measuring the weights we recommend a balance with a measuring range of 200g and an accuracy of 0,01g
2. For drying you need an oven with adjustable temperatures of 40, 102, 104 and 105°C
3. Take a probe from wood with a sharp saw, avoid edge parts. For building materials take a probe with a sharp chisel to a depth of approx 3cm. the probe should be at least 20g
4. It is very important to take the weight of the first probe immediately, as air humidity may change the moisture content. Name of the first weight: wet weight (WW)
5. The probe must be dried in the oven until the weight is constant.

The drying temperatures:

wood:	ISO 3130-1975)	104 °C
paper:	DIN EN 20287)	105 °C
building materials	DIN EN ISO 12570)	40 - 105 °C, we recommend always 40°C
leather	DIN 53340	102 °C

Universal Moisture Meter type AD4A

wood (ISO 3130-1975):
building materials (DIN EN ISO 12570):

$$\text{moisture} = \frac{(WW - DW)}{DW} * 100 \%$$

paper and cardboard (DIN EN 20287):
leather (DIN 53340)

$$\text{moisture} = \frac{(WW - DW)}{WW} * 100 \%$$

With the PC-software AD4A-S customer specific calibration curves can be downloaded (page 14)

Basic calibration, test measurement:

The meter can be checked and recalibrated for material moisture measurements with optional test modules.

Two test modules are available:

1. **PE05:** for measurements mainly at mineral building materials
rated value 2000
2. **PE30:** for measurements mainly at paper, cardboard and wood
rated value 800

Start basic calibration:

calibration -> CODE: 097 -> OK

The basic calibration takes place with code 97.

1. zero point

The zero point only can be tested, not adjusted. On the display the zero point (zpv) and the actual measuring value (mv) are shown. At the test the sensors have to be clean and dry! The instrument has to be held free in the air. Then wait until **zpw** and **mv** are nearly equal. The value should be between 100 and 400. If **mv** = 0 or **mv** > 500, then no zero point calculation is working, in this case the instrument needs to be repaired. Press the OK-button to the next calibration step.

2. **measuring on test module at high amplification**

As shown on the picture below, the instrument has to be pressed on the test module. With the rotating switch the factor (F1) can be changed until the display shows as exact as possible the rated value. Press the OK-button to the next calibration step.

3. **measuring on test module at low amplification**

With the rotating switch the factor (F2) can be changed until the display shows as exact as possible the rated value.. Press the OK-button to the next step.

4. With the knob you can choose between "save" and "back".

>save: the changed calibration factors will be stored and the meter will use the new modified calibration factors.

>back: the modified calibration factors will not be stored and the meter will use the old calibration factors again.

calibration

code: 097

mv = 0712
>zpv= 254
F1=200 F2=200
save
back

mv = 2002
zpv= 254
>F1=215 F2=200
save
back

mv = 2002
zpv= 254
F1=215 F2=187
>save
back



Special Uses, Recommendation

Measuring moisture in **caravans, trailers, mobile homes**

For these applications we produce instruments with shortened sensors as shown in the picture. With such sensors measurements can be made in edges without being influenced through the adjoined wall.

We recommend the material group setting:

adjustments -> select instr. -> HD5

with the material number 2 (turning the rotating switch).

Measurement:

1. make a reference measurement at a dry place
2. change the material setting until the instrument shows approx. 5%
3. now different similar places can be checked for higher moisture content.

Attention:

Frames may also cause higher moisture readings. Therefore the instrument can also be used to detect frames.

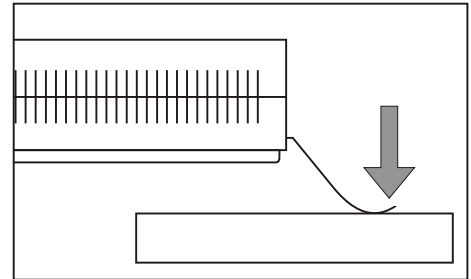

Moisture measurement in plastic boats:

Caused through osmose plastic boats can get blisters below the water line. In blisters the moisture in the plastic rises up. Before starting a repair such parts must be completely dry.

We recommend the material group setting:

adjustments -> select instr. -> HD5 with the material number 0 (turning the rotating switch).

The measured area have to be dry at the surface!

Measurement:

1. take a reference measurement above the water line
2. select the material no. until the reading is approx 10%
3. now you can measure at similar places to see the moisture differences.

Attention: Frames, higher wall thickness or mountings may also cause higher moisture readings. Therefore the moisture meter can also be used to detect frames or mountings at the opposite side of the wall.

Air Moisture, Air Temperature, Dew Point and Surface Temperature:

What are the effects of incorrect humidity?

Low humidity will cause cold, illness and is bad for indoor plants, antiques and paintings. Too high humidity will cause rust, mould and other problems.

Air is able to store water. If it has stored the maximum quantity, it is saturated, the air humidity is 100% rH (relative humidity).

At 100% rH and 20°C the absolute humidity is approx. 17 g/m³.

At 100% rH and 10°C the absolute humidity is approx. 9 g/m³.

If air with 20 °C and 50% rH humidity gets colder to 10 °C, the humidity rises up to approx. 100% rH, if this air gets colder than 10°C, dew comes out; this can be seen at steamed windows. This limit temperature with 100% rH is called dew point.

If an air with 0°C and 50°C gets warmer until 20°C, the air humidity goes down to approx 15% rH. Caused by people, pets or plants the humidity rises up again.

Mould grows through the dew water caused by cold walls, especially at wall edges the danger for dew water is high.

To prevent mould growing there are two important points:

1. The wall isolation must be high, so that the surface temperature at the walls does not go down to the dew point.
2. Regular air ventilation with the opening of windows completely helps to keep the air moisture at low values.

With the connected sensor LFLT20 (20 cm length) or LFLT402 (40 cm length) the air moisture and air temperature can be measured. For surface temperature measurement connect the touching WT-sensor or the non contact infrared sensor WT-IR.

Universal Moisture Meter type AD4A

Sensor menu

In the main menu select “**ext. sensors**” for opening the sensor menu.

As long as the OK-button is pushed the selected serial no. of the sensors will be displayed. The calibration parameters for the selected sensor will be loaded. Then the instrument is looking for external sensors and the shortages for the active sensors will be shown

AM: relative air moisture (humidity)

AT: air temperature

ST: surface temperature

DP: dew point

>sensor values: sensor values will be displayed; the dew point will be calculated with air humidity and air temperature, if the AM and AT values are available. Pushing the OK-button stops the sensor measurements.

>datalogger: With the integrated datalogger there can be logged up to 16000 sensor values. They can be separated in up to 20 different storages (blocks)

Datalogger menu:

>delete: all storages of the datalogger will be deleted.

>storage no: the required datalogger storage can be selected. the storage no. marked with a filled rectangle contains existing data, the storage with an empty rectangle has to be selected for logging new values.

Logging new values:

>interval: adjust the time distance in minutes for storing sensor values

>start: the recording will start

>back: logging menu will be cancelled without starting the logging procedure

Display during recording:

amount: no. of storings, at each storing values for each connected sensor will be recorded

AM, At, ST: actual sensor values

ATTENTION:

During recording the number of connected sensors have not to be changed!

While the data is recording the meter will not switch off automatically!

Take care that the batteries will keep for the required logging time.

By pushing the OK-button the data record will be finished.

Reading logging data:

After selecting a storage no. with filled rectangle, the displays shows start date and time, shortages of the recorded sensors and the number of storings

>statistic: min-, max- and the average of the stored values will be shown.

>back: back to the sensor menu

With the optional software AD4A-S the stored measured values can be transferred to a PC, diagrammed and filed.

```
active sensors
AM AT ST
>sensor values
datalogger
back
```

```
sensor values
AM= +38.3 %
AT= +23.8°C
ST= +23.2°C
DP= +8.7
```

```
datalogger
delete
storage no 1 ■
>storage no 2 □
```

```
storage no 2
AM AT ST
interval 015
>start
back
```

```
logger active
amount 13
AM= 39.5 %
AT= 23.3°C
ST= 16.0°C
```

```
storage no 1
25.09.08 11:18
AM AT ST 00013
>statistic
back
```

Universal Moisture Meter type AD4A

Sensor calibration:

The meter can be calibrated for the sensors, the calibration values are stored in the AD4A.

Calibration factors and offsets can be changed. The offset for the air temperature will be adjusted in 0,1% steps. +20 is therefore equal with a movement of the measured value about 2,0%. The offset for the air values will be shown in 0,1°C steps. At adjustment Fahrenheit the temperature will be calculated first in °C but will be converted afterwards and displayed in °F.

The AD4A can be calibrated for up to 10 LFLT sensors and for up to 10 WT sensors.

Calibration codes (select code no. and press OK button):

- code: 002** select LFLT sensor
- code: 003** select WT sensor
- code: 012** change ser.no of selected LFLT sensor
- code: 013** change ser.no. of selected WT sensor and decide if it is an NTC or an IR sensor
- code: 076** change the calibration parameters for the selected sensors e.g. air moisture AM:210 -018:
calibration factor 210, for AM measurement, is flashing, it can be changed with the rotating switch, confirm with "OK".
Then -018 is flashing. This is the offset -018 = -1,8%. Adjust this again with the rotating switch and confirm with "OK". Then the calibration factor for air temperature measurement is flashing and can be changed and so on ...
After the last changes (offset of the surface temperature measurement) the new values will be stored and the instrument switches off.

We recommend that the sensors be calibrated at least once a year!

Battery:

The meter works with 2 batteries type AA (Mignon)
e.g.. DURACELL PLUS AA Alkaline MN1500

If the battery is running low, the display shows „BAT“.

Change battery:

With a screwdriver remove the 4 screws at the back of the meter, then remove the cover. Change the batteries and screw the cover on.

Attention!

In accordance with battery legislation, all used batteries must be disposed off in special battery collecting bins.

The disposal of old or used batteries as part of normal waste is not allowed!

calibration

code: 002

**SELECT LFLT
>LFLT no= 01
ser.no:34567**

**CHANGE WT SNR
WT no: 01
ser.no: 34568
>IR <-> NTC**

**calibration
AM:210 -018
AT:200 +000
ST:200 +000**

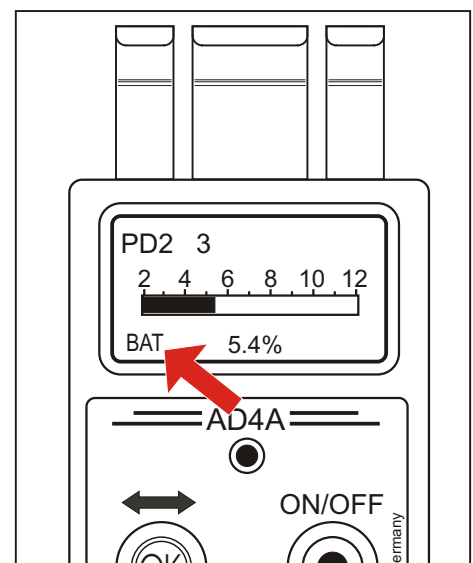

Universal Moisture Meter type AD4A

turn off the meter:

- push ON/OFF-button, the display shows the switch off text as long as the ON/OFF button is pushed
- after releasing the ON/OFF-button the meter stores the settings and switches off
- after an adjustable time, the meter switches off automatically.

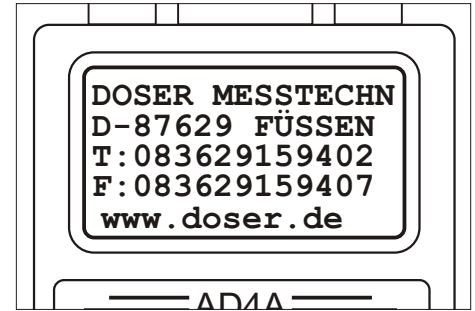

Locking the main menu

If the main menu is locked, only material moisture measurement with the adjusted material group is possible.

For locking remove the 4 screws at the back of the meter with a screwdriver, then remove the cover. Switch the instrument on, select the item **“mat.moisture”** in the main menu. Do not worry if the zero point error is displayed, this is because the case is open. Then press the **“inner key”**, hold it pressed and switch the instrument off. Switch it on again and check if the main menu is now closed. Screw the cover on and restart the instrument for correct zero point measurement

For opening the main menu again, remove the cover and press the **“inner key”** during switching on. The main menu is now unlocked and will be displayed.

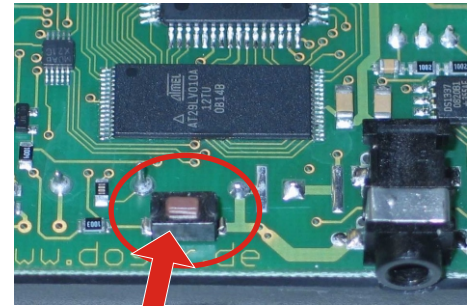

inner key

Optional extras:

- calibration certificate
- test modules PE05 and PE30 for testing and calibrating the material measurement (on request with certificate)
- customer specific calibration of the moisture meter
- air humidity and air temperature sensors
- proof system for measurement of rel. air humidity in drilled holes
- surface temperature sensor IR, without contact
- surface temperature sensor touching
- PC-software AD4A-S incl. interface cable
- battery (DURACELL PLUS AA Alkaline MN1500)



Universal Moisture Meter type AD4A

PC-Software AD4A-S

System requirements:

- * IBM compatible Computer
- * minimum of 128 Megabyte RAM
- * minimum of 80 Megabyte free place on hard disc
- * Microsoft Windows version 95, Windows 98, Windows 2000, Windows XP
- * mouse

Installation:

The installation starts automatically. Otherwise the setup can be started with the program "setup.exe".

The proposed files should not be changed to keep a well running system.

Agreement

At system start up of the software the agreement panel will be displayed. Read all the regulations carefully and confirm the regulations with click on "I agree". Without this consent, the software can not be used. This agreement panel can always be opened with click on "Info"

Basic Adjustments

Click on "Configuration" for opening the configuration panel. Adjust the following settings

1. COM Port
adjust the comport where you want to connect the AD4A
2. Name of the user:
In the box **standard user** you can include your name, then in all documentations your name will be shown
3. Path for storing:
In the box "**path data files:**" you can select a folder where you want to store data. Then this folder will always be shown at saving data.

Connect AD4A to the PC

For connecting the AD4A to the PC the special interface cable has to be used. The PC is sending a type request every second. Switch the AD4A on and on the AD4A-display you should see at the left side on the bottom line "OL:T" every second. The AD4A sends data back and on the PC Screen the type AD4A and the ser .no. of the instrument appears. This ser .no. must be the same as the printed ser. no. on the back of the instrument.

Show Material Moisture values

Click on "show material moisture" for reading the actual material moisture values. With click on "Start Measurements" the recording will start. The recorded values will be displayed graphically. The scaling can be done automatically or it can be changed manually.

- stop measurements** stops the recording
 - remark** add your comment
 - store to file** saves the data in a folder on your PC,
 - read from file** loads stored data on the screen
- the box "file:" shows the source of the data in the PC

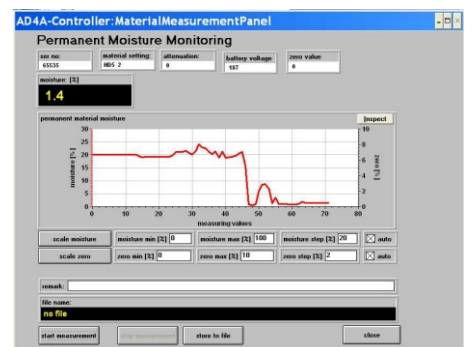
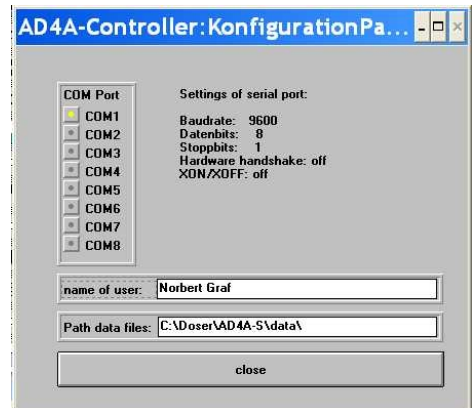
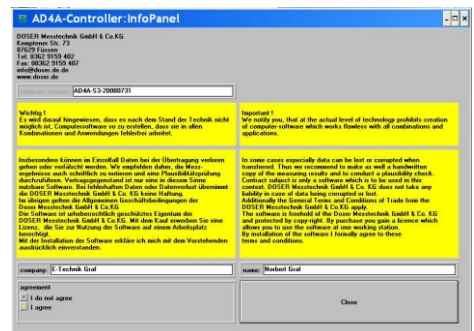
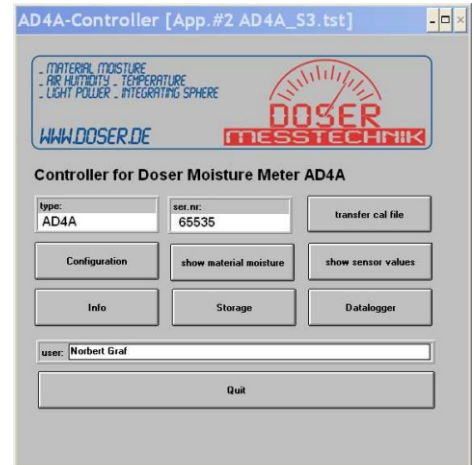

Universal Moisture Meter type AD4A

Read Stored Material Moisture Values

Click on “**Storage**” opens the panel “**Storage Material Moisture**”. If a AD4A is connected, the AD4A will send stored data automatically.

- read storage** the data can be transferred manually from the AD4A.
- storage no** the required storage no. can be selected. The AD4A can store data in up to 16 different storages. On the screen the stored data will be displayed graphically.
- remark:** add your comment.
- store all data to file** all stored values will be stored into the selected folder
- load values from file** data of a PC folder will be read and displayed
- file name** shows the source of the data in the PC
- delete storage** the storage in the AD4A will be deleted

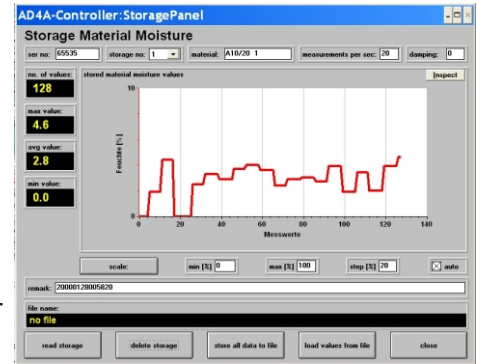

External Sensors

At the **AD4A** external sensors for air humidity, air temperature, dewpoint and surface temperature can be connected. With click on “**show sensor values**” a panel for recording the sensor values into the PC will appear.

- interval[s]:”** adjust the time distance between the recordings
- start measurements** starts recording, the values will be displayed
- AM / AT** air humidity / air temperature
- WT / DP** surface temperature / dewpoint (calculated value)
- with click in the corresponding boxes curves can be switched on and off the scale can be done automatically or manually
- stop measurements** stops the recording
- statistics** statistic results will be calculated and displayed
- remark:** add your comment
- store data to file** data will be stored in to the selected PC folder
- read data from file** data of a PC folder will be read and displayed
- file name** shows the source of the data in the PC

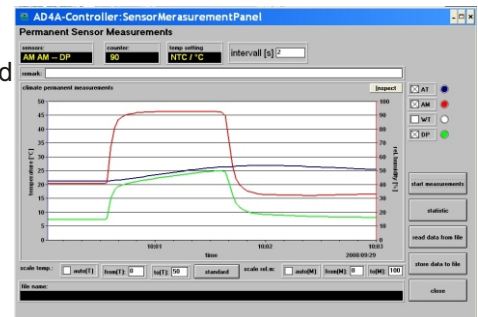

Datalogger (AD4A):

In the **AD4A** up to 16000 sensor values can be stored. With **read datalogger** this stored values can be displayed on the PC. There are up to 20 different storings (blocks) possible. After transferring the data, the first block will be displayed.

- blocks** selection box for selecting the required storing
- delete datalogger** the datalogger storages in the **AD4A** will be deleted
- date/time** the clock of the AD4A will be synchronized with the PC
- counter** number of loggings in the selected block
- interval** time between the loggings in the selected block
- AM / AT** air humidity / air temperature
- WT / TP** surface temperature / dewpoint (calculated value)
- with click in the corresponding boxes curves can be switched on and off the scale can be done automatically or manually
- statistic** statistic values will be calculated and displayed
- remark:** add your comment
- store data to file** data will be stored in to the selected PC folder
- read data from file** data of a PC folder will be read and displayed

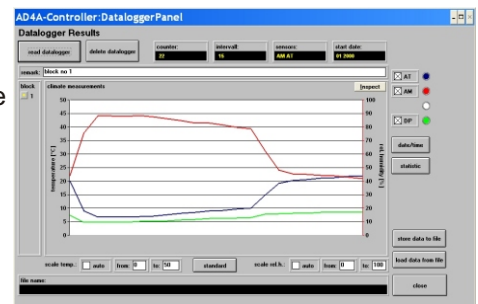

Universal Moisture Meter type AD4A

Customer Specific Calibration Curves for Material Moisture Measurement

For the material moisture measurement for each instrument a special collection of calibration curves can be made. Together with the serial no. a special file will be generated.

This file only applies to the instrument with the correct ser. no. and attempts to load the file into another instrument may corrupt the calibration curves of this instrument.

The calibration file always contains all customer specific calibration curves for one instrument.

In a special database the special calibration curves for each instrument will be stored. On optional request a special calibration file will be generated. This file can be sent via email and then downloaded to the AD4A with the correct ser.no.

Click on **“transfer cal file”** opens the corresponding panel

select file selects the calibration file

transfer data calibration file will be downloaded into the instrument

After restarting the instrument the new calibration curves can be selected with **“adjustments ->mat. groups”**

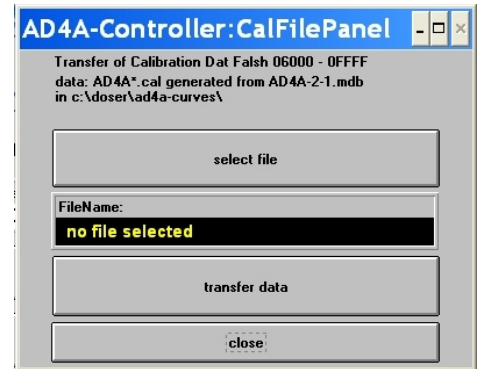

Our operating instructions are intended for guidance and to provide information on our products and their uses. They should not be taken to imply special characteristics or suitability for any specific purpose, other than those stated.

We constantly work to improve our products and reserve the right to alter our products and operating instructions without advanced notification.