

~~UNCLASSIFIED//FOR OFFICIAL USE ONLY~~



Defense Intelligence Reference Document

Acquisition Threat Support

6 April 2010

ICOD: 1 December 2009

DIA-08-1004-007

Concepts for Extracting Energy From the Quantum Vacuum

~~UNCLASSIFIED//FOR OFFICIAL USE ONLY~~

This document is made available through the declassification efforts
and research of John Greenewald, Jr., creator of:

The Black Vault



The Black Vault is the largest online Freedom of Information Act (FOIA)
document clearinghouse in the world. The research efforts here are
responsible for the declassification of hundreds of thousands of pages
released by the U.S. Government & Military.

Discover the Truth at: <http://www.theblackvault.com>

Concepts for Extracting Energy From the Quantum Vacuum

Prepared by:

(b)(3):10 USC 424

Defense Intelligence Agency

Author:

(b)(6)

Administrative Note

COPYRIGHT WARNING: Further dissemination of the photographs in this publication is not authorized.

This product is one in a series of advanced technology reports produced in FY 2009 under the Defense Intelligence Agency, (b)(3):10 USC 424 Advanced Aerospace Weapon System Applications (AAWSA) Program. Comments or questions pertaining to this document should be addressed to (b)(3):10 USC 424;(b)(6) AAWSA Program Manager, Defense Intelligence Agency, ATTN: (b)(3):10 USC 424 Bldg 6000, Washington, DC 20340-5100.

Contents

I. Summary	v
II. Historical Concepts for Extracting Energy and Thermodynamic Considerations	1
III. Origin of Zero-Point Field Energy.....	4
Elements of QED Theory	4
Elements of SED Theory	6
IV. Review of Selected Experiments.....	7
Voltage Fluctuations in Coils Induced by ZPF at High Frequency.....	7
ZPF Energy Extraction by Ground State Energy Reduction	10
Tunable Casimir Effect	14
EV Phenomenon	17
V. Theoretical Considerations and Issues.....	22
QED Vacuum Revisited	22
QED Vacuum as a Plenum.....	22
QED Vacuum as a Mathematical "Placeholder" for Fluctuating Matter Fields	23
Casimir Effect Revisited	24
Casimir Effect in the Plenum Picture	24
Casimir Effect in the Fluctuating Matter Fields Picture	24
Type I (Transient) and Type II (Continuous) Machines.....	25
Degradability of the Vacuum	25
Alternatives to QED.....	26
Neoclassical Theories of QED Vacuum Fluctuation Effects.....	26
SED Model Revisited.....	27
QED Without Second-Quantized Fields	28
Examples of Degradable of Decaying Vacuum.....	28
Gravitational Squeezing of the Vacuum.....	29
Redshifting the Vacuum	29
Vacuum Field Stress: Negative Vacuum Energy from the Casimir Effect.....	30

Squeezed Quantum Vacuum.....	32
Dirac Vacuum Decay: "Sparking the Vacuum".....	33
Magnetically Induced Decay of the Dirac Vacuum	34
Melting the QCD Vacuum.....	35
Summary: ZPF Modes and Vacuum Field Energy	37
VI. Conclusion: The Way Forward to 2050.....	37
Acknowledgements	41
Appendix: The QCD Bag Model	42
References	44

Figures

Figure 1. Illustration of the Casimir Effect	1
Figure 2. Vacuum-Fluctuation Battery.....	1
Figure 3. ZPE Resonant Dielectric Spheres Electrical Power Generation.....	3
Figure 4. Theoretical Voltage Spectral Density of a Tungsten Coil.....	9
Figure 5. Energy Released from Ground State Suppression of Hydrogenic Atom in a Microcavity	11
Figure 6. Apparatus for Ground State Energy Suppression: Casimir Segmented Tunnels	13
Figure 7. Alternative Apparatus for Ground State Energy Suppression: Casimir Strip and Spacer-Channels	13
Figure 8. Experimental Apparatus for Ground State Energy Reduction Tests	14
Figure 9. Tunable Casimir Effect: Conductor vs. Dielectric.	15
Figure 10. Tunable Casimir Effect: Engine Cycle.....	16
Figure 11. Schematic of EV (Pulse Discharge Source) Device.....	18
Figure 12. SEM of EV Damage to Ceramic Plate.	19
Figure 13. SEM of EV Damage to Palladium Target	20
Figure 14. EV Moving at Downward Angle Away From Its Source.	21

Concepts for Extracting Energy From the Quantum Vacuum

I. Summary

Quantum theory predicts that the vacuum of space throughout the universe is filled with electromagnetic waves, random in phase and amplitude, propagating in all possible directions, and with a cubic frequency distribution. This differs from the cosmic microwave background radiation and is referred to as the electromagnetic quantum vacuum, which is the lowest energy state of otherwise empty space. When integrated over all frequency modes up to the Planck frequency, ν_p ($\sim 10^{43}$ Hertz [Hz]), it represents an energy density of as much as 10^{113} J/m³, which is far in excess of any other known energy source, even if only an infinitesimal fraction of it is accessible. Even if one is constrained to integrate over all frequency modes only up to the nucleon Compton frequency ($\sim 10^{23}$ Hz),¹ this energy density is still enormous ($\sim 10^{35}$ J/m³). In addition, the electromagnetic quantum vacuum is not alone; it intimately couples to the charged particles in the Dirac sea of virtual fermion particle-antiparticle pairs (aka the Dirac vacuum) and thereby couples to the other interactions inherent in the Standard Model (weak and strong force vacua). However, in the Standard Model of particle physics, the weak force vacuum is essentially the electromagnetic vacuum, because photons serve as the massless eigenstates of (unified) electroweak theory with an "effective" coupling constant that is in fact electromagnetic in strength.² And we can safely ignore any coupling of the quantum electromagnetic vacuum to the quantum chromodynamic vacuum in this paper because the latter coexists in two phases: (1) the ordinary vacuum exterior to the hadron, which is impenetrable to quark color, and (2) the vacuum interior of the hadron,³ in which the Yang-Mills fields that carry color (gluons) propagate freely. Both vacuum phases are separated by a boundary at the surface of the hadron on which the Yang-Mills and quark fields satisfy boundary conditions.

Even though this zero-point field (ZPF) energy seems to be an inescapable consequence of quantum field theory, its energy density is so enormous as to make it difficult to reconcile. Instead, many quantum calculations subtract the ZPF energy by ad hoc means (for example, renormalization). However, the effects of the quantum vacuum ZPF that are responsible for a variety of well-known physical effects are observed, such as:

- Lamb shift.
- Spontaneous atomic emission.

¹ The characteristic frequency associated with the size of nucleons.

² The weak force coupling constant is merely the quantum electrodynamic/electromagnetic coupling constant (i.e., the fine structure constant, α) that is "suppressed" by a simple inverse-quadratic ratio of the virtual weak force particle mass to the proton mass (a factor of 10^{-4}).

³ Hadrons are the class of strongly interacting elementary particles which are a bound state of quarks. This class of particles has two subclasses: baryons (e.g., protons and neutrons comprised of three quarks) and mesons (comprised of two quarks).

- Low-temperature van der Waals forces.
- Casimir effect.
- Source of photon shot and fluctuating radiation-pressure noise in lasers.
- Astronomically observed cosmological constant (aka dark energy, a form of Casimir energy according to the Schwinger-DeWitt quantum ether prescription [Reference 1-4]).

Rather than eliminate the ZPF energy from the equations, there is much left to be learned by exploring the possibility that it is a real energy. From this perspective, the ordinary world of matter and energy is like foam atop the quantum vacuum sea. If the ZPF is real, then there is the possibility that it can be tapped as a source of power or be harnessed to generate a propulsive force for space travel. This notion of exchanging energy with the quantum vacuum is the focus of this paper.

An aircraft propeller or jet engine can push air backwards to propel the aircraft forward. A ship or boat propeller does the same thing in water. On Earth there is air or water to push against. But a rocket in space has no material medium to push against, and so it needs to carry and eject propellant in order to provide momentum. A deep-space rocket must start out with all the propellant it will ever require, and this quickly results in the need to carry additional propellant just to propel the propellant. The breakthrough desired in space travel is to eliminate the need to carry propellant at all, that is, to generate a propulsive force without carrying and ejecting propellant?

II. Historical Concepts for Extracting Energy and Thermodynamic Considerations

The Casimir force is a force associated with the electromagnetic quantum vacuum (Reference 5). This force is an attraction between parallel uncharged metallic plates that has now been well measured and can be attributed to a minute imbalance in the ZPF energy (ZPE) density inside the cavity between the plates versus the region outside the plates as shown in Figure 1 (Reference 6-8). As shown in the figure, the vacuum is full of virtual photons (that is, zero-point vacuum fluctuations), but photons with wavelengths, λ , more than twice the plate separation, d , are excluded from the space between them, which causes the imbalance that pushes the plates together.

The primary requirement for space travel is energy. It is sometimes assumed that attempting to extract energy from the vacuum ZPF would somehow violate the laws of thermodynamics. Fortunately, it turns out that this is not the case. A thought experiment published by Forward (Reference 9, 10) demonstrated how the Casimir force could in principle be used to extract energy from the vacuum ZPF. Forward showed that any pair of conducting plates at close distance experiences an attractive Casimir force that is due to the electromagnetic ZPF of the vacuum. A "vacuum-fluctuation battery" can be constructed by using the Casimir force to do work on a stack of charged conducting plates as shown in Figure 2. By applying a charge of the same polarity to each conducting plate, a repulsive electrostatic force will be produced that opposes the Casimir force. If the applied electrostatic force is adjusted to be always slightly less than the Casimir force, the plates will move toward each other and the Casimir force will add energy to the electric field between the plates. The battery can be recharged by making the electrical force slightly stronger than the Casimir force to re-expand the foliated conductor.

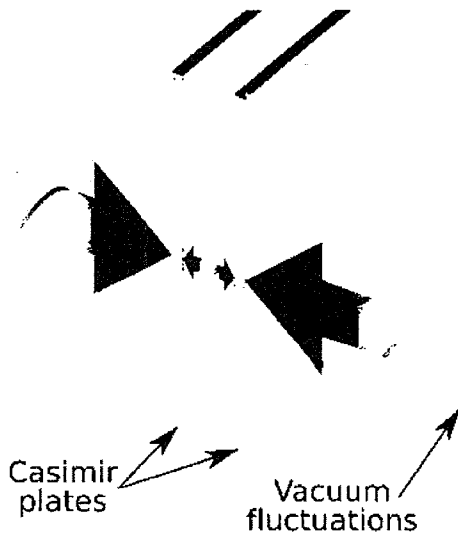

Figure 1. Illustration of the Casimir Effect

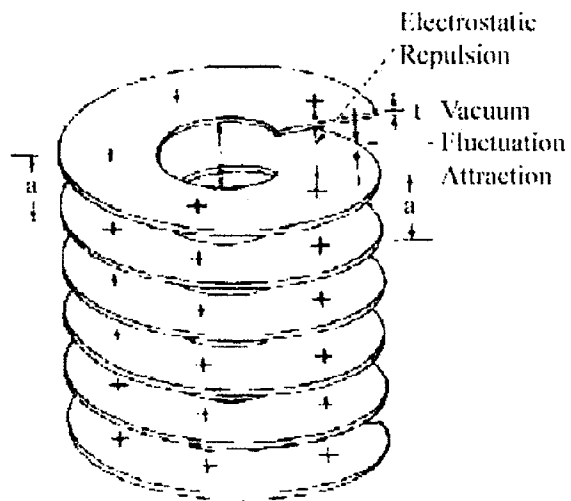

Figure 2. Vacuum-Fluctuation Battery (Reference 9)

Cole and Puthoff (Reference 11) verified that (generic) energy extraction schemes are not contradictory to the laws of thermodynamics. For thermodynamically reversible processes, no heat will flow at temperature $T = 0$. However, for thermodynamically

irreversible processes, heat can be produced and made to flow, either at $T = 0$ or at any other $T > 0$ situation, such as by taking a system out of mechanical equilibrium. Moreover, work can be done by or done on physical systems, either at $T = 0$ or $T > 0$ situations, whether for a reversible or irreversible process. However, if one is considering a net cyclical process on the basis of, say, the Casimir effect, then energy would not be able to be continually extracted without a violation of the second law of thermodynamics. Thus, Forward's process cannot be cycled to yield a continuous extraction of energy. Here, the recharging of the battery would, owing to frictional and other losses, require more energy than is gained from the ZPF. There is no useful engine cycle in this process; nonetheless, the plate-contraction phase of the cycle does demonstrate the ability to cause "extraction" of energy from the ZPF. It does reflect work done by the ZPF on matter.

Another illustrative example of an early scheme for extracting energy from the ZPF is described in a patent by Mead and Nachamkin (Reference 12). They propose that a set of resonant dielectric spheres be used to extract energy from the ZPF and convert it into electrical power. They consider the use of resonant dielectric spheres, slightly detuned from each other, to provide a beat-frequency downshift of the more energetic high-frequency components of the ZPF to a more easily captured form. Figure 3 shows two embodiments of the invention. The device includes a pair of dielectric structures (items 12, 14, 112, 114 in the figure) that are positioned proximal to each other and which intercept incident ZPE radiation (items 16, 116 in the figure). The volumetric sizes of the structures are selected so that they resonate at a particular frequency of the incident radiation. But the volumetric sizes of the structures are chosen to be slightly different so that the secondary radiations emitted from them (items 18, 20, 24, 118, 120, 124 in the figure) at resonance interfere with each other, thus producing a beat frequency radiation that is at a much lower frequency than that of the incident radiation, and that can be converted into electrical energy. A conventional metallic antenna (loop or dipole type, or a RF cavity structure; items 22, 122 in the figure) can then be used to collect the beat frequency radiation. This radiation is next transmitted from the antenna to a converter via an electrical conductor or waveguide (items 26, 126 in the figure) and converted to electrical energy. The converter must include: 1) a tuning circuit or comparable device so that it can effectively receive the beat frequency radiation, 2) a transformer to convert the energy to electrical current having a desired voltage, and 3) a rectifier to convert the energy to electrical current having a desired waveform (items 28, 30, 32, 34, 128, 130, 132 in the figure).

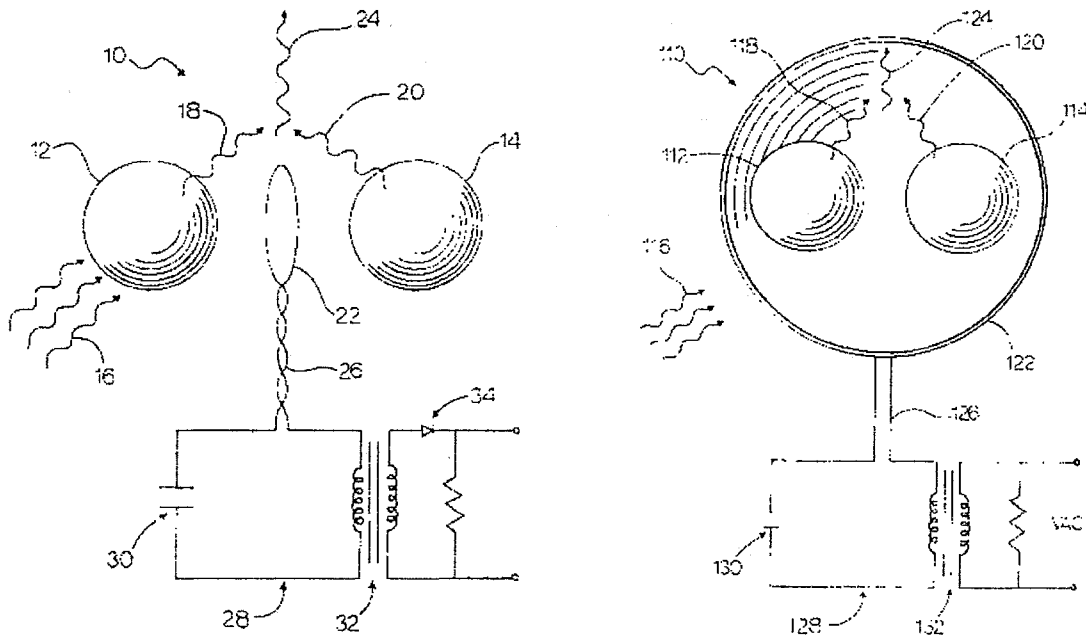

Figure 3. ZPE Resonant Dielectric Spheres Electrical Power Generation (Reference 12)

The receiving structures are composed of dielectric material in order to diffract and scatter the incident ZPE radiation. The volumetric sizing requirements for the receiving structures are selected to enable them to resonate at a high frequency corresponding to the incident ZPE radiation, based on the parameters of frequency of the incident ZPE radiation, and the propagation characteristics of the medium (vacuum or otherwise) and the receiving structures. Since the ZPE radiation energy density increases with increasing frequency, greater amounts of electromagnetic energy are potentially available at higher frequencies. Consequently, the size of the receiving structures must be miniaturized in order to produce greater amounts of energy from a system located within a space or volume of a given size. Therefore, the smaller the size of the receiving structures, the greater the amount of energy that can in principle be produced by the system.

Although a computer model study performed at the Air Force Research Laboratory (Edwards AFB, CA) indicates that the invention could work, no experimental study has been performed to validate this in the lab (F. B. Mead, private communication, 2002). Regarding critiques, it is not clear how the beat frequency can be picked up by the receiving loop antenna. There is no nonlinear method in the invention showing that an electromagnetic beat frequency can be generated and coupled to the loop. Without a nonlinear coupling method there will be no sidebands, one of which would be frequency down-shifted and called the beat frequency. The coupling method requires the generation of sidebands in the mixing of two different frequencies via a nonlinear technique. However, an easy resolution to this potential deficiency is that the resonant dielectric spheres could be constructed of a nonlinear dielectric material.

Although several novel ZPF energy extraction mechanisms have been proposed in the popular and technical literature, no practicable technique has been successfully demonstrated in the laboratory. To better understand how ZPE extraction methods

might work, it is necessary to characterize the physics of the ZPF and proposed energy extraction techniques, and to evaluate their feasibility for application to space power and propulsion systems. In what follows, the physics of the ZPF and the experimental investigations being pursued to address the question of extracting energy from the quantum vacuum are summarized.

III. Origin of Zero-Point Field Energy

ELEMENTS OF QED THEORY

The basis of the ZPF is typically attributed to the Heisenberg Uncertainty Principle. According to this principle, A and B are any two conjugate observables that one is interested in measuring, and they obey the commutation relation $[A,B] = i\hbar$.⁴ Their corresponding uncertainty relation is $\Delta A \Delta B \geq \hbar/2$, where ΔA is the variance (aka uncertainty) of observable A and ΔB is that of the conjugate observable B . This relation states that if one measures observable A with very high precision (that is, its uncertainty ΔA is very small), then a simultaneous measurement of observable B will be less precise (that is, its uncertainty ΔB is very large), and vice versa. In other words, it is not possible to simultaneously measure two conjugate observable quantities with infinite precision. This minimum uncertainty is not due to any correctable flaws in measurement, but rather reflects the intrinsic fuzziness in the quantum nature of energy and matter. Substantial theoretical and experimental work has shown that in many quantum systems the limits to measurement precision is imposed by the quantum vacuum ZPF embodied within the uncertainty principle. Nowadays one would rather see the Heisenberg Uncertainty Principle as a necessary consequence, and therefore, a derived result of the wave nature of quantum phenomena. The uncertainties are just a consequence of the Fourier nature of conjugate pairs of quantities (observables). For example, the two Fourier-wave-conjugates time and frequency become the pair of quantum-particle conjugates time and energy and the two Fourier-wave-conjugates displacement and wavenumber become the pair of quantum-particle conjugates position and momentum. For more on this see, for example, Reference 13.

Classically, electromagnetic radiation can be pictured as waves flowing through space at the speed of light. The waves are not waves of anything substantive, but are in fact ripples in the state of a field. These waves carry energy, and each wave has a specific direction, frequency and polarization state. This is called a "propagating mode of the electromagnetic field." A useful tool for modeling the propagating mode of the electromagnetic field in quantum mechanics is the ideal quantum mechanical harmonic oscillator: a hypothetical charged mass on a perfect spring oscillating back and forth under the action of the spring's restoring force. The Heisenberg Uncertainty Principle dictates that a quantized harmonic oscillator (aka a photon state) can never come entirely to rest, since that would be a state of exactly zero energy, which is forbidden by the commutation relation outlined above. Instead, every mode of the field has $\hbar\omega/2$ as its average minimum energy in the vacuum.⁵ (This is a small amount of energy, but the number of modes is enormous, and indeed increases as the square of the frequency. The product of this minuscule energy per mode, multiplied by the huge spatial density of modes, yields a very high theoretical energy density per unit volume.)

⁴ i is the unit complex number. \hbar is Planck's reduced constant, 1.055×10^{-34} J-s.

⁵ ω is the mode or photon frequency and $\hbar\omega$ is the energy of a single mode or photon.

This ZPE term is added to the classical blackbody spectral radiation energy density $\rho(\omega)d\omega$ (that is, the energy per unit volume of radiation in the frequency interval $(\omega, \omega + d\omega)$) (Reference 14):

$$\begin{aligned} \rho(\omega) d\omega &= \frac{\omega^2}{\pi^2 c^3} \left[\frac{h\omega}{\exp(h\omega/kT) - 1} + \frac{h\omega}{2} \right] d\omega \\ &= \frac{h\omega^3}{2\pi^2 c^3} \coth\left(\frac{h\omega}{2kT}\right) d\omega, \end{aligned} \tag{1}$$

where c is the speed of light (3.0×10^8 m/s), k is Boltzmann's constant (1.3807×10^{-23} J/K), T is the absolute temperature, and $\omega = 2\pi\nu$ is the angular frequency. The factor outside the square brackets in the first line of Equation (1) is the density of mode (or photon) states (that is, the number of states per unit frequency interval per unit volume); the first term inside the square brackets is the standard Planck blackbody radiation energy per mode; and the second term inside the square brackets is the quantum zero-point energy per mode. Equation (1) is called the Zero-Point Planck (ZPP) spectral radiation energy density. Planck first added the ZPE term to the classical blackbody spectral radiation energy density in 1912, although it was Einstein, Hopf, and Stern who actually recognized the physical significance of this term in 1913 (Reference 14). Direct spectroscopic evidence for the reality of ZPE was provided by Mulliken's boron monoxide spectral band experiments in 1924, several months before Heisenberg first derived the ZPE for a harmonic oscillator from his new quantum matrix mechanics theory (Reference 15).

Following this line of reasoning, quantum physics predicts that all of space must be filled with electromagnetic zero-point fluctuations (aka the zero-point field) creating a universal sea of zero-point energy. The density of this energy depends critically on where the frequency of the zero-point fluctuations ceases. Since space itself is currently thought to break up into a kind of "quantum foam" at the Planck length, λ_p ($\sim 10^{-35}$ m), it is argued that the ZPF must cease at the corresponding ν_p . If true, then the ZPE density would be $\sim 10^{113}$ J/m³, 108 orders of magnitude greater than the radiant energy at the center of the Sun! Formally, in Quantum Electrodynamics (QED) theory, the ZPE energy density is taken as infinite; however, arguments based on quantum gravity considerations yield a finite cutoff at ν_p . Therefore, the spectral energy density is given by $\rho(\omega)d\omega = (\hbar\omega^3/2\pi^2c^3)d\omega$, which integrates to an energy density, $\rho_E = \hbar\nu_p^4/8\pi^2c^3 \approx 10^{113}$ J/m³. As large as the ZPE is, interactions with it are typically cut off at lower frequencies depending on the particle coupling constants or their structure. Nevertheless, the potential ZPF energy density predicted by quantum physics is enormous.

Many experts have claimed that an enormous vacuum ZPF energy density would produce a corresponding enormous gravitational force of attraction (via Einstein's General Theory of Relativity) that would cause the immediate collapse of the entire universe. Thus they argue that such enormous vacuum energy cannot be real due to the fact that our universe is observed to be undergoing accelerated expansion. However, such arguments are spurious because numerous studies in quantum field theory show that it is the low-frequency ZPF modes that contribute significantly to the physical vacuum energy, because 1) only the low-frequency modes are affected by the

presence of cosmological spacetime curvature, and 2) the high-frequency modes are unaffected by the presence of cosmological spacetime curvature so they take the flat Minkowski spacetime form; that is, these modes contribute nothing to the physical vacuum energy (Reference 4). This then enforces a very low-frequency cutoff that renormalizes the total vacuum energy, leading to a minute residual cosmological vacuum energy density of 10^{-9} J/m³, which has been observed. Also, investigators studying supersymmetric and superstring quantum gravity theories have proposed the limited cancellation of some positive energy electromagnetic ZPF modes by some negative energy fermionic (Dirac vacuum) ZPF modes as an explanation for the observed minute vacuum energy density.

ELEMENTS OF SED THEORY

An alternative to QED, stochastic electrodynamics (SED) identifies the origin of the ZPF as a direct consequence of a classical ZPF background. SED begins with the ordinary classical electrodynamics of Maxwell and Lorentz, but instead of assuming the traditional homogeneous solution of the source-free differential wave equations for the electromagnetic potentials, one instead considers that due to multiple charged particles moving throughout the universe, there is always a random electromagnetic radiation background present that affects the particle(s) in any experiment. This new boundary condition (random radiation background) replaces the prior null background of traditional classical electrodynamics. Moreover, the principle of relativity dictates that identical experiments performed in different inertial frames must yield the same result, and that this random classical electromagnetic radiation must be isotropic in all inertial frames; it is invariant under scattering by a dipole oscillator, invariant under redshift (Doppler, cosmological, gravitational, no Einstein-Hopf drag force), and must therefore have a Lorentz-invariant energy density spectrum. The only energy density spectrum that obeys such conditions is one that is proportional to the cubic power of the frequency. Interestingly, this is exactly the same frequency dependence as that of the QED spectral ZPF energy density described above, when the temperature T is set to zero in Equation (1). Thus in SED, the random radiation assumes the role of the ZPE of QED, and is termed the classical electromagnetic ZPE. Planck's constant appears then in SED as an adjustable parameter that sets the scale of the ZPE spectral density.

The formulation of the SED model has evolved over time, beginning with the work of Nernst in 1916 and the later foundational work of Marshall and Boyer in the 1960s (Reference 14). The original Standard SED model was based on random phases with fixed electric-field mode amplitudes. The more recent Modified SED model employs random phases with random electric-field mode amplitudes and a full probability distribution for the ground state amplitude, in agreement with quantum theory (Reference 16). A comparison of SED with quantum theory shows that the first and second moments of the spectral energy distribution are identical, but beyond that, the distributions diverge widely. Nevertheless, several quantum theory results have been reproduced by means of the SED approach, such as (Reference 14, 17):

- Quantum mechanical harmonic oscillator.
- Lamb shift.
- Blackbody radiation.

- Van der Waals forces.
- Casimir forces.
- Diamagnetism.
- Davies-Unruh Effect.

The strength of the SED model is that it is heuristically appealing, with transparent derivations, and it is applicable to linear systems. SED calculations have also been shown to be in one-to-one correspondence with the expectation values of the Heisenberg quantum equations of motion for linear systems. Both SED and QED will play a role in the discussions to follow.

IV. Review of Selected Experiments

In what follows, is an outline each of the proposed experimental concepts that were selected for theoretical and laboratory investigation. A subset of our proposed concepts has undergone preliminary evaluation by Lockheed-Martin review panels involving both internal R&D personnel and outside experts on theory and experimentation (V. Teofilo, private communication, 2005).

VOLTAGE FLUCTUATIONS IN COILS INDUCED BY ZPF AT HIGH FREQUENCY

In a series of experiments, Koch et al. (Reference 18-20) measured voltage fluctuations in resistive wire circuits that are induced by the ZPF. The Koch et al. result is striking corroboration of the reality of the ZPF and proves that the ZPF can do real work (cause measurable currents). Although the Koch et al. experiment detected minuscule amounts of ZPF energy, it shows the principle of ZPF energy circuitry to detect vacuum fluctuations and opens the door to consideration of means to extract useful amounts of energy. The secondary consequences on other phenomena, if energy can be successfully extracted, have not yet been investigated.

Blanco et al. (Reference 21) have proposed a method for enhancing the ZPF-induced voltage fluctuations in circuits. Theoretically treating a coil of wire as an antenna, they argue that the antenna-like radiation resistance of the coil should be included in the total resistance of the circuit, and suggest that this total resistance should be used in the theoretical computation of ZPF-induced voltage fluctuations. Because of the strong dependence of the radiation resistance on the number of coil turns (quadratic scaling), coil radius (quartic scaling), and frequency (quartic scaling), any enhanced ZPF-induced voltage fluctuations should be measurable in the laboratory at readily accessible frequencies (100 MHz compared to the 100 GHz range necessary in the Koch et al. experiments).

In the theory of Blanco et al., random voltage fluctuations are conveniently described by their frequency spectrum. That is, given a sufficient time interval of measured voltages, the measurements are Fourier transformed to the frequency domain to determine how the voltage fluctuations are distributed (for example, quantity of low-frequency, long duration fluctuations relative to high-frequency, short-duration

fluctuations). Theoretically, the spectrum of voltage fluctuations, $S(\omega, T)$, of a resistive circuit is given by (Reference 21):

$$S(\omega, T) = \frac{R(\omega, T)}{\pi} \frac{h\omega}{2} \coth\left(\frac{h\omega}{2kT}\right) \quad (2)$$

where $R(\omega, T)$ is the total resistance (ohmic plus radiative), ω is the (angular) frequency, and T is the absolute temperature. The resistance $R(\omega, T)$ is temperature dependent through its ohmic contribution.⁶ Note the similar hyperbolic cotangent functions appearing in Equation (2) and in the second line of Equation (1). The postulate of Blanco et al. is that the total resistance must include the radiation resistance of the circuit (Reference 21):

$$R(\omega, T) = R_{\text{ohmic}}(\omega, T) + R_{\text{rad}}(\omega) \quad (3)$$

Under the assumption that the wavelengths of the ZPF modes of interest are larger than the dimensions of the circuit, the radiation resistance of a coil is given by (Reference 21):

$$R_{\text{rad}}(\omega) = \frac{2}{3} \frac{\pi^2 N^2}{c} \left(\frac{a\omega}{c}\right)^4 \quad (4)$$

where N is the number of coil turns, and a is the radius of the coil winding.

According to Blanco et al., large enhancements in ZPF-induced voltage fluctuations are possible. By reducing the temperature to minimize ohmic resistance, making the coil of many turns and large radius, and performing measurements at high frequency, it should be possible to investigate this amplification effect. The predicted coil-enhanced voltage spectrum can readily be computed. The result is shown in Figure 4 for a 1 cm diameter coil of 2000 turns, made of 38 AWG tungsten wire, and kept at a temperature of 3 K. In Figure 4, the upper (blue) curve represents the predicted voltage spectral density for the combined ohmic plus radiation resistance. The lower (red) curve is the predicted result when radiation resistance is ignored. If the postulate of Blanco et al. is correct, the enhancement in voltage fluctuations due to the antenna-like nature of the coil should be easily measured at frequencies as low as 100 MHz (where the coil enhancement effect is ~ 100 -fold for tungsten).

⁶ The radiation resistance depends only on frequency.

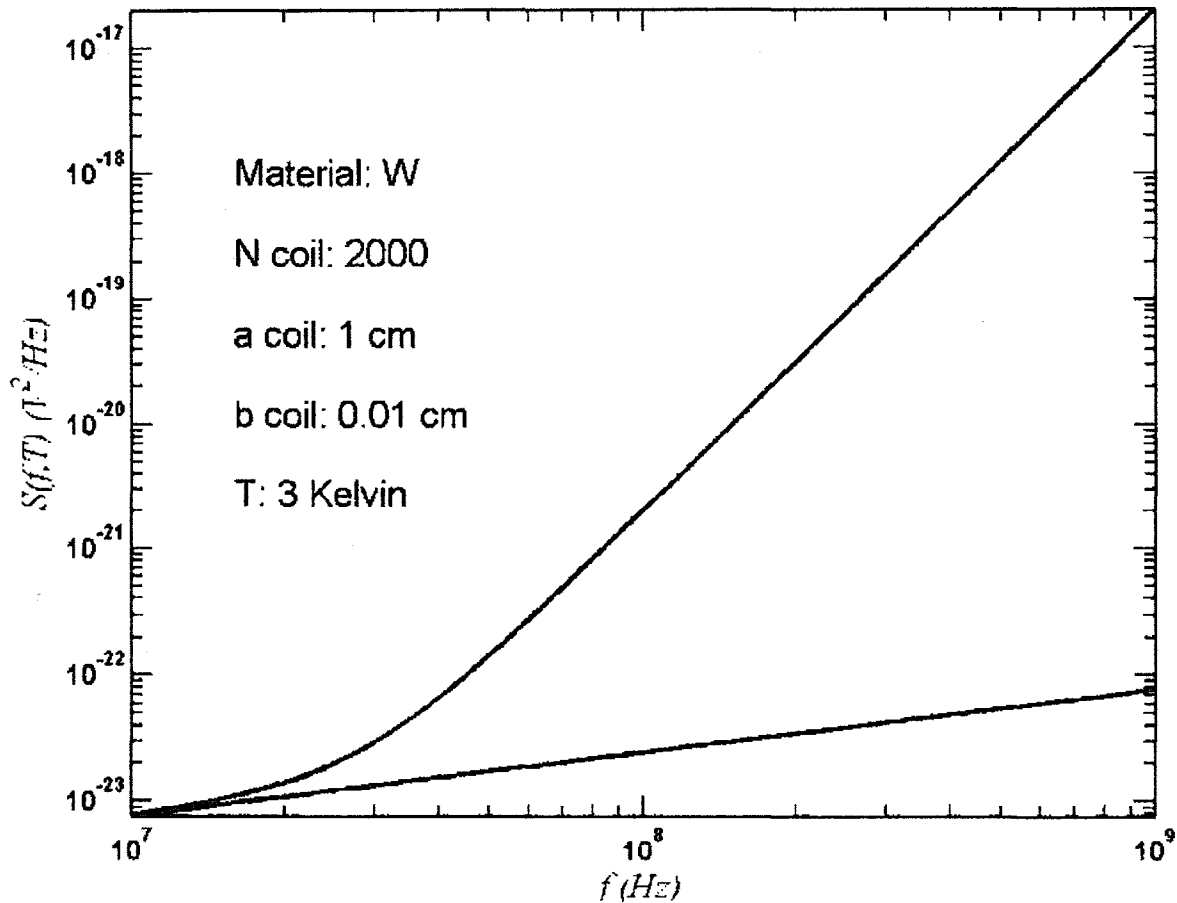

Figure 4. Theoretical Voltage Spectral Density of a Tungsten Coil

To successfully measure the ZPF-induced voltage fluctuations, the requirements of low temperature, large coil, and high frequency must be met. The low-temperature requirement is met by performing the experiment in a cooled dewar. Existing high-quality cryogenic dewars (pumped down to 3 K) and sensitive laboratory instruments are suitable for the measurements. The cold spot in one particular dewar under consideration is cylindrical, 2.5 cm in both diameter and height. The largest coil that can be installed will thus have a coil radius of approximately $a = 1$ cm. To keep the linear dimension of the coil small will require a small wire thicknesses, perhaps $b = 0.01$ cm (gauge 38 AWG). By winding the coil in a number of layers (10 or 12 layers), a large number of turns can be accommodated, perhaps $N = 2,000$ turns. To minimize ohmic resistance, wire made of tungsten (W) is preferred; however, copper (Cu) is a suitable alternative.

Voltage fluctuations in the 100 MHz range are easily detected using commercially available laboratory equipment; hence this experiment could be performed using tungsten without resorting to the more sophisticated Josephson junction techniques required by Koch et al. for their higher frequency measurements. For a copper wire coil, the magnitude of the enhancement effect is reduced somewhat compared to the tungsten results shown in Figure 4. But for frequencies approaching the GHz regime, the radiation resistance enhancement effect in copper wire is still predicted to be over

four orders of magnitude larger. Commercial equipment readily allows measurements of the voltage spectrum in the GHz regime. Therefore, given a cost tradeoff of copper vs. tungsten coil fabrication, the use of copper coils may be preferred. Suitable coils can be fabricated by a custom coil-winding vendor. A second coil can be used in a control experiment constructed with the same parameters as the first coil, but with half of its turns wound in the reverse direction. This will make the coil non-inductive so that its voltage spectral density should correspond to the lower red curve in Figure 4.

ZPF ENERGY EXTRACTION BY GROUND STATE ENERGY REDUCTION

As first analyzed by Boyer (Reference 22), and later refined by Puthoff (Reference 23), the following paradox was addressed: even though atomic ground states involve electrons in accelerated motion, such states are nonetheless radiationless in nature – even though it is well known from classical electrodynamics that charged particles undergoing acceleration must always emit radiation. For the standard Bohr ground state orbit of the hydrogen atom, this was interpreted as an equilibrium process in which radiation by the electron in its ground state orbit was compensated by absorption of radiation from the background vacuum electromagnetic ZPE. This interpretation has recently been strengthened by the analyses of Cole and Zou (Reference 24, 25) using a SED model for the vacuum ZPE. Since the balance between emitted orbital-acceleration radiation and absorbed ZPE radiation is modeled as taking place primarily at the ground state orbital frequency, one can consider the possibility of using this feature in some type of mechanism to extract energy from the ZPF. One fundamental difference between the SED interpretation and that of quantum mechanics is that in quantum mechanics the 1s state of the electron is regarded as having zero angular momentum, whereas in the SED interpretation the electron has an angular momentum of $m_e c r_e / 137$.⁷

The Bohr radius of the hydrogen atom in the SED view is 0.529 Å. This implies that the wavelength (λ) of zero-point radiation responsible for sustaining the orbit is $2\pi \cdot 0.529 \cdot 137 = 455$ Å (or 0.0455 μm). It has been conjectured by Puthoff and Haisch (private communication, 2004) that suppression of zero-point radiation at this wavelength (and at shorter wavelengths) inside a Casimir microcavity could result in the decay of the electron to a lower energy state determined by a new balance between classical emission of an accelerated charge and absorption of zero-point radiation at $\lambda < 455$ Å, where λ depends on the microcavity plate separation (d). Since the frequency of this orbit is 6.6×10^{15} Hz, no matter how quickly the atom were to be injected into a Casimir microcavity, one would assume that the decay process would be a slow one as experienced by the orbiting electron. Figure 5 shows a schematic representation of a hydrogenic atom in free space and inside a microcavity.

⁷ m_e = electron mass (9.11×10^{-31} kg), r_e = electron radius, atomic fine structure (a.k.a. QED coupling) constant $\alpha = 1/137$, and $c/137$ is the classical orbital velocity of the ground state electron.

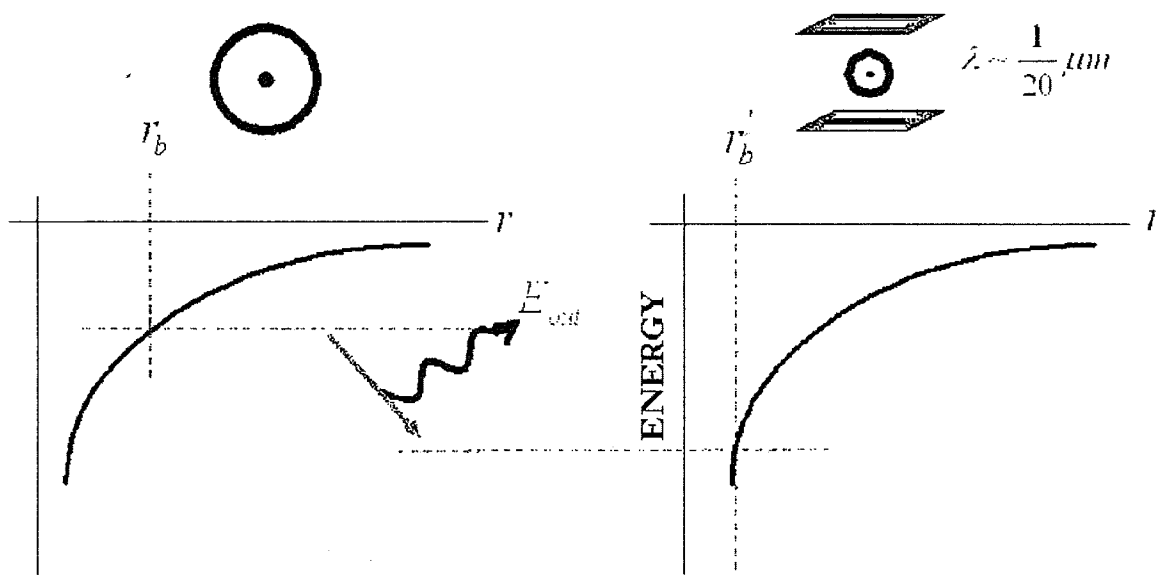

Figure 5. Energy Released from Ground State Suppression of Hydrogenic Atom in a Microcavity. (r_b = free-space Bohr orbit radius, r'_b = suppressed Bohr orbit radius, λ = resonant wavelength of Bohr orbit, and E_{out} = released energy).

Consider the possibility that the decay to a new sub-Bohr ground state would involve gradual release of energy in the form of heat, rather than a sudden optical radiation signature. Since the binding energy of the electron is 13.6 eV,⁸ it is estimated that the amount of energy released in this process could be on the order of 1 to 10 eV for injection of the hydrogen atom into a Casimir cavity of $d = 250 \text{ \AA}$. Furthermore, consider the possibility that when the electron exits the cavity it would reabsorb energy from the zero-point field and be re-excited to its normal state. If these conjectures were to be verified by experiment, then the energy extracted in the process comes at the expense of the zero-point field, which in the SED interpretation propagates at the speed of light throughout the universe. In effect the energy would be extracted locally and replenished globally. The secondary consequences on other phenomena, if this energy conversion were to succeed, have not yet been investigated. However, on a cautionary note, the conflicts between SED and QED theories (discussed in Section V) raise questions as to whether the conjectured approach discussed here is viable. This issue is perhaps best addressed by experiment for its resolution.

In terms of an experimental test, consider using monatomic gases or liquids flowing in a block with Casimir tunnels, which has the following attributes: 1) no dissociation process is required for monatomic gases or liquids, 2) heavier element atoms are approximately two to four times larger than hydrogen and thus can utilize and be affected by a larger Casimir cavity, 3) heavier elements have numerous outer shell electrons, several of which may be simultaneously affected by the reduction of zero-point radiation in a Casimir cavity.

All of the noble gas elements contain ns electrons. He ($Z = 2$, $r = 1.2 \text{ \AA}$) has two $1s$ electrons. Ne ($Z = 10$, $r = 1.3 \text{ \AA}$) has two each of $1s$ and $2s$ electrons. Ar ($Z = 18$, $r = 1.6 \text{ \AA}$) has two each of $1s$, $2s$, and $3s$ electrons. Kr ($Z = 36$, $r = 1.8 \text{ \AA}$) has two of each

⁸ 1 eV = 1.602×10^{-19} J.

of 1s, 2s, 3s, and 4s electrons. Xe ($Z = 54$, $r = 2.05 \text{ \AA}$) has two of each of 1s, 2s, 3s, 4s and 5s electrons. Larger Casimir cavities would also be expected to have an effect on the energetics of the outer electron shells (at larger radii). One could therefore expect that a Casimir cavity having $d = 0.1 \text{ \mu m}$ could have an effect on reducing the energy levels of the outermost pair of s electrons, and possibly also p electrons and intermediate shell s electrons as well.

Continuing with this model, it is reasonable to expect that a 0.1 \mu m Casimir cavity could result in a release of 1 to 10 eV for each injection of a He, Ne, Ar, Kr or Xe atom into such a cavity. According to Maclay (Reference 26), a long cylindrical Casimir cavity results in an inward force on the cavity walls due to the exclusion of interior ZPF modes. In the "exclusion of modes" interpretation of the Casimir force, this implies that a cylindrical cavity of diameter 0.1 \mu m could yield the desired decay of outer shell electrons and subsequent release of energy. If one lets the length of the cylinder be 100 times the width, this results in $\lambda = 10 \text{ \mu m}$ for the length of the Casimir tunnel. Taking advantage of this effect, Puthoff (private communication, 2004) and Haisch and Moddel (Reference 27) propose a segmented tunnel consisting of alternating conducting and non-conducting materials, each 10 \mu m in length. In a length of 1 cm, there could be 500 such pairs in segments, resulting in 500 energy releases (each yielding 1 to 10 eV) for each transit of an atom through the entire 1 cm-long Casimir tunnel.

Now consider a 1 cm^3 block that is built up of 10 \mu m thick alternating layers as described above (see Figure 6 for an illustration of this apparatus). Assume that tunnels of 0.1 \mu m diameter could be drilled through the cube perpendicular to the layers (this is not physically possible, of course; tunnel manufacture must be done differently). If 10 percent of the cross section comprises entrance to some 1.3 billion tunnels, then the amount of energy released would be proportional to the flow rate of the gas through the tunnels (for the number of entrances and exits through Casimir segments). A flow rate of 10 cm/s through a total cross sectional area of 0.1 cm^2 yields 1 cm^3 of gas per second flowing through the tunnels, which at STP would be 2.7×10^{19} atoms. A very simple sealed, closed-loop pumping system could maintain such a continuous gas flow. Since each atom interacts 500 times during its passage, there would be 1.3×10^{22} transitions per second in the entire cube of 1 cm^3 . An energy release of 1 to 10 eV per transition corresponds to 2,150 to 21,500 W of power released from the entire Casimir cube of tunnels. This can also be achieved by using a pair of plates with conducting strips creating Casimir cavities (via 5000 strip pairs) that are separated by 0.1 \mu m spacers, through which Hg liquid or monatomic gases (for example, He, Ne, Ar, Kr, or Xe) flow (Reference 27). See Figure 7 for an illustration of this apparatus. However, again, all of this assumes that the chain of conjectures detailed above is correct. Fortunately, this can be experimentally tested.

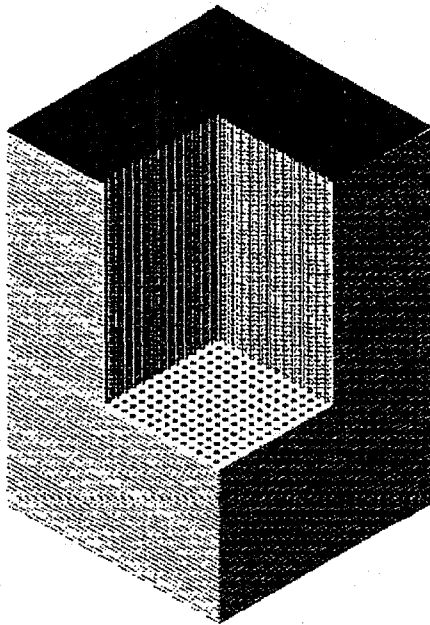

Figure 6. Apparatus for Ground State Energy Suppression: Casimir Segmented Tunnels

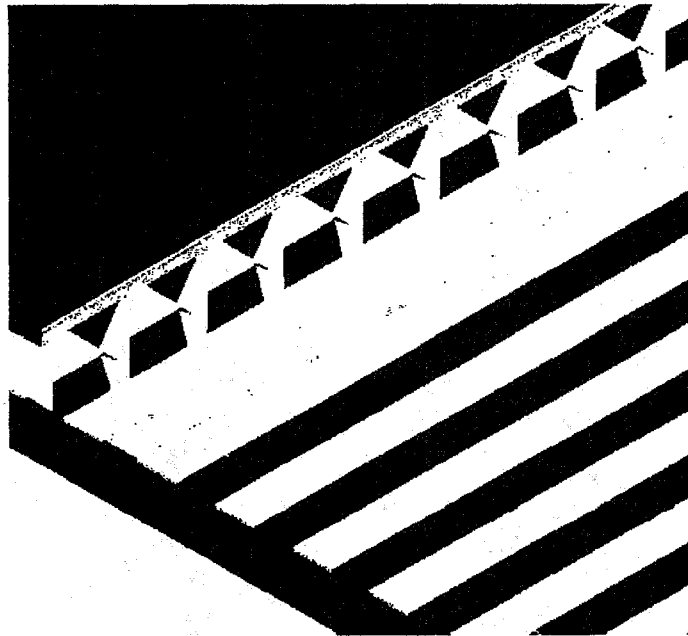

Figure 7. Alternative Apparatus for Ground State Energy Suppression: Casimir Strip and Spacer-Channels

Microcavity fabrication to match the atomic ground states is daunting because there will potentially be fabrication irregularities that cause edge and surface effects which act upon the particles as they enter or exit the Casimir region. And it is not possible to drill 1.3 billion tunnels having diameters of $0.1 \mu\text{m}$. However, it should be feasible to use microchip technology to etch holes into the individual layers first and then assemble the stack. Extremely fine coregistration and alignment of stacks would be an issue, but a surmountable one. A much smaller number of layer pairs and tunnels would suffice for a measurable demonstration of release of ZPE by this process. If such a small-scale demonstration succeeds, larger versions that convert more energy could be built that also take advantage of more efficient thermal-to-electrical energy conversion methods. Also if successful, such apparatuses could be used to explore for secondary effects of converting quantum vacuum energy into thermal, then electrical energy.

Further investigation by Puthoff et al. (Reference 28) was based on the premise that the above principle is broadly applicable to other than just atomic ground states. In their experiment, H_2 gas was passed through a $1 \mu\text{m}$ Casimir cavity to suppress the ZPE radiation at the vibrational ground state of the H_2 molecule. The anticipated signature for such a process would be an increase in the dissociation energy of the molecule. Initial experiments, shown in Figure 8, were carried out at the Synchrotron Radiation Center at the University of Wisconsin at Madison, where an intense UV beam is available to disassociate gas molecules. Unfortunately, problems with the synchrotron beam (unrelated to the experiment) prevented a definitive result from being obtained, so the efficacy of this ZPE-extraction approach remains undetermined at the present time. Further experimentation to investigate this hypothesis has yet to be completed.

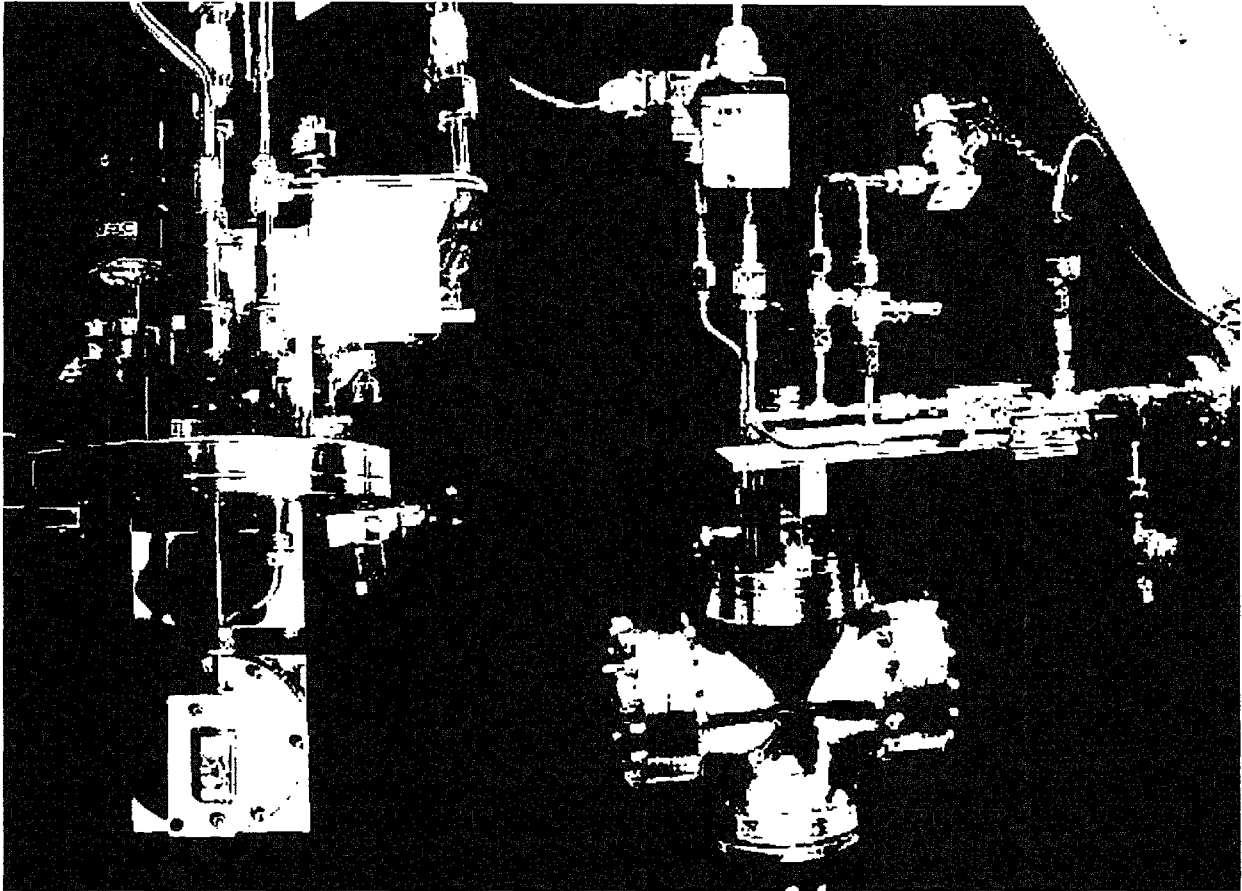

Figure 8. Experimental Apparatus for Ground State Energy Reduction Tests

TUNABLE CASIMIR EFFECT

As previously discussed, the Casimir Effect is a unique ZPF-driven quantum force that occurs between closely-spaced conductive cavity walls (or plates). If left unfettered, the plates will collapse together and energy is converted from the ZPF into heat (or other forms of energy) in accordance with the expression $E/A = -\pi^2 \hbar c / 720 d^3$, where E/A is the energy per unit area of the plates and d is the plate separation. Investigation of this mechanism by Cole and Puthoff (Reference 11) showed that this process fully obeys energy conservation and thermodynamic laws.

Although the Casimir force is conservative, and thus the Casimir device might appear to be a one-shot device, the fact that the attractive Casimir force is weaker for dielectric plates compared to conductive plates raises the possibility of the use of thin-film switchable mirrors to obtain a recycling engine (Reference 29-31). Figure 9 shows a comparison of the strength of the Casimir force in a conductive cavity with that in a dielectric cavity. In such an application the plates are drawn together by the stronger force associated with the conducting state and withdrawn after switching to the dielectric state. The engine cycle for this concept is shown in Figure 10. Assuming optimistic conditions for practical devices (negligible energy required for switching; plate separation oscillations between 30 nm and 15 nm for 1 cm² plates; driving circuit

≈ 10 times the weight of the Casimir plates, and so forth), an estimate of the achievable power might be obtained. Based on the described parameters, and assuming a switching from a purely conductive state to a dielectric constant of $K = 4$, yields a figure of merit of $\approx 35 \times f(\text{MHz}) \text{ W/kg}$ ($f =$ switching rate) for the power density (Reference 29). This can be compared to the power density of $\approx 5 \text{ W/kg}$ achieved by current radioisotope thermoelectric generators. The predicted output power per unit area for this experimental device is $\approx 10^{-6} f(\text{MHz})/4[d(\mu\text{m})]^3 \text{ W/cm}^2$.

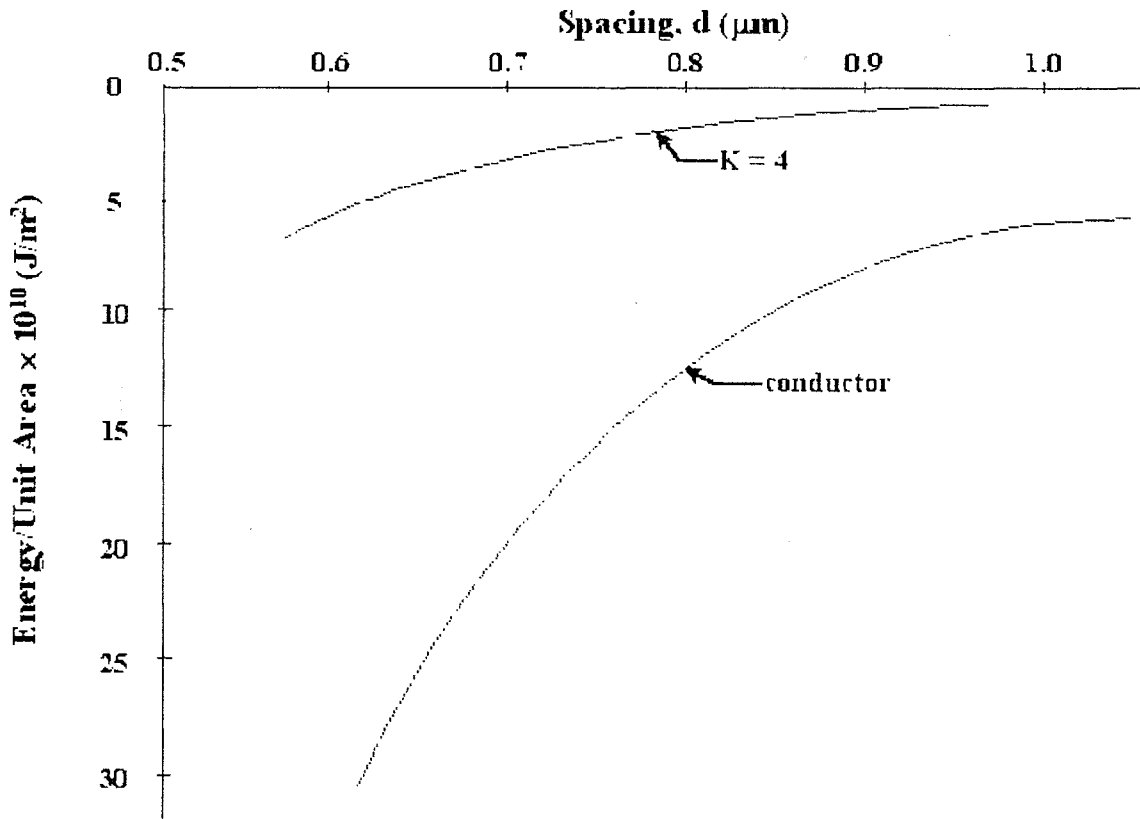

Figure 9. Tunable Casimir Effect: Conductor vs. Dielectric

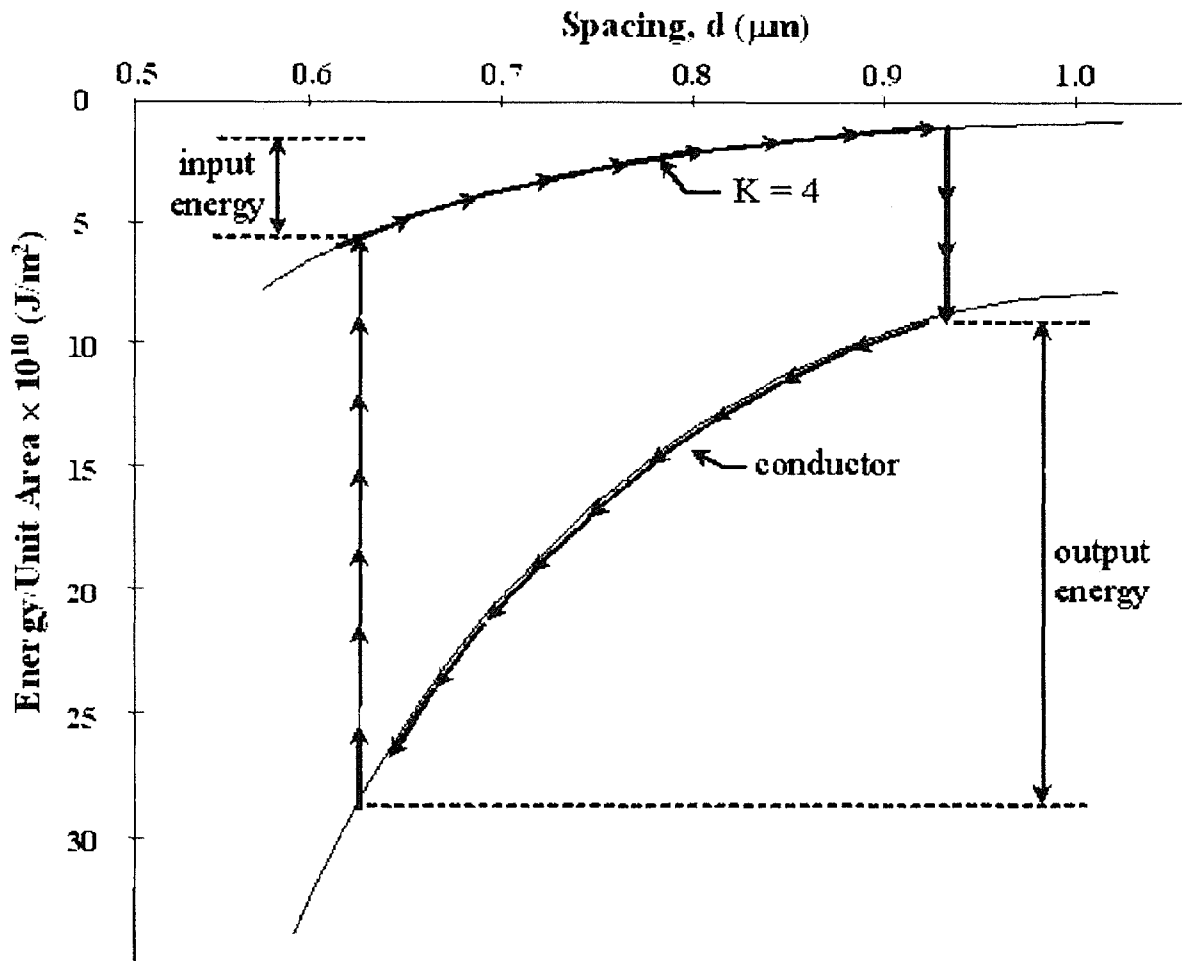

Figure 10. Tunable Casimir Effect: Engine Cycle

Another "tunable" conductive-type plate experiment under consideration involves the use of plates consisting of three-dimensional photonic crystals, with the bandgap of the photons that can transmit through the structure being a "tunable" value. Using microelectromechanical processing methods, Sandia National Laboratory has produced such crystals and is researching methods of actively modifying the structures while in use (Reference 32). The technology requirements for this concept are the nano-fabrication of microcavities with thin-film deposited surfaces, RF-driven piezoelectric mounts for cavity oscillation, mirror-switching modality (for example, hydrogen pressure modulation), and calorimetric measurement of energy/heat production.

An initial experiment to explore this concept was recently performed by Iannuzzi et al. (Reference 33). They investigated the effect of hydrogen switchable mirrors (HSMs) on the Casimir force. HSMs are shiny metals in their "as deposited" state. However, when they are exposed to a hydrogen-rich atmosphere, they become optically transparent. Because the electromagnetic ZPF depends on the optical properties of the surfaces, the Casimir force of attraction between two HSMs in air should be different than the attraction between the same HSMs immersed in a hydrogen-rich atmosphere. That is because one expects that the Casimir force will be much weaker when the HSM is in the

transparent state rather than in the reflective state. The experiment tested this for plate separations of 70 - 400 nm.

Iannuzzi et al.'s experimental results showed that the Casimir force did not noticeably decrease after filling the experimental apparatus with hydrogen. This may have occurred for two reasons. First, the dielectric properties of the HSMs used in the experiment are only known only in a limited range of wavelengths spanning 0.3 - 2.5 μm , while the experiment measured the transparency of the HSMs over a wavelength range of 0.5 - 3 μm . This narrower wavelength span excludes the rest of the electromagnetic ZPF modes having wavelengths shorter than 0.5 μm and longer than 3 μm . The ZPF modes lying outside this narrow wavelength span were not affected by the hydrogenation-induced transparency of the HSMs, hence their contribution to the total Casimir force acting between the HSMs was not included. One would expect to see a significant decrease of the Casimir force if the hydrogenation-induced transparency of the HSMs had affected all of the ZPF mode wavelengths ranging from IR to UV (ZPF modes with $\lambda \gg 2.5 \mu\text{m}$ will not give rise to large contributions to the force). Second, the experiment demonstrated a property of the Lifshitz theory (see Reference 33 for more detail), that in order to significantly change the Casimir force between surfaces at separations on the order of 100 nm it is not sufficient just to change their optical (IR and visible) reflectivity, but it is necessary to modify their dielectric functions over a much wider spectral range. This comports with the first reason, and indicates that more theoretical and experimental work is needed to overcome the shortcomings of this experiment, and allow for the design and testing of new experiments that can achieve Casimir plate transparency over a wider spectral range.

A notion similar to the tunable Casimir Effect involves changing the dimensions of a rectangular "Casimir box." Forward (Reference 34) proposed a paradox in which energy could be extracted by altering the aspect ratio of a conductive rectangular Casimir cavity over a specific cycle of dimension changes (for example, varying width while holding length constant). It was subsequently shown by Maclay (Reference 26, 35), that the Casimir energy inside the box is not isotropic, varying in such a way that more work is expended in cycling the box dimensions than can be extracted. It appears that no net gain of energy is theoretically possible in this scheme. Whether such considerations apply to the tunable Casimir cavity concept remains to be assessed.

EV PHENOMENON

Shoulders (Reference 36) developed an experimental program to explore the physics of microscopic plasma vortices (aka force-free plasmoids), which are thought to be a form of ball lightning (Reference 37). This study was motivated by the earlier experimental work of Wells at the Princeton University Plasma Physics Laboratory, Bostick and Nardi at the Stevens Inst. of Technology, and their collaborators (Reference 38-45). Shoulders became interested in the possibility of stable, quantized force-free structures that could be taken apart by some process to yield a net energy gain for power generation. The foundation for this speculation was Nardi et al.'s (Reference 45) observation of strange electron concentrations they called vortex filaments that formed in an electron beam made by plasma focus or relativistic electron beam machines, which exhibited electron concentrations that appeared to violate the space charge law. Furthermore, Nardi et al. observed that the vortex filaments were striking exposed materials (for example, metals, dielectrics, ceramics, glass), boring smooth channels straight through them, and sometimes exploding with such a large force that they

created impact craters or holes in the materials. Piestrup et al. (Reference 46) performed more recent experiments to investigate this unusual phenomenon. This discovery inspired Shoulders to consider vortex filaments as a potential new source of energy, and hence he named them electromagnetic vortices or "EVs." However, given that he could not experimentally verify the vortex nature of the phenomenon, he later redefined EV to mean Electrum Validum (roughly translated as *strong electron*).

Bostick and Shoulders began collaborating and realized that EVs were much easier to generate and observe using micro-arc discharge devices because they are usually obscured by surrounding plasma in large high-power plasma machines. This led Shoulders to design a series of low-voltage, low-power micro-arc discharge (or condensed-charge emission) devices to produce EVs in the lab. Figure 11 shows a schematic diagram for one embodiment of an EV (pulse discharge source) device. The EVs are generated at the cathode tip and then follow the path (dashed line above the dielectric) to the impact site on the ground plane (in the figure, C = capacitor and V = voltage). The EVs generated by such devices were able to reproduce the material damage observed in Nardi et al.'s earlier experiments.

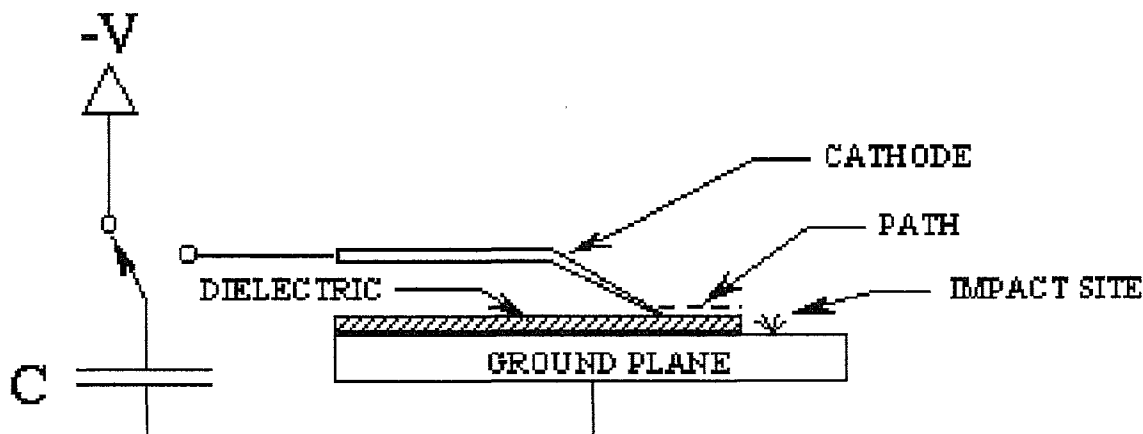

Figure 11. Schematic of EV (Pulse Discharge Source) Device (Reference 47)

Figure 12 shows a scanning electron microscope (SEM) photograph of the damage inflicted by a single EV burst fired along an aluminum-oxide ceramic plate. The EV bored through the ceramic forming a smooth symmetrical channel along its path.



Figure 12. SEM of EV Damage to Ceramic Plate (20 um scale) (Reference 36)

Figure 13 shows a SEM photo of a single EV shot on a Palladium (Pd) target from a 40 pF capacitor charged to 3,000 Volts (containing 7.5×10^{11} electrons). At least 100 tiny craters were formed in the target. The larger craters formed in the Pd target as seen in the photo suggest a very energetic impact that melted the Pd locally, making a small hole surrounded by a crater wall.

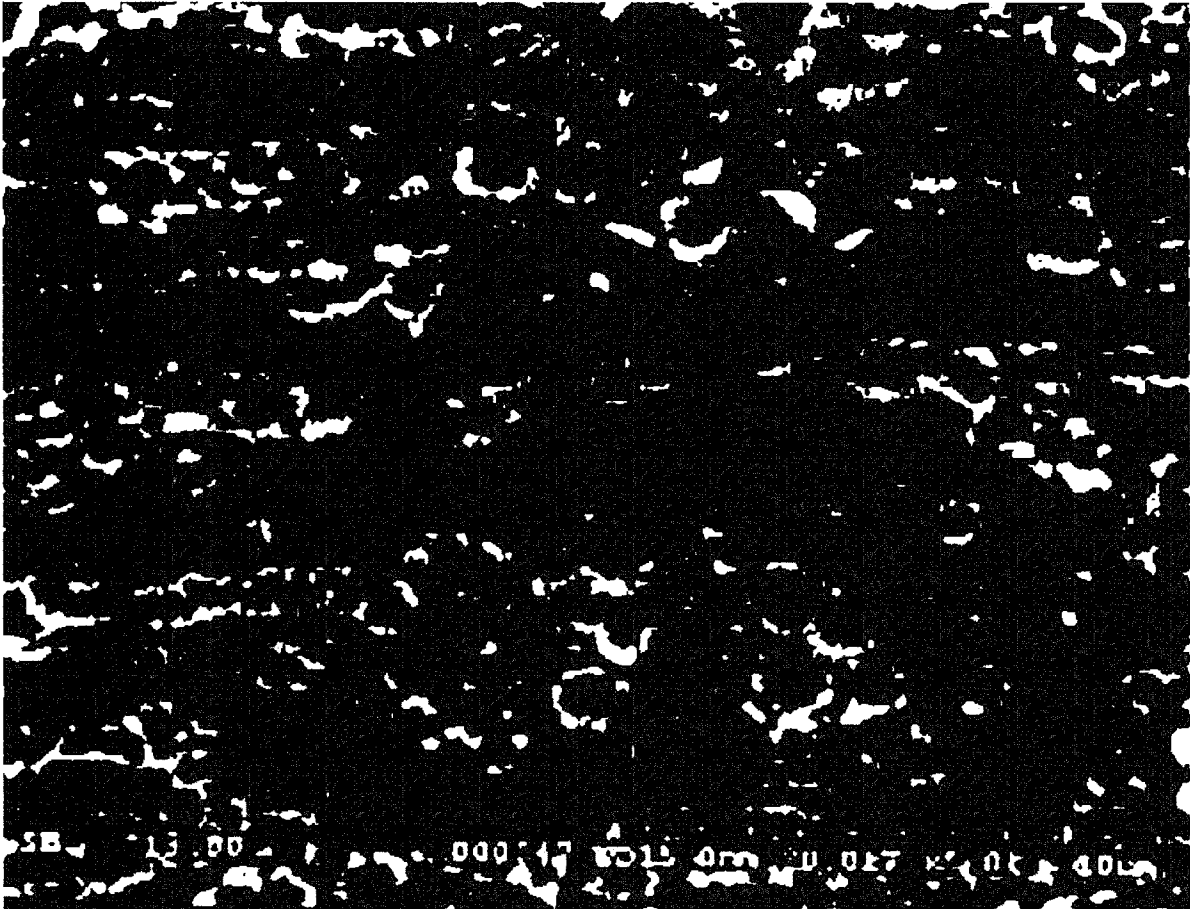

Figure 13. SEM of EV Damage to Palladium Target (Reference 36)

Figure 14 shows an example of an EV moving away from its source and shedding electrons while giving off light as it was decaying.

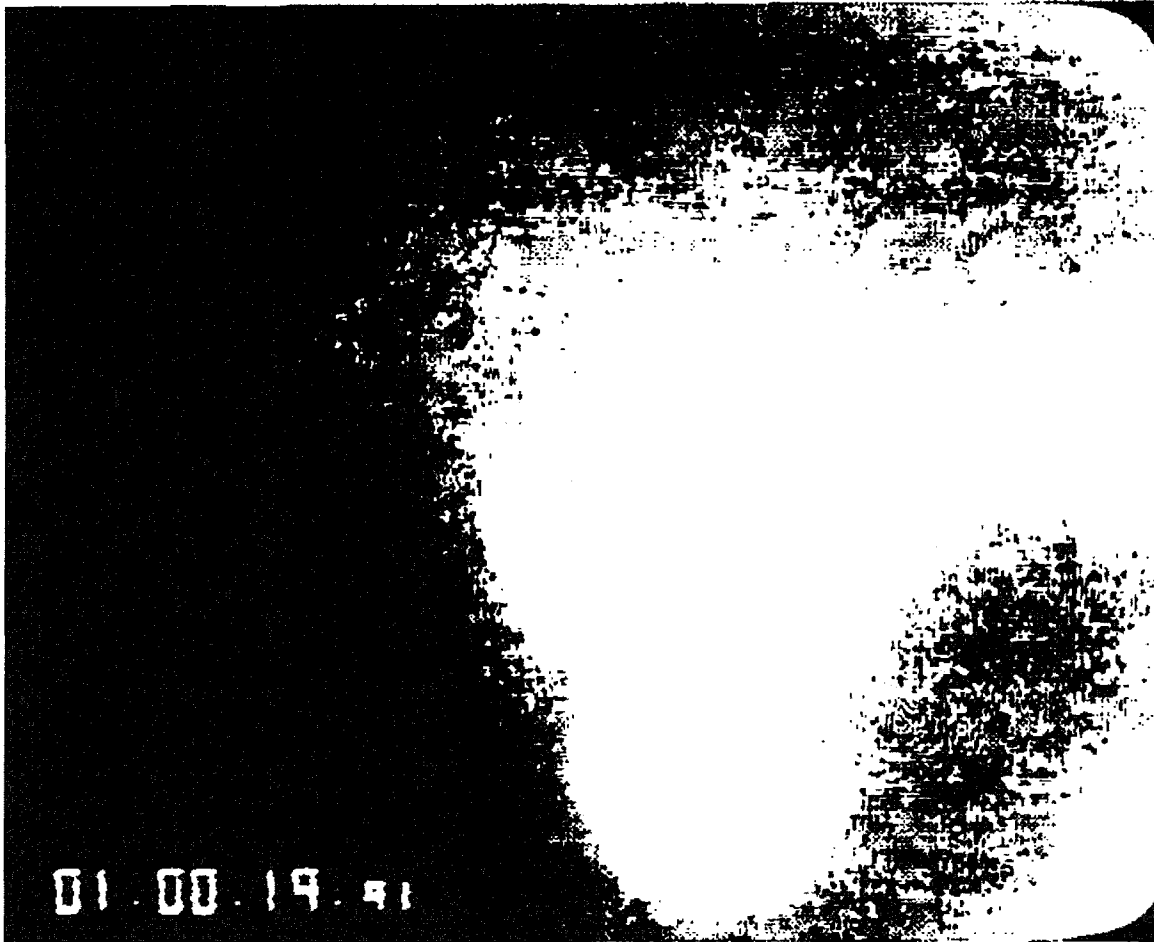

Figure 14. EV (large blob at bottom) Moving at Downward Angle Away From Its Source (smaller blob near center of photo) (Reference 36)

Shoulders' experimental studies claim that EVs have physical characteristics corresponding to the phenomenon observed by Nardi et al. His conclusions were that EVs are compact spherically shaped balls (diameter $\approx 1 - 20 \mu\text{m}$) of condensed high-density charge ($\sim 10^{30}$ electrons/ m^3) with an internal electric field $> 10^8$ V/m, a charge-to-mass ratio of 1.7588×10^{11} Coulomb/kg (\approx electron's charge-to-mass ratio), and a surface current density of 6×10^{15} Amps/ m^2 (Reference 36). Shoulders also reported that EVs are a source of (copious) X-rays; a single EV discharge gun can produce multiple EVs in which the coupling between adjacent EVs produces quasi-stable structures (chains); and EVs respond like an electron under deflection by external fields of known polarity.

Since electrons would not be expected to bind together due to their mutual Coulomb repulsion, a speculative model based on the vacuum electromagnetic ZPF was formed

to explain the existence of EVs. The emerging laboratory evidence led investigators to consider the hypothesis that the Casimir effect may be a major contributing mechanism to the formation of EVs in micro-arc discharges. This conjecture is based on models by Casimir (Reference 48) and Puthoff and Piestrup (Reference 49) suggesting that the generation of a relatively cold, dense, non-neutral (charged) plasma results in charge-condensation effects that may be attributable to a Casimir-type pinch effect (that is, ZPF-induced pressure forces) in which the inverse square-law Coulomb repulsion is overcome by an attractive inverse fourth-law Casimir force to yield a stable configuration of bound charges at small dimensions. This is a derivative of Casimir's semi-classical model of the electron in which a dense shell-like distribution of charge might suppress vacuum fields in the interior of the shell (Reference 48). However, initial application of Casimir's model found that the vacuum field inside the modeled electron was found to augment rather than offset the divergent Coulomb field thus rendering the electron's self-energy divergent. Puthoff (Reference 50) later resolved this problem by developing a self-consistent vacuum-fluctuation-based model in which the net contribution to the point-like electron's self-energy by its Coulomb and vacuum fields vanishes thus rendering a stable finite-mass electron.

Shoulders and collaborators subsequently investigated different approaches to extracting useful energy from the vacuum ZPF by way of exploiting EV phenomenon. Even though EVs can be easily produced in the lab, efforts to test this hypothesis have not met with success due to technical problems. However, this topic is ideal to pursue for future research.

V. Theoretical Considerations and Issues

QED VACUUM REVISITED

QED Vacuum as a Plenum

Continued theoretical and experimental research has revealed that the vacuum constitutes an active agent that contributes to a host of phenomena ranging from microscopic level shifts of atomic states to possible connections to the cause of cosmological expansion (Reference 14, 51). As more of its attributes are explored, the vacuum has been found to exhibit phenomena characteristic of an optical medium, such as induced birefringence in the presence of an applied magnetic field (Reference 52), and breakdown (decay) in the presence of external electric fields (Reference 53-55). The current view is that the vacuum has structure, and can be considered much like a medium of classical physics. However, the vacuum differs significantly from that of a classical medium due to the existence of quantum fluctuations. A primary attribute of quantum theory is the concept of matter and field fluctuations, rooted in Heisenberg's Uncertainty Principle.

In second-quantized QED theory, the theory that applies to the electromagnetic vacuum, the canonical approach to representing fluctuations of the free vacuum electromagnetic field is to express the field distribution in terms of standing- or traveling-wave normal modes. Section I suggested that the large value of the integrated ZPE density fuels the concept of potentially useful vacuum energy conversion to other forms, should even some small part of the spectral energy distribution be accessible for conversion by technological means.

QED Vacuum as a Mathematical "Placeholder" for Fluctuating Matter Fields

The treatment of the QED vacuum as a fluctuating plenum with (formally) infinite energy density has caused some physicists to call into question the viability of the second-quantized QED formalism. Jaynes, for example, in considering the consequences for calculation of the Lamb shift of the 2s level of the hydrogen atom under the assumption of a much more modest electron Compton frequency cutoff ($\sim 10^{21}$ Hz), calculates a fluctuating power flow for the Poynting vector of 6×10^{20} MW/cm² – comparable in every square centimeter to the total power output of the sun – and states that "real radiation of that intensity would do a little more than just shift the 2s level by 4 microvolts" (Reference 56). However, despite alternatives to the formalism of QED that have been suggested (more on this later), second-quantized QED cannot be lightly dismissed; and this is so even though the infinities that must be dealt with by such procedures as renormalization caused even one of its founders, Paul Dirac, to remark: "This is just not sensible mathematics. Sensible mathematics involves neglecting a quantity when it turns out to be small – not neglecting it because it is infinitely great and you do not want it" (Reference 57).

A second argument that can be raised against using the QED formalism to further explore vacuum fluctuation physics is that, despite the magnitude of the energy density potentially associated with vacuum electromagnetic fluctuations, observation of the cosmological constant—a measure of net vacuum energy density—has a value that is only on the order of the average energy density of (ordinary + dark) matter in the universe $\approx 10^{-9}$ J/m³ (Reference 58, 59). This leads to what is often referred to as the 120 orders-of-magnitude problem, or "cosmological coincidence." In the mainstream view, rather than the QED value being discounted, the resolution of this problem is thought to lie in the domain of infinity (or divergent integral) cancellations, requiring instead an accounting for the fine-tuning requirements of such cancellations (Reference 60, 61).

Again, the root cause of the difficulties that accompany second quantization of the vacuum field is that an unbounded plenum possesses an infinite number of degrees of freedom, each with its assigned ground-state fluctuation energy. In an attempt to circumvent the difficulties associated with an unbounded, second-quantized plenum, alternative approaches to QED have been explored in the literature in some detail, a few of which are discussed in Section V. A number of these alternative viewpoints interpret the second-quantized QED vacuum with its infinite degrees of freedom as simply an over-idealized mathematical placeholder for "real" fields that originate in matter fluctuations whose number of degrees of freedom is necessarily always limited. Nevertheless, though the alternative formalisms and associated interpretations differ significantly from the canonical approach, detailed calculations yield results identical to those generated by the second-quantized field formalism. As a result, even treated as a mathematical placeholder for matter fluctuation fields, at this point in our discussion the QED value must be taken seriously. The proposed corollary concerning the potentially significant conversion of QED vacuum energy to other forms is further evaluated in the sections that follow.

CASIMIR EFFECT REVISITED

The most-quoted quintessential configuration for the conversion of vacuum energy to other forms of energy is the Casimir effect. As previously discussed, when parallel conducting plates are placed in a vacuum, they attract one another by a very weak force that varies inversely as the fourth power of the distance between them. First computed by Casimir in terms of van der Waals forces (a matter-fields approach – see below), he soon realized that, because the force turns out to be independent of the molecular details of the conductors, it could be computed as a problem in vacuum energy, and that is the way it is now generally presented in the literature (the “plenum approach”) (Reference 5, 62).

Casimir Effect in the Plenum Picture

One begins with the free quantum vacuum electromagnetic field fluctuations, and then determines their modification due to the insertion of two parallel plane conductors (that is, plates) as additional boundary conditions, which constrain a discrete set of intra-cavity modes of integer half-wavelengths. Aside from an unobservable, high-frequency-cutoff-dependent, free-field term that remains from the mathematical regularization procedure, the resulting (renormalized) vacuum stress-energy tensor⁹ is given by $\langle T_{\text{vac}}^{\mu\nu} \rangle = (\pi^2 \hbar c / 720 d^4) \text{diag}(-1, 1, 1, -3)$, where the angular brackets denote the quantum (vacuum state) expectation value of the tensor $T_{\text{vac}}^{\mu\nu}$, d is the plate separation, and $\text{diag}(-1, 1, 1, -3)$ denotes the diagonal elements of a 4x4 matrix (Reference 1-3, 62).¹⁰ $\langle T_{\text{vac}}^{\mu\nu} \rangle$ represents the real physical stress carried by the vacuum field fluctuations in the presence of the parallel plane conductors, and it encodes the Casimir effect in terms of (1) an interaction energy per unit area, $E/A = -\pi^2 \hbar c / 720 d^3$, and (2) a corresponding force per unit area, $F/A = -\pi^2 \hbar c / 240 d^4$. If free to move in response to the attractive Casimir force, the motion of the plates toward each other is understood in the plenum approach to progressively eliminate intra-cavity modes, converting their associated ground-state energies first into kinetic energy, and then, upon collision of the plates, into heat. Section II described the Casimir-force-driven collapse of Forward’s charged slinky as a Casimir-type configuration for building up an electric field to charge a battery, and how such processes were shown not to violate either conservation of energy or thermodynamic constraints.

Casimir Effect in the Fluctuating Matter Fields Picture

Complementary to the vacuum mode description (plenum approach), the Casimir effect can be described, like van der Waals attraction, as arising from correlations in the state of electrons in the two plates through the intermediary of their coupled fields. From this standpoint (matter-fields approach) there is no requirement for the high energy density vacuum field of the plenum approach to reside throughout all space.

⁹ The stress-energy-momentum tensor, $T^{\mu\nu}$, is a matrix quantity that encodes the density and flux of a matter source’s energy and momentum. Greek indices denote the matrix components over the spacetime coordinates.

¹⁰ For this derivation, the vacuum fluctuations of other quantum fields are essentially undisturbed by the presence of the conductors or are affected only in the immediate vicinity of the atomic nuclei that they contain.

Unfortunately with regard to energy generation, though the Casimir forces involved can be of significance for MEMS applications (Reference 63), the associated Casimir energies involved are too small to be considered of significance for energy applications, so if the possibility for vacuum energy conversion exists, one must look elsewhere to other types of matter-vacuum interactions.

TYPE I (TRANSIENT) AND TYPE II (CONTINUOUS) MACHINES

A key feature of the Casimir process just described, regardless of viewpoint (plenum or matter-fields), is that it is a "one-shot," transient, energy-producing machine. That is, after delivering its energy, E , the matter that comprises the machine is in a "used" state (this used matter is commonly referred to as "ash") and cannot be restored to the original state without an input of energy that is greater than or equal to E . This "one-shot" feature can be generalized to define a category of machine called a Type I transient machine, with the Casimir machine constituting the prototypical representative. Should gravitation eventually be traced to a vacuum ZPF origin as proposed by Sakharov (Reference 64), then the fall of an object of mass m through a height h in a gravitational field (g = acceleration of gravity at Earth's surface), delivering its gravitational energy mgh upon impact with the ground, would constitute another example.

In contrast, one can envision a Type II (continuous) machine in which vacuum ZPF energy is converted to a useful form on a recycling basis without net alteration to its own matter state. A hypothetical example is the tunable Casimir device that was reviewed in Section IV. The cycle of energy generation would consist of the collapse of conducting plates with delivery of energy, followed by separation of plates switched to insulating mode for which the attractive force is considerably weaker, only to be switched back to conducting mode for the next cycle, and so forth. Provided the input switching energy required per cycle is less than the output energy delivered per cycle, a continuous generation of energy without a net change in matter configuration would result. A second example would be a nonlinear oscillator that continuously, on a steady-state basis, down-shifted high-frequency components of the vacuum ZPF spectrum to lower frequencies for convenient collection and application, without a net change in its own operation.

Clearly a Type II machine would be far more useful than a Type I machine for energy extraction. Type II machines would constitute a fuel-less energy source, with the ambient vacuum ZPF providing essentially unlimited energy. For this to be the case, however, another requirement needs to be satisfied, which the next section will address.

DEGRADABILITY OF THE VACUUM

The possibility of continuous conversion of vacuum ZPE to other forms (that is, by a Type II machine) requires that, in principle, vacuum energy must be degradable (that is, continuously consumable), not just that there be a surfeit of energy in place to harvest. This perspective leads to a remarkable question for deeper explorations of QED. It turns out that the mathematical structure of QED is based on a formalism in which the vacuum mode structure and vacuum fluctuation energy per mode are quantized in what could be called a "hard-wired" fashion; that is, they possess fixed immutable values. Therefore, at the end of a cycle of a hypothetical Type II machine, in

which both matter and vacuum mode structure have been returned to their original states, the vacuum modes must of necessity contain at a minimum the same, "hard-wired," energetic content as before the cycle. Therefore, assuming local detailed-balance energy conservation, continuous conversion of vacuum ZPE to other forms via a Type II machine is, from the QED viewpoint, forbidden in principle since the vacuum as described by the QED formalism is non-degradable. (Globally, vacuum energy is not conserved during cosmological expansion, with work being done by the negative vacuum pressure to maintain positive constant vacuum energy density and therefore increasing the vacuum energy (Reference 65) This outcome of second-quantized QED theory permits of but two interpretations with regard to continuous vacuum energy conversion: 1) QED theory, despite criticisms that can be leveled against it, is correct in its description of vacuum fluctuation dynamics, and even though vacuum ZPE exists, it cannot be continuously converted to other forms, or 2) the axiomatic inconvertibility is an artifact of an over-idealized mathematical structure, and therefore the possibility of conversion remains an open question.¹¹ What is not in question, however, is that QED, as an axiomatic, quantum formalism based on the concept of an immutable, non-degradable vacuum, does not support the concept of continuous vacuum energy conversion.

ALTERNATIVES TO QED

As noted in Section V, despite its successes the second-quantized QED formalism with its infinite vacuum degrees of freedom and associated infinite energy density has been the subject of criticism and, as a result, alternatives have been proposed and investigated in the literature. The alternatives run the gamut from neoclassical theories in which matter is quantized but the fields are not (for example, the voluminous work of E. T. Jaynes), through classical theories where both matter and fields are treated classically, with vacuum fluctuations fields taken to be real but of a classical nature (for example, SED), to formalisms which eliminate the concept of vacuum fields altogether (for example, direct-action approaches investigated by A. O. Barut and others; see the references cited below). Each of these will be examined briefly with regard to the possibility of useful "vacuum energy conversion."

Neoclassical Theories of QED Vacuum Fluctuation Effects

A major proponent of the neoclassical approach has been E. T. Jaynes, who has questioned whether the quantized vacuum field is physically real or merely an artifice of the second-quantized QED formalism. Based on the fact that the QED formalism permits expression of effects in terms of quantized "self" or "source" fields as an alternative to expression in terms of quantized vacuum fluctuation fields, Jaynes advanced the hypothesis that QED effects can be attributed to the self-fields of quantized matter without considering independent quantization of the vacuum fields, expressions in terms of the latter just being a placeholder for the former. Pointedly, with regard to QED being "the jewel of physics because of its extremely accurate predictions," Jaynes' position is that "those accurate experimental confirmations of QED come from the local source fields, which are coherent with the local state of matter," and that "the quantized free field only tags along (Reference 66)." Jaynes nonetheless arrived at a conclusion that one might call Jaynes' Axiom, namely, "This complete

¹¹ A number of publications by E. T. Jaynes, A. O. Barut and their collaborators are based on the premise that second quantization is an unnecessary artifact of an over-idealized formalism.

interchangeability of source-field effects and vacuum-fluctuation effects...shows that source-field effects are the same as if vacuum fluctuations were present." Applied to the case of a radiating atom, Jaynes provides a specific example of his conclusion with the statement "The radiating atom is indeed interacting with an electromagnetic field of the intensity predicted by the zero-point energy, but this is just the atom's own radiation reaction field (Reference 67)." As a result, with the axiomatic second-quantized field formalism set aside, in the neoclassical approach any consideration of the conversion of vacuum ZPE for use must be displaced to consideration of the conversion and degradability of source or matter-fields fluctuation energy for use, issues yet to be addressed in the literature.

SED Model Revisited

SED is a classical (that is, non-quantized) theory of particle-field interactions that assumes the existence of classical particles and a classical random background electromagnetic field distribution whose Lorentz-invariant spectral energy density is chosen to match that originally appearing in second-quantized QED. Given SED's heuristic value of classical-like modeling and ease of calculation and its seeming ability to address many quantum mechanical problems with success (as outlined in Section III), the SED approach has been employed in the literature to explore vacuum energy conversion. In the absence of a formalism for vacuum field quantization, there are no fundamental immutability constraints that would mitigate against vacuum energy degradability, so that issue is not testable under this formalism.

Investigations to date have included the use of cavity-QED techniques to suppress atomic or molecular ground states (Reference 28), and evaluation of the use of a nonlinear oscillator to continuously downshift high-frequency components of the vacuum fluctuation spectrum to lower frequencies for convenient collection and use. With regard to the latter, the result of a nonrelativistic SED analysis is that the downshifting process acts to convert an initial hypothetical cubic-frequency vacuum fluctuation spectrum towards a Rayleigh-Jeans rather than a Planck heat spectrum (the former being a low energy approximation of the latter) (Reference 68, 69). Extension of the analysis to the relativistic regime does not alter this conclusion (Reference 70, 71). Though further work remains, these considerations lead one to conclude that SED in its present form is incomplete, and may not be useful for the assessment of the potential conversion of vacuum energy to other forms; its predictions concerning such must be treated with caution.

Additional shortcomings of the SED model include convoluted attempts to derive interference effects or Schrödinger's equation, and the difficulty in explaining sharply-defined stationary states (that is, sharp atomic spectra), though there have been many attempts (Reference 17). QED and SED do not in general yield the same results for nonlinear systems, although they are in agreement for the range of linear systems examined. The apparent disagreements between SED and QED are quite serious, and occur in areas in which QED is highly successful. Perhaps the source of these difficulties lies in accurately dealing with the nonlinear stochastic differential equations in SED for these problems. Even still, it is likely that differences will remain, which should clearly be testable by experimental means (Reference 72). For a very thorough, detailed and scholarly review of SED, see (Reference 17) and the corresponding review by Cole and Rueda (Reference 73).

Given the heuristic value of certain aspects of SED modeling, but with the shortcomings outlined above noted, SED theorists de la Pena and Cetto have proposed a modification to SED they call LSED (linear SED) (Reference 74). The modification consists of the addition of three new constraining principles that result in a form of convergence with nonrelativistic quantum mechanics while retaining some of the appealing attributes of standard SED (for example, quantum states being stable on the basis of a dynamic balance between absorption and emission of background vacuum fluctuation fields). The added constraints (for example, an added constraint that invokes detailed energy balance for separate frequencies) result in correcting several known problems with standard SED. For example, now the equilibrium spectrum is Planck's, not Rayleigh-Jeans, and wavelike behavior of matter and nonlocality issues can be addressed, and so forth. The issue of continuous vacuum energy conversion has yet to be addressed in this new formalism, however, so that remains for the future.

QED Without Second-Quantized Fields

As yet another alternative to canonical second-quantized QED, Barut (Reference 75) has proposed that effects attributable to vacuum ZPF can be derived with a theory in which there are source (matter) fluctuation fields but no vacuum fluctuation fields, and that even the former can be eliminated. Barut's approach is developed in considerable detail as an independent, self-consistent, formulation of QED in its own right. Barut argues that effects normally attributed to vacuum fluctuations in the second-quantized, linear theory of the radiation field can be equally well computed within the framework of a non-second-quantized, nonlinear theory which is based entirely on matter wave functions alone. His program is to assess how far one can go in understanding radiative processes without second quantization or vacua that fluctuate. Barut and his collaborators have successfully applied the theory to the Lamb shift and spontaneous emission (Reference 76, 77), problems of cavity QED (Reference 78), Casimir-Polder and van der Waals forces (Reference 79), calculations of the electron's g_e-2 factor (Reference 80-82),¹² and the Davies-Unruh effect (Reference 83) among others.

Given that the formalism of second-quantized field operators are not used at all in the Barut approach, the seemingly quantized properties of fields are taken to simply reflect first quantization of the sources. Therefore, in the absence of the independent existence of second-quantized field fluctuations, the QED arguments concerning immutability and nondegradability of quantized vacuum fluctuation fields, and the corollary proscription against potential conversion of energy from such fields, do not apply. As in the neoclassical approach, the question of the conversion of quantum ZPE to other forms must be diverted to consideration of the global properties of matter fluctuation interactions in the as-yet-incomplete development of the Barut approach.

EXAMPLES OF DEGRADABLE OF DECAYING VACUUM

In closing, several examples of a degradable vacuum that are predicted by quantum field theory, quantum field theory in curved spacetime, and the Standard Model of elementary particle physics will be reviewed. It turns out that the vacuum in QED theory is in fact degradable in spite of its "hardwired" ZPF modes.

¹² g_e is the electron's gyromagnetic ratio.

Gravitational Squeezing of the Vacuum

In their study of traversable wormholes, Hochberg and Kephart (Reference 84) discovered that the gravitational field of any astronomical body produces a zone of negative energy around it by "dragging" some of the virtual quanta (a.k.a. vacuum ZPF) downward. They applied their discovery to the problem of creating and stabilizing traversable wormholes. Their quantum optics analysis showed that there is a distortion of the vacuum electromagnetic ZPF due to the interaction with a prescribed gravitational background, which results in "squeezed" vacuum states that possess a negative energy density. Squeezing of the vacuum is a quantum process that is roughly analogous to the compression of an ordinary fluid. This means that as the vacuum field is continuously being squeezed by the gravitational field of a body, its energy is continuously being degraded with respect to the undisturbed remote vacuum field.

The magnitude of the gravitational squeezing of the vacuum can be estimated from the quantum optics squeezing condition for given transverse (to the direction of gravitational acceleration) momentum and (equivalent) energy eigenvalues, $j = 8\pi r_s/\lambda$,¹³ of two electromagnetic ZPF field modes, subject to the squeezing condition $j \rightarrow 0$, where λ is the ZPF mode wavelength and r_s is the Schwarzschild radius of the astronomical body under study (Reference 84).¹⁴ This condition simply states that substantial gravitational squeezing of the vacuum occurs for ZPF field modes with $\lambda \geq 8\pi r_s$. The corresponding local vacuum state energy density that this effect produces is $\rho_{E-gsvac} = -2\pi^2\eta c/\lambda^4$.

It is not clear whether this mechanism can be exploited to extract energy from the vacuum. Conservation of energy suggests one of two possible outcomes: 1) the lost energy is injected into the gravitational energy of the body, or 2) the lost energy reappears as an accumulation of positive energy density ZPF modes elsewhere in the universe. Further research will be needed to address this question.

Redshifting the Vacuum

Calloni et al. (Reference 85, 86) explored the possibility of verifying the equivalence principle for the zero-point energy of QED. They used semi-classical quantum gravity theory to evaluate the net force produced by the quantum vacuum ZPF acting on a rigid Casimir cavity in a weak gravitational field which is modeled using the standard Schwarzschild spacetime metric geometry.¹⁵ They evaluated the regularized (or renormalized) stress-energy tensor $\langle T_{vac}^{\mu\nu} \rangle$ of the quantized vacuum electromagnetic field between two plane-parallel ideal metallic plates lying in a horizontal plane. $\langle T_{vac}^{\mu\nu} \rangle$ encodes the Casimir effect, which has a negative energy density and a negative pressure along the vertical (gravitational acceleration) axis between the plates. Bimonte

¹³ Note that j contains an extra factor of two (compared to the j derived in Reference 84) in order to account for the photon spin.

¹⁴ $r_s = 2GM/c^2$ is the critical radius at which a body of mass M collapses into a black hole. It is used here as a convenient distance parameter to simplify the inequality, but there is no actual black hole collapse involved in this mechanism. G is Newton's universal gravitation constant (6.673×10^{-11} Nm²/kg²).

¹⁵ A spacetime metric is a Lorentz-invariant distance function between any two points in spacetime, which is defined in terms of a metric tensor, $g_{\mu\nu}$, that encodes the geometry of spacetime (Greek indices $\mu, \nu = 0...3$ denote spacetime coordinates, $x^0...x^3$, such that $x^1...x^3 \equiv$ space coordinates and $x^0 \equiv$ time coordinate).

et al. (Reference 87-89) also studied this problem using Green-function techniques in the Schwinger-DeWitt quantum ether prescription for $\langle T_{\text{vac}}^{\mu\nu} \rangle$ in a curved spacetime. The results from these studies agreed with the equivalence principle and showed that quantum vacuum ZPF does gravitate since the energy of each ZPF mode is redshifted by the factor $(-g_{00})^{1/2} = [1 - (2GM/c^2r)]^{1/2}$ even though the modes remain unchanged (M is the mass of a gravitating body, r is the radial distance from the body, and g_{00} is the time-time component of the Schwarzschild metric tensor).

These studies suggest that cavity electromagnetic vacuum states are continuously degrading inside a background gravitational field. The total energy (E_{CasGrav}) stored in the Casimir device is given by (Reference 87, 89):

$$E_{\text{CasGrav}} = -\frac{\pi^2 A \hbar c}{720 d^3} \left(1 + \frac{5}{2} \frac{g d}{c^2} \right) \quad (J) \quad (5)$$

where A is the area of the plates, d is their separation, and g is the acceleration of gravity at Earth's surface (9.81 m/s^2). But can one extract energy from this mechanism? The answer to this question is not known at present, but consideration of the conservation of energy suggests that the same two possible outcomes given in the previous section would seem to apply: 1) the lost energy is injected into the gravitational energy of the body, or 2) the lost energy reappears as positive energy density ZPF modes elsewhere in the universe. Further research will be needed to address this question as well.

Vacuum Field Stress: Negative Vacuum Energy from the Casimir Effect

As this report has already discussed, the standard Casimir effect (neglecting spacetime curvature, a.k.a. background gravitational fields) is by far the easiest and most well known way to produce negative vacuum energy. Therefore, the vacuum within certain types of Casimir cavity geometries is degraded. It turns out that there are many different types of Casimir effects found in quantum field theory (Reference 1-3, 62, 90). For example, if one introduces a single infinite plane conductor into the Minkowski (flat spacetime) vacuum by bringing it adiabatically from infinity so that whatever quantum fields are present suffer no excitation but remain in their ground states, then the vacuum (electromagnetic) stresses induced by the presence of the infinite plane conductor produces a Casimir effect. This result holds equally well when two parallel plane conductors (with separation distance d) are present, which gives rise to the familiar Casimir effect inside a cavity. Note that in both cases, the spacetime manifold is made incomplete by the introduction of the plane conductor boundary condition(s). The vacuum region put under stress by the presence of the plane conductor(s) is called the "Casimir vacuum." The generic expression for the energy density of the Casimir vacuum is $\rho_{\text{CE}} = -\Lambda_D \hbar c d^{-1}$, where $A_D = \zeta(D)/8\pi^2$ in spacetimes of arbitrary dimension D (Reference 1-3). The appearance of the zeta-function $\zeta(D)$ is characteristic of expressions for vacuum stress-energy tensors, $T_{\text{vac}}^{\mu\nu}$. In our familiar 4-dimensional spacetime ($D = 4$), $A_D = \pi^2/720$. To calculate $T_{\text{vac}}^{\mu\nu}$ for a given quantum field is to calculate its associated Casimir effect.

When the plates in a Casimir cavity are put into non-uniform accelerated motion, it is possible in principle to create real photons out of the vacuum. This effect is referred to in the literature as the "dynamical Casimir effect," or motion-induced radiation (Reference 62, 91). One version of the dynamical Casimir effect provides a way to degrade the vacuum whereby negative vacuum energy is produced by a single moving reflecting (conducting) surface (a.k.a. a moving mirror). A mirror moving with increasing acceleration generates a flux of negative vacuum energy that emanates from its surface and flows out into the space ahead of the mirror (Reference 4, 92). This is essentially the simple case of an infinite plane conductor undergoing acceleration perpendicular to its surface. If the acceleration varies with time, the conductor will generally emit or absorb photons (that is, exchange energy with the vacuum), even though it is neutral. This is an example of the well-known quantum phenomenon of parametric excitation. The parameters of the electromagnetic field oscillators (for example, their frequency distribution function) change with time owing to the acceleration of the mirror (Reference 93).

Analogous of the Casimir effect also exist for fields other than the electromagnetic field. When considering the vacuum state of other fields, one must consider boundary conditions that are analogous to the perfect-conductor boundary conditions for the electromagnetic field at the surfaces of the plates (Reference 1-3, 62, 91). Other fields are not electromagnetic in nature; that is to say they are non-Maxwellian, and so the perfect-conductor boundary conditions do not apply to them. It turns out that complete manifolds exhibit what is called the "topological Casimir effect" for any non-Maxwellian fields. In order to define boundary conditions for other fields replace the conductor boundary conditions and Minkowski spacetime by a manifold of the form $\mathfrak{R} \times \Sigma$ (that is, a product space), where \mathfrak{R} is the real line defining the time dimension for this particular product space and Σ is a flat 3-dimensional manifold having any one of the following topologies: $\mathfrak{R}^2 \times S^1$, $\mathfrak{R} \times T^2$, T^3 , $\mathfrak{R} \times K^2$, and so forth, \mathfrak{R} being the real line that defines any linear space dimension (for example, $\mathfrak{R} = \text{line}$, $\mathfrak{R}^2 = 2\text{-dimensional plane}$), T^n being the n-torus, K^2 the 2-dimensional Klein bottle, S^1 the circle, and so forth.

The case $\Sigma = \mathfrak{R}^2 \times S^1$ has the closest resemblance to the electromagnetic Casimir effect, the difference being that instead of imposing conductor boundary conditions, one imposes periodic boundary conditions on some of the space coordinates in the 3-dimensional manifold. When imposing this topological constraint on the field theoretic calculation of the topological Casimir effect (for linear massless fields), one finds that the generic expression for the energy density is also $\rho_{\text{CF}} = -A_{\text{CF}} \hbar c d^{-1}$, where

$A_{\text{CF}} = \pm d_f (\pi^2 / 90)$, d_f is the number of degrees of freedom (for example, helicity states) per spatial point, the plus sign holds for boson fields (giving a negative energy density) and the negative sign for fermion fields (giving a positive energy density).

If one were to admit spin structure in the manifolds described above and the field is spinorial, then there is another important subtlety that must be taken into account when evaluating $T_{\text{vac}}^{\mu\nu}$. However, this introduces an additional complexity involving the relationship between the spin structure and the global structure (that is, the configuration space or fibre bundle) of the field in question whereby the topology not only of the base manifold, but of the fibre bundle itself has an effect on $T_{\text{vac}}^{\mu\nu}$. In addition to this, there are (compactified) extra-space dimensional quantum field (that is, D-

Brane or "brane world") analogs of the Casimir effect yet to be explored. But a detailed consideration of these is beyond the scope of this report and will be left for future investigation.

Squeezed Quantum Vacuum

It was discovered in 1965 that quantum field theory has the remarkable property of allowing states of matter containing local regions of negative (vacuum state) energy density or negative fluxes (Reference 94). In general, the local (vacuum state) energy density in quantum field theory can be negative due to quantum coherence effects (Reference 94). A primary byproduct of this discovery is the "squeezed quantum vacuum," which later gave rise to new phenomenon such as the gravitationally squeezed vacuum discussed previously. Substantial theoretical and experimental work has shown that in many quantum systems the limits to measurement precision imposed by the quantum vacuum ZPF can be breached by decreasing the noise in one observable (or measurable quantity) at the expense of increasing the noise in the conjugate observable; at the same time the variations in the first observable, say the energy, are reduced below the ZPF such that the energy becomes "negative." "Squeezing" is thus the control of quantum fluctuations and corresponding uncertainties, whereby one can squeeze/reduce the variance of one (physically important) observable quantity provided the variance in the (physically unimportant) conjugate variable is stretched/increased. The squeezed quantity possesses an unusually low variance, meaning less variance than would be expected on the basis of the equipartition theorem. One can in principle exploit quantum squeezing to extract energy from one place in the ordinary vacuum at the expense of accumulating excess energy elsewhere.

The squeezed state of the electromagnetic field is a primary example of a quantum field that has negative energy density and negative energy flux. Such a state became a physical reality in the laboratory as a result of the nonlinear-optics technique of "squeezing"; that is, of moving some of the quantum-fluctuations of laser light out of the $\cos[\omega(t - z/c)]$ part of the beam and into the $\sin[\omega(t - z/c)]$ part (Reference 95-100).¹⁶ The observable that gets squeezed will have its fluctuations reduced below the vacuum ZPF. The act of squeezing transforms the phase space circular noise profile characteristic of the vacuum into an ellipse, whose semimajor and semiminor axes are given by unequal quadrature uncertainties (of the quantized electromagnetic field harmonic oscillator operators). This applies to coherent states in general, and the usual vacuum is also a coherent state with eigenvalue zero. As this ellipse rotates about the origin with angular frequency, ω , these unequal quadrature uncertainties manifest themselves in the electromagnetic field oscillator energy by periodic occurrences, which are separated by one quarter cycle, of both smaller and larger fluctuations compared to the unsqueezed vacuum.

Caves (Reference 101) points out that if one squeezes the vacuum—that is, if one puts vacuum rather than laser light into the input port of a squeezing device—then one gets at the output an electromagnetic field with weaker fluctuations and thus less energy density than the vacuum at locations where $\cos^2[\omega(t - z/c)] \cong 1$ and $\sin^2[\omega(t - z/c)] \ll 1$; but with greater fluctuations and thus greater energy density than the vacuum at locations where $\cos^2[\omega(t - z/c)] \ll 1$ and $\sin^2[\omega(t - z/c)] \cong 1$. Since the vacuum is

¹⁶ ω is the angular frequency of light, t is time, and z denotes the z -axis direction of beam propagation.

defined to have vanishing energy density, any region with less energy density than the vacuum actually has a negative (renormalized) expectation value for the energy density – hence, this is a degradable vacuum. Therefore, a squeezed vacuum state consists of a traveling electromagnetic wave that oscillates back and forth between negative energy density and positive energy density, but has positive time-averaged energy density.

For the squeezed electromagnetic vacuum state, the energy density $\rho_{E-sqvac}$ is given by (Reference 102):

$$\rho_{E-sqvac} = \left(\frac{2h\omega}{L^3} \right) \sinh \xi \left[\sinh \xi + \cosh \xi \cos(2\omega(t - z/c) + \delta) \right] \quad (J/m^3) \quad (6)$$

where L^3 is the volume of a large box with sides of length L (that is, put the quantum field in a box with periodic boundary conditions), ξ is the squeezed state amplitude (giving a measure of the mean photon number in a squeezed state), and δ is the phase of squeezing. Equation (6) shows that $\rho_{E-sqvac}$ falls below zero once every cycle when the condition $\cosh \xi > \sinh \xi$ is met. It turns out that this is always true for every nonzero value of ξ , so $\rho_{E-sqvac}$ becomes negative at some point in the cycle for a general squeezed vacuum state. On another note, when a quantum state is close to a squeezed vacuum state, there will almost always be some negative vacuum energy densities present.

Dirac Vacuum Decay: “Sparking the Vacuum”

Fulcher et al. (Reference 53), Rafelski and Müller (Reference 54), and Rafelski (Reference 55) describe a phenomenon whereby the QED vacuum¹⁷ behaves like a nonlinear dielectric medium and undergoes breakdown (or decay) in the vicinity of super-heavy (supercritical) atomic nuclei¹⁸ or in the presence of externally applied electric or magnetic fields of critical (or supercritical) strength.¹⁹ This decay results in the spontaneous production of electron-positron pairs from the vacuum. This phenomenon is known as the Heisenberg-Euler-Schwinger mechanism, which Rafelski and collaborators euphemistically call “*sparking the vacuum*.” Ringwald (Reference 104) prefers to call it “*boiling the vacuum*.” Supercritical atomic nuclei can be created by the slow collision of two uranium (or heavier) nuclei while critical/supercritical electric or magnetic fields can be produced by ultrahigh intensity chirped-pulse amplification lasers (with power intensities on the order of 10^{19} to 10^{30} W/m²).

To be more precise, when an electric field is made sufficiently strong so that the vacuum polarization (that is, virtual electron-positron pairs, aka ZPF) becomes real, then, due to charge conservation, the balancing charge must be eliminated, and so during the process of changing the vacuum from a neutral to a charged state, some charge must be emitted. And if in the vicinity of the electric field of a super-heavy nucleus or of an externally applied electric or magnetic field, the vacuum carries the charge of an electron, the emitted particle must always be a positron. Studies have

¹⁷ For historical reasons, the QED vacuum is also called the “Dirac sea” or “Dirac vacuum” (Reference 103).

¹⁸ Supercritical atomic nuclei have an electric charge (proton number) of $Z > 173$, which produces supercritical electric fields.

¹⁹ The critical QED vacuum breakdown electric field strength is $E_c = 2m_e^2 c^3 / \hbar e \approx 10^{18}$ V/m, where e is the electron charge (1.602×10^{-19} C). This quantity is defined by the total rest-energy of an electron-positron pair created from the vacuum divided by the electron’s Compton wavelength. And the critical QED vacuum breakdown magnetic field strength is $B_c = E_c / c \approx 10^{10}$ Tesla. Supercritical fields have strengths greater than E_c or B_c .

shown that this positron must have a very well defined energy. The applied electric field determines how large this energy will be. If the electric/magnetic field is increased above critical strength, then more electron-positron pairs will be produced from the vacuum.

Clearly, the charged vacuum is a *new ground state* of space and matter. The normal, undercritical, electrically neutral vacuum is no longer stable in supercritical fields: it decays spontaneously into the new stable but charged vacuum. Thus the standard definition of the vacuum, as a region of space devoid of real elementary particles, is no longer valid in very strong external fields. The vacuum is better defined as the energetically deepest and most stable state that a region of space can have while being penetrated by certain fields.

Magnetically Induced Decay of the Dirac Vacuum

Xue (Reference 105, 106) developed a Dirac vacuum decay mechanism that is different from the Heisenberg-Euler-Schwinger mechanism and proposed that energy could be continuously extracted from it. He modeled his decay mechanism after the (vacuum electromagnetic) Casimir effect wherein the vacuum state is modified by boundary conditions. From an energetic point of view, the Casimir effect can be physically understood as the following: 1) the continuous energy spectrum of vacuum electromagnetic fields is modified by boundary conditions to be discrete; 2) the vacuum energy of the "final" vacuum state, computed from the discrete energy spectrum in a given finite volume, is smaller than the vacuum energy of the "initial" vacuum state, computed from the continuous energy spectrum in the same volume; 3) as a result, the vacuum gains energy and becomes energetically unstable and has to decay from the "initial" vacuum state to the "final" vacuum state by quantum field fluctuations. This difference of vacuum energies between two vacuum states must be released, and this leads to the attractive and macroscopic force observed in the Casimir effect. Xue suggests that instead of modifying the energy spectrum of virtual photons by boundary conditions as in the Casimir effect, one should attempt to vary the vacuum energy by modifying the negative energy spectrum of virtual fermions (in the Dirac vacuum) by an externally applied magnetic field (of strength B). In this case, the externally applied magnetic field acts as a boundary condition on the Dirac vacuum.

Xue defines the vacuum state with $B = 0$ as the "initial" vacuum state and the vacuum state with $B \neq 0$ as the "final" vacuum state. The negative energy spectrum²⁰ of the initial vacuum state is modified to the negative energy spectrum²¹ of the final vacuum state, due to the external magnetic field. If the vacuum energy of the final $B \neq 0$ vacuum state made by virtual fermions fully filling its negative energy spectrum is

²⁰ The *negative and nondegenerate* energy spectrum of free virtual charged fermions in the Dirac vacuum is:

$\epsilon_v(|p|) = -\left(p_x^2 + p_y^2 + p_z^2 + m^2\right)^{1/2}$, where p is the magnitude of the fermion's momentum, (p_x, p_y, p_z) are the spatial momentum components, and m is the fermion's mass. This spectral energy density is integrated over all possible momentum states of the quantum field fluctuations in order to give the total (negative) Dirac vacuum energy.

²¹ The energy spectrum of virtual charged fermions in the presence of an external constant magnetic field (a.k.a.

the Landau levels) is: $\epsilon_L(p, n, h) = -\left(p_x^2 + m^2 + |e| B(2n+1) - eBh\right)^{1/2}$, where e is the fermion's bare charge, $h = \pm 1$ is the fermion's helicity, $n = 0, 1, 2, 3, \dots$, and the magnetic field B is along the z-axis. This negative energy spectrum is *degenerate* in the phase space of (p_x, p_y) . This spectral energy density is integrated over all possible momentum states of the quantum field fluctuations in order to give the total (negative) Dirac vacuum energy.

smaller than that of the initial $B = 0$ vacuum state made by virtual fermions fully filling its negative energy spectrum, then the vacuum state gains energy and must decay from the initial vacuum state to the final vacuum state by quantum field fluctuations. The difference in vacuum energies between the two vacuum states must be released.

Xue makes all the usual vacuum expectation value renormalization calculations upon ϵ_F and ϵ_L , and found that the energetic difference between the vacuum states $B = 0$ and $B \neq 0$ is negative, indicating that the vacuum energy of the $B \neq 0$ state is smaller than the vacuum energy of the $B = 0$ state; that is, the vacuum state gains energy when the external magnetic field is applied to it. He shows that this effect occurs because in a finite volume of space and with a finite momentum cutoff at the Planck scale Λ_P , the total number of fermion states in the vacua of negative energy spectra ϵ_F and ϵ_L are finite and all these fermion states of negative energy levels from $-\Lambda_P$ to $-mc^2$ are fully filled. The negative energy spectrum ϵ_F is not degenerate, while the negative energy spectrum ϵ_L is degenerate, and the total numbers of fermion states in both cases are the same. On the basis of quantum field fluctuations toward the lowest energy state and the Pauli principle, when the external magnetic field is applied upon the vacuum, the vacuum reorganizes itself by fully filling all fermion states according to the degenerate negative energy spectrum ϵ_L , instead of the nondegenerate ϵ_F . As a consequence, the vacuum makes its total energy lower. The energy released by this decay process is: $\Delta E = -8\alpha B^2 V / 3\pi$, where V is the volume of space occupied by the external magnetic field, and α is the electromagnetic fine structure constant.

In principle, this effect can occur for any value of the applied magnetic field, and in this particular decay process a non-critical magnetic field is required. Xue predicts possibly observable effects such as the vacuum acting like a paramagnetic medium that effectively screens the strength of the external magnetic field to a smaller magnitude; the associated ZPF could lead to the emission of neutrino-antineutrino pairs from the vacuum; and photons will be spontaneously emitted. He estimated that the released vacuum energy (ΔE) will be about 1 percent of the total energy stored in the external magnetic field, so it is not yet clear whether this vacuum decay mechanism will lead to any beneficial energy extraction.

Melting the QCD Vacuum

The idea of supercriticality as discussed in Section V also has applications in other field theories, such as those of pion fields, gluon fields (quantum chromodynamics or QCD), and gravitational fields (general relativity). Static fields that are strong enough to cause the normal vacuum, which is devoid of real particles, to break down into a new vacuum in which real particles exist is also predicted for these fields. A review a vacuum decay concept that is different from supercriticality in QCD theory follows.

In their study of the structured vacuum, Rafelski and Müller (Reference 54) and Rafelski (Reference 55) analyze the nature of the strongly interacting (QCD) vacuum and elucidate its character from the Standard Model of particle physics and high energy particle accelerator data. They concluded that in addition to the electroweak vacuum (that is, the unified electromagnetic and weak force vacua) there exists a dual QCD vacuum structure: one vacuum structure that is everywhere in space and consists of a complicated soup of interacting gluons which confine the quarks – this is called the ordinary or “frozen” vacuum; and another vacuum structure that is found inside

elementary particles (for example, hadrons), and which behaves like the dielectric vacuum of electrodynamics. In this second vacuum structure, particles that have a strong charge (such as quarks or gluons) can move freely, but are confined by the frozen vacuum that is everywhere else. This is called the perturbative, or gluon, or "melted" vacuum, which can also be pictured as a quark-gluon plasma. They estimate that there is a "latent heat" of $\sim 1 \text{ GeV}/\text{fm}^3$ (or $10^{35} \text{ J}/\text{m}^3$)²² associated with the phase change of transforming from one vacuum structure to another when the gluonic structures of the perturbative vacuum are melted. It is important to point out here that this is a degradable vacuum structure.

This unusual dual vacuum structure led Rafelski and Müller to speculate on a mechanism for the "burning of matter" as the ultimate source of energy in which it might be possible that the energy contained within baryons could be converted into useful energy. Their idea is to remove or destroy the three quarks residing inside a baryon in order to gain energy, the latent heat, from the melted vacuum inside the baryon. This process also entails the decay of the quarks via lepton-quark interactions, which is a topic that is beyond the scope of this chapter. They suggest that it might be possible that producing a quark-gluon plasma in high energy nuclear collisions could be a very efficient source of energy. In this process atomic nuclei would be collided at high energy in order to form a compressed high density zone in the region where the two nuclei overlap. This would lead to the melting of the vacuum and the subsequent direct conversion of matter into radiation, thus releasing $\sim 10^{35} \text{ J}/\text{m}^3$ of energy density. This magnitude of energy density would be very useful as a source of energy for space propulsion applications.

Rafelski and Müller point out that the commonly held view that the centers of neutron stars are dead and cold, due to their nuclear fuel having burnt out and the energy of gravitational collapse having been expended for the conversion of the collapsed star into a gigantic atomic nucleus, is not the complete story. They hold open the possibility that the entire rest-mass of all the baryons inside neutron stars might become available and converted into heat. In their scenario, the core of a neutron star is actually composed of condensed quark matter, and the rest-mass of baryons is burnt up into radiation inside the quark core. They also point out that supernovae explosions, gamma ray bursts, positron emission from the center of our galaxy, quasars, and galactic nuclei have been observed to emit extreme amounts of thermal energy, the mechanisms of which are still not understood today.

Gogohia (Reference 107, 108) modeled Rafelski and Müller's idea by using an effective potential approach for composite condensate²³ operators to formulate a general method of calculating the non-perturbative (NPC) Yang-Mills vacuum energy density (aka the QCD bag model constant, B_g)²⁴ in the covariant gauge QCD vacuum-ground state. His result that $B_g = 1.84 \text{ GeV}/\text{fm}^3$ (or $2.95 \times 10^{35} \text{ J}/\text{m}^3$) found very good agreement with its phenomenological value and with Rafelski and Müller's naïve estimate. Gogohia also calculated the contribution of the gluon condensate energy density to B_g : $\langle \alpha_s \Gamma^2 / \pi \rangle = 1.82 \text{ GeV}/\text{fm}^3$ (or $2.92 \times 10^{35} \text{ J}/\text{m}^3$), where α_s is the strong

²² $1 \text{ GeV} = 10^9 \text{ eV}$; $1 \text{ fm} = 10^{-15} \text{ m}$.

²³ In quantum field theory, the vacuum expectation value (of a quantum operator) is also called a "condensate," and this is denoted by placing angular brackets around the quantum operator.

²⁴ See Appendix A for a detailed explanation of the QCD bag model.

coupling strength (aka quark-gluon coupling) and Γ is the gluon field strength tensor (tensor indices suppressed). The quark condensate energy density contribution to B_g is down by two orders of magnitude from this estimate. Gogohia argues that the bag constant determines the energy which can be released from the NPC vacuum, which he considers to be a "*perpetuum source of infinite energy*." He did not propose a detailed physical mechanism that specifies how to release a finite portion of the bag constant energy or whether one could introduce some type of cyclic process to extract energy. This requires further research in order to resolve this question.

Summary: ZPF Modes and Vacuum Field Energy

The previous examples illustrate how the vacuum becomes degradable or can decay when perturbed under certain conditions. In each of the examples, the vacuum ZPF modes were perturbed by boundary conditions, quantum optics effects, or interacting/externally applied fields in such a way as to drive the QED field's vacuum state energy below zero, or the QED vacuum undergoes decay along with the spontaneous production of particle-antiparticle pairs, or the vacuum undergoes a phase change and releases energy as in the QCD case. The (electromagnetic) Casimir effect is an example in which certain ZPF modes are excluded by physical boundary conditions that perturb the free-space vacuum ZPF modes, thus driving the vacuum electromagnetic field energy below zero inside a Casimir cavity.

In accordance with the discussion in Sections III and V, the ZPF modes serve only as a placeholder for a quantum field's vacuum state calculations. Therefore, the "hardwired" ZPF modes cannot be driven below the ground state. It is only a quantum field's overall (*renormalized*) vacuum state energy that can be driven down to or below the ground state. The QED vacuum (in both of its incarnations: virtual bosonic electromagnetic vacuum and virtual fermionic Dirac vacuum) and the QCD vacua are degradable while both can also undergo decay via numerous mechanisms. Energy release is predicted for some of the decay mechanisms while it has already been observed via the Casimir effect and the inflationary expansion of the universe.

Therefore, one can conjecture that the key to exploring the possibility of extracting energy from the vacuum is to invent new boundary conditions or new combinations of boundary conditions as well as new methods of modifying the quantum vacuum boundary conditions that perturb the ZPF modes of any quantum field under study. Quantum vacuum boundary conditions can take many different forms: they can be physical boundaries like the conductor or dielectric plates used in Casimir cavities, which can also involve complex cavity geometries; they can be topological—that is, complex spacetime geometries with special coordinate constraints; or they can be in the form of interacting or externally applied fields such as gravitational, electromagnetic, electroweak, scalar, QCD, massive fields or dense, moving nuclear matter on the quantum vacuum, and so forth. This is a topic that is in need of dedicated theoretical and experimental research (Reference 62, 91, 103).

VI. Conclusion: The Way Forward

What are the conclusions that can be drawn from the considerations presented in this report regarding the concept of continuous conversion of energy from the quantum electromagnetic vacuum, the Dirac vacuum, or even the QCD vacua?

First, one sees that although the original inspiration for the concept of continuous vacuum energy extraction came from second-quantized QED theory, it must be acknowledged that QED, as an axiomatic, quantized formalism based on the concept of an immutable, non-degradable vacuum, does not support the concept of *continuous vacuum energy conversion*. Given that second-quantized QED is our most comprehensive quantum theory to date, its lack of support for continuous vacuum energy conversion must be given serious consideration.

Second, SED as an alternative theory, whose formalism has been taken to support the concept of continuous vacuum energy conversion, has enough shortcomings in its current state of development that one must conclude that it is not at present an adequate tool for the assessment of potential vacuum energy conversion. SED predictions must thus remain suspect in the absence of experimental confirmation. The purpose of the experimental program outlined in Section IV is meant to address this need.

Third, the concept of the conversion of energy from vacuum fluctuations is in principle not falsifiable, given the unknowns which present theory has yet to resolve (for example, cosmological dark energy, multiple vacuum structures), and the numerous approaches currently being brought to bear in the development of quantum theory.

Finally, even though experimental efforts at energy extraction from the vacuum have been proposed or are already under way at various laboratories, definitive theoretical support underpinning the concept of useful extraction of energy from quantum fluctuations is not yet in place. Such support awaits theoretical developments that either posits a plenum that (unlike second-quantized QED) can be shown to be degradable, or posit conversion of energy associated with matter fluctuations, also in a degradable fashion. Since the quantum fluctuations of interest are associated with quantum ground states, what is minimally required are particle-vacuum or particle-particle interactions that result in the formation of alternate lower-energy, ground states of matter/field configurations. Suggested approaches to be explored are those which are known to yield results consistent with the existence of vacuum fluctuation fields, but without the formalism of independently postulated second-quantized vacuum fields. Whether useful conversion of energy from quantum fluctuations can be accomplished, and identifying the unequivocal conditions under which this can be achieved, are yet to be determined.

It has been shown that the QED vacuum is in fact degradable under the action of a variety of Casimir effects, quantum optical vacuum squeezing, gravitation-induced vacuum squeezing, or gravitational redshifting. There is also QED vacuum *decay* via the critical/supercritical electric fields of superheavy atomic nuclei, X-ray free-electron lasers, or externally applied (non-critical) magnetic fields. However, it is not known whether these effects can be exploited for the *continuous* extraction of useful energy from the vacuum. The concept of a dual, degradable vacuum structure in QCD can possibly lead to the generation of useful energy via the release of latent heat from melting the QCD vacuum.

A game changer may appear that could dramatically accelerate or alter the direction of theoretical and experimental programs. Such a game changer could entail a complete, comprehensive unified field theory (that is, a finalized quantum superstring theory, or some other theory that replaces it), or a completely new theory for the quantum

vacuum and its related spacetime physics (for example, “emergent” spacetime/gravity theories (Reference 109-111)). New materials or combinations of materials, such as condensed matter (superconductors), semiconductors or metamaterials, would also be an important game changer because of the unique ways that quantum fields would interact with them to produce phenomena of interest.

In going forward to the potential demonstration of *continuous* energy extraction from the vacuum, one should consider the following additional action items for further R&D:

- The quantum vacuum electromagnetic effects outlined in Section IV were computed to scale with Planck’s constant and are therefore very small. In order to have a practical device based on quantum vacuum properties, it would be preferable that the vacuum effects the scale, meaning that the effects are essentially independent of Planck’s constant and consequently may be much larger. By itself this requirement does not guarantee a large enough magnitude, but it certainly helps. Electromagnetic Casimir effects are typically small and difficult to measure. In fact, measurements have only been made for simple geometries such as the parallel plate or the sphere-plate geometries. This fact raises a question: Is it possible to amplify these effects and bring them into a useful range? This is certainly one of the challenges of vacuum engineering. The experiment described in Section IV could address this question.
- Experiments are needed to explore some of the issues that are beyond the present computational ability of QED; for example, the effect of complex geometries on vacuum forces, or the effect of interacting or externally applied fields or dense, moving nuclear matter on the quantum vacuum. Is it possible to make a stable vacuum field that has a large variation in energy density? Can energy density gradients be found on a length scale that is useful for technological applications? One needs to greatly increase our knowledge of the quantum vacuum. The development of a very sensitive small probe that provides a frequency decomposition of the local vacuum energy density would very useful.
 - A first step in this direction was recently proposed by Marecki (Reference 112) who generalized the analysis of the output of balanced homodyne detectors (BHDs). The most important feature of these devices is their ability to quantify the quantum vacuum fluctuations of the electric field because the output of BHDs provides information on the one- and two-point functions of arbitrary states of quantum fields. Marecki computed the two-point function and the associated spectral density for the ground state of the quantum electric field in Casimir geometries, and predicts a position- and frequency-dependent pattern of BHD responses if a device of this type is placed inside a Casimir cavity. The proposed device allows for the direct detection of quantum vacuum fluctuations and provides a spatial mapping of the vacuum energy contained inside the cavity. This offers a potential new characterization of ground states in Casimir geometries, which would provide an understanding of the vacuum energy densities present in some regions in these geometries.
- From the status of current research in Casimir forces, it is clear that one is at the cusp of describing the properties of the quantum vacuum for real systems with real material properties. For example, there is no general agreement regarding the calculations of static vacuum forces for geometries other than infinite parallel plates

of ideal or real metals at a temperature of absolute zero. Non-zero temperature corrections for flat, real metals are uncertain. There are fundamental disagreements about the computation of vacuum forces for spheres or rectangular cavities, and about how to handle real material properties and curvature in these and other geometries. Indeed, it is very difficult to calculate Casimir forces for these simple geometries and to relate the calculations to an experiment. Calculations have yet to be done for more complex geometries. The usual problems in QED (for example, divergences due to unrealistic boundary conditions, to curvature, to interfaces with different dielectric coefficients) abound. These problems require theoretical and experimental resolution.

- As stated in Section V, there is need to find new boundary conditions for the vacuum that can alter the vacuum energy density by orders of magnitude more than with the current boundary conditions, which are primarily metallic or dielectric surfaces. Perhaps the use of new materials (for example, those with a negative index of refraction, or an ultra-high electrical carrier density, either steady state or transient), or novel condensed matter (superconducting) materials may open the door to new Casimir phenomena. Recently the use of (negative index) *metamaterials* was proposed to make a repulsive Casimir force (Reference 113). With significantly increased funding for research, some breakthroughs in this area might be possible.
- There are several important experiments that can aid our understanding of vacuum energy and Casimir forces that may lead to significant improvements in our engineering capability:
 - Experiments measuring the Casimir forces for semiconductor surfaces would be helpful in the development of new applications of vacuum forces and to demonstrate that it is possible to alter the Casimir force by altering the carrier density.
 - The measurement of Casimir forces and energies for different geometry and composition objects, such as rectangular cavities or spheres, would provide data for theoretical modeling. Measurements of Casimir forces between separate, nonplanar surfaces are also needed. There may be surfaces that have larger forces than the classic parallel plates.
 - New boundary conditions or new methods of modifying the known quantum vacuum boundary conditions may be needed to generate the large changes in free-field vacuum energy required if “vacuum engineering” as proposed in this report is ever to become practical. For example, the vacuum energy density difference between parallel plates and the region outside them in free space is simply not large enough in magnitude for large-scale engineering purposes. Energy densities, positive or negative, that are orders of magnitude greater are required. Such energy density regions may be possible, at least in some cases. For example, a region appeared in the one-dimensional dynamic system in which the energy density was below that of the Casimir parallel plate region (Reference 114).
 - Experiments to verify the adiabatic Casimir effect have been suggested in the literature. This is an important theoretical issue that has ramifications in different

fields, including astrophysics and elementary particle physics. Clever experimental approaches should be developed to explore the adiabatic Casimir effect.

- There are numerous potential ways in which the ground state of the vacuum electromagnetic field might be engineered for use in MEMS and NEMS applications.
- Dirac vacuum decay via external (non-critical) magnetic fields requires further evaluation, and it should become possible to experimentally test this in the laboratory within two to five years.
- Theoretical and laboratory studies of the dual QCD vacuum have been underway for over 20 years. The progress in experimental particle physics is such that one gains an order of magnitude in the resolution (that is, energy) of elementary particle structures roughly every decade. It is hoped that the commissioning of the Large Hadron Collider will lead to higher resolution probing of the dual QCD vacuum structure, and help to determine whether there are deeper grand unified and/or Higgs vacuum structures residing within quarks. Future accelerator experiments should be designed to explore Rafelski and Müller's and Gogohia's proposal to extract energy from the "melted" QCD vacuum.

Acknowledgements

The author wishes to thank colleagues H. E. Puthoff (EarthTech, Int'l), V. Teofilo (Lockheed Martin), B. Haisch (ManyOne Networks), L. J. Nickisch (Northwest Research Assoc.), A. Rueda (California State University-Long Beach), D. C. Cole (Boston University), M. Ibison (Inst. for Advanced Studies at Austin), S. Little (EarthTech Int'l), and M. Little (EarthTech Int'l), for their technical contributions to this report. We also thank J. Newmeyer (Lockheed Martin), E. H. Allen (Lockheed Martin), T. W. Kephart (Vanderbilt Univ.), and P. C. W. Davies (Arizona State Univ.) for their very useful input.

Appendix: The QCD Bag Model

When considering the effective masses of quarks bound within hadrons, it is common to think of the constituent masses of the quark and antiquark pair as their zero-point energy (ZPE) when they are bound by the confining potential²⁵ (acting between a quark and an antiquark) with an energy spectrum that corresponds to the masses of the observed mesons. For charm, and heavier quarks, it appears that the total ZPE is not much different from the masses of the lowest-lying meson states. This picture also holds true for baryons. The quark-gluon model for hadrons is called “the bag model.”

Even in an “empty” bag—that is, one containing no quarks—there will be nonzero fields present because of quantum zero-point fluctuations (ZPF). This gives rise to a zero-point (ZP) or Casimir energy inside the empty bag. The estimated total ZP/Casimir energy of the confined gluon field inside a spherical bag is $E_{ZP} \approx +0.7/a$ (or $+0.7\hbar c/a$ in MKS units), where a is the radius of the bag in GeV^{-1} units. E_{ZP} is numerically the entire story because the ZPE contribution of the confined fermion (quark) field is far smaller than E_{ZP} (the leading approximation per degree of freedom is down by two orders of magnitude). A typical empty bag has an estimated radius $a \approx 2.6 \text{ GeV}^{-1}$ (0.5 fm), so $E_{ZP} \sim 10^{-1} \text{ GeV}$ (or 10^{-11} J), and this result remains approximately true if one uses $a = 5.07 \text{ GeV}^{-1}$ (1 fm) for a nucleon-sized bag. If the bag contains quarks, then this result does not change because the quarks don’t affect the ongoing quantum ZPF inside the bag due to asymptotic freedom.

The inventor of the empty bag model (Ken Johnson) proposed that space is filled with closely packed empty bags, and that the energy of space filled with contiguous bags is simply the sum of the field energies contained within each bag. But this is not widely accepted since the phenomenologically preferred model for the exterior “ordinary” vacuum is given as follows.

QCD color confinement in hadrons is approximated by the phenomenologically successful “bag model.” In this model, the “ordinary” vacuum external to hadrons is a perfect color magnetic (or chromomagnetic) conductor; that is, the chromomagnetic permeability μ is infinite, while the chromomagnetic vacuum in the interior of the bag is characterized by $\mu = 1$. This implies that the color electric (\mathbf{E}_{QCD}) and magnetic (\mathbf{B}_{QCD}) fields are confined to the interior of the bag, and that they satisfy the following boundary conditions on its surface S : $\mathbf{n} \cdot \mathbf{E}_{\text{QCD}}|_S = 0$, $\mathbf{n} \times \mathbf{B}_{\text{QCD}}|_S = 0$, where \mathbf{n} is a unit normal vector to S . In other words, this model defines QCD vacua that coexist in two phases: 1) an ordinary vacuum exterior to the bag, impenetrable to color; and 2) a vacuum interior of the bag, in which the Yang-Mills fields that carry color (gluons) propagate freely. Both phases are separated by the surface boundary of the bag upon which the Yang-Mills and fermion (quark) field satisfy the aforementioned boundary

²⁵ Quarks carry “color charge” as well as electric charge. Color charge is considered to be the “true” charge of strong interactions. Gluons are the “photons” of strong interactions, and color is exchanged by eight bicolored gluons, which are massless and have spin 1. Color interactions are assumed to be a copy of electromagnetic interactions. Theoretical and phenomenological studies found that the confining potential $V(r)$ lies between a Coulomb and a harmonic oscillator potential: $V(r) = -(4\alpha_s/3r) + kr$, where r is the radial distance between confined quarks, k is a constant parameter, and $\frac{1}{3}$ is the color factor associated with α_s for the case of quark-antiquark pair confinement in mesons. For the case of baryons (qqq), the color factor in $V(r)$ is replaced by $\frac{2}{3}$.

conditions. It is always assumed that perturbation theory is valid inside the bag, while the remainder of space is occupied by a "non-perturbational" chromomagnetic vacuum.

References

- [1] DeWitt, B. S., "Quantum Field Theory in Curved Spacetime," *Physics Reports*, Vol. 19C, 1975, pp. 295-357.
- [2] DeWitt, B. S., "Quantum gravity: the new synthesis," *General Relativity: An Einstein Centenary Survey*, edited by S. W. Hawking and W. Israel, Cambridge Univ. Press, Cambridge, 1979, pp. 680-745.
- [3] DeWitt, B. S., "The Casimir Effect in Field Theory," *Physics in the Making, Essays on Developments in 20th Century Physics, In Honour of H. B. G. Casimir*, edited by A. Sarlemijn and J. Sparnaay, North-Holland Elsevier Science Publ., New York, 1989, pp. 247-272.
- [4] Birrell, N. D., and Davies, P. C. W., *Quantum fields in curved space*, Cambridge Univ. Press, Cambridge, 1984.
- [5] Casimir, H. B. G., "On the Attraction Between Two Perfectly Conducting Plates," *Proc. Kon. Ned. Akad. Wetensch.*, Vol. 51, 1948, pp. 793-796.
- [6] Lamoreaux, S. K., "Demonstration of the Casimir Force in the 0.6 to 6 μm Range," *Physical Review Letters*, Vol. 78, 1997, pp. 5-8.
- [7] Mohideen, U., "Precision Measurement of the Casimir Force from 0.1 to 0.9 μm ," *Physical Review Letters*, Vol. 81, 1998, pp. 4549-4552.
- [8] Chen, F., et al., "Theory confronts experiment in the Casimir force measurements: Quantification of errors and precision," *Physical Review A*, Vol. 69, 2004, 022117.
- [9] Forward, R. L., "Alternate Propulsion Energy Sources," Air Force Rocket Propulsion Laboratory, Air Force Space Tech. Ctr. Space Div., Air Force Systems Command, Final Report AFRPL TR-83-067, Edwards AFB, CA, 1983, pp. A1-A14.
- [10] Forward, R. L., "Extracting Electrical Energy from the Vacuum by Cohesion of Charged Foliated Conductors," *Physical Review B*, Vol. 30, 1984, pp. 1700-1702.
- [11] Cole, D. C., and Puthoff, H. E., "Extracting energy and heat from the vacuum," *Physical Review E*, Vol. 48, 1993, pp. 1562-1565.
- [12] Mead, Jr., F. B., and Nachamkin, J., United States Patent No. 5,590,031 for "System for Converting Electromagnetic Radiation Energy to Electrical Energy," 1996.
- [13] Peres, A., *Quantum Theory: Concepts and Methods*, Kluwer, Dordrecht, Holland, 1993.
- [14] Milonni, P. W., *The Quantum Vacuum: An Introduction to Quantum Electrodynamics*, Academic Press, New York, 1994, Chaps. 1, 2, 8.
- [15] Mulliken, R. S., "The Band Spectrum of Boron Monoxide," *Nature*, Vol. 114, 1924, p. 349.
- [16] Ibison, M., and Haisch, B., "Quantum and classical statistics of the electromagnetic zero-point field," *Physical Review A*, Vol. 54, 1996, pp. 2737-2744.

- [17] de la Peña, L., and Cetto, A. M., *The Quantum Dice: An Introduction to Stochastic Electrodynamics*, Kluwer, Dordrecht, Holland, 1996.
- [18] Koch, R. H., Van Harlingen, D. J., and Clarke, J., "Quantum-Noise Theory for the Resistively Shunted Josephson Junction," *Physical Review Letters*, Vol. 45, 1980, pp. 2132-2135.
- [19] Koch, R. H., Van Harlingen, D. J., and Clarke, J., "Observation of Zero-Point Fluctuations in a Resistively Shunted Josephson Tunnel Junction," *Physical Review Letters*, Vol. 47, 1981, pp. 1216-1219.
- [20] Koch, R. H., Van Harlingen, D. J., and Clarke, J., "Measurements of quantum noise in resistively shunted Josephson junctions," *Physical Review B*, Vol. 26, 1982, pp. 74-87.
- [21] Blanco, R., França, H. M., Santos, E., and Sponchiado, R. C., "Radiative noise in circuits with inductance," *Physics Letters A*, Vol. 282, 2001, pp. 349-356.
- [22] Boyer, T. H., "Random electrodynamics: The theory of classical electrodynamics with classical electromagnetic zero-point radiation," *Physical Review D*, Vol. 11, 1975, pp. 790-808.
- [23] Puthoff, H. E., "Ground state of hydrogen as a zero-point-fluctuation-determined state," *Physical Review D*, Vol. 35, 1987, pp. 3266-3269.
- [24] Cole, D. C., and Zou, Y., "Quantum Mechanical Ground State of Hydrogen Obtained from Classical Electrodynamics," *Physics Letters A*, Vol. 317, 2003, pp. 14-20.
- [25] Cole, D. C., and Zou, Y., "Analysis of Orbital Decay Time for the Classical Hydrogen Atom Interacting with Circularly Polarized Electromagnetic Radiation," *Physical Review E*, Vol. 69, 2004, 016601.
- [26] Maclay, G. J., "Analysis of zero-point electromagnetic energy and Casimir forces in conducting rectangular cavities," *Physical Review A*, Vol. 61, 2000, 052110.
- [27] Haisch, B., and Moddel, G., "Quantum Vacuum Energy Extraction," United States Patent No. 7,379,286 B2, May 2008.
- [28] Puthoff, H. E., Little, S. R., and Ibison, M., "Discussion of experiment involving lowering of ground state energy for oscillation in a Casimir cavity," *Int'l Conf. on Squeezed States and Uncertainty Relations (ICSSUR 2001): Special Session on Topics of Physics Related to Stochastic Electrodynamics*, Boston University, 2001.
- [29] Puthoff, H. E., "Vacuum energy extraction by conductivity switching of Casimir force," Technical Memo, Inst. for Advanced Studies at Austin, Austin, TX, 1985 (unpublished).
- [30] Lipkin, R., "Thin-film mirror changes into a window," *Science News*, Vol. 149, 1996, p. 182.
- [31] Pinto, F., "Engine cycle of an optically controlled vacuum energy transducer," *Physical Review B*, Vol. 60, 1999, pp. 14740-14755.

- [32] Lin, S. Y., Moreno, J., and Fleming, J. G., "Three-dimensional photonic-crystal emitter for thermal photovoltaic power generation," *Applied Physics Letters*, Vol. 83, 2003, pp. 380-382.
- [33] Iannuzzi, D., Lisanti, M., Munday, J. N., and Capasso, F., "The design of long range quantum electrodynamic forces and torques between macroscopic bodies," *Solid State Communications*, Vol. 135, 2005, pp. 618-626.
- [34] Forward, R. L., "Apparent Endless Extraction of Energy from the Vacuum by Cyclic Manipulation of Casimir Cavity Dimensions," *NASA Breakthrough Propulsion Physics Workshop Proceedings*, NASA/CP-1999-208694, NASA Lewis Research Center, Cleveland, 1999, pp. 51-54.
- [35] Maclay, G. J., "Unusual Properties of Conductive Rectangular Cavities in the Zero Point Electromagnetic Field: Resolving Forward's Casimir Energy Extraction Cycle Paradox," *Proceedings of the STAIF-1999: Conference on Applications of Thermophysics in Microgravity and Breakthrough Propulsion Physics*, edited by M. S. El-Genk, AIP Conf. Proc. Vol. 458, AIP Press, New York, 1999, pp. 968-973.
- [36] Shoulders, K. R., *EV: A Tale of Discovery*, Jupiter Technologies, Austin, TX, 1987.
- [37] Stenhoff, M., *Ball Lightning: An Unsolved Problem in Atmospheric Physics*, Kluwer Academic/Plenum Publ., New York, 1999.
- [38] Bostick, W. H., "Experimental Study of Ionized Matter Projected Across Magnetic Field," *Physical Review*, Vol. 104, 1956, p. 292.
- [39] Bostick, W. H., "Experimental Study of Plasmoids," *Physical Review*, Vol. 106, 1957, p. 404.
- [40] Bostick, W. H., Prior, W., and Farber, E., "Plasma Vortices in the Coaxial Plasma Accelerator," *Physics of Fluids*, Vol. 8, 1965, p. 745.
- [41] Wells, D. R., "Observation of Plasma Vortex Rings," *Physics of Fluids*, Vol. 5, 1962, p. 1016.
- [42] Wells, D. R., "Axially Symmetric Force-Free Plasmoids," *Physics of Fluids*, Vol. 7, 1964, p. 826.
- [43] Wells, D. R., "Injection and Trapping of Plasma Vortex Rings," *Physics of Fluids*, Vol. 9, 1966, p. 1010.
- [44] Wells, D. R., and Schmidt, G., "Observation of Plasma Rotation Produced by an Electrodeless Plasma Gun," *Physics of Fluids*, Vol. 6, 1963, p. 418.
- [45] Nardi, V., Bostick, W. H., Feugeas, J., and Prior, W., "Internal structure of electron-beam filaments," *Physical Review A*, Vol. 22, 1980, pp. 2211-2217.
- [46] Piestrup, M. A., Puthoff, H. E., and Ebert, P. J., "Measurement of Multiple-Electron Emission in Single Field-Emission Events," *Journal of Applied Physics*, Vol. 82, 1997, pp. 5862-5864.

- [47] Shoulders, K. R., United States Patent No. 5,054,046 for "Method and apparatus for production and manipulation of high density charge," 1991.
- [48] Casimir, H. B. G., "Introductory remarks on quantum electrodynamics," *Physica*, Vol. 19, 1953, pp. 846-849.
- [49] Puthoff, H. E., and Piestrup, M. A., "On the Possibility of Charge Confinement by van der Waals/Casimir-type Forces," Cornell University Library E-Print Physics Abstracts Archive arXiv.org Database (online database), URL: <http://arxiv.org/physics/papers/0408/0408114.pdf> (cited Aug. 2004, revised 2005).
- [50] Puthoff, H. E., "Casimir Vacuum Energy and the Semiclassical Electron," *International Journal of Theoretical Physics*, Vol. 46, 2007, pp. 3005-3008.
- [51] Volovik, G. E., *The Universe in a Droplet of Helium*, Clarendon Press, Oxford, 2003.
- [52] Zavattini, E., et al., "Experimental Observation of Optical Rotation Generated in Vacuum by a Magnetic Field," *Physical Review Letters*, Vol. 96, 2006, 110406.
- [53] Fulcher, L. P., Rafelski, J., and Klein, A., "The decay of the vacuum," *Scientific American*, Vol. 241, 1979, pp. 150-159.
- [54] Rafelski, J., and Müller, B., *The Structured Vacuum: Thinking About Nothing*, Verlag Harri Deutsch Publ., Frankfurt, Germany, 1985.
- [55] Rafelski, J., "Vacuum Structure – An Essay," *Vacuum Structure in Intense Fields*, edited by H. M. Fried and B. Müller, NATO ASI Series, Series B: Physics Vol. 255, Plenum Press, New York, 1991, pp. 1-28.
- [56] Jaynes, E. T., "Survey of the Present Status of Neoclassical Radiation Theory," *Coherence and Quantum Optics*, edited by L. Mandel and E. Wolf, Plenum Press, New York, 1973, pp. 35-81.
- [57] Dirac, P. A. M., in *Directions in Physics*, edited by H. Hora and J. R. Shepanski, John Wiley & Sons, New York, 1978.
- [58] Schwarzschild, B., "High-redshift supernovae indicate that dark energy has been around for 10 billion years," *Physics Today*, Vol. 60, 2007, pp. 21-25.
- [59] Particle Data Group, "Review of Particle Physics," *Journal of Physics G: Nuclear and Particle Physics*, Vol. 33, 2006, pp. 210-232.
- [60] Weinberg, S., "The Cosmological Constant Problem," *Reviews of Modern Physics*, Vol. 61, 1989, pp. 1-23. (See also, "The Cosmological Constant Problems," Cornell University Library E-Print Physics Abstracts Archive arXiv.org Database (online database), URL: http://arxiv.org/PS_cache/astro-ph/pdf/0005/0005265.pdf (cited 12 May 2000).
- [61] Volovik, G. E., "Vacuum Energy: Myths and Reality," *International Journal of Modern Physics D*, Vol. 15, 2006, pp. 1987-2010.

- [62] Milton, K. A., *The Casimir Effect: Physical Manifestations of Zero-Point Energy*, World Scientific, Singapore, 2001, p. 13.
- [63] Chan, H. B., et al., "Quantum Mechanical Actuation of Microelectromechanical Systems by the Casimir force," *Science*, Vol. 291, 2001, pp. 1941-1944.
- [64] Sakharov, A. D., "Vacuum Quantum Fluctuations in Curved Space and the Theory of Gravitation," *Soviet Physics Doklady*, Vol. 12, 1968, pp. 1040-1041.
- [65] Peacock, J. A., *Cosmological Physics*, Cambridge Univ. Press, Cambridge, 1999, pp. 25-26.
- [66] Jaynes, E. T., "Probability in Quantum Theory," *Complexity, Entropy, and the Physics of Information*, edited by W. Zurek, Addison-Wesley, New York, 1990, pp. 381-403.
- [67] Jaynes, E. T., "Electrodynamics Today," *Coherence and Quantum Optics*, edited by L. Mandel and E. Wolf, Plenum Press, New York, 1978, pp. 495-509.
- [68] Boyer, T. H., "Equilibrium of Random Classical Electromagnetic Radiation in the Presence of a Nonrelativistic Nonlinear Electric Dipole Oscillator," *Physical Review D*, Vol. 13, 1976, pp. 2832-2845.
- [69] Pesquera, L., and Claverie, P., "The Quartic Anharmonic Oscillator in Stochastic Electrodynamics," *Journal of Mathematical Physics*, Vol. 23, 1982, pp. 1315-1322.
- [70] Blanco, R., Pesquera, L., and Santos, E., "Equilibrium Between Radiation and Matter for Classical Relativistic Multiperiodic Systems. Derivation of Maxwell-Boltzmann Distribution from Rayleigh-Jeans Spectrum," *Physical Review D*, Vol. 27, 1983, pp. 1254-1287.
- [71] Blanco, R., Pesquera, L., and Santos, E., "Equilibrium Between Radiation and Matter for Classical Relativistic Multiperiodic Systems. II. Study of Radiative Equilibrium with Rayleigh-Jeans Radiation," *Physical Review D*, Vol. 29, 1984, pp. 2240-2254.
- [72] Cole, D. C., "Simulation Results Related to Stochastic Electrodynamics," *Proceedings of the Int'l Conference on Quantum Theory: Reconsideration of Foundations-3*, edited by G. Adenier, A. Khrennikov, and T. M. Nieuwenhuizen, AIP Conference Proceedings Vol. 810, No. 1, New York, 2005, pp. 99-113.
- [73] Cole, D. C., and Rueda, A., "The Quantum Dice: An Introduction to Stochastic Electrodynamics," *Foundations of Physics*, Vol. 26, 1996, pp. 1559-1562.
- [74] de la Peña, L., and Cetto, A. M., "Contribution from stochastic electrodynamics to the understanding of quantum mechanics," Cornell University Library E-Print Physics Abstracts Archive arXiv.org Database (online database), URL: http://arxiv.org/PS_cache/quant-ph/pdf/0501/0501011.pdf (cited 4 Jan. 2005).
- [75] Barut, A. O., "Quantum electrodynamics based on self-energy versus quantization of fields: Illustration by a simple model," *Physical Review A*, Vol. 34, 1986, pp. 3502-3503.

- [76] Barut, A. O., and van Huele, J. F., "Quantum electrodynamics based on self-energy: Lamb shift and spontaneous emission without field quantization," *Physical Review A*, Vol. 32, 1985, pp. 3187-3195.
- [77] Barut, A. O., et al., "Relativistic theory of the Lamb shift in self-field quantum electrodynamics," *Physical Review A*, Vol. 45, 1992, pp. 7740-7745.
- [78] Barut, A. O., and Dowling, J. P., "Quantum electrodynamics based on self-energy: Spontaneous emission in cavities," *Physical Review A*, Vol. 36, 1987, pp. 649-654.
- [79] Barut, A. O., and Dowling, J. P., "Quantum electrodynamics based on self-energy, without second quantization: The Lamb shift and long-range Casimir-Polder van der Waals forces near boundaries," *Physical Review A*, Vol. 36, 1987, pp. 2550-2556.
- [80] Barut, A. O., Dowling, J. P., and van Huele, J. F., "Quantum electrodynamics based on self-fields, without second quantization: A nonrelativistic calculation of $g-2$," *Physical Review A*, Vol. 38, 1988, pp. 4405-4412.
- [81] Barut, A. O., and Dowling, J. P., "Quantum electrodynamics based on self-fields, without second quantization: Apparatus dependent contributions to $g-2$," *Physical Review A*, Vol. 39, 1989, pp. 2796-2805.
- [82] Barut, A. O., and Dowling, J. P., "QED based on self-fields: A relativistic calculation of $g-2$," *Zeitschrift für Naturforschung*, Vol. A44, 1989, p. 1051.
- [83] Barut, A. O., and Dowling, J. P., "Quantum electrodynamics based on self-fields: On the origin of thermal radiation detected by an accelerated observer," *Physical Review A*, Vol. 41, 1990, pp. 2277-2283.
- [84] Hochberg, D., and Kephart, T. W., "Lorentzian wormholes from the gravitationally squeezed vacuum," *Physics Letters B*, Vol. 268, 1991, pp. 377-383.) Calloni, E., et al., "Gravitational effects on a rigid Casimir cavity," *International Journal of Modern Physics A*, Vol. 17, 2002, pp. 804-807.
- [86] Calloni, E., et al., "Vacuum fluctuation force on a rigid Casimir cavity in a gravitational field," *Physics Letters A*, Vol. 297, 2002, pp. 328-333.
- [87] Bimonte, G., et al., "Energy-momentum tensor for a Casimir apparatus in a weak gravitational field," *Physical Review D*, Vol. 74, 2006, 085011.
- [88] Bimonte, G., et al., "Erratum: Energy-momentum tensor for a Casimir apparatus in a weak gravitational field," *Physical Review D*, Vol. 75, 2007, 089901(E).
- [89] Bimonte, G., et al., "Novel features of the energy-momentum tensor of a Casimir apparatus in a weak gravitational field," *Journal of Physics A: Mathematical and Theoretical*, Vol. 41, 2008, 164056.
- [90] Brown, L. S., and Maclay, G. J., "Vacuum Stress between Conducting Plates: An Image Solution," *Physical Review*, Vol. 184, 1969, pp. 1272-1279.
- [91] Mostepanenko, V. M. and Trunov, N. N., *The Casimir Effect and its Applications*, Oxford University Press, Oxford, 2007.

- [92] Walker, W. R., "Negative energy fluxes and moving mirrors in curved space," *Classical and Quantum Gravity*, Vol. 2, 1985, pp. L37-L40.
- [93] Moore, G. T., "Quantum Theory of the Electromagnetic Field in a Variable-Length One-Dimensional Cavity," *Journal of Mathematical Physics*, Vol. 11, 1970, pp. 2679-2691.
- [94] Epstein, H., Glaser, V., and Jaffe, A., "Nonpositivity of the Energy Density in Quantized Field Theories," *Nuovo Cimento*, Vol. 36, 1965, pp. 1016-1022.
- [95] Drummond, P. D., and Ficek, Z. (eds.), *Quantum Squeezing*, Springer-Verlag, Berlin, 2004.
- [96] Slusher, R. E., et al., "Observation of Squeezed States Generated by Four-Wave Mixing in an Optical Cavity," *Physical Review Letters*, Vol. 55, 1985, pp. 2409-2412.
- [97] Slusher, R. E., and Yurke, B., "Squeezed Light," *Scientific American*, Vol. 254, 1986, pp. 50-56.
- [98] Robinson, A. L., "Bell Labs Generates Squeezed Light," *Science*, Vol. 230, 1985, pp. 927-929.
- [99] Robinson, A. L., "Now Four Laboratories Have Squeezed Light," *Science*, Vol. 233, 1986, pp. 280-281.
- [100] Saleh, B. E. A., and Teich, M. C., *Fundamentals of Photonics*, Wiley Series in Pure and Applied Optics, John Wiley & Sons, Inc., New York, 1991, pp. 414-416.
- [101] Caves, C. M., "Quantum-mechanical noise in an interferometer," *Physical Review D*, Vol. 23, 1981, pp. 1693-1708.
- [102] Pfenning, M. J., "Quantum Inequality Restrictions on Negative Energy Densities in Curved Spacetimes," Ph.D. Dissertation, Dept. of Physics and Astronomy, Tufts Univ., Medford, MA, 1998.
- [103] Saunders, S., and Brown, H. R. (eds.), *The Philosophy of Vacuum*, Clarendon Press, Oxford, 1991.
- [104] Ringwald, A., "Boiling the Vacuum with an X-Ray Free Electron Laser," Cornell Univ. Library arXiv.org e-Print Archive, URL: <http://arxiv.org/hep-ph/0304139.pdf> [cited 15 April 2003].
- [105] Xue, S.-S., "Possible vacuum-energy releasing," *Physics Letters B*, Vol. 508, 2001, pp. 211-215.
- [106] Xue, S.-S., "Magnetically induced vacuum decay," *Physical Review D*, Vol. 68, 2003, 013004.
- [107] Gogohia, V., et al. (1999), "Vacuum energy density of chiral QCD in the zero modes enhancement quantum model," *Phys. Lett. B*, vol. 453, pp. 281-288.

[108] Gogohia, V., "Energy From The Nonperturbative QCD Vacuum," http://arxiv.org/PS_cache/hep-ph/pdf/0508224.pdf (cited 22 Aug. 2005, revised 7 March 2008).

[109] Novello, M., Visser, M., and Volovik, G. (eds.), *Artificial Black Holes*, World Scientific, New Jersey, 2002.

[110] Volovik, G. E., *The Universe in a Droplet of Helium*, Clarendon Press, Oxford, 2003.

[111] Wilczek, F., *The Lightness of Being: Mass, Ether, and the Unification of Forces*, Basic Books, New York, 2008.

[112] Marecki, P., "Balanced homodyne detectors and Casimir energy densities," *Journal of Physics A: Mathematical and Theoretical*, Vol. 41, 2008, 164037.

[113] Leonhardt, U., and Philbin, T. G., "Quantum levitation by left-handed metamaterials," *New Journal of Physics*, Vol. 9, 2007, p. 254.

[114] Law, C. K., "Resonance Response of the Quantum Vacuum to an Oscillating Boundary," *Physical Review Letters*, Vol. 73, 1994, pp. 1931-1934.