

IC-7300 - Test



The IC-7300 is a direct-sampling HF/50/70MHz* transceiver and is characterized by the following features: RF direct sampling, real-time spectrum scope, RMDR 97dB at 1kHz offset, IP+ (dither) function, touch screen color display, built-in antenna tuner and 100 watts transmit power. The features and functions of the IC-7300 have been described in many reports, so that only the most important RF test results will be presented below. *70 MHz only in Region 1

Receiver

Sensitivity (MDS)

The measurement of the sensitivity (MDS = Minimum Discernible Signal) defines the noise floor of the receiver. If one applies a signal to the receiver input whose level (P_i) raises the receiver noise at the audio output by 3dB, then the power of the signal corresponds to the noise floor, according to $(S+N)/N = 2$. For this measurement one can use a signal generator with 0 dBm output level (**Fig. 1**), 0-150dB step attenuator and an RMS-Voltmeter connected to the AF (NF) output.

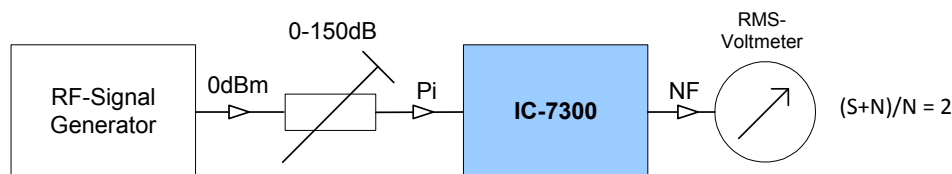

Fig. 1: Measurement setup to determine sensitivity (MDS)

First set the output level at the voltmeter to relative 0dB without an RF signal. When the RF signal is connected, the attenuation is increased until the AF output voltage at the voltmeter just increases by a factor of 1.414 ($20 \log U_2/U_1=3\text{dB}$). The tuning dial is offset by approx. 700 Hz. The sensitivity (MDS) of the receiver then corresponds to the attenuator setting.

IC-7300 Settings: B=500Hz, CW, ATT off, NR off, NB off, Notch off, AGC-M, max. RF Gain

	3,6MHz	7,1MHz	14,1MHz	28,1MHz	50,1MHz	70,1MHz
P.AMP off	-132	-133	-134	-133	-132	-131
P.AMP 1 on	-141	-142	-142	-142	-141	-140
P.AMP 2 on	-142	-143	-143	-143	-142	-141
P.AMP off, IP+	-124	-125	-126	-125	-126	-127

Table 1: Sensitivity (MDS) in dBm at B = 500Hz (CW)

Note: Enabling IP + reduces sensitivity by up to 8dB.

According to the formula $P_N = k \times t_0 \times B$, the noise power (P_N) at constant temperature (t_0) is directly dependent on the measuring bandwidth B . Therefore, when specifying MDS, the measuring bandwidth (more precisely: noise bandwidth) must always be indicated. In the example $B = 500\text{Hz}$.

Reciprocal mixing and sideband noise (RMDR and SBN)

Reciprocal mixing dynamic range (RMDR) and sideband noise (SBN) are further important criteria for the qualitative assessment of a receiver. Strong SBN of the receiver can "cover up" a small signal beside a strong signal and thereby make a receiver insensitive. During the sampling process, the sideband noise of the clock generator is mixed with the received signal (reciprocal mixing) and can block the receiver (1). Despite sufficient selectivity, this effect can cause the phase noise of the clock generator (oscillator) to cover small signals in the vicinity of strong signals. The sideband noise of the clock generator should therefore be very low.

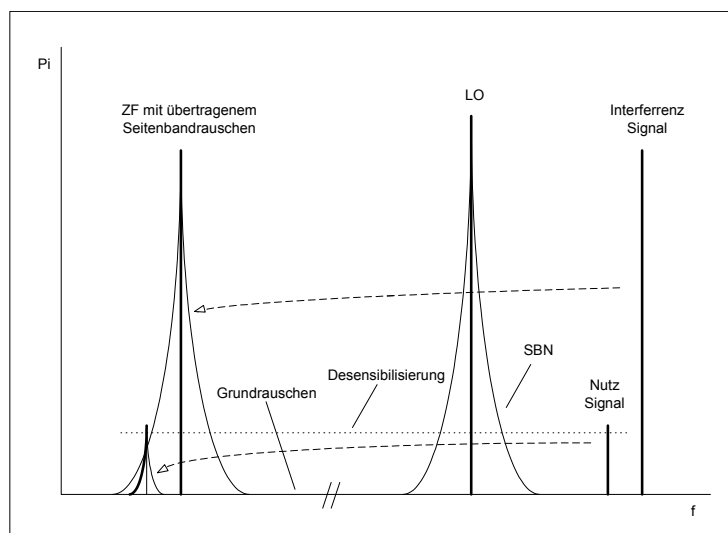

Figure 2: Dynamic range reduction due to reciprocal mixing

The noise amplitudes on both sides of a generator are caused by phase modulation of the carrier with random noise signals, in which the sideband noise is not constantly distributed over the frequency range, but drops from the carrier with approximately 9dB / octave. For this reason, it must be defined at which distance from the carrier the sideband noise is measured. SBN is given as well as the noise floor in power/bandwidth (dBm/Hz).

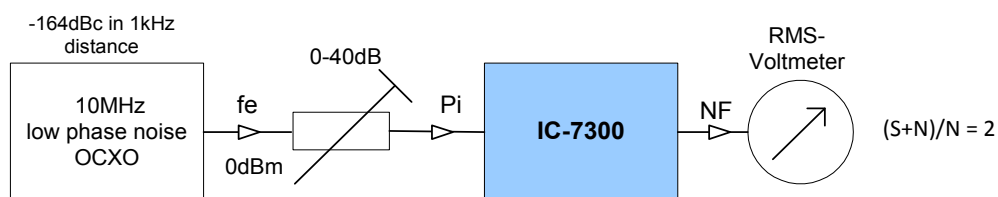

Figure 3: Test setup for RMDR and SBN measurement

For the SBN measurement we use the same setup as for the sensitivity measurement, and once again we use the "3dB method". The only difference from a sensitivity measurement is that now an extremely low-noise test signal is required. The SBN of the used test oscillator must be at least 10 dB better at all frequency intervals than that of the receiver to be tested. Otherwise we are measuring the SBN of the test oscillator and not that of the receiver, because unfortunately reciprocal mixing works in both directions. As an almost noise-free test signal source, I use a 10MHz KVG OCXO with an SBN of -164dBc/Hz in 1 kHz offset from carrier.

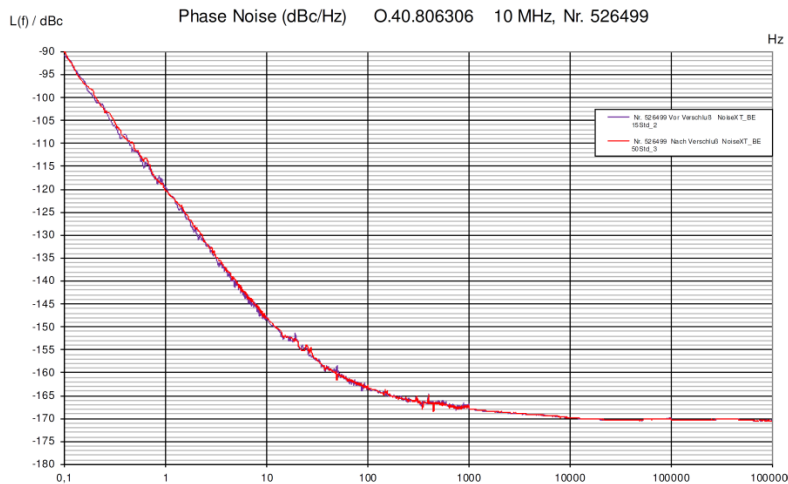

Figure 4: Characteristic of 10MHz test oscillator with very low phase noise

The frequency of the receiver is initially set to $f_e = \pm 1$ kHz and the signal level is increased until the AF output voltage has increased by 3dB (desensitization). In the example this happens at $P_e = -33$ dBm in $\Delta f = 1$ kHz. The SBN level thus reaches the value of the noise floor (MDS) of -135 dBm / 500Hz which means that a noise-free -33 dBm input signal desensitizes the sensitivity of the receiver at 1kHz carrier offset by 3dB.

This results in a reciprocal mixing dynamic range of

$$\text{RMDR} = P_i - \text{MDS} = -33\text{dBm} - (-135\text{dBm}) = 102\text{dB} \rightarrow \text{ICOM indicates } 98\text{dB here}$$

And in a sideband noise of

$$\text{SBN (Phase Noise)} = -(\text{RMDR} + 10\log B) = -(102\text{dB} + 10\log 500\text{Hz}) = -129\text{dBc/Hz}$$

Subsequently, the SBN is measured point by point at larger offsets Δf relative to the carrier and graphically plotted (Table 2, Figure 5). The larger the frequency spacing, the greater the required test signal level. The limit of the RMDR/SBN measurement is reached shortly before ADC clipping or saturation (OVF indicator on).

In a nutshell: The higher the RMDR and the lower the SBN, the better the receiver.

IC-7300 Settings: CW, B=500 Filter, preamp off, Att. off, NR off, NB off, AGC-M, IP+ off, RF Gain max

Offset kHz	Pi dBm	RMDR dB	SBN dBc/Hz
1	-33	102	-129
2	-29	106	-133
3	-28	107	-134
5	-24	111	-138
10	-19	116	-143
20	-15	120	-147
30	-12	123	-150
40	ADC Clip!		

Table 2: RMDR and SBN (Phase Noise) as a function of Δf and P_i , MDS = -135 dBm / 500Hz

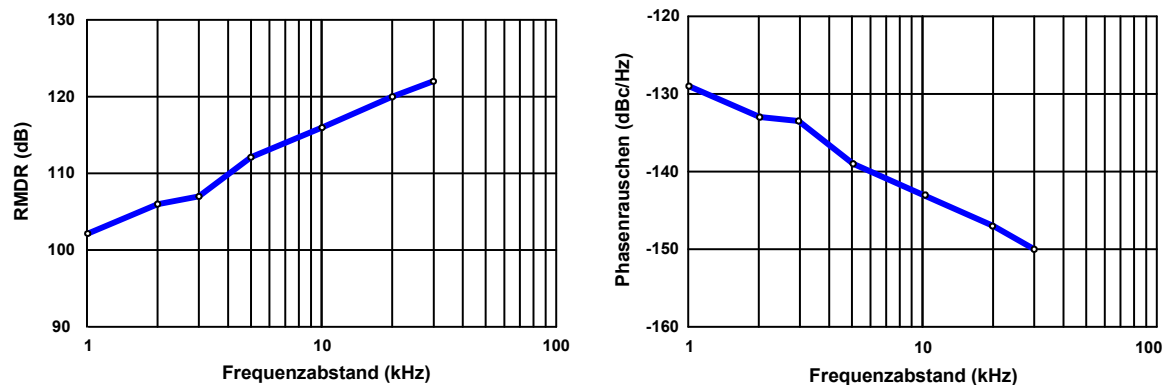

Figure 5: History of RMDR and phase noise

In a good receiver, the usable input power (P_i) up to the onset of desensing (blocking) at 1kHz offset should reach at least the upper drive limit at which the first intermodulation products (IMD3) appear, as otherwise the SBN will determine the large-signal behavior of the receiver. The IC-7300 meets this requirement, as shown below.

Intermodulation (IMD)

To determine the IMD3 power level, an RF 2-tone signal is used as standard (**Fig. 6**) (2). Two equally large, closely-spaced RF signals ($f_1 = 7.050\text{MHz}$, $f_2 = 7.052\text{MHz}$), are applied to the RF input of the receiver and their level is increased until the unwanted IMD3 interference at $(2f_1 - f_2)$ and $(2f_2 - f_1)$ reaches the same level as the receiver noise floor, corresponding to 3dB above the noise floor. The difference between input level (P_i) and noise floor (MDS) gives the IMD-free dynamic range (DR3) of the receiver. This value is also termed IFSS (Interference Free Signal Strength), VA70J/AB40J.

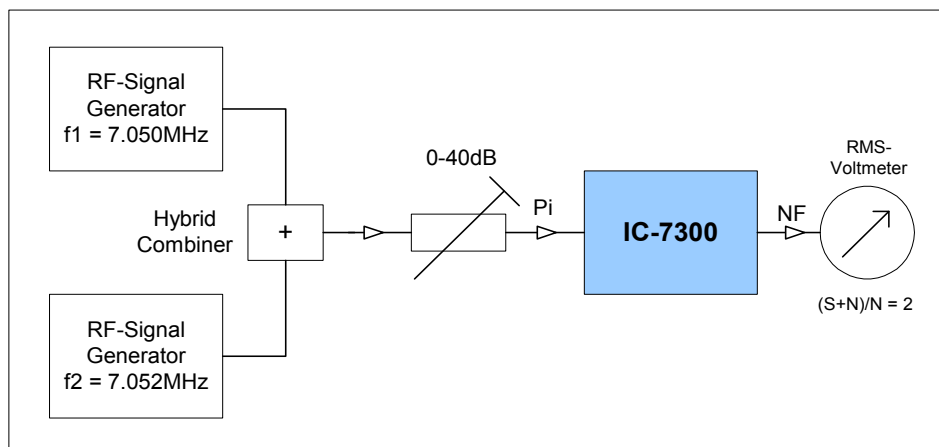

Figure 6: Test setup for IMD measurement

Unlike analogue receivers, the IMD3 products of direct sampling SDRs do not increase according to a 3rd-order law, but remains at a low baseline level. High-quality SDR receivers produce IMD products which are always below the receiver's noise floor right up to the receiver's limit (OVF, Saturation).

Figure 7 shows the IFSS curves of the IC-7300, with IP+ on/off and with preamplifier activated. The results are quite good and comparable with other high quality receivers.

IC-7300 Settings: AGC off, Notch off, NB off, NR off, CW, BW 500Hz

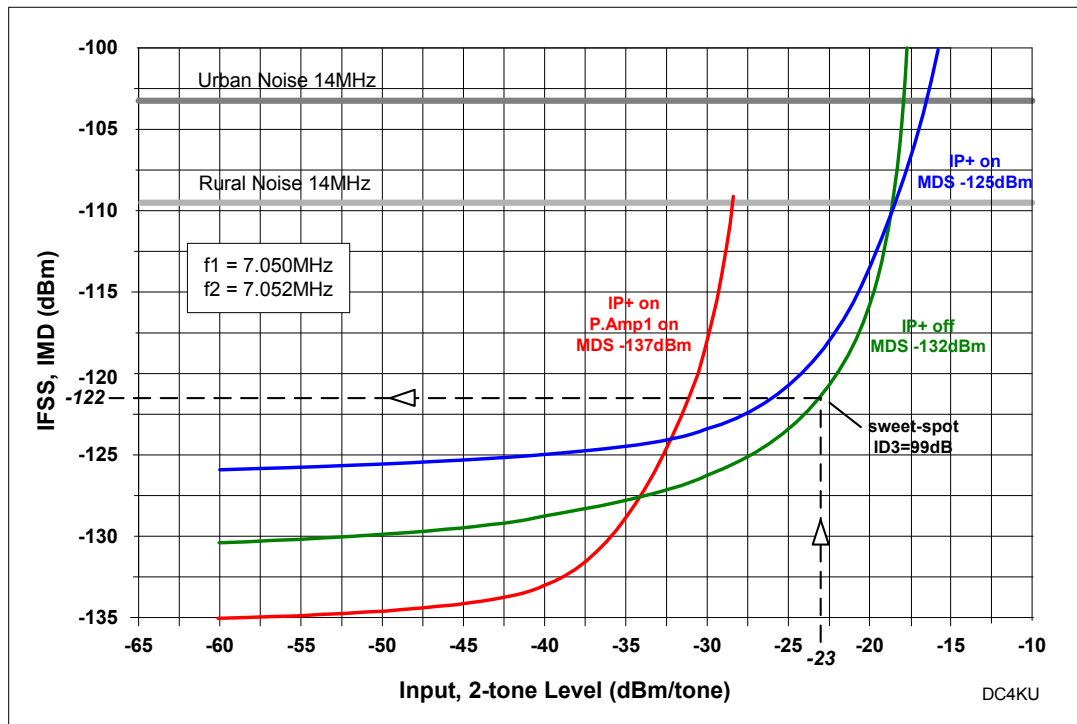

Figure 7: IFSS curves for different settings, IP + on / off and preamplifier on / off

All traces are far below the Rural- and Urban Noise lines (3). With an antenna connected the distortion products are always below the receiver noise floor and only appear at an input level > -17dBm (S9 +56 dB). If the preamplifier (P.AMP 1) is switched on (red curve), the dynamic range is reduced by the amount of preamp gain. A 3rd-order intercept point (IP3) cannot be determined (calculated) from the curves in Fig. 7, as IP3 does not exist in a direct-sampling SDR.

The analogue input section of the IC-7300 has only a few bandpass filters, a number of signal-routing relays and two selectable preamplifiers. Here, ICOM has obviously succeeded in building the bandpass filters in such a way that they do not produce any additional intermodulation. This is worth mentioning because some other SDR receivers are experiencing massive problems in this area.

OVF (ADC clip).

In this test, the receiver is tuned 25 kHz above or below the test signal and the signal level is increased until the OVF indicator (Overload) illuminates (Table 3). The receiver can only be overdriven by signals that are outside the receive frequency; otherwise the automatic gain control (AGC) would attenuate the signal.

IC-7300 Settings: IC-7300 tuned to 14,200MHz, test signal at 14,225MHz, CW 500Hz

	OVF Clip level
P.AMP off	-8 dBm
P.AMP off, IP+	-8 dBm
P.AMP 1 on	-24 dBm
P.AMP 2 on	-28 dBm
Attenuation on	+10 dBm

Table 3: ADC Clip Level

What to do when OVF lights up?

Overload in a receiver is usually caused not by one large signal, but by the sum of all received signals, which can coincidentally reach the clipping level -8dBm (0.16mW, 90mV rms). For a brief moment, the ADC will be pushed to its limit, as indicated by the OVF LED lighting up. Superheterodyne receivers do not have such an indicator; overload of the first mixer commences relatively early and is usually unnoticed by the user.

A short-term overload of the IC-7300 is not as problematical as it first appears, and radio reception will not be affected. First, you should check whether the preamp (P.AMP) is on, and if so, you should turn it off. On the bands from 160 to 20m you should not use a preamp at all, because the ambient noise at the antenna at these frequencies is still considerably above the low noise floor of the IC-7300 and increasing the the sensitivity achieves nothing, except to torment the ADC with excessive signals (3). Another simple way to prevent overdriving is to reduce RF gain by turning the RF/SQL potentiometer a few degrees to the left. **RFG** (Reduced RF Gain) then appears on the screen.

What's about the IP+ function?

Enabling IP + in the ADC improves the linearity and IMD dynamics of the receiver. In this case, a noise signal (dither) is supplied to the ADC so that it reaches its optimum working range earlier. However, with IP+ on, the receiver loses about 8dB of sensitivity. Whether you work with IP+ or not depends on the conditions. When I was working with the IC-7300 I could not see any improvements in the IMD whether I turned on IP+ or not. The reason for this could be that the antenna is already producing enough noise so that IP + is no longer required. But In a contest, with very good conditions and using an efficient antenna, the IP+ function can bring benefits and should be activated. The linearity of the IC-7300 shows the spectrum in **Figure 8**. The two signals generated at 2 x -15dBm exceed the reference level (top line in the spectrum) by 15 dB and interference products are not yet detectable in the noise. This results in a distortion-free dynamic range of 80dB + 15dB = 95dB. The receiver shows the same result with and without IP+.

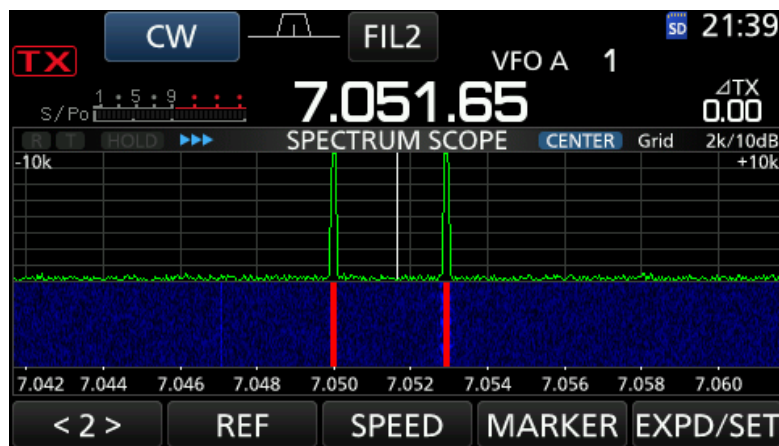

Figure 8: Linearity of the IC-7300

Noise Power Ratio (NPR)

In the NPR measurement, the receiver is driven by band-limited RF white noise (e.g. B=5MHz). A sharp, narrow notch (bandstop) filter suppresses the noise completely in a test channel, centered on 2.4 MHz in this example. Thus, within the test channel, the receiver will not receive any noise and will operate at its normal sensitivity. Subsequently, the noise loading is increased until a small level increase above the noise floor is just visible at the bottom of the notch. Using a receiver with an ADC in the front end, this increase occurs shortly before ADC saturation. The difference between the injected noise power (P_{TOT}) and the sensitivity (MDS) of the receiver then equals the noise power ratio (4). Note that the -3 dB bandwidth of the notch must be slightly wider than that of the receiver's passband.

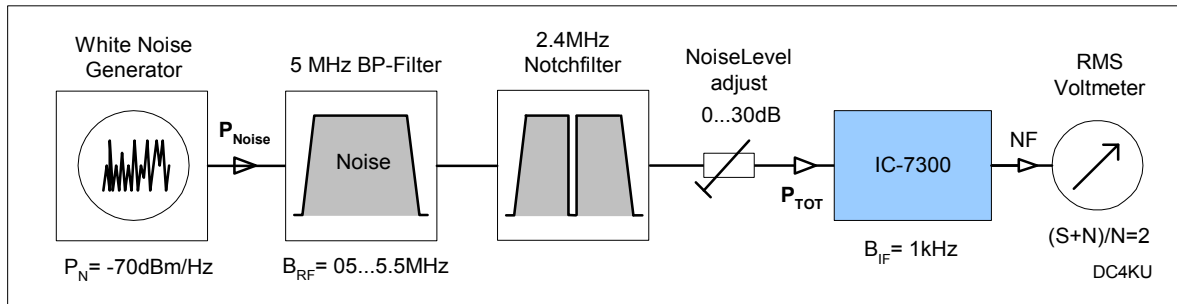

Figure 9: NPR measurement setup

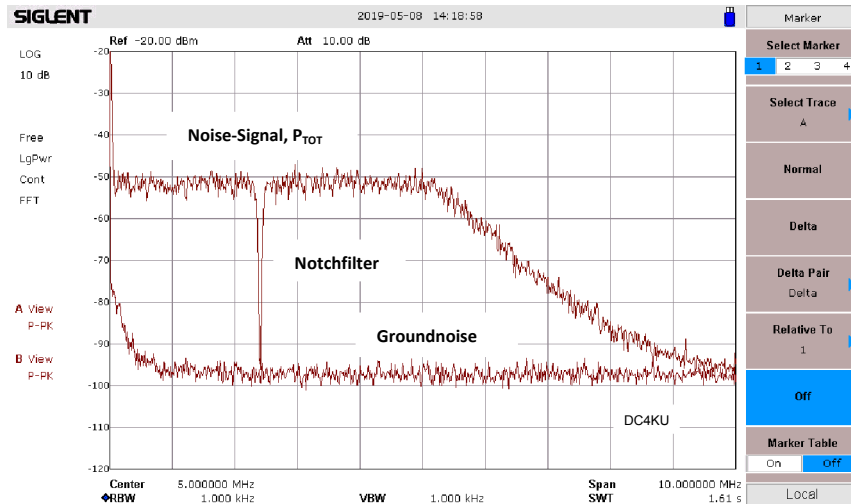

Figure 10: Signal at the output of the NPR measuring station, measured with a spectrum analyzer

IC-7300 Settings: ATT off, RF Gain max, Preamp off, IP+ off, NB off, NR off, Notch off, SSB, B=1kHz

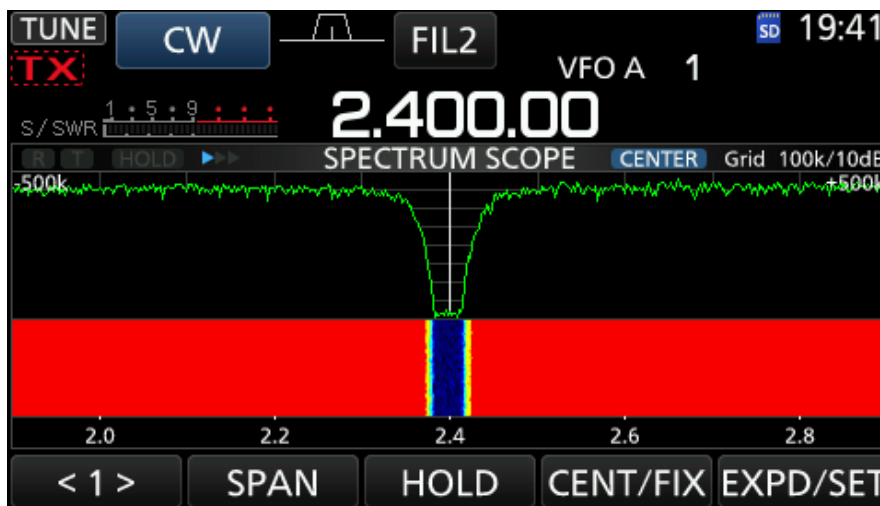

Figure 11: NPR spectrum with notch filter in the display of the IC-7300

At a noise level of -48dBm/1kHz, the receiver is only 1 ... 2dB below OVF (Saturation) and reaches its maximum NPR. With a sensitivity of -125dBm/1kHz this results in a noise power ratio of

$$NPR = P_{TOT} - MDS = -48dBm - (-125dBm) = 77dB$$

The IC-7300 achieves a very good NPR value, comparable to those of high-quality SDR receivers.

Transmitter

RF output power of the transmitter

To determine the RF output power, we apply a 1 kHz sinusoidal signal (CW signal) to the microphone input and measure the RF output power (P_a) via a 40dB dummy load with a calibrated spectrum analyzer (P_s).

$$P_a = P_s + 40\text{dB (Dummy Load)}$$

Figure 12 shows the power measurement at 14.2MHz.

$$P_a = 10.07\text{dBm} + 40\text{dB} = 50.07\text{dBm} = 101.6\text{Watts}$$

IC-7300 Settings: SSB 2.4kHz, RF Power 100%, Mic Gain 20%, Comp 2, Supply voltage 13.8VDC

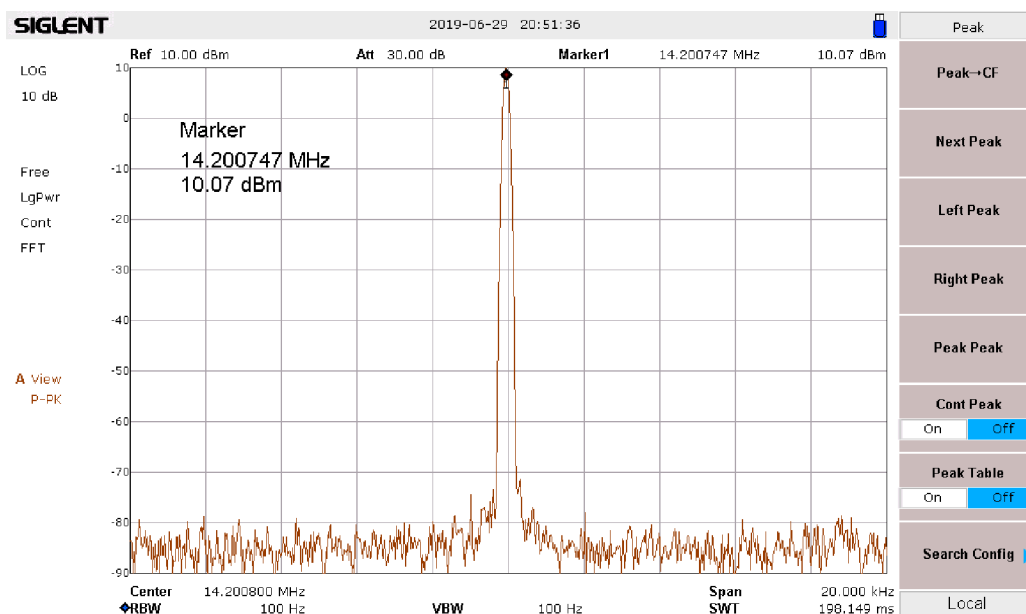

Figure 12: Maximum HF output power in the 20m band

Frequency	P_a Watts
3,6 MHz	101.4
14,1 MHz	101.6
28,3 MHz	102.5
51 MHz	98.7

Table 4: Maximum RF output power on the different bands

Intermodulation in the power amplifier

To measure the intermodulation of the MOSFET power amplifier, we connect the microphone input to an AF 2-tone generator ($f_1 = 700\text{Hz}$, $f_2 = 1500\text{Hz}$) and adjust the microphone input voltage so that the transmitter reaches a PEP output power of 100W (Fig 13) (5). Since the transmitter is now driven by two closely spaced sinusoidal signals of equal amplitude, inter-frequency effects occur, with the signals adding or canceling (Fig. 14). Therefore the average power of the transmitter does not reach 100W but only $2 \times 25\text{W} = 50\text{W}$ and the levels of the two RF signals are 6dB below the maximum

power of 100W. Only at the maxima of the beat does the signal have twice the voltage or four times the power of a single tone, and the transmitter reaches its maximum power of 100W PEP.

IC-7300 Settings: Modulation 700Hz +1500Hz, SSB, B= 2,4kHz, RF Power 100%, Mic Gain 20%, Comp 1, Supply voltage 13.8VDC, Frequency: 3.6MHz, 14.1MHz, 28.1MHz and 50.1MHz

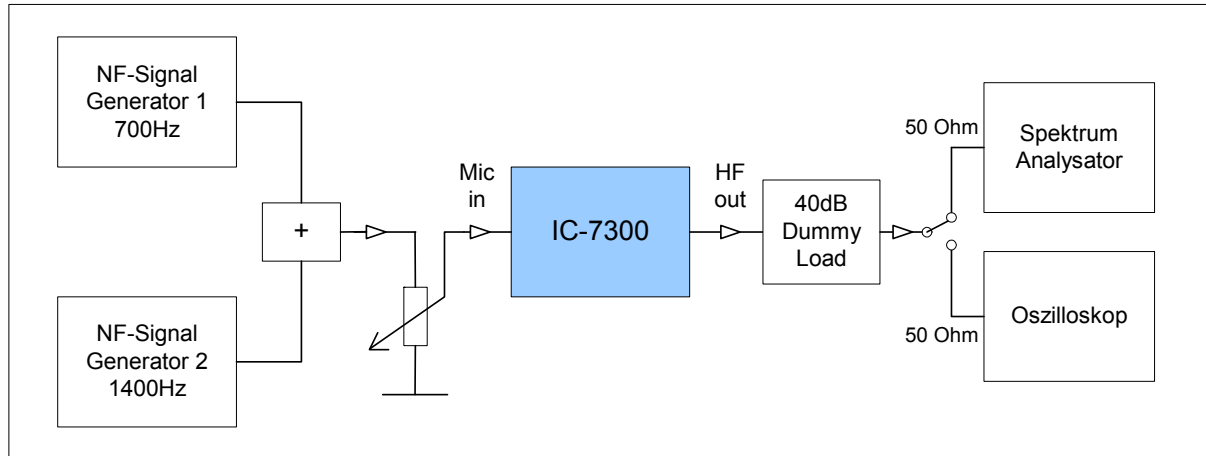

Figure 13: Measurement setup for transmitter intermodulation

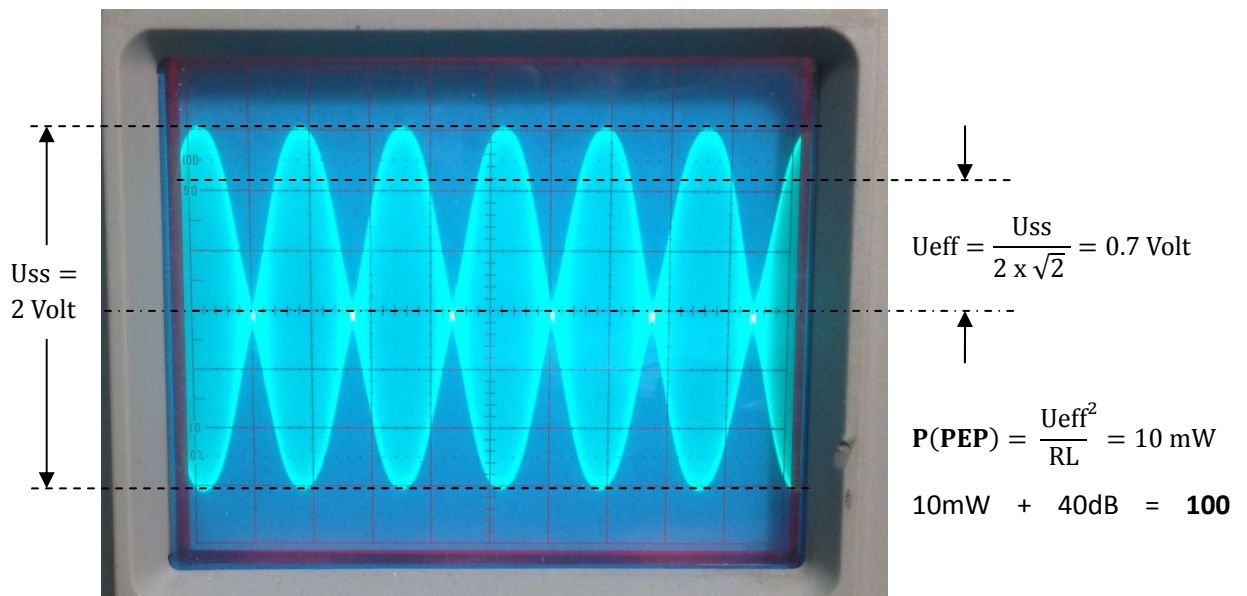

Figure 14: HF 2-tone signal with 100 Watt PEP on the scope in the time domain, at 14.1 MHz

Fig. 15 to 17 show the resulting intermodulation of the transmitter at 3.6, 14.1 and 28.1MHz. A good transmitter suppresses the IMD3 products at full power by more than 25dBc and the higher order IM products should drop relatively quickly, so that the adjacent channels are not disturbed. At an IMD3 distance of only 20dBc, the demodulated signal would sound already a bit harsh and distorted, the harmonic distortion of an SSB signal would already be 10%. Table 5 shows the measured IMD3 values with 100W PEP on different frequencies.

Frequency	3.6 MHz	14.1 MHz	28.1 MHz	50.1MHz
IMD3 Level	43dBc	38dBc	30dBc	25dBc

Table 5: IMD3 measurement results on different bands

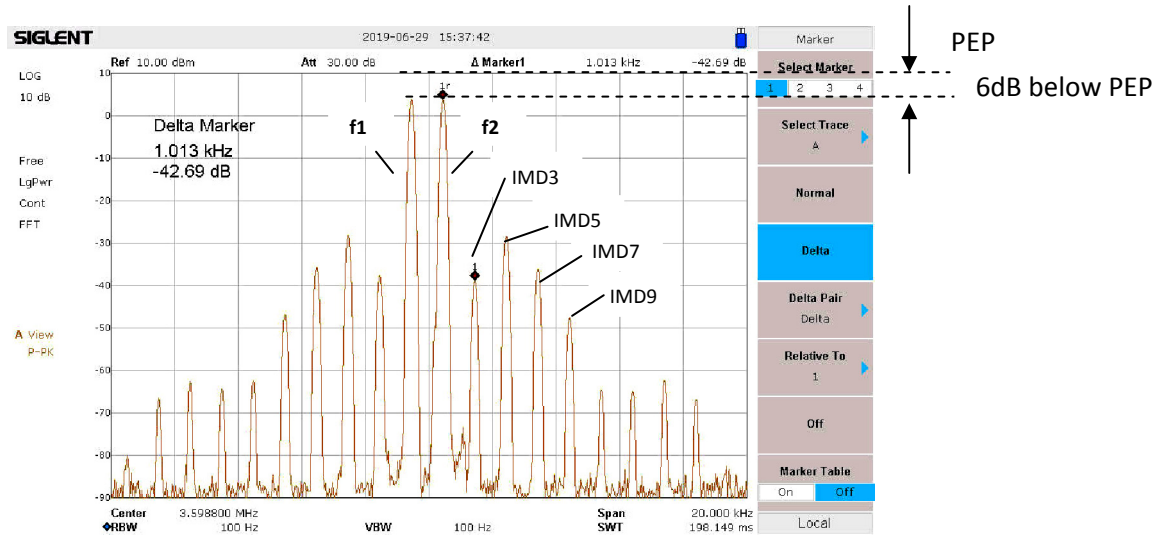

Figure 15 3.6MHz: IMD3=42.6dBc, IMD5=32dBc, IMD7=40dBc, IMD9=50dBc

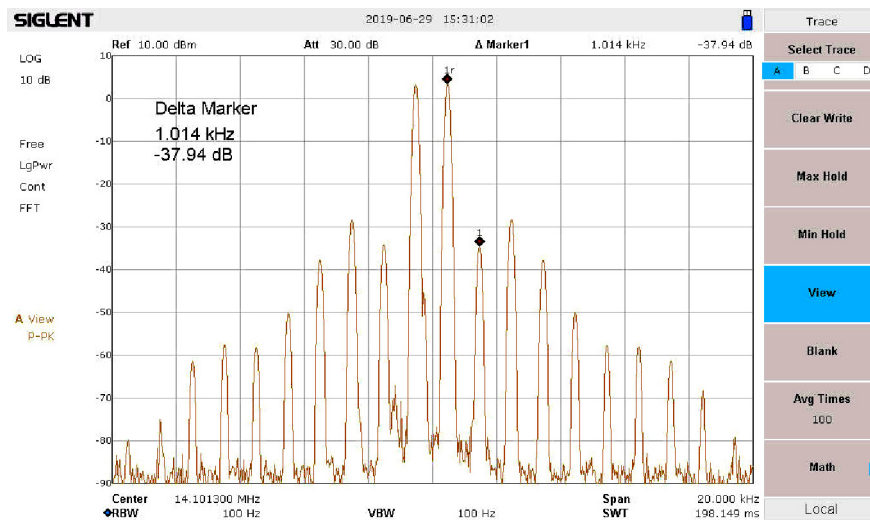

Figure 16: 14.1MHz: IMD3 ≈ 38dBc

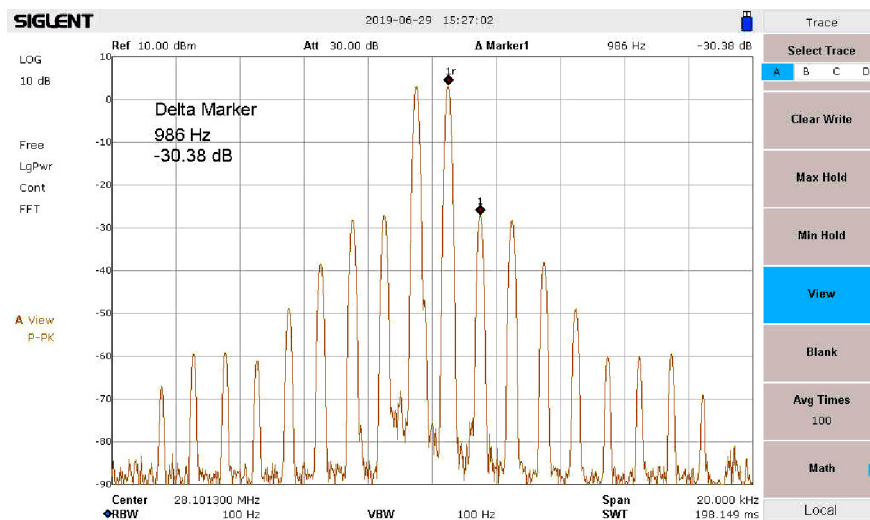

Figure 17: 28.1MHz: IMD3 ≈ 30.4dBc

Harmonic rejection of the transmitter

Adjust the transmitter to the maximum RF output power and measure the 2nd harmonic suppression ($2xf_1$) with a spectrum analyzer. Between the transmitter output and the spectrum analyzer a 60dB attenuator is connected.

A measuring level of -10 dBm at the analyzer (**Fig. 18**) corresponds to an output power of 100W. For harmonic measurements it is important to make sure that the spectrum analyzer itself does not generate harmonics that could distort the result. For this measurement the analyzer has to work with a harmonic separation of at least 80dB (**6**).

IC-7300 Settings: Modulation 1000Hz, SSB 2.4kHz, RF Power 100%, Mic Gain 20%, DC supply voltage 13.8VDC

Frequency, f_1	Suppression 2. Harmonic $2xf_1$
3.7 MHz	80 dBc
7.1MHz	77 dBc
14.1 MHz	81 dBc
28.3 MHz	68 dBc
50.1 MHz	78 dBc

Table 6: Harmonic rejection on different bands

Analyzer Settings: Attenuation 25dB, Span 1.8 - 8MHz, RBW 100Hz

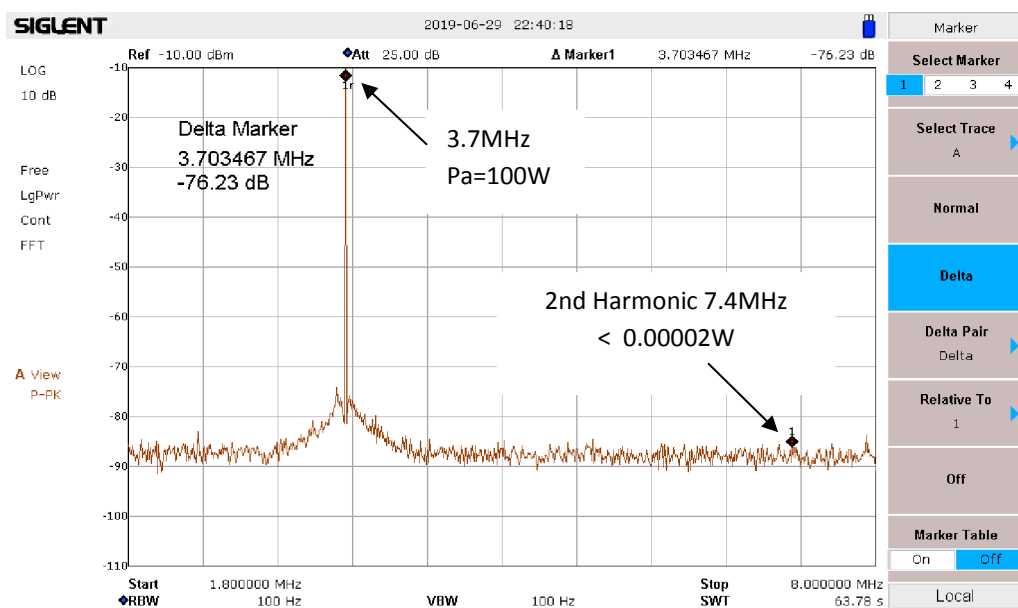

Fig. 18: The harmonic of the 3.7 MHz CW-Signal is not visible in the spectrum, as it is less than 0.02mW

References:

- (1) Messung des Seitenbandrauschens von Empfängern und Oszillatoren
https://dc4ku.darc.de/Messung_Seitenbandrauschen.pdf
- (2) HF 2-Ton-Generator für IM3-Messungen
https://dc4ku.darc.de/HF_Zweiton_Generator.pdf
- (3) Antennenrauschen im KW-Bereich
https://dc4ku.darc.de/Antennenrauschen_im_Kurzwellenbereich.pdf

(4) NPR-Messung

<https://dc4ku.darc.de/Noise-Power-Ratio.pdf>

(5) NF 2-Ton-Generator mit Wien-Robinson-Brücke

https://dc4ku.darc.de/NF_Doppeltongenerator_mit_Wien_Robinson_Bruecke.pdf

(6) IM3-Festigkeit eines HF 2-Ton-Generators

https://dc4ku.darc.de/IM3_Festigkeit_eines_HF_2_Tongenerators.pdf

Werner Schnorrenberg

DC4KU

17.07.2019