Design Guide for Engineered Bahareque Housing

Sebastian Kaminski, Andrew Lawrence, David Trujillo



About INBAR Technical Reports

INBAR Technical Reports provide detailed analyses of specific aspects of rattan and bamboo research. They are based on validated research outputs and/or lessons learned from INBAR or recognised partner initiatives.

Acknowledgements

This work was primarily funded by the Government of the People's Republic of China, with contributions from Arup and Coventry University. We are also grateful to the Common Fund for Commodities, which has enabled this research to be disseminated to private sector and government partners in Nepal following the 2015 earthquake.

Key words

Bamboo, Bahareque and housing

Copyright and Fair Use

This publication is licensed for use under the Creative Commons

Attribution-Non-commercial-Share Alike 4.0 Unported License. To view this licence, visit <https://creativecommons.org/licenses/by-nc-sa/4.0/>

Unless otherwise noted, you are free to copy, duplicate, or reproduce and distribute, display or transmit any part of this publication or portions thereof without permission and to make translations, adaptations, or other derivative works under the following conditions:

Attribution: The work must be attributed, but not in any way that suggests endorsement by the publisher or the author(s).

Non-commercial: This work may not be used for commercial purposes.

Share Alike: If this work is altered, transformed, or built upon, the resulting work must be distributed only under the same or similar license to this one.

International Network for Bamboo and Rattan (INBAR)

PO Box 100102-86, Beijing, 100102, P. R. China

Tel: +86-10-6470 6161; Fax: +86-10-6470 2166; E-mail: info@inbar.int

ISBN: 978-92-990082-3-2

©2016 INBAR – International Network for Bamboo and Rattan

Authors

Lead author

Sebastian Kaminski, structural engineer and bamboo specialist, Senior Engineer at Arup, Member of INBAR task force – Bamboo Construction

Second authors

Andrew Lawrence, structural engineer and timber specialist, Associate Director at Arup, Member of INBAR task force – Bamboo Construction

David Trujillo, structural engineer and bamboo specialist, Senior Lecturer at Coventry University, Chair of INBAR task force – Bamboo Construction

Contributors and reviewers

David Barber, fire engineer, Associate at Arup

Maya Shinozaki, sustainability specialist, Engineer at Arup

Daniel Roe, sustainability specialist, Engineer at Arup

Tara Clinton, structural engineer, Engineer at Arup

Liam Davis, architect, Architectural Assistant at Arup

Luis Felipe López, structural engineer, Head of Engineering at Base Bahay Foundation, Member of INBAR task force – Bamboo Construction

Juan Francisco Correal, structural engineer, Head of Department of Faculty of Engineering, Universidad de los Andes, Member of INBAR task force – Bamboo Construction

About the lead author

Sebastian is a Senior Structural Engineer working in the Advanced Technology and Research Team in Arup, London. He works with a variety of materials, including reinforced concrete, steel, masonry, timber and bamboo. Sebastian has experience in designing buildings and housing in both the developed and developing world, in particular in seismic design of low-cost housing.

Sebastian is one of Arup's specialists in bamboo, having worked on a number of projects using bamboo and cane around the world. He has presented and run courses on the structural use of bamboo in countries, including Haiti, Nepal, and Ecuador. He is currently also involved in a number of research projects involving bamboo, and is lead author of a new bamboo-in-the-round design guide to be published in the UK shortly.

Executive Summary

Engineered bahareque is a form of vernacular-improved construction that takes traditional wattle-and-daub type housing and improves it, using modern materials, knowledge, and construction techniques. Engineered bahareque generally consists of reinforced concrete foundations supporting a reinforced masonry upstand that elevates the timber and/or bamboo structural frame. An organic matrix of cane, small diameter bamboo, bamboo laths, or bamboo mats is nailed to the frame, and galvanised steel chicken mesh is nailed to the matrix to act as reinforcement. The walls are then finished with cement mortar render to form solid walls. The roof is normally constructed from cement fibreboard sheeting or clay tiles.

Engineered bahareque houses have successfully been constructed in various countries around the world, including: Costa Rica, Colombia, Nepal, Ecuador, El Salvador, and The Philippines. When properly designed and built, they have demonstrated their effectiveness as an affordable, hazard-resilient, safe, and durable form of housing. Engineered bahareque has significant potential in many countries around the world where bamboo grows, and is particularly suited to one and two-storey housing units.

Engineered bahareque housing has been shown to be environmentally-superior to other forms of housing such as masonry, with as little as half of the embodied carbon, and an ability to be built largely using fast-growing sustainable materials such as bamboo. Its sustainability can be maximised by ensuring the bamboo and timber is taken from a local and sustainable source, minimising the thickness of cement mortar render and maximising the use of cement replacements such as lime. Non-toxic treatment chemicals should be used whenever possible for the bamboo and timber.

Engineered bahareque housing can be a durable form of housing, achieving a 50-year design life through good design. Bamboo and timber are vulnerable to insect and rot attack and therefore need to be protected. To protect against insects, the bamboo should be treated with boron and the timber should either be treated or naturally durable. To protect against rot, the bamboo and timber must be kept dry through good design details such as: elevating the frame on an upstand, including a damp-proof membrane, large overhangs to protect the walls from driving rain, an impermeable wall, good drip details, and ventilated cavities. Steel connections should be painted or galvanised.

The engineered bahareque technique provides a convenient way to protect the naturally susceptible timber and bamboo from fire. Using 15mm of cement mortar render can provide a nominal level of protection, and increasing this to 25mm can provide a 30 minute fire resistance rating. Not all walls in single family occupancy

buildings normally need a fire resistance rating, however a nominal level of protection is generally recommended.

Engineered bahareque housing is a strong and robust construction system, which can be designed to resist earthquakes and strong winds in even the most hazardous regions of the world. The frame, matrix, and cement mortar render has been shown to behave compositely structurally, acting as a shear wall. The system should be designed such that the gravity, wind and earthquake load path is simple and continuous, the elements are all robustly fixed together with steel connections – especially at the base of the wall – and the cement mortar render is tied on well to the matrix via the chicken mesh, which in turn is nailed to the frame.

Engineered bahareque housing is safe to construct and uses no toxic chemicals, can be constructed by the beneficiaries themselves, does not require significant maintenance, and has been shown to be very popular with beneficiaries in many case studies. It can provide a hygienic, safe, durable and thermally-comfortable home.

This technical report is intended to be used by architects and engineers at both concept and detailed design. It is intended as a guide for designing and constructing engineered bahareque housing in both developed and developing countries around the world. The report provides guidance on design for sustainability, durability, fire, and structural (wind and earthquake) loads. Typical construction details are also provided, along with guidance for quality control during construction.

Resumen Ejecutivo

El bahareque encementado es una forma constructiva vernácula mejorada, que utiliza el sistema estructural tradicional del bahareque y lo mejora por medio de materiales, conocimiento y técnicas constructivas modernas. El bahareque encementado generalmente consiste en: cimentación de concreto (hormigón) reforzado soportando un sobrecimiento de mampostería reforzada o confinada sobre el cual se construye un esqueleto estructural de bambú y/o madera. Una matriz orgánica de caña, bambú de diámetros pequeños, tablillas de bambú o esterilla se fija por medio de clavos a la armadura; una malla de gallinero se clava a la matriz para que actúe como refuerzo. Los muros se terminan con un revoque (o enlucido) de mortero de cemento para formar muros sólidos. El techo (o cubierta) se construyen normalmente de tejas de fibro-cemento o de barro (arcilla).

El bahareque encementado ha sido utilizado exitosamente en varios países alrededor del mundo, incluyendo: Costa Rica, Colombia, Ecuador, El Salvador y Las Filipinas. Cuando se diseña y construye correctamente, ha demostrado que puede ser usado para vivienda asequible, segura, durable y resistente a las amenazas ambientales. El bahareque encementado tiene un potencial importante en muchos países del mundo en los que crezca el bambú, y es particularmente apropiado para unidades de vivienda de uno y dos pisos.

Se ha demostrado que el bahareque encementado es ambientalmente superior a otros sistemas de vivienda, como por ejemplo la mampostería, pues tiene el 50% del carbono incorporado y la posibilidad de ser construido en buena medida de materiales de rápido crecimiento, como lo es el bambú. Su sostenibilidad se puede maximizar al asegurarse que el bambú y la madera se obtengan de fuentes sostenibles, locales; minimizando el espesor del mortero de cemento, y maximizando el uso de sustitutos de cemento como la cal. Desde que sea posible, preservantes químicos no tóxicos se deben usar para la madera y el bambú.

La vivienda de bahareque encementado es un tipo de vivienda durable, alcanzando, a través del buen diseño, una vida de diseño de 50 años. El bambú y la madera son vulnerables a ataques por insectos y pudrición, y por ende deben ser protegidos. Para proteger el bambú contra insectos se debe preservar con boro, y la madera debe ser preservada o proceder de una especie naturalmente durable. Para proteger el bambú y la madera contra la pudrición se deben mantener secos mediante detalles de diseño apropiados: elevar sobre un sobrecimiento, barreras a la humedad, voladizos grandes en el techo para proteger las paredes contra la lluvia y usar corta goteras, un muro impermeable, y ventilación en las cavidades de los muros. Las recomendaciones fundamentales son: tratar el bambú con boro, usar madera preservado o naturalmente durable. Las conexiones de acero deben ser pintadas o galvanizadas.

El bahareque encementado provee una forma conveniente de proteger del fuego al bambú y a la madera, que son combustibles. Usar un revoque de 15mm de mortero de cemento provee una resistencia mínima al fuego, incrementarlo a 25mm puede proveer 30 minutos de resistencia al fuego. No todos los muros en una vivienda unifamiliar requieren poseer resistencia al fuego, sin embargo una resistencia al fuego mínima es generalmente recomendable.

La vivienda de bahareque encementado es un sistema estructural resistente y robusto, el cual puede ser diseñado para ser resistente a sismos y viento extremo, incluso en las regiones del mundo sujetas a mayor amenaza. El esqueleto, la matriz y el revoque de mortero de cemento han demostrado comportarse como un compuesto, cuando actúa como muro de corte. El sistema debe diseñarse para que la marcha de cargas gravitacionales y horizontales sea simple y continuo, los elementos del esqueleto sean fijados apropiadamente por medio de conexiones de acero (particularmente en la base del muro) y que el mortero de cemento se fije bien a la matriz mediante la malla de gallinero, que a su vez se fije mediante clavos al esqueleto.

La vivienda de bahareque encementado es segura de construir y utiliza químicos no tóxicos, se pueden construir por los propios beneficiarios, no requiere mucho mantenimiento y ha demostrado ser muy popular con beneficiarios en muchos estudios. Puede brindar una vivienda higiénica, segura, durable y térmicamente confortable.

La finalidad de esta memoria técnica es su empleo por parte de arquitectos e ingenieros durante las fases de diseño conceptual y diseño constructivo. Está concebida como una guía de diseño y construcción para el bahareque encementado tanto en países desarrollados como en países en vías de desarrollo por todo el mundo. El reporte es una guía de diseño para la sostenibilidad, la durabilidad, el fuego y las cargas estructurales (viento y sismos). Detalles constructivos típicos se proveen, junto con orientaciones para el control de calidad durante el diseño.

Key messages

- When properly designed and constructed, engineered bahareque structures provide an effective, resilient, safe and durable form of housing. It is a strong and robust construction system that can be designed to resist earthquakes and strong winds in disaster-prone regions.
- Engineered bahareque housing is more environmentally-friendly than other forms of housing – containing as little as half the embodied carbon, and uses fast-growing sustainable material, including bamboo.
- Engineered bahareque housing has significant potential wherever bamboo grows – and has already proved to be very beneficial as a form of resilient, low-cost housing in many parts of the world, including Costa Rica, Colombia, Nepal, Ecuador, El Salvador, and The Philippines.
- There are practical, sustainable and cost-effective ways to enhance the resilience of bamboo bahareque housing, reduce susceptibility to insects, rot, and fire, and achieve a life-span of 50 years. To protect against insects, bamboo should be treated with boron; to protect against rot, the bamboo needs to be kept dry – through simple measures such as elevating the frame, including a damp-proof membrane, and constructing large overhangs to protect the walls from driving rain; and to protect against fire, the use of cement mortar renders provide effective resistance.
- The construction of engineered bahareque housing involves simple and practical construction systems, which means that houses can be easily maintained and constructed by beneficiaries, thereby utilising local skills and helping to enhance community ownership. The houses have proved to be very popular in many previous housing initiatives.

Contents

Authors.....	II
About the lead author.....	II
Executive Summary.....	III
Resumen Ejecutivo.....	V
Key messages.....	VII
1.0 Overview of report.....	1
2.0 Introduction to Engineered <i>Bahareque</i> Housing.....	3
2.1 Background to traditional <i>bahareque</i> housing.....	3
2.2 Engineered <i>Bahareque</i> Housing.....	6
2.3 Case Studies.....	9
2.4 When is engineered <i>bahareque</i> housing suitable?.....	14
3.0 Designing for Sustainability.....	16
3.1 Introduction.....	16
3.2 Embodied carbon and environmental impact of engineered <i>bahareque</i> housing.....	18
3.3 Summary of recommendations for designing for sustainability.....	22
4.0 Designing for Durability.....	23
4.1 Introduction.....	23
4.2 Causes of decay.....	23
4.3 Protection against decay.....	26
4.4 Treatment options.....	28
4.5 Seasoning.....	30
4.6 Timber.....	31
4.7 Cement mortar render.....	32
4.8 Steel components of engineered <i>bahareque</i> housing.....	32
4.9 Summary of recommendations for designing to ensure durability.....	33
5.0 Designing for Fire.....	34
5.1 Introduction.....	34

5.2	What is fire resistance?	34
5.3	Regulatory requirements	35
5.4	Bamboo and engineered <i>bahareque</i> fire properties	36
5.5	Discussion on fire testing results	38
5.6	Summary of recommendations for designing fire resistance	40
6.0	Designing for Structural Loads	44
6.1	Key structural considerations of bamboo	44
6.2	Designing for gravity loads	45
6.3	Designing for earthquake and wind loads	46
6.4	Lateral load-stability systems	48
6.5	Designing individual bamboo elements and connections	50
6.6	Designing engineered <i>bahareque</i> shear wall systems	52
7.0	Typical Construction Details of Engineered <i>Bahareque</i> Houses	56
7.1	Upstand detail	56
7.2	Upstand to sole plate detail	56
7.3	Studs/bracing to sole plate/foundation	58
7.4	Matrix details	60
8.0	Ensuring Good Quality construction	61
9.0	Other Important Considerations for Design	63
9.1	Health, safety and labour standards for construction	63
9.2	Maximising use of housing beneficiaries for construction labour	63
9.3	Maintenance	63
9.4	Housing occupant health and wellbeing	64
10.0	Summary	66
	References	67
	Appendix A: Example drawings of engineered <i>bahareque</i> housing	74

1.0 Overview of report

This technical report is an output from INBAR's Technical Advisory Committee on Bamboo and Rattan Standardisation Task Force on Bamboo Construction. It is intended as a guide for designing and constructing engineered *bahareque* housing in both developed and developing countries around the world. The report is broken up into the following sections:

- **Section 2.0: Introduction to Engineered *Bahareque* Housing** – discusses the traditional and the engineered *bahareque* housing systems, presents three case studies of engineered *bahareque* housing constructed in several countries, and proposes appropriate contexts for its adoption.
- **Section 3.0: Designing for Sustainability** – discusses the embodied carbon and environmental impact of the key materials used for engineered *bahareque* housing, and proposes how the designer can maximise the sustainability of the house.
- **Section 4.0: Designing for Durability** – discusses the durability of the key materials used for engineered *bahareque* housing, and proposes how the designer can meet a standard design life of 50 years, with a focus on bamboo elements.
- **Section 5.0: Designing for Fire** – discusses the behaviour of bamboo and engineered *bahareque* in a fire scenario, provides recommendations on what fire resistant ratings they should be designed to, and proposes how the designer can achieve these ratings.
- **Section 6.0: Designing for Structural Loads** – discusses the key structural considerations of bamboo, and provides recommendations on how to design engineered *bahareque* for gravity, wind, and earthquake loads.
- **Section 7.0: Typical Construction Details of Engineered *Bahareque* Houses** – provides some key structural details for building engineered *bahareque* houses such that they are disaster resilient, durable, and robust.
- **Section 8.0: Ensuring Good Quality construction** – lists key issues to manage during construction to ensure good quality.
- **Section 9.0: Other Important Considerations for Design** – discusses other important considerations when designing engineered *bahareque* houses, such as health and safety, use of beneficiaries for labour, maintenance, and occupant health and wellbeing.

This technical report is intended to be used as a guide by architects and engineers at both concept and detailed design. The report should always be used in conjunction with good practice engineering judgement and local engineering and architectural codes of practice for housing, and is not intended to replace them. In all cases an appropriately qualified and experienced engineer should verify the final design.

Designing homes should always be informed by robust economic, social and environmental assessments of the target community, and engineered *bahareque* housing is no exception. Some high level points to consider in this respect are also included in this report. However, since it is intended as predominantly a technical design report this is not the main focus.

2.0 Introduction to Engineered *Bahareque* Housing

This section discusses the traditional and the engineered *bahareque* housing systems, presents three case studies of engineered *bahareque* housing constructed in several countries, and proposes appropriate contexts for its adoption.

2.1 Background to traditional *bahareque* housing

Bahareque is a vernacular/traditional construction system that has been popular in many countries across the world for thousands of years (Gutiérrez, 2004). It is known as *wattle-and-daub* in the United Kingdom, *bahareque* in El Salvador and Colombia, *quincha* in Peru, *cuje* in Cuba, *pao pique* in Brazil, and *tabiquería* in other parts of Latin America (Carazas-Aedo & Rivero-Olmos, 2013). Similar forms of wattle-and-daub type housing also exist in other countries around the world. For the purposes of this report, all of these derivatives will be referred to as *traditional bahareque*. Figure 1, Figure 2, Figure 3, and Figure 4 show some examples of traditional *bahareque* housing.



Figure 1: A well-constructed traditional rural bahareque house in Armenia, Colombia (Kaminski, 2016)



Figure 2: Traditional bahareque housing in Berlín, El Salvador. The outer render has been replaced with corrugated-iron sheeting (Kaminski, 2016)



Figure 3: Traditional bahareque housing in Berlín, El Salvador. The outer render has spalled off (Kaminski, 2016)



Figure 4: Traditional rural bahareque housing in El Salvador. No outer render has been applied (Kaminski, 2016)

Traditional *bahareque* typically consists of a timber and/or bamboo frame, clad in a matrix of split or opened bamboo (known as *esterilla*), cane, twigs or timber strips, and finally plastered in manure or soil, sometimes with straw added for strength (López et al., 2004). It is normally elevated on top of a stone or brick upstand to reduce the risk of dampness, has a good roof overhang, and uses naturally durable timber or treated timber and bamboo (in Latin America pig soap is used – a traditional soap made from pig fat and ash) (Carazas-Aedo & Rivero-Olmos, 2013). Figure 5 illustrates some of the main structural features of traditional *bahareque* systems.

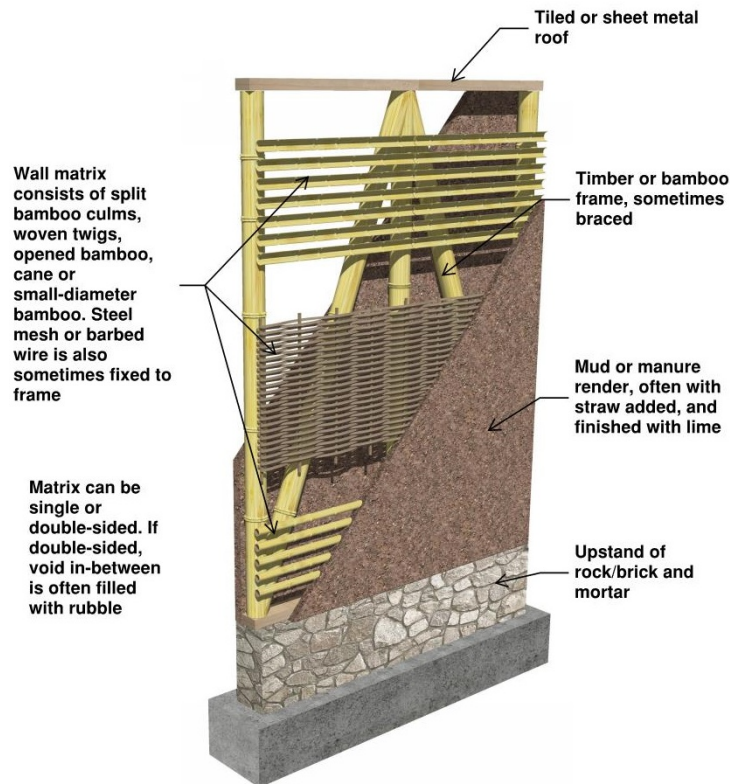

Figure 1: Traditional *bahareque* in Latin America

Roof build-ups vary. In Latin America, historically, the roof was constructed from palm fronds but switched to cooler yet heavier clay tiles after the Spanish invasion (López et al., 2004). Corrugated iron sheets are now sometimes used for the roof in some areas of Latin America.

Wall matrix material varies according to what was most easily available locally, normally hardwood timber strips, bamboo, or cane. Figure 6, Figure 7, Figure 8, Figure 9 and Figure 10 present some of the matrix types, and Figure 11 illustrates a typical solid traditional *bahareque* infill. Traditional *bahareque* can be constructed to differing degrees of formality, from rural informal single storey housing that needs frequent maintenance, to urban two storey formal housing, which may be regarded as relatively upmarket.

Properly constructed and maintained traditional *bahareque* has been shown to possess good structural unity and flexibility, and therefore has a surprisingly high degree of earthquake resistance (Gutiérrez, 2000; López et al., 2004). Some forms

of traditional *bahareque* can also be relatively light when compared to modern construction systems such as reinforced concrete with masonry infill. Lighter buildings experience lower earthquake loads, hence are less likely to experience damage and collapse; should collapse occur, lighter buildings are also less likely to cause injury.

However, traditional *bahareque* requires a reasonable standard of construction, detailing and maintenance so as not to deteriorate under fungal or insect attack. In addition, the traditional treatments used are not entirely effective and damage due to termites and borer beetles is still common (both of which are a significant risk in many parts of the world – see Section 4.0). Because of this, frequent maintenance is essential, which includes periodic rendering and painting, replacing damaged elements, and controlling water ingress – without this, traditional *bahareque* generally becomes very vulnerable to earthquakes after around 5-10 years (López et al., 2004). The Muisne earthquake in Ecuador on 16th April 2016, for instance, illustrated this clearly, since some traditional *bahareque* houses were severely damaged or collapsed primarily because of rot and insect damage (Franco et al., in press).



Figure 6: Esterilla (Colombia) or caña picada (Ecuador): Sheets of bamboo formed by physically opening / splitting a large diameter culm along its length and then unrolling it (Kaminski, 2016)



Figure 7: Esterilla (Colombia) or caña picada (Ecuador): Sheets of bamboo formed by physically opening / splitting a large diameter culm along its length and then unrolling it (Kaminski, 2016)



Figure 8: Reglilla (Colombia) or latillas (Ecuador): Laths of bamboo formed by cutting a large diameter culm along its length into strips (Kaminski, 2016)



Figure 9: Caña brava (Costa Rica) or vara de castilla (El Salvador): Small diameter bamboo-like cane (Kaminski, 2016)

Another important disadvantage of traditional *bahareque* is that it is prone to harbouring insects, notably 'the kissing bug', or *chinche*, as it is known in Latin America. This small biting insect can transmit Chagas Disease, a potentially life-threatening illness that is estimated to currently affect 10 million people worldwide, mostly in Latin America (WHO, 2010).

Traditional *bahareque* is not known to be endorsed by seismic codes around the world, and therefore does not generally attract the attention of potential charities to sponsor housing projects.



Figure 10: Timber hardwood battons nailed together to form a rectangular matrix spanning between larger vertical studs (Kaminski, 2016)



Figure 11: Close-up of infill material used in solid traditional bahareque in El Salvador – note the pieces of clay tiles added to the soil (Kaminski, 2016)

2.2 Engineered Bahareque Housing

Over the past 40 years there has been a growing trend of building with *engineered bahareque* housing (“*bahareque encementado*” in Spanish) as a form of low-cost housing for development and post-disaster contexts in developing countries (Kaminski, 2013). This housing takes the vernacular form of *bahareque* and engineers it to reduce or remove *bahareque*'s natural deficiencies, and generally improve it with modern materials, knowledge, and construction techniques. Well-designed engineered *bahareque* typically has the following characteristics (Figure 12 and Figure 13):

- **Foundations:** reinforced concrete strip footings.
- **Upstand elevating base of wall:** reinforced concrete or reinforced masonry upstand.
- **Primary wall structure:** timber or bamboo columns, wall studs, beams, floor joists and rafters, joined together by modern mechanical connections such as bolts, nails or screws. In some systems, bracing is used, especially in two-storey buildings. Timber is normally used for the sole and head plate. Damp-proof membrane separates the frame from the upstand.
- **Walling system:** a matrix consisting of either cane, small diameter bamboo, bamboo laths, or bamboo mats is nailed to the timber or bamboo wall structure, and galvanised steel chicken mesh nailed to the matrix acts as

reinforcement. The reinforcement is then plastered with cement mortar render, sometimes with lime added. In some systems an expanded steel mesh such as Expamet (2016) acts as both the matrix and the reinforcement, and this is nailed directly to the frame. The most common system is large diameter bamboo studs with a timber sole plate and head plate, with opened bamboo *esterilla* forming the matrix. The walling system is both structural and forms the internal partitions and external façade. The matrix and cement mortar render can be fixed to just one or both sides of the studs – the latter is more common.

- **Upper floors:** timber or bamboo beams, with flooring made from plywood, bamboo mats with concrete poured on top, or timber floorboards.
- **Roof:** timber or bamboo rafters and purlins form the frame, joined together by modern mechanical connections such as bolts, nails or screws, with a roof covering of metal or cement fibreboard sheeting, or in some cases clay tiles.
- **Number of storeys:** only one or two – more than two storeys is not recommended for fire and structural reasons.

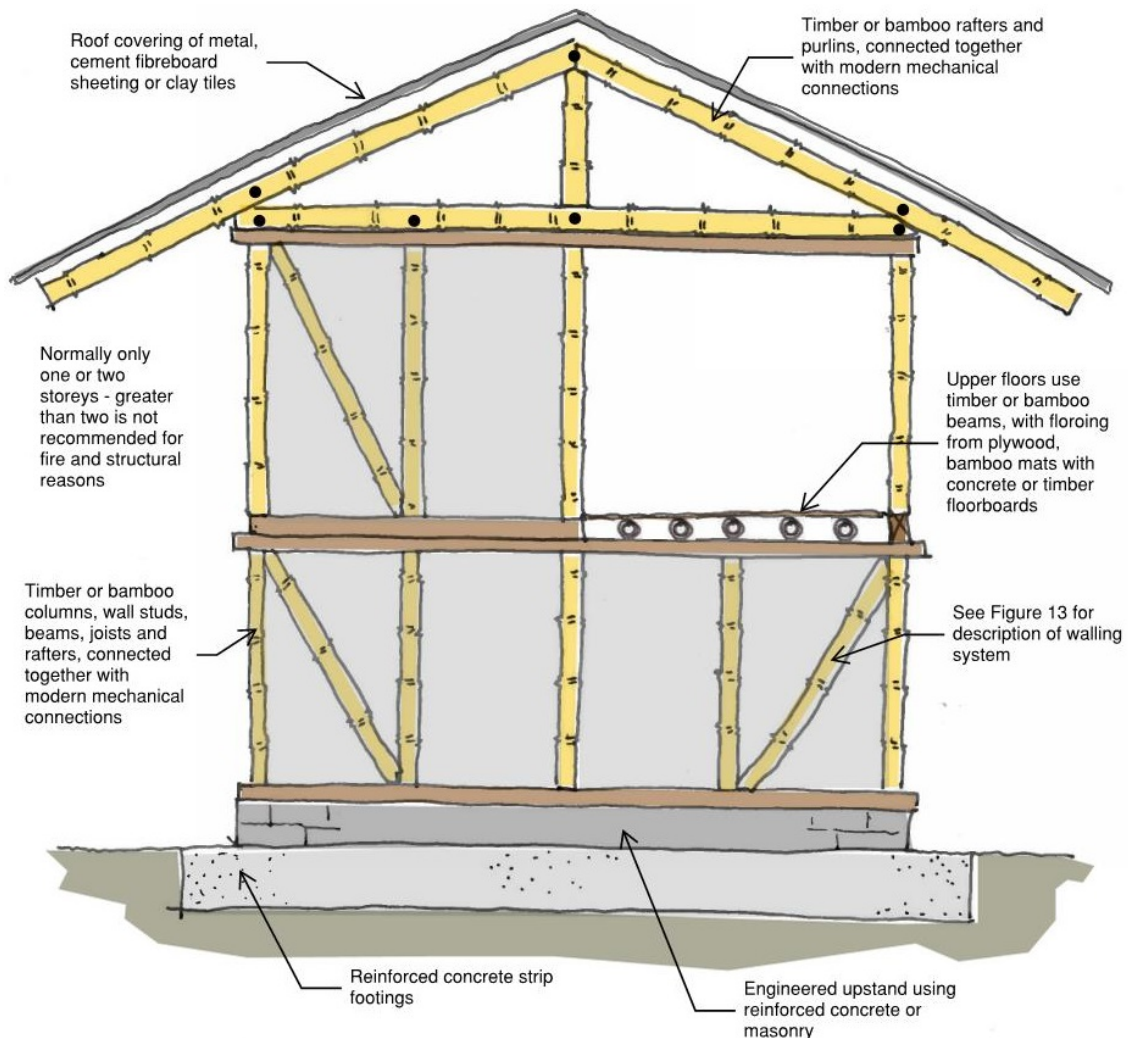

Figure 12: Characteristics of modern well-designed engineered bahareque housing: overview

In all cases, the timber used is either naturally durable timber or treated timber, and the bamboo is treated.

With the changes outlined above, coupled with good construction and maintenance, this sort of structural system is a significant improvement over traditional *bahareque*, in terms of:

1. **Durability:** the system can have a design life exceeding 50 years (see Section 4.0).
2. **Structural performance in earthquakes and winds:** the system can exceed earthquake design requirements in high seismic zones (see Section 6.3).
3. **Hygiene:** the use of cement mortar render, and a cement-based floor provides a finish that is easier to clean and durable, hence providing a more hygienic internal environment for the occupants.
4. **Status:** the system is perceived as a modern-looking home, important for communities in lower socio-economic brackets who aspire to have what they perceive to be a better and more durable house, and one which reflects a higher level of prosperity in comparison to their neighbours (Gutiérrez, 2000; López et al., 2004; Kaminski, 2013).

In comparison with other modern forms of low-cost housing currently constructed around the world in both post-disaster and development contexts, engineered *bahareque* has been shown to be of equal or lower cost (see Section 2.3), has greater seismic resistance (see Section 2.3 and 6.3), superior sustainability credentials (see Section 3.0), and can use more local materials, which brings more direct benefit to local communities (see Section 2.3).

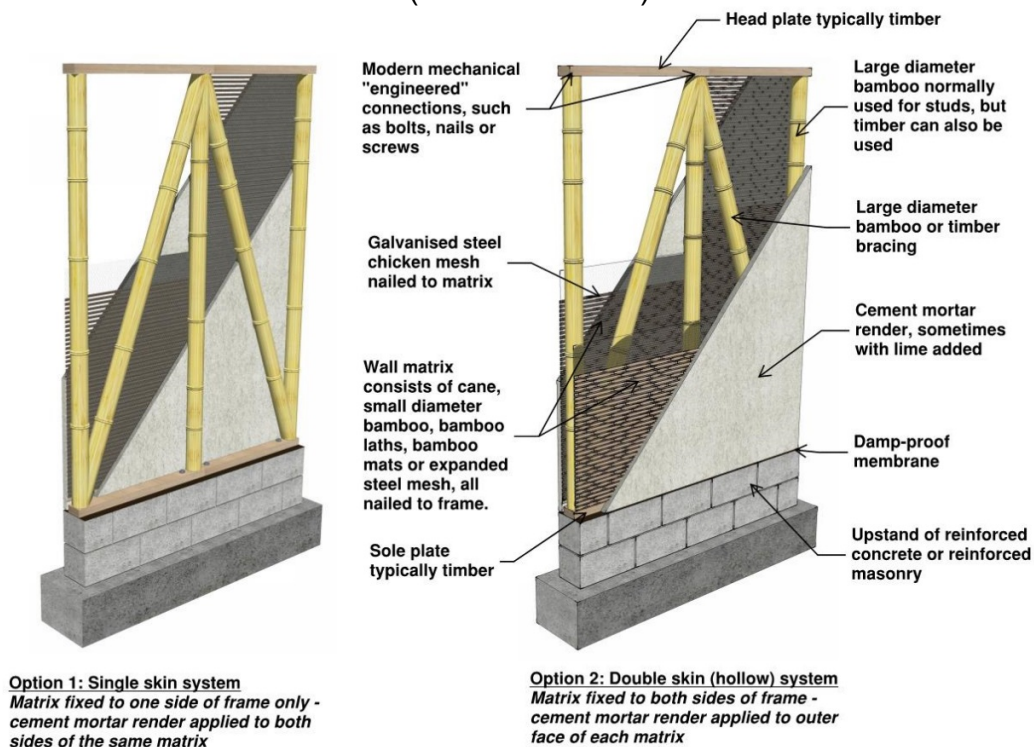

Figure 13: Characteristics of modern well-designed engineered bahareque housing: details of walling system

2.3 Case Studies

The following are a few examples of engineered *bahareque* housing constructed in various countries around the world.

National Bamboo Project, Costa Rica

In 1988 the Costa Rican National Bamboo Project (*Proyecto Nacional de Bambú – PNB*) (Gutiérrez, 2000) developed and implemented engineered *bahareque* as a cheaper and more sustainable form of housing. Because there was no significant tradition of building with bamboo, the project involved a technology transfer of growing and designing with cane and bamboo from Colombia, and in total, up until 1995 around 4000 of these single storey low-cost houses were built for poor communities who had been living in sub-standard or cramped housing across the country. The designs varied and used either a naturally durable hardwood, or treated *guadua* for the frame, with a matrix of *esterilla* or *caña brava* (a strong cane) for the wall matrix, covered in cement mortar render, with a lightweight corrugated iron sheeting roof. The *guadua* was treated with boron by the modified boucherie sap-displacement method (Section 4.4), and the *caña brava* and *esterilla* were also treated with boron, but by the dip-diffusion method. Some pre-fabrication of the panels was implemented, which sped up the construction process on site.

Full scale in-plane wall tests were conducted at the University of Costa Rica in order to determine the shear capacity of the walls to resist wind and earthquakes (Mendoza & Villalobos, 1990), and the tests demonstrated that the capacity was greater than the design requirements. Further confirmation of the strength of these types of panels was seen when a number of newly constructed houses survived a Magnitude M_w 7.8 earthquake in Limón in 1991, with local MMI intensities up to IX (Gonzalez & Gutierrez, 2003).



Figure 14: PNB houses in Costa Rica under construction in the 1980s (Chaves, 2016)

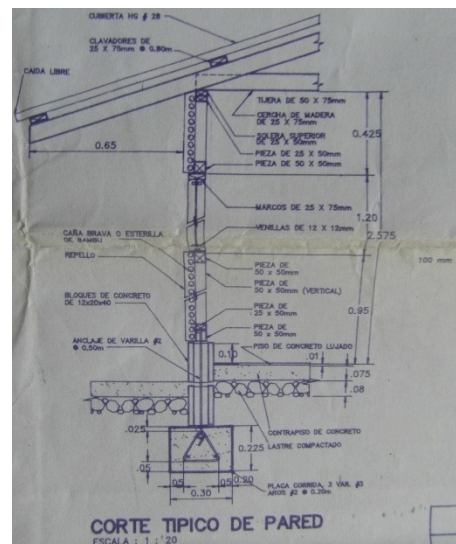

Figure 15: Typical section through PNB house in Costa Rica (Chaves, 2016)



Figure 16: PNB house in Milano, Costa Rica – photo taken at 20+ years since construction (Kaminski, 2016)



Figure 17: Interior view of PNB house in Milano, Costa Rica – photo taken at 20+ years since construction (Kaminski, 2016)

An independent review of 26 of these houses in 2012, i.e. 12-24 years since construction, concluded that they were sufficiently well-liked by the beneficiaries to have changed many of their preconceptions regarding building with bamboo. The majority of the houses appeared to be in excellent condition and the treatment methods successful (Kaminski, 2013).

Coffee-growing region earthquake housing, Colombia

In 1999 a Magnitude M_w 6.4 earthquake struck the coffee-growing region of Colombia, resulting in 300,000 people being made homeless (Tistl & Velásquez, 2002). After this event it was noticed that while more modern masonry and reinforced concrete buildings suffered significant damage and often collapsed, the vernacular *bahareque* style and modern bamboo housing had fared significantly better (Trujillo, 2007). As such, a number of NGOs and international development agencies implemented housing reconstruction projects that principally used bamboo for the building structure following the *bahareque* style, but with engineering input and modern details (Figure 18, Figure 19, Figure 22, Figure 23, Figure 20 and Figure 21). This interest spurred the Colombian Earthquake Engineering Association (AIS) to conduct research into engineered *bahareque*, which included a series of shear tests on the wall panels – the results of the tests were generally similar to those obtained in Costa Rica. Following this, the *Construction Manual for Seismically-Resistant Housing using Mortared Bahareque* (*Manual de construcción sismo resistente de viviendas en bahareque encementado*) was written (Prieto et al., 2002), alongside a new chapter in the Colombian design and building code – NSR-98 (AIS, 2002), to which some of the new bamboo houses were designed (although some of the projects were implemented before this new research was published). The houses were a mixture of one and two storeys, and varied from detached to terraced. Wall systems also varied and included braced and unbraced *guadua* and/or timber frames, and used either *esterilla* or expanded steel mesh for the matrix. Most, if not all, of the bamboo used for the different types of houses was treated using boron and applied most commonly by either immersion or injection.



Figure 18: Post-earthquake engineered bahareque housing in Barcelona, near Armenia (Kaminski, 2016)



Figure 19: Post-earthquake engineered bahareque housing in Montenegro, near Armenia (Kaminski, 2016)



Figure 20: Post-earthquake engineered bahareque housing in Montenegro, near Armenia (Kaminski, 2016)



Figure 21: Engineered bahareque in Ricaurte in the Magdalena valley (Kaminski, 2016)

An independent review of 29 of these houses in 2012 (around 10-12 years after construction) concluded that there were mixed opinions about these houses by beneficiaries (Kaminski, 2013). While the houses generally did appear to be in good condition, much more of the wall and structural elements were exposed to driving rain than the PNB houses, which appeared to be the cause of the visible water ingress and corrosion to the chicken mesh in some houses –suggesting that in some places there could be further hidden rot damage of the bamboo matrix inside the walls. Some beneficiaries also complained about vermin living inside the wall cavities and running around the roofs. Where housing was in good condition with no water ingress or vermin, the opinions were very positive.



Figure 22: Post-earthquake engineered bahareque housing in Barcelona, near Armenia (Kaminski, 2016)



Figure 23: Post-earthquake engineered bahareque housing in Montenegro, near Armenia (Kaminski, 2016)

REDES housing, El Salvador

Since 2012, Arup, in conjunction with the El Salvadoran NGO named *Fundación Salvadoreña para la Reconstrucción y el Desarrollo* (REDES), have been exploring the possibility of building low-cost homes using more sustainable and local materials, in order to reduce their environmental impact and support the local community (Kaminski et al., 2016a). The aims were to produce a viable housing technology and design that was:

- Low-cost.
- Disaster-resilient.
- Durable and termite-resistant.
- Thermally comfortable.
- Easy to construct by semi-skilled labour.
- Easy to maintain by un-skilled labour.
- Safe to construct.
- Culturally acceptable.
- Flexible in layout.
- Constructed with community-sourced materials.
- Required minimal maintenance.
- Had appropriate room layouts and uses.

The design was intended to be available for use in both long-term development and post-disaster contexts to replace existing sub-standard or damaged housing in rural and peri-urban areas across El Salvador.

After reviewing the local market and both traditional and modern housing styles, the local traditional *bahareque* construction was identified as a solution that could be improved, by making it a more durable and stronger form of housing. The design that was developed is a single storey four roomed 6m x 6m building, with two bedrooms, one living room, and one kitchen (Figure 24, Figure 25, Figure 26 and Figure 27). The foundations of the house were a thin reinforced concrete slab sitting on reinforced concrete ground beams under the walls. Two courses of hollow reinforced blockwork elevate the frame, which is made from simple 2"x4" structurally graded and pressure-treated imported pine timbers, connected together with nails and steel straps. The walls were wrapped in a thin galvanised chicken mesh on both sides, and *vara de castilla* (also known as caña brava (*Gynerium sagittatum*) – a local type of bamboo-like cane approximately 25mm in diameter and up to 6m long (Chan, 2014)) was nailed to the frame. The *vara de castilla* was sourced from local farmers and was treated on site against insects with boron. Cement mortar render was then plastered on both sides of the walls to form the 60mm thick shear walls. No bracing was added.



Figure 24: Cane and timber housing, El Salvador – before application of render. Note the large overhangs on all sides and the elevated frame on a damp-proof membrane (Kaminski, 2016)



Figure 25: Cane and timber housing, El Salvador – complete (Kaminski, 2016)



Figure 26: Cane and timber housing, El Salvador – complete (Kaminski, 2016)



Figure 27: Cane and timber housing, El Salvador – complete. Note the upstand, damp-proof membrane and large overhang, all protecting the wall from moisture and rain (Kaminski, 2016)

The lower halves of the walls were painted with waterproof paint to protect against driving rain. The roof consisted of lightweight cement fibreboard sheeting screwed down onto the timber purlins and rafters, and had a large overhang on all sides. In comparison with reinforced blockwork, which is currently widely used as the low-cost housing of choice by the government, NGOs, and communities themselves, this new form of housing uses up to 40% less cement and steel. The raw materials for the housing are also lighter overall and hence easier and cheaper to transport to more rural areas.

In order to test the walls structurally, a series of cyclic shear tests were conducted at Imperial College London using different geometrical and material characteristics (Málaga-Chuquitaype et al., 2014). The tests showed that this form of structure exceeded the load requirements for the high seismic loads of El Salvador (Kaminski et al., 2015). The final detail adopted uses two layers of chicken mesh, one either side of the cane with steel wire through-ties (Davies, 2014) – thereby eliminating any risk of spalling in large earthquakes and improving the in-plane strength of the wall, while also further reducing the importance of the quality of the cement mortar, which can be hard to control.

For the roof, a simple duo-pitch timber frame was selected, which also follows the traditional *bahareque* style. Instead of using the heavy traditional clay tiles for the roof covering, a corrugated cement-fibreboard sheeting material was used.

As a final verification of the seismic behaviour of the design, a full-scale 3m x 3m model of one room of the house was constructed on a shake-table at the University Mariano Gálvez, Guatemala City (Beteta et al., 2015). The specimen was subjected to earthquake design loads up to 1.5 times greater than the code requirements, and experienced insignificant damage. These observations are similar to other unpublished testing from Colombia, which shows two-storey engineered *bahareque* housing having excellent performance on shake-tables.

On completion of two prototypes of the house in 2012, a structural and sociological evaluation of the design was carried out (Bunclark, 2013), showing very positive results. In addition, all the beneficiaries liked the design, and some now prefer it to reinforced masonry.

A selection of drawings of the houses are presented in Appendix A.

2.4 When is engineered *bahareque* housing suitable?

The following questions should be considered when deciding whether engineered *bahareque* is suitable for housing in a particular context:

1. ***Is there a sufficient quantity of sustainably sourced bamboo and/or timber?*** This makes engineered *bahareque* most suited to countries with plentiful supplies of these materials.

2. ***Is there community acceptance of the use of bamboo/timber for housing?***
Many cultures consider bamboo and timber a poor man's material. However, studies have shown that this perception can be changed (Kaminski et al., 2016a).
3. ***Are the occupants financially able and willing to maintain the houses?***
Engineered *bahareque* housing can be designed to be very durable, but like timber housing generally needs a little more care and maintenance throughout their lifespan.
4. ***Is the housing type to be built on one or two storeys?*** Engineered *bahareque* is most suitable for one or two storey housing.
5. ***Is there a risk of flooding?*** Engineered *bahareque* is unlikely to be appropriate for areas at risk of flooding.

3.0 Designing for Sustainability

This section discusses the embodied carbon and environmental impact of the key materials used for engineered *bahareque* housing, and proposes how the designer can maximise the sustainability of the house.

Engineered *bahareque* housing has been shown to be environmentally superior to other forms of housing such as masonry, with as little as half of the embodied carbon and the ability to be built largely using fast-growing sustainable materials such as bamboo. Its sustainability can be maximised by ensuring the bamboo and timber is taken from a local and sustainable source, minimising the thickness of cement mortar render and maximising the use of cement replacements such as lime. Non-toxic treatment chemicals should be used whenever possible for the bamboo and timber.

3.1 Introduction

Engineered *bahareque* housing has been shown to be superior to many other forms of modern permanent housing in terms of sustainability and its environmental impact, especially housing systems using materials such as masonry and concrete. The two main reasons for this are that engineered *bahareque*:

- Utilises a lot of natural materials, namely bamboo and timber, which:
 - Do not require significant processing before use.
 - Are relatively light and therefore easy to transport.
 - Effectively “lock up” carbon during the life-span of the structure, helping to act as a carbon sink. Bamboo, in particular, is a good carbon sink – studies have shown that a managed bamboo forest accumulates around 300 tonnes of carbon per hectare after 60 years, compared with around 170 for fast growing tree species such as Chinese Fir (Kuehl & Yiping, 2012).
- Is overall a light and efficient construction system, where the walls double up as both partitions and structure, reducing the amount of needed material.

As a case study, Murphy et al. (2004) conducted a Life Cycle Assessment (LCA) of an engineered *bahareque* house in order to assess in detail its environmental impact. The example house was one built in the early 2000s in Colombia, as part of the 1999 earthquake reconstruction program (Section 2.3).

In this study, the environmental impact of the house was calculated and compared to that of a hypothetical house built to the same standard using conventional masonry construction. The results showed that the engineered *bahareque* house had around half the environmental impact of the conventional house (Figure 28). The elements of the building that contributed most towards its environmental impact (95%) were the materials used for the foundation (sand, coarse aggregate, cement, and steel reinforcement) and the render of the walls (sand and cement) (Figure 29).

The following sections explore the embodied carbon and environmental impacts of engineered *bahareque* housing in more depth.

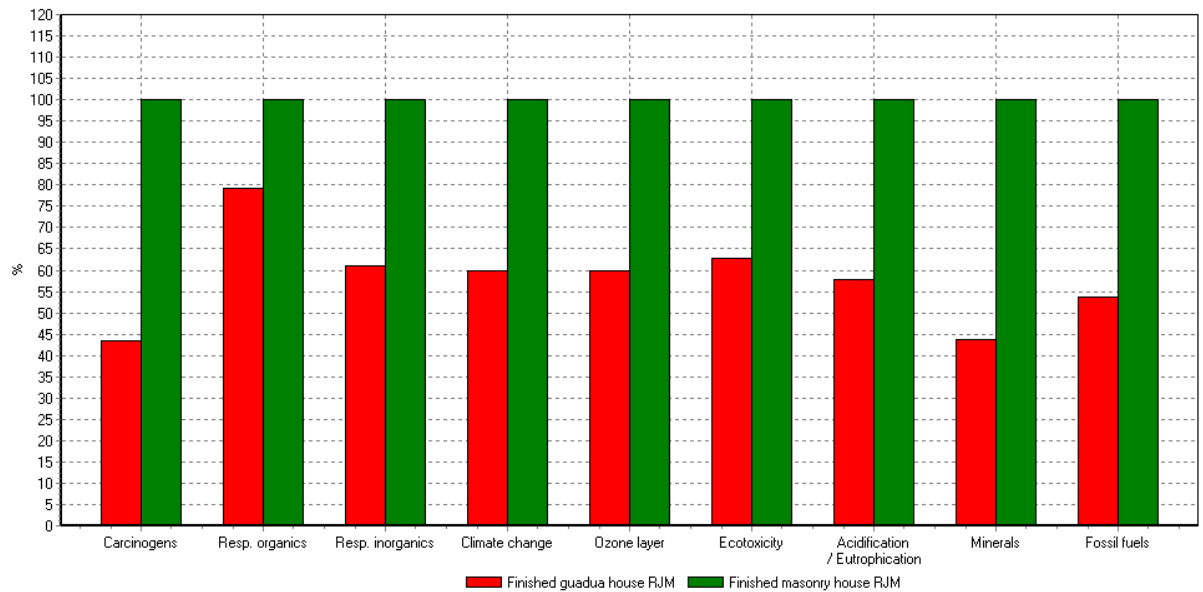

Comparing 1 p assembly 'Finished guadua house RJM' with 1 p assembly 'Finished masonry house RJM'; Method: Eco-indicator 99 (H) V2.1 excl. Land Use & Radn. / Europe EI 99 H/A / characterization

Figure 28: Relative environmental impact of an engineered bahareque and masonry house (Murphy et al., 2004)

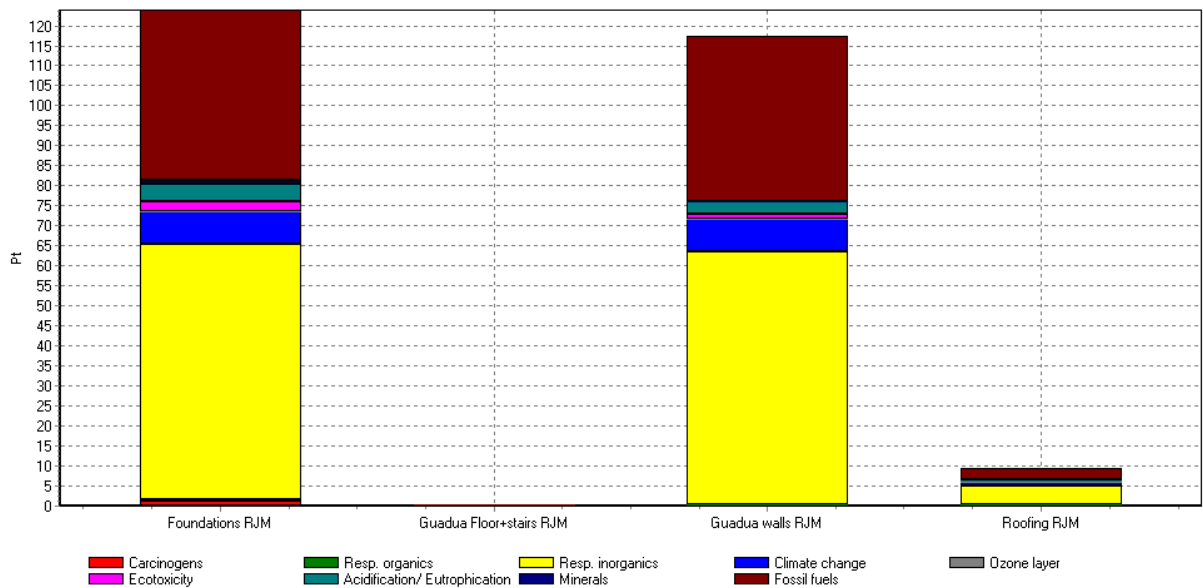

Comparing product stages; Method: Eco-indicator 99 (H) V2.1 excl. Land Use & Radn. / Europe EI 99 H/A / single score

Figure 29: Relative environmental impact of the elements of an engineered bahareque house (Murphy et al., 2004)

3.2 Embodied carbon and environmental impact of engineered *bahareque* housing

The embodied carbon of a material is the total amount of CO₂ emitted throughout its life cycle. The environmental impact of a material is any effect a material may have, whether positive or negative, on the surrounding environment throughout its life cycle.

There are many ways to define the life cycle of a material, and many internationally recognised standards available (ISO, 1997; Eco-Indicators, 2000). However, the European construction industry standard is EN 15978 (BSI, 2011). The key stages can broadly be broken down into the following:

- a) **Raw material sourcing:** the impact due to sourcing/excavating/harvesting the materials for building.
- b) **Processing:** the impact due to processing of the materials ready for construction.
- c) **Transport:** the impact of transporting the materials at every stage in the supply chain.
- d) **Construction:** the impact of constructing the building.
- e) **Use:** the impact of using and maintaining the building.
- f) **End of life:** the impact of disposal of the building at end of life.
- g) **Recycle and reuse:** the impact of recycling and reusing the materials in the building.

It is important to take a holistic approach and consider the whole life cycle of all materials used for construction, in order to avoid any single focus of environmental and sustainability assessments.

Each of the above stages are considered below for the key components of engineered *bahareque* housing, i.e. the frame, walls, floors, finishes etc.: treated bamboo/cane, timber, cement mortar render, upstand, steel connections and components. This section intentionally does not discuss the materials used to make the foundations or the roof finishes, because these are largely identical in all forms of housing (all houses require foundations, which are normally reinforced concrete, and all houses require a durable and waterproof roof).

Treated bamboo/cane elements

Treated bamboo (and/or cane) normally makes up a significant portion of engineered *bahareque* housing. Its embodied carbon and environmental impact is discussed in Table 31.

Sourcing	<ul style="list-style-type: none"> • Little embodied carbon impact. • Should be harvested from well-managed plantations (Kuehl & Yiping, 2012). Forest Stewardship Council (FSC, 2016) or similar certified plantations are very rare, so assessments of how well-managed a plantation is can be subjective. Over-harvesting of bamboo/cane can lead to death of the clump and reduction of plant cover, which in turn can lead to erosion of the soil. Note that some species of bamboo (especially running species) can be aggressive and invasive (Shyama, 2016), and these sources should be reviewed to ensure they are not contributing to damaging the local flora.
Processing	<ul style="list-style-type: none"> • Embodied carbon depends primarily on whether energy is required for drying the bamboo or heating up the treatment liquid – neither are necessary, however both speed up the process. A solar kiln can reduce the energy required for drying, as can using offcuts of the bamboo for a fired kiln.
Transport	<ul style="list-style-type: none"> • Embodied carbon depends entirely on distance from plantation – studies have shown that under 200km the impact is relatively low.
Construction	<ul style="list-style-type: none"> • Embodied carbon is generally very low as little machinery or tools are used.
Use	<ul style="list-style-type: none"> • Embodied carbon depends on maintenance required, which can be kept to a minimum by designing for durability, as per Section 4.0. • Boron treated bamboo is safe to touch.
End of life	<ul style="list-style-type: none"> • Embodied carbon varies depending on whether the bamboo is burnt as a biofuel or used to fire bricks, therefore recovering energy, or whether it is simply left to rot in which case the carbon is released back into the atmosphere. • Boron treated bamboo can normally be safely buried or composted. However, bamboo treated with copper-based chemicals is more difficult to safely dispose of, should not be burnt, and generally should be buried. • Any residual solution from the boron treatment can be safely diluted down and used as a fertiliser. However, overuse or simply dumping into rivers can have detrimental impacts such as eutrophication of rivers.
Recycle and reuse	<ul style="list-style-type: none"> • Bamboo cannot realistically be recycled, but it can be reused, for example, for building something else – thereby reducing its embodied carbon.

Table 1: Embodied carbon and environmental impact of bamboo and cane used in engineered *bahareque* housing

Timber elements

Timber is often used for some parts of engineered *bahareque* housing, especially for the sole and head plate of walls, floor joists, and floorboards. Its embodied carbon and environmental impact is discussed in Table 2.

Sourcing	<ul style="list-style-type: none"> • Little embodied carbon impact. • Should be harvested from well-managed plantations. There are many Forestry Stewardship Council (FSC, 2016) and Programme for the Endorsement of Forest Certification (PEFC, 2016) certified softwood plantations around the world, and for those that are not, they can vary very much in how well-managed they are. There are very few FSC or similar certified hardwood plantations around the world – these vary even more in how well managed they are. Guidance on what is a well-managed hardwood plantation is provided by the FSC and PEFC. • Over-harvesting of timber can lead to deforestation.
Processing	<ul style="list-style-type: none"> • Embodied carbon during processing of timber is higher than bamboo. Cutting and planing of timber uses a little energy. However, most is used during the kiln drying process, which is an essential part of most chemical treatment processes for softwoods. Hardwoods are normally used green or naturally dried, so use less energy to process.
Transport	<ul style="list-style-type: none"> • Embodied carbon depends entirely on distance from plantation and sawmill.
Construction	<ul style="list-style-type: none"> • Embodied carbon is generally very low as little machinery or tools are used.
Use	<ul style="list-style-type: none"> • Embodied carbon depends on maintenance required, which can be kept to a minimum by designing for durability, as per Section 4.0. • The safety of treated timber to touch depends upon what chemical was used to treat it.
End of life	<ul style="list-style-type: none"> • Embodied carbon varies, depending on whether the timber is burnt as a biofuel or used to fire bricks, therefore recovering energy, or whether it is simply left to rot in which case the carbon is released back into the atmosphere. • Timber treated with copper-based chemicals is more difficult to safely dispose of, should not be burnt, and generally should be buried.
Recycle and reuse	<ul style="list-style-type: none"> • Timber cannot realistically be recycled but it can be reused, for example, for building something else. This would reduce its embodied carbon.

Table 2: Embodied carbon and environmental impact of timber used in engineered *bahareque* housing

Cementitious materials, including cement mortar render and upstands

The cement mortar render and the upstand (which is normally reinforced concrete or masonry) uses a significant amount of cement, sand and coarse aggregate, which make up the bulk of the embodied energy impact. Its embodied carbon and environmental impact is discussed in Table 3.

Sourcing	<ul style="list-style-type: none"> • Sourcing of the components of cement has some embodied carbon impact due to the machinery used for mining. • The use of cement replacements such as pulverised fuel ash and ground granulated blast-furnace slag reduced the embodied energy impact significantly, as these are waste products. Some of the cement can also be replaced with lime, which also has a low embodied energy impact. • Aggregates have varying levels of impact depending on their sourcing. The most common coarse aggregates are quarried. This process is not significantly energy intensive. However, secondary or recycled aggregates can be used to offset a percentage of this impact.
Processing	<ul style="list-style-type: none"> • Cement has a significantly high embodied impact, due to the manufacturing process required. This impact is relatively consistent regardless of where it is sourced. • The manufacture of concrete blocks is not a carbon intensive process since no energy is typically required for heating.
Transport	<ul style="list-style-type: none"> • Embodied carbon depends on the distance from the plant to site and can vary widely. However, sourcing and processing generally use a lot more energy.
Construction	<ul style="list-style-type: none"> • Generally very low as little machinery or tools are used.
Use	<ul style="list-style-type: none"> • Embodied carbon depends on maintenance required, which can be kept to a minimum by designing for durability, as per Section 4.0.
End of life	<ul style="list-style-type: none"> • At end of life cement mortar render and the upstand is normally disposed of by landfill, so no energy is recovered. However, as these are inert materials, they do not give off any gasses at end of life.
Recycle and reuse	<ul style="list-style-type: none"> • Cement mortar render or the materials used to make the upstand cannot realistically be recycled or reused. • Concrete can be crushed to be used as secondary aggregate or fill.

Table 3: Embodied carbon and environmental impact of cementitious materials used in engineered bahareque housing

Steel connections and components

Steel elements in general have a high embodied energy impact and therefore their use should be minimised. However, some steel connections are normally essential since these are what provide engineered *bahareque* with strength and ductility in earthquakes and strong winds (Section 6.3).

3.3 Summary of recommendations for designing for sustainability

From an environmental perspective, engineered *bahareque* housing has been shown to be superior to other forms of housing such as masonry. The following is a summary of the key recommendations for minimising the embodied carbon of this housing and reducing its environmental impact:

- Ensure the timber and bamboo is taken from a sustainable source.
- Use local sources of material wherever possible to reduce energy used in transport – long distance transport by ship can be more efficient than by road.
- Minimise the size and extent of foundations as much as possible, and maximise more sustainable alternatives such as nearby rubble/rocks and cement replacements.
- Minimise the thickness of cement mortar render as much as possible, reduce the sand: cement ratio and maximise more sustainable cement replacements such as lime.
- Ensure all treatment chemicals for the bamboo and timber are disposed of properly – boron is the safest effective chemical to use in this respect.
- Consider end of life for the treated bamboo, and timber.

4.0 Designing for Durability

This section discusses the durability of the key materials used for engineered *bahareque* housing, and proposes how the designer can meet the standard design life of 50 years, with a focus on the bamboo elements.

Engineered *bahareque* housing can be a durable form of housing, achieving 50 years design life through good design. Bamboo and timber are vulnerable to insect and rot attack and therefore need to be protected. To protect against insects, the bamboo should be treated with boron and the timber should be treated or be naturally durable. To protect against rot, the bamboo and timber must be kept dry through good design details such as: elevating the frame on an upstand, a damp-proof membrane, large overhangs to protect the walls from driving rain, an impermeable wall, good drip details, and ventilated cavities. Steel connections should be painted or galvanised.

4.1 Introduction

Each of the main components of engineered *bahareque* are discussed in terms of their durability in the following sections:

- Bamboo: discussed in Sections 4.2, 4.3, 4.4 and 4.5.
- Timber: discussed in Section 4.6
- Cement render: discussed in Section 4.7.
- Steel components: discussed in Section 4.8.

The focus in this report is on the durability of bamboo and timber, especially the former, because these are generally the most susceptible components of engineered *bahareque* housing, and are the ones where published information is lacking. This report assumes the housing is to be designed for a standard design life of 50 years with normal maintenance (painting, repairing of minor structural elements etc.).

4.2 Causes of decay

Bamboo has effectively no natural durability to decay because of a lack of natural toxins (Janssen, 2000), and in addition, its typically thin walls mean that a small amount of decay can have a significant percentage loss of capacity. There are two causes of decay in bamboo (Kaminski et al., 2016c; BRE, 2003):

Insect attack

Certain beetles are attracted to the starch in bamboo and lay their eggs inside the section, after which the eggs hatch and the larvae eat along the section and eventually outwards to escape, leaving small round or oval exit holes (about 1mm–6mm diameter) (BRE, 2003). Powderpost beetles (*Dinoderus minutus*), (which leave 1mm–2mm exit holes) are particularly common (Figure 30 and Figure 31). The rate of attack is fastest with fresh green bamboo (which is more susceptible), but even dry bamboo can be attacked in warm humid climates where the equilibrium moisture content of the bamboo outside (but under cover) will often be higher than in more

temperate climates (Liese et al., 2002). Beetles can be found in most warm climates around the world.



Figure 30: Beetle damage in bamboo, Ecuador – exit holes are clearly visible (Kaminski, 2016)



Figure 31: Beetle damage in bamboo, Colombia – exit holes are clearly visible (Kaminski, 2016)



Figure 32: Termites attacking bamboo, Costa Rica. The termites are just visible as the translucent insects crawling on the inside of the bamboo (Kaminski, 2016)



Figure 33: Severe termite damage to timber and cane in traditional bahareque, El Salvador (Kaminski, 2016)



Figure 34: Severe termite damage in bamboo, Costa Rica. Note how the outer painted silica shell of the bamboo is still intact in some areas and hence appears in good condition (Kaminski, 2016)



Figure 35: Severe termite damage in bamboo, Costa Rica. The small round black drywood termite droppings are just visible (Kaminski, 2016)

Termites are small ant-like insects, which live in colonies and feed on plant material. They are also attracted to the starch in bamboo, but unlike beetles have enzymes, which also enable them to break down the cellulose. Because they live in large colonies they can cause rapid damage (Figure 32, Figure 33, Figure 34, Figure 35 and Figure 36). There are two generic types of termites: subterranean and drywood. The former live in the (preferably damp) ground whereas the latter make their nests in the timber itself. Subterranean termites are translucent so build tunnels or find hidden paths to avoid sunlight (BRE, 1999) (Figure 37). Termites are found on all continents and prefer warmer, wetter climates.



Figure 36: Cross-section through insect-damaged bamboo (Trujillo, 2014)



Figure 37: Subterranean termite shelter tube emerging from crack (Kaminski, 2016)

Fungal attack (rot)

Rot is caused by a fungus. For the fungus to survive, the bamboo needs to be relatively wet with at least 20% moisture content, which essentially means the bamboo must be exposed to rain or ground moisture (Ridout, 1999) (Figure 38, Figure 39, Figure 40, Figure 41, Figure 42 and Figure 43).



Figure 38: Fungal damage, splitting and bleaching of boron-treated bamboo exposed to the sun and rain after around 10 years, Colombia (Kaminski, 2016)



Figure 39: Rot to the exposed end of the bamboo in a roof, Costa Rica (Kaminski, 2016)



Figure 40: 100% section loss of cane to the base of walls, Costa Rica. Note the mould visible at the base of the walls due to splashback from the roof. The cement and paint is clearly not sufficient protection under driving rain (Kaminski, 2016)



Figure 41: Spalling of render after earthquake, revealing rotten bamboo esterilla below, Ecuador (Kaminski, 2016)



Figure 42: Engineered bahareque house in Colombia with no roof overhang – the mould on the wall is clearly visible (Kaminski, 2016)



Figure 43: Rot (and possibly termite) damage to traditional bahareque housing, Ecuador (Kaminski, 2016)

4.3 Protection against decay

The most effective ways to protect bamboo from decay are by building with dry bamboo (Section 4.5), and by adopting appropriate design and detailing (Figure 48), as follows:

1. The bamboo should be kept dry, which can be achieved by:
 - Always placing it under a waterproof roof with a good overhang to protect against wind-blown/driving rain.
 - Providing good drip details and avoiding water traps, particularly at the bases of walls and columns – this will prevent rot and also decrease the rate of beetle and termite attack.
 - Protecting external facing engineered *bahareque* walls with a waterproof layer. There is some evidence that bamboo embedded inside cement render walls can experience some rot damage if these walls are fully exposed to driving rain (Kaminski, 2013) (Figure 40, Figure 41 and Figure 42), i.e. the cement mortar render is not fully waterproof. The water resistance of the cement mortar render walls can be improved by several methods including: better quality cement mortar render (including higher cement content and lower water-to-

cement ratio), good curing of render, use of chicken mesh reinforcement (which reduces cracking), thicker render, use of some lime (which also reduces cracking), and periodic painting. Single storey engineered *bahareque* buildings are likely to experience less rot damage than multiple storey ones because less of the wall is exposed to rain (Kaminski, 2013) – where multiple storeys are being used, consideration should be given to ways to reduce exposure and/or improve the water-resistance of the walls. The introduction of soil into the cement render mix is likely to reduce the water resistance of the wall, and in turn, reduce the durability of the bamboo embedded inside.

- Allowing it to always “breathe”. For example, any cavities in the wall should have ventilation holes to allow air to circulate, especially, any which form external walls. Additionally, never cast bamboo directly into masonry or concrete foundations as it cannot “breathe” and is very likely to rot, even if the bamboo is painted with bitumen or a similar chemical.
- Providing a sacrificial outer façade of the matrix and cement mortar that protects the frame and bracing inside – the bracing would need to be designed for the full earthquake load (Section 6.6), and the façade may need to be replaced periodically.

2. The bamboo should be separated from the ground with a good barrier, preferably a concrete ground slab, thereby forcing the termites out into the open. This will make it harder for *subterranean* termites to attack the bamboo. Maintenance will still be required to remove any termite shelter tubes, which the termites build to protect themselves against light.

In colder climates, such as Europe, these measures will often be adequate, but in warmer humid climates, where there is the risk of beetle and drywood termite attack, structural bamboo must be preservative-treated if a reasonable design life is required – although this will slightly increase the initial cost of the bamboo, it will reduce the overall life cost of the structure. For non-structural members, decay of which will not pose a safety risk, it is possible to leave them untreated and accept that the members will need to be regularly replaced. However, they will lose their attractive appearance as they start to degrade, and beetles leave significant amounts of dust from the exit holes, which can be a nuisance.

	Untreated	Treated with boron	Treatment with fixed preservatives *
Internal	2–6 years	30+ years	30+ years
External above ground	0.5–4 years	2–15 years	30+ years
External in ground contact	<0.5 years	< 1 year	15+ years

*Note: This is an inferred estimate based on a combination of limited testing conducted so far using fixed preservatives in bamboo, and on evidence from stake tests of timber (Lebow, 2004). It is not yet known whether severe exposure to rain increases the likelihood of splitting, which would weaken the culm and its connections, and allow further water ingress.

Table 4: Suggested approximate length of time before bamboo will need to be replaced (assuming a warm aggressive environment with a risk of termite and beetle attack)

The length of time bamboo will last before it needs to be replaced will depend on the environment in which it is used and the treatment type; Table 4 suggests the approximate design life of bamboo in a warm aggressive environment and indicates clearly why it should preferably be only used in a dry internal environment, and also why it should be treated. Note that the variation in time depends on the prevalence of termites nearby.

4.4 Treatment options

When selecting a treatment type or chemical and application method for bamboo, the following considerations are important (Liese et al., 2002):

- Quantity of bamboo to be treated.
- Availability of treatment facilities.
- Availability of chemicals.
- Intended use of bamboo: inside or outside.
- National legislation.
- Species: some species are more readily treatable than others.
- Transport time from harvest location to treatment facility: some treatment methods require very freshly cut bamboo.
- Budget.
- Effectiveness of treatment type or chemical and application method.
- Whether the chemical affects the structure of the bamboo or any metal fastenings.
- Toxicity of chemical to humans throughout whole life (treatment, use and disposal).
- Toxicity of chemical to environment throughout whole life (treatment, use and disposal).

Traditional treatment options

Several traditional and simple treatment options commonly used in developing countries exist (Liese & Kumar, 2003), including soaking for several weeks in water (which washes out some of the starch), smoking (which provides a light protective layer and partially heat treats the surface), and painting (which provides some protection against water). Unfortunately, these all have limited effects and hence are not normally recommended for permanent structural bamboo – they may be appropriate only for marginally prolonging the life of non-structural bamboo, or temporary shelters. Painting or varnishing, for example, does not adhere well to bamboo due to its smooth silica outer skin, tends to breakdown rapidly under ultra-violet light, and as the bamboo changes size under different moisture conditions, the paint will also crack and allow water in. Other traditional treatment methods exist that use more naturally-occurring chemicals. However, these are also not recommended as their effectiveness is limited and some may be harmful to humans.

Preservative treatment options

Preservatives are essentially toxins, which are added to the bamboo to deter fungal and insect attack. Although numerous types of treatment are available, many have limited effectiveness or are unsuitable because they pose major health and safety

risks (such as: older copper-based preservatives, including copper-chrome-arsenic (CCA) and ammoniacal-copper-arsenate (ACA), and other chemicals such as creosote and chlorpyrifos). This leaves just two basic types of preservative that are widely considered to be by far the most appropriate for bamboo:

- **Boron:** cheap to apply, effective, but soluble, so elements treated with boron cannot be used externally i.e. where they are exposed to the rain.
- **Modern copper-based wood preservatives:** expensive to apply, effective, and reasonably well fixed against leaching, so they can be used externally.

Treatment using boron

In nearly all cases, boron is by far the most appropriate chemical with which to treat bamboo (Liese & Kumar, 2003), and has a good track record (Kaminski, 2013). Boron has insecticidal (poisonous to insects) and fungicidal properties. It generally has a low mammalian toxicity, although in higher concentrations can irritate the skin and eyes, and if ingested is moderately toxic (System Three, 2013; Green Building Press, n.d.). Although boron-treated bamboo is safe to touch, there are conflicting views on whether it is hazardous when burnt (data sheets say as a general rule that boron-treated timber/bamboo should not be burnt, but some research has suggested that the risks may be much lower than this). Therefore, boron treated bamboo should only be burnt with caution. Boron treatment is also relatively low-cost.

Boron is normally used in compound form, typically as a salt. These compounds are readily available in most countries as relatively cheap fertilisers that just need to be dissolved into water. The mixture is sometimes also heated to assist in the treatment process. In all treatment methods the boron solution can be reused multiple times (but not indefinitely), and any residual solution can be safely diluted down and used as a fertiliser. The most commonly used boron-containing compound is disodium octaborate tetrahydrate ($\text{Na}_2\text{B}_8\text{O}_{13}\cdot 4\text{H}_2\text{O}$) (trade names *Tim-bor* or *Solubor*).

Although significant research has been conducted to see whether a boron-containing compound can be fixed into bamboo/timber (Liese et al. 2002), so far there has been no success, and hence all boron-containing compounds will eventually have their boron leached out when exposed to rain.

Ways of applying boron to bamboo include: modified boucherie, bath/soaking, dip diffusion, vertical soak diffusion (Environmental Bamboo Foundation, 2003), and pressure vessel (Liese & Kumar, 2003; Kaminski et al, 2016c). Provided the boron is able to fully diffuse throughout the section thickness, most of these methods can be effective and the choice of method would depend more on budget, time and proximity to source. It is worth noting that the modified Boucherie method is the only one that avoids the need to rupture the diaphragms. Maintaining a solid diaphragm improves the ability to reliably infill the internode with grout/mortar/epoxy, which is typically essential for good structural connections, and may also play an important role in controlling splitting and buckling of the culm wall. However, the modified Boucherie method can only be used within 24 hours of harvesting, which makes it impractical in certain regions. Where other methods are used, consideration should

be given to the affect that a pierced diaphragm will have on the structural performance of the elements and connections.

Treatment using modern copper-based preservatives

Modern forms of copper-based preservatives are significantly less toxic to humans than older forms because they no longer use arsenic and chromium, and instead contain a mixture of copper, biocides, and sometimes boric acid. They are very effective against fungi, termites and beetles, and are chemically relatively well-fixed into the bamboo (with the exception of any boric acid component), hence can be used externally and sometimes in contact with the ground.

Copper-based preservatives are somewhat corrosive to steel, hence galvanised or even stainless steel fixings may need to be considered. The corrosive potential will depend on the percentage retention of the active chemical. The recommended forms of modern copper-based preservatives that could be used for bamboo are copper azole types B and C (CA-B and CA-C), because they do not contain boron (which will leach out over time) and are less corrosive to steel than other forms. These copper-based preservatives are safe in use as the toxic chemical is fixed into the bamboo. However, the treated bamboo should not be burnt at end of life because this may release hazardous chemicals.

In general, copper-based preservative treatments are significantly more expensive than boron-based treatments because they all require semi-industrial pressure treatment, and also because the bamboo must be fully kiln-dried before treatment. After treatment, the bamboo needs to be re-dried by kiln drying or natural drying.

It is important to note that limited work and testing has been conducted on the use of copper-based preservatives for treatment of bamboo – although indications so far suggest that it could be very successful (Ya-mei, 2011). Testing would need to be conducted to determine the required percentage retention of the active chemical to be effective, and exactly what pressure treatment process would be suitable for this.

4.5 Seasoning

Seasoning (drying) of bamboo is important in order to carefully reduce the moisture content to a level similar to the equilibrium moisture content in service (this is moisture content of the bamboo in equilibrium with the humidity of the air, and normally varies between 10-18%). Seasoning also improves bamboo's resistance to fungi and insect attack, and is especially important before it is transported. It also limits the amount of drying shrinkage in service, which could otherwise lead to splitting, weakening, and failure of the elements, especially at the connections. Therefore, using "green" bamboo for construction of the primary structural elements should be avoided at all costs, even though green bamboo is cheaper and carpenters will tend to push for it because it is much easier to work than dry bamboo. Green bamboo should never be used for forming the matrix of engineered *bahareque* walls since it will not be able to breathe and dry out inside the cement render, and therefore is likely to rot.



Figure 44: Air drying of bamboo outside, Colombia
(Kaminski, 2016)



Figure 45: Kiln drying of bamboo, Colombia
(Kaminski, 2016)

Seasoning of large-diameter culms by leaving them to dry naturally (air drying) takes a long time (Figure 44) (several months), so solar or heated kilns are often used to speed up the process (Figure 45). Seasoning should be done slowly enough for the bamboo to shrink uniformly, otherwise cracks and splits may occur. Kiln drying therefore cannot be too fast and may need to be preceded by slower, more natural, drying.

4.6 Timber

Timber varies widely in its natural durability, depending on species (Figure 46 and Figure 47). For non-naturally durable softwoods, the information and recommendations outlined in Sections 4.2, 4.3, 4.4 and 4.5 generally applies, with the following key changes:

- Softwoods may be *slightly* more durable than bamboo.
- Drying and treatment centres are established in most countries, and therefore off-the-shelf treated timber is often available, unlike bamboo. Most of these tend to use either modern copper-based preservatives, which are very effective, or the older and more toxic (but also very effective) arsenic and chromium based chemicals – the latter should be avoided because of the health risks during the processing, construction, in-use and end-of-life of the building. Pine species are some of the few timbers which are sufficiently permeable to be amenable to preservative treatment.
- Treating softwoods generally requires kiln drying before treatment, and therefore they are generally already dry when bought off-the-shelf (except for the residual moisture from the treatment process).
- Like softwoods, most hardwoods have little or no natural durability against rot or insects. Only a small number of species have resistance to rot (Figure 46), and an even smaller number to beetles. Almost no hardwoods are termite resistant.



Figure 46: Rotten durable hardwood at the base of a column which had been cast into concrete, after extraction



Figure 47: Rot damage to timber in traditional bahareque housing, Ecuador (Kaminski, 2016)

4.7 Cement mortar render

Good quality cement mortar render is very stable and durable under different weather conditions. Render may spall when water ingress into the wall makes the matrix swell – this can be avoided by improving the water-resistance of the wall, as outlined in Section 4.3.

4.8 Steel components of engineered *bahareque* housing

Engineered *bahareque* housing generally requires steel components to connect elements together, such as nails, bolts, steel straps, and chicken mesh. Steel can corrode when not protected, especially in tropical and sub-tropical humid climates, and hence consideration should be made to protect the steel, or alternatively, provide sufficient thickness of material, so that some of the steel is sacrificial (assuming realistic corrosion rates for the steel in that particular exposure condition for the life of the structure).

Steel can be protected by hot dip galvanising, painting, or embedding it in concrete. For both galvanising and painting, ensure that the type and thickness of the coats are specified, as this can vary significantly – for galvanising refer to ISO1461 (ISO, 2009a) or ASTM A153 (ASTM, 2016), and for paint use zinc rich epoxy primers, referring to ISO12944-5 (ISO, 2007) or ASTM A780 (ASTM, 2015). All coatings, paint and galvanising require maintenance during the design life. Alternatively, stainless steel can be used, with the higher initial cost being somewhat offset by long term certainty in performance and reduced maintenance costs: refer to ISO3506-1 (ISO, 2009b) for the specification of stainless steel components.

Eurocode 5 (CEN, 2014) provides good guidance on what level of protection of steel components should be provided for different temperatures and humidity.

4.9 Summary of recommendations for designing to ensure durability

Figure 48 provides a summary of the key recommendations for designing and detailing engineered *bahareque* housing for durability.

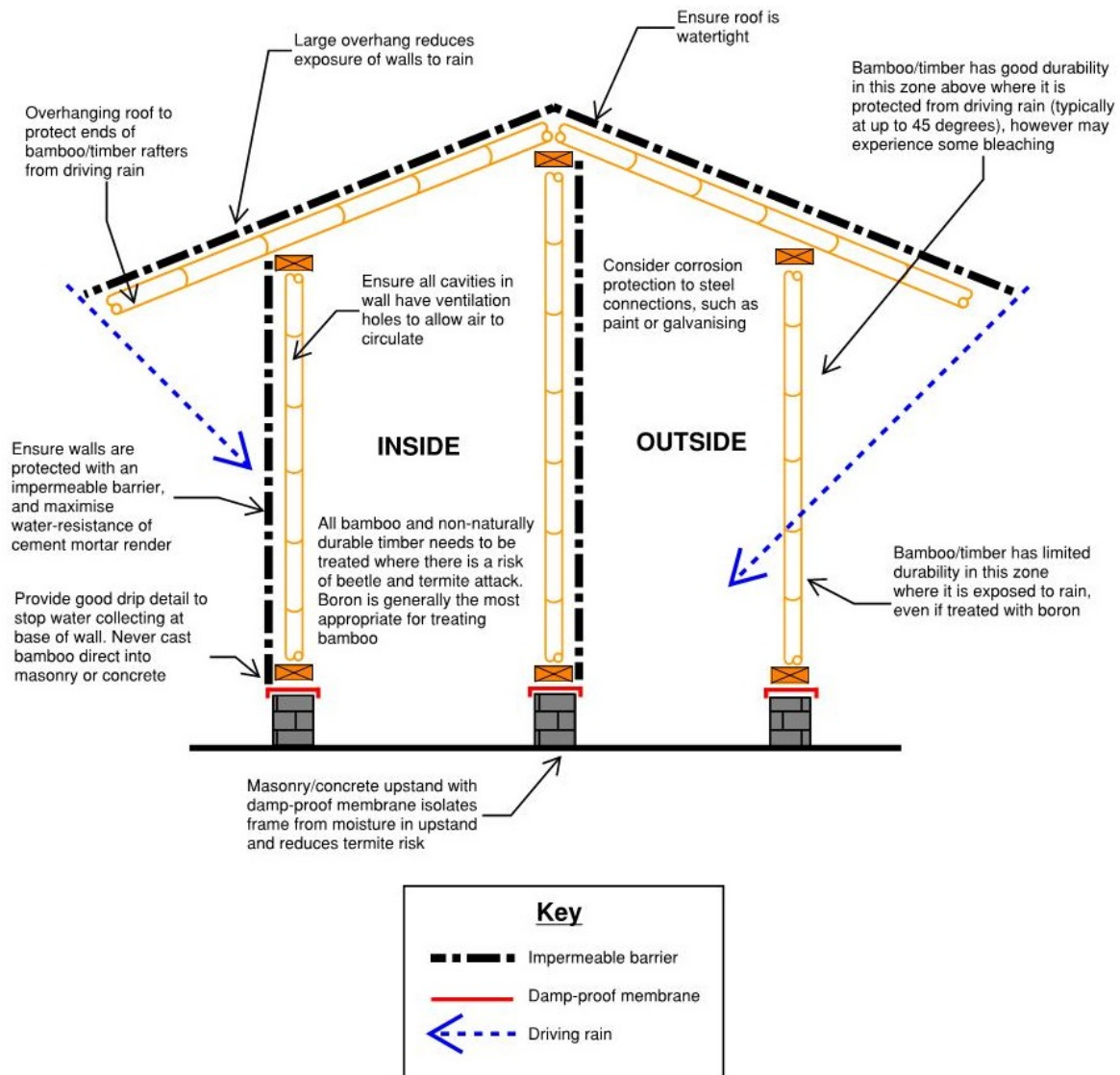

Figure 48: Recommendations for detailing engineered *bahareque* structures to protect against rot and insects (Kaminski, 2013; Kaminski et al., 2016c; Trujillo et al., 2013)

5.0 Designing for Fire

This section discusses the behaviour of bamboo and engineered *bahareque* in a fire scenario, provides recommendations on what fire resistant ratings they should be designed to, and proposes how the designer can achieve these ratings.

The engineered *bahareque* technique provides a convenient way to protect the naturally susceptible timber and bamboo from fire. Using 15mm of cement mortar render can provide a nominal level of protection, and increasing this to 25mm can provide 30 minutes fire resistance rating. Although not all walls in single family occupancy buildings normally need a fire resistance rating, a nominal level of protection is generally recommended.

5.1 Introduction

Building components constructed to resist fire are designed by understanding their material properties, and the performance is proven through fire testing. For both bamboo and engineered *bahareque*, there is very limited information on how the materials perform when exposed to fire. Using the information that *is* available, the fire safety performance of bamboo and engineered *bahareque* can be addressed by assessing the performance of the bamboo and/or timber elements as framing members, and the engineered *bahareque* as a wall assembly.

Bamboo has only a limited resistance to fire and those limitations need to be understood, so that it can be used appropriately during housing construction. For many floor and wall assemblies, the combination of differing construction elements can improve the overall fire performance of a weak element. For engineered *bahareque*, the limited fire performance of bamboo can be improved by the combination and assembly of materials, including cement mortar render.

Timber on the other hand has been well researched in its reaction to fire. Where solid timber of the same dimensions is used in lieu of bamboo in engineered *bahareque* construction, its behaviour in fire can be considered to be similar or better.

5.2 What is fire resistance?

Fire resistance is measured through fire testing, whereby a building element, such as a floor, wall or beam is exposed to a standardised heating regime and the time to failure is measured. The building element may have loads applied. The building element is assessed to resist three different criteria:

1. Structural resistance to determine how long the element can carry the applied loads;
2. Integrity to resist heat and hot gases passing through the wall or floor;
3. Insulation to prevent temperatures rising on the non-fire side.

If an element such as a wall can resist the applied loads, prevent hot gases passing through, and limit the temperature on the cold side for a period of 60 minutes exposure to the standard heating regime, then the element will be certified as achieving a 60 minute fire rating. This is referred to as a fire resistance rating (FRR).

Building materials can also be designed to limit flames spreading in the early stages of a fire, known as “surface spread of flame”, which can provide additional time for occupants to evacuate. To measure how quickly flames spread along a wall or ceiling, tests are undertaken to understand the influence of the material properties and their resistance to heat (Figure 49).

5.3 Regulatory requirements

For single family buildings, building and fire codes vary from country to country. The local regulatory requirements will determine the required fire performance of the structure, floors and walls.



Figure 49: Fire tests on engineered bahareque at Trada (Webb, 2015)

In most developed countries (e.g. Europe, US, Canada, Australia), the relevant building codes do not require single storey houses to achieve any required fire resistance for the floors or walls, provided the house is separated from its neighbour by a distance of around 2m or more. The requirements are based on the ability of firefighters to access the side of a house and spray water to prevent fire spreading

between neighbouring houses. This is not always the case, and in some countries minimum fire ratings are required for houses regardless of their location, given the limited availability of firefighting. In the UK and some other countries, fire resistance starts to be required at two storeys and above, even for detached houses.

However, where a two storey building has separate family homes located vertically above each other, an FRR is normally required in most building codes, which may be 30 minutes to 90 minutes, to prevent fire spreading from the lower unit to the upper unit, and allowing the upper floor occupants to evacuate.

If a house is constructed adjacent to another house and they share a party wall (terrace or row houses), then most codes normally require that the party wall achieves a minimum level of fire resistance, which may range from 30 to 90 minutes FRR. The approach to prevent fire spreading between houses can be based on providing the fire resistant materials to either side of the party wall between the houses. This is convenient since owners can protect themselves from a neighbouring house that may not have the required fire resistant construction. The most conservative approach is to apply the fire resistant materials to both sides of the party wall.

Engineered *bahareque* is and can be used in a wide range of countries, and the need for fire resistant construction will vary country to country. For the purposes of this report, using the more advanced building codes for fire from around the world, the following is recommended and assumed to be required in most countries:

- A minimum of 30 minute FRR for walls that are adjacent to neighbours (within 3m of a neighbour but not in direct contact).
- A minimum of 60 minutes FRR for party walls, where the houses are in direct contact).

These requirements are considered reasonable, given the expected fire load within the house for this type of housing system and the need to protect neighbouring houses from fire spread.

5.4 Bamboo and engineered *bahareque* fire properties

To understand how round bamboo and *bahareque* perform under fire conditions, relevant research has been reviewed. Fire tests on bamboo have been carried out by Mena et al. (2012), with the aim to understand ignition, flame spread, and charring rates on the bamboo species *Guadua angustifolia* Kunth (*guadua*), sourced from Colombia. The bamboo has a recorded density of 700kg/m³, which is considered a higher than average bamboo density.

For ignition, the research showed that piloted ignition was 14kW/m², which is higher than the 12kW/m² quoted for solid wood, but reasonable given the higher density of the bamboo. As the authors point out in the research, the performance is better than softwood plywood (made out of *Radiata* pine). For flame spread, the bamboo recorded an average critical heat flux of 5kW/m². This is again better than plywood

(typically about 3.5kW/m^2) and similar to other solid wood materials. Hence, for early fire development, the bamboo tested showed good resistance to heat and flames. However, since bamboo has only thin walls, bamboo will lose strength in a fire quicker than a similarly sized timber element, and hence by itself is unable to provide a reasonable minimum FRR of 30 minutes.

Mena et al. (2012) also measured the char rate for the bamboo and this was recorded as 0.2-0.24mm/min, which is a surprisingly low value. As a comparison, solid wood is typically in the range of 0.6 to 0.7mm/min. This value should be treated with caution, as it implies that solid bamboo has a superior resistance to fire through charring. This is in contrast to the observed behaviour of bamboo when exposed to a sustained fire, in that it chars at a relatively fast rate once ignited and the open cell structure does not resist continued heating once ignited. The flexural strength was also checked at differing temperatures and found to reduce with temperature, but to perform better than softwood plywood.

Salzer et al. (2016) also carried out fire testing (2016) on an engineered *bahareque* system. The bamboo species tested was *Gigantochloa apus* from Indonesia. Fire tests were carried out to Indonesian national standards, with the fire test similar to ISO834 (ISO, 2014). The aim was to achieve an FRR of 60 minutes. The test panels consisted of a bamboo frame with either a 25mm thick or 50mm thick layer of cement mortar render to one face, supported by an expanded steel mesh or bamboo lath matrix, with bamboo of approximately 100mm diameter and 10mm wall thickness. Test specimens were just over 1m^2 .

The results showed that the test panels achieved an insulation rating (one of the three criteria that is required to be passed to achieve a fire rating), with temperatures on the non-furnace side reaching a maximum rise of 100°C . This showed that the system is effective in preventing heat transfer through the panel, if the panel integrity can remain in place. The tests also showed that using an expanded steel mesh for supporting the cement mortar render performed better than an organic based matrix. Char rates were also not recorded as the thickness of cement mortar render mostly prevented the occurrence of charring.

The research also showed that connections between the horizontal and vertical supports impact on load-carrying capacity under fire. The larger the wall thickness of the bamboo, the better the connections were able to resist the movement induced by the fire, resulting in an improved fire resistance.

A number of fire tests of engineered *bahareque* panels were also conducted through research at Coventry University. Webb (2015), under the auspices of BMTRADA, using a number of differing panel configurations. Bamboo specimens ranged from 80mm to 110mm in diameter, and wall thicknesses of 5mm to 14mm. The density was recorded as 677kg/m^3 for one specimen. One panel used chicken wire with bamboo strips for the matrix, and the second used expanded steel mesh. Fire tests were undertaken to BS476-22 (BSI, 1987) and the panels were 1.35m x 1.35m. The cement mortar render thickness was approximately 14mm and was applied to one side of the bamboo matrix, which was fixed to one side of the bamboo frame only.

The aim of the fire tests was to achieve 30 minutes FRR, which was not achieved, with the panels failing before this time period. The failures were an insulation failure (increase in temperature on the cool side) – although the panels did achieve integrity (preventing flames and smoke leaking through).

Char rates under this test were measured and ranged from 0.71mm/min to 0.96mm/min - results that are similar to those recorded for wood products with a density of 300 to 450kg/m³. Char rates were also recorded within a cone calorimeter test to ISO5660-1 (ISO, 2015), which is a small scale but more accurate method – recording 1.56mm/min. The cone calorimeter char rate is obviously significantly different to the char rates recorded through the fire testing. The accuracy of char rates is difficult to accurately determine in fire testing, but the significant difference between the fire test and cone calorimeter results is beyond a measurement error. The very high charring rate from the *single* cone calorimeter test is likely to be a consequence of large splits in the specimen. Cone calorimeter tests require specimens to be flat, and the flattening of the bamboo culm piece resulted in cracks or splits, through which the heat was able to penetrate the rear of the specimen and hence accelerate the apparent charring rate.

The results and discussion contained in Webb (2015) provide some useful information on how engineered *bahareque* construction can be improved to increase fire resistance, and demonstrate that a 30 minute FRR is feasible and achievable.

5.5 Discussion on fire testing results

Bamboo

Round bamboo has some resistance to fire and heat due to the high silica content of the fibres in the bamboo. The silica content reduces towards the inner wall of the bamboo, hence the fire resistance reduces once the line of heating starts to move past the outer skin. Char rates are dependent on bamboo density, moisture content, and fibre direction. Moisture content will vary between species, as will density.

From the fire testing reviewed, there are a range of char rates recorded, from 0.2mm/min to 1.56mm/min, which is a significant variance. As all fire tests discussed above had the same fibre direction, the differences show that density, moisture content, and test methodology have a significant impact on behaviour.

Density for bamboo is recorded as 300 to 800kg/m³ from various sources (Wood Database, 2016; Trujillo, 2007; Kaminski et al., 2016b). The Australian Standard AS 1720-4 (Standards Australia, 2006) has a method for determining a char rate based on density and using a density of 300, 500 and 700kg/m³, with a moisture content of 12% assumed, leads to a char rate of 1.27mm/min, 0.71mm/min and 0.56mm/min. Given that the density of bamboo is more typically recorded at 500 to 750kg/m³, this indicates that char rates more in line with 0.5mm/min to 0.7mm/min appear to be reasonable.

Providing structural fire resistance (load-carrying capacity under fire) to unprotected round bamboo is a challenge, due to the hollow shape and relatively thin walls. With

char rates of 0.5mm/min to 0.7mm/min, for a bamboo column of 100mm, with walls of 8mm to 12mm, this leads to a fire resistance rating of 16-24 minutes. If the bamboo were highly loaded, then the fire resistance would also reduce.

The performance of bamboo culms could be slightly improved with the use of surface spread of flame coatings or treatments. These treatments are expensive, typically require specific pressure treatment in production plants, and may not offer a significant increase in fire resistance for the bamboo as they are intended to only reduce the spread of flame. In addition, corrosive chemicals are released when they are applied, and the treatment can hinder any possible end of life applications for the bamboo. Therefore, fire retardant coatings or treatments are generally not recommended for bamboo culms. Accordingly, exposed bamboo will always have limited fire resistance, unless it is enclosed within a fire resisting material (such as cement mortar render or gypsum plasterboard).

Engineered *bahareque* shear walls

The engineered *bahareque* technique improves the fire performance of the round bamboo (and timber) acting as a load-bearing structure by providing insulation to the load-bearing bamboo elements, and in addition providing a more resilient structure. The cement mortar render protects the structure; analogous to the passive protection that gypsum plasterboard provides to steel columns.

Hence, to improve the fire resistance of the bamboo and timber structure, the integrity of the cement mortar render needs to be maintained. The fire testing discussed above shows that cement mortar render with a thickness of 25mm or more on one side of the matrix provides an insulation and integrity rating that exceeds 30 minutes. The testing also showed that expanded steel mesh to support the cement mortar render is superior to an organic mesh, but not essential. The testing by Webb with a 14mm thickness of cement mortar render on one side of the matrix provided an insulation and integrity rating of around 15-30 minutes.

Engineered *bahareque* will only provide a FRR between rooms and protect the bamboo and timber frame if the fire demand is on the same side as the mortar. Therefore, if a FRR needs to be provided from both sides of the wall, the hollow engineered *bahareque* wall system will need to be used (with a matrix nailed to each side of the frame, and cement mortar render applied to both outside faces of the matrix) (Figure 51).

In a double skin (hollow) engineered *bahareque* wall, once the fire burns through the first skin, the timber/bamboo frame will be immediately exposed to the fire load in addition to the matrix on the other side (since it's not physically possible of course to apply a cement mortar render to the inside faces of both skins in a double skin system). Therefore, the second skin cannot be considered to provide any significant improvement to the overall FRR rating.

In a single skin engineered *bahareque* wall, although the cement will protect the matrix, the timber/bamboo frame will be completely exposed on one side. Therefore,

this system can only have a reliable FRR when the fire demand is on the same side as the mortar.

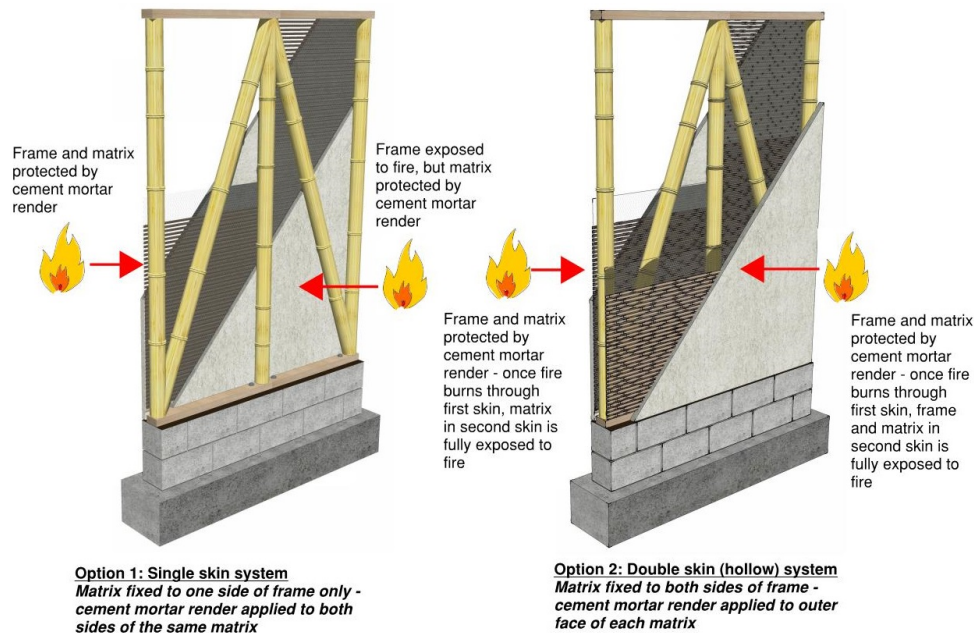

Figure 50: Behaviour of single and double skin engineered bahareque walls to fire

Cement mortar render fire properties

To further improve the fire resistance of the engineered *bahareque* system, the thickness of the cement mortar render can be further increased. There are various guides and standards available that provide recommendations on fire resistance based on supported render – a very good source of information is NFPA 914 (NFPA, 2015), a standard on existing historic building construction. NFPA 914 has recommendations that include:

- A 2" x 4" (50mm x 100mm) stud wall with ½" (12mm) thick gypsum plaster on wood lath to both sides achieves 30 minutes FRR. With a cavity filled with non-combustible insulation, this structure can achieve 45 minutes FRR.
- A 2" x 4" (50mm x 100mm) stud wall with ¾" (18mm) thick gypsum plaster on metal lath to both sides achieves 30 minutes FRR.

5.6 Summary of recommendations for designing fire resistance

Based on the above findings, different FRR ratings can be achieved for engineered *bahareque* walls using the following (Figure 51):

Nominal FRR (probably around 10-15min FRR)

- Enclose all ground floor timber and bamboo elements with cement mortar render on an expanded steel mesh, bamboo strip/*esterilla*, or cane matrix on all sides (providing a double skin hollow engineered *bahareque* system), and apply a minimum of 15mm cement mortar render to the walls. Where an organic matrix is used, chicken wire mesh is essential.

30 min FRR

Either:

- a) Making the wall itself FRR which involves:
 - When using bamboo for the columns, ideally these should have a wall thickness of at least 12mm and be robustly fixed to sole and head plates.
 - On the face of the wall exposed to the fire demand, use a cement mortar render with a minimum thickness of 25mm on a matrix of expanded steel mesh or bamboo strip/*esterilla*. Expanded steel mesh is superior to the laths in a fire, and cane has not been tested - with its very thin walls it may behave inferior to bamboo laths. Where an organic matrix is used, chicken wire mesh is essential.
- b) Use gypsum-based plasterboard, with a minimum thickness of 12mm, fixed to the face of the engineered *bahareque* wall exposed to the fire.

60 min FRR

- Use gypsum-based plasterboard, with a minimum thickness of 24mm, fixed to the outside face of the engineered *bahareque* wall exposed to the fire.

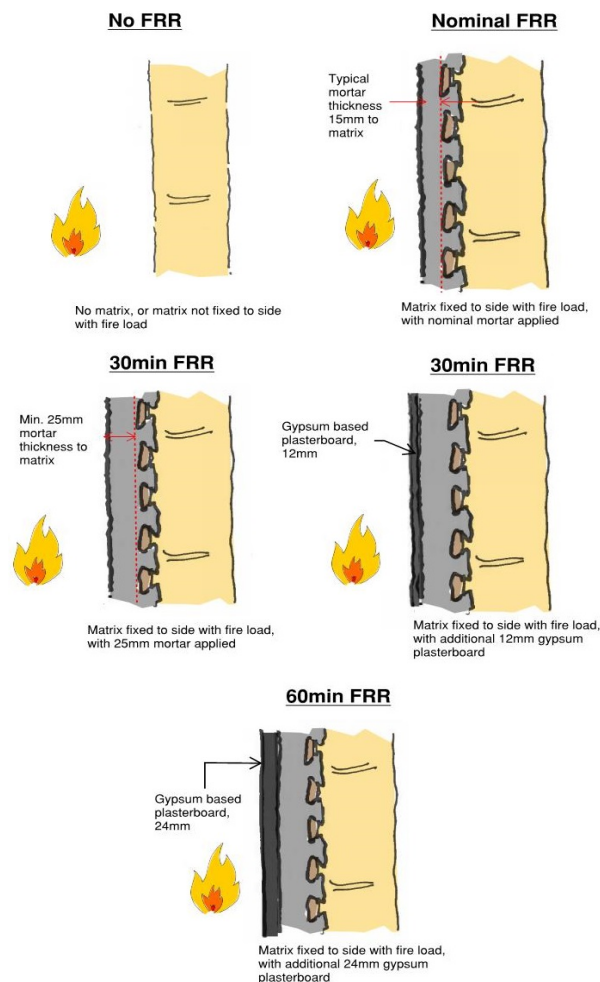

Figure 51: Different ways of achieving different FRR for engineered *bahareque* housing

The following rules are recommended for engineered *bahareque* housing with single family occupancy buildings (Figure 52):

Internal walls in single storey housing

- Bamboo and timber can be exposed internally.
- No fire requirements for any of the walls, columns, floors or roof within the house.

Internal walls in two storey housing

- As a minimum, provide a nominal FRR to all sides of all bamboo and timber elements on the ground floor.
- Ideally, provide a 30 min FRR to all sides of all bamboo and timber elements on the ground floor.
- No fire requirements for any of the floors or roof within the house.

External walls in housing that is 3m or more away from a neighbour

- For single storey housing, no fire requirements.
- For two storey housing, follow as for internal walls for two storey housing.

External walls in housing that is less than 3m away from a neighbour

- Provide a minimum of 30 minutes FRR to either the inside or the outside face of both (facing) external walls.

Shared party walls (walls shared between housing)

- Provide a minimum of 60 minutes FRR to both sides of the party wall.

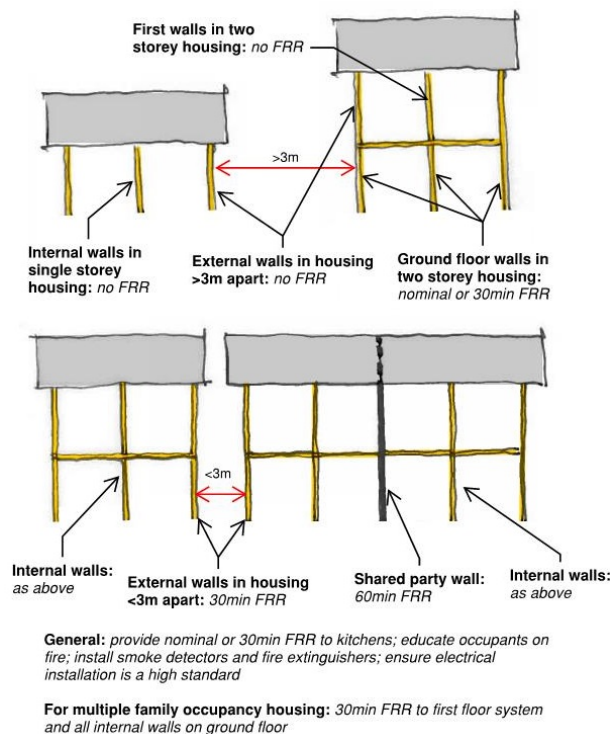

Figure 52: Recommended FRR rules for designing engineered bahareque housing

Areas subject to naked flames, for example kitchens

- As a minimum, provide a nominal FRR to all sides of all bamboo and timber elements at risk of being exposed to the flames.
- Ideally, provide a 30 min FRR to all sides of all bamboo and timber elements at risk of being exposed to the flames.
- Consider nominal or 30 min FRR to any first floor system above the flames.

Other general considerations

Other considerations for reducing the risk of fires in engineered *bahareque* housing include:

- Education of occupants on risks of fires.
- Installation of smoke detectors and fire extinguishers.
- Not storing flammable materials inside the houses.
- Ensuring electrics are installed to a good standard – sub-standard electrics are a common reason for fires.

For multiple family occupancy buildings, follow recommendations above but provide a minimum of 30mm FRR to the first floor system and all internal walls on the ground floor.

6.0 Designing for Structural Loads

This section discusses the key structural considerations of bamboo, and provides recommendations on how to design engineered *bahareque* for gravity, wind and earthquake loads.

Engineered *bahareque* housing is a strong and robust construction system, which can be designed to resist earthquakes and strong winds in even very hazardous regions of the world. The frame, matrix and cement mortar render has been shown to behave as a structural composite, acting as a shear wall. The system should be designed such that the gravity and horizontal load path is simple and continuous, the elements are all robustly fixed together with steel connections – especially at the base of the wall – and the cement mortar render is tied on well to the matrix via the chicken mesh, which in turn is nailed to the frame.

6.1 Key structural considerations of bamboo

The structural characteristics of all materials used in engineered *bahareque* housing needs to be considered when designing for structural loads. Although structural characteristics of materials such as timber and concrete are well understood and published, information on bamboo is more limited. Because of this, and since bamboo normally makes up a large proportion of the materials in engineered *bahareque* housing, the following is a list of key characteristics of bamboo that should be considered when designing for structural loads (Trujillo, 2007; Kaminski et al., 2016b):

- Bamboo culms are weak when loaded in compression and tension perpendicular to the fibres – the strength of the wall is significantly less in crushing perpendicular to the fibres than parallel to the fibres, the fibres are weakly bonded in tension perpendicular to grain (which affects shear), and the section is susceptible to local crushing since it is hollow.
- Bamboo and its connections are stronger and simpler to assemble in compression parallel to the fibre.
- Connections are in nearly all cases the weakest point in the structure.
- Although bamboo itself is strong in tension, in practice it is very difficult to achieve anywhere near the full tensile capacity of a culm as the connection will always govern.
- Bamboo is not particularly stiff in bending in comparison to a similar dimension timber section.
- Bamboo is not perfectly straight, so buckling of slender sections in compression needs to be considered.
- It is very difficult to make multiple bamboo elements work reliably as composite sections.
- If untreated and exposed to the environment, bamboo is susceptible to rot and insect attack (see Section 4.0).

6.2 Designing for gravity loads

Engineered *bahareque* houses, like all forms of structures, are best designed to have a simple and reliable vertical load path to carry the gravity loads of the structure down to the foundations. This makes the design and construction simpler and more reliable, and will reduce the risk of failure in an earthquake or strong winds. Working with the characteristics outlined in Section 6.1 and good practice structural engineering, it is recommended that a clear and simple gravity load path might be designed as follows (see Figure 53).

- Provide a simple and continuous vertical load path.
- Finishes on the roof and floors should generally be kept as light as possible, in order to reduce the gravity load demand.
- Roof and floor structure should use large diameter culms as secondary structural beams (i.e. beams that span onto walls or primary beams, such as joists and rafters), in order to reduce the deflection and avoid high loads on the beams.
- Point loads on beams should be avoided in order to prevent local crushing of the culm.
- When two or more bamboo culms are bundled together, do not assume composite action, as this is very difficult to achieve in practice.
- Primary bamboo beams (i.e. beams that carry other beams) should be avoided as local crushing or shear of the beam ends is likely.
- Loads should be transferred through connections in bearing wherever possible, since this is a stronger, stiffer and more reliable load path.

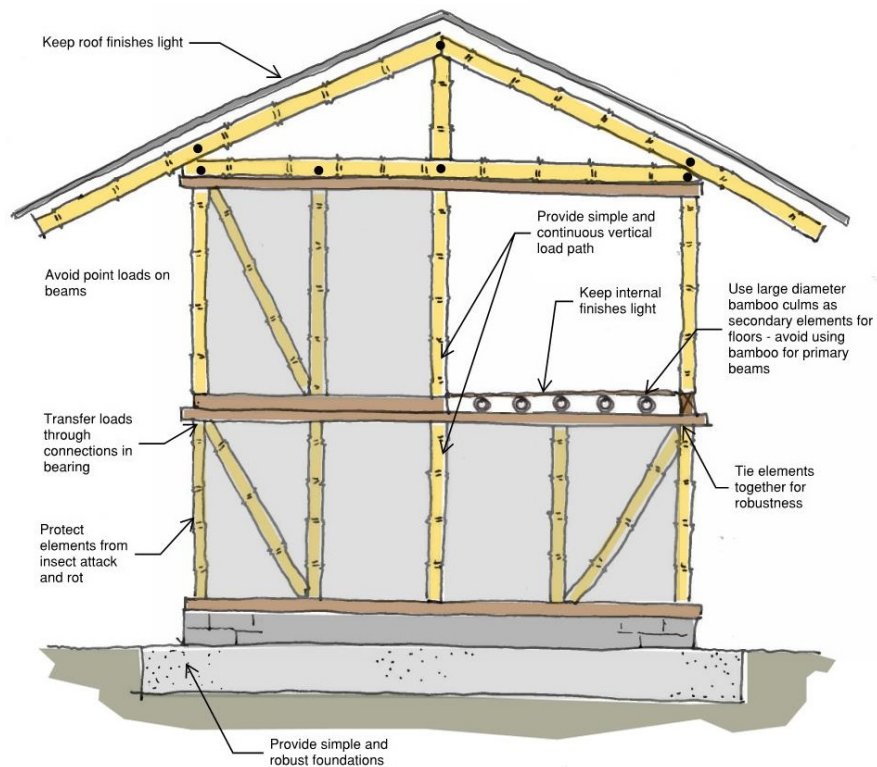

Figure 53: Key points for a clear and simple gravity load path for engineered bahareque housing

- Sections should be tied together for *robustness* – to reduce the risk of significant collapse failure, if failure of any element or connection occurs.
- Bamboo elements should be protected from insects and rot as per Section 4.0.
- Simple and robust foundations suitable for local soil conditions should be provided.

The vertical load path for an engineered *bahareque* house is normally very easy to calculate by hand since most elements are simply supported. It is not recommended to use computer programs for structural analysis since these may pick up alternative load paths that are not correct or relevant. Some complex roof configurations may warrant the use of computer programmes, but these should be used with great caution; in particular, it should always be assumed that connections are pinned unless demonstrated otherwise. For calculating the capacity of bamboo sections and connections, see Section 6.5. For calculating the capacity of timber sections and connections, use international structural design codes such as Eurocode 5 (CEN, 2014) and the US National Design Specification for wood (American Wood Council, 2015).

6.3 Designing for earthquake and wind loads

Earthquake and wind loads are relatively similar in that they both effectively apply a horizontal load to the building that has to be transmitted down to the foundation. The key differences are:

- Earthquake loads are proportional to the self-weight of the structure, while wind loads are independent of this.
- Earthquake loads are cyclic which can cause fatigue failure of connections.
- There is greater uncertainty about the magnitude of earthquake loads, therefore some damage may occur, provided the damage occurs in a controlled manner. No damage should occur under wind loads.

It is a common misconception that bamboo as a material is somehow ‘miraculously’ good in earthquakes and strong winds. In fact, as an individual element it possesses several brittle failure modes which could affect its seismic and wind performance. Traditional bamboo and *bahareque* buildings have historically performed well in earthquakes for two key reasons:

1. Their lightweight nature (high strength-to-weight ratio), which keeps the building light overall.
2. Their ductility (essentially the ability to absorb energy) at connections and junctions, especially when using nails. This has been seen after earthquakes in vernacular buildings such as *bahareque* (Kaminski, 2013; Franco et al., in press), which normally use nailed connections. Some energy is also absorbed by cracking of mud renders on traditional *bahareque* housing.

The flexible nature of some traditional bamboo constructions may also be favourable in earthquakes, but this is not a characteristic that can be easily exploited in modern constructions, which tend to be heavier, have smaller movement tolerances, and require a greater certainty of resistance to earthquakes than traditional buildings.

Modern bamboo structures generally require, and are normally built, with higher strength bolted connections with mortar, which are relatively brittle. However, where

good practice seismic design principles are applied in conjunction with more ductile connections such as nails, greater earthquake resistance and overall building ductility can be achieved (Kaminski et al., 2015).

Working with the characteristics above, those outlined in Section 6.1, and good practice wind and earthquake design, it is recommended that a sensible earthquake and wind load path might be designed as follows:

- In an earthquake zone it is best to keep the structure as light as possible. In contrast to this, in a high wind zone, weight is beneficial as it can prevent the building overturning. Engineered *bahareque* has the benefit of having reasonable mass, more than a lightweight timber building, but less than a masonry structure. In very windy locations, wind loads may govern the design.
- Check for overturning of the frame and building – the self-weight of the structure may be insufficient to counteract the horizontal load. Where the overturning load is high, tie-down straps may be required from the roof down to the foundations, and the foundations may need to be made heavier to stop the whole building overturning.

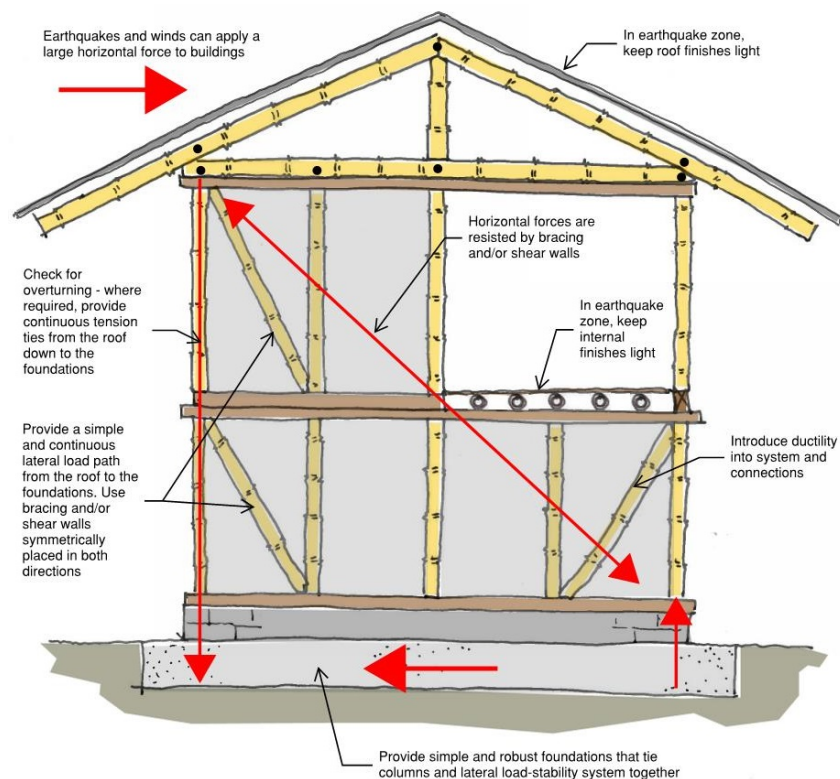

Figure 54: Key points for a sensible earthquake and wind load path for engineered *bahareque* housing

- Maintain a simple and continuous lateral load path from the roof to the foundations – avoid discontinuities.
- Introduce ductility into the system and connections (see Sections 6.5 and 6.6).
- Ensure there is a dedicated lateral load-stability system – i.e. bracing or shear walls (see Section 6.4). Bamboo moment frames are very difficult to reliably achieve.

- Ensure the lateral load-stability systems are: able to resist load in both orthogonal directions, are broadly symmetrical on both sides of the building, and evenly spaced. Maintain the same lateral load-stability system on both elevations.
- Provide simple and robust foundations that tie the columns and lateral load-stability system together.

Horizontal load paths for an engineered *bahareque* house are normally very easy to calculate by hand. It is not recommended to use computer programs for structural analysis since these may pick up alternative load paths that are not correct or relevant.

6.4 Lateral load-stability systems

As in any structure, bamboo housing requires a dedicated lateral load-stability system to resist horizontal wind and earthquake loads. It is not recommended to use moment frames in bamboo structures because of the following:

- Adequate connections with sufficient strength, stiffness and ductility have not been developed.
- Single bamboo elements would not have the required strength or stiffness to form a portalised system. Bamboo bundles could be used, but as composite action between members is difficult to achieve, it would be very difficult to achieve a satisfactorily rigid connection.
- These systems are unlikely to have much ductility and therefore could fail in a brittle and sudden manner.

The remaining lateral load-stability systems which are most suitable for engineered *bahareque* housing are braced frames and shear walls (with or without additional bracing). The selection of the system will affect the detailing.

Braced frame

This is essentially a simple triangulated frame, which transfers the loads down to the foundations by axial (tension and compression) loads in the elements. Braced frames can be tension only, compression only, or both compression and tension. Bamboo culms work well in compression. However, since it is difficult to transmit large tension forces into bamboo elements at their connections, and their failure may be quite brittle, it is recommended to either have sufficient bracing such that the tensile load is never large, to only rely upon the bracing elements that can work in compression, or to simply add steel rods to take the tension (these could be parallel to the bamboo culms or even inside them).

Pure bamboo braced frames are unlikely to have as large capacity as shear walls because of the likelihood of tension or local crushing failures at the connections. However, they may be sufficient for housing when the bracing is plentiful and the loads are low. The forces in this system are simple to calculate, and in most cases, the strength of the system will be limited by either the connections or buckling of the bamboo culms in compression (see Section 6.5).

Figure 55 proposes the four different options of braced frame systems for engineered *bahareque* housing.

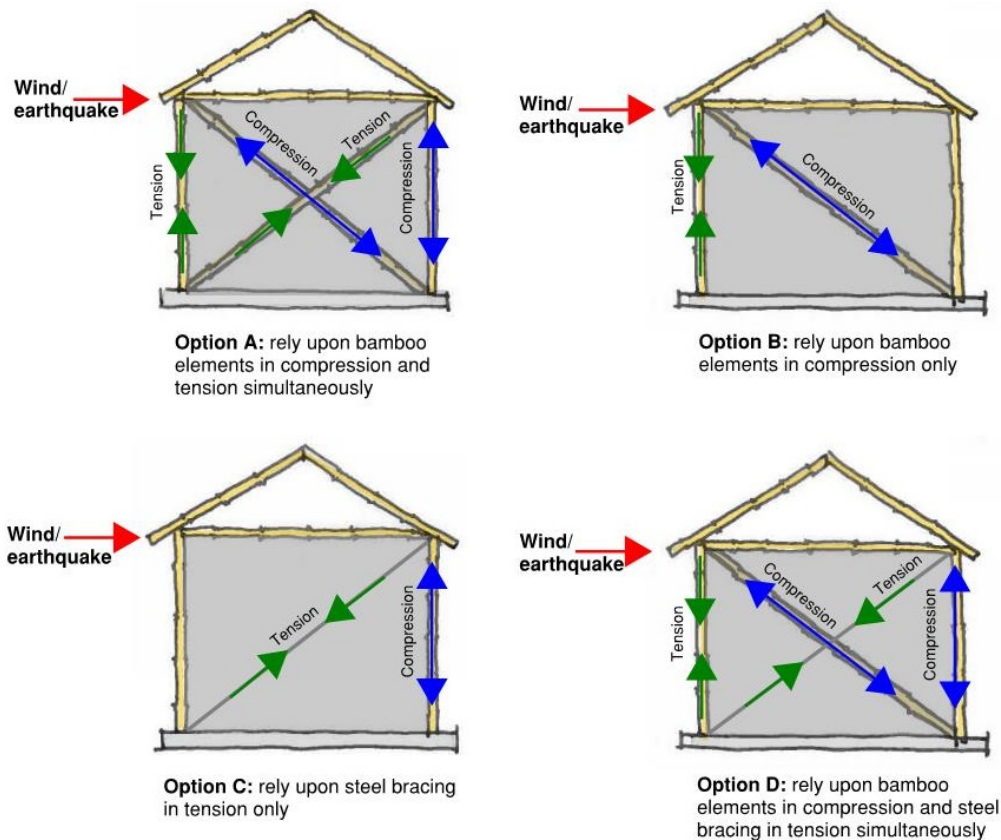

Figure 55: Different bracing systems for engineered *bahareque* housing

Shear wall (with or without additional bracing)

This is a walling system made from a solid continuous material, which transfers the load down to the foundations by a shear force distributed along the length of the wall. Engineered *bahareque* wall systems with a frame, matrix, and cement mortar render can act as effective structural shear walls when properly designed – the matrix, frame and mortar all work compositely, with the mortar resisting the shear force, the matrix stopping the mortar buckling and providing the connection between the mortar and the frame, and the frame resisting the vertical push-pull force induced in the system and also locally resisting the shear loads (Figure 56 and Figure 57). Some shear wall systems have bracing – these become hybrid shear walls and braced frame systems, where the load is shared according to the relative stiffness of each system.

Engineered *bahareque* shear walls have good capacities when properly designed and detailed. They also tend to have some ductility (Mendoza & Villalobos, 1990; Prieto et al., 2002; Kaminski et al., 2015). The capacities are, however, difficult to determine from first principles, and hence testing has normally been conducted to ascertain their behaviour in winds and earthquakes (see Section 6.6 for more information).

One of the key advantages of engineered *bahareque* shear walls over traditional braced frames is that the structural shear wall itself becomes the façade/partition wall, which means another cladding or infill material is no longer required. This reduces their cost and results in a more affordable housing system.

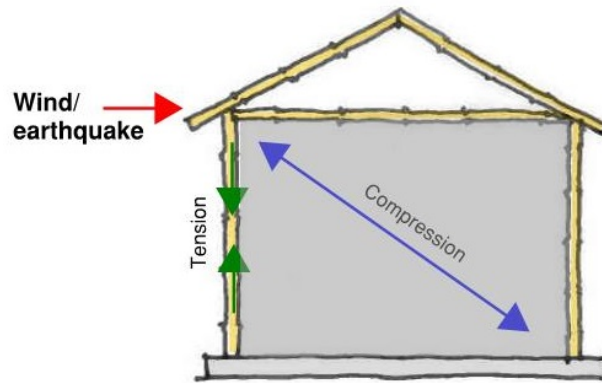

Engineered *bahareque* shear walls: rely upon the composite cement mortar render and matrix resisting the horizontal load through a diagonal compression strut in the wall

Figure 56: Horizontal load path for engineered bahareque shear walls

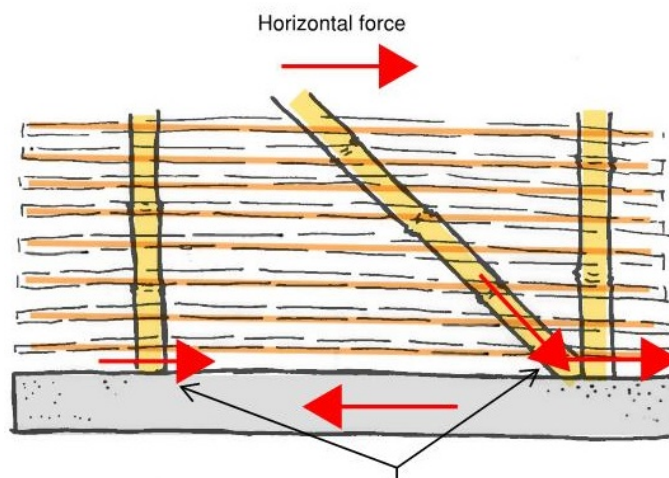

There is normally insufficient shear or physical connection between the cement mortar render and the sole plate for any shear to be reliably transmitted across it. Therefore all of the shear tends to be transferred via the bracing and/or the vertical studs in shear

Figure 57: Horizontal load path at base of engineered bahareque shear wall

6.5 Designing individual bamboo elements and connections

There are few published bamboo design codes available, limited test data on bamboo species and very limited test data on connections. The following material has been found to be the most useful:

- **ISO 22156** (ISO, 2004a): ISO published code on determining material properties from test data. Useful for processing test data, provides connection

test concepts, and contains questionable criteria for derivation for permissible stresses. It contains little on practical structural design guidance.

- **ISO 22157-1 and 22157-2** (ISO, 2004b & 2004c): ISO published code on determining physical and mechanical properties of bamboo. Most useful guide for element tests.
- **NSR 10-G12** (AIS, 2010): Colombian standard for designing with guadua bamboo. Together with the NEC-SE-Guadua, this is arguably the most comprehensive national design code published to date, and includes element and connection design methods and guidance.
- **Engineered bahareque construction manual: *Manual for earthquake-resistant construction of one and two storey houses with cemented bahareque*** (Prieto et al., 2002): Provides design guidance, shear wall capacities, and example details. Useful for concepts and details.
- **Technical Note Series on Structural Use of Bamboo** (Kaminski et al., 2016b; 2016c; in press a; in press b; in draft a): Independent guide for determining material properties from test data, checking elements for the main failure mechanisms, and proposing conservative design values for any bamboo. Although it draws on information from ISO 22156 (ISO, 2004a) and NSR 10-G (AIS, 2010), it uses the Eurocode approach. A recommended starting point for element and connection design.
- **NEC-SE-Guadua** (MIDUVI, in press): New Ecuadorian standard for designing with guadua bamboo. Together with the NSR 10-G12, this is arguably the most comprehensive national design code published to date, and includes element and connection design methods and guidance.
- **Norma Andina para diseño y construcción de casas de uno y dos pisos en bahareque encementado** (INBAR, 2015): Recently published code for designing with *guadua* bamboo. Does not contain the detailed element design methods found in the NSR, but does contain useful good practice design rules and connection details.

As mentioned before, like timber, bamboo elements possess several brittle failure modes. As such, when designing for earthquake loads an appropriate behaviour factor for a structure which uses bamboo elements for the lateral load-resisting system (i.e. a braced frame) should in most cases be low, for example $q = 1.5$ to Eurocode 8 (CEN, 2013) or $R = 1.5$ to ASCE7-10 (ASCE, 2010) (i.e. the structure should remain broadly elastic in the design event). Where failure is confined to connections which use steel nails where the failure mode is a plastic hinge forming in the nail (i.e. modes b, d, e, g, h, k, m to Eurocode 5 (CEN, 2014)) and rigorous seismic *capacity design/overstrength* principles are applied (Paulay & Priestly, 1992), it is possible that more global ductility can be achieved. However, little test data exists on this to date. Therefore, in general, nails and screws should be preferred over bolts in highly seismic areas, since they will have more inherent ductility, even if this is not specifically accounted for by applying higher behaviour factors. Nails and screws should be predrilled for most connections as bamboo is very susceptible to splitting – the exception is fixing the matrix to the frame, where nailing is encouraged (Section 6.6).

6.6 Designing engineered *bahareque* shear wall systems

The design of engineered *bahareque* shear wall systems has been codified in the following:

- **Engineered *bahareque* construction manual:** Manual for earthquake-resistant construction of one and two storey houses with cemented *bahareque* (Prieto et al., 2002). It provides design guidance, shear wall capacities, and example details. Useful for concepts and details.
- **NSR-10-E.7: *Bahareque* encementado** (AIS, 2002): Provides design guidance and wall capacities of engineered *bahareque*. This code is expanded upon in Correal (2016).
- **NEC-SE-Guadua** (MIDUVI, in press): Provides design guidance and wall capacities of engineered *bahareque*.
- **Norma Andina para diseno y construccion de casas de uno y dos pisos en *bahareque* encementado** (INBAR, 2015): Provides design guidance and wall capacities of engineered *bahareque*.

In addition, full-scale testing has been conducted on these systems in a number of countries with a number of different materials and setups. The results of these tests have also been published:

- National Bamboo Project, Costa Rica (Gonzalez & Gutierrez, 2003; Mendoza & Villalobos, 1990): A full-scale in-plane cyclic testing of 7 panels was conducted.
- FOREC Project (Fund for reconstruction of the coffee-producing region), Colombia (Prieto et al., 2002): 14 monotonic full-scale shear wall tests conducted on walls of different configurations and detailing. Some included diagonals, and others did not. Two full-scale cyclic, bi-axial tests of a single room were also conducted.
- El Salvador low-cost housing project:
 - Full-scale in-plane cyclic testing of 5 cane, timber and mortar panels (Málaga-Chuquitaype et al., 2014).
 - Full-scale out-of-plane shake table testing of 5 similar panels (Davies, 2014).
 - Full-scale bi-axial shake-table testing of a single room of the design (Beteta et al., 2015). The specimen was deemed “life safe” even at peak ground accelerations of 1.0g.

The results of these tests showed that engineered *bahareque* shear wall systems can be robust lateral load-stability systems, which exceed the seismic design requirements of even the highest risk seismic countries around the world (>0.4g peak ground acceleration for return period of 475 years – Kaminski et al., 2015). When well detailed, they also tend to have some ductility.

Recommendations for design

Drawing on the tests conducted on engineered *bahareque* shear wall systems, the following general recommendations are provided for design (Figure 58):

- Use the four published structural design codes as a starting point (Prieto et al., 2002; AIS, 2002; INBAR, 2015; MIDUVI, in press).
- Vertical studs can be timber or bamboo and should not exceed 1m centres – closer centres should be considered if the matrix is unable to span out-of-plane by itself between studs (for example opened bamboo (*esterilla*) and expanded steel mesh is thinner in section so studs may need to be closer, although 25mm diameter canes can span 1m (Chan, 2014)). Studs should be sized for the out-of-plane load, and connected robustly to the sole plate and header beam with nails, a nail plate, or bolts.
- Studs at the end of walls and adjacent to openings such as windows and doors may experience net uplift due to overturning. They should be robustly fixed down directly or indirectly (via the sole plate) to the foundation, with a steel connection (Figure 67 and Figure 69).
- A sole plate provides a convenient and robust base detail for the studs, although it is not essential. The sole plate should be fixed to the foundations with bolts or steel plates, designed to resist the in-plane and out-of-plane loads, and vertical overturning loads, if relevant (Figure 61 and Figure 63). Sole plates are best made from timber as bamboo culms are likely to crush under local point loads. Where wall panels are prefabricated, sole plates become essential.
- A continuous head plate is essential for tying the head of the columns together and providing an out-of-plane load path for the wall panel. Head plates are best made from timber as the connection between the plate and the studs is simpler and stronger, and bamboo culms are likely to crush under local point loads.
- The connection between the base of the studs and the sole plate/foundation should be designed for the in-plane shear forces. Since these are high, the simplest option is a piece of timber wedged in-between the studs and nailed down to the sole plate (Figure 66 and Figure 70).
- Cane, bamboo strips, opened bamboo *esterilla* and expanded steel mesh can all work successfully as the matrix inside the cement mortar. A gap of around 10-20mm within the matrix was found to be the best for the mortar to adhere and lock together with the matrix and the mortar on the rear side (Figure 59). The matrix should be nailed to all studs.
- If not using expanded steel mesh, as a minimum, chicken mesh reinforcement should be placed on at least one side of the matrix and nailed or tied to it (Figure 59). It should be taut and nailed to all studs, sole plates, and header beams. The chicken mesh helps greatly with the rendering process, prevents spalling of the mortar on the face to which it is attached, and is effective at retaining significant enough portions of mortar on the wall for the mortar to still contribute to the strength and stiffness of the panel after damage.
- Bamboo or steel bracing is not always essential. When the structure is single storey, engineered *bahareque* shear walls can work effectively without bracing. For multi-storey houses, bracing provides an added level of robustness in the event of any failure of the shear walls.
- The mortar surfaces in-between coats must be well-prepared, for example by scoring or wetting, otherwise debonding can occur early.

- The cement to sand ratio in the mortar should not exceed 1:5 – higher ratios lead to a weaker mortar. The construction workers should also avoid adding too much water to the mortar mix. Lime can also be introduced to the mix to improve workability without compromising strength - in this instance a mix ratio of 1:1:6 (cement: lime; sand) may be used.

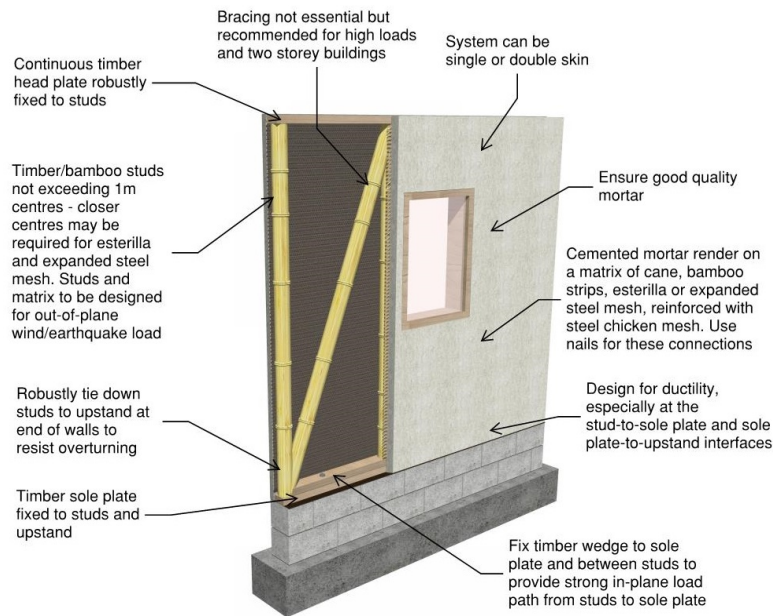

Figure 58: Recommendations for designing engineered bahareque shear walls

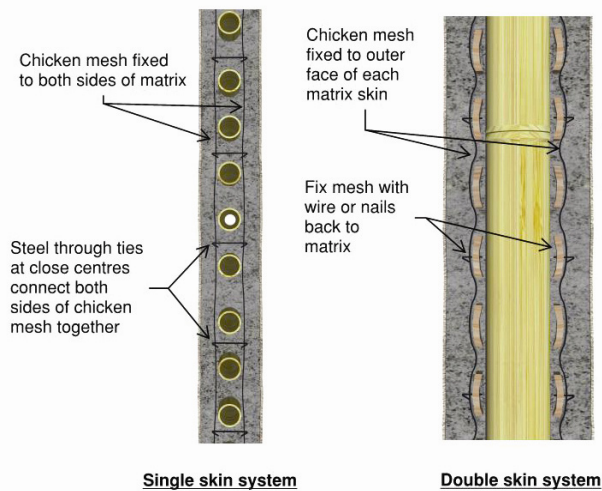

Figure 59: Details for securing the cement mortar render back to the matrix in single and double skin systems

- In terms of design for ductility, as mentioned in Section 6.5, bamboo elements possess several brittle failure modes, and so an engineered *bahareque* shear wall will not automatically have ductility. Key areas of failure are at the stud-to-sole plate and sole plate-to-upstand interfaces, where nails and nailed steel plates are recommended, and bolts should be avoided, unless they are designed using *overstrength* principles with confidence. Nailing the matrix to the frame also provides some ductility, as does the nailed chicken mesh.

However, even if these recommendations are implemented, because of the widely varying behaviour of engineered *bahareque* shear walls, it is recommended that an appropriate behaviour factor is $q = 1.5$ to Eurocode 8 (CEN, 2013) or $R = 1.5$ to ASCE7-10 (ASCE, 2010) (i.e. the structure should remain broadly elastic in the design event). Where full-scale testing has been conducted and rigorous *capacity design/overstrength* principles are applied, it is possible that more global ductility can be achieved. Although, little test data exists on this to date.

If no bracing is included and the shear wall consists of just the matrix and cement render, the following additional recommendations are made:

- For systems with a matrix nailed to one side of the frame only (Figure 59):
 - Cement render should be placed on both sides of the matrix. The joint between the two should be rough and pre-wetted.
 - Chicken mesh reinforcement should be placed on both sides of the matrix, along with steel wire through-ties to allow both sides of the render to engage and prevent spalling.
- For systems with a matrix nailed to both sides of the frame and a void in-between (Figure 59):
 - Cement render should be placed on the outer face of both matrices.
 - Chicken mesh reinforcement should be placed on the outer face of both matrices, fixed robustly to the matrix itself with closely-spaced nails or steel wire ties, to allow the render to work compositely with the matrix and prevent spalling.

Where bracing is included as part of the shear wall, consideration should be made to designing the frame as a braced frame along with the respective connection loads for the *full* earthquake loads – this then covers the scenario of the braced frame taking all of the load and not failing in a sudden and brittle manner.

Where bracing is included as part of the shear wall for externally facing walls exposed to driving rain, it is worth also considering designing the bracing for the *full* earthquake load, and allowing the matrix and mortar to be effectively a sacrificial façade that protects the frame and bracing inside from rot.

Where these recommendations are followed along with good practice engineering and the wall system selected closely matches that used in existing testing, the published test data can be used as a basis of design without further testing. Where the system deviates, full-scale testing is recommended.

Recommendations for testing

There is currently no guidance or code for conducting full-scale testing of engineered *bahareque* walls. Research is currently being conducted on what test procedure would be most appropriate to use, and this will be published shortly in a complementary publication by INBAR (Kaminski et al., in draft b).

7.0 Typical Construction Details of Engineered *Bahareque* Houses

This section provides some key structural details for building engineered *bahareque* houses such that they are disaster resilient, durable and robust. A selection of general and detailed drawings of engineered *bahareque* designed for El Salvador are presented in Appendix A.

7.1 Upstand detail

It is essential to elevate the base of the structure above the foundation to protect against moisture (from heavy rain, flooding, splashback from roof etc.). Elevating the base also makes it more difficult for termites to construct shelter tubes and access the structure. The upstand should be able to resist the in-plane, out-of-plane, and vertical loads from the wall, which generally means it must be reinforced in some way. Options for elevating the base include: brick or stone masonry, hollow reinforced blockwork, or reinforced concrete (Figure 27 and Figure 60). Approximately 200mm is considered a bare minimum upstand height, while 400mm is better. It is also recommended to add a damp-proof membrane (such as a simple plastic sheet) between the frame and the upstand, to avoid the frame absorbing any moisture from the upstand.



Figure 60: Example of simple upstand of engineered *bahareque* housing in El Salvador, consisting of two courses of reinforced blockwork, totalling 400mm high from the foundation

7.2 Upstand to sole plate detail

In most systems a timber sole plate is used to provide a convenient fixing element at the base of the walls and sitting on the upstand. Depending on the system, the loads from the wall elements (studs and bracing) are transferred either via the sole plate into the upstand, or directly to the upstand. Where the sole plate is used structurally, this needs to be fixed robustly to the upstand and will need to resist any earthquake and wind loads, which could be in-plane, out-of-plane, and vertical. Options include:

- Simple bolts.
- Cast-in off-the-shelf bespoke straps.
- Cast-in fabricated steel straps.

While bolts are the simplest and most widely available for fixing sole plates (Figure 61 and Figure 62), drilling the holes for the sole plate precisely for the locations of the cast-in bolts can be difficult and often results in over-sized holes, which can lead to a less stiff connection. In addition, their horizontal load-carrying capacity can be somewhat limited, as is their ductility. Off-the-shelf bespoke steel straps such as the Y-straps, available from several international manufacturers, are a good alternative as they are cheap, ductile in an earthquake, and simplify installation since the sole plate can be easily nailed to the plate after the plate has been cast in – they therefore provide greater allowance for tolerances (Figure 63, Figure 64 and Figure 65). Unfortunately, they are not available off-the-shelf in many countries. However, consideration should be made to bulk shipping them because of their benefits.

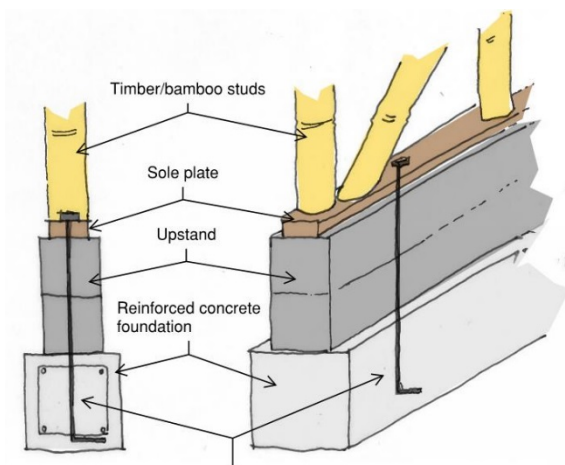

Simple steel rod or rebar, cast into upstand and foundation and fixed at top with nut and washer, or simple bent down



Figure 61: Detail of sole plate fixed to upstand with bolts Figure 62: Photo of sole plate fixed to upstand with bolts

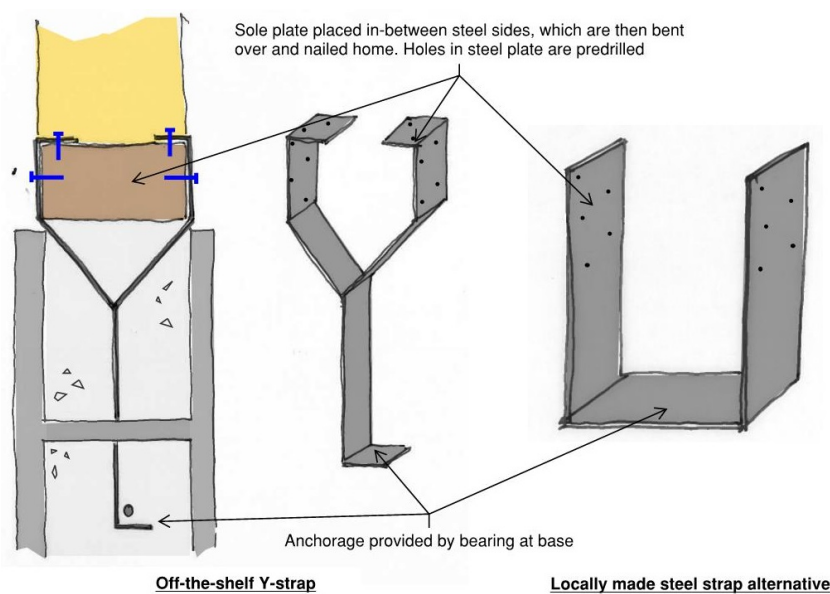

Figure 63: Detail of sole plate fixed to upstand with cast-in off-the-shelf or locally made steel straps



Figure 64: Photo of sole plate fixed to upstand with cast-in off-the-shelf steel straps, before casting straps into reinforced blockwork



Figure 65: Photo of sole plate fixed to upstand with cast-in off-the-shelf steel straps, after nailing

7.3 Studs/bracing to sole plate/foundation

A robust connection is required between the studs/bracing and the sole plate/foundation, to transfer the in-plane shear, out-of-plane shear, and axial forces (compression and tension) in an earthquake or strong winds. Options include:

- Skew/toe-nail screws or nails.
- Steel angle plates.
- Steel rod cast into the bamboo.
- Steel plate bolted to bamboo.
- Steel strap screwed to bamboo.



Figure 66: Photo of steel angle used to fix timber stud to sole plate

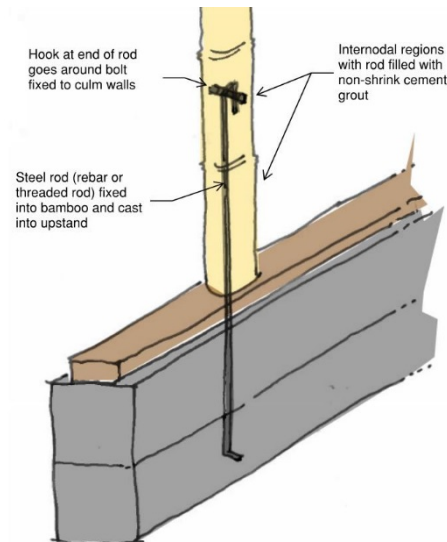

Figure 67: Detail of steel rod cast into bamboo used to fix bamboo stud/column to foundation. Has reasonable bi-axial shear capacity and some tensile capacity. However, may not be suitable when tensile loads are very high

Although skew/toe-nail screws or nails are simple and cheap, and can provide adequate out-of-plane shear capacity, they will not have significant in-plane shear or axial tension capacity by themselves. Steel angle plates improve upon simple skew nailed connections, but only work well for timber studs (Figure 66) since bamboo has a curved surface.

The most common detail is a threaded steel rod or reinforcement bar placed inside the bamboo culm, which is then infilled with cement mortar (Figure 67). A steel bolt is often added to provide a direct load path, rather than relying solely upon the shear capacity of the nodal diaphragm and the bond between the mortar and the inside face of the bamboo. The detail has reasonable bi-axial shear capacity and some tensile capacity.

For bamboo columns/studs experiencing high shear loads, a simple steel plate (Figure 68) can be used. This can be cast into the foundation first, then bolted to the bamboo.

For bamboo columns/studs experiencing high axial tensile loads, such as for those at the end of shear walls resisting overturning, a simple thin steel strap (Figure 69) can be used. This can be cast into the foundation first, then screwed to the bamboo.

For bamboo columns forming part of engineered *bahareque* shear walls, it is recommended to add in long bamboo or timber “wedges” in-between the columns to provide a direct in-plane load path for the wind and earthquake loads.

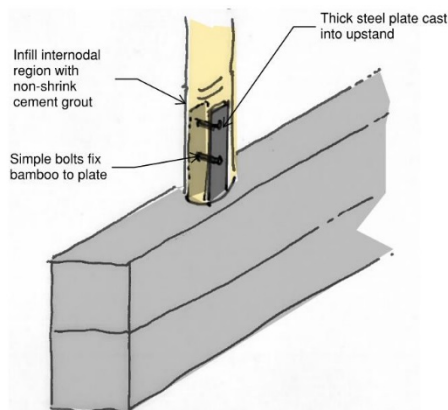

Figure 68: Steel plate cast into upstand and bolted to bamboo

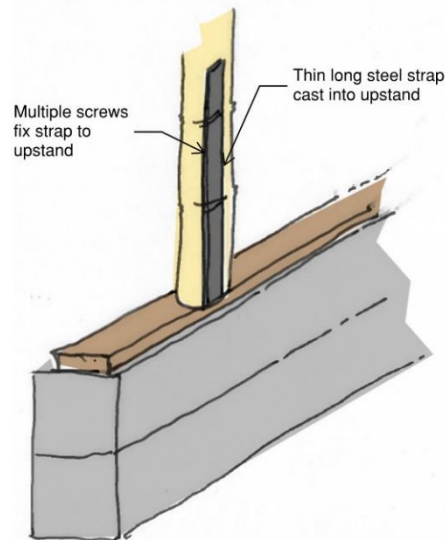

Figure 69: Steel strap cast into upstand and screwed to bamboo

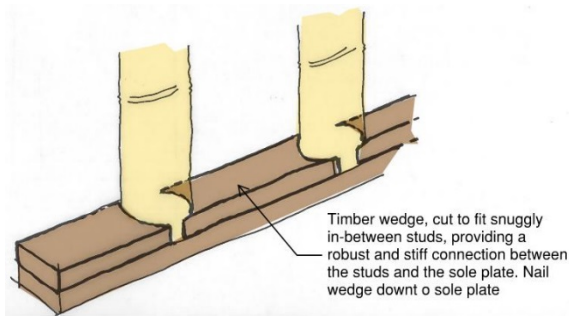

Figure 70: Detail of long timber “wedges” placed in-between timber studs, to provide an in-plane load path for the shear loads inside the engineered bahareque shear wall



Figure 71: Photo of long timber “wedges”

7.4 Matrix details

It is important to fix the cement mortar render well to the matrix, especially in systems relying upon the composite shear walls structurally, and lacking bracing. This is achieved by fixing chicken mesh to the matrix – the mesh can be fixed with nails or with wire. Where mortar is applied to both sides of the same matrix, it is recommend to place chicken mesh to both sides of the matrix, and add steel wire through-ties to tie each side together (Figure 59 and Figure 72) – thereby mitigating the risk of spalling and allowing the wall to work compositely well together.



Figure 72: Installing steel wire through-ties to connect chicken mesh on both sides of the matrix

8.0 Ensuring Good Quality construction

Like all buildings, ensuring the high quality construction of engineered *bahareque* is essential to the strength and durability of the housing. The following is a brief list of some key issues to manage during construction:

- Ensure all timber is graded to exclude large knots and insect and rot damage.
- Ensure all bamboo is selected and visually graded by a reputable and experienced individual (note current visual grading of bamboo is very limited in detail, mostly comes from experience, and has not yet been correlated with strength data). Criteria for grading should include:
 - Exact species and origin.
 - Acceptable age range (note this is difficult to control, and requires using reputable and trustworthy suppliers).
 - Culm length, minimum external diameter, and minimum wall thickness.
 - Taper.
 - Straightness (1% out-of-straightness limit recommended).
 - Absence of splitting (no splitting is acceptable and this should be checked after the material has been dried).
 - Absence of insect and fungal damage.
 - Treatment, fumigation and seasoning.
 - Moisture content (recommended to be delivered dry).
- Ensure an experienced bamboo carpenter is used.
- Where elements have split during construction, either replace or reinforce with circulate steel pipe ties (Figure 73).
- Ensure all bamboo connections with cement mortar infill use a high strength dry mortar mix, which is tightly packed into the internode.



Figure 73: Steel pipe ties used to strengthen bamboo after it had split, Colombia (Kaminski, 2016)



Figure 74: Maintaining a good bond between subsequent cement mortar render layers by roughening the previous layer while still setting (Kaminski, 2016)

- Ensure a good quality cement mortar render by:
 - Controlling the water: cement ratio (plasterers will often add excess water as this makes the cement mortar render much easier to apply). A drier mortar is stronger and more durable.
 - Maintaining a good bond between subsequent mortar layers. This should be done by roughening the previous layer well while it is still setting (Figure 74), and wetting the previous layer with water just before applying the new layer.
 - Avoid applying the mortar in very thick layers, as there is a risk of the mortar falling under its own self-weight. Individual layers of 5-10mm thickness tend to be the optimum.
 - For the first layer, avoid applying the mortar to both sides of the matrix at once, since the mortar tends to fall off one side when it is applied from the other.
 - Curing the mortar by spraying with water for at least 5 days after application.

9.0 Other Important Considerations for Design

This section discusses other important considerations when designing engineered bahareque houses, such as health and safety, use of beneficiaries for labour, maintenance, and occupant health and wellbeing.

Engineered *bahareque* housing is safe to construct and uses no toxic chemicals, can be constructed by the beneficiaries themselves, does not require significant maintenance, and has been shown to be very popular with beneficiaries in many case studies. It can provide a hygienic, safe, durable and thermally comfortable home.

9.1 Health, safety and labour standards for construction

Engineered *bahareque* does not normally require any dangerous construction methods or toxic chemicals. When designing, consider the health and safety for all of the workers for all stages of the life cycle of the building. Considerations should include:

- Safety during harvesting the bamboo.
- Safety in the bamboo processing plant, especially handling and disposal of any treatment chemicals such as boron – relevant personal protective equipment may be required such as gloves. Waste boron liquid should be disposed of safely and not into any watercourses, where it may end up in drinking water.
- Safety during construction, including working from height, cutting and handling treated bamboo (especially if treated with chemicals other than boron), excavations, and exposed sharp edges (nails, bolts etc.). Prefabrication can minimise this risk by reducing construction time and minimising working from height.
- Safety at end of life, including disposal of any hazardous material, especially bamboo treated with chemicals other than boron.

9.2 Maximising use of housing beneficiaries for construction labour

Engineered *bahareque* can be constructed by unskilled labour with adequate supervision. Wherever possible, it is recommended that the labour contribution of housing beneficiaries is maximised, as this increases their satisfaction through an improved feeling of involvement and attachment to the finished house, and may in turn lead to houses being better maintained and thus reducing the risk of occupants abandoning the property due to deterioration (IFRC, 2010; Lyons & Schilderman, 2010). It also increases their knowledge of the construction system, which can assist in maintenance (Section 9.3).

9.3 Maintenance

Engineered *bahareque* housing does not require significant maintenance beyond the following:

- Ensuring there are no leaks from the roof into the walls.
- Periodically painting the walls and fixing any cracks.
- Checking for damaged bamboo or timber and replacing, as appropriate.
- Checking for termite shelter tubes and destroying them.

Ensure that repair and reconstruction is possible either by the occupants themselves or local labour, preferably through the use of low-tech tools. Materials required for maintenance should be locally available. A training program for housing maintenance for the beneficiaries is recommended.

9.4 Housing occupant health and wellbeing

Engineered *bahareque* has been shown to be very popular with beneficiaries in many case studies. Key considerations for occupant health and wellbeing include:

- Hygiene: engineered *bahareque* housing can be made to be very hygienic by ensuring durable wall and floor finishes with few cracks (where vermin can hide) – the use of cement for the walls and floors helps with this. The introduction of soil into the cement mortar render mix is likely to reduce the durability of the wall, which may lead to cracks and vermin. When using treated timber or bamboo, ensure it is safe to use inside the building – this is one of the advantages of boron compared to other chemicals. Ensure all ventilation holes to wall cavities (which are essential to allow the timber and bamboo to “breathe” as discussed in Section 4.0) are sealed against vermin (both rodents and insects).
- Indoor air quality: ensure a reasonable level of natural ventilation, not only for the supply of fresh air but also such that if it is culturally desirable it allows occupants to, for example, cook indoors. In warm countries a general rule is that all rooms should have a window with a clear opening of at least 10% of the area of the room on plan.
- Indoor lighting: ensure a reasonable amount of natural light through windows and skylights.
- Noise: the use of cement render mortar walls can provide reasonably good acoustic barriers between rooms.
- Security: engineered *bahareque* walls are very strong and provide excellent protection against intruders.
- Personalisation of home: provide the beneficiaries with the ability to personalise the décor and internal layout as much as possible. Use an *owner-driven* approach wherever possible (IFRC, 2010).
- Aspirations of beneficiaries: research has shown that well-constructed engineered *bahareque* is very popular with communities, and that people’s perception of timber and bamboo as a “poor man’s material” can be changed (Section 2.3).

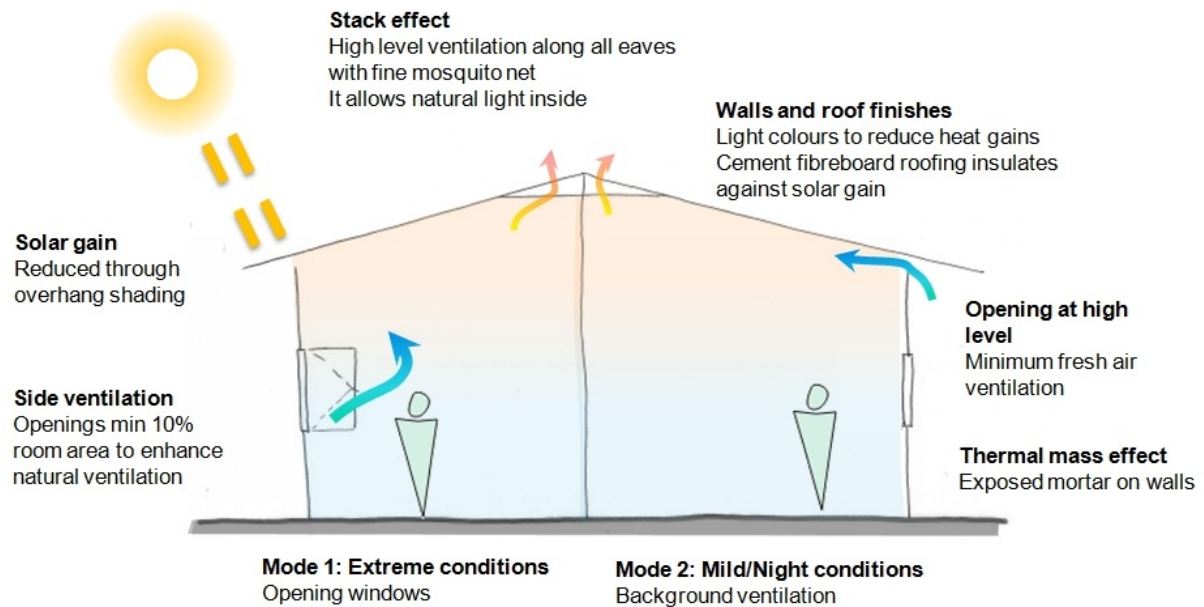

Figure 75: Techniques to keep engineered bahareque housing cool in hot climates

- Thermal considerations:
 - In warm climates engineered *bahareque* can be an excellent solution for housing because of its inherent thermal mass which can even out the day and night temperatures. Other techniques of keeping the house cool during the day include encouraging natural ventilation through windows and ventilation holes, increasing the length of the roof overhang to reduce solar gain on the walls, a high ceiling, having a light-coloured roof and walls to reduce solar gain, and using an insulating roofing material such as cement fibreboard sheeting (Figure 75).
 - In cold climates heating may be required. Also consider adding an insulating material to the wall cavity.

The case study in El Salvador in Section 2.3 (Kaminski, 2016a) discusses these in more detail.

10.0 Summary

This technical report has shown that when properly designed engineered *bahareque* can be an affordable, environmentally-friendly, hazard resilient, safe and durable form of housing. It has significant potential in many countries around the world where bamboo or cane grow, and is particularly suited to one and two-storey housing units. Like any form of construction it has some limitations. However, with good design it can meet most country fire requirements, can have a design life exceeding 50 years, and can resist earthquakes and strong winds in even the most hazardous regions of the world.

References

- American Society of Civil Engineers (ASCE) (2010) *Minimum Design Loads for Buildings and Other Structures, ASCE7-10*. Virginia, USA: ASCE
- American Society for Testing and Materials (ASTM) (2016) *ASTM A153 / A153M: Standard specification for zinc coating (hot-dip) on iron and steel hardware*. Conshohocken, PA: ASTM International
- American Society for Testing and Materials (ASTM) (2015) *ASTM A780: Standard practice for repair of damage and uncoated areas of hot-dip galvanised coatings*. Conshohocken, PA: ASTM International
- American Wood Council (2015) *National Design Specification for Wood Construction*. Leesburg, VA: American Wood Council
- Asociación Colombiana de Ingeniería Sísmica (AIS) (2010) *NSR-10: Reglamento Colombiano de construcción sismo resistente. Título G: Estructuras de madera y estructuras de guadua*. Bogotá, Colombia: AIS
- Asociación Colombiana de Ingeniería Sísmica (AIS) (2002) *NSR-98: Capítulo E.7: Reglamento colombiano de construcción sismo resistente - Casas de uno y dos pisos en bahareque encementado*. Bogotá, Colombia: AIS
- Beteta M., Gil J., Cabrera A., Kaminski S. & Alemán J. (2015) *Ensayo en mesa vibratoria de estructura de vivienda experimental en bahareque mejorado: construcción y programa experimental*. Internal Report, University Mariano Gálvez, Guatemala
- BRE (2003) *Recognising wood rot and insect damage in buildings, 3rd edition (BR 453)*. Bracknell, UK: BRE
- BRE (1999) *Termites and UK Buildings: Biology, detection and diagnosis – Digest 443 Part 1*. Bracknell, UK: BRE
- British Standards Institution (BSI) (2011) *BS EN 15978:2011: Sustainability of construction works – Assessment of environmental performance of buildings – Calculation method*. London: BSI
- British Standards Institution (BSI) (1987) *BS 476-22: Fire tests on building materials and structures. Method for determination of the fire resistance of non-loadbearing elements of construction*. London: BSI
- Bunclark L. (2013) *ICE QUEST Travel Award Report: People-centred seismically-resistant sustainable housing in El Salvador*. ICE Report

Carazas-Aedo W. & Rivero-Olmos A. (2013) *A Wattle and Daub Anti-seismic Construction Handbook*. [Online]. Available at: <http://www.misereor.org/fileadmin/redaktion/Wattledaub%20handbook%20anti-seismic%20construction.pdf>. (Accessed: September 2016)

CEN (2014) *EN 1995-1-1: 2004 +A2 2014: Eurocode 5: Design of Timber Structures – Part 1-1: General – Common rules and rules for buildings*. Brussels: CEN

CEN (2013) *EN 1998-1 (2004+A1: 2013): Eurocode 8: Design of Structures for Earthquake Resistance – Part 1: General rules, seismic actions and rules for buildings*. Brussels: CEN

Chan C. (2014) *The Mechanical Properties of the Local Cane in El Salvador and its Utilisation in Wall Matrix Structure of Bespoke Housing*. MSc dissertation, Coventry University, Coventry, UK

Chaves, A. (2016) *Personal photo collection*

Correal, J. (2016) Bamboo design and construction. In: Harries, K. & Sharma, B. eds. *Nonconventional and Vernacular Construction Materials: Characterisation, Properties and Applications*. Cambridge, UK: Woodhead Publishing. pp. 393-429

Davies E. (2014) *Out-of-plane shake table testing of cane and mortar walls*, Graduate Dissertation, Cambridge University, Cambridge, UK

Eco-Indicators (EI99) (2000) *Manual for Designers*. Ministry of Housing, Spatial Planning and the Environment, The Netherlands

Environmental Bamboo Foundation (2003) *Vertical soak diffusion for bamboo preservation*. [Online]. Available from: <http://www.bamboocentral.org>. (Accessed September 2016)

Expamet (2016) *Expanded metal mesh and lath*. [ONLINE]. Available from: <http://www.expamet.co.uk/products/expanded-metal-mesh-and-lath>. (Accessed September 2016)

Forestry Stewardship Council (FSC) (2016) *Forestry Stewardship Council*. [ONLINE]. Available at: <https://ic.fsc.org/en> (Accessed September 2016)

Franco G., Stone H., Ahmed B., Chian S., Hughes F., Jirouskova N., Kaminski S., López J., van Drunen N. & Querembás M. (in press) The April 16 2016 MW7.8 Muisne Earthquake in Ecuador – Preliminary Observations from the EEFIT Reconnaissance Mission of May 24 - June 7. In *16th World Conference on Earthquake Engineering, 16WCEE 2017*, Santiago, Chile, January 2017

Gonzalez G. & Gutierrez J. (2003) *Cyclic Load Testing of Bamboo Bahareque Shear Walls for housing protection in Earthquake Prone Areas*. Internal report. Materials and Structural Models National Laboratory, School of Civil Engineering, University of Costa Rica

Green Building Press (n.d.) *Boron, our Health and the Environment*. [Online] Available from: <http://www.greenbuildingpress.co.uk/archive/Boron.php>. (Accessed November 2014)

Gutiérrez J. (2000) *Technical Report 19: Structural adequacy of traditional bamboo housing in Latin America*. Beijing: INBAR

Gutiérrez J. (2004) Notes on the seismic adequacy of vernacular buildings. In *13th World Conference on Earthquake Engineering, Vancouver, Canada*. Paper No. 5011

INBAR (2015) *Norma Andina para diseño y construcción de casas de uno y dos pisos en bahareque encementado*. Beijing: INBAR

International Federation of the Red Cross and Red Crescent Societies (IFRC) (2010) *Owner-Driven Housing Reconstruction Guidelines*. IFRC, Geneva, Switzerland
International Network of Bamboo and Rattan (INBAR) (2015) *Norma Andina para diseño y construcción de casas de uno y dos pisos en bahareque encementado*. Beijing: INBAR

International Organization for Standardization (ISO) (2015) *ISO 5660-1. Reaction-to-fire tests – Heat release, smoke production and mass loss rate – art 1: Heat release rate (cone calorimeter method) and smoke production rate (dynamic measurement)*. Geneva: ISO

International Organization for Standardization (ISO) (2014) *ISO834-11. Fire resistance tests – Elements of building construction – Part 11: Specific requirements for the assessment of fire protection to structural steel elements*. Geneva: ISO

International Organization for Standardization (ISO) (2009a) *ISO1461. Hot dip galvanized coatings on fabricated iron and steel articles – specifications and test methods*. Geneva: ISO

International Organization for Standardization (ISO) (2009b) *ISO3506-1. Mechanical properties of corrosion-resistant stainless steel fasteners – Part 1: Bolts, screws and studs*. Geneva: ISO

International Organization for Standardization (ISO) (2007) *ISO12944-5: Paints and varnishes – corrosion protection of steel structures by protective paint systems – Part 5: Protective paint systems*. Geneva: ISO

International Organization for Standardization (ISO) (2004a) *ISO22156. Bamboo: Structural design*. Geneva: ISO

International Organization for Standardization (ISO) (2004b) *ISO22157-1. Bamboo: Determination of physical and mechanical properties. Part 1: Requirements*. Geneva: ISO

International Organization for Standardization (ISO) (2004c) *ISO22157-2. Bamboo: Determination of physical and mechanical properties. Part 2: Laboratory manual*. Geneva: ISO

International Organization for Standardization (ISO) (1997) *ISO 14040:1997. Environmental Management – Life Cycle Assessment – Principles and Framework*. Geneva: ISO

Janssen J. (2000) *Technical Report 20: Designing and Building with Bamboo*. Beijing: INBAR

Kaminski S. (2016) *Personal photo collection*

Kaminski S. (2013) Engineered Bamboo Houses for Low-Income Communities in Latin America. In *The Structural Engineer*, October 2013, pp.14-23

Kaminski S., Coates K., Lawrence A. & Aleman J. (2015) Seismic Design of Low-Cost and Sustainable Cane, Timber and Mortar Housing for El Salvador. In *SECED 2015 Conference: Earthquake Risk and Engineering towards a Resilient World*, Cambridge, UK. July 2015

Kaminski S., Lawrence A., Coates K. & Foulkes L. (2016a) A low-cost vernacular improved housing design. In *Proceedings of the Institution of Civil Engineers – Civil Engineering*: 169(5): 25–31

Kaminski S., Lawrence A. & Trujillo D. (2016b) Technical Note Series: Structural use of bamboo – Part 1: Introduction to bamboo. In *The Structural Engineer*, August 2016, pp.40-43

Kaminski S., Lawrence A., Trujillo D. & King C. (2016c) Technical Note Series: Structural use of bamboo – Part 2: Durability and Preservation. In *The Structural Engineer*, October 2016, pp. 38-43

Kaminski S., Lawrence A. & Trujillo D. (in press a) Technical Note Series: Structural use of bamboo – Part 3: Design Values. In *The Structural Engineer*. In press

Kaminski S., Lawrence A. & Trujillo, D. (in press b) Technical Note Series: Structural use of bamboo – Part 4: Durability and Preservation. In *The Structural Engineer*. In press

Kaminski S., Lawrence A. & Trujillo D. (in draft a) Technical Note Series: Structural use of bamboo – Part 5: Connections. In *The Structural Engineer*. In draft

Kaminski S., Lawrence A. & Trujillo D. (in draft b) *Technical guide for full-scale testing of engineered bahareque shear walls*. Beijing: INBAR. In draft

Kuehl Y. & Yiping L. (2012) *INBAR Working Paper 71: Carbon Off-setting with Bamboo*. Beijing: INBAR

Lebow S. (2004) *Alternatives to chromated copper arsenate for residential construction*. Research Paper FPL-RP-618. Madison, WI: U.S. Department of Agriculture, Forest Service, Forest Products Laboratory

Liese W., Gutiérrez J. & González G. (2002) Preservation of bamboo for the construction of houses for low income people. In *Bamboo for Sustainable Development*, pp.481-494

Liese W. & Kumar S. (2003) *INBAR Technical Report 22: Bamboo Preservation Compendium*. Beijing: INBAR

López M., Bommer J. & Méndez P. (2004) The seismic performance of bahareque dwellings in El Salvador. In *13th World Conference on Earthquake Engineering, Vancouver, Canada*. Paper No. 2646

Lyons M. & Schilderman T. (eds) (2010) *Building Back Better, Delivering People-centred Housing Reconstruction at Scale*. Practical Action Publishing, Rugby, UK

Málaga-Chuquitaype C., Kaminski S., Elghazouli A. & Lawrence A. (2014) Seismic response of timber frames with cane and mortar walls. In *Proceedings of the Institute of Civil Engineers – Structures and Buildings*, December 2014, 167(SB12), 693-703

Mena J., Vera S., Correal J. & Lopez M. (2012) Assessment of fire reaction and fire resistance of *Guadua angustifolia kunth* bamboo. In *Construction and Building Materials*. 27 (2012) pp 60–65

Mendoza H. & Villalobos C. (1990) *Capacidad Estructural de Paneles de Bambú*. Graduation Project, School of Civil Engineering, University of Costa Rica

Murphy R., Trujillo D. & Londoño, X. (2004) Life Cycle Assessment (LCA) of a Guadua House. In *Simposio Internacional Guadua 2004*. Pereira-Colombia, 27 Sept – 2 Oct 2004

Ministerio de Desarrollo Urbano y Vivienda (MIDUVI) (in press) *Código NEC-SE-Guadua – Estructuras de Guadua (GaK)*. Ministerio de Desarrollo Urbano y Vivienda, Quito

National Fire Protection Association (NFPA) (2015) *NFPA 914: Code for Fire Protection of Historic Structures*. Washington: NFPA

Paulay T. & Priestly M. (1992) *Seismic design of reinforced concrete and masonry buildings*. New York: John Wiley & Sons, Inc.

Prieto S., Mogollón J. & Farbiarz J. (2002) Manual for earthquake-resistant construction of one and two storey houses with cemented bahareque. In *Proceedings of the International Workshop on the Role of Bamboo in Disaster Avoidance*. Guayaquil, Ecuador, 6-8 August 2001. pp.149-166

Programme for the Endorsement of Forest Certification (PEFC) (2016) Programme for the Endorsement of Forest Certification. [ONLINE]. Available at: <http://www.pefc.org/>. (Accessed September 2016)

Ridout, B. (1999) *Timber Decay in Buildings: The Conservation Approach to Treatment: (Guides for Practitioners)*. UK: Historic Scotland

Salzer C., Wallbaum H. & Tambunan L. (2016) Fire Resistance for Low-Rise Housing in The Tropics: Test Results For Bamboo-Based Construction Systems. In *Proceedings of World Conference on Timber Engineering*, Austria

Shyama P. (2016) *INBAR Working Paper No. 77: Bamboos and Invasiveness*. Beijing: INBAR

Standards Australia (2006) *AS 1720-4: Timber structures - Fire resistance for structural adequacy of timber members*. Sydney: Standards Australia

System Three (2013) *Material Safety Data Sheet: Board Defence*. [Online]. Available from: https://www.systemthree.com/reslibrary/msds/Board_Defense_MSDS.pdf. (Accessed September 2016)

Tistl M. & Velásquez J. (2002) 'Roofs instead of tents: a reconstruction project in the Colombian Coffee Zone after the Earthquake of January 25th, 1999', *Proceedings of the International Workshop on the Role of Bamboo in Disaster Avoidance*. Guayaquil, Ecuador, 6-8 August 2001. pp.140-148

Trujillo D. (2007) Bamboo structures in Colombia. In *The Structural Engineer*, March 2007, pp.25-30

Trujillo D., Ramage M. & Chang W. (2013) Lightly modified bamboo for structural applications. In *Proceedings of the Institute of Civil Engineers – Construction Materials*, 166(4), pp. 238–247

Trujillo D. (2014) *Personal photo collection*

Webb K. (2015) *Investigation of the Fire Performance of Bamboo and the Construction Method Bahareque*, Report for Department of Civil Engineering, Architecture and Building, Coventry University. [ONLINE]. Available from: <https://connect.engr.pitt.edu/p421i6wlkzn/?launcher=false&fcsContent=true&pbMode=normal>. (Accessed September 2016)

WHO (2010) *Fact sheet 340: Chagas disease*. [Online]. Available at: <http://www.who.int/mediacentre/factsheets/fs340/en/index.html>. (Accessed: September 2016)

Wood Database (2016) *Bamboo*. [ONLINE]. Available at: <http://www.wood-database.com/bamboo/>. (Accessed September 2016)

Ya-mei W., Xi-ming W. & Jun-liang L. (2011) Decay and leach resistances of bamboo treated with CuAz preservatives. In *2011 International Conference on Agricultural and Biosystems Engineering: Advances in Biomedical Engineering*. Vols. 1-2. pp. 338-341

Appendix A: Example drawings of engineered *bahareque* housing

The following set of drawings are a sample taken from the REDES housing project in El Salvador, as described in Section 2.3. The drawings are intended to be illustrative of some of the details required, and are presented here for information purposes – they should not be used for construction.

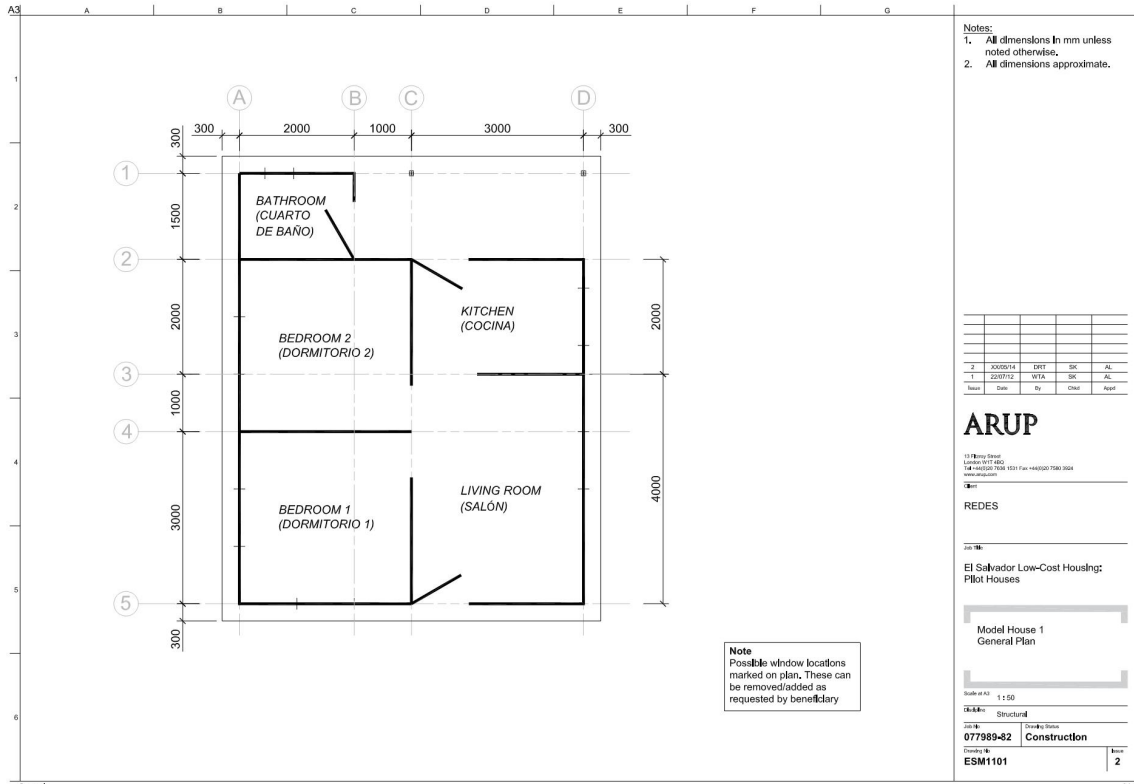

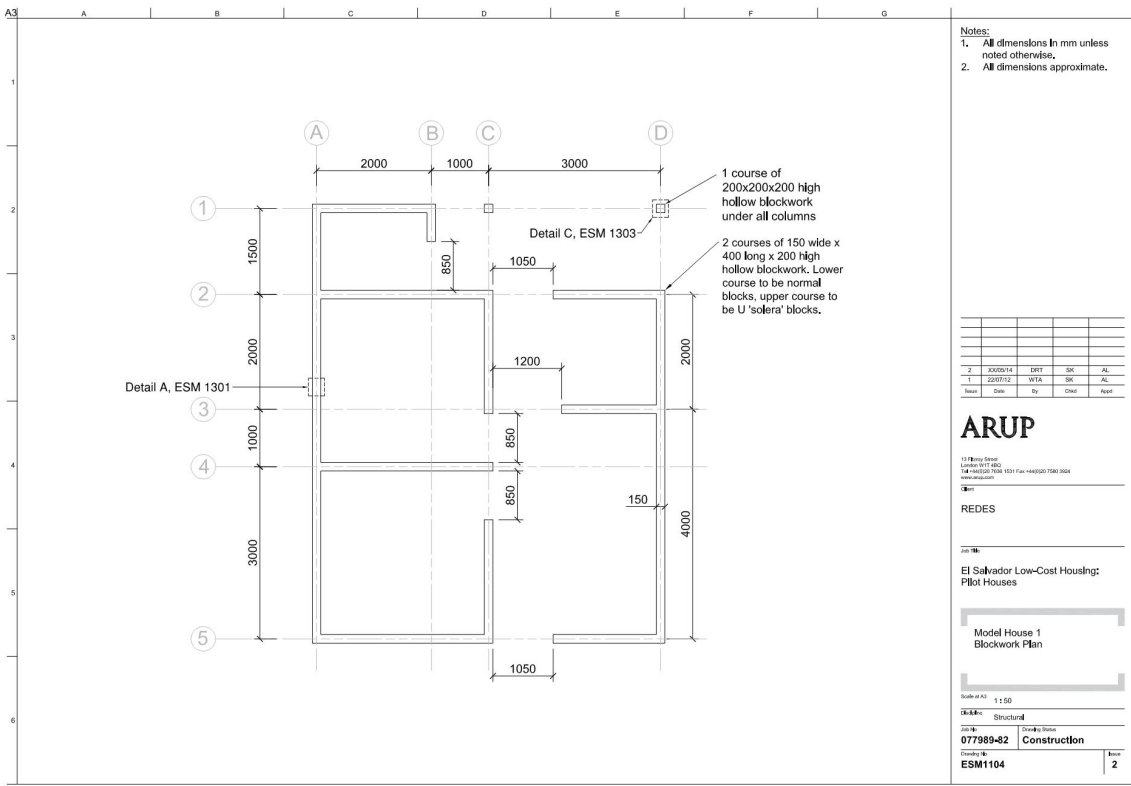
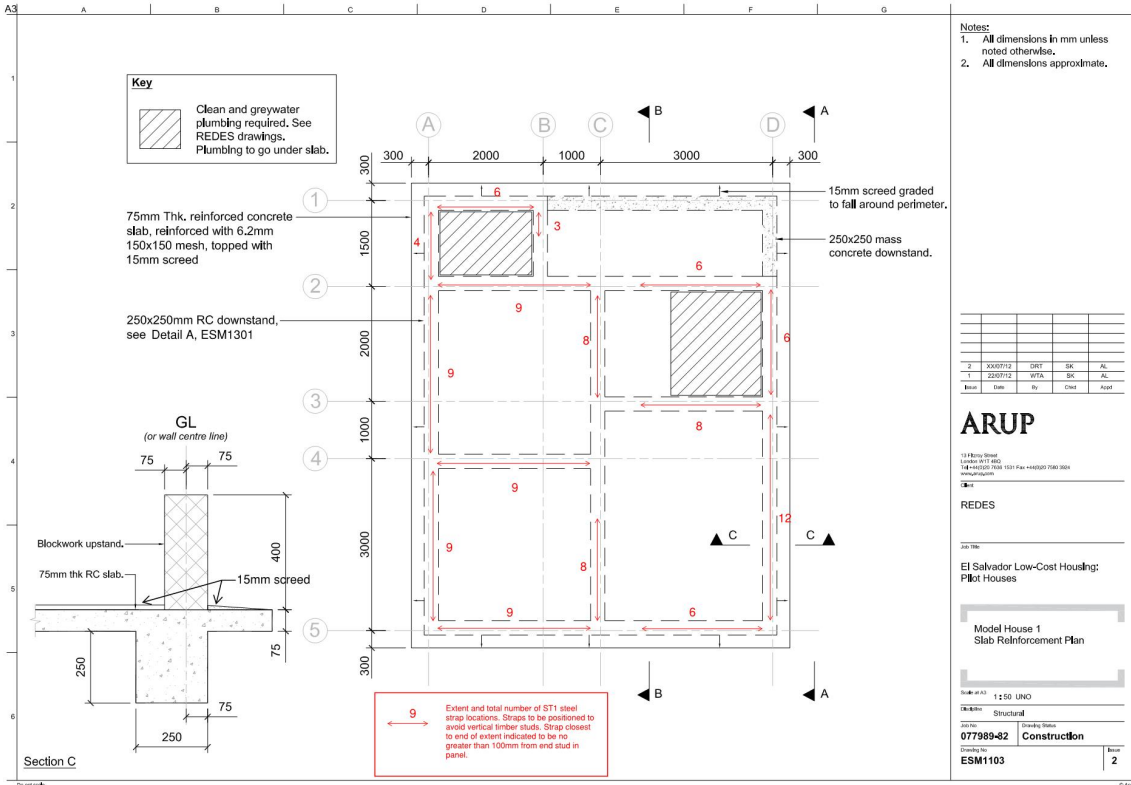

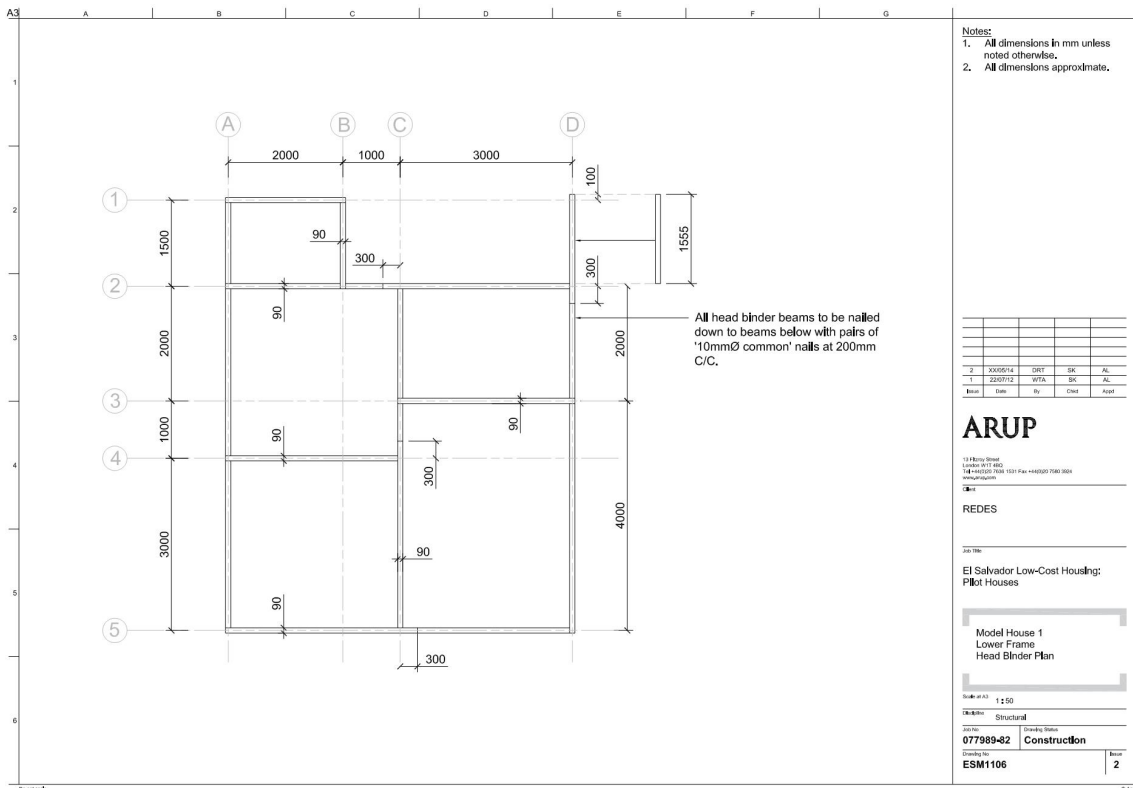
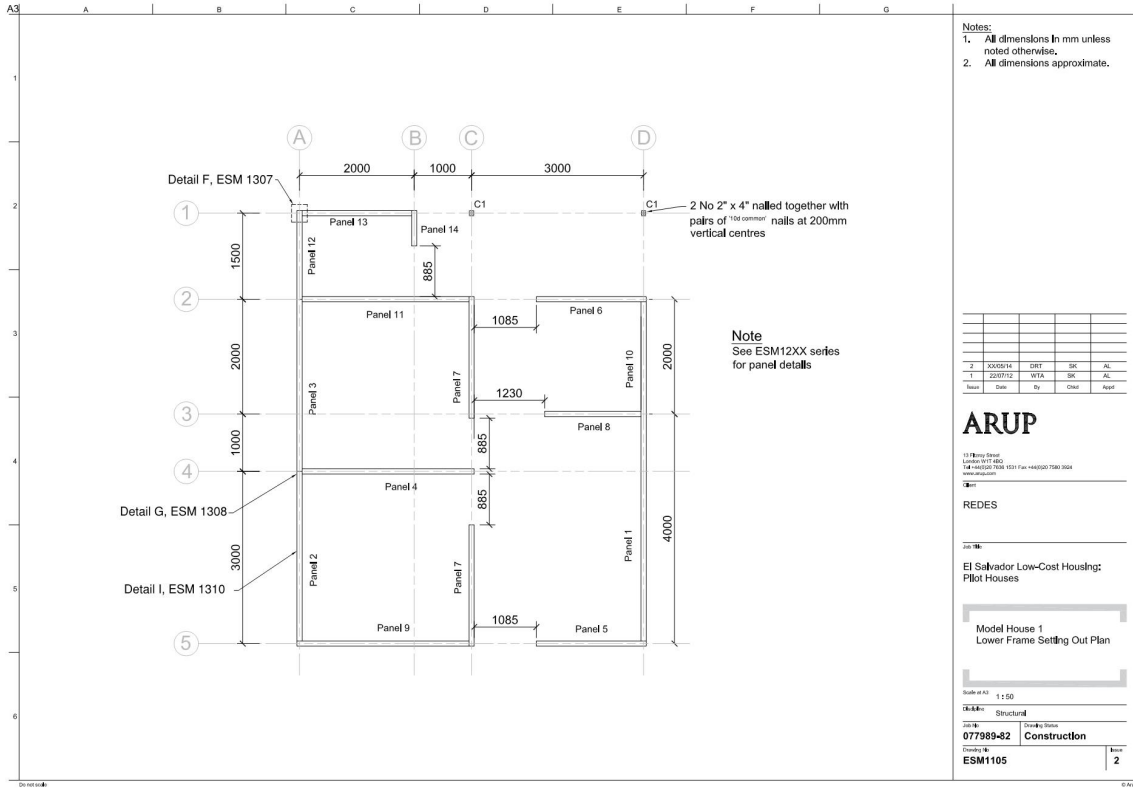

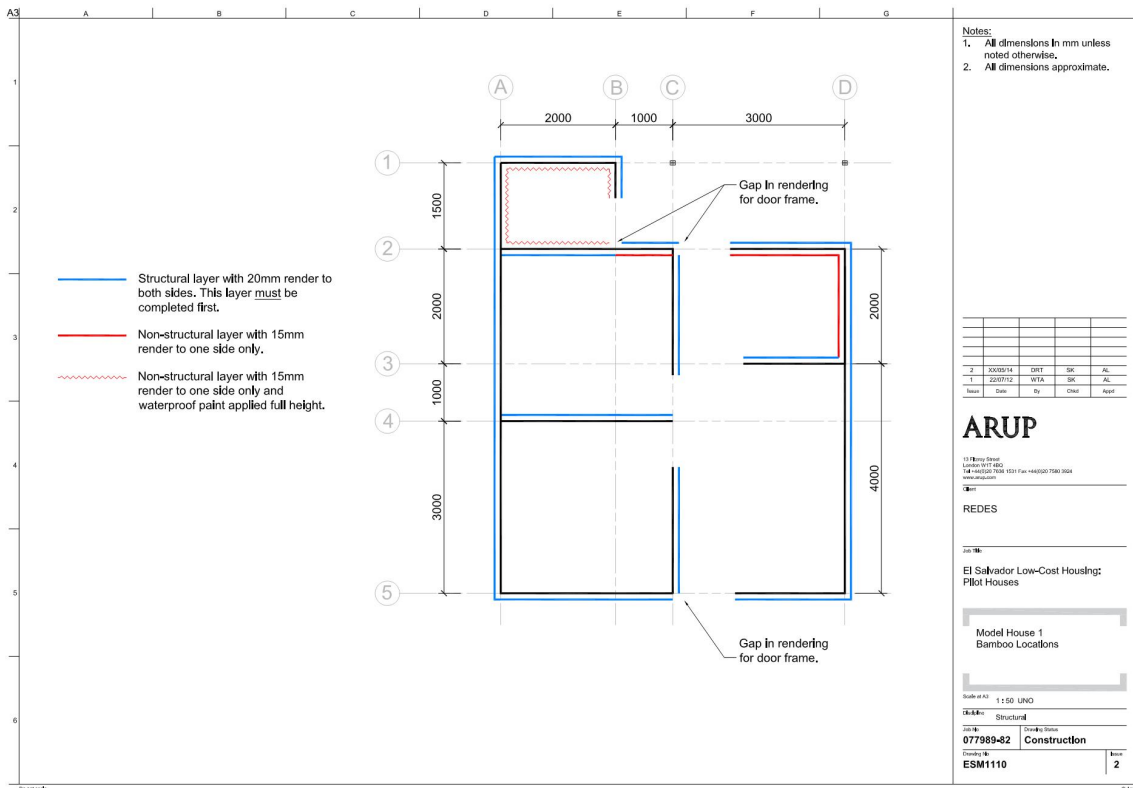
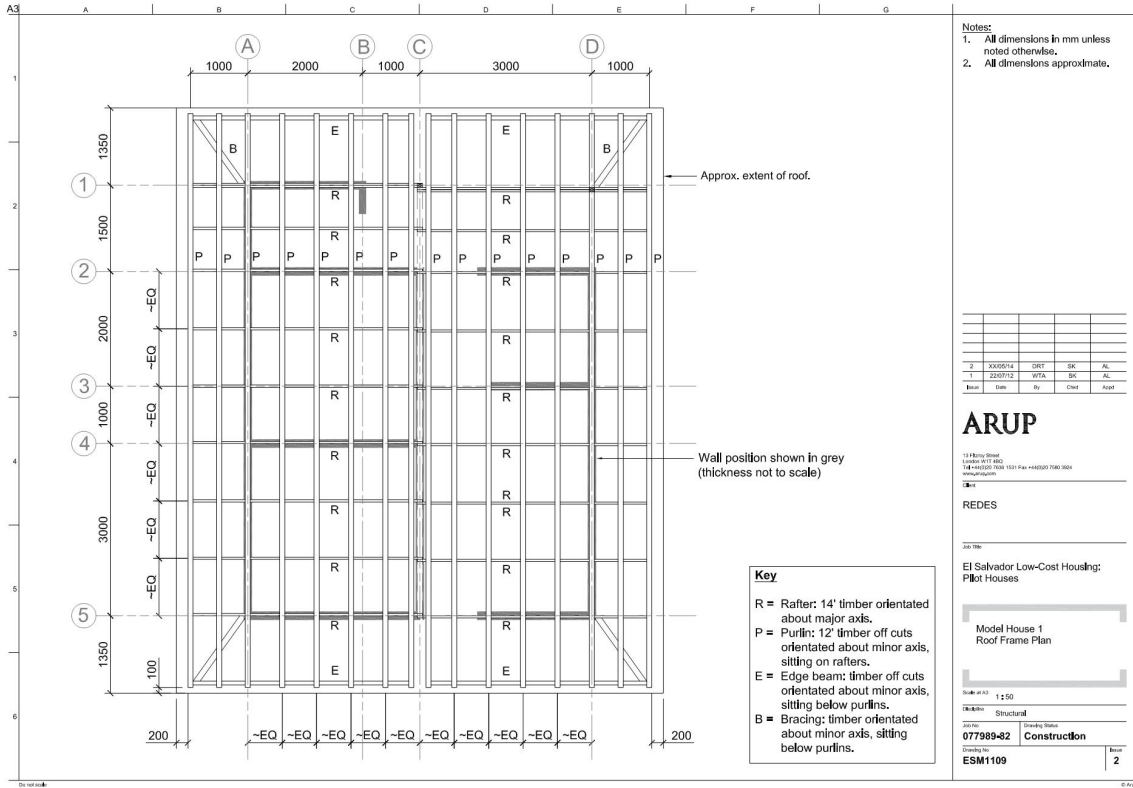

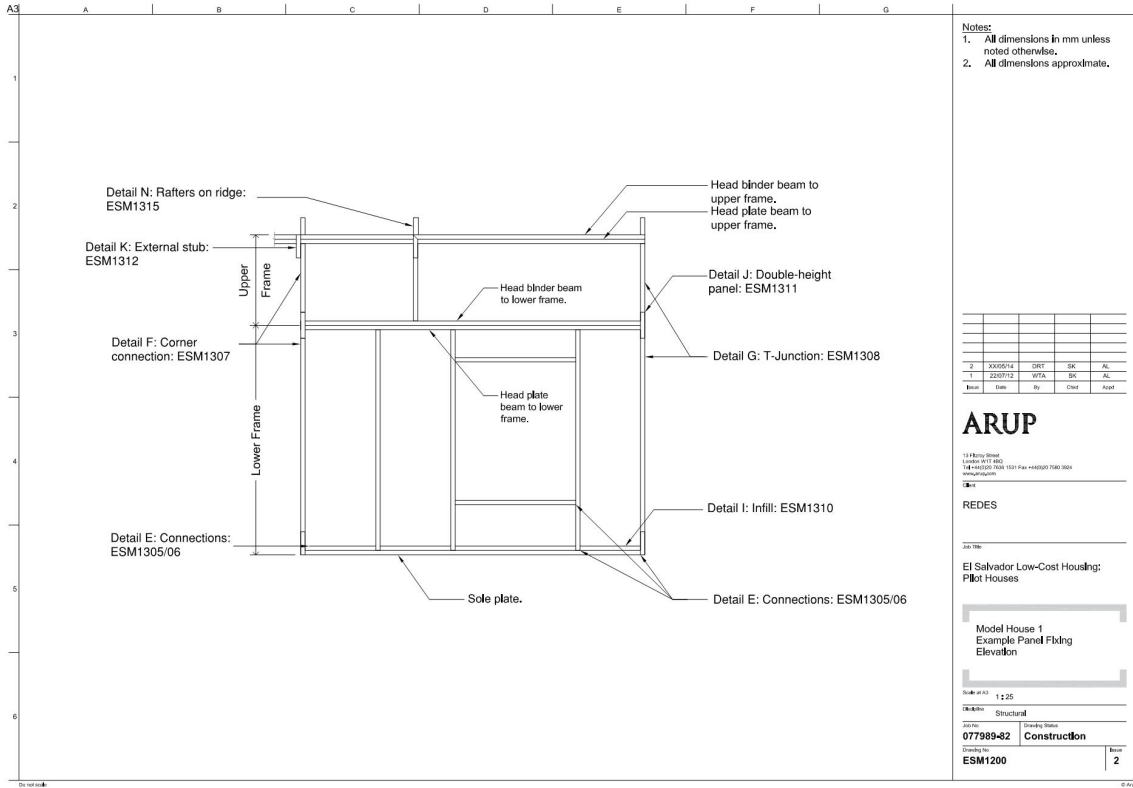

- Notes:
1. All dimensions in mm unless noted otherwise.
 2. All dimensions approximate.

Rev	Date	By	Check	Appr
2	20/05/14	DRT	SK	AL
1	22/07/12	WTA	SK	AL

ARUP

111 Market Street
London W1T 7BG
Tel: +44(0)20 7601 1311 Fax: +44(0)20 7601 3004
www.arup.com

REDES

Job Title:
El Salvador Low-Cost Housing:
Pilot Houses

Model House 1
Example Panel Fixing
Elevation

Scale of A3: 1:25

Discipline: Structural

Job No: 077989-02 Drawing Status: Construction

Drawing No: ESM1200

Sheet: 2

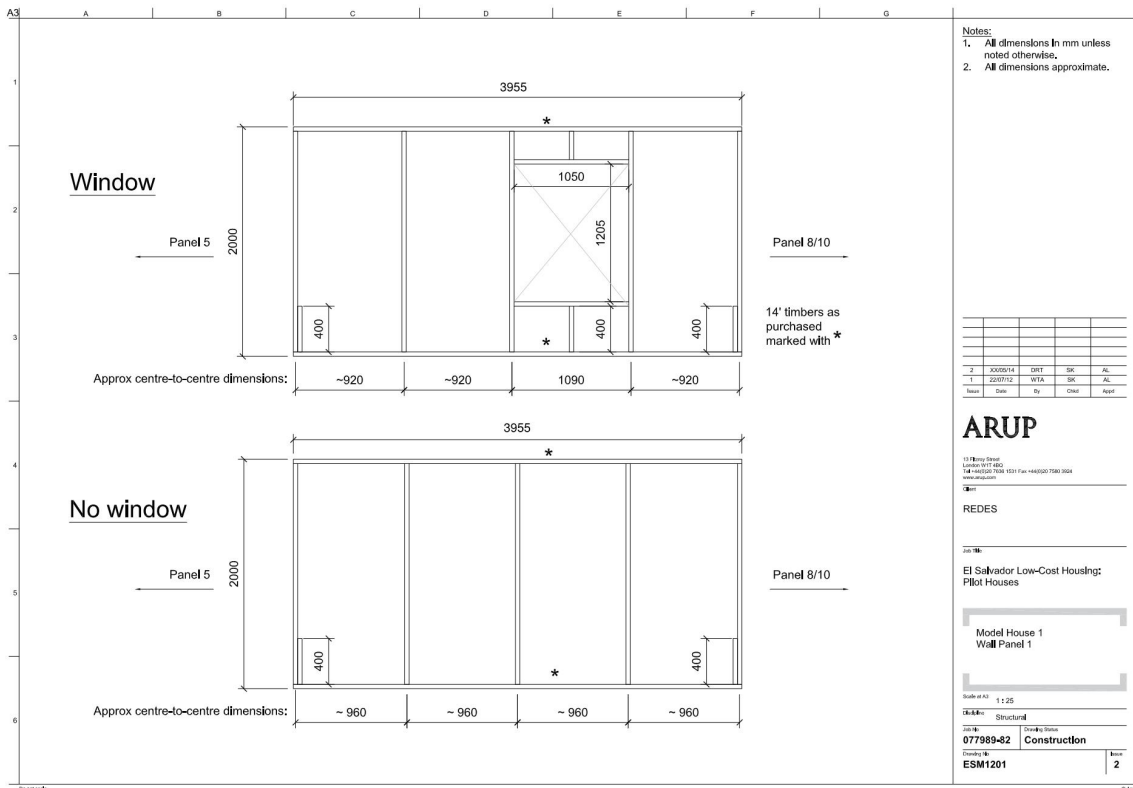

- Notes:
1. All dimensions in mm unless noted otherwise.
 2. All dimensions approximate.

Rev	Date	By	Check	Appr
2	20/05/14	DRT	SK	AL
1	22/07/12	WTA	SK	AL

ARUP

111 Market Street
London W1T 7BG
Tel: +44(0)20 7601 1311 Fax: +44(0)20 7601 3004
www.arup.com

REDES

Job Title:
El Salvador Low-Cost Housing:
Pilot Houses

Model House 1
Wall Panel 1

Scale of A3: 1:25

Discipline: Structural

Job No: 077989-02 Drawing Status: Construction

Drawing No: ESM1201

Sheet: 2

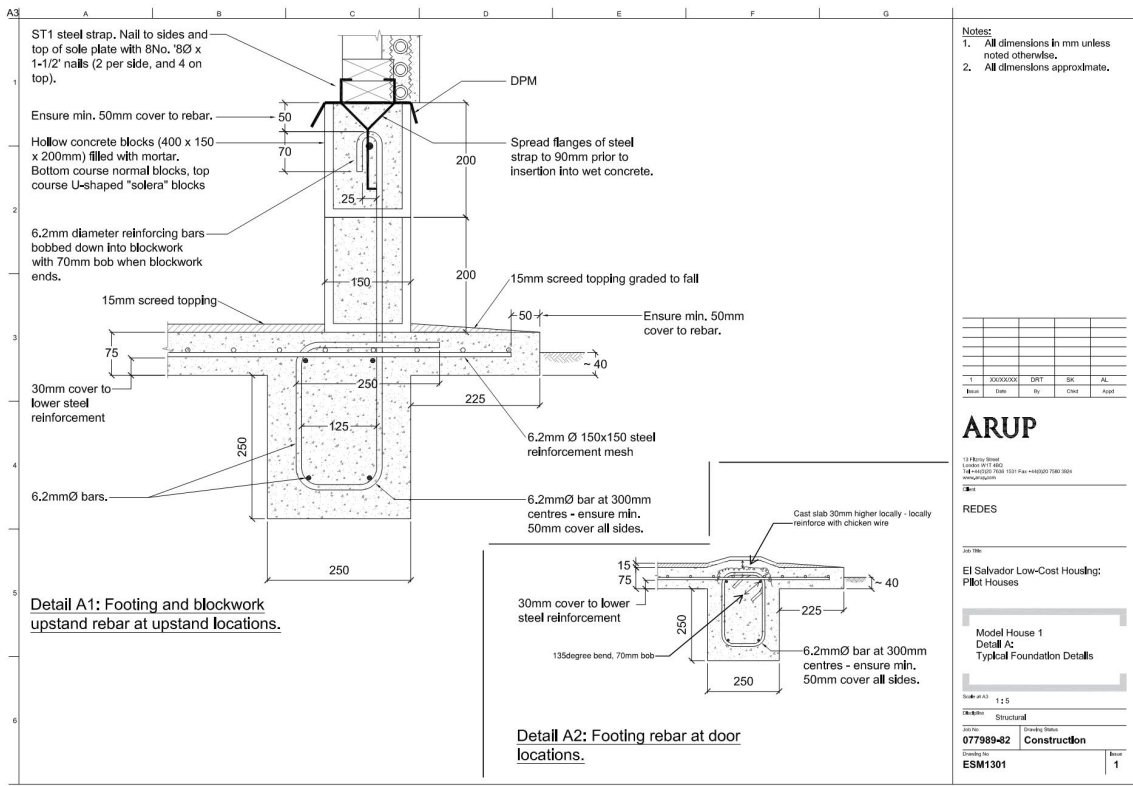
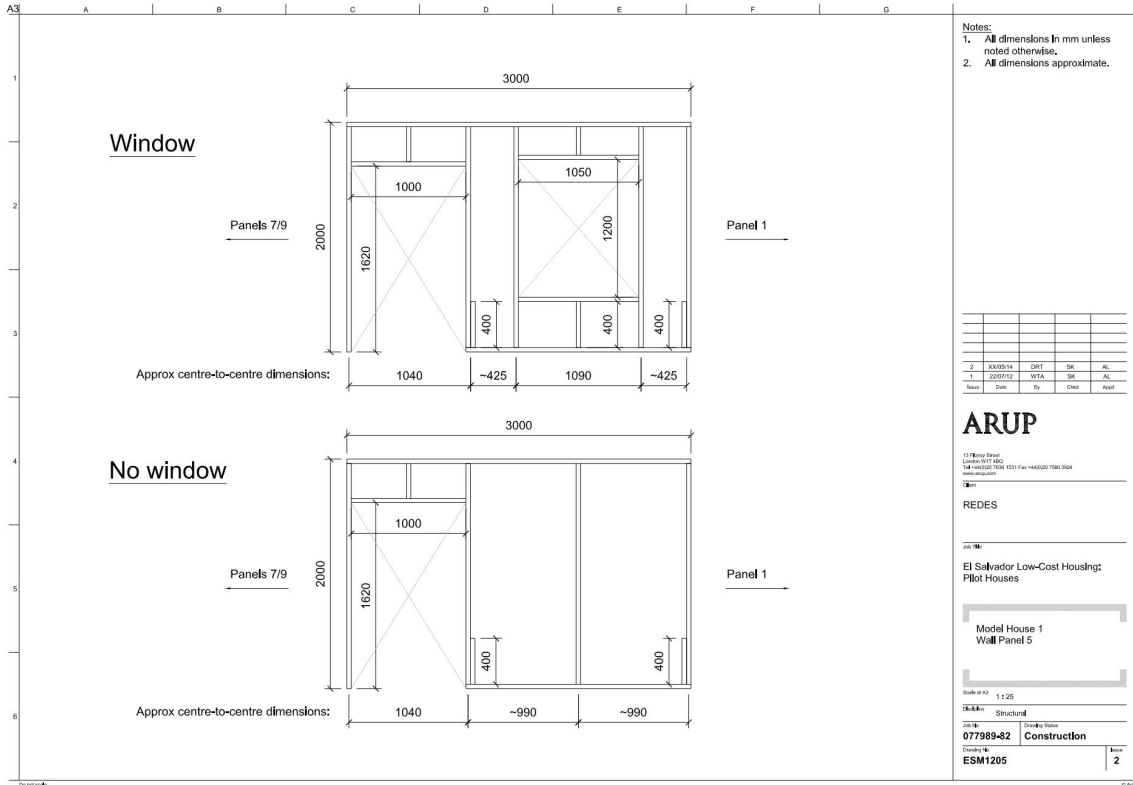

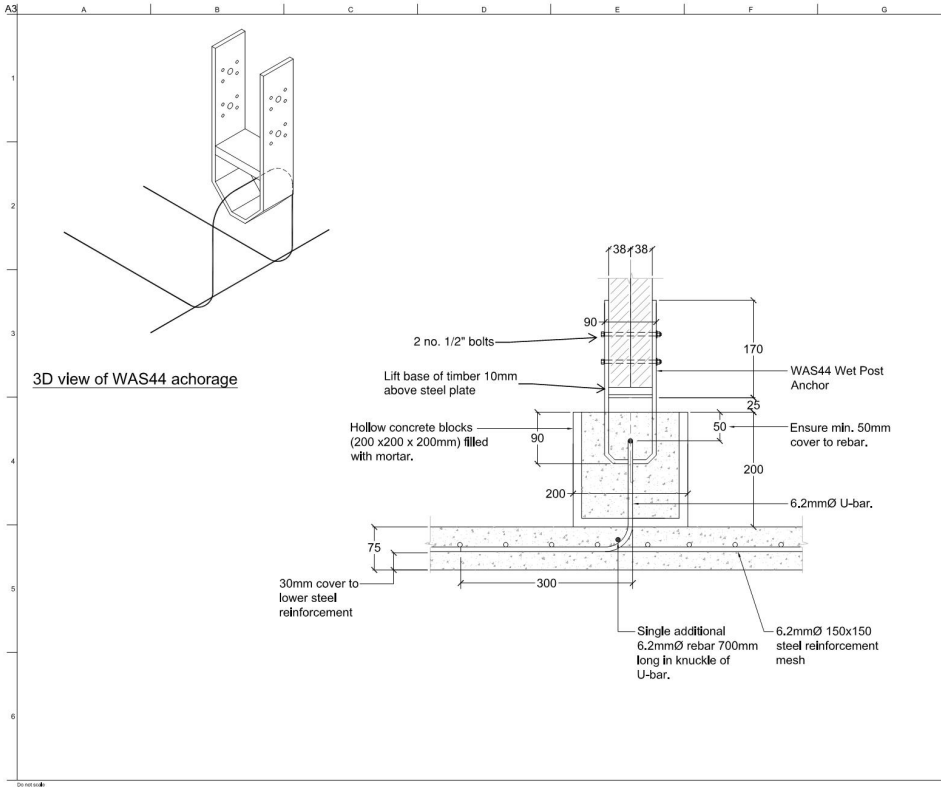

Notes:
 1. All dimensions in mm unless noted otherwise.
 2. All dimensions approximate.

1	2000000	DRT	SK	AL
Issue	Date	By	Check	App'd

ARUP
 11 Mary Street
 London EC2M 4PU
 Tel: +44 (0)20 7800 6000
 www.arup.com

REDES

Job No: **077989-02**
 El Salvador Low-Cost Housing Pilot Houses

Model House 1
 Detail C:
 External Column
 Base Detail

Scale: A3 1:5
 Discipline: Structural
 Job No: 077989-02
 Drawing Title: Construction
 Drawing No: ESM1303
 Sheet: 1

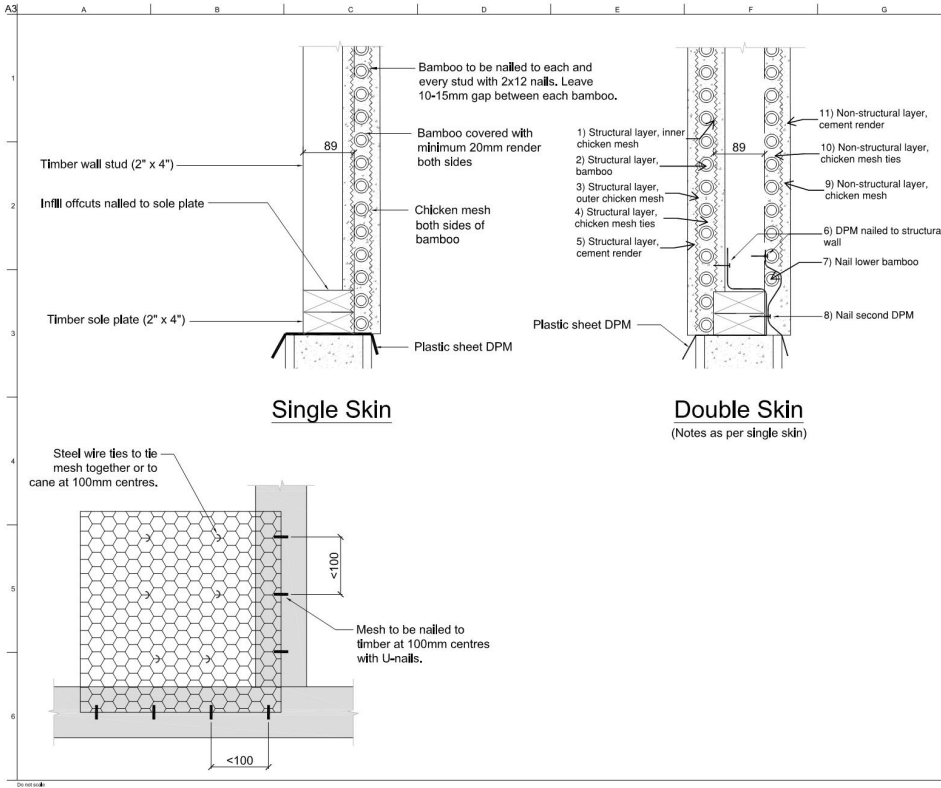

Notes:
 1. All dimensions in mm unless noted otherwise.
 2. All dimensions approximate.

2	2000000	DRT	SK	AL
1	22/07/12	WFA	SK	AL
Issue	Date	By	Check	App'd

ARUP
 11 Mary Street
 London EC2M 4PU
 Tel: +44 (0)20 7800 6000
 www.arup.com

REDES

Job No: **077989-02**
 El Salvador Low-Cost Housing Pilot Houses

Model House 1
 Detail D:
 Wall Base Detail

Scale: A3 1:5
 Discipline: Structural
 Job No: 077989-02
 Drawing Title: Construction
 Drawing No: ESM1304
 Sheet: 2

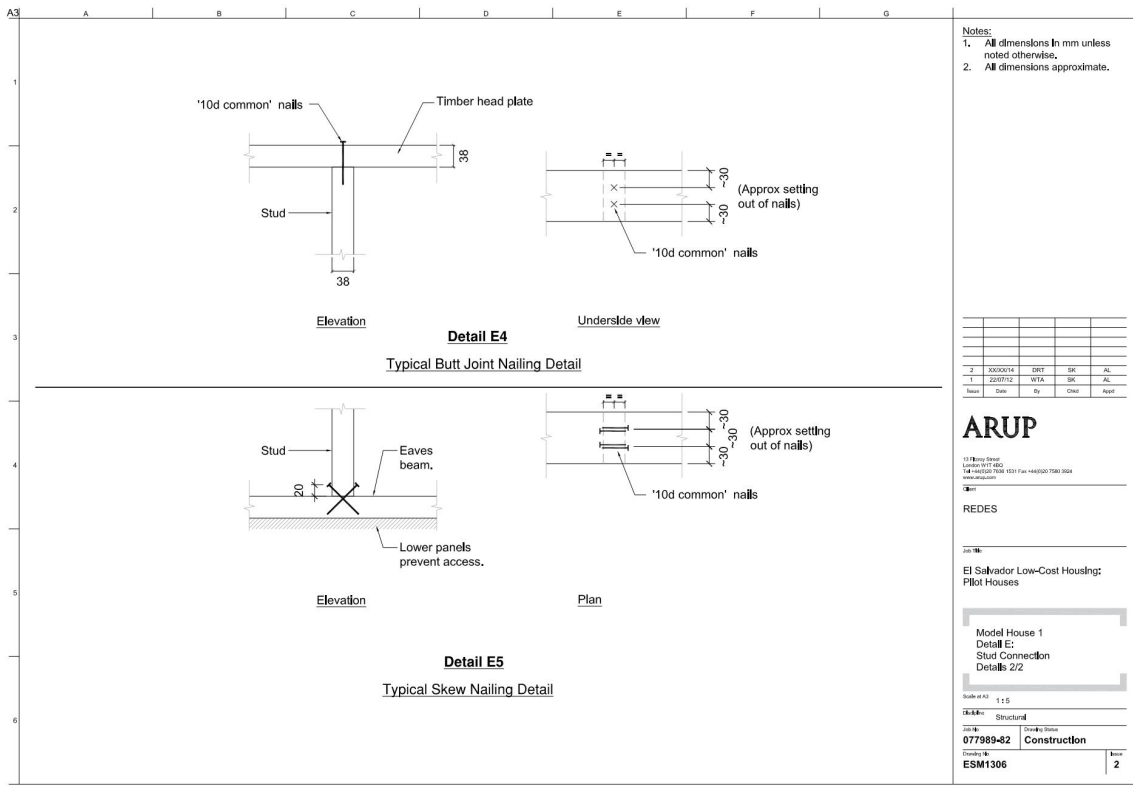
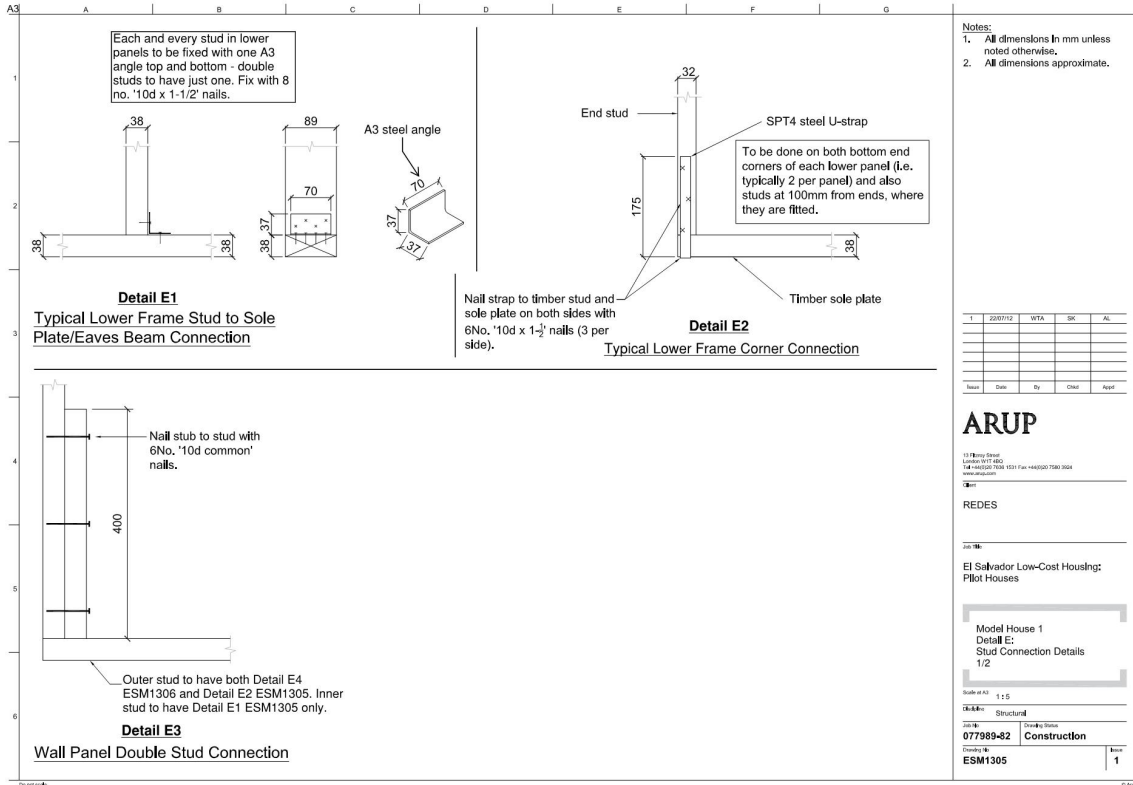

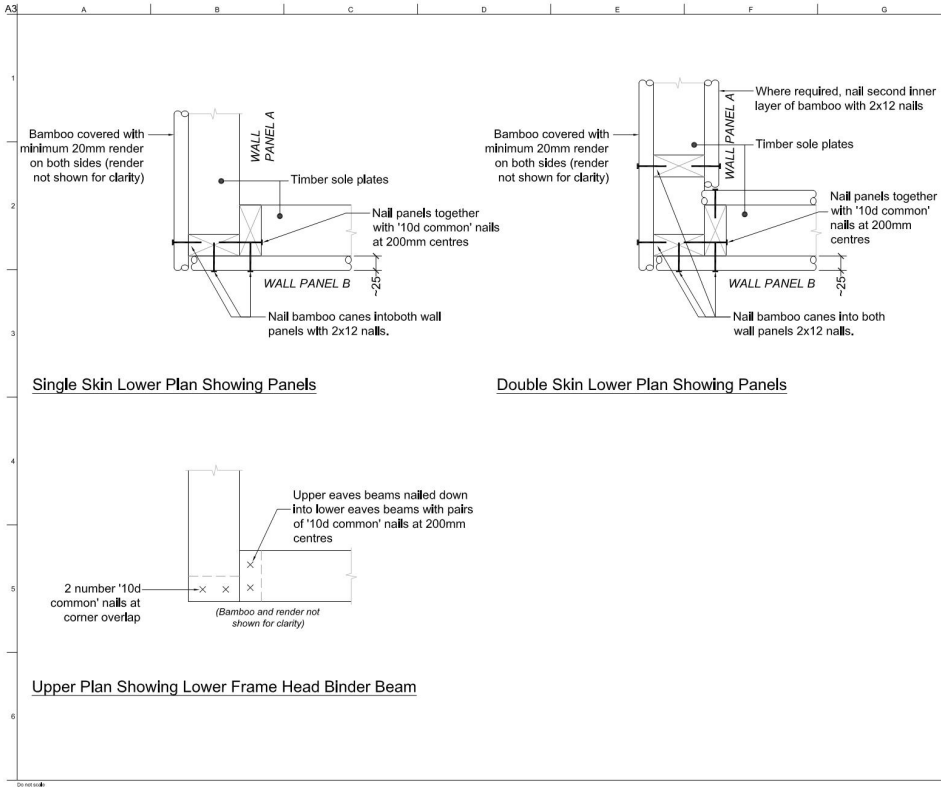

Notes:

- All dimensions in mm unless noted otherwise.
- All dimensions approximate.

2	2009/14	DRT	SK	AL
1	220712	WTA	SK	AL
Issue	Date	By	Check	App'd

ARUP

11 Mary Street
London W1T 8EG
+44 (0)20 7651 1511 Fax: +44(0)20 7651 3004
arup.com

REDES

Job No:
El Salvador Low-Cost Housing Pilot Houses

Model House 1
Detail F:
Two-Panel
Corner detail

Scale of A3: 1:5

Discipline: Structural

Job No: **077989-02** Drawing Issue: **Construction**

Drawing No: **1307** Sheet: **2**

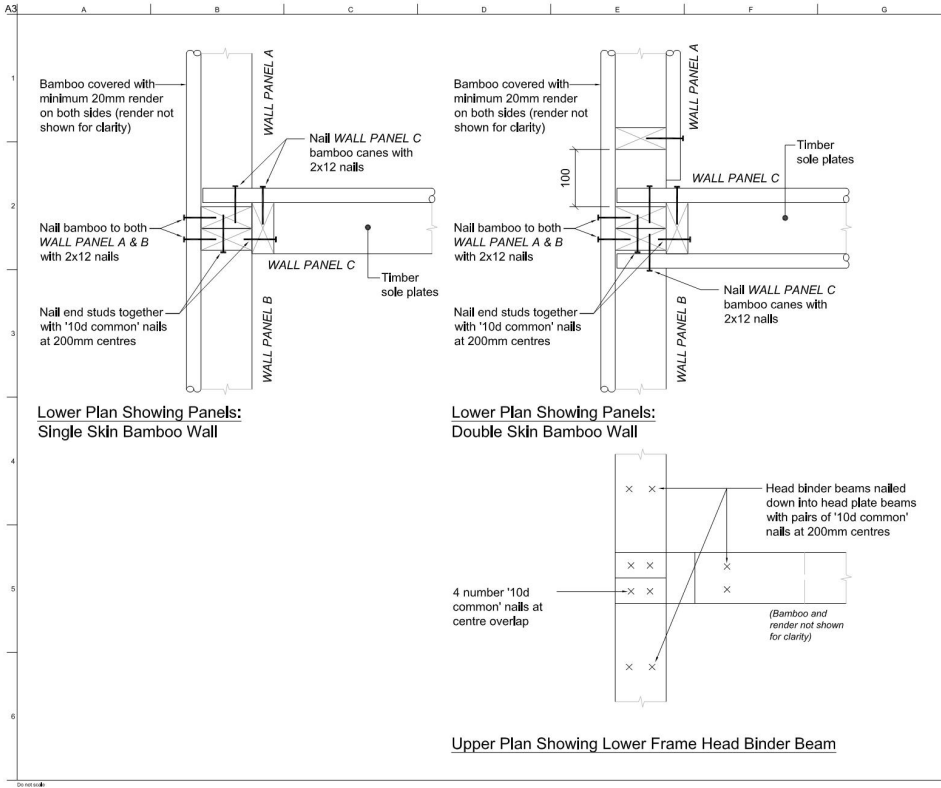

Notes:

- All dimensions in mm unless noted otherwise.
- All dimensions approximate.

2	2009/14	DRT	SK	AL
1	220712	WTA	SK	AL
Issue	Date	By	Check	App'd

ARUP

11 Mary Street
London W1T 8EG
+44 (0)20 7651 1511 Fax: +44(0)20 7651 3004
arup.com

REDES

Job No:
El Salvador Low-Cost Housing Pilot Houses

Model House 1
Detail G:
Typical Three-Panel Corner Details

Scale of A3: 1:5

Discipline: Structural

Job No: **077989-02** Drawing Issue: **Construction**

Drawing No: **ESM1308** Sheet: **2**

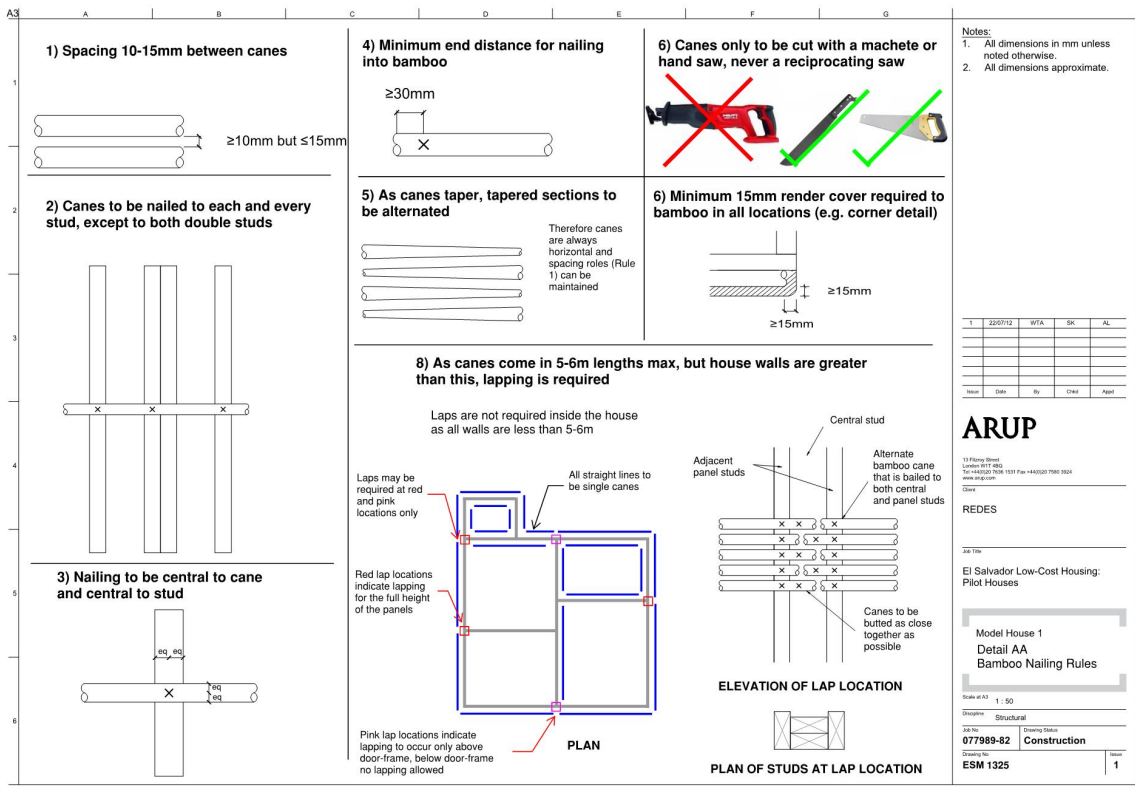
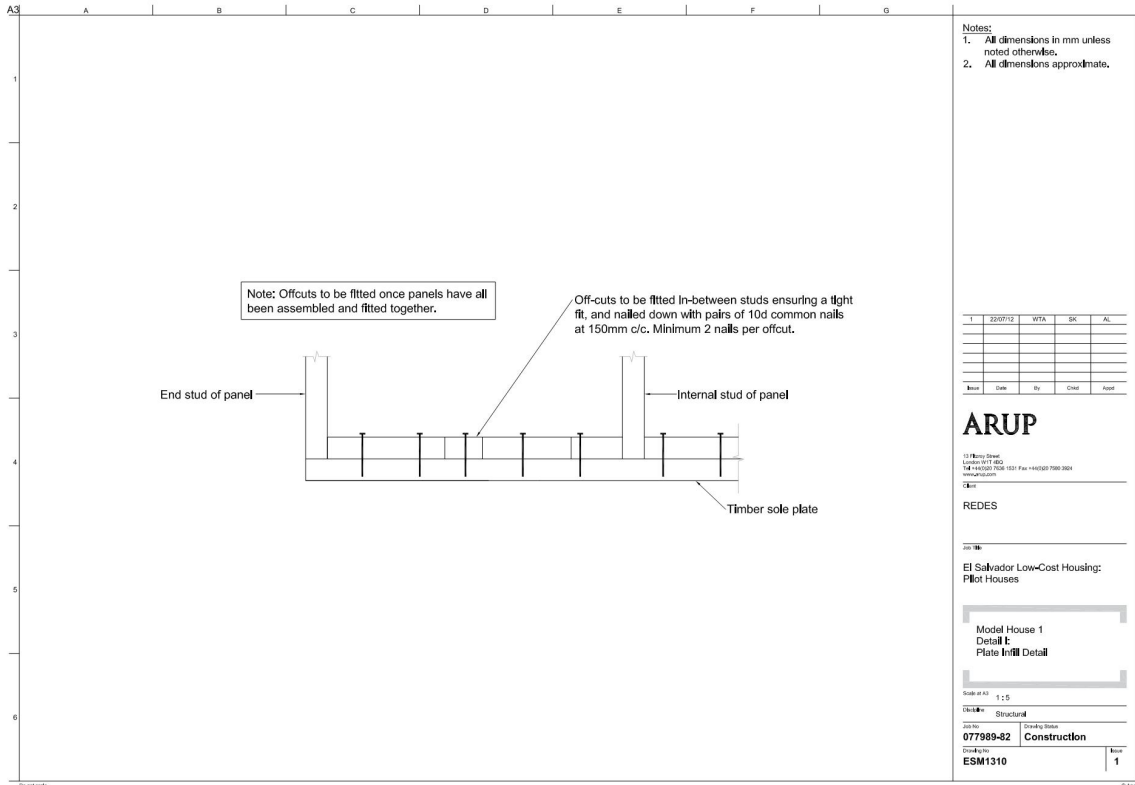

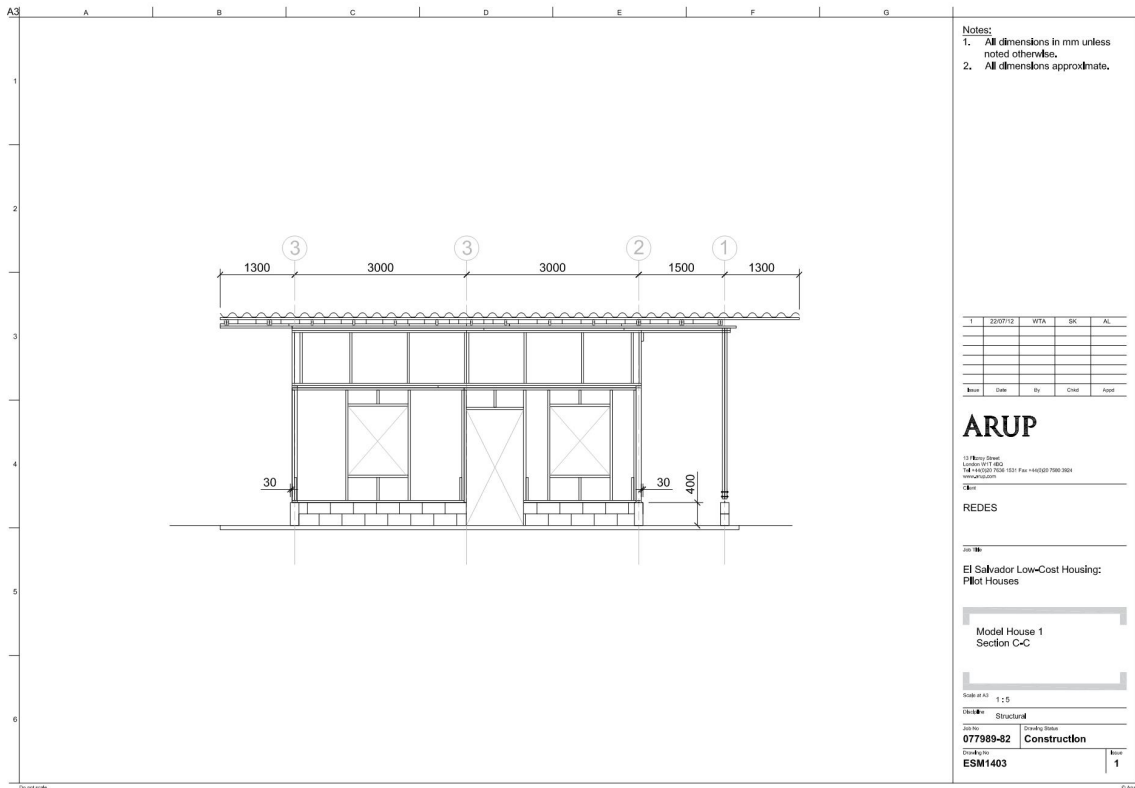
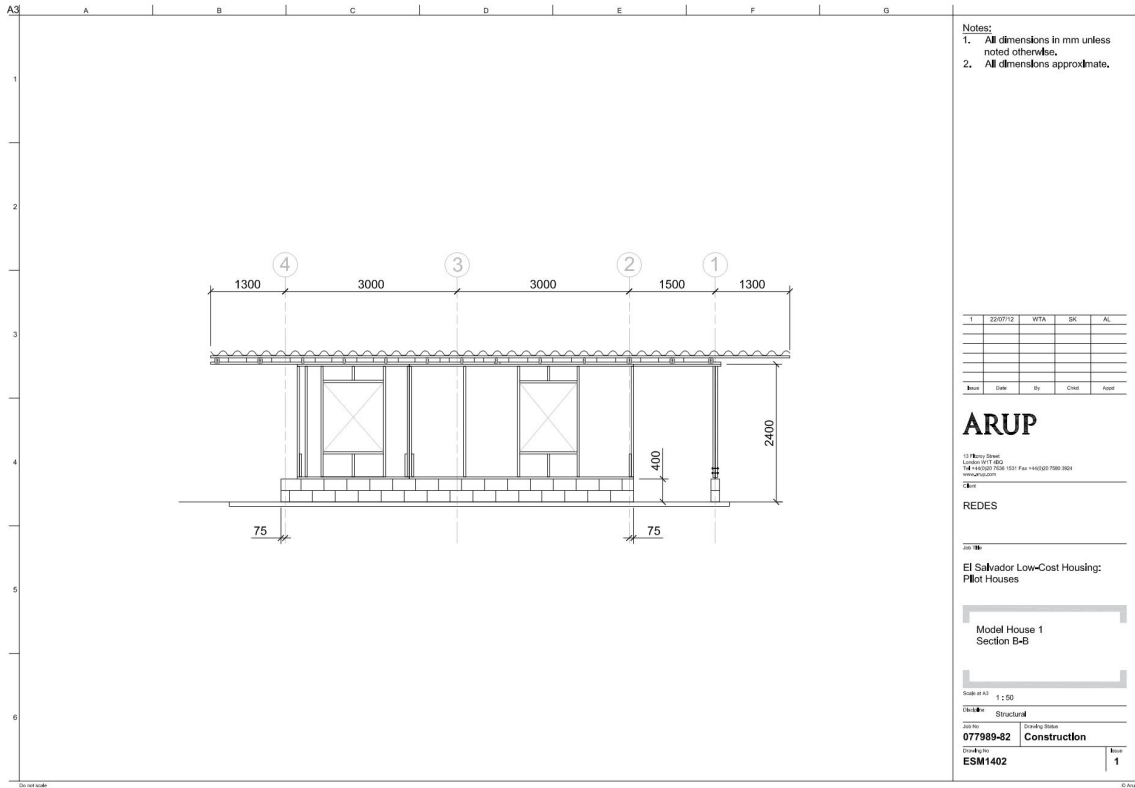

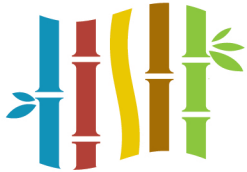

The International Network for Bamboo and Rattan (INBAR) is an intergovernmental organisation established in 1997. INBAR is dedicated to improving the social, economic, and environmental benefits of bamboo and rattan. INBAR plays a unique role in finding and demonstrating innovative ways of using bamboo and rattan to protect environments and biodiversity, alleviate poverty, and facilitates fairer pro-poor trade. INBAR connects a global network of partners from the government, private, and not-for-profit sectors in over 50 countries to define and implement a global agenda for sustainable development through bamboo and rattan.

ARUP is an independent firm of designers, planners, engineers, consultants and technical specialists offering a broad range of professional services. Arup influences many people's lives through its projects. Shaping a sustainable future – particularly through the urban environment – will be one of the greatest challenges in the 21st century. Arup is rising to the challenge: investing in research, innovating and creating better solutions for its clients and the wider world.

International Network for Bamboo and Rattan (INBAR)
P. O. Box 100102-86 Beijing 100102
P. R. China Tel: + 86 10 64706161 Fax: + 86 10 64702166
Email: info@inbar.int
www.inbar.int

ISBN: 978-92-990082-3-2

© 2016 INBAR – International Network for Bamboo and Rattan

