

STARTS AFTER PAGE 38

InsideMRO™

How Private Flyers Are Boosting Business Aviation



737 MAX Return Nears



\$14.95 OCTOBER 12-25, 2020

# AVIATION WEEK

& SPACE TECHNOLOGY

# HYDROGEN IN AVIATION



RICH MEDIA EXCLUSIVE



AVIATION WEEK NETWORK

## **Digital Edition Copyright Notice**

The content contained in this digital edition (“Digital Material”), as well as its selection and arrangement, is owned by Informa and its affiliated companies, licensors, and suppliers, and is protected by their respective copyright, trademark and other proprietary rights.

Upon payment of the subscription price, if applicable, you are hereby authorized to view, download, copy, and print Digital Material solely for your own personal, non-commercial use, provided that by doing any of the foregoing, you acknowledge that (i) you do not and will not acquire any ownership rights of any kind in the Digital Material or any portion thereof, (ii) you must preserve all copyright and other proprietary notices included in any downloaded Digital Material, and (iii) you must comply in all respects with the use restrictions set forth below and in the Informa Privacy Policy and the Informa Terms of Use (the “Use Restrictions”), each of which is hereby incorporated by reference. Any use not in accordance with, and any failure to comply fully with, the Use Restrictions is expressly prohibited by law, and may result in severe civil and criminal penalties. Violators will be prosecuted to the maximum possible extent.

You may not modify, publish, license, transmit (including by way of email, facsimile or other electronic means), transfer, sell, reproduce (including by copying or posting on any network computer), create derivative works from, display, store, or in any way exploit, broadcast, disseminate or distribute, in any format or media of any kind, any of the Digital Material, in whole or in part, without the express prior written consent of Informa. To request content for commercial use or Informa’s approval of any other restricted activity described above, please contact the Reprints Department at (877) 652-5295. Without in any way limiting the foregoing, you may not use spiders, robots, data mining techniques or other automated techniques to catalog, download or otherwise reproduce, store or distribute any Digital Material.

NEITHER Informa NOR ANY THIRD PARTY CONTENT PROVIDER OR THEIR AGENTS SHALL BE LIABLE FOR ANY ACT, DIRECT OR INDIRECT, INCIDENTAL, SPECIAL OR CONSEQUENTIAL DAMAGES ARISING OUT OF THE USE OF OR ACCESS TO ANY DIGITAL MATERIAL, AND/OR ANY INFORMATION CONTAINED THEREIN.



Everyone wakes up every morning to a world that must keep turning. And because the world can't stop, neither can we. Because the things we make help make the world go round. So with every turn, **we'll keep building a world that works.**



Building a world that works





## Read Aviation Week Anytime, Anywhere

Now 3 Ways to Read Online



By Article:

[AviationWeek.com/awst](https://www.aviationweek.com/awst)

By Issue:

[AviationWeek.com/awst\\_current](https://www.aviationweek.com/awst_current)

Download and Read Offline:

[AviationWeek.com/download](https://www.aviationweek.com/download)

### DEPARTMENTS

- 5 | Feedback
- 6 | Who's Where
- 8-9 | First Take
- 10 | Up Front
- 12 | Going Concerns
- 14 | Leading Edge
- 15 | The Launchpad
- 72 | Marketplace
- 73 | Contact Us
- 73 | Aerospace Calendar

### FEATURES

#### 16 | Cold Logic



Boeing consolidates 787 production in South Carolina to cut costs, raising questions about implications for its facilities in Washington state

#### 32 | Clean Power



The drive to decarbonize aviation raises green hydrogen challenges but spurs European cooperation

#### 44 | ATM Evolution

With traffic activity suppressed by the pandemic, the air traffic management community focuses on future scenarios

#### 50 | War Footing

An inside look at the U.S. Army's, Project Convergence experiment, a sensor-to-shooter demonstration

#### 67 | Divided Market



New customers enter the business aviation market through charter and membership programs—but will they stay?

#### COMMERCIAL AVIATION

19 | Proposed new Boeing 737 MAX training emphasizes pilot awareness



22 | GE Aviation sets up for novel GE9X dust-buster testing

# AVIATIONWEEK

## & SPACE TECHNOLOGY

October 12-25, 2020 · Volume 182 · Number 20

JESSE H.  
NEAL  
AWARDS  
Est. 1955

66  
WINNER

2020 Winner

## 34

*Radiative forcing from contrails, such as these seen over France, is expected to become a more significant factor as air travel increases.*

24 | Metal fatigue caused Airbus A380 engine breakup, BEA says

26 | Novel coronavirus threatens Air India's privatization efforts

28 | Air cargo's digital drive is being boosted by the pandemic

29 | COVID-19 prompts idea for boarding-door temperature checks

#### AIR TRAFFIC MANAGEMENT

47 | UK NATS raises revenue by offloading radar sites

#### ELECTRIC PROPULSION

48 | Electric R44 offers an alternative path to urban air mobility

49 | Swedish startup targets zero-emissions regional flying

#### DEFENSE

56 | KC-46 progress revives U.S. Air Force next-gen tanker talks

58 | Croatia fighter replacement competition proceeds apace

59 | Swiss fighter procurement passes in slim referendum win

60 | Generational change planned for post-Brexit British Armed Forces

62 | Drones lead air campaign over disputed Nagorno-Karabakh region

#### SPACE

64 | U.S. Space Force buys into rocket reuse with refurbishment insight

65 | ESA spacecraft to gauge NASA's asteroid-deviation trial

#### ASK THE EDITORS

71 | What is the forecast for MRO business growth in next few years?

#### VIEWPOINT

74 | Three predictions for the post-pandemic supply chain

### ON THE COVER

*Universal Hydrogen is developing a logistics system that comprises hydrogen modules transported by intermodal container and loaded onto aircraft before flight. The startup is modifying the Dash 8-300 regional airliner to fuel-cell propulsion to kick-start demand. Universal Hydrogen concept.*

Aviation Week publishes a digital edition every week. Read it at [AviationWeek.com/AWST](https://www.aviationweek.com/awst)



**DIGITAL EXTRAS** Access exclusive online features from articles accompanied by this icon.





# EXPANDING OUR CAPABILITIES EXTENDING THE LIFE OF YOUR LEGACY AIRCRAFT

5 World Class  
Manufacturing and  
MRO Facilities

The **Leading** Global  
Provider of OEM  
Pedigree Parts

**Trusted** to Keep  
Your Fleets Flying  
for Over 45 Years

☎ 818-678-6555

📧 [Onticexpert@ontic.com](mailto:Onticexpert@ontic.com)



## AVIATIONWEEK<sup>↑</sup> & SPACE TECHNOLOGY

**Editor-In-Chief** Joseph C. Anselmo [joe.anselmo@aviationweek.com](mailto:joe.anselmo@aviationweek.com)

### Executive Editors

Jen DiMascio (Defense and Space) [jen.dimascio@aviationweek.com](mailto:jen.dimascio@aviationweek.com)

Jens Flottau (Commercial Aviation) [jens.flottau@aviationweek.co.uk](mailto:jens.flottau@aviationweek.co.uk)

Graham Warwick (Technology) [warwick@aviationweek.com](mailto:warwick@aviationweek.com)

**Editors** Lindsay Bjerregaard, Sean Broderick, Michael Bruno, Bill Carey, Thierry Dubois, William Garvey, Ben Goldstein, Lee Hudson, Irene Klotz, Helen Massy-Beresford, Jefferson Morris, Guy Norris, Tony Osborne, Bradley Perrett, James Pozzi, Adrian Schofield, Lee Ann Shay, Steve Trimble

**Chief Aircraft Evaluation Editor** Fred George

**Director, Editorial and Online Production** Michael O. Lavitt

**Associate Managing Editor** Andrea Hollowell

**Art Director** Lisa Caputo

**Artists** Thomas De Pierro, Rosa Pineda, Colin Throm

**Copy Editors** Jack Freifelder, Arturo Mora, Natalia Pelayo, Andy Savoie

**Production Editors** Audra Avizienis, Theresa Petruso

**Contributing Photographer** Joseph Pries

**Director, Digital Content Strategy** Rupa Haria

**Content Marketing Manager** Rijia Tariq

### Data & Analytics

**Director, Forecasts and Aerospace Insights** Brian Kough

**Senior Manager, Data Operations/Production** Terra Deskins

**Manager, Military Data Operations** Michael Tint

### Editorial Offices

2121 K Street, NW, Suite 210, Washington, D.C. 20037

Phone: +1 (202) 517-1100

605 Third Avenue, New York, N.Y. 10158

Phone: +1 (212) 204-4200

### Bureau Chiefs

#### Auckland

Adrian Schofield [avweekscho@gmail.com](mailto:avweekscho@gmail.com)

#### Cape Canaveral

Irene Klotz [irene.klotz@aviationweek.com](mailto:irene.klotz@aviationweek.com)

#### Chicago

Lee Ann Shay [leeann.shay@aviationweek.com](mailto:leeann.shay@aviationweek.com)

#### Frankfurt

Jens Flottau [jens.flottau@aviationweek.co.uk](mailto:jens.flottau@aviationweek.co.uk)

#### Houston

Mark Carreau [mark.carreau@gmail.com](mailto:mark.carreau@gmail.com)

#### London

Tony Osborne [tony.osborne@aviationweek.co.uk](mailto:tony.osborne@aviationweek.co.uk)

#### Los Angeles

Guy Norris [guy.norris@aviationweek.com](mailto:guy.norris@aviationweek.com)

#### Lyon

Thierry Dubois [thierry.dubois@aviationweek.com](mailto:thierry.dubois@aviationweek.com)

#### Moscow

Maxim Pyadushkin [mpyadushkin@gmail.com](mailto:mpyadushkin@gmail.com)

#### Paris

Helen Massy-Beresford [helen.massy-beresford@aviationweek.co.uk](mailto:helen.massy-beresford@aviationweek.co.uk)

#### Washington

Jen DiMascio [jen.dimascio@aviationweek.com](mailto:jen.dimascio@aviationweek.com)

#### Wichita

Molly McMillin [molly.mcmillin@aviationweek.com](mailto:molly.mcmillin@aviationweek.com)

**President, Aviation Week Network** Gregory Hamilton

**Managing Director, Intelligence & Data Services** Anne McMahon



By Informa Markets

## PERFECTING RESPONSE

The advances in AI described in “Air Combat by Algorithm” (*Aug. 31-Sept. 13, p. 46*) are wonderful, but this is not the first time a computer program has beaten a human fighter pilot.

The TAC Brawler dogfight simulation code, Fortran from the 1970s, did it all the time once it was integrated into man-in-the-loop simulations such as the excellent one Lockheed created out at Rye Canyon in the early days of the F-22. It kicked my rear end, although I’m not a good example since I’m not a fighter pilot, except in my dreams. But real fighter pilots had to be on their toes, too.

The problem, then and now, is deciding how much information the computer program is allowed to possess versus the human pilot. Given perfect situational awareness, the code can always determine the perfect response. But in the real world, no fighter pilot—human or otherwise—ever gets perfect situational awareness. But we’re working on it!

*Daniel P. Raymer, Playa Del Ray, California*  
President of Conceptual Research Corp. and former director of advanced design at Lockheed



**“AS WE MOVE FORWARD TO DEVELOPING AGENTS FOR 2-2, 4-4 AND LARGER ENGAGEMENTS I HOPE THAT WE REWARD SCENARIOS WHERE THE HUMAN SURVIVES, ENCOURAGING THE UNMANNED WINGMAN TO SELF-SACRIFICE . . .”**

— ERWIN HUNTER comments online

## SILO THINKING

P. Barry Butler’s commentary on Embry-Riddle’s goals, “Age of Automation” (*Aug. 31-Sept. 13, p. 10*), is encouraging but needs a course correction.

Cross-disciplinary training is vital to solving the complex problems that are part of truly integrated systems. Systems engineering principles of integration across the entire spectrum of the program are also required. However, Butler’s statement that “silo mentality restricts our field of view” is short-sighted because it does not recognize that truly successful programs need traditional “silo thinking” along with “system thinking.” Neither, by itself, can be successful. Successful programs and program managers know how to use the individual specialized disciplines of both.

Let’s not forget that students are not just stamped out on an assembly line. Individual students have unique skills and career goals. Some are born to be analysts and prefer to reside in silos and will ultimately thrive in that environment. Others know how to think and work in terms of systems (or are multidisciplinary, in his lexicon). Successful curricula should enable the students to know where they fit in and, ultimately, what they want to do.

*Tom Megna, Littleton, Colorado*

## SYSTEMS THINKING

I read with interest Vaughan Askue’s letter “Direct Law” (*Aug. 31-Sept. 13, p. 6*). His views on engineers and program managers resonated with my 40+ years in the turbine engines industry. As a career design engineer, engineering program manager and GE Aviation chief engineer for systems engineering, I agree with his reference to engineers

as specialists, problem solvers and designers who routinely evolve more complex designs.

In my experience, some of those engineers use their tools like a hammer looking for a nail, offering only one view—like brain surgeons who only offer brain surgery. Engineers today sometimes take too much pride in making their designs and analysis overly conservative while not taking a broader view of the system-level requirements.

Don’t get me wrong. I am not bashing these engineers; I was one of them for a while. They are vital and necessary—but not sufficient. What the industry needs is more system thinkers: systems engineers who know what the customer/operator really wants and needs and directs, with authority, the engineering team to address all requirements and all implications of the system, subsystem and component designs. The opposite of “Direct Law” is what can and does happen when system thinkers with authority are not available, not engaged and/or are marginalized by other considerations or organizational culture.

*Robert R. Kursmark, Plymouth, Massachusetts*

## CORRECTION

“New 787 Problems Spotlight Boeing’s Quality Issues” (*Sept. 14-27, p. 28*) should have stated that the Boeing 787 was grounded in January 2013.

Address letters to the Editor-in-Chief, *Aviation Week & Space Technology*, 2121 K Street, NW, Suite 210, Washington, DC, 20037 or send via email to: [awstletters@aviationweek.com](mailto:awstletters@aviationweek.com)  
Letters may be edited for length and clarity; a verifiable address and daytime telephone number are required.



**Anke Kaysser-Pyzalla** has been named chair of the executive board of German aerospace center *DLR*. The materials scientist and engineer was president of the Technical University of Braunschweig, managing director of the Max Planck Institute and scientific director of the Helmholtz Centre for Materials and Energy.



Microsatellite developer *Astranis* has named former NASA Administrator **Dan Goldin** as a senior advisor to the company and chairman of its new technical advisory board.



**William A. LaPlante** has been hired as president and CEO of the *Charles Stark Draper Laboratory*. He was MITRE Corp.

national security senior vice president. He succeeds the interim president and CEO, U.S. Army Lt. Gen. (ret.) Francis Kearney.

**Chris Dimes** has been named *Thomas Instrument* director of operations. He previously held leadership positions at Parker Aerospace and before that as a director at Honeywell Aerospace.

**Vytautas Ledakas** has been promoted to CEO of *BAA Training China* from acting type rating training organization director. He will oversee pilot training development for a new facility being built at the Zhengzhou Airport Economic Zone. The joint venture with Avia is planned to have six full flight simulators for Boeing and Airbus aircraft.



To advance development of its low-sonic-boom supersonic jet, *Spike Aerospace* has hired to its executive team **Ray Benvenuti**, founder of industrial markets specialist Concord Investment Partners; **Brian Foley**, former Dassault Falcon Jet marketing director of 20 years; and **John Thomas**, former CEO of Virgin Australia Airlines.

*Airports Council International World* has hired **Thomas Romig** as director of safety, operations and technical affairs. Romig, the former head of operations control and development at Geneva

Airport, succeeds David Gamper, who is retiring.

*AE Industrial Partners* has named **Kelly Romano** operating partner. She was United Technologies Corp. president of intelligent building technologies and held several executive roles over 27 years at UTC. AEI also has hired **Laurence Vigeant-Langlois** as managing director. She is a former GE Aviation product management executive for the Passport, CF34-3 and CF34-8C engines on Bombardier and Mitsubishi aircraft and held leadership roles at Sikorsky, CIT and the Weather Co.



**Richard Hozik** has joined *Constellis* as chief financial officer. Hozik has more than 45 years of financial and operations executive experience in the U.S. and internationally at both publicly traded and privately held government contractors.

*Vertex Aerospace* has appointed **Bill Beard** as senior vice president of corporate operations and strategy. Beard had been vice president and general manager of GKN Aerospace.

*Serco* has hired **Gordon Foster** as senior vice president and chief financial officer. He was CFO at Constellis, executive vice president and CFO at ASRC Federal and CFO of Northrop Grumman's civil, cyber and intelligence systems divisions. Foster succeeds Gary Shankman, who will retire at year-end.



*Western Aircraft* has hired **John Kochel** as director of parts and logistics and **Russell Crouch** as Gulfstream service manager. Kochel was Western territory manager for GlobalParts. aero, and Crouch was a Gulfstream Aerospace senior sales analyst.

*Security Engineered Machinery* has

appointed **Ben Figueroa** as strategic account manager. Figueroa was North American sales director for information technology and cloud services with a Fortune 500 platform-as-a-service company.

**Stephen Astemborski** has been named director of aerospace for the *South Carolina Council on Competitiveness*. He was a supply chain specialist for GE Aviation manufacturing.

*Liteye Systems* has hired **David Olszewski** to lead business development for U.S. Navy and maritime requirements. Olszewski has worked with naval services more than 40 years.

*CDB Aviation* has hired **Cronan Enright** as head of strategy for the wholly owned Irish subsidiary of China Development Bank. He joins CDB from Avanti and before that was GECAS chief marketing and strategy officer.



*Aero Asset* has hired **Joe Viveiros** and **Sebastien Delmaire** as sales directors. Viveiros has extensive qualifications both in fixed- and rotary-wing aircraft. Delmaire was Aston Martin Helicopters vice president of corporate development and strategy.

*The New England Air Museum* has elected **Robert Stangarone** as board chairman and president. He previously held senior management positions at United Technologies Corp., Pratt & Whitney, Sikorsky, Rolls-Royce, Litton, Fairchild Dornier, Cessna and Embraer. He succeeds Scott Ashton, who will remain on the board for a one-year term.

*Space-Eyes* has appointed four new advisory board members: **Sue Payton**, former assistant secretary of the Air Force for acquisition; U.S. Navy Adm. (ret.) **Timothy Keating**, former commander of the U.S. Pacific Command; U.S. Air Force Gen. (ret.) **Kevin A. Chilton**, former commander of the U.S. Strategic Command; and U.S. Air Force Maj. Gen. (ret.) **Cathy A. Chilton**, former commander of Air, Space and Information Operations. ☺

To submit information for the Who's Where column, send Word or attached text files (no PDFs) and photos to: [whoswhere@aviationweek.com](mailto:whoswhere@aviationweek.com) For additional information on companies and individuals listed in this column, please refer to the Aviation Week Intelligence Network at [AviationWeek.com/awin](http://AviationWeek.com/awin) For information on ordering, telephone U.S.: +1 (866) 857-0148 or +1 (515) 237-3682 outside the U.S.

# Excellence In Flight



Leonardo has been at the leading edge of the air domain for over 100 years.

Providing best-in-class aircraft, helicopters, aerostructures, unmanned aerial systems, airborne mission systems and sensors to military, para-public and civil customers; enabling mission success.

Inspired by the vision, curiosity and creativity of the great master inventor - Leonardo is designing the technology of tomorrow.



# FIRST TAKE

For the latest, go to  
[AVIATIONWEEK.COM](http://AVIATIONWEEK.COM)



EHANG

## TECHNOLOGY

**China's EHang has unveiled** a dedicated unmanned logistics version of its 216 two-seat electric vertical-take-off-and-landing (eVTOL) autonomous air taxi.

**Paris is to create an urban air mobility (UAM) test area** at the suburban Pontoise-Cormeilles Aerodrome, with the goal of showcasing air taxi operations during the 2024 Olympics.

**Japan Airlines plans to work** with German eVTOL developer Volocopter to promote UAM for passenger and cargo transportation in Japan.

**Plug Power is to develop** the fuel-cell power system for Universal Hydrogen's conversion of the De Havilland Canada Dash 8-300 regional turboprop to hydrogen-electric propulsion (see page 36).

**Sweden has opened** facilities to test electric and unmanned aircraft at Are Ostersund Airport under a European Union-supported cross-border project with Norway.

## DEFENSE

**Deliveries of Russia's new Il-112V** light transport aircraft have been delayed again, to 2023, as Ilyushin designers work to reduce its weight.

**Safran has added Spain's ITP Aero** to its team developing a 1,400-1,800-hp turboprop engine—from the Arden 3 turboshaft—to power the EuroDrone.

**The Royal Thai Air Force has ordered** 12 Textron Aviation T-6C trainers and ground-based training systems to replace its Pilatus PC-9Ms.

**The Israel Missile Defense Organization** delivered the first of two Rafael Iron Dome counter-rocket batteries to the U.S. Army on Sept. 30.

**Germany has canceled a tender** to replace its CH-53G transport helicopters, saying offers of the Boeing CH-47F and Sikorsky CH-53K were unaffordable.

## SPACE

**China is developing a multishot** plan for a manned Moon landing that would feature docking in lunar orbit and a low-risk launcher provisionally called the New Generation Manned Launch Vehicle.

**The U.S. Space Development Agency** has awarded L3Harris Technologies \$193 million and SpaceX \$149 million to each build four satellites to detect and track ballistic and hypersonic missiles.

**Northrop Grumman's Cygnus capsule**, its 14th NASA-contracted resupply mission, reached the International Space Station early Oct. 5, delivering nearly 7,800 lb. of cargo.

**A joint venture of the UK government and Indian mobile network operator Bharti Global** has won U.S. bankruptcy court approval to buy broadband satellite operator OneWeb.

**COVID-19-related work delays** have postponed by a year, to 2027, the launch of NASA's Dragonfly astrobiology mission on its 8.5-year journey to Saturn's moon Titan.

**The U.S. Space Force will launch** a pair of upcoming GPS-III satellites on previously flown Falcon 9 rockets, saving taxpayers nearly \$53 million (see page 64).

## COMMERCIAL AVIATION

**Boeing is to consolidate** production and final assembly of the 787 widebody at its Charleston, South Carolina, facility from mid-2021 in a move to save money in a smaller market (see page 16).

**Boeing needs to find** new customers for 13% of the 737 MAXs it has built but not delivered following orderbook shuffling by customers, an Aviation Week analysis shows (see page 19).

**The world's airlines stand to burn** through \$77 billion in the second half of 2020 and are not expected to become cash positive until 2022, IATA has forecast.

**European air traffic has fallen** again, dropping to 44.8% of 2019 levels in the week to Oct. 4, Eurocontrol says, as travel restrictions due to COVID-19 continue to hold back demand.

**The FAA has extended** slot rule waivers at three congested U.S. East Coast airports through the end of March 2021 in an effort to relieve the burden on airlines hit hard by the pandemic.

**Rolls-Royce announced** a £2 billion (\$2.6 billion) rights issue on Oct. 1, part of a larger effort to raise £5 billion to shore up its balance sheet.

**Spirit AeroSystems has formally** walked away from a two-year effort to acquire Belgian aerospace supplier Asco Industries for \$420 million.



DESAER

**A joint venture between Portugal's CEiiA and Brazil's Desaer** plans to develop and produce the ATL-100 multipurpose light transport aircraft in Portugal for delivery beginning in 2026.

## AWARDED

**Aviation Week Senior Editor Guy Norris** won the 2020 Defense Media Awards' "Best Defense Military Submission" in a virtual ceremony on Oct. 8 for "Secret Service" (*AW&ST* Oct. 28-Nov. 10, 2019, p. 18), which revealed that the U.S. Air Force's secret, stealthy unmanned aircraft—thought to be called the RQ-180—had become fully operational.

## OBITUARY

**Mark Rosenker**, former U.S. National Transportation Safety Board chairman, died Sept. 26 in Alexandria, Virginia. He was 73. A retired U.S. Air Force major general and a tireless transportation safety advocate, he led the agency as acting chairman and chairman from 2005-09. National Business Aviation Association President Ed Bolen hailed Rosenker's "passion for aviation and determination to make a meaningful difference."

## Pandemic Trims Boeing's 20-Year Commercial Aircraft Delivery Forecast

Customers will take 11% fewer new commercial aircraft deliveries in the next decade than projected a year ago as the industry slowly emerges from the demand crisis created by COVID-19, says Boeing's updated forecast.

The annual 20-year commercial aviation outlook paints a difficult picture for airlines, which Boeing believes will not recover to prepandemic traffic levels until at least 2023. And it may take as long as five years for the industry to resume its long-term growth trajectory.

The year-over-year drop in global revenue passenger kilometers—down about 75%—and little hope of a fast recovery will invoke significant systemic changes to the world fleet, says Darren Hulst, Boeing's vice president of commercial marketing.

Outlining a two-phase recovery scenario, Hulst says the near-term ramifications include early retirement of older aircraft. Although more than 70% of the active fleet has returned from temporary storage, many others will never come back. Of the 18,350 deliveries Boeing now forecasts by 2029, 56% will be replacement aircraft—12% more than its 2019 projection.

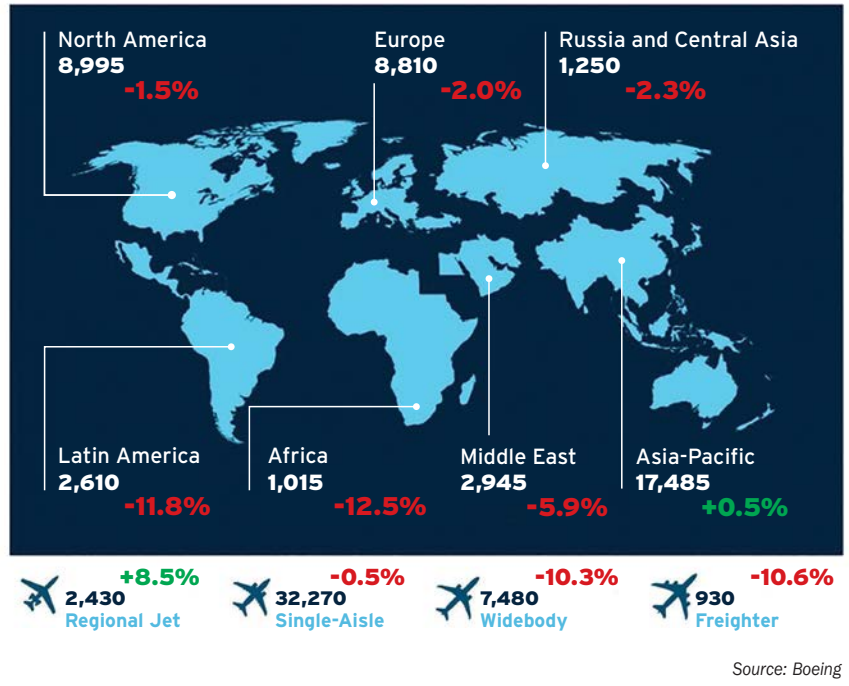

Boeing forecasts a changing global fleet mix, one with a greater focus on single-aisle market growth than before the pandemic and a shift away from the trend toward narrowbody upscaling that dominated much of the 2010s.

Boeing's overall forecast of 43,100 deliveries by 2039 is almost 1,000 aircraft fewer than last year's 20-year market prediction. Much of the decline is in

the widebody sector, now projected to account for 7,480 deliveries, against last year's estimate of 8,340.

The only sector predicted to grow is the regional market: Boeing now believes it will see deliveries of around 2,430 aircraft over the next two decades, compared with 2,240 in last year's forecast. Boeing defines regional aircraft as anything below 90 seats. ☺

### 35 YEARS AGO IN AVIATION WEEK

Gulfstream Aerospace was planning to equip its newest jet, then under development, with four Rolls-Royce RB401 engines, each rated at 7,000 lb. thrust. But when word reached Gulfstream's headquarters in Savannah, Georgia, that the British engine-maker was developing a refanned version of the Spey engine, which powered the Gulfstream II and III, the planemaker asked for details. And Rolls obliged.

It took several months, but once former Gulfstream Chairman and CEO Allen Paulson became convinced that the new engine, the Tay 611-8, was a better match, he took action. During a Rolls-Royce Christmas luncheon at New York's Waldorf Astoria hotel in 1982, Paulson and Ralph Robins—then the engine company's commercial director, who would go on to be knighted as its chairman and CEO—struck a deal for 200 Tays. Their agreement was famously recorded on a 3 X 5-in. card and a cocktail napkin.



When the Gulfstream G-IV took flight for the first time on Sept. 19, 1985, it appeared to be a 5-ft. stretch of its predecessor. But it was much more. The first noticeable difference was its sound. The Spey engines delivered an ear-piercing shriek whereas the wide-fanned Tays, by comparison, whooshed. And with each generating 12,240 lb. thrust (later updated to 13,850 lb.), the Tays carried the 72,000-lb. executive jet aloft at 4,000 ft./min., and gave it a high-speed cruise of 487 kt. The new aircraft also had an advertised, unprecedented intercontinental instrument-flight-rules range of 4,322 nm. Beyond that, it boasted the first "all-glass" flight deck featuring six cathode ray tube displays and was the first business jet

with a cabin featuring three full seating sections.

The G-IV entered service in 1987, with Gulfstream delivering more than 900 units by the time production of the type and its several variants ended in 2018. ☺

Subscribers can access every issue of Aviation Week back to 1916 at: [archive.aviationweek.com](https://archive.aviationweek.com)





## UP FRONT

# ANTOINE GELAIN



### LAST WEEK, ROLLS-ROYCE

announced its intention to raise £3 billion (\$3.75 billion) through an equity issue and a bond offering to help shore up its balance sheet as it keeps bleeding money amid the worst crisis in its history. This is just the latest piece of bad news about a company whose fate looks increasingly like that of a fallen hero in a Greek tragedy: a victim of both misfortune and its own hamartia, punished by the gods and forced to navigate through titanic storms and raging seas until it either finds redemption or suffers eternal damnation.

## Fallen Icon

How Rolls-Royce lost its way

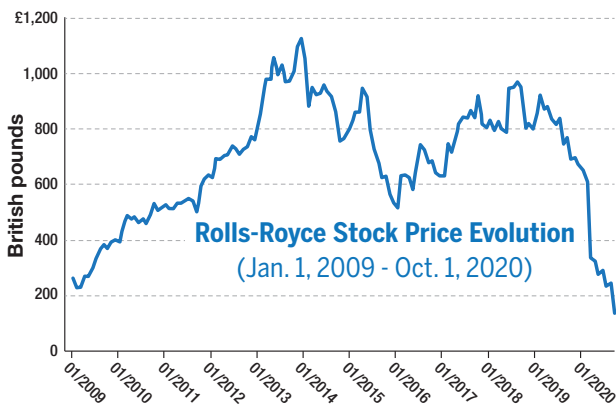

Source: Yahoo Finance

There is indeed much to feel sorry about for Rolls-Royce, once the jewel of the British high-tech industry. After suffering a record \$6.75 billion loss for the first half of the year and witnessing its credit rating being downgraded to junk by Standard & Poor's in May, the recent cash call announcement has now brought its stock price to the ground (see chart). The 100-year-old, \$19 billion-revenue corporation, which once stood for engineering artistry and world-class technology, is now valued at less than \$4 billion. By comparison, 17-year-old Tesla, which is about the same size in revenues and staff, is valued at close to \$400 billion!

Such a reversal of fortune raises a lot of questions about what led to such tragedy. Of course, one cannot blame the company for finding itself in the midst of an unprecedented collapse in air travel. But one could argue that this crisis is just laying bare and amplifying Rolls-Royce's underlying weaknesses and past mistakes. Ultimately, a company's success rests on three main pillars: culture, strategy and leadership. It looks like Rolls-Royce lost its way on each of these.

Culture shapes a company's resilience, its ability to consistently perform under any circumstances. Rolls-Royce's culture of innovation, superior quality and work ethic used to be its strongest asset. Yet

over the last few years, lingering quality issues with the Trent 1000 engine have cost the company billions in corrective actions and undermined its reputation with customers. This reputation was further damaged when Rolls-Royce was indicted in the UK and the U.S. on multiple counts of conspiracy to corrupt, false accounting and failure to prevent bribery over the span of three decades. The case was settled in 2017 with the payment of an \$800 million fine. Somehow, over time, Rolls-Royce's business culture had strayed far away from what its legendary Chief Executive Ernest Hives once described as the "moral business standard of the Rolls-Royce company," adding: "We must never allow a question of profit to jeopardize this position."

While product quality and commercial practices are somewhat unrelated, it does suggest that the company's culture has been impacted by an increasing focus on financial management and shareholder return. It is therefore probably not a complete coincidence if the company's stock price increased fivefold between 2009 and 2013 while problems were building below the surface.

As far as strategy is concerned, the most questionable decision was the company's exit from the lucrative single-aisle market. While Rolls-Royce was a founding member of the IAE consortium that developed the V2500 turbofan for the Airbus A320 family, it sold its stake to Pratt & Whitney (P&W) in 2012. By doing so, Rolls-Royce not only exited the most profitable aeroengine market segment but also marginalized itself at a time when its main competitors—GE, Safran and P&W owner United Technologies—were all beefing up their product and service portfolio to position themselves as "super tier-ones."

Ironically, it was the second time in its history that P&W—as the big beneficiary of this exit—could thank Rolls-Royce for its luck. At the beginning of the Cold War, the experience that Pratt gained from a licensing contract to produce two Rolls military engines enabled it to become one of Rolls-Royce's major competitors.

As for the company's leadership, it is hard not to notice how many top executives have come and gone over the last decade. Since 2010, there have been three CEOs, four CFOs and four different heads of the civil aerospace business. Such a high management turnover, unprecedented in Rolls-Royce history, certainly impacted the company's performance and is either a cause or a consequence of failed leadership.

At least one thing has not changed at Rolls-Royce: its Britishness. Almost all the top executives and board members have always been and still are British. In a global industry like aerospace, this may be the company's most tragic flaw: its culture, strategy and leadership have all but reinforced an insularity that, compounded with Britain's imminent exit from the European Union, could prove fatal. ☹

Contributing columnist Antoine Gelain is the managing director of Paragon European Partners. He is based in London.

1918



1959



1982

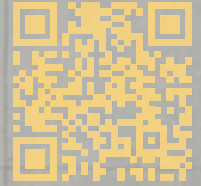

# 104 YEARS COUNTLESS MILESTONES



1934

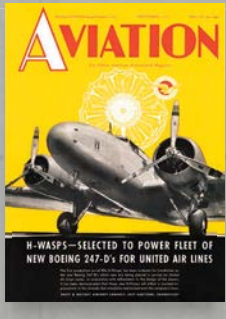

1967



1995



2019



1944



1968



2007

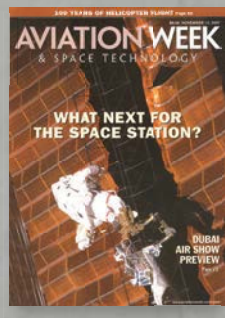

2020



Boeing is proud to sponsor the *Aviation Week* digital archive, which provides unmatched access to the last 10 decades of aerospace innovation with nearly 500,000 pages of content.

[archive.aviationweek.com](https://archive.aviationweek.com)

**AVIATION WEEK**  
NETWORK







## GOING CONCERNS

# MICHAEL BRUNO

**FORGIVE THE FUTURE AEROSPACE** and defense recruit who might ask: “What cloud do you mean?” Suddenly, the future of the aerospace and defense sector is looking cloudy on purpose—but this time, it has to do with dollars, not flying.

Late September saw a stream of A&D announcements related to the cloud, the term used to describe remote banks of large data processing, storage and other information technology that do not require direct, active management by users or owners.

Microsoft took center stage on Sept. 22, when it unveiled Azure Orbital, a cloud-based ground station service aimed at the burgeoning commercial satellite boom. The tech giant also announced partnerships with A&D providers Amergent Technologies, Kratos, Kongsberg Satellite Services and Viasat. While most of those companies are established hardware players, another interesting participant is Kubos, a startup that provides cloud-based mission control software.

Likewise, there is SES, the O3b mPOWER system purveyor, which says it will be the medium-Earth-orbit (MEO) connectivity partner for Microsoft Azure Orbital under a multiyear agreement to jointly develop turnkey cloud-based video and data connectivity managed services. The first MEO and Earth-observation (EO) gateways will be in Phoenix and Quincy, Washington, home of Microsoft’s massive data center.

“In the last 12-18 months, our focus has been to accelerate our customers’ cloud adoption plans,” says SES CEO J.P. Hemingway. “This agreement leverages both companies’ know-how, SES’ experience in satellite infrastructure and Microsoft’s cloud expertise, [which] are building blocks in developing new and innovative solutions for the future.”

Microsoft’s launch comes on the heels of a summer splash by rival Amazon. In June, Amazon Web Services (AWS) revealed its Aerospace and Satellite Solutions business unit for cloud-based services in support of orbital operations and launches. AWS Ground Station is already used by NASA’s Jet Propulsion Laboratory and many other customers, Amazon says.

The June announcement included partnerships with leading defense prime Lockheed Martin as well as with Geollect and Maxar Technologies. Then, on Sept. 23, AWS announced a job opening to head its worldwide business development for the aerospace industry.

The Amazon-Microsoft race to provide cloud services to A&D does not surprise industry consultants. Shivaprakash Muruganandham of Northern Sky Research (NSR) says the satellite industry has significantly lagged overall information and communication technology markets in its cloud adoption. And a cloud-based approach will be essential to the new-space sector to make business models work.

NSR’s “Cloud Computing via Satellite” report, released this summer, forecasts a \$15.4 billion revenue opportunity for cloud-based services in the satellite and space industry this decade. Altogether, NSR sees 52 exabytes of cloud data traffic via satellites in 2029.

Delivery of cloud services via satcom represents the largest space-related market, growing to at least \$1.8 billion in 2029 from nearly \$200 million in 2019. EO data downlink is the next subsector, while geospatial analytics and orbital infrastructure are smaller but significant markets with sales driven by business model and technological evolution trends.

At the same time, with the gradual adoption of the free-service model for inflight connectivity, the aerospace market also is projected to grow to almost \$1.8 billion annually by 2029. “Here, too, cloud migration strategies will be a key driving factor, as in the case of Gogo’s AWS migration in 2019,” Muruganandham says.

Others see growth in air transport, too. “A few major airlines have already committed to migrating their entire [information technology] infrastructure to the cloud over the next 3-5 years, and this trend is likely to continue and grow, mainly among low-cost carriers,” says Abhilash Varkey Abraham, A&D research analyst at Frost & Sullivan.

Nearly three-quarters of A&D companies Accenture surveyed last year have recognized or expect to recognize major benefits from lower tooling costs, thanks to cloud adoption. About 60% expect better security in the cloud, as the technology giants can provide better cybersecurity than the A&D companies themselves.

Still, A&D companies are far from cloud-ready, Accenture notes. Only 38% have mature cloud practices and tools in place, and just over half have a cloud-strategy execution road map in place with key performance indicators to measure progress. “For an industry that is beset by a dynamic and changing market combined with competitive disruption, these findings should be cause for concern,” Accenture says. ☛



Enabling the Extraordinary  
To Fly To Power To Live



# EXTREME

---

Advanced thermal management for extreme military environments

Around the globe, military and aerospace systems designers have turned to Meggitt to help them meet thermal and power management challenges with compact, lightweight, and efficient vapor cycle systems, liquid cooling systems and components including fans, pumps and compressors.

Meggitt has developed cooling solutions for the most challenging flight conditions, missions, and extreme environments. From low supersonic flight, to high hot wet hover, to desert and arctic operations, our thermal management solutions are proven and ready to meet the challenge of the more electronic platform and battlefield.

Tel: +1 949 465 7700

E-mail: [gerry.janicki@meggitt.com](mailto:gerry.janicki@meggitt.com)

**MEGGITT**

[www.meggittdefense.com](http://www.meggittdefense.com)





## LEADING EDGE

# GUY NORRIS

### LITTLE WONDER THAT BOOM

Supersonic founder Blake Scholl describes the Oct. 7 rollout of the company's sleek XB-1 demonstrator as "a little surreal." Since creating Boom in 2014 to bring back supersonic civil flight, Scholl's ambitious plan has been derided as crazy by some and unrealistic by others.

Now, with a completed aircraft set to begin ground tests in the coming weeks and design work transitioning to the follow-on Overture airliner, Boom's vision is

to Mojave. Then we put the throttle forward and go fly, and that'll probably be later next year."

Acknowledging his earlier overoptimistic schedule and "many setbacks and roadblocks" along the way, first flight is provisionally slated for "something like the third quarter," Scholl says. "I don't want to promise anything too specific, and then we'll be supersonic by the end of next year."

A major source of skepticism about Boom during the last six years has centered on the lack of a definitive plan for how to power its supersonic airliner. Three GE Aviation J85s will power the XB-1. But until recently, nothing was known about the engine choices for the Overture. With the recent disclosure that Rolls-Royce has been in talks with Boom for five years and is now the chosen propulsion partner for the airliner, more details are beginning to emerge.

"A few months ago, Rolls had three different engine concepts for the aircraft, and by November we'll be selecting one," Scholl says. "We think we know what the winner is already, actually. But we're kind of dotting the 'i's and crossing the 't's and making sure that we've got that right." Few specifics are known, but Scholl says all the options are medium-bypass midthrust derivatives of existing cores. "The options are a completely off-the-shelf core, an upgraded core or a photo-scaled core," he adds. All will be adapted with a new low-pressure system, distortion-tolerant fan and exhaust.

With engine plans firming up and the XB-1 ready for testing, Boom's schedule for the Overture is also coming into sharper focus.

Based on lessons learned from the demonstrator, final configuration freeze is targeted for the end of 2021. The program will be officially launched in 2022, coinciding with groundbreaking for the as-yet-unnamed production site. "In 2023, we'll start building the first parts and tools, and then rollout of Overture is in 2025. First flight is 2026," Scholl says.

"Then the question becomes, how long does flight test and certification take? The [Airbus] A350 did it in 18 months. I suspect that would be pretty sporty for us, given the airplane and that we're in the post-737 MAX era," he adds. At the rollout, entry into service was given as 2029, but Scholl says: "Our commitment is to carry passengers by the end of the decade—and there's some margin in there."

Boom also plans to whittle down its list of 15 potential U.S. assembly sites to around five finalists by year-end. "If you look at the schedule, we better know where we're going to be by the middle of next year," Scholl says. He adds that the final arrangement could include an option for an inland final assembly facility and a coastal site for supersonic flight test and delivery. 🌐

## Baby Boom

XB-1 demonstrator rollout adds credibility to supersonic airliner plans



BOOM SUPERSONIC

gaining ground and—just as important—credibility.

Although the 71-ft.-long, delta-wing XB-1 trijet looks to have more in common with a high-speed fighter than an airliner, the completed demonstrator has already proven to Boom's backers that it has the design and manufacturing capability to produce the first privately developed air-breathing civil supersonic aircraft.

But the next real test will be in taking flight. Comparing the XB-1 to the pioneering role played by the Falcon 1 launch vehicle for SpaceX, Scholl says the major challenge will be proving the baseline aerodynamics of Boom's ogive delta wing and engine inlet design across the low-speed, transonic and high-speed envelopes. Flight tests will begin in Mojave, California, later in 2021 following initial ground tests at Centennial Airport near Denver.

Internally nicknamed "Baby Boom," the XB-1 will be put through an initial battery of 36 major ground tests ranging from hydraulic system checks and engine runs to failure modes and ground vibration tests. "We'll do taxi tests here in Colorado, and then we take the vertical tail off, put it on a truck and take it down



## THE LAUNCHPAD

# IRENE KLOTZ

**IT'S BEEN A PIVOTAL YEAR FOR** the International Space Station, the \$100 billion-plus research outpost in low Earth orbit that has been permanently staffed by rotating crews of astronauts, cosmonauts and the occasional guest flyer, for 20 years as of Nov. 2.

SpaceX's May 30-Aug. 2 Demo-2 Crew Dragon flight test paved the way for the resumption of crewed U.S. transportation services as early as Oct. 31. Demo-2 marked the first visit to the International Space Station (ISS) by a U.S.-launched crew since the final STS-135 space shuttle mission in July 2011.

NASA astronauts Michael Hopkins, Victor Glover and Shannon Walker, along with the Japan Aerospace Exploration Agency's Soichi Noguchi are preparing for launch aboard the Commercial Crew Program's first operational crew rotation mission to the ISS. The flight, known as SpaceX Crew-1, also marks the FAA's first licensed commercial orbital spaceflight. Liftoff aboard a SpaceX Crew Dragon capsule is scheduled for Oct. 31 from the Kennedy Space Center.

If the schedule holds, the crew will be met at the ISS by NASA astronaut Kathleen Rubins, who is scheduled to take NASA's last paid ride aboard a Russian Soyuz capsule. Launch of Rubins and Russian cosmonauts Sergey Ryzhikov and Sergey Kud-Sverchikov aboard the Soyuz MS-17 spacecraft is scheduled for Oct. 14 from the Baikonur Cosmodrome in Kazakhstan.

Buying seats on Roscosmos' Soyuz spacecraft has been NASA's only option for ferrying crew to and from the ISS since the space shuttles were retired in 2011. The three-person spaceships—originally designed to carry cosmonauts to the Moon—are certified to remain docked at the ISS for up to 200 days. Typically, two capsules are docked at the station to support crews of up to six astronauts and cosmonauts.

Since 2006, NASA has purchased 71 Soyuz seats, at a total cost of about \$4 billion, including five seats procured through Boeing for a total \$373.5 million, NASA says.

Overall, the agency paid an average cost per seat of \$56 million for the 71 missions, which come to an end with the return of Rubins and the Expedition 64 crew aboard the Soyuz MS-17 in April 2021. Prices ranged

from \$21.3 million to \$90 million for each roundtrip.

Aside from reviving U.S. human orbital flight capabilities, NASA's goal is to parlay the new spaceflight services being offered by SpaceX (and beginning next year by Boeing as well) into a new commercial industry that sells rides to low Earth orbit (LEO) for not just professional astronauts but also researchers, business ventures and tourists.

And while NASA's paid rides on Soyuz are coming to

an end, astronaut-cosmonaut seat swaps are expected to continue for the remainder of the ISS program. Flying crew from each country ensures at least one American and one Russian are aboard the ISS at all times to operate the connected U.S. and Russian segments.

The barter agreements, which are still being negotiated, are expected to begin next year, NASA's ISS Program Manager Joel Montalbano tells Aviation Week. "My goal is that next year we're rotating [crewmembers] on each other's vehicles. But we're still working

through the negotiations with that," he says.

U.S.-Russian space collaboration began with the 1975 Apollo-Soyuz linkup in LEO (or as it is known in Russia, the Soyuz-Apollo mission). Following the fall of the Soviet Union in December 1991, NASA and Russia launched an astronaut-cosmonaut exchange program, beginning with cosmonaut Sergei Krikalev flying with the STS-60 space shuttle mission in February 1994.

That was succeeded by a flight demonstration and nine shuttle dockings at Russia's Mir space station, paving the way for Russia's inclusion in the ISS program. Russia launched the ISS Expedition 1 crew on Oct. 31, 2000, beginning 20 years of joint operations.

"The relationship for science, exploration and discovery is really strong, and it needs to be maintained," NASA Administrator Jim Bridenstine tells Aviation Week. "We're looking forward to a future where the partners can each contribute to our activities in [LEO]—and even beyond, depending on their level of interest.

"It's going to be a partnership where we work together and collaborate, though not necessarily with the United States buying services from Russia," Bridenstine adds. "I think the future is bright, just like the history has been impressive. But the nature of the relationship is going to change." ❧

## Dosvedanya, Baby

### NASA's last paid ride on Russia's Soyuz



ANDREX SHELPIN/GCOTC/NASA

**NASA astronaut Kate Rubins had her Sokol suit pressure checked during the Soyuz MS-17 spacecraft fit check Sept. 28.**



# COLD LOGIC

- > BOEING'S 787 CONSOLIDATION ADDS PRESSURE IN CHARLESTON, SOUTH CAROLINA
- > WHAT ARE IMPLICATIONS FOR THE COMPANY'S WASHINGTON SITES?

**Guy Norris** Los Angeles and **Sean Broderick** Washington

**B**oeing's unprecedented decision to consolidate 787 assembly at its Charleston, South Carolina, facility raises more questions than it answers about the company's future production strategy and its ongoing restructuring in the wake of the air transport market's collapse.

The move, triggered by the decision in July to slash 787 production rates to just six per month by around mid-2021 and announced Oct. 1, will have a significant impact on capacity and employment at its main widebody factory in Everett, Washington. Around 1,000 employees work on the Everett 787 assembly line, which has been making the aircraft since 2007.

The 2021 transfer period will also coincide with the last full year of production in Everett of the 747-8 following the company's decision this summer to end the 52-year-old program in 2022. It also comes as the combined 777-300ER/777F and 777X production rate slims down to just two aircraft per month in 2021 (*AW&ST* Aug. 17-30, p. 15). The slower production rate plans reflect the market impact of the COVID-19 pandemic as well as the decision—also announced earlier this year—to slide initial deliveries of the 777-9, the first of the 777X family, to 2022 from 2021.

Some of this reflects a general slump in the widebody market, but most of it stems from a grim recognition that air transport demand will not return to 2019 levels for several years after the novel coronavirus

pandemic subsides. Long-haul demand—and by extension the widebody market—will suffer more than that for shorter flights and thus narrowbodies. The prospects are dire enough to lead Boeing to reduce its projection of the total fleet size in two decades compared to last year's forecast, an unheard-of move for the usually upbeat manufacturer.

The only Everett program largely unaffected by the turmoil is the 767, the second-oldest production model after the 747. Assembly of the twinjet freighter and the KC-46A





military tanker derivative will remain unchanged at three per month.

Taken overall, the reductions mean that unless there is a sudden and dramatic uptick in demand for the 777/777X over the next two years, Boeing will be delivering only about 60 widebodies per year by 2023 from its West Coast site. This is markedly lower than the expectation in 2017 that it would be assembling more than 200 widebody aircraft per year in Everett starting this year. The bottom line is that the mammoth Washington site, still the largest covered

production facility by volume in the world, will likely be working at 25-33% capacity within 18 months of the 787 transition to Charleston.

Boeing Commercial Airplanes President Stan Deal says the company's decision was not easy and came after a two-month evaluation study. The OEM considered logistics, efficiency and the long-term health of the production system. "It became clear that consolidating to a single 787 production location in South Carolina will make us more competitive and efficient, better positioning Boeing to



SEAN BRODERICK/AW&ST

# 787

## Life of program

**1,062**

**Total built**

**404**

**Built in Charleston**

**2019-20**

**253**

**Total built**

**125**

**Built in Charleston**

Figures as of Sept. 30, 2020

Source: Aviation Week Fleet Discovery

weather these challenging times and win new business," Deal wrote in an Oct. 1 memo to employees.

"[The 787 move] does not change our commitment to Washington state," Deal added. "We've made many long-term investments in the Puget Sound region to support our development programs, including the 777X and completing the 737 MAX family. These programs and our people are just as important to the future of our company as the 787."

Despite these reassurances, the move to South Carolina, which has the lowest percentage of unionized workers among the 50 states, has been roundly criticized by Washington's state government and two of the largest Boeing employee unions. Gov. Jay Inslee says Boeing indicated the transition move was presented to him as a fait accompli. "The Boeing Co. never asked or suggested to the state of Washington that we could do [anything] to assure continued production of this airplane. Simply put, we did everything we could to keep this production here."

The 787 transition to Charleston is also a one-way ticket, according to Inslee. "[Boeing] has not even left on the table an option to restart the 787 line in Washington when this market rebounds," he says. "When this



market comes back, so should these jobs. We will do everything in our power toward that end.”

The Boeing study also included options to effectively mothball the Everett line to keep alive the possibility of reopening in a few years, according to industry sources. But this was ultimately ruled out because of workforce concerns. Company experience on other programs, including the 737 MAX and 777X, has reinforced the lesson that production line restarts and ramp-ups are paced by the experience of the workforce rather than the availability of equipment.

If and when Boeing begins to ramp up the 787 production rate, it will require the assembly line to run with a flow time of around 12 days rather than the 30-40-day flow time of a start-up assembly line. Even assuming the industry’s recovery is underway by 2022, company sources say the current skilled 787 workforce at Everett by then will have been dispersed to other programs or have left Boeing altogether.

Jon Holden, president of the International Association of Machinists and Aerospace Workers (IAM) union/District 751, says: “[The move] is the wrong decision and just another in a string of bad decisions Boeing has made that fails to capitalize on the strengths of our workforce. . . . Favoring a nonunion site is only about control of the workforce, nothing more.” Ray Goforth, executive director of the Society of Professional Engineering Employees in Aerospace union, also calls the move “a mistake.”

Boeing revealed in documents disclosed as part of a 2011 legal dispute with the IAM that its decision to open a second line in Charleston was in part a reaction to an expensive eight-week labor strike in 2008 triggered largely by outsourcing on the 787 program. Aside from creating a new center of excellence for large, composite commercial aircraft and a logistically efficient production hub, Boeing’s motivation also included an escape route from what it described as the “current hostage situation” at the hands of the unions, according to internal documents published in August by The Air Current.

While Boeing officially says that labor considerations were not a factor in the 787 decision, that Charleston is still a nonunion site will be

considered a positive factor for the manufacturer, which has voiced concerns about rising labor costs in Washington state. However, the total transition of the line to South Carolina makes Boeing solely dependent on the facility for the entire 787 product range and, ironically, may embolden the IAM to renew its push to unionize the facility.

The union made attempts to represent workers at the North Charleston site in 2015 and again in 2017. Although some employees voted in favor of union representation in 2018, the bid was later overturned by the National Labor Relations Board.

Boeing 787 Program at a Glance*			
	In Service	On Order	Model Total
787-8	374	48	422
787-9	549	333	882
787-10	58	145	203
<b>FAMILY TOTAL</b>	<b>981</b>	<b>526</b>	<b>1,507</b>

\*As of Aug. 31, 2020

Source: Boeing

Boeing, meanwhile, underlines the basic logic behind the move to Charleston, which became the center of gravity for the program in 2014 following the decision to make it the exclusive site for production of the longest 787-10 family variant (*AW&ST* Dec. 26, 2016-Jan. 8, 2017, p. 36). This move was, in turn, not unexpected since the 110-ft. midbody section of the 787-10 airliner is 10 ft. longer than that of the 787-9, making it too long to be transported in the fleet of specially converted 747-400 Large Cargo Freighters that form the backbone of the logistics network designed to supply parts to both assembly lines. The recent study also evaluated other sea and land transport options for the section, but they were ruled out because of costs.

This large fuselage unit is made up from the Alenia-built Sections 44 and 46, the Kawasaki-built Section 43 and 45 main landing gear wheel well, and the center wingbox made by Fuji in Japan. The midbody and aft fuselage sections for all 787 versions are completed in Charleston before either being trucked to the adjacent line for local assembly or flown cross-country to Everett, another logistical justification for the transition decision.

The roots of the decision to place

the fuselage work at Charleston reach back to the origins of the program in 2003, when Boeing adopted the former McDonnell Douglas risk-share partner concept to launch the new airliner project. The new approach, which also included a review of 80 potential alternative final assembly sites around the world, attracted Alenia, which formed a joint venture—Global Aeronautica—with Vought Aircraft Industries to bid for fuselage structural work.

In 2004, Global Aeronautica selected Charleston, and construction on the site plus an adjacent Vought facility for production of aft fuselages began in 2005.

However, following quality issues and production delays, Boeing purchased Vought’s share in mid-2008, making Global Aeronautica a joint venture of Boeing and Alenia North America. In July 2009, Boeing

bought Vought’s North Charleston operations and in December 2009 purchased Alenia’s portion of Global Aeronautica.

The joint venture was dissolved, and the new site was renamed Boeing Charleston (and later Boeing South Carolina), laying the foundation for the 2009 selection of the facility for a second 787 final assembly and delivery line (*AW&ST* Nov. 22, 2010, p. 52). Production of the first aircraft began in July 2011, with the initial delivery to Air India in October 2012.

But the quality issues did not dissipate. Boeing struggled to ramp up production in Charleston amid reports of problems with everything from loose bolts to tools left on aircraft. While some dismissed the reporting as being fed by pro-union sources from Puget Sound, feedback from customers suggested otherwise.

One 787 customer, Qatar Airways, is understood to have actively refused to take 787s from the Charleston line after encountering several issues, citing unhappiness with delays and the need for fixes in aircraft post-delivery. Qatar has 37 787s, including seven built in Charleston. It has taken delivery of more than half its 787 fleet since its last Charleston delivery, in 2014. The Abu Dhabi-based

carrier has 23 more on order, with the next seven earmarked to be built in Everett.

An August 2019 report by Charleston's *The Post and Courier* suggested that Charleston's quality issues are lingering. The report quoted more than a dozen post-delivery surveys in which several airlines expressed concerns over specific issues and overall factory quality. It also said three carriers—China Eastern Airlines, Hainan Airlines and United Airlines—gave the plant “above-average marks.” The story does not reference comparable surveys on Everett deliveries.

While delays hampered Charleston's ramp-up, the facility in recent years has carried an increasingly larger load of 787 program production. In 2017, 54 of the 134 787s rolled out came off the Charleston line, according to the Aviation Week Network Fleet Discovery database. By February 2019, the balance was even. That year's total of 163 produced was nearly split between the two sites, with Everett holding an 83-80 advantage.

It is completely even so far this year, with each site rolling out 45 787s. Several production-related issues have slowed deliveries down, however, as customers have taken only about 50 787s this year, including 13 built in late 2019. The problems affect fuselages made in Charleston and horizontal stabilizers assembled at a Boeing facility in Salt Lake City. Boeing has not said how many of the 1,060 787s built are affected by at least one of the issues, but a source with knowledge of the issue tells Aviation Week it is likely hundreds (*AW&ST* Sept. 14-27, p. 22).

Whether consolidating 787 final assembly in one location will help eliminate quality issues remains to be seen. The move also raises the question of whether Boeing will consider the drastic possibility of transferring production of the 737 from Renton to utilize the acres of empty space in Everett. This is a highly unlikely possibility due to several factors, according to industry sources. These include the difficulty of workforce relocation, recent investments in the Renton production system and the likelihood that the demonstrated 20-aircraft-per-month rate of each of the site's three main lines will fulfill capacity needs for the life of the program.

Alternatively, the added capacity at Everett may make it an option for producing the 737 replacement later this decade. Even though the Everett site was not believed to be in the running for the now-canceled new midmarket airplane project, the changing circumstances triggered by the pandemic fallout may prompt a reconsideration when it comes to

developing any successor to the company's smallest twinjet family. ☎

—With Jens Flottau in Frankfurt and Bo-Goran Lundkvist in Pahoā, Hawaii



**Check 6** Aviation Week editors discuss the 787's adieu to Seattle: [AviationWeek.com/podcast](https://www.aviationweek.com/podcast)

## Proposed New 737 MAX Training Emphasizes Pilot Awareness

> BASELINE STANDARDS ADD MORE REQUIREMENTS FOR ANY PILOT FLYING THE MAX

> THE PROPOSED TRAINING IS OUT FOR PUBLIC EVALUATION

Sean Broderick Washington

**N**ew proposed minimum training requirements for Boeing 737 MAX pilots underscore how much has changed since the last draft was scrapped more than a year ago after pushback, prompting regulators to delve deeper into human factors as part of their return-to-service analysis for the grounded model.

The draft Flight Standardization Board (FSB) 737 training document, issued Oct. 6, includes what the FAA calls “special emphasis training” for MAX pilots. The new appendix covers the MAX family's revamped flight control computer (FCC) software, including the Maneuvering Characteristics

Augmentation System (MCAS) flight control law that provides automatic nose-down horizontal stabilizer commands during specific, rare, manual-flight profiles.

The curriculum is a mix of ground training and full-flight-simulator work—the first required simulator sessions for pilots transitioning from older 737s to the MAX family. Initially, all MAX pilots will undergo the new training as part of the grounded fleet's return to revenue service.

Inadvertent MCAS activations played key roles in two fatal MAX accidents that led regulators to park the 385-aircraft in-service fleet and



**FAA Administrator Steve Dickson completed the new 737 MAX training before piloting a demonstration flight.**

MIKE SIEGEL/POOL/GETTY IMAGES



review the aircraft's systems and certification. Ten days after the first fatal MAX accident, Lion Air Flight 610 in October 2018, instructions from Boeing and the FAA emphasized using the runaway stabilizer procedure to counter the combination of "uncommanded horizontal stabilizer trim movement" and any one of nine other issues. While the FAA directive does not mention the system by name, it describes MCAS-related failures.

Because the MCAS was designed to operate in the background, Boeing opted to keep it out of flight crew

and regulators' concerns expanded beyond the MCAS.

Training became a focus, but not immediately. An FAA-led review of Boeing's proposed MCAS updates in late March 2019 involving North American pilots flying simulators found the new software acceptable. The review determined that while pilots should have some MCAS training, it could be done on computers. Simulator work demonstrating the MCAS or practicing related scenarios, such as the runaway stabilizer procedure, were not needed, they concluded. The

software changes beyond the MCAS. The latest FSB reflects the results of these efforts.

Last year's draft FSB briefly touched on the MCAS. The proposed updated training includes a review of the revamped MCAS as well as demonstrations of it in the simulator.

Related failure scenarios also must be practiced in the simulator. The new MCAS training appendix will stand alongside existing special-emphasis areas, including alternate go-around flaps operations and head-up guidance training.

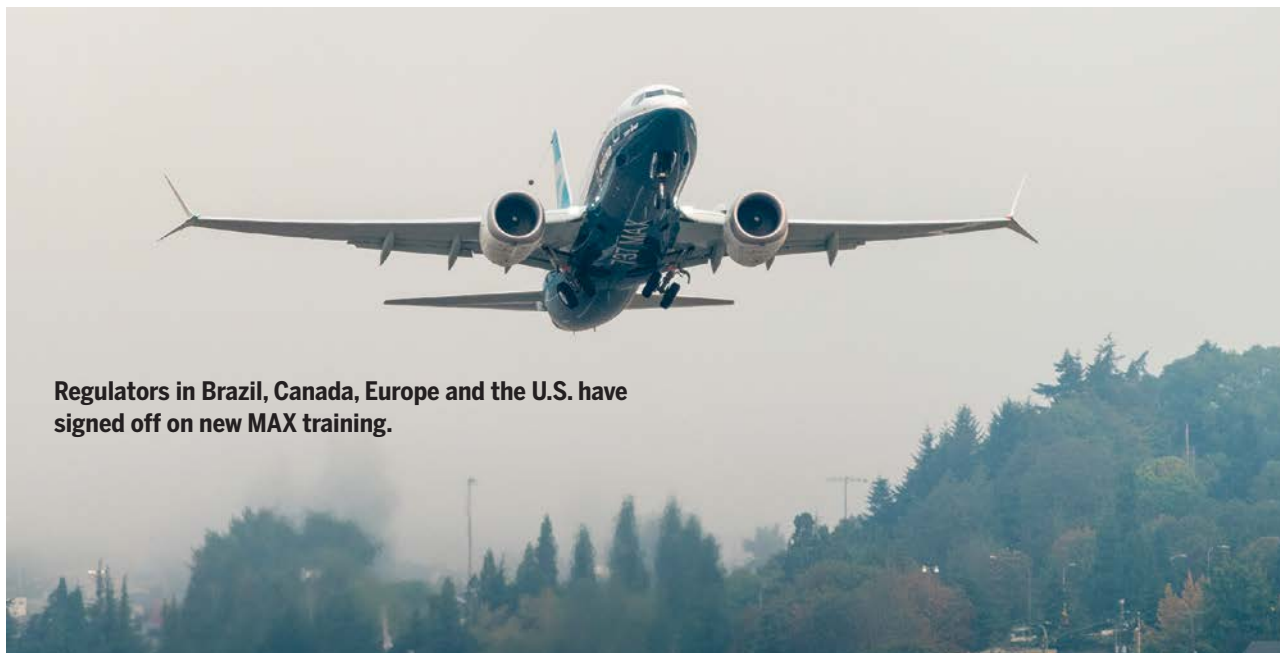

STEPHEN BRASHEN/GETTY IMAGES

**Regulators in Brazil, Canada, Europe and the U.S. have signed off on new MAX training.**

manuals—part of a deliberate and ultimately disastrous strategy to minimize training costs for customers (*AW&ST* Jan. 27-Feb. 9, p. 20). Days after the FAA directive describing an MCAS-related emergency, Boeing followed up by providing the first explanation of the MCAS that most pilots had seen. The OEM also started work, with the FAA's approval, on an MCAS update that would be retrofitted on in-service aircraft.

None of this helped the pilots of Ethiopian Airlines Flight 302 on March 10, 2019. Faced with the same scenario that the Lion Air crew had faced less than five months earlier, a faulty angle-of-attack (AOA) sensor triggering unneeded MCAS nose-down horizontal stabilizer inputs, the Ethiopian crew could not maintain control of its 737-8 and crashed. The MAX was soon grounded worldwide,

team's views formed the basis of a new draft FSB.

In early April 2019, the FAA briefed airlines and pilot union representatives on the accident investigations, Boeing's proposed MAX software changes and training updates, including the new draft FSB. Some pilots expressed concern with details emerging from the accident probes, including the Ethiopian crew's apparent difficulty using manual trim—a key step on the runaway stabilizer checklist that requires hand-cranking a wheel mounted beside each pilot and mechanically linked to the horizontal stabilizer.

The pilots' concerns helped build momentum for a broader review of 737 non-normal procedures. Meanwhile, regulators pushed Boeing to validate their analysis of myriad failures, including many that relied on pilots to react quickly. This led to FCC

The proposed simulator work includes manual trimming during a runaway stabilizer event, manual trimming during an approach and go-around, erroneous AOA data on takeoff that triggers an unreliable airspeed warning, and activation of a new STAB OUT OF TRIM alert Boeing has added.

Pilots also must review seven checklists and training material being updated as part of Boeing's changes, which include revamping the MCAS to ensure it will not activate repeatedly (*AW&ST* April 22-May 5, 2019, p. 16).

While most of the changes are linked to the MCAS and FCC software modifications, some of the simulator scenarios—notably the manual-trim work—could apply to older 737 models. The updated FSB does not propose any new training on older 737 models, however.

The draft FSB also reveals that the recent Joint Operations Evaluation Board (JOEB) review of the proposed MAX changes by Brazilian, Canadian, European and U.S. regulators deemed the new MCAS software “operationally suitable,” or ready for rollout. The team of regulators and pilots noted issues with one checklist, Airspeed Unreliable, that the FAA says it will review. Among the board’s concerns: noted thrust settings for a potential go-around are not clear, and a change to the behavior of flight directors—graphic images that guide pilots to proper pitch and bank angles—in certain scenarios may not be clear to pilots.

While the training still could change, the package seems close to addressing numerous issues uncovered in reports and investigations triggered by the accidents. FAA Administrator Steve Dickson, a former airline pilot with 737 experience, prepared for a Sept. 30 demonstration flight that he captained by taking Boeing’s proposed new training, including the simulator lessons.

“I felt the training prepared me to be very comfortable,” Dickson said moments after stepping off Boeing 737-7 testbed 1E001 after a 2-hr. flight. While upbeat about the modified aircraft’s performance, Dickson said he would bring up a few issues with Boeing related to training-material verbiage.

A few days before Dickson flew, Patrick Ky, European Union Aviation Safety Agency (EASA) executive director, expressed optimism that his agency could give the MAX its blessing as soon as November, “not long” after the FAA. Ky also confirmed that Boeing will add a computer-generated AOA calculation to back up the MAX’s two physical AOA sensors, providing even more redundancy that the FAA has demanded, at least publicly.

Ky says Boeing will add the functionality to the 737-10, which rolled out in November 2019 and is in certification testing, and make it available for retrofit throughout the rest of the fleet. Boeing declined to comment.

EASA’s lone outstanding issue concerns how to provide pilots a way to disable nuisance stick-shaker stall warnings, Ky says. The issue has been raised by other stakeholders as well.

The Allied Pilots Association (APA), which represents pilots for MAX operator American Airlines, said recent simulator tests showed an erroneous stall warning—which pilots in both

MAX accident sequences received because of the faulty AOA data—still presents unnecessary risk.

“Feedback from APA participants . . . confirmed that the continuous erroneous activation of the stall warning system (stick shaker) resulted in considerable and unnecessary distraction, significantly compromising the process of managing the non-normal condition and recovering the aircraft,” the union says.

The Air Line Pilots Association and British Airline Pilots Association also raised the issue to the FAA in feedback on the agency’s proposed return-to-service requirements.

Dickson declined to address the synthetic AOA issue or stick-shaker issues specifically. However, he hinted that more changes to the MAX are coming beyond those linked directly to the accidents and needed to render the model safe to return to service.

“We will continue to work with the manufacturer on those issues going forward,” he said.

Additional modifications, including the new AOA source, are expected to come via normal continued airworthiness channels such as service bulletins that regulators mandate. Such commitments have helped allay concerns brought up by other regulators that go beyond what the FAA’s return-to-service airworthiness directive will address. Only one regulator, the United Arab Emirates General Civil Aviation Authority, submitted public comments on the FAA’s proposed directive. This suggests behind-the-scenes dialog between the FAA and its counterparts has been productive.

“There is very little daylight between the authorities,” Dickson said. “I anticipate that we will be aligned.”

Once the FSB is finalized, it will be incorporated into the final FAA directive laying out what operators must do to get MAXs and their pilots ready to return to service. Comments on the draft directive closed Sept. 21, and the FAA is sorting through 230 sets of comments as well as the JOEB feedback.

“We are in the process of finalizing everything that needs to be finalized,” Ky says. “I think that for the first time in a year and half now, I can say that the end is in sight.”

**Check 6** Aviation Week editors discuss the latest ups, downs and relocations at Boeing: [AviationWeek.com/podcast](http://AviationWeek.com/podcast)

AviationDaily  
AerospaceDaily  
& DEFENSE REPORT  
SpeedNews  
THE WEEKLY OF  
BusinessAviation



Go beyond the news of the day with Aviation Week Intelligence Network’s Market Briefings.

- Stay ahead of the market
- Identify new opportunities
- Drive revenue

Learn more: [aviationweek.com/marketbriefings](http://aviationweek.com/marketbriefings)

AVIATION WEEK NETWORK



## GE9X Sets Up for Novel Dust Buster Testing

- > CYCLONIC SEPARATOR REMOVES DUST AND SAND
- > INGESTION TESTS TO USE IMPORTED DUST TO VALIDATE INDUCER PERFORMANCE

**Guy Norris** Los Angeles

Following certification of the GE9X turbofan for Boeing's 777X, GE Aviation aims to complete testing for Extended Operations approval by year-end and is preparing another engine for validation tests of an innovative flow-inducer device designed to reduce the impact of dust and debris on durability.

The GE9X, which is the largest turbofan ever developed, is due to enter service on the 777-9 in 2022 with airlines such as Emirates Airline that operate in challenging hot and dusty environments. To improve the engine's durability and resistance to sand and dust, GE has incorporated a new layer of protection. This goes beyond the engine's standard variable bypass valve system, which rejects debris from the core, to add a system that filters particles out of cooling bleed air.

"In 2021, we plan to run an engine that will purposely ingest dust to see how it will react in that kind of environment," GE9X program lead Karl Sheldon says. "So we will get an experimental validation of some of the technologies we put in the engine to enhance its durability in that region. That's the next big milestone in what we're looking to do on the test."

In hot, dry areas or regions of heavy atmospheric pollution, dust particles can cause durability issues in two main ways. They can accumulate on the external surface of blades and stators, thereby degrading the insulation coatings. They can also block the internal cooling channels of the blades and nozzles and thus degrade the cooling effectiveness of

the engine's secondary flow path.

The flow inducer, also known as a cyclonic separator, is "specifically designed to help keep dust and sand out of the secondary flow path, which is where you get into trouble when those passages get clogged," Sheldon says. Although the company is reluctant to detail the operation of the device, pat-

have a pneumatically powered rig that we set up in front of the engine that injects particles of dust and sand into the free stream in front of the fan. We will run that engine day and night with representative amounts of debris, and then we will borescope it, tear it down and validate that we've done what we intended to do."

The test sequence will include specifically tailored cycles to reproduce particle ingestion at points in the flight envelope where the engine is most vulnerable such as takeoff, descent and landing. "We will do our best to replicate those conditions where we might expect that kind of environmental situation," he adds. The tests, which will include runs in reverse-thrust mode, are expected to

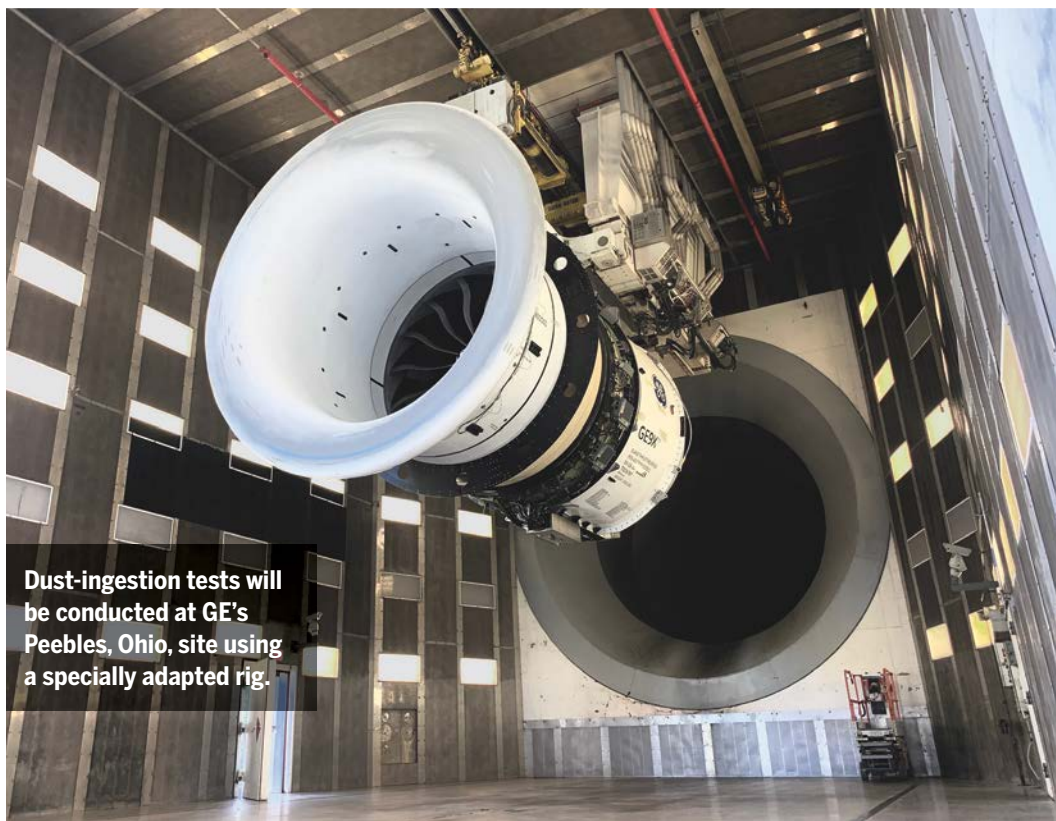

Dust-ingestion tests will be conducted at GE's Peebles, Ohio, site using a specially adapted rig.

GE AVIATION

ent documents reveal that the inducer takes cooling flow from the bleed system and centrifugally separates out any particles. Clean airflow is directed into the cooling system, while the contaminated air flows through a scavenge outlet into the bypass duct.

To replicate environments as realistically as possible, GE has created representative dust mixes as well as "brought it in from specific regions around the world," Sheldon says. "We

be completed by the middle of 2021.

The inducer, similar to several other elements of the GE9X, is made from a cobalt-chrome alloy using an additive manufacturing process. Using additive machines, the device can be printed as one piece instead of comprising the 13 individual elements required using conventional fabrication techniques. Other additively made parts include 28 fuel-nozzle tips, also consisting of cobalt-chrome, each of

which would otherwise require 20 individual components.

The largest area of use in terms of component parts is the low-pressure turbine where 228 fifth- and sixth-stage blades are made additively from titanium aluminide. The process and material combines to produce a 50% weight savings on conventional alternatives, GE says. Another part benefiting from the approach is the fuel-oil heat exchanger, which is printed as one part from aluminum F357. That single part replaces 163 individual components and is 25% cheaper to make and 40% lighter.

The GE9X also incorporates a printed casing for the T25 sensor, which measures pressure and temperature at the high-pressure compressor inlet for the engine control system. The unit is based on the design of the sensor housing for the GE90—the first additive component of a GE engine that the FAA certified, in 2015. The unit is 30% more precise in its measurements and combines 10 elements into one. The engine's combustion mixer is also a printed cobalt-chrome alloy part and is three times more durable and 6% lighter than a conventional alternative.

With FAR Part 33 engine certification completed, GE is finishing factory acceptance testing of the first batch of production GE9X units. In addition, an engine that was already delivered to Boeing in August under the experimental ticket prior to certification, is now considered a production standard unit. "And we're scheduled to start shipping the rest of the production engines early next year," Sheldon adds.

The engine-maker also plans to continue ground runs of an engine in support of Extended Operations (ETOPS) Part 25 approval. The runs will involve an engine that has already amassed 1,000 cycles for the Initial Maintenance Inspection (IMI), which establishes the maximum hours or cycles of service between maintenance intervals. The IMI also contributes to the ongoing 3,000 cycles of run time for ETOPS. "In the next two weeks, we will take the asset that ran IMI and continue that through ETOPS testing, which we should complete by the end of the year," Sheldon says.

During engine certification, which was delayed following the discovery

in 2019 of stator durability issues in the high-pressure compressor, the test engines accumulated just under 5,000 hr. and 8,000 cycles. The certification program included flights on the company's 747-400 flying testbed. Overall, 72 GE9X flight tests, totaling more than 400 hr., were flown on the 747, which first flew with the engine in the left

inboard wing position in March 2018.

GE cleared a redesign in time for the start of 777-9 flight tests in January. Eight GE9X engines plus two spares have so far been delivered to Boeing, including powerplants for the fourth and final 777-9 test aircraft, which joined the certification campaign on Sept. 20. ✪

中国 MRO China 2020

# 2020

## 中国航空维修峰会

同舟共济 聚力迎新

中国·厦门 2020.10.28

◀ 详情请联系 ▶

MRO China 组委会 010-85672519 010-85672518

主办单位: 中国航空维修协会 支持单位: 中国航空维修协会 协办单位: 中国航空维修协会

支持媒体: 中国航空维修协会 中国航空维修协会 中国航空维修协会

网络支持: 中国航空维修协会 中国航空维修协会 中国航空维修协会



# Metal Fatigue Caused Airbus A380 Engine Breakup, BEA Says

- > TITANIUM ALLOY WAS THOUGHT TO BE IMMUNE TO KNOWN METALLURGIC FAILURE MODE
- > NEW SYSTEMS DEVELOPED TO FIND METAL PART UNDER THICK LAYER OF ICE



**Thierry Dubois** Le Bourget

**T**he BEA's final report on an Air France-operated Airbus A380 accident is a striking example of how rewarding it can be to conduct an investigation to the end, despite the high costs.

The findings by the French BEA accident investigation office may have consequences for engine design and manufacturing. The aircraft suffered an inflight breakup of one of its four Engine Alliance GP7200 turbofans when climbing over Greenland on Sept. 30, 2017. Investigators determined the root cause of the accident—characterized as such because it was deemed considerably more serious than most engine failures—was dwell fatigue in a metal that had been viewed as immune to such deterioration.

Flight Air France Flight 66 (AF66) took off from Paris to Los Angeles with 521 people on board, including 497 passengers. The fan rotor on engine No. 4 (outboard on the right wing) separated during climb from flight level 370. No occupants were

harmed by the debris, and it caused little damage to the surrounding airframe structure. The crew diverted to Goose Bay, Newfoundland, without further damage.

The probe offers another example of the BEA's persistence—an echo of the four search phases that eventually led to the discovery of the wreckage of an Air France A330 that crashed in the South Atlantic in 2009 (often referred to as the Rio de Janeiro-Paris flight, or Air France Flight 447). This time, safety experts at the BEA had to conduct three research phases in the Arctic ice sheet to find the component holding the telltale sign: the fan hub.

Again, the outcome of the investigation proved worth the effort.

The results of the A380 inquiry are generating key lessons in metallurgy for large turbofans.

Before the analysis determined the root cause was in design and manufacturing, most stakeholders in the investigation—including specialists from the BEA and various

**France's accident investigation bureau describes the AF66 event as an accident because it was more serious than most engine failures: The aircraft's entire fan module detached.**

OEMs—believed the origin of the failure was in maintenance. They theorized that a mechanic had inadvertently created a dent or pit in the fan hub's front face, and that the defect had developed into a crack.

In fact, the problem stemmed from a surprising weakness that can occur during the manufacturing process.

To understand how close the industry came to missing an important engineering lesson had the inquiry been dropped, consider the context. When the investigation began, the A380 was still in production. The fleet of aircraft powered by the Engine Alliance GP7200 (a GE Aviation-Pratt & Whitney joint venture) stood at 130 out of 239 A380s in service. The event was the first major incident involving a

GP7200, and both Airbus and the engine-maker still hoped to sell many more of their products.

In early 2019, Airbus announced the termination of the A380, before discovering the missing piece of the puzzle. Twice the BEA sought additional funding for the next phase of the search in Greenland. Discouraging factors included the new status of the program and the aforementioned belief that a poorly conducted servicing operation caused the accident.

But the BEA persevered. With his Danish counterpart (who had delegated the investigation to the BEA), Executive Director Remi Jouty expected significant lessons if the fan hub was found. The investigation's total cost was "close to" €5 million (\$6 million), Jouty says.

Massive numbers surround the event. Virtually the entire fan module, weighing more than 1.2 metric tons, detached. The powerplant system, including the engine and the nacelle, lost 5.5 m (18 ft.)—more than half its length. Of the 240-kg (530-lb.) fan hub, 220 kg were missing.

Large pieces of debris jettisoned vertically, and only by sheer luck were not ejected horizontally, which would probably have brought the aircraft down, Jouty says.

In the first remains the investigators could study, every piece of evidence suggested all damage was the consequence of something that had happened at the hub level, he recalls. Analysis showed a crack developed from inside.

Metallurgy aims at producing isotropic materials, which have the same properties in every direction. This was a key design driver when a titanium alloy called Ti-6-4, including 6% aluminum and 4% vanadium, was invented.

Sometimes, however, anisotropic zones develop, creating local fragility. But such weakened zones had been demonstrated to remain small enough in Ti-6-4 to solve a premature failure problem seen in the 1970s with other alloys.

The AF66 A380 accident proved the demonstration had been flawed. The accident hub logged 3,500 cycles, well below its design life, Stephane Otin, an investigator at the BEA's materials and failure analysis laboratory, explains. Yet it had performed 1,650 cycles after the crack formed, including 700 cycles during which the crack was invisible.

The microscopic fissure initiated 1.5 mm (0.06 in.) beneath the surface.

An analysis determined that a so-called macro zone of anisotropy—where the crack originated—was created during the part's forging process. It was 10 times greater and stronger than what statistics from analyzed production samples suggested.

The larger the part, the greater the probability to find a hazardous macro zone, Jouty adds.

Compounding the macro zone's existence was that it was orienting the weakness in the same direction as the load the part undergoes. Moreover, loads were highest at the macro zone location.

Then, the fatigue process took place in constant-load phases (essentially when the engine runs at constant rotation speed), as opposed to transient loads, leading to dwell fatigue and the crack's expansion. But due to the supposed properties of Ti-6-4, fatigue tests on production samples included virtually no constant-load phase. Such evaluations focused on transients.

The consequence for engine manufacturers, Jouty says, is that they will have to review the way they design rotating parts on large engines. Manufacturers may need to find an acceptable, perhaps lower load in the future, altering a part's geometry and opting for a different material. These changes could, however, result in heavier parts. Manufacturing processes, especially forging, will have to be reassessed and an inspection regime created, Jouty points out.

The BEA thus recommends that the European Union Aviation Safety Agency (EASA) and the FAA ensure design and manufacturing processes keep the risk of failure under control. In a second recommendation, the BEA asked the EASA and FAA to "carry out a review of engine rotor-grade critical parts" made of titanium alloys of the same family as Ti-6-4 and ensure engines are inspected accordingly.

For the GP7200's fan hub, frequent inspections were required after the failure process was understood. Since Nov. 21, 2019, eddy-current and ultrasonic inspections must be conducted every 330 cycles. Because fan blades must be removed during inspections, the blade lock ring was redesigned to reduce the risk of damaging the hub's front face.

To understand the failure mode,

the investigators needed to first find the accident fan hub, which eluded them for almost 20 months. Debris that had fallen from the aircraft had scattered since the fragments' speed and aerodynamic characteristics were different. The hub's location was thus distinct from the area where most other pieces hit the ground, and the region's percolation phenomenon caused the part to sink.

For these reasons, search helicopter flights in early October 2017 found other pieces such as fan blade fragments. But snowfall quickly covered the surface, leading investigators to find other means of recovering the missing debris.

The second phase began, but several methods proved ineffective.

Eventually, an airborne synthetic aperture radar, developed by French aerospace research center ONERA, was successful. The experimental system uses hyperfrequency-imaging remote detection (SETHI) and can "see" a large swath under the ice and snow surface with a 20-cm (8 in.) resolution. The radar system was carried by a modified Dassault Falcon 20 business jet.

The heterogeneous layers of ice and snow, however, disturbed the radar signal, Jouty explains. The probe's organization and the weather slot gave ONERA limited time during the second phase. An algorithm developed on site proved helpful as well as the use of three frequencies and the combination of images, Jouty says. ONERA could suggest six target locations, but engineers expressed limited confidence in their results. The targets turned out to be false positives.

ONERA engineers, convinced that further SETHI data processing would provide solid results, persisted.

Meanwhile, Pratt & Whitney refined the failure analysis. Because the shape, weight and speed of the missing part were calculated more accurately, the ballistic computation could also be refined, leading to a more precise idea of where to explore.

The final link in the search chain was a towed transient electromagnetic system developed by Denmark's Aarhus University. It was modified for BEA's purposes and tested on a Swiss glacier. On May 23, 2019, an "unambiguous signal" was acquired, and the hub was subsequently discovered 3.3 m under the surface. 🗺️



# COVID-19 Threatens Air India Privatization Efforts

- > GOVERNMENT MAY HAVE TO DELAY AIR INDIA SALE OR ALTER TERMS
- > PANDEMIC HAS EXACERBATED THE CHALLENGES FACING THE AIRLINE



Air India and other Indian carriers are gradually increasing domestic traffic, but demand and capacity remain significantly down from pre-COVID-19 levels.

SAJJAD HUSSAIN/AFP VIA GETTY IMAGES

## Adrian Schofield

**E**scalating problems for India's airline industry are making the government's long-held ambition to sell Air India more difficult than ever. The flag carrier and many of the country's other airlines have struggled to convert long-term potential into profitability, and now the COVID-19 crisis has weakened the sector even further.

The proposed Air India sale is arguably the most significant airline privatization effort underway, with major implications for local and international markets. However, the Indian government faces a dilemma about how to proceed with its attempt to divest the debt-ridden carrier. The latest deadline for submissions of interest is Oct. 30, but with that date looming there appears to be little appetite among potential investors.

Of course, India is far from the only market where the coronavirus pandemic has disrupted proposed airline sales. In South Korea, for example, acquisition deals for Asiana and Eastar Jet both collapsed before they could be closed.

In Air India's case, the proposed sale faced significant challenges even before COVID-19 emerged. Factors counting against it are the airline's enormous financial liabilities, high costs and strong competition from aggressive local low-cost carriers (LCC).

The airline does have some aspects in its favor, chiefly its extensive domestic and international network and slots, a powerful brand and its presence in a massive home market. But an expected slow rebound for international travel limits the value of those advantages.

The government unsuccessfully tried to sell a majority stake in Air India in 2018, but shelved the effort when it did not attract any buyers. It relaunched the process in January 2020, this time offering 100% of the airline and carving off more than half of its 600 billion rupee (\$8.1 billion) debt.

But interest was still weak, and the government has been forced to extend its bid deadline four times. Indian conglomerate Tata Group—which already has stakes in joint ventures Vistara and AirAsia In-

dia—said earlier this year it was considering a bid, but a formal submission has not been made.

Another short- or long-term deadline postponement appears likely as the government considers its options for Air India. The *Hindustan Times* reports that among the steps being considered are a 2-3 year postponement to allow the industry climate to improve. The government could also assume more of the airline's debt load, and is reportedly considering allowing bidders to propose how much of the debt they would be prepared to take on.

One thing that is clear, however, is that the government still intends to divest the airline. Indian Civil Aviation Minister Hardeep Singh Puri has stressed that the choice is between privatization or closing the airline down.

The government "remains absolutely determined to divest its ownership of Air India and is open to feedback on the transaction structure," says Binit Somaia, director of CAPA India (an affiliate of CAPA - Centre for Aviation). However, because of



the difficult environment caused by COVID-19, it is possible that the deadline for submissions of interest could be extended to Dec. 31. Any parties looking at the opportunity “are keeping their cards close to their chest,” Somaia says.

The grounding of flights due to the pandemic has been a massive revenue drain for India’s carriers. Domestic flights were suspended in March and were allowed to resume on May 25. The government has kept significant restrictions in place, however. Initially, airlines were limited to 33% of normal domestic capacity, which was raised to 45% in June and 60% on Sept. 2. Price caps have been imposed until Nov. 24.

Demand has not returned quickly enough to threaten the capacity limits. Domestic passenger movements in August were about a quarter of the previous year’s levels, according to data from India’s Directorate General of Civil Aviation.

Daily domestic passenger levels have now increased to just below half

of pre-COVID-19 levels, Puri said recently in a televised interview on the Times Network. He estimates that domestic traffic will move well past 50% by the Diwali holiday period in mid-November and increase further by year-end.

LCC IndiGo is among the most optimistic of India’s airlines regarding capacity recovery prospects. The airline predicts its domestic capacity will reach 60-70% of the previous year’s levels in the October-December quarter if the government raises its capacity limits. AirAsia India expects to restore 75% of its domestic capacity by the end of the year.

International traffic will take longer to recover. India has negotiated travel corridors with nine other countries, and these are mainly used for repatriation flights. The government has said a broader reopening of international services will not be considered until domestic traffic reaches at least 50% of precoronavirus levels.

Lower capacity and traffic—particularly in international markets—

means many aircraft in India will not be required for some time. CAPA India predicts that of the country’s pre-COVID-19 fleet of 650 aircraft, there will still be a surplus of 200-250 aircraft by the end of March 2021.

Overcapacity has been one of the main factors constraining airline profitability in India in recent years. However, the collapse of Jet Airways last year helped curb capacity, and the COVID-19 crisis is likely to make airlines very cautious about growth for some time. Some degree of industry consolidation is also more likely following the pandemic.

Of course, India’s LCCs still have huge numbers of aircraft on order. IndiGo, SpiceJet and GoAir account for more than 850 narrowbody orders, of which 70% are from IndiGo. But the rate at which these aircraft arrive will likely be slower than planned. For example, IndiGo has signaled that its new Airbus 320neo deliveries will be channeled to fleet replacement rather than growth for the immediate future. ☉

## PHILPOTT BALL & WERNER

### Investment Bankers

#### Sell Side Advisor to the Aerospace, Defense, Intel and Technology Markets

PB&W advises companies in North America, the United Kingdom and the European Union that design and produce highly-engineered products, software and systems for the Aerospace, Defense, Intel and Technology Markets. PB&W’s services include Company Sales, Mergers, Corporate Divestitures, Acquisitions, Select Private Placements and Fairness Opinions.

Driven by a research focused approach, in-depth market knowledge, strong industry relationships and transaction expertise, PB&W strives for industry-leading client returns.

#### Boston

50 Dunham Road  
Suite 1450  
Beverly, MA 01915  
978.526.4200

#### Charlotte

11235 N. Community House Road  
Suite 430  
Charlotte, NC 28277  
704.358.8094

[www.pbandw.com](http://www.pbandw.com)

All security transactions are conducted by Philpott Ball & Werner LLC, a member firm of FINRA/SIPC

#### Announcing PB&W’s Latest Transactions

RF amplifiers and power supplies for defense, aerospace and industrial applications

RF/EMI absorbing materials for naval, airborne and telecom applications

Antennas for HF, SATCOM, EW and radar applications

UUVs for ISR, mine countermeasures and other applications

# COVID-19 To Help Air Cargo's Digital Drive

- > AIR CARGO HAS LAGGED PASSENGER-SIDE DIGITAL ADVANCEMENTS
- > COVID-19 CRISIS IS ENCOURAGING AIR CARGO OPERATORS TO GO CONTACTLESS

**Helen Massy-Beresford** Paris

In the short term, the air cargo sector has been holding up against the COVID-19 crisis better than the passenger side of the airline business: The need for transporting medical supplies gave an initial boost, and e-commerce plus the beginnings of economic recovery in some markets are now underpinning demand.

According to figures from the International Air Transport Association (IATA), air cargo demand in August was 12.6% lower than in 2019, a slight improvement on the 14.4% year-on-year decline recorded in July.

By contrast, meanwhile, restrictions and uncertainty meant that July passenger demand was 79.8% lower.

The main problem the air cargo industry currently faces is a capacity shortage, since belly hold capacity from the many grounded international flights is off the table for now.

In this context, operators know they need to focus on anything that can improve efficiency, and the novel coronavirus pandemic is expected to encourage them to tackle a long overdue task—improving digitalization.

“With regard to [digitalization], we have seen an acceleration just in the last few months,” IATA’s global head of cargo, Glyn Hughes, said during a briefing on the sector earlier this month.

Part of the renewed drive toward greater digitalization stems from the realization that digital processes that help boost transparency through increased automation and tracking capabilities will be important for improving efficiency.

Hughes sees initiatives such as One Record promoting greater efficiency. The IATA-backed data-sharing standard creates a single record view of a shipment that can be shared via a standardized and secure application programming interface, helping to smooth processes and clearances within the air cargo supply chain.

One Record aims to make data sharing easier and more transparent throughout the supply chain and is part of the association’s broader drive to digitally transform the air cargo industry fully, such as through the replacement of paper documentation with electronic air waybills.

The COVID-19 pandemic has given that digitalization initiative a rather dramatic and unexpected boost.

“What this crisis has taught us is that cargo that sits on the ground in a warehouse doesn’t help anybody—whether that is pharmaceuticals, fresh flowers or perishables, cargo is designed to be moved,” Hughes said. “So if we can automate, if we can digitize, if we can improve the processes to get that cargo moving quicker, then the industry will help to be reshaped going forward.”

But the explanation is also simpler, Hughes said. Even in a sector that has clung to physical processes such as paper air waybills far longer than its more digital passenger counterpart, because of the coronavirus “people don’t



**Cargo operators, including Lufthansa Cargo, have been making digital progress for some time, but the COVID-19 pandemic is accelerating their efforts.**

want to share a pen when they sign a piece of paper, and people don’t want to hand over a piece of paper from one individual to another.”

Celine Hourcade, transition director at The International Air Cargo Association (TIACA), agrees.

“No doubt the COVID-19 crisis has accelerated the digital transformation of our industry: Suddenly thousands of employees had to work from home and rely on digital technologies and processes, realizing this is possible, efficient and can be implemented fast when there is no other choice,” Hourcade says. This represents “a mindset shift for those who were still thinking, ‘It is difficult; it takes time; it has been working well as it is—so why change?’”

Now, though, there are no more excuses, she says. “If we can, we must be digital. It is required to be competitive, to meet customers’ expectations, to be efficient, to be attractive to employees and to meet regulators’ demands,” she adds.

TIACA, which has been pushing for more digitalization in the industry for some time, believes the practice should happen at every stage of the process from booking to invoicing, information exchange, safety, security and cargo monitoring. “I think the starting point is to listen to customers to understand what they need and what they expect, listen to employees to identify the blind spots and pain points and rethink processes by embedding digital and sustainability principles,” Hourcade says.

Hughes also noted that the unprecedented coronavirus crisis has brought home an understanding within the en-





tire aviation sector that it needs to look at what lessons can be learned to help prepare for the next major global crisis, whatever and whenever that may be—and here again, transparency, better and faster information sharing, and streamlined processes will be essential.

If and when a COVID-19 vaccine becomes available, the air cargo industry will also play a pivotal role in ensuring it is distributed around the world. IATA estimates that if even a single dose of a COVID-19 vaccine were to be distributed to all of the nearly 8 billion people in the world, the shipment would fill more than 8,000 Boeing 747 freighters.

“Shippers need speed, reliability and transparency,” Hourcade says. “Digitalization is key to meeting customers’ expectations.”

IATA has been calling for better international cooperation on security arrangements and border processes to help facilitate the effort. Because that task is both delicate and important—vaccines are not only temperature-sensitive but valuable and vulnerable to theft—IATA has launched One Source, an online platform that helps the air cargo industry match shipping needs with available infrastructure capabilities and service provider certifications across the value chain, in a bid to help provide shippers with accurate information for time- and temperature-sensitive shipments.

Hughes also believes that the air cargo industry could use lessons learned from the uncoordinated response to the pandemic from various countries to restart efforts. “Every country has done something different,” he notes. “We need much more global coordination with matters that impact particularly aviation, which is a global industry. So I would say, going forward, there will be a greater role for collaboration and cooperation and transparency and certainly digitalization will be accelerated.”

For its part, TIACA and its members see the pandemic as an opportunity to boost transformation. “This crisis offers an opportunity to rethink and redefine business practices, priorities, operational processes,” Hourcade says. “There is a real appetite from, and call to, the air cargo players to accelerate their digital and sustainable transformation.”

## COVID-19 Prompts Idea for Boarding Door Temperature Screening

- > NEW SYSTEM PUTS SCREENING IN AIRLINES’ CONTROL BY ADDING HARDWARE TO AIRCRAFT
- > DEVELOPMENT FILLS A GAP THAT CURRENTLY RELIES ON PASSIVE ONBOARD TACTICS

**Sean Broderick** Washington

**A** Texas-based company has identified aircraft boarding doors as a vacant spot in the effort to help prevent viruses from spreading during air travel and plans to fill the gap with a system that automatically scans people for signs of a fever as they step onboard.

The premise is straightforward: The system, christened Nightingale, uses infrared cameras mounted inside aircraft doors to screen passengers, flight crew and anyone else who walks onboard for elevated body temperature (EBT). When the defined temperature range is exceeded,



**Nightingale will use Flir’s A400/700 camera series to perform body-temperature screening at aircraft boarding doors. The idea is to add another layer of defense against health risks during travel that is both in the airline’s control and visible to passengers.**

a signal such as a red light is triggered. The operator determines the next step based on the protocol in place, explains Kempen Cloete, founder of Cusi Aerospace.

Cloete and his team are developing the idea in response to the novel coronavirus pandemic that has brought passenger air travel to its knees. But they see it as having staying power and becoming part of a layered approach to both ensure and reassure passengers and crew that they are not exposing themselves to elevated risk during certain types of global health crises.

The response to ensure safety for travelers and workers in the current pandemic is evolving as a mix of different tactics. Some airports have rolled out temperature checks, and rapid testing for the COVID-19 illness is ramping up as well. On aircraft, new cabin-cleaning protocols have been introduced, adding to highly effective HEPA cabin filtration systems already in place.

Each tactic, while effective, has drawbacks. Testing protocols are location-specific—a passenger may be screened

“Our system sends an alert of elevated temperature,” Cloete says. “It’s not a symptom checker. It applies a good, proven tool that allows aircraft operators to do something and provide a measure of control.”

Cusi’s plan calls for using Flir Systems A400/A700 series cameras configured to read certain areas on a person’s face, preferably the canthus, or where the upper and lower eyelids meet. The system will look not for absolute temperatures but rather anomalies, says Chris Bainter, vice president of business development at Flir Systems. “Core body temperature can vary by person, time of day and many other factors,” he says. “You want a camera that can compensate its measurement based on the environment.”

The initial configuration puts an independent system at every door that passengers or aviation professionals—pilots, flight attendants, caterers, mechanics—could use.

**Nightingale’s developers believe airlines will embrace an on-aircraft temperature-screening system that is both effective and visible to passengers.**

Each person is screened automatically, and the result is displayed and stored locally. A positive result could lead to secondary screening or other protocols, as determined by the operator.

“A pilot can pull a report anytime to look at what has happened since the previous cycle,” Cloete says. “Most new cleaning procedures are not being done in between flights. A report from our system can show potential cleaners, mechanics or others who accessed the aircraft and had elevated temperatures. Then it is within the pilots’ capability to call for more extensive measures.”

Future versions will link each system together on a single aircraft and could be configured to transmit results remotely, perhaps to the ground or a central processing center. EBT screening could reinforce more complex strategies such as using facial recognition to support contact tracing or ID verification at the aircraft that could help streamline boarding processes.

Several airlines have expressed interest in Nightingale, Cloete says, including one North American operator with a fleet of more than 100 aircraft. “They are very, very excited about what this can do for an airline,” Cloete says. “The fact that passengers actually see a system on the aircraft that scans people—they will know the person sitting next to them will have gone through the device.”

Customer interest will drive the STC development strategy, but the initial approvals are expected to be within the Airbus A320 and Boeing 737 families. Cusi is targeting initial approvals in the second quarter of 2021.

Cusi’s goal is to ensure installation occurs during overnight checks, one camera at a time. The aircraft can be dispatched following each installation, so an entire system can be put in place within a week without adding any aircraft downtime, Olmstead says.

Cusi will pursue “approved model level” STCs, where the same baseline data is certified for installation on multiple aircraft models, Olmstead says. “This is about as simple a system as you can get,” he says. “The brains are in the camera.”



DEPOSITPHOTOS

before one leg of a journey but not the next. Testing for COVID-19 is a useful but temporary measure—after this pandemic, it should no longer be needed. Measures taken onboard the aircraft are either invisible to passengers, such as the HEPA system, or passive, such as plastic barriers between seats.

“Passengers should feel safe in an aircraft cabin,” Embraer’s Asia-Pacific business development and contracts manager, Lais Port Antunes, said during a recent Aviation Week webinar. “But they need to see actions.”

Cusi is developing Nightingale with this in mind.

“This is only going to be solved by defense in depth” using varied approaches for detecting and preventing illnesses during the travel process, says Nick Olmstead, a product-certification expert working with Cusi on Nightingale’s supplemental type certification (STC). “It’s pretty clear to us that the missing link is something on an aircraft.”

Cloete acknowledges that temperature checks can do only so much. Although an elevated temperature may signal COVID-19 or a common cold, it is also a symptom of many other viruses, making EBT screening a useful layer in any health response to an outbreak. Furthermore, putting the technology in the hands of aircraft operators allows them to provide consistency and certainty to customers without relying on external policies.



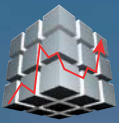

# PLATINUM FORECAST SYSTEM

***The ONLY System***  
***Designed to Meet the Demands of a Pandemic***  
Breaking News and Updated Forecasts  
In Minutes!



**MARKET INTELLIGENCE AND FORECASTING**

[forecastinternational.com](http://forecastinternational.com)

[sales@forecast1.com](mailto:sales@forecast1.com)

203.426.0800

## HYDROGEN IN AVIATION

- > Contrails p. 34
- Safety p. 34
- Fuel cells p. 36
- Combustion challenges p. 38
- European cooperation p. 40



# CLEAN POWER



- > FUEL CELLS OFFER A NEAR-TERM PATH TO HYDROGEN
- > LONG-RANGE FLYING FAVORS DIRECT COMBUSTION
- > SHORT-HAUL FLIGHTS COULD USE HYBRID APPROACH

**Graham Warwick** Washington, **Guy Norris** Los Angeles and **Thierry Dubois** Lyon



ONE IN A SERIES

Sustainability has returned rapidly to the agenda for an aviation industry still struggling to survive the COVID-19 pandemic. And hydrogen has suddenly and unexpectedly risen to the top.

Airbus is leading the charge, with plans to deliver a zero-emissions commercial aircraft by 2035 backed by massive investment in hydrogen research from the French and German governments. The European manufacturer on Sept. 21 unveiled three different concepts for liquid-hydrogen-fueled airliners (*AW&ST* Sept 28-Oct. 11, p. 16).

The reasons are understandable. Hydrogen offers the potential to decarbonize single- and twin-aisle commercial aircraft, the big contributors to aviation's climate footprint, while also tapping into wider investment in hydrogen infrastructure because of its broad appeal as a zero-emissions energy carrier. This is particularly true in Europe, which is blazing the trail toward a hydrogen economy (see page 40).

But the challenges are not to be underestimated. From production to

consumption, significant technical, operational and economic obstacles must be overcome to bring hydrogen to aviation. But from industry leader Airbus to disruptive startup ZeroAvia, there is a belief that hydrogen propulsion's time has come.

Not everyone is as convinced. Boeing sees the longer-term advantages of switching to a hydrogen ecosystem but believes the process will take longer than the schedules suggested by Airbus. "We do see promise in a transition to more hydrogen-based fuels over time. However, I don't believe it's something that's right around the corner. There's a lot of infrastructure and regulatory framework that has to evolve with the technology, and that is not a fast process," says Mike Sinnett, Boeing Commercial Airplanes vice president of product develop-

ment and future airplane development.

"We know a lot about how kerosene is burned, how it can be stored safely and how it can be transported, and how engines use that fuel in all environments from the Arctic to the desert," he says (see page 34). "As we transition to more sustainable fuels, we have to ensure there's no backpedaling in those levels of safety. And that means there's still a lot to learn about how you would create, transport and use hydrogen in all the operational environments, ranging from a Siberian winter to an Algerian summer."

There are three main ways to use hydrogen in aircraft: in fuel cells to generate electricity, direct combustion in turbine engines, and in the production of synthetic sustainable aviation fuels (synfuels). Fuel cells can be used indirectly, to produce emergency and auxiliary power; and directly for propulsion. Turbine engines can burn hydrogen with some modifications to the combustion and fuel systems. Synfuels are drop-in replacements for fossil-based kerosene and require no significant aircraft or engine changes.



## Airbus is studying three different liquid-hydrogen aircraft concepts.



According to the “Hydrogen-Powered Aviation” report released in May by Europe’s Clean Sky and Fuel Cell and Hydrogen research programs, fuel cells can reduce the climate impact of aircraft by 75-90%, direct combustion by 50-75% and synfuels by 30-60%. Hydrogen does have the potential to increase contrails, which can adversely impact climate change, but more research is required (see page 34).

Fuel cells are in widening use in the automotive sector, with producer Ballard projecting a \$100 billion market over the next 10 years to power medium- and heavy-duty trucks. But the power density of fuel cells needs to be increased by two to three times to make them suitable for aircraft (see page 36). Direct combustion requires liquid hydrogen storage, which has a major impact on aircraft design and demands the development of light-weight cryogenic tanks (see page 38).

Synfuels, also called e-fuels, are produced by combining carbon captured from the atmosphere with green hydrogen, which is produced by electrolysis of water using renewable electricity. These fuels emit CO<sub>2</sub> when burned in flight, but can be considered carbon neutral because they recycle atmospheric carbon. The technology is still in its infancy, however, though large synfuel projects are planned in Denmark and Norway.

The report foresees fuel-cell propulsion being used in new-design commuter and regional airliners within 10-15 years, and sooner in retrofitted or modified aircraft using gaseous hydrogen storage. Medium- and long-range twin-aisle aircraft powered by hydrogen-fueled turbines could enter service within 20-25 years, the report projects.

Between these two categories, the report foresees the emergence within 15 years of a new class of short-range airliner with hybrid hydrogen propulsion—a 165-passenger single-aisle

aircraft with reduced, 2,000-km (1,100-nm) range and slower, Mach 0.72 cruise speed but a 70-80% lower climate impact.

Using liquid-hydrogen storage, this concept combines hydrogen-fueled turbofans with a powerful, 11-megawatt fuel-cell system driving electric motors mounted on the main turbine shafts. Both systems work for takeoff and climb, and the fuel cell drives the fans in cruise when the turbines are turned off.

“In our view the bookends of the aircraft range spectrum are fairly well-established,” says Alan Newby, Rolls-Royce director of aerospace technology and future programs. “We have all-electric at one end, for general-aviation-type operations. And in the medium to long range, we think sustainable aviation fuel is the only credible solution at the moment.

“So where we come back to is this middle ground with commuters, regionals and then maybe shorter-haul midmarket operations where hydrogen may offer a solution and potentially either in combination or in competition with a hybrid-electric solution,” he says.

Rolls sees clear potential in fuel cells for smaller aircraft. Already developing electric propulsion for aircraft, the company is now gaining experience with fuel cells through an agreement with a Daimler-Volvo joint venture to use systems developed for heavy trucks for standby power at data centers.

“We’ve seen companies like Zero-Avia looking at what fuel cells might do for smaller aircraft, and for us that sector of the market is quite attractive because we have both parallel and series hybrid-electric solutions,” Newby says. Today those systems use batteries, “but it is quite conceivable as fuel cells get developed that you could swap those in and essentially keep the same electrical system,” he adds.

Despite their zero-emissions promise, hydrogen fuel cells are not expected to power long-haul aircraft. “For longer ranges, the power density of fuel cells becomes a challenge. It is more likely that such aircraft would use liquid hydrogen and burn it directly in the gas turbine,” Newby says.

“The gas turbine has a long way ahead of it for medium- and long-range transport, whether powered by hydrogen or by sustainable aviation fuels—there’s nothing to displace it for the longer-range mission,” he says. “So we

need to keep investing in the gas turbine to minimize its use of whatever fuel is chosen.”

Whether it is consumed in a fuel cell, burned in a turbine or converted to synfuel, production and distribution of enough green hydrogen to meet the expected demand for decarbonization coming from all sectors of industry and society could prove one of the biggest challenges facing aviation.

“In 2019, around 90% of the hydrogen produced in the planet was from fossil sources. In 2019, the commercial fleet burned just shy of 100 billion gal. of fuel,” says Michael Winter, Pratt & Whitney senior fellow for advanced technology. “If you were to replace 10% of that enthalpy with hydrogen, you’ve used 90% of the world’s hydrogen production in 2019. So the question is, if we’re going to put money into infrastructure, where would we rather put it as a society: synthetic aviation fuel or hydrogen?”

Winter questions whether there will be enough renewable energy to make all the green hydrogen Europe is talking about producing, and he points out that a modern turbofan in cruise is already 10% cleaner than the world’s electrical power grid on a CO<sub>2</sub>/kWh basis. “Will there be an abundance of clean water to use for electrolysis in the future?” he asks, noting that if desalination is required, it is an energy-intensive process.

Newby echoes the concerns about scaling up green hydrogen production but points to Rolls’ work on small modular nuclear reactors as one potential path. While countries are expanding their wind, solar and other renewable energy sources, small nuclear reactors could also feed electricity to the grid as a zero-carbon source, drive electrolyzers to produce hydrogen, or use hydrogen as a feedstock for synfuels.

Hydrogen may hold out hope for decarbonizing aviation, but a sustainable way to scale up production is essential. “That will need investment, and it will need the appropriate incentives, because we’re going to need hydrogen to decarbonize the whole world, not just aviation,” Newby says. “One of the particular challenges we face as an industry is how that adoption will be prioritized among various sectors.”



**Check 6** *Aviation Week* editors discuss Airbus’ ambitious hydrogen propulsion plans and the challenges ahead: [AviationWeek.com/podcast](https://www.aviationweek.com/podcast)

# Will Contrails Be Hydrogen Fuel's Achilles' Heel?

- > HYDROGEN CONTRAILS ARE MORE FREQUENT BUT LIKELY LESS REFLECTIVE
- > FURTHER RESEARCH IS NEEDED INTO MITIGATION STRATEGIES

**Guy Norris** Los Angeles

**O**n a cold February day over Lake Erie in 1957, test pilot Joe Algranti made history when he switched one of the two engines on his Martin B-57B midflight to run on hydrogen rather than standard JP-4 jet fuel.

Anxiously scanning his instruments, Algranti was relieved to see no appreciable change in engine speed, tailpipe temperature or throttle response. The Wright J-65 engine ran smoothly for 20 min. until the dropping hydrogen fuel level prompted him to switch back to JP-4 and return safely to what is now NASA Glenn Research Center at Lewis Field, Ohio.

The National Advisory Committee for Aeronautics (NACA) experiment demonstrated for the first time the feasibility of using liquid hydrogen in flight for air-breathing jet propulsion. It also hinted at a potentially troubling phenomenon: Algranti reported the test engine produced a dense and persistent condensation trail, or contrail, while the conventional engine did not. The observation merited a mere footnote 63 years

ago but today warrants closer attention as hydrogen takes on new importance in the search for sustainable aviation.

Burning hydrogen in the air does not produce carbon dioxide (CO<sub>2</sub>), but it does generate significant volumes of water. Combusting 1 kg (2.2 lb.) of hydrogen produces 9 kg of water vapor, which condenses into clouds of ice crystals when exhausted into the atmosphere at sufficiently low temperatures and saturation vapor pressure.

Contrails are a form of high-altitude cirrus cloud, and they affect the Earth's net radiative equilibrium both by reflecting incoming sunlight back into space and by trapping heat from the surface. Extensive studies indicate that contrails trap more heat than they reflect into space, which means the net radiative forcing results in warming.

The contribution from contrails to climate change is

## Misleading Impression

- > PAST PROGRAMS CONCLUDED HYDROGEN IS SAFE IN AIRCRAFT
- > DEMONSTRATORS ARE NEEDED TO DEVELOP SAFE SYSTEMS

**Graham Warwick** Washington

**I**n 1956, early on in the design of the hydrogen-fueled Lockheed CL-400—a precursor to the SR-71—the Skunk Works' Kelly Johnson and Ben Rich conducted experiments to determine the hazards of hydrogen.

Pressurized liquid-hydrogen (LH<sub>2</sub>) tanks were deliberately ruptured, and a small charge was used to ignite the escaping fuel. The resulting fireball quickly dissipated because of hydrogen's rapid flame speed and low density. Only two explosions occurred in 61 attempts, according to NASA's history site, and in both they had to mix oxygen with the hydrogen.

This is not the public's image of hydrogen in aviation.

Instead, hydrogen is forever associated with the fatal conflagration that engulfed the airship Hindenburg as it attempted to moor at NAS Lakehurst, New Jersey, on May 6, 1937. It is gen-

erally accepted hydrogen contributed to, but did not cause, the Hindenburg fire. But, decades later, the safety of hydrogen—real and perceived—is a central challenge to its use in aviation.

"I am tired of hearing about Hindenburg and hydrogen explosions," says Josef Kallo, coordinator for energy systems integration at German aerospace center DLR. "They had rubber and fabric and they put hydrogen inside that balloon. Now, we have materials that can store hydrogen completely safely.

"As engineers, we have to say repeatedly: 'Please do not compare 100-year-ago accidents with the possibilities which we have today,'" he says.

The public image does not reflect the research reality. "Every single hydrogen flight demonstrator has tackled the safety issue, and in every case they've come out with the fact that hydrogen is safer than jet fuel," says Paul Eremenko,



CEO of startup Universal Hydrogen. "And the reason that it's safer than jet fuel is that it burns quickly and it burns up. It doesn't pool."

Safety comes first for an aviation industry proud of its record. "We need to look at any new technology in this context," says Glenn Llewellyn, Airbus vice president for zero-emissions technology. "Kerosene is the existing technology . . . and what few people know is the effort that goes on in the background, in terms of aircraft design and operations, to make kerosene an extremely safe system.

"We will have to develop the same kinds of systems, meeting the same or even more ambitious safety tar-



NASA



## Hydrogen contrails might differ in character and persistence from those produced by today's kerosene-fueled aircraft.

fic volume, the effects are likely to increase as airliner flights multiply in tropical areas and at higher altitudes in midlatitude where tropospheric conditions favor contrail formation.

German aerospace research agency DLR reported in 2019 that global contrail cirrus radiative forcing is predicted to grow more than threefold, reaching as much as 180 milliwatts/m<sup>2</sup> by 2050, compared with an estimated 49 milliwatts/m<sup>2</sup> in 2006. The gloomy forecast accounted for offsets such as improvements in engine efficiency: This will reduce the soot particles around which ice crystals form, thus making contrails less dense.

But what happens if much of the 2050 fleet is powered by hydrogen? Will the added water content of hydrogen exhaust make contrails worse and therefore counteract the benefits of eliminating CO<sub>2</sub>?

There are no simple answers. Even though hydrogen-powered jet aircraft will potentially generate contrails more readily, the characteristics of the contrail itself “may be different,” says Andrew Gettelman, senior scientist at the National Center for Atmospheric Research in Boulder, Colorado. “The same physics applies for contrail formation from a kerosene- or a hydrogen-powered aircraft,” Gettelman says. “It’s just the emission index of water vapor is higher for a hydrogen-powered aircraft because this is essentially pure water.”

expected to increase as air traffic eventually resumes its post-COVID-19 pandemic growth rate.

Beyond sheer global traffic volume, the effects are likely to increase as airliner flights multiply in tropical areas and at higher altitudes in midlatitude where tropospheric conditions favor contrail formation.

The higher emissions index creates an increase in the potential for contrail formation. “These would be more frequent, assuming they would fly at the same altitude,” Gettelman says. “This would tend to have a radiative effect. However, you’re going to get an offset because the contrail will likely consist of fewer and larger ice crystals.”

Ice crystals forming from combusted hydrogen in super-saturated air below the tropopause will grow by absorbing humidity from the surrounding air. The hydrogen propulsion process will allow the crystal size to be larger than those found in jet fuel contrails, which condense around soot particles. “If you have larger ice crystals, two things are going to happen,” Gettelman says. “They’re a little bit dimmer radiatively, so they do not reflect and absorb as much radiation. Second, they are going to sediment, or fall out, faster.”

However, Gettelman cautions that while conventional contrails have been studied closely, virtually nothing is known about the microphysics and ice crystal formation associated with burning hydrogen from an air-breathing engine at altitude. Such work will be required to validate upper-atmospheric models that will help with development of lower-emission designs and contrail-mitigation strategies.

These will likely revolve around avoiding ice-supersaturated regions, either by flying at lower altitude or, depending on local conditions, flying above the tropopause into the dry air of the stratosphere where contrails do not form. Such strategies will also have to balance out the net environmental and cost effects of potentially flying for longer versus contrail formations. ☼



NASA

gets,” he says. “They will be slightly different, as hydrogen has different characteristics to kerosene.”

Val Miftakhov, CEO of hydrogen-electric power train startup ZeroAvia, says: “It’s about the safety system around the fuel, and hydrogen is no different from other chemically energetic substances. There are actually some fundamentals that are even better from a safety perspective on the hydrogen side—things like ignition temperature, radiative heat and rapid dispersion in the atmosphere.”

The “Hydrogen-Powered Aviation” report released in May by Europe’s Clean Sky and Fuel Cells and Hydrogen research programs lists safety con-

## Aviation has had to make kerosene safe, with tests such as NASA’s 1984 Crash Impact Demonstration.

cerns from production to consumption. A requirement for 500 tons of LH<sub>2</sub> a day at an airport means 125 truckloads that could pose a safety risk on access roads. The size of the safety perimeter around the necessary three-day store of LH<sub>2</sub> is not known, the report notes.

LH<sub>2</sub> refueling trucks will differ from Jet-A tankers and call for different training and safety frameworks. Safety precautions required while refueling could compromise parallel operations during turnaround. Losing more than 10 min. of turnaround time three or four times a day could cost a short-haul aircraft one flight in an 18-hr. operating period, reducing revenue.

New regulations for turnaround operations will be needed to ensure safe handling of cryogenic LH<sub>2</sub> and of risks such as spontaneous ignition on contact with water, asphyxiation and vertical dispersion. The effect on ignition-free zones around refueling trucks is unclear. They may be smaller because the hydrogen does not pool, but more research is needed.

On the aircraft, LH<sub>2</sub> tank standards will have to specify boil-off requirements. If those can be reduced, and still ensure safe ground handling and storage of aircraft, tanks could be lighter. Safe, light efficient hose connections compatible with unconventional tank configurations and safe LH<sub>2</sub> system components such as double-insulated pipes must be developed.

“We need demonstrators and demonstrators which fly safely,” says Simon Taylor, GKN Aerospace chief engineer for hybrid and electric aircraft. “And the key with these demonstrators is that we move quickly but we don’t rush, so there are no accidents. Any startup working with hydrogen where we have an explosion and a fatality will potentially set the whole sector back.”

Part of the perception problem is the public’s lack of experience with hydrogen as an energy carrier, but that will change. “Hydrogen is not more or less dangerous than all the other fuels we use,” DLR’s Kallo says. “It will become normal when we use it day by day. We will see the numbers on accidents, and then all these discussions will just go away.” ☼

## Hydrogen Fuel Cells Offer Near-Term Path to Zero-Emission Aviation

- > AUTOMOTIVE FUEL CELLS ARE PROVIDING THE STARTING POINT
- > HIGHER POWER DENSITY AND OTHER IMPROVEMENTS ARE NEEDED

ZeroAvia's Piper M350 testbed has a 260-kW motor powered by automotive fuel cells. The next step is a PT6A-size 600-kW system.



Graham Warwick Washington

ZEROAVIA

**F**lying a circuit of Cranfield Airport on a windy English day, ZeroAvia's Piper M350 testbed on Sept. 24 established an aviation milestone, the six-seater becoming the largest aircraft yet to fly on hydrogen fuel-cell propulsion.

The startup plans to conduct a 250-300-mi. demonstration flight from Orkney, Scotland, before year-end. It is a key step in its strategy to develop hydrogen fuel-cell power trains for 10-seat single-engine and 20-seat twin-engine commercial aircraft. ZeroAvia's goal is to certify its first retrofit within three years.

It is not alone. Universal Hydrogen, a startup led by former Airbus chief technology officer Paul Eremenko, is developing a fuel-cell propulsion retrofit for the De Havilland Canada Dash 8-300 and ATR 42 regional turboprops to kick-start demand for its aviation hydrogen infrastructure, aiming for market entry by 2024.

Drawing on automotive technology, fuel cells are widely viewed as the most promising route to bring hydrogen into aviation in the near term. "For commuter and regional aircraft, fuel-cell-powered propulsion emerges as the most energy-efficient, climate-friendly and economic option," concludes the "Hydrogen-Powered Avia-

tion" report jointly released in May by Europe's Clean Sky and Fuel Cells and Hydrogen research programs.

"Aircraft using fuel-cell systems can reduce climate impact the most, by an estimated 75-90%," says the report. This compares with a 50-75% reduction for direct combustion of hydrogen in turbine engines and 30-60% for synthetic fuels (synfuels) produced from renewable hydrogen and direct air capture of CO<sub>2</sub>.

The technology available for aviation use today is the low-temperature proton exchange membrane (PEM) fuel cell, the report notes. Hydrogen flows into the fuel cell and onto the anode, where it is split by a platinum catalyst into hydrogen ions (protons) and electrons. The ions permeate across the PEM electrolyte to the cathode, while the electrons flow through an external circuit and generate electrical power. Oxygen, in the form of air, is supplied to the cathode, where it combines with the hydrogen ions and electrons to produce water and heat.

Fuel-cell propulsion produces no CO<sub>2</sub> or nitrogen oxide (NO<sub>x</sub>) emissions. By comparison, direct combustion of hydrogen produces NO<sub>x</sub> but no CO<sub>2</sub>, and synfuels emit both CO<sub>2</sub> and NO<sub>x</sub> in flight. Both fuel cells and direct combustion produce 2.5 times more

water vapor than burning kerosene or synfuel. This is a concern for contrail production, "but the water vapor produced by a fuel cell is cooler and fully controllable inside the aircraft, when it could be conditioned," the report notes (see page 34).

Universal Hydrogen, for example, plans to collect the water produced by the fuel cells in the outer wing tanks to ensure no contrails are generated. "And then you can dump the water at a condition when no contrail will be produced," Eremenko says.

Fuel cells work with either gaseous or liquid hydrogen storage. Universal Hydrogen's logistics system is built around interchangeable 850-bar pressurized-gas and insulated liquid-hydrogen capsules so that an airline can choose between them for each flight. The Dash 8 will fly 400 nm on gaseous modules, and 550 nm on liquid. Both module types are transportable via the global intermodal container network.

Fuel cells are promoted as an alternative to batteries for zero-emission flight, the higher energy density of hydrogen enabling longer ranges while still allowing the use of high-efficiency, low-noise, minimal-maintenance electric drivetrains. But the power density of fuel cells needs to improve for aviation use.



The automotive fuel cells being used for initial aviation applications have a power density of around 0.75 kW/kg. “We see a path to 1.5-2 kW/kg within five years, compared with small turbines powering 20-seaters at 3 kW/kg,” says ZeroAvia CEO Val Miftakhov, adding that 4-5 kW/kg—similar to a CFM56 turbofan—could be achievable within 10 years.

Fuel cells have other advantages over batteries. One is life. Improvement is needed for aircraft use, the report says, but fuel cells in trucks typically last for 25,000 hr. before stacks need to be rebuilt. High-power battery packs in electric aircraft last around 1,000 cycles. Refueling is also faster than recharging.

Low-temperature PEM cells respond quickly to power demands, but not instantaneously as do batteries. Some fuel-cell drivetrains incorporate batteries to handle transient loads and power peaks, but Miftakhov argues batteries are too heavy to make sense as a buffer.

Because it uses air, the output of a fuel cell lapses with altitude, as does the thrust of a gas turbine—but not the power of an electric motor. This will require careful design of the turbo-compressor, says Simon Taylor, chief engineer for hybrid and electric aircraft at GKN Aerospace.

Low-temperature PEM cells are susceptible to contamination and require 99.99%-pure hydrogen. Not much of the hydrogen produced today is pure enough. But the green hydrogen aviation wants to use, produced via electrolysis using renewable electricity, is pure, says Andy Marsh, CEO of fuel-cell producer Plug Power.

Research into fuel-cell propulsion has been underway for more than a decade. A two-seat motor glider modified by Boeing became the first aircraft to fly straight and level on fuel-cell power in Spain in 2008. In 2009, German aerospace center DLR’s Anatares DLR-H2 became the first to take off only on fuel-cell power.

DLR then created a spinoff, H2Fly, to pursue emission-free flight, its four-seat fuel-cell-powered Hy4 flying in 2016. The aircraft will shortly fly with an improved, integrated fuel-cell system under the European Mahepa research project to develop a modular hybrid-electric propulsion architecture.

All these aircraft have flown on pressurized gaseous hydrogen. In 2022, under the European research project Heaven, the Hy4 is planned to become

the first aircraft to fly on a combination of high energy-density cryogenic liquid-hydrogen storage and a high power-density pressurized fuel-cell system.

In August, DLR partnered with MTU Aero Engines to develop a complete hydrogen fuel-cell power train for flight testing in a Dornier Do 228 from 2026. One of the 19-passenger regional aircraft’s two turboprops will be replaced by a 500-kW electric drivetrain powered by the fuel-cell system.

With almost 13 years of experience, “we have seen that the challenges are not in the functionality of the fuel cell,” says Josef Kallo, coordinator of energy system integration at DLR. “The functionality of hydrogen propulsion is there, no doubt about that. We have seen we can go 1,500 km [800 nm] with four people.” Where the challenge lies is in the “balance of plant,” the components around the fuel cell, from air compression to thermal and water management, that turn it into a power system.

Aviation can benefit from work already done by the automotive industry,

stay essentially the same and reducing weight for aircraft use will focus on the materials used, and tighter integration of components, within the balance of plant, Marsh says.

Managing water and temperature so that the fuel cell does not freeze or flood requires careful design. Another issue with the high-power systems needed for aircraft is cooling. “A low-temperature PEM fuel cell is generating heat at 80-100C [175-210F]. If you have a 50%-efficient system that is producing 2 megawatts, then you have 1 megawatt of low-quality heat that you need to be able to dissipate,” Taylor says. “That is a significant problem. There are ways of doing it, but they are not trivial.”

One solution is to move to high-temperature PEM fuel cells. These operate at 140-200C, which not only enhances electrochemical performance and water management, but also simplifies cooling because of the greater temperature difference between waste and ambient air. “In the long term, that allows us to dissipate an awful lot of heat into the air, and to have more

Four 12-kW fuel-cell modules make up the propulsion system developed for the hydrogen-powered Hy4 under Europe’s Mahepa project.

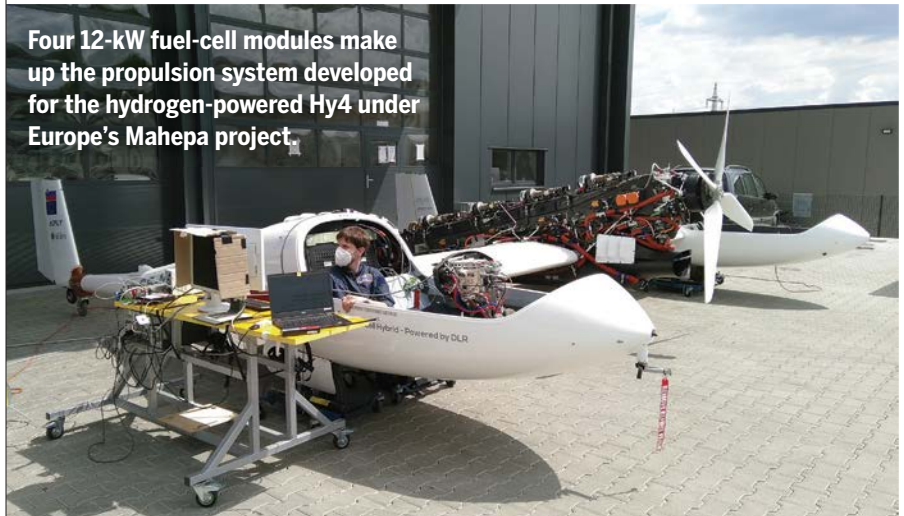

MAHEPA PROJECT

but power density is not a big driver for fuel cells in vehicles, so much of what needs to be done by the aerospace industry involves reducing system weight to get to 1.5-2 kW/kg or better. “We also need to resolve the parasitic losses going forward as they are the biggest energy consumer as part of the balance of plant,” Taylor says.

Plug Power is developing the 2-megawatt fuel-cell system for Universal Hydrogen’s Dash 8 conversion, based on its ProGen system for heavy trucks. The heart of the fuel cell—stacks of membrane electrode assemblies—will

effective heat exchangers,” Taylor says.

But high-temperature PEM fuel cells are still in the laboratory, at a low technology readiness level. “The low-temperature PEM fuel cell is the most promising from today’s perspective, and we see a huge investment, roughly \$5-8 billion over the next five years, to improve power density for automotive, heavy-duty, trains and ships,” says Kallo. “There are challenges related to the low-temperature fuel cell, but the challenge in bringing this to aviation is in the handling of hydrogen and the balance of plant.”

# Engine-Makers Face Hydrogen Combustion Challenges

> THERMAL MANAGEMENT, EMBRITTLEMENT AND SEALING ARE KEY ISSUES

> INDUSTRIAL POWER AND ROCKET EXPERIENCE WILL AID DESIGN

Guy Norris Los Angeles

Engine-makers have long studied hydrogen as an alternative to conventional jet fuel. But does the European-led decarbonization push mean aviation will finally adopt the most abundant chemical substance in the universe?

The short answer is almost certainly “yes.” Previous attempts, all driven by different motivations, were not backed by inclusion in national government

However, engine-makers, the power brokers of the industry, have mixed views on the realities of the rush to hydrogen—particularly the ambitious timelines for adoption outlined by Airbus. While clearly supporting the sustainability goals of the initiative, they caution that many technical, safety, certification and operational hurdles remain before hydrogen can be considered sufficiently mature for main-

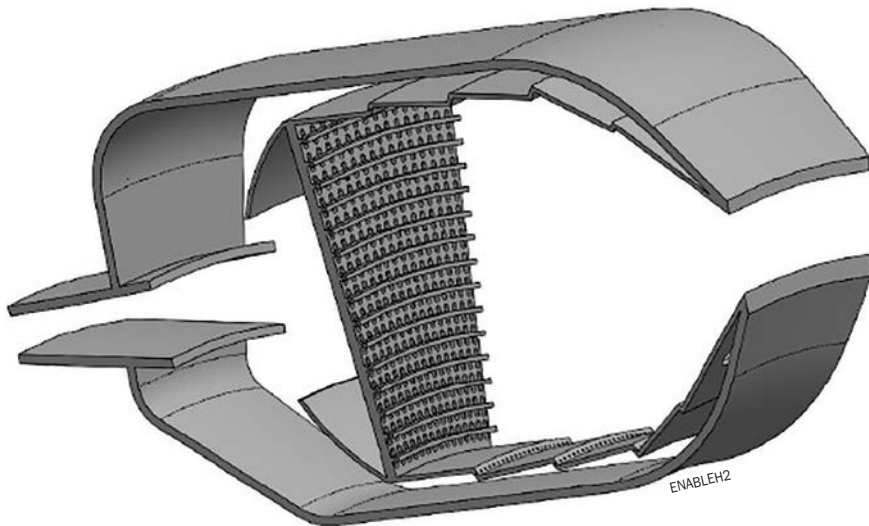

stream commercial aircraft propulsion—especially for direct combustion in turbofans in place of kerosene.

energy-policy agendas or the promise of investments to engineer wholesale modifications to energy system infrastructure—both of which appear to be new factors underpinning Europe’s recent pivot toward hydrogen.

In the 1950s, U.S. studies evaluated hydrogen for its potential to boost the performance of high-altitude military aircraft. The 1970s oil crisis sparked studies of alternative fuels—including hydrogen—to reduce Western dependence on the Middle East. In the 1980s and 1990s, concerns over potential oil shortages again brought hydrogen back into the mix, particularly in Europe. But climate change and the search for sustainability have thrust hydrogen back into the spotlight.

stream commercial aircraft propulsion—especially for direct combustion in turbofans in place of kerosene.

Although some at engine manufacturers see a nearer-term path toward the development and application of hydrogen fuel cells in civil transports, most believe the road toward direct combustion will be longer and more difficult. One of the key challenges is that although liquid hydrogen (LH<sub>2</sub>) has three times the energy density of kerosene, it occupies more than four times the volume for the same amount of energy. Because the drag penalty of an LH<sub>2</sub>-fueled aircraft would be prohibitive for long-range routes, industry focus has been on hydrogen-powered regional and short-to-midrange airliners.

For direct hydrogen combustion, most propulsion studies are zeroing in on the 20,000-40,000-lb.-thrust range of current single-aisle aircraft engines. Regardless of whether or not hydrogen is adopted for this sector, engine-makers believe the long-range widebody fleet will continue to rely on current and future generations of turbofans—but powered by sustainable aviation fuel (SAF).

Aside from the considerable challenges of developing lightweight, insulated high-strength fuel tanks and systems on the airframe side, engine-makers say the key challenges depend on first answering the principal question: Is the hydrogen gaseous or liquid? “If it’s gaseous, then the problem is relatively straightforward, because the pressure from the tank drives the hydrogen into the engine. So then it becomes effectively a metering problem,” says Alan Newby, Rolls-Royce director of aerospace technology and future programs.

**Hydrogen combustors, like this Micromix concept, will be shorter and incorporate thousands of very small injectors.**

Valving, metering and system leakage are more challenging because diatomic hydrogen is the smallest molecule that exists and one that diffuses most easily into surrounding materials such as metals, which can become embrittled.

Airbus prefers liquid hydrogen for its single-aisle airliner concept because of the greater potential storage volume and therefore greater range. “In that case, you have two choices,” Newby says. “The question is, How long are you leaving it in liquid form? We know from rocket experience that we can pump hydrogen, so that’s not a problem. But then do you meter in its liquid form—which is closer to how we manage kerosene today—or do you meter it in a gaseous form? We’re doing the trades on those to see which makes most sense.”

Metering in a gaseous form operated successfully in early 1957 in a modified Martin B-57B, marking the first flight of a hydrogen-fueled jet aircraft. Powered by a specially adapted Wright J65, the license-built version of the Rolls-Royce heritage Armstrong Siddeley Sapphire, the experimental B-57B project was developed by



OCTOBER 2020

# InsideMRO™



## Accelerating Virtual



**Engineering's  
New Twist**

**MIDTIER  
AFTERMARKET  
Ripe for M&A**

**AVIATION WEEK**  
NETWORK

**YOU DO YOU**

**WE'LL DO  
THE WHEELS  
AND BRAKES**

**WHEELS AND BRAKES  
IT'S THAT SIMPLE**



## MRO 4 NEWS BRIEFS & CONTRACTS

### SAFETY & REGULATORY

- MRO 6 New GP2700 Inspections
- MRO 7 Evacuation Data
- MRO 8 ARSA Update

### AIRLINE INSIGHT

- MRO 9 Malaysia Airlines  
How Malaysia Airlines is using technology to meet supply chain demands

### REGIONAL FOCUS

- MRO 12 Snapshot of European MRO COVID-19 Adjustments  
New services and tech, layoffs and buyouts dominate the landscape

### TECHNOLOGY

- MRO 14 MROs Adapt to Pandemic Challenges by Going Virtual  
Aftermarket companies are adapting to technology to meet their needs during the COVID-19 crisis
- MRO 19 Slow Progress  
Electronic tech log adoption is still minimal, despite its benefits over paper

### OPERATIONS

- MRO 22 Wind and Fire  
Protecting aircraft from typhoons and other natural disasters

### SUPPLY CHAIN

- MRO 23 Looming Deal Heralds Change  
Potential TransDigm acquisition of Triumph could reshape the aftermarket landscape

### ENGINEERED

- MRO 25 Engineering Innovations  
Engineers, designers innovate for a post-pandemic world

### ENGINE ANALYSIS

- MRO 28 Narrowbody Stalwart  
Despite deferred shop visits, the V2500 should recover well from the COVID-19 crisis

### MARKETPLACE

- MRO 29 Boutique Engineering

### VIEWPOINT

- MRO 31 Nicole Noack, Independent Aircraft Modifier Alliance

## MAINTENANCE CHECK

# Numbers Game

Statistics have become a big part of our daily lives and affect what we do. The number of people who are infected with COVID-19 in particular geographies affects where we can (or should) go.

From a business perspective, we eagerly watch passenger-traffic figures, the percentage of fleets that are flying and flight hours to monitor the commercial aviation industry's recovery.

This numbers game can feel like a roller coaster, except the downward part is more scary than hands-up-in-the-air thrilling.

For instance, recently Alexandre de Juniac, director general and CEO of the International Air Transport Association (IATA), said: "August's disastrous traffic performance puts a cap on the industry's worst-ever summer season. International demand recovery is virtually nonexistent, and domestic markets in Australia and Japan actually regressed in the face of new outbreaks and travel restrictions. A few months ago, we thought that a full-year fall in demand of -63% compared to 2019 was as bad as it could get. With the dismal peak summer travel period behind us, we have revised our expectations downward to -66%."

There is nothing pollyannish about this statement from the airline association. However, this is for total traffic—and we know that domestic markets are recovering faster than international passenger traffic.

While the MRO market is hardly flourishing, some momentum is starting to build. For instance:

- Cargo ton-kilometers were down 12.6% in August year-over-year due to capacity constraints caused by parked passenger aircraft, but IATA says daily widebody freighter utilization is about 11 hr. per day, the highest since that figure has been tracked. For MROs servicing widebody freighters, this is a bit of good news.



*The ebb and flow of parked aircraft is starting to change.*

- Airlines are making decisions about their future fleets. Australia's Regional Express Holdings (Rex) will lease six Boeing 737-800s to begin U.S. East Coast routes in March. Alaska Airlines is accelerating the retirement of 10 Airbus A320s, as it appears to be seriously considering moving to an all-Boeing fleet. Avianca resumed flying in September after a five-month stop and is focusing on Airbus A320s for domestic and Boeing 787s for international flights. Delta Air Lines is launching the Airbus A220-300 in November and will retire its 717s, 767-300s and Bombardier CRJ-200s by 2025.

- Carriers such as Air Seychelles, Qatar and United Airlines are resuming some international routes.

- The ebb and flow of parked aircraft is starting to change. Ascent Aviation Services is seeing almost an equal number of aircraft returning to service as are coming in to be parked. It also is beginning to see increased demand for teardowns. AerSale purchased 24 757-200s and their Rolls-Royce RB211-535 engines for conversion to cargo aircraft as well as for teardown for spares.

- On the engine side, MTU is seeing a change to newer configurations of engines, such as the V2500 Select, and a "stronger connection of asset management and smart MRO to reduce cost for owners, as well as change from a long-term strategic to a short-term tactical investment behavior," says Andrea Luebke, managing director.

Watching the fluctuating daily and monthly numbers really is short-term tactical behavior, and that is necessary right now. ☺

—Lee Ann Shay

MAIN IMAGE: COVIPOBBA/GETTY IMAGES  
INSET IMAGES (TOP TO BOTTOM): SR TECHNICS, TESTIA, LUFTHANSA TECHNIK, LIBRESTREAM

## Highlights

### FAA and Foreign Regulators Are Aligning on 737 MAX Changes

Calls from foreign regulators to expand Boeing 737 MAX updates beyond what the FAA has proposed in a draft rule will be heeded, FAA Administrator Steve Dickson suggested Sept. 30, signaling that further changes are in the works after the model's return to service.

"There is very little daylight between the authorities," Dickson said, following a 2-hr. flight on a 737-7 test aircraft that had the former 737 pilot in the captain's seat. "I anticipate that we will be aligned."

His comments come on the heels of an announcement by his counterpart at the European Union Aviation Safety Agency (EASA), Director General Patrick Ky, that EASA secured a commitment from Boeing to add a third angle-of-attack (AOA) data source to the MAX. Ky said the change, a synthetic AOA sensor that calculates AOA using other parameters, would be added in phases.

In the interim, Boeing and EASA agreed to operational provisions that address and mitigate a malfunction of one of the MAX's two physical AOA vanes—the issue that started both fatal MAX accident sequences and led to the model's ongoing grounding.

Dickson said the FAA's top priority, and the draft rule's aim, is to address issues central to the MAX accidents, including revamping both the flight control computer software and pilot training. Changes to the software, and the Maneuvering Characteristics Augmentation System (MCAS) flight control law specifically, are designed to minimize the risk of a single AOA failure causing a cascade of issues that confuses pilots. EASA wanted a third AOA source, however, and pressed both the FAA and Boeing on the issue.

Declining to address the synthetic AOA issue specifically, Dickson said the FAA's "continued operational safety" process for in-service safety improvements, which includes issuing airworthiness directives based on service bulletins, will come into play on the MAX. Developing a procedure to address a nuisance stick-shaker stall warning—another issue EASA is pushing for—may also come following the return-to-service approval.

### Service Return Forecast for Stored Aircraft

About half of the aircraft stored in the early stages of the pandemic are expected to return to service by 2023, according to Aviation Week's 2021 Commercial Aviation Fleet & MRO Forecast. The majority are predicted to return by the end of 2021—with widebody aircraft seeing the slowest reentry into service. ☁

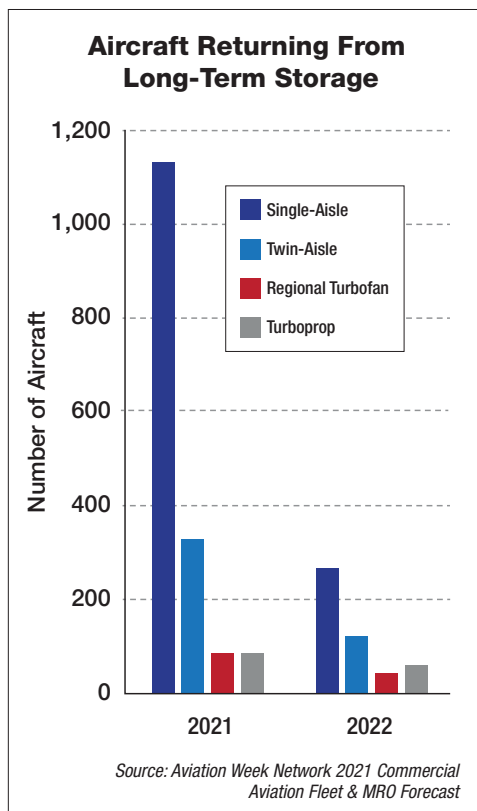

## Contracts

**Aeronautical Engineers** was selected to convert a fourth Boeing 737-800 to a freighter for **Aviation Holdings III Investments**; **HAECO Xiamen** will perform modification work in China starting in January 2021.

**eCube Solutions** of the UK was selected by **Carlyle Aviation Partners** to part out an ex-Brussels Airlines Airbus A319-100.

**Liebherr-Aerospace** won a contract with **Austral Lineas Aereas** to perform Embraer 190 landing gear overhauls out of its facility in Saline, Michigan.

**Lufthansa Technik Shenzhen** secured a long-term total component support contract from **China Aviation Supplies (Casc)** to support more than 40 Airbus A320s operated by Qingdao Airlines. The companies also plan further collaboration in aviation material support.

**RHE Southern** of the UK won a two-year **Marshall Aerospace and Defence Group** contract to support its aircraft jacking and lifting requirements.

**Sanad** won a \$272 million **Pratt & Whitney** contract to provide V2500 maintenance/overhauls at Abu Dhabi.

**ST Engineering**, through its ST Engineering Aerospace America and EFW subsidiaries, received a letter of intent from **Global Crossing Airlines (GlobalX)** to convert five Airbus A321s to freighters starting in the second half of 2021.

**Thales/ACSS** was selected by **China Eastern Airlines** to equip its fleet of 203 Boeing 737s with NXT-800 DO-260B-compliant transponders (utilizing Boeing's service bulletin for certified inter-mix retrofit) to meet the CAAC's ADS-B Out mandate due by the end of 2022.

Contract Source: SpeedNews





GO BEYOND

## ENGINEWISE

# TOMORROW'S MAINTENANCE SOLUTIONS. AVAILABLE TO YOU TODAY.

**ADVANCING THE PERFORMANCE, RELIABILITY AND HEALTH OF YOUR ENGINES.**

Pratt & Whitney's complete EngineWise® service platform combines predictive technologies, tailored solutions and shared expertise to deliver unprecedented levels of support to your fleet. Reducing your costs and providing greater insights – it's how we help you operate your engines worry-free.

EXPLORE OUR DIGITAL SOLUTIONS AT [ENGINEWISE.COM](https://www.pw.com/enginewise)

## New GP2700 Inspections?

Conclusions from the persistent investigation of an Engine Alliance GP7200 engine failure found that maintenance actions played no role in the accident chain, but the probe could lead to new engine-inspection protocols as part of an effort to mitigate risks uncovered by investigators.

French accident investigation bureau BEA released its final report on Air France Flight 66 (AF66) nearly three years to the day after the accident took place on Sept. 30, 2017. The probe con-

cluded that a crack started in a specific area, called a macro zone, introduced during forging of the fan hub. The crack formed 1,850 cycles into the part's 15,000-cycle life and expanded over the next 1,650 due to dwell fatigue until the part failed. The failure left only a small part of the fan hub attached to the Airbus A380's No. 4 engine, offering investigators a key early clue.

Macro zones, or micro-texture regions, are common in forged titanium parts. Unlike the rest of the part, these zones are anisotropic, meaning they do not have the same physical properties in all directions. This makes them ideal spots for cracks to start under certain conditions.



Investigators spent months searching remote areas of Greenland for the evidence they needed to understand why a GP2700 hub broke apart.

cluded that a crack started in a specific area, called a macro zone, introduced during forging of the fan hub. The crack formed 1,850 cycles into the part's 15,000-cycle life and expanded over the next 1,650 due to dwell fatigue until the part failed. The failure left only a small part of the fan hub attached to the Airbus A380's No. 4 engine, offering investigators a key early clue.

Macro zones cannot be detected via nondestructive inspections, but treatments during the forging process reduce their size and, in theory, their risk. Larger parts usually include larger macro zones.

Dwell fatigue, which caused several premature fan disk failures in the early

1970s, is well understood as a product of a material's response to constant stress. However, up until AF66, there was no evidence dwell fatigue presented risks to parts like the GP7200 made from titanium alloy Ti-6-4, due to the material's properties.

Because of this and factors linked to how GP7200 blades are maintained, investigators—working hand-in-hand with Engine Alliance joint-venture partners GE Aviation and Pratt & Whitney—assumed a maintenance

issue was the most logical explanation for why the hub broke apart. But the BEA wanted to be sure, and the only way to confirm the theory was to inspect the failed parts. AF66's circumstances made the always-challenging task of evidence recovery especially daunting. The Airbus A380 was flying over Greenland at Flight Level 370, en route from Paris to Los Angeles, when the No. 4 engine failed. Debris, including pieces of the failed engine's fan hub, were soon scattered over the snow-covered ground below. The crew diverted to Goose Bay, Canada, and landed without incident.

It took investigators three separate search phases over 21 months using myriad techniques, including an experimental radar technology that detected key parts buried beneath snow and ice, to find the parts they needed. In the interim, however, investigators focused on maintenance as the most likely explanation for what started the process that led to the hub fracturing.

Simulations by Engine Alliance showed that a certain amount of damage in a high-stress area on the hub could produce the type of failure the Air France engine experienced. GP7200 operators faced a series of visual and eddy-current inspection mandates targeting the most likely area of concern—the front surface of parts that could be damaged by tools or other maintenance actions.

The inspections found damage to more than 20 hubs, and early findings further supported the maintenance-damage theory. “The size of the surface damage required for a crack to initiate and propagate to failure, in a number of cycles comparable to [the engine that failed] was of the same order of magnitude as certain damage observed during these post-accident inspections,” the BEA's final report notes.

Guided in part by the findings, Engine Alliance experts identified a particular maintenance procedure that—if done incorrectly—could lead to damage and, under the right circumstances, a fan hub failure. The manufacturer redesigned a key part, a blade lock ring, involved in the procedure.

Despite findings mapping possible failure scenarios, investigators needed evidence that linked maintenance actions to the Air France engine failure. In July 2019, they found the evidence they needed but were surprised at what it proved.

Examination of the hub fragment recovered showed evidence of a low-cycle fatigue crack that originated within the part. It was 5.6 in. behind the front hub face and 0.055 in. below the part's surface. No maintenance-related damage was found, nor were there any manufacturing or material-quality anomalies.

“The fragment was analyzed and revealed that the failure, which originated in a macro zone in the subsurface of a blade slot bottom, occurred due to a cold dwell fatigue phenomenon,” the BEA report says. “At the time of the part design and engine certification, it was accepted by the scientific community, the industry and the certification authorities that Ti-6-4 was not sensitive to the cold dwell fatigue phenomenon.”

The BEA's findings prompted it to recommend that the European Union



Aviation Safety Agency (EASA) and the FAA review manufacturing of “rotor-grade critical parts” made out of Ti-6-4 and certain other titanium alloys so that risks presented by macro zones can be better understood.

“The tendency to increase the size of engine fans to reduce engine fuel

consumption may lead engine designers to try and substantiate higher acceptable stress levels, to limit the weight of these engines,” the BEA says. “This may lead to an increase in the risk of a cold dwell fatigue incipient crack in a macro zone.”

In-service engines also need attention.

“EASA and the FAA will subsequently make sure, where appropriate, that an adapted in-service inspection program is implemented to detect possible incipient cracks which might lead to the failure of the part,” the BEA says. ☛

—Sean Broderick

## Evacuation Data

The FAA plans to begin collecting data on emergency evacuations and scrutinizing manufacturers’ data more carefully to ensure its certification standards are sufficient, but work on seat pitch is not likely to lead to major changes. It also is pushing back on an audit report’s suggestion that one part of its requirements—the 90-sec. evacuation demonstration—needs overhauling.

“Stakeholders have raised concerns about the validity of the assumptions that drive FAA’s evacuation standards and industry tests and simulations for certifying new aircraft,” a Transportation Department Inspector General (IG) report made public in September says. Lawmakers asked the IG to review the FAA’s standards, particularly in light of changes in recent years. Among them: reports of passengers pausing during evacuations to retrieve carry-on bags, shrinking seat pitches, larger passengers and more emotional-support animals flying.

The FAA introduced a 90-sec. evacuation demonstration requirement in 1967. It has been updated five times since, but only after accidents and only once in the last two decades.

Critics contend that the lack of real-world parameters used in the tests, such as the participants’ demographics and the FAA’s acceptance of modeling data in lieu of real tests, limits their usefulness. The IG also says the agency should be using data collected from sources other than accidents to update the requirements.

“FAA largely updates its evacuation standards only after accidents, and its last update that was based on an accident occurred in 1991,” the IG says. “FAA also has not conducted sufficient

research on passenger behaviors and seat dimensions to determine how they affect evacuation standards.”

The agency countered that timely evacuations are only one factor in accident survivability. Other parameters, such as flammability standards, have continued to evolve, contributing to improved safety standards and lower fatalities in all accident scenarios, it contends.

“The 90-sec. evacuation standard does not represent all accidents, because many variables are present in real-world evacuations, and accident scenarios vary widely,” the FAA told the IG in a response to the report. “Numerous requirements apply to evacuation, including addressing occupant protection, prolonging the time for egress and enabling faster egress. The report is largely silent on these requirements and focuses only on what is addressed in the full-scale evacuation demonstration. Thus, the draft report creates the impression that the full-scale demonstration is the most important component; however, that conclusion is not consistent with a systems approach to the evaluation of evacuation requirements.”

The FAA has begun a seat-pitch study in response to a 2018 congressional mandate that wants the agency to mandate minimum pitch, length and width. But the agency says such

rules are not required because of other regulations, notably FAR Part 25.562, related to evacuation standards. Among them is a requirement that there must be at least 9 in. between the front of one seat and the nearest point on the back of the next seat. Seat bottoms have measured 18 in. front-to-back since the 1980s, the agency adds. Combining the two factors creates 27 in. of space.

An Emergency Evacuation Standards Aviation Rulemaking Committee (ARC) of industry experts has completed a report on evacuation requirements, actual evacuations and seat-pitch testing. The FAA is reviewing the report.



The FAA is collecting data on evacuation safety but is not expected to order changes to seat spacing.

JOEPRIEAVIATION.NET

The agency has no plans to study carry-on baggage retrieval or the ramifications of emotional-support animals on evacuations.

The IG recommends that the FAA start collecting evacuation data as well as analyzing information supplied by manufacturers to ensure it is “accurate and up-to-date.” The FAA says it plans to implement both recommendations by the end of 2021. ☛

—Sean Broderick

## ARSA UPDATE

# Fools Rush In

“NEWLY FORMED OR PROMINENT”—the Merriam-Webster Dictionary definition of “emerging” provides the common pairings with adjectives such as “nations,” “artists,” “markets” and, of course, “technology.”

In aviation, “newly formed” ideas and technologies emerge for a long time. From additive manufacturing and unmanned aircraft systems to remote connectivity and supersonic transport—which was “emerging” when my father graduated from engineering school—years are spent groping around to explore the details while other industries use those same ideas and technologies much sooner.

Taking the time to study, review, pilot and implement regulatory and business regimes surrounding new technologies provides the feeling of enhanced safety. It seems prudent to slow down the pace of change for the sake of system management, but the result is becoming reactionary rather than proactive. Government agencies dither over how to accommodate new production methods or inspection pro-

cedures even when such accommodation is unnecessary.

The association has a long list of “emerging” technology-related frustrations. Our team has called out hand-wringing over 3D printing, use of virtual inspection technology and electronic recordkeeping. We have joked about agency struggles with online versions of previously in-person events and used pandemic-response demands to advance stalled efforts to align guidance with the rules.

From this regulatory focus comes optimism. Digging deeper into Webster’s definitions, “emerge” also gives us: “Come into being through evolution.” Perhaps the industry’s sluggish response is not evidence of obstinacy—perhaps it’s not *entirely* evidence of it—but instead the result of an ongoing use and refinement of resources. ARSA’s commitment to performance-based rules serves this long-term evolution.

A performance-based rule measures compliance based on outcomes rather than process alone. ARSA’s favorite example is in 14 CFR §43.13(b), which requires maintenance providers to return products or articles “at least equal to [their] original or properly altered condition” with regard to qualities af-

fecting airworthiness. While the section does cover acceptability of methods, techniques and practices as well as tools, equipment and test apparatus, it does not proscribe or limit other methods or equipment out of hand.

A focus on outcomes affords the flexibility that moves “emerging” to “emerged.” Whether technicians collaborate in person or over a mobile device while reviewing print paperwork or scrolling a tablet, the standard of performance for their work is unaffected. Although we often get caught up in the details getting to “original or properly altered,” that’s a human factors failure, not a regulatory one.

ARSA will continue to press for performance-based rules and adhere to the basic principle that what’s not prohibited is allowed. In aviation, fools don’t rush in . . . they hide behind the purported limitations of the rules. ☛

*Brett Levanto is vice president of operations at Obadal, Filler, MacLeod & Klein, managing firm and client communications in conjunction with regulatory and legislative policy initiatives. He provides strategic and logistical support for the Aeronautical Repair Station Association.*

# SpeedNews<sup>7</sup>

## Reliable News, Concise Format

SpeedNews is the source for relevant insights, news and information powering commercial aviation. Sent electronically, top executives rely on its unique, quick-read format to:

- Monitor your competition.
- Uncover new business opportunities.
- Connect and network with industry leaders.

Learn More at  
[aviationweek.com/speednews](http://aviationweek.com/speednews)



AVIATION WEEK  
NETWORK



# Malaysia Airlines

*Having successfully resumed third-party MRO services in 2019, the COVID-19 pandemic has posed unprecedented challenges for Malaysia Airlines. A representative from the airline explains how the carrier is using technology to meet demands across the supply chain and for its day-to-day operations.*

## Which tools has Malaysia used to help it gain greater visibility into its after-market operation?

Successfully implemented in March 2019, MAB Engineering has been using AMOS, MRO software designed for the airline's engineering department as part of its ongoing transformation that serves as its maintenance information system. It also uses Skywise as its big data analytic platform. With AMOS, the airline ensures the airworthiness, operational and financial control at an enhanced level with the longer-term objective of benefiting from process and organizational efficiencies. The system manages end-to-end processes within engineering, enabling the airline's engineering department to better manage costs and increase efficiency in maintenance.

## How have these tools helped you gain greater visibility of the business and the wider supply chain?

The AMOS software can provide real-time airworthiness information and requirements, which is crucial for our operations, while Skywise provides statistics of past consumption, giving us the ability to estimate the reordering level for future needs.

## How do you manage MRO spending effectively?

Due to volatility in the market, compounded by the COVID-19 crisis, we have been adopting lean and agile cost



Malaysia Airlines has modernized its widebody fleet with new arrivals including the Airbus A350.

AIRBUS

structures to ensure cost efficiency. We continuously pursue operational improvements to optimize cost efficiency across the board by simplifying and digitizing processes. We are also capitalizing on big data analytics output and are driving for greater automation and efficiency through digitization to find solutions to bring our cost structure down without impacting safety, quality and customer experience. We are focusing on preserving liquidity and investing in safety and maintenance projects. We took advantage of the aircraft grounding period to use available resources and ground time productively to refurbish our cabins in supporting the airline's Fly Confidently campaign, repainting our livery and performing modifications to increase aircraft efficiency. This is crucial to ensure that these aircraft are in immaculate condition once we are back in full service.

## How has using big data aided both your decision-making as a maintenance provider and your operational management of the airline?

We are currently using our big data of historical consumption to predict future ordering requirements. At the same time, we are embarking on proactive maintenance, using the analytic platform to analyze recurring aircraft defects and current aircraft sensor output to predict impending failures

## Malaysia Airlines Fact File

**HISTORY:** Founded in 1947 as Malaysia Airways, it became Malaysia-Singapore Airlines after the separation with Singapore. Eventually, it was renamed Malaysian Airline System before becoming Malaysia Airlines.

**FLEET:** The carrier has 81 aircraft, comprising of 48 narrowbodies made up of Boeing 737-family aircraft and 33 widebodies, including Airbus A330, A350 and A380 aircraft. Nearly half its fleet was sent into long-term storage in the wake of the novel coronavirus outbreak.

**MAINTENANCE:** Having ceased offering third-party MRO services in 2015, the airline returned to external customer work last year. Its partnerships include a landing gear repair service in conjunction with Revima, available to third-party customers. The maintenance and engineering division employs nearly 2,000 staff across Malaysia.

**HANGARS:** The airline's main two hangars in Kuala Lumpur service about 70% of the Malaysia Airlines fleet, with the other 30% dedicated to third-party customers in the Asia-Pacific region. 📍

of aircraft systems. These have certainly increased our operational efficiency and improved technical dispatch reliability.

## **Where do you source your parts from, and what are some of the challenges related to this?**

The majority of parts are secured through contract. We have a power-by-the-hour (PBH) contract that ensures availability of parts under Recommended Spare Parts List (RSPL) Essentiality (ESS). Additionally, we have consignment stock based on operational consumption at lower costs than on an ad hoc basis, thus improving the efficiency of working capital tied to inventory holding. Other than for contracted parts, the main supplier for our maintenance business are the OEMs themselves. The major challenges are to optimize the inventory levels and minimize the lead time. Many airlines have moved to asset-light operation. In achieving this, accurate parts-consumption prediction is required.

## **Going forward, which areas do you feel are ripe for further improvement in the Malaysia supply chain?**

First, we have an internal supply chain including our own MRO that is capable to repair and overhaul aircraft and components. Second, strengthening our internal supply chain will further improve our cost structure. This is an integral part of the MAB MRO strategy as well. Recently, we signed a memorandum of understanding with Piedmont Propeller System to support Malaysia and regional ATR propeller repair. We have the infrastructure ready and skillset to further improve our MRO and supply chain.

## **Will COVID-19 have an impact on the way in which this is managed, or on any other parts of your maintenance operation?**

COVID-19 has impacted the whole world, and the aviation sector is among the worst-affected industries. While the number of flights was significantly reduced, we took the opportunity to increase maintenance activities



**Malaysia conducts its maintenance from Kuala Lumpur.**

ADRIAN SCHOFIELD/AW&ST

during downtime. We positioned our maintenance under active parking, a flight-ready condition where we have lower return-to-service costs and higher safety due to frequent maintenance. We keep the cost down by using our internal supply chain and consuming our existing inventory.

The longer you park an aircraft, the more you need to do to keep it in good shape and return it to flying condition. The aircraft needs to be kept in a condition that enables quick resumption of operations. In this case, the parking procedure is applicable so that the number of tasks needed to prepare the aircraft for flight operations is minimized. It must be noted that aircraft with only parking procedures applied still require several recurring maintenance actions to ensure that the aircraft remains in a “ready-for-flight” condition.

Our engineers are working around the clock maintaining the grounded fleet, a process that includes running engines and powering-up aircraft, checking flight controls, and covering sensors and engines to protect inner workings from insects and dust.

## **Where do you stand on blockchain, and do you believe it could give greater visibility across your operation in the future?**

Blockchain is still nascent in aircraft MRO. There is currently no law that regulates blockchain in Malaysia, including the aviation industry. Blockchain verification requires exchanging information between members, and this would raise issues of trust and confidentiality. Blockchain can be used for tracing aircraft parts in use and their status and condition, and this will help in ensuring on-time-performance. We see this as the future and will evaluate this technology application for MAB.

## **In the future, how do you think MROs like yours will manage your supply chain differently from today? Will it be more technology-driven?**

We are always looking for improvements in supply chain management through development of technology, since the industry is also heavily driven by its evolution. Our challenge would always be on the implementation of new technology to suit our business needs consistent with the latest technology development available. Currently, we are in the process of developing process automation and using AI to improve efficiency with the tools that we are using. We foresee that supply chain management will be more technology-driven, with progressive staff upskills needed more than ever. ☺





We Innovate For Those Who Move The World™.

# Always reaching higher

Every day, aircrews and passengers depend on our flight critical systems. We bring four decades of experience in designing highly reliable and efficient systems that operate in the harshest environments.

[boesystems-ps.com](http://boesystems-ps.com)

# Snapshot of European MRO COVID-19 Adjustments

New services and technologies as well as layoffs, spinoffs and buyouts are dominating the landscape

James Pozzi London

## UK

Flybe collapses, citing COVID-19 as a factor, and its maintenance hangar in Exeter is eventually acquired by Dublin Aerospace.

Job losses begin to affect UK-based MRO, with Rolls-Royce and British Airways' engineering division announcing staff cuts.

British company Aircraft Interior Recycling Association (AIRA) merges with North Carolina-based North American Aerospace Industries (NAAI) in September.

## IRELAND

SR Technics offloads the inventory-optimization software specialist Armac Systems as part of a management buyout.

Lufthansa Technik opens a new engine mobile shop in Dublin.

## FRANCE

In response to the COVID-19-induced traffic decline, Airbus backs out of its MRO joint venture with Thai Airways at U-Tapao Airport.

Due to unprecedented aircraft storage demand, Tarmac Aerosave starts expanding sites in Tarbes and Turuel, while adding a fourth location at Paris-Vatry Airport in the summer of 2020.

## SPAIN

## SPAIN

Iberia Maintenance uses the initial downturn in shop visits to focus on services for its cargo flights.

## SWITZERLAND

As part of efforts to reshape its business to focus on engine services, SR Technics offloads its design engineering division to GroWING.aero, while launching a new quick-turn engine MRO service.

## ITALY

MROs offer new services to compensate for the loss of scheduled airline maintenance work. Atitech turns to storage services, while the MRO unit of Alitalia focuses on heavy maintenance work for its in-house aircraft fleet in the absence of third-party work.

Pratt & Whitney appoints a new designated maintenance facility in Foggia to provide line maintenance for its PT6B, PT6C, PT6T, PW200 and PW210 engines.

## NORWAY

Aero Norway joins the growing number of engine MRO specialists using remote table inspections.

## DENMARK

Airbus Canada transfers the overall Airbus A220 material management services to Copenhagen-headquartered Satair in September.

## NETHERLANDS

Twente Airport moves ahead with plans to build an MRO hub.

## SWEDEN

Taby Air Maintenance welcomes its first ATR72 into workshops at Orebro Airport in June.

## FINLAND

The engine division of GA Telesis opens a new aircraft engine hospital shop in Helsinki to service demand for minor repairs, test cell runs and end-of-lease inspections.

## ESTONIA

Magnetic MRO completes its first virtual aircraft inspection in the summer of 2020 as a result of COVID-19. Having relocated from the UK earlier this year, MAC Interiors is approved by Airbus to make interior elements for its aircraft.

## POLAND

Despite the pandemic, LOT Aircraft Maintenance Services presses ahead with plans to construct a new maintenance base at Rzeszow-Jasionka Airport.

## ROMANIA

Aerostar opens a new 90,000-ft.<sup>2</sup> facility in Iasi for Boeing 737 and Airbus A320 aircraft.

## GERMANY

Lufthansa CEO Carsten Spohr says the airline group will resist selling off key assets such as its Lufthansa Technik division as it looks to adjust long-term after the virus.

Lufthansa Technik and MTU Maintenance resort to several cost-saving initiatives such as reducing staff work hours to offset the effects of the COVID-19 crisis.

Bombardier buys out its former partners to take control of Berlin-based Lufthansa Bombardier Aviation Services.

MAP: OLGA TURKAS/GETTY IMAGES. ICONS: SHUTTERSTOCK





# SES Fly Certain

We're the people  
to keep you flying

Shannon Engine Support has the world's largest leasing portfolio of CFM56 and LEAP engines strategically located across the globe. Short or long-term leases, our tailored solutions are created by people with unrivalled knowledge and expertise, who understand your business and the strength of partnership. In challenging times, that's good to know.

SES. A CFM International company.

[www.ses.ie](http://www.ses.ie)

*Julie Dickerson*

Julie Dickerson  
Chief Executive Officer

**SES** Fly Certain

# MROs Adapt to Pandemic Challenges by Going Virtual

Aftermarket companies are adapting technology to meet their needs during the COVID-19 pandemic

Lindsay Bjerregaard **Chicago**

**T**he world has become accustomed to conducting business in a virtual environment due to the COVID-19 pandemic; but for the MRO industry—which requires manual work in a shop or hangar—the situation has posed extra challenges. Technicians still need to stay socially distant, and international travel restrictions have placed heavy limitations on the ability of experts or inspectors to travel to customer sites.

Prior to the pandemic, many airlines and MROs were beginning to test or adopt emerging technologies such as paperless software, wearables and automated aircraft inspections, but change was happening slowly. However, pandemic constraints have forced the industry to embrace new technologies and accelerate their adoption as a way to keep business running.

## REMOTE INSPECTIONS

According to Peter Troman, service integration manager at Rolls-Royce, the pandemic has accelerated projects within the engine OEM's portfolio and brought about new ideas for how to use its existing digital capabilities. One digital collaboration tool that was already in its toolbox pre-pandemic was Librestream Onsite Connect, which enables workers in the field to securely share live videos and images with remote experts across mobile and Wi-Fi networks.

“Pre-pandemic we were using this tool, but it was very much in a sort of break-the-glass situation where people in the field needed additional support on a fairly ad hoc basis,” says Troman. “Once lockdown happened, we could no longer travel to support our customers, and we were at the point of a number of our customers going AOG [aircraft on ground] because we couldn't fly in inspectors to perform specialist Trent 1000 inspections.”

Now, Rolls-Royce is using Librestream to train airline engineers to remotely carry out complex tasks such as checking the condition of Trent 1000 IP compressor blades. Using the technology, trainers are able to demonstrate the task before trainees perform it themselves, sharing images from a borescope and an oscilloscope screen to confirm that the probe is in the right place and that the equipment is being used correctly.

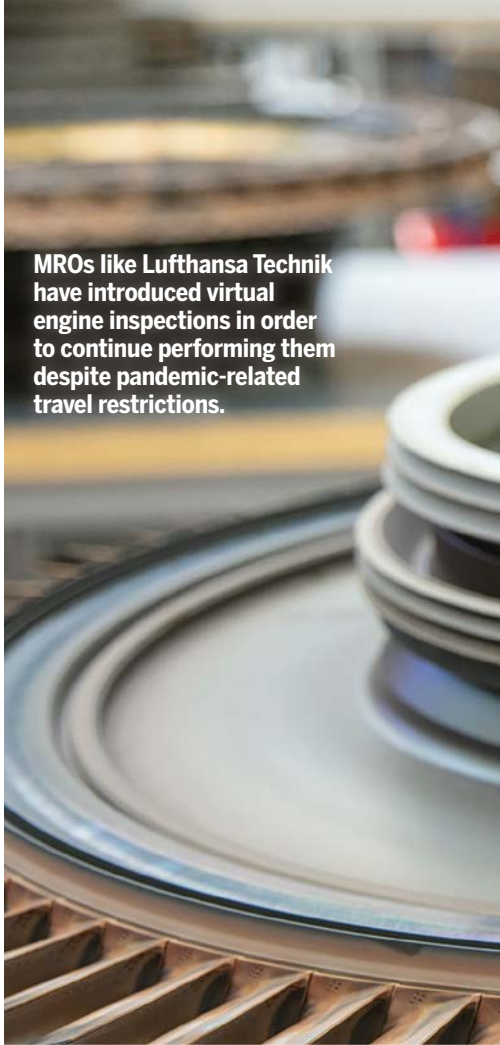

MROs like Lufthansa Technik have introduced virtual engine inspections in order to continue performing them despite pandemic-related travel restrictions.

Troman says the practice has already averted a number of AOG incidents and saved customers “a considerable amount of time and money,” such as a situation with Air China that he notes was the catalyst for offering this remote training in the first place. The airline had seven engines that needed to be inspected and was planning to remove them and physically truck them 1,300 mi. to Hong Kong, where the nearest inspectors were located. “This would have been a huge disruption to the airline and very expensive and time-consuming. The use of Librestream definitely helped Air China to avoid that,” says Troman.

Like Rolls-Royce, AAR had already invested in Librestream's augmented reality platform alongside RealWear HMT-1 headsets to test out whether the technology could improve efficiencies. Brian Sartain, senior vice president for repair and engineering





LUFTHANSA TECHNIK

services at AAR, says the remote-collaboration capabilities of both technologies have now been adopted as a way to effectively social distance.

“We’ve done some testing with that same wearable technology to limit the amount of time a person—let’s say an engineer who might be working from home—has to actually come onto the floor and into a facility,” he says. “A hangar being an essential workplace and the way that the work is done there, a majority of the employees are still coming to work, but [for] those who can’t or have special conditions, we’re encouraging them to stay home and then we can use all of the technology that we have available to us.”

In addition to using the technology for in-house collaboration, AAR is leveraging the technology for conducting audits with the FAA. “The FAA is telling us what they want to audit and what they want to look at, and we’re actually

taking them through a virtual audit so they don’t have to come on-site,” he says.

The use of remote video for regulatory inspections and audits is also being leveraged at MRO Holdings, which earlier this year used a video conferencing system on a mobile device to facilitate a walk-through of an entire repair station to gain regulatory approval for a facility expansion. Gregg Brown, vice president of compliance and technical solutions at MRO Holdings, says the technology functioned as the “eyes and ears for the inspector” during a walk-through of the facility, enabling them to see everything they would normally inspect and to receive even more digital evidence than would normally have been obtained.

“It allowed for a timely approval for the facility to be in use immediately afterwards,” says Brown. “From a timing perspective it had the potential, for a capex-intensive project, to sit idle for

months—if not longer. But instead, it’s now already being used as it was intended, so it was a great outcome.”

Magnetic MRO, which introduced virtual inspections this year in response to the pandemic, says feedback from customers has been positive, particularly since the technology has enabled work to be performed in less time and with lower costs during the crisis. Tonno Toompuu, engineering manager at Magnetic MRO, says demand is only increasing for inspection services due to more frequent fleet changes. However, some in the industry still lean toward traditional methods.

“In some cases, physical on-site inspections are still the preferred way to go and virtual inspections are considered as a last resort. However, in my opinion, virtual inspections can absolutely be part of the aviation world’s future,” says Toompuu. “It should not be considered as a substitute for the

physical inspections we are accustomed to, rather as an additional option and tool in supporting the industry's ever-changing needs and challenges. Certain inspections, like prepurchase inspections, for example, could move into the virtual realm."

**AUTOMATED INSPECTION DATA**

Prior to the pandemic, AAR was testing the use of Donecle drones for making visual inspections of aircraft more efficient. The drones can take between 1,500-1,900 pictures per narrowbody aircraft, which can be sent to FAA inspectors as part of the certification process for the technology.

Josselin Bequet, CEO and co-founder of Donecle, says this remote data sharing with external parties is a benefit that has become extremely advantageous during the pandemic. "MROs or airlines, during a routine inspection, have to send a finding to OEMs, and usually it's a paper report with some images attached. It's fairly cumbersome and not always time-efficient," he says. "The ability to very easily produce a digital report from the drone inspection enables them to be much more efficient in that regard."

Bequet says the functionality is also beneficial for aircraft handovers or transitions, since airlines or operators would typically need to send a consultant on-site to inspect the aircraft. "Obviously in recent months this hasn't been possible, and most operators have been limited in terms of crew they can send, when it can send them and where they can send them," he says. "So the ability to have a facility scan the aircraft and then send a full 3D digital picture of that aircraft at a given moment in time [has] really enabled them to speed up that process."

Nondestructive testing (NDT) specialist IMITec GmbH, which has been developing a remote-controlled aircraft inspection device planned for market release this month, notes that travel restrictions highlight the benefits of this technology. "To travel abroad is very difficult, even for maintenance personnel like NDT inspectors," says Christian Duerager,

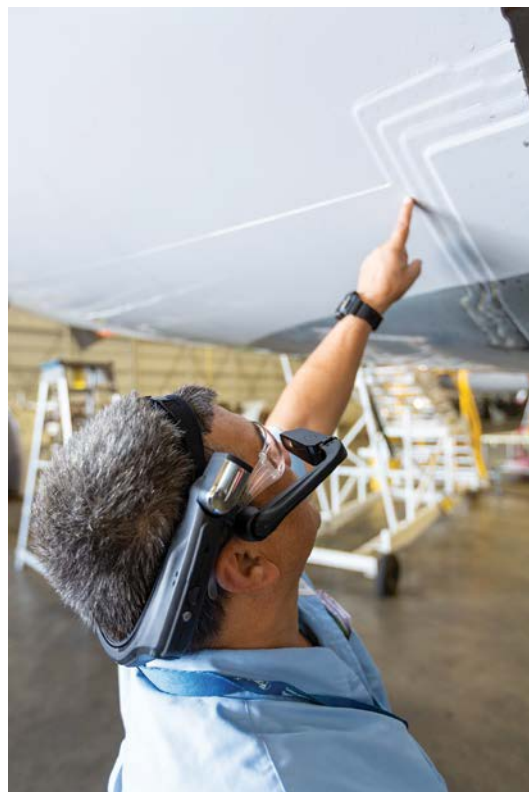

AAR

managing director at IMITec.

He says IMITec recently received a request from a European low-cost airline to demonstrate the device on one of their aircraft. Since the airline has no internal NDT capability, it had to contract this testing out and fly in an NDT inspector—which is not only costly but a major challenge due to COVID-19 travel restrictions. Duerager says the airline would currently have to allow for NDT inspectors quarantining for 10 days when entering and leaving the country. "That's an absolute nightmare for the airline," he adds, noting that a remote-inspection device that can be sent abroad would avoid this red tape.

**DIGITAL DATA TOOLS**

In addition to seeing more traction for automated aircraft inspection technologies during the pandemic, Bequet notes that he is seeing a push toward more digital MRO processes in general. "We're seeing a lot of interest from other operators, airlines and MROs who have sort of been forced to move forward because of the pandemic in terms of moving away from paperless processes [and] moving to things like digital signatures, digital

sign-off and people, inspectors or experts having to work remotely and provide their opinion on aircraft conditions [without] being on-site," he says.

Previously, notes Bequet, many airlines and MROs were still focused on keeping data

**AAR is using wearables and augmented reality to enable remote audits and ensure social distancing.**

hosted locally. "A lot of people out there are starting to move to cloud-based environments and other solutions to be able to share data more efficiently, especially when their employees aren't necessarily on-site or [are] in different locations," he says.

At Airbus, a growing number of customer fleet challenges during the pandemic have been the catalyst for introducing new capabilities to its Skywise data platform. "The COVID-19 crisis highlighted

the relevance of digital solutions to provide airlines with ever more efficient means to manage fleet performance in real time and in a tailored manner—helping airlines to make the most of their sometimes reduced or constrained resources," says Valerie Manning, senior vice president for customer support at Airbus.

The OEM introduced a new Parking Management App for Skywise, which Manning says enables customers to "administer their fleet in terms of aircraft location, maintenance needs and storage procedures by 'tagging' their grounded aircraft in Skywise" and virtually parking them in various locations at airports and stations, such as in hangars, at gates or on taxiways. "They can then quickly pull contextual data such as the aircraft's age, latest and next checks, last major assembly overhaul and more," she says.

To further help airlines make the most of aircraft downtime during the unprecedented situation, Airbus deployed additional capabilities for its Skywise Reliability offering for automating reliability reporting. It can help airlines identify and prioritize technical issues across their





**Airbus has delivered more than 65 synchronous distance learning courses this year in the wake of the pandemic.**

fleets, offering up the most relevant service bulletins and maintenance tasks that could be performed during aircraft downtime.

#### **VIRTUAL TRAINING**

Airbus is also leveraging digital technology to provide training to customers

during the pandemic. “Among our first actions was to organize webinars with customers worldwide to help them through some of the basic parking and storage procedures, provide [the] first work-alleviation recommendations and to take inputs and requests,” notes Manning. “We held dozens of webinars; in each session, between 100-150 customers were

connected, and their feedback was generally very positive.”

In the wake of travel restrictions, the OEM’s Training Services unit also set up and obtained European Union Aviation Safety Agency (EASA) approval for a synchronous distance learning solution for instructor-led

maintenance courses that normally take place in a classroom. The solution enabled customers to perform theoretical training locally, led by an Airbus instructor at a remote location. Its field service teams then acted as “training invigilators” to support on-site training examinations worldwide. By September, it had delivered more than 65 synchronous distance-learning courses to more than 546 mechanics, and Airbus says feedback has been very positive.

At 8tree, which provides 3D aircraft inspection tools, existing virtual demonstration processes have been adapted to onboard new customers and provide online training. What was previously a two-day, in-depth training class at a customer site has been transformed into a personalized online classroom for a small number of trainees. “I think there are always going to be a few bumps along the way as we adapt the curriculum and delivery of it, but so far feedback from customers

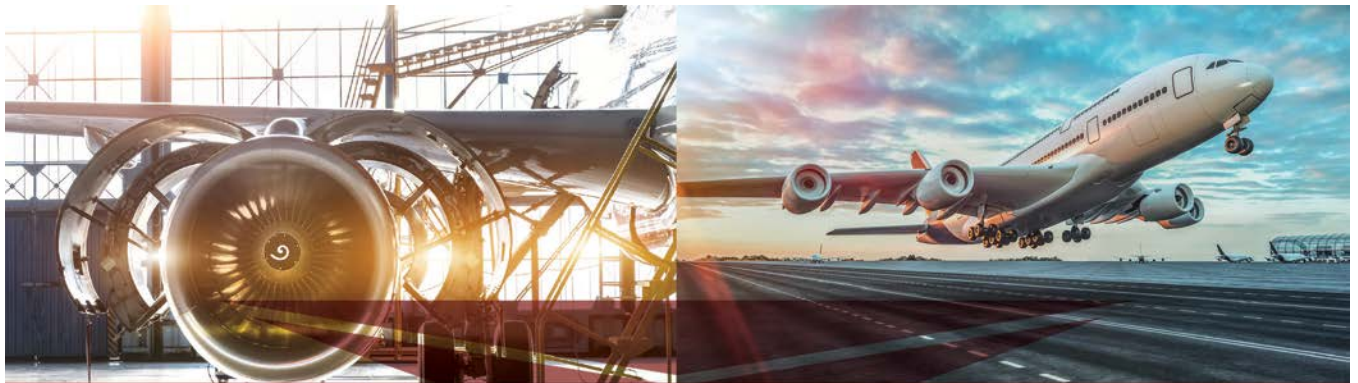

**Your partner in the aircraft lifecycle**



CustomerService@TriumphGroup.com  
AOG@TriumphGroup.com

US toll-free 1-822-FLY-WTGI  
Worldwide +1-817-804-9471

**TriumphGroup.com**

@TriumphGroup @triumphgroup Triumph Group

has been very positive and we feel very encouraged about that,” says Arun Chhabra, cofounder and CEO of 8tree. “Customers really sort of fall off their seats when they see that all of this can be done without the tool ever leaving them and without anyone coming on-site, and so to us that really is a big enabler to customer satisfaction.” Post-pandemic, Chhabra believes that this model “may pave the path to much more efficient customer interaction.”

Magnetic MRO recently received EASA Part 147 approval for online training, and it is now offering Airbus A320 and Boeing 737 type training online. “This was just a natural step in the current situation, as it provides the option to continue rather than postpone the education,” says Toompuu. “More and more people are expressing interest toward such training, so we are working on providing additional courses and new dates to accommodate growing demand.”



MAGNETIC MRO

Moving forward, Toompuu expects the pandemic to be a driver for the MRO industry’s acceptance and usage of new technology. “In prepandemic times, in some cases the industry was

running on ‘that’s how we always do it,’ but times like these require a new approach—and now this approach becomes not even the ‘new normal,’ but just ‘normal,’” he says.

At Rolls-Royce, which recently delivered its first remote training

**Magnetic MRO is capturing high-resolution videos and photos during virtual inspections that customers can access in the cloud.**

course to an overhaul shop on how to use specialist tooling to dress the leading edge of fan blades, the benefits of adapting technology are outweighing reluctance to embrace new ways of working. “I think we’ve seen a huge acceleration of the adoption of technology. What the pandemic has done is broken down those barriers,”

says Troman. “I just don’t think we’ll revert back to the old ways of working, and I’m already seeing requests from MROs and the customers on other tasks we can train remotely.”

# MROProspector<sup>7</sup>

## Navigate the Road to Recovery with Confidence

The only solution dedicated to commercial aftermarket professionals, MRO Prospector contains accurate and reliable MRO data and intelligence so you can find new opportunities.



Details on thousands of contracts covering 37,000 aircraft and 80,000 engines.



Discover maintenance opportunities, including component repairs by ATA Chapter.



Research operator’s fleets by tail number, including age, hours, cycles and lease status.

Visit [aviationweek.com/MROP](http://aviationweek.com/MROP) to schedule your demo.

Or call:  
Anne McMahon at +1 646 291 6353, or  
Thom Clayton +44 (0) 20 7017 6106





# Slow Progress

Electronic tech log adoption is still minimal, despite its benefits

Henry Canaday **Washington**

**W**ith maintenance staff increasingly connected both with each other and critical maintenance systems, it is logical to bring pilots into this productive digital loop. After all, cockpit crews need to know the problems and maintenance status of their aircraft, and they need to enter new defects and flight data essential for maintenance work and planning.

So why not replace the paper tech logs now used by most airlines with electronic technical logs (ETL), installed on the electronic flight bags most pilots carry?

ETLs have been and are being deployed, but it is happening slowly. Even though benefits are real and significant, implementation is a major effort, involving regulators, numerous airline staff and units, IT changes, communication requirements, training and change management. Yet veteran ETL providers see prospects for further adoption, and several new entrants validate their enthusiasm.

Here is a roundup of some ETLs on the market.

## ULTRAMAIN

MRO software-maker Ultramain's ETL is used by 10 airlines, including Cathay Pacific Airways, Japan Airlines, British Airways and Air New Zealand. Director of Business Development Jene Adams says other implementations are underway, and she is seeing solid market interest.

Adams cites ETL accuracy—as the tool enforces standardized fault codes better than paper—and universal and real-time access to the latest data as major benefits. “This results in fewer gate delays, fewer maintenance cancellations and fewer deferrals and no fault founds,” she says. Uniformly accurate data also should improve reliability analysis.

The Ultramain tool has been used for more than a decade, and the company

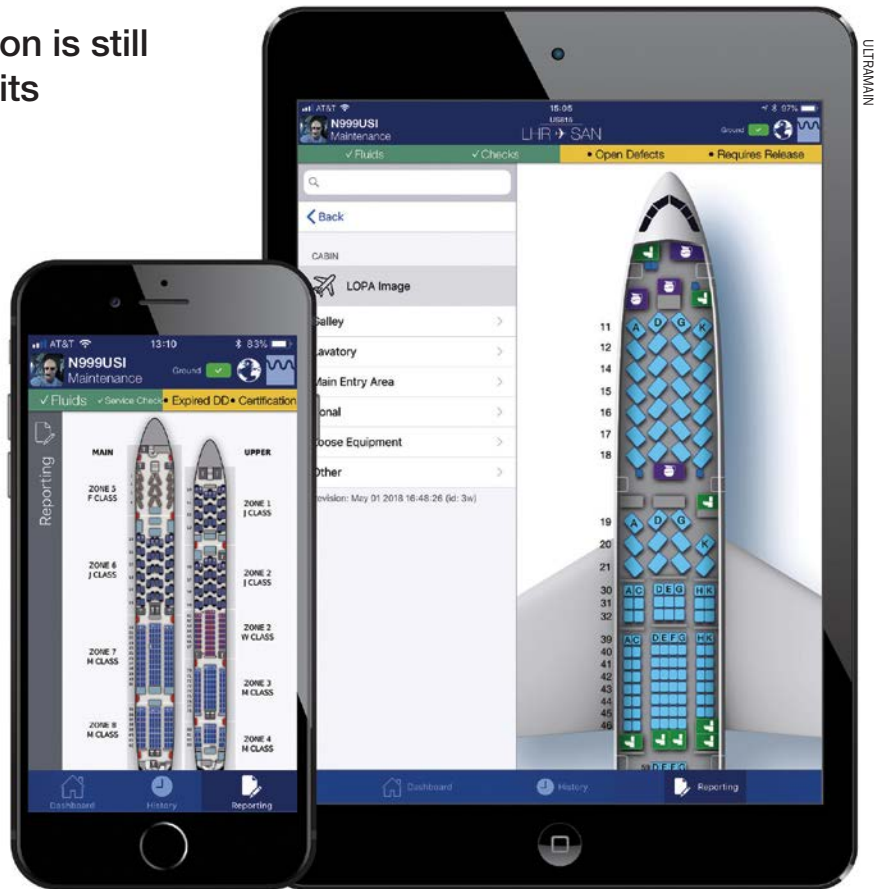

Electronic technical logs like this one from Ultramain can help enforce standardized fault codes better than paper records.

says it is easy to use and works on either iOS or Windows Mobile 10 devices. Compliant with Spec 2000 Chapter 17, the ETL can be integrated into any MRO software that is also compliant. It interfaces with five SAP systems, AMOS, Ultramain itself and two other MRO applications.

Hosted or on-premises, the app itself can be set up in one week. Adams argues that mobile devices have eased hardware installation challenges, and regulatory authorities are getting used to ETLs. “The only hurdle to . . . implementation is going through sizable business process change in switching from using paper to digital. Big changes always involve projects, and it takes effort to get them started,” she says.

## CONDUCE

According to Hayley Russell, manager at ETL provider Conduce, implementation of its eTechLog8 software by a

low-cost carrier with 240 aircraft can yield a 300% return on investment in five years. She says up to 2,000 pages of paper per year on a Boeing 767 can be eliminated, and substantial time can be saved by pilots and line engineers during aircraft turnarounds and by ground staff avoiding manual scanning, faxing and entry of paper data.

Russell says the electronic approach also reduces errors and missing data with automatic checks, and journey data from each flight moves into MRO systems much faster, taking just 90 sec. versus up to four days for paper records.

eTechLog 8 supports 200 aircraft flown by carriers such as Smartlynx, Royal Brunei Airlines, Titan Airways, Etihad Airways and DHL.

Russell argues that the slowness of adoption has been due to inadequate hardware, software and communication. She believes Panasonic's

Toughpad, Microsoft touchscreen software and cheaper 4G roaming charges now strengthen the business case.

## SKYPAQ

One early adopter of ETLs is Finnair, which began using Skypaq's ETL on Embraer 190s in 2008. Henri Lonn, flight operations development manager, says ETLs were scarce then, and only Skypaq matched his requirements. Gains from using it have included better data coverage and quality for maintenance analysis, real-time data-sharing, efficiency, lower paper costs, fewer errors with less manual entries and up-to-date technical data on the fleet. In addition, "in the first few years we saw a 48% reduction in average defect closing times," he says.

Deployment required developing new processes to match

**Electronic flight bags can eliminate entry errors and improve information flow from the flight deck to MRO systems.**

digital workflows. ETLs are not just copies of paper logs but must meet regulatory requirements created for paper logs. Finnair had to integrate ETLs with other systems and develop business rules, usually less documented than data schemes. "There are a surprising number of stakeholders in an airline wanting to import technical or journey log data once it's available," Lonn says.

Skypaq now interfaces directly with AMOS and a few other systems. Data is available indirectly to other systems—for example, Airbus' Skywise application—and more interfaces are being developed.

Next, Finnair had to test Skypaq realistically, including what Lonn calls "edge cases." Finally, the airline had to manage change, and communicate with and train users.

Finnair tweaks its ETL constantly as requirements and other systems change. Lonn wants to further improve data quality and deepen Skypaq's integration with AMOS, new data sources and other pilot tools.

He sees moving from paper to digital tech logs as very worthwhile but urges airlines to ensure they select the

best system, for now and the future. "Changing the system involves a lot of work and risk," he says. Lonn advises bringing regulators into the process early and identifying everybody inside and outside the airline affected by adoption. Finally, "do not lock yourself into a specific platform unless long-term support is guaranteed," he adds.

Skypaq CEO Richard McKenna notes its app is also deployed at Ryanair and Finnish regional Norra, and he has worked with Pinnacle Airlines.

Skypaq is integrated with both AMOS and the Aircraft Maintenance and Spares Information System, maintenance software offered by an Airbus subsidiary. Compared with paper logs,



McKenna says Skypaq cuts maintenance log entries per write-up by 80%, manual entries to various IT systems per write-up by 80% and aircraft visits per write-up by 66%, all while eliminating paper storage and physical visits to records.

He stresses that Skypaq is OEM-agnostic, can work with mixed fleets and preserves confidentiality of airline data. The ETL is now cloud-based, and airlines can use platforms such as Microsoft PowerApps, Salesforce and Mendix to modify the app. The company now enables signing in to Skypaq on PowerApps to avoid the burden of multiple sign-ins.

Skypaq runs on smartphones, tablets and laptops with Windows, iOS or Android operating systems. The app gets gate-out, wheels-off, wheels-on and gate-in times automatically from ACARS.

## CROSSMOS

Meanwhile, other providers are eager

to enter the market. Boeing acquired Crossconsense's Crossmos ETL in autumn 2018 and adapted it into a Windows-based ETL, Mobile Logbook, introduced in 2019. An iOS version should be available in the second quarter of 2020, according to Steve McFeely, managing director of maintenance digital solutions. Several airlines have expressed interest in Mobile Logbook. "We anticipate new deployments with customers later this year," he says.

McFeely sees multiple advantages for users: significant time savings from bidirectional data transfers with any maintenance system that complies with ATA 2000 Chapter 17, more accurate

fault reporting and maintenance disposition, and more complete data capture.

Mobile Logbook can be customized for airline business processes and installed "rather quickly," McFeely says. However, much more time is needed for airline units to assess and alter processes to work with the tool.

## MAINTENIX

IFS Maintenix has partnered with Comply365, which specializes in mobile software to ensure regulatory compliance, to develop an ETL that is part of, and works only with, Maintenix itself. IFS Aerospace & Defense product manager Kirk Strutt argues that other, separate ETLs simply mirror paper technical logs, are not really part of the maintenance system, may overload pilots with data they do not need and are not ideal for night environments.

Strutt says the new Maintenix tool will ensure real-time compliance as mechanics perform work, thoroughly connect pilots and the entire workforce



on the day of operations, enable multi-horizon planning—including strategic maintenance planning—and ensure the right part is available, after checking conflicts and materials. “It is accessible from anywhere—airport, hotels or coffee shops—on the device they are using,” Strutt says. “And it’s a natural extension of the maintenance system, not a separate system. Pilots, mechanics, material and maintenance controllers, planners and line supervisors are all using the same system in real time.”

Strutt notes that Maintenix has supported e-signatures, based on public key infrastructure, used in its ETL for a decade. A QR code embedded in the cockpit and scanned by the electronic logbook camera would double-check that the pilot is using the correct aircraft’s data.

The IFS Comply365 app is now available on iPads and IFS will look at using Android and Windows-based devices. Strutt says implementation challenges include gaining regulatory approval and developing a backup plan for any loss of connectivity or other disruptions in ETL functions.

#### TRUSTFLIGHT

TrustFlight’s ETL has been used in business aviation, and the company is now working with several European airlines on deployment. Managing Director Karl Steeves cites efficiency, cost savings, fewer errors and clearer data on airworthiness as major benefits.

TrustFlight’s ETL is part of a larger suite of digital products, including an electronic task cards application and an aircraft records platform. Steeves stresses that TrustFlight is a European Union Aviation Safety Agency Part-M Continuing Airworthiness Management Organization that understands maintenance requirements and can continuously improve its products. Its ETL now has a fully digital minimum equipment list and can record flight-duty periods.

Steeves says many regulators have not dealt with ETLs before, which can be a hurdle to implementation. On the other hand, he is seeing start-up airlines adopt ETLs from the beginning, avoiding the need for a switchover in the future. ☺

## AVIATION WEEK Fleet&MRO FORECASTS

DISCOVER  
ANALYZE  
PLAN  
FORECAST

2021 Commercial Fleet & MRO  
Forecast – **Just Released!**

## Predictive Intelligence to Drive Results

With Aviation Week Network’s **Fleet & MRO Forecast**, gain a 10-year outlook to **minimize risk** and **maximize revenue**.

- Fleets, trends, and projections
- Predictive view of market share
- MRO future demand

**Take your business to the next level.**

For more information, visit  
[aviationweek.com/forecasts](http://aviationweek.com/forecasts)

or call Anne McMahon at +1 646 291 6353  
or Thom Clayton +44 (0) 20 7017 6106

Available for:  
**COMMERCIAL  
MILITARY  
BUSINESS  
HELICOPTER**

**AVIATION WEEK**  
NETWORK

# Wind and Fire

## Protecting aircraft from typhoons and other natural disasters

Chen Chuanren **Singapore**

**P**art of the Asia-Pacific region straddles the so-called Pacific Ring of Fire, one of the most active tectonic and volcanic regions in the world. The area is also the birthplace of some of the strongest typhoons, causing billions of dollars in infrastructure damage in East Asia. So far, 2020 has seen five typhoons and 10 tropical storms. With mass groundings and travel restrictions related to COVID-19, provisions must be made to protect parked aircraft, which cannot be easily repositioned prior to an incoming natural disaster.

In recent months, the Korean peninsula experienced some 50 consecutive days of rain and was struck by three successive strong typhoons—Bavi, Maysak and Haishen—the last two arriving within four days of each other.



**Korean Airlines' widebody fleet, sealed and parked at Seoul Gimpo Airport.**

At its peak in May, South Korean flag-carrier Korean Air had around 40 aircraft comprising 10 aircraft types parked at Seoul Incheon, Seoul Gimpo and Gimhae airports. Usually, in preparation for a typhoon, aircraft are fueled to the maximum to increase their weight, and will be drained following the storm. However, for KAL, fuel is loaded to the “normal” extent as it usually takes too long to drain the fuel.

“For the stronger levels of wind, we moor the aircraft or load sandbags on the aircraft,” a KAL representative tells *Inside MRO*, going on to say that the most effective way to protect aircraft is to relocate them. This year, the carrier adjusted its flight schedule to reposition its aircraft to other domestic and international stations. The airline says there were no reports of any damage from the three recent typhoons.

KAL also added a desiccant with the engine coverings to prevent engine corrosion during the unusually long wet

season. Cabin humidity is managed through checks and conducting air conditioning runs in cycles of 3-7 days. Sealing the aircraft also protects the airframe from dust storms that blow in from China’s Gobi Desert.

Taiwan’s China Airlines sometimes assigns engineers to sit in aircraft during a typhoon to make adjustments to prevent any airflow over the wings that might create undesired movements.

Filipino low-cost carrier Cebu Pacific has to contend with both typhoons and the potential eruption of volcanoes across the archipelago. The Taal volcano erupted in January, forcing the closure of most airports around Manila.

Due to COVID-19, the carrier has already parked 14 aircraft, including Airbus A320s and A330s, at Alice Springs’ Asia-Pacific Aircraft Storage in Australia, to protect them against natural disasters and other environmental threats.

Although typhoons usually hit the Philippines’ north, Ian Wolfe, Cebu Pacific senior advisor for engineering and fleet management, says parking aircraft is dictated by commercial demands and is scattered across various hubs. Depending on the strength of the typhoon, aircraft may be evacuated to another airport in the country or simply moored

to the ground. But volcanoes are harder to predict and warnings usually provide less time to react than those for typhoons.

“Volcanoes may already be emitting smoke, but you will never know exactly when they will erupt. This can go on for days, or even weeks,” says Wolfe. In the aircraft preservation process, all openings are covered to prevent foreign objects from entering, including volcanic ash. Should there be an ash fall, there are specified procedures in aircraft maintenance manuals that must be completed.

For example, Boeing’s aircraft maintenance manual calls for a phased approach to aircraft inspection to allow the inspections to stop if no signs of damage or ash fall are found, so aircraft can return to service quickly. Superficial inspections include checks for unusual abrasion on pitot tubes, windows and lights, while a more detailed inspection of internal ash buildup on ozone converters, bleed systems and other sensitive components are done if the engines have a history of ash contamination.

Additional lightning protection for commercial airliners is unnecessary since it is designed into the aircraft. The metal frame forms a Faraday Cage in which the current passes through the airframe and is discharged safely. However, Wolfe adds that any ground activities would be halted during thunderstorms, depending on the airport’s lightning risk warning. In the Philippines, the Lightning Activity System categorizes the lightning risk as red or yellow, corresponding to the weather’s proximity and intensity. ☼



# Looming Deal Heralds Change

## Potential TransDigm acquisition of Triumph could reshape the aftermarket landscape

Michael Bruno **Washington**

**M**ergers and acquisitions across aerospace and defense are expected to pick up as the effects of COVID-19 ripple across the sector. Lately, attention is turning to one niche seen as ripe for poaching: financially strained midsize manufacturers with established aftermarket revenue streams.

In mid-September, news emerged that embattled Triumph Group was fielding M&A interest from suitors, reportedly including serial A&D acquirer TransDigm Group as well as Curtiss-Wright and Woodward. None of the companies would comment on the speculation, but

**Triumph's aircraft repair and overhaul support includes pneumatics, hydraulics, environmental systems, actuation, heat transfer, engine controls, fuel accessories and gearboxes.**

the prospect resonated with financial analysts who cover the sector.

"TransDigm's success with the Esterline Technologies acquisition points to the attractiveness of acquiring large, underperforming businesses," Jefferies analysts Sheila Kahyaoglu and Greg Konrad said Sept. 18, referring to TransDigm's takeover of the midtier provider last year. "Triumph fits the bill, as it is in the midst of a major restructuring."

Indeed, Triumph was shedding assets before COVID-19, but the Tier 2 company had a plan to remain a going concern that centered on aftermarket and engineering services. Triumph in August announced a deal to sell its composites operations to private equity investor Arlington Capital Partners,

one of the last steps to divesting its aerostructures work. That deal is supposed to close imminently.

Since 2016, Triumph has divested 13 "noncore" businesses, including the latest announcement, as part of its downsizing efforts to reduce the corporation's leverage. The corporation. Even so, its publicly traded share price remains down roughly 70% this year through Sept. 21.

On top of company-specific issues, the challenge for Triumph and others is that while the aftermarket usually

or 2024, and extensive retirement or parking of older aircraft, the commercial aftermarket is set for an extended period of depressed demand," Moody's Investors Service said separately the month before. This will be only partially mitigated by demand for the services needed to bring a fraction of the parked aircraft back into operation.

MRO companies focusing on military aircraft maintenance, such as Vertex Aerospace Services and Ontic, should enjoy relatively robust revenue, Moody's continued. The broader defense aftermarket outlook remains healthy, with around 60% of suppliers seeing growth, Canaccord Genuity echoed in its September supplier survey.

Eventually, the commercial aftermarket also should return, albeit lagging commercial air traffic by a few quarters, at least. "We have more confidence in the 2021 recovery, but it is fragile," Canaccord's Ken Herbert wrote in a commercial MRO survey report in July. "Inventory levels



TRIUMPH

outperforms during recessions, thanks to a healthy installed base, that is not expected to happen in this downturn due to an expected flood of airliner retirements. Industry experts forecast a 50% drop-off in commercial aftermarket business this year, according to insight offered during the Aviation Week SpeedNews Commercial Aviation Industry Suppliers Conference in September.

"With airline passenger traffic unlikely to recover 2019 volumes until 2023

remain inflated, and pricing pressure has increased. Moreover, airline cash conservation is not expected to let up, and the MRO industry needs to reduce capacity; but as long as traffic continues to improve, the aftermarket recovery is a question of when, not if."

But it remains a question of surviving until then, and several suppliers are feeling financially squeezed. According to longtime industry advisor Bill Alderman, almost 39% of respondents to a supplier survey his

consultancy carried out in July said they may not have enough liquidity to ride out a prolonged downturn. Almost half of those surveyed by Alderman & Co. said they were more concerned now than they were in May.

Put it all together, and many industry observers see consolidation ramping up over the next year or so. MROs that are at risk are those with weaker balance sheets and low precrisis margins, according to Eric Bernardini, co-leader of the A&D practice at consultancy AlixPartners. The strongest effects of the downturn are expected in cabin modifications and engine overhauls, he said in May. Consolidation is “very likely,” with private equity investors seen to be interested to enter at low valuation points. “Some MRO providers and aftermarket parts providers have highly leveraged balance sheets,” he said.

Other industry analysts agree. “Because we need capital and we need restructuring, and we have many

companies on the precipice, you’re going to see private equity and well-positioned holding companies, like TransDigm and Heico, public companies with strong balance sheets, and possibly governments come in and buy companies,” AeroDynamic Advisory Managing Director Kevin Michaels told an Aviation Week event Sept. 15.

The downturn has been so severe and so fast that balance sheets should be the prime factor separating different players in the manufacturing-MRO niche, rather than the traditional considerations of whether targeted companies are participating on certain aircraft programs. For instance, both TransDigm and Triumph recently issued secured debt to boost their liquidity—8% for \$1.1 billion with a 2025 maturity for TransDigm and 8.875% for \$700 million with a 2024 maturity for Triumph.

But TransDigm’s leaders took out the new debt as a precautionary move against COVID-19’s effects as well as

to be ready for M&A, and it is currently on track to end its fiscal year with about \$4.5 billion of cash. That would more than cover a purchase of Triumph, which Jefferies analysts estimated could require about \$2 billion.

Triumph, meanwhile, is expected to burn through about \$225 million in cash in its current fiscal year, according to UBS analysts—equivalent to roughly two-thirds of Triumph’s market capitalization of about \$355 million.

TransDigm traditionally bought small providers of proprietary A&D parts, but its roughly \$4 billion deal last year for Esterline proved to be such a successful foray into buying larger companies that it opened management to considering other deals. “We’d love to see some good acquisitions in our space come up, but again, that’s always hard to predict,” Executive Chairman Nick Howley said on Aug. 4. “But if we’re out there chipping away at the rock, I can’t imagine we won’t find something.”



CERTIFICATIONS: FAA • E.A.S.A • I.S.O

## AIR SHUNT

INSTRUMENTS, INC.

**“WE’RE UP THERE WITH YOU”**

**SPECIALIZING IN MILITARY AND COMMERCIAL AVIONICS INSTRUMENT REPAIR**

WORLDWIDE SUPPORT OF:

- ALTIMETERS
- GYROS
- FUEL QUANTITY INDICATORS
- AIR SPEED INDICATORS
- RECEIVER TRANSMITTERS
- TRANSPONDERS

**SUPPORTING PRODUCTS MANUFACTURED BY:**

ROCKWELL COLLINS • ALLIED SIGNAL • MARCONI • GENERAL ELECTRIC • KOLLSMAN • AEROSONIC • LITTON • GULL ELECTRONICS • ASTRONAUTICS • GRIMES • LEAR SIEGLER • HONEYWELL • LORAL • R.C. ALLEN • TELEDYNE

**WWW.AIRSHUNT.COM**

Air Shunt Instruments, Inc. 19101 Winnetka Ave. | Chatsworth, CA 91311 | T: (818) 700.1616 | F: (818) 700.2882

**WE HOUSE OVER 10 MILLION SPARE PARTS FOR ALL AIRCRAFT**

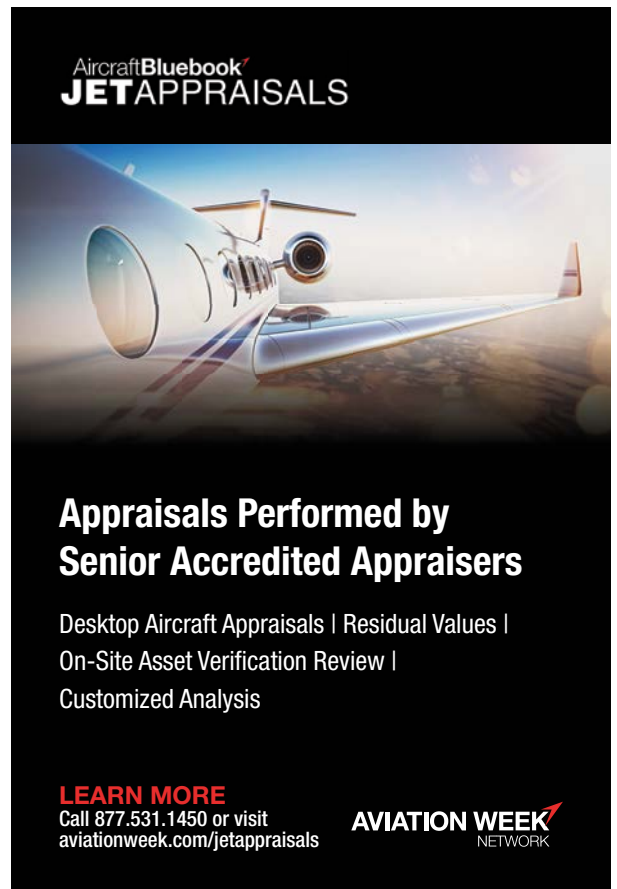

AircraftBluebook<sup>7</sup>  
**JET APPRAISALS**

## Appraisals Performed by Senior Accredited Appraisers

Desktop Aircraft Appraisals | Residual Values |  
On-Site Asset Verification Review |  
Customized Analysis

**LEARN MORE**  
Call 877.531.1450 or visit  
aviationweek.com/jetappraisals

**AVIATION WEEK**  
NETWORK



# Aircraft Interiors in a Post-Pandemic World

Engineers and cabin designers innovate for a world transformed by COVID-19

Paul Seidenman and David Spanovich **San Francisco**

**B**efore the novel coronavirus outbreak, engineering and modification was the fastest-growing segment of the commercial airline MRO market. Today, it is running at about 50% of what it was in 2019. But while the COVID-19 pandemic has upended the market, it also is driving new and evolving concepts in passenger safety and revenue generation for the post-COVID future.

Among the innovations being explored are revolutionary changes in cabin configurations, including PriestmanGoode's "Pure Skies Rooms" and "Pure Skies Zones." Discussions

with the firm's airline customers, seat vendors and suppliers indicated "it was time to think about the future and how airline cabins could be altered so people would have more confidence in flying" in the post-COVID-19 environment, says Luke Hawes, director of the London-headquartered design house.

Pure Skies Rooms, the designer's business-class concept, offers each passenger a fully enclosed personal space, partitioned by full-height curtains, as well as a new seat design with minimal split lines and seam-welded fabrics, places where microbials could breed. The unit also contains

antimicrobial materials and finishes, an inflight entertainment system (IFE) fully synchronized with the passengers' personal electronic devices, as well as its own overhead luggage storage area and wardrobe.

Because each room is a complete module, PriestmanGoode will need to work with the airframe manufacturers to address "the architectural hurdles," Hawes says. "This will be far more involved than installing new seats on seat tracks," he adds.

Pure Skies Zones is how PriestmanGoode envisions a redesigned economy section. Greater separation will be achieved by installing transparent dividing screens in back of every other row, as well as staggered seating. The seats themselves would be designed with back-of-seat shells, without

**PriestmanGoode's Pure Skies Zones cabin design includes barriers set at specific intervals between rows and seating that minimizes split lines and seams, which are dirt traps and microbial breeding areas.**



PRIESTMANGOODE

gaps, to eliminate trapped dirt. The split lines and hard-to-clean areas of the recline mechanism would also be eliminated by containing the mechanism within the fabric skin.

“The dividing screens not only enhance privacy but also provide the cabin itself with a more hygienic look and feel,” says Hawes. “There would be no increase in seat pitch, and revenue potential would not change. However, the seat design would result in a product that would cost more.”

Hawes reports that Pure Skies Rooms and Pure Skies Zones designs also target high-touch items—especially seat-back monitors. “We would

with an unnamed client to provide the expertise for its design, installation and regulatory compliance requirements.

“UV lighting as an antimicrobial has been worked on since 2015 by different companies, but this project is the first prototype installation on an aircraft,” Gil states. The installation took place in December 2019 within a lavatory, but he notes that it can be placed throughout the cabin and galley, and it is being evaluated for a fleet-wide campaign.

The system components were designed for simplicity, using LED strips and the associated board that energizes them. “The design was

IPVideo’s joint-venture partner for all aerospace markets, including military/government, business and general aviation, and Part 121 and Part 135 commercial operations.

“L2 Aviation is providing the avionics expertise and experience to both ruggedize and ‘aviationize’ the Halo design for the robust requirements of inflight environments,” says Lebovitz. “L2Aviation will develop the [supplemental type certificates] for FAA and foreign validation and [parts manufacturer approval of] the equipment for many aircraft types.”

Halo is composed of units or suites, each embedded with 12 sensors working in conjunction to detect environmental conditions and provide a multitude of measurements. An additional ozone sensor is to be added later this year. “No other product we know of has the ability to detect and measure chemicals in the air such as ozone, carbon dioxide and carbon monoxide; as well as [volatile organic compounds] and particulates impacting air quality,” he says. “It also detects environmental factors such as temperature, dew point and barometric pressure, plus lighting.”

The joint venture is targeting the Boeing 737 and Airbus A320 retrofit market initially. For a single-aisle airliner, three units would be placed in the cabin to create channels between multiple zones. “With three or more zones installed, the differences noted and trending between sensor-suite locations can be used to determine if a smell or other event started in a section of the cabin or in a common point like the pressurized bleed air from the engine,” explains Lebovitz.

Halo is enabled for the Internet of Things (IoT) for data transmission, using several modes of connectivity including wireless such as existing IFE equipment, and cellular for transmitting upon weight-on-wheels (WoW), or a parking brake.

“For aircraft connectivity systems like cellular (4G) and Gatelink Wi-Fi, which are designed or certified to operate only while the aircraft is on the ground, the WoW and/or parking brake discrete inputs enable the ground communication system to power-on the radio, connect and start transmitting the HALO air cabin data. In some configurations the data

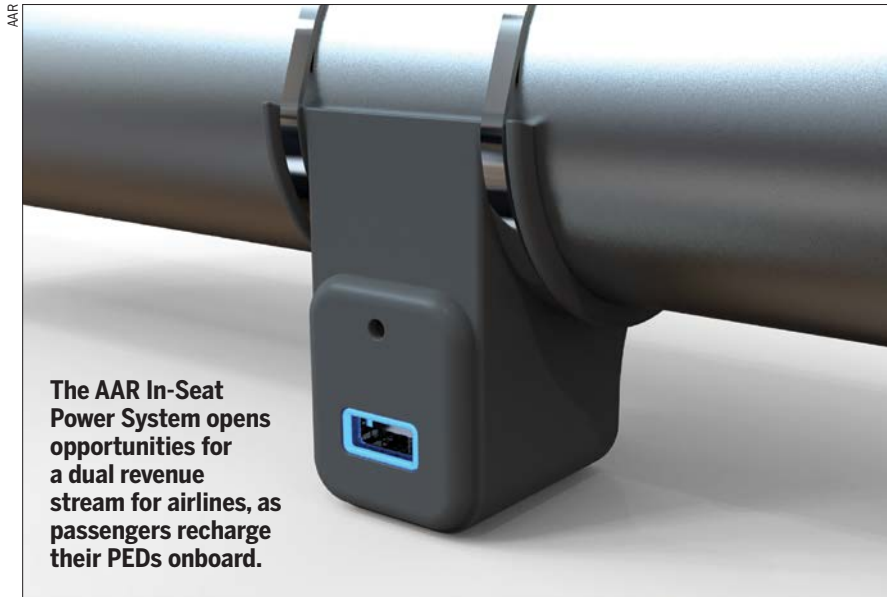

**The AAR In-Seat Power System opens opportunities for a dual revenue stream for airlines, as passengers recharge their PEDs onboard.**

totally eliminate them in favor of a passenger’s electronic device,” he says. “If passengers could stream content from the airline’s own server through a Wi-Fi connection, it would eliminate a high-touch item and the weight of the monitor and wiring. When not being used, the electronic device could be stored in a seat-back pocket.”

Ultraviolet (UV) lighting is another area of industry interest for its antimicrobial properties. “UV lighting may catch on if for no other reason than a ‘branding initiative’ to help improve revenue through passenger confidence,” says Teddy Gil, chief administrative officer of Sheffield Aerospace, an engineering consulting firm in Houston. Gil reports that Phillip Cheng, Sheffield’s director of operations and lead electrical engineer, is working

intended for ease of installation, making it compatible with both retrofit and line fit,” he says.

Sheffield has proposed that the UV system would be in an active mode when the cabin is unoccupied, out of an abundance of caution to assure passenger safety. Asked if it would be effective against virus strains, Gil says that it was specifically designed to kill bacteria, and more research is required to determine its full potential.

An innovative project in development for the aircraft cabin involves Halo, an air-quality sensor system produced by IPVideo. For the past two years, Halo has been marketed to—and installed in—commercial buildings and educational facilities, such as public schools and college dorms, according to Mark Lebovitz, CEO of L2Aviation,



## MOVING TOWARD NEXT-GEN COMPOSITES

transfer can start when the aircraft lands. However, sometimes it is preferred to wait until the parking brake is set," he explains.

Lebovitz adds that under some circumstances, Halo could tie in to L2's other connectivity supplemental type certificates for the ability to interface with satcom or ACARS for real-time transmission and predictive maintenance—not just event-based reporting from the aircraft—and all without requiring human interaction. "The data packets are small and would not present a bandwidth penalty or be expensive to transmit over satellite or ACARS," Lebovitz notes.

One innovation that could help the cash-strapped airlines is AAR's In-Seat Power System (ISPS), which will enable airlines to generate extra revenue as passengers use the airline's USB power to recharge their personal electronic devices (PED). If the airline selects AdPower, an optional, highly customized feature of the outlet units, ancillary revenue through advertising can be realized.

Customization for each operator is available via a software development kit that interfaces with each airline's app. The software is compatible across Apple and Android devices and "provides the opportunity for dual revenue streams—charge-to-charge and advertisements on behalf of itself or partner brands," says James Leech, an AAR Engineering Services senior manager. Operators have the choice when selecting the AdPower option to capture either, both or neither revenue stream.

"Assuming the USB outlet with AdPower is chosen, this will be the first such ISPS that enables airlines to generate ancillary revenue through advertisement income, displayed as passengers charge their personal electronic devices. It will also be the first device that enables the passenger to receive ISPS power through an airline's app," Leech says. The AdPower app will generate a code that activates the USB outlet to deliver power to the PED.

Leech points out that the ISPS will work if the app is pre-installed on the passenger's PED. However, AAR is also exploring options with various inflight connectivity providers to determine the feasibility of launching the app through a browser-based application.

The current decade is likely to see some major innovations in composites technology, particularly with respect to recyclability and manufacturing.

Lufthansa Technik, in partnership with composite materials specialist Bcomp, expects to have a natural-fiber-based composite material for cabin and cargo compartment applications ready for certification and serial production by the end of 2021.

"These cabin components will be designed for a sustainable production and recycling process," says Claudia Nehrke, Lufthansa Technik's head of strategy and business development for base maintenance services. "Due to an innovative and patented layer structure, we are also targeting weight reduction of up to 20%."

At Collins Aerospace, the focus for next-generation advanced structures technologies is on thermoplastic composites and additive manufacturing, according to David McConnell, associate director for advanced materials and process for interiors. He reports that thermoplastic technologies are being used in seating, panels and galley systems. Collins, he adds, continues to focus on even more advanced processes, structures and additional aircraft applications.

"Thermoplastic composites allow for recyclability through the development of new materials and manufacturing processes. It also allows for significant chemical and energy-intensive process reduction because of a shortened manufacturing time," explains McConnell. "They are replacing many different materials and processes across our product lines, from traditional thermoset prepreg-based composites, resin-infusion processes and metal alloys."

McConnell adds that while thermoplastics are tougher and lighter-weight than conventional composites, they also benefit from automated processes and consolidation technologies. "This translates to improvements in system-level performance, improved quality and reduction in the total cost of ownership," he says. ☺

The AAR ISPS is available with two versions of USB Type A outlets from which the customer can choose. These include the traditional one-way outlet as well as a bidirectional outlet that allows a PED to be inserted into the outlet in two ways, reducing customer-induced damage. The outlet is installed on the seat spar instead of the seat back or armrest area.

"AAR has designed a USB outlet mounting bracket that can fit most seat types. Should a special type of seat installation be required, AAR will work with the customer to adapt our design for that particular seat," Leech adds.

He explains that the ISPS was designed as a low-maintenance product. For example, the need to install a seat power box on each seat assembly has been eliminated. Instead, the

robust USB power-supply units (PSU) are installed outboard of the side-walls of the aircraft. "The AAR ISPS requires only 8 PSUs for a narrowbody aircraft as opposed to approximately 30 PSUs for a traditional ISPS," Leech notes. Total weight of the outlet is 1.3 lb. per triple seat assembly. Installation time per seat assembly is 15-20 min. and can be accomplished during an overnight check.

AAR was in discussions with multiple airlines that were interested in installing the ISPS with the ancillary revenue features prior to COVID-19, says Leech. "We were preparing to launch it during [Aircraft Interiors Expo] 2020. Due to the pandemic, the launch has been delayed, but the design is ready to be incorporated," he says. ☺

# Narrowbody Stalwart

Despite deferred shop visits, the V2500 should recover well from the COVID-19 crisis

James Pozzi London

**B**efore the COVID-19 crisis stalled the growth of the commercial aftermarket, demand for the International Aero Engines (IAE)-manufactured V2500-family engine, an option for the Airbus A320, was predicted to remain robust in the long term. Back in 2019, operators would commonly mention that finding an engine slot for an overhaul or repair was one of their primary challenges, with parts shortages from the OEMs and heightened demand for current-generation narrowbody equipment contributing factors.

However, given the novel coronavirus crisis, the dynamics of the market have changed this year, leading airlines to defer or cancel costly engine shop visits as a means of preserving liquidity. As a result, the engine aftermarket likely will see a sharp decline in shop visits this year, a slowdown already identified by OEMs and independent MROs. A September poll conducted by Aviation Week Network's Aero Engines Europe also suggests this trend, with 35% of respondents predicting a 40%-50% drop in shop visits in 2020.

This is supported by Aviation Week Network Commercial Fleet & MRO Forecast data revised for COVID-19, which anticipates a steady decline in MRO spending and fleet numbers over the course of this decade as the V2500 market gradually transitions to its PW1000G successor. As of next year, the newly revised figure of 2,784 in-service V2500s is expected to be reduced to approximately 2,049 by 2029. In the second quarter of 2020, Pratt & Whitney says demand for the V2500 fell around 60%. This may reflect trends in the wider engine MRO sector, which saw an estimated revenue drop of 50%-60% in the second quarter, according to an analysis by consultancy IBA.

One bright spot among the downturn is more requests for engine preservation support, with more module exchanges and minor MRO

tasks expected. Lessors are also seeing some buoyant activity, particularly in areas such as V2500 component demand. "We've seen a lot of requests for V2500 parts that we don't yet have for part-out [though we] do own engines that are still on

their lease," Anca Mihalache, vice president for engine trading at APOC Aviation, said during a panel discussion at Aviation Week's Aero Engines Europe in September.

Greentime engine requests for powerplants like the V2500 have also increased during the pandemic. Typically, this has emanated from lessors looking to postpone shop visits rather than airlines, said Fabrizio Laurenti, senior manager for engine lease at MTU Maintenance Lease Services, which specializes in short-term leases of more than four months. He expects the greentime trend to persist if cash remains short and price reductions continue.

Newer variants of the V2500, alongside its CFM56 competitor, are likely to continue returning to service as airlines gradually increase their flights

**JetBlue outsourced maintenance of its newer V2500 engines to Pratt & Whitney in recent months.**

starting with short-haul routes. Speaking of the Airbus fleet, Paul Richardson, vice president of sales at AAR, says: "It's important to remember that 75% of Airbus A320neos are under 15 years old, so taking into consideration the age side of things, half of those engines haven't had their first shop visits yet."

However, some older V2500 models could make good teardown candidates, although a post-COVID-19 wave of teardowns—both for aircraft and engines—is not anticipated initially. Aviation Week predicts V2500s will retire at a steady pace over the next decade. About 58 will be retired next year, with an estimated 160 units returning from storage. Retirements for the V2500 are expected to peak at 242 in 2026.

The expectation is that plenty of shop visits will come due once some semblance of normality returns to the market, something that is already being seen for engines like the V2500 as short-haul flying increased in recent months. Abu Dhabi-based Sanad Aerotech, anticipating this trend, has moved to adjust its capacity accordingly. In late September, the company signed a new \$272 million agreement with Pratt & Whitney to increase services for the V2500. 📍





# Boutique Engineering

Lindsay Bjerregaard **Chicago**

## 1. New Part 21 Provider

**Company:** ALL4JETS

**Specifications:** Originally launched in 2013 as a Part 147 maintenance training organization, ALL4JETS now holds Part M certification as a Continuing Airworthiness Management Organization (CAMO) and Part 21 Design Organization Approval (DOA). In partnership with Polish MRO WZL 2, it provides “One-Stop-Shop” services and specializes in training, engineering and maintenance support services for airlines, lessors and MROs. Its Part 21 J certification enables ALL4JETS to provide minor changes to external livery, placards and markings for large aircraft. Next year its DOA team plans to expand its offerings to cabin interior modifications for internal placards, equipment and textiles.

[marketplace.aviationweek.com/  
company/all4jets](http://marketplace.aviationweek.com/company/all4jets)

## 2. Cabin Design Expertise

**Company:** Factorydesign

**Specifications:** UK-based Factorydesign specializes in all aspects of cabin interior design for airlines and component manufacturers, such as seats, lavatories and cabin features. It has designed interior features for airlines such as Delta, Etihad and Virgin Atlantic and places a special focus on exploring new materials and manufacturing techniques to facilitate cabin maintenance. Factorydesign recently released two new design concepts focused on social distancing within the cabin: the Isolate Screen Kit and Headzone Passenger Divide. Both products are designed to be simple, portable solutions to physically separate passengers with partitions that are easy for airlines to add or remove.

[marketplace.aviationweek.com/  
company/factorydesign](http://marketplace.aviationweek.com/company/factorydesign)

## 3. Full Package Interiors Approach

**Company:** ABC International

**Specifications:** ABC International provides custom engineering, design and certification services focusing on cabin interiors,



including carpets, seat covers, curtains, interior monuments and cabin branding elements. It holds European Union Aviation Safety Agency (EASA) DOA Part 21 J approval for cabin interior modifications and external schemes, placards and markings for aircraft, and it offers a “full package approach” that includes design, certification and kit manufacturing, and installation. It is the primary cabin branding elements supplier for airlines such as Air Canada, Alitalia, GOL, JAL and Southwest, and it recently extended its EASA CS-23 approvals pertaining to areas such as avionics, cabin interiors, landing gears and wings. This year it launched two new products: the Boom Headrest, which provides passengers with various neck and head support options, and the Rigid Lifevest Box, which is designed to be lightweight, adaptable, durable and easy to check.

[marketplace.aviationweek.com/  
company/abc-international-srl](http://marketplace.aviationweek.com/company/abc-international-srl)

## 4. Diverse Airframe Consulting

**Company:** Atkins

**Specifications:** As a global design, engineering and product management consultancy, Atkins has been working with aviation customers for more than 50 years to provide expertise across project life cycles. Through its DOA from EASA, Atkins is able to work on structural modifications and repairs for aircraft and unmanned air systems. It has provided services as an engineering consultant both to OEMs on major aircraft programs as well as small startups working in areas such as electric propulsion and urban air mobility. Atkins is in the process of

expanding the scope of its design organization to offer MRO services in software and avionics. It was recently appointed, in tandem with Gama Aviation, as the design organization responsible for supporting airworthiness of the Viking T1 over the next 2-3 years by the UK's Ministry of Defense.

[marketplace.aviationweek.com/  
company/atkins](http://marketplace.aviationweek.com/company/atkins)

Go to [marketplace.aviationweek.com](http://marketplace.aviationweek.com) for more information.

### 5. Innovating Aircraft for the Future

**Company:** AKKA

**Specifications:** Engineering and technology consulting group AKKA works as an innovation accelerator for its clients, supporting aerospace companies throughout the life cycle of their products with technologies such as artificial intelligence, robotics and big data in areas such as aerodynamics, propulsion and performance. It has a dedicated aeronautic center of competency that has successfully provided more than 1,000 EASA and FAA-approved cabin modifications, and earlier this year it began a collaboration with Avianor to certify passenger-to-freighter conversions. Its ongoing Link&Fly project seeks to address air mobility challenges of the future (such as increased congestion) through a multimodal air transport system that includes a detachable cabin, a wing-propulsion carrier and verticalized airport and in-city infrastructure elements.

[marketplace.aviationweek.com/  
company/akka](https://marketplace.aviationweek.com/company/akka)



### 6. Assisting Regulatory Approvals

**Company:** Aero Design Services

**Specifications:** Based in St. Petersburg and Melbourne, Florida, Aero Design Services provides design, tooling, integration, manufacturing, validation and certification services to customers including airlines, MROs and leasing companies. It specializes in FAA Designated Engineering Representative approval of interiors, for projects ranging from executive aircraft components to entire interior installations on commercial aircraft, including flammability, structures, mechanical systems, and static and dynamic seat certification and installation. It was recently awarded an FAA Supplemental Type Certificate for its Boeing 737-800 0/183 Cabin Seating Configuration, in which the first four seat rows have additional seat pitch.

[marketplace.aviationweek.com/  
company/aero-design-services-inc](https://marketplace.aviationweek.com/company/aero-design-services-inc)

Go to [marketplace.aviationweek.com](https://marketplace.aviationweek.com) for more information.

## SpeedNews<sup>7</sup> Aircraft & Engine Marketplace



# Placing Your Assets Made Easy

It has never been easier or more cost-effective to move your aircraft, engines/APUs, and/or parts inventories through *SpeedNews*, the most efficient way to get your available assets in front of the right audience.

For more information, contact  
**Steve Costley**  
scostley@speednews.com  
+1 424-465-6509







By **NICOLE NOACK**

*Nicole Noack is managing director of the Independent Aircraft Modifier Alliance.*

# The Future of Aircraft Modification

## What factors are most important to aircraft modification, and where will it lead?

**T**he pandemic crisis has shaken the aviation world as almost no other has. The golden outlook the aviation industry projected at the end of 2019—from airframe manufacturers, suppliers, MRO and modifiers—has since been replaced with the need to navigate very uncertain weather.

However, some things are certain: Changes will have to be made across the travel ecosystem to regain trust, and the industry must be well-prepared for a similar future eventuality.

These changes must be timely. And within each aircraft, every change needs aviation authority approval—which leads us to aircraft modification by supplemental type certificate (STC). Whether we're talking about touchless cabin solutions, inflight lavatory disinfection, cabin layout adaptations, social-distancing solutions, inflight entertainment and connectivity upgrades or any other optimization—they will all need approval. It is time for the aviation industry to make this process change happen, and I envision this effort leading to a new customer-focused aftermarket ecosystem.

Aircraft modifiers around the world are tasked to design and develop the relevant installation documentation for authority approval. In our new environment, where solutions must be rapidly matured, cost-effective, agile and innovative, the most pressing concern is: What do operators consider important when modifying aircraft? This is particularly relevant when the next step in an aircraft's life cycle is uncertain, including where the aircraft may—or may not—operate next.

My team at the Independent Aircraft Modifier Alliance interviewed

aircraft owner and operator representatives to learn their specific needs around aircraft modification. Our findings reflect the increasing importance of a customer-centric approach. Though aviation au-

thorities worldwide define mandatory requirements for the approval of a modification, standardized requirements throughout the whole value chain are rarely defined.

Owners and operators told us that their highest-ranking needs are effective communication, risk management and reliable after-sale service. In 2019, the International Air Transport Association published its “Best Practices Guide—Cabin Interior Retrofits and Entry-into-Service Program.” It examines the challenges of managing complex multisupplier modification projects from an airline perspective.

Since then, we've focused on this major concern regarding proper communication among all integration stakeholders. Modifiers are expected to provide such services in a structured manner, including predictable risk management to ensure on-time, on-budget modification projects—right up to reliable prototype overlays. Particularly during times of rapid innovation, where new materials and techniques often find their way onto aircraft, strong communication among stakeholders and with regulators is paramount, since no

certification blueprint for such novel modifications yet exists.

The second-most important need after communication is reliable after-sale service. Although the continued airworthiness instructions provide approved methods to reliably operate a modified aircraft, there are many situations in which modifier support is crucial. These include component improvements, software updates, accidental damage repair or spare-parts availability. Aircraft owners in particular concurred with this requirement. When the modifier is not available to support changes during aircraft lease transfers, owners can face huge challenges. Transfer of usage rights, customized adaptations, modification removal or its validation by another authority are where these challenges arise.

It's clear that the solution to these demands is to be customer-focused. In uncertain times, an aftermarket offering that provides airlines real choice for the safe integration of innovative products, while maintaining the predictability and reliability of STC projects and after-sale support, would provide a significant upside for operators. Isn't it time for such new customer-centric, cross-stakeholder cooperation, with rules that ease the difficulties and ensure competition?

Can you envision a new aftermarket ecosystem emerging where the community truly works together to meet customer demands at every level? Where passenger surveys directly feed innovation ideas? Where rapid feedback loops spur incremental improvement within the design process? Where regulators work alongside manufacturers and modifiers to develop worldwide best practices, ensuring the safety and integrity of new methods and products? Where all stakeholders have reliable and secure data interfaces for safe integration? Can you imagine digital collaboration across all stakeholders to optimize the entire modification process—from product definition to approval and after-sale support? I can. ☺

**It's clear that the solution to these demands is to be customer-focused.**

**Aviation Week Marketplace** is an online service that connects **buyers and sellers** in the MRO industry. Become a power user by registering at [marketplace.aviationweek.com/register](https://marketplace.aviationweek.com/register). Registration is **FREE**, enabling you to find hundreds of products like the ones featured below and to connect with more than 8000 companies. You can create a personalized save list, learn about companies' specialties, get contact details and request information at [marketplace.aviationweek.com](https://marketplace.aviationweek.com).

To advertise in the Marketplace, contact **Elizabeth Zlitni at 913-967-1348 or [elizabeth.zlitni@aviationweek.com](mailto:elizabeth.zlitni@aviationweek.com)**.

On November 17-18, 2020, the **Military Aviation Logistics & Maintenance Symposium and Showcase (MALMS Virtual)** will provide an unprecedented virtual forum for members of the U.S. military and commercial aerospace industry to discuss process improvements and operational readiness concerns regarding aircraft maintenance, logistics, and sustainment operations. The Symposium drives the U.S. military to partner with the private sector for rapid innovation, process improvements and increased operational readiness. **MALMS Virtual** is held with the support of the logistics and sustainment leadership of the United States Army, Air Force, Navy, and the Logistics Officers Association.

Join the conversation with military, MROs, suppliers, OEMs, and industry experts to define the future of military aircraft sustainment and logistics. **Attendance is FREE for active-duty and reserve members of the United States Armed Forces from all branches and Department of Defense civilian employees.** Learn more and register to attend at [malms-virtual.aviationweek.com](https://malms-virtual.aviationweek.com).

Visit [aviationweek.com/events](https://aviationweek.com/events) for more information, including complete exhibitor listings!

**AMSAFE BRIDPORT**

**Leading Net & Evac Slide MRO in North America!**

AmSafe Bridport's Part 145 repair centers in Bridport, UK and Anaheim, CA provide aftermarket repair services covering Safety Restraints, Cargo Liners, Main Deck Nets & Smoke Curtains.



The Anaheim facility also specializes in Emergency Evacuation Systems and carries a full line of Slide and O2 Cylinders.

[www.amsafebridportmro.com](https://www.amsafebridportmro.com)  
<https://marketplace.aviationweek.com/product/leading-net-evac-slide-mro-north-america>

Services

[leading-net-evac-slide-mro-north-america](https://marketplace.aviationweek.com/product/leading-net-evac-slide-mro-north-america)

**BAE SYSTEMS**

**Tailored to Suit Your Needs**

Our highly effective asset management programs are tailored to the needs of our customers. We offer innovative exchange, lease, and spares programs that are designed to provide differentiating cost and operational benefits to airlines.



Proud to be rated the top avionics supplier in the 2020 Air Transport Aftermarket Customer Satisfaction Survey.

[www.baesystems.com](https://www.baesystems.com)

Services •

Asset Management

<https://marketplace.aviationweek.com/product/tailored-suit-your-needs>

**IBERIA MAINTENANCE**

**Excellence, reliability and efficiency**

Iberia Maintenance delivers premium MRO services for 320s CEO/NEO, 330, 340 & A350. Engine process on CFM56-5B/-7B, V2500 & RB211-535E4, but also power generation systems, associated accessories & thrust reversers. State-in-the-art technologies to provide the highest levels of safety and quality.



Airframes • Avionics/Instruments  
 • Cabin Interiors/InFlight  
 Entertainment • Components •  
 Engines/Engine Systems •  
 Third Party Maintenance

[www.iberiamaintenance.com](https://www.iberiamaintenance.com)  
<https://marketplace.aviationweek.com/product/excellence-reliability-and-efficiency>

**K&H INDUSTRIES, INC.**

For over 55 years, KH Industries has been a U.S. manufacturer of portable lighting and temporary power solutions for a wide variety of industries. We have a dedicated group of skilled professionals that take pride in manufacturing quality, durable products locally, and helping our customers design and build customized solutions. Our website showcases our most popular lighting and power products, including explosion proof lights, retractable power cord reels, and LED work lights. We offer thousands of products to meet our customers' unique needs, including custom configuration. Let us know how we can provide a solution for you.



[khindustries.com](https://www.khindustries.com)

Original Equipment •  
 Consumables/Supplies

<https://marketplace.aviationweek.com/company/kh-industries-inc>

Go to [marketplace.aviationweek.com](https://marketplace.aviationweek.com) for more information.



**NIJL AIRCRAFT DOCKING**

**Multipurpose & Reduced footprint**

With more than 50 years of experience, NIJL Aircraft Docking has become a world leader in supplying aircraft docking systems. We supply lightweight and durable multipurpose equipment with reduced footprint for commercial, military, recycling, painting markets and final assembly lines.



[www.aircraftdocking.com](http://www.aircraftdocking.com)

<https://marketplace.aviationweek.com/product/multipurpose-reduced-footprint>

Ground Support Equipment

- Hangars & Equipment ▪
- Test Equipment

<https://marketplace.aviationweek.com/product/multipurpose-reduced-footprint>

**REVIMA**

**WORLD'S LEADING INDEPENDENT MRO SOLUTIONS PROVIDER**

Revima has built a solid repair & overhaul expertise in APUs, Landing Gears and associated LRUs.



It is one of the world leaders in its sector thanks to on time delivery, dedicated customer support, worldwide AOG Support 24/7, pool access, full in-house repair capabilities.

[www.revima-group.com](http://www.revima-group.com)

<https://marketplace.aviationweek.com/product/worlds-leading-independent-mro-solutions-provider>

Landing Gear/APU/Leasing

<https://marketplace.aviationweek.com/product/worlds-leading-independent-mro-solutions-provider>

**SPAIRLINERS GMBH**

**LOAN, EXCHANGE & SALE**

**Your instant access to our extensive component pool in case of urgent need**

Spairliners provides airlines with one-to-one component exchanges from our pool locations in Munich, Frankfurt, Paris, Singapore, and Miami. This minimizes your on-site stock needs and ensures that your aircraft operations remain optimal.



[www.spairliners.com](http://www.spairliners.com)

Components ▪ MRO ▪ Aircraft on the Ground

<https://marketplace.aviationweek.com/product/loan-exchange-sale>

**TAT TECHNOLOGIES**

**Thermal Management and Power & Actuation Services**

Your One Stop Shop Partner for:

Thermal Management:

- Cooling systems
- Heat exchangers
- Cold plates



Power & Actuation

- APU
- Landing Gears
- Machining Plating and Grinding (MPG)
- Jet Engine Components

[tat-technologies.com](http://tat-technologies.com)

Components ▪ Engines/Engine Systems ▪ Heat Coating/Brazing ▪ Hydraulics/Pneumatics ▪ Landing Gear/Wheels/Brakes

<https://marketplace.aviationweek.com/product/thermal-management-and-power-actuation-services>

<https://marketplace.aviationweek.com/product/thermal-management-and-power-actuation-services>

**TECHNOLOGY**

AVIATION WEEK  
**Marketplace** Where Buyers Meet Suppliers.



Join **12,000+** Global Suppliers and Growing

Aviation Week Marketplace is the next generation interactive supplier directory. Buyers turn to Aviation Week Marketplace to find, research, and connect to products and services around the world.

Learn more at [AviationWeek.com/Marketplace](http://AviationWeek.com/Marketplace)



AVIATION WEEK NETWORK

**TITAN TOOL SUPPLY, INC.**

**Videoscope Records Video & Still MRO Inspections**

Titan Tool Supply's Model TVSG Videoscope enables visual inspections at remote MRO sites to be recorded in both still images and video. Models are available in 4.5 mm or 6.4 mm diameters and 1.5 m or 3.0 m lengths. Full 360° joystick articulation control.



[www.titantoolsupply.com](http://www.titantoolsupply.com)

<https://marketplace.aviationweek.com/product/videoscope-records-video-still-mro-inspections-0>

Tools & Equipment

Go to [marketplace.aviationweek.com](https://marketplace.aviationweek.com) for more information.

**AIRCRAFT ON THE GROUND**

Spairliners GMBH.....MRO33

**AIRFRAMES**

BAE Systems.....MRO32

Iberia Maintenance.....MRO32

**AVIONICS/INSTRUMENTS**

Iberia Maintenance.....MRO32

**CABIN INTERIORS/INFLIGHT ENTERTAINMENT**

BAE Systems.....MRO32

Iberia Maintenance.....MRO32

**COMPONENTS**

Iberia Maintenance.....MRO32

Spairliners GMBH.....MRO33

TAT Technologies.....MRO33

**CONSUMABLES/SUPPLIES**

K&H Industries, Inc.....MRO32

**ENGINES/ENGINE SYSTEMS**

Iberia Maintenance.....MRO32

TAT Technologies.....MRO33

**GROUND SUPPORT EQUIPMENT**

NIJL Aircraft Docking.....MRO33

**HANGERS & EQUIPMENT**

NIJL Aircraft Docking.....MRO33

**HEAT COATING/BRAZING**

TAT Technologies.....MRO33

**HYDRAULICS/PNEUMATICS**

TAT Technologies.....MRO33

**LANDING GEAR/WHEELS/BRAKES**

Revima.....MRO33

TAT Technologies.....MRO33

**MRO**

BAE Systems.....MRO32

**ORIGINAL SYSTEMS**

K&H Industries, Inc.....MRO32

**SERVICES**

AmSafe Bridport.....MRO32

**TEST EQUIPMENT**

NIJL Aircraft Docking.....MRO33

**THIRD PARTY MAINTENANCE**

Iberia Maintenance.....MRO32

**TOOLS & EQUIPMENT**

Titan Tool Supply, Inc.....MRO33

# Can't come together for in-person events? Aviation Week's MRO Series has you covered!

## VIRTUAL

### MRO TransAtlantic

#### VIRTUAL

October 27-29, 2020

### MILITARY AVIATION LOGISTICS & MAINTENANCE SYMPOSIUM (MALMS)

#### VIRTUAL

November 17-18, 2020



#### WHY GO VIRTUAL?

Key reasons to attend and features you can expect at Aviation Week Virtual events:

- Networking: opportunities to reconnect you with the industry.
- Education: insight on best recovery practices and growth opportunities.
- Suppliers: discover and source new products/solutions.
- Experts and innovators: meet the people leading the way forward

Learn more at [events.aviationweek.com](https://events.aviationweek.com)     

AVIATION WEEK  
 NETWORK 

Go to [marketplace.aviationweek.com](https://marketplace.aviationweek.com) for more information.



AVIATION WEEK  
**MRO**  
AMERICAS

Uniting the MRO Americas and MRO Europe audiences for one truly global, virtual event!

AVIATION WEEK  
**MRO**  
EUROPE

# MRO TransAtlantic

October 27-29

V I R T U A L



## WHEELS UP THIS OCTOBER!

**SPEAKERS INCLUDE:**



**Christoph Blaha**  
VP Technical Service,  
Luxair



**Antonella Del Gaizo**  
Head of Maintenance  
Improvement & Sales,  
Alitalia



**Pradeep Fernandes**  
Managing Director,  
Confident Travel  
Initiative Strategy,  
Boeing



**Robert Isom**  
President,  
American Airlines



**Valerie Manning**  
SVP,  
Customer Support,  
Airbus



**Jeff Martin**  
COO,  
WestJet



**Dave Ricketts**  
Vice President and  
Transportation Portfolio  
Lead: Americas  
DXC Technology



**Boris Rogoff**  
Technical Director,  
Vueling



**Constance von Muehlen**  
Senior Vice President,  
Maintenance &  
Engineering,  
Alaska Airlines



**Mark Wibben**  
VP, Technical Operations  
Engineering & Programs,  
Southwest Airlines

Multiple price points for entry! [mrotransatlantic.aviationweek.com](https://mrotransatlantic.aviationweek.com)

Download the MRO TransAtlantic brochure for the latest updates and a 25% savings!

AVIATION WEEK  
NETWORK

#MROTAV |     



### Thank You to Our Sponsors

Platinum Sponsors



Gold Sponsors



Custom-repaired flange:

***Thousands of  
dollars saved.***

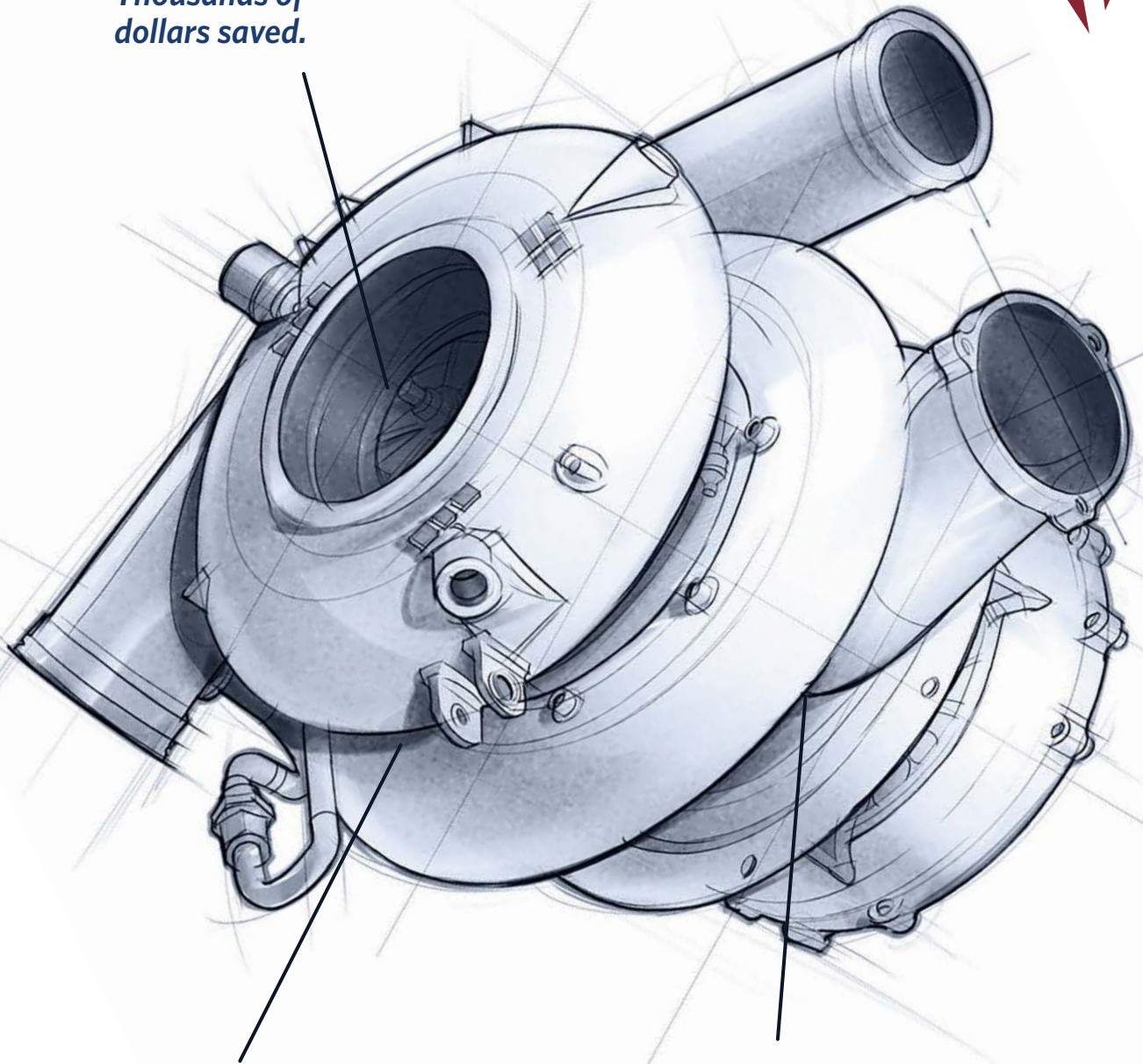

Corrosion-free bearing plate:

***Hundreds of cool,  
comfortable passengers.***

Longer-lasting compressor shroud:

***More uptime for your fleet.***

## **A small component repair that translates into big savings.**

 **DELTA**  
**TechOps**

We know a lot about your air cycle machine. Like that when one isn't working, passengers will get heated. Or that our DER repair costs 50 percent less than the standard OEM replacement — and lasts longer. So, if you want an MRO that will give your bottom line a lift, visit [DeltaTechOps.com](https://www.DeltaTechOps.com) and learn how our Oper-chanics mindset can work for you.



# Project Bee

## Hydrogen-powered B-57B

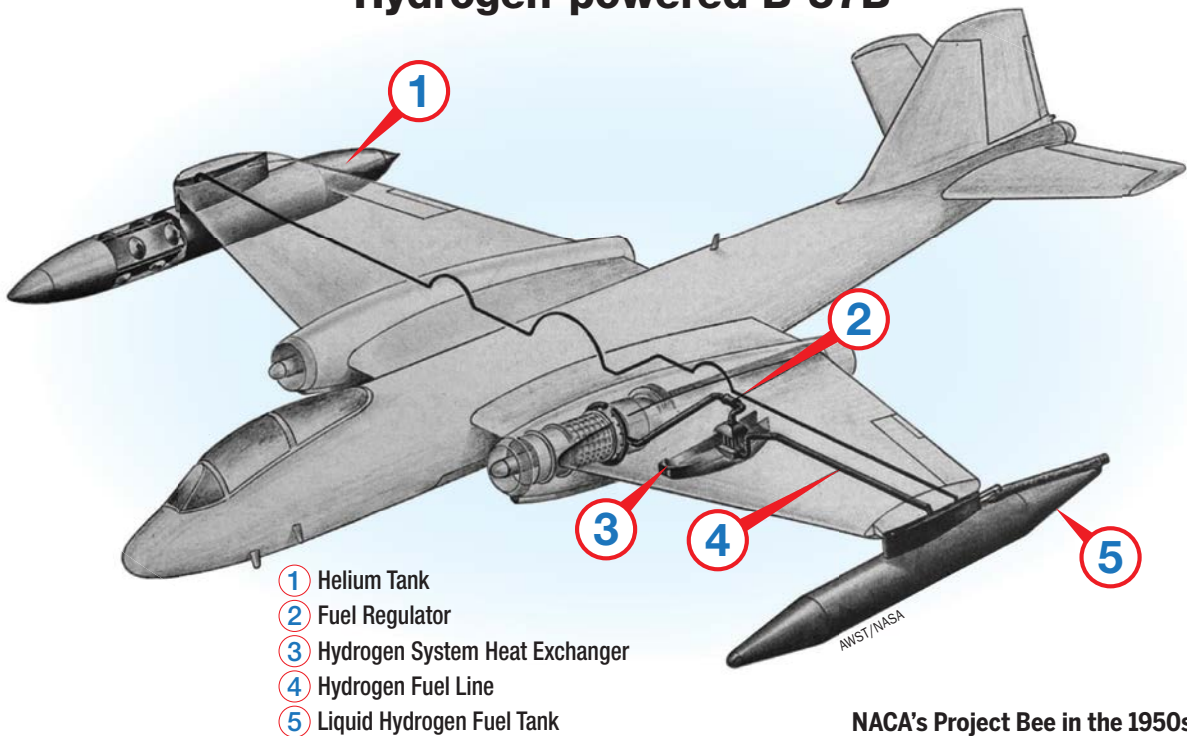

**NACA's Project Bee in the 1950s proved the feasibility of using liquid hydrogen in flight for air-breathing jet propulsion.**

NASA forerunner NACA (National Advisory Committee for Aeronautics), for the U.S. Air Force under a classified effort dubbed "Project Bee."

With the aim of researching the potential benefits of hydrogen fuel for high-altitude aircraft, the B-57B was flown with LH<sub>2</sub> stored in the left wingtip tank and pressurized helium in the right wingtip tank. The helium was used to force the LH<sub>2</sub> out of the tank to the left engine via a heat exchanger, which vaporized the fuel before injecting it into a modified combustor. The engine, which was switched from regular JP-4 fuel to hydrogen during the flight, operated smoothly throughout. Altitude chamber tests in NACA's Lewis Flight Propulsion Laboratory also showed stable combustion with hydrogen was possible in the J65 up to 89,000 ft. compared with 65,000 ft. for JP-4, while fuel consumption was up to 70% lower with hydrogen.

Combustion itself also represents challenges, although hydrogen burns easily and quickly. A combustion temperature around 100F hotter than kerosene provides opportunities for shortening the combustor section and therefore the engine length. However,

hotter temperatures create the potential of generating additional nitrogen oxides (NO<sub>x</sub>), which contribute to the greenhouse effect. "People will be looking at designs of combustion systems that will allow control of that temperature because you don't want to solve the CO<sub>2</sub> problem at the expense of making a NO<sub>x</sub> problem," Newby says.

One such design is under evaluation as part of the European Union's Horizon 2020-backed EnableH2 (enabling cryogenic hydrogen-based CO<sub>2</sub>-free air transport) research effort. Coordinated by Cranfield University, England, the project partners include GKN Aerospace, Safran, research management company Arttic, Heathrow Airport, the European Hydrogen Association and other universities in London and Sweden. Due to run through August 2021, the three-year €4 million (\$4.7 million) program is focused on revitalizing enthusiasm for LH<sub>2</sub> in civil aviation and, specifically, maturing advanced "Micromix" combustor technology and fuel-heat-management systems.

Bobby Sethi, EnableH2 project leader and deputy director of research for Cranfield's School of Aerospace,

Transport and Manufacturing, says: "We recognize that we cannot combust hydrogen in a standard conventional combustion system. This is because we've seen that at stoichiometric conditions, hydrogen flame temperatures are very high, and we'd be producing an excessive amount of NO<sub>x</sub> if we do not have perfect fuel and air mixing. And we could potentially achieve this through premixing, but that would not be acceptable because of the safety issues associated with premixing."

Originally proposed by Aachen University in Germany during the Airbus Cryoplane project in 2000, the Micromix combustor concept relies on thousands of very small injectors rather than the small number of large injectors usually found in current designs. "We can still retain a diffusion flame but enhance the fuel-air mixing and therefore eliminate or reduce substantially these localized hot spots that would burn at high temperatures," Sethi says.

Updating progress on EnableH2 at the American Institute of Aeronautics and Astronautics/Electric Aircraft Technologies Symposium virtual conference in August, Sethi

said: “There’s a big design space that we need to explore to optimize the design of these injectors. The Micro-mix allows us, in combination with hydrogen’s wider flammability limits and lower residence time, to attack the key technological challenge, which will be the combustion system by hydrogen-fueled gas turbines.”

Testing includes controlling the fuel flow in the injector array. “This means we can control outlet temperature distributions without the need of the dilution zone, and we don’t have the luxury of a dilution zone anymore in the combustor, because we have to use all this air to facilitate the lean combustion,” Sethi said. “We’ve also done some studies to show that thermal

acoustic instabilities that we encounter as we go to lean combustion could be again controlled through clever fuel scheduling in the injector array.”

Advanced combustor configurations are also under study by GE Aviation, which says it is working “to accelerate enabling technologies required to support transition to LH<sub>2</sub>.” Very high hydrogen flame speed “leads to extremely short flames that require careful aerodynamic design,” the company adds. “Increased combustor velocities may also require higher pressure drops that negatively impact engine performance.” The design challenges “imply that LH<sub>2</sub> fuel is not a simple drop-in,” GE Aviation notes. “Aircraft engines present additional

challenges for transient operations that require precise fuel control.”

GE is leveraging the industrial design experience behind the aeroderivative engine operations of its Gas Power division, which has installed more than 70 gas turbines around the world that burn hydrogen blended with other fuels to generate electricity. Developed originally as part of a U.S. Energy Department program to design a high H<sub>2</sub>-concentration-capable gas turbine, the technology could help further GE’s progress toward potential aircraft engine concepts.

Possible areas where GE’s industrial engine know-how may be useful range from starting and shutdown procedures—including hydrogen

## Europe Outlines Cooperation Between Hydrogen and Aviation Industries

- > EUROPEAN COMMISSION PLANS HYDROGEN INFRASTRUCTURE
- > AVIATION TO BENEFIT FROM PROGRESS IN OTHER INDUSTRIES

**Thierry Dubois** Lyon

**T**he European aviation industry, led by Airbus and under pressure from governments, is jump-starting a conversion to hydrogen as the primary means of energy usage and storage in future aircraft.

The European Commission (EC) and some major EU member states such as France and Germany are working simultaneously on stimulus packages and long-term plans for decarbonizing hydrogen production and increasing its use. This means players in commercial aviation may expect to benefit from progress made in other sectors. It also implies, however, that aviation will compete for hydrogen volumes.

Meanwhile, the hydrogen and aviation industries will have to find a way to work together. There are several factors encouraging this push toward hydrogen technology. Battery technology progress has been deemed too slow. Relying only on the use of sustainable aviation fuels, while a drop-in solution, is a risky strategy, notes Ron van Manen, head of strategy for the Clean Sky 2 Joint Undertaking, a public-private partnership for aviation re-

search and technology in Europe. “You are not sure about volumes, and it only has a net CO<sub>2</sub> effect, as CO<sub>2</sub> is still emitted at some point,” he says. “Hydrogen is a compelling research theme, a ‘high-risk, high-reward’ option, but with big implications downstream and upstream . . . including the safety case.”

It also is seen as the required companion to renewable energies. Wind turbines and photovoltaic panels do not necessarily produce power when needed and hydrogen can be one reservoir, van Manen says. It then can be used directly or as an ingredient in the production of synthetic fuel. “There is no silver bullet to create a green aviation, but the combination of renewable energies and hydrogen is key to aviation’s low-carbon future,” he says.

New levels of renewable electric power production will be needed, he adds. The role of nuclear plants in powering electrolyzers for hydrogen production has yet to be defined.

The EC considers hydrogen “green” if it is produced with renewable energy sources, as opposed to hydrogen produced from fossil fuels. The



AIR LIQUIDE



purge requirements—to fuel injection technology and experience for combustor flashback avoidance and NOx emissions. “Some areas that present new challenges are thermal management of LH<sub>2</sub>, hydrogen embrittlement and sealing the fuel system for safety,” GE adds.

Michael Winter, Pratt & Whitney senior fellow for advanced technology, stresses that while existing engines may be adapted to LH<sub>2</sub> as an interim measure, the full benefits of switching to hydrogen will be gained only by developing more integrated engine designs with thermodynamic cycles that take advantage of the fuel’s stored energy and heat sink capacity. “If you just burn it, you’re throwing a lot of oppor-

tunity away,” he says. “In terms of the operation of an aircraft, that’s going to be true as well. As an industry, we need to embrace all the efficiency measures that are available to us.”

Pratt & Whitney plans to explore the possibilities of modifying the PW1100G geared turbofan for use with LH<sub>2</sub>. “Most likely, it wouldn’t make sense to modify today’s engines to just burn hydrogen,” Winter underlines. “You’ll probably want to design your engines differently—also recognizing that the existing engines are going to be in the fleet for the next 30-plus years. The technology for the engines and airplanes that we are designing now need to reach [technology readiness level 6] by 2025 to enter the fleet in the early

2030 time frame and are going to be in the fleet to 2065. So you’re better off going with something that will work with the existing fleet, such as SAF, for the foreseeable future.”

As with GE and Rolls-Royce, Pratt & Whitney believes the fundamental gas turbine has a lot of runway ahead of it, with more room for efficiency improvement. “We don’t control the timing of the introduction of new aircraft,” Winter says. “But we do invest in technologies, and it’s going to require the full basket of measures to [reach] the goal of achieving 50% of 2005 emissions levels by 2050. And those include continued growth and efficiency of aircraft engines on the order of 1.5-2% per year as well as operational improvements.”

The European Commission has devised a strategy for the production of decarbonized hydrogen, such as with this Air Liquide pilot plant in Denmark.



French government, which wants to make the most of its large electro-nuclear power capacity, instead references decarbonized energy sources. Thirteen countries in the EU operate electro-nuclear power plants.

Some choices are already being made in the aviation sector. At the beginning of the summer, Airbus CEO Guillaume Faury said his engineers were reviewing every option. But some picks have come quickly, as shown with the “concept planes” unveiled in September (*AW&ST* Sept. 28-Oct. 11, p. 16).

All three concepts use liquid hydrogen, as opposed to gaseous, compressed hydrogen. Gaseous hydrogen stored at 700 bar would require a prohibitively heavy tank, some researchers contend. The suitability of liquid versus gaseous hydrogen can be measured with the gravimetric index—the ratio between the fuel’s mass and the combined mass of the fuel and its tank. By that measure, liquid hydrogen is believed to be a better fit than its gaseous form.

But progress is needed in designing liquid hydrogen tanks that work for aviation, and other challenges remain. One is the required storage temperature, -253C (-420F). In addition, liquefaction is exothermic, meaning energy is lost in the process.

The second of Airbus’ defining choices will look at burning hydrogen in turbine engines instead of using it to produce electricity in a fuel cell. The latter’s efficiency, at 55-60%, compares favorably to that of a gas

## HYDROGEN IN AVIATION

turbine—40-45%, according to consultancy McKinsey & Co. But the key factor was probably weight—a turbine engine's power density (or power per weight unit) is greater.

Selecting liquid hydrogen and turbine engines will shape aviation's research and technology work over the next decade. That work will benefit from a Europe-wide all-encompassing endeavor. The EC has devised a "hydrogen strategy for a climate-neutral Europe," where hydrogen is characterized as an important part of the approach to meeting the 2050 climate neutrality goal in the European Green Deal.

The aim of the strategy is to "decarbonize hydrogen production—made possible by the rapid decline in the cost of renewable energy and acceleration of technology developments—and to expand its use in sectors where it can replace fossil fuels," the EC says.

In the first phase (2020-24) the EC's objective is to decarbonize existing hydrogen production for current uses, such as in the chemical sector. It will also promote it for new applications.

This phase relies on the installation of at least 6 gigawatts of electrolysis capacity, with the goal of producing up to 1 million metric tons annually of renewable hydrogen. By comparison, approximately 1 gigawatt of electrolyzers are installed in the EU today, the EC says.

In the second phase (2024-30), more electrolyzers are planned to be installed, reaching a total 40 gigawatts. Total annual production of renewable hydrogen would thus be increased to 10 million metric tons by 2030. Hydrogen use will gradually be expanded to sectors such as steel production, truck and rail propulsion, and some maritime transport applications. It will still mainly be produced close to the user or close to the renewable energy sources, in local ecosystems.

In a third phase, between 2030 and 2050, renewable hydrogen technologies should reach maturity and be deployed on a large scale to reach all sectors, even those currently difficult to decarbonize.

Aviation is seen as one of those sectors. The good news is that such a time horizon is compatible with aircraft development time frames, including the creation of an infrastructure, van Manen notes.

Aviation may also benefit from cumulative investment in renewable hydrogen in Europe, which will total €180-470 billion (\$210-550 billion) by



**Airbus is studying various concepts but has already chosen to use hydrogen, in its liquid form, in turbine engines.**

AIRBUS/IVS

2050. And the EC is betting on a fast decrease in the cost of renewable hydrogen. "Electrolyzer costs are expected to halve by 2030. . . . In regions where renewable electricity is cheap, electrolyzers are expected to compete with fossil-based hydrogen in 2030," the commission anticipates.

The strategy outlines an investment agenda for production, transport and storage, as well as the retrofitting of the existing gas infrastructure. The EC will support the deployment of hydrogen "by incentivizing private investment, with a strong leverage effect" through the newly formed European Clean Hydrogen Alliance.

"Among the members of the alliance, there are already companies with interest in hydrogen use for synthetic aviation fuels," an EC official says. "We will ensure that the alliance sets ambitious milestones for investment in clean hydrogen projects that contribute to climate neutrality."

For infrastructure, regional airports may have to rely on a handful of trucks for daily hydrogen delivery. Larger hubs may have to resort to a gaseous pipeline from a nearby electrolysis unit and a dedicated liquefaction facility at the airport, McKinsey & Co. suggests.

While aviation will benefit from common infrastructure and technologies, some issues are specific to the sector.

Aircraft refueling is one, with turnaround time a significant contributor to operating costs, van Manen notes.

Collaborative efforts to address the issue are underway. Energy conglomerate Engie and space launcher manufacturer ArianeGroup have signed a cooperation agreement regarding renewable liquid hydrogen "to accelerate the decarbonization of heavy-duty and long-distance transportation," chiefly maritime.

As Airbus and Safran are ArianeGroup's only shareholders, the commercial aircraft industry can expect to benefit from the joint effort. Most of the aerospace sector's current expertise in hydrogen involves work on space launchers. In addition, commercial aircraft OEMs and system suppliers have been looking into nonpropulsive applications of hydrogen, such as for auxiliary power units.

The proposed joint undertaking for hydrogen research will include aviation in its road map. It will involve aviation and hydrogen specialists, intersecting the two sectors, van Manen says.

Recovery funding schemes at EU and national levels will help. Unlike other programs, recovery funding is spent essentially over the first three years. This means there is the potential for an aggressive start in 2021-23, van Manen says. 🌐





WHEN IT COMES TO PERFORMANCE,  
WE'RE YOUR WINGMAN.

**PEACE OF MIND, SINCE 1948.**

Count on The Lee Company for relentless support and unsurpassed reliability. That's been our approach for over 70 years, which has placed our field-proven Microhydraulic fluid control components on board every military and commercial aircraft flying today. So, whether you need a standard or custom-engineered solution, choose The Lee Company and relax. We've got your back.

Your Microhydraulics Flight Manual.  
The Lee *Technical Hydraulic Handbook* has, for decades, served as the industry-standard engineering reference for hydraulic components. Request your free copy today at [www.theleeco.com/new-hydraulic-handbook](http://www.theleeco.com/new-hydraulic-handbook).



**The Lee Company** 860-399-6281 • [www.theleeco.com/aerospace](http://www.theleeco.com/aerospace)  
WESTBROOK • LONDON • PARIS • FRANKFURT • MILAN • STOCKHOLM



# Newer Actors Driving Evolution of ATM

- > NEWER AIRSPACE ENTRANTS REPRESENT NEW REVENUE
- > FAA EXPECTS TO CERTIFY UAM AIRCRAFT BY 2022

**Bill Carey** Washington

**W**ith aircraft movements reduced, technology deployments slowed and many professionals working from home because of the COVID-19 pandemic, the air traffic management industry is contemplating future operational scenarios and what were once considered nontraditional actors in the airspace system.

low-altitude flights, and integrated manned and unmanned aircraft operations is driving the need for new air traffic management (ATM) procedures and regulations, says the International Civil Aviation Organization (ICAO).

“With unprecedented innovation taking place in the aviation industry, and with the current COVID-19 situation, the long-held assumptions of the future of the aviation industry will be substantially reshaped,” the U.N. agency advises.

Air navigation service providers that are struggling to remain financially viable during the pandemic,

Despite the pandemic’s impact on traditional aviation operations, the development of small drones, urban air mobility (UAM) vehicles, supersonic jets, commercial spacecraft and

high-altitude pseudo-satellites (HAPS) and balloons continues apace.

The envisioned mix of new electric- and jet-powered vehicles with differing performance characteristics, high- and

as well as third-party service providers, see nontraditional airspace actors as a potential source of new revenue streams.

The state-owned Kenya Civil Aviation Authority (KCAA) is deriving revenue from high-altitude balloons.

An Airbus Zephyr S high-altitude pseudo-satellite aircraft set a flight endurance record of nearly 26 days in August 2018.

AIRBUS

In July, Telkom Kenya and Alphabet's Loon launched a new mobile internet service in Kenya. Loon supports the network with a fleet of 35 balloons, each equipped with LTE wireless base stations, that move in constant motion through the stratosphere at 20 km (65,000 ft.) over eastern Africa.

"That is a revenue stream for us because we charge them navigation fees like other airplanes," says KCAA Director General Gilbert Kibe.

With the number of traffic operations at U.S. Core 30 airports down 51% from normal in mid-September, drones and UAM vehicles figured prominently during the annual Air Traffic Control Association (ATCA) Technical Symposium, held virtually because of the coronavirus pandemic.

Describing his branch as a kind of gateway into the airspace system, Earl Lawrence, executive director of the FAA's Aircraft Certification Service, said that his office is working on numerous type certification (TC) projects involving electric vertical-take-

drones under Part 91 operating rules that apply to general aviation pilots and 32% under Part 135 for commercial air-carrier services.

The balance of 24% of applicants seek to operate drones under both Part 91 and Part 107, the regulation that applies to commercial drones weighing less than 55 lb., says Lawrence.

"I have four active formal TC applications for electric vertical-lift aircraft right now that are going to be the urban air mobility aircraft of the future," he told the ATCA symposium. "These aren't concepts; these are full-up active type certification projects. And I expect to be issuing a type certificate to one of these aircraft prior to 2022."

The branch is also processing multiple applications for supplemental type certificates (STC) to modify existing aircraft with automated flight decks, "literally putting robots in the seats and taking the crews away, particularly for cargo operations," said Lawrence. "Those are active STC applications, mostly for study right now, but

The space office supported as many launches in August as it did in 2010-11 combined, notes Wayne Monteith, FAA associate administrator for commercial space transportation. "Even with a global health emergency, AST is still looking at our busiest year ever, and we're gearing up to provide 50, 75, 100 operations a year in the near future," Monteith told a virtual meeting of the Commercial Space Transportation Advisory Committee.

While commercial space activity has ramped up, the FAA had not activated the space data integrator (SDI), a system that feeds telemetry data from rockets as they transition through the airspace into the agency's traffic flow management system. Years in development, the SDI will help reduce the amount of time and airspace the FAA fences off during launches. Slated to enter service in August, the system has been delayed because of restrictions imposed during the pandemic.

The lapse in traditional air traffic movements has not made AST's job any easier, FAA Deputy Administrator Dan Elwell informed the ATCA symposium.

"The SDI is not up and running yet," Elwell acknowledged. "The launches haven't been made easier because we give out launch licenses, and the work of giving out a launch license has not changed. We have been able to refine the [launch] window more dynamically, and that's been a collaborative effort between the operator and the FAA. We have gotten much better both at the airspace we protect and how long the period of time the window is open."

In March, the FAA released Version 2 of its UAS Traffic Management (UTM) concept of operations. The Version 2

off-and-landing (eVTOL) aircraft and drones intended for infrastructure inspection and delivery missions.

The branch is processing 30 unmanned aircraft system (UAS) type certification applications. Of those applicants, 44% are seeking to fly

they are coming our way."

The FAA's Office of Commercial Space Transportation (AST) had licensed 32 commercial space launches as of mid-September and expected to authorize as many as four more during the fiscal year, setting a new record.

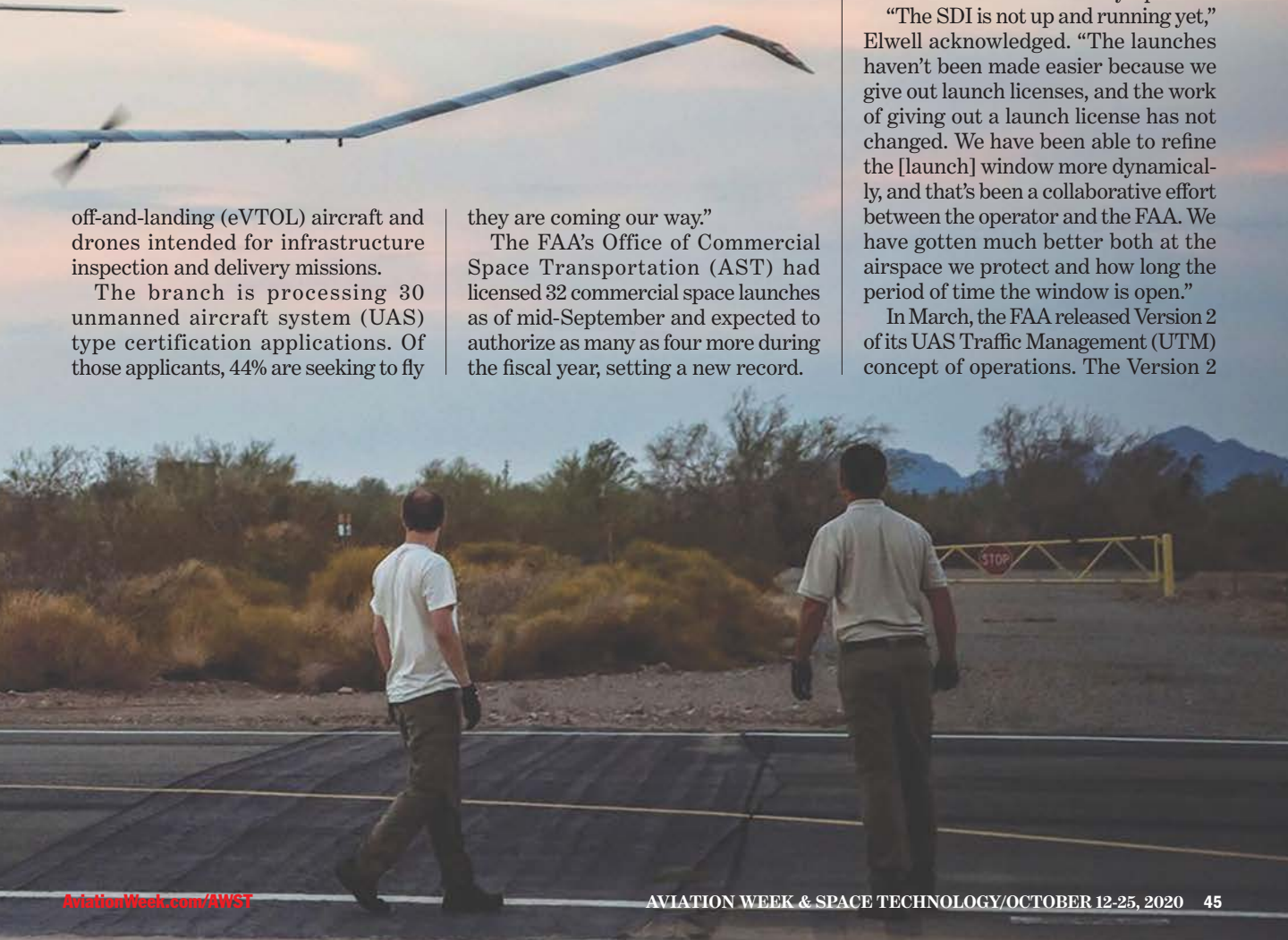



The SpaceX Falcon 9 Starlink-11 mission launched from Kennedy Space Center, Florida, on Sept. 3.

SPACEX STARLINK



document describes a framework for managing drone traffic up to 400 ft. above ground level, but also addresses increasingly complex operations traversing Class G uncontrolled airspace and other classes of controlled airspace.

The product of a concept originated by NASA in 2013, UTM is founded on a cloud service infrastructure supported by third-party UAS Service Suppliers, acting under the FAA's regulatory authority, to cooperatively manage low-altitude drone flights through networked information exchanges.

The UTM construct is being validated by the FAA in a second round of field demonstrations. In April, the agency selected the Virginia Tech Mid-Atlantic Aviation Partnership in Blacksburg, Virginia, and Griffiss International Airport in Rome, New York, to test the provision of drone traffic management services under its UTM Pilot Program Phase 2 effort. Data collected during the exercise "will help inform a cross-agency UTM Implementation Plan," the FAA says.

The ATM units of Boeing and Airbus have produced a joint vision of a single, integrated airspace management system extending up from the ground and encompassing all airspace users. They briefed ICAO's Air Navigation Commission on the vision in mid-June, in a presentation called "A New Digital Era for Aviation."

The manufacturers anticipate the merger of UTM and ATM, a convergence that weaves together airspace realms using automation, digitalization and connectivity as common threads. Those technology pillars underpinning UTM will migrate into an airspace system that still relies in large part on human monitoring and intervention and radio-based communications between pilots and controllers.

"In order to make sure that we can integrate different types of vehicles—

not only for small drones, not only for the lower part of the airspace—we see UTM as a huge opportunity," says Isabel del Pozo de Poza, Airbus vice president and head of UTM.

"It's explicitly the ambition that we share with Boeing, to develop vehicles that can be globally integrated and serve the purpose of the end users,"

A Loon high-altitude balloon carried an LTE antenna, with a mobile gantry crane launcher in the foreground.



NOOT

adds del Pozo in an ICAO video interview. "This needs to be managed in an interoperable way according to global standards and global ways of understanding traffic management. It goes hand in hand with the development of the vehicle."

Boeing, explaining the joint presentation in a statement to Aviation Week, said: "The aim is to engage all aviation stakeholders by sharing future expectations for airspace and traffic management that will safely accommodate new vehicle operations with existing aircraft. In particular, the ATM system will need to continue to adapt to enable near-term operations as well as support longer-term industry growth and innovation."

In May, the FAA released a Version 1 concept of operations (conops) for

Upper Class E Traffic Management (ETM) of air vehicles operating above 60,000 ft. The document arose from tabletop exercises that NASA's Ames Research Center hosted with the FAA and aerospace companies in April and December 2019 to gain an understanding of planned flight operations at those less-traveled altitudes.

Industry participants in the exercises were Aerion Corp., developer of the AS2 supersonic business jet; Northrop Grumman, manufacturer of the RQ-4 Global Hawk high-altitude, long-endurance UAS; Loon, the Alphabet subsidiary advancing high-altitude balloons; Sceye, developer of stratospheric airships; and AeroVironment, Airbus and Boeing Aurora Flight Sciences, developers of the solar-powered, fixed-wing Hawk30, Zephyr and Odysseus HAPS aircraft, respectively.

There are currently no airspace

management provisions specific to civil aircraft operations at that level, the FAA says. The applicable regulations are for operations in Class E airspace at lower altitudes—generally controlled airspace up to 18,000 ft. that is not otherwise classified.

ETM will draw from the same UTM construct that NASA Ames conceived with small drones in mind.

"While ETM development leverages UTM conceptual elements where possible, its cooperative separation environment is modified to support characteristics unique to the airspace—long duration, multinational flights, extreme deltas between vehicle speeds and performance characteristics and high-altitude safety risks, among others," the conops document states. 🌐

# UK NATS Raises Revenue by Offloading Radar Sites

- > AIR TRAFFIC VOLUME OVER THE UK REMAINS DOWN
- > NATS STOPS EDUCATING NEW CONTROLLER TRAINEES

UK NATS plans to deploy a new radar capable of filtering out false returns from wind turbines at its Lowther Hill site in Scotland by late 2021.

**Bill Carey** Washington

**U**K NATS is selling a number of dormant radar sites as well as leasing space at other locations to reduce its costs and raise revenue during the COVID-19 pandemic—moves made possible, it says, by advances in technology.

“This is absolutely not about selling off the family silver,” says Paul Hughes, NATS head of assets and development, in an Oct. 1 announcement of the land sales.

“We are maintaining full ownership and access to all our critical infrastructure,” Hughes adds. “But where we have land and accommodation we no longer need, it makes sense to find a better use for it, while also helping us reduce our maintenance and running costs at what remains a very difficult time for the aviation industry.”

The UK air navigation service provider (ANSP) is divesting unused radar sites at a time when the air traffic activity it manages stands at 40% of the level it handled a year ago. As with other ANSPs in Europe, the public-private partnership, which is 49% owned by the UK government, has been hit hard by the pandemic-related lapse in air travel and the resulting loss of revenues it generates through its air traffic services.

At the front end of the pandemic, in March and April, NATS controllers managed only about 10% of normal traffic levels. In mid-April, the ANSP received a £92 million (\$119 million) loan from Eurocontrol to help cover its operating expenses. NATS En Route, its operating subsidiary, furloughed more than half of its staff.

But air traffic in Europe has not rebounded as ANSPs had hoped.

“In our response to the impact the pandemic is having on the aviation industry, we have prioritized protecting operational jobs to ensure we have the capacity to manage traffic when it returns to 2019 levels,” NATS CEO Martin Rolfe wrote in a Sept. 16 blog post. “That’s why we did not include our controllers in the voluntary redundancy program we launched in August, under which we will sadly say goodbye to several hundred of our nonoperational colleagues by November.”

In September, NATS notified 122 controller trainees at its college in Whiteley, Hampshire, that it was ending their instruction. A review of training needs with the Prospect trade union had concluded that “there is no realistic scenario in which [NATS] will need further trainees from the college until

2022 at the earliest,” Rolfe wrote. “In fact, we will not have any capacity to support further new trainees at Swanwick, our biggest operational center, for the next two years.”

NATS is divesting unused radar sites and leasing other space while simultaneously modernizing its infrastructure.

On Sept. 28, the ANSP said it is investing in a new radar capable of filtering out false returns from wind turbines at its Lowther Hill, Scotland, site. Long-range surveillance radar at that location provides coverage of the central belt of Scotland, including the cities of Glasgow and Edinburgh, the southern part of the country, northern England and parts of the Irish Sea and Northern Ireland.

Expected to enter service in late 2021, the new radar will replace the Raytheon ASR-23 L-band primary surveillance radar now at Lowther Hill. NATS declined to identify the supplier or the cost of its investment, saying it plans to release a tender for its next radar replacement program soon and does not want to prejudice that process.

The NATS press release announcing the new wind turbine mitigation radar describes it as a shared investment “with developers that benefit from it, then [contribute] to its ongoing operation.”

Separately, Raytheon’s UK subsidiary on Sept. 29 announced that it has completed the construction of a new radar testing and training facility at Solent Airport in Hampshire, England, on behalf of NATS. The new Radar Reference Facility comes with a contract Raytheon UK won in June 2016 to supply primary surveillance and Mode S monopulse secondary surveillance radars at 23 sites across the UK.

NATS says it has 70 acres of land available for sale at six radar sites and has heard from potential buyers, including home builders and local entrepreneurs. As part of its broader strategy of responding to the coronavirus pandemic, it has partnered with Shared Access, an owner and operator of shared wireless communications towers, to lease space at some sites to mobile telecommunications companies.

“We have 124 sites all over the country that would be perfect locations for mobile phone networks to put their own masts and antennas, helping to improve coverage in harder-to-reach locations and giving us a new source of income,” Hughes says. 📍



# Electric R44 Offers an Alternative Path to Urban Air Mobility

- > UNITED THERAPEUTICS IS FUNDING ELECTRIC R44 CONVERSION FOR ORGAN TRANSPORT
- > ECO HELICOPTERS WILL USE FOR ON-DEMAND AIR-TAXI SERVICE IN LA

**Graham Warwick** Washington

Seeking an early foothold in the urban air mobility market, a program has been launched that provides a pathway through electrification of the Robinson R44 helicopter. Modification of the four-seat, piston-engine R44 to electric propulsion is already underway for the organ transport mission.

Rather than asking investors to wait years for their returns, Eco plans to sell new R44s to owners then lease them back and operate them under its Part 135 charter certificate. Owners will prepay for their modification to electric EcoMax helicopters once the STC is available.

TIER 1 ENGINEERING



**Tier 1 Engineering flew a proof-of-concept battery-powered Robinson R44 in 2016.**

Rather than wait for certification of an electric vertical-takeoff-and-landing (eVTOL) aircraft and then set up an air taxi service, Southern California-based Eco Helicopters plans to begin operations with R44s that will be converted to electric propulsion once a supplemental type certificate (STC) is approved.

United Therapeutics has contracted with Tier 1 Engineering to develop and certify an electric propulsion unit for the R44, to be used primarily for the delivery of manufactured organs for human transplants. Tier 1, which flew a proof-of-concept battery-powered R44 in 2016 with funding from United Therapeutics, has an agreement to provide the modification to Eco Helicopters for air-taxi use.

This will give owners immediate revenue from Eco's operation of standard R44s, which will increase when the helicopters are converted to electric propulsion with its lower operating costs. Eco plans to begin on-demand R44 operations in the Los Angeles basin in the second quarter of 2021.

Eco has been formed by Palm Springs-based OC Helicopters, an established helicopter charter operator. Using R44s leased back from owners and earmarked for conversion to EcoMaxs, Eco plans to offer urban air mobility (UAM) flights between 12 airports across Southern California already served by OC.

The electric-powered EcoMax will have a shorter range than the av-

gas-fueled R44, but sufficient flight endurance between battery recharging or swapping to cover the same service area. "It won't fly to 2.5 hr., but it will fly the same routes," says Eco CEO Ric Webb, who was project test pilot for Tier 1's prototype conversion, setting a world distance record for an electric-powered helicopter of 30 nm in December 2018. At the time, Tier 1 said it expected range to increase as batteries improved.

Following the record flight, "we decided if we could bring all the pieces of the puzzle together—the aircraft, electric propulsion unit, Part 135 certificate and booking app—we could do what the other UAM companies are trying to do," Webb says.

The team developing the R44 electric modification "has been working for many years and is at the tail end of getting the STC. Do we wait for the STC then start selling or do we get close enough to start buying aircraft?" Webb says. Basing the launch decision on the lead time for new R44s and expected timing of the STC, "this was the quarter to do it," he says.

"Putting money down on an eVTOL aircraft, going through certification, getting ready for market, finding a Part 135 operator—that's years an investor is holding paper. Type certification and 135 approval take time. We can start building the business today, then swap in electric. No one else can do that," Webb says.

"In our model, we don't call them an investor; we call them a purchaser," he says. "The helicopter is in their name, and that reduces the revenue risk of entering the UAM market. If they need out, it is simple to get out. We save the Lycoming motor, put it back in and give them back the aircraft. It's a safer bet."

The price to buyers includes a "fully decked out" new R44, a set-aside for the electric propulsion unit and its retrofit cost, plus a contribution toward funding final development of the STC, says Gary Standel, managing partner of Eco's marketing partner KiloWatt Aviation.

In return, owners will get a stipend from net operating revenue that Standel says will "skyrocket" after conversion of their R44s to EcoMaxs because of the "roughly 50%" reduction in direct operating costs from electrification of the propulsion system. ☛

## Swedish Startup Targets Zero-Emissions Regional Flying



- ALL-ELECTRIC 19-SEATER AIMS FOR 2026 SERVICE ENTRY
- PROPULSION SYSTEM RUNNING IN GROUND-TEST RIG

**Graham Warwick** Washington

Sweden's aerospace industry is known for producing aircraft uniquely suited to the country's operating conditions. Some, like the Saab 340 regional airliner, have achieved international success.

Now Sweden and its Scandinavian neighbors want to take the lead in electrifying aviation to reduce carbon emissions: Norway wants all domestic flights to be electric by 2040, while Sweden wants air transport to be fossil-free by 2045.

Launched to capitalize on the region's interest in zero-emissions aviation, Swedish startup Heart Aerospace on Sept. 24 unveiled the electric propulsion system for its planned 19-seat regional airliner, the ES-19. The company has begun ground tests of the motor, motor controller and battery pack—developed internally with supplier partners—on a test rig at Gothenburg's Save Airport.

The high-wing ES-19 has four propulsion system nacelles, each housing a dual-redundant lithium-ion battery pack, dual controllers and a large electric motor with dual windings for redundancy. The ground-test rig represents a single propulsion nacelle, including the propeller.

Battery energy density is 200 Wh/kg at the pack level using automotive cells, which is sufficient for a 400-km (215-nm) operating range including reserves, says Heart founder and CEO Anders Forslund. He expects

**Heart's ES-19 is a 19-seat regional airliner concept with four all-electric propulsion modules in nacelles under the wing.**

initial electric aircraft routes to be 200-250 km.

Rated at 400 kW continuous power, the 650-mm-dia. (26-in.), 120-kg (265-lb.) electric motor produces high torque at low rpm, allowing it to directly drive the propeller and eliminating the need for a gearbox. The motor is 97% efficient, the controller 99.7% and propeller 88%, Heart says.

The slow-turning, low-noise seven-blade propeller is supplied by Germany's MT-Propeller. The inner part of a propeller blade does not generate much thrust, so Heart has taken advantage of the size of the propulsion nacelle and motor to enlarge the hub and reduce drag, Forslund says.

Planning to certify the ES-19 under European Union Aviation Safety Agency CS-23 regulations, Heart says it has letters of intent from eight airlines for 147 aircraft valued at €1.1 billion (\$1.3 billion). The ES-19 is expected to enter service in 2026.

Optimized for a 180-kt. cruise speed, slower than a turboprop, the ES-19 has a conventional aluminum airframe. "We have concentrated our innovation on a very efficient propulsion system," Forslund says. The goal is low direct operating costs through reduced energy and maintenance expenses compared with regional turboprops.

Heart has designed its own motor controller so it can be tightly integrated with the battery pack. "The pack is

lightweight, but we put a lot of sensors in there. The key to unit economics and range is to understand what is going in the battery, to accurately model the state of charge and know if there are any cells not behaving properly," he says.

The ES-19 will be recharged between flights. The initial market is expected to be in Norway, which has committed to begin domestic electric flights by 2030. Charging the aircraft 1 min. for every 2 min. of flying will fit in with those operations, Forslund says. This will require 2 megawatts per aircraft, a charging standard already emerging for commercial trucks, he adds.

The startup has completed initial aerodynamic and structural design of the ES-19, and plans to ramp up staffing to begin preliminary design work once funding is in place. The team includes engineers with experience from the Bombardier C Series airliner and Zunum Aero electric regional aircraft.

Heart graduated from the Y Combinator accelerator in 2019 and is about to launch its Series A funding round, having received grants from the Swedish and Norwegian governments as well as the European Commission, Forslund says. A 20%-scale model is expected to fly by year-end, and a preliminary design review is planned for mid-2022, leading to a prototype flying in mid-2024. 🛩️



# WAR FOOTING

> ARMY'S AMBITIOUS DEMO LINKS WEAPONS ON FUTURE BATTLEFIELD

> THE SERVICE WILL HAVE TO PRODUCE "HUNDREDS" OF SOFTWARE ENGINEERS



An unmanned aircraft system used in Project Convergence 2020 attacked the enemy while carrying multiple payloads.

**Lee Hudson** Yuma Proving Ground, Arizona

**T**he U.S. Army realizes that whoever can harness artificial intelligence to shorten the decision cycle on the battlefield will win the next war.

Since 2017, the service has worked quickly to modernize its aging weapons, pursuing next-generation helicopters and artillery systems with a range of 500 km (300 mi.). Within the past year, service leadership launched Project Convergence, a technology experiment that would link modernization portfolios such as Future Vertical Lift or Long-Range Precision Fires. The goal calls for those new measures to work together with sensors, satellites and shooters to speed decision-making in a future conflict, Army Secretary Ryan McCarthy told reporters aboard an Air Force Boeing C-40 flight to see the endeavor in action.

Over 500 people took part in the inaugural Project Convergence experiment. The Army anticipates producing results and recommendations on the path forward by early next year, but it is already planning future iterations of Project Convergence. In 2021, the experiment will include the joint force, and in 2022 coalition partners will join the effort.

Yuma Proving Ground in Arizona served as home base for the six-week live test of key modernization technol-

ogies and weapon systems. A principal objective of Project Convergence is to advance and integrate the Army's contributions to the joint force via Multidomain Operations (MDO). The service took journalists from a group of publications, including Aviation Week, to view a live demonstration of Project Convergence at Yuma.

MDO is the Army's contribution to Joint All-Domain Command and Control (JADC2), which is a Defense Department concept to connect sensors from all the military services (Air Force, Army, Marine Corps, Navy and Space Force) within a single network. JADC2 is one of the Pentagon's top priorities, according to Gen. John Hyten, vice chairman of the Joint Chiefs of Staff.

The ambitious experiment, which included scenarios from different phases of a land invasion, culminated with a live demonstration featuring 34 new technologies.

The first phase, Penetrate, used satellites in low Earth orbit to detect enemy ground launchers for anti-aircraft missiles. The information was sent from space to a ground pro-

cessing station—the Tactical Intelligence Targeting Access (TITAN) node—located at Joint Base Lewis-McChord in Washington state. From there, the TITAN operator sent a target data message to Yuma, where a fire command was processed and sent to the Extended-Range Cannon Artillery (ERCA) system that will replace the Paladin.

Next, a scout helicopter—filling in as a surrogate for the Future Attack Reconnaissance Aircraft (FARA)—located the enemy air defenses' C2 node, a wheeled amphibious armored personnel carrier, using object detection artificial intelligence (AI) known as Dead Center. Air-Launched Effects (ALE) were then fired from the helicopter to provide a floating mesh network beyond 50 km, and an autonomously flying MQ-1C Gray Eagle swooped in at 300 ft.—far below its normal operating level of 10,000 ft.—to hit the target with a Hellfire missile.

The second phase, Disintegrate, intended to eradicate the remainder of an enemy's anti-aircraft capabilities. A FARA surrogate equipped with ALEs canvassed for other targets, sending that data back through the mesh network. An AI concept called Firestorm (FIRES Synchronization to Optimize Responses in MDO) took the data, mapped the battlefield,

and generated recommendations for which weapon was best positioned to hit the target. ERCA fired a shot, hitting a multiple-launch rocket system roughly 56 km away.

An MQ-1C transmitted target data based on visual information, without GPS or laser designation, to another Gray Eagle that attempted to hit the target with a GBU-69 munition. In this scenario, the Army faced a hiccup because the communication link was lost and the target was not hit.

The third phase, Exploit, located manned and unmanned vehicles patrolling the area. The Army employed Aided Target Recognition Software (AiDTR) to find targets such as armored transport vehicles. Firestorm sent Next-Generation Combat Vehicle (NGCV) surrogates to hit targets. A small unmanned aircraft system (UAS) equipped with AiDTR, Tarot, launched and detected infantry fighting vehicles. Firestorm directed soldiers to use mortars to suppress the adversary until they could hit the target directly. Soldiers in the NGCVs directed unmanned ground vehicles to launch small helicopter reconnaissance. As enemies continued to emerge, Firestorm sent recommendations on which weapons to fire.

Behind the scenes, Army personnel sat side by side with Carnegie Mellon University (CMU) staff to figure out how to get all the new equipment—the FARA surrogate, ALE, autonomous UAS, mesh network and fires—to work together. CMU received a five-year contract in the spring of 2020 to support research and development of an innovation framework for accelerating Advanced Algorithms, Autonomy and Artificial Intelligence (A4I) technologies.

The team was able to reduce the decision-cycle time from about 20 min. to 20 sec., made possible by leveraging space-based assets, an existing network and AI.

The Army employed “coding at the edge,” meaning software engineers were on-site in the desert’s 105F heat rewriting and updating algorithms in real time. One of the items Army Secretary McCarthy assessed while at the demonstration was determining the number of software engineers the service will need on a future battlefield.

“We’re going to have to produce hundreds of people,” McCarthy says.

McCarthy likens the push to have software engineers on the front lines

as similar to Wall Street’s move in the early 2000s to locate activities as close as possible to the stock exchange. This allowed firms to process trades milliseconds faster than competitors.

“They were literally fighting over office space in southern Manhattan to get closer to the exchange,” says McCarthy. “We have to get closer to the edge because the speed of finding a target and sending it to something that can process it—the speed of calling a fire mission, a medevac mission—that’s what we’re after.”

As with all experiments, not everything worked perfectly. For example, the video stream showed a weapon firing and the target still standing. “Aided target recognition, it’s brittle,” says Brig. Gen. Ross Coffman, NGVC cross-functional team director and director of Project Convergence. “We need more work [and] more sets, to continue to train and solidify [aided target recognition] and do it on the

The Air Force’s pitch for JADC2 is building an Internet of Things, known as the Advanced Battle Management System (ABMS), a system for network connectivity similar to the Army’s now-defunct Future Combat Systems. Initially, ABMS was supposed to replace the Northrop Grumman E-8C Joint Surveillance Target Attack Radar System, but the effort evolved into a JADC2 solution.

Air Force acquisition executive Will Roper acknowledged the similarity last month, but said the main difference is the Air Force is attempting the undertaking in the internet age.

“This is a program to touch everything we build,” Roper said. “Unlike [the Army’s] Future Combat Systems, we are doing it in a way that has never been attempted before. That’s why it just might succeed.”

Air Force and Army leadership met for staff talks on Sept. 24, and one of the topics on the docket was

### An air-launched effects system was loaded onto a Sikorsky UH-60L Black Hawk used at Project Convergence 2020.



move with rough terrain and stability systems. The air-to-air and air-to-ground coordination worked extremely well. The mapping worked very well. I’m very pleased, but we all have our eyes wide open.”

The exercise positions the Army for what will certainly be a budget battleground among military services. With defense budgets projected to stay flat regardless of who is in the White House, any effort connected to the Joint Chiefs of Staff-backed JADC2 is a growth area in which services can compete for funding.

how they will each contribute to MDO and JADC2, including how to reduce the sensor-to-shooter cycle time, according to Army Chief of Staff Gen. James McConville.

A key result of the staff talks is the Air Force and Army signing a two-year collaboration agreement to develop Combined Joint All-Domain Command and Control capabilities with a focus on defining mutual standards for data sharing on a future battlefield. The new initiative combines the Army’s Project Convergence with the Air Force’s ABMS. 🗨



## HALE UAS and Business Jets Join Army Vision for Airborne ISR



- > HIGH-ALTITUDE UAS ARE PART OF THE ARMY'S LONG-TERM PLAN
- > ANALYSIS OF ALTERNATIVES IS NEARING FOR HADES PAYLOAD

**Steve Trimble** Washington

**A** U.S. Army RQ-4D Global Hawk flying at 65,000 ft. detects a communication signal from an enemy's corps-level headquarters. The Global Hawk's processor uses a geo-location technique to cue the onboard signals intelligence (sigint) receiver, and synthetic aperture radar payloads verify the target and location. The targeting data is then relayed over the horizon to an Army Precision Strike Missile battery, which fires a round hundreds of kilometers downrange.

It may seem incongruous to envision an Army-owned, high-altitude, unmanned aircraft system (UAS) flying at heights now reserved solely for the U.S. Air Force's intelligence, surveillance and reconnaissance (ISR) fleet.

And it may feel unnatural for that Army-owned UAS to provide over-the-horizon targeting to an artillery system that is capable of reaching targets at distances now reserved only for the Air Force's stealthy bomber fleet.

But the Army Futures Command has defined an ambitious long-term vision that severs the traditional reliance on the Air Force's ISR and striking power to address threats to the ground-maneuvering forces. The Army's concept for a Multi-Domain Sensor System (MDSS) seeks to

build a new organic capability to find and strike targets far beyond the range limit of 186 mi. of the current Advanced Tactical Missile System.

That vision could include a new version of the RQ-4, even as the Air Force seeks authority from Congress this year to divest two-thirds of its own Global Hawk fleet.

"Northrop Grumman is looking into a Global Hawk that will fly higher than around 60,000 ft., which it's flying at right now, and give us more range," Ted Girouard, the Army's deputy capability manager for sensors, said at an Association for Unmanned Vehicle Systems International conference in September.

The Army's Program Executive Office for Intelligence, Electronic Warfare and Sensors (IEW&S) has started the acquisition process for the service's first operational high-altitude ISR capability.

The IEW&S office staff is preparing to launch an analysis of alternatives study for the MDSS, which will shape the acquisition strategy for the future airborne ISR program.

By definition, the strategy is not set until the analysis is complete, but Girouard, who has five decades of Army experience, already has a

**The U.S. Army's first-ever manned aerial intelligence, surveillance and reconnaissance jet—named the Airborne Reconnaissance and Targeting Multi-Mission Intelligence System, or Artemis—provides high-altitude sensing capabilities.**

feeling for how it will work out.

A higher-altitude version of the Global Hawk or similar high-altitude, long-endurance (HALE) UAS would need to be developed by Northrop or other contractors, but several other options exist at lower altitudes. These include derivatives of commercial airliners and business jets already in service with the Air Force and the Navy, including the Boeing 737-derived P-8A, Bombardier Global 6000-derived E-11 and Gulfstream G550-derived C-37.

"Given the state of the technology and [the availability] of a business jet-based platform, that might be the first platform we go to" for MDSS, Girouard says.

A fleet of fewer than 10 business jet derivatives would be viewed as an interim bridge to the full MDSS in 2035. In both cases, the goal is to improve dramatically the altitude and sensor capability of the Army's current fleet, which is limited to the 35,000-ft. service ceiling of the RC-12X Guardrail Common Sensor.

"We're looking for a platform that can give us more altitude, so that we get what the engineers call the

geometry to be able to look farther and find targets,” Girouard says.

The Army’s new dedication to high-altitude ISR and long-range strike has not gone unnoticed inside the blue-hued corridors of the Pentagon. Gen. David Goldfein, the Air Force’s recently retired chief of staff, refused repeatedly to engage in any criticism of the Army’s investment strategy when pressed by journalists during his tenure. His replacement, Gen. Charles Brown, Jr., however, appears more willing to raise the Air Force’s objections in public.

“We do need to have a conversation about how we ensure, with the limited dollars we’re going to have, [that we] look at the disparate mission sets,” Brown says. “It’s worth a dialog. We’ve got to talk about this.”

But as the Defense Department prepares the fiscal 2022 budget request for release in February, the Army

As the high-level discussions begin in the Pentagon, the Army’s airborne intelligence branch is rapidly getting up to speed on high-altitude ISR collection. Fifteen years have passed since the Army canceled the Embraer ERJ-145-derived Aerial Common Sensor program. During the interim, the service was mostly focused on the counterinsurgency and counterterrorism mission; new versions of the RC-12 and a modernized version of the ARL-7 Airborne Reconnaissance Low were deemed sufficient.

By 2016, the Army started to pivot to more sophisticated threats. Its striking power had been limited to the Army Tactical Missile System, with a maximum range set 124 mi. short of the 310-mi. threshold for the 1987 Intermediate-Range Nuclear Forces (INF) Treaty. As soon as the INF Treaty expired in August 2019, however, the Army was pre-

the Advanced Battle Management System but has identified no direct replacement for the Joint Stars’ APY-7 synthetic aperture radar (SAR) with a ground-moving-target-indicator (GMTI) mode.

The Army decided to take matters into its own hands. Gen. John Murray, the head of Army Futures Command, signed an initial capabilities document in February 2019 for a new airborne ISR-collection payload. The High-Accuracy Detection and Exploitation System (HADES) seeks to combine the functions of an E-8C and an RC-135 onto the same platform, with sigint and SAR/GMTI sensors aboard. Murray signed the capability decision document on Aug. 17 for HADES, Girouard says. The latter approval allows the IEW&S program executive office to begin preparing for the analysis of alternatives.

The Air Force chose not to replace the E-8C for a reason: Looming threats after 2025 would render radiating ISR aircraft such as Joint Stars too vulnerable to perform the mission, according to Air Force officials. Despite that warning, the Army does not seem deterred by the Air Force’s perspective on the near-term threat. For that matter, the Army’s opinion seems endorsed by the Navy, which has continued investing in the P-8A and Northrop MQ-4C Triton, the maritime version of the Air Force’s Global Hawk.

The study will benefit from flight-test data collected by a testbed aircraft deployed to Okinawa in July. The Airborne Reconnaissance and Targeting Multi-Mission Intelligence System (Artemis) is a Leidos-owned Bombardier Challenger 650 business jet equipped with commercial off-the-shelf sensors. The Challenger 650 has a 41,000-ft. service ceiling, giving the Army a sneak peek into the advantages of ISR collection at higher altitudes. The Artemis aircraft redeployed to Europe from Okinawa in September.

Meanwhile, Army officials are drafting a requirements documents for sensor performance on a high-altitude aircraft. The requirements document is called the MDSS 1000 payload, Girouard says. The Army’s top priority within the payload suite is the electronic-intelligence sensor, followed by the radar system. The Army also wants the payload to include a communications-intelligence receiver. ☛



**A member of the U.S. Air Force RQ-4 signals-intelligence fleet, pictured landing at Misawa Air Base in Japan, could be retired next year, but the Army is considering a new version of the Global Hawk for high-altitude surveillance.**

does not appear to be backing down. Building an organic long-range strike capability within the Army is seen as central to the Multi-Domain Operations concept, and the Long-Range Precision Fires program is the top modernization priority. The Army also does not view overlapping investments in long-range strike as necessarily a bad thing.

“I’m convinced that across the joint force, we all recognize that there’s enough targets out there for all of us,” Col. John Rafferty, the Long-Range Precision Fires program manager, said in August. “And we’re going to have to figure out how to sort this out.”

pared to lift the maximum range of the Precision Strike Missile (PRSM) beyond 310 mi. Raytheon’s withdrawal from the PRSM competition in April left Lockheed as the only remaining supplier. The Army expects to field the PRSM battery in fiscal 2023.

A long-range missile requires high-altitude targeting support. In previous decades, the Army had relied on the Air Force’s satellites and ISR aircraft, such as the radar-equipped E-8C Joint Stars and sigint-oriented RC-135 Rivet Joints. The Air Force plans to replace the battle management and command-and-control functions of the E-8C in 2025 with



# A Scout for a Scout: Army Plots Future Air-Launched Effects

> FIRST ALE ENTER COMPETITIVE DEVELOPMENT

> OPERATIONAL PROTOTYPES' DELIVERY SLATED FOR FISCAL 2024

Steve Trimble Washington

The U.S. Army's next scout aircraft could enter service in 2024, six years before the scheduled debut of the Future Attack Reconnaissance Aircraft.

The Army's long-awaited, purpose-built successor to the Bell OH-5D Kiowa Warrior, which was retired in 2015, the Future Attack Reconnaissance

platform vendors—Raytheon, Northrop Grumman and Area-I—to develop competitive prototypes. Three more companies—L3Harris Technologies, Raytheon Technologies and Boeing subsidiary Aurora Flight Systems—are developing candidate mission systems. Finally, more companies—Raytheon, Leonardo, Technology Service Corp.

A Sikorsky UH-60 fired an Altius-600 ALE (inset) during a recent Army demonstration.



sance Aircraft (FARA) in Sikorsky's and Bell's respective versions is designed to function as scout rotorcraft, like the OH-58D, roving ahead of ground forces and picking out the enemy's long-range missile launchers and other formations. But the FARA, unlike the OH-58D, will not be able to perform that mission alone. To survive in the 2030s, the FARA fleet needs its own scout fleet, which the Army now calls Air-Launched Effects (ALE).

"ALE is almost a scout for a scout," says Dustin Engelhardt, chief warrant officer five and the requirements lead for ALE in the Army's Aviation Platforms Requirements Determination Directorate.

The first ALE could enter service on the Army's existing helicopter and fixed-wing unmanned aircraft systems (UAS) fleet in less than four years, well ahead of the FARA rotorcraft's scheduled in-service date near 2030. In August, the Army selected three ALE

and Northrop—are competing to develop multiple types of payloads.

The winning companies will develop the first generation of a new kind of aerial platform. Blurring the lines between a traditional UAS and a munition, the Army envisions a new class of ALE that is low-cost enough to be disposable after a single use but valuable enough to potentially be recovered for reuse. The Army's concept is similar in many ways to the Air Force's Low-Cost Attributable Aircraft Technology program, also known as Loyal Wingman. But there are significant differences.

The Air Force envisions the Loyal Wingman as capable of roving across hundreds or even thousands of miles of contested airspace, whereas the Army's requirements call for less range, albeit a similar mission.

As threats to manned aircraft drove the development of a wide range of fully reusable UAS to perform the "dull, dirty and dangerous" missions

more than two decades ago, those UAS themselves now need support, by cheaper and more disposable ALE, to perform the same missions.

"When we looked at the capabilities organic to the platform and organic to FARA, and the challenge just to make a rotary-wing aircraft operate survivably [in the future], it puts a lot of additional requirements and complexity to that system," Engelhardt says. "To that end, we've looked at how we can reach out, how we can find those targets and how we can stimulate them to provide some sort of a targetable signature. And, ultimately, how we can degrade and destroy them. So we came up with the concept of [air-launched] effects."

The Army defines four primary missions for the future ALE: detect, identify, locate and report. As the FARA operates from a safer distance, the crew will launch 4-8 ALE into a hostile area, each with different capabilities. Some will carry electronic warfare payloads, and others will serve as decoys. Others could operate as loitering missiles.

The attritable nature of the ALE will require some performance concessions to cost. "As an example, if I've got a payload that can deliver effects at 10 km [6 mi.], can we dial that down and see where the ecosystem still works?" Engelhardt says. "Can we manufacture these things a little bit different than we have previously, so that we can provide that solution that we're okay with battlefield attrition?"

The volume of ALE on the battlefield will change how the Army operates teams of manned and unmanned aircraft.

"What we don't want is what we typically see with UAS and manned systems right now: where it's a steady stream of high-definition video, it's very data-heavy, network-heavy and requires a lot of input from the operator," Engelhardt says. Instead, the ALE will "execute a series of preprogrammed and dynamic instructions and report back as needed to the FARA."

The Army is developing a mesh network to allow the ALE to share data. The processors on the network will select a subset of data most relevant to a host aircraft such as the FARA. The FARA crew could then use the future Long-Range Precision Munition or call in the Army's surface-launched, long-range precision fires, like the Precision-Strike Missile or the Strategic Long-Range Cannon, Engelhardt says. ☉

# MILITARY AVIATION LOGISTICS & MAINTENANCE SYMPOSIUM (MALMS)

AVIATION WEEK  
NETWORK

November 17-18, 2020 V I R T U A L

## Exchange Ideas, Share Best Practices and Network with Military and Industry Sustainment Leaders

A dynamic virtual forum for members of the U.S. military and commercial aerospace industry to discuss process improvements and operational readiness concerns regarding aircraft maintenance, logistics, and sustainment operations.



### 2020 Speakers Include:



**Mark Angelo**

DVP C-17  
Services,  
Boeing Global  
Services



**Dennis  
D'Angelo**

Executive  
Director, Air Force  
Sustainment  
Center, Tinker AFB



**Shirley  
Franko**

Strategic  
Sustainment  
Plans &  
Policy, DASN  
Sustainment



**Rear Adm.  
Shane  
Gahagan**

PEO, Tactical  
Aircraft  
Programs,  
U.S. Navy



**Brig Gen  
Linda Hurry**

Director of Logistics,  
DCS/Logistics,  
Engineering & Force  
Protection  
USAF



**Bruce Litchfield**

VP & GM  
Sustainment  
Operations,  
Lockheed Martin  
Aeronautics  
Company



**Steven  
Morani**

Assistant  
Secretary  
of Defense  
for Materiel  
Readiness



**COL Joseph  
Parker**

Commander,  
Corpus Christi  
Army Depot,  
US Army



**Brig Gen David  
Sanford**

U.S. Air Force,  
Commander, Defense  
Supply Center  
Richmond and  
Defense Logistics  
Agency Aviation

Attendance is FREE for active-duty and reserve members of the United States Armed Forces from all branches and Department of Defense civilian employees.

Learn more and register at [malms-virtual.aviationweek.com](https://malms-virtual.aviationweek.com)

#MALMS |     

Lead Sponsors



MALMS Sponsors



Exhibitors





# DefenseChain Conference

Business Strategy  Supplier Opportunities  Program Excellence

OCTOBER 19–21, 2020  
A VIRTUAL EVENT

AVIATION WEEK  
NETWORK

Join Defense Industry EXPERTS, LEADERS and DECISION MAKERS from Primes to Suppliers at DefenseChain

At DefenseChain, you will interact with these industry experts:



**SHAWN A. BARNES**  
Deputy Assistant Secretary  
Space Acquisition and Integration  
US Air Force



**MARK CHERRY**  
Vice President & General Manager,  
Phantom Works  
Boeing



**KIM B. DOERING**  
Vice President, Space Division  
Dynetics



**TAY FITZGERALD**  
Vice President, Advanced Concepts  
& Technologies  
Raytheon Technologies



**RAANAN HOROWITZ**  
President & Chief Executive Officer  
Elbit Systems of America



**WESLEY D. KREMER**  
President, Integrated Defense  
& Missile Systems  
Raytheon Technologies



**JOHN LUDDY**  
Vice President, National Security  
Policy  
Aerospace Industries Association



**MIKE MADSEN**  
President & Chief Executive Officer  
Honeywell Aerospace

PLATINUM SPONSOR:

**SIEMENS**  
*Ingenuity for life*

SPONSORS:

**MEGGITT**



**interos**

**KEARNEY**

MEDIA PARTNERS:

**AerospaceDaily**  
& DEFENSE REPORT

**AVIATIONWEEK**  
& SPACE TECHNOLOGY

**SpeedNews**

# DefenseChain Conference

Business Strategy  Supplier Opportunities  Program Excellence

OCTOBER 19–21, 2020 / A VIRTUAL EVENT



**DefenseChain Conference** includes the **Aviation Week Program Excellence** initiative, an industry-led effort to identify lessons learned and that honors programs who are setting the standard for performance excellence.

## The THREE MAIN PILLARS of the DefenseChain Conference are:

### Business Strategy



#### Supercharge Your Business Strategy

Delegates at DefenseChain engage with top industry analysts who offer their views of the industry, provide forecasts for business planning, present DoD priorities, long-term strategies around Defense operations, consolidation and restructuring, and OEM and prime initiatives.

### Supplier Opportunities



#### Grow Your Business or Organization

DefenseChain shows suppliers how to make their mark with top Defense programs and clear the fiscal realities and the deal-making models that prime contractors are utilizing today. Delegates discover how the Defense supply chain is reshaping itself to create winning positions on major programs.

### Program Excellence



#### Stay Informed on Breakthroughs to Program Performance

Discover program breakthroughs and technological innovations as speed and disruption become increasingly important factors. Gain visibility into the processes and systems that enable program and project leaders to reach the highest levels of program execution as we honor the 2020 Program Excellence finalists and winners.

## DAY 1 / MONDAY, OCTOBER 19 — 1:00 PM EDT

1:00-1:05 PM	<b>INTRODUCTION</b> Greg Hamilton, President, Aviation Week Network
1:05-1:45 PM	<b>DISSECTING PROGRAM TRANSFORMATION</b> <b>PART 1:</b> Moderated by <b>Guy Norris</b> , Senior Editor, Aviation Week Network <b>Robert F. Leduc</b> , 2020 Aviation Week Lifetime Achievement Award Recipient and Retired President, Pratt & Whitney <b>PART 2:</b> Moderated by <b>Carole Rickard Hedden</b> , Executive Editor-Aviation Week Executive Intelligence and Program Excellence <b>Wesley D. Kremer</b> , President, Integrated Defense & Missile Systems, Raytheon Technologies
2:00-3:00 PM	<b>AVIATION WEEK NETWORK'S 63RD ANNUAL LAUREATE AWARDS</b> A Virtual Event

## DAY 2 / TUESDAY, OCTOBER 20 — 9:00 AM EDT

9:00-9:05 AM	<b>WELCOME ADDRESS</b> <b>Joanna Speed</b> , Managing Director, A&D Events, Aviation Week Network <b>Michael Bruno</b> , Senior Business Editor & Content Manager, Aviation Week Network
9:05-9:25	<b>OPENING ADDRESS</b> Moderated by <b>Joe Anselmo</b> , Editorial Director, Aviation Week Network <b>HONEYWELL AEROSPACE</b> – <b>Mike Madsen</b> , President & Chief Executive Officer
9:25-9:35	<b>NETWORKING REFRESHER BREAK</b> Sponsored by <b>Siemens Digital Industries Software</b>
9:35-10:15	<b>THE FOUR HORSEMEN – OUTLOOK AND TRENDS WITHIN THE A&amp;D INDUSTRY</b> Moderated by <b>Michael Bruno</b> , Senior Business Editor & Content Manager, Aviation Week Network <b>CANACCORD GENUITY</b> – <b>R. John Stack</b> , Managing Director, Head of A&D Investment Banking <b>CAPITAL ALPHA PARTNERS</b> – <b>Byron K. Callan</b> , Managing Director <b>GRUNDMAN ADVISORY AND THE ATLANTIC COUNCIL</b> – <b>Steven Grundman</b> , Principal & Senior Fellow <b>RENAISSANCE STRATEGIC ADVISORS</b> – <b>Pierre Chao</b> , Founding Partner Discussion and Questions
10:15-10:25	<b>NETWORKING REFRESHER BREAK</b> Sponsored by <b>Siemens Digital Industries Software</b>
10:25-10:35	<b>SUPPLY CHAIN PROGRAM EXCELLENCE AWARDS</b> Presented by <b>Barry Chapman</b> , Vice President, Aerospace, Defense, Federal and Marine, Siemens Digital Industries Software, and <b>Michael Bruno</b> , Senior Business Editor & Content Manager Sponsored by <b>Siemens Digital Industries Software</b>
10:35-11:05	<b>MANAGING THE DEFENSE SUPPLY CHAIN</b> Moderated by <b>Jen DiMascio</b> , Executive Editor, Defense & Space, Aviation Week Network <b>AEROSPACE INDUSTRIES ASSOCIATION</b> – <b>John Luddy</b> , Vice President, National Security Policy <b>US ARMY</b> – <b>Patrick H. Mason</b> , Deputy Program Executive, Aviation Discussion and Questions
11:05-11:15	<b>NETWORKING REFRESHER BREAK</b> Sponsored by <b>Siemens Digital Industries Software</b>
11:15-11:40	<b>THE NEW REQUIREMENTS TO BE A U.S. DEFENSE SUPPLIER</b> Moderated by <b>Joanna Speed</b> , Managing Director, A&D Events, Aviation Week Network <b>INTEROS</b> – <b>Jennifer Bisceglie</b> , Chief Executive Officer <b>KEARNEY</b> – <b>Ryan Elliot</b> , Partner Discussion and Questions

Register and Learn More at:  
[defensechain.aviationweek.com](https://defensechain.aviationweek.com)



# DefenseChain Conference

Business Strategy ∞ Supplier Opportunities ∞ Program Excellence

OCTOBER 19–21, 2020 / A VIRTUAL EVENT

“The Conference provides access to senior government and industry leaders, with cutting edge access to information and analysis. It is a gathering of the movers and shakers!”

## JAY MULHALL

Vice President, Business Development  
CPI Aero, Inc.

### Topics focus on key components driving the industry:

- ∞ Defense industry and Pentagon budget outlooks
- ∞ Shaping acquisitions of the future
- ∞ Supply chain opportunities
- ∞ The technology innovation capacity of the industry
- ∞ The program leadership response to 2020s

### Who benefits from attending?

- ∞ Strategic planning, business development, engineering and technology leaders
- ∞ Supply chain executives and senior decision makers
- ∞ Program and project leaders
- ∞ Analysts, investment and financial community members

11:40-12:20 PM	<b>SUPPLIER PRESSURE</b> <i>Moderated by Kenneth “Ken” Herbert, Managing Director, Canaccord Genuity</i> <b>ACORN GROWTH COMPANIES</b> – Rick Nagel, Managing Partner <b>DESTINY EQUITY PARTNERS</b> – Chris R. Celtruda, Managing Principal <b>ELBIT SYSTEMS OF AMERICA</b> – Raanan Horowitz, President & Chief Executive Officer <b>JEFFERIES</b> – Sheila Kahyaoglu, Managing Director, Equity Research Discussion and Questions
12:20-12:40	<b>OEM PROGRAM EXCELLENCE AWARDS</b> <i>Presented by Michael Bruno, Senior Business Editor &amp; Content Manager</i> Sponsored by <b>Siemens Digital Industries Software</b>
12:40	<b>WRAP-UP</b> – Joanna Speed

## DAY 3 / WEDNESDAY, OCTOBER 21 – 9:00 AM EDT

9:00-9:05	<b>WELCOME ADDRESS</b> <b>Carole Rickard Hedden</b> , Executive Editor-Aviation Week Executive Intelligence and Program Excellence, Aviation Week Network
9:05-9:35	<b>A NEW ERA IN BUYING SPACE-BASED SYSTEMS AND EQUIPMENT</b> <i>Moderated by Lee Hudson, Pentagon Editor, Aviation Week Network</i> <b>US AIR FORCE</b> – Shawn A. Barnes, Deputy Assistant Secretary of the Air Force for Space Acquisition and Integration
9:35-9:50	<b>NETWORKING REFRESHER BREAK</b> Sponsored by <b>Siemens Digital Industries Software</b>
9:50-10:30	<b>EDGE OF INNOVATION: ADVANCING AEROSPACE TECHNOLOGIES</b> <i>Moderated by Graham Warwick, Executive Editor-Technology, Aviation Week Network</i> <b>BOEING</b> – Mark Cherry, Vice President & General Manager, Phantom Works <b>LOCKHEED MARTIN</b> – Jeff Babione, Vice President & General Manager, Skunk Works <b>RAYTHEON TECHNOLOGIES</b> – Tay Fitzgerald, Vice President, Advanced Concepts & Technologies <b>NORTHROP GRUMMAN</b> – Richard Sullivan, Vice President, Advanced Program/FCUAS, Aerospace Systems Discussion and Questions
10:30-10:45	<b>SPECIAL PROJECTS PROGRAM EXCELLENCE AWARDS</b> <i>Presented by Michael Bruno, Senior Business Editor &amp; Content Manager</i> Sponsored by <b>Siemens Digital Industries Software</b>
10:45-10:50	<b>NETWORKING REFRESHER BREAK</b> Sponsored by <b>Siemens Digital Industries Software</b>
10:50-11:15	<b>DEFINING NAVY ACQUISITION OF THE FUTURE</b> <i>Moderated by Lee Hudson, Aviation Week Pentagon Editor</i> <b>US NAVY</b> – James F. Geurts, Undersecretary for Acquisition Discussion and Questions
11:15-11:20	<b>NETWORKING REFRESHER BREAK</b> Sponsored by <b>Siemens Digital Industries Software</b>
11:20-11:50	<b>PROGRAM DEEP DIVE: MODEL-BASED ENGINEERING</b> <i>Moderated by Barry Chapman, Vice President, Aerospace, Defense, Federal and Marine, Siemens Digital Industries Software</i> <b>HUNTINGTON INGALLS INDUSTRIES NEWPORT NEWS SHIPBUILDING</b> – Tim Sweitzer, Director, Digital Shipbuilding <b>NORTHROP GRUMMAN</b> – Jeffrey Reed, Director, Engineering, Model Based Tool Development Discussion and Questions
11:50-12:25 PM	<b>PROGRAM DEEP DIVE: RETURNING TO THE MOON</b> <i>Moderated by Jen DiMascio, Executive Editor, Defense &amp; Space, Aviation Week Network</i> <b>DYNETICS</b> – Kim B. Doering, Vice President, Space Division <b>COLLINS AEROSPACE</b> – Greg Stonesifer, Program Director, One EVA Discussion and Questions
12:25 PM	<b>WRAP-UP</b> – Carole Rickard Hedden

Register and Learn More at:  
[defensechain.aviationweek.com](https://defensechain.aviationweek.com)

# DISTINGUISHED SPEAKERS AND PANELISTS INCLUDE:



**JEFF BABIONE**

Vice President & General Manager,  
Skunk Works  
**Lockheed Martin**



**SHAWN A. BARNES**

Deputy Assistant Secretary  
Space Acquisition and Integration  
**US Air Force**



**JENNIFER BISCEGLIE**

Chief Executive Officer  
**Interos**



**BYRON K. CALLAN**

Managing Director  
**Capital Alpha Partners**



**CHRIS R. CELTRUDA**

Managing Principal  
**Destiny Equity Partners**



**PIERRE CHAO**

Founding Partner  
**Renaissance Strategic Advisors**



**BARRY CHAPMAN**

Vice President, Aerospace,  
Defense, Federal and Marine  
**Siemens Digital Industries Software**



**MARK CHERRY**

Vice President & General Manager,  
Phantom Works  
**Boeing**



**KIM B. DOERING**

Vice President, Space Division  
**Dynetics**



**RYAN ELLIOT**

Partner  
**Kearney**



**TAY FITZGERALD**

Vice President, Advanced Concepts  
& Technologies  
**Raytheon Technologies**



**JAMES F. GEURTS**

Undersecretary for Acquisition  
**US Navy**



**STEVEN GRUNDMAN**

Principal & Senior Fellow  
**Grundman Advisory and  
The Atlantic Council**



**KENNETH "KEN" HERBERT**

Managing Director  
**Canaccord Genuity**



**RAANAN HOROWITZ**

President & Chief Executive Officer  
**Elbit Systems of America**



**SHEILA KAHYAOGU**

Managing Director, Equity Research  
**Jefferies**



**WESLEY D. KREMER**

President, Integrated Defense  
& Missile Systems  
**Raytheon Technologies**



**ROBERT F. LEDUC**

2020 Lifetime Achievement Award  
**Pratt & Whitney**



**JOHN LUDDY**

Vice President,  
National Security Policy  
**Aerospace Industries Association**



**MIKE MADSEN**

President & Chief Executive Officer  
**Honeywell Aerospace**



**PATRICK H. MASON**

Deputy Program Executive, Aviation  
**US Army**



**RICK NAGEL**

Managing Partner  
**Acorn Growth Companies**



**JEFFREY REED**

Director, Engineering-Model  
Based Tool Development  
**Northrop Grumman**



**R. JOHN STACK**

Managing Director,  
Head of A&D Investment Banking  
**Canaccord Genuity**



**GREG STONESIFER**

Program Director-One EVA  
**Collins Aerospace**



**RICHARD SULLIVAN**

Vice President, Advanced Programs,  
Aerospace Systems  
**Northrop Grumman**



**TIM SWEITZER**

Director, Digital Shipbuilding  
**Huntington Ingalls Industries  
Newport News Shipbuilding**

For updates, please visit:  
[defensechain.aviationweek.com](https://defensechain.aviationweek.com)



# AVIATION WEEK PROGRAM EXCELLENCE AWARDS

OCTOBER 20–21, 2020 / A VIRTUAL EVENT



The **2020 Program Excellence Awards** will bring together program executives, their customer counterparts, and leaders from across the industry to recognize the best in performance and leadership. Finalists and winners will be identified in categories that reflect system and sub-system level programs at all phases of the lifecycle. Nominees will share lessons learned during day two of **DefenseChain Conference**.

## PROGRAM EXCELLENCE EVALUATION TEAM



## DELEGATES

Delegates at **Aviation Week Network's DefenseChain Conference** will gain vital insight into Defense industry spending trends, hear solutions to supply chain issues, and be presented with new industry initiatives. Program outlooks, Defense acquisition reforms, and methods to overcome supplier challenges will all be covered during two-days of keynote presentations, interactive panel discussions and networking opportunities.

### DELEGATES EXPECTED TO ATTEND OVER 250

#### DELEGATE PROFILE

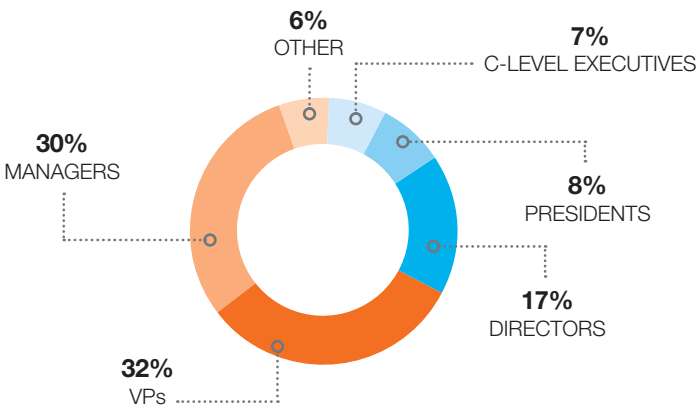

### COMPANY/ORGANIZATION PROFILE

MANUFACTURERS	67%
CONSULTANTS	11%
INDUSTRY ORGANIZATIONS	8%
INFORMATION PROVIDERS	7%
FINANCE	3%
OTHER	3%
DISTRIBUTORS	1%

## SPONSORSHIPS

Sponsorships enable you to promote your brand, products and/or services on the expansive Aviation Week Network, and throughout the Conference. Customized sponsorships are also available. The earlier you begin your Sponsorship – the more valuable it is! The Aviation Week Network averages more than two million page views per month – that's millions of potential views of your organization if you start today! To become a Sponsor contact Joanna Speed, Managing Director, A&D Conferences at +1-310-857-7691.

Register and Learn More at:  
[defensechain.aviationweek.com](https://defensechain.aviationweek.com)

# DefenseChain Conference

Business Strategy ∞ Supplier Opportunities ∞ Program Excellence

OCTOBER 19–21, 2020 / A VIRTUAL EVENT



## REGISTRATION INFORMATION

### Virtual Conference Registration Rate

Registration includes access to all live planned briefings, panel discussions, and presentations over the three days. Recordings will also be available within 24 hours of each session.

\$678.00 per Delegate

Register and Learn More at:  
[defensechain.aviationweek.com](https://defensechain.aviationweek.com)



## KC-46 Progress Revives Next-Generation Tanker Talks

- > KC-46 UPGRADE ENTERS PRODUCTION IN 2024
- > U.S. AIR FORCE AND AIR MOBILITY COMMAND LEADERS START DISCUSSIONS



Boeing is expected to deliver the second-generation remote vision system for the KC-46 in 2023.

JOSHUA J. SEVIERY/U.S. AIR FORCE

**Steve Trimble** Washington

**P**roposals for a next-generation tanker that would come after the last Boeing KC-46 delivery in fiscal 2029 have popped up every few years since 2006, only to get sidetracked by yet another acquisition-process misstep or technical problem afflicting the program's frustrating development phase.

As a fresh sense of optimism gathers among senior U.S. Air Force leaders about the direction of the KC-46 program, a new discussion has started between Defense Department officials and the Air Mobility Command (AMC) about the future of the air-refueling mission. Some proposals in the discussions include revived versions of various older concepts for weaponized larger tankers and smaller stealth tankers. But this time, discussions involve taking a wider view of the overall need to defend and deliver fuel to aircraft in combat, with implications for base defenses, the size and range of future fighters and next-generation tanker designs.

A perceived turnaround in the fortunes of the KC-46 program allows the Air Force to reopen the next-generation discussion. Since at least 2016, a heated dispute over Boeing's original design—and later proposed fixes—for the KC-46's remote vision system (RVS) sidetracked planning for a next-generation tanker. Air Force officials complained that Boeing's original RVS design fell short of operator requirements, especially when the receiver aircraft was backlit by the Sun. In addition, the canted layout of the belly-mounted, panoramic cameras created subtle distortions in the displayed video that proved bothersome to some RVS operators, Air Force officials say.

The Air Force and Boeing finally agreed to a redesign plan in January 2019. The Air Force is finalizing a test report on an enhanced RVS, which was formerly known as RVS 1.5. AMC officials have committed to review the test data but offered no promises on whether they would approve the enhanced RVS to be installed in the KC-46. The installation

would require parking a fleet of more than 36 delivered KC-46s to complete the retrofit, and the AMC remains unsure whether the improvement is worth the delay.

The enhanced RVS offers only software updates to the current system, but the AMC clearly wants more. Boeing has committed to a more dramatic upgrade, called RVS 2.0. Including hardware and software changes, this Boeing-funded, second-generation RVS system is expected to meet the image-resolution standards demanded by the Air Force and create a path to inserting the software algorithms necessary to give the KC-46 an optional autonomous-refueling mode.

Boeing is scheduled to deliver the first 12 RVS 2.0 shipsets by the end of 2023 and begin the retrofit process on delivered KC-46s, says Gen. Jacqueline Van Ovost, the AMC commander. The AMC expects a production cut for RVS 2.0 starting in 2024, although Boeing's KC-46 global sales and marketing director, Mike Hafer, says the first RVS 2.0-equipped aircraft could start rolling off the assembly line in late 2023.

Will Roper, the Air Force's assistant secretary for acquisition, technology and logistics, says the progress toward fielding the RVS 2.0 makes him feel "excited" about the KC-46 program. "I think we've turned a new page," he says.

In mid-September, Roper and Van Ovost met to discuss what will follow the KC-46. The next-generation tanker discussion comes after a series of dramatic acquisition decisions surrounding Air Force aircraft. Most visibly, Roper led a push in 2018 to cancel the Joint Stars recapitalization program, which was replaced with the Advanced Battle Management System (ABMS). More quietly, Roper also drove the Air Force to rethink the acquisition strategy for the Next-Generation Air Dominance (NGAD) program. The ABMS and NGAD are now characterized by an architecture of multiple systems, with no single-aircraft, silver bullet solution.

Roper acknowledges that the nature of tanker operations does not immediately lend itself to a distributed multiplatform solution.

“We can break up a J-Stars [replacement into multiple systems],” Roper says. “We may be able to break up an [E-3 Airborne Warning and Control System] in the future, but we can’t break up fuel easily.”

Still, Roper prefers to address the future air-refueling problem in an era of great power competition with an architectural approach similar to ABMS and NGAD.

“When there’s a solvable problem and you need to turn multiple knobs, the Pentagon likes to turn one and only one,” Roper says. “And [aerial refueling] sounds like a really good architectural question that you’d want to have an architected solution for—[rather than] design a one-solution candidate in the form of a platform.”

Roper’s turnable knobs for a future air-refueling system cover a wide range of options, including two with only indirect impact on a tanker aircraft design. To Roper, the problem of air refueling includes defending the bases closest to an adversary where aircraft can be refueled on the ground. Likewise, another part of the solution is to move away from relatively small fighter aircraft that lack sufficient range for a Pacific theater scenario.

“Maybe having small, currently sized fighters is not the way to go in the future,” Roper says. “Thinking about bigger fighters is a natural question to lay alongside the question, ‘How does your future tanker force look?’”

Air-refueling capacity is also partly a function of the vulnerability of the tanker aircraft. Fewer and perhaps smaller tankers may be possible if existing tanker aircraft could operate closer to the battlefield. The Air Force now uses fighters on combat air patrols to defend high-value assets such as tankers, surveillance and command-and-control aircraft. Those fighters conducting the patrols add to the refueling burden. A possible solution is to weaponize tankers such as the KC-46 and KC-135. The Air Force is developing podded defensive lasers and miniature self-defense munitions.

“We don’t put weapons and sensors on tankers to shoot down aircraft, but the current KC-46 is a big airplane with the ability to mount sensors and weapons on the wings,” Roper says. “We’re going to look at all those [options].”

The Air Force also believes a new tanker aircraft is necessary. As far back as 2002, research began on stealthy mobility aircraft under the Air Force Research Laboratory’s Speed Agile program. As the KC-X acquisition program kicked off, the Air Force released a tanker road map in 2006 that called for launching a KC-Y acquisition pro-



U.S. AIR FORCE RESEARCH LABORATORY

**Next-generation tanker research led to wind-tunnel testing of this Lockheed Martin design under the Speed Agile program, which existed between 2002 and 2012.**

gram in 2022 and a KC-Z program by 2035. By 2016, AMC leaders openly discussed proposals for leapfrogging the KC-Y requirement, which sought to buy a larger version of a commercial derivative. Instead, AMC officials began investigating concepts for an autonomous stealthy aircraft. By 2018, Lockheed Martin’s Skunk Works had defined a concept for such an aircraft, which featured an undisclosed refueling technology that could dock with a receiver aircraft without compromising radar stealth.

As discussions have reopened in September, the Air Force is again considering the acquisition of a mix of larger and smaller aircraft to fulfill the demand for inflight refueling in the 2030s and 2040s.

“One trade we can do is having bigger tankers that stand off a lot farther,” Roper says, “[and] having smaller, micro-tankers that do that last mile, the dangerous mile—and we expect to lose some of them.”

The Air Force’s budget-justification documents suggest research on a next-generation tanker will continue at a low level: Nearly \$8 million was requested in fiscal 2021 to “assess promising configurations in high- and low-speed wind tunnels.” The Air Force also is designing a small, pod-mounted tactical air-refueling boom, according to budget documents. The latter suggests that one option for increasing refueling capacity for aircraft equipped with boom receivers is to integrate a podded fuel-delivery system on tactical aircraft such as the Lockheed Martin C-130.

“I expect that as we really look at airpower in the truly contested environment, we’ll be looking at fuel very strategically,” Roper says. “We may have a different solution for outside [a threat area] versus inside. And I think we will value, increasingly, aircraft that have range for the last mile.”



# Croatia Fighter Replacement Competition Proceeds Apace

> FOUR NATIONS SUBMITTED BIDS FOR REQUEST FOR PROPOSALS

> REPEAT ISRAELI OFFER INCLUDES GUARANTEES OF U.S. INVOLVEMENT

**Tony Osborne** London

**C**roatia hopes to select a new fighter type by year-end, but defense officials hope the selection will be free of the drama surrounding the last such attempt.

After Croatia selected ex-Israeli Block 30 model F-16s in 2018, senior U.S. officials stepped into the fray. They prevented Tel Aviv from making the transfer until the aircraft, which had been extensively modified, was reset to their predelivery standard with NATO-standard communi-

cal communications equipment. The Israelis wanted the U.S. to pay for the reset, but the U.S. refused. The deal was annulled, and Croatia was forced to restart the fighter tender, adding a new delay to the replacement of its aging and largely obsolete MiG-21 Fishbed fighters that date to the 1960s.



**Croatia is one of two NATO countries, along with Romania, still using the MiG-21 for air defense.**

CHRIS LOFTING

cal communications equipment. The Israelis wanted the U.S. to pay for the reset, but the U.S. refused.

The deal was annulled, and Croatia was forced to restart the fighter tender, adding a new delay to the replacement of its aging and largely obsolete MiG-21 Fishbed fighters that date to the 1960s.

Russian-sourced Cold War-era equipment is still prevalent in the inventories of many Balkan countries, particularly those with fast jet fleets. As more of the countries align with the West and NATO, a wave of modernization is sweeping the region.

Some see Croatian and Serbian efforts to purchase new fighters and helicopters as representative of a new arms race in the region, particularly since the arrival to Serbia from Russia of donated Russian Aircraft Corp. MiG-29 Fulcrums as well as purchased new Mil Mi-35 Hind and Mi-17 Hip

helicopters and Chinese-made armed unmanned aircraft systems. These aircraft, along with advanced air defense systems, have arguably delivered a much-needed capacity boost 20 years after the NATO bombing decimated Serbia's armed forces in 1999 and left the economy in shambles—and struggling ever since.

“The term ‘arms race’ is often banded around,” says Douglas Barrie, aerospace fellow with the London-based International Institute for Strategic Studies. “But in the case of the Balkans, there was a need to upgrade and modernize defense capabilities in the region irrespective of the security situation.”

After the Israeli deal fell through, Croatia restarted its fighter contest at the beginning of 2020, only to announce it was pausing it in April due to the novel coronavirus pandemic and an earthquake that shook the capital city of Zagreb in late March—a one-two punch to the national economy. The pause did not last long, however. During the summer, Croatia invited seven countries to deliver proposals, with officials considering both secondhand and new-build aircraft to replace the MiG-21 fleet used for air defense and air policing.

Of the seven countries invited, only four met the Sept. 9 deadline to deliver their proposals. France is offering secondhand Dassault Rafales, Israel is

again proposing used Block 30 F-16s, the U.S. is suggesting new-build Block 70 configuration F-16s like those being ordered by Bulgaria and Slovakia, and Sweden is proposing the C/D-model of the Saab Gripen. Norway, which announced its participation in the procedure, withdrew its bid of secondhand F-16s because it could not meet the set criteria, while Greece, also offering secondhand F-16s, and Italy, offering used Eurofighter Typhoons, could not respond to the bids within the set deadlines, Croatian officials said.

France has also offered 12 Rafales to Greece—but it is unclear whether France has enough surplus Rafales if both Croatia and Greece decide to adopt the type.

The Israeli offer also includes guarantees that the U.S. would be involved from the very beginning, so as to secure a tripartite agreement and avoid the issues that dogged the previous procurement.

The Croatian evaluation is being carried out by a multimember commission: The procedure is being “conducted professionally with clearly defined criteria, and each segment will be systematically examined in order to make the final choice the best for the Republic of Croatia,” officials said in a statement. They have not elaborated on how they will compare bids for new-build versus secondhand aircraft.

Croatia has long preferred to develop its own organic air defense capability rather than rely on others—an option available as a NATO member.

The air defense of neighboring Slovenia, for example, is provided by Hungary and Italy; Italy also shares air patrols over Albania with Greece.

Croatia's defense plans extend beyond new fighters. Zagreb has purchased a fleet of surplus U.S. Army Bell OH-58D Kiowa Warriors armed with Hellfire precision-guided missiles and is also planning to buy Sikorsky UH-60 Black Hawk helicopters, which will be partly funded by the U.S. Defense Department. It expects to purchase up to eight, paving the way to replace the Mi-8 helicopters still in use. Other countries in the region are also making investments—including Montenegro, which has ordered Bell 505 Jet Ranger X light helicopters for training and liaison duties.

Zagreb expects to sign contracts for fighters during 2021. 🇨🇷



# Swiss Fighter Procurement Secured by Slim Referendum Win

> JUST 50.1% VOTED IN FAVOR OF FIGHTER BUY

> 60% OF FIGHTER CONTRACT VALUE WILL BE OFFSET

**Tony Osborne** London

Switzerland's defense chiefs have breathed a sigh of relief after a referendum gave them a mandate to proceed with the procurement of new fighter aircraft.

For the second time in six years, the country's votation system has been used to make a critical decision about national air defense capability.

But this time, the need was more urgent: The Swiss air force's Northrop F-5 Tigers could easily be outgunned by modern opponents, officials say, and the legacy-model McDonnell Douglas F/A-18 Hornets, while still capable, have required a life extension to see them through to retirement in around 2030.

And a growing concern about the security situation at Europe's eastern borders is prompting Switzerland's neighbors to increase their defense equipment spending.

Yet public approval came with the slimmest of margins. Only 50.1% of voters gave their backing to the 6 billion Swiss franc (\$6.5 billion) Air 2030 plan on Sept. 27, a lead of just under 9,500 people, from a turnout of 3.2 million, or 59% of the country's voters.

Critics state that the Swiss armed forces face a credibility issue. They have long questioned why the country, a landlocked neutral nation that has never fought in a conflict in the modern era, needs an advanced combat aircraft for the air-policing and air-defense mission.

The "No" campaign argued that the air-policing mission could be performed by a light combat type such as the Korea Aerospace FA-50 or Leonardo's M-346 for considerably lower procurement and operating costs and that such platforms were not considered.

Spending 6 billion Swiss francs on fighter aircraft was never going to be an easy sell, especially after the COVID-19 pandemic's impact on the economy. Nonetheless, the "Yes" vote—even one with a wafer-thin approval—means that ministers can now push ahead regardless, and both the 30-strong C/D-model F/A-18 Hornet fleet and the 26 Northrop F-5 Tigers can be re-

placed with a single type from 2025.

"It was clear that this was a controversial topic," Viola Amherd, Switzerland's minister of defense, told a press

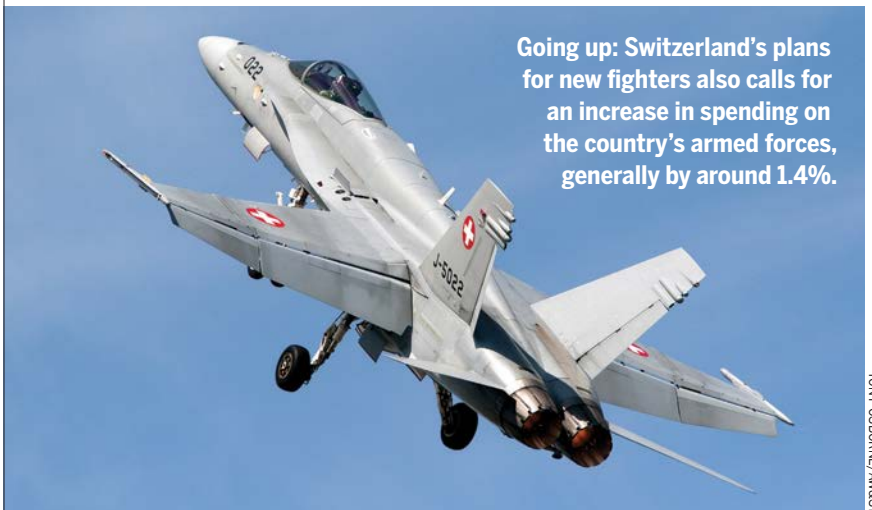

Going up: Switzerland's plans for new fighters also calls for an increase in spending on the country's armed forces, generally by around 1.4%.

TONY OSBORNE/ANSA

conference following the referendum.

Fighter proponents also blamed the pandemic, stating that the novel coronavirus had meant the government-backed Security-Yes campaign had struggled to get its voice heard.

Amherd said the result would allow the Swiss armed forces to "fulfill its tasks and protect our population against air attacks." A No vote, Amherd added, would have left an "important pillar of the army . . . severely weakened."

There was no Plan B had the country voted the other way. The Air 2030 initiative was the government's Plan B after a referendum in 2014 voted down plans to purchase the Saab JAS 39E/F Gripen as a replacement for the F-5 Tiger.

Switzerland has already carried out extensive in-country evaluations of the Western fighter types bidding to be the country's future fighter. Four remain in the running, including the Eurofighter being proposed by Airbus in Germany; Dassault Rafale, being pushed by France; while the U.S. is offering both the Boeing F/A-18E/F Super Hornet and the Lockheed Martin F-35A. Saab

withdrew its JAS 39E/F Gripen after being advised by Swiss authorities that the aircraft could not carry out some of the evaluations expected of the aircraft.

Details of the Foreign Military Sales packages for the U.S.-built fighters emerged on Sept. 30. Of the two packages detailed, the F-35 appears to be the cheaper option, with a 40-strong fleet priced at \$6.58 billion, which, based on current exchange rates, almost exactly matches the Swiss budget. The F/A-18 Super Hornet package includes 36 aircraft for \$7.452 billion, considerably

more than the Swiss budget. Both deals include small numbers of weapons such as Sidewinder air-to-air missiles and guidance kits for bombs.

Swiss officials insist the purchase of the fighters will bring economic benefits, because the program calls for offsets worth 60% of contract value, and the work will be spread across the country.

In addition to fighters, the Air 2030 program is spending 2 billion Swiss francs on new ground-based air defense systems, but the purchase of those systems was not subject to the referendum. Switzerland hopes the budget of 6 billion Swiss francs will cover the acquisition of 30-40 aircraft, but officials note that the exact number will depend on how much each aircraft costs and which of them is chosen. The bidders will deliver their best and final offers this November.

An evaluation report, to be published in 2021, will compare the bidders by effectiveness, weighted 55%; product support, 25%; the level of co-operation, 10%; and the types of offsets offered, 10%. Contracts will follow parliamentary approvals a year later. 

# Generational Change Planned for Post-Brexit British Armed Forces

- NEW OPERATING CONCEPT IMAGINED FOR INTEGRATED REVIEW
- PLANS CALL FOR MORE USE OF NETWORKED SYSTEMS AND AUTONOMOUS TECHNOLOGY

Tony Osborne London

The UK will need to restructure its military, establish a greater military footprint overseas and operate more like its adversaries if it intends to fight competitively in a new era of warfare.

“None of our rivals can afford to go to war as we define it,” Carter said. And with arms control and counter-proliferation treaties evaporating, there is a threat of “unwarranted escalation and therefore miscalcula-



BELINDA ALKIER/ROYAL NAVY

**The Royal Navy’s new Queen Elizabeth-class aircraft carriers could act as “lily pads” for operations in Asia, as the UK looks to expand its presence in the region.**

While its new Integrated Operating Concept recognizes the leaps in capability and technology in the conventional forces of China and Russia, “their goal is to win without going to war,” British Army Gen. Nick Carter, chief of the UK Defense Staff, said at the Policy Exchange think tank in London Sept. 30. He said the UK’s adversaries want to achieve their objectives by “breaking our willpower, using attacks below the threshold that would prompt a warfighting response.”

Carter said the British Armed Forces must “fundamentally change our thinking if we are not to be overwhelmed,” and will need to “compete below the threshold of war in order to deter war.”

tion between military protagonists,” he added.

He pointed to the creation of China’s Strategic Support Force, which commands satellite information attack and defense forces, electronic assault forces and internet assault forces for space and cyberwarfare. He also cited Russia’s use of a private military company, the Wagner Group, which gives Moscow a form of “limited power projection,” with “plausible denial.”

The UK needs to face such issues head-on by placing a greater emphasis on competition, said Carter: “[We need] continuous operating on our terms and in places of our choosing.”

Part of the approach calls for more so-called jointery, not just between

the UK’s armed forces—something the services do routinely—but also with the government and allies, in a bid to be more assertive and to act faster politically.

“This posture will be engaged and forward-deployed—armed forces much more in use rather than dedicated solely for contingency—with training and exercising being delivered as operations,” Carter explained.

Part of this focus could be on Asia, Gen. Mark Carleton-Smith, head of the British Army, has suggested, with the use of the UK’s new aircraft carriers as “lily pads” to enable operations with allies such as Japan and South Korea.

Britain’s first operational cruise of the new HMS Queen Elizabeth is expected to head to the Far East with its embarked Lockheed Martin F-35s.

To be ready, said Carter, the British Armed Forces will have to reallocate resources and adjust its force structure as well as its training and exercise activities.

Such restructuring could come with “some risk and some failure,” Carter said, but would help stimulate innovation and lead to better cost control.

The strategy has been developed to align with the government’s upcoming Integrated Review of the UK’s foreign policy and defense posture, preparing for the UK’s power projection for the post-Brexit era.

Future warfare is increasingly “a competition between hiding and finding,” said Carter. Such an approach will drive a different concept of equipment procurement, similar to the U.S.’ Third Offset strategy. It would call for smaller and faster capabilities to avoid detection, relying more heavily on low-observable and stealth technologies, with fleets including a mix of crewed, uncrewed and autonomous platforms.

These platforms would be tuned in to sophisticated networks and combat clouds to pass data around, with open systems architectures for the rapid integration of new capabilities. The concept also calls for more use of fires beyond the line of sight and nonlethal methods of disabling adversary systems with lasers and radio frequency-based systems.

“[The concept] means that some industrial age capabilities will increasingly have to meet their sunset to create the space for capabilities needed for sunrise,” said Carter. He would



not elaborate, but an implication of the strategy is that expensive crewed platforms are increasingly vulnerable to swarms of self-coordinating smart munitions arriving at hypersonic speeds or ballistically from space.

The Royal Air Force is already taking steps to modernize in line with the concept. Initiatives such as the Tempest Future Combat Air System will use a mix of crew and autonomous additive capabilities, along with low-observable technologies (*AW&ST* Sept. 28-Oct. 11, p. 51).

Defense chiefs have been keen to emphasize that the upcoming review will not be simply cutting capabilities, as previous reviews have often done. However, it is clear some of the services will experience pain; exactly where has not been made explicit. Reports in the national media have suggested an impact on the planned purchase of F-35s, such as not buying the full complement of 138, as well as a reduction in the number of Boeing E-7 Wedgetail early-warning platforms to be bought.



**The Integrated Operating Concept calls for greater cooperation with allies, such as this September exercise in which British paratroopers trained with their Ukrainian counterparts.**

There may also be cutbacks in the air mobility capability, with fleets potentially shrinking. Extensive investments are being made in new unmanned capabilities, as well as standoff weaponry and directed

energy, but few are getting past the research and development barrier to be transformed into fully fledged programs. The review may shed light on some of that when it is published in November. ☛

# FleetDiscovery<sup>7</sup>

## Fleet Discovery Military

### Discover Opportunity with Unparalleled Tracking of Global Military Fleets

Aviation Week Network's **Fleet Discovery Military Edition** simplifies tracking global military aircraft and engines — piloted and unpiloted, fixed wing and rotary — so you can discover new opportunities to grow your business.

- **Featuring over 70,000 aircraft and 110,000 engines** in service with more than 400 military operators.
- **Searchable and filterable by** aircraft, engine, category, mission, lift type, weight class and more.

**See for yourself** how Fleet Discovery Military can help you track aircraft and engines so you never miss a business opportunity.

To learn more, go to [aviationweek.com/FDMilitary](http://aviationweek.com/FDMilitary)

Or call: **Anne McMahon** +1 646 291 6353 | **Thom Clayton** +44 (0) 20 7017 6106

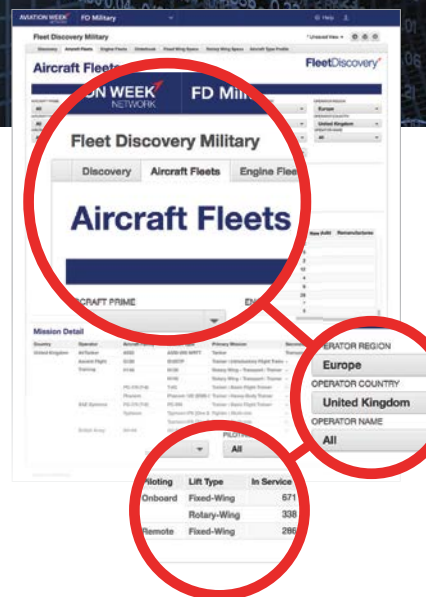

# Drones Lead Air Campaign Over Disputed Nagorno-Karabakh Region

- > MANNED FIGHTERS HAVE BEEN LARGELY HELD BACK FROM COMBAT
- > CANADA WITHDRAWS EXPORT PERMITS TO TURKEY OVER UAV EXPORTS

**Tony Osborne** London

**A**rmed unmanned aircraft systems, loitering munitions and intratheater ballistic missiles have spearheaded an air campaign over the region torn by dispute between Armenia and Azerbaijan.

Frontline combat aircraft assets have been so far largely held back from the engagement, which erupted in late September after 25 years of hostility over the Nagorno-Karabakh enclave, a de facto independent state

with an ethnic Armenian majority.

Armenia and Azerbaijan waged war over the landlocked region in 1988-94, eventually declaring a cease-fire but never reaching a settlement. Tensions have simmered ever since, with the current fighting the worst since the cease-fire.

Both sides have issued sizable daily tallies of claimed victories on social media, but there are few independent means of confirming the number

of shoot-downs of aircraft, UAVs and helicopters.

Both sides have made extensive use of UAVs during the fighting. But while Armenia appears to be using them for intelligence and surveillance, armed systems have been deployed by Azerbaijan to target Armenian positions. Footage of such attacks published on social media from electro-optical cameras fitted to Turkish-supplied Baykar Makina Bayraktar TB2 tactical UAVs reveals the use of small munitions to top-attack the weakest point on armored infantry fighting vehicles, artillery pieces and surface-to-air missile systems, with the UAVs operating with apparent impunity. Military personnel often refer to such imagery as "Kill TV." The Bayraktars appear to have been supported by Israel Aerospace Industries (IAI) Harop/Harpy and Aeronautics Defense Orbiter

**The success of Turkey's Bayraktar TB2 UAV during operations in Syria and Libya has prompted significant export interest in the platform and its armed capabilities.**



BAYKAR MAKINA



loitering munitions that Azerbaijan has ordered through defense agreements with Israel during the past decade.

Azerbaijani President Ilham Aliyev confirmed in an interview with Turkey's TRT state television channel that Turkish UAVs were being used. Aliyev said their use had reduced Azerbaijani casualties at the front. "Our army could have been harmed very much if we did not have such equipment," he told TRT.

Turkish media announced in June that Azerbaijan would be purchasing the Bayraktar platform. It is unclear whether these could have been delivered in time for the current operations or if Azerbaijan has leaned on its close relationship with Turkey to borrow or hurriedly transfer the systems to its military.

Armenia claims Turkey is operating in lockstep with Azerbaijan.

Armenian officials say command of Azerbaijan's offensive air operations has been handed to the Turkish Air Force, and that an Armenian Sukhoi Su-25 "Frogfoot" ground-attack aircraft was shot down on Sept. 29 by a Turkish F-16 forward-deployed in Azerbaijan. Armenian officials also suggests that Turkey has been providing an air picture from one of its Boeing E-7 airborne early warning aircraft, operating from within Turkish airspace and peering into Armenia.

Both the Azerbaijani and Turkish governments have denied Ankara's involvement in the shootdown, but the two nations exercise their armed forces together regularly.

It is easy to draw parallels between the Azeri UAV campaign and similar ones seen in Syria or Libya, where Turkey used the Bayraktar platform in large numbers to attack armored

vehicles and air defense systems, including the vaunted Russian-made Pantsir self-propelled anti-aircraft defense system in the case of Libya, with relatively few UAVs lost. British Defense Secretary Ben Wallace told the Royal Air Force's Air and Space Power Conference in July that the implications of the UAV's use by Turkey were "game-changing."

Several media reports have speculated that Azerbaijan has been using remote-controlled Antonov An-2 biplanes to locate the ground-based air defense systems, possibly accounting for claims of aircraft being shot down.

Both sides have accused each other of using intratheater ballistic missiles. Footage from a security camera captured an Azerbaijani IAI Long-Range Artillery ballistic missile hitting but not destroying a bridge near the village of Asagi Sus.

Azerbaijan, likewise, claims several Tochka battlefield ballistic missiles were fired at the city of Mingachevir by Armenia.

Disinformation has also muddied the waters, each nation accusing the other of shelling towns, possibly in an attempt to escalate or draw in regional allies.

"The coverage of the events in the Nagorno-Karabakh is fairly sparse, so it is difficult to get a detailed sense of the losses from both sides," says Douglas Barrie, defense aerospace specialist with the London-based International Institute for Strategic Studies.

"What is clear is the vulnerability of armored vehicles, artillery, and some ground-based air defense systems to small unmanned air systems and loitering munitions if there is an inadequate capability to engage or counter these . . . in a cost-effective way."

The international response to the conflict has been muted, although Canada announced Oct. 5 that it was suspending export permits for the electro-optical cameras used on the Turkish-made UAVs after pressure from the country's Armenian community.

Both nations make use of frontline combat aircraft supplied by Russia, with Armenia operating a four-strong fleet of Sukhoi Su-30 Flankers and nine Su-25s, while Azerbaijan has 14 Russian Aircraft Corp. MiG-29 Fulcrums and 21 Su-25s, according to the Aviation Week Intelligence Network's Military Fleet Discovery database. 





## Space Force Buys Into Rocket Reuse

- > SPACEX GRANTS SPACE FORCE DEEP INSIGHT INTO REFURBISHMENT PROCESS
- > SHAKEDOWN RUNS FOR PHASE 2 MISSIONS

Irene Klotz Cape Canaveral

**S**paceX has broken through the final barrier in a 3.5-year effort to retire safety and reliability questions about its rocket reuse program, winning U.S. Space Force approval to fly a pair of upcoming GPS III satellites on previously flown Falcon 9 boosters.

Modifications to the launch contracts, originally awarded

**SpaceX recovered the Falcon 9 first stage used to launch the U.S. Space Force GPS III-SV03 satellite on June 30.**



in March 2018, now permit GPS III-SV05 and GPS III-SV06 to launch on recycled Falcon 9 first stages, saving the Space Force \$52.7 million, says Walter Lauderdale, director of the Space and Missile Systems Center (SMC) Launch Enterprise Mission.

The changes, announced on Sept. 23, also permit SpaceX to recover boosters used for four GPS III launches. “Industry’s innovation has been key to SMC’s success over our 60-plus-year existence. I am thrilled to welcome SpaceX’s innovative reuse into the National Security Space Launch [NSSL] program,” SMC Commander Lt. Gen. John F. Thompson said in a statement.

The Space Force is the last of SpaceX’s customers to buy into rocket reuse. Satellite operator SES in March 2017 paved the way with the first commercial mission on a previously flown Falcon 9. By the end of that year, NASA began using recycled Falcon 9s for cargo runs to the International Space Station (ISS). It intends to do likewise with upcoming crew flights, beginning with SpaceX’s second ISS operational mission next year.

“We appreciate the effort that the U.S. Space Force invested into the evaluation and are pleased that they see the benefits of the technology,” SpaceX President and Chief Operating Officer Gwynne Shotwell said in the statement.

SpaceX and the SMC successfully launched and recovered the GPS III-SV03 booster on June 30, opening the door for the SMC to begin looking at reusing boosters, Lauderdale said during a conference call with reporters.

“That allowed us to get started doing our nonrecurring design validation for reuse . . . and set the stage for our continued partnership with SpaceX on the Phase 2 contract, which allows the launch service providers to provide previously flown hardware,” he said.

The booster from the pending GPS III-SV04 launch also will be recovered and refurbished for use on the GPS III-SV05 mission, now targeted for launch in July 2021—five months later than previously planned. “The launch date would end up moving to summer 2021 to accommodate our work together on doing our nonrecurring design validation of the reuse activity,” Lauderdale said.

“It’s not just the booster,” he added. “This is our journey in understanding how SpaceX executes refurbishment of previously flown hardware. . . . That requires review of a number of different systems and making sure that we’re good across the board for previously flown hardware.

“SpaceX will present us their information about how they do things [and] what they have for their qualifications,” Lauderdale continued. “We will review that information against our criteria and use that to ensure that we understand the technical baseline. We need to establish the same kind of technical baseline for hardware that has already flown.”

The SMC’s Launch Enterprise also agreed to reuse a Falcon booster for the launch of GPS III-SV06.

Across the two contracts, “we’re going to be saving over \$52 million for the taxpayer,” Lauderdale noted. “This also sets up what we need for our partnership with SpaceX going into Phase 2. . . . We’re looking forward to this journey with SpaceX, as we get even more experienced with them using reusable hardware.”

SpaceX and United Launch Alliance were selected in August for NSSL Phase 2 Launch Service Procurement awards, the first such solicitation since 2005. The first flights are expected in 2022. ☛

# ESA Spacecraft To Gauge NASA's Asteroid Deviation Trial

- > HERA MISSION TO HELP CREATE DEVIATION METHOD
- > ASTROPHYSICISTS AWAIT KEY DATA IN SOLAR SYSTEM HISTORY

Europe's Hera probe will precisely measure the consequences of the collision between a NASA spacecraft and an asteroid system in 2022.



OHB

Thierry Dubois Lyon

**A**s the COVID-19 pandemic has shown, a catastrophic event at a global scale is not just a phenomenon found in science fiction movies. And even as citizens the world over continue working to curtail the spread of the coronavirus, scientists still must keep a vigilant eye toward the sky for a common movie threat: asteroids.

With such a catastrophic event in mind, NASA's Double Asteroid Redirect Test (DART) mission will be the first program aimed at impacting an asteroid to deviate its path. The current crisis only reinforces the case for such a trial and the creation of models to help deviate any Earth-threatening asteroid.

Gathering data to design such a model will be the focus of the European Space Agency's (ESA) Hera mission, a follow-on to DART. Hera, named after the Greek goddess of marriage, is scheduled to launch in October 2024 and begin its survey close to the impacted asteroid late in 2026.

Hera will help researchers understand the collision and its consequences more precisely, thereby providing a solid basis to devise a deviation technique. The mission will also test autonomous proximity navigation, which may be useful in future Moon missions. Last but not least, it will give astrophysicists key information to estimate the age of a celestial body.

The collaboration between U.S. and European scientists is called the Asteroid Impact and Deflection Assessment, and it marks the start of planetary defense efforts.

The target for DART, which is due to launch in July 2021, is called Dimorphos. The 160-m-long (520-ft.) moon in

the binary asteroid system Didymos was chosen for the 6 km/sec. (3.7 mi./sec.) kinetic impact on Sept. 30, 2022.

It is just over the 140-m threshold defined as a critical size. Beyond that size, an asteroid impact may have catastrophic consequences for a country or a region. The calculated average frequency of such asteroids colliding with the Earth (most probably in a sea) is once every 10,000 years. There are currently 4,000 asteroids documented.

After DART hits Dimorphos, observation from Earth will enable NASA and the ESA to see a change in the asteroid's orbital period. This will confirm the impactor spacecraft struck the moonlet and thus validate guidance, explains Patrick Michel, Hera lead scientist at France's national research organization CNRS. Observation from the ground will enable the teams to calculate the deviation, "but we will not know exactly what happened," adds Ian Carnelli, head of ESA's Hera mission.

Hera will follow up with a detailed post-impact survey to turn the experiment into a well-understood and repeatable asteroid deflection technique. To validate the impact model, "we need Dimorphos' mass as well as exhaustive data on the crater," Michel says.

Experience with Japan's Hayabusa2 probe has shown the difficulty of predicting the size of an impact crater. "On the Ryugu asteroid, [the impact crater] was anticipated to be between 1-3 m in diameter," Michel says. "We measured it at 15 m. For a very low-gravity surface, the impact process is tricky to calculate and laboratory ex-

periments are done at a reduced scale."

Information on the crater's shape will allow the validation of impact modeling, Carnelli says. In particular, the topography of the crater after impact will help NASA and ESA calculate the mass of ejected rock. Thanks to the conservation of momentum, that ejection will act as an accelerator.

Hera's main spacecraft will be assisted by two cubesats, Juventas and Milani, to measure the asteroid's physical properties. Using a radar, Juventas will map the interior structure, notably determining the location of voids. Milani will determine Dimorphos' mineralogical composition with a multispectral camera. Computers onboard Hera's main spacecraft will calculate the asteroid's mass.

After being released from the mothership, both cubesats will be on their own to approach Dimorphos. All three spacecraft will use autonomous proximity navigation to fly close to the surface, where they will determine their position and detect terrain. An infrared camera will enable navigation over the dark side of Dimorphos.

The mothership will fly at a nominal distance of 3-10 km (2-6 mi.) from the surface; the distance between the main asteroid and its moon is 1 km. Altitude will be brought down to 150 m during an experimental phase, and there is hope that the technique could help devise autonomous navigation systems for future robotic missions to the Moon.

Both cubesats will eventually land and help the teams understand the surface's dynamic characteristics. Meanwhile, the mothership will record images. Surface elasticity and softness are important parameters in predicting the consequences of an impact.

Another lesson is hoped to be learned from more accurately modeling the way a crater forms. Astronomers estimate the age of an asteroid based on the number and size of the craters on the surface. The ability to calculate the age of an asteroid is important because they are seen as "the remaining bricks in the Solar System's building process," Michel says.

ESA awarded €129 million (\$151 million) to prime contractor OHB in September for the detailed design, manufacturing and testing of Hera. The €300 million mission, which includes launch and operations, is part of ESA's new "Space Safety & Security" program. 🌌



# Top Shot

AVIATIONWEEK  
2020 PHOTO  
CONTEST

Open to images taken  
since 2000



- International Recognition
- Cash Prizes

**Deadline extended to October 26, 2020**

Get more information and enter your photos  
at [AviationWeek.com/photo-contest](https://AviationWeek.com/photo-contest)

# DIVIDED MARKET

- > CHARTER FLIGHTS LEADING RECOVERY IN ACTIVITY
- > LARGE-CABIN JET BUSINESS LAGS LIGHTER AIRCRAFT



Fractional operator NetJets Europe has reversed pilot furlough and fleet reductions imposed in April as flight activity flatlined.

Graham Warwick Washington

NETJETS

**C** OVID-19 has caused a divide in business aviation. This is not like the bifurcation of the market after the 2008 economic crisis, when wealth destruction and over-production caused light-jet demand to collapse while sales of large-cabin jets continued largely unscathed.

Instead, driven by health concerns, it is a division of the market between private and corporate flying. Business-aircraft activity has recovered more quickly than commercial aviation. But that rebound has been led by private flights to the safety of second homes and not corporate flying on business trips.

The recovery has been overwhelmingly in domestic flights, with little sign of any rebound in international flying because of constantly changing travel restrictions as governments respond to a resurgence in the novel-coronavirus pandemic.

The story is in the data, with flight activity looking quite different than its normal pattern as business aviation recovers. "It's a whole new world when it comes to how charter behaves," Greg Johnson, president and chief technology officer of booking platform Tuvoli, told a September webinar organized by the National Business Aviation Association (NBAA).

"There are bright lights, new things that are happening that are encouraging, and there are certain geographies and parts of the business that are really challenged in this environment," he said. One of those bright lights is

the charter market, largely fueled by customers new to business aviation.

FAA aircraft movement data show a gradual resurgence of domestic U.S. activity since the April trough, with Part 91 private operations stabilizing by the end of August at around 18% less than in 2019. "The Part 135 charter market is doing much better, at 5% below 2019" and continuing to grow, Johnson said.

Geographically, the impact has not been spread evenly across the industry with corporate-aviation hubs such as Teterboro Airport in northern New Jersey near New York seeing a much slower recovery than airports in vacation destinations such as Florida or second-home locations such as Vail, Colorado.

A mecca for private aviation, Teterboro started to see a recovery in Part 91 and 135 activity as people began to return to the New York City area but, by



the end of August, was still down by more than 50% over the same month in 2019, said Johnson, adding: "It's really had a hard time coming back."

At the same time, second-home locations were showing an increase in traffic. Activity at Eagle County Regional Airport in Vail was trending 33% above 2019 levels for August. "Jackson Hole [Wyoming] and Aspen [Colorado] also were doing better," he said. "Throughout the pandemic, Florida was impacted less, its airports tracking pretty darned close to 2019."

"Charter operators are doing well, but it's regionalized," says Ryan Waguespack, senior vice president of the National Air Transportation Association. "In certain areas there are not enough aircraft. In others, they are at 45-65% capacity, at non-destination cities and places where it was 100% business travel."

Flight activity data also show a disparity based on aircraft size. During August, charter activity with midsize jets was running 2% above 2019 levels. "Large-cabin is a very different pattern. Throughout the pandemic they have really struggled. Because of the challenges with different restrictions, it is much harder to travel internationally than domestically," Johnson said. "It is better than it was, but large-cabin is not coming back at same rate as smaller domestic aircraft."

"It's a tale of two markets," says Paul Kirby, executive vice president of aircraft brokerage QS Partners. "Large cabin remains pretty soft. Inventory is rising and transactions are decreasing because they have nowhere to go. There's not much utility for a 6,000-nm aircraft right now. You can contrast that pretty dramatically with what we are seeing in the light-cabin market. Transaction volume is up, inventory is stable and prices are stable because there is utility there for domestic travel."

Part of that light-jet demand is from people new to business aviation. "We are seeing a lot of first-time airplane buyers . . . in the \$6 million and under, [Embraer] Phenom 300 and below, light-cabin segment. The common theme is people who have the means and are saying they are not going to travel on the airlines," says Kirby. "We are also seeing a lot of people upgrading out of single-engine turboprops."

Flight schools also have seen a recovery in activity, despite the pilot



**By late August, Wheels Up membership sales for 2020 were 20% up from the total for all of 2019.**

WHEELS UP

furloughs at the airlines. "It's a very dynamic environment," says Robert Rockmaker, president and CEO of the Flight Schools Association of North America. "We estimate we've lost at least 50-100 schools of different sizes, but the good news is schools that are open are operating at 70-100% of their pre-COVID levels."

While there will be no near-term shortage of pilots, both Waguespack and Rockmaker say longer-term the downturn could exacerbate the problem. With the delay in the restart of international flying, senior captains now on furlough face the prospect of returning to duty in a couple of years only to be forced to retire at 65 by regulations. Instead many are choosing to retire early.

"We are encouraging people to continue entering the industry. To pause is a big mistake," says Rockmaker. "Business aviation and charter are only going to grow because of health concerns, and there will be a need for more pilots to fly them. And there are going to be fewer and fewer pilots out of the military. That is no longer the supply chain, and it is not going to change."

Manufacturers reacted swiftly to COVID-19's global spread, shuttering factories and adjusting production rates for the rest of 2020 and into 2021 to align with expected lower demand for aircraft in the economic recession riding the pandemic's wake. The factories reopened, but as travel restrictions persisted so did difficulties delivering aircraft to existing customers and selling aircraft to new buyers.

Business-jet, turboprop, piston-aircraft and helicopter deliveries all declined during the first six months of 2020 compared to the same period of 2019, reports the General Aviation

Manufacturers Association (GAMA). Deliveries were down 26.7% for jets, 34.2% for turboprops and 37.1% for turbine helicopters. The total value of aircraft deliveries through the second quarter of 2020 was \$7.9 billion, down 20.2%, says GAMA.

"Gulfstream was able to deliver only 23 aircraft in the first quarter due to travel restrictions. We struggled with the same problem in the second quarter, but managed largely to mitigate that problem with 32 deliveries. There were several G650s to international customers that we couldn't deliver," Phoebe Novakovic, CEO of parent company General Dynamics, told investors in July.

The situation was similar at Textron Aircraft in the second quarter. "We delivered 23 jets, down from 46 last year, and 15 commercial turboprops, down from 34," Textron CEO Scott Donnelly told analysts in July. "The decrease in Citation volume largely reflected a decline in demand related to the pandemic and to a lesser extent delays in the acceptance of aircraft related to travel restrictions."

Orders were also down. "From an order perspective, sales activity in the quarter was extremely difficult, exacerbated by fears concerning the economy, inability to travel, inability to arrange demonstration flights and difficulty getting before the customers other than by telephone," said Novakovic, noting: "It's very difficult to sell an airplane, in fact impossible, over the telephone."

While Novakovic said customers contacted by Gulfstream "expressed the same needs and requirements as they had going into this downturn," it is hard to sell a large-cabin jet when corporations are concerned about the survival of their businesses as well as

the safety of their executives.

The lower end of the market presents a different story, fueled by individuals and families seeking a safer way to travel.

"We certainly have seen a pickup," said Donnelly. "The level of activity and orders that are closing have been stronger on the light side. King Air 250s are very strong. [Citation] M2s are strong. They're more for private businesses, high-net-worth individuals." Larger Citations are primarily corporate-owned. "We're not seeing as much activity yet in Latitudes and Longitudes, but there's a lot of dialogue going on."

But, despite a pickup at the lower end, the overall market is down significantly. "We still see 2020 business-jet deliveries industry-wide down approximately 30% year-over-year," Bombardier CEO Eric Martel told analysts in early August. But longer-term trends are encouraging, he said, with "very limited" cancellations of existing orders and pre-owned inventories remaining at healthy levels.

Holding to the revised forecast of 125-130 Gulfstream deliveries for 2020, down from around 150, Novacovik said, "Our backlog is holding up pretty strongly, which is in marked contrast to 2008-9, where the backlog experienced some significant erosion." They may not be placing new orders, but customers are telling Gulfstream their needs are unchanged. "This is just a question of timing," she said.

"As people go into the end of the year and beginning of 2021, we expect to see an uptick in the order activity," said Donnelly. Textron is encouraged by the recovery so far, "but we need to see that continue to progress and start to head back to some degree of normalcy," he said. The company is looking keenly to the beginning 2021 "as the corporate piece of America starts to make capex commitments again."

With the plant shutdowns and rate adjustments, Textron expects to be down 30-40% in deliveries for 2020. "The run rates anticipate you'd probably get half that reduction back as you go into 2021. But there's a long

way between here and 2021," Donnelly told analysts.

When Aviation Week first looked at how business aviation might recover from the pandemic, in June, evidence that the relative safety and convenience of private aircraft could draw new customers away from commercial aviation was anecdotal. Now there is solid data. But the question remains: Is the uptick here to stay, or will business aviation fall back to its normal demand pattern and customer base?

New customers entering business aviation tend to follow a pathway. "It starts with charter and club and hour, and moves into fractionals before whole ownership," said Donnelly. "Somebody that's never been on a business jet before doesn't buy a new airplane. They're going to start by getting some experience with it by the hour and progress to fractionals."

This model appears to be holding. "The addressable market today is not what it was last year," Alan Mann, director of safety at membership company Wheels Up, told the NBAA

AVIATION WEEK

# A&D Mergers and Acquisitions Conference

A VIRTUAL EVENT

NOVEMBER 11, 2020

1:00 PM EST / 10:00 AM PST

Gain Market Intelligence and Insight Into the Future of Aerospace & Defense Deal-Making

Aviation Week's A&D Mergers and Acquisitions Conference will provide a unique opportunity for leading dealmakers, CEOs, business development specialists and analysts to gain valuable insights into the outlook, opportunities and challenges facing the industry. In partnership with **Lazard** and **CSP Associates**, this half-day virtual event will explore how these issues will shape the outlook for mergers and acquisitions following the U.S. Presidential and Congressional elections, and as we head into 2021.

Speakers and panelists will include CEOs from leading OEMs, private equity investors focused on the A&D sector, and leading advisors who will provide first-hand perspectives and insights.

Topics focus on key components driving the industry:

- Early takeaways from third quarter results and U.S. 2020 elections
- COVID-19 recovery scenarios and implications for aircraft demand and defense spending priorities
- OEM and Top Tier supplier strategies plus supply chain analysis and impacts on restructuring, with a focus on expected investor interest and M&A activity
- What do recent transactions and valuations suggest for the M&A outlook in 2021
- Which sectors are likely to offer the best opportunities for supplier consolidation

Who should attend?

The Aviation Week virtual A&D Mergers and Acquisitions Conference has been developed for professionals at all levels of the A&D industry, from middle market companies to OEMs, supply chain strategy executives, private equity investors, government officials, analysts and consultants, providing exclusive insights that enable them to keep a competitive advantage in these dynamic markets.

IN PARTNERSHIP WITH:

LAZARD

CSP ASSOCIATES

AVIATION WEEK NETWORK

REGISTER and Learn More at:

[adma.aviationweek.com](http://adma.aviationweek.com)



CLAY LACY AVIATION



**Aircraft and fixed-base operators have imposed stringent COVID-19 health regimes to ensure the safety of business aviation.**

webinar. “People used to flying first class or business class don’t want to do that anymore. When companies are starting flying again, they’re saying to board members and CEOs, ‘you’re not

flying on airlines. It’s private only.”

Flying at Wheels Up was up 10% in August and, by the third week of that month, membership sales for the year were 20% above the total for all of 2019. “That is because the addressable market is so much bigger,” he said. “People that could afford to fly privately last year and didn’t think about it are thinking about it. I think [business aviation] will come back. But it’s all about the private flyer right now.”

In July, fractional operator NetJets Europe recalled furloughed crews and reinstated Dassault Falcon 2000EXs to its fleet. In the U.S, NetJets reported a strong increase in new owners joining the program as individuals and businesses. The fractional is a big customer for Textron. “They are seeing the same thing that we’re seeing from a sales standpoint. There’s demand out there,” Donnelly said.

“It’s across everything. It’s charter companies that are flying older aircraft, it’s guys like Wheels Up that are strong club membership models, it’s the NetJets seeing folks that are interested in cards but also fractional shares,” he said. “So I don’t think it’s anecdotal. I think it’s quite real. But from our perspective it starts in a non-equity mode and migrates through the path toward ownership.”

But consultant Brian Foley has sounded a cautious note about “unsubstantiated exuberance” over the charter-led recovery. “There is growing concern that summer may have been the high point for the aircraft charter season. Once the frolicking at the beach is over and people return home, the focus normally turns to business trips in the fall,” he wrote in *Forbes* in late August. And those trips look scant.

But countering that view are anecdotal reports from charter operators, cited by Johnson, that their customers have “flipped and are now making their primary home in the second-home city.” Real-estate markets in those same cities are “on fire,” he said. If substantiated, this trend could sustain charter activity to these cities as well as demand for private flying from customers new to business aviation. ☛

United States Postal Service		Statement of Ownership, Management, and Circulation (Requester Publications Only)	
1.	Publication Title: BCA Business & Commercial Aviation		
2.	Publication Number: 503-450		
3.	Filing Date: 9/30/2020		
4.	Issue of Frequency: Monthly		
5.	Number of Issues Published Annually: 11		
6.	Annual Subscription Price: Free to Qualified		
7.	Complete Mailing Address of Known Office of Publication (Not Printer): Informa Media, Inc., 22701 W 68th Terrace, Ste 100, Shawnee, Johnson County, KS 66226-3583	Contact Person: Tyler Molsinger	Telephone: 913-967-1623
8.	Complete Mailing Address of Headquarters or General Business Office of Publisher (Not Printer): Informa Media, Inc., 605 Third Ave, New York, NY 10158		
9.	Full Names and Complete Mailing Addresses of Publisher, Editor, and Managing Editor - Publisher: Frank Craven, Informa Media, Inc., 22701 W 68th Terrace, Ste 100, Shawnee, Johnson County, KS 66226-3583; Editor: Bill Garvey, Informa Media, Inc., 605 Third Ave, New York, NY 10158; Managing Editor: Jessica Salerno, Informa Media, Inc., 605 Third Ave, New York, NY 10158		
10.	Owner - Full name and complete mailing address: Informa Media, Inc., 605 Third Ave, New York, NY 10158; Informa Operating Holdings, Inc. (owns 100% of the stock of Informa Media, Inc.), 605 Third Ave, New York, NY 10158		
11.	Known Bondholders, Mortgagees, and Other Security Holders Owning or Holding 1 Percent or More of Total Amount of Bonds, Mortgages or Other Securities: None		
12.	Tax Status (For completion by nonprofit organizations authorized to mail at nonprofit rates) (Check one) The purpose, function, and nonprofit status of this organization and the exempt status for federal income tax purposes: N/A		
13.	Publication Title: BCA Business & Commercial Aviation		
14.	Issue Date for Circulation Data: August 2020	Average No. Copies Each Issue During Preceding 12 Months	No. Copies of Single Issue Published Nearest to Filing Date
15.	Extent and Nature of Circulation		
a.	Total Number of Copies (Net press run)	23,282	23,424
b.	Legitimate Paid and/or Requested Distribution (By Mail and Outside the Mail)		
(1)	Outside County Paid/Requested Mail Subscriptions stated on PS Form 3541. (Include direct written request from recipient, telemarketing and Internet requests from recipient, paid subscriptions including nominal rate subscribers, employer requests, advertiser’s proof copies, and exchange copies.)	9,020	9,739
(2)	In-County Paid/Requested Mail Subscriptions stated on PS Form 3541. (Include direct written request from recipient, telemarketing and Internet requests from recipient, paid subscriptions including nominal rate subscribers, employer requests, advertiser’s proof copies, and exchange copies.)	0	0
(3)	Sales Through Dealers and Carriers, Street Vendors, Counter Sales, and Other Paid or Requested Distribution Outside USPS®	1,525	1,992
(4)	Requested Copies Distributed by Other Mail Classes Through the USPS (e.g. First-Class Mail®)	0	0
c.	Total Paid and/or Requested Distribution (Sum of 15b (1), (2), (3), and (4))	10,545	11,731
d.	Nonrequested Distribution (By Mail and Outside the Mail)		
(1)	Outside County Nonrequested Copies Stated on PS Form 3541 (include Sample copies, Requests Over 3 years old, Requests induced by a Premium, Bulk Sales and Requests including Association Requests, Names obtained from Business Directories, Lists, and other sources)	8,692	8,378
(2)	In-County Nonrequested Copies Stated on PS Form 3541 (include Sample copies, Requests Over 3 years old, Requests induced by a Premium, Bulk Sales and Requests including Association Requests, Names obtained from Business Directories, Lists, and other sources)	0	0
(3)	Nonrequested Copies Distributed Through the USPS by Other Classes of Mail (e.g. First-Class Mail, Nonrequestor Copies mailed in excess of 10% Limit mailed at Standard Mail® or Package Services Rates)	0	0
(4)	Nonrequested Copies Distributed Outside the Mail (Include Pickup Stands, Trade Shows, Showrooms and Other Sources)	2,897	2,356
e.	Total Nonrequested Distribution (Sum of 15d (1), (2), (3), and (4))	11,589	10,734
f.	Total Distribution (Sum of 15c and 15e)	22,134	22,465
g.	Copies not Distributed	1,148	959
h.	Total (Sum of 15f and g)	23,282	23,424
i.	Percent Paid and/or Requested Circulation (15c divided by 15f times 100)	47.64%	52.22%
16.	Electronic Copy Circulation		
a.	Requested and Paid Electronic Copies	20,935	18,826
b.	Total Requested and Paid Print Copies (Line 15c) + Requested/Paid Electronic Copies (Line 16a)	31,480	30,557
c.	Total Requested Copy Distribution (Line 15f) + Requested/Paid Electronic Copies (Line 16a)	43,069	41,291
d.	Percent Paid and/or Requested Circulation (Both Print & Electronic Copies) (16b divided by 16c x 100)	73.09%	74.00%
<input checked="" type="checkbox"/> I certify that 50% of all my distribution copies (electronic and print) are legitimate requests or paid copies.			
17.	Publication of Statement of Ownership for a Requester Publication is required and will be printed in the:	issue of this publication.	Date
18.	Tyler Molsinger, Sr. Audience Development Manager		9/30/20
I certify that all information furnished on this form is true and complete. I understand that anyone who furnishes false or misleading information on this form or who omits material or information requested on the form may be subject to criminal sanctions (including fines and imprisonment) and/or civil sanctions (including civil penalties).			
PS Form 3526-R, July 2014			

**Business Aviation Week Online** See interviews with CEOs and other industry leaders, photo galleries of coming aircraft and more: [AviationWeek.com/bizav2020](http://AviationWeek.com/bizav2020)

## What is the Forecast for MRO Business Growth in the Next 2-3 years?

**Aviation Week Network Chief Editor, MRO, Lee Ann Shay and Air Transport and Safety Editor Sean Broderick**

**answer:** Maintenance, repair and overhaul (MRO) demand typically is a lagging indicator of airline demand. Many industry forecasters and major players—the International Air Transport Association and Boeing among them—do not see airline activity returning to 2019 levels before 2024 at the earliest. That puts a full MRO recovery to similar levels out a year or so further.

In the meantime, the aviation aftermarket will see several years of transition. Keep in mind the civil aftermarket segments do not move in lock-step. Line maintenance, for example, will recover more quickly than engine overhauls. Even within segments, there can be variation. An all-narrow-body engine shop will rally from this downturn more quickly than a wide-

and technology tools, looking for innovations and providing stellar customer service, which includes flexibility. If you think airlines were cost-conscious last year, you haven't seen anything yet.

The good news is that the trough of MRO revenue most likely occurred in the second quarter of this year for many companies. That said, the recovery will not be smooth. The engine-services business, which is about 40% of the global MRO spend, will see a lot of bumps, as airlines seek module swaps, parts exchanges and short hospital-type visits before committing to expensive engine overhauls.

with many airlines, but aircraft most likely to be parked are also the ones that do not have long-term agreements attached.

For companies with a bit of cash to spare, there will be opportunity. Component companies are helping airlines with liquidity by buying their excessive inventory, for instance. Aviation Week's latest Civil Aviation Fleet & MRO Forecast pegs MRO demand to be \$71.1 billion in 2021 but climbing to \$82.2 billion in 2023. In 2023, also expect China to generate the most MRO demand, followed by North America, then Western Europe. However, in 2021, Western

**Civil Aviation MRO Demand, 2021-23**  
(U.S. \$ Billions)



Source: Aviation Week Network Civil Aviation Fleet & MRO Forecast



NIGEL HOWARTH/AW&ST

body engine shop, because widebody long-haul services will take longer to overcome depressed travel demand.

A lot of decisions will pivot on which fleets the airlines decide to bring back, and that will not become clear in 2020. For passenger aircraft, emissions and sustainability will be big factors in those decisions, so expect older aircraft and engines that were slated for eventual retirement to see accelerated exits. This should be a key consideration for MROs' long-term strategy.

Now is the time for MROs to plan for the future by examining processes

The pandemic is providing lots of choices: green-time engines on idled aircraft, used-serviceable materials, and suddenly available spare-parts inventories from airlines that either do not need them or no longer exist.

While the market has not seen a mass of teardowns yet, several players have been testing the market to see what values they can get. But the situation is still more of a "wait and see." MRO service providers will see a greater share of the fleet in power-by-the-hour contracts post-pandemic. Not only are they proving popular

Europe will be the top MRO driver, and in 2022 North America, according to Aviation Week's forecast.

Bottom line: The rest of this year will be relatively quiet for MROs, but then the return will start happening in 2021. ☺

*The Aviation Week Network invites readers to submit questions to our editors. Answers are published online at [AviationWeek.com](http://AviationWeek.com). To access our answer archive or post a new question, go to: [AviationWeek.com/asktheeditors](http://AviationWeek.com/asktheeditors)*



**Aviation Week Marketplace** is a digital directory connecting **buyers with sellers** in the aerospace, air transport, business aviation, MRO and defense industries. *Become a power user by registering at [marketplace.aviationweek.com/register](http://marketplace.aviationweek.com/register). Registration is FREE, enabling you to find thousands of products like the ones featured below and to connect with more than 12,000 global suppliers. Create a personalized save list, learn about companies' specialties, get contact details and request information. Connect today at [marketplace.aviationweek.com](http://marketplace.aviationweek.com). Aviation Week Marketplace is the one source to find everything needed in aviation.*

Advertise on the Marketplace: contact **Elizabeth Zlitni** at **913-967-1348** or [elizabeth.zlitni@aviationweek.com](mailto:elizabeth.zlitni@aviationweek.com).

Place a classified ad: contact **Steve Copley** at **440-320-8871** or [stephen.copley@aviationweek.com](mailto:stephen.copley@aviationweek.com).

**MEDIA**

**Luckiest Engineer**

**An Aerospace Engineer's Memoir**

Available in print and as an ebook, *Luckiest Engineer* is a memoir about the work of a farm boy turned engineer whose involvement working on unparalleled aerospace vehicles and systems of the last 50 years makes for some great stories. *Luckiest Engineer* also shows the humorous side of aerospace engineering, highlighting many hilarious personal anecdotes.

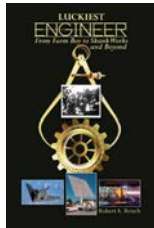

[luckiestengineerbook.com](http://luckiestengineerbook.com)

<https://marketplace.aviationweek.com/product/luckiest-engineer>

**TRAINING**

**Abaris Training**

**Advanced Composites Training and Services**

Abaris Training offers over 23 different intensive courses in engineering, manufacturing, and repair of advanced composite structures. All courses are a mix of classroom and hands-on lab exercises designed to provide students a thorough learning experience.



[abaris.com](http://abaris.com)

<https://marketplace.aviationweek.com/product/advanced-composites-training-and-services>

**CABIN HYGIENE**

**Waypoint Interiors**

**UV Lighting Solutions, Germ-Free Airline Travel**

- Long-term solution for COVID-19 and future viral threats!
- 99%+ effective
- Disables virus or bacteria
- Disinfects surfaces and airborne germs
- No harsh chemicals
- Latest LED UV light technology
- Permanently installed



[www.waypointinteriors.com](http://www.waypointinteriors.com)

<https://marketplace.aviationweek.com/product/uv-lighting-solutions-germ-free-airline-travel>

**TEST EQUIPMENT**

**Matec Instrument Companies, Inc.**

**Ultrasonic Testing Systems**

Matec Instrument Companies is an industry leader in providing superior nondestructive conventional and phased-array ultrasonic testing solutions. Our systems range from small laboratory tanks to complex, multi-axis, immersion and gantry systems capable of scanning large parts and complex contour geometries.



Matec provides a full range of in-house services including mechanical and electronic design, machining and fabrication, instrumentation and control, applications testing, and data acquisition and analysis software.



Matec's support services include installation and start-up, commissioning, training, instrument calibration, and repairs to ensure proper system alignment and calibration, and to deliver optimum performance and value.



Northborough, MA - Banning, CA | 508-393-0155 | [sales@matec.com](mailto:sales@matec.com)

[www.matec.com](http://www.matec.com)

<https://marketplace.aviationweek.com/product/ultrasonic-testing-systems>

Go to [marketplace.aviationweek.com](http://marketplace.aviationweek.com) for more information.

# Contact Us

**President/Publisher:** Gregory D. Hamilton;  
+1 (212) 204-4368; hamilton@aviationweek.com  
**Managing Director, Global Media:** Iain Blackhall (UK);  
+44 (0)20 7975 1670; iain.blackhall@aviationweek.co.uk

## U.S. Sales Offices

**Managing Director, Americas:** Beth Wagner;  
(202) 517-1061; beth.wagner@aviationweek.com  
**Director, Commercial Sales:** Tom Davis;  
(469) 854-6717; tom.davis@aviationweek.com

## International Regional Sales Offices

**Publisher, Defense, Space & Security:**  
Andrea Rossi Prudente (UK); +44 (207) 182 4524;  
andrea.rossiprudente@aviationweek.co.uk

## Marketing Services

**Director, Digital Customer Solutions:** Jason Washburn;  
(216) 931-9161; jason.washburn@informa.com

**Sales Team Listings:** @AviationWeek.com/sales-contacts

## Business/Production

**Senior Manager, Ad Production:** Jim Heffron;  
(630) 524-4552; jim.heffron@informa.com  
**Ad Operations Specialist:** Bonnie Streit;  
(630) 524-4456; bonnie.streit@informa.com

## Advertising/Marketing Services

**Media Kits, Promotions or Custom Media:**  
www.aviationweek.com/mediakits or Elizabeth Sisk;  
(860) 245-5632; elizabeth.sisk@aviationweek.com

**Business and Finance Manager:** Gabriel Balmes;  
+44 (0) 7881-010660; gabriel.balmes@informa.com

## Subscriber Service

**U.S.:** (877) 369-3767

**Outside the U.S.:** +1 (913) 850-6931

**Manage Your Subscription (and Claim Digital Edition) at:**  
aviationweek.com/awstcustomers

## Conferences/Exhibitions

www.aviationweek.com/events

**To Sponsor/Exhibit:** Beth Eddy;  
(561) 279-4646; betheddy@aviationexhibits.com

**To Register:** Virginia Gongora;  
(212) 204-4202; virginia.gongora@aviationweek.com

## AW&ST Mailing List Rental and Sales

**Anthony Treglia:** (212) 204-4231; Anthony.treglia@informa.com

## Reprints, Photocopies and Permissions

**Custom Reprints:** informa@wrightsmedia.com

**Wright's Media,** 2407 Timberloch Place, Suite B  
The Woodlands, Texas 77380  
Office: (281) 419-5725  
Toll Free: (877) 652-5295  
Cell: (713) 724-6987  
Fax: (281) 419-5712  
wrightsmedia.com/sites/aviation-week/contact.cfm

## Social Media

**Join the conversation. Follow us at:**

linkedin.com/company/aviation-week  
twitter.com/AviationWeek  
facebook.com/AvWeek  
youtube.com/AviationWeek

*Aviation Week & Space Technology* is published biweekly, with one issue in August by Informa Markets, a trading division of Informa PLC, 22701 W. 68th Terrace, Ste. 100, Shawnee, KS 66226-3583. Member of Audit Bureau of Circulations and Magazine Publishers of America. Periodicals postage paid at Kansas City, MO and additional mailing offices. Canadian GST #R126431964. Title reg.® in U.S. Patent Office. Copyright © 2020 by Informa Markets, a trading division of Informa PLC. All rights reserved. All rights to these names are reserved by Informa Markets. **Postmaster:** Send address changes to *Aviation Week & Space Technology*, Attention: Subscription Services, 22701 W. 68th Terrace, Ste. 100, Shawnee, KS 66226-3583.

**Aviation Week & Space Technology**  
**OCTOBER 12-25, 2020, VOL. 182, NO. 20**  
**(ISSN 0005-2175)**

# Aerospace Calendar

To submit Aerospace Calendar Listings

email: [aero.calendar@aviationweek.com](mailto:aero.calendar@aviationweek.com)

**Oct. 19-20**—SpaceCom. Virtual event. See [spacecomexpo.com](http://spacecomexpo.com)

**Oct. 19-20**—Directed Energy Systems 2020. Virtual event. See [idga.org/events-directed-energy/agenda-mc](http://idga.org/events-directed-energy/agenda-mc)

**Oct. 19-20**—Military PNT (satellite positioning, navigation, and timing) Conference. Virtual event. See [smi-online.co.uk/defence/uk/conference/militarypnt](http://smi-online.co.uk/defence/uk/conference/militarypnt)

**Oct. 20-22**—Precision Strike Technology Symposium (PSTS-20). Virtual event. See [ndia.org/events/2020/10/20/1pst-precision-strike-technology-symposium#](http://ndia.org/events/2020/10/20/1pst-precision-strike-technology-symposium#)

**Oct. 21-Nov. 17**—RTCA Plenary Sessions/Committee Meetings. Virtual or various locations. See [rtca.org/content/upcoming-committee-meetings](http://rtca.org/content/upcoming-committee-meetings)

**Oct. 27-28**—Mexico's Aerospace Summit. Hybrid event. Queretaro Congress Center. Queretaro, Mexico. See [mexicoaerospacesummit.com](http://mexicoaerospacesummit.com)

**Oct. 27-28**—2020 FAA International Rotorcraft Safety Conference. Virtual event. See [faahelisafety.org](http://faahelisafety.org)

## Aviation Week Network Events

+1 (800) 722-6344 or [Events.AviationWeek.com](http://Events.AviationWeek.com)

**Oct. 14**—CAPA Live. Virtual event.

**Oct. 19**—Aviation Week Laureates Awards. Virtual event.

**Oct. 19-21**—Aviation Week DefenseChain Conference. Virtual event.

**Oct. 20-21**—Aviation Week Program Excellence Awards. Virtual event.

**Oct. 26-27**—TakeOff North America 2020. Denver.

**Oct. 27-29**—MRO TransAtlantic. Virtual event.

**Nov. 11**—Aviation Week A&D Mergers & Acquisitions Conference. Virtual event.

**Nov. 11**—CAPA Live. Virtual event.

**Nov. 16**—Business & General Aviation Conference. Virtual event.

**Nov. 17-18**—Military Aviation Logistics & Maintenance Symposium (MALMS). Virtual event.

**Nov. 30-Dec. 4**—Routes Reconnected. Hybrid event. Amsterdam.

**Dec. 9**—CAPA Live. Virtual event.

## ADVERTISERS IN THIS ISSUE

Aviation Week Events	
A&D Mergers and Acquisitions Conference	69
Military Aviation Logistics & Maintenance Symposium (MALMS)	55
Aviation Week Network	
Aviation Week Intelligence Network	3rd Cover
Fleet Discovery Military	61
Market Briefings	21
2020 Photo Contest	66
Boeing	11
Forecast International	31
GE Aviation	2nd Cover
Leonardo	7
Lockheed Martin	4th Cover
Meggitt	13
MRO China	23
Ontic	4
Philpott Ball & Werner	27
Statement of Ownership	70
The Lee Co.	43

Inside MRO (between pages 38 & 39)	
Air Shunt	MRO24
Aviation Week Events	
MRO Virtual Events	MRO34
MRO TransAtlantic	MRO35
Aviation Week Network	
Aircraft Bluebook Jet Appraisals	MRO24
Fleet & MRO Forecasts	MRO21
MRO Prospector	MRO18
SpeedNews	MRO8
SpeedNews Marketplace	MRO30
BAE Systems	MRO11
Delta TechOps	MRO36
Pratt & Whitney	MRO5
Shannon Engine Support	MRO13
TPAerospace	MRO2
Triumph Group	MRO17
AVIATION WEEK MARKETPLACE	72
Abaris Training	72
Luckiest Engineer	72
Matec Instrument Cos.	72
Waypoint Interiors	72



# The Supply Chain After COVID-19

By Kevin Michaels

**A**fter 15 years of uninterrupted growth, jetliner industry production rates are in a downward spiral, thanks to the Boeing 737 MAX production shutdown and the COVID-19 crisis.

While Airbus and Boeing will navigate through the crisis weakened but intact, the outlook for suppliers is less certain. The jetliner supply chain expanded and evolved in recent decades to cope with uninterrupted growth and new customer needs. Three major changes are likely for it in the post-COVID world.

First, aircraft and aeroengine OEMs and major Tier 1 companies will shed noncore and underperforming assets acquired or developed over the last 20 years.

Rolls-Royce, which lost \$7 billion in the first half of 2020, announced it will shutter several UK facilities as well as Trent engine final assembly operations in Singapore and Germany. More is on the way: It plans to sell £2 billion (\$2.6 billion) in assets, including Spanish subsidiary ITP Aero.

Airbus recently terminated its initiative to insource A320neo nacelles, resulting in the loss of 350 jobs. Spirit AeroSystems also has scrapped its planned acquisition of component supplier Asco and may do the same with Bombardier's aerostructures businesses.

Is this the end of OEM vertical integration? Not necessarily. OEMs may need to acquire major suppliers to ensure the viability of their supply chains—much like Boeing's acquisition of Global Aeronautica in 2008-09. They will also continue to make investments in strategic technologies. And in some instances, they may insource to protect jobs and increase capacity utilization. What is clear is that the muscular pursuit of more capability to access profit pools and build service revenues no longer makes sense.

Second, we will see widespread failures and some consolidation among smaller build-to-print manufacturers, commonly known as Tier 3s. This supplier group faces the greatest pressure from the COVID-19 crisis. Tier 3 suppliers endured a four-part train wreck. They were first asked to make significant financial concessions to accommodate OEM supply chain cost-out initiatives. Next, they were asked to expand capacity to prepare for production rates of 60+ single-aisles per month. Then came this year's 737 MAX production shutdown, followed by COVID-19. Thousands of suppliers are vulnerable.

Some governments are trying to ameliorate this lethal combination. In North America, the U.S. paycheck protec-

tion program provided sustenance through the summer, but it has ended. Mexican suppliers appear to be on their own. In Europe, the French and German governments established generous support packages, while support in the UK has been much more restricted. Impresa Aerospace declared bankruptcy on Sept. 24, and more are sure to follow. Some analysts believe Tier 3 attrition could be 10-20%.

Third, there will be deleveraging of the significant Tier 4 vertical integration plays over the last decade. As I wrote in an Up Front column seven years ago, leading suppliers of raw materials, forgings and castings—Tier 4 suppliers—acquired downstream operations in machining and component manufacturing to improve productivity and capture profit pools (*AW&ST* Sept. 9, 2013, p. 18). Precision Cast-

parts led the charge, acquiring 20+ companies between 1999 and 2016 before its acquisition by Berkshire Hathaway for \$37 billion.

With the COVID-19 crisis, the logic of many of these acquisitions has been reversed. Machine shops that alleviated production bottlenecks have become financial sinkholes. The most aggressive company in unwinding these moves is Alcoa, which spun off its downstream aerospace assets and created two new companies: Arconic and investment castings supplier Howmet. More is likely to follow.

These changes underscore the need for capital injection and acquisitions of weak and failing suppliers. Acquirers will include private equity, aerospace holding

companies with strong track records (such as TransDigm and HEICO) and aerospace companies with strong balance sheets. We could also see governments enter the fray if a strategic asset or national champion is at risk.

If these predictions come true, we will have a much different jetliner supply chain architecture by the mid-2020s. There will be far fewer Tier 3s, as this is where most of the attrition and consolidation will take place. At the same time, we could see more Tier 2 component and subassembly suppliers as the drive to attain scale ends. TransDigm's acquisition of Esterline is a harbinger, transforming an underperforming Tier 1 avionics conglomerate into more than 15 Tier 2 suppliers. Spin-offs of OEMs and Tier 1s will add to the Tier 2 ranks. Finally, we will see slimmed down and more focused OEMs, Tier 1 and Tier 4 suppliers. ☛

## "THERE WILL BE FEWER TIER 2s, MORE TIER 3s AND SLIMMER TIER 1s AND 4s."

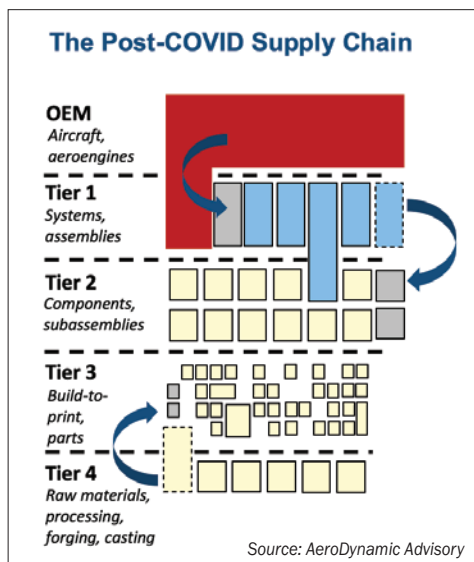

# Stay Informed. Stay Connected. Stay Engaged.

Access authoritative market insights and analysis along with company, program, fleet and contact databases covering the global aviation, aerospace and defense communities with an **Aviation Week Intelligence Network (AWIN) Membership**.



120,000 industry  
personnel



26,000+ global  
organizations



Details on 150,000+  
commercial, business and  
military aircraft



16,000 suppliers of  
more than 175,000  
products and services

## Become a member today.

Visit [aviationweek.com/AWINinfo](https://aviationweek.com/AWINinfo) to schedule your demo.

Or call **Anne McMahon** at +1 646 291 6353 or  
**Thom Clayton** +44 (0) 20 7017 6106



## Go for everyone on Earth.

From the Moon, to Mars and beyond, only Orion is designed to explore deep space. And it's going for more than just exploration. It's going for progress. It's going for human discovery. It's going to spark innovation. From automated software to advanced life support systems, new technologies will lead to new jobs for a new generation of explorers. Whether it's fueling our economy or igniting our imagination, Orion will do more than just take us farther into space. It will take us further as a species.

[www.lockheedmartin.com/orion](http://www.lockheedmartin.com/orion)

Lockheed Martin. Your Mission is Ours.®

