

# TECH BRIEFS

Welcome to your Digital Edition of *Tech Briefs* and *Photonics & Imaging Technology*

Included in This July Edition:

Tech Briefs



[Click Here](#)

COMSOL News



[Click Here](#)

Photonics & Imaging Technology





[Click Here](#)

## How to Navigate the Magazines:

At the bottom of each page, you will see a navigation bar with the following buttons:

 **Arrows:** Click on the right or left facing arrow to turn the page forward or backward.

 **Intro** **Introduction:** Click on this icon to quickly turn to this page.

 **Cov** **Cover:** Click on this icon to quickly turn to the front cover.

 **ToC** **Table of Contents:** Click on this icon to quickly turn to the table of contents.

 **Zoom In:** Click on this magnifying glass icon to zoom in on the page.

 **Zoom Out:** Click on this magnifying glass icon to zoom out on the page.

 **Find:** Click on this icon to search the document.

You can also use the standard Acrobat Reader tools to navigate through each magazine.



# Are you pushing the limits?



## We can help.

A 30+ year legacy of space qualified RF/Microwave components and subsystems, connectors and cable assemblies.

A heritage of innovative solutions for the most demanding applications.

As your global partner for **innovative connectivity solutions** we can provide you with a competitive advantage when tackling the challenges of higher power, higher data rates, wider bandwidth, and greater connectivity **all within a smaller footprint.**

## smiths interconnect

bringing technology to life

more > [smithsinterconnect.com](http://smithsinterconnect.com)

Free Info at <http://info.hotims.com/72995-900>



# TECH BRIEFS

ENGINEERING SOLUTIONS FOR DESIGN & MANUFACTURING



## The Next Giant Leap

*Special Apollo 50th  
Anniversary Issue*



# YOUR PREFERRED COMPONENT PART SEARCH? SURVEY SAYS...



#1



5

2

6

3

7

4

8



Source: <sup>ELECTRONICS</sup> sourcing  
ESNA Reader Survey 2018  
MMG Publishing LLP

1.800.344.4539  
**DIGIKEY.COM**

**Digi-Key**<sup>®</sup>  
ELECTRONICS

Digi-Key is an authorized distributor for all supplier partners. New products added daily. Digi-Key and Digi-Key Electronics are registered trademarks of Digi-Key Electronics in the U.S. and other countries. © 2019 Digi-Key Electronics, 701 Brooks Ave. South, Thief River Falls, MN 56701, USA

**ECIA MEMBER**  
Supporting The Authorized Channel

Free Info at <http://info.hotims.com/72995-713>



The most rugged mission of all time.



Thank you, Buzz  
Thank you, Michael  
Thank you, Neil

**We'll be there for the next.**

Learn the ways PulseR can help your  
company reach the stars by visiting:  
[www.pulseruggedized.com](http://www.pulseruggedized.com)

**PulseR**  
Ruggedized Solutions





# EXPERTS IN CARRIER GRADE DATA LINE PROTECTION SOLUTIONS



**In-Stock and Available for  
Same-Day Shipping!**



## CPX SERIES - DATA SIGNAL SURGE PROTECTION

- Compact, 1RU modular chassis fits up to 16 ports
- Front access, modular for multi-protocol installations
- 10/100 Ethernet, GbE and T1/E1 fused and non-fused modules
- Coordinated Level 1 and Level II lightning protection
- UL 497A and UL 497B models
- Telcordia standard GR-1089-CORE
- Dual lug grounding studs



transtector.com | +1 (208) 635-6400

Superior Protection | Patented Technology | Guaranteed Performance

Free Info at <http://info.hotims.com/72995-721>

Visit our new website!  
www.centuryspring.com

# THE WORLD'S LARGEST SELECTION OF STOCK SPRINGS

...at your fingertips



- Order Online
- Stock & Custom Parts
- 35,000 Designs in Stock
- Same Day Shipping on in-stock parts\*
- Download CAD Drawings on demand
- Cross Reference with competitor part numbers

\*Order must be placed by noon PST



**MADE IN USA**  
800-237-5225  
AS9100 Rev. D + ISO 9001:2015  
info@centuryspring.com

**NOW AS9100 REV D. for  
aerospace custom spring orders.**

Don't see what you're looking for?  
Contact our **Custom Department.**

## CUSTOMIZABLE FASTENERS WHEN SPEED MATTERS

When you need a quick solution to a fastener problem, **Accurate Screw Machine** delivers.

Specializing in custom fasteners for the aerospace industry, we design, manufacture prototypes and ship at record speeds to meet your tight timelines.

**Now  
AS9100D  
Certified**

AS9100D + ISO 9001:2015  
Certified QMS



**MADE IN USA**  
www accuratescrew.com  
(973) 244-9200



ACCURATE  
SCREW MACHINE

**MW Industries, Inc.**

Visit our new website for free  
CAD downloads and more:  
[www accuratescrew.com](http://www accuratescrew.com)



Free Info at <http://info.hotims.com/72995-716>



# Contents

## Features

- 10 **Products of Tomorrow**
- 16 **The Sensors Behind the GEN II Wearable Device**
- 49 **Special Section — The Next Giant Leap: Back to the Moon and on to Mars**
- 91 **Application Briefs**
- 92 **Facility Focus**
- 96 **NASA Spinoff: Apollo 11 VR Experience**

## Solutions

- 24 **Test & Measurement**
- 24 Noninvasive Device Tests Sweat Continuously for Hours
- 24 High-Throughput Friction and Wear Tester
- 26 Automated Guided Wave System for In-Process Cure Monitoring of CFRP Composite Laminates
- 26 More Sensitive Measurement of Semiconductor Material Quality
- 27 New Technique Tests for Viral Infections
- 28 Smartphone Test Spots Poisoned Water Risk
- 30 **Power & Energy**
- 30 Thin-Film System Converts Heat from Electronics into Energy
- 30 Fuel Cell Technology Runs on Solid Carbon
- 32 Hybrid Transformer
- 33 Stretchable Power Source for Wearables
- 34 **Materials & Coatings**
- 34 Graphene Lid Extends Photoemission Electron Microscopy to Liquids
- 36 Multistep Self-Assembly for Reconfigurable Materials
- 38 Supergel System Cleans Radioactively Contaminated Structures
- 39 Phase-Switching Liquids as Anti-Icing Materials

*(Solutions continued on page 6)*

24



88



91

## Departments

- 8 UpFront
- 12 Q&A
- 14 5 Ws
- 95 Advertisers Index

## New for Design Engineers

- 88 New on the Market



### Special Advertising Supplement

**1a – 32a  
COMSOL News**

COMSOL's annual multiphysics simulation magazine.





**KIMARIE YOWELL**

—  
VP, Talent Development  
Quicken Loans



**“ MICHIGAN IS A  
PLACE WHERE YOU  
CAN GROW, BE  
CREATIVE AND LIVE  
YOUR BEST LIFE.”**

—

In Michigan, you don't have to choose between working and having a life. High-paying specialized jobs and a low cost of living are huge draws for our talented workforce. And our business-friendly environment and global relationships make Michigan just as attractive to businesses. Whether you're a job seeker or job maker, come to Michigan or get left behind.

Visit [michiganbusiness.org/pure-opportunity](http://michiganbusiness.org/pure-opportunity)



**MICHIGAN.  
PURE OPPORTUNITY.**

**MICHIGAN ECONOMIC  
DEVELOPMENT CORPORATION**

Free Info at <http://info.hotims.com/72995-717>



# THE FUTURE DEPENDS ON OPTICS

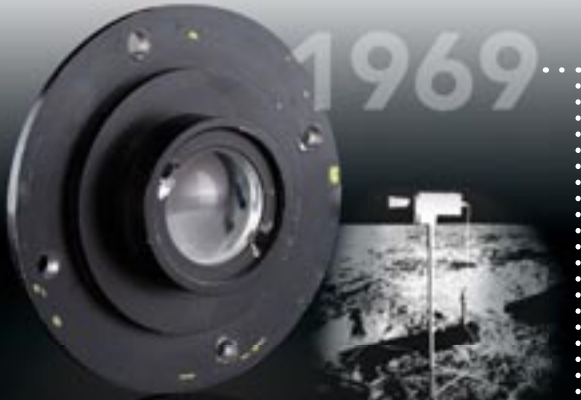

This **Edmund Optics**® lens became a part of US space history as a critical component in the first color TV camera to record APOLLO landings on the moon.



**Edmund Optics**® continues to supply optical components and imaging lens assemblies for the next wave of space exploration.

▶ Find out more at  
[www.edmundoptics.com](http://www.edmundoptics.com)

**EO**® **Edmund**  
optics | worldwide

## Contents

### 40 Manufacturing & Prototyping

40 Fabricating Nanochips via Thermal Lithography

40 Combining Origami and 3D Printing to Make Complex Structures in One Step

41 Self-Assembled Micro-Organogels Enable 3D Printing of Silicone Structures

42 Shear Assisted Processing and Extrusion

44 Wafer-Level Microchannel Fabrication Process for Lab-on-a-Chip Devices

45 3D Printing of Flexible Circuits

### 46 Aeronautics

46 Sensor Network for Air Vehicles

47 Aircraft Engine Icing Event Avoidance and Mitigation

48 Advanced Over-the-Wing Nacelle Transport Configuration

## Product of the Month

Dewesoft (Whitehouse, OH) introduced single-channel KRYPTON data acquisition modules for use in harsh environments.



88

## On the cover



On July 20, 1969, humans touched down on another world for the first time. This issue celebrates the 50th anniversary of that historic Moon landing and takes the "next giant leap" with NASA and its partners, highlighting a return to the Moon and the vision of landing on Mars. Our special section, Back to the Moon and on to Mars, begins on page 49.

(Image: NASA)

Permissions: Authorization to photocopy items for internal or personal use, or the internal or personal use of specific clients, is granted by Associated Business Publications, provided that the flat fee of \$3.00 per copy be paid directly to the Copyright Clearance Center (222 Rose Wood Dr., Danvers, MA 01923). For those organizations that have been granted a photocopy license by CCC, a separate system of payment has been arranged. The fee code for users of the Transactional Reporting Service is: ISSN 0145-319X/194 \$3.00+ .00



DC to 500 kHz / 5 MHz

# MFLI Lock-in Amplifier

# MFIA Impedance Analyzer

starting at

\$6,210

starting at

\$11,270

## All Instruments include



Spectrum Analyzer



Imaging Module



Parametric Sweeper



Threshold Unit Tip Protection



Oscilloscope with FFT



MATLAB®, LabVIEW®, .NET, C, and Python interfaces

## Upgrade options

### 4 PID/PLL Controllers

- PID Advisor suggests initial set of parameters
- Auto-tune automatically minimizes residual PID error
- PLL Mode with  $\pm 1024 \pi$  phase unwrap for robust locking

### AM/FM Modulation

- Generation and analysis of AM/FM modulated signals
- Single and higher order sideband analysis
- Adjustable filter settings for each frequency

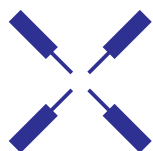

Zurich  
Instruments

Your Application. Measured.

Intl. +41 44 515 0410  
USA 855-500-0056 (Toll Free)  
info@zhinst.com  
www.zhinst.com

Let's discuss your application

Start the conversation today

Free Info at <http://info.hotims.com/72995-719>



Intro

Cov

ToC





## Share Your Apollo Story

To celebrate the 50th anniversary of the Apollo 11 Moon landing, the NASA Explorers: Apollo commemorative audio series will examine the Moon's cultural and scientific influence over the last half-century while looking to the future of exploration. NASA invites you to help tell the Apollo story by sharing your perspective on lunar exploration or by interviewing someone who lived during the Apollo era. NASA will select submissions to feature in the audio series, on its website, and/or social media. The deadline to submit your story is December 31, 2019.

E-mail your audio recording to [apollostories@mail.nasa.gov](mailto:apollostories@mail.nasa.gov)

## What's New on Techbriefs.com



Ayato Kanada came up with his leech-like robot in a place you'd least expect: his bathroom. "The shower hose went wild, as if it had come alive, when I turned on the faucet at maximum," Kanada said. See how the shower hose with a life of its own led to the creation of a flexible "LEeCH" robot that can climb walls. Go to the Motion Control and Automation hub of [techbriefs.com](http://techbriefs.com) to read a Web-exclusive interview with Toyohashi University of Technology's Ayato Kanada. Contact me at [billy@techbriefs.com](mailto:billy@techbriefs.com).

## Next Month in Tech Briefs

The August issue will discuss how the use of simulation is imperative for autonomous vehicle designers. Using acoustic, visual, and haptic information, designers can more accurately predict how a vehicle will behave in specific situations.

## We Are Going

With those three words, NASA Administrator Jim Bridenstine announced the agency's directive to land the first American woman and the next American man at the South Pole of the Moon by 2024, followed by a sustained presence on and around the Moon by 2028 — and in the 2030s, land astronauts on Mars.

This issue features a special section highlighting NASA's "Next Giant Leap." Marking the 50th anniversary of the Apollo 11 Moon landing, our special coverage also includes an interview with former NASA astronaut Mike Massimino, an in-depth look at the technologies we'll need to return to the Moon and maintain a presence there, how we'll get there this time, and a preview of some of NASA's current work that will enable future Mars missions.

NASA's Apollo Program was a stunning demonstration of the United States' strength of will and technological power — a feat that inspired generations of young people. Just as Apollo 11 inspired a generation 50 years ago, NASA continues to inspire with the Artemis program that will return us to the Moon — the first step to begin this next era of exploration.



## Spacecraft to Use "Green" Fuel for the First Time



Ball Aerospace engineers perform final checks before the spacecraft shipped to Kennedy Space Center. (Credit: Ball Aerospace)

A non-toxic, rose-colored liquid could fuel the future in space and propel missions to the Moon or other worlds. NASA will test the fuel and compatible propulsion system in space for the first time with the Green Propellant Infusion Mission (GPIM).

GPIM will demonstrate the features of the fuel, developed by the Air Force Research Laboratory (AFRL). The propellant blends hydroxyl ammonium nitrate with an oxidizer that allows it to burn, creating an alternative to hydrazine, the highly toxic fuel commonly used by spacecraft today.

The new propellant is denser than hydrazine and offers nearly 50% better performance, enabling spacecraft to travel farther or operate for longer with less propellant onboard.

Aerojet Rocketdyne in Redmond, WA, designed, built, and tested the GPIM propulsion system. Ball Aerospace of Boulder, CO, leads the NASA technology demonstration mission.

Visit [www.nasa.gov/mission\\_pages/tdm/green/index.html](http://www.nasa.gov/mission_pages/tdm/green/index.html)

## Connect with Tech Briefs



[facebook.com/TechBriefsMagazine](https://facebook.com/TechBriefsMagazine)



[linkedin.com/company/tech-briefs-media](https://linkedin.com/company/tech-briefs-media)



[twitter.com/TechBriefsMag](https://twitter.com/TechBriefsMag)



Intro

Cov

ToC



# Looking beyond our solar system with ray tracing simulation...

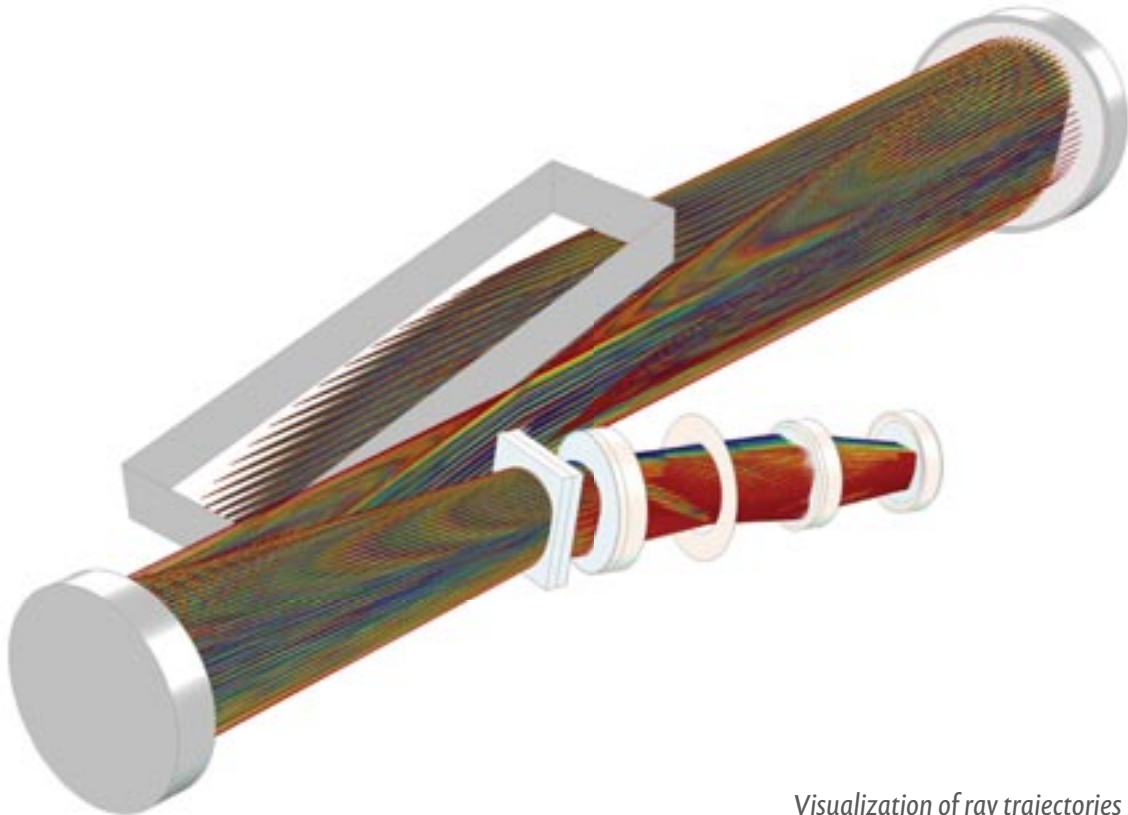

*Visualization of ray trajectories in a white pupil échelle spectrograph.*

Astronomers detected an Earth-like planet 11 light-years away from our solar system. How? Through data from an échelle spectrograph called HARPS, which finds exoplanets by detecting tiny wobbles in the motion of stars. Engineers looking to further the search for Earth-mass exoplanets can use ray tracing simulation to improve the sensitivity of échelle spectrographs.

The COMSOL Multiphysics® software is used for simulating designs, devices, and processes in all fields of engineering, manufacturing, and scientific research. See how you can apply it to spectrography.

[comsol.blog/echelle-spectrographs](https://comsol.blog/echelle-spectrographs)

# Products of Tomorrow

This column presents technologies that have applications in commercial areas, possibly creating the products of tomorrow. To learn more about each technology, see the contact information provided for that innovation.



## ► Multilayered Fire Protection System

NASA's Langley Research Center has developed a flexible, lightweight, and portable thermal protection system — a multilayer thermal blanket designed to handle external temperatures up to 2000 °F. The system creates an environment for protecting equipment, facilities, and people from a high-intensity incident heat source such as a fire. The Multilayered Fire Protection System uses technology from spacecraft flexible heat shields for future planetary missions. It includes an outer textile layer that reflects more than 90 percent of the radiant heat, an insulated layer that protects against convective heat and hot gases, and a non-porous film layer that is a gas barrier layer. The system can be formed as a sleeping bag, a tent, a blanket, a vertical barrier, a curtain, a flexible rollup doorway, or a wrap.

Contact: Langley Research Center  
Phone: 757-864-1178  
E-mail: [LARC-DL-technologygateway@mail.nasa.gov](mailto:LARC-DL-technologygateway@mail.nasa.gov)  
<https://technology.nasa.gov/patent/LAR-TOPS-212>



## ► Compact Antenna Enables Communication Where Radios Fail

A pocket-sized antenna was developed at the SLAC National Accelerator Laboratory that could enable mobile communication in situations where conventional radios don't work such as underwater, through the ground, and over very long distances through air. The device emits very low frequency (VLF) radiation with wavelengths of tens to hundreds of miles. These waves can penetrate environments that would block radio waves with shorter wavelengths. While today's most powerful VLF technology requires gigantic emitters, this antenna is only four inches tall, so it could potentially be used for tasks that demand high mobility including rescue and defense missions.

Contact: Andrew Gordon, SLAC National Accelerator Laboratory  
Phone: 650-926-2282  
E-mail: [agordon@slac.stanford.edu](mailto:agordon@slac.stanford.edu)



## ► Wearable Device Captures Cancer Cells from Blood

The University of Michigan developed a wearable device that can continuously collect live cancer cells directly from a patient's blood. Over a couple of hours in the hospital, the device could continuously capture cancer cells directly from the vein, screening much larger volumes of a patient's blood. The device shrinks a machine that is typically the size of an oven down to something that could be worn on the wrist and connected to a vein in the arm. It mixes the blood with heparin, a drug that prevents clotting, and kills bacteria without harming the cell-targeting immune markers, or antibodies, on the chip. The device could optimize treatments for human cancers by enabling doctors to see if the cancer cells are making the molecules that serve as targets for many newer cancer drugs.

Contact: Katherine McAlpine, University of Michigan  
Phone: 734-763-2937  
E-mail: [kmca@umich.edu](mailto:kmca@umich.edu)



IGNITING THE SPARK OF IMAGINATION



## ADVANCING INNOVATION FOR OVER 100 YEARS

A famous scientist once said *"Logic will get you from A to B. Imagination will take you everywhere"*.

Through our creative design and development expertise, we help our customers dream beyond today's technology and achieve the impossible.

NEWENGLANDWIRE.COM



NEW ENGLAND WIRE  
TECHNOLOGIES

603-838-6624 • [info@newenglandwire.com](mailto:info@newenglandwire.com)

Free Info at <http://info.hotims.com/72995-738>



## High Precision Displacement Sensors



Unaffected by  
Oil, Dirt, Water,  
Radiation & more

Position  
Vibration  
Alignment  
Dimensioning

For more information about  
our full line of eddy current  
sensors, contact us today!

800-552-6267  
measuring@kaman.com  
kamansensors.com

**KAMAN**  
Precision Products / Measuring

# Q&A

## Power Anomalies Detect Malware in Embedded Systems



Aydin Aysu, Ph.D., is Assistant Professor in the Electrical & Computer Engineering Department at North Carolina State University in Raleigh, where he

helped develop a technique for detecting micro-architecture malware that uses a system's architecture to thwart traditional security measures.

**Tech Briefs:** How does micro-architecture malware thwart traditional security measures?

**Professor Aydin Aysu:** Typically, malware detection relies on a software issue. There is a database of potential software vulnerabilities. If such a vulnerability is being exploited, you can detect it. This is called signature-based detection. Micro-architecture malware, on the other hand, uses hardware vulnerabilities, which are fundamentally different. This is done in all modern microcontrollers or processors — things like sharing tasks and data across applications. In the past three or four years, we have figured out ways this fundamental optimization strategy can be abused. That is what we mean by micro-architectural attacks — they can occur because of how the hardware fundamentally operates.

**Tech Briefs:** How does the malware get into the microprocessor?

**Dr. Aysu:** There is a unit called a cache — a full memory structure in the hardware that is shared across different programs. When a program executes, caches are shared among programs to accelerate their execution. Malware doesn't actually listen in on the software; it listens for how the software changes the hardware execution. If there is a certain behavior in memory or cache access in some security-critical program, then

while this is executing, the malware listens to its signatures — memory access, execution time, etc. Based on this information, the malware tries to reverse-engineer what is being done in the target victim's software. It can do this without having to access the target program's execution. It simply observes how the program is executed in the hardware and observes the traces it leaves in the architecture.

**Tech Briefs:** How did you come to the idea of tracking power fluctuations?

**Dr. Aysu:** We found that although malware can be successful, the perpetrators would have to change the software instantiation by adding extra instructions. That would change the power consumption as it's being executed. There are millions of electronic devices today. People are trying to patch in software to make the devices more secure against malware but it's not successful in my opinion. What we envision in the future is an out-of-the-box, plug-and-play software monitor that can then be attached to the microcontroller of the system it's going to protect.

**Tech Briefs:** Won't hackers try to fool your detector?

**Dr. Aysu:** Once you have this system, the next step for the malware designers is to mimic the power behavior of a trusted application and still do some malicious activity. Depending on the system configuration and its power measurement capabilities, there is room for malware to mimic power consumption. This is not valid for all malware but even where it can be effective, its power will be reduced. We observed that if the malware is shaped to mimic normal power behavior, our detector causes it to slow down by over 86%.

Read the full transcript of this Q&A at [www.techbriefs.com](http://www.techbriefs.com).





# MESHING COMPLEX GEOMETRY REQUIRES EXPERT MESHING TOOLS



**IF THIS IS ALL YOU'RE MESHING,  
YOU PROBABLY DON'T NEED US.  
FOR EVERYTHING ELSE ...**

# csimsoft™

TRY IT HERE: [CSIMSOFT.COM](http://CSIMSOFT.COM)



# 5 Ws of PDK Recyclable Plastic



## Who

Anyone who uses products made of plastic. The new recyclable plastic could be a good alternative to many nonrecyclable plastics in use today.



## What

All plastics — from water bottles to automobile parts — are made up of large molecules called polymers, which are composed of repeating units of shorter carbon-containing compounds called monomers. During processing at recycling plants, plastics with different chemical compositions are mixed together and ground into bits. When chopped-up plastic is melted to make a new material, it's hard to predict which properties it will inherit from the original plastics. This has prevented plastic from becoming a “circular” material whose original monomers can be recovered for reuse for as long as possible, or “upcycled” to make a new, higher-quality product. The new plastic, called poly(diketoenamine), or PDK, can be disassembled into its constituent parts at the molecular level and then reassembled into a different shape, texture, and color again and again without loss of performance or quality. With PDKs, the bonds of conventional plastics are replaced with reversible bonds that allow the plastic to be recycled more effectively. Unlike conventional plastics, the monomers of PDK plastic could be recovered and freed from any compounded additives simply by dunking the material in a highly acidic solution. The acid helps to break the bonds between the monomers and separate them from the chemical additives that give plastic its look and feel.

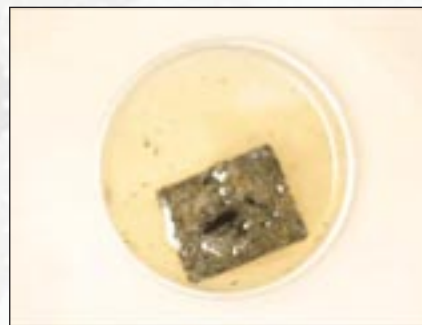

PDK plastic degrades in acid to its molecular building blocks. (Peter Christensen/Berkeley Lab)

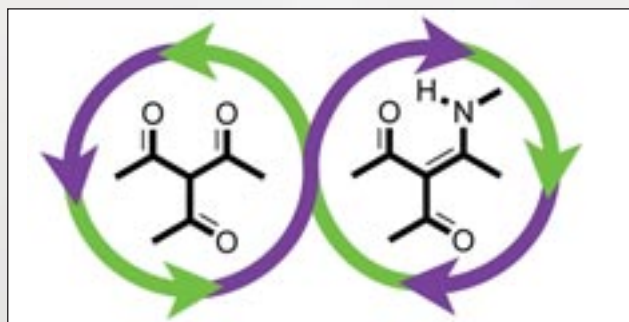

PDK plastics are a “circular” material whose original monomers can be recovered for reuse for as long as possible, or “upcycled” to make a new, higher-quality product. (Peter Christensen et al./Berkeley Lab)



## Where

Lawrence Berkeley National Laboratory, Berkeley, CA



## Why

Very few plastics can be recycled without loss in performance or aesthetics. Even the most recyclable plastic, poly(ethylene terephthalate), or PET, is only recycled at a rate of 20 to 30%, with the rest typically going to incinerators or landfills where the carbon-rich material takes centuries to decompose.



## When

The researchers plan to develop PDK plastics with a wide range of thermal and mechanical properties for applications as diverse as textiles, 3D printing, and foams. In addition, they are looking to expand the formulations by incorporating plant-based materials and other sustainable sources. The technology is available for licensing and collaboration.

Watch how the plastic degrades on Tech Briefs TV at [www.techbriefs.com/tv/pdk\\_plastic](http://www.techbriefs.com/tv/pdk_plastic).  
Contact Berkeley Lab's Intellectual Property Office at [ipo@lbl.gov](mailto:ipo@lbl.gov); 510-486-4306.



# Miniature reed relay technology enables ultra high density switching test & simulation modules

Reed relay pioneer, Pickering Electronics and PXI/LXI/PCI test & simulation module leader, Pickering Interfaces combine to deliver innovative solutions for high-rel applications

When reed relay specialist manufacturer Pickering Electronics introduced the 120 series 4mm<sup>2</sup>™ reed relay family last year that stack on a 4mm x 4mm footprint, this was big news for manufacturers of A.T.E. switching matrices or multiplexers, as it effectively quadrupled the stacking density possible, enabling sixteen new devices to be packed onto a PCB space of 1.6cm x 1.6cm. By comparison, only four industry-standard footprint reed relays can be fitted into the same area.

As an example of what this means in practice, Pickering's sister company, Pickering Interfaces, the designer of modular signal switching and instrumentation for use in electronic test and simulation, has managed to pack 4224 of these tiny footprint relays into its latest **BRIC™** ultra-high-density large PXI matrix range (model 40-559), robust 1A/20W switching modules, delivering up to 4,096 crosspoints – more than any other competing product in the same format. The matrices are available in 2, 4, or 8-slot PXI sizes and are designed for high-performance matrix requirements. They are used in many industries including automotive ECU and semiconductor package testing.

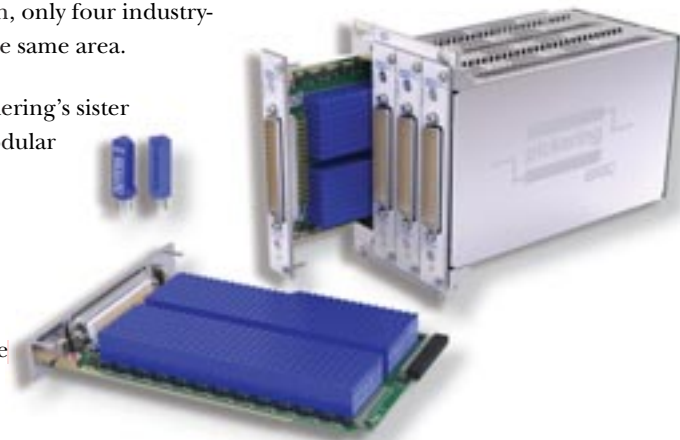

Pickering Electronics's latest Series 124 4mm<sup>2</sup>™ reed relay features a reduced height of just 9.5mm – down from 15.5mm with the 120 4mm<sup>2</sup>™ series, making it industry's smallest through-hole reed relay by both footprint and by volume. In common with all Pickering reed relays, the new devices feature the highest grade reed switches – in this case a sputtered ruthenium switch rated at 5W, 0.5A – making them suitable for demanding applications. If a higher rating is required, Series 120 reed relays are rated up to 1A at 20W.

Pickering Interfaces' test and simulation modules are used in high-rel industries, including space, aerospace, automotive and semiconductor manufacturing. The company offers industry's widest range of switching and simulation solutions for PXI, LXI & PCI applications. To support its switching and simulation solutions, Pickering Interfaces also offers a full range of supporting connectivity and cabling solutions along with applications software and software drivers.

In this case, the close collaboration between two businesses, one a component manufacturer and the other a component user, has driven product innovation benefitting the customers of both companies.



[pickeringrelay.com](http://pickeringrelay.com) | [pickeringtest.com](http://pickeringtest.com)

Free Info at <http://info.hotims.com/72995-724>



# The Sensors Behind the GEN II Wearable Device

The population is aging and more people need healthcare support, which is having a big impact on the overall cost of medical care. As a result, authorities and health insurance companies are putting more emphasis on prevention, health awareness, and lifestyle including more interest in monitoring certain vital body parameters. This is why companies in the smart watch and health watch business have seen their revenue grow over the past few years. Buying a health watch and monitoring certain body parameters over a period of time gets the user familiar with these num-

bers and uses them to adapt day-to-day life for improvement.

This article focuses on Analog Devices' wearable VSM platform and the sensor technologies used (Figure 1). ADI is not a manufacturer of final products; however, this platform has been designed as a reference to help the electronic designer and system architect speed up the development process while designing smarter, more accurate wearable devices for the professional and medical market.



Figure 1. ADI's GEN II integrated wearable device reference design.

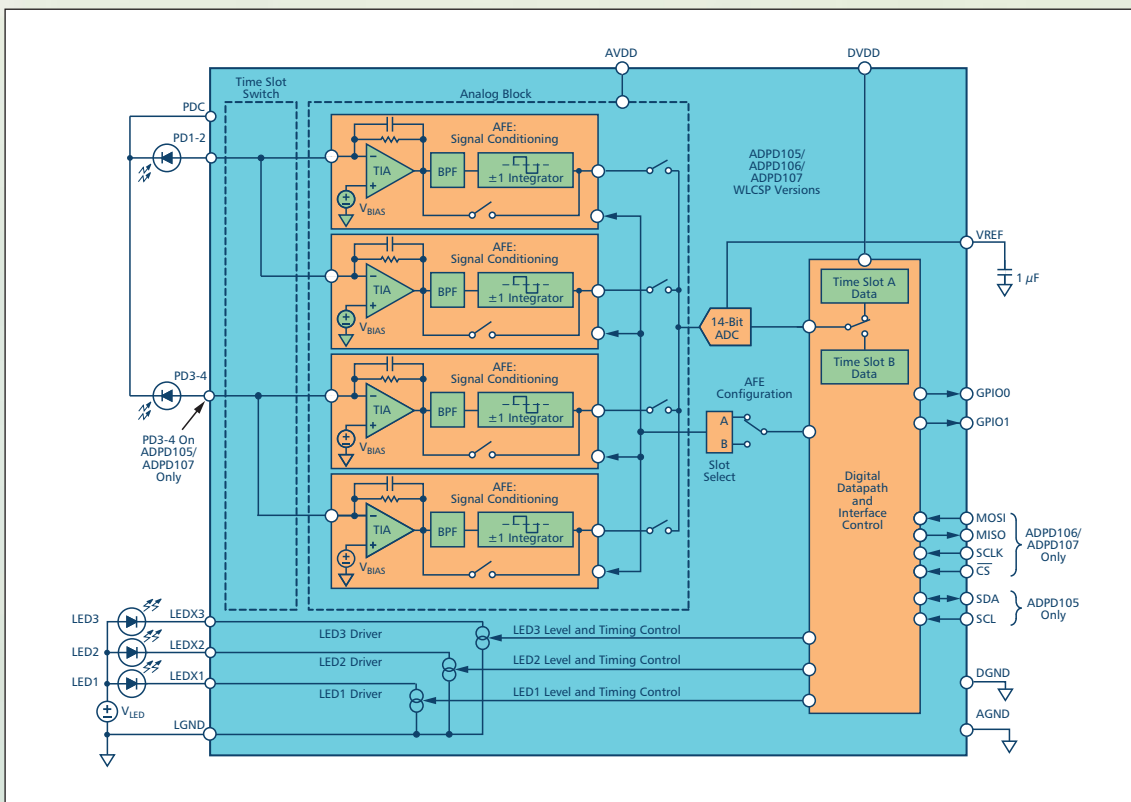

Figure 2. Block diagram of ADPD105/ADPD106/ADPD107.

## What Are We Measuring? How and Where?

A broad range of vital parameters can be measured with a wearable device. Depending on the overall objective, certain parameters are more important to measure than others. The location of the wearable device on the body has a big impact on what can be measured and what cannot. The most obvious location is the wrist. We are accustomed to wearing a device on our wrist, which is why so many smart watches and wrist-worn devices are on the market. Besides measuring on the wrist, the head is another good location for wearables; for example, headphones and earbuds are offered in different styles that contain embedded sensors to measure parameters such as heart rate, oxygen saturation, and temperature. The third location for wearables on the body is the chest. First-generation heart rate monitors were designed around a chest strap and this biopotential measurement method is still a very accurate technique.

Today, we tend to prefer a chest patch, as the strap is not very

comfortable to wear. Several manufacturers are involved in the design of smart patches to monitor vital parameters.

Depending on body location, we are not just faced with the choice of which parameters can be measured but what technology should be used. For heart rate measurement, biopotential measurement is one of the oldest technologies. Signals are strong and easy to retrieve from the body by utilizing two or more electrodes. For this approach, integration of the circuitry in a chest strap or headphones is perfect; however, measuring biopotential signals at a single point like the wrist is nearly impossible. You need to measure across the heart, where these electric signals are being generated. For single-spot measurement, optical technology is more appropriate. Light is sent into the tissue and its reflection, as a result of blood flow in the arteries, is captured and measured. From this optically received signal, beat-to-beat information can be retrieved. This technology sounds rather straightforward; however, there are several challenges and influencers that can make the design difficult, such as motion and ambient light.

Analog Devices' GEN II wearable device reference platform has most of the previously described technologies onboard. The device is designed to be worn on the wrist but the soft belt can

be removed and the device attached to the chest to use it as a smart patch. The device includes technology to support biopotential measurement, optical heart rate measurement, bioimpedance measurement, motion tracking, and temperature measurement — all integrated in a tiny, battery-operated device.

The goal for a system like this is to evaluate various sensing technologies and to measure, in an easy way, several vital parameters on the body. These measurements can be stored into flash memory or sent over a BLE wireless connection to a smart device. Since the measurements are done simultaneously, it also can help to find correlation among several parameters. Biomedical engineers, algorithm providers, and entrepreneurs continuously are looking for new technologies, applications, and use cases to detect diseases at an earlier stage in order to minimize negative effects or damage to the body that might occur at a later stage.

## Sensors Make the Device

The device is designed around two PCBs that are stacked as a sandwich. The main board contains a low-power processor, a BLE radio, and the complete



By Syda Productions/Shutterstock.com

## GEN II WEARABLE DEVICE

power management section including battery conditioning and charging. A second board supports all sensing technologies. The optical system for PPG (photoplethysmogram) measurement is built around the ADPD107, ADI's second-generation optical analog front end. The block diagram is shown in Figure 2.

The analog front end operates as a complete transceiver, driving the LEDs in the system and measuring the return signal from the photodiode(s). The objective is to measure photocurrent that is as high as possible for a given amount of LED current spent (current transfer ratio). The input receive signal chain is designed around a configurable transimpedance amplifier where the gain can be programmed in four steps up to 200k. The second stage is responsible for ambient light rejection. Ambient light interferers are a big issue, especially when the light is modulated, as with solid-state lighting systems with LEDs or energy-saving lamps. The ambient light rejection block contains a bandpass filter followed by an integrator to support synchronous demodulation. This is a key function and rejects external light interferers very effectively. When the ambient light rejection stage is not needed, this block can be bypassed completely.

The optical system makes use of light pulses. There are three LED current sources that are fully programmable. The maximum LED currents are programmable and can be as high as 370 mA. Also, the pulse width is programmable and can be as narrow as 1  $\mu$ s; however, for a good signal response, pulse width should be around 2  $\mu$ s to 3  $\mu$ s. Usually a series of LED pulses is given while the analog-to-digital converter is sampling the photodiode receive signals related to the pulsed LED transmit pulses. The digital engine is able to average multiple samples to increase the overall effective number of bits.

Along with the optical system, mechanical design also has a major impact on overall performance. In this GEN II device, the optical components have been selected as discrete devices. This provides flexibility on the photodiode selections and the LED wavelengths as well as mechanical constraints such as spacing between LEDs and photodiodes. The GEN II device supports two green LEDs, one

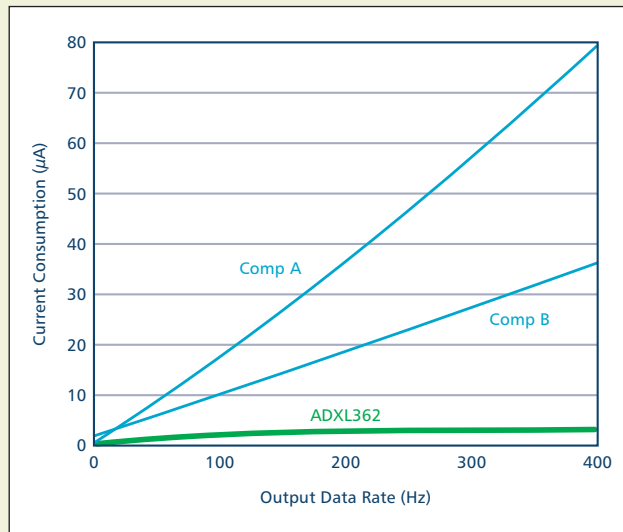

Figure 3. ADXL362 power consumption as a function of the output data rate.

red LED, and one infrared LED. For those without experience in designing optical systems, it might be easier to integrate a complete optical module.

There are different options in terms of the number of photodiodes, their sizes, and the selection of LED wavelengths. The latest modules have been developed in such a way that they show a great optical performance even when they are mounted behind a plastic window. The first generation required a split window to reject internal light pollution, which can be seen as optical crosstalk. A split window helped to reduce dc offsets from light coming directly from the LEDs without penetration into the body. Such a split window is not easy to integrate, nor is it attractive from a cost point of view. The latest families have been improved substantially and even with just one complete window, the ILP effects have been reduced to almost zero.

Biopotential measurement is supported by two individual AD8233 analog front ends. The AD8233 is a single-lead ECG front end with embedded right leg drive (RLD) capability, and has been designed to extract, amplify, and filter small biopotential signals in the presence of noisy environments. Focus applications for this component are wearable devices, portable home care systems, and exercise equipment. The AD8233 operates in a dc coupled configuration. The input stage is divided over two gain stages. The first stage, with limited gain, is followed by a second-order, high-pass filter and a second gain stage. The total gain of this input block is 100 V/V, which includes the subtraction of the offset as a result of the electrode half-cell poten-

tial. The second stage is combined with a third-order, low-pass filter. It is second-order Sallen Key working in unity followed by an additional low-pass filter. The objective of this filter is to reject all EMG-related signals coming from muscle activity.

The operating frequency of the biopotential front end depends on the use case. For a normal heart rate monitor, where just QRS detection is needed, the operating frequency range is much less compared to an ECG monitor where more information is required, such as timing and amplitude data from the P-wave vs. QRS-Complex vs. T-wave. The band of interest can be configured by external resistors and capacitors.

To support flexibility, the GEN II wearable device has the ECG front end connected to the embedded electrodes, configured in a sports bandwidth, supporting a band of interest from 7 Hz to 25 Hz. The second AD8233 that can be operated in combination with external electrodes is configured to monitor signals from 0.5 Hz up to 40 Hz. In principle, nearly any bandwidth can be selected; however, this requires modifications of the hardware by changing R and C settings.

Depending on the required accuracy, output can be sent to the 12-bit successive approximation register (SAR) ADC embedded in the Cortex®-M3 processor on the sensor board, or digitization can be done by the standalone 16-bit SAR ADC. Tradeoffs can be made and depend on either accuracy or battery lifetime.

At the back side of the device are two electrodes. These have a double function: in addition to ECG measurement, these also can be used for electrodermal activity (EDA) or galvanic skin response (GSR). This is related to the conductivity of the skin, which is momentarily changed by emotion, coming from either an internal or external stimulus — skin impedance changes, for instance, as a result of stress or epilepsy. The GEN II device is able to detect this minute change in conductivity. The system is making use of an ac excitation signal that is applied over the two dry electrodes. Wet electrodes can be used as well and will be better; however, this device is just making use of two embedded dry stainless steel electrodes. The main advantage

# CONGRATULATIONS NASA



ON 50 YEARS OF FIRST IMPRESSIONS

Apollo 11, EAGLE-LEM, JULY 20, 1969 at 20:17 UTC



1969  
First Moon Landing  
Forever/USA

PICO ELECTRONICS

TRANSFORMERS | INDUCTORS | DC-DC CONVERTERS

[www.picoelectronics.com](http://www.picoelectronics.com)

50 year partners  
1969 - 2019

Free Info at <http://info.hotims.com/72995-725>



## GEN II WEARABLE DEVICE

of using an ac excitation signal is that this will not polarize the electrodes.

The receive signal chain represents a transimpedance amplifier, followed by the 16-bit, SAR ADC. The ADC sampling rate is much higher than the excitation rate for performance reasons. The ADC output is followed by a discrete Fourier transform (DFT) engine, running on the ADuCM3029 processor, to represent the complex impedance. The measurement principle described above is capable of measuring skin impedance or skin conductance at a high signal-to-noise ratio and a very good suppression of 50 Hz/60 Hz environmental noise. The circuit around this measurement principle is completely built with discrete components. The main reason for this design decision is flexibility and accuracy at a rather low power dissipation.

### Vital Measurement Parameters

A wearable device is worthless for measuring vital parameters without having a notion of what the human body is doing. For that reason, motion detection and profiling are important. Some use cases

like optical heart rate monitoring are very sensitive to motion, and motion can destroy the accuracy of the measurement completely. For that reason, motion also needs to be tracked to compensate for artifacts. Motion sensors will help to track movement and, where needed, motion can be compensated in the final outcome of the readings. The ADXL362 low-power motion sensor has a 3-axis MEMS sensor with an integrated 12-bit ADC to detect motion in the X-, Y-, and Z-axes. The output data rate (ODR) of the ADC represents the power dissipation of the sensor, which is 3  $\mu$ A at the full ODR of 400 Hz per axis. In Figure 3, a plot of the power dissipation as a function of the output data rate is shown.

This sensor can also be used as a motion activation switch. There is a possibility to reduce the sampling rate to just 6 Hz. Every 150 ms, the sensor wakes up and measures the motion activity. Without motion, it goes straight back to sleep for another 150 ms. At the moment, motion is being detected at a g-force equal to or higher than the preprogrammed threshold level. For at least the minimum time programmed, the sensor

generates an interrupt or enables a power switch to turn on the application. With this mode, the sensor is consuming only 300 nA, and can run for years on a single coin cell battery. All the use cases summarized make the motion sensor a must-have in a wearable device.

Temperature sensing is another vital parameter; the GEN II wearable has two temperature sensors embedded. The wrist-worn device uses NTCs to measure both skin temperature and the temperature inside the device — there are multiple methods to measure temperature via sensors contacting the body. The NTCs are powered and conditioned by discrete circuitry and the 16-bit ADC finally converts the signals into the digital domain.

### Bringing it all Together

The GEN II device makes use of two processors. This is not absolutely needed but provides more flexibility. The interface board with BLE radio has one processor and the same device is used on the sensor board to be able to run autonomously. The ultra-low-power ADuCM3029 has been integrated to collect sensor data and run the algorithms.

# MASSA

GENERATIONS AHEAD IN  
SONAR & ULTRASONIC TECHNOLOGY

As NASA commemorates the 1<sup>st</sup> lunar landing, America celebrates the spirit of innovation. Since 1945, MASSA, a 3<sup>rd</sup> Generation Family Business, designs, engineers, manufactures, and pioneers electroacoustic technology that can go where no products have gone before.

Our capabilities allow us to harness the science of sound and detect objects (or life) through ice, gas, and liquids. MassaSonic® can enable NASA to see and hear, in new ways, in worlds beyond.

Massa is a preferred supplier and innovator for the Navy.

Ready to Explore  
the Unknown?  
So are We!



[www.massa.com](http://www.massa.com)





# Low cost power solutions...

for dependable power monitoring and control



## Power Monitors from Socomec

Socomec low-cost power monitors can reduce operating costs and downtime while improving efficiency and performance by measuring and monitoring energy quality and costs.

### DIRIS A10 Power Monitors

The DIRIS A10 multifunction meter measures and displays electrical values and parameters in low voltage networks and can be utilized for communication and/or output functions.

- LCD backlight display
- DIN rail mount
- Integrated temperature sensor
- Integral pulse output allows external accumulation of energy consumption
- Direct access keys for currents, voltages, power and energies
- Hour meter, temperature and programming menu access pushbutton
- Metrological LED (energy metering indication)

### DIRIS A20 Power Monitors

The DIRIS A20 panel-mounted multifunction meter provides all the measurements required to successfully carry out energy efficiency projects and ensure electrical distribution monitoring.

- Large LCD backlight display
- Multiple viewing screens display multi-measurement and metering values
- Direct access keys for currents, voltages, power and energies
- Optional configurable output module and optional Modbus RTU (RS485) communications module

## SIRCOVER UL 1008 Manual Transfer Switches

These extremely durable UL 1008-rated manual transfer switches are tested and approved for use in the most demanding applications. The compact design and quality features provide a reliable and cost-efficient solution for power distribution, manufacturing, and domestic applications.

### Applications:

- Resistive load or total system applications
- Normal power supply to generator transfer
- Bypass operations
- Motor phase changing for rotation control
- Equipment grounding

### Features:

- Three stable, completely isolated positions
- Compact design based on back-to-back switching technology
- Reliable double breaking per pole sliding bar contacts system
- 2-, 3-, 4-poles
- Up to 600 VAC operating voltage ratings
- Up to 400 Amp ratings



Research, price, buy at:

[www.automationdirect.com/manual-transfer-switches](http://www.automationdirect.com/manual-transfer-switches)

[www.automationdirect.com/power-meters](http://www.automationdirect.com/power-meters)

**Order Today, Ships Today!**

\*See our Web site for details and restrictions. © Copyright 2010 AutomationDirect, Cumming, GA USA. All rights reserved.



**AUTOMATIONDIRECT**.com  
1-800-633-0405 the #1 value in automation

Free Info at <http://info.hotims.com/72995-727>

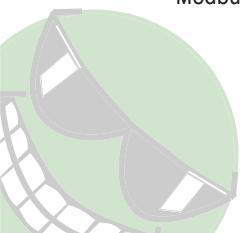

## GEN II WEARABLE DEVICE

The core is a 26-MHz Cortex-M3 with a rich peripheral set, onboard memory, and an analog front end. There are four operating modes; in full operation, the chip consumes 38  $\mu\text{A}$  per MHz. If processing power is not needed, the device can run in flexi-mode in which the analog front end is running, peripherals are active, and the measured signals can be stored in memory through DMA. This mode consumes 300  $\mu\text{A}$ , making the chip very attractive for low-power, bat-

tery-operated systems. There are several security features embedded for code protection and a hardware accelerator for cryptographic functions.

### Selection of Use Cases

The GEN II wearable device can be used for many purposes. The sensors can be integrated in smart watches but the range of functions, including accurate heart rate monitoring and activity measurement/calorie burn, are also helpful for sport

watches. The tradeoff between a smart watch and sport watch is mainly made between accuracy vs. battery lifetime.

The device can be used to measure stress or emotional state. Usually a combination of measurements is used to get a reliable reading such as skin impedance together with heart rate variability and temperature. Blood pressure monitoring is another interesting use case. This is a very important parameter but most of the systems are cuff-based, which are hard to integrate in a wearable and continuous system. There are certain techniques that can be used to measure blood pressure without the need for a cuff. One technology is by making use of the pulse-wave transmit time (PTT). This requires ECG measurement in combination with PPG measurement. The sensors inside the GEN II wearable device can support this.

The last key market is related to elderly care and independent living. There is huge need for systems that can help caregivers monitor certain parameters remotely. This wearable device supports 95% of the features needed. The system monitors several vital parameters. It can track if people are moving or walking but is also able to detect falls. The missing piece in the wearable design is an emergency button but this is a matter of connecting one I/O pin on the processor to a switch on top of the device.

### Conclusion

The GEN II device has many high-performance sensors and features embedded in a small, wearable system. Besides the electronic design, many mechanical aspects have also been taken into consideration. This makes the platform very attractive to design companies and device manufacturers focusing on the semi-professional sports market, the medical market, and companies involved in systems for smart buildings, independent living, or elderly care. All parameters can be measured simultaneously but algorithms need to complement the application to support the use cases. Instead of building hardware before testing and validating the algorithms, this device will give developers and device manufacturers a quick start.

*This article was written by Jan-Hein Broeders, Healthcare Business Development Manager for Analog Devices' Healthcare Business in Europe, the Middle East, and Africa. For more information, visit <http://info.hotims.com/72995-121>.*



**Reliable Motion Control Solutions backed by over 25 years in the field**



- Custom solutions
- Multi axis capabilities
- Compact size
- Reliability
- Access to Tech support

**(800) 707-8111**

**[www.OMSmotion.com](http://www.OMSmotion.com)      [Info@OMSmotion.com](mailto:Info@OMSmotion.com)**



MICROFLUIDICS.

*Congratulations to NASA and all of  
the men and women who made this  
historic moon landing possible.*

# MACRO CAPABILITIES.

## REDUCING THE SIZE AND WEIGHT OF FLUID CONTROL.

Designing systems to safely put a man on the moon is difficult enough. But factor in the need to keep components as small and light as possible, and you've got a real challenge. Fortunately, you've got a real solution. The Lee Company.

For more than 70 years, we've been engineering state-of-the-art precision fluid control components with diameters as small as 0.10 in. and weighing as little as 0.1g, but able to withstand pressures up to 8,000 psi.

And because every one of our designs originates out of an application need, and is scrutinized with 100% testing and inspection, we're found in just about every mission-critical fluid control challenge you could imagine – from miles above the earth in satellite positioning systems, to miles below in downhole drilling. Plus many applications in between.

If you require precise fluid control, and absolute reliability, go with the experts. Contact The Lee Company.



Innovation in Miniature  
**LEE**  
The Lee Company

2 Pettipaug Rd, Westbrook CT 06498-0424  
860-399-6281 | Fax: 860-399-2270 | 1-800-LEE PLUG | [www.TheLeeCo.com](http://www.TheLeeCo.com)

WESTBROOK • LONDON • PARIS • FRANKFURT • MILAN • STOCKHOLM

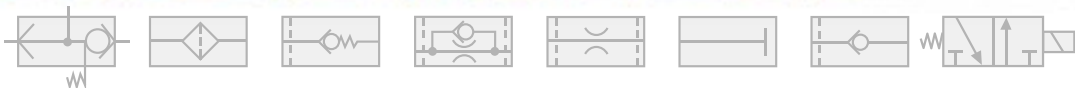

Free Info at <http://info.hotims.com/72995-729>





# Test & Measurement

## Noninvasive Device Tests Sweat Continuously for Hours

This device can record the same health information in sweat that doctors examine in blood.

*University of Cincinnati, Ohio*

A continuous-testing device was developed that samples sweat as effectively as blood but in a noninvasive way and over many hours. After examining the use of saliva, tears, and interstitial fluid,

researchers concluded that sweat holds the most promise for noninvasive testing because it provides similar information as blood and its secretion rate can be controlled and measured.

The device consists of sensors on a wearable patch the size of a Band-Aid® that stimulates sweat even when a patient is cool and resting. The sensor measures specific analytes over time that doctors can use to determine how the patient is responding to a drug treatment. The sensors can be tailored to measure anything from drugs or hormones to dehydration.

The continuous sensor allows doctors to track health over time to see whether a patient is getting better or worse. And they can do so in a noninvasive way with a tiny patch applied to the skin that stimulates sweat for up to 24 hours at a time.

For medications, sweat can be used to get an exact measurement of concentrations in the blood. Once concentrations of therapeutics in blood are measured, drug dosing can be tailored based on things such as liver or kidney failure, or how quickly someone metabolizes a drug.

*For more information, contact Michael Miller at [mille7m9@ucmail.uc.edu](mailto:mille7m9@ucmail.uc.edu); 513-556-6757.*

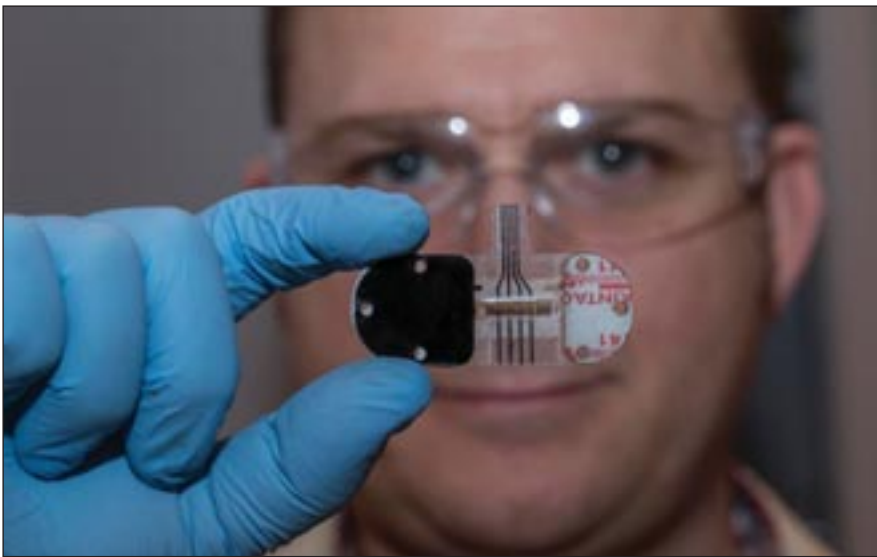

The sweat sensor is about the size of a Band-Aid®. (Photo: Joseph Fuqua II/UC Creative Services)

## High-Throughput Friction and Wear Tester

This system enables inexpensive testing for material development, qualification, or quality control.

*Sandia National Laboratories, Albuquerque, New Mexico*

There is a need for high-volume material testing/qualification but industry and researchers are currently limited by commercially available testing devices. Most wear testers can only handle one sample at a time and are often expensive.

The High-Throughput Friction and Wear Tester enables testing on up to 16 samples simultaneously. It can complete a statistical study of material coatings under a variety of environmental conditions in a few hours rather than months.

The tester can be used to investigate deposition and chemical optimization, speed dependence, reliability, uniformity of coating, and friction/wear behavior. The tester contains multiple environmentally isolated testing modules; each



Interior view of one of the environmentally isolated testing modules.

comprises four load cells, loading arms, deadweight loads, and specially designed quick-change ball holders. Each module can have different environmental and loading conditions, allowing users to eval-

uate the same coating under different conditions. Alternatively, users can test different materials in similar environments to select the right coating for a particular application.

Once the samples are in place, the system's specially designed software allows users to set test conditions (length, speed, cycle) in each module and automatically acquires, organizes, saves, and displays real-time testing data. In addition to real-time data, the software generates a comprehensive data analysis summary for quick and easy review.

*For more information, contact Sandia National Laboratories, Intellectual Property Office, at [ip@sandia.gov](mailto:ip@sandia.gov), or visit <https://ip.sandia.gov>.*



CELEBRATING THE  
**APOLLO 11**  
MOON LANDING

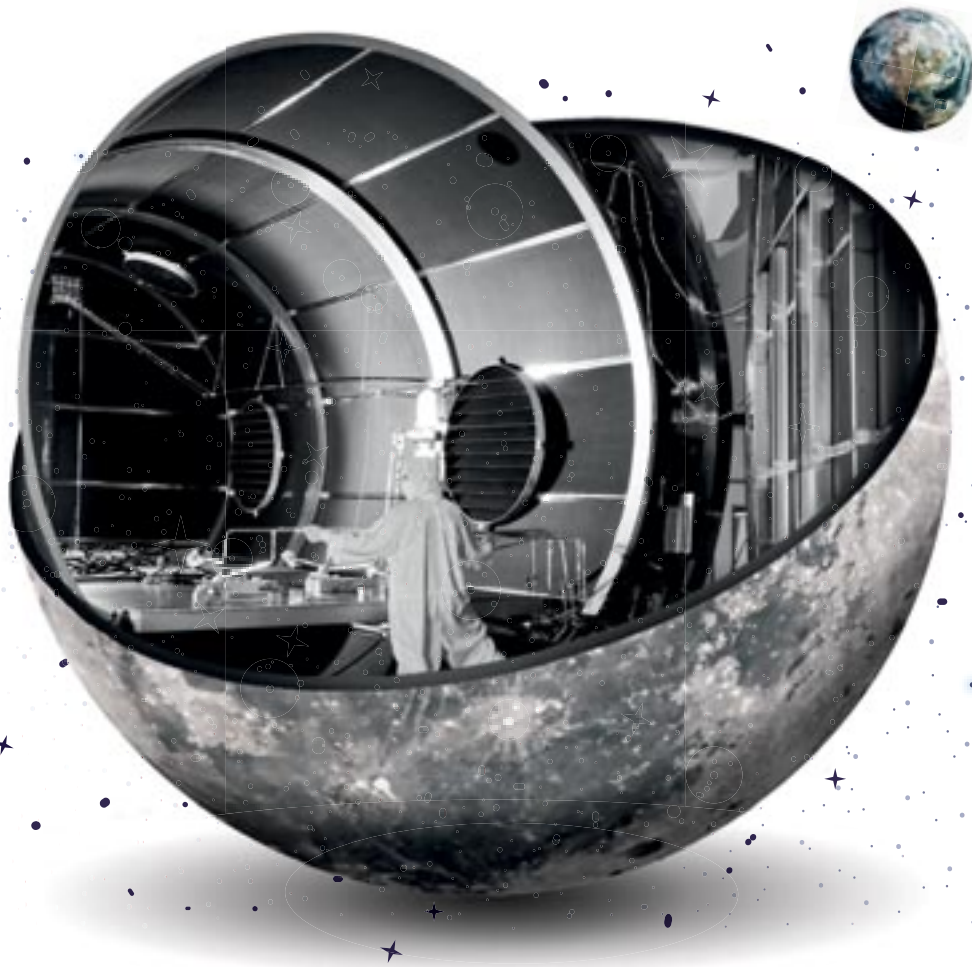

In 1969, NTS worked with NASA to ensure Apollo 11 landed on the moon safely. It was an honor to play a small role in a historic event that symbolized a giant leap for mankind—but that was only the beginning. Today, NTS is helping NASA and top space companies explore the next frontier in spaceflight. To learn more about how NTS is at the center of space testing, please visit [NTS.com/Space](https://www.nts.com/space).



844.332.1885



**NTS**

**A HIGHER  
STANDARD**

TESTING | INSPECTION | CERTIFICATION



# Automated Guided Wave System for In-Process Cure Monitoring of CFRP Composite Laminates

Applications exist in aerospace, automotive, wind turbines, and marine/boating.

Langley Research Center, Hampton, Virginia

In the polymer composites industry, cure cycles are typically developed from trial-and-error or a more effective processing science approach to reduce the final porosity level in the composite laminate.

Using a guided wave-based in-process cure monitoring technique for carbon fiber reinforced polymer (CFRP) composites, high-temperature piezoelectric transducers were utilized to interrogate a 24-

ply unidirectional composite panel fabricated from Hexcel IM7/8552 prepreg during cure. It was shown that the amplitude of the guided wave increased sharply around vitrification, and the time of arrival (TOA) curve possessed an inverse relationship with degree of cure.

A key cure transition point (vitrification) was identified and the degree of cure was monitored using metrics such as amplitude and TOA of guided waves. Using the technique to perform in-process cure monitoring in an autoclave, defect detection during cure, and a closed-loop process control to maximize composite part quality and consistency enables a significant improvement in non-destructive evaluation, which could lead to fabrication process improvements.

NASA is actively seeking licensees to commercialize this technology. Please contact The Technology Gateway at [LARC-DL-technologygateway@mail.nasa.gov](mailto:LARC-DL-technologygateway@mail.nasa.gov) or 757-864-1178 to initiate licensing discussions. Follow this link for more information: <https://technology.nasa.gov/patent/TB2016/LAR-TOPS-271>.

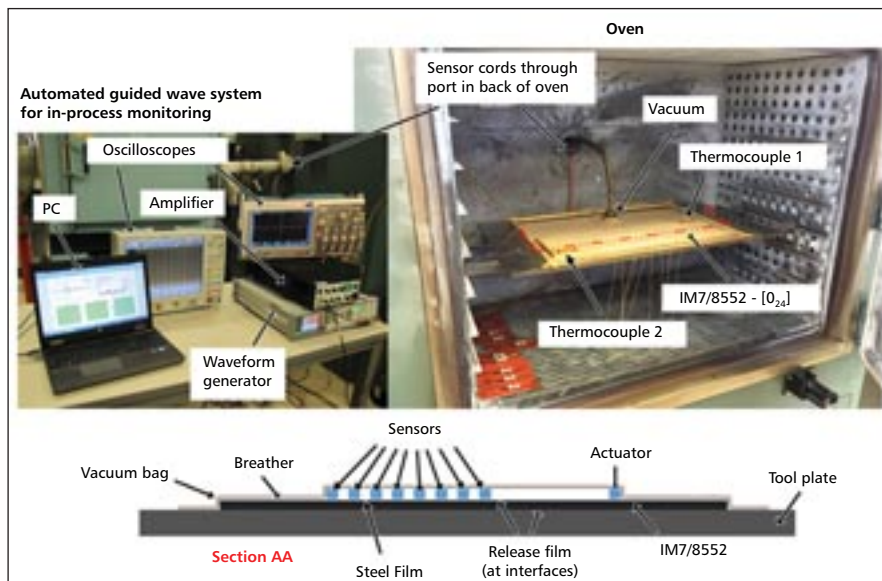

The automated guided wave system for in-process cure monitoring. (NASA)

# More Sensitive Measurement of Semiconductor Material Quality

The new measuring technique characterizes materials at scales much smaller than any current technologies.

University of Texas, Austin

Accurately measuring semiconductor properties of materials in small volumes helps engineers determine the range of applications for which these materials may be suitable in the future, particularly as the size of electronic and optical devices continues to shrink. A measurement technique was developed that is capable of achieving this level of sensitivity.

The approach provides quantitative feedback on material quality, with particular applications for the development and manufacturing of optoelectronic devices. The method is capable of measuring many of the materials that one day may be ubiquitous to next-generation optoelectronic devices.

Optoelectronics is the study and application of electronic devices that can source, detect, and control light. Optoelectronic devices that detect light, known as photodetectors, use materials that generate electrical signals from light. Photodetectors are found in smartphone cameras, solar cells, and in the fiber optic communication systems that make up broadband networks. In an optoelectronic material, the amount of time that the electrons remain "photoexcited," or capable of producing an electrical signal, is a reliable indicator of the potential quality of that material for photodetection applications.

The current method used for measuring the carrier dynamics, or lifetimes, of

photoexcited electrons is costly and complex, and only measures large-scale material samples with limited accuracy. The new technique uses a different method for quantifying these lifetimes by placing small volumes of the materials in specially designed microwave resonator circuits. Samples are exposed to concentrated microwave fields while inside the resonator. When the sample is hit with light, the microwave circuit signal changes, and the change in the circuit can be read out on a standard oscilloscope. The decay of the microwave signal indicates the lifetimes of photoexcited charge carriers in small volumes of the material placed in the circuit.



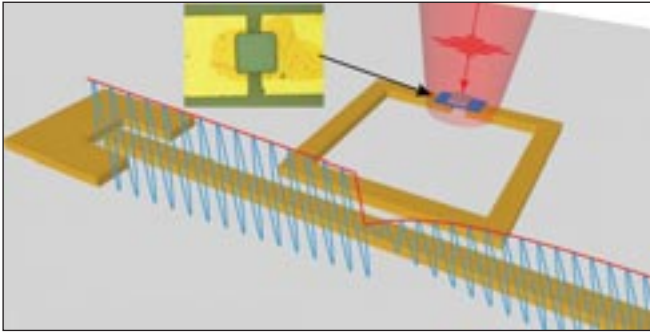

Rendering of a microwave resonator showing the microwave signal (blue) size change resulting from a light pulse (red) once the pulse hits the infrared pixel (micrograph image of pixel is shown in the inset).

Carrier lifetime is a critical material parameter that provides insight into the overall optical quality of a material while also determining the range of applications for which a material could be used when it is integrated into a photodetector device structure. Materials with a very long carrier lifetime may be of high optical quality and therefore very sensitive, but may not be useful for applications that require high speed.

One area that will benefit from the real-world applications of the technology is infrared detection, a vital component in molecular sensing, thermal imaging, and certain defense and security systems. High-speed detectors operating at these frequencies could enable the development of free-space communication in the long wavelength infrared — a technology allowing for wireless communication in difficult conditions, in space, or between buildings in urban environments.

For more information, contact John Holden at [john.holden@utexas.edu](mailto:john.holden@utexas.edu); 512-529-6013.

## New Technique Tests for Viral Infections

The technology can detect extremely small amounts of antibodies in a person's blood.

*Colorado State University, Fort Collins*

Currently, most U.S. medical offices and hospitals use the ELISA (enzyme-linked immunosorbent assay) test to determine whether or not a person has a viral infection. It's a common test but ELISA's sensitivity is relatively low, so clinicians need a fairly high number of antibodies in a person's blood to get a positive test result. It also often takes seven to 10 days after an infection for the test to register.

A technology was developed that can detect extremely small amounts of antibodies in a person's blood. Antibodies develop to infect cells or kill pathogens, essentially fighting off a bacteria or virus. The levels of antibodies in the blood can tell whether that person is sick.

Using a small wire that is one-fourth the size of a human hair, the researchers developed a sensor that can detect as few as 10 antibody molecules within 20 minutes. Standard medical testing requires billions or trillions of antibody molecules for detection and can take up to a day to process. The new cost-effective instrument could help clinicians treat diseases sooner in people and could be used in low-resource settings.

Tech Briefs, July 2019

**M2p**  
series



**New multi-channel  
AWG series**



- 1 to 8 channels  
8 product variations
- 16 bit resolution  
with 40 MS/s and 125 MS/s
- 700 MByte/s streaming  
over fast PCIe x4 interface
- Output  $\pm 6\text{ V}$  (1 M $\Omega$ )  
or  $\pm 3\text{ V}$  (50  $\Omega$ )



**SPECTRUM**  
INSTRUMENTATION

Perfect fit – modular designed solutions

US: Phone (201) 562 1999 | Asia / Europe: Phone +49 (4102) 695 60

[www.spectrum-instrumentation.com](http://www.spectrum-instrumentation.com)



Researchers chemically attached proteins related to Zika and chikungunya viruses to inexpensive, small gold wires. These particular viruses, along with West Nile and dengue, are transmitted by infected mosquitoes. Medical laboratories use these proteins in ELISA tests to look for antibodies that have developed to fight infections.

Next, they ran an electrical current through the wire, creating a charge on the

wire similar to that of a battery. Antibodies were then added to bind to the viral proteins on the wire, which increased the mass on the outside of the wire. This also increased the ability of the wire to hold the charge. They then measured the change in mass to quantify the number of antibodies on the surface of the wire. The team did not see any reaction or reactivity from antibodies targeting other viruses, which can sometimes lead to false-positive test results.

The team is working to make the technology useful for point-of-care diagnostics and develop it into a compact hand-held system that can be used in the clinic or in resource-limited areas. It could also be used in agricultural settings for livestock disease surveillance and environmental sensing.

*For more information, contact the College of Veterinary Medicine & Biomedical Sciences at [cmbs-bms@colostate.edu](mailto:cmbs-bms@colostate.edu); 970-491-6187.*



**HORIBA**  
66 Years of Innovative Technology  
[www.horiba.com](http://www.horiba.com)

PROCESS SOLUTIONS

- Control:** Process Flow
- Monitor:** Chemicals
- Analyze:** Nano Particles
- Measure:** Film Thickness
- Vaporize:** Precursors



Semiconductor



Thin Films



Water Treatment



Coatings



[request.info@horiba.com](mailto:request.info@horiba.com)

## Smartphone Test Spots Poisoned Water Risk

A smartphone device could help millions avoid drinking water contaminated by arsenic.

*University of Edinburgh, Scotland*

Researchers have developed a biosensor that attaches to a smartphone and uses bacteria to detect unsafe arsenic levels. The device generates easy-to-interpret patterns similar to volume-bars that display the level of contamination.

The contamination of water by heavy metals is a worldwide health issue. UNICEF reports that arsenic-contaminated drinking water is consumed by more than 140 million people worldwide. In resource-limited countries, there is a lack of sufficiently skilled personnel and healthcare facilities to test water for contamination.

The new device could replace existing tests, which are difficult to use, need special laboratory equipment, and can produce toxic chemicals. The biosensor was developed by manipulating the genetic code of the bacteria *Escherichia coli*. Genetic components were added to act as amplifiers when arsenic is detected.

Researchers tested the arsenic sensors using environment samples from affected wells in Bangladesh, which suffers from some of the world's highest levels of arsenic-contaminated ground water. Water samples were fed into a plastic device containing bacteria suspended in a gel. This produced fluorescent proteins that were visible in the presence of arsenic.

The approach could be used to detect other environmental toxins, diagnose diseases, and locate landmines.

*For more information, contact [press.office@ed.ac.uk](mailto:press.office@ed.ac.uk); +44 (0)131 650 9547.*



Intro

Cov

ToC





# Another First

AirBorn is excited to introduce the **latest disruptive technology** to hit the *space & mil/aero* markets in a generation. This innovation **revolutionizes space communications** as it embodies all the **benefits of fiber** with the **ease & reliability of copper**.

**Please join us on 7/16**, the 50th anniversary of the Apollo 11 launch, for an introductory webinar. *Be a part of our mission*, as we launch our new, state-of-the-art interconnect system *for OEMs & design engineers worldwide!*

**Reserve your spot now: [www.techbriefs.com/webinar645](http://www.techbriefs.com/webinar645)**

 **AirBorn**

AirBorn Inc. |

p. 512.863.5585 |

[www.airborn.com/aoc](http://www.airborn.com/aoc)

Free Info at <http://info.hotims.com/72995-733>

smiths interconnect  
bringing technology to life



Intro

Cov

ToC



# Power & Energy

## Thin-Film System Converts Heat from Electronics into Energy

This system can be applied to sources of waste heat to produce energy at unprecedented levels.

*Lawrence Berkeley National Laboratory, Berkeley, California*

Nearly 70 percent of the energy produced in the United States each year is wasted as heat. Much of that heat is less than 100 °C and emanates from things like computers, cars, or large industrial processes. A thin-film system was developed that can be applied to sources of waste heat like these to produce energy at levels unprecedented for this kind of technology.

The thin-film system uses a process called pyroelectric energy conversion that is well suited for tapping into waste-heat energy supplies below 100 °C, or low-quality waste heat. Pyroelectric energy conversion, like many systems that turn heat into energy, works best using thermodynamic cycles, similar to how a car engine works. But unlike a car engine, pyroelectric energy conversion can be realized entirely in the solid state with no moving parts as it turns waste heat into electricity.

This nanoscopic thin-film technology might be particularly attractive for installing on and harvesting waste heat from high-speed electronics but could have a large scope of applications. For fluctuating heat sources, the thin film can turn waste heat into usable energy with higher energy density (1.06 Joules per cubic centimeter), power density

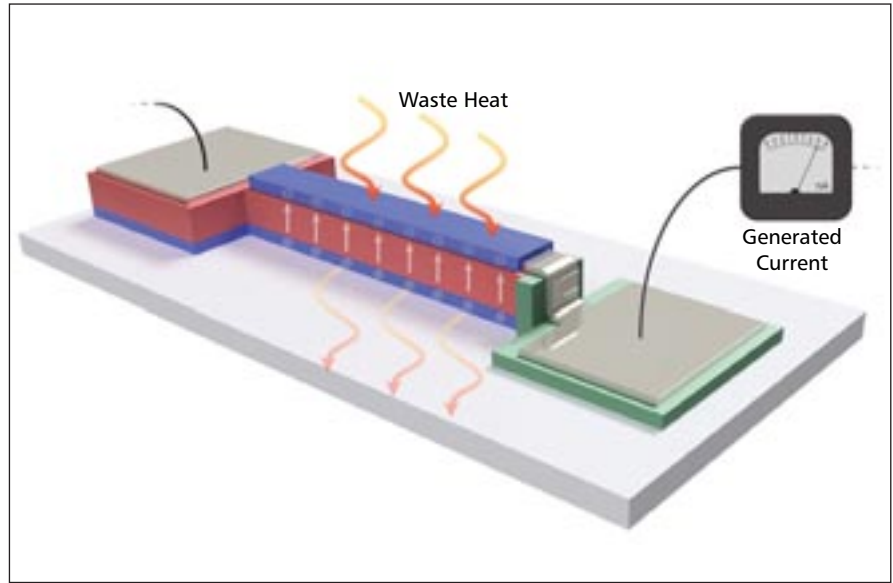

This illustration shows how the thin-film system converts waste heat into energy. (Shishir Pandya)

(526 Watts per cubic centimeter), and efficiency levels (19 percent of Carnot efficiency, which is the standard unit of measurement for the efficiency of a heat engine) than other forms of pyroelectric energy conversion.

Thin-film versions of materials 50-100 nanometers thick were synthesized. The pyroelectric-device structures based on

these films were fabricated and tested. These structures allow simultaneous measurement of temperature and electrical currents created, and source heat to test the device's power generation capabilities — all on a film that is less than 100 nanometers thick.

*For more information, contact Roqua Montez at [rmontez@berkeley.edu](mailto:rmontez@berkeley.edu); 510-642-3591.*

## Fuel Cell Technology Runs on Solid Carbon

This technology could make electricity generation from resources such as coal and biomass cleaner and more efficient.

*Idaho National Laboratory, Idaho Falls, Idaho*

Whereas hydrogen fuel cells (e.g., proton exchange membrane (PEM) and other fuel cells) generate electricity from the chemical reaction between pure hydrogen and oxygen, direct carbon fuel cells (DCFCs) can use any number of carbon-based resources for fuel, including coal, coke, tar, biomass, and organic waste.

Because DCFCs make use of readily available fuels, they are potentially more

efficient than conventional hydrogen fuel cells. But earlier DCFC designs have several drawbacks. They require high temperatures — 700 to 900 °C — which makes them less efficient and less durable. Further, as a consequence of those high temperatures, they are typically constructed of expensive materials that can handle the heat. Also, early DCFC designs are not able to effectively utilize the carbon fuel.

A new fuel cell was developed that incorporates innovations in three components: the anode, the electrolyte, and the fuel. Together, these advancements allow the fuel cell to utilize about three times as much carbon as earlier DCFC designs. The fuel cell also operates at lower temperatures and demonstrated higher maximum power densities than earlier DCFCs.

The true direct carbon fuel cell is capable of operating at lower tempera-



Replaces 3 or more wet tantalum capacitors in parallel or series

Superior capacitance retention at -55°C

Less weight and requires less space

Rugged stainless steel case withstands up to 80g's

Glass-to-metal seal prevents dry-out for exceptionally long life

## YOUR MISSION-CRITICAL APPLICATIONS REQUIRE SLIMPACK PERFORMANCE

MLSH Slimpack is designed to meet the most demanding military and aerospace applications. It's the world's only hermetic aluminum electrolytic capacitor with a glass-to-metal seal. Slimpack delivers extremely high capacitance at ultra-low temperatures. Energize your next idea with MLSH Slimpack.

[cde.com/MLSHSlimpack](http://cde.com/MLSHSlimpack)

Free Info at <http://info.hotims.com/72995-734>



Intro

Cov

ToC



tures — below 600 °C. The fuel cell makes use of solid carbon, which is finely ground and injected via an airstream into the cell. To address the need for high temperatures, an elec-

trolyte was developed using highly conductive materials: doped cerium oxide and carbonate. These materials maintain their performance at lower temperatures.

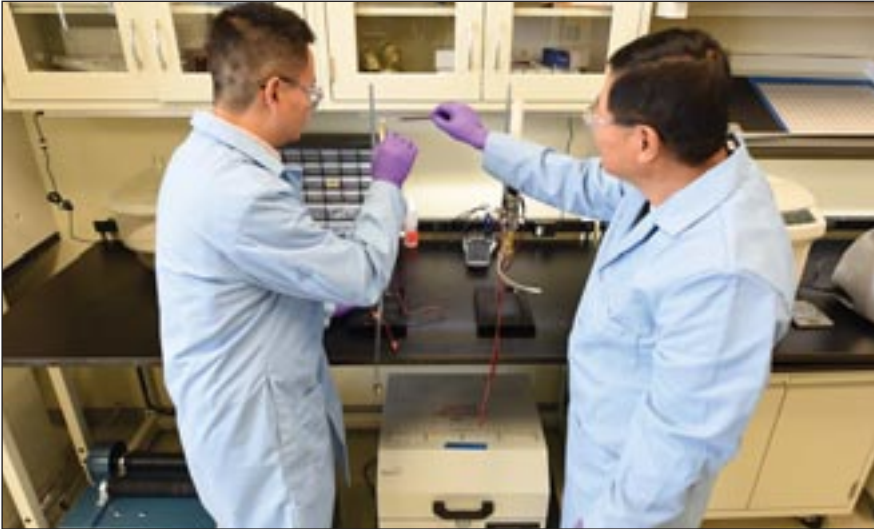

A new fuel cell was developed that incorporates innovations in three components: the anode, the electrolyte, and the fuel.

Carbon utilization was increased by developing a 3D ceramic textile anode design that interlaces bundles of fibers together like a piece of cloth. The fibers themselves are hollow and porous. All of these features combine to maximize the amount of surface area available for a chemical reaction with the carbon fuel. A composite fuel was developed made from solid carbon and carbonate. At the operating temperature, the composite is fluid-like and flows easily into the interface. The molten carbonate carries the solid carbon into the hollow fibers and the pinholes of the anode, increasing the power density of the fuel cell.

The resulting fuel cell looks like a green, ceramic watch battery about as thick as a piece of construction paper. A larger square is 10 centimeters on each side. The fuel cells can be stacked on top of one another, depending on the application.

*For more information, contact Ryan Bills, Senior Commercialization Manager, Technology Deployment, at [ryan.bills@inl.gov](mailto:ryan.bills@inl.gov); 208-526-1896.*

## Hybrid Transformer

This transformer is suited for limited-space applications such as in aerospace, personal power adapters, and stacked circuit boards.

*Sandia National Laboratories, Albuquerque, New Mexico*

Researchers have developed a hybrid transformer that has the benefit of a full planar transformer design but uses a wire-wound secondary winding to keep the parasitic winding capacitances lower. Alone, planar transformers have the advantage of a lower profile and bet-

ter reproducibility, but wire-wound transformers allow for less parasitic capacitances. By combining elements from traditional wire-wound transformers and planar transformers, the overall performance and reliability were improved.



The hybrid transformer uses a wire-wound secondary winding to keep the parasitic winding capacitances lower.

The hybrid transformer consists of a split planar primary winding. Between two primary planar printed circuit boards (PCBs), the secondary winding is wound using a traditional wire-wound transformer technique instead of conventionally stacking PCBs, which can lead to high parasitic winding capacitances. In addition, the use of the wire-wound technique reduces the profile height of the transformer, which would benefit many industries seeking to reduce volume of their assemblies.

Separation between the primary and secondary wiring ensures the reliability of a high-voltage transformer instead of relying on manual taping processes. The lowered parasitic capacitances can be beneficial for high-voltage flyback transformers in which the parasitic secondary capacitance can significantly impact the output voltage performance.

*For more information, contact Sandia National Laboratories, Intellectual Property Office, at [ip@sandia.gov](mailto:ip@sandia.gov), or visit <https://ip.sandia.gov>.*



## Stretchable Power Source for Wearables

Stretchable supercapacitors can be used in wearable electronic systems, implantable biomedical devices, and smart packaging systems.

*Michigan State University, East Lansing*

Researchers have created highly stretchable supercapacitors for powering wearable electronics that consist of crumpled carbon nanotube (CNT) forests. The supercapacitors demonstrated solid performance and stability, even when stretched to 800% of their original size for thousands of stretching/relaxing cycles.

Instead of having a flat, thin film strictly constrained during fabrication, the design enables a three-dimensionally interconnected CNT forest to maintain good electrical conductivity, making it much more efficient, reliable, and robust.

In the medical field, stretchable/wearable electronics are being developed that are capable of extreme contortions and can conform to complicated, uneven surfaces. In the future, these innovations could be integrated into biological tissues and organs to detect disease, monitor improvement, and even communicate with medical practitioners. Another application could be patches of smart skin for burn victims that can monitor healing while powering themselves.

The crumpled standing CNTs grow like trees with their canopies tangled on wafers. This forest, however, is merely 10 to 30 micrometers high. After transferred and crumpled, the CNT forest forms stretchable patterns like a blanket. The 3D-interconnected CNT forest has a larger surface area and can be easily modified with nanoparticles or adapted to other designs.

Even when stretched up to 300% along each direction, they still conduct efficiently. Other designs lose efficiency, can usually be stretched in only one

direction, or malfunction completely when they are stretched at much lower levels.

Metal oxide nanoparticles can be easily impregnated into the crumpled CNTs so that the invention's efficiency im-

proves much more. The approach can spark the advancement of self-powered, stretchable electronic systems.

*For more information, contact Layne Cameron at [Layne.Cameron@cabs.msu.edu](mailto:Layne.Cameron@cabs.msu.edu); 517-353-8819.*

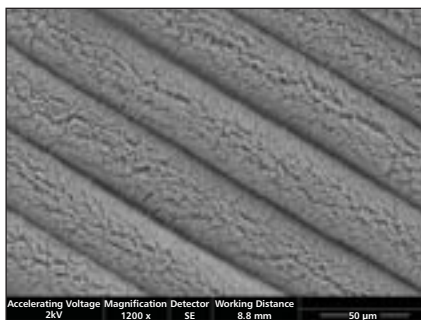

An improved power source for wearables is provided via crumpled carbon nanotube (CNT) forests. (Image: MSU)



### High current space fuse

**The industry's smallest SMD fuse with the highest breaking capacity provides superior pulse withstand and short-circuit protection.**

- Compact size 3220 SMD fuse with sealed thin film solid state construction
- Rated current (continuous) 5-15A at 125 VDC / 63 VAC
- Breaking capacity at rated voltage DC / AC = 1000 A / 200 A
- Extension of original MGA-S series 1206 SMD fuse, rated 0.14-3.5A at 125 VDC / 63 VAC
- Qualified and listed by ESA ESCC

[schurter.com](http://schurter.com)

**SCHURTER**  
ELECTRONIC COMPONENTS





# Materials & Coatings

## Graphene Lid Extends Photoemission Electron Microscopy to Liquids

This technique could advance the development of batteries, capacitors, and catalysts such as those used in the chemical industry.

*National Institute of Standards and Technology, Gaithersburg, Maryland*

**B**y capping liquids with graphene (an ultrathin sheet of pure carbon), researchers can easily image and analyze liquid interfaces and the surface of nanometer-scale objects immersed in liquids. In the imaging technique known as photoemission electron microscopy (PEEM), ultraviolet light or X-rays bombard a sample, stimulating the material to release electrons from a region at or just beneath its surface. Electric fields act as lenses, focusing the emitted electrons to create an image.

The method has been used for decades to discern such fine-scale features as the patterns of chemical reactions on the surface of catalysts, the magnetic field structure of memory devices, and the molecular architecture of biological compounds. PEEM has typically been restricted to solid surfaces that are in a high vacuum environment; the method hasn't had the ability to study liquids and gases at ordinary pressures. A liquid sample, for instance, would evaporate and create sparks if directly exposed to the high vacuum in the PEEM setup.

In the past, scientists have attempted to overcome these challenges by using a tech-

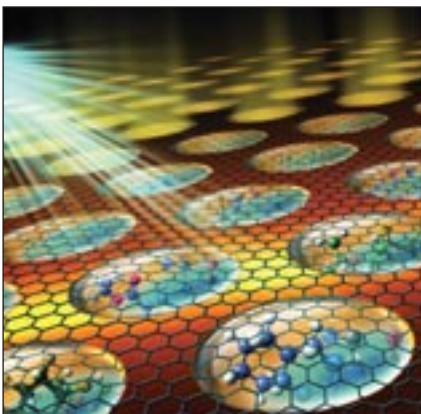

Experimental setup shows an array of graphene-capped liquids. The caps enable the liquids to be studied using an image technique that previously was restricted to studying solid surfaces. (A. Kolmakov/NIST)

nique known as differential pumping that bridges the gap between the high pressure of the sample and the essentially zero pressure of the microscope. But such instrumentation is not sufficient to reach truly ambient pressure conditions, and is too expensive and not widely accessible for routine use. Sealing a liquid or

gaseous sample with a graphene lid just one or two atomic layers in thickness keeps the sample at atmospheric pressure while allowing the system to be placed under vacuum.

The graphene lid enables electrons emitted by the test liquid to pass nearly unimpeded to the detector, yet keeps

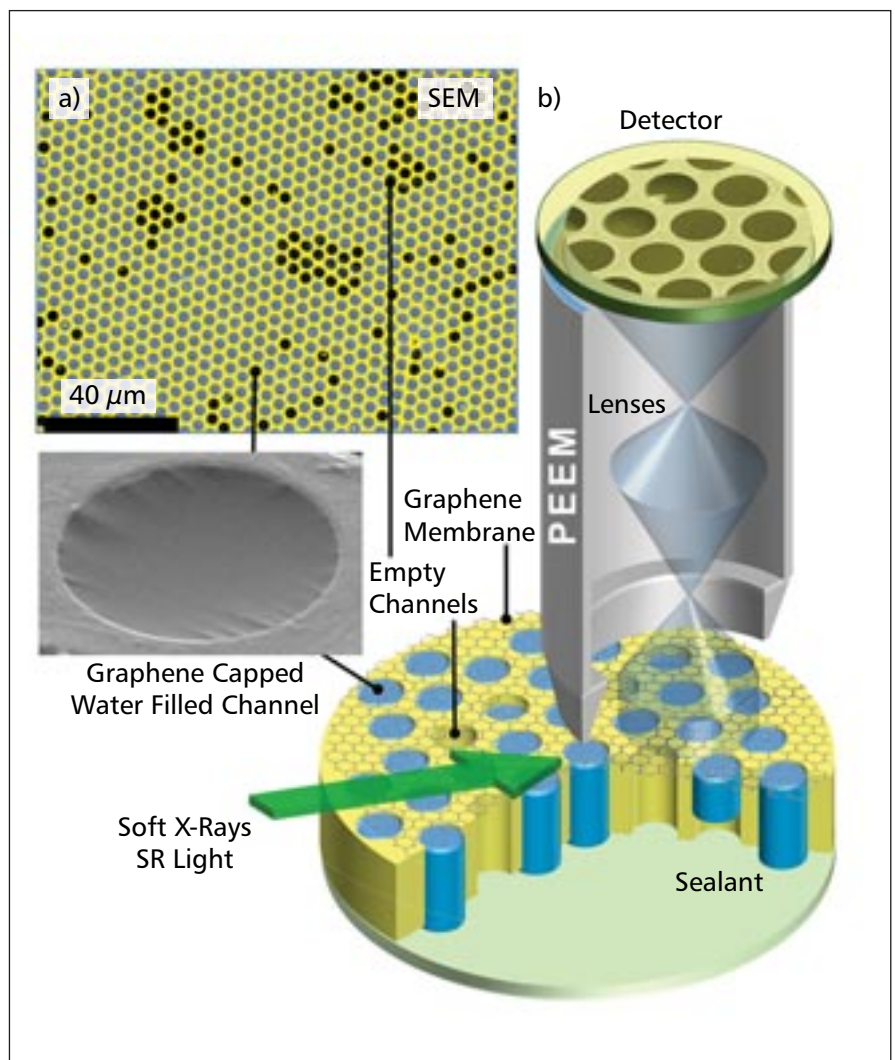

(a) X-rays illuminate a graphene-capped array of liquids, prompting molecules in solution to emit electrons. (b) The graphene caps allow the electrons to pass freely, carrying information on the chemical state of the molecules, but prevent water from leaking out, ensuring that the liquid samples do not dry out. (A. Strelkov/NIST)





# From bottle rockets to lunar landers...

## ***NASA sets the standard for innovation.***

As a proud partner and trusted supplier, Zeus recognizes the 50th anniversary of Apollo 11.

Congratulations to the men and women of NASA – the innovators, the explorers, and the discoverers. Your courage and ingenuity have set the standard for innovation in the last 50 years, and we are honored to have been a part of it.

*Cheers to 50 more years.*



Turning polymers into possibilities.

**AMERICAS:** +1 803.268.9500

**EUROPE:** +353 (0)74 9109700

**ASIA/PACIFIC:** +(86) 20-38254909

[support@zeusinc.com](mailto:support@zeusinc.com) | [zeusinc.com](http://zeusinc.com)

Free Info at <http://info.hotims.com/72995-736>



the liquid from escaping into the vacuum of the PEEM. An array of the lids retained the liquid samples for hours under high vacuum — long enough to perform routine electron imaging and spectroscopy experiments. The lids allow

the liquid to be changed while an experiment is in progress, helping researchers understand the behavior of the sample under different chemical environments.

In addition, because the setup uses an array of identical lids, each can be a differ-

ent sample, and the technique can be used in conjunction with powerful statistical analysis, data mining, and pattern recognition methods.

*For more information, contact Ben Stein at [benjamin.stein@nist.gov](mailto:benjamin.stein@nist.gov); 301-975-2763.*

## Multistep Self-Assembly for Reconfigurable Materials

This process creates new reconfigurable materials for use in applications such as solar cells and catalysis.

University of Illinois at Urbana-Champaign, Champaign

Self-assembling synthetic materials come together when tiny, uniform building blocks interact and form a structure; however, nature lets materials like proteins of varying size and shape assemble, allowing for complex architectures that can handle multiple tasks.

The behavior of microscale silver plates of varied size and nanoscale thickness in liquids was observed. Because the particles used in self-assembling materials are so small, they behave like atoms and molecules, which allows

researchers to use classical chemistry and physics theories to understand their behavior.

The non-uniform particles repel and attract according to laws of nature in plain, deionized water; however, when salt is added to the water, changing electrostatic forces trigger a multistep assembly process. The non-uniform particles begin to assemble to form columns of stacked silver plates and further assemble into increasingly complex, ordered, 3D hexagonal lattices.

Particles can be seen assembling in this hierarchy using a light microscope. This enables tracking of particle motions one by one and studying the assembly dynamics in real time.

This work could enable development of reconfigurable self-assembly materials that can change from one type of solid crystal to another type with different properties for a variety of applications.

*For more information, contact Qian Chen, Professor, Materials Science and Engineering, at [qchen20@illinois.edu](mailto:qchen20@illinois.edu); 217-300-1137.*

ofs  
A Furukawa Company

OPTICAL FIBER & CABLE SOLUTIONS FOR  
Aerospace & Defense Applications

SENSING

NAVIGATION

INFLIGHT COMMUNICATIONS

Optical Fiber

Fiber Optic Cable

[www.ofsoptics.com/aerospace-defense](http://www.ofsoptics.com/aerospace-defense)





# HELI-CAL PRODUCTS

## CELEBRATING

# 60 YEARS



## AS THE MOTION EXPERT



CELEBRATING

# 60<sup>TH</sup>

ANNIVERSARY

*The Motion Experts*

SINCE  
1958



To our customers, employees, distributors,  
vendors, media partners past and present,

**THANK  
YOU,**



# HELI-CAL

PRODUCTS COMPANY

MW Industries, Inc.

[www.heli-cal.com](http://www.heli-cal.com)

805-928-3851

Free Info at <http://info.hotims.com/72995-741>



**EP93FRHT**

**Epoxy Meets Demanding AIRBUS STANDARDS**

EP93FRHT Passes Tests for Flame Retardancy, Smoke and Gas Emissions

Service temperature range  
-80°F to +400°F

Tensile lap shear strength, 75°F  
1,200-1,400 psi

Volume resistivity, 75°F  
>10<sup>14</sup> ohm-cm

**MASTERBOND®**  
ADHESIVES | SEALANTS | COATINGS

Hackensack, NJ 07601, USA • +1.201.343.8983 • main@masterbond.com

www.masterbond.com

Free Info at <http://info.hotims.com/72995-739>

[www.hunterproducts.com](http://www.hunterproducts.com)

**MICRO-METALLIZER PLATING PENS MIL & QQ Standards GOLD 14K, 18K, 24K, SILVER, RHODIUM, PALLADIUM, NICKEL, COPPER, TIN, BLACK NICKEL, AND CHROME COLOR PENS AVAILABLE.**

Environmentally friendly, these low-cost disposable applicators permit instantaneous selection from a variety of plating possibilities without the preparation of solutions. Specially formulated compounds and can be used for contact repair, prototype development work, electronic instrument repair, medical instrument repair etc.

### Hunter Products, Inc.

36 Madison Ave  
Flemington, NJ 08822  
908 526 8440 • Fax: 908 526 8348  
hunter@hunterproducts.com



## Supergel System Cleans Radioactively Contaminated Structures

Supergel can be used to decontaminate structures, collect radioactive contamination samples for nuclear forensics, and convert liquid radioactive waste to stabilized solids for disposal.

*Argonne National Laboratory, Argonne, Illinois*

A system was developed that can remove radioactive cesium contamination from porous structures such as brick and concrete that are hard to clean, as well as contamination from metal surfaces. The Supergel system focuses on rapid response, capturing as much of the contamination as possible, as quickly as possible, and filling a technology gap immediately.



The Supergel system safely captures and disposes of radioactive elements in porous structures. The technology could be used in the event of an attack using a "dirty bomb" or other radioactive dispersal device.

The system consists of engineered nanoparticles and a super-absorbent polymer gel that work together to clean structures exposed to radioactive materials. The polymer Supergel that absorbs the radioactivity is similar to the absorbent material found in disposable diapers. When exposed to a wetting agent, the polymers form a kind of structural "scaffold" that allows the gel to absorb great amounts of liquid. The amount of contamination removed depends on the characteristics of the contaminated structure — its age, type of material, and whether painted or un-

painted — and the radioactive isotope involved. Removal rates have ranged from roughly 80 to nearly 100 percent.

Operating much like an automatic car wash, the Supergel system follows a three-step process:

1. Remote spray washers apply a wetting agent and a super-absorbent gel onto the contaminated surface.
2. The wetting agent causes the bound radioactivity to re-suspend in the pores. The super-absorbent polymer gel suctions the radioactivity out of the pores, and it becomes fixed in the engineered nanoparticles that sit in the gel.
3. The gel is vacuumed and dehydrated, with only a small amount of radioactive waste remaining for disposal.

A key benefit of the Supergel technology is that it leaves structures intact. Until now, no effective technique existed to remove radioactive contamination. Contaminated objects were typically demolished since they could not be cleaned. Because the Supergel system preserves surfaces, buildings are not defaced during radiation removal.

*For more information, contact Technology Commercialization and Partnerships at [partners@anl.gov](mailto:partners@anl.gov); 800-627-2596.*



# Phase-Switching Liquids as Anti-Icing Materials

The materials delay frost up to 300 times longer than existing anti-icing coatings.

*University of Illinois, Chicago*

Techniques to prevent frost and ice formation on surfaces rely heavily on heating or on liquid chemicals that need to be repeatedly reapplied because they easily wash away. Even advanced anti-icing materials have problems functioning under conditions of high humidity and subzero conditions.

Several unique properties of materials known as phase-switching liquids (PSLs) hold promise as next-generation anti-icing materials. PSLs can delay ice and frost formation up to 300 times longer than state-of-the-art coatings being developed in laboratories.

PSLs are phase change materials that have melting points higher than the freezing point of water (0 °C), meaning they would be solids at temperatures close to that at which water freezes. Such materials include cyclohexane, cyclooctane, dimethyl sulfoxide, and glycerol.

While researchers have known about phase change materials for a long time, their unique anti-icing and anti-frosting properties have not been investigated. In the current work, researchers cooled a range of PSLs to -15 °C, rendering them all solid. Under high-humidity conditions, the solidified PSLs melted directly underneath and in the immediate vicinity of water droplets condensing on the PSLs. The droplets showed the same hopping motion, even at very low temperatures.

PSLs are extremely adept at trapping released heat. This quality, combined with the fact that condensed water droplets become extremely mobile on cooled PSLs, means that the formation of frost is significantly delayed. Eventually, ice forms but some of the PSLs are water-soluble; this contributes to their anti-freezing properties and can help delay ice formation much longer

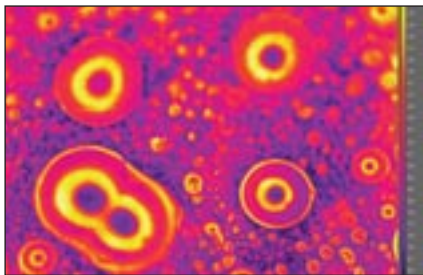

Water condenses on phase switching liquid. (Image: Rukmava Chatterjee)

than even the most advanced anti-icing coatings.

PSLs could be used to coat objects like car windshields without compromising the object's functionality. PSLs also have a range of optical transparencies, can self-repair after being scratched, and can

purge liquid-borne contaminants. Because PSLs are solids at low temperatures, they wouldn't need to be applied as often as liquid anti-icing agents because they would have better staying power.

*For more information, contact Sharon Parmet at [sparmet@uic.edu](mailto:sparmet@uic.edu); 312-413-2695.*



## SCS Parylenes: Protecting Advanced Space Technologies

For over 45 years, Parylene conformal coatings have provided reliable protection to electronics and components used in satellites, space-borne instrumentation, vehicles and more.

- Ultra-thin, lightweight, pinhole-free conformal coatings
- Superior moisture, chemical barrier and dielectric properties
- Thermal stability up to 350°C long-term, 450° short-term
- RoHS and REACH compliant

With 19 locations around the world, SCS is the leader in Parylene coatings and technologies. For more information on protecting your advanced technologies, contact SCS today.

US: +1.317.244.1200

[scscoatings.com/space](http://scscoatings.com/space)

  
**SPECIALTY COATING SYSTEMS™**  
A KISCO Company



Intro

Cov

ToC





# Manufacturing & Prototyping

## Fabricating Nanochips via Thermal Lithography

This process produces higher-quality, lower-cost nanochips with mass-production potential.

*New York University Tandon School of Engineering, Brooklyn*

A process for fabricating atom-thin processors can be used to produce at the nanoscale for smaller and faster semiconductors.

Lithography using a probe heated above 100 °C was used to fabricate metal electrodes on 2D semiconductors such as molybdenum disulfide (MoS). Such transitional metals are among the materials that may supplant silicon for atomically small chips. The fabrication method — called thermal scanning probe lithography (t-SPL) — offers a number of advantages over electron beam lithography (EBL).

Thermal lithography significantly improves the quality of the 2D transistors, offsetting the Schottky barrier, which hampers the flow of electrons at the intersection of metal and the 2D substrate. Also, unlike EBL, the thermal lithography allows chip designers to easily image the 2D semiconductor and then pattern the electrodes where desired. Also, t-SPL fabrication systems promise significant initial savings as well as operational costs. They dramatically reduce power consumption by operating in ambient conditions, eliminating the need to produce high-energy elec-

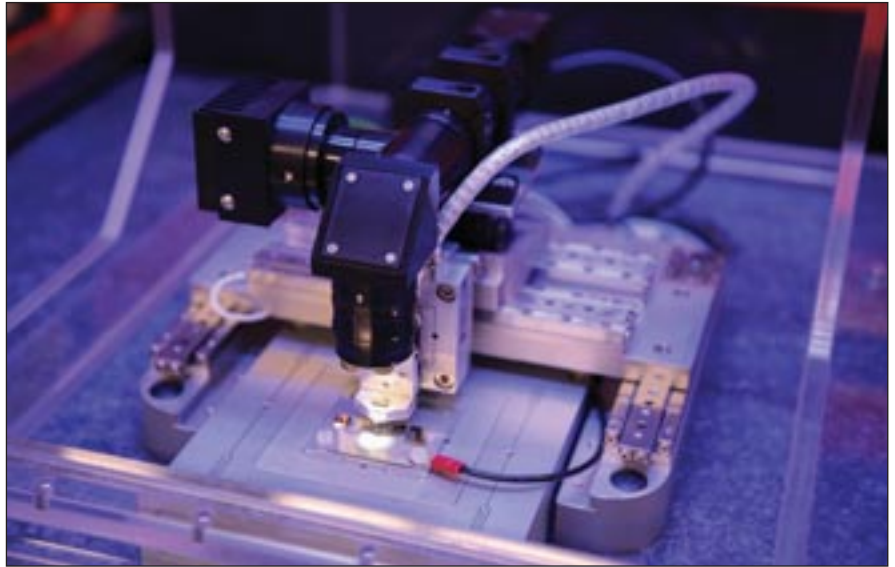

Hot-probe equipment called NanoFrazor by SwissLitho was modified for a new process of fabricating 2D semiconductors. Here, the equipment patterns a one-atom-deep layer of molybdenum disulfide with electrodes. (Credit: NYU Tandon)

trons and to generate an ultra-high vacuum. Finally, thermal fabrication can be easily scaled up for industrial production by using parallel thermal probes.

The t-SPL method could take most fabrication out of cleanrooms and into indi-

vidual laboratories. The t-SPL tools with sub-10-nanometer resolution run on standard 120-volt power in ambient conditions.

*For more information, contact Kathleen Hamilton at [kathleen.hamilton@nyu.edu](mailto:kathleen.hamilton@nyu.edu); 646-997-3792.*

## Combining Origami and 3D Printing to Make Complex Structures in One Step

This one-step approach to creating lightweight, expandable, strong structures could have applications in areas from biomedical devices to equipment used in space exploration.

*Georgia Institute of Technology, Atlanta*

There are many different types of 3D printing technologies. The most familiar — inkjet — has been around for some 20 years. But until now, it has been difficult to create 3D-printed structures with the intricate hollow features associated with complex origami because removing the supporting materials necessary to print these structures is challenging. Further, unlike paper, the 3D-printed materials could not be folded

numerous times without breaking. Making such structures has involved multiple steps, more than one material, and assembly from smaller parts.

Researchers developed an integrated system for manufacturing complex origami using a relatively new kind of 3D printing called Digital Light Processing (DLP) to create groundbreaking origami structures that are not only capable of holding significant weight but can also

be folded and refolded repeatedly in an action similar to the slow push and pull of an accordion. When first reported, these structures, or “zippered tubes,” were made of paper and required gluing. In the current work, the zippered tubes — and complex structures made out of them — are composed of one plastic (a polymer) and do not require assembly.

DLP has been in the lab for a while, but commercialization only began about five





Closeup of the origami structures created through Digital Light Processing 3D printing. (Christopher Moore, Georgia Tech)

years ago. Unlike other 3D printing techniques, it creates structures by printing successive layers of a liquid resin that is then cured, or hardened, by ultraviolet light. For the current work, the researchers first developed a new resin that, when cured, is very strong — it can be folded hundreds of times without breaking. The resin, in turn, is key to an equally important element of the work: tiny hinges. These hinges, which occur along the creases where the origami structure folds, allow folding because they are made of a thinner layer of resin than the larger panels of which they are part. (The panels make up the bulk of the structure.)

Together, the new resin and hinges worked. The team used DLP to create several origami structures ranging from the individual origami cells that the zippered tubes are composed of to a complex bridge composed of many zippered tubes. All were subjected to tests that showed they were not only capable of carrying about 100 times the weight of the origami structure, but also could be repeatedly folded and unfolded without breaking.

For more information, contact John Toon at [jtoon@gatech.edu](mailto:jtoon@gatech.edu); 404-894-6986.

## Self-Assembled Micro-Organogels Enable 3D Printing of Silicone Structures

This method promises vastly superior medical implants.

University of Florida, Gainesville

For the millions of people every year who have or need medical devices implanted, an advancement in 3D printing technology could enable significantly quicker implantation of devices that are stronger, less expensive, more flexible, and more comfortable than anything currently available. Such devices are molded, which could take days or weeks to create customized parts designed to fit an individual patient. The 3D printing method cuts that time to hours; additionally, small and complex devices such as pressure-sensitive valves, simply cannot be molded in one step.

There are countless ways to use soft, solid materials that fluidize and become solid again with small variations in applied stress. The traditional routes of microgel synthesis produce materials that

# CLICK BOND®

Adhesive-Bonded Fastener Technology

## Celebrating Apollo's 50th Anniversary



Next step Mars, and our parts...

are already there

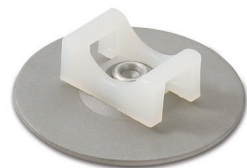

PIONEERING > ADVANCED > SOLUTIONS

2151 Lockheed Way Carson City NV 89706 +1-775-885-8000

[WWW.CLICKBOND.COM/TB2](http://WWW.CLICKBOND.COM/TB2)



Intro

Cov

ToC



**NEW!**

**4 AXIS SERVO**  
FROM  
**ALLMOTION**

2.25"



- BRUSHED OR BLDC MOTORS
- 5 AMPS PER AXIS
- 16 ANALOG INPUTS
- 16 ON/OFF DRIVERS
- HOME AND LIMIT IN
- LIVE TECH SUPPORT
- MADE IN THE USA

See the  
**EZQUAD SERVO**  
in action!



**WWW.ALLMOTION.COM**

**(510) 471-4000**

30097 Ahern Avenue  
Union City, CA 94587  
Technical Support  
(408) 460-1345



Silicone is 3D-printed into the micro-organogel support material. The printing nozzle follows a pre-defined trajectory, depositing liquid silicone in its wake. The liquid silicone is supported by the micro-organogel material during this printing process.

swell in aqueous solvents or, less often, in aggressive organic solvents, constraining ways that these useful materials can be used. Aqueous microgels, for example, have been used as the foundation of 3D bioprinting, but the incompatibility of available microgels with nonpolar liquids, such as oils, limits their use in 3D printing with oil-based materials such as silicone.

The new method makes micro-organogels swollen in mineral oil, using block copolymer self-assembly. The rheological properties of this micro-organogel material can be tuned, leveraging the jamming transition to facilitate its use in 3D printing of silicone structures. The new material provides support for the liquid silicone as it is 3D printing, allowing the creation of very complex structures and even encapsulated parts out of silicone elastomer. It also could pave the way for

new therapeutic devices that encapsulate and control the release of drugs, or small molecules for guiding tissue regeneration or assisting diseased organs such as the pancreas or prostate.

The new method was born out of work done to create printable organs and tissues. The team made a significant discovery when it created a revolutionary way to manufacture soft materials using 3D printing and microscopic hydrogel particles as a medium. The previous granular gel materials were water-based, so they were incompatible with oily "inks" like silicone. The solution was to develop an oily version of the microgels. The oily silicone inks printed into the oily microgel materials enabled the printed parts to hold their shapes.

*For more information, contact news@ufl.edu; 352-392-0186.*

## Shear Assisted Processing and Extrusion

This extrusion manufacturing technology will benefit automotive, aerospace, oil and gas, electric power, medical, and semiconductor industries.

*Pacific Northwest National Laboratory, Richland, Washington*

**S**hear Assisted Processing and Extrusion (ShAPE™) allows creation of wire, bar, and tubular extrusions that show significant improvement in material properties; for example, magnesium extrusions have been manufactured

with unprecedented ductility (how far the material can stretch before it breaks) and energy absorption (how much energy can be absorbed during compression of a tubular extrusion) over conventional methods.



Intro

Cov

ToC



The technology is part of PNNL's suite of Solid Phase Processing (SPP), an approach to metals manufacturing that can be better, cheaper, and greener than melt-based methods typically associated with metals manufacturing.

In ShAPE, a canister holding feedstock material — such as metal powder, flake, or billet — is forced into a rotating die. Frictional heating is generated at the interface between the feedstock material and die, softening only the material being extruded and eliminating the need for feedstock pre-heating or application of external heat used in conventional extrusion. Spiral grooves on the die face feed the material inward toward the extrusion orifice, which greatly reduces the force required during extrusion.

As an example, using ShAPE, nano-structured aluminum powder can be extruded directly into round bars using 50 times less force and much lower power consumption than conventional extrusion, while achieving twice the ductility. Costly and time-consuming steps required by conventional powder processing are entirely



In ShAPE, a canister holding feedstock material is forced into a rotating die. Frictional heating is generated at the interface between the feedstock material and die, softening only the material being extruded and eliminating the need for external heat used in conventional extrusion.

eliminated. The lower force and power enable substantially smaller production machinery.

With an extrusion ratio of 200:1 demonstrated for magnesium, ShAPE achieves in

a single pass what would take multiple passes with conventional extrusion. The technology enables control over grain refinement and microstructure orientation in extrusions, which is not possible

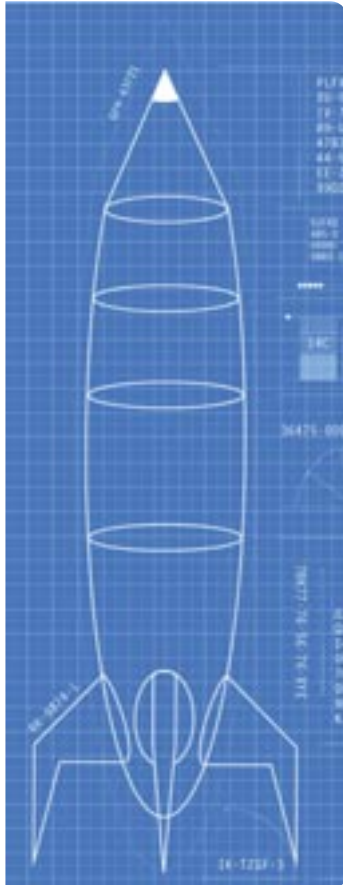

## Your worldwide source for high performance Tapes, Films, Fabrics, & Silicone

**DESIGN WITH THE BEST PERFORMANCE MATERIALS**



**CS Hyde Company** is a full service converter specializing in custom slitting, rapid prototyping, die cutting, automated sheeting, conveyor belting, and adhesive lamination.

**Specialty Materials:**  
Kapton®, PEEK™, Mylar, Virgin PTFE, Skived PTFE, Nylon, FEP  
High Temperature Silicone



800-461-4161  
sales@cshyde.com  
www.cshyde.com



with other extrusion processes. In addition, magnesium extrusions made by ShAPE do not require costly rare earth elements to produce extrusions with sufficient ductility and energy absorption for use in some structural automotive applications (e.g., automobile bumpers), allowing more affordability in mass production.

ShAPE could be a viable method for the production of creep-resistant steels that could be used for heat exchangers in the electric power industry, and high-conductivity copper and advanced magnets for application in electric motors. It has also been used to produce high-strength aluminum rods

with application in the aerospace industry. In yet another potential application, ShAPE shows promise as a method to produce semiconducting thermoelectric materials.

*For more information, contact Sara Hunt, Technology Commercialization Manager, at [sara.hunt@pml.gov](mailto:sara.hunt@pml.gov).*

## Wafer-Level Microchannel Fabrication Process for Lab-on-a-Chip Devices

Microchannels of 75- $\mu$ m-diameter are used to separate molecular species.

*Goddard Space Flight Center, Greenbelt, Maryland*

Microchannels fabricated into a silicon-Pyrex wafer with a diameter of 75 mm and total channel length of 40, 60, 80, or 100 mm — characterized by specialized microbeads within the channel — have been successfully created, tested, and used at NASA Goddard Space Flight Center. Designed to collect and separate amino acids towards finding the building blocks of life on other planets, this technology could be essen-

tial to many other lab-on-a-chip or microfluidic applications.

The microchannel chip is created from a silicon bottom wafer and Pyrex top wafer anodically bonded. Specialized microbeads with specific structure and surface chemistry are placed along the channels. Different species of analyte molecules will interact more strongly with the column chemistry and will therefore take longer to traverse the column, i.e.,

have a longer retention time. In this way, the channels separate molecular species based on their chemistry.

The specific shape and surface chemistry of these microchannels do more than just move analyte molecules — the molecules are separated by how they are affected by the channel's chemistry for expedited analysis. Paired with mass spectroscopy or ChemFET technology, this technology could enhance research and development in microchemistry, microfluidics, and lab-on-a-chip technology.

Another embodiment of this invention includes microposts inside the microfluidic channel for particle separation, rather than using microbeads. The silicon microposts can be built inside a silicon microfluidic channel by MEMS technology. The size of microposts can vary depending on the application. The

### Wear-Free Angle Measurement

RFC 4800 Series of touchless sensors use a magnet attached to your application's rotating shaft. Now with IO-Link output option, these sensors can be easily connected with a 3-wire version. Voltage, current and other digital output options provide design flexibility. They keep measuring even during a loss of power, reporting the correct position when it is restored.

**Key specifications:**

- Repeatability to 0.1°
- Resolution to 14-bit
- 2-ch. version option
- Measures 0 to 360°
- Linearity  $\leq \pm 0.5\%$  of F.S.
- Speed output option

**Free touchless angle sensors primer: [www.novotechnik.com/rfc48](http://www.novotechnik.com/rfc48)**

Novotechnik U.S., Inc. Telephone: 508-485-2244  
Email: [info@novotechnik.com](mailto:info@novotechnik.com)

**novotechnik**  
Siebel Group



This figure shows four silicon-Pyrex wafers with 40-, 60-, 80-, and 100-mm length microchannels, respectively.





microposts function as an in-line filter to block unwanted big particles and protect the microfluidic chip. Furthermore, micropost chips with microvalves can physically select different size cells, mol-

ecules, viruses, etc. It can also be used to select different particles in bioengineering and pharmaceutical testing.

*NASA is actively seeking licensees to commercialize this technology. For more information, contact the Goddard Strategic Partnerships Office at [techtransfer@gsc.nasa.gov](mailto:techtransfer@gsc.nasa.gov) or 301-286-5810. Follow this link for more information: <https://technology.nasa.gov/patent/GSC-TOPS-66>.*

## 3D Printing of Flexible Circuits

This process 3D-prints flexible and transparent electronics.

*Deutsches Elektronen-Synchrotron DESY, Hamburg, Germany*

A process was developed for 3D printing that can be used to produce transparent and mechanically flexible electronic circuits. The electronics consist of a mesh of silver nanowires that can be printed in suspension and embedded in various flexible and transparent plastics (polymers). This technology can enable new applications such as printable light-emitting diodes, solar cells, or tools with integrated circuits. The approach integrates electronics into existing structural units and improves components in terms of space and weight.

At the heart of the technology are silver nanowires that form a conductive

mesh. The silver wires are typically several tens of nanometers (millionths of a millimeter) thick and 10 to 20 micrometers (thousandths of a millimeter) long. X-ray analysis shows that the structure of the nanowires in the polymer is not changed, but the conductivity of the mesh improves thanks to the compression by the polymer as it contracts during the curing process.

The silver nanowires are applied to a substrate in suspension and dried. For cost reasons, the aim is to achieve the highest possible conductivity with as few nanowires as possible. This also increases the transparency of the material. In this

way, layer-by-layer, a conductive path or surface can be produced. A flexible polymer is applied to the conductive tracks, which in turn can be covered with conductive tracks and contacts. Depending on the geometry and material used, various electronic components can be printed in this way.

Researchers will test how the structure of the conductive paths made of nanowires changes under mechanical stress including how well the wire mesh holds together during bending and how stable the polymer remains.

*For more information, contact DESY at [desyinfo@desy.de](mailto:desyinfo@desy.de); +49 40 8998-0.*



**Largest selection of Stock Metric GEARS in North America**

Over 20,000 Stock Metric Gears Available at [www.khkgears.us](http://www.khkgears.us)

**KHK-USA** 259 Elm Place, Mineola, NY 11501  
Phone: 516.248.3850 | Fax: 516.248.4385  
Email: [info@khkgears.us](mailto:info@khkgears.us)

MEMBER **PTDA**





# Aeronautics

## Sensor Network for Air Vehicles

This system senses the environmental and structural conditions of air vehicles.

*Ames Research Center, Moffett Field, California*

Aircraft currently fly based on coarse estimations of environment and aircraft state. Real-time measurements are traditionally restricted to laboratory environments (e.g. wind tunnel) due to the size and weight of instrumentation. NASA Ames has developed a distributed system for sensing the environmental and structural conditions of an air vehicle. It consists of many identical lightweight and low-power network modules that can connect to each other as well as to a number of different sensors of any type. The resulting network produces a robust, responsive system that can transfer structural and environmental information into actionable control objectives in real time.

The Distributed Asynchronous Air Vehicle Sensor System (DAVSS) consists of a modular sensor system that distributes collection and computation throughout the aircraft body. Sensor nodes are distributed throughout an air vehicle, either attached to the skin or to the substructure. These nodes are then connected to nearby sensor modules, from which they can collect data that they then either transmit to

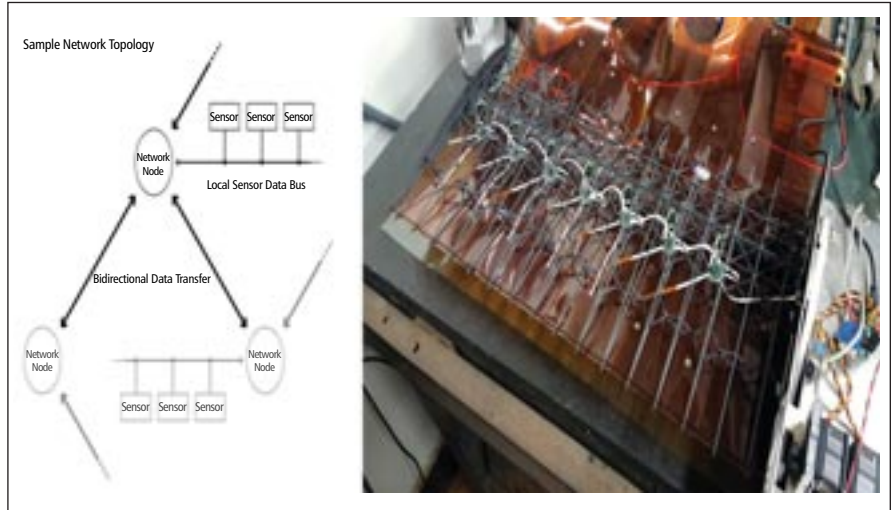

(Left) Block diagram representing a sample network topology for a sensor node mesh network. (Right) Example integration of sensor nodes with aircraft structure. Initial linear layout prior to completion of additional connections for mesh redundancy is shown for clarity.

other nodes via a bidirectional data network or use to perform local computations. The internode network enables each node to communicate with more than two other neighbors and can access N nearby sensors via a data network implemented with asynchronous mesh routing.

Each sensor bus is local to the sensor node, so address space within each node's sensor bus is distinct. The use of local computation could reduce the response time of the air vehicle and reduce overhead since sensors no longer have to be wired through the entire vehicle to the central processor and polled

## Miniature RF & Power Magnetics for Wearable Technology

*Coilcraft*



- Wirewound chip inductors as small as 0201 size
- Shielded power inductors as thin as 0.5 mm
- Coupled inductors as small as 2.2 x 1.5 mm for LED display drivers

Learn more @ [coilcraft.com](http://coilcraft.com)



from this source. Instead, local networks can inter-communicate and respond to stimuli directly without having to traverse the entire network. This invention is used to efficiently spread the computation required to collect and act on environmental and structural stimuli that act on an air vehicle.

*NASA is actively seeking licensees to commercialize this technology. For more information, contact the Ames Technology Transfer Office at ARC-TechTransfer@mail.nasa.gov or 855-627-2249. Follow this link for more information: <https://technology.nasa.gov/patent/TOP2-280>.*

## Aircraft Engine Icing Event Avoidance and Mitigation

This simulation tool reduces icing risk without sacrificing specific fuel consumption.

John H. Glenn Research Center, Cleveland, Ohio

Innovators at NASA's Glenn Research Center have developed a new means of avoiding and mitigating icing events for aircraft flying above 14,000 feet, dramatically improving aviation safety and reducing operating costs.

Often undetectable with current radar, ice crystals in convective storm cells can produce a phenomenon referred to as "ice crystal icing," in which ice accumulates, or accretes, in turbofan engines. Ice-crystal accretion can cause serious engine operational problems and sometimes even catastrophic engine failures. Using a combination of sensors, engine system modeling, and compressor flow analysis code, Glenn's innovation performs real-time analysis to determine the potential of ice accretion. This analysis allows pilots to avoid potential icing while using a more direct route than would otherwise be possible. Thus, Glenn's system reduces fuel consumption and engine wear while fulfilling the crucial objective of increasing aircraft safety.

The existence of an ice-crystal environment in the atmosphere is determined by one or more of three methods: (1) an external data monitoring system that detects ice crystals directly, (2) the control system that detects changes in key engine parameters such as the ratio of fan speed to core engine speed or fuel flow rate, and (3) advanced radar that detects ice crystals in the flight path of the aircraft. If risk of icing is present, Glenn's tool signals the control system to modify the engine operating parameters so as to pre-emptively prevent a significant amount of accretion from occurring, or alternatively, guides the aircraft to a location where ice crystal accretion will not occur.



The tool offers real-time analysis of conditions that could produce ice accretion and threaten the operation of turbine engines.

Standard practice has been for pilots to navigate at least 100 miles around visible storms, but with the improved accuracy provided by Glenn's innovation, the pilot can fly as close as 20 miles to the ice-crystal environment while still maintaining enhanced safety. Since the magnitude of change to the engine operating parameters is so small (and the level of engine thrust set by the pilot remains the same), any modification will be imperceptible to both the pilot and passengers. In addition, Glenn's system can be easily integrated into new engines or retrofitted into existing technologies.

*NASA is actively seeking licensees to commercialize this technology. Please contact the Technology Transfer Office at [grc-techtransfer@mail.nasa.gov](mailto:grc-techtransfer@mail.nasa.gov) or 216-433-3484. Follow this link for more information: <https://technology.nasa.gov/patent/LEW-TOPS-125>.*



MICRO-EPSILON



## 2D/3D BLUE LASER SCANNER

- For red hot glowing metals, transparent and organic materials
- Measuring rate up to 2,560,000 points/sec
- Profile frequency up to 4kHz
- Resolution x-axis up to 1,280 points
- Ethernet GigE-Vision / RS422
- Direct connection to PLC



## OPTICAL MICROMETER

- Measuring ranges up to 100mm
- Frequency response up to 100kHz
- Resolution <0.1µm
- Repeatability <1µm
- Diameter, gap, width and position measurement

[www.micro-epsilon.com](http://www.micro-epsilon.com)

MICRO-EPSILON

Raleigh, NC 27617 / USA

Phone +1/919 787 9707

[me-usa@micro-epsilon.com](mailto:me-usa@micro-epsilon.com)

Free Info at <http://info.hotims.com/72995-748>



# PROUD TO BE PART OF NASA HISTORY

J W S T

O R I O N

S H U T T L E

A P O L L O



**dp Data Physics**  
dataphysics.com

**Lansmont**  
lansmont.com

**Team**  
teamcorporation.com

Members of the **N|V|T** GROUP

## Advanced Over-the-Wing Nacelle Transport Configuration

This novel aircraft wing design reduces drag and community noise.

*Langley Research Center, Hampton, Virginia*

**N**ASA's Langley Research Center has developed a new aircraft design with the engine nacelle over the wing, improving engine ground clearance and freeing landing gear design. While previous over-the-wing designs have produced unacceptably high drag conditions, the new NASA design reduces drag on the wing. By optimizing the nacelle design and the wing leading edge location, NASA's design confines the shock to the leading edge of the wing. Also, placing the exhaust nozzle over the wing reduces noise to the communities below.

NASA developed the novel configuration to address the drag penalties associated with traditional over-the-wing nacelle designs. The novel features of the wing design include the unswept inboard wing section between the fuselage and the nacelle with an extended chord. The chord is extended so that it is almost in line with the front face of the nacelle, promoting near two-dimensional channel flow between the nacelle and the fuselage that pulls the standing shock wave farther forward. Confining the shock naturally enhances the leading edge suction and eliminates the shock traditionally located near the trailing edge. The net effect is reduced compressibility-based interference drag.

Noise is reduced because the engine nozzle is tangential to the wing upper surface and near the middle of the wing chord to put the exhaust noise source in the best position to be shielded from the community by the wing below it.

*NASA is actively seeking licensees to commercialize this technology. Please contact The Technology Gateway at [LARC-DL-technologygateway@mail.nasa.gov](mailto:LARC-DL-technologygateway@mail.nasa.gov) to initiate licensing discussions. Follow this link for more information: <https://technology.nasa.gov/patent/LAR-TOPS-70>.*



Noise is reduced because the engine nozzle is tangential to the wing upper surface and near the middle of the wing chord.



# **Back to the Moon & on to Mars**



**The Next Giant Leap  
Pg. 50**



**One Small Step  
Pg. 52**



**An Astronaut's View  
Pg. 56**



**Back to the Moon  
Pg. 58**



**Getting There  
Pg. 61**



**On to Mars  
Pg. 64**

Cover image: Right now, NASA is taking steps to begin the next era of exploration — a return of humans to the Moon and getting them to Mars. (NASA)



This illustration depicts how important precision landing is to a successful lunar mission. The identification of level ground near scientifically important and hazardous sites is essential for the success of long-term missions. (NASA)

Back to the Moon  
& on to Mars

# The Next Giant Leap

On May 25, 1961, President John F. Kennedy announced before a special joint session of Congress the dramatic and ambitious goal of sending an American safely to the Moon before the end of the decade. Kennedy felt great pressure to have the United States “catch up to and overtake” the Soviet Union in the space race.

After consulting with Vice President Lyndon Johnson, NASA Administrator James Webb, and other officials, Kennedy concluded that landing an American on the Moon would be a very challenging technological feat, but an area in which the U.S. actually had a potential lead. At the time of Kennedy’s announcement, America’s first human spaceflight effort, Project Mercury, was already underway. During the five-year life of the Mercury project, six human-tended flights and eight automated flights were completed, proving that human spaceflight was possible.

On November 4, 1967, NASA released the planned schedule for Apollo missions to be flown in 1968 and 1969, leading to a lunar landing. The announcement came just five days before the launch of Apollo 4, the first flight since the Apollo 1 fire in January 1967 and the first unmanned flight of the Saturn 5 rocket. The timetable was highly dependent on Apollo 4 and the assumed success of all

subsequent missions. Critical components were the timely completion and delivery of the Command and Service Module (CSM) and especially the Lunar Module (LM) — at the time, significantly behind schedule. The plan outlined six Apollo flights in 1968 and five in 1969, a combination of unmanned tests and manned flights on both the Saturn 1B and Saturn 5 rockets.

On October 11, 1968, Apollo 7 — the first manned Apollo mission — successfully got to space.

And on July 20, 1969, Apollo 11 astronaut Neil Armstrong became the first human to set foot on the Moon. Six more Apollo flights followed. On December 14, 1972, the Apollo 17 Lunar Module ascent stage lifted off the Moon — the last time man would be on the Moon.

The Moon has remained of great interest to NASA and scientists around the world. In the half-century since people visited the Moon, NASA has continued to push the boundaries of knowledge to deliver on the promise of American ingenuity and leadership in space.

NASA stands on the verge of commercializing low-Earth orbit. These experiences and partnerships will enable NASA to go back to the Moon in 2024 — this time to stay — with the U.S. leading a coalition of nations and industry.



NASA has been discussing concepts for human lunar exploration since the Apollo flights ended. In this artist’s concept, a lunar mining operation harvests oxygen from the lunar soil a few kilometers from the Apollo 17 landing site. (SAIC/Pat Rawlings)

The Moon will provide a proving ground to test technologies and resources that will take humans to Mars and beyond. NASA’s work at the Moon, which is pressing forward right now, is preparing us for “the next giant leap” — missions to Mars and other deep-space destinations.

As we celebrate the 50th anniversary of the Apollo 11 Moon landing this month, NASA is moving forward to the Moon and on to Mars — and wants the world to come along.

## Resources

[www.nasa.gov/moon](http://www.nasa.gov/moon)  
[www.nasa.gov/specials/m2m-toolkit/](http://www.nasa.gov/specials/m2m-toolkit/)

We Are NASA  
<https://youtu.be/WeA7edXsU40>

NASA’s Next Giant Leap  
<https://youtu.be/xwhnXJdJEk8>

We Are Going  
<https://youtu.be/vl6jn-DdafM>



# NTK's Winning Hand!



NTK can handle all your Heat Resistant Super Alloy machining needs using our winning hand of cutting tool grades

## SiAION Ceramic

For a variety of HRSA applications

NEW

**SX3** Roughing / Semi-finishing

- Best Grade for Turning and Milling even newest HRSA Materials

**SX5** Roughing / Interrupted cut

- Best Grade for Roughing Waspaloy Scale

**SX9** Roughing / Semi-finishing

- Best Grade for Roughing Inco 718 Scale

**SX7** Semi-finishing

- Best Grade for Milling Inco 718

## BIDEMICS

World's new grade for HRSA materials

NEW

**JX1 / JX3** Semi-finishing / Finishing

- Cut HRSA @ 1600 SFM
- Longer tool life vs. whisker
- Produces mirror surface finish

**JP2** Finishing

- Cut HRSA @ 1700 SFM
- 10-15 x speed vs. carbides
- Produces mirror surface finish

## Whisker Ceramic

Versatile grade for HRSA materials

**WA1** Semi-finishing / Finishing

- General Purpose Grade

**NTK**  
CUTTING TOOLS

Wixom, MI | Toll free: 866-900-9800 | [ctinfo@ntktech.com](mailto:ctinfo@ntktech.com) | [WWW.ntkcuttingtools.com](http://WWW.ntkcuttingtools.com)



Free Info at <http://info.hotims.com/72995-750>



# APOLLO

50 NEXT GIANT LEAP

# One Small Step

The Apollo 11 astronauts  
(left to right):  
Neil A. Armstrong,  
Commander;  
Michael Collins,  
Command Module  
Pilot; Edwin E.  
"Buzz" Aldrin,  
Lunar Module  
Pilot.



**O**n July 20, 1969, humans walked on another world for the first time in history. After a landing that included dodging a lunar crater and boulder field and almost running out of fuel just before touchdown, Neil Armstrong and Buzz Aldrin explored the area around their lunar landing site for 21 hours and 36 minutes while Michael Collins piloted the Command Module around the Moon. They collected soil and rock samples, set up experiments, planted an American flag, and left behind medallions honoring the Apollo 1 crew and a

plaque saying, "We came in peace for all mankind."

At 10:56 pm EDT, Armstrong planted the first human foot on the Moon. With more than half a billion people watching on television, he climbed down the ladder and proclaimed: "That's one small step for a man, one giant leap for mankind." An estimated 530 million people around the world watched on television. In the United States, 93 percent of the population's TVs were tuned to one of the three major networks covering the occasion.

Astronaut Jim Lovell served on the crew of Apollo 8, the first crew to leave



Earth orbit and travel to orbit the Moon in December 1968. He saw how Apollo brought people around the world together to celebrate the achievement. “You have to remember what the United States was like in 1968 with the Vietnam War, the murders (of Rev. Martin Luther King Jr. and Sen. Robert Kennedy), and the riots. Apollo 8 was the high point in my space career. NASA put a spacecraft around the Moon on Christmas Eve, and it changed the whole attitude of the country.”

The legacy of Apollo, said Lovell — the first person to fly in space four times — is that “if you set your mind to do something, get everybody together and everybody agrees we should accomplish it, and then we go ahead — it became something we all could be proud of.”

Apollo 11 astronaut Michael Collins explained that with Apollo 11, the crew “had three important things going for us, two of which we don’t have today. The first one was, I wouldn’t say money was no object, but we were getting slightly over three percent of the federal budget. The second one was a deadline — by the end of the decade. You could motivate people... saying, ‘We gotta do this by the end of the decade.’ It was a very powerful tool. The third thing, we still have. We had a lot of smart people, young people, dedicated people who got to work early, stayed at work late. You didn’t have to tell them they were part of a team — they knew they were part of a team.”

The team that would serve as mission control for Apollo 11 was led by Eugene Kranz and three other flight directors. Said Kranz, the team was made up of the finest systems engineers in the world — the average age was 26 (Kranz was 36). When July 20, 1969 came, he told the team, “It’s now time to get down to business. From the day of our birth, we were meant for this time and place, and today we will land an American on the Moon. Whatever happens here today,” said Kranz, “I will stand behind every decision you will make. We came into this room as a team and we will leave as a team.”

Said Buzz Aldrin, “Apollo 11 was about exploration. About taking risks for great rewards in science and engineering. About setting an ambitious goal before the world and then finding the political will and the national means to achieve it. The voyage of Apollo still seems incredible. We are inspired by the magnitude and team efforts of people from all walks of life. From industries big and small that worked in tandem to



The Apollo 11 crew launched on the Saturn V, a 363-foot-tall, 6,400,000-pound rocket. This high-angle view of the launch was provided by a “fisheye” camera mounted on the launch tower. (NASA)

**Back to the Moon  
& on to Mars**

attain a long-term goal of magnificent achievement.”

Fifty years later, Apollo 11 remains one of humankind’s greatest achievements and much more than “one small step” — it was a leap that would create the International Space Station, start a commercial launch business, and drive rovers on the surface of Mars.

### The First Leap

Before taking that “giant leap” onto the surface of the Moon, NASA had to decide how to get there. At the time, many NASA managers and engineers believed the most feasible method was direct ascent — a spacecraft launched by

an enormous rocket traveling directly to the Moon and landing as one unit. After exploring the surface, a portion of the lander would blast off, returning to Earth. Another approach, called Earth Orbit Rendezvous, involved launching several Saturn 1 rockets. A spacecraft, similar to the direct method, would be assembled in space for the lunar mission.

A small group of engineers had an idea called Lunar Orbit Rendezvous that proposed two separate vehicles — one to land on the surface while another circled the Moon. The risky part was that the landing craft had to rendezvous with the “mother ship” in lunar orbit so the astronauts could return home. At that time,





Astronaut Buzz Aldrin walks on the surface of the Moon near the lunar module Eagle during the Apollo 11 mission. Mission commander Neil Armstrong took this photo with a 70-mm lunar surface camera. (NASA)

bringing two spacecraft together in space had never been tried. While initially a skeptic, Dr. Wernher von Braun, director of NASA's Marshall Space Flight Center in Alabama, agreed that the lunar orbit rendezvous approach would simplify reaching the goal in a timely manner. Von Braun led the team that developed the Saturn V rocket to launch the two spacecraft.

In 1962, NASA Administrator James Webb announced that by adding one vehicle to those already under development, landing on the Moon could be accomplished in a shorter time span and with less money. Initially called the lunar excursion module, the name was later changed to lunar module (LM), which was designed and built by Grumman Aerospace.

Initial LM designs included large, curved windows and seats, and a redundant forward docking port. Redesigns were required to save weight and enhance safety. The cockpit windows were replaced with smaller triangular versions. A rectangular overhead window was included for use in rendezvous with the

command module after leaving the lunar surface. A forward hatch was designed to make it easier to climb out while wearing bulky spacesuits with backpacks.

While there were many key LM systems, nothing was more important than the engines that would allow the spacecraft to land on the Moon and another to return to the command module. At the base of the LM was the descent propulsion system that allowed astronauts to control the final decent from about 50,000 feet, including hovering as the commander picked out the best spot to land.

### The Science of Apollo 11

The primary goal of the first Moon landing mission was to demonstrate that the Apollo spacecraft systems could safely land two astronauts on the surface and return them safely to Earth. During the first lunar surface extravehicular activity (EVA), the crew was to spend about two hours outside the LM. In addition to collecting rock and soil samples for return to Earth, the astronauts would also conduct science. In 1968, NASA announced that

when Apollo astronauts first landed on the Moon, they would deploy three scientific experiments — a passive seismometer, a laser ranging retroreflector, and a solar wind composition experiment.

The seismometer was a 100-pound seismic station to detect moonquakes. The experiment was solar-powered and had its own communications capability to transmit its results back to Earth after the astronauts departed the lunar surface. If the Moon was seismically active, the instrument could provide information about its internal structure and possibly yield clues about its formation.

The laser ranging retroreflector weighed about 70 pounds and consisted of an array of precision optical reflectors to serve as a target for Earth-based lasers. By precisely measuring the time it takes a laser beam to travel from Earth and bounce back from the retro-reflector, scientists calculated the Earth-Moon distance to an accuracy of eight centimeters. Measurements taken over time and from different stations on Earth helped determine fluctuations in Earth's rotation and recorded continental drift.



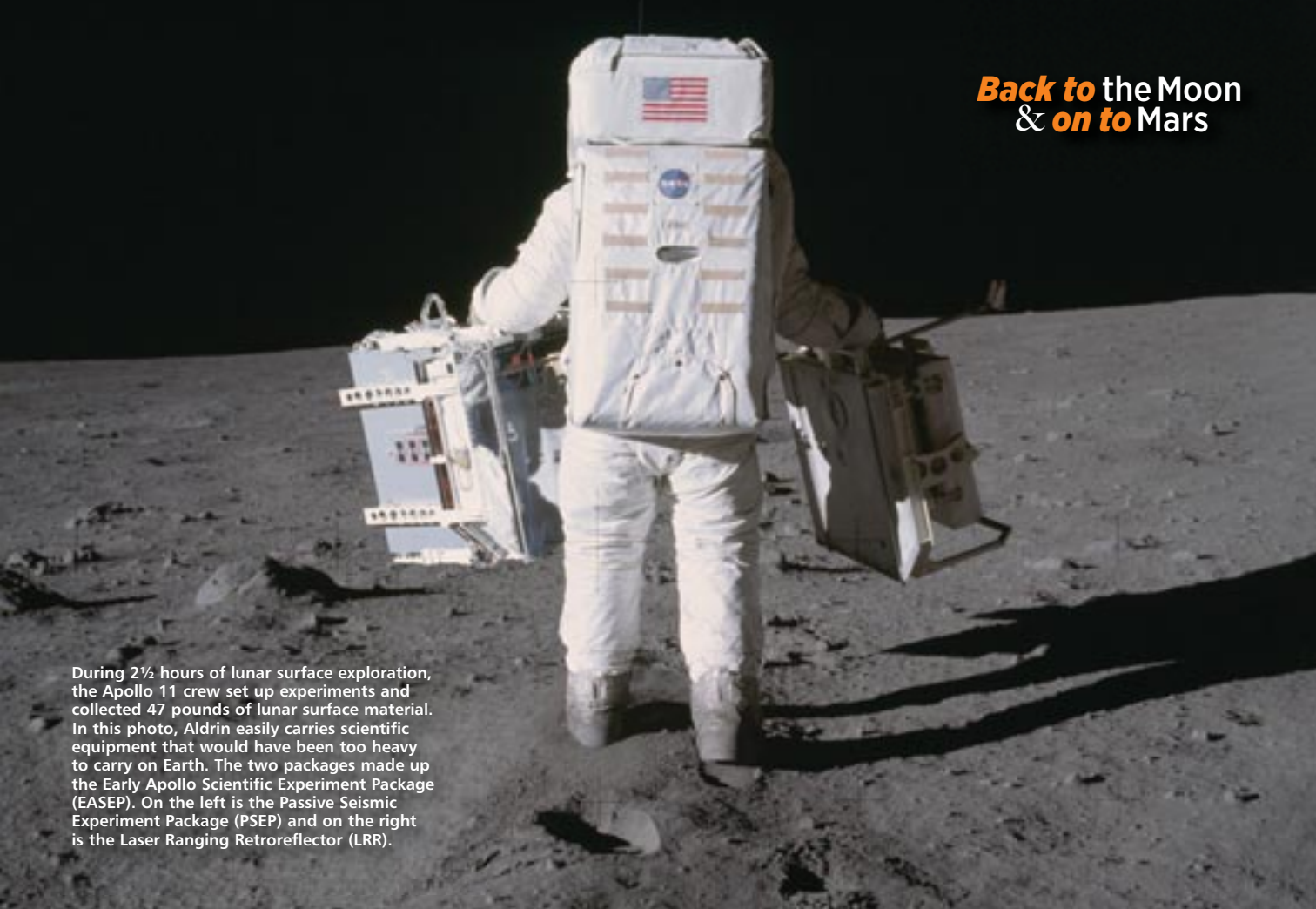

During 2½ hours of lunar surface exploration, the Apollo 11 crew set up experiments and collected 47 pounds of lunar surface material. In this photo, Aldrin easily carries scientific equipment that would have been too heavy to carry on Earth. The two packages made up the Early Apollo Scientific Experiment Package (EASEP). On the left is the Passive Seismic Experiment Package (PSEP) and on the right is the Laser Ranging Retroreflector (LRR).

The solar wind composition experiment consisted of a sheet of aluminum to trap particles of the solar wind; in particular, helium, neon, argon, krypton, and xenon. The astronauts unfurled the aluminum foil collector near the beginning of their EVA and then rolled it up and returned it to Earth for laboratory analysis.

During their flight from Earth, the experiments were stowed in the scientific equipment bay of the LM's descent stage. The crew manually retrieved the packages once on the lunar surface and deployed the experiments. Beginning with the second Moon landing, astronauts deployed more sophisticated experiments as part of the Apollo Lunar Surface Experiments Package (ALSEP) and conducted more extensive geological surveys.

### Apollo's Impact on Future Leaps

Apollo started out as a demonstration of America's technological, economic, and political superiority. But a portion of Apollo, like the entire space program, was always dedicated to scientific research. Apollo taught us a lot, and not just about the Moon.

Some of the earliest beneficiaries of Apollo research were Earth scientists.

The Apollo 7 and 9 missions, which stayed in Earth orbit, took photographs of the Earth in different wavelengths of light, highlighting things that might not be seen on the ground, like diseased trees or crops. This research led directly to NASA's Landsat Program, which has been studying Earth's resources from space for more than 45 years.

Apollo hardware was used in building Skylab, America's first space station. The Skylab craft was an Apollo Saturn IV-B upper stage, and its launch was the last use of the Apollo Saturn V booster. When it came time to build the space shuttle, NASA engineers used what they had learned during Apollo to make the shuttle's basic structure stronger and safer while reducing weight.

The Apollo astronauts brought back more than 800 pounds of rocks. They included material with a large amount of natural glass, formed when meteorites struck the Moon. Some of the glass was formed more than 4 billion years ago, preserved by the lack of water and atmosphere on the Moon, giving scientists insights into the early days of the solar system.

The discovery of a rock called anorthosite showed that the Moon had

once been the site of very complex geological processes, not always the "magnificent desolation" that Buzz Aldrin described.

Perhaps the most important finding came from comparing similarities in the composition of lunar and terrestrial rocks and then noting differences in the amount of specific substances.

The Apollo lunar flights ended in 1972, but Apollo's legacy goes well beyond science. In 1975, the Apollo-Soyuz Test Project saw the last Apollo spacecraft dock with a Soviet Soyuz, and their two crews conducted joint operations in orbit — a legacy that continues today as the United States, Russia, and 16 other countries work together aboard the International Space Station.

### Resources

[www.nasa.gov/apollo50](http://www.nasa.gov/apollo50)

Apollo 11 Introduction  
<https://youtu.be/8il6rx-9a3c>

Seventeen Seconds of Fuel Remained  
[https://youtu.be/n3\\_m-ljOm4g](https://youtu.be/n3_m-ljOm4g)

One Small Step  
<https://youtu.be/na0scpoRB00>



# An Astronaut's View

**B**efore becoming an astronaut candidate in 1996, Mike Massimino was busy earning degrees — an undergraduate degree from Columbia University and four additional degrees from the Massachusetts Institute of Technology (MIT), including a doctorate in mechanical engineering.

His first mission was on the Space Shuttle *Columbia* in 2002, during which he helped upgrade the Hubble Space Telescope during two spacewalks. His second mission, aboard *Atlantis*, was the final Hubble servicing mission on which he also performed two spacewalks. He became the first human to Tweet from space and the first astronaut to reach one million followers on Twitter.

Today, he is an engineering professor at his alma mater, Columbia, and serves as Senior Space Advisor for the Intrepid Sea, Air & Space Museum in New York City. *Tech Briefs* spoke recently with Massimino, who discussed the technological importance of the Apollo missions, the benefits of space tourism, and why we should return to the Moon.

**Tech Briefs:** Many technologies we use every day came out of the Apollo program. As an engineer and former astronaut, how do you see the impact the space program has had on improving the quality of life here on Earth?

**Mike Massimino:** I think everything we do in space improves our quality of life on Earth. NASA has always tried to tell the public the great things they do and quantify it at times. It's very hard to do that — it's hard to say, "you've got this much benefit for every penny you've spent on the space program." When the Russians put up Sputnik, it created motivation for our country to get more involved in research and development and it also created interest in science in general. It gave us these new problems of launching things into space, communicating with them, and eventually trying to get to the Moon. All those problems needed to be solved, which at the time, seemed impossible. With what they had back then, they had to make all these new materials, fuel pumps, engines, and computer technology, and had to understand navigation and mathematics.

I don't know what this planet would look like if it wasn't for the space program, but I think our lives would be very different. I can't say we wouldn't have this or that, but I can't imagine we would be at the same technological level we are at now without the space program. We wouldn't be as far along in so many different areas like electronics and computers, and even the cell-phones we communicate with. I also think the space program has provided some inspiration for education. It's been a great



way to inspire young people and older people, too, to learn about science and technology.

And it's an international cooperative effort. Back in the Apollo days, it was primarily the U.S. going to space against the Soviet Union. Now that's turned into a very international program on the International Space Station and almost every project we do in space — not just one country is involved.

Those are some of the benefits of the space program: international collaboration, education, the technology it has provided us with over 50 years of the manned space program. I don't think we've seen anything yet — it's really going to take hold now that real economic benefit can come with the privatization effort we're seeing. It will open up in the next few decades — it will be very exciting.

**Tech Briefs:** What are your feelings about NASA's goal to return to the Moon?

**Massimino:** I think we should go back — not just return, but go and settle there and live off of Earth and the International Space Station. Twenty years ago, we started building the space station and in 2020, it will be 20 years that we've had people onboard. The next step is to go and live somewhere else. The place that would make the most sense and is the most exciting is the Moon.





Massimino works with the Hubble Space Telescope in the cargo bay of the Space Shuttle Atlantis during his second mission to service Hubble.

When the Apollo astronauts went there, it was an unbelievable achievement and we learned a lot, but now if we go back, it shouldn't be just short visits — it should be to establish something more permanent.

**Tech Briefs:** Should our presence on the Moon be a jumping-off point to get to Mars?

**Massimino:** Well, it could be, but the Moon is a pretty good place by itself. We can learn a lot more and there are resources we can use. It's a great place for tourists and for exploration. Just because it's a lot closer than Mars doesn't mean it's not far enough away to be challenging. You'll be dealing with building a habitat and learning how to deal with rocks and dust and zero gravity.

I don't think the end benefit will be that it gives us a better way to get to Mars. It will give us information on how to live on Mars and give us a jumping-off point — we can go there and on to the next place, and also maybe launch from there. There is a lot that can be gained by going to the Moon and not just as a way to get to Mars.

**Tech Briefs:** Other than the excitement associated with it, what do you see as the benefits of space tourism?

**Massimino:** Hopefully, it could expand our opportunities to go to space. The initial driver might be wanting to experience what it's like — get off the planet and look at Earth and the atmosphere and see the Sun in the black sky — all these really cool things that are not easy for us to see unless you're an astronaut. I hope more people will get a chance to do that. My students at Columbia are working on a flight experiment that will fly on the

Blue Origin spacecraft, so there is also the science part of it. There is definite scientific benefit there.

When we first had airplane travel, we really didn't know what to do with it. It started from a government program and got more and more commercial. Now we have a thriving commercial airline industry that is a necessity for business. With commercial space tourism, we don't yet have business travel, but I think we will eventually. While tourism may open it up, people will start going to space for business reasons. It's kind of like barnstorming was for airplanes — at first it was fun and interesting, but the purpose will be more discoverable as we take those steps. It's huge — there are a lot of things we can't even imagine that could come from this.

**Tech Briefs:** If given the opportunity, would you go back into space?

**Massimino:** I would go back. I left NASA when I could have kept flying but I decided I had had enough and wanted to try something else. I never thought that would happen but it did, and it happens for everybody eventually. There were many things I enjoyed about being an astronaut but given the chance to go up to Hubble and space walk, look at our planet, and work on that amazing instrument — it was the highlight of my life. And I got to do that twice. The other great thing was the people you work with — the best friends and coworkers I've ever had were my fellow astronauts.

I think about going back all the time. The astronaut job is great but it takes a lot of work. It was a wonderful experience but I don't know if I could go through that training again. I'm getting kind of old for that. I really hope space tourism takes hold because I'd go back as a tourist for a visit.

# Back to the Moon

“We will go with innovative new technologies and systems to explore more locations across the surface than was ever thought possible. This time, when we go to the Moon, we will stay. And then we will use what we learn on the Moon to take the next giant leap — sending astronauts to Mars.”

- NASA Administrator Jim Bridenstine

The Moon is a treasure chest of science. The lunar samples returned during the Apollo program dramatically changed our view of the solar system, yet they just scratch the surface of what we know about the Moon — knowledge that can be acquired with a sustained human and robotic presence on the Moon. Although Americans first walked on its surface 50 years ago, footprints were left at only six sites during a total of 16 days on the surface. The next wave of lunar exploration will be fundamentally different.

Exploration of the Moon and Mars is intertwined. NASA's sustainable Moon to Mars exploration approach is reusable and repeatable. It involves building an open exploration architecture with as many capabilities that can be replicated as possible for missions to Mars. The Moon is a testbed for Mars, providing an opportunity to demonstrate new technologies that could help build self-sustaining outposts off Earth.



## The Artemis Program

Artemis is the twin sister of Apollo and goddess of the Moon in Greek mythology. Now, she personifies the next

path to the Moon as the name of NASA's program to return humans to the lunar surface by 2024. When they land, Artemis astronauts will set foot where no human has been before: the Moon's South Pole.

NASA has selected 11 companies to conduct studies and produce prototypes of human landers for the Artemis lunar exploration program. Through Next Space Technologies for Exploration Partnerships (NextSTEP) contracts, the selected companies, over the next six months, will study and/or develop prototypes that reduce schedule risk for the descent, transfer, and refueling elements of a potential human landing system.

NASA's proposed plan is to transport astronauts in a human landing system that includes a transfer element for the journey from the lunar Gateway to low-lunar orbit, a descent element to carry them to the surface, and an ascent element to return them to the Gateway. The agency also is looking at refueling capabilities to make these systems reusable.

The Gateway orbital outpost with the Orion spacecraft docked. (NASA)

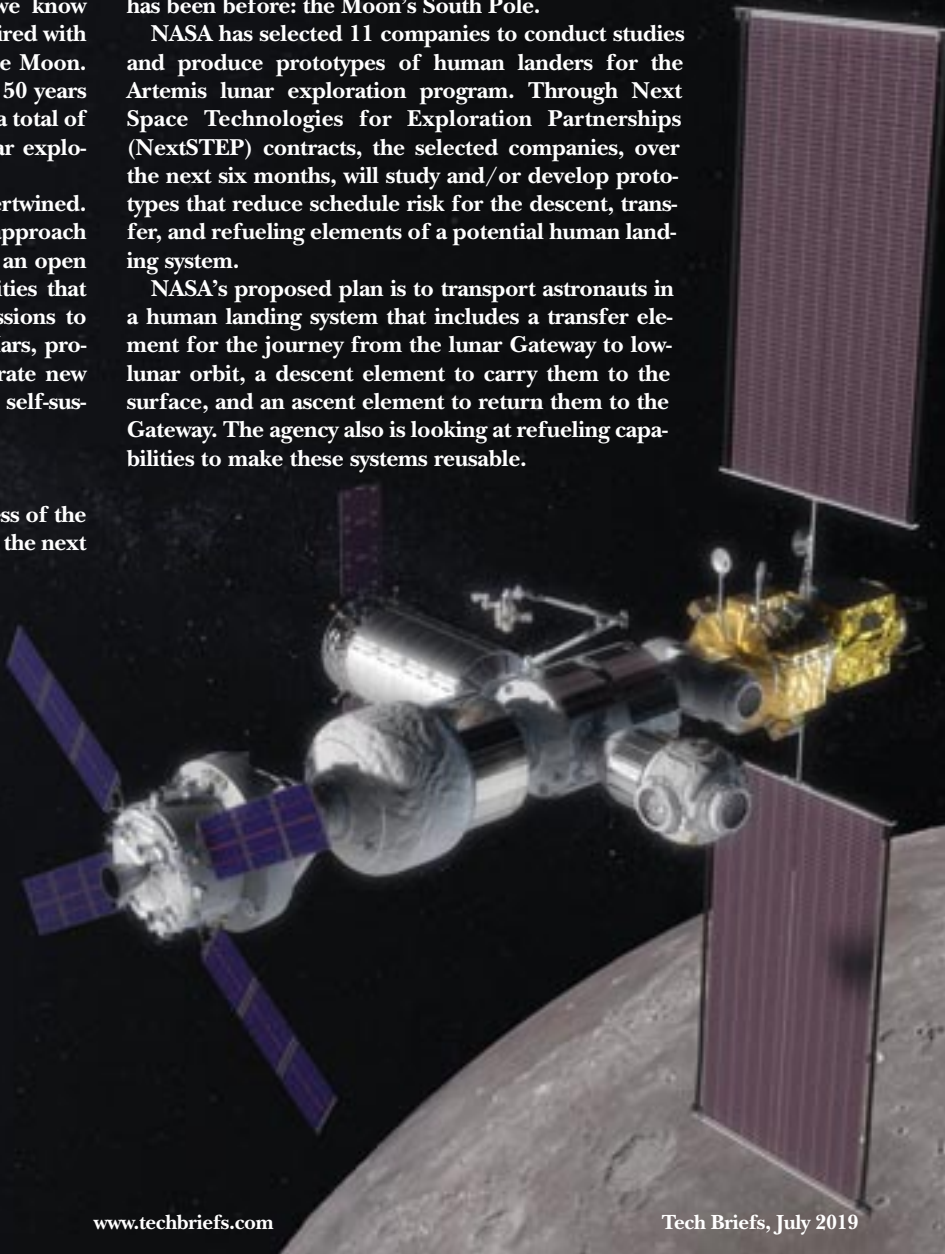

## The Gateway

To return to the Moon and prepare for Mars, NASA has designed the Gateway — an orbital outpost concept in the vicinity of the Moon — with U.S. industry and International Space Station partners (Canada is the first to sign on). The Gateway will be a small spaceship in orbit around the Moon for astronauts as well as science and technology demonstrations. Located about 250,000 miles from Earth, the Gateway will be a temporary home and office for astronauts, enable access to the entire surface of the Moon, and provide new opportunities in deep space for exploration.

“The Gateway will give us a strategic presence in cislunar space. It will drive our activity with commercial and international partners and help us explore the Moon and its resources,” said William Gerstenmaier, Associate Administrator, Human Exploration and Operations Mission Directorate, at NASA Headquarters in Washington. “We will ultimately translate that experience toward human missions to Mars.”

Even before the first trip to Mars, astronauts will use the Gateway to train for life far away from Earth, and practice moving a spaceship in different orbits in deep space. On the Gateway, NASA will study how living organisms react to the radiation and microgravity of a deep space environment over long periods. The Gateway will have living quarters, laboratories for science and research, docking ports (like doors) for visiting spacecraft, and more.

The power and propulsion element of the Gateway is a high-power, 50-kilowatt solar electric propulsion spacecraft — three times more powerful than current capabilities. (NASA)



Astronauts will visit the Gateway at least once a year but they won't stay year-round like crews on the International Space Station (ISS). The Gateway is much smaller than the ISS — its interior is about the size of a studio apartment (the ISS is larger than a six-bedroom house). Once docked, astronauts can live and work aboard the spaceship for up to three months at a time, conduct science experiments, and take trips to the surface of the Moon. Even without crew present, cutting-edge robotics and computers will operate experiments inside and outside the spaceship, automatically returning data back to Earth.

NASA is looking at options for astronauts to use to shuttle between the Gateway and the Moon on reusable landers. Just like an airport, spacecraft bound for the lunar surface or for Mars can use the Gateway to refuel or replace parts and resupply things like food and oxygen without going home first. For months-long crew expeditions to the Gateway, this could allow multiple trips down to the lunar surface, and exploration of new locations across the Moon.

NASA plans to launch elements of the Gateway on its Space Launch System (SLS) or commercial rockets for assembly in space. The Gateway will be built with just



Concept image of the interior of a Gateway deep space habitat. (NASA)



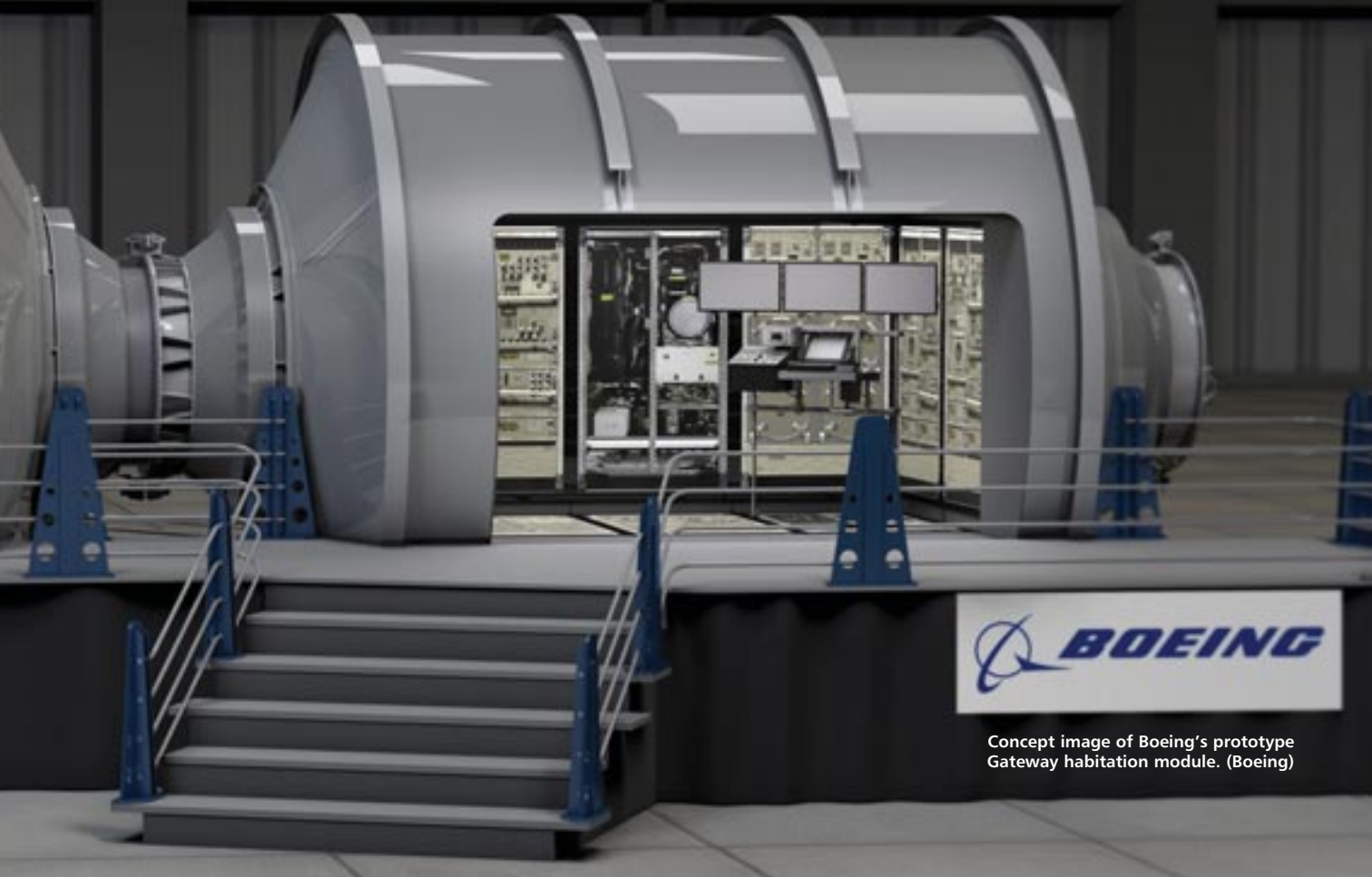

Concept image of Boeing's prototype Gateway habitation module. (Boeing)

five or six launches (it took 34 launches to build the ISS). The power and propulsion element will be the initial component and is targeted to launch in 2022. Using high-power solar electric propulsion, the element will maintain the Gateway's position and can move it between lunar orbits over its lifetime. The power and propulsion element will also provide high-rate and reliable communications for the Gateway including space-to-Earth and space-to-lunar uplinks and downlinks, spacecraft-to-spacecraft crosslinks, and support for spacewalk communications.

Adding an airlock to the Gateway in the future will enable crew to conduct spacewalks, enable science activities, and accommodate docking of future elements. NASA is also planning to launch at least one logistics module to the Gateway that will enable cargo resupply deliveries, additional scientific research and technology demonstrations, and commercial use.

Drawing on the interests and capabilities of industry and international partners, NASA will develop progressively complex robotic missions to the surface of the Moon with scientific and exploration objectives in advance of a human return. Robotic lunar surface missions will begin as early as 2020 with a focus on scientific exploration of lunar resources, and preparing the lunar surface for a sus-

tained human presence. By the late 2020s, a lunar lander capable of transporting crews and cargo will begin trips to the surface of the Moon. The sustainable, long-term lunar surface activities enabled by these efforts, in tandem with the Gateway, will expand and diversify over time, taking advantage of the Moon and near space for scientific exploration in the broadest sense.

Mobility platforms, such as rovers, will carry science instruments and look for and sample water-ice (volatile) deposits. Landing a rover in 2023 on the Moon will provide knowledge of how to use water-ice for fuel, oxygen, and drinking water for human exploration missions to the lunar surface.

### Living There

NASA is conducting ground tests inside five full-size, deep space habitat prototypes. The mockups, constructed by five American companies, offer different perspectives on how astronauts will live and work on the Gateway. Rather than selecting one habitat, the tests will help NASA evaluate the design standards, common interfaces, and requirements for a future U.S. Gateway habitat module, while reducing risks for eventual flight systems.

Engineers and technicians will analyze habitat system capabilities and perfor-

mance proposed by each prototype, while human factors teams consider layout and ergonomics to optimize efficiency and performance. During the tests, future Gateway flight operators at Johnson Space Center will collect actual live telemetry streams from each prototype. They will monitor habitat performance and support realistic mission activities as astronauts conduct "day-in-the-life" procedures within each prototype, providing their perspectives as potential crewmembers who may one day live and work on the Gateway.

In addition to the physical enclosure, each company has outfitted their prototype with the basic necessities to support humans during deep space expeditions including environmental control and life support systems, avionics, sleeping quarters, exercise equipment, and communal areas.

### Resources

<https://www.nasa.gov/moon2mars>

Technology Drives Exploration  
<https://youtu.be/wJOia4M2dxx>

Go Forward to the Moon  
<https://youtu.be/bivXt0hVufk>

Science Discoveries Beyond Earth  
[https://youtu.be/OSKjX4\\_r\\_vU](https://youtu.be/OSKjX4_r_vU)





# Getting There

**F**or the first time in a generation, NASA is building a human spacecraft for deep-space missions that will usher in a new era of space exploration. A series of increasingly challenging missions awaits, and this new spacecraft will take astronauts farther than they've gone before, including to the Moon and Mars.

## The Crew Capsule: Orion

Drawing on more than 50 years of spaceflight research and development, the Orion spacecraft is designed to

meet the evolving needs of NASA's deep space exploration program for decades to come. It will be the safest, most advanced spacecraft ever built, and will be flexible and capable enough to travel to a variety of destinations. Orion will serve as the exploration vehicle that will carry a crew to space, provide emergency abort capability, sustain astronauts during their missions, and provide safe re-entry from deep space return velocities.

Orion features dozens of technology advancements and innovations including both crew and service mod-

For the first time in almost 40 years, a NASA human-rated rocket has completed all steps needed to clear a critical design review. The Space Launch System (SLS) is the first exploration-class rocket since the Saturn V. (NASA/MSFC)

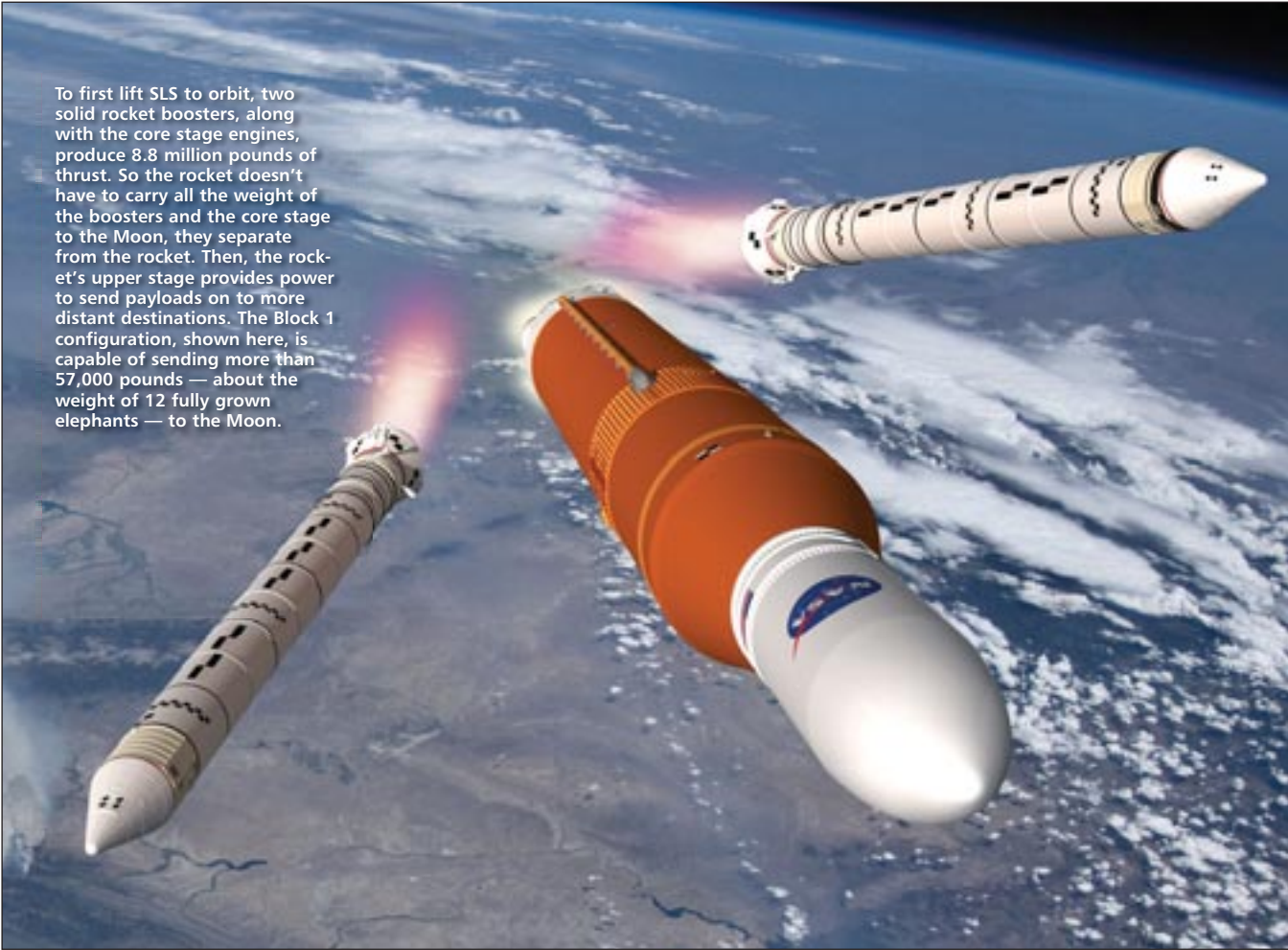

A photograph of the Space Launch System (SLS) rocket in space. The rocket is shown from a low angle, ascending towards the top right. It has a white core stage with a NASA logo, two orange solid rocket boosters, and a white upper stage. The Earth's surface is visible in the background, showing clouds and landmasses. The rocket is emitting a large plume of fire and smoke from its engines.

To first lift SLS to orbit, two solid rocket boosters, along with the core stage engines, produce 8.8 million pounds of thrust. So the rocket doesn't have to carry all the weight of the boosters and the core stage to the Moon, they separate from the rocket. Then, the rocket's upper stage provides power to send payloads on to more distant destinations. The Block 1 configuration, shown here, is capable of sending more than 57,000 pounds — about the weight of 12 fully grown elephants — to the Moon.

ules, a spacecraft adaptor, and a revolutionary launch abort system that will significantly increase crew safety. Orion's unique life support, propulsion, thermal protection, and avionics systems — in combination with other elements — will enable extended-duration deep space missions. These systems have been developed to facilitate integration of new technical innovations as they become available in the future.

Multiple Apollo-derived technologies are being extended to the scale required for the Orion crewed exploration vehicle. Some of those capabilities, including skip entry guidance, will be employed for the first time in a flight implementation. Thermal Protection System (TPS) technologies developed for Apollo and the space shuttle were being recycled or re-qualified for current human spacecraft concepts. Recent development of ablative materials, primarily in support of Orion, has resulted from NASA efforts to revive the Apollo-era TPS. A woven

TPS-derived material has been developed to meet Orion's needs for a multifunctional (structural and TPS) compression pad.

Orion has been rigorously tested as engineers prepare it for a journey beyond low-Earth orbit. Most of the major manufacturing for the first mission is complete and this year, teams will focus on final assembly, integration, and testing, as well as early work for future missions. NASA is focused on launching the first mission, Exploration Mission-1 (EM-1), in 2020 that will send Orion on the Space Launch System (SLS) rocket from Kennedy Space Center in Florida on an uncrewed test flight before sending crew around the Moon and back on the second mission, Exploration Mission-2 (EM-2) by 2023.

Engineers will continue outfitting and testing the crew module, including pressuring the capsule to verify its structural integrity, powering it on for the first time to ensure it can route commands properly, and routing electrical

and propulsion lines. Teams will also perform welding for the environmental control system and fit it for the outer back shells and heatshield. In preparation for EM-2, NASA is also testing the spacecraft's launch abort system to demonstrate that it can carry the crew to safety if an emergency were to happen on the way to space.

Orion will utilize advances in propulsion, communications, life support, structural design, navigation, and power. With destinations including near-Earth asteroids, the Moon, the moons of Mars, and eventually Mars itself, Orion will carry astronauts into a new era of exploration.

### The Rocket: Space Launch System (SLS)

NASA's Space Launch System (SLS) is an advanced launch vehicle that provides the foundation for human exploration beyond Earth's orbit. With its unprecedented power and capabilities, SLS is the only rocket that can send Orion, astronauts, and large cargo to





(Left) Interior of the Orion Medium Fidelity Mockup at Johnson Space Center in Houston. (Right) Spacesuit engineers demonstrate how four crewmembers would be arranged for launch inside Orion. (NASA/Robert Markowitz)

the Moon on a single mission. Offering more payload mass, volume capability, and energy to speed missions through space than any current launch vehicle, SLS is designed to be flexible and evolvable, and will open new possibilities for payloads including robotic scientific missions to places like the Moon, Mars, Saturn, and Jupiter.

The SLS is NASA's first exploration-class rocket built since the Saturn V. To fill future needs, SLS will evolve into increasingly more powerful configurations. SLS will provide the power to help Orion reach a speed of at least 24,500 mph needed to break out of low-Earth orbit and travel to the Moon. That is about 7,000 mph faster than the International Space Station travels around Earth. To reduce cost and development time, NASA is using proven hardware from the space shuttle and other exploration programs while making use of cutting-edge tooling and manufacturing technology. Some parts of the rocket are completely new; other parts of the rocket have been upgraded with modern features that meet the needs of challenging deep space missions.

Every SLS configuration uses the core stage with four RS-25 engines. The first SLS vehicle, Block 1, can send more than 26 metric tons (57,000 pounds) to orbits beyond the Moon. It will be powered by twin five-segment solid rocket boosters and four RS-25 liquid propellant engines. After reaching space, the Interim Cryogenic Propulsion Stage (ICPS) sends Orion on to the Moon.

The next planned evolution of the SLS, the Block 1B crew vehicle, will use a new, more powerful Exploration Upper Stage (EUS) to enable more ambitious missions. The Block 1B vehicle can, in a single launch, carry the Orion crew vehicle along with exploration systems like a deep space habitat module. The Block 1B crew vehicle can send approximately 37 metric tons (81,571 pounds) to deep space including Orion and its crew.

The next SLS configuration, Block 2, will provide 11.9 million pounds of thrust and will be the workhorse vehicle for sending cargo to the Moon, Mars, and other deep space destinations. SLS Block 2 will be designed to lift more than 45 metric tons (99,000 pounds) to deep space. An evolvable design provides the nation with a rocket able to pioneer new human space-flight missions.

The Boeing Company in Huntsville, AL is building the SLS core stage, including the avionics that will control the vehicle during flight. Towering more than 200 feet with a diameter of 27.6 feet, the core stage will store 730,000 gallons of super-cooled liquid hydrogen and liquid oxygen that will fuel the RS-25 engines. The core stage is being built at NASA's Michoud Assembly Facility in New Orleans using state-of-the-art manufacturing equipment including a friction-stir-welding tool that is the largest of its kind in the world.

All major structures are built and are being outfitted for EM-1, and Boeing

has started building structures for EM-2. The SLS avionics computer software is being developed at NASA's Marshall Space Flight Center in Huntsville.

Aerojet Rocketdyne of Sacramento, CA, is upgrading an inventory of 16 RS-25 space shuttle engines to SLS performance requirements including a new engine controller, nozzle insulation, and required operation at 512,000 pounds of thrust. During the flight, the four engines provide around two million pounds of thrust. The engines for EM-1 are built, tested, and ready for attachment to the core stage.

Two shuttle-derived solid rocket boosters will be used for the initial flights of the SLS. To provide the additional power needed for the rocket, the prime contractor for the boosters — Northrop Grumman of Redondo Beach, CA — modified the original shuttle configuration of four propellant segments to a five-segment version. The design includes new avionics, propellant design, and case insulation and eliminates the recovery parachutes.

## Resources

[www.nasa.gov/sls](http://www.nasa.gov/sls)  
[www.nasa.gov/orion](http://www.nasa.gov/orion)

**Built to Explore**  
<https://youtu.be/JYd2jpCZyys>

**SLS Launch Simulation**  
<https://youtu.be/u2nod-ek7ys>

**Inside the Orion Spacecraft**  
<https://youtu.be/gNbxP6ASrMU>



# On to Mars

Just 54 years ago, the first photograph of Mars from a passing spacecraft appeared to show a hazy atmosphere. Now, decades of exploration on the planet itself has shown it to be a world that once had open water — an essential ingredient for life.

Today, engineers and scientists around the country are developing the technologies astronauts will use to live and work on Mars and safely return home.

## Building a Mars Spacecraft

When a spacecraft built for humans ventures into deep space, it requires an array of technologies to keep it and a crew inside safe. Both distance and duration demand that spacecraft have systems that can reliably operate far from home, keep astronauts alive in case of emergencies, and still be light enough that a rocket can launch it.

There are five technologies necessary for a spacecraft to survive deep space:

**1. Systems to Live and Breathe.** As humans travel farther from Earth for longer missions, the systems that keep them alive must be highly reliable while taking up minimal mass and volume. Orion will be equipped with advanced environmental control and life support systems designed for the demands of a deep space mission. A high-tech system being tested aboard the International Space Station

will remove carbon dioxide and humidity from inside Orion, which is important to ensure air remains safe for the crew. Water condensation on the vehicle hardware is controlled to prevent water intrusion into sensitive equipment or corrosion on the primary pressure structure. The system also saves volume inside the spacecraft. Without such technology, Orion would have to carry many chemical canisters that would otherwise take up the space of 127 basketballs inside the spacecraft — about 10 percent of crew livable area.

Highly reliable systems are critically important when distant crew will not have the benefit of frequent resupply shipments to bring spare parts from Earth. Even small systems have to function

reliably to support life in space, from an automated fire suppression system to exercise equipment that helps astronauts counteract the zero-gravity environment in space that can cause muscle and bone atrophy. Distance from home also demands that Orion have spacesuits capable of keeping astronauts alive for six days in the event of cabin depressurization to support a long trip home.

**2. Proper Propulsion.** The farther into space a vehicle ventures, the more capable its propulsion systems need to be to maintain its course on the journey and ensure its crew can get home. Orion has a highly capable service module that is the powerhouse for the spacecraft, providing propulsion capabilities that enable Orion to go around the Moon



Roving vehicles enabled Apollo astronauts to complete almost 20 trips across the surface of the Moon. With each successive mission, NASA improved the rovers' capabilities and continues to build on the lessons learned from Apollo to simulate operating unmanned rovers on Mars. Shown here is the surface version of the Space Exploration Vehicle (SEV). (Regan Geeseman)



and back on its exploration missions. The service module has 33 engines of various sizes. The main engine will provide major in-space maneuvering capabilities throughout the mission; the other 32 engines are used to steer and control Orion on orbit.

In part due to its propulsion capabilities — including tanks that can hold nearly 2,000 gallons of propellant and a backup for the main engine in the event of a failure — Orion's service module is equipped to handle the rigors of travel for missions that are both far and long, and has the ability to bring the crew home in a variety of emergency situations.

**3. Holding Off the Heat.** The farther a spacecraft travels in space, the more heat it will generate as it returns to Earth. Getting back safely requires technologies that can help a spacecraft endure speeds 30 times the speed of sound and heat twice as hot as molten lava or half as hot as the Sun. Orion's advanced heat shield, made with a material called AVCOAT, is designed to wear away as it heats up. It is the largest of its kind ever built and will help the spacecraft withstand temperatures around 5,000 °F during re-entry though Earth's atmosphere. A thermal protection system, paired with thermal controls, will protect Orion during periods of direct sunlight and pitch black darkness while its crews will comfortably enjoy a safe and stable interior temperature of about 77 °F.

**4. Radiation Protection.** As a spacecraft travels on missions beyond the protection of Earth's magnetic field, it will be exposed to a harsher radiation environment than in low-Earth orbit, with greater amounts of radiation from charged particles and solar storms that can cause disruptions to critical computers, avionics, and other equipment. Humans exposed to large amounts of radiation can experience both acute and

chronic health problems ranging from near-term radiation sickness to the potential of developing cancer in the long term.

Orion is equipped with four identical computers that each are self-checking, plus an entirely different backup computer to ensure it can still send commands in the event of a disruption. It also has a makeshift storm shelter below the main deck of the crew module. In the event of a solar radiation event, NASA has developed plans for crew to create a temporary shelter inside using materials onboard. A variety of radiation sensors will also be onboard to help scientists better understand the radiation environment far away from Earth.

**5. Constant Communication and Navigation.** Spacecraft venturing far from home go beyond the Global Positioning System (GPS) in space and above communication satellites in Earth orbit. To talk with mission control in Houston, Orion will

use all three of NASA's space communications networks. As it rises from the launch pad and into cislunar space, Orion will switch from the Near Earth Network to the Space Network, and finally to the Deep Space Network that provides communications for some of NASA's most distant spacecraft.

Orion is also equipped with backup communication and navigation systems to help the spacecraft stay in contact with the ground and orient itself if primary systems fail. The backup navigation system, a relatively new technology called optical navigation, uses a camera to take pictures of the Earth, Moon, and stars and autonomously triangulate Orion's position from the photos.

## Hazards of Life in Space

A human journey to Mars offers an inexhaustible amount of complexities. NASA's Human Research Program has determined five hazards of human



The Bio-Analyzer enables near-real-time, onboard analysis using biological samples such as blood, urine, saliva, sweat, and cell cultures. This diagnostic tool could help test specific countermeasures that are key to future exploration missions to the Moon, Mars, and beyond. (NASA)





Kennedy Space Center chemical engineer Annie Meier adjusts the trash-to-gas reactor she is developing to recycle trash during deep space missions. Materials such as scraps, wrappers, packaging, and other garbage could be converted into methane gas, oxygen, and water. (NASA/Dan Casper)

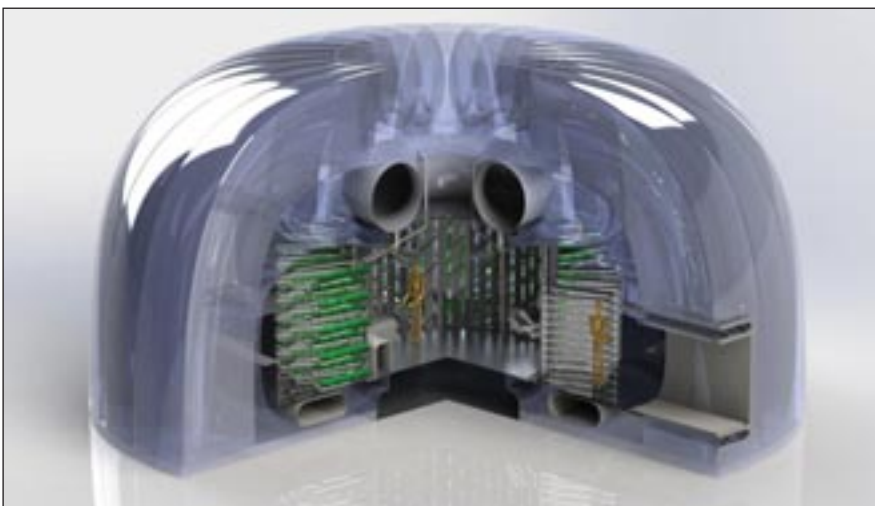

The Deployable Enclosed Martian Environment for Technology, Eating, and Recreation (DEMETER) from Dartmouth College — winner of the 2019 Breakthrough, Innovative and Game-changing (BIG) Idea Challenge — is a habitat-sized Mars greenhouse with the primary purpose of food production. An efficient and safe greenhouse design could not only assist with Mars missions but also long-term lunar missions.

spaceflight; however, these hazards do not stand alone. They can feed off one another and exacerbate effects on the human body. Various research platforms including the International Space Station, as well as field tests in locations that have physical similarities to Mars, give NASA insight into how the human body and mind might respond during extended trips into space.

**1. Radiation.** Radiation is not only stealthy but is considered one of the most menacing of the five hazards. Above Earth's natural protection, radiation exposure increases cancer risk, damages the central nervous system, can alter cognitive function, reduce motor function, and cause behavioral changes. To learn what can happen above low-Earth orbit, NASA studies how radiation affects biological samples on the ISS, which lies just within Earth's protective



magnetic field. Deep space vehicles will have significant protective shielding, dosimetry, and alerts. Research is also being conducted in the field of medical countermeasures such as pharmaceuticals to help defend against radiation.

**2. Isolation and Confinement.** Behavioral issues among groups of people in a small space over a long period of time, no matter how well trained they are, are inevitable. Crews will be carefully chosen, trained, and supported to ensure they can work effectively as a team for months or years in space. The more confined and isolated humans are, the more likely they are to develop behavioral or cognitive conditions such as a decline in mood, cognition, morale, or interpersonal interaction; sleep disorders; depression; fatigue; and boredom. Research is being conducted in workload, light therapy for circadian alignment, phase shifting, and alertness.

**3. Distance from Earth.** Mars is, on average, 140 million miles from Earth. Rather than a three-day lunar trip, astronauts would be leaving Earth for roughly three years. While ISS expeditions serve as a rough foundation for the expected impact on planning logistics for such a trip, the data isn't always comparable. If a medical event or emergency happens on the ISS, the crew can return home within hours. Additionally, cargo vehicles continually resupply the crews with fresh food, medical equipment, and other resources. Once you burn your engines for Mars, there is no turning back and no resupply. Facing a communication delay of up to 20 minutes one way and the possibility of equipment failures or a medical emergency, astronauts must be capable of confronting an array of situations without support from their team on Earth.

**4. Gravity (or lack of it).** There are three gravity fields astronauts will experience on a Mars mission: weightlessness between planets, 1/3 of Earth's gravity on

NASA is developing the technologies to build a spacesuit for use on Mars. Engineers consider everything from traversing the Martian landscape to picking up rock samples. The Z-2 suit will help solve unique problems faced by the first humans to set foot on Mars. One of the challenges is that the red soil on Mars could affect the astronauts and systems inside a spacecraft if tracked in after a spacewalk. To counter this, new spacesuit designs feature a suitport on the back, so astronauts can quickly hop in from inside a spacecraft while the suit stays outside, keeping it clean indoors. (NASA/Bill Stafford)



Mars, and normal gravity upon returning to Earth. When astronauts finally return home, they will need to readapt many of the systems in their bodies to Earth's gravity. Bones, muscles, and cardiovascular system will all be impacted by years without standard gravity. Hazards of gravity changes include changes to spatial orientation, head-eye and hand-eye coordination, balance, and locomotion. Fluids shifts could put pressure on the eyes, causing vision problems.

**5. Hostile/Closed Environments.** A spacecraft is not only a home, it's a machine. The ecosystem inside the spacecraft plays a big role in everyday astronaut life. Important factors include temperature, pressure, lighting, noise, and amount of space. Everything is monitored, from air quality to possible microbial inhabitants. Microorganisms that naturally live on the body are transferred more easily from one person to another in a closed environment. Extensive recycling of resources — oxygen, water, carbon dioxide, and human waste — is also imperative.

### The Latest Robotic Explorer

When the Mars 2020 rover launches next year, its science goal is to look for

signs of ancient life. It will be the first spacecraft to collect samples of the Martian surface, caching them in tubes that could be returned to Earth on a future mission. The vehicle also includes technology that paves the way for human exploration of Mars.

Landing a rover like this one gives NASA more experience putting a heavy spacecraft on the surface of Mars; the challenge of landing in the thin Martian atmosphere scales with mass. The first crewed spacecraft will be titanic by comparison, carrying with it life support systems, supplies, and shielding.

Mars 2020 has a guidance system that will take a step toward safer landings. Called Terrain Relative Navigation, the system figures out where the spacecraft is headed by taking camera images during descent and matching landmarks in them to a preloaded map. If the spacecraft drifts toward dangerous terrain, it will divert to a safer landing target.

Mars 2020 will carry a ground-penetrating radar called the Radar Imager for Mars' Subsurface Experiment (RIM-FAX) that will be the first operated at the

Martian surface. Mars 2020 scientists will use its high-resolution images to look at buried geology, like ancient lake beds. The radar could one day be used to find stores of underground ice that astronauts could access to provide drinking water.

To help engineers design spacesuits to shield astronauts from the elements, NASA is sending five samples of space-suit material along with one of Mars 2020's science instruments, called Scanning Habitable Environments with Raman & Luminescence for Organics & Chemicals (SHERLOC). A piece of an astronaut's helmet and four kinds of fabric are mounted on the calibration target for this instrument. Scientists will use SHERLOC, as well as a camera that photographs visible light, to study how the materials degrade in ultraviolet radiation. It will mark the first time space-suit material has been sent to Mars for testing and will provide a vital comparison for ongoing testing at Johnson Space Center.

Humans exploring Mars will need more than good spacesuits — they'll need a place to live. Mars 2020 will collect science that may help engineers design better shelters for future astro-



NASA's Mars 2020 rover will demonstrate technologies for future human expeditions to Mars. These include testing a method for producing oxygen from the Martian atmosphere, identifying resources, improving landing techniques, and characterizing weather, dust, and other environmental conditions. (NASA/JPL-Caltech)





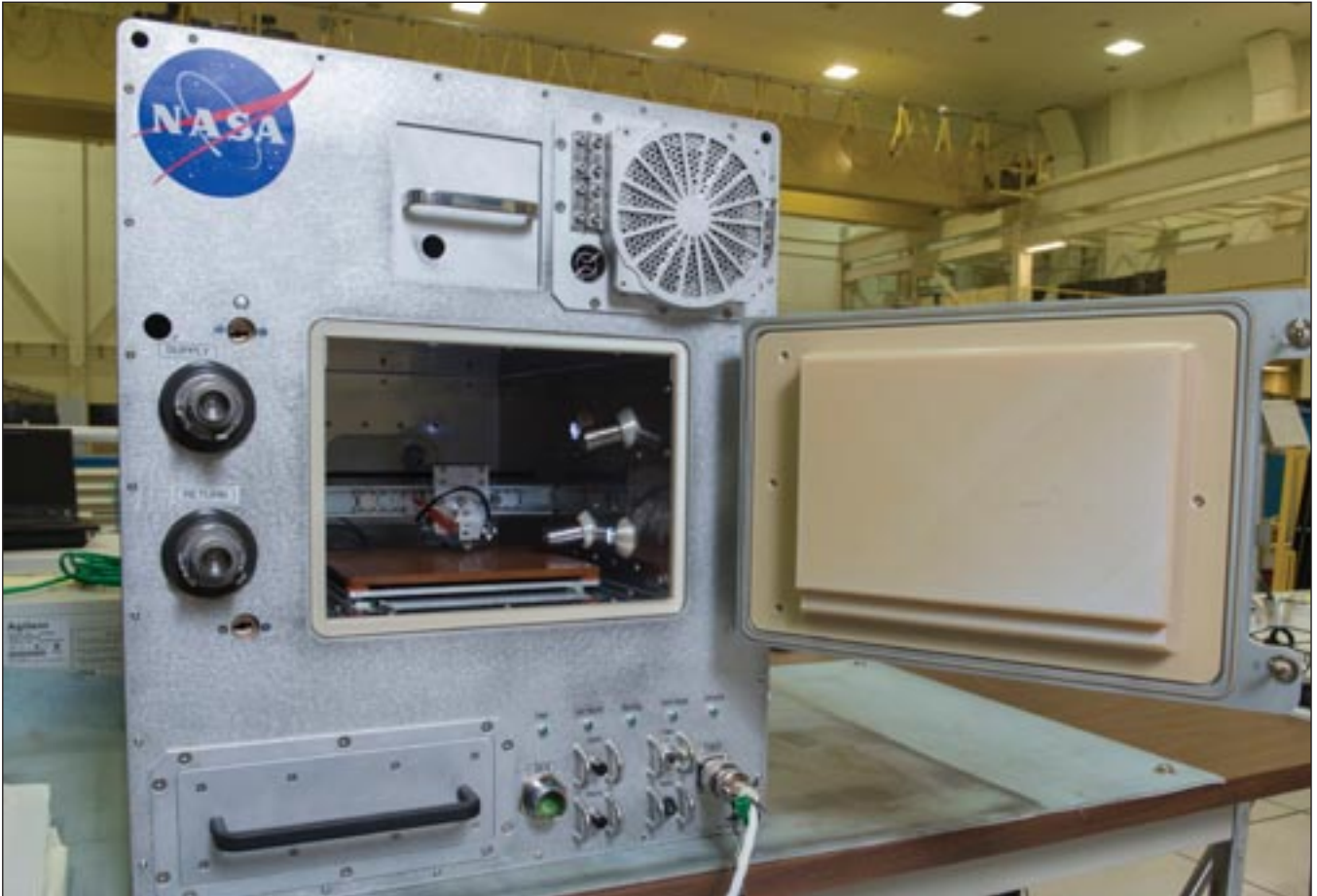

As crews head to Mars, there may be items that are unanticipated or that break during the mission. Having the ability to manufacture new objects on-demand while in space will be imperative. The Refabricator is the first integrated 3D printer and recycler that recycles waste plastic materials into high-quality 3D-printer filament, providing the potential for sustainable fabrication, repair, and recycling capabilities on long-duration space missions.

nauts. Like the Curiosity rover and InSight lander, 2020 has weather instruments to study how dust and radiation behave in all seasons. This suite of sensors, called the Mars Environmental Dynamics Analyzer (MEDA), is the next step in the kind of weather science Curiosity collects.

### The Mars Toolbox

When astronauts land on Mars, limited resources will allow for a short window of time each day to explore new surroundings. Instruments that quickly reveal the terrain's chemistry and form will help them understand the environments around them and how they change over time.

NASA's Goddard Space Flight Center is testing and refining chemical-analyzing and land-surveying tools that will assist human explorers of Mars. Many of the technologies build upon ones that have already equipped robotic orbiters and rovers that sniff out the cosmos. NASA's Curiosity rover, for in-

stance, is studying the composition of soil with the help of spectrometers to identify what rocks are made of by measuring how their chemical elements interact with electromagnetic radiation.

Though the technologies powering these tools already exist, NASA's objective is to make the instruments small and efficient enough to help robots, and one day astronauts, analyze on the spot the composition of the surface of planets, moons, and asteroids. This will allow for well-informed decisions about which few samples explorers can return to Earth on a spacecraft of limited size.

What the team has learned from doing experiments, particularly with astronauts on the space station, is that speed and ease-of-use are essential for space tools. Astronauts doing extravehicular activities (EVAs) have limited oxygen and other resources, so device features such as instrument size, number of buttons, and the data display are crucial. Time spent scrolling through

volumes of information means less opportunity to walk farther away from the lander to make new discoveries.

NASA's sustainable exploration approach is reusable and repeatable, building an open exploration architecture in lunar orbit with as many capabilities as possible that can be replicated for missions to the Red Planet.

### Resources

[www.nasa.gov/mars2020](http://www.nasa.gov/mars2020)

[www.nasa.gov/content/living-and-working-on-mars](http://www.nasa.gov/content/living-and-working-on-mars)

Exploration: It's What We Do  
<https://youtu.be/jAbj2C3Jdpg>

"Practicing" Science on Mars  
<https://youtu.be/OM-SWMrOsk>

Preparing for our Journey to Mars  
<https://youtu.be/tCHAR5uyHV4>

Mars Exploration Zones  
<https://youtu.be/94blW7e10tg>



# AirBorn

**AirBorn Inc.**

3500 AirBorn Circle  
Georgetown, TX 78626  
Phone: 512-863-5585  
E-mail: [www.airborn.com/about/contact](http://www.airborn.com/about/contact)  
[www.airborn.com](http://www.airborn.com)

### About Our Company

AirBorn is an employee owned company whose core business is engineering and manufacturing specialized connectors and



electronic components for OEMs (Original Equipment Manufacturers) worldwide. AirBorn solutions are relied on by medical, defense, aerospace, and industrial leaders to design and deliver products used in the most demanding environments.

AirBorn solutions are relied on by defense, aerospace, medical, and industrial leaders to operate their most critical systems in the most demanding environments.

### Contribution to the Space Program

AirBorn components are a part of many historical space applications. Beginning with the Apollo missions and extending into the Voyager I & II space vehicles, Space Shuttles, International Space Station, Hubble Telescope, Mars Rovers and innumerable Earth-orbiting satellites. Customers trust AirBorn products and have since our inception in 1958.

[www.airborn.com](http://www.airborn.com)



Free Info at <http://info.hotims.com/72995-751>





**MW Industries Aerospace Solutions**

9501 Technology Blvd.  
Rosemont, IL 60018  
Phone: 847-349-5760  
E-mail: gcontorinis@mw-ind.com  
mwaerospacesolutions.com

**About Our Company**

MW Aerospace Solutions is the nose-to-nozzle metal component supplier to the aerospace and defense industry. Our solutions for focused industry segments are based on specialized manufacturing technologies. The key to our success is our coalition of industry-leading brands including:

- Accurate Screw Machine
- Ameriflex
- Atlantic Spring
- BellowsTech
- Century Spring
- Helical
- Servometer



**Contribution to the Space Program**

Technology advancements are setting new expectations for product performance. Aircrafts are more sophisticated, rockets are reaching new heights, and defense capabilities are expanding. MW Industries is responding to these industry advancements with new materials and manufacturing technologies. We design and manufacture springs, fasteners, and related products for a wide range of aerospace applications, including components for engines, flight controls, propulsion, landing gear, interiors, avionics, and the most advanced space exploration vehicles including robotics, rovers, shuttles, satellites, and more! MW Aerospace Solutions sets a new standard in mission critical components because everything we do meets the rigorous system safety and performance standards of organizations such as the FAA, DoD, and NASA. Our custom springs, wire

forms, and assemblies are employed under a Quality Management System (QMS) that is AS9100D and ISO9001:2015 certified – international standards that the Aircraft, Space, and Defense (AS&D) industry as well as the civil and military aviation industries rely on. We are also an ITAR registered contractor and highly experienced with DFARS materials. We are committed to providing customers with the highest quality parts, manufactured with meticulous quality management, high-tech processes, short lead times and proven reliability – even in the most extreme operating conditions imaginable.



[mwaerospacesolutions.com](http://mwaerospacesolutions.com)

Free Info at <http://info.hotims.com/72995-752>





**The Lee Company**

2 Pettipaug Rd.  
 Westbrook, CT 06498  
 Phone: 860-399-6281  
 E-mail: inquiry@theleeco.com  
 www.theleeco.com

**About Our Company**

Since its beginning in 1948, The Lee Company has pioneered the design and development of miniature fluid control components to a wide range of industries including aerospace, high performance racing, oil exploration, automotive and medical/scientific instruments.

Lee Company products are all manufactured in the USA and are recognized worldwide for superior quality, reliability and performance. Lee's unique capabilities in miniaturization and engineering expertise keep the company at the forefront of fluid control technology and identify Lee as a leading innovator in the field of fluid handling and control.

The Lee Company has over a million square feet of state-of-the-art facilities on three sites in Connecticut and over 1100 employees. Advanced equipment and software allow a large staff of project engineers to predict performance and diagnose issues while field sales engineers located across eight US cities and 17 countries provide unmatched customer service and support.



**Contribution to the Space Program**



In 1969, The Lee Company provided a specially calibrated, screened restrictor to control oxygen flow to the astronauts from their backpack when they walked on the Moon. Though a much smaller company at the time, Lee had a unique skill in manufacturing and testing such restrictors. Our employees and management took great pride in helping the successful and historic mission, a pride that continues to this day.

Since that time, Lee products flew on the Space Shuttle engines, flight controls, and cabin accessories; on the Voyager probe that explored the outer reaches of the solar system; and on the International Space Station.

Today, The Lee Company is partnering with both pedigreed industry giants and privately funded companies to develop components that improve performance on current and next-generation launch vehicles and satellites. The Lee Company's products have been qualified for the harsh environmental conditions experienced during launch and operation in space and can be found controlling hydraulics, fuels and pneumatics in a wide variety of flight critical applications.

[www.theleeco.com](http://www.theleeco.com)

Free Info at <http://info.hotims.com/72995-762>





**Digi-Key Electronics**

701 Brooks Ave S  
Thief River Falls, MN 56701  
Phone: 1-800-344-4539  
E-mail: sales@digikey.com  
www.digikey.com

articles and videos, multimedia libraries, and much more. Technical support is available 24/7 via email, phone and webchat. Additional information and access to Digi-Key's broad product offering can be found by visiting [www.digikey.com](http://www.digikey.com).

**About Our Company**

Digi-Key Electronics, headquartered in Thief River Falls, Minn., USA, is an authorized global, full-service distributor of electronic components, offering more than 8.7 million products, with over 1.7 million in stock and available for immediate shipment, from over 800 quality name-brand manufacturers. Digi-Key also offers a wide variety of online resources such as EDA and design tools, datasheets, reference designs, instructional



**Contribution to the Space Program**

In the realm of space exploration, a broad range of products is required not only for particular applications, but also for the related development and testing processes. Representing over 800 suppliers enables Digi-Key to provide the necessary electronic components in the semiconductor, electromechanical, interconnect, optoelectronic, passive, power, wireless, and sensor sectors, among others. This broad product offering creates limitless opportunities to engage customers involved in nearly all aspects of space exploration.

One such opportunity came when the University of Alabama in Huntsville purchased a stepper motor driver board that was manufactured using only Digi-Key sourced components, which they had targeted for use in a 3-dimensional microgravity accelerometer experiment. After working with a member in our Applications Engineering department, the slightly modified board passed its qualification testing with flying colors, literally. It subsequently made a trip into space on October 27, 1998, aboard the space shuttle Discovery along with astronaut John Glenn and the rest of the STS-95 crew. It successfully returned to earth on November 7, 1998.

<https://www.digikey.com/en/new-products>

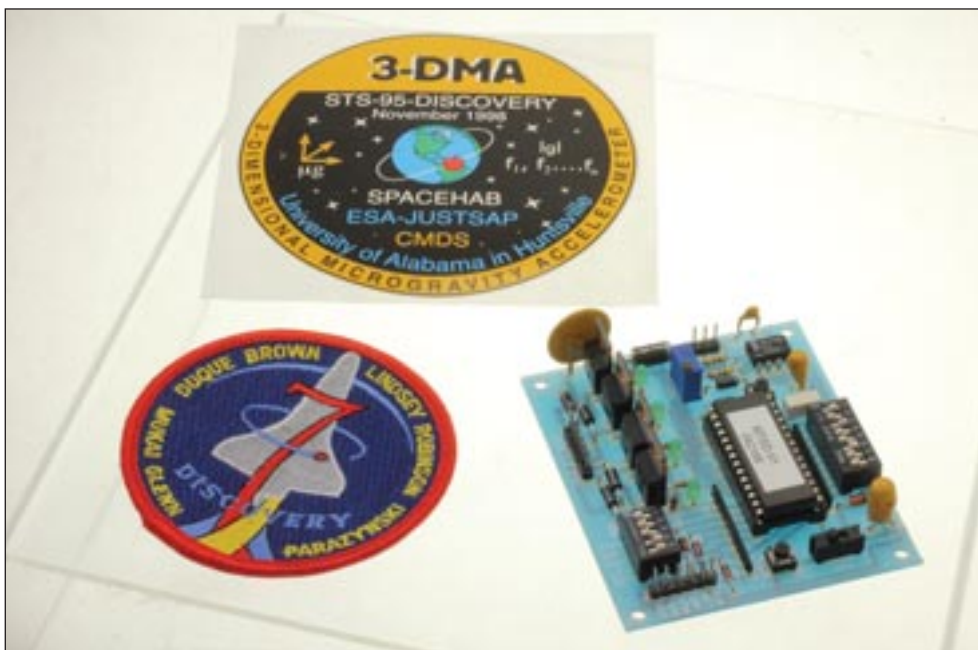

UAH 3-DMA Commemorative Sticker, Discovery Mission STS-95 Arm Patch, and MTSD-V1 Stepper Motor Driver Board from the Discovery Mission

Free Info at <http://info.hotims.com/72995-754>





**Dynabrade**

8989 Sheridan Drive  
Clarence, NY 14031  
Phone: 800-828-7333  
E-mail: customer.service@dynabrade.com  
www.dynabrade.com

**About Our Company**

Dynabrade, the leader for abrasive power tools and process solutions, has earned a reputation for excellence in the innovative design and manufacturing of unique portable pneumatic power tools, related accessories, and dust collection. Our innovative solutions improve the operator's environmental safety, process time, and finishes, which reduces our customers' costs. Our portfolio is able to meet the specific needs of many industries, including aerospace. Dynabrade products are used in a variety of applications on nearly any material that requires material removal, surface preparation and finishing. We are easy to do business with and supply these products quickly to customers through a worldwide network of professional distributors. We strive to have a positive and meaningful impact for all of our stakeholders: Our Customers, Employees, Shareholders, and Community. We listen. We observe. We OPTIMIZE. That's the Dynabrade Difference.

**Contribution to the Space Program**

Dynabrade tools and process solutions deliver value to manufacturers of spacecraft, rockets, and satellites in several respects from production and assembly to safety and compliance. Dynabrade has a 50-year history of diligently supporting OEM manufacturers and their suppliers by offering innovative, time saving and safety enhancing tools and clean air solutions. The



rapidly evolving aerospace industry has come to rely upon Dynabrade for the ability to customize solutions as new processes are developed and instituted.

Abrasive belt tools, like the Dynaflex® II, as well as die grinders, disc sanders and drills are very commonly found in the production setting fabricating critical parts to the exacting standards the industry demands. A keen understanding of industry challenges has led Dynabrade to manufacture oil-free pencil grinders for use in areas sensitive to contamination. Further, as the need to capture airborne, potentially hazardous particulates revealed itself, Dynabrade responded with specific and certified clean air solutions for the capture of metallic (ferrous and non-ferrous) dust.

As the Apollo mission celebrates its 50th anniversary so too does Dynabrade. In the spirit of innovation and reaching new heights, Dynabrade is prepared to support Aerospace manufacturers for the next 50 years and beyond.

<http://www.dynabrade.com>

Free Info at <http://info.hotims.com/72995-755>





# NEW ENGLAND WIRE

## TECHNOLOGIES

### New England Wire Technologies

130 N. Main St.  
 Lisbon, NH 03585  
 Phone: 603-838-6624  
 E-mail: [info@newenglandwire.com](mailto:info@newenglandwire.com)  
[www.newenglandwire.com](http://www.newenglandwire.com)

### About Our Company

New England Wire Technologies designs and manufactures custom specialty wire and cables including multi-conductor cables, miniature/microminiature coaxes, high/low temperature cables, low noise cables, flexible interconnects, Litz wire, custom hybrid cable configurations, and a full range of proprietary cable designs. We service a variety of industries including aerospace/defense, medical electronics, robotics/automation, alternative energy, and industrial manufacturing. Our advanced extrusion expertise and extensive wire processing capabilities enable us to provide the most technologically advanced cables in the industry, all built to exacting customer specifications.



### Contribution to the Space Program

New England Wire Technologies was well-positioned to play a role in the Apollo program. Founded in 1898, just years after Edison's invention of the lightbulb, the company became an important supplier to the 19th century's budding electrical production industry. It grew as the demand for motors and other electrical devices accelerated. And by the 1960s, technological advances had created demand for innumerable types of cable which NEWT continued to fulfill.

The company's contribution to space flight began much earlier than the Apollo program. The Mercury space program ran from 1958-1963. Its goal was to place an astronaut into Earth orbit and return him safely. NASA then followed with the Gemini program, which ran from 1961-1963. It put two-man crews into orbit and perfected various maneuvers – extra-vehicular "space walks," orbital adjustments and con-

trol protocols required to rendezvous and dock with other spacecraft. Gemini served as the testing and proving ground for subsequent Apollo missions. NEWT provided cable to both programs and gained valuable insight into the diverse needs of spacecrafts. NEWT continued to participate in innovative projects including the Space Shuttle Columbia and International Space Station. Today, New England Wire Technologies continues to support NASA space discoveries in present day projects.

<https://www.newenglandwire.com/>

Free Info at <http://info.hotims.com/72995-756>

# NTK

## CUTTING TOOLS

### NTK Cutting Tools USA

46929 Magellan Drive  
 Wixom, MI 48696  
 Phone: 866-900-9800  
 E-mail: [ctinfo@ntktech.com](mailto:ctinfo@ntktech.com)  
[www.ntkcuttingtools.com](http://www.ntkcuttingtools.com)

### About Our Company

NTK Cutting Tools USA, a division of NGK Spark Plugs Co., is a global supplier that develops and manufactures the industry's highest quality of advanced tooling featuring Ceramics, BIDE MICS, Carbide, CBN, and PCD insert grades. The company is dedicated to product innovations that enable part manufacturers to achieve success. Our company provides engineering and technical support to assist in the selection and development of the best tooling combination for each application. Our customer base manufactures parts for industries which include: Aerospace, Agriculture, Electronics, Hydraulics, Medical, Oil and Gas, Power Generation, and Transportation.



### Contribution to the Space Program

NTK delivers the best grades to successfully complete Heat Resistant Super Alloy machining applications. BIDE MICS – an industry changing composite insert material (patented by NTK)

– performs operations on Cases and Shafts machining at accelerated speeds, even reaching 1600SFM on Inconel and Rene 65. JX1 runs at 1300 SFM machining turbine disks from Inconel 718. BIDE MICS physical properties allow them to achieve much higher speeds than the competition.

NTK's SiAION's SX3, SX5, SX7, and SX9 are the "work-horse" ceramic grades with specific material characteristic combinations achieving toughness and wear resistance. Encompassing a wide range of HRSA applications, NTK grades are durable enough for roughing through scale to semi-finishing with interruptions or machining continuous cuts. SX9 grade in RNG45 geometry easily machines Inconel 718, generating part features for a manifold injector housing at high speeds and feeds (850SFM and 0.120 IPR). Reliable performance that increases machining efficiency without affecting or influencing the quality of the part.

Applications from heat exchangers in Inco 625, shafts and cases in Inco 718 and Renes, turbine parts from Inconel 792, and Waspaloy and Inco 783 rings.

Look for the upcoming NTK technical guide to machining HRSA materials, providing guidance on insert geometries, grades, and machining tips.



[www.ntkcuttingtools.com](http://www.ntkcuttingtools.com)

Free Info at <http://info.hotims.com/72995-757>







**National Technical Systems (NTS)**

2125 E Katella Ave. Suite 2500  
Anaheim, CA 92806  
Phone: 1-800-270-2516  
E-mail: sales@nts.com  
www.nts.com

**About Our Company**

NTS is the worldwide leader in space testing. With 28 labs in North America, NTS leverages advanced test and engineering capabilities to mitigate risk and develop custom programs. As the pioneers in space testing, NTS has participated in every major space program since the inception of manned space exploration.

**Contribution to the Space Program**

As the world's most prominent company in space testing, NTS has worked with NASA for more than 50 years. In fact, NTS has participated in every major space program since the inception of manned space exploration. Experience includes work on the Apollo/Saturn programs, Space Shuttle, Mars Rover, International Space Station, Evolved Expendable Launch Vehicle Terminal High Altitude Area Defense Lunar Atmosphere

and Dust Environment Explorer, MX Peacekeeper, CloudSat Cloud Profiling Radar Antenna Subsystem, and more. Today, NTS is supporting research and development on new supercritical CO<sub>2</sub> combustion cycles as well as several Space Launch System programs. In addition, NTS is providing advanced testing services to commercial companies to support the new space race.

From basic engineering and evaluation services to large-scale project management, NTS is a leading provider of services and engineering solutions for all space and satellite testing. NTS operates a national network of test laboratories and engineering centers, offering a vast array of technical capabilities to meet the needs of the commercial and governmental space industry. These laboratories are accredited by A2LA and NVLAP to ISO 17025 for a wide range of aerospace industry standards.

[www.nts.com](http://www.nts.com)



Free Info at <http://info.hotims.com/72995-758>





# Pickering Interfaces

**Pickering Interfaces, Inc.**

2900 NW Vine Street  
 Grants Pass, OR 97526  
 Phone: 541-471-0700  
 E-mail: [ussales@pickeringtest.com](mailto:ussales@pickeringtest.com)  
[www.pickeringtest.com](http://www.pickeringtest.com)

**About Our Company**

Pickering Interfaces designs and manufactures modular signal switching and simulation for use in electronic test and verification. We offer the largest range of switching and simulation products in the industry for PXI, LXI/USB, and PCI applications. To support these products, we also provide cable and connector solutions, modular chassis, diagnostic test tools, along with our switch routing application software and software drivers created by our in-house software team.

Pickering's products are specified in test systems installed throughout the world and have a reputation for providing excellent reliability and value. Pickering Interfaces operates globally with direct operations in the US, UK, Germany, Sweden, France, Czech Republic and China, together with additional representation in countries throughout the Americas, Europe and Asia. We currently serve all electronics industries including automotive, aerospace & defense, energy, industrial, communications, medical and semiconductor.

All products manufactured by Pickering carry a three year warranty and guaranteed long-term product support.

**Contribution to the Space Program**

Pickering Interfaces has a proud history of specifying and designing switching systems for NASA and their partners. We are unique in the industry in that we already have over 1,000 switching modules and continue to create new designs as required for newer and more challenging applications. We are



also platform-agnostic in that we can provide switching solutions in all major platforms used in Test and Measurement.

Examples where Pickering Interfaces has supported NASA and their partners include:

- RTD simulators for testing a satellite's controller circuitry that monitors temperatures throughout the satellite itself;
- Medium to high current switching for testing power distribution in a spacecraft;
- Defining high I/O matrices for HILS Testing of various spacecraft components.

Going forward, Pickering Interfaces will create custom switching designed for the aerospace industry that exactly meets the needs of customers providing efficient solutions so that no compromise on test quality is required.

[www.pickeringtest.com](http://www.pickeringtest.com)



Free Info at <http://info.hotims.com/72995-759>

**Pico Electronics**

143 Sparks Avenue  
Pelham, NY 10803-1837  
Phone: 800-431-1064  
E-mail: [info@picoelectronics.com](mailto:info@picoelectronics.com)  
<https://www.picoelectronics.com/>

**About Our Company**

PICO ELECTRONICS – THE BIG NAME IN SMALL COMPONENTS  
At Pico Electronics, we develop miniature and ultra-miniature units that meet the high-quality, high-reliability specifications of space, military, commercial, and other critical applications.

When Pico Electronics was founded in 1967, transformers and converters were quite large, and not terribly efficient. Our mission was to change that. It wasn't long before we became the ultra-miniature inductor and transformer resource for anything that requires power conversion.

We then applied our miniaturization expertise into DC-DC power converters and AC-DC power supplies, becoming a recognized leader in high power voltage (to 10,000 volts) DC-DC output. Today, we offer high-power (to 300 watts) units, regulated, programmable, and dual-output packages and DC input voltages ranging from 5 to 380 volts – all made in the USA.



**Contributions to the Space Program**

Pico's low-profile converters have traveled the universe in Haybusa 1 & 2, ridden the space shuttle, operated on the International Space Station, powered the Sojourner and many other far-reaching journeys besides powering those critical operations required right here at home. From the depths of the oceans to the surface of Mars, Pico components have excelled at use in the harshest environments and most demanding operational conditions.

Pico offers a large catalog of standard parts as well as being a QPL part supplier for MIL PRF27 and MIL PRF 21038. All products are manufactured in accordance to these MIL standards. Pico is proud to be an ISO 9001D certified facility and our



Quality and Reliability Departments have in-house capabilities to maintain the high levels of reliability and product integrity that are required.

Space, flight, or critical ground applications – all have been manufactured for over 50 years at Pico. Whether DC-DC Converters, Transformers, or Inductors, Pico's US manufacturing facility also allows us to offer custom solutions to optimize operation in your application, with a rapid turnaround for your evaluation and approval. Pico engineering is always available for assistance at the design stage, production, and after completion of your project.

<https://www.picoelectronics.com/>

Free Info at <http://info.hotims.com/72995-760>



# PulseR

## Ruggedized Solutions

### PulseR Ruggedized Solutions

311 Sinclair Road  
 Bristol, PA 19007  
 Phone: 215-781-6403  
 E-mail: [productinfomilitary@pulserruggedized.com](mailto:productinfomilitary@pulserruggedized.com)  
[www.pulserruggedized.com](http://www.pulserruggedized.com)

### About Our Company

PulseR, LLC. (formerly Pulse Electronics Military & Aerospace/Specialty Products) is a world-class manufacturer with 70 years' experience supplying catalog and custom magnetic components to the military, commercial aerospace, manned and unmanned space, high reliability industrial, medical, transportation and power-grid infrastructure markets around the world. The company was originally founded as Technitrol in 1947 and produces D.S.C.C. qualified products that are listed for MIL-PRF-21038, MIL-83531 & MIL-PRF-83532 magnetic devices.

PulseR's experienced engineering teams offer cutting-edge technical solutions and manufacturing expertise which provide comprehensive production at AS9100D certified facilities located both domestically and off shore. PulseR offers complete design support and qualification testing services to meet your demanding requirements. PulseR's award-winning quality and delivery services will help you meet your program's rugged demands, no matter the mission.



### Contribution to the Space Program

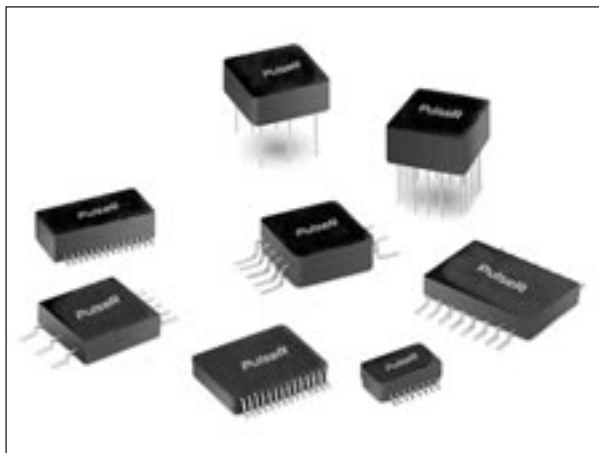

Whether it's PulseR's Fibre Channel, Ethernet and 1553 products utilized on 11 mission critical systems on the Orion Manned Spacecraft, or its custom power magnetics supplied for the Europa Jupiter System Mission, PulseR is proud to support Space Programs around the world. PulseR's world-class AS9100D-certified facilities are designed to build, test, and qualify parts that supply mission critical, manned and unmanned Space initiatives.

The ISS, James Web Telescope, Starumu, WorldView-3 and GPS Block III satellites, Galileo, Juice and Orion spacecrafts, plus many commercial space programs with reusable launch systems all trust PulseR's catalog of custom power and signal products for their critical missions.

When failure is not an option, the Space Industry chooses PulseR Ruggedized Solutions.

[www.pulserruggedized.com](http://www.pulserruggedized.com)

Free Info at <http://info.hotims.com/72995-761>





**Cotronics Corporation**

131 47th Street  
 Brooklyn, NY 11232  
 Phone: 718-788-5533  
 E-mail: sales@cotronics.com  
<http://www.cotronics.com>

718-788-5533 for Cotronics' application engineers for specific technical information, adhesive suggestions and custom solutions; Cotronics' customer service department for price quotes and placing orders for high temperature stock materials.

**Cotronics is now ISO 9001:2015 certified.**

You have challenging applications... we have solutions.

<http://www.cotronics.com>

Free Info at <http://info.hotims.com/72995-764>

**About Our Company**

For almost 50 years, Cotronics' highly skilled staff of researchers, engineers, chemists, technicians and sales assistants have provided the aerospace, automotive, nuclear, semiconductor, instrumentation, appliance, and chemical processing industries a reliable source of superior quality, high temperature products specially formulated to meet the demanding specifications that today's technology requires. Cotronics is ISO 9001:2015 certified and provides the utmost in excellence.

**Contribution to the Space Program**

High temperature adhesives and materials for electrical, structural and industrial applications for use to 4000 °F have been used in the NASA space program.

We offer high temperature solutions to satisfy the most difficult electrical, structural, and industrial applications with our proven Cotronics brand name products: **Duralco™** (High Temperature Epoxies), **Resbond™** (High Temperature Ceramic Adhesives), **Rescor™** (Machinable and Castable Ceramics), **Thermeez™** (Insulation Products), **Durabond™** (Maintenance and Repair Products) and **High Purity Materials**.  
 Email: sales@cotronics.com or call



# HIGH TEMPERATURE MATERIALS FOR

## ELECTRICAL | STRUCTURAL | INDUSTRIAL

### APPLICATIONS TO 4000°F

**Flexible Conductive Silver Based Epoxy**  
 Duralco™ 125 thermally conductive electrical epoxy bonds to most metals, ceramics and plastics to form a stress-free adhesive bond. Continuous service up to 450°F.

**High Temperature Low Expansion Adhesive**  
 Resbond™ 905 Quartz is formulated for bonding low expansion and thermal shock resistant ceramics. Ideal for electronic and metallurgical applications to 2500°F.

**Thermally Conductive Adhesives**  
 Duralco™ 132 thermally conductive adhesives combine Cotronics' unique, high temperature resins with highly conductive fillers to form thermally conductive, adhesive bonds with continuous service up to 500°F.

**High Expansion Adhesive**  
 Thermeez™ 7030 bonds and protects to 1800°F. Apply to ceramics, ceramic cloths, door and tadpole gaskets and metals. Excellent adhesion to steel, stainless, aluminum, lead and ceramics.

**High Purity, Alumina Adhesive Protects Critical Electronic Components**  
 Resbond™ 989 offers continuous protection to 3000°F. Apply directly to metals, glass, ceramics, graphite and silicon carbide. Provides high bond strength and excellent electrical, moisture, chemical and solvent resistance for bonding and sealing.

131 47th Street, Brooklyn, NY 11232  
[www.cotronics.com](http://www.cotronics.com) | [sales@cotronics.com](mailto:sales@cotronics.com) | 718.788.5533 | Fax: 718.788.5538

**Congratulations from your friends at Cotronics.**

QUALITY PRODUCTS | CUSTOM FORMULATIONS | ISO 9001:2015 CERTIFIED



Turning polymers into possibilities.

**Zeus Industrial Products, Inc.**

3737 Industrial Blvd.  
Orangeburg, SC 29118  
Phone: 803-268-9500  
Fax: 803-533-5694  
E-mail: support@zeusinc.com  
www.zeusinc.com

**About Our Company**

For more than 50 years, Zeus has delivered precision polymer solutions that transform businesses, markets, and lives. We have dedicated ourselves to building partnerships, products and services for the benefit of our customers.

Headquartered in Orangeburg, South Carolina, Zeus employs approximately 1,700 people worldwide with facilities in Aiken, Gaston, and Orangeburg, South Carolina; Branchburg, New Jersey; Chattanooga, Tennessee; Guangzhou, China; and Letterkenny, Ireland. Zeus products and services serve companies in the medical, automotive, aerospace, fiber optics, energy, and fluid management markets.



Zeus Engineering Center of Excellence, Orangeburg, SC.

**Contribution to the Space Program**

One credo that has been with Zeus since the beginning is founder Frank Tourville, Sr.'s desire to "do it better." Innovation and invention have been at the core of Zeus' and its customers' success. Through close collaboration and understanding of client needs, Zeus has helped find solutions for industries as diverse as automotive to energy to medical – and now space exploration!

For over 50 years, NASA has been exploring the surface of Mars and in 1976 landed unmanned spacecraft there. In the years since and as technology improved, more sophisticated craft were landed on the red planet. Yet nothing has come back from Mars. To bring back samples has been a long-time goal of Mars explorers. The engineers faced the problem of finding a space-qualified material that could support a very high integrity seal for any canister that would carry Martian samples. Zeus heard this call and stepped in. Zeus produced a special modified version of expanded PTFE (ePTFE). Used in conjunction with a soft metal mating surface, the Zeus-aided seal worked! This Zeus product is now poised to be part of the first sample return mission to Mars.



Zeus Aeos™ ePTFE.

[www.zeusinc.com](http://www.zeusinc.com)

Free Info at <http://info.hotims.com/72995-763>





**Click Bond, Inc.**  
 2151 Lockheed Way  
 Carson City, NV 89706  
 E-mail: sales@clickbond.com  
 www.clickbond.com

**About Our Company**

For more than 30 years Click Bond has designed and manufactured adhesive-bonded fasteners for the aerospace industry. Products that include rivetless nutplates, sleeves, brackets, cable-tie mounts, studs, standoffs, and the Click Patch®. Fasteners that weigh less, require fewer holes, streamline manufacturing, & facilitate repairs.



Free Info at <http://info.hotims.com/72995-766>

**Contribution to the Space Program**

Click Bond is proud to be part of NASA's space programs. Programs that include the Mars Rover. Our adhesive-bonded fasteners made the journey to Mars on both the Opportunity and the Curiosity. NASA engineers were quick to recognize that adhesive-bonded fastener solutions weigh less, and because they require no holes, they help preserve the structural integrity of the vehicles. And, these fasteners are designed to survive in the harshest environments, including Mars. Our rivetless nutplates are used on the Delta rocket program, because riveting is extremely difficult, costly, and time consuming. Click Bond is working with NASA engineers today on new projects such as the Orion. We congratulate NASA, and the amazing individuals who worked together 50 years ago to put a man on the Moon.



[www.clickbond.com](http://www.clickbond.com)



**CS Hyde Company**  
 1351 N. Milwaukee Avenue  
 Lake Villa, IL 60046  
 Phone: 800-461-4161  
 E-mail: sales@cshyde.com  
 www.cshyde.com

**About Our Company**

CS Hyde Company is a worldwide converter, distributor, and manufacturer of high-performance tapes, films, fabrics, silicone and belting. Our converting services allow us to be a solution-based provider for multiple industries including aerospace, industrial, packaging, and medical. CS Hyde is your source for superior products with the quickest turnaround possible.



Free Info at <http://info.hotims.com/72995-767>

**Contribution to the Space Program**

CS Hyde specializes in high-performance materials ranging from plastic films, pressure sensitive adhesive tapes, PTFE coated and non-coated fabrics, as well as specialty silicone sheeting. We work

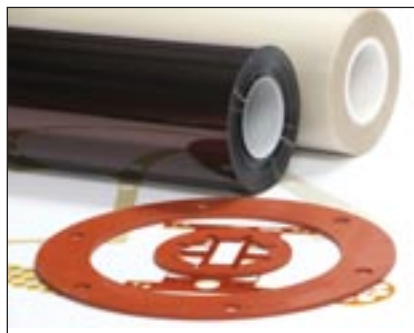

closely with aerospace companies to find materials and solutions that endure extreme elements like high temperature, barometric pressure, and abrasion resistance. Our converting capabilities enable us to design specialty die-cuts and gaskets for aeronautical components. We commonly work with Dupont Kapton® and Mylar. Both of these films have been widely used throughout the space program. Aluminum Kapton® Foil was utilized on the Apollo Lunar Module as a thermal blanket insulator to maintain engine temperature during takeoff. CS Hyde prides itself on supplying materials required to achieve astronomical accomplishments.

[www.cshyde.com](http://www.cshyde.com)



# KHK-USA

**KHK USA Inc.**

259 Elm Place  
 Mineola, NY 11501  
 Phone: 516-248-3850  
 E-mail: info@khkgears.us  
<https://www.khkgears.us>

**About Our Company**

KHK USA offers the largest selection of stock metric gears in North America. With over 20,000 configurations and 200 styles of gearing, no other supplier offers the depth and breadth of gear products. Materials include carbon steel, nylon, alloy steel, acetal, stainless steel, bronze, cast iron, and aluminum bronze.

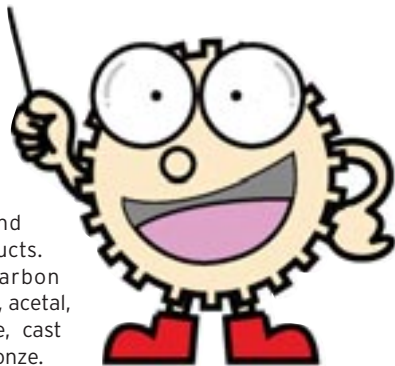

**Contribution to the Space Program**

KHK has been a supplier to various research projects conducted both on the ground and in near space. With the wide variety of products, NASA scientists have been able to select stock gears for their projects instead of needing to source custom gears. This has saved thousands of dollars by offering standardized products. KHK USA's 20,000 products are supported by 3D CAD models which allow NASA employees to prove their concepts digitally before moving forward with physical prototypes.



<https://www.khkgears.us>

Free Info at <http://info.hotims.com/72995-768>

# MASSA

*GENERATIONS AHEAD IN  
 SONAR & ULTRASONIC TECHNOLOGY*

**Massa Products Corporation**

280 Lincoln Street  
 Hingham, MA 02043  
 Phone: 781-749-4800  
 E-mail: innovation@massa.com  
[www.massa.com](http://www.massa.com)

**About Our Company**

Massa Products Corporation, 3rd Generation American-Family-Business, established by industry pioneer, Frank Massa in 1945. Before "MASSA," Frank designed the necessary SONARS used to win WWII. Today, MASSA holds over 165 patents, and over 675 devel-

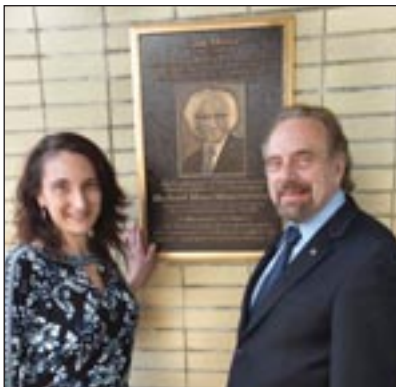

opment/production Navy Contracts. No one else on Earth can harness the science of sound like MASSA.

**Contribution to the Space Program**

As we set forth to discover new worlds, MassaSonic® can be our guide where we have never gone before. Our investigation of different applications in the space industry shows that our sensors can help us learn more about the universe. The unparalleled fundamental understanding of electroacoustic invention, innovation and manufacturing is what makes MASSA a preferred partner for Government Contracts. Our knowledge of Applied Acoustics spans across diverse applications including collision avoidance, and sensors for use in space stations. Our various advanced SONAR developments can be implemented in extraterrestrial exploration under or through thick ice, or in varied atmospheres and caustic environments. When looking for more out there, we hear you! If there's life out there, MASSA can harness the science of sound to find it!

[www.massa.com](http://www.massa.com)

Free Info at <http://info.hotims.com/72995-769>





A Furukawa Company

**OFS**

2000 Northeast Expressway  
Norcross, GA 30071  
Phone: 1-770-798-5555  
www.ofsoptics.com

**About Our Company**

OFS is a world-leading designer, manufacturer and provider of optical fiber, fiber optic cable, connectivity, fiber-to-the-subscriber (FTTx) and specialty photonics products. Focused on loyalty, customer service and a dedication to research, OFS has helped lead the way in pioneering innovative fiber optic applications for more than a decade. We listen to the needs of our customers and use what we learn to manufacture the best products for their applications.

**Contribution to the Space Program**

OFS is a world-leading designer, manufacturer and provider of optical fiber, fiber optic cable, connectivity, fiber-to-the-subscriber (FTTx) and specialty photonics products. OFS has over 30 years of experience manufacturing fiber optic products for

the Aerospace and Defense markets. Some of these opportunities have been in support of customers supplying products for various space programs. We are able to support the stringent requirements for various space programs due to our broad portfolio of specialty coating, buffering and cabling materials that allows our engineers to design to key requirements such as high temperatures, resistance to fluids (such as solvents and jet fuel), and specific standards for smoke and toxicity, to name a few.

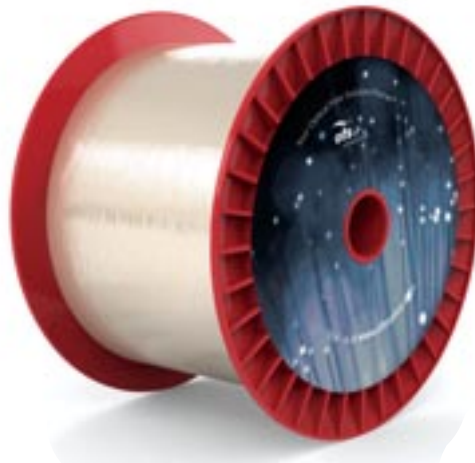

<https://www.ofsoptics.com/aerospace-defense/>

Free Info at <http://info.hotims.com/72995-770>



**OMS Motion Inc.**

15201 NW Greenbrier Pkwy, Ste. B1  
Beaverton, OR 97006  
Phone: 503-629-8081  
E-mail: [Info@OMSmotion.com](mailto:Info@OMSmotion.com)  
[www.OMSmotion.com](http://www.OMSmotion.com)

**About Our Company**

OMS Motion, aka Oregon Micro Systems, has been successfully producing motion control for more than 35 years. OMS evolved from patented motion control technology that provides superior advantages and has built a strong reputation for reliable and quality motion control products across many diverse markets in automation and robotic equipment and instruments.

**Contribution to the Space Program**

OMS Motion has had relationships with NASA and other Aerospace organizations dating back to the 90's where OMS products have been utilized in numerous applications and projects. Test systems for some of the most high-profile projects, such as the Space Shuttle, ISS and Mars programs are common

uses for OMS products. OMS has worked with universities and research groups on projects that have traveled on the Space Shuttle over the course of many years to help understand our planet's atmosphere and climate. The University of Arizona has used OMS motion controllers in several projects, including contributions to the Mars Odyssey program. Accurate, dependable motion produced by OMS products is one reason these organizations return to OMS for their motion control needs.



<http://www.OMSmotion.com>

Free Info at <http://info.hotims.com/72995-771>





Members of the NVT GROUP

**NVT Group Headquarters**

17 Mandeville Court  
 Monterey, CA 93940  
 www.nvtgroup.com

**About Our Company**

**Data Physics** provides comprehensive vibration test solutions, including electrodynamic shakers, vibration controllers, and dynamic signal analyzers. **Lansmont** manufactures field data recorders and test equipment that measures shock, vibration, compression, and impact. **Team Corporation** manufactures high-performance vibration equipment, innovative components, and single- and multi-axis test systems.

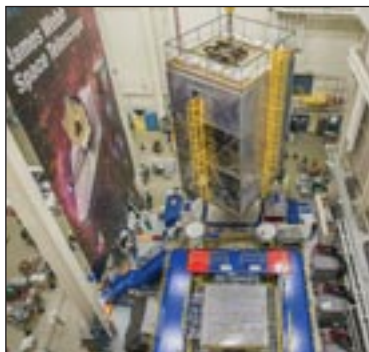

**Contribution to the Space Program**

Starting in the late 1950s, Team Corporation provided NASA with Hydrashakers for vibration testing of both the Apollo and Saturn spacecraft. In the 2000s, Lansmont Corporation contracted with ATK to provide SAVER™ portable shock and vibration measurement systems which were used to measure the transport of the Shuttle's RSRMs from Utah to the Kennedy Space Center. In 2011, Lansmont was awarded the Small Business Subcontractor of the Year by the Marshall Space Flight Center.

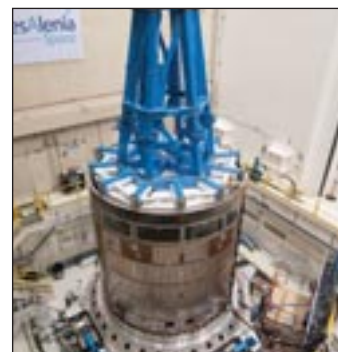

In the late 2000s, Team built the world's most powerful multi-axis test system at NASA's Plum Brook Station for vibration testing of the Orion spacecraft. In 2016, Team and Data Physics partnered to provide a complex multi-shaker test system at NASA Goddard for vibration testing of the James Webb Space Telescope.

[www.nvtgroup.com](http://www.nvtgroup.com)

Free Info at <http://info.hotims.com/72995-853>

Upcoming...

# Webinars

## The Next Giant Leap: Back to the Moon and On to Mars

Wednesday, August 7, 2019, Noon U.S. EDT

Humanity is moving out into the solar system, starting with a sustainable return to the Moon and then to Mars. This 60-minute Webinar from the editors of Tech Briefs Media will describe how the collaboration of government, commercial partners, and international allies lays the foundation for the forward path to the Moon in preparation for Mars.

Topics will include the lunar Gateway as well as lunar objectives such as telerobotic and crewed exploration of the Moon. Learn how NASA and its partners will send humans back to the Moon by 2024 with a sustainable presence by 2028.

An audience Q&A follows the technical presentation.

Technical Content Provided by:



**Speakers:**



**Rob Chambers**  
 Director, Human Spaceflight Strategy and Business Development, Lockheed Martin Space Systems



**Walt Engelund**  
 Director, Space Technology and Exploration Directorate, NASA Langley Research Center



**John Lowry**  
 Chief Aerospace Engineer, Timken

Please visit [www.techbriefs.com/webinar651](http://www.techbriefs.com/webinar651)

# CONNECT COLLABORATE INNOVATE



Connect with the leaders in Semiconductors, MEMS, Sensors, Flexible Electronics, Packaging, Advanced Materials, 3D, and Design and Manufacturing. SEMI gathers the global electronics manufacturing supply chain in large, medium and intimate events. Join our expositions or conferences and take your business to the next level.

**SEMICON<sup>®</sup>  
CHINA**  
FPDCHINA

**M** MEMS & SENSORS  
Technical Congress<sup>®</sup>

2019  
**FLEX**  
U.S.

**SEMICON<sup>®</sup>  
EUROPA**

**M** MEMS & SENSORS  
Executive Congress<sup>®</sup>

2019  
**FLEX**  
Japan

**SEMICON<sup>®</sup>  
JAPAN**

**M** European  
MEMS & SENSORS  
Summit

**ISS** INDUSTRY  
STRATEGY  
SYMPOSIUM  
AMERICAS

2019  
**FLEX**  
Taiwan

**SEMICON<sup>®</sup>  
KOREA**

**ISS** INDUSTRY  
STRATEGY  
SYMPOSIUM  
EUROPE

2019  
**FLEX**  
Korea

**SEMICON<sup>®</sup>  
SOUTHEAST  
ASIA**

**ASMC** ADVANCED  
SEMICONDUCTOR  
MANUFACTURING  
CONFERENCE

2019  
**FLEX**  
China

**SEMICON<sup>®</sup>  
TAIWAN**

**SMC** SEMICONDUCTOR  
MATERIALS  
CONFERENCE  
AMERICAS

**SMC** SEMICONDUCTOR  
MATERIALS  
CONFERENCE  
KOREA

**SEMICON<sup>®</sup>  
WEST**

**ITPC** INTERNATIONAL  
TRADE  
PARTNERS  
CONFERENCE

2018  
**FLEX** be flexible  
Europe



Visit [www.semi.org/events](http://www.semi.org/events)

AMERICAS • CHINA • EUROPE • JAPAN • KOREA • SOUTHEAST ASIA • TAIWAN

Free Info at <http://info.hotims.com/72995-772>



# New on the MARKET

## Product of the Month



Dewesoft, Whitehouse, OH, introduced single-channel KRYPTON data acquisition modules for use in harsh environments such as exposure to extreme temperatures, water spray or submersion, or high shock and vibration. The modules measure  $62 \times 56 \times 29$  mm ( $2.44 \times 2.2 \times 1.14$ "

and are machined from an aluminum brick. After the industrial-grade electronics are installed, the units are sealed with thermally conductive and electrically isolating rubber. Units are waterproof and can withstand shocks up to 100 G. The modules meet IP67 protection against water, dust, and other elements. Operating temperature ranges from  $-40$  to  $85$  °C ( $185$  °F). The EtherCAT interface runs at 100 Mbps Full Duplex bus speed, providing for 6 MB/s to 10 MB/s data throughput per chain. Modules intended for dynamic measurements can sample up to 40 kS/s. All modules on the chain, which can be spread out as far as 100 m (328 feet) between nodes, are precisely synchronized.

For Free Info Visit <http://info.hotims.com/72995-120>



## Sensor Controller

The induSENSOR MSC7401 sensor controller from Micro-Epsilon, Ortenburg, Germany, is used for displacement and distance measurements and is operated with LVDT and LDR measuring gauges and displacement sensors. Parameter setup of the controller is possible via keys or the software tool included. An IP67-rated aluminum housing protects the controller from dust and water.

For Free Info Visit <http://info.hotims.com/72995-108>

## RF Connector

The MHF 4L LK Micro RF coaxial connector from I-PEX Connectors, Austin, TX, offers a locking feature to prevent it from disengaging from the PCB receptacle. It has a mating height of 2.0 mm and uses 1.37-mm OD coax. It is designed for shock and vibration environments where signal performance is critical.



For Free Info Visit <http://info.hotims.com/72995-106>

## Environmental Sensor



Laird Connectivity, Akron, OH, released the Sentries RS1xx External Series sensor that features integrated antennas, an external temperature probe, and rugged IP65 enclosure that allows users to mount the sensor outside of a device and measure the temperature inside via the cabled sensor. The probe supports a temperature range of  $-55$  to  $125$  °C and sends sensor data in harsh RF environments over long distances to remote LoRaWAN gateways.

For Free Info Visit <http://info.hotims.com/72995-101>

## Desktop 3D Printer

Stratasys, Eden Prairie, MN, introduced the Stratasys F120™ desktop 3D printer that uses FDM® technology and offers remote self-monitoring, plug-and-print functionality, user-friendly touchscreen interface, and GrabCAD Print™ workflow. The printer offers large filament boxes that enable up to 250 hours of uninterrupted printing. Other features include auto-calibration, easy material swaps, fast-draft mode that prints initial design concepts quickly, and hands-free soluble support removal.

For Free Info Visit <http://info.hotims.com/72995-104>



## Optical/Electrical Connector

The Diamond Multipurpose DM4 from Diamond SA, Losone, Switzerland, is an optical/electrical connector insert that transmits optical and electrical signals for both analog and digital applications. The insert incorporates four optical or electrical terminals; IP ratings are met through solid connector construction with ingress protection. The insert is constructed to fit into a variety of different connector housings. Based on a 2.5-mm fiber optic ferrule, the terminals use integrated springs to avoid contact interruptions. Compatibility with tight cable and semi-loose cable/fiber construction is ensured.

For Free Info Visit <http://info.hotims.com/72995-102>

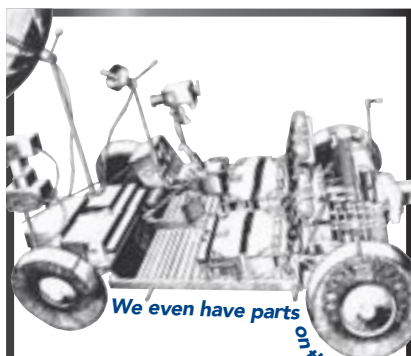

## DID YOU KNOW?

The founders of AGI manufactured the Load Cells for the Lunar Rover Vehicle.

**Engineered To Endure**

**AGI** AMERICAN GRIPPERS, INC.  
Manufacturers of Sophisticated  
Pneumatic Automation Products

203.459.8345 p | 203.452.5943 f  
[info@agi-automation.com](mailto:info@agi-automation.com)

Free Info at <http://info.hotims.com/72995-747>

[www.techbriefs.com](http://www.techbriefs.com)

Tech Briefs, July 2019



## Power Module

The LTM4700 from Analog Devices, Norwood, MA, is a dual 50A or single 100A step-down  $\mu$ Module<sup>®</sup> DC/DC regulator featuring remote configurability and telemetry-monitoring of power management parameters over PMBus. The module consists of analog control loops, mixed-signal circuitry, EEPROM, power MOSFETs, inductors, and supporting components.



For Free Info Visit <http://info.hotims.com/72995-107>



## Vision Sensors

Teledyne DALSA, Billerica, MA, announced BOA<sup>™</sup> Spot XL vision sensors for industrial automation and inspection. The sensors come with integrated LED lighting, lens cover, and application software. Embedded vision tools include positioning, part locating, pattern matching, measuring, and feature or defect detection.

For Free Info Visit <http://info.hotims.com/72995-105>

## Synthetic Hose

HASCO America, Fletcher, NC, introduced Z8525 flexible, non-twist, and kink-resistant EPDM hose that features synthetic textile reinforcement for systems operating with water or superheated steam. The hose is suitable for operating pressures of up to 20 bar and a temperature range of -70 °C to +140 °C. Hoses are available in diameters of 9, 13, and 19 mm and standard lengths of 10 m and 50 m.



For Free Info Visit <http://info.hotims.com/72995-109>

## Anti-Seize Coating

ZYP Coatings, Oak Ridge, TN, offers Seize-Stop non-metallic anti-seize coating formulated with lubricating oil and powder lubricants. It provides protection in industrial applications where metal-containing products are not allowed. It is suited for most metals and prevents seizing, corrosion, rusting, and galling between metal parts.



For Free Info Visit <http://info.hotims.com/72995-110>



## 3D Stereoscopic Display

Vision Engineering, New Milford, CT, offers the DRV (Deep Reality Viewer) digital 3D stereoscopic display that creates stereo high-definition 3D images without using a monitor or requiring operators to wear headsets or special glasses. The system interacts with other local or remote users and other tools/PCs. The display uses TriTeQ3 digital 3D display technology and incorporates a zoom microscope module.

For Free Info Visit <http://info.hotims.com/72995-111>

## Nine-Axis Sensor

Mouser Electronics, Mansfield, TX, offers the BMX160 nine-axis sensor from Bosch. The sensor incorporates a 16-bit digital triaxial accelerometer, 16-bit digital triaxial gyroscope, and triaxial geomagnetic sensor to measure orientation and detect motion in nine degrees of freedom. It offers acceleration ranges of  $\pm 2$  to  $\pm 16$  g and gyroscopic range up to 2,000 degrees per second.

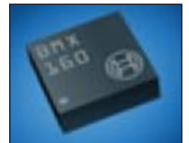

For Free Info Visit <http://info.hotims.com/72995-103>



## MODEL & SIMULATE DESIGNS, DEVICES, AND PROCESSES

COMSOL Multiphysics<sup>®</sup> is an integrated software environment for creating physics-based models and simulation applications. Add-on products expand the simulation platform for electromagnetics, structural, acoustics, fluid flow, heat transfer, and chemical applications. Interfacing tools enable the integration of COMSOL Multiphysics<sup>®</sup> simulations with all major technical computing and CAD tools. Simulation experts rely on COMSOL Compiler<sup>™</sup> and COMSOL Server<sup>™</sup> products to deploy applications to their colleagues and customers worldwide. <https://www.comsol.com/products>

**COMSOL, Inc.**

Free Info at <http://info.hotims.com/72995-773>

## NEW GPIB PIEZO DRIVER AMPLIFIER



Krohn-Hite's new GPIB Piezo Electric Transducer Driver Power Amplifier offers extended output power (17W/34W) and voltage (141Vrms/282Vrms) capabilities, low distortion, and versatility at a reasonable cost. Please visit the complete data sheet at <http://www.krohn-hite.com/ads/7602ad.htm>. Phone: 508-580-1660, email: [sales@krohn-hite.com](mailto:sales@krohn-hite.com); [www.krohn-hite.com](http://www.krohn-hite.com).

**Krohn-Hite Corporation**

Free Info at <http://info.hotims.com/72995-774>



## POTTING COMPOUND FEATURES LOW CTE

Master Bond EP42HT-3AO is a two component, moderate viscosity epoxy with good flow properties. It is ideal for small to moderate size encapsulating, potting and casting applications. EP42HT-3AO is designed to optimize heat dissipation properties and improve the quality and reliability of electronic devices subjected to thermo-mechanical stresses. <http://www.masterbond.com/tds/ep42ht-3ao>

**Master Bond Inc.**

Free Info at <http://info.hotims.com/72995-775>

## THICK & THIN FILM RESISTORS



For over 40 years, MSI has been delivering superior quality products. Absolute tolerances starting at 0.01% and TCR's at  $\pm 2$  ppm/C. Applications include medical implantables, military, aerospace, microwave/RF, and telecommunications. Call (508) 695-0203, visit [www.Mini-SystemsInc.com](http://www.Mini-SystemsInc.com), or e-mail [Info@mini-systemsinc.com](mailto:Info@mini-systemsinc.com)

**Mini-Systems Inc.**

Free Info at <http://info.hotims.com/72995-776>



## FRAGILE PART CLAMPING

Do you have thin films, small parts or delicate samples that need to be held flat and firmly without mechanical clamping? This porous ceramic chuck comes in a variety of sizes and has been applied in laser, microscopy and other applications. Contact us today: [Sales@photomachining.com](mailto:Sales@photomachining.com), 603-882-9944, [www.photomachining.com](http://www.photomachining.com).

**PhotoMachining, Inc.**

Free Info at <http://info.hotims.com/72995-777>



## FOG-GRADE MEMS INERTIAL MEASUREMENT

The latest high-performance, ultra-reliable, all-MEMS inertial measurement unit from Silicon Sensing Systems, DMU30 offers inertial performance equivalent to fibre-optic devices but with greater reliability and lower size, weight and cost. The company's family of inertial products (gyros, accelerometers and low-cost IMUs) meets requirements across the price/performance curve with system integrators supported by Silicon Sensing's evaluation tools and inertial system experts. [www.siliconsensing.com/general](http://www.siliconsensing.com/general)

**Silicon Sensing Systems Ltd.**

Free Info at <http://info.hotims.com/72995-778>



Intro

Cov

ToC



Upcoming...

# Webinars

## Developing Higher Density Materials for Lithium-Ion Batteries

**ThermoFisher**  
SCIENTIFIC

Thursday, July 11, 2019 at 10 am U.S. EDT

Developing better materials for lithium-ion batteries requires a variety of analytical methods and evaluation materials, as well as a better understanding of the mechanisms involved in charge/discharge cycles. This 30-minute Webinar discusses the different analytical techniques used in characterization of battery materials.

**Speakers:**



**Ferdinand Schimtt**  
Sales Manager,  
MBRAUN



**Tony Williams**  
Senior Manager, Market  
Development, Materials &  
Structural Analysis Division,  
Thermo Fisher Scientific

**This 30-minute Webinar includes:**

- Live Q&A session
- Application Demo
- Access to archived event on demand

Please visit [www.techbriefs.com/webinar647](http://www.techbriefs.com/webinar647)

## Game-Changing Interconnect Technology for Space Exploration

**AirBorn**

Tuesday, July 16, 2019 at 11 am U.S. EDT

This 30-minute Webinar is serving as the launch of a new state-of-the-art interconnect system for OEMs and design engineers. It will examine the latest disruptive technology that combines the benefits of fiber with the ease and reliability of copper for space, military, and aerospace applications. Experts will discuss how the technology solved the challenges that a major prime contractor in the space market had using fiber interconnects.

**Speakers:**



**David Koenig**  
Vice President,  
Business Unit Manager –  
Space, AirBorn



**Jason Smith**  
Senior Director of Technology  
Development, AirBorn

**This 30-minute Webinar includes:**

- Live Q&A session
- Application Demo
- Access to archived event on demand

Please visit [www.techbriefs.com/webinar645](http://www.techbriefs.com/webinar645)

## Innovative Approach for Ultrahigh-Speed Machine Vision

**VISION**  
RESEARCH

Wednesday, July 17, 2019 at 2:00 pm U.S. EDT

This 30-minute Webinar looks at an innovative approach to ultrahigh-speed digital imaging. Discussion will focus on digital high-speed imaging options for applications that require detailed real-time analysis or extremely long record times, such as 3D printing in the metal industry and digital microscopy.

**Speaker:**



**Uma Gobena**  
Vision Application Engineer,  
Vision Research

**This 30-minute Webinar includes:**

- Live Q&A session
- Application Demo
- Access to archived event on demand

Please visit [www.techbriefs.com/webinar646](http://www.techbriefs.com/webinar646)



# APPLICATION BRIEFS

## Machining Capabilities Enhance Space-Related Programs

Insaco  
Quakertown, PA  
www.insaco.com

Since 1947, Insaco has been machining, grinding, and polishing ceramics, sapphire, and glass to meet and often exceed client specifications. A large portion of the company's machining capabilities have centered around the aerospace industry, starting with sapphire cover plates on the first Telstar communications satellite in the early 1960s.

As a provider of parts for microwave tubes used in communication with satellites, Insaco was chosen by Telstar to supply sapphire cover plates for the satellite's solar cells — which covered the outer surface of the satellite — as a precaution against electromagnetic radiation. The sapphire coating protected the solar cells from gamma rays and other forms of electromagnetic interference.

In another recent application, Stanford Research Systems (SRS), NASA Goddard Space Flight Center (GSFC), and Johnson Space Center (JSC) worked together to adapt the SRS RGA100

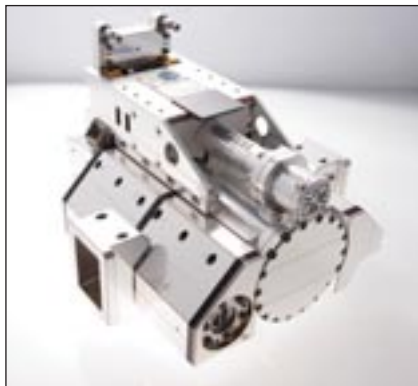

The robotic external leak locator for the International Space Station.

quadrupole mass spectrometer for operation in the vacuum of space. The instrument, containing parts made by Insaco, was held at the end of the International Space Station (ISS) robot arm. By moving the device around suspect areas outside the ISS, NASA was able to identify the source of ammonia

leaks from heat exchangers.

One drawback is that the instrument has to be stored inside the ISS and taken outside when needed — a time-intensive task. NASA and SRS are currently working to devise an improved system that would live in what NASA calls a “Dog House” —

a protective structure outside the ISS in vacuum — saving transition time.

In addition to the mass spectrometer, Insaco has met a number of space-related challenges including providing parts for the Chandra X-Ray Telescope, additional mass spectrometer parts and Mars Organic Molecule Analyzer parts for NASA Goddard, sapphire imaging chips for the Hubble Space Telescope, spacesuit parts, and key sapphire sight tubes for the ISS urine reclamation system.

The company also has provided various machined parts for applications in which extremely tight tolerances were required for NASA centers including Jet Propulsion Laboratory, JSC, Kennedy Space Center, Langley Research Center, Marshall Space Flight Center, and the Wallops Flight Facility.

For space applications, products must work the first time and every time as needed. Each part within a system for space use must meet exact specifications, and often, the parts must be made of hard materials such as sapphire or ceramic to withstand the harsh environment of space. Insaco often makes recommendations on material selection, and machines parts to the extremely tight tolerances and surface requirements of space applications.

For Free Info Visit <http://info.hotims.com/72995-115>



Telstar 1 — a 171-pound, 34.5-inch sphere with solar panels covered with sapphire cover plates — was placed in orbit on July 10, 1962.

## Humidity Measurement Devices for Mars Are Ready for Final Testing

Vaisala Corp.  
Helsinki, Finland  
www.vaisala.com

The Finnish Meteorological Institute (FMI) is delivering pressure and humidity measuring devices based on Vaisala technology for use on NASA's next robotic mission to Mars — the Mars 2020 rover. The pressure measurement devices were finalized earlier this year; the humidity measuring instruments are now completed and ready for final testing.

The devices are provided by FMI as part of Spain's Mars Environmental Dynamic Analyzer (MEDA) device package, which will be installed in the rover. The rover will also carry Vaisala's pressure and humidity sensors, which have never been used on Mars terrain.

FMI's MEDA PS and MEDA HS instruments will measure the pressure and humidity of the atmosphere of Mars. The measuring instrumentation is now calibrated and finalized; before handing it over to NASA later this year, the devices will be tested with the MEDA package's main computer.

Vaisala's HUMICAP® and BAROCAP® sensors are used in applications such as the Mars 2020 rover for their ability to tolerate dust, chemicals, and harsh environmental conditions.

For Free Info Visit <http://info.hotims.com/72995-116>



# FACILITY FOCUS

## NASA's John F. Kennedy Space Center

On September 1, 1961, NASA requested appropriations for initial land purchases on Merritt Island on Florida's east coast to support the Apollo Lunar Landing Program. Designers quickly began developing plans for Launch Complex 39 facilities, which include the Launch Control Center, Pads A & B, and the huge hangar now known as the Vehicle Assembly Building (VAB).

The combined spaceport of Kennedy and Cape Canaveral Air Force Station (CCAFS) has served as the departure gate for every American human space mission — from Project Mercury to the space shuttle — and for hundreds of rocket launches carrying advanced research and interplanetary spacecraft.

Today's Kennedy Space Center (KSC) is the doorway to further exploration of the solar system, reaching out to the Moon, Mars, and beyond.

### Programs and Facilities

*Ground Systems Development and Operations Program* – The Orion Multi-Purpose Crew Vehicle is being assembled, tested, and ultimately will launch aboard the Space Launch System (SLS) from KSC. Launch Pad 39B is in the process of being refurbished to support commercial users and the SLS.

*Commercial Crew Program* – The 2010 NASA Authorization Act established commercial providers as the primary means for future crew transportation to the International Space Station (ISS). The objective of the Commercial Crew Program is to invest in and work closely with industry providers to produce a certified end-to-end crew transportation system capable of flying to and from the ISS.

*Exploration Ground Systems* – This program is one of three NASA programs based at KSC including the Launch Services and the Commercial Crew programs. EGS was established to develop and operate the systems and facilities necessary to process and launch rockets and spacecraft during assembly, transport, and launch. Significant enhancements are continuing at Launch Pad 39B, as the EGS prepares the pad to support



Seen to the right of the iconic Vehicle Assembly Building (VAB), a crane positions the Orion crew access arm (CAA) so it can be attached to the mobile launcher (ML). (NASA/Bill White)

the launch of the SLS for deep space missions and the Journey to Mars.

EGS has helped transform KSC from a historically government-only launch complex to a spaceport that can handle several different kinds of spacecraft and rockets. A key aspect of the program's approach to long-term sustainability and affordability is making processing and launch infrastructure available to commercial and other government customers, distributing the cost among multiple users and reducing the cost of access to space.

*Launch Services Program* – NASA's Launch Services Program (LSP) is responsible for launching uncrewed rockets delivering spacecraft that observe the Earth, visit other planets, and explore the universe — from weather satellites, to telescopes, to Mars rovers and more. The program meets the needs of a customer base that includes NASA's space and Earth science, exploration, technology, and education requirements, as well as support to the national security community, the National Oceanic and Atmospheric Administration (NOAA), and international cooperative partners.

*Vehicle Assembly Building* – The Vehicle Assembly Building (VAB) is the only facility where assembly of a rocket occurred that carried humans beyond low-Earth orbit and on to the Moon. It also served as the final assembly point for space shuttle orbiters to external fuel tanks and solid rocket boosters. One of the largest buildings in the world by area, the VAB covers eight acres, is 525 feet tall, and 518 feet wide.

*Applied Physics Laboratory* – This research facility is located in the Neil Armstrong Operations and Checkout (O&C) building. The lab conducts scientific investigations and develops practical, innovative solutions to problems as they arise in support of ground processing and spaceflight including technical issues involving fluids, heat transfer, material properties, optics, mechanics, and other areas.

For 20 years, the lab supported ground processing for the Space Shuttle Program. The lab invented tools and systems for detecting flaws in the orbiter windows including a light-coupling hand tool to illuminate and highlight defects, a window scanner to map defects and stress areas, and a portable tool to measure surface topography down to a height resolution of one micron.

The lab developed a number of devices over the years. Two items the lab commercialized were a laser-based scaling tool — originally made for the shuttle to measure bird scratches and damage from hail — and an ultrasonic leak detection tool initially created to detect hydrogen leaks in the orbiter.

The lab is responsible for window inspection for Orion, the ISS, and commercial partners in support of current spaceflight operations. Additionally, the lab is developing Solar White, a coating expected to be about 80 times more reflective than anything else currently available. The coating will protect systems from heat radiated from the Sun and may open up new potential for the long-term storage of cryogenics in space.





Heat shield back shell panels are prefitted on the Orion spacecraft inside the Neil Armstrong Operations and Checkout Building high bay. The back shell panels serve as the outer layer of the spacecraft and will protect it against the extreme temperatures of re-entry from deep space. (NASA/Kim Shiflett)

*Electrostatics and Surface Physics Laboratory* – ESPL conducts scientific investigations to protect flight hardware and launch equipment from the phenomenon of electrostatic discharges, commonly known as sparks, since a spark near rocket propellant or other chemicals could be catastrophic. The lab studies lunar and Martian dust and the physics behind the particles' dynamic electrical states. It also develops new technologies that leverage electrostatics to solve problems such as filtering dust from air or repelling dust from surfaces using electrostatic forces.

The ESPL provided electrostatic studies for a number of space shuttle components including hydrogen fuel lines, crew escape life preserver and life raft inflators, thrust vector control actuator blankets, and thermal control system blankets. The lab also provided an electrostatic evaluation some design change recommendations for the Hubble Space Telescope's imaging spectrograph hardware.

In 2012, the lab became part of Swamp Works and started focusing on more in-situ resource utilization work; for example, the ESPL worked jointly with the Granular Mechanics and Regolith Operations lab to test the idea of a heat shield made from space dirt. Making a heat shield in space instead of launching it from Earth could potentially save fuel and launch costs. The lab made rounded bricks out of a lunar simulant, then tested the bricks under extreme heat similar to what a payload would experience entering an atmosphere. The bricks stayed relatively cool on the back, showing that, with more investigation, space dirt might work as a material to thermally protect payloads.

## Research and Technology

Developments by scientists and engineers at KSC are critical to the future success of space exploration and also play important roles in improving the quality of life on Earth.

*Spaceport Command and Control System* – The SCCS is the first new processing and launch software to be developed for NASA

since the space shuttle was retired in 2011. It will operate, monitor, and coordinate the ground equipment for launch of the Space Launch System and Orion spacecraft. The SCCS will comprise a suite of complex software linking the launch team operators with the SLS and Orion in processing areas such as the VAB, Mobile Launcher, and Launch Complex 39B. It will also allow controllers at Kennedy to communicate with astronauts inside Orion, controllers at the Air Force Eastern Range, and other NASA control centers.

*Growing Plants in Space* – On the ISS, astronauts receive regular shipments of a wide variety of freeze-dried and prepackaged meals — resupply missions keep them freshly stocked. To provide astronauts with nutrients on long-duration missions to the Moon and Mars, the Veg-PONDS-02 experiment is currently underway aboard the ISS. The present method of growing plants in space — called Veggie — uses seed bags, or pillows, that astronauts push water into with a syringe. Using this method makes it difficult to grow certain types of “pick and eat” crops beyond lettuce varieties. Crops like tomatoes use a large amount of water, and pillows don't have enough holding capacity to support them. As an alternative to the pillows, 12 passive orbital nutrient delivery system (PONDS) plant growth units are being put through their paces. The PONDS units are less expensive to produce, have more water holding capacity, provide a greater space for root growth, and are a completely passive system — they can provide air and water to crops without extra power.

*Corrosion-Resistant Coating* – Corrosion is a real concern at KSC due to humidity, salt, ultraviolet light, and exhaust from rocket launches. Of special concern are the launch pad and ground support equipment being prepared for the SLS and Orion. KSC developed an environmentally friendly smart coating that could be used to detect and stop corrosion in metal. The coating was recognized by *Tech Briefs* magazine's Create the Future Design Contest as the top winner in the Automotive & Transportation category in 2015. The coating features corro-



A Mars rover concept vehicle operates on an electric motor, powered by solar panels and a 700-volt battery. The rover separates in the middle with the front area designed for scouting and equipped with a radio and navigation provided by the Global Positioning System. The back section serves as a full laboratory that can disconnect for autonomous research. (NASA/Kim Shiflett)





A Zero Launch Mass 3D printer is being tested at the Swamp Works at KSC. The printer can be used for construction projects on the Moon and Mars. It uses pellets made from simulated lunar regolith (dirt) and polymers, enabling astronauts to use resources at their destination instead of taking everything with them. (NASA/Glenn Benson)

sion inhibitors packaged inside tiny micro capsules or micro containers that remain dormant until corrosion begins underneath the coating. The shells of the micro capsules break open and deploy the corrosion inhibitor.

**Flame Suppressant** – A nontoxic environmentally safe flame suppressant does not deplete the ozone, which contributes to stratospheric ozone destruction. The invention consists of water mist that is microencapsulated in a flame-retardant polymer capsule. It uses the small water-containing droplets to retard and suppress a flame while, at the same time, overcomes the known problems associated with the use of such water droplets by themselves (freezing or evaporating).

**Nanotube Printer Ink** – A conductive carbon nanotube ink for inkjet printing combines carbon nanotube inks with other additives, such as metallic nanoparticles, for use in standard inkjet printing. These inks are water-based and can be readily applied to a number of surfaces including paper and textiles.

**Wire Damage Detection** – An in-situ wire damage detection and rerouting system consists of a miniaturized inline connector containing self-monitoring electronics to detect wire faults and determine fault type and fault location on powered electrical wiring. When a damaged or



NASA astronaut Christina Koch initiates the Veg-PONDS-02 experiment on the International Space Station within Veggie by filling the upper reservoir. (NASA/David Saint-Jacques)

defective wire is identified, the system autonomously transfers electrical power and data connectivity to an alternate wire path, limiting damage not only to the core conductor but also to the insulation layer before the core conductor becomes compromised.

**Mobile Robotic Platform** – The Regolith Advanced Surface Systems Operations Robot (RASSOR) Excavator is a tele-operated mobile robotic platform with a unique space regolith excavation capability. Its design allows it to load, haul, and dump space regolith under low-gravity conditions with high reliability. The compact, lightweight unit enables the launch of an efficient, rugged, versatile robotic excavator on precursor landing missions with minimum cost. It can be scaled up and used for terrestrial mining operations in difficult-to-reach or dangerous locations.

### Technology Transfer

The Technology Transfer Office (TTO) at Kennedy Space Center supports commercialization efforts for KSC-developed technologies. The office facilitates the transfer of these technologies to companies, universities, non-profits, other government agencies, and individuals to benefit the U.S. economy and the general public.

Contact the Technology Transfer Office at [KSC-DL-TechnologyTransfer@mail.nasa.gov](mailto:KSC-DL-TechnologyTransfer@mail.nasa.gov); 321-861-7158. Find KSC technologies available for licensing at <https://technology-ksc.ndc.nasa.gov>.

## TECH BRIEFS

www.techbriefs.com

Publisher .....	Joseph T. Pramberger
Editorial Director.....	Linda L. Bell
Editor, Photonics & Imaging Technology.....	Bruce A. Bennett
Digital Editorial Manager.....	Billy Hurley
Associate Editor .....	Edward Brown
Content Strategist, Audience Development.....	Kendra Smith
Production Manager.....	Adam Santiago
Manufacturing Manager.....	Kevin Coltrinari
Creative Director .....	Lois Erlacher
Graphic Designer .....	Annette Murphy
Marketing Director.....	Deborah Rothwell
Marketing Communications Manager.....	Crystal Haylett
Marketing Assistant.....	Dylan Legarda
Audience Development Director.....	Christine Oldenbrook
Audience Development Coordinator.....	Stacey Nelson
Subscription Changes/Cancellations .....	TEB@OMEDA.COM (866) 354-1125

### TECH BRIEFS MEDIA GROUP, AN SAE INTERNATIONAL COMPANY

261 Fifth Avenue, Suite 1901, New York, NY 10016  
(212) 490-3999 FAX (646) 829-0800

Chief Executive Officer.....	Domenic A. Mucchetti
Executive Vice President.....	Luke Schnirring
Technology Director .....	Oliver Rockwell
Systems Administrator.....	Vlad Gadoun
Digital Development Manager.....	Peter Bonavita
Digital Production Manager.....	Howard Ng
Digital Media Associate.....	Md Jaliluzzaman
Digital Production Associate.....	Jerry Aultz
Digital Production Associate.....	Andrew Greenberg
Digital Production Associate .....	Symba Wong
Credit/Collection .....	Felecia Lahey
Accounting/Human Resources Manager.....	Sylvia Bonilla
A/R Credit & Collection Manager.....	Crystal Ortiz
Office Manager .....	Alfredo Vasquez

### TECH BRIEFS ADVERTISING ACCOUNT EXECUTIVES

MA, NH, ME, VT, RI, Eastern Canada .....	Ed Marecki (401) 351-0274
CT.....	Stan Greenfield (203) 938-2418
NJ, PA, DE.....	John Murray (973) 409-4685
TX, LA, OK, MS, AL, TN .....	Ray Tompkins (281) 313-1004
Southeast.....	Bill Ebner (908) 917-6311
NY, OH .....	Ryan Beckman (973) 409-4687
MI, IN, WI .....	Chris Kennedy (847) 498-4520 ext. 3008
MN, ND, SD, IL, KY, MO, KS, IA, NE, Central Canada.....	Bob Casey (847) 223-5225
Northwest, N. Calif., Western Canada.....	Craig Pitcher (408) 778-0300
S. Calif., AZ, NM, Rocky Mountain States.....	Tim Powers (424) 247-9207
Europe — Central & Eastern .....	Sven Anacker 49-202-27169-11 Joseph Heeg 49-621-841-5702
Europe — Western .....	Chris Shaw 44-1270-522130 886-4-2329-7318
Integrated Media Consultants.....	Patrick Harvey (973) 409-4686 Angelo Danza (973) 874-0271 Scott Williams (973) 545-2464 Rick Rosenberg (973) 545-2565 Todd Holtz (973) 545-2566 Christian DeLalla (973) 841-6035 Casey Hanson (973) 841-6040
Reprints.....	Jill Kaletha (219) 878-6068

# Advertisers Index

Advertisers listed in bold-face type have banner ads on the *Tech Briefs* Web site — [www.techbriefs.com](http://www.techbriefs.com)

Advertiser	Page	Web Link	Advertiser	Page	Web Link
Accurate Screw Machine	3	<a href="http://www accuratescrew.com">www accuratescrew.com</a>	OFS	36, 85	<a href="http://www.ofsoptics.com">www.ofsoptics.com</a>
AirBorn Inc.	29, 70	<a href="http://www.airborn.com">www.airborn.com</a>	OMS Motion Inc.	22, 85	<a href="http://www.OMSmotion.com">www.OMSmotion.com</a>
<b>Allied Electronics</b>	<b>Cover 4</b>	<b><a href="http://www.alliedelec.com">alliedelec.com</a></b>	PhotoMachining, Inc.	89	<a href="http://www.photomachining.com">www.photomachining.com</a>
AllMotion, Inc.	42	<a href="http://www.allmotion.com">www.allmotion.com</a>	Pickering Interfaces	15, 78	<a href="http://pickeringrelay.com">pickeringrelay.com</a> <a href="http://pickeringtest.com">pickeringtest.com</a>
American Grippers Inc.	88	<a href="http://www.agi-automation.com">agi-automation.com</a>	Pico Electronics	19, 79	<a href="http://www.picoelectronics.com">www.picoelectronics.com</a>
AutomationDirect	21	<a href="http://www.automationdirect.com">automationdirect.com</a>	PulseR Ruggedized Solutions	1, 80	<a href="http://www.pulseruggedized.com">www.pulseruggedized.com</a>
Century Spring - MW Industries	3	<a href="http://www.centuryspring.com">www.centuryspring.com</a>	SCHURTER, Inc.	33	<a href="http://www.schurter.com">schurter.com</a>
Click Bond, Inc.	41, 83	<a href="http://www.clickbond.com">www.clickbond.com</a>	SEMI	87	<a href="http://www.semi.org/events">www.semi.org/events</a>
Coilcraft CPS	46	<a href="http://www.coilcraft.com">coilcraft.com</a>	Silicon Sensing Systems Ltd.	89	<a href="http://www.siliconsensing.com/general">www.siliconsensing.com/general</a>
Computational Simulation Software, LLC	13	<a href="http://www.csimsoft.com">csimsoft.com</a>	Specialty Coating Systems, Inc.	39	<a href="http://www.scscoatings.com/space">scscoatings.com/space</a>
<b>COMSOL, Inc.</b>	<b>9, 89, Cover 3</b>	<b><a href="http://www.comsol.com">comsol.com</a></b>	Spectrum Instrumentation GmbH	27	<a href="http://www.spectrum-instrumentation.com">www.spectrum-instrumentation.com</a>
Cornell Dubilier	31	<a href="http://www.cde.com/MLSHslimpack">cde.com/MLSHslimpack</a>	The Lee Company	23, 72	<a href="http://www.TheLeeCo.com">www.TheLeeCo.com</a>
Cotronics Corp.	81	<a href="http://www.cotronics.com">www.cotronics.com</a>	Transtector Systems	2	<a href="http://www.transtector.com">transtector.com</a>
CS Hyde Company	43, 83	<a href="http://www.cshyde.com">www.cshyde.com</a>	Zeus, Inc.	35, 82	<a href="http://www.zeusinc.com">zeusinc.com</a>
<b>Digi-Key Electronics</b>	<b>Cover 2, 73</b>	<b><a href="http://www.DIGIKEY.COM">DIGIKEY.COM</a></b>	Zurich Instruments AG	7	<a href="http://www.zhinst.com">www.zhinst.com</a>
Dynabrade Inc.	74	<a href="http://www.dynabrade.com">www.dynabrade.com</a>	<b>Photonics &amp; Imaging Technology</b>		
Edmund Optics	6	<a href="http://www.edmundoptics.com">www.edmundoptics.com</a>	Aerotech Inc.	Cover 4	<a href="http://www.aerotech.com">aerotech.com</a>
Helical Products Company, Inc.	37	<a href="http://www.heli-cal.com">www.heli-cal.com</a>	Asphera Inc.	19	<a href="http://www.asphera.co">www.asphera.co</a>
HORIBA	28	<a href="http://www.horiba.com">www.horiba.com</a>	Chroma Technology Corp.	3, 16	<a href="http://www.chroma.com">chroma.com</a> <a href="http://www.chromanorth.com">89north.com</a>
Hunter Products, Inc.	38	<a href="http://www.hunterproducts.com">www.hunterproducts.com</a>	Diverse Optics Inc.	5, 18	<a href="http://www.diverseoptics.com">www.diverseoptics.com</a>
Kaman Precision Products	12	<a href="http://www.kamansensors.com">kamansensors.com</a>	<b>Master Bond Inc.</b>	<b>13, 28</b>	<b><a href="http://www.masterbond.com">www.masterbond.com</a></b>
KHK USA Inc.	45, 84	<a href="http://www.khkgears.us">khkgears.us</a>	Precision Glass & Optics	Cover 2	<a href="http://www.pgo.com">www.pgo.com</a>
Krohn-Hite Corporation	89	<a href="http://www.krohn-hite.com">www.krohn-hite.com</a>	Rosendahl Nextrom	1, 17	<a href="http://www.rosendahlnextrom.com">www.rosendahlnextrom.com</a>
Massa Products Corporation	20, 84	<a href="http://www.massa.com">www.massa.com</a>	Spectrum Scientific, Inc.	7, 18	<a href="http://www.ssiptics.com">www.ssiptics.com</a>
<b>Master Bond Inc.</b>	<b>38, 89</b>	<b><a href="http://www.masterbond.com">www.masterbond.com</a></b>	<b>Supplement to Tech Briefs: 2, 3, 4</b>		
Michigan Economic Development Group	5	<a href="http://www.michiganbusiness.org/pure-opportunity">michiganbusiness.org/pure-opportunity</a>	<p><i>Tech Briefs</i>, ISSN 0145-319X, USPS 750-070, copyright © 2019 in U.S. is published monthly by Tech Briefs Media Group, an SAE International Company, 261 Fifth Avenue, Suite 1901, New York, NY 10016. The copyright information does not include the (U.S. rights to) individual tech briefs that are supplied by NASA. Editorial, sales, production, and circulation offices at 261 Fifth Avenue, Suite 1901, New York, NY 10016. Subscription for non-qualified subscribers in the U.S. and Puerto Rico, \$100.00 for 1 year. Single copies \$30.00. Foreign subscriptions one-year U.S. Funds \$195.00. Digital Copies, \$24.00 for 1 year subscription. Remit by check, draft, postal, express orders or VISA, MasterCard, and American Express. Other remittances at sender's risk. Address all communications for subscriptions or circulation to <i>Tech Briefs</i>, 261 Fifth Avenue, Suite 1901, New York, NY 10016. Periodicals postage paid at New York, NY and additional mailing offices.</p> <p>POSTMASTER: Send address changes and cancellations to <i>Tech Briefs</i>, P.O. Box 3525, Northbrook, IL 60062.</p>		
Micro-Epsilon Messtechnik GmbH	47	<a href="http://www.micro-epsilon.com">www.micro-epsilon.com</a>			
Mini-Systems, Inc.	89	<a href="http://www.Mini-SystemsInc.com">www.Mini-SystemsInc.com</a>			
MW Industries Aerospace Solutions	71	<a href="http://www.mwaerospacesolutions.com">mwaerospacesolutions.com</a>			
National Technical Systems (NTS)	25, 77	<a href="http://www.nts.com">www.nts.com</a>			
New England Wire Technologies	11, 75	<a href="http://www.newenglandwire.com">www.newenglandwire.com</a>			
Novotechnik	44	<a href="http://www.novotechnik.com">www.novotechnik.com</a>			
NTK Cutting Tools USA	51, 76	<a href="http://www.ntkcuttingtools.com">www.ntkcuttingtools.com</a>			
NVT Group	48, 86	<a href="http://www.nvtgroup.com">www.nvtgroup.com</a>			





# SPINOFF

Spinoff is NASA's annual publication featuring successfully commercialized NASA technology. This commercialization has contributed to the development of products and services in the fields of health and medicine, consumer goods, transportation, public safety, computer technology, and environmental resources.

## Apollo 11 History Archive Helps Virtual Reality Program Come to Life

NASA historical data ensures accuracy of Apollo 11 VR experience.

Imagine yourself in the cramped cockpit of the Apollo spacecraft heading to the Moon. Look around to see Earth out the window. Reach out to the control panel. This is Apollo 11 VR, a virtual reality experience that enables users to relive the Apollo 11 mission and take some of the first steps on the Moon. The company behind the project — Immersive VR Education of Waterford, Ireland — calls it an “experience” or “a new type of documentary.”

The project required extensive study on the part of developers, according to Immersive VR Education CEO David Whelan. And it wouldn't have been possible without the vast amounts of information NASA posts on publicly accessible websites.

Stephen Garber, one of two historians at NASA Headquarters who maintains the Agency's historical websites, coordinates with volunteers to offer information on a variety of large and small projects, but the Apollo mission pages — especially the Lunar Surface Journal — are among the most popular NASA archives online.

Whelan said these repositories provided his company with extremely detailed design plans that illustrated the interiors of the spacecraft, the lander, and the command module. Apollo 16 astronaut Charlie Duke got to experience an early version of the software before its release, and his observations helped developers improve the accuracy of the control panel for the final release.



The combination of a virtual reality environment and NASA data and media resources helped the company make its app a larger-than-life experience.

“We put him back where he sat in the 1970s, and based on his feedback, we changed a few things,” said Whelan, who believes every switch and dial on the control panel is now exactly accurate.

On NASA's website, the team found a spectacular photo mosaic of the initial landing site created from many photos taken on earlier Apollo flights stitched together. The developers essentially drew their virtual world on top of that image.

“When players look out of the lander, they see every crater and every valley exactly as the astronauts would have seen them,” said Whelan. “Everything is cataloged really well,” he said of NASA's websites. “I would have thought we'd have to contact NASA quite a lot more to get a lot of information that was actually freely available.”

Apollo 11 VR also includes original audio heightened with music that makes the experience feel more momentous. “We find that if you get an emotional reaction from somebody, the experience sticks with them a lot more,” Whelan said.

Immersive VR Education creates virtual classrooms. The company's flagship product, Engage, lets up to 30 people participate in real time in a virtual lecture or meeting from anywhere in the world. Such events can then be posted online for later “experiencing.” The company built

Apollo 11 VR to demonstrate a new way of teaching and learning history. “We're trying to show the general public that virtual reality isn't just for video games and entertainment,” Whelan said. “It's also very useful for education.”

Though popular as a paid app, the program is free for teachers. Enthusiasts can buy it for the Oculus Rift, HTC Vive, and Sony PlayStation virtual reality headsets. It can also be viewed on a regular computer monitor, but much of the impact is lost without the more sophisticated equipment.

In its first year, Apollo 11 VR was purchased more than 40,000 times and that was before it was available for PlayStation headsets. Immersive VR Education went on to develop an entirely free Mars Rover experience as a demonstration of their Engage platform and hopes to start projects about other Apollo missions, as well as a Space Shuttle series around deploying and repairing the Hubble Space Telescope.

“We construe our mission broadly in that we try to cover the panoply of activities that NASA is involved in,” Garber said. “Clearly, people are still interested in the Apollo program almost 50 years after it ended.”

Visit [https://spinoff.nasa.gov/Spinoff2018/cg\\_1.html](https://spinoff.nasa.gov/Spinoff2018/cg_1.html).



Apollo 11 VR puts users in the pilot seat of the command module.



# COMSOL CONFERENCE 2019 BOSTON

OCTOBER 2-4  
BOSTON MARRIOTT NEWTON



## Explore the latest innovation and techniques in **multiphysics simulation.**

Join us at the COMSOL Conference 2019 where you'll get a firsthand look at how innovators in your field are adopting multiphysics modeling and simulation applications, learn new technical skills, and gain inspiration for your next project.

**MINICOURSES | PANEL DISCUSSIONS | USER PRESENTATIONS | EXHIBITION**

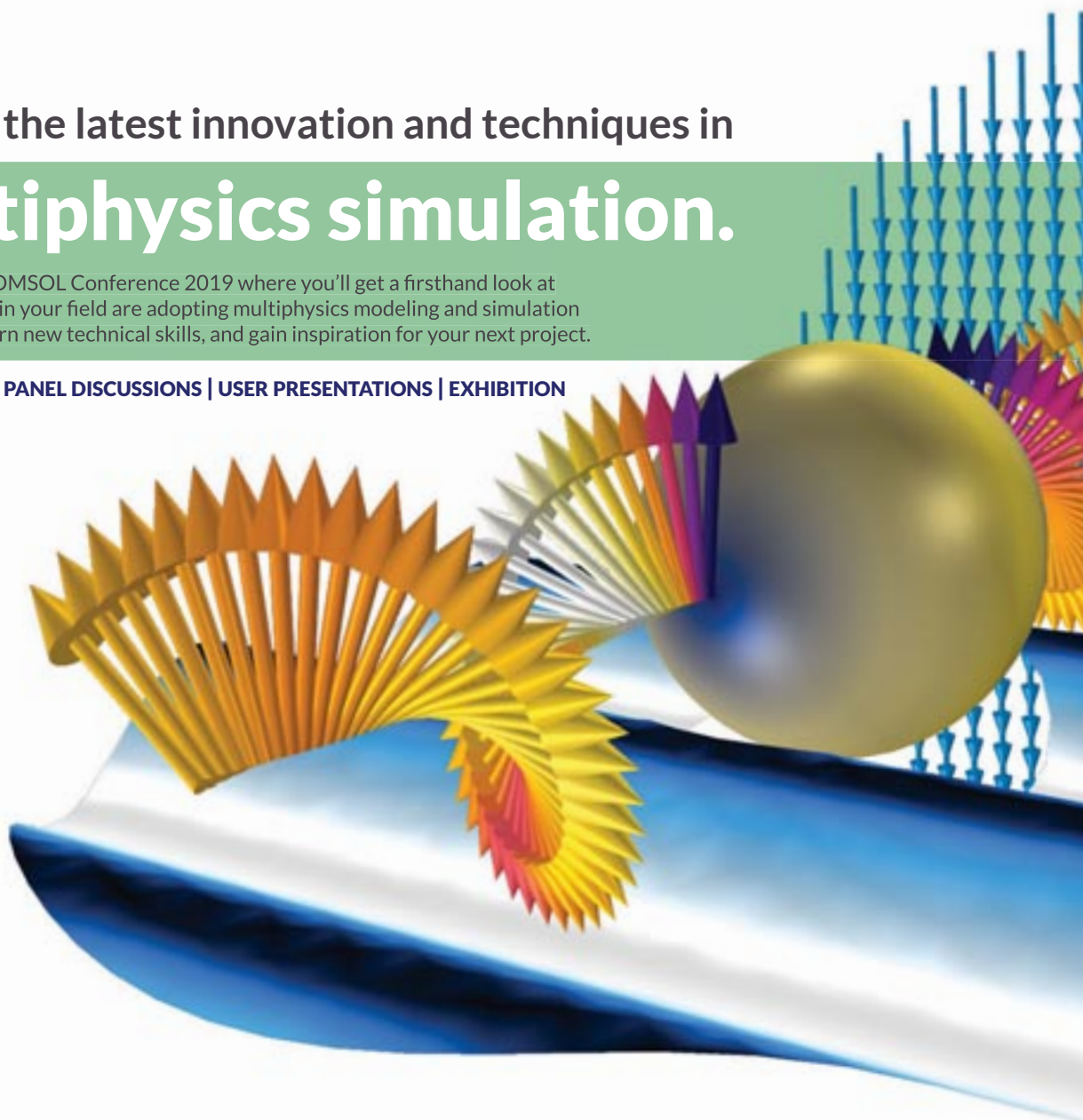

► Learn more and register today at [comsol.com/conference](https://www.comsol.com/conference)

 COMSOL

Free Info at <http://info.hotims.com/72995-779>





**ALLIED**  
ELECTRONICS & AUTOMATION

# SENSE

Is it cold in here or did your boss just walk in?

**We have a sensor for that.**



**Shop Allied. It makes sense.**

 **1.800.433.5700**

© Allied Electronics & Automation, 2019

Get your A&C fill at  **alliedelec.com**

Free Info at <http://info.hotims.com/72995-780>

**smiths interconnect**  
bringing technology to life



Intro

Cov

ToC



# COMSOL NEWS

THE MULTIPHYSICS SIMULATION MAGAZINE

## Competing in Hyperspeed

Students travel from Switzerland to California with multiphysics

PAGE 14a

# Competing in Hyperspeed

Whether it's a competition entered by a group of students or the pressure of staying competitive in today's cutthroat marketplace, multiphysics simulation speeds up the workflow for engineers everywhere.

Very few ideas or products come to fruition through the work of one single person. Collaboration is key when designing products that will change our future in unforeseeable ways. In this year's issue of COMSOL News we find that everyone from students to professionals are working together. Both with each other and their customers to uncover the next development in their design work. Ingraining a strong sense of teamwork in young engineers will enable them to outperform their peers once they arrive in the workforce. Beyond academia it is imperative to have both the technical skills to do your job, and as well as the communication skills to work well with others.

This issue informs readers about the teamwork involved in a variety of multiphysics projects from electromagnetic flowmeters at ABB, and radiant heating and cooling at Viega, to simulation applications that help us pave the road towards democratization. Our cover story features students at EPFL who teamed up on this multidisciplinary project to study the fluid, electrical, mechanical, and materials science phenomena required to design and build their hyperloop pod.

We are excited to present to you all of the COMSOL users who shared their expertise and insights throughout the following pages.

Enjoy!



Natalia Switala  
COMSOL, Inc.

## INTERACT WITH THE COMSOL COMMUNITY

**BLOG** [comsol.com/blogs](https://comsol.com/blogs)

**FORUM** [comsol.com/forum](https://comsol.com/forum)

**LinkedIn™** [linkedin.com/company/comsol-inc](https://linkedin.com/company/comsol-inc)

**Facebook®** [facebook.com/multiphysics](https://facebook.com/multiphysics)

**Twitter®** [twitter.com/@COMSOL\\_Inc](https://twitter.com/COMSOL_Inc)

We welcome your comments on COMSOL News; contact us at [info@comsol.com](mailto:info@comsol.com).

# COMSOL NEWS

© 2019 COMSOL. COMSOL, COMSOL Multiphysics, Capture the Concept, COMSOL Desktop, COMSOL Server, and LiveLink are either registered trademarks or trademarks of COMSOL AB. All other trademarks are the property of their respective owners, and COMSOL AB and its subsidiaries and products are not affiliated with, endorsed by, sponsored by, or supported by those trademark owners. For a list of such trademark owners, see [www.comsol.com/trademarks](https://www.comsol.com/trademarks).

LinkedIn is a trademark of LinkedIn Corporation and its affiliates in the United States and/or other countries. Facebook is a registered trademark of Facebook, Inc. TWITTER, TWEET, RETWEET and the Twitter logo are trademarks of Twitter, Inc. or its affiliates. Google+ is a trademark of Google LLC.

# CONTENTS

## RADIANT HEATING & COOLING

4a | The Unseen Wonders of Radiant Heating, Cooling, and Snowmelting



## SIMULATION APPLICATIONS

7a | Democratizing Simulation with Simulation Applications

## DIGITAL TWINS

10a | ABB's Electromagnetic Flowmeter Digital Twin Drives Performance

## HYPERLOOP POD DESIGN

14a | Inspiring Young Engineers to Design for the Future at EPFL

## OPTICAL ANTENNA DESIGN

16a | Virtually Optimizing Metasurface Topology with a Genetic Algorithm



## ON THE COVER

Students from EPFL routing their hyperloop pod's power cabling. Image courtesy: EPFL



# FEATURES

## THERMAL MANAGEMENT OF BUILDINGS

19a | Complex Fenestration System for Energy Efficiency

## SIMULATION APPLICATIONS FOR TEACHING

22a | Adding Quantitative Systems Pharmacology to the Pharmaceutical Sciences Curriculum

## SEISMIC ENGINEERING ANALYSIS

24a | Seismic Safety Evaluations of Dams with Numerical Simulation

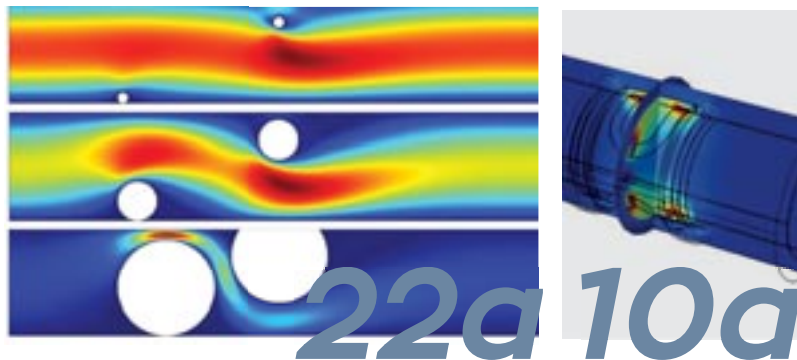
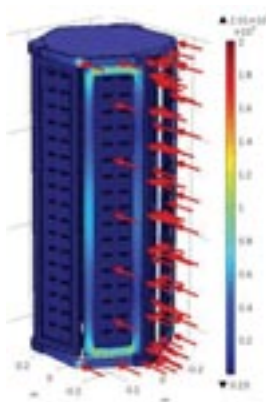

## SMART CITIES

27a | Multiphysics Simulation Drives Smart City Technology

## BATTERY DESIGN

30a | Keeping Dendrites at Bay with Numerical Simulation

## GUEST EDITORIAL

32a | Collaboration is Key for Individualized Medicine

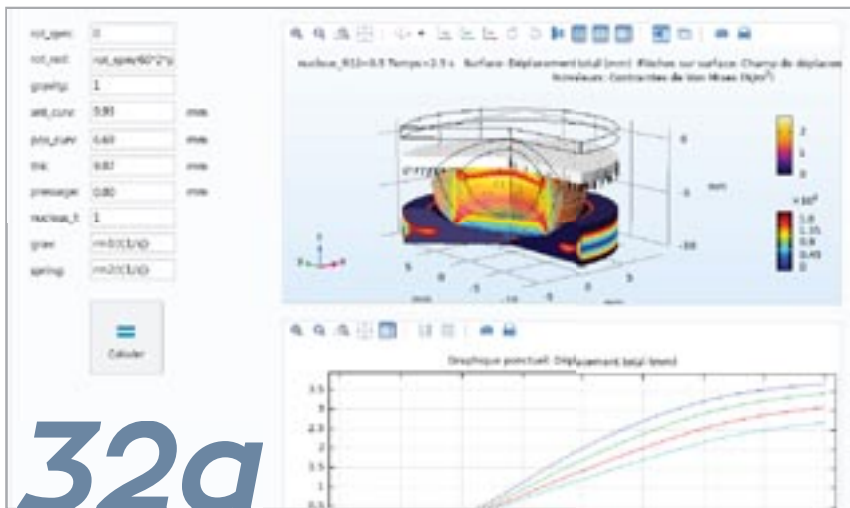

Intro

Cov

ToC



# THE UNSEEN WONDERS OF RADIANT HEATING, COOLING, AND SNOWMELTING

Engineers at Viega use simulation applications to share results of finite element modeling with their customers, offering them valuable engineering support as they design radiant heating and cooling systems for both residential and commercial applications.

by **NICOLAS HUC**

Imagine the race against time that emergency workers compete in on a daily basis, as well as, the panic, stress, adrenaline, and rush that comes with driving an ambulance or emergency helicopter. Now, imagine the emergency worker arriving on scene in the dead of winter, only to find the helicopter landing zone covered in ice and snow. Under such intense time constraints, can this area be shoveled quickly enough? What about emergency vehicles slipping on hidden ice? Is it worth the risk to be held at the mercy of these arctic conditions with such high stakes?

Fortunately, there is technology that can safeguard against these issues, and it is becoming increasingly prominent: hydronic snowmelt systems. Piping encased in a panel (typically concrete) allows for warm water to circulate throughout the area requiring snowmelt. With regards to an emergency situation, when designed properly, the system will prevent the buildup of ice and snow, thus alleviating the need for manual cleanup.

When it comes to applications where heating or cooling is required, radiant floor systems use a similar piping design to control space temperature and comfort by regulating the flow and temperature of water in tubing installed beneath the floor (Figure 2).

Viega, a company that both designs and manufactures radiant heating systems, helps tackle situations where special methods of temperature control are needed.



**FIGURE 1.** Emergency helicopter hangar on a snow-melted apron by Viega.

## ⇒ RADIANT FLOOR SYSTEMS

Although they have existed in various forms since the Roman Empire, radiant systems are turning out to be particularly useful in modern society for both commercial and residential applications. Radiant heating is used not only for floor warming applications but also to control the temperature of a room. When the floor can be kept at a warm temperature, it will give off thermal radiation in the room. This radiation will only be absorbed by opaque surfaces; in other words, it will be absorbed by our bodies (but not the air), creating a feeling of warmth.

A tubing layout is designed in a specific configuration by Viega. The tubing is then laid beneath the flooring in a panel system. Hot water (or cold water in cooling applications) runs through the tubing and heats the surrounding material. The uppermost surface of the floor then radiates heat

to the rest of the room. This is just like when you move from a shady spot to a sunbathed one; although the air temperature is the same, your skin feels much warmer because of the absorption of thermal radiation. The special tubing is made of a cross-linked, high-density polyethylene (known commonly as PEX). The cross-linking benefits are two-fold: It provides the capability to withstand higher temperatures and pressures and increases its resistance to stress cracking. These tubes are vigorously tested, adhering to standards for temperature and pressure ratings, minimum bending radii, and pipe wall thickness.

The recent emergence of environmental consciousness and energy efficiency at the forefront of building design has contributed strongly to the increased popularity in radiant heating. Radiant heating systems pair quite well with modern, high-efficiency water boilers, and since they don't circulate air



and utilize lower water temperatures than a baseboard system (115°F vs. 180°F), they optimize the energy consumption. The water temperature in the tubing distribution is simply controlled by the opening and closing of valves and even yields a more constant temperature throughout the room.

### ⇒ SYSTEM DESIGN

Brett Austin, supervisor of heating and cooling design at Viega, uses the COMSOL Multiphysics® software to design a system to meet their customers' needs. "COMSOL® supplements our heating and cooling design and layout program," Austin says. "We draw the layout on floor plans, move it into COMSOL, and eventually share it with customers. Simulation allows us to provide engineering data to support our designs." When a project is proposed to them, a mechanical engineer from the site provides requirements for heating and cooling outputs, structural specifications, floor covering materials, and usually a range of acceptable water temperatures. They then use simulation to determine tube placement and spacing, temperature distributions (Figure 3), and air-side requirements to make sure the customers' needs are met. COMSOL is primarily helpful for nonstandard applications where there is multidirectional output or more complex structures," Austin says.

Viega truly benefits from multiphysics simulation through the use of simulation applications and COMSOL Server™ to share them with their customers. When Viega's team is at meetings with prospective customers, they can now quickly adjust parameters, like water temperature or tubing diameter, and show the output of the heating or cooling system on the spot. "Prospective customers often have many initial questions involving multiple iterations," Austin explains. "But the simulation applications allow us to go above and beyond and offer them the invaluable service of visualization. It is a great tool that allows us to share data virtually anywhere in the world from our office."

### ⇒ ARTIC

In environments like Southern California, cooling contributes more to comfort

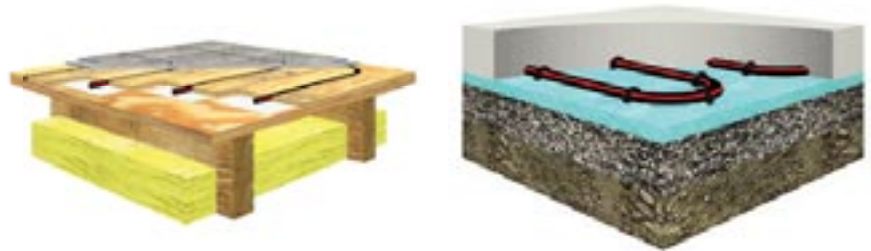

**FIGURE 2.** Radiant tubing in climate panel (left). Radiant tubing in concrete (right).

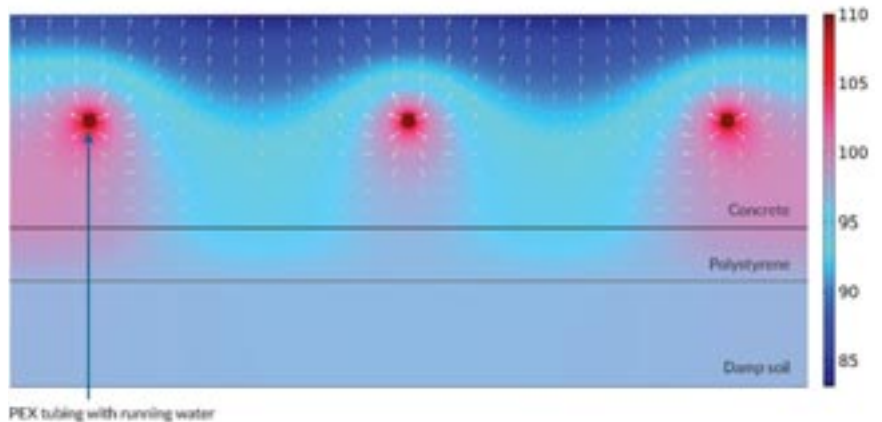

**FIGURE 3.** Cross-sectional temperature distribution of a radiant heating system. The arrows denote the direction of the conductive heat flux, showing the rate of heat transfer to the upper surface of the floor and thus the air above. Temperatures are shown in °F.

than heating. That's why the Anaheim Regional Transportation Intermodal Center (ARTIC, Figure 4) came to Viega about installing a radiant cooling system. Because of the massive size of the building, a forced-air circulation system would be near impossible to achieve and hopelessly expensive. Once again, the team underwent the task of modeling smaller sections of flooring and extrapolating the data to the entire layout. This scenario, however, had some added difficulty and required quite the balancing act from Austin. For starters, because of the dome-shaped structure and high amount of window space (Figure 5), there were abnormally high solar gains that added significant heat energy to the building. The cooling capacity, therefore, had to be very high to counteract this. On the flip side, because of constraints from the engineers on the ARTIC side, the water temperatures in the tubing had to be much lower than usual cooling systems (50°F vs. 58°F); but as temperatures neared dew point at the surface of the floor in some areas that had closely

spaced tubing, Viega wanted to ensure peace of mind to the customer that condensation was not a concern.

Using COMSOL Multiphysics, they were able to determine what to do to prevent condensation from forming; installing a thin layer of insulation around the pipe. "We worked out a solution with the onsite engineer to add an insulation layer on top of the supply tubing to slightly reduce the output," Austin says. "It seems counterintuitive, but in this case, it prevents condensation in areas that had closely spaced tubing due to construction constraints." Additionally, on other projects, they have used COMSOL to run time-dependent simulations to help develop a control strategy where the slabs in the floor are cooled overnight to conserve energy. The chilled water is run throughout the night, cooling the concrete to a low temperature. In the morning, the water is turned off and the floor temperature stays cool for the remainder of the day. This contributes strongly to the reduction of necessary cooling power. Simulation was used to see how long the output will





**FIGURE 4.** The Anaheim Regional Transportation Intermodal Center (ARTIC).

continue throughout the day and if this is a feasible strategy.

⇒ **SUN VALLEY SKI RESORT**

Even though snow-melting systems can act as a critical safety feature for emergency entrances and helicopter landing pads, they can be equally as useful at the other end of the spectrum: luxury. High-end ski resorts place extreme value on their customers' comfort, and a sophisticated and reliable snow-melt system is essential to their experience. In a snow-melt system, the ground is kept at a warm temperature, which continuously melts snow and ice.

When Sun Valley Ski Resort, located in Ketchum, Idaho, came to Viega, Austin knew how sizeable a task they were about to undertake. The ski resort wanted to install a radiant snow-melting system throughout the entire resort, requiring more than 60,000 square feet of walk areas and driveways. To deal with such a large project using simulation, Austin and his team had to model sections of the system. "Fortunately, there are similar types of panels throughout most jobs," he explains. "We used our internal program to draw out a section in a CAD format. Then we'd draw a small cutpiece in the software, specify the radiant panel material properties and water temperatures, and then run the simulation." Simulation applications made it seamless to present the results to



**FIGURE 5.** Top: ARTIC with radiant heating system installed, prior to the actual flooring being laid. Bottom: End result of the inside of ARTIC.

Sun Valley representatives and played a major part in completing this job.

Sun Valley Ski Resort benefitted tremendously from Viega's design and installation. All pathways and areas with high foot traffic were involved (Figure 6). As it was not always feasible to plow or shovel these areas, another method of snow removal was needed. A snow-melt system such as this minimizes any cleanup, reduces maintenance, and contributes to a professional appearance as there is no need for salt or chemicals.



**FIGURE 6.** The tubing installed at Sun Valley Ski Resort in Idaho.

It also, most importantly, adds an extra level of safety and reduces liability by allowing for "ice-free" zones.

⇒ **CONTINUING WITH COMSOL SERVER™**

COMSOL Server has provided a robust solution to couple Viega's services with their sales team. "COMSOL has given much added value to our work and extended finite element modeling to our sales team," Austin says. "It was very intuitive and easy to pick up the software and we plan on using more coupled physics interfaces in the future to increase our modeling capabilities." ❖



The team at Viega. From left to right: Liam Collins, Associate Radiant Design Engineer; Travis Simoneau, Associate Radiant Design Engineer; Josef Marcum, Radiant Design Engineer; and Brett Austin, Supervisor, Heating and Cooling Design.

# DEMOCRATIZING SIMULATION WITH APPLICATIONS

Simulation applications (and the ability to distribute them) benefit organizations by making modeling accessible to a wider range of engineers, colleagues, and customers.

by **THOMAS FORRISTER**

Simulation is a powerful tool that enables users to save time and money by studying physics phenomena within designs to predict operating conditions before prototyping. However, computational modeling is often left to the simulation specialist, which can limit resources and production within a company. While other team members may not be experts in simulation, their insights can be invaluable to research, design, and manufacturing processes.

Extending the reach of multiphysics simulation enables companies to get higher-quality products to market faster and cheaper than by developing iteration after iteration of a prototype. By creating and distributing simulation applications, specialists can include nonexperts in simulation in the process, demystifying it and breaking down barriers within an organization so that there is more room for collaboration, prediction of outcomes, innovation, and optimization.

At Veryst Engineering, AltaSim Technologies, and GLL Bio-Med Analytics, building and distributing applications helps make their customers' design workflows more efficient.

## ⇒ APPLICATION DEVELOPMENT AND DISTRIBUTION MADE EASY

Applications enable anyone to test parameters and run repeated analyses without a simulation specialist. This larger group of customers or colleagues without engineering backgrounds can make quick, informed decisions with

confidence. This way, teams can work together more effectively.

To get an overview of the workflow from model to application, a simulation expert will start by creating a model in COMSOL Multiphysics®. Then, the expert can use the Application Builder in COMSOL Multiphysics to turn the model into an application. Applications can be created in minutes using drag-and-drop functionality. The result is a specialized interface with restricted inputs and outputs, so that the end user focuses only on the parameters pertinent to their work.

"The application development process itself is very easy and user friendly," says

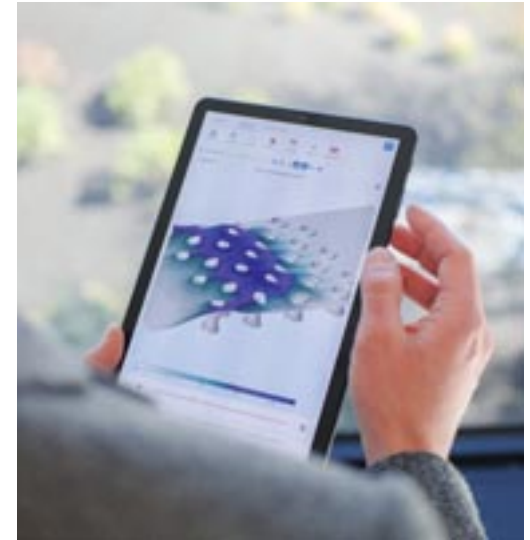

**FIGURE 1.** Users can access applications via COMSOL Server™ and run them on a web browser or client.

Nagi Elabbasi from Veryst Engineering, a consulting firm that offers simulation expertise to customers. He added that applications have a lot of functionality, and for Veryst, they are also a good marketing tool. As Elabbasi explained, "In the applications, you have access to extensive Java® functionality," which means that Veryst can link applications to their material library, PolyUMod, allowing for even more advanced application development to share with their customers.

To give collaborators access to

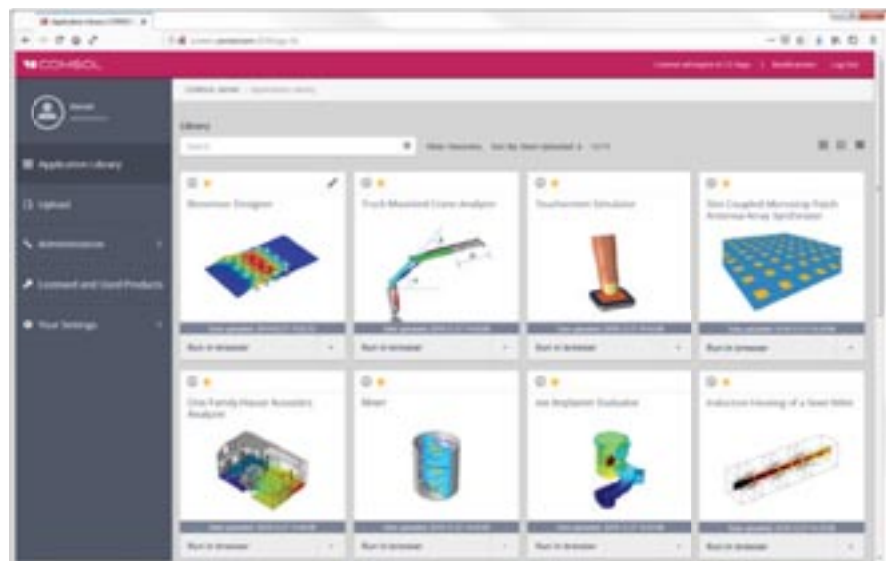

**FIGURE 2.** Applications and their usage can be managed using COMSOL Server™.

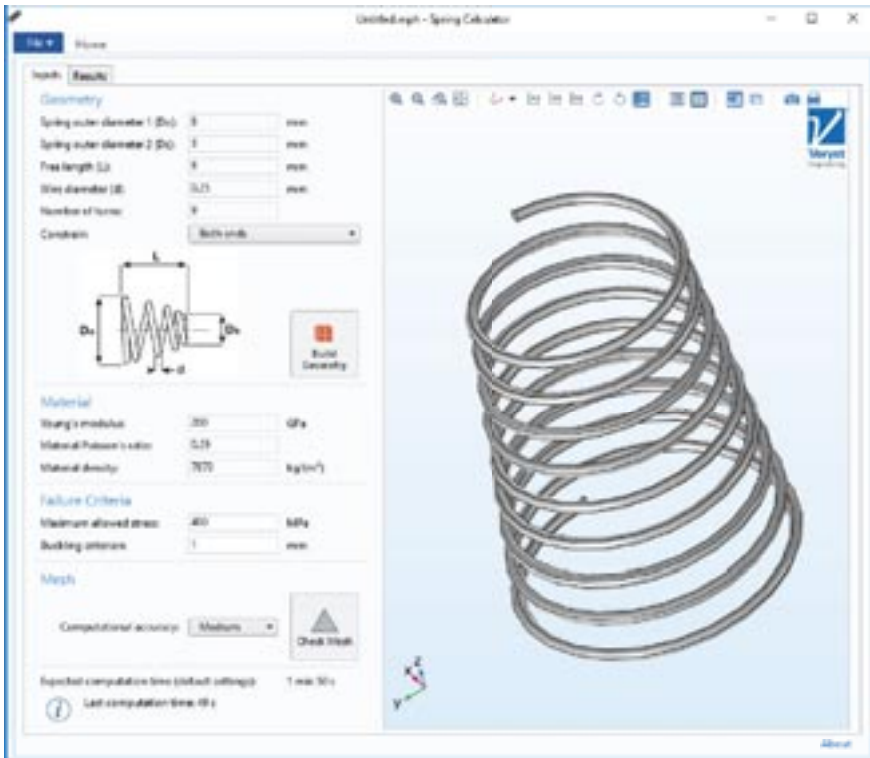

FIGURE 3. A spring calculator application. Image courtesy Veryst Engineering.

applications, there are two methods: compiling standalone executable files or distributing them via an application-management tool. As the name implies, COMSOL Compiler™ is used for creating compiled applications that can be run without a COMSOL® software license on Windows®, Linux®, or macOS. COMSOL Server™ is the choice for those who want to upload and manage applications for their organization and let their application users run simulations via web

browser or client (Figures 1–2).

⇒ **PRESENTING SIMULATION APPLICATIONS AS CUSTOMER SOLUTIONS**

The ways in which consultants use simulation applications with their customers varies. For instance, GLL has received positive feedback from their customers about how applications allow even those without a physics background to run analyses. "You can see a light

going on in their head," says Gary Long of GLL, "when they realize they can produce their own simulations and results."

Sometimes, a customer realizes the possibilities opened up by applications after working with a model developed for them. In Veryst's experience, customers will "realize how the model is useful to them, want to use it internally, and then they see how an application can help them do that," says Elabbasi, adding that the more the awareness of applications spreads, the earlier they will be able to introduce applications when working with customers.

At AltaSim, applications come into play after learning more about what their customers need. "We go through a lot of discovery with our clients to understand what it is, exactly, that they're looking for," says Kyle Koppenhoefer of AltaSim, "and if we find some key parameters, then we typically suggest an application."

⇒ **BUILDING SPECIALIZED APPLICATIONS TO MEET A VARIETY OF CUSTOMER NEEDS**

Even the most complex models can translate into easy-to-use interfaces (applications). Veryst's customers use applications to simulate design variations and perform parametric studies and sensitivity analyses, which "helps them focus on their core expertise of improving the product," says Elabbasi, "and not worry about the simulation settings." Some of Veryst's customers just use applications as interactive model viewers

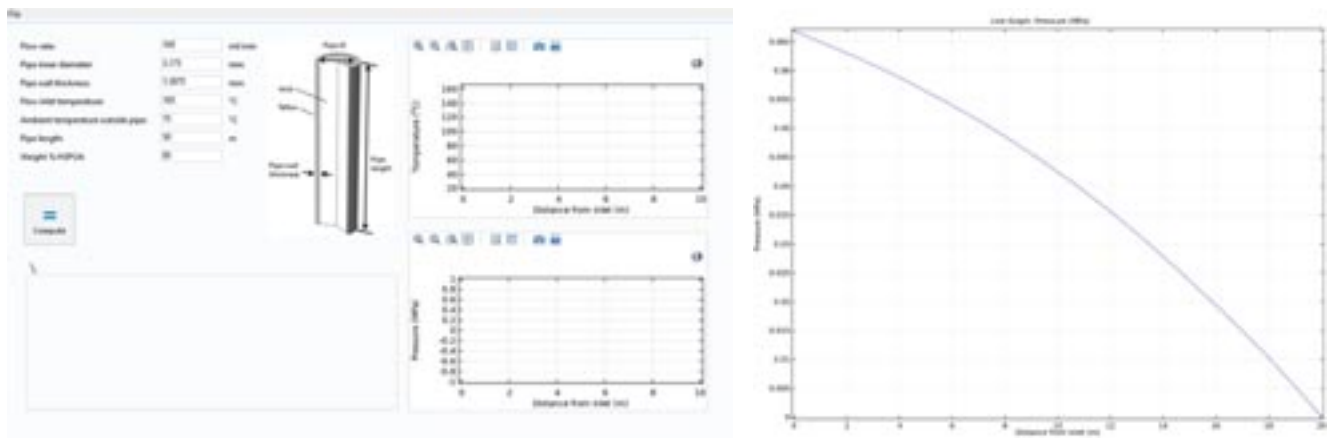
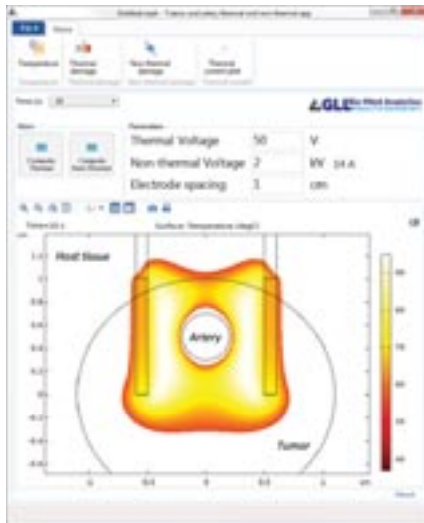

FIGURE 4. An application can be built with restricted inputs (left) and outputs (right) for ease of use. Image courtesy AltaSim Technologies.



**FIGURE 5.** Two simulations in one application: a thermal and nonthermal tumor ablation application created by Gary Long of GLL. Image courtesy GLL.

that enable them to visualize model results in 3D, including rotating the model, looking at results at different cross-sections or at different times, and more (Figure 3). That helps them better understand the model predictions.

Applications enable organizations' internal simulation experts to focus on more advanced modeling projects by distributing applications to other teams. Koppenhoefer says

that applications give field engineers a better understanding of how their designs operate, so they are better able to make design decisions.

AltaSim assists with their customers' challenge of reducing rework. For example, variations in factors like temperature and flow rate make it difficult to accurately predict a device's real-world behavior, leading to designs that have to be continuously reworked. This process can be greatly reduced with applications, because

**“Customers will realize how the model is useful to them, want to use it internally, and then they see how an application can help them do that.”**

— NAGI ELABBASI, VERYST ENGINEERING

engineers from a range of specialties can run as many tests as they need, leading to increased productivity and revenue. (Figure 4)

Many of GLL's customers are medical device startups that often perform their own experiments. GLL simulates these experiments to demonstrate the accuracy of modeling to their customers. "It's very powerful to see the [simulation] results and compare them to experimental results," says Long. They then build applications from the validated models to get simulation engineers, application users, and other team members (often doctors) on the same page by visualizing simulation results in real time.

GLL built a medical device application (Figure 5) that simulates thermal and nonthermal tumor ablation. The

application helps engineers design devices that ablate cancer cells, visualize ablation zones, and even import MRI and CT scans for specific anatomies. The user interface for the application includes a menu so that users can easily choose a study. For instance, because the temperature and thermal necrotic zones are time dependent, users can specify a time at which they can see the damage due to the heat or temperature profile in the results (Figure 6). The application includes three inputs for parameters: thermal voltage, nonthermal voltage, and electrode spacing. The current can be plotted via the experimental current so that users can easily validate the simulation.

### ⇒ COLLABORATION PROMOTES INNOVATION

As illustrated by these three simulation experts, the democratization of applications is well underway. The Application Builder makes it simple to build a simulation application in as little as a few minutes, and COMSOL Server and COMSOL Compiler help bring the applications to the people. Through the democratization of simulation, specialists, researchers, engineers, and customers can develop and innovate by working together. ❖

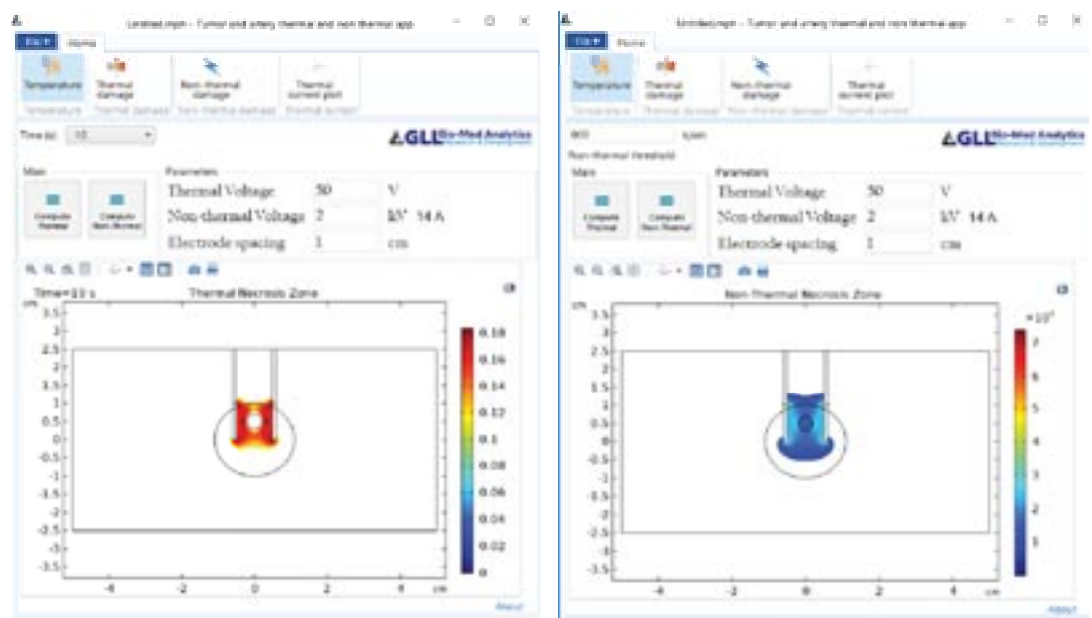

**FIGURE 6.** A medical device application enables users to study thermal or nonthermal necrosis zones. Image courtesy GLL.

# ABB'S ELECTROMAGNETIC FLOWMETER DIGITAL TWIN DRIVES PERFORMANCE

ABB's flow measurement products reflect state-of-the-art developments in flow sensing technology. ABB's new tool, a digital twin, mimics the actual flowmeter in a virtual environment and predicts electromagnetic (EM) flowmeter performance. The digital twin based on multiphysics modeling enables flowmeter design improvement and performance prediction under field conditions.

by **SUBHASHISH DASGUPTA** and **VINAY KARIWALA**

During the last decade new technologies and digitization have begun to dramatically impact conventional process industries involving liquids, such as water and wastewater transport and treatment. As these exciting applications have become more plausible and available, ABB's dedicated research teams have worked to ensure customers receive the best and most cost-effective tools to improve their competitive edge. Digital twin technology can do just that by enabling the detection of physical issues early on and predicting outcomes accurately. Looking to the future, ABB has seized the opportunity to apply digital twin technology to improve its flowmeter products to meet process challenges, deliver value faster than ever before, and fulfill ever-increasing customer expectations.

## ⇒ ELECTROMAGNETIC FLOWMETERS

Production processes require reliable and accurate instrumentation to meet high-performance standards. For more than 40 years, ABB has been a reliable partner to the global water industry because of their dedication to product development, system solutions, and service. ABB's flowmeters are traditional workhorses in the production process industry because they are robust, reliable and, above all, accurate (Figure 1A).

Comprising a major share in ABB's

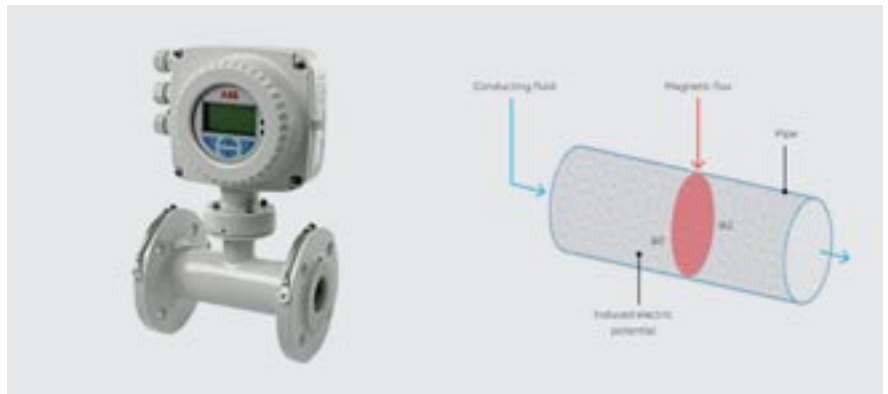

**FIGURE 1.** (A) ABB's EM flowmeter is shown. (B) Interaction of the magnetic flux with moving conductive fluid induces an electric potential ( $\Phi_2$ ) proportional to the fluid velocity  $\Phi_1 - \Phi_2$ .

flow measurement portfolio, EM flowmeters are especially appealing to customers who transport or process conductive liquids due to a unique set of advantages: simplicity of installation, negligible impact on pressure drop, and high accuracy. Furthermore, EM flowmeter performance is not susceptible to variations in temperature, pressure, or density, nor are they influenced by minor fluctuations in flow profiles. Independent of flow direction, with measurement errors contained within  $\pm 0.2$  percent over wide flow ranges, EM flowmeters enable accurate measurement at low flow rates.

ABB continually explores tools to improve their electromagnetic flowmeter offerings with the aim of meeting

high-performance standards and cost optimization demands. By combining deep knowledge of flowmeter physics with new verifiable modeling techniques, ABB endeavors to add value to existing flowmeters.

EM flowmeters rely on Faraday's law of electromagnetic induction to determine flow velocity. When a magnetic field is imposed within a pipe through which a conductive liquid, like water, flows, electric potential or electromotive force (EMF) is induced across the pipe cross section (Figure 1B). The EMF is proportional to the flow rate or velocity, and by measuring the induced EMF, flow rate can be estimated. The ratio of induced EMF to fluid velocity is sensitivity,





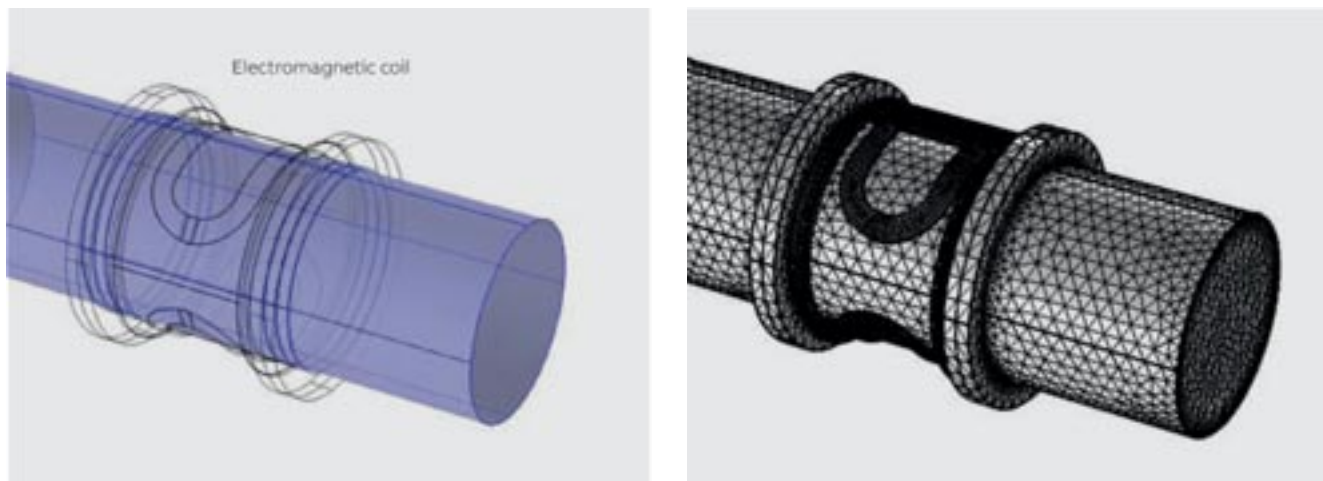

**FIGURE 2.** (A) Geometry of EM flowmeter built using CAD. (B) Discretized geometry for FEA calculations.

which is related to the calibration factor. While it is important to predict sensitivity, it is just as critical to predict the variations in sensitivity that result from changing conditions. Thermal and structural events that can impact flowmeter operation must be evaluated in the interest of product safety and to assess flowmeter performance under harsh conditions.

#### ⇒ DIGITAL TWIN CONCEPT

What if one could develop a predictive model based on knowledge of physical processes that would predict flowmeter performance and minimize the need for testing? The result would be unparalleled productivity and heightened performance. ABB has developed a software model of an EM flowmeter based on a multiphysics finite element analysis (FEA) technique to accomplish this. This software model, or digital twin, is a replica that represents the physical asset in the virtual world, thereby mimicking the physical asset's real

behavior. Performance complexities can be understood, problems can be detected, and designs can be improved based on the resultant acquired process knowledge. This information can subsequently be used to build and operate the product in the field. Digital twins can simulate almost any condition in the virtual world with confidence that the same behavior would occur in the real world.

#### ⇒ MULTIPHYSICS MODEL

FEA modeling involves discretizing the geometry of an object into smaller finite spaces. The computational model is supplied with information such as material properties as well as operating and boundary conditions. The model solves physics-based equations over the finite domains to derive parameters. This method, which yields three-dimensional and, if necessary, time-varying information, is employed for performance prediction and design

improvement of equipment across industries like oil and gas and aviation. The use of FEA modeling, as opposed to conventional testing methods, ensures that complex processes can be easily understood. Laboratory testing methods are limited by their dependence on the number and placement of sensors employed within the equipment, which is cost intensive and difficult for process industry applications to accomplish. In contrast, the recent advances and decreasing costs of high-performance

“ABB has developed a software model of an EM flowmeter based on a multiphysics finite element analysis (FEA) technique [to improve productivity and performance.]”

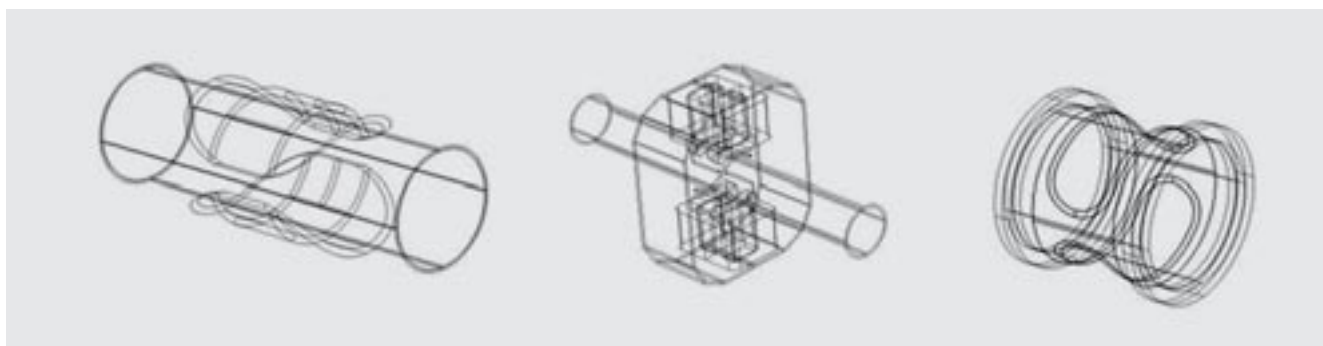

**FIGURE 2.** (C) Several varieties of flowmeters, differing in component design and/or size, were modeled.



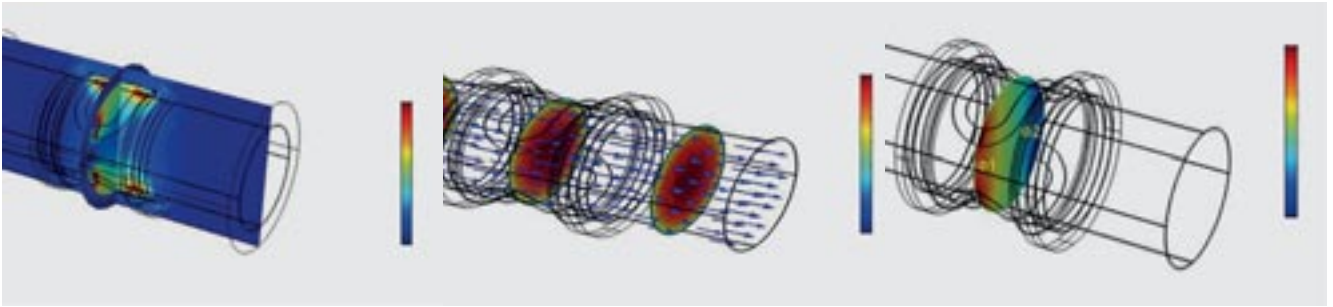

**FIGURE 3.** Qualitative physical phenomena were evaluated; red represents maximal values. (A) Magnetic flux distribution. (B) Fluid velocity contours. (C) Electric potential.

computing allows diverse and complex physics-based equations to be easily and iteratively solved using FEA.

ABB chose a multiphysics model of an EM flowmeter to improve their already outstanding flowmeter product offerings.

⇒ **INTEGRATION OF PHYSICAL PHENOMENA**

Initially, the geometry of a flowmeter was constructed using a CAD software (Figure 2A). The geometry, or the computational domain, was then discretized into minuscule elements across which equations were solved (Figure 2B). Several flowmeter samples of varying designs and sizes were modeled (Figure 2C).

The integration of the two primary phenomena, electromagnetism and fluid dynamics, and other diverse physical phenomena within a single model is challenging. Electromagnetism is analyzed by solving Maxwell’s equations. These equations initially calculate the magnetic flux density within the computational domain (Figure 3A). The fluid dynamics is analyzed by solving equations of mass and momentum conservation for various flow conditions — simulating fluid flow through the pipe (Figure 3B). Next, the induced EMF, the result of magnetic flux and fluid velocity interaction, is calculated by integrating the magnetic and flow fields, using the Lorentz equations, derived from Faraday’s law of electromagnetic induction (Figure 3C). The primary outcome is sensitivity, or the ratio of the induced EMF to the fluid velocity. To obtain a comprehensive picture, the model also solves for thermal propagation and structural dynamics parameters. Thermal and hydraulic stresses acting on the pipe wall are calculated (Figure 4). Such advanced simulations are essential to predict the

effect of challenging, harsh conditions on flowmeter health, like the impact of high-temperature and/or high-pressure liquids passing through the pipe. The ultimate result of these exhaustive calculations is a complete multiphysics model of the flowmeter that can predict performance as well as impending failure under adverse conditions.

Clearly, modeling has the benefit of minimizing the need for testing efforts, which are cost intensive and time consuming. Several ABB flowmeters, of unique design and varying line sizes, were successfully simulated in 2017. A comparison of the sensitivities calculated by the model and obtained during field tests revealed an agreement of 95 percent — establishing the model as a realistic and accurate predictive tool (Figure 5). Besides predicting sensitivity, the model could predict the linearity of the flowmeter or, in other words, the constancy of the sensitivity with changing flow rates — measurement accuracy. Not only is the digital twin concept an asset during the testing phase, but the model has also been extensively

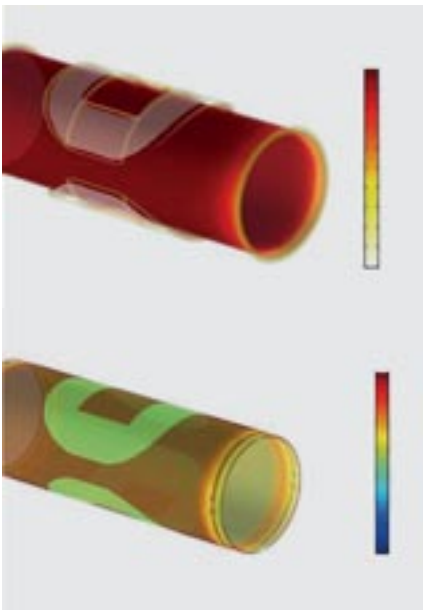

**FIGURE 4.** Qualitative thermal and hydraulic stress fields are illustrated; red represents a maximal value. (A) Temperature field. (B) Stress field.

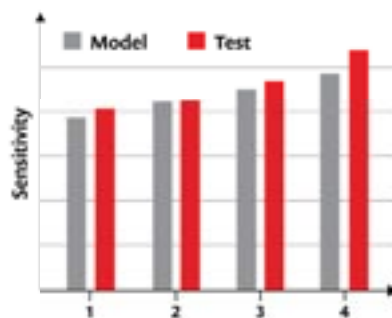

**FIGURE 5.** Several flowmeter varieties were modeled and compared with test data.

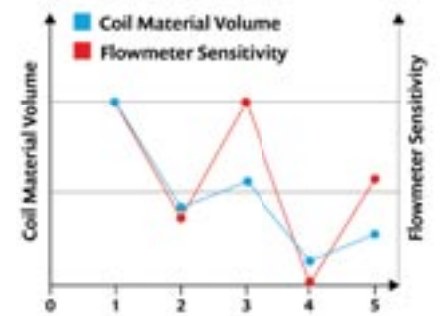

**FIGURE 6.** Iterative modeling performed for optimal coil design.

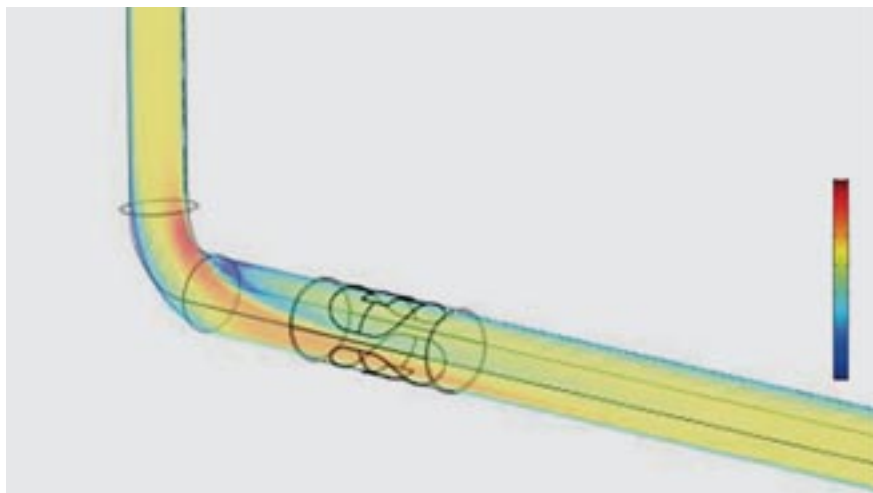

**FIGURE 7.** Modeling an EM flowmeter installed in a customer piping system to predict field performance under distorted flow conditions.

customer piping system (Figure 7).

The effect of flow modification on measurement accuracy was studied to provide insight into the impact of system features such as upstream bends. As a result, ABB could determine the best location to install flowmeters within a given piping system, thereby enabling the correction of flowmeter readings for an installed flowmeter.

To date, the tool has demonstrated veracity in predicting flowmeter performance and enabled engineers to improve the design of flowmeters. The expansion of the model to simulate the manner in which flowmeter operations influence the flow profiles of customer piping systems also opens up new avenues for the improvement of measurement accuracy. The digital twin technology can also be employed to serve as a useful guide for flowmeter installation in the field, which enabled industries like water management facilities to improve their flow control systems in the interest of radically enhancing industrial process performance.

Extensive research at ABB concentrates on developing the digital twin model for use in other process industries to provide customers with the most advanced digital means of reaching unparalleled productivity and performance. ABB focuses on maximizing value and producing products with fewer defects, ensuring optimal operation, bringing products quickly to market, and improving operation. ⇨



Subhashish Dasgupta,  
ABB  
Corporate  
Research,  
Bangalore,  
India



Vinay Kariwala,  
ABB BU  
Measurement  
& Analytics,  
Bangalore,  
India

leveraged to modify the existing design of the flowmeter to improve quality. By incorporating novel component designs and innovative ideas into the model, improvement in flowmeter performance could be evaluated.

The modified flowmeter was found to outperform the existing flowmeter product better than the current flowmeter — setting the stage for future design improvements. The digital twin, when applied to flowmeter development efforts, will increase flowmeter sensitivity, improve measurement accuracy, and reduce manufacturing costs. Extensive efforts are currently underway to test prototypes of the flowmeter and incorporate the various design modifications and evaluate the feasibility of some of the novel ideas.

#### ⇨ DOING LESS CREATES MORE

The primary goal of product development is to minimize material usage while maintaining or maximizing the performance level. Accordingly, the digital twin model has been used to optimize the

“Digital twins can reliably simulate almost any condition in the virtual world with confidence that the same behavior would occur in the real world.”

design of flowmeter components with the intent of reducing material costs.

Being an important component, the EM coil was modified to obtain the optimal size and/or shape for the ultimate flowmeter performance. Size variation of a given coil was evaluated in a series of iterations (Figure 6). In a particular iteration, the original sensitivity of the flowmeter could be maintained using significantly less copper coil material. Furthermore, simulations of radically novel coil designs were shown to reduce the amount of material needed to maintain the original performance level. This is of particular value for the development of large flowmeters because coil costs can make up a substantial portion of the total flowmeter material costs. Recently, proposed solutions to reduce the overall flowmeter footprint for large flowmeters have been evaluated and verified in the subsequent prototype testing phase.

#### ⇨ REPLICATING FIELD CONDITIONS

While development and testing are important phases in the product life cycle, the installation phase has its unique challenges too, given that system features like bends and valves can distort flow profiles and impair measurement accuracy. Understanding the systemic effect of piping features on flowmeter performance is therefore crucial. ABB’s flowmeter digital twin was expanded to include a



Intro

Cov

ToC



# Inspiring Young Engineers to Design for the Future at EPFL

EPFLoop, one of the top three teams invited to the SpaceX Hyperloop Pod Competition, used multiphysics simulation to hit the ground running with a unique design advantage.

by **BRIANNE CHRISTOPHER**

Over the course of the annual SpaceX Hyperloop Pod Competition, engineering teams work to design and build hyperloop pods. The ultimate goal of the hyperloop concept is to achieve a mode of transportation that is high speed, intercontinental, and self-propelled. Such a system would both revolutionize the experience of transportation and offer a greener alternative to other modes of travel.

The Hyperloop Pod Competition, which started in 2015 as the brainchild of Elon Musk, culminates with a weeklong competition each summer in Hawthorne, California, located in southwestern Los Angeles. Over the course of the competition week, participants get to test their hyperloop pod designs on a mile-long track (Figure 1) at speeds of approximately 500 km per hour.

## ⇒ WORKING ALONGSIDE THE WORLD'S TOP ENGINEERS

Each year, the top 20 teams worldwide are invited to the California testing facility, and the top three teams can run on the track under vacuum at the final event. As a first-time competitor, EPFLoop exceeded all expectations by making a presence in the finale as one of the three teams to run in vacuum that year. Even more impressive was the fact that they classified first at the end of the testing week and were told that their pod showed the highest design reliability. Overall, the EPFLoop team ended up placing third in the high-speed run on the final day of the competition due to the unexpected presence of dust on the test track, which affected their pod's performance. Their experience at SpaceX proved to be invaluable for many reasons.

Made up of engineering students and technical advisors, the EPFLoop competition team formed at the Swiss Federal Institute of Technology Lausanne (EPFL). Dr. Mario Paolone, principal advisor of the EPFLoop team, says that the Hyperloop Pod Competition is a "chance for students and young engineers to participate in a state-of-the-art challenge, with some of the

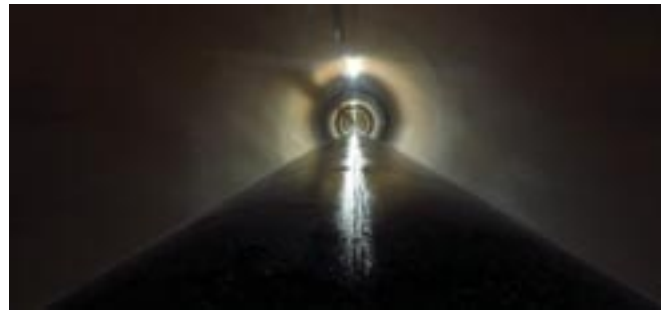

**FIGURE 1.** An inside view of the hyperloop test track.



**FIGURE 2.** The EPFLoop hyperloop pod design.

world's top engineers." Besides the chance to use high-tech testing equipment and rub elbows with professional engineers, the experience is a great opportunity for students to learn the importance of researching energy-efficient modes of transportation. It also gets students excited about research and inspires them to pursue careers in engineering.

## ⇒ SIMULATING THE HYPERLOOP POD

Aside from the opportunity to visit SpaceX and experience an advanced testing facility, the students who participate in EPFLoop have something more to gain: valuable experience using multiphysics simulation. Each aspect of EPFLoop's hyperloop pod design (Figure 2) involves modeling and simulation. In fact, Paolone calls simulation the "core" of their project. One obvious reason: The team's 60-meter test track is nowhere close

to the mile-long test track at SpaceX. Consequently, even if their tests confirmed the results of the simulations at low speeds, they still relied on simulation software to gain insight into what will happen at very high speeds. "Every single component of the pod has to be simulated and validated," says Dr. Lorenzo Benedetti, the technical leader of EPFLoop.

Using the COMSOL Multiphysics® software, the EPFLoop team was able to analyze the complex components of their hyperloop pod and predict its performance before ever setting foot on the SpaceX premises. Furthermore, the team needed to be able to look at multiple physical effects at once, including mechanical, fluid, electrical, and materials science phenomena. "This project is inherently multidisciplinary," says Benedetti. For example, the design team wanted



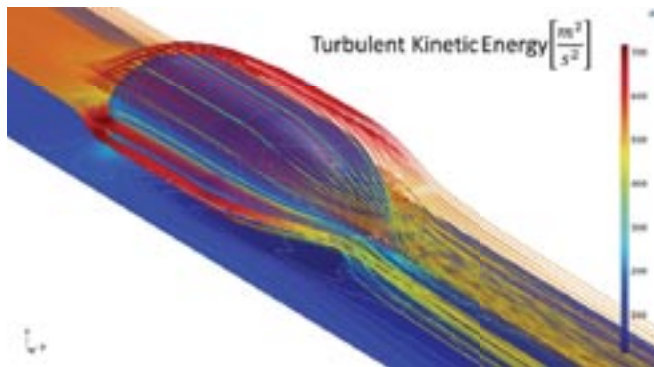

**FIGURE 3.** The turbulent kinetic energy around the hyperloop's composite aeroshell structure.

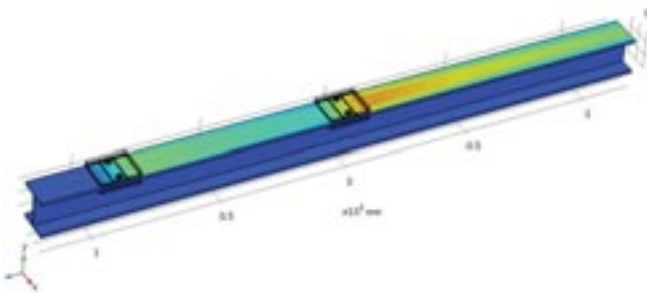

**FIGURE 4.** The temperature profile in the hyperloop's braking system.

to see how the pod's aeroshell, made out of a lightweight composite carbon fiber, would fare on the test track. To minimize the aerodynamic resistance of the shell, they performed a computational fluid dynamics (CFD) analysis coupled with shape optimization and mechanical stress studies (Figure 3).

The aeroshell had to be both lightweight and able to withstand aerodynamic forces during acceleration and deceleration. The team used the High Mach Number Flow interface to find the lift and drag coefficients of the pod. The pressure distribution results from the CFD analysis were then used to find an optimized aerodynamic shape via the LiveLink™ for MATLAB® interfacing product.

The team also needed to see how the pod's pressure vessel would perform in the tube, under vacuum, during the high-speed run. They designed vacuum-proof enclosures, which are responsible for storing the batteries and electrical components of the pod. In fact, some electronics cannot sustain vacuum conditions, and a subpar design could cause the inner components to be directly exposed to the track — which is essentially a vacuum tube — and destruct. The team performed a structural analysis of the vessel's design, a composite pressure vessel, using the Shell interface in the COMSOL® software to account for the superposition of layers. They then optimized the structural response to be able to have the minimum weight possible. The Tsai–Wu safety factor and principal stresses were then studied in the optimized pod design.

### ⇒ SLIDING TO A STOP

The hyperloop's braking system is another example of multiphysics design. The brakes need to be able to safely slow the pod down

after it has reached its top speed. However, there is an extreme temperature increase in the braking system due to the vacuum conditions in the tube: Without air, there is no convective dissipation of heat to the air and the heat remains stored in the brake pads. To ensure that the braking components would perform as expected, the EPFLoop team coupled heat transfer and mechanical simulations for their brake system design (Figure 4).

Using the Heat Transfer in Solids interface, the team analyzed the temperature profile in the brake system during and after braking to ensure that it would not become hot enough to cause damage to the hyperloop pod. They then used the Translational Motion feature to estimate the power dissipation caused by the friction, and therefore, the temperature rise in the brakes. Using this information, the team performed a material sweep of the different brake pad options, including ones made out of leather, thermoplastic polyurethane, plaster, and some more classical braking pad materials used in the automotive industry. The simulation analysis helped the team to identify that a customized material created for them by an external company was the

best material option for the brake pads because it kept the braking system within the desired temperature range.

The team's detailed simulation work paid off: "One of the judges called our approach 'extremely compelling'," says Benedetti.

### ⇒ LIFE-SHAPING EXPERIENCES

The most impressive aspect of EPFLoop is not their pod design or competition ranking, but the project's impact on the students who participated. Nicolò Riva, a PhD student at EPFL who also heads the team's aerodynamics group, said that the experience made him "want to stay in academia and participate in similar projects." Zsófia Sajó, another student involved in the 2018 competition team, said that EPFLoop inspired her to "do something about solar power and clean energy for transportation."

Paolone's impression of the project echoes the takeaways of his team members. He said that students set aside their personal and free time to participate in EPFLoop with motivation, drive, and commitment. "We need these kinds of people," he said, to be engaged in designing clean modes of transportation for the future. ❖



The EPFLoop team.



Intro

Cov

ToC



# VIRTUALLY OPTIMIZING METASURFACE TOPOLOGY WITH A GENETIC ALGORITHM

An optimization algorithm inspired by natural selection is used to determine the best design configuration for the metasurface of an optical antenna.

by SARAH FIELDS

Often in engineering, we look to the natural world to find inspiration for new ways to approach our design problems. Whether we are taking inspiration from fluid flow around wings to inform a system for cooling devices, studying slug slime to invent better medical adhesives, or designing the nose of a bullet train to resemble the beak of a bird, nature holds the key to even the most elusive design solutions.

At its essence, optimization involves minimizing a loss function by systematically selecting input values from within a set of parameters governing the system under study. It is unsurprising that even in the mathematics-dense world of the optimization of electromagnetic metasurfaces, nature has something to say.

Bryan Adomanis of the Air Force Institute of Technology (AFIT) was interested in creating a pixelated grid antenna that would function as a 3D Huygens source; that is, a 3D, metal, nanoparticle-based optical antenna capable of propagating only in a specified direction while maintaining the desired amplitude and phase delay. In the development of such an antenna, the geometry of the metasurface is the primary driver of the

**“Due to the nonlinear nature of the problem and the large parameter space, other optimization methods were insufficient — They were either too computationally intensive or could not be trusted to find the global minimum. In this context, genetic algorithms get the job done.”**

— BRYAN ADOMANIS, AIR FORCE INSTITUTE OF TECHNOLOGY

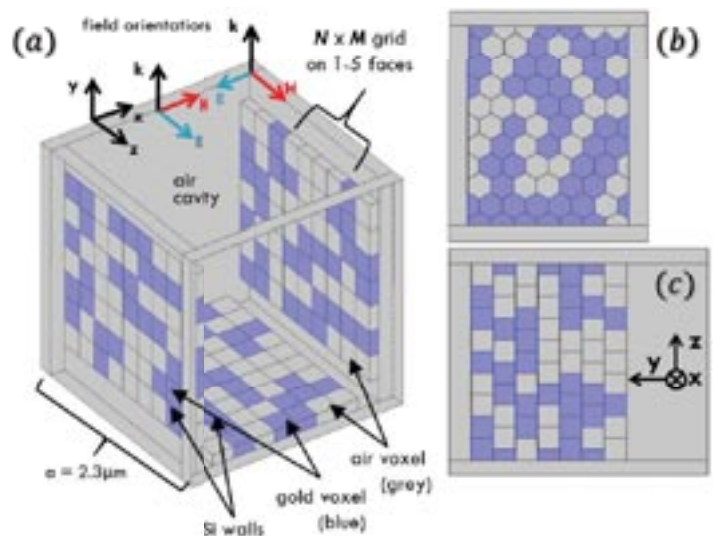

**FIGURE 1.** Sample voxel and cavity geometries, which can be used for the genetic algorithm.

electromagnetic response. As such, by optimizing the geometry of a “blank slate” — this grid of 3D pixels (voxels) — it is possible to find the best design, which would possess a high forward scattering and minimal backscattering.

The challenge in designing this antenna is the large design space: A voxel can exist as either gold or air, and

there are so many possible geometrical configurations for the antenna that it was unclear how to identify the best design. For even the lowest-resolution design,  $2^{40}$  (over 1 trillion) unique models could be generated (Figure 1). Gold and air voxels (cubes) are represented in blue and gray, respectively. Using a genetic algorithm (GA) routine, the COMSOL® software finds the



best solution, or arrangement of voxels, in about 2000–4000 models. Also, there was no identifiable correlation among patterns of geometry and performance (transmittance and phase), and as such, no function to minimize. Therefore, a COMSOL model was implemented to efficiently solve these highly nonanalytical models.

Essentially, this pixelated grid antenna is a scattering unit cell, where the walls can be populated with dielectric and metal as needed. In selecting the best geometry for metal, nanoparticle-based antenna out of nearly one trillion possible configurations, a routine inspired by biological reproduction and natural selection was the answer.

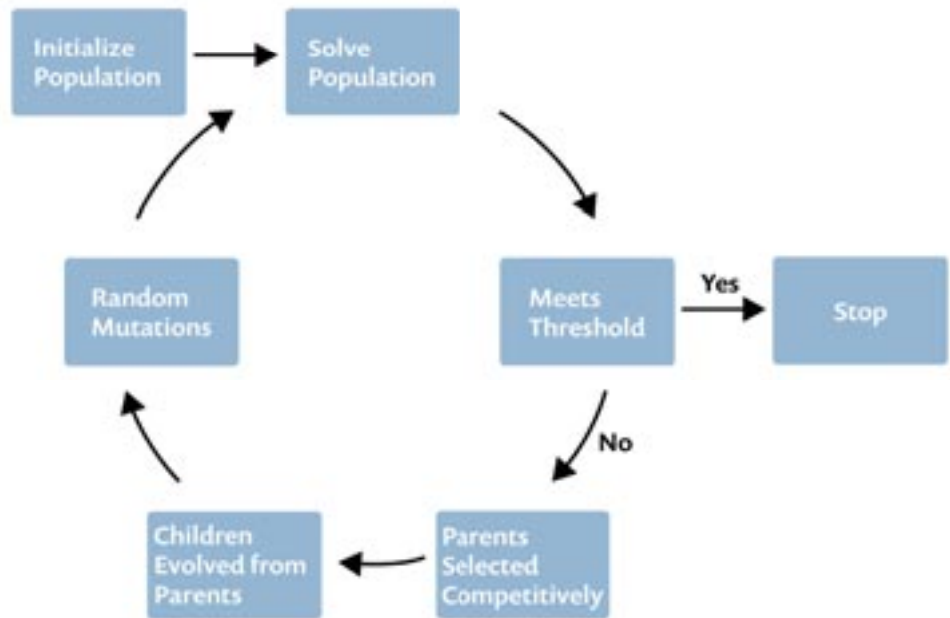

FIGURE 2. Genetic algorithm solution steps.

## ⇒ GENETIC ALGORITHM ROUTINE

“Due to the nonlinear nature of the problem and the large parameter space, other optimization methods were insufficient — They were either too computationally intensive, or could not be trusted to find the global minimum. In this context, genetic algorithms get the job done,” Adomanis explains.

In a genetic algorithm (Figure 2), a design parameter, what can be thought of as the gene, exists within a group of design parameters, or the chromosome. Each group of design parameters represents a unique design, or what can be thought of as the individual, with all unique designs forming a total population. The fitness of each individual in the population is scored, which informs the likelihood of the individual becoming a parent to an individual in the next generation.

**“We have high confidence that our design is working properly, since we have composed a properly functioning, full-scale simulated lens using the results of each individual element in that model.”**

— BRYAN ADOMANIS, AIR FORCE INSTITUTE OF TECHNOLOGY

In his implementation of a genetic algorithm, Adomanis initializes the population with individuals representing different voxel arrangements or antenna designs. He used MATLAB® to create the population, generated its binary representation or “mask,” which enters the GA routine for each set of

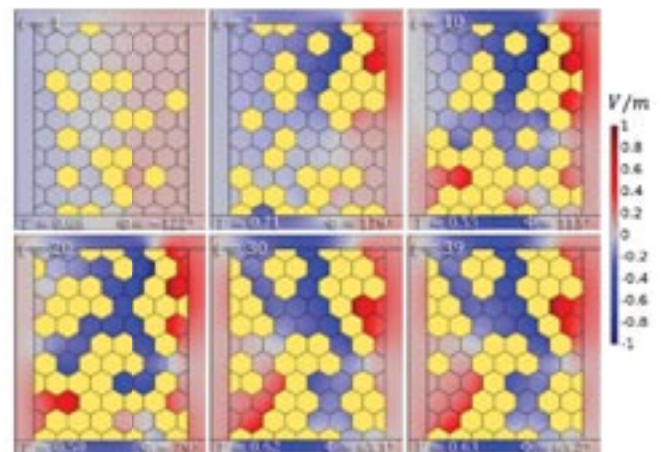

FIGURE 3. Simulation results showing the magnetic field (scaled in terms of V/m) resulting from the optical antenna in intermediate steps of optimization. As the topology forms, so do strong magnetic modes.

unique parameters; and feed it to the COMSOL model.

He then used multiphysics simulation to evaluate the fitness of each individual, or unique design, within the population, or set of unique designs. An individual is fit when a fitness threshold representing the desired

scattering is met. After the fitness of the individuals, or unique models, in the population, or set of unique models, is computed, individuals who do not meet the threshold are removed from the routine. The next generation of models, or “children,” is then populated

from the unique models that met the fitness threshold and formed by “crossovers,” where substrings of two binary representations are concatenated in a child, and “mutations,” where a bit within the binary string is switched. Adomanis integrated MATLAB® with COMSOL Multiphysics® through the add-on product LiveLink™ for MATLAB®.

### ⇒ CONVERGING ON THE BEST DESIGN

To identify the best topology for the metasurface of the optical antenna, Adomanis needed to optimize the phase delay of a total field transmittance in a given direction while maintaining the amplitude. The electromagnetics modeling capabilities were used for this purpose, allowing him to set his GA routine to go through many sets of voxel configurations and compute the resulting electromagnetic radiation without needing to dive too far into the complexity of the physics. Figure 3 shows the magnetic field resulting from the antenna in various stages of optimization.

As the individuals of a generation are evaluated, parents are selected, the child generation populated, and the individuals of the child generation evaluated, the routine continues, and the population shifts toward the best design (Figure 4). Using the genetic algorithm routine, the COMSOL® software generated the best design in a few thousand models, compared to a parameter space of approximately one trillion possible designs.

With this routine, Adomanis could maximize transmittance at various phase values. Within 30 generations,

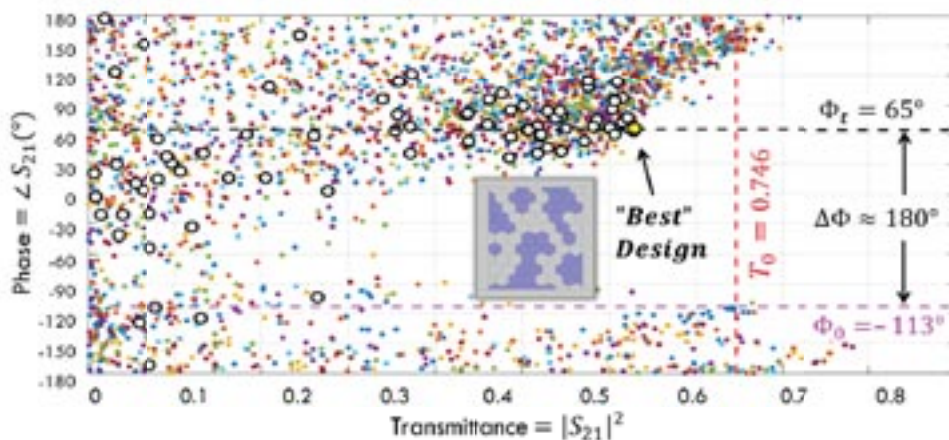

**FIGURE 4.** Plot of the transmittance, or the scattering parameter  $|S_{21}|^2$ , against the phase. Generations are distinguished with color.

the unique designs of the population began to meet his performance criteria (Figure 5).

Visualizing the performance in a multiobjective solution space allowed Adomanis to select a design based on the criteria that is most important for a specific application. In one design, he might prioritize the highest transmittance, while in another design, he might want to prioritize accuracy in the phase delay.

Adomanis was able to successfully generate the colocalized electric and magnetic dipoles from a pixelated grid that produces a total field only in the forward direction, with little backward scattering. By combining a GA routine with electromagnetics simulation, he could generate an optical antenna that functions across the entire  $2\pi$  phase space. An example is shown in Figure 5. “This work represents the first time that the topology of a pixelated grid antenna has been optimized with a genetic algorithm in 3D,” Adomanis comments.

### ⇒ LEADING DESIGN BECOMES REALITY

After Adomanis determines the best design from the GA routine, his next challenge is creating a real-world prototype based on the optimized design. However, because the smallest features of the optical antennas are about 100 nanometers, a specialized, newly developed fabrication process was necessary to implement the concept.

To accomplish this, Adomanis is collaborating with a research team at Sandia National Laboratory that has the capability to print the antenna. He simply provides the group with the optimized pixelated grid that resulted in optimal scattering in his simulation. “We have high confidence that our design is working properly, since we have composed a properly functioning, full-scale simulated lens using the results of each individual element in that model.” Adomanis concludes, “Being able to use COMSOL for computing the performance of the antenna was powerful, as we could focus on implementing the GA routine to optimize the design instead of the details of the electromagnetics computation of an arbitrary array of voxels.” ❖

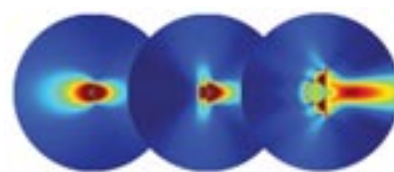

**FIGURE 5.** Genetic algorithm optimization of the geometry of an optical scatterer called the omega particle. The aim is to design a scatterer with, from left to right, maximum forward scattering and minimal backward scattering.



Bryan Adomanis, Air Force Institute of Technology



Intro

Cov

ToC





# COMPLEX FENESTRATION SYSTEM FOR ENERGY EFFICIENCY

Scientists at Eurac Research are using simulation to improve the energy efficiency of buildings and enhance visual and thermal comfort for people.

by **JENNIFER HAND**

Energy efficiency can save money for the operators, improve comfort for occupants, and reduce environmental impact, so it is a key consideration for any building and fenestration, the term applied to any opening in a building envelope. Components such as the frames, glass and shading attachments of windows, and doors and skylights make a significant contribution to energy efficiency. By controlling direct sunlight and heat gain, they minimize glare; distribute daylight comfortably; and reduce demand for heating, cooling, and artificial light.

The interplay of fenestration components can, however, have an unexpected influence, and this is not fully covered by ISO 15099:2003, which gives calculation procedures for determining the thermal and optical transmission properties of window and door systems. The standard does not, for instance, account for characteristics such as the complex geometry of shading systems or particular types of applied coatings, such as highly reflective ones.

“The main problem is that the standard method of calculation treats any shading system (for example, a blind that sits between two glass panes) as a parallel layer and not a 3D structure,” explains Ingrid Demanega, junior researcher at Eurac Research in Bolzano, Northern Italy. “The slats of a blind are regarded as simple 1D openings through which air flows, even if the slats are curved as they are in a Venetian blind, and convective

heat transfer is measured only in terms of pressure drop. The slats are also assumed to be ideal diffuse surfaces. This approach affects the accuracy of both the optical and thermal modeling” (Figure 1).

Led by Demanega, a team at Eurac Research, in collaboration with the research groups in building physics at the Free University of Bozen-Bolzano and remove the University of Innsbruck, set out to identify limits in the current approach to modeling and define a new approach by comparing simulation results with the physical testing of a commercial fenestration system installed at the Living Labs of the Free University of Bozen-Bolzano (Figure 2).

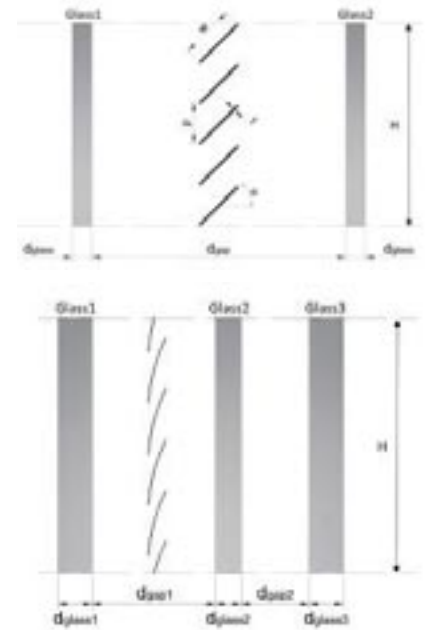

**FIGURE 1.** Standard (top) and complex (bottom) fenestration system.

## ⇒ CREATING A NEW OPTICAL MODEL

The on-site fenestration installation that the team set out to simulate is a triple-glazed system incorporating two sealed cavities with an integrated blind in the external cavity. This blind has curved slats that have a highly reflective coating designed to block solar radiation and provide comfort for people inside the



**FIGURE 2.** Setup at the Living Labs of the Free University of Bozen-Bolzano, including two heat flux plates, an in situ device designed by the University of Innsbruck to measure the overall heat flux, and several thermocouples for the surface and air temperature measurement.

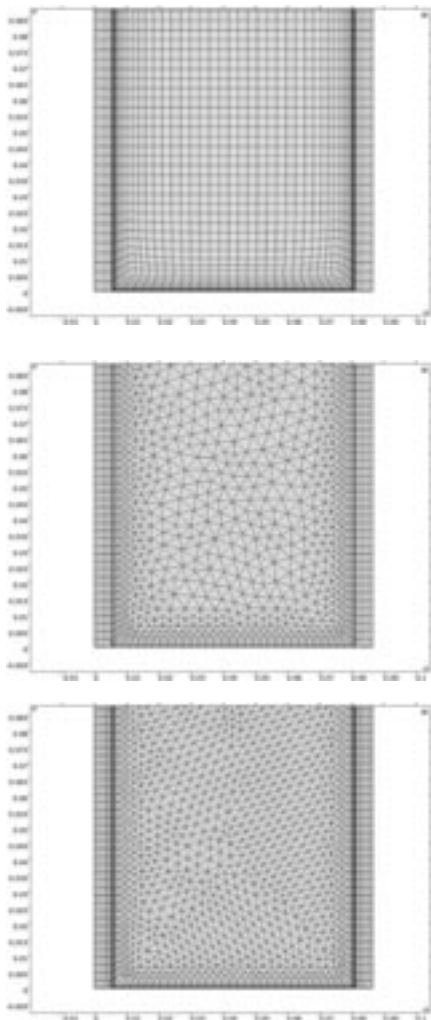

**FIGURE 3.** Mesh typologies for standard fenestration system without blinds: normal structured (top), coarser unstructured (middle), and normal unstructured (bottom).

building. The first step was to employ optical modeling to calculate the amount of solar radiation absorbed by the installation.

The main fenestration simulation tools, such as Window7, are based on ISO 15099 and the radiosity approach; however, it is possible to modify this by adding more detailed modeling data. Working with Radiance, the Eurac team used data based on the bidirectional scattering distribution function. This function describes how a solar ray splits and how its intensity changes as it passes through a surface so that it can be applied to complex geometries and highly reflective surfaces. Through ray tracing plus analysis of each pane of glass and each shading component, the team calculated the total amount of solar

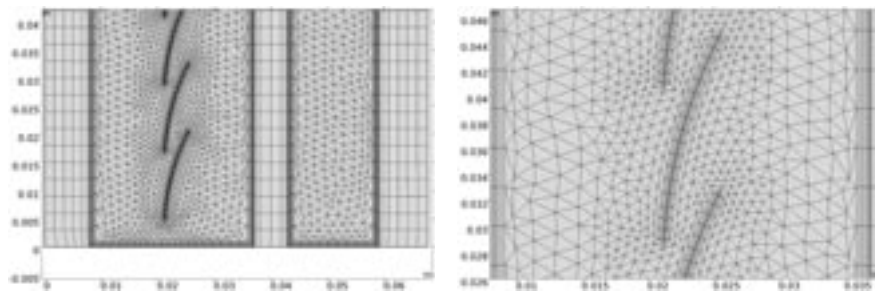

**FIGURE 4.** From left to right – glass pane, cavity containing blind, second glass pane, second cavity containing argon and air only, and third glass pane. In this case, the two cavities are sealed, not ventilated. Close-up image of the mesh around the blind and near the edges of the cavity.

radiation absorbed by the glazing system.

### ⇒ MODELING HEAT FLUX AND FLUID FLOW

The absorbed fraction of solar irradiance was then transferred into COMSOL Multiphysics® for comprehensive thermal modeling. Demanega performed a mesh sensitivity analysis by modeling the fenestration system installed locally (Figure 3). In the preanalysis, she used the Boussinesq approximation and considered both incompressible flow with the Boussinesq approximation and compressible flow. “I noticed that, simulation time was much longer for a compressible fluid, but the results were similar, so I decided to use incompressible fluid,” she explains.

To calculate radiation exchange, Demanega used the surface-to-surface (radiosity) method for long-wave radiation. She also created two radiation groups: one for the internal walls and blinds of the first cavity and another for all of the internal walls of the second cavity.

“After considering different approaches, I selected solving the fluid flow problem using the k-epsilon turbulence model with a low Reynolds number wall treatment. This led to a robust simulation with accurate results.”

Using a triangular mesh in the center and a rectangular, mapped mesh at the boundaries, Demanega finalized the settings. “I altered the size until I could find no further improvement. In the end, the mesh was more or less 20,000 elements” (Figure 4).

### ⇒ SIMULATING STATIONARY CONDITIONS

Following standard National Fenestration Rating Council (NFRC)

“The validation of a technique using Radiance and COMSOL® means that the Eurac Research team now has a very useful tool to accurately assess the temperature of components and the heat flow through a complex fenestration system.”

stationary boundary conditions for summer, the outside temperature was set at 32°C/89.6°F, with 24°C/75.2°F inside and a solar radiance of 783 W/m². The integrated blind was modeled in three separate positions: completely closed (75° angle), almost fully open (18°), and halfway between (37°) (Figure 5).

The team members performed two types of simulation. They used Radiance for optical modeling to calculate the absorbed fraction of solar irradiance, then COMSOL Multiphysics for heat transfer and fluid flow; they also followed the standard method using Window7 with ISO 15099 calculations.

As a control, the team also modeled a standard fenestration system with and without a blind using stationary conditions. Simulation results showed clear correspondence between the two approaches for the system without a blind and nearly perfect correspondence for a standard system with a blind.

### ⇨ TIME-DEPENDENT CONDITIONS

For simulation of dynamic behavior, the team used data from the local weather station for input to the optical simulation and measured the surface temperatures of internal and external glazing as boundary conditions for the CFD simulation. These boundary conditions were implemented in COMSOL Multiphysics by importing a dataset with discrete temperature values and time steps of 300 seconds. These values were then interpolated with a polynomial function and assigned to the proper glazing faces. Simulation of heat flux on the internal surface of the window system was compared with measured heat flux on the same surface (Figure 6).

"We were very pleased to find correspondence between our simulation results and physical measurements for the blinds in a fully closed position, especially because conducting the simulation in two different environments meant that there was potential to fail in one or the other," comments Demanega.

### ⇨ A VERY USEFUL TOOL

The validation of a technique using Radiance and COMSOL® means that the Eurac Research team now has a very useful tool to accurately assess the temperature of components and the heat flow through a complex fenestration system.

According to Demanega, the results show the value of detailed optical modeling to understand primary solar radiation before thermal modeling in order to measure secondary heat gain caused by the absorption and re-emission of radiation.

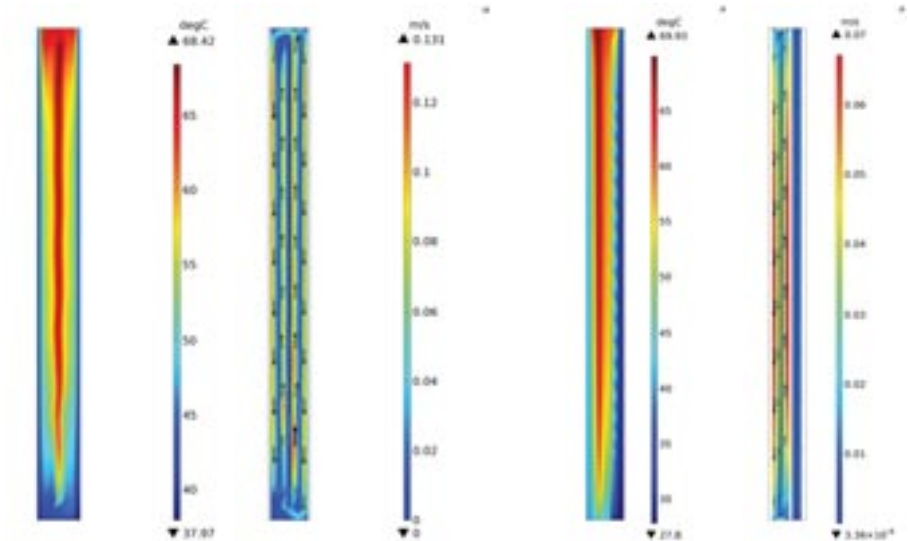

**FIGURE 5.** CFD results show how convection affects the temperature of a window in a standard (left) and complex (right) fenestration system.

"In particular, the standard approach does not account for the vertical distribution of temperature. It is important to learn more about the distribution of temperature from top to bottom of a cavity, pane of glass, and blind because component temperature influences both the structural integrity of a building facade and the comfort of people within."

With the knowledge gained, the team is now validating the approach for different blind positions and is looking forward to applying the approach to naturally ventilated cavities containing integrated blinds, often found in double-skin facades. The team is also looking at how to disseminate this information within the construction industry and is considering the feasibility of a simulation application that would enable modeling of complex

fenestration systems to be more widely available to professionals. ⇨

### ACKNOWLEDGEMENT

*This study has been developed in the framework of the research activities of the project FACEcamp n. ITAT1039, funded by European Regional Development Fund and Interreg ITA AUT programme and the project "IBAS — Intelligent Building Automation System for optimization of energy consumptions and indoor environmental quality" of the Free University of Bozen-Bolzano.*

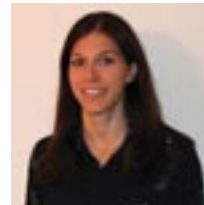

Ingrid Demanega, Junior Researcher, Eurac Research

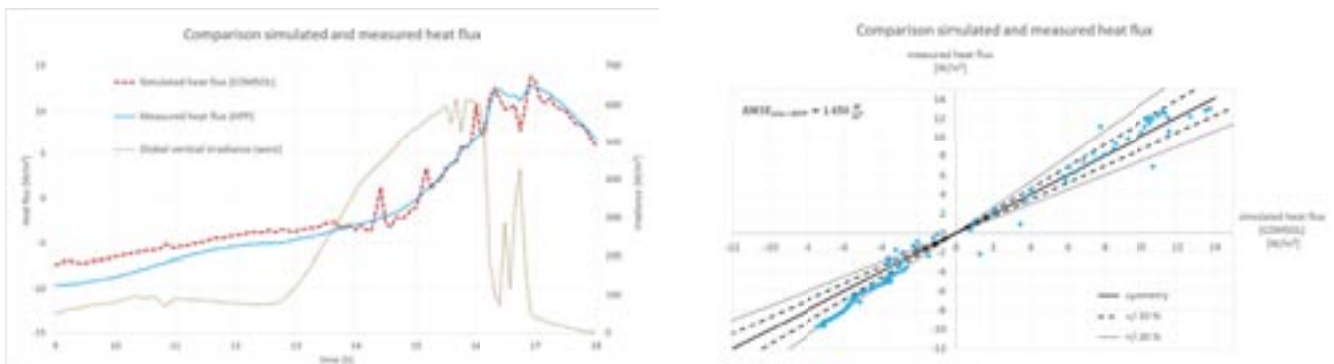

**FIGURE 6.** Correspondence between the time-dependent simulation of the commercial system at Free University of Bozen-Bolzano and physical measurements of heat flux on the internal side over the total height of window.

# Adding Quantitative Systems Pharmacology to the Pharmaceutical Sciences Curriculum

The University of Oklahoma College of Pharmacy is teaching PhD students in pharmaceutical sciences how to create multiscale models in order to analyze drug disposition within the human body.

by **BRIDGET PAULUS**

Optimizing drug dosages, evaluating side effects, improving clinical trials, and reducing costs and time to market — these are just a few of the benefits of model-informed drug development. Due to these advantages, the United States Food and Drug Administration (FDA) is encouraging pharmaceutical companies to include simulation in their product development cycles. There is just one problem: Companies often have a hard time finding candidates with strong experience in simulation, as mathematical modeling is minimal in most pharmaceutical sciences programs.

To address this issue, the Institute of Quantitative Systems Pharmacology and the College of Pharmacy at the University of Oklahoma Health Sciences Center partnered in 2014 to develop an innovative curriculum. Within this program, Research Assistant Professor Roberto A. Abbiati designed a PhD-level course on simulation for pharmaceutical sciences students at the University of Oklahoma College of Pharmacy. The class gives an overview of numerical analysis and the modeling workflow in the COMSOL Multiphysics® software. Students learn how to apply modeling to pharmacokinetics, the branch of pharmacology that studies the effect of the human body on the administered drugs. Specifically, Abbiati applies modeling to streamline the quantification of drug concentration levels in the human body and the intended target sites over time — an important concern when developing potentially life-saving treatments.

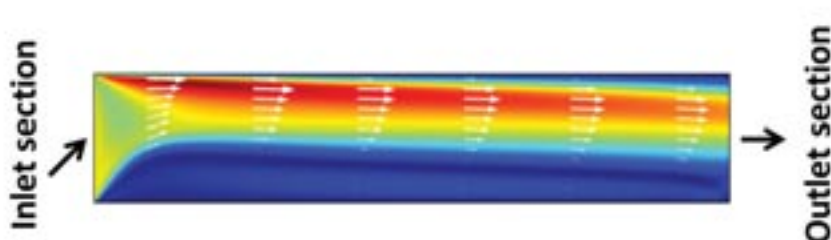

**FIGURE 1.** Velocity map for laminar fluid flow in a channel.

## ⇒ TEACHING MODELING TO THE NEXT GENERATION OF PHARMACEUTICAL SCIENTISTS

Pharmaceutical sciences students learn about a wide variety of subjects, but simulation is not typically one of them. According to Abbiati, this is a problem: "Besides being a desired skill by companies, modeling and simulation help design better experiments," he says.

Abbiati's courses are designed to teach PhD students in pharmaceutical sciences how to take advantage of simulation software in their work. The course starts students off with the MATLAB® software, which serves as a bridge to other kinds of mathematical modeling software. As the course continues, Abbiati and his students delve into numerical analysis and the finite element method.

Eventually, students learn how to build models in COMSOL Multiphysics. Abbiati takes them through each step of the modeling workflow. Students learn how to build geometries (starting in 2D, like the laminar flow example in Figure 1); set up the physics; determine the best mesh for a model (Figure 2); and postprocess the results (Figure 3).

Throughout the course, the class learns how to create both compartmental and multiscale models. The former is the standard for pharmacokinetic applications and is an easier concept to understand. Abbiati says that a standard compartmental model "assumes the human body is like a box, with one flux in and one flux out." Using ordinary differential equations, compartmental modeling is a simple way to determine the drug concentration in the human body over time. There is a major limitation with this type of model, though. Abbiati says, "It cannot determine where the drug is localized within specific tissues, which is a critical limitation in several applications including cancer treatment."

"I'm using COMSOL® to understand why and how the physical structure of the tumor is a barrier for the delivery of the drug."

— **ROBERTO A. ABBIATI, ASSISTANT PROFESSOR, UNIVERSITY OF OKLAHOMA HEALTH SCIENCES CENTER**



Intro

Cov

ToC



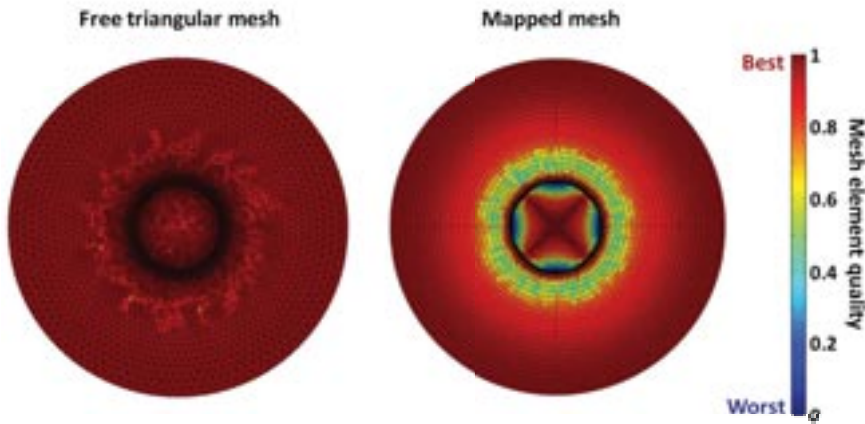

**FIGURE 2.** Mesh comparison used to introduce students to various mesh options.

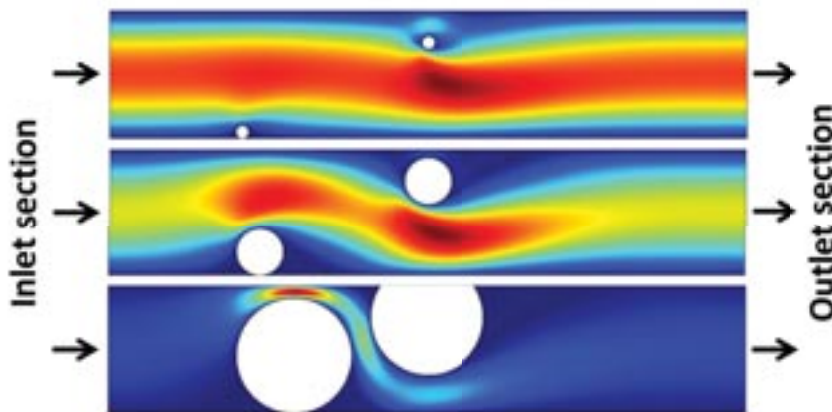

**FIGURE 3.** Velocity pattern for laminar fluid flow in a channel with obstacles of different sizes, an example from Abbiati's course.

Enter multiscale modeling. While it requires a more detailed understanding of physiological and biological processes compared to compartmental modeling, multiscale modeling is able to provide valuable insight into how deep a drug can penetrate a certain tissue or organ. This type of simulation involves accounting for size scales ranging from the entire human body, individual organs, single cells, down to the molecular level. Although it sounds like a complex subject, Abbiati demonstrates a step-by-step approach that is easier for the students to learn.

### ⇒ GAINING INSIGHT INTO TUMOR TREATMENT

Dr. Abbiati highlighted the benefits of multiscale modeling for pharmacokinetics by sharing some of his

own research performed with his team at the Institute of Quantitative Systems Pharmacology. He is currently studying how drugs interact with solid tumors.

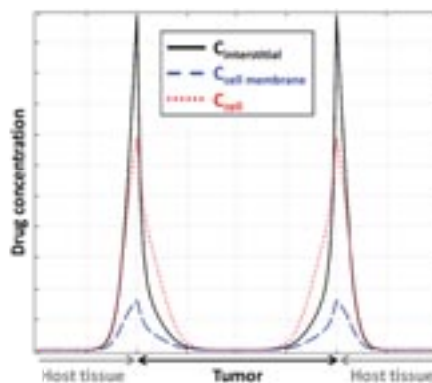

**FIGURE 4.** The drug concentration profile in a tumor.

These drugs, which typically travel via the bloodstream, can have a hard time getting into tumors. The issue is that these types of masses have "physical barriers that limit drug delivery," explained Abbiati. Tumor sites often have high pressure, which makes it difficult for the drug to penetrate them, for instance.

"I'm using COMSOL® to understand why and how the physical structure of the tumor is a barrier for the delivery of the drug," says Abbiati. To gain such insight, he uses multiphysics simulation to model blood flow in microvascular vessels, drug transport within the tumor interstitial space, and drug interaction with tumor cells. Abbiati modeled how the fluid moves according to the pressure gradient within a tumor mass, assuming that the fluid carries the drug with it. He then used the Transport of Diluted Species interface to describe the drug concentration.

Abbiati said that he was able to use this model "to determine how deep the drug penetrates the tumor, depending on changes in its physical structure over time" (Figure 4). The advantage of using multiphysics analysis was that he could "describe where the drug is located at any given time and any given location of the tumor." From his research, it is clear that multiscale modeling is a useful tool for pharmacokinetics, enabling researchers to better understand how drug concentrations are affected by the human body.

By teaching simulation in his PhD-level pharmaceutical sciences courses, Abbiati is giving students a valuable skill for drug research that could greatly improve future drug development processes. Aside from that, because these students will graduate with a simulation background, they are more attractive to pharmaceutical companies when they are ready to enter the workforce. ⇨



Roberto A. Abbiati, Assistant Professor, University of Oklahoma Health Sciences Center



Intro

Cov

ToC



# SEISMIC SAFETY EVALUATIONS OF DAMS WITH NUMERICAL SIMULATION

Researchers at Pisa University are using numerical simulation to investigate the accuracy and soundness of dam safety evaluations during earthquakes and other seismic events.

by **GEMMA CHURCH**

Structural integrity and adherence to code requirements are paramount in the development of all types of large constructions and buildings. Numerical simulation can be of great help but is only as good as the assumptions that go into the mathematical model, and when it comes to the seismic safety evaluation of dams, there is a growing demand for a more rigorous approach. The failure of large structures poses serious safety concerns and often causes severe damage, with a higher risk during earthquakes.

Dams are huge barriers built across rivers and streams to restrict the flow of water for purposes such as irrigation and the production of hydroelectricity. Because of the unique interactions with both soil and water, modeling techniques used for conventional buildings are not directly applicable to dams. Assessing the behavior of these dam-reservoir-soil systems is complex and has been approximated and simplified for years. But through new efforts led by a team of researchers at Pisa University in Italy, a renewed accuracy and soundness of dam simulations has been developed and looks to make the future of these gargantuan structures much safer.

Under the influence of earthquake excitation, the concrete gravity dam, water reservoir, and soil foundation behave as a coupled system.

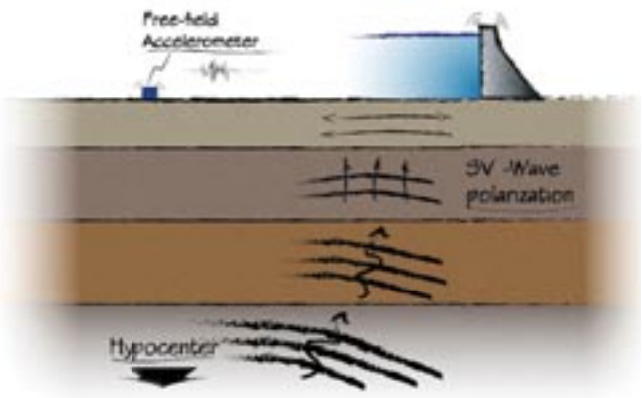

**FIGURE 1.** Schematic of the waves generated in the terrain by an earthquake.

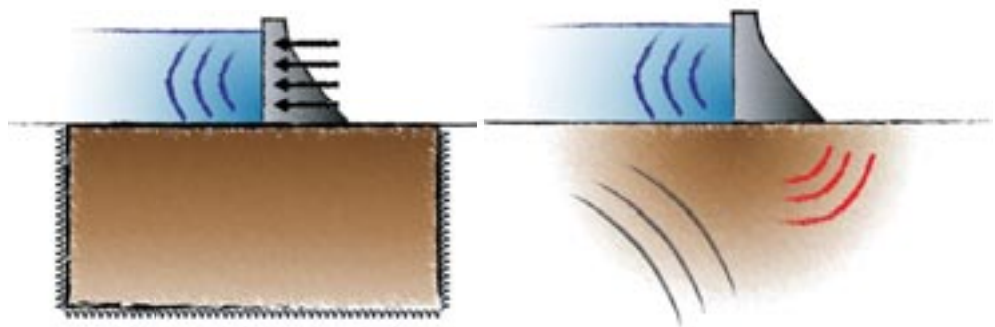

**FIGURE 2.** Comparisons of the direction of energy transfer between the massless foundation (left) and the infinite terrain model (right).

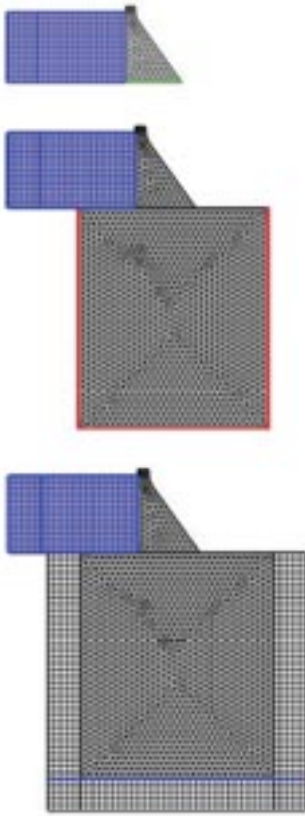

**FIGURE 3.** Geometry adopted for the three modeling techniques: rigid base (top), massless foundation (middle), and infinite terrain (bottom).

Due to the high complexity involved, the computational sophistication required has not been readily available; thus, the soil-structure interaction is frequently neglected or roughly estimated via simplified assumptions. The risk in not considering these interactions is the possibility of unexpected stress amplifications within the dam body.

### ⇒ SOIL-STRUCTURE INTERACTION

Both kinematic and inertial effects are part of the soil-structure interaction, but the inertial effects are rarely accounted for. While the kinematics are governed by soil flexibility and are

influenced by the structure's stiffness, the inertial effects are influenced by the structure's and the soil's density properties. Under excitation, the concrete wedge making up a dam moves back and forth in the soil, but the soil is not massless and does not simply move along with the slab. The soil and structure both directly influence each other, and this interaction generates elastic waves that travel through the soil, carrying energy away from the system (Figure 1). This is known as "radiation damping."

Currently, simulating soil effects on seismic behavior consists of a couple of methods, but they all leave something to be desired. Soil effects are considered in conventional building models by using code-provided response spectra based on the type of soil. However, structural differences between conventional buildings and dams render these methods inappropriate. Furthermore, for dams specifically, a technique called the "massless foundation" model (Figure 2) has been extensively implemented in dam-foundation analysis, modeling the soil solely in terms of flexibility and displacement at its boundaries. By disregarding the inertial effects and assuming the soil is "massless", all of the kinetic energy in the system is transferred to the base of the dam, which is unrealistic and results in substantial overestimates of the seismic response.

### ⇒ UPPING THE COMPLEXITY WITH NUMERICAL SIMULATION

Numerical simulation allowed Matteo Mori of the Department of Energy Engineering of Systems of Land and Construction at Pisa University to explore the full soil-structure interactions in his simulations. "The flexible nature of COMSOL® makes it the most straightforward software to work with, and in our case, we appreciate the breadth of features available for the study of elastic, or acoustics, waves," Mori says. "It is comprehensive in nature and a powerful tool for our research."

The viability of any new technique to model concrete gravity dams needs to be considered in context, so Mori decided to run three different models under multiple scenarios. He investigated the dynamic response of each system under earthquake excitation and compared the findings. The three models, rigid base, massless foundation, and (full) infinite terrain analysis, are shown in Figure 3; each has an additional degree of sophistication beyond the former.

The blue rectangular area represents the water reservoir, the triangular region represents the dam, and the large rectangular region represents the soil. The soil domain in the massless model is simply that, massless soil with only flexibility and displacement.

To ensure consistency across the model types, the horizontal harmonic acceleration boundary condition at the base of the dam (green, red, and blue lines), which simulates the earthquake excitation, is set up such that the base acceleration at the dam is the same for all three models. A global equation feature, available in COMSOL, is used in the third model to ensure that the boundaries allow for waves to pass through.

A key aspect of the infinite terrain model is the perfectly matched layer (PML) surrounding the soil. A powerful feature in the COMSOL Multiphysics® software, PMLs absorb all incident waves, regardless of angle and frequency, preventing them from returning back into the medium after incidence at the boundaries. This feature helps incorporate radiation damping and energy dissipation, treating the unboundedness of the soil domain as a perfectly absorbing material and creating a decaying oscillation of the concrete slab without any reflection of the energy waves.

"COMSOL offers the suitable tools to perform accurate multiphysics simulations, including fully coupled fluid-structure interaction (FSI) analysis and infinite domains," Mori

"The flexible nature of COMSOL® makes it the most straightforward software to work with, and in our case, we appreciate the breadth of features available for the study of elastic, or acoustics, waves. It is comprehensive in nature and a powerful tool for our research."

— MATTEO MORI, DEPARTMENT OF ENERGY ENGINEERING OF SYSTEMS OF LAND AND CONSTRUCTION, PISA UNIVERSITY



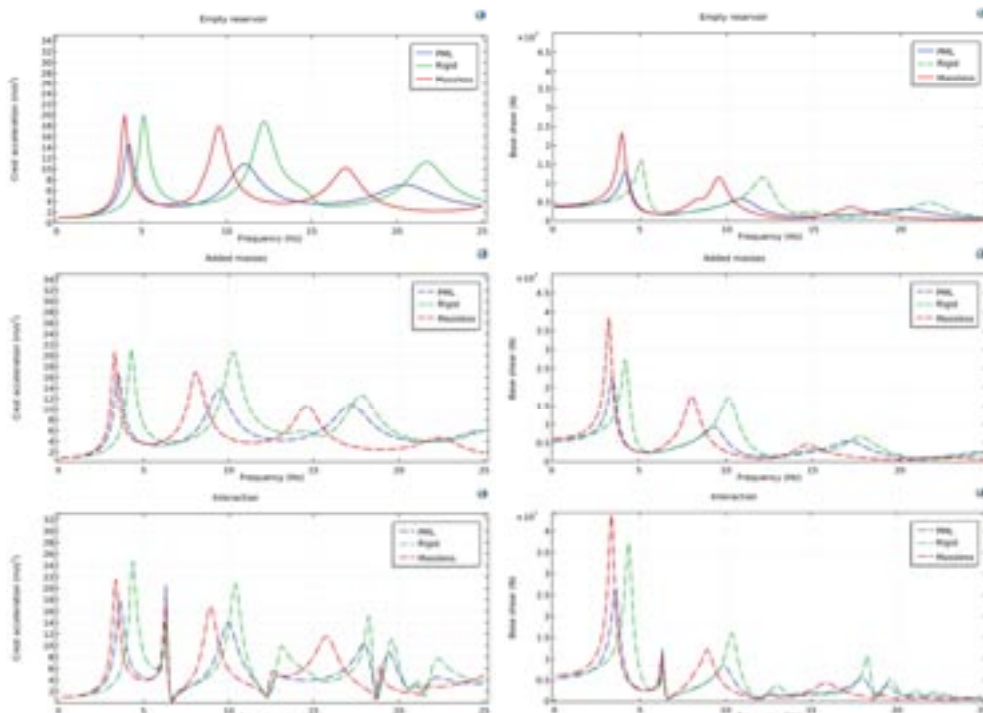

**FIGURE 4.** Base shear and crest acceleration for an empty reservoir (top), an added mass approach (middle), and a full elastic wave coupling approach (bottom).

says. The fluid subsystem is solved using the Helmholtz equation in the hypothesis of small vibrations and neglected viscosity, the soil and dam subsystem is solved with solid mechanics, and the unbounded terrain is modeled with the PML functionality.

⇒ **OBTAINING RESULTS IN CONTEXT**

The soundness of the infinite terrain model is assessed by applying multiple scenarios to a 65-meter-tall concrete monolith, namely both empty and filled reservoirs. Furthermore, the filled basin is simulated in two ways: with a full elastic wave coupling and a simplified “added mass” model. Added mass is a way to simulate the hydrodynamic effect of the basin, also known as “virtual mass.” As the slab accelerates, it must also move the neighboring water, as the

two cannot occupy the same physical space simultaneously. This adds inertia and essentially increases the effective mass of the slab.

The results obtained from these simulations are calculated with each technique (rigid base, massless foundation, and infinite terrain) for each basin scenario (empty reservoir, added mass, and full interaction). Compared to the rigid base and massless foundation models, the infinite terrain technique (blue curves, Figure 4) noticeably reduces and smooths the peak responses in all three cases. This smoothing is, as expected, due to the newly implemented considerations of radiation damping. As this phenomenon dissipates energy from the system into the unbounded earth terrain (simulated with the PMLs),

a smaller and more realistic amount of kinetic energy is thus transferred to the slab. The other two modeling techniques fail to account for this.

There are also noticeable differences in the mechanical displacement, fluid pressure, and mechanical energy flux, as shown above in Figure 5. Whereas the massless model displays circulatory streamlines (which represent the acoustic energy flux) without a defined incoming wave front, the infinite terrain model’s energy flux is clearly directionally defined. This is both visually and qualitatively indicative of the radiation damping that transmits energy away from the system, and it confirms that lower amounts of energy are transferred to the dam.

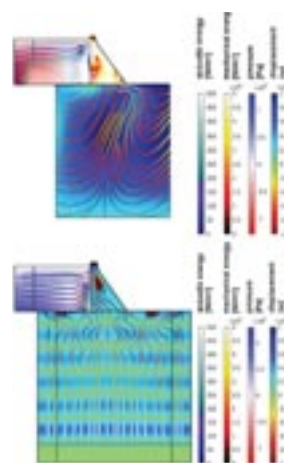

**FIGURE 5.** Plot of the mechanical displacement, fluid pressure, and mechanical energy flux streamlines for the massless foundation (top) and infinite terrain (bottom).

⇒ **FINAL STEPS AND FUTURE WORK**

“The fidelity of the model is the biggest challenge in our work because this is not a mathematically perfect problem and accurate predictions are difficult. The infinite terrain model is one method that can be considered a good solution, but there are still some developments required, which we are working on right now,” Mori says. “Concrete is a brittle material,” Mori explains. “We would like to be able to identify cracks in the dam structure.”

They plan on implementing deconvoluted experimental data from accelerograms that monitor seismic activity to set more accurate boundary conditions in their models. This would yield tremendous power and accuracy for dam modeling in Italy as well as all over the world. ❖



# Multiphysics Simulation Drives Smart City Technology

Reimagining the utilitarian power box into a modular, modern installment requires a complete design reinvention to balance the physical phenomena at play.

by SARAH FIELDS

Contemporary power boxes (or feeder pillars, as they are known outside of the United States), are mounted in the street and control the electrical supply to dwellings within a neighborhood. As residents increasingly prioritize the aesthetic and continue to place a high value on urban living, there is a need for less conspicuous power boxes.

But as it turns out, there is a valid reason behind the bulky size of the power boxes. The size of the traditional design holds the hardware necessary to reduce the high power of the long-distance power line to a power suitable for distribution to homes and businesses. The worthy goal of reducing the size of the power boxes comes with the additional challenge of routing power with considerably less area while considering resistance and Lorentz forces, a not insignificant undertaking.

Ishant Jain, principal researcher in R&D at Raychem RPG, applied his years of simulation experience to the challenge of creating a smart city-ready and space-conscious power box. He along with his team at Raychem enlisted multiphysics simulation to tackle the engineering challenges that accompanied the creation of this radical new design.

## ⇒ HOW POWER BOXES WORK

Thanks to this article, you are reminded of that obtrusive metal box near your sidewalk. But how exactly does a power box work?

The enclosure of a power box provides protection to an

electrical distribution system. Its purpose is to distribute the current of a low-voltage supply line, suitable for electrical transport across short distances, into homes and businesses. Power boxes are used to both reduce physical losses of electricity as well as to more precisely distribute and account for the usage of that electricity.

"It is highly beneficial for power boxes to occupy less space," Jain says, "We could create a modular unit with all of the capabilities of the original model adapted for the needs of cities in the 21st century."

Jain and his team swiftly noted many aspects of the design of a classical power box to be improved. These upgrades included a reduction of the cost and of the electrical losses due to substandard connections as well as improvements in safety, size, installation ease, serviceability, and aesthetic.

Jain and his team were also motivated to create a futuristic power box that would be readily adopted by smart cities. This new power box would include

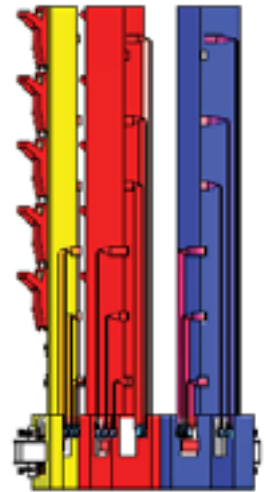
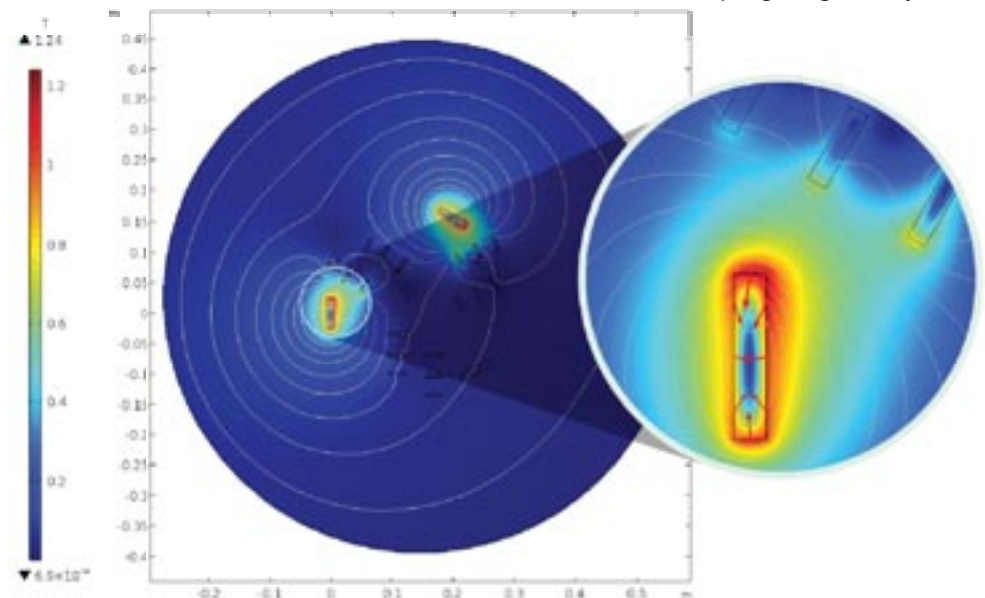

**FIGURE 1.** The innovative busbar system serves to distribute the same amount of power yet is contained within a smaller space than a conventional power box.

smart features to allow for online monitoring of energy usage, as well as to monitor the health of the system and individual fuses.

## ⇒ MINIMIZING ELECTROMOTIVE FORCES

The immediate challenge in adapting the geometry of an



**FIGURE 2.** Three-phase power box, showing the magnetic flux density norm, surface plot, and the Maxwell surface stress tensor ( $N/m^2$ ), arrow plot.



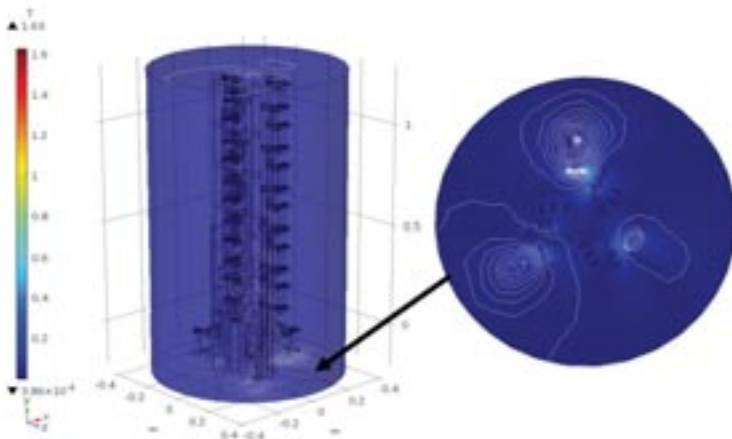

FIGURE 3. Magnetic flux density throughout the power box.

electrical distribution system to a radically small enclosure is the need to mitigate competing electromagnetic forces arising from the change in the design.

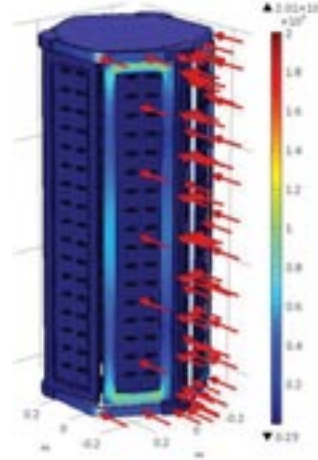

FIGURE 4. Induced von Mises stress at a wind flow velocity of 103 m/s.

Due to the dynamic nature of the physics and the complexity of the geometry, the need for multiphysics simulation in ensuring the stability of the design was immediately evident to the engineers.

To realize such a steep decrease in the size of the power box, the engineers needed to create a busbar system that would distribute the same amount of power yet fit within a smaller geometry (Figure 1).

Jain and his team created a 2D simulation to ensure that their design was suitable to

reduce the cumulative impact of the electromagnetic forces (Figures 2 and 3). The 120° alignment of the panels serves to balance the forces acting on the busbars.

“The simulation gave us confidence that the design would work,” Jain explains, “We could tell that the electromotive forces would be balanced by the 120° alignment.”

### ⇒ ENSURING THERMAL AND STRUCTURAL INTEGRITY THROUGH SIMULATION

Another important consideration is the overall structural soundness of the power box. For this, Jain and team developed a structural simulation of the power box that would allow them to evaluate its durability. From a time-dependent study of winds of up to 103 m/s blowing against the structure, it was determined that the power box was structurally sound (Figure 4). The engineers also slowly increased the boundary load until the induced stress reached a critical value and determined that the design is safe up to a wind velocity of 570 m/s.

A transient heat transfer analysis of the complete panel assembly was done to ensure the thermal integrity of the system in operation. The validated simulation allowed the team to calculate the temperature rise for conditions that could not be evaluated experimentally. The thermally optimized connectors make the final design safer and more efficient than its predecessors (Figure 5). The resulting design is also modular and scalable (Figure 6).

### ⇒ VERSATILE MODELING FOR BETTER DESIGN

Jain and his team were able to create a design (Figure 6) that is much smaller but can still dissipate the same level of power and current as traditional power boxes. The final power box design takes up the least amount of space of all power boxes on the market and is thermally sound and efficient.

“Using multiphysics simulation, we were able to ensure the integrity of the final contemporary design,” Jain concludes,

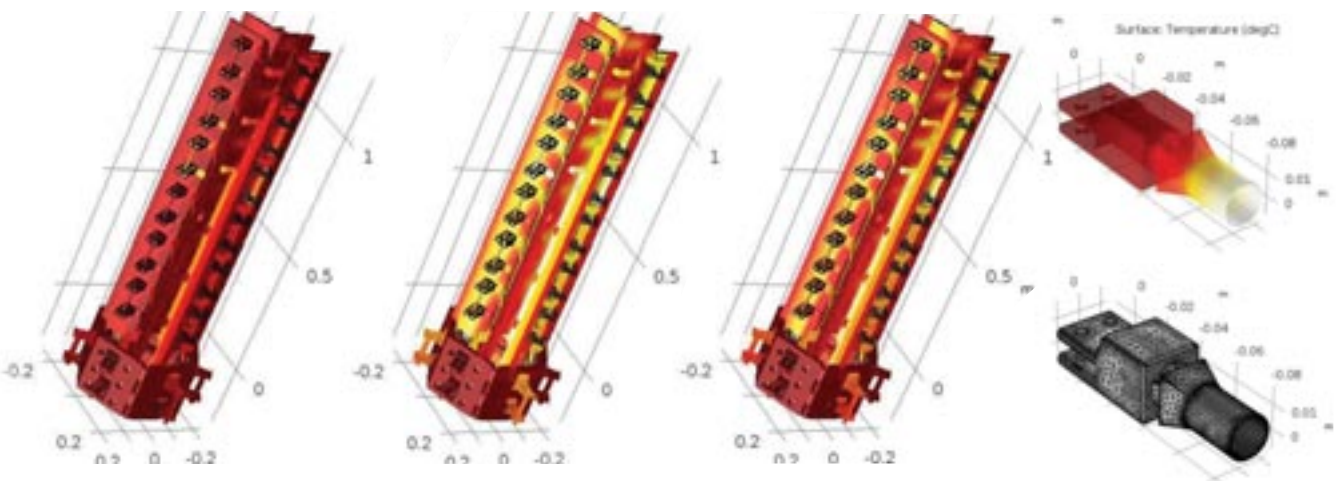

FIGURE 5. Simulation results from a transient analysis of the power box's thermal profile (left) the power box and connectors (right).

“We think that the benefit and impact will be far-reaching as it is adopted across the world.”

The final design includes smart features such as a safety and theftproof system as well as the capability for remote monitoring of energy, fuse health, and the thermal profile. It includes fuse housings that are insulated and safe to work with while the system is operating as well as connectors with lower resistive losses.

Suffice to say, in developing a power box that is a fraction of the size of the industry standard, with its reimagined and efficient busbar system, Jain and his team succeeded in reinventing the power box, using multiphysics simulation at every step. ❖

*This work was supported by Raychem RPG Ltd. We would like to express our gratitude to D Sudhakar Reddy at Raychem Innovation Centre for*



FIGURE 6. Engineers at Raychem developed an innovative, smart city-ready power box design.

*his guidance during the project. We thank Sumit Zanje, Nitin Pandey, Sanjay Mhapralkar, and Jayesh Tandlekar for their unrelenting spirit and commitment during the course of completion of the work. We would like to thank the COMSOL team (Bangalore and Pune) that provided insight and expertise that greatly assisted the research.*

“Using multiphysics simulation, we were able to ensure the integrity of the final contemporary design. We think that the benefit and impact will be far-reaching as it is adopted across the world.”

— ISHANT JAIN, PRINCIPAL RESEARCHER IN R&D AT RAYCHEM RPG

## LORENTZ FORCE CALCULATIONS IN COMSOL by Durk de Vries

The electromagnetic forces that the busbars in the power box are subjected to are known as Lorentz forces. Lorentz forces arise when a current is passing through a magnetic field (as opposed to electrostatic forces or forces between magnets). Just how powerful a Lorentz force can be is illustrated by some railgun designs: With a high-enough current, busbar systems can be ripped apart. Another issue occurs with constantly varying loads (fatigue problems).

In the COMSOL® software, Lorentz forces can be evaluated in various ways. One way is by using the Maxwell surface stress tensor. The projection of this tensor is available on the exterior boundaries of the busbar as an electromagnetic pressure. In the *Magnetic Fields* physics interface in the AC/DC Module, the *Force Calculation* domain feature integrates this pressure and derives lumped quantities, such as the total force and torque on the busbar. Alternatively, the pressure can be used locally, like in a structural mechanics model.

Another way to determine the Lorentz forces is to evaluate the cross product between the current density,  $J$ , and the magnetic flux density,  $B$ . The vector field resulting from this computation has been predefined as the Lorentz force contribution. Integrating it over the volume will give the total force on the busbar. Generally speaking, the volume integral results in a much more accurate figure than the surface stress tensor boundary integral, but the boundary integral approach is more versatile. Both methods are demonstrated in the *Electromagnetic Forces on Parallel Current-Carrying Wires*, tutorial model available online in the COMSOL Application Gallery.

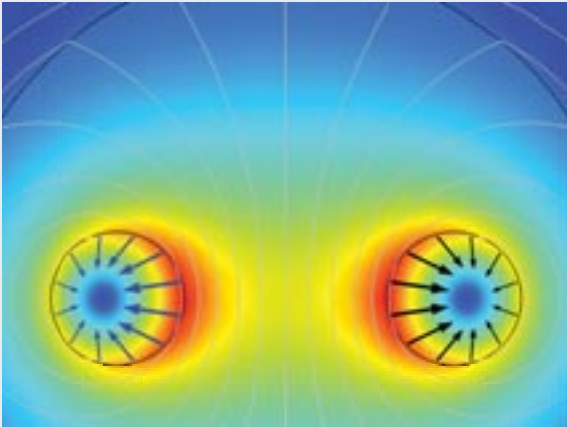

Electromagnetic forces on parallel current-carrying wires.



# KEEPING DENDRITES AT BAY WITH NUMERICAL SIMULATION

Numerical simulation drives the development of new approaches in lithium-ion battery research.

by **SARAH FIELDS**

Lithium-ion batteries can come in the form of laminated lithium-ion batteries for mobile electronic devices, cylindrical batteries for industrial power tools, and other cylindrical batteries for energy storage systems. The R&D division of Murata Manufacturing Co., Ltd., is using multiphysics simulation to examine batteries using lithium metal as a negative electrode material.

Dendrites, needle-like growths, are a fierce antagonist to efficient lithium-ion battery functioning. Dendrites form when a current is applied to a lithium metal electrode and can cause unwanted side reactions that result in short-circuiting, drastically limiting the life of the battery.

Mitigating dendrite formation is an active area of research for the entire battery industry. Most researchers approach the problem of safety hazards and life span due to dendrite formation by changing the chemistry in some way. However, gains in this area have been painstakingly slow, prompting some researchers to take an alternative path.

When examining batteries that use lithium metal as a negative electrode material, Jusuke Shimura a R&D

engineer at Murata looked to investigate the effect of changing the charging current pattern on dendrite formation.

This approach is gaining traction in the battery and energy storage world as the industry ramps up to meet the needs of an era of electrification and renewable energy.

## ⇒ USING MULTIPHYSICS TO MINIMIZE DENDRITES

Lithium dendrite occurs when current is applied to the lithium metal electrode, resulting in a short circuit. "In order to commercialize lithium-ion batteries with lithium metal electrodes, this problem must be solved," says Shimura.

The key to his approach was identifying a current pattern for charging that would minimize the growth of lithium dendrites. This approach works because at the off-time between pulses, the concentration gradient at the electrode interface decreases, minimizing dendrite buildup. Also, introducing reverse pulses in the current pattern plays an important role by repeatedly dissolving formed dendrites.

To capture the electrochemical effects over his geometry, Shimura enlisted the

battery modeling capabilities of COMSOL Multiphysics®. He used a combination of experimental evidence and simulation to determine the best charging pattern.

Many researchers have been exploring this challenge from a chemical and material perspective. To make strides in this area, Shimura wanted to establish a baseline understanding of his physical system experimentally. It was important

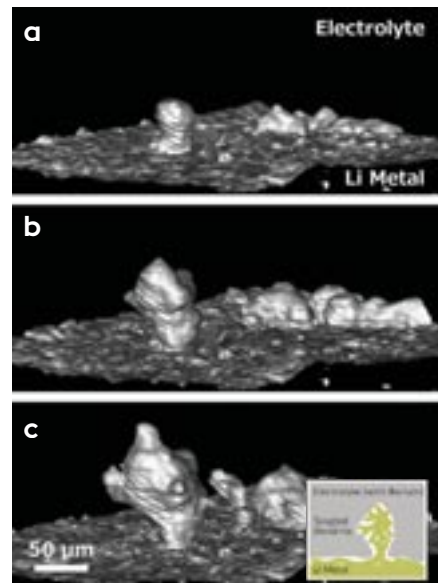

**FIGURE 1.** X-ray computed tomography (CT) results showing that the surface of electrolyte membrane is pushed up by lithium dendrites due to flowing current of  $50 \mu\text{A}/\text{cm}^2$  for 6 h (a), 13 h (b), and 20 h (c).

**“Thanks to COMSOL, we were able to show with a first-principles-based simulation that the optimized charging pattern improved the lifetime of the battery.”**

— JUSUKE SHIMURA, RESEARCH ENGINEER AT MURATA MANUFACTURING CO. LTD.





**FIGURE 2.** Mesh of the lithium-ion battery geometry.

for him to understand the shape of dendrite formation over time. To accomplish this, he created an X-ray CT-compatible laminated cell that contains a contrast agent in its

electrolyte membrane, and visually measured the formation of dendrites over time (Figure 1).

“I created a laminated cell that could be imaged with X-ray computed tomography, so that I would know where the dendrites are forming. Then, I used COMSOL® to find the best pulse pattern of charging to limit dendrite growth based on the shape and the size of the formed dendrites,” explains Shimura.

With the data from the X-ray computed tomography Shimura created a model of a lithium metal cell and analyzed the effect of changing the current pattern. The results showed how much lithium metal precipitated onto the dendrite (Figure 2).

Using multiphysics modeling, Shimura evaluated various current patterns to determine the current pattern with the slowest rate of dendrite formation (Figure 3). This method allowed him to examine which has more lithium deposition — the electrode surface with planar diffusion (bottom part of Figure 3) or the dendrite with spherical-like diffusion (left part of Figure 3) through one cycle of the pulse pattern.

He ultimately found that a repetition of reverse pulse for 20 seconds, off-time for 10 seconds, forward pulse for 20 seconds, and off-time for 10 seconds resulted in the least dendrite growth (Figure 4).

“With this pattern, we saw the growth rate of dendrites becomes less than

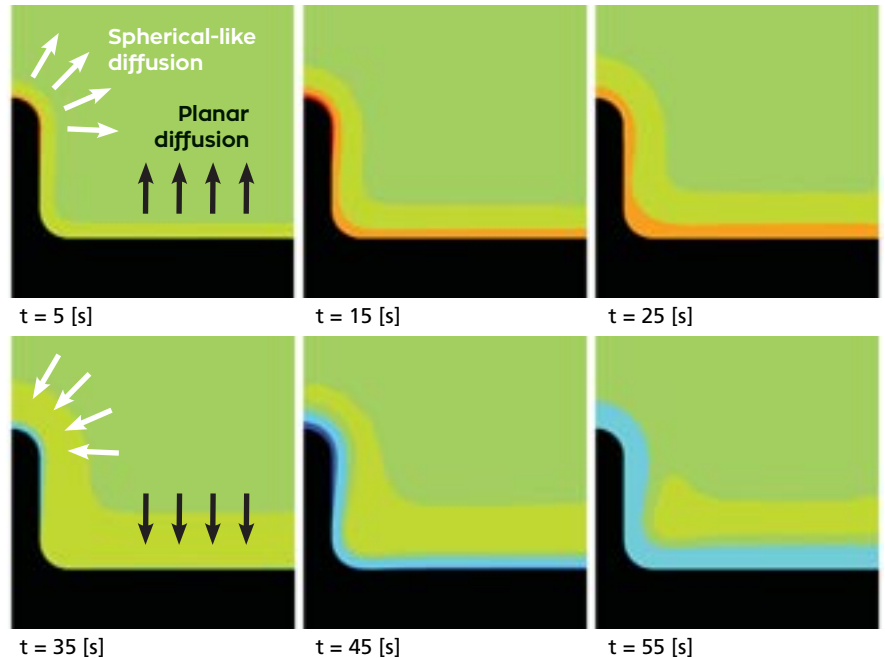

**FIGURE 3.** Simulation results of the dendrite growth with different pulse charging patterns.

one-third. As we expected, this was accomplished solely by changing the charging pattern — the chemistry stayed the same,” Shimura explains.

Shimura’s simulation was based on the experimentally determined size of the dendrite. It made use of the battery modeling capabilities of COMSOL Multiphysics that enlist the concentration-dependent Butler-Volmer equation to model the reactions of the electrodes and coupled diffusion-migration equations to model the lithium-ion transport.

### ⇒ DEVELOPING THE BATTERIES OF THE FUTURE

Using simulation, Shimura found the best pulse pattern to charge a lithium-ion battery with a lithium metal electrode. Compared to applying direct current, this approach improved the lifetime of the battery more than three times. “Thanks to COMSOL, we were able to show with a first-principles-based simulation that the optimized charging pattern improved the lifetime of the battery,” Shimura says.

In the future, Shimura sees multiphysics simulation playing a continuing role in maintaining the fast pace of their research and concludes: “We look forward to continuing to use COMSOL to bring the advantages of

optimized charging patterns to batteries on the market.” ❖

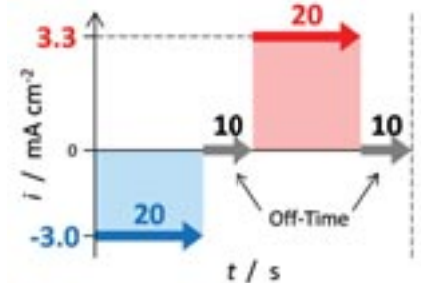

**FIGURE 4.** This pulse pattern was determined to be the best by finite element method simulation for the laminated cell. With the optimized current pattern, it is easier to dissolve lithium from the dendrite and more difficult to deposit lithium on the dendrite.



Dr. Jusuke Shimura is a research engineer at Murata.

# Collaboration Is Key for Individualized Medicine

by **DAVID ENFRUN, CEO & COFOUNDER OF KEJAKO**

In the field of medical technology, we strive to transform lives through innovative solutions that improve the daily lives of our patients. From product development, to the customization of a patient's actual needs, to the postmarket survey, simulation has a role to play. Sooner or later, the use of simulation will be a standard in the medical technology industry.

In the R&D department, our job always starts with the physics to build a model, whether we are using simulation to reverse engineer an existing solution or to test new products and scenarios. The goal of simulation is to retrieve all necessary insights for product development in order to reach in silico proof of concept before prototyping and in vivo trials. Simulation is our guarantee toward the path of performance and safety. Our experience has proven that the hours spent in numerical simulation are worth years spent in development.

“It is clear that COMSOL envisioned the power of multiphysics simulation when they introduced the Application Builder. Simulation applications allow other departments to test different configurations for their particular requirements and pick the best design.”

When a model is accurate enough, the prototyping phase is significantly reduced.

Beyond the R&D department, numerical simulation has the capability to serve as the path toward individualized medicine. Imaging and diagnosis techniques have reached a high level of standards. The next step that we envision for the future is to upload the biometry into a parametric model where calculation tools finalize the diagnosis and allow a physician to preplan a customized solution before any procedure is conducted. The possibilities of personalized healthcare have the ability to transform lives through meaningful innovation.

It is clear that COMSOL envisioned the power of multiphysics simulation when they introduced the Application Builder. Simulation applications allow other departments to test different configurations for their particular requirements and pick the best design.

Internally, simulation applications have enabled us to foster a culture of collaboration. From an R&D perspective, it's

very useful to be able to share a specific interface with just the parameters relevant to a particular group, knowing the model and physics are protected. This allows all departments to benefit from multiphysics simulation. With this level of collaboration, the model expands to serve as a physical benchmark, with more or fewer features depending on the end user.

Additionally, simulation applications have the potential to embed a multiphysics model within the workflow of a healthcare professional. This technology will provide them with the full picture of the diagnosis, empowering them to execute a new level of custom treatment planning.

As the CEO of Kejako, I am excited about the future of medicine and the revolution where simulation expertise and medical technologies will join forces!

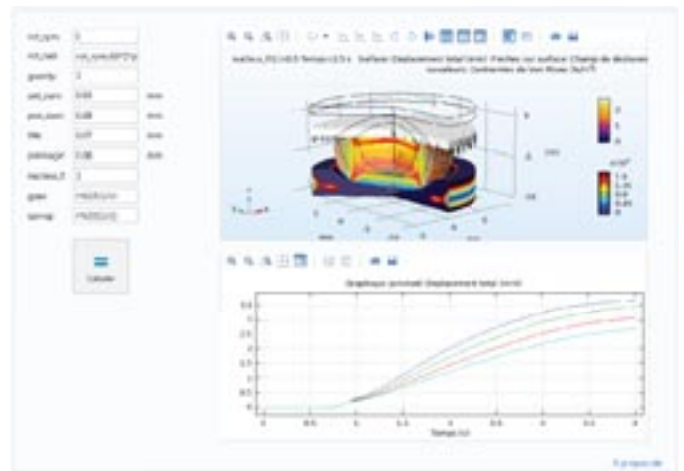

Simulation application of a parametric 3D eye simulation for physical benchmarking to be used in a clinical setting.



## ABOUT THE AUTHOR

David Enfrun, MSc from Arts et Métiers Paris (France), CEO & cofounder of Kejako, has 20 years of experience in the medical devices industry on its technology side for ophthalmology, aesthetics, and cardiology. David strives to position Kejako with the appropriate partners and in the right direction, including the use of simulation in the field of individualized ophthalmology.



Intro

Cov

ToC



July 2019

# PHOTONICS & IMAGING TECHNOLOGY

**Automotive Lidar Trends**

**Design of an Energy-Efficient  
Critical Angle Lens Reflector**

**Enhancing the Capabilities of  
High-Speed CMOS Image Sensors**

**SPECIAL SECTION:  
Technology Leaders in Optics**

Supplement to *Tech Briefs*



Intro

Cov

ToC



# CONTENTS

## FEATURES

- 2 Design of an Energy-Efficient Critical Angle Lens Reflector
- 6 Enhancing the Capabilities of High-Speed CMOS Image Sensors

## APPLICATION BRIEFS

- 20 Optimizing Image Sensors for Security Cameras
- 21 Automotive Lidar Trends

## TECH BRIEFS

- 24 Revolutionary Camera Allows Scientists to Predict Evolution of Ancient Stars
- 24 Integrated Silicon Photonic Switch Demonstrates Lowest Signal Loss Ever in High-Speed Data Transmission
- 25 Face-Tracking Robot
- 26 Bringing Human-Like Reasoning to Driverless Car Navigation
- 27 Breakthrough Could Enable Infrared Cameras for Electronics, Self-Driving Cars

## DEPARTMENTS

- 28 New Products

## SPECIAL SECTION

### 9 Technology Leaders in Optics

- 9 Inspection of Bulk Material with Trilinear Line-Scan and Prism Cameras
- 14 Key Trends in Custom Optics for Aerospace

## ON THE COVER

3D lidar is being extensively tested for use in autonomous vehicles. Because automotive lidar operates in near infrared with wavelengths in the range of hundreds of nanometers, it can easily resolve distances as small as a millimeter or two. To learn more, read the applications brief on page 21.

*(Image courtesy of Velodyne)*

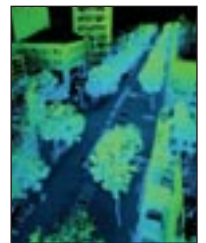

## SEE WHAT'S NEW AT PG&O



### Introducing Finished Infrared Optics

PG&O now offers the finest in precision finished infrared optical components for a variety of commercial and defense applications. Our infrared substrates include calcium fluoride, germanium, magnesium fluoride, silicon, zinc selenide and zinc sulfide and operate from 0.75  $\mu\text{m}$  (NIR) to 15  $\mu\text{m}$  (LWIR). Call today for more information.



[www.pgo.com](http://www.pgo.com) / 714.540.0126 / [info@pgo.com](mailto:info@pgo.com)



Intro

Cov

ToC





"Inspiration isn't something one can buy."

Dr. Nergiz Özcan-Ketola,  
R&D Engineer Nextrom



## BEST PREFORMS BY INSPIRING R&D

When caring for a family, you encounter so many inspiring aspects in your daily life. Working in the Preform R&D Center is the best place to live those inspirations. We love to create, develop and turn an idea into reality. This kind of passion cannot be bought, it is a part of us.



MEET US THERE!



[www.rosendahlnextrom.com](http://www.rosendahlnextrom.com)



Free Info at <http://info.hotims.com/72995-702>



Intro

Cov

ToC



# Design of an Energy-Efficient Critical Angle Lens Reflector

The critical angle lens reflector has commercial applications that supersede ordinary mirrored reflectors. The physics of the critical angle lens reflector are based on the optics principle of total internal reflection. Total internal reflection is characterized as follows: (1)

as shown in Figure 2, the light rays are reflected off of the reflecting surface whereby the angle of reflection – with respect to the perpendicular to the reflecting surface – is equal to the angle of incidence of the ray, and (2) the reflection of the light ray takes place with no loss of energy upon reflection.

Total internal reflection is an advantageous condition for the reflection of light because it is reflection without energy or heat loss. Total internal reflection has practical applications in fluorescent microscopy, optical emission spectrometers, and ordinary prism reflectors that are used in binoculars and field glasses.

Ordinary silver-mirrored surface type reflectors – found in typical flashlights, automobile headlamps, residential and architectural lighting fixtures – similarly reflect light adhering to the same principle as above whereby the angle of reflection is equal to the angle of incidence. However, compared to total internal reflection, the distinct difference here is a loss of light energy during the reflection process. This light energy loss is manifest in the absorption of heat energy in the reflecting surface. These reflectors are energy absorbing devices that diminish reflecting power, generate unwanted residual heat loss, and put a drain on air conditioning resources in commercial lighting fixtures.

The critical angle lens reflector described here is a solid, lens-shaped

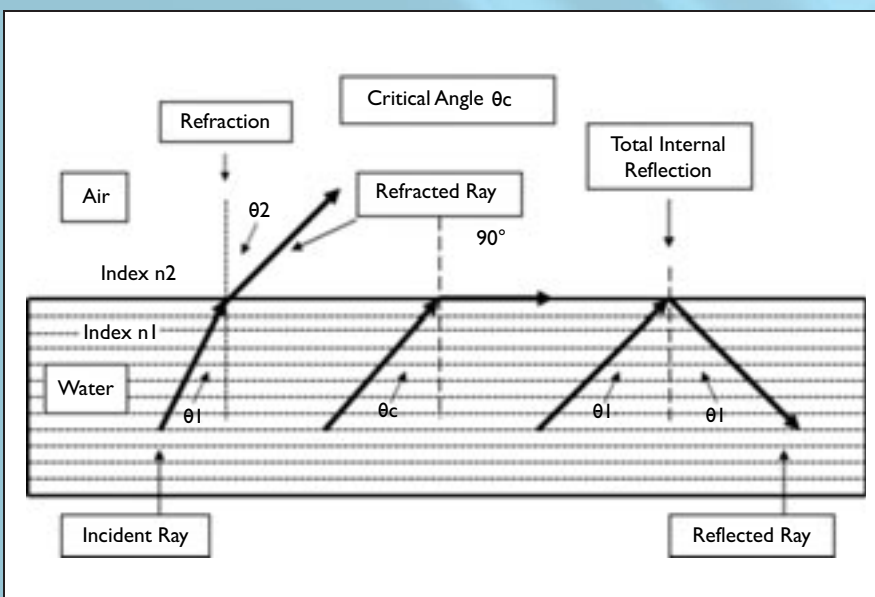

Figure 1. Illustration of Snell's Law



## LIGHT RE-ENGINEERED

## PROTOTYPE TO PRODUCTION



**Custom Engineering  
and Manufacturing**

**Durable High Transmission  
Sputtered Filters from UV to NIR**

Optical System Layout and Optimization

Optical Components, Custom and OTS • Low and High Volume Builds

Sourcing and Supply Chain Management • Industrial Design

Flow Cytometry • Machine Vision • Point-of-Care

Laser Applications • Raman • Fluorescence

Astronomy • High Resolution Imaging

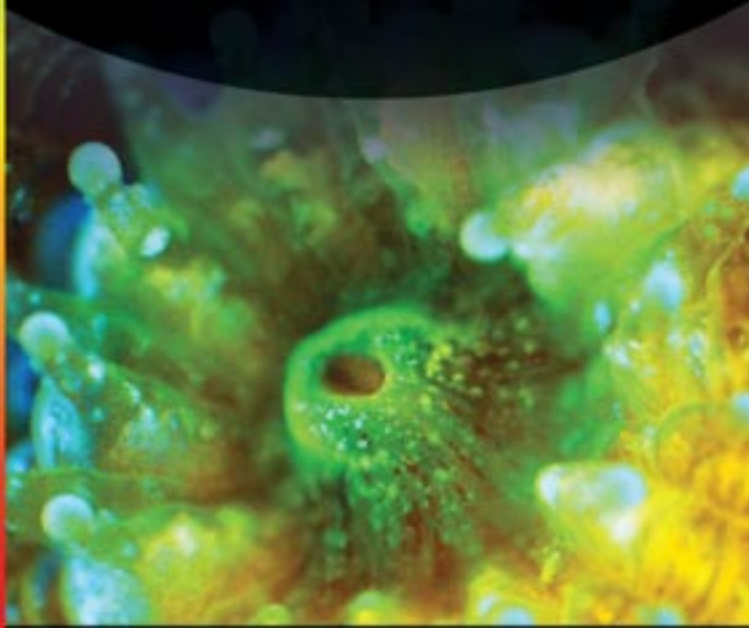
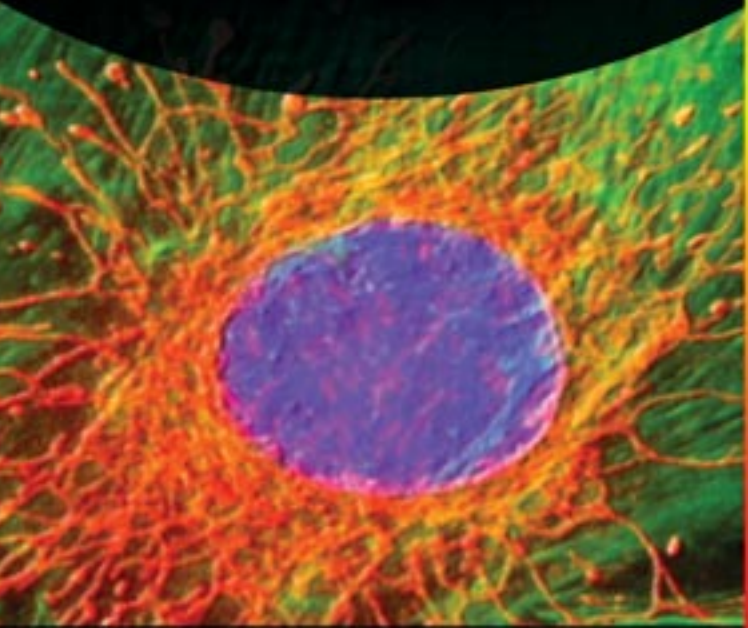

PHONE +1-802-881-0302  
1-877-417-8313

WEB sales@89north.com  
89north.com

PHONE +1-802-428-2500  
1-800-824-7662

WEB sales@chroma.com  
chroma.com

Free Info at <http://info.hotims.com/72995-703>



Intro

Cov

ToC



# CRITICAL ANGLE LENS REFLECTOR

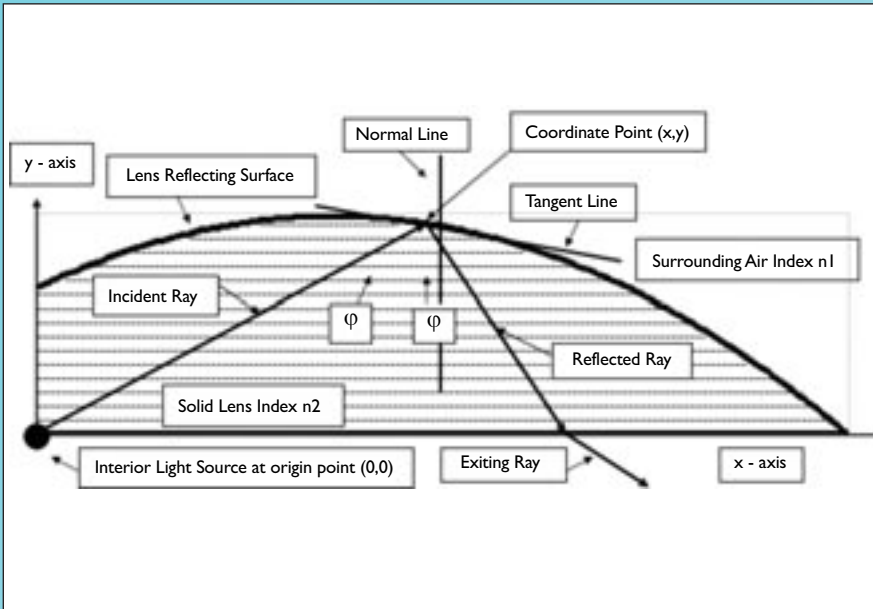

Figure 2. Two-Dimensional Cross Section of Reflecting Surface in Right Half Plane

object that is fabricated from a visibly transparent material such as glass, plastic, silicone or epoxy. The reflector would be typically used in a practical application in a surrounding transparent medium – such as in air, liquid, solid or gas. The lens shaped surface of the reflector has that particular geometrical profile such that light rays – emanating from an interior light source – strike the interior reflector surface with a preferred, fixed incident angle whose magnitude is larger than the optical critical angle. From the basic principles of

geometrical optics in physics, the optical critical angle is that particular angle whereby incident light rays that strike the reflecting surface – with an incident angle that is larger than the critical angle – will undergo total internal reflection.

The optics-physics behind critical angle reflectivity is incorporated in Snell's law illustrated in Figure 1.

Figure 1 shows a light ray incident upon a water-air interface. The index of refraction of the water is  $n_1$  and the index of refraction of the air is  $n_2$  where, for total internal reflection to occur,  $n_1 > n_2$ .

The incident ray makes an incident angle  $\theta_1$  with the vertical (normal line) and the refracted ray makes a refracted angle  $\theta_2$  with the vertical (normal line).

$$n_1 \sin(\theta_1) = n_2 \sin(\theta_2)$$

Snell's law shows the connection between the incident and refracted angles and the corresponding indices of refraction of the two media in the system –  $n_1$  for water and  $n_2$  for air where  $n_1 > n_2$ . As the incident angle is increased, then, for the case where  $n_1 > n_2$ , the refracted angle  $\theta_2$  approaches 90 degrees. At the point where angle  $\theta_2$  equals 90 degrees, there is no longer a refracted ray that crosses the boundary interface into the air medium and the corresponding incident angle in medium 1 is called the "critical angle" denoted as  $\theta_c$ . Mathematically, at  $\theta_2 = 90$  degrees, since  $\sin(90) = 1$ , then from Snell's law, the magnitude of the critical angle  $\theta_c$  is given by

$$\theta_c = \arcsin(n_2/n_1)$$

Some typical values of critical angles  $\theta_c$  for various material interfaces for  $n_1 > n_2$  are:

For a water-air interface,  $n_1 = 1.33$ ,  $n_2 = 1.00$ ,  $\theta_c = \arcsin(1/1.33) = 48.6^\circ$

For Lucite-water interface,  $n_1 = 1.50$ ,  $n_2 = 1.33$ ,  $\theta_c = \arcsin(1.33/1.50) = 62.7^\circ$

For a Lucite-air interface,  $n_1 = 1.50$ ,  $n_2 = 1.00$ ,  $\theta_c = \arcsin(1/1.50) = 41.8^\circ$

The lens shape of the critical angle lens reflector has the geometrical profile that forces the condition that light rays – emanating from an interior light source – strike the interior surface interface with a fixed incident angle  $\phi$  that is larger than the critical angle of the system as defined by the two component materials at the interface. The cross-section geometrical profile of the lens-shaped surface has the shape of a curve whose coordinate points  $(x, y)$  are determined by the mathematical differential equation shown below:

$$dy/dx = (y - x \tan(90 - \phi)) / (y \tan(90 - \phi) + x)$$

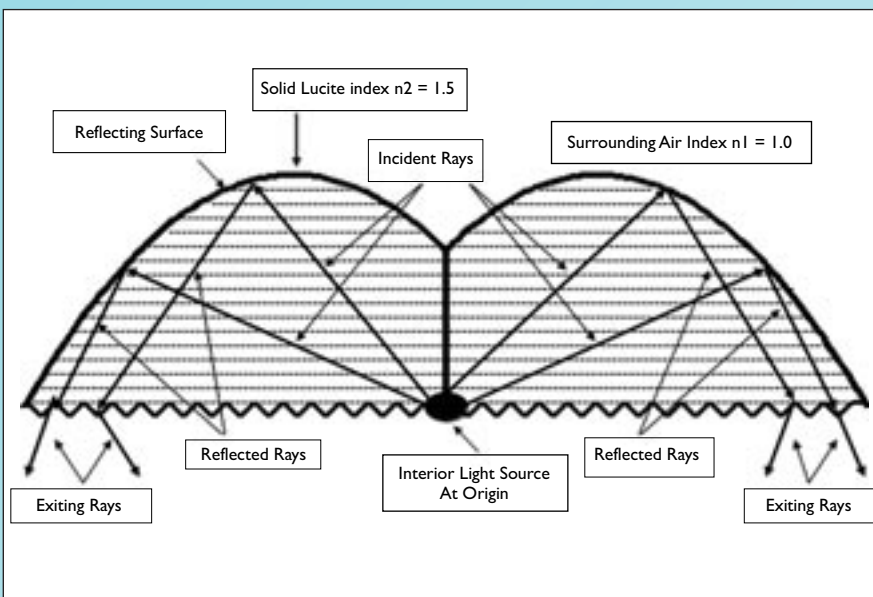

Figure 3. Two-Dimensional Cross Section of Entire Reflecting Surface



This equation is valid over the two-dimensional domain  $x \geq 0, y > 0$ . In this equation,  $(x, y)$  are the coordinate points on the geometrical profile curve,  $dy/dx$  is the slope (derivative) of the curve and  $\varphi$  is the preferred, fixed angle of incidence of the light ray emanating from the light source. The three-dimensional profile of the preferred reflecting surface is a revolution of this two-dimensional curve about the symmetry  $y$ -axis.

In a practical implementation of this equation, the value of the preferred, fixed angle of incidence  $\varphi$  must first be declared in order to achieve total internal reflection of the light rays. This angle is determined by the material from which the lens is fabricated and the medium which surrounds the lens. As an example, we chose a practical system interface whereby the lens reflector material is clear Lucite plastic and the surrounding medium is air. From the above calculation for this particular system, the critical angle was evaluated to be 41.8 degrees.

Therefore, to get total internal reflection, the preferred, fixed incident angle must be larger than 41.8 degrees. We choose the preferred, fixed incident angle to have the magnitude  $\varphi = 45$  degrees. For this example, the above equation for the two-dimensional geometrical profile configuration curve of the surface then reduces to the differential equation:

$$dy/dx = (y - x)/(y + x)$$

for  $x \geq 0, y > 0$ . This differential equation has a unique solution for the given practical boundary condition  $y(0) = 1$ . Figure 2 shows the two-dimensional solution curve to this equation in the right-hand plane region  $x \geq 0, y > 0$ .

Figure 2 shows a single ray coming from the coordinate origin point  $(0,0)$  and striking the reflecting surface at the particular coordinate point  $(x, y)$ . The tangent line and the normal (perpendicular) line to the curve are shown at this particular point. At this point, the ray from the origin makes an incident angle of 45 degrees and the reflected ray also makes an angle of 45 degrees with respect to the normal line to the curve at this point. This is the exact forced condition that was used to generate the above differential equation – the forced condition being that the ray would experience total internal reflection.

The points satisfying the above differential equation forces the condition that all light rays emanating from the coordinate origin point will make a preferred, fixed incident angle of 45 degrees with respect to the normal line to the curve at all interception points on the reflecting curve. Thus, all these rays will undergo total internal reflection at the reflecting surface. The revolution of this two-dimensional curve about the symmetry  $y$ -axis generates the preferred three-dimensional geometrical profile of the lens shaped reflecting surface, the cross section of which is shown in Figure 3 for the Lucite-air example.

The bottom surface of this lens is shown to have a dimpled array which enhances the randomness of the exiting angles of the rays exiting from the bottom surface of the lens.

*This article was written by George A. Articulo, Ph.D., Professor of Mathematical Physics, Rutgers University (New Brunswick, NJ). For more information, contact Dr. Articulo at george.articulo@rutgers.edu.*

# OPTICS AS UNIQUE AS OUR CUSTOMERS

## CUSTOM MANUFACTURING

Injection Molding • Diamond Turning  
Design Support • Assembly & Bonding

## PRECISION POLYMER OPTICS

Simplify Design • Trim Weight  
Improve Performance • Reduce Costs

**(909) 559-1300**  
**DIVERSEOPTICS.COM**



Intro

Cov

ToC



# Enhancing the Capabilities of High-Speed CMOS Image Sensors

For many years now, CMOS (Complementary Metal-Oxide-Semiconductor) based sensors have dominated the high-speed imaging market. Cameras are being released with ever-higher headline imaging rates. The fundamental limitation in the speed of operation of CMOS devices is the time it takes to read out the image data from the sensor. This restricts the full-frame capture rate to a few tens-of-thousands of frames per second. Faster frame rates can be achieved by reading out smaller areas of the image, but this severely limits the usefulness of these devices at very high frame rates.

Two main approaches have been used to increase the speed of operation. The first approach is to convert the pixel charge from analog to digital locally, and read out the data through parallel buses using LVDS signalling. This approach has the big advantage of simplifying the external circuitry, but readout speed is now limited by the bandwidth of the digital interface. In addition, a significant amount of useful light sensing area has to be sacrificed to accommodate the data conversion and storage functions. The second (and potentially faster readout) approach is to use parallel analog outputs – digitization is carried out (in parallel) off-chip which adds significantly to the complexity of the camera system. Readout rate here is limited by the capacitance of the analog buses, which can also cause image artifacts due to crosstalk between these sensitive connection paths.

There also remains the trade-off between spatial resolution and frame rate, limited by the available output bandwidth. This trade-off does not preclude operation at up to one-million frames per second, or more, but means that images at this fast rate are reduced to just a few hundred pixels per frame. Such resolution is of limited value to most users, and certainly no use for applications that need fine detail in the images such as Digital

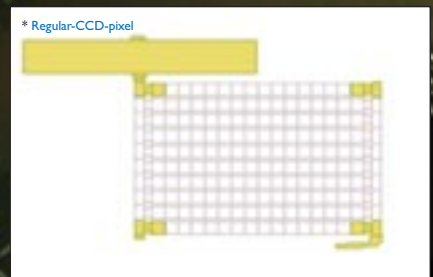

Figure 1. Kirana image sensor



Intro

Cov

ToC



Image Correlation, where a speckle pattern is applied to the sample and then displacements down to 1/100th pixel can be measured by using pattern correlation from one image to the next.

### Going Faster

The best way of overcoming the readout bandwidth limitations is not to readout the images in real time at all. By adding storage elements within the sensor, capture rate is not compromised by waiting for the previous image to be removed from the sensor. Once a sequence of images is captured, readout can be carried out at modest readout rates, thereby simplifying the overall system design.

An early approach to high-speed image sensors (using CCD devices) was to employ a frame transfer technology, but to optically mask strips of pixels along the readout axis. Then, by shifting each pixel along the readout register, the acquired image was moved under the optical mask and stored. After a second exposure period, the next image could also be shifted along the readout axis to be stored under the mask. In this way, 16 or more images could be stored on the chip before final readout at normal rates. This

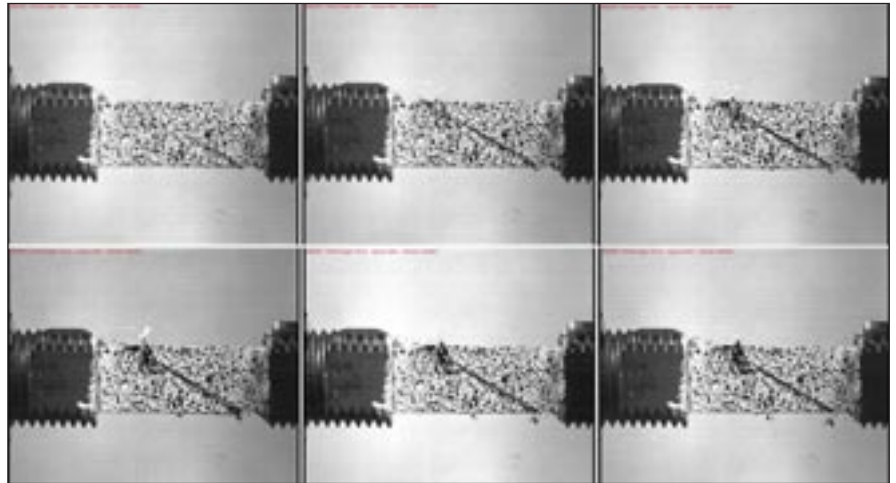

Figure 2. Digital Image Correlation

approach can give very high acquisition speeds for a relatively small number of frames, albeit at the expense of usable image pixels. Extending this concept to the CMOS domain using local storage has resulted in sensors with local pixel data storage of up to 100 frames at each photosite. However, this has again come at the expense of light sensitive area, and therefore sensitivity. The more storage nodes there are in

each pixel, the less area is available for detecting light. Additionally, the number of available pixels over the sensor area has had to be reduced to accommodate the local storage and digitization elements.

### Improvements

Increasing the frame readout rate in image sensors is fundamentally limited by the physics of the devices – i.e. large area

**SSI**  
Spectrum Scientific, Inc.

Holographic Diffraction Gratings  
Aberration Corrected Gratings  
Freeform Mirrors  
Hollow Retroreflectors  
Off-Axis Parabolic Mirrors  
Ellipsoidal mirrors  
Miniature UV Spectrometers

High specification replicated optics  
Cost effective solutions for volume requirements

Spectrum Scientific +1 949 260 9900 ssiptics.com

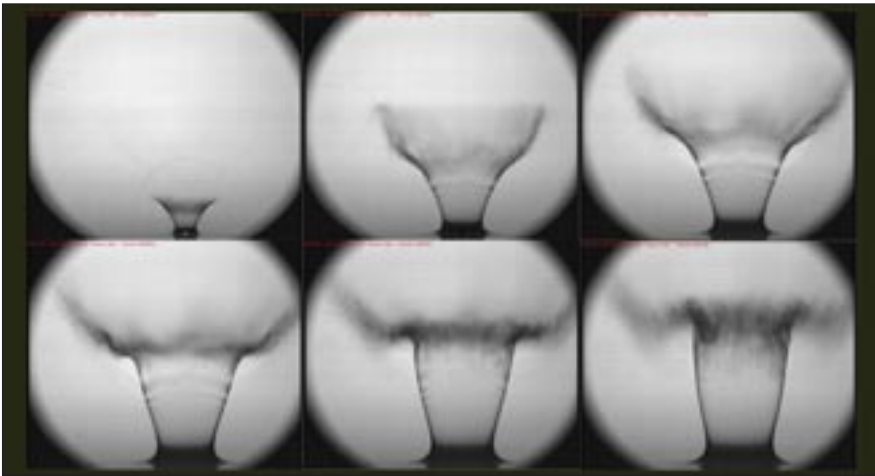

Figure 3. Fluid Dynamics

arrays have large capacitance output structures which restrict the bandwidth for analog readout techniques. High-speed digital readout is limited by the number of parallel paths that can be accommodated in the physical device and by the number of bits per frame that must be transmitted over each path.

The earliest ultra-high-speed image sensors used CCD technology to temporarily store a number of images within linear CCD structures. This however came at the expense of area within the pixel field, and a slow readout rate because of the serial nature of the CCDs themselves. An example of this approach can be found in the Shimadzu HPV2 camera which had a CCD sensor consisting of  $312 \times 260$  pixels, each with 100 frames of CCD storage. Depending on image content, moiré artefacts are sometimes introduced due to the pattern of exposed pixels, especially in areas where there is a lot of fine detail.

A later alternative to CCDs used capacitors as the storage element in a CMOS sensor whereby charge from the photodiode is converted to voltage and stored in an array of CMOS capacitors. The disadvantage of this approach is the comparatively large area required for capacitors. The Shimadzu HPVX camera, for example, has 200 frames of storage for each pixel, organized into banks outside the photosensitive pixel field, making optical screening much easier. But to achieve this, as much as 50% of the total sensor area has to be sacrificed.

## Getting the Best of Both Worlds

The Kirana image sensor developed by Specialised Imaging is a hybrid, taking advantage of the benefits of CCD charge storage, but within a CMOS pixel.

It would be very simple to connect each photodiode to a linear CCD, but this would have a couple of drawbacks. Firstly, the CCD's would need to be interleaved between photosites, making the sensor layout extremely difficult. Secondly, all of the CCD elements would operate at the image capture rate. Imagine a million CCD's (one per pixel) each 180 elements long – that's nearly two billion CCD cells – all running at a rate of 1MHz, all generating heat, which could easily damage the sensor.

The storage concept behind the Kirana image sensor is based on conventional CCD technology, but modified to try and reduce some of the inevitable drawbacks of running at very high capture rates.

In the Kirana image sensor, charge is extracted from the photodiode into a short (10-element) CCD, running at the capture rate. After ten frames, this CCD is full, so all 10 charge packets are moved sideways into a bank of ten further CCD's running at 1/10th capture rate, allowing the 10 element CCD to be filled with the next ten charge packets. In this way only a small fraction of the total number of CCD cells is run at the capture rate, with the other CCD elements running at

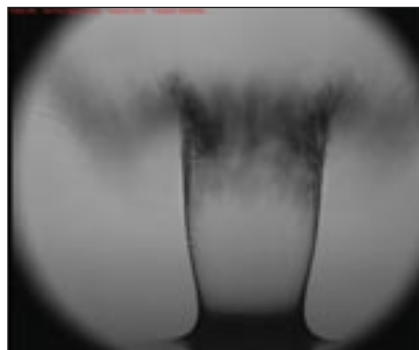

Figure 4. Fluid Dynamics Striations

1/10th of this rate, thereby generating a lot less heat.

Having this matrix arrangement also makes the sensor layout simpler as there is no need to weave the CCD elements between the photodiodes. Another benefit of this arrangement is that the CCD blocks are compact, which means shielding them from the incoming light is much easier than it would have been with long thin storage elements.

## Applications

This novel sensor architecture has been used at frame rates in excess of 5 million frames per second on the Kirana high-speed video camera to allow the capture of near-megapixel resolution images in areas as diverse as materials research, plasma physics, shock physics, and cavitation to mention a few.

### Digital Image Correlation (Figure 2)

A speckle pattern allows microscopic changes in the material surface to be analyzed under stress to deduce the behavior of the material under study. Images from a sequence here taken 5 microseconds apart shows how quickly a fracture can take place. The fine detail in the speckle pattern is necessary to allow accurate analysis of the sample. (Image courtesy of Technical University, Munich, Germany).

### Fluid Dynamics (Figure 3)

This example, laser ablation in a liquid, shows how microscopic droplets flow in and around the resulting plume. Such fine details are required to fully understand the dynamics of the event. These images were captured at 5 million frames per second – only every tenth frame is shown. (Image courtesy of King Abdulla University of Science and Technology, Saudi Arabia).

In Figure 4, the minute striations in the image demonstrate the complexity of the flows taking place.

## Conclusion

Careful choice of architecture, together with combining different technologies on the same sensor can lead to significant performance benefits in ultra-high-speed video cameras. The resultant increased image fidelity at extreme frame rates can facilitate fundamental research into the processes occurring all around us that the human eye simply cannot see.

*This article was written by Keith Taylor, Technical Director, Specialised Imaging Ltd. (Pitstone, UK). For more information, contact Mr. Taylor at [keith@specialised-imaging.com](mailto:keith@specialised-imaging.com) or visit <http://info.hotims.com/72995-220>.*





# Inspection of Bulk Material with Trilinear Line-Scan and Prism Cameras

Traditionally, prism-based cameras are often selected over trilinear cameras when it comes to bulk material scanning, as the inherent line-shift of a trilinear camera can only be corrected when the object scan velocity is known. In this article it is demonstrated that the traditional approach is not always necessary if the right trilinear sensor is selected and operated in binning mode to average multiple pixels.

## Introduction

There exist various manufacturing applications where bulk materials are required to be inspected in an automated fashion at high speed. Industrial cameras, especially with line-scan camera technology, are very well suited for the typical high velocity at which the bulk material moves. In the simplest case, a line-scan camera consists of a single linear line of sensor cells. A two-dimensional image similar to an image from an area sensor is created by moving the scan scene perpendicular to the sensor while acquiring successive lines of the image. The single-line sensor can produce a single-channel image, typically in grayscale. However, many bulk material inspection applications require color images. There exist two types of technologies to acquire full-color images:

- A single trilinear line-sensor.
- A prism-based camera with three single line-sensors.

In the case of the trilinear sensor, the three image lines of a single object point are acquired at different moments in time with the resulting channel-shift in transport direction typically corrected internally. For a perfect correction the scan object velocity needs to be constant and precisely predetermined. In the case of a prism-based camera, the three image channels are acquired at the same moment in time and therefore no extra correction is needed. (Figure 1)

Whenever bulk material is transported on a conveyer belt the object velocity is typically well known. However, there

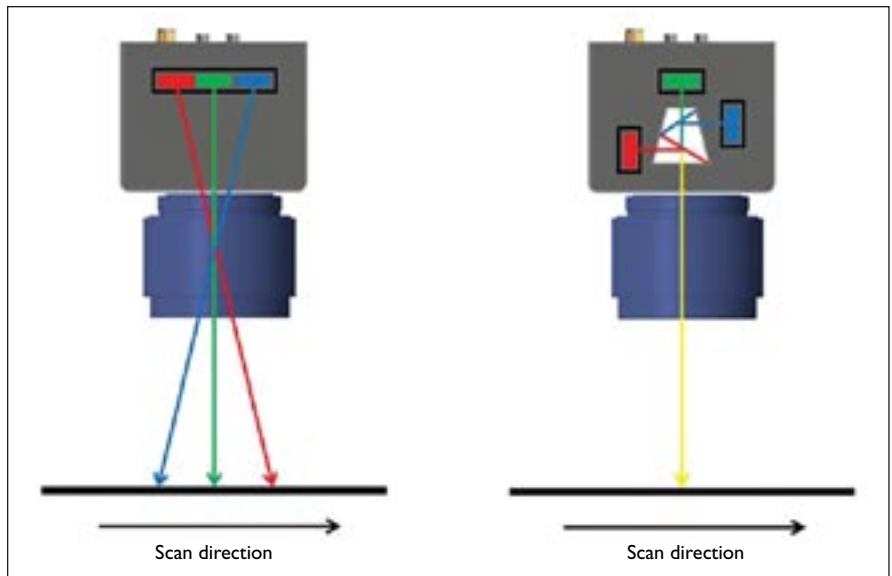

Figure 1. Trilinear (left) versus prism-based (right) line-scan technology.

also exist applications for which this is not the case, such as:

### Free falling bulk material

The velocity distribution among individual material pieces is rather homogenous and only slightly influenced by air friction.

### Bulk material on an inclined plane

The velocity distribution among individual material pieces is influenced by the coefficient of friction of the material and the plane.

For the case of a trilinear line-sensor, unknown object velocity can result in the so-called *color fringe* or *halo* effect, for which object contours appear with false color in the transport direction. An example is shown in Figure 2.

However, with the correct selection of a trilinear camera sensor type and proper configuration, it can be equivalent in performance to a prism-based camera in terms of color image quality. We demonstrated this by testing several bulk materials. We did a one-to-one comparison of the trilinear sensor-based camera, — Chromasens allPIXA wave — with an industry-standard prism camera.

## Camera Selection

As mentioned earlier, trilinear sensor-based cameras can be used as alternatives to prism-based cameras in many conditions. The color fringe effect with trilinear sensors stems from the fact that the color image channels have to be shifted relative to each other by an amount that depends on the physical



Figure 2. Color fringe effect due to uncorrected pixel line-shift.

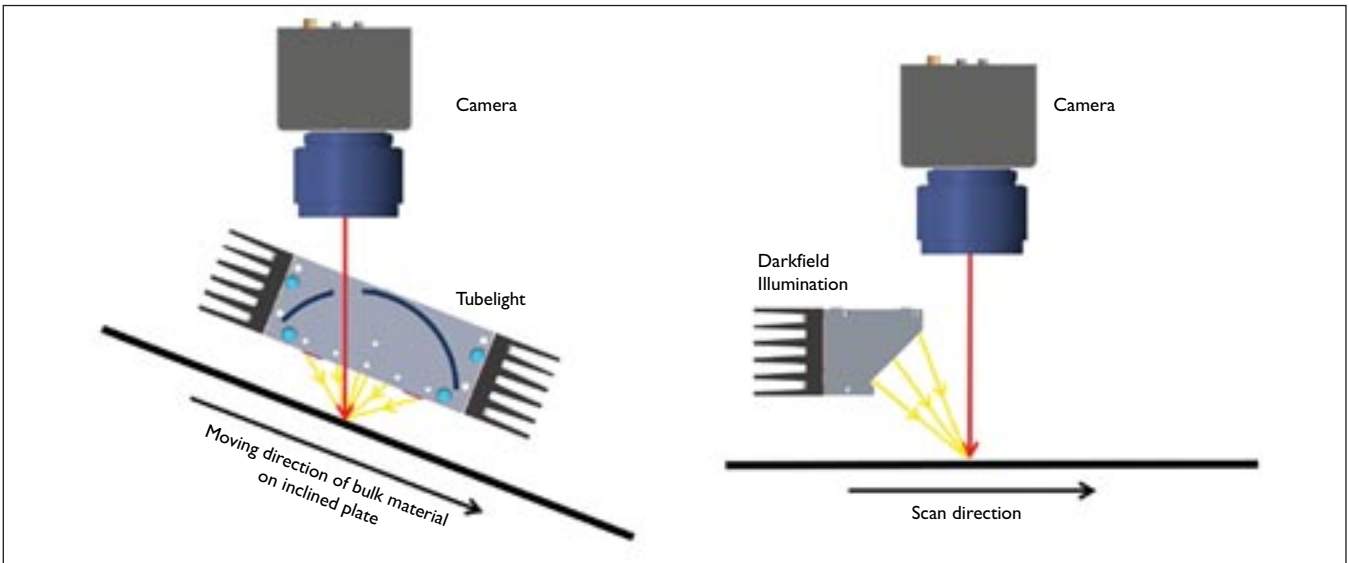

Figure 3. Inclined plane setup (left); linear stage setup (right).

distance ( $\Delta$ ) between the sensor lines (typically R, G, and B) and the magnification  $\beta$ . In sensor datasheets,  $\Delta$  is referred to as the pixel-pitch between sensor lines. The physical size of the color shift between two lines (in meters) is  $\beta \times \Delta$ . Typically, the scan speed ( $v_{scan}$ ) of the object is adjusted to a nominal velocity  $v_0$  in such a way that transport resolution and optical resolution are the same (square pixels). The size of the color fringe in pixels is dependent on the ratio of these two velocities and can be calculated using the physical size of a pixel (S) instead of the magnification:

$$d_{Halo} = \frac{\Delta}{S} * \frac{v_{scan}}{v_0}$$

The Chromasens allPIXA wave that was used in testing has a pixel pitch of 10.2  $\mu\text{m}$  and a pixel size of 5.6  $\mu\text{m}$ , resulting in reduced color fringe compared to trilinear cameras that have larger pitches and pixel sizes.

The size of the fringes can be further reduced by increasing the image resolution (smaller  $\beta$ ). For the most part standard commercial prism-based line-scan cameras for industrial applications have at most 4096 pixels. Cameras of the Chromasens allPIXA wave family are available with up to 15360 pixels. Accordingly, given the same field of view but more pixels the magnification can be decreased as shown in the following example:

- Field of view: 100mm
- Camera resolution:**
- with 2k (2048) pixel sensor, 48.8 $\mu\text{m}$ /pixel
  - with 4k (4096) pixel sensor, 24.4 $\mu\text{m}$ /pixel
  - with 15k (15360) pixel sensor, 6.5 $\mu\text{m}$ /pixel
- Line-shift relative to the camera resolution:**
- with 4k (4096) pixel sensor, a factor of 2 smaller than for 2048-pixel sensor
  - with 15k (15360) pixel sensor, a factor of 7.5 smaller than for 2048-pixel sensor

Accordingly, with a 15k trilinear line-scan sensor instead of a 2k trilinear sensor, there will be a factor of 151 less of a color fringe effect with the same field of view.

The remaining color fringe has maximum visibility at an edge where the color changes from black to white in the transport direction. For the trilinear camera tested, the image of the edges in two neighboring color channels is shifted by two pixels relative to each other. An additional trick helps to reduce the fringe further. If multiple pixels are averaged into one single pixel, a process called binning, the shifted edges of all color channels will fall into the same pixel. The remaining shift is now at a sub-pixel level and results at most in a slight discoloration of the edge.

When setting up a trilinear line-scan camera the internal line-shift correction

is set to the nominal velocity of the application. The binning approach then only has to correct for velocity variations. Typically, binning windows of 2 to 4 pixels have been useful in this case.

**Laboratory Setup and Test Material**

Two configurations were tested. The first is the *inclined plane setup* (see Figure 3, left side). The inclined plane setup is a worse case than the free-falling bulk

Camera setup Technology	Trilinear	Prism-based
Native sensor resolution	15360 px	2048 px
Maximum line rate	18.4 kHz	19.0 kHz
Lens	76mm f/5.6 Conventional lens	56mm f/2.8 Optimized for prism camera
Field of view	690 mm	365 mm
Optical resolution	140 dpi	140 dpi

Light source:	
Inclined plane setup	Chromasens Corona II tube-light CP000200-C0007-340T-10_R2
Linear stage setup	Chromasens Corona II dark-field illumination CP000200-510C-04-XXXX



Figure 4. Bulk material used for testing: white rice (left); almond kernels (middle); gravel (right).

material, as the velocity distribution of the bulk material particles is larger. The second configuration is the *linear stage setup* (see Figure 3, right side), in which the bulk material is distributed on a plane that is then moved under the camera. This setup allows adjusting the movement velocity in a controlled fashion. In that way, it is possible to do a one-to-one comparison of individual material particles with both camera types for different velocities.

#### Bulk Material Used for Testing:

- White rice — white objects can be considered as a worst-case scenario, as the color-fringe effect becomes most visible.
- Almond kernels
- Gravel

#### Analyzing Velocity Distribution of Bulk Material on Inclined Plane

In conventional line-scan applications with trilinear sensor cameras, the line shift is corrected in the camera for a given global velocity. With free-moving bulk material — inclined plane or free-falling — the adjustment is done for the average velocity, which has to be determined once, when setting up the system.

We analyzed the individual particle speed of bulk material on the inclined plane setup for the case of white rice samples. This was done by blob analysis of the line-shift of each rice kernel of a scanned image. The resulting velocity distribution is illustrated in Figure 5.

We identified a velocity standard deviation of 10%. Assuming our distribution is adequately approximated by a Gaussian distribution we can conclude that 68% of all particles are within the velocity range of  $\pm 10\%$ , and 95% in the range of  $\pm 20\%$  from the average velocity.

#### One-to-One Comparison of Cameras

Assuming the parameters of the velocity distribution of white rice, we can acquire image data with the linear stage setup at different speeds. For testing, we considered average velocity  $\pm 20\%$ . We performed the experiment for the trilinear

and the prism-based cameras using an identical scan scene.

Figure 6 shows a direct comparison of image data.

Comparing the trilinear camera images with native resolution and nominal velocity (right column, 2<sup>nd</sup> row) with

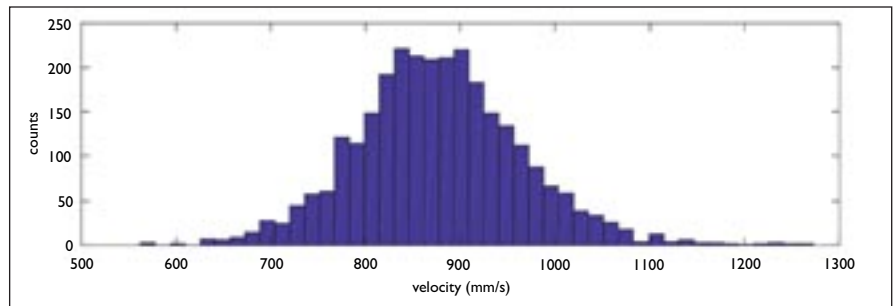

Figure 5. The engineering design of the AO series pays off in unprecedented speed and quality of copper welds.

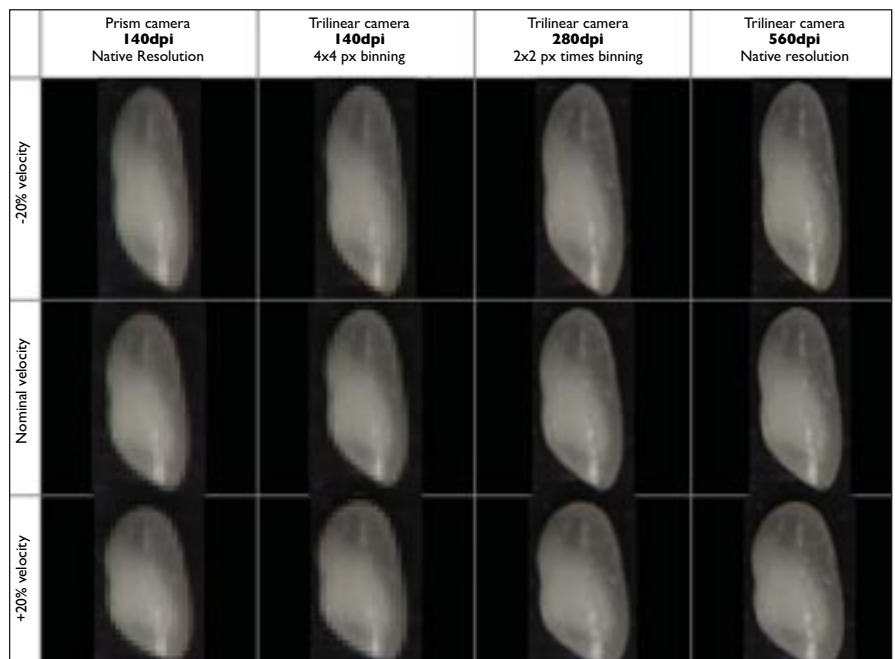

Figure 6. Direct comparison of prism and trilinear camera image of a single rice kernel.

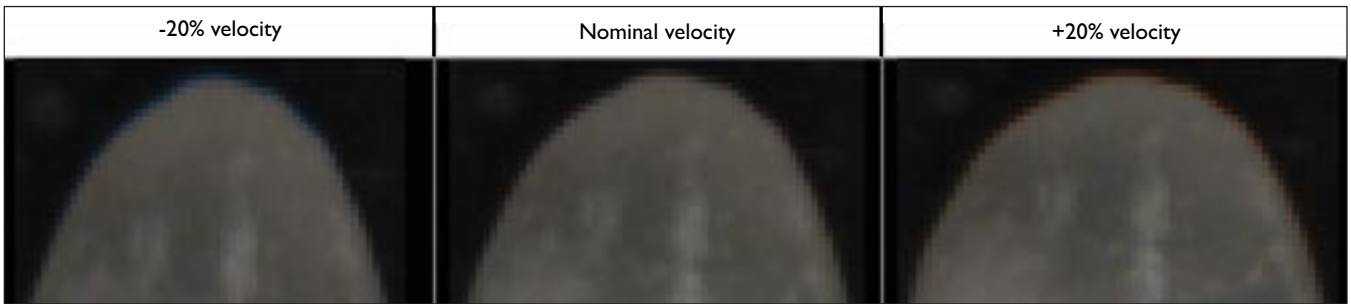

Figure 7. Zoomed view in native resolution.

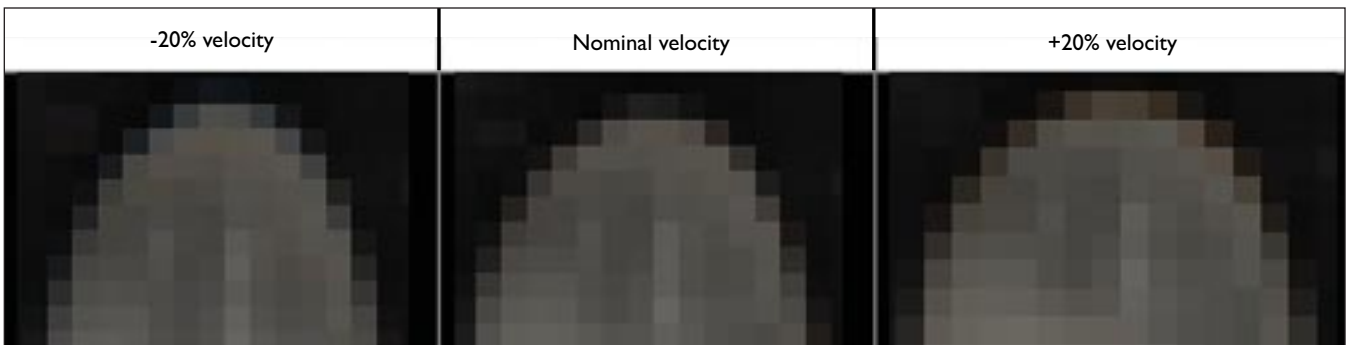

Figure 8. Zoomed view with 4 × 4 binning.

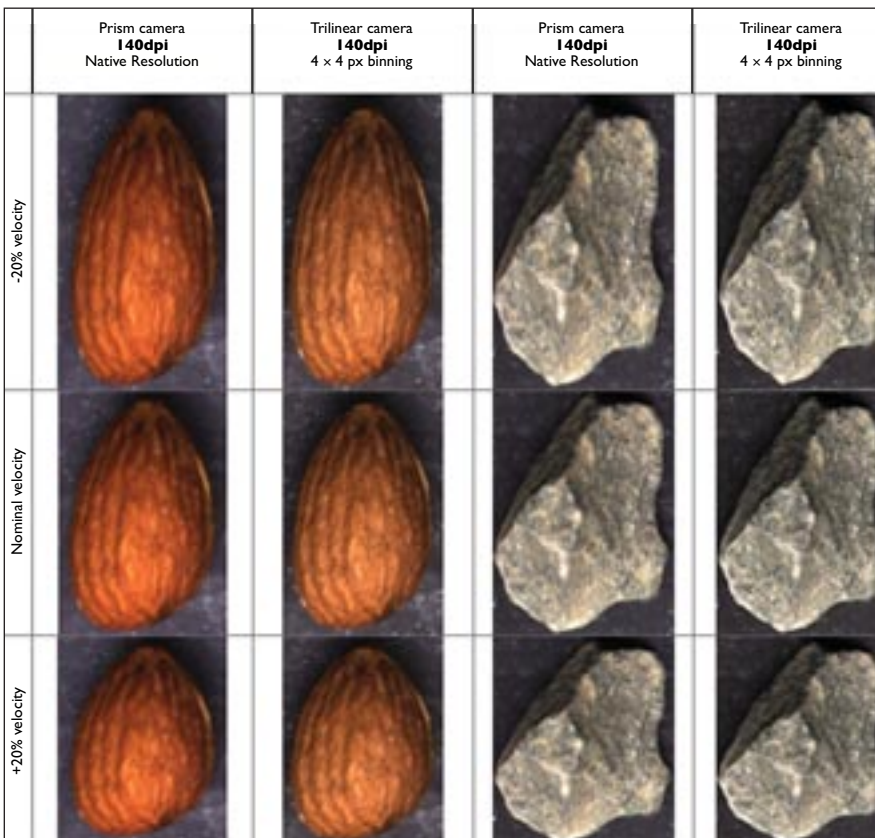

Figure 9.

those acquired with +/-20% speed (right column, 1<sup>st</sup> and 3<sup>rd</sup> rows), we can observe color fringes at the upper and lower ends of the rice kernel. The zoomed-in image of the upper end of the rice kernel shown in Figure 7 illustrates the effect in more detail.

Binning the native resolution images with 2 × 2 or 4 × 4 pixels removes the effect down to minimal discoloration residue. For the case of 4 × 4-pixel binning, we show zoomed-in versions in Figure 8.

White objects on dark background are the worst-case scenario in terms of the color fringe effect for trilinear cameras. In Figure 9, we illustrate sample images of the other scan objects considered.

The image quality of trilinear and prism-based cameras seems rather similar. The color difference between the cameras stems from differences in the spectral responsivities of the two sensors.

#### Sample Images of Bulk Material on Inclined Plane

In previous experiments, bulk material was scanned with the linear stage setup for 1-to-1 comparison. A more realistic scenario is acquiring images of bulk material on an inclined plane as shown in Figures 10 and 11.



Figure 10. Almond core bulk material on inclined ramp.

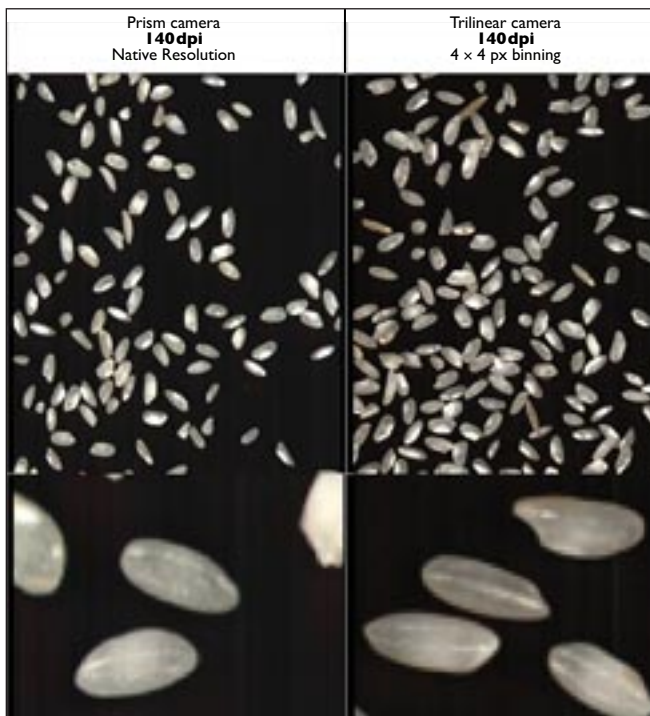

Figure 11. Rice kernel bulk material on inclined ramp.

## Summary

A comparison of trilinear and prism-based cameras for bulk-material inspection was performed by visual assessment of the color-fringe effect. This effect appears, for instance, when individual particles have distinct velocities. It was demonstrated that selecting a camera with small physical pixel-line distance in combination with high-resolution sensors and pixel-binning can effectively remove visible color-fringes.

Objects for which the reflected light is spectrally flat such as those that appear white in images, exhibit the largest color fringe effect. For other objects, the color fringe effect is generally smaller and for many applications, invisible. If in doubt whether or not color fringe effects are visible in images scanned by a trilinear sensor, it is advisable to test empirically.

There are several advantages to the proposed approach. First of all, there are less expensive trilinear sensors with much higher resolution as compared to prism-based cameras. Further, using a trilinear sensor offers much more flexibility in the selection of stock lenses, as there is no special compensated lens required for the extended optical path of a prism-based camera.

*This article was written by Timo Eckhard, Team Leader Research & Innovation, Innovation & IP Management; and Sebastian Georgi, Research & Innovation Manager, Chromasens (Konstanz, Germany). For more information, visit <http://info.hotims.com/72995-223>.*

## EPOXY for Chip Coating & Glob Top Applications

### ONE PART ADHESIVE EP17HTND-CCM

NASA low outgassing approved

Thermal conductivity  
9-10 BTU•in/ft<sup>2</sup>•hr•°F

Electrical insulation  
Volume resistivity >10<sup>15</sup> ohm-cm

Service temperature range  
-80°F to +600°F



**MASTERBOND**<sup>®</sup>  
ADHESIVES | SEALANTS | COATINGS

Hackensack, NJ 07601 USA • +1.201.343.8983 • main@masterbond.com

[www.masterbond.com](http://www.masterbond.com)



Intro

Cov

ToC



# Key Trends in Custom Optics for Aerospace

The convergence of “new” materials, improved free-form shape fabrication, and changes in the aerospace marketplace has transformed the previously static field of custom optics into a very dynamic market segment. In this article, we examine the impact of four key trends that characterize this changing landscape.

On the technology side, there are the maturation of “new” optical materials that avoid some of the performance/weight/cost trade-offs of traditional substrate materials, and the development of robotic methods that can deterministically create substrates with free-form shapes and low wavefront errors. On the applications/market side, the two important trends are an increased demand for volume manufacturing of custom components, and outsourced component integration, where end users are looking for subsystems and even complete systems rather than just optical elements.

## New Material Capabilities

Traditionally, many of the custom optics for aerospace applications were fabricated either from some type of glass, a thermally stable ceramic (e.g., Zerodur), or beryllium. These all involved trade-offs in terms of stiffness, thermal (expansion/contraction) sensitivity, weight and cost. For example, glass (and fused silica) is lower cost, easy to polish and has a low coefficient of thermal expansion (CTE). However, it is not particularly stiff, so components need thickness or other structural optimization, which adds weight and is undesirable for airborne or spaceborne applications.

Recently there have been important advances in two alternative materials – bare aluminum and silicon carbide – that avoid some of the traditional trade-offs. Aluminum is both light and stiff, which explains its ubiquitous use in airframes. However, aluminum alloys have historically been used only in high performance reflective optics when given a thick cladding of a harder, more polishable metal, such as nickel. In addition to their



Figure 1. An important material advance is the ability to create optical quality surfaces on aluminum substrates, by deterministic polishing of surfaces created by SPDT.

higher cost, these bimetallic optics are then notoriously sensitive to thermal deformations due to the difference in CTE for nickel and aluminum.

This has now changed thanks to the latest multi-step fabrication methods that enable optical finishes on even low-cost aluminum alloys. At Coherent this entails an initial heat treating cycle to dissipate the nanoscale particles of iron, bismuth and other materials. This is followed by using single point diamond turning (SPDT). This diamond turning inevitably imparts a grooved surface finish. The surface figure is carefully measured using Fizeau interferometry relative to a computer generated holographic (CGH) optic used as a null lens. The surface roughness may also be separately measured using a phase measuring microscope. These data are then used to program a robotic system used for “Deterministic Polishing” (see section on free-form polishing) followed by thermal stress relief, and application of a high-performance optical coating. The final rms surface figure on these optics can then be as good as  $\lambda/100$  (at 633 nm) with (rms) surface roughness of just a few Å (Figure 1). These values mean that aluminum optics now can even be used for ultraviolet applications. And since aluminum is the most common metal used in mounts and housings etc., the entire assembly is thermally matched and hence provides stable alignment and focusing.

Improvements in silicon carbide represent another material advance, particularly for spaceborne applications. Silicon car-

bide is an excellent compromise between glass and beryllium. It is stiffer than glass but much less thermally responsive than beryllium. However, silicon carbide traditionally was a difficult material that was rarely used for larger optics. The problem was principally one of supply; producers of silicon carbide did not have the capacity and experience to reliably deliver large, high-quality blanks. Thanks to a volume demand from the semiconductor industry, the material has advanced substantially in terms of lead time, size limits, manufacturability and quality.

## Robotic Manufacturing of Free-Form Shapes

Free-form optics refer to optical surfaces that are non-spherical/cylindrical and go beyond simple symmetrical asphere forms. The extra degrees of freedom provided by free-form shapes enable designers to build systems with fewer components (i.e., lower weight, size and cost) and reduced aberrations and distortions, resulting in a wider field of view, superior resolution, and so forth. The military were early users of free-form optics for applications such as heads up displays in aviation, where performance and minimum size were pre-eminent considerations. But today, as more designers are becoming aware of free-form capabilities, and the cost to produce them has decreased, free-form optics are now one of the fastest growing areas of custom optics.

Coherent is supporting this market growth by the use of cost-effective fabrica-



Figure 2. The irregular free-form shape of the optic being tested here can clearly be seen in the reflection of the engineer's patterned shirt.

tion of free-form (and aspheric) optics. In particular this fabrication relies on completely new robotic production techniques, which utilize a concept called *Deterministic Polishing*.

Traditional (spherical, cylindrical) optics have been fabricated by the same method for hundreds of years, i.e., random (stochastic) grinding and polishing that delivers a radially symmetrical result. Conversely, aspheres are typically created in a deterministic way by fine cutting using SPDT. However, SPDT alone leaves a grooved surface that must then be polished in some way to reach an optical quality sufficient for ultraviolet or laser applications. The latest Deterministic Polishing methods combine the deterministic shape control of SPDT but with the surface finish of random polishing. In simple terms, the

fabrication involves repeated shape and surface metrology and computer software that precisely controls the (non-random) motion of a robotically driven polishing pad. (Of course, this approach is contingent on proprietary tools which can efficiently test a free-form shape.)

There are two main advantages to Deterministic Polishing. First it enables the production – within certain limits – of any continuous CAD/CAM defined surface, providing the optical designer with unprecedented freedom and system capabilities (Figure 2). Second, because it is a software-controlled robotic process, it is highly repeatable. This latter advantage dovetails perfectly with a key market trend, namely the demand for higher capacity manufacturing of custom surfaces.

#### Volume Demand

Historically, many custom optics for aerospace were “one-off” single units, such as used in satellites, or in space (i.e., Hubble) or ground-based telescopes, often under the auspices of NASA. But today this is changing for two reasons. First is the advent of a global commercial spaceflight industry, often referred to as New Space. Here the payloads are frequently a distributed system of several smaller satellites, e.g., based on the so-called CubeSat communications network protocol, rather than just a single, big-ticket payload. Second, both spaceborne and

ground-based telescopes increasingly use a segmented primary mirror consisting of individual segments that are adaptively focused to correct for various aberrations and atmospheric distortions.

There is thus a growing need to produce custom optics using volume manufacturing. This must deliver both some economy of scale cost benefit, and the ability to repeatably create multiple identical optical elements (Figure 3). The new Deterministic Polishing methods mean that aspheric and free-form shapes can now be produced with equal or better repeatability than conventional spherical lenses and mirrors. Examples of this include the segments Coherent polished for the next-generation Webb space telescope currently scheduled for launch in 2021.

#### Subsystems and Systems

Another important trend in the demand for custom aerospace optics is common to several other market sectors, namely the drive to improve the performance/cost ratio of end products by outsourcing sub-systems, or even complete systems, to qualified manufacturers. This enables the primary customer to move towards specifying system performance, rather than component performance. Key fabrication, assembly and testing tasks are all collectively outsourced to a vendor. This minimizes both the direct capital costs of the overall system and also the indirect costs by reducing the need for in-house photonic expertise and the time to design, build and test internally. As with volume fabrication, this is now one of the fastest growing areas for high performance optics in aerospace.

In conclusion, custom optics for aerospace applications is a rapidly evolving market segment, following decades of relative stasis. The changes in manufacturing techniques and usable materials, as well as increased commercialization of aerospace, particularly for space flight, are all combining to provide new opportunities and exciting capabilities for vendors and customer alike.

*This article was written by Michael Orr, Product Line Manager – Custom Optics, Coherent. For more information, contact Mr. Orr at [michael.orr@coherent.com](mailto:michael.orr@coherent.com) or visit <http://info.hotims.com/72995-224>.*

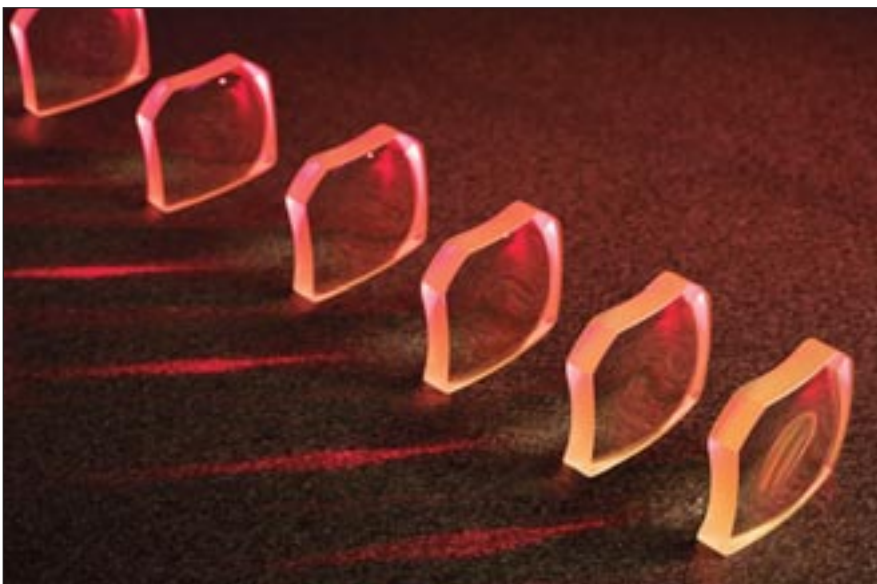

Figure 3. These volume manufactured optics are highly aspheric lenses intended for a Heads Up Display application.





**Chroma Technology Corp**

10 Imtec Lane  
 Bellows Falls, Vermont 05101  
 Phone: 802-428-2500  
 Fax: 802-428-2525  
 E-mail: sales@chroma.com  
 www.chroma.com

**Company Description**

Chroma Technology produces high-quality optical interference filters and guidance optics for photonics applications. A leader in fluorescence imaging technologies, Chroma also designs and manufactures optical filters for applications in astronomy, machine vision, remote sensing, Raman spectroscopy, colorimetry and environmental monitoring. Chroma is 100% employee owned.



**Products/Services Offered**

Chroma Technology manufactures high performance, hard-coated optical interference filters using advanced coating techniques, resulting in filters with enhanced durability and longevity. Our machine vision filters provide superior levels of transmission and optical density, using coatings designed to accommodate wide fields of view, delivering bright images with the highest contrast. We provide a broad array of sputtered filters ranging from 200-3000nm, manufactured in the U.S., with in-house engineering and small to high volume production.



[www.chroma.com](http://www.chroma.com)

Free Info at <http://info.hotims.com/72995-707>







### Rosendahl Nextrom Oy

Ensimmäinen savu 2  
 Vantaa 01510, Finland  
 Phone: +358 9 50251  
 E-mail: office.finland@rosendahlnextrom.com  
 www.rosendahlnextrom.com

#### Company Description

Nextrom is the leading global supplier of production technologies for optical fibers and fiber optic cables. Creating excellence with our partners is our mission. Lifetime partnership is of utmost importance to us.



OFC 20 (NIF 200 – NEXTROM Induction Furnace)



OFC 12 MCVD System

#### Target Markets

Optical glass making, fiber drawing, fiber coating, fiber coloring, ribbon making, proof testing and fiber optic cable production.

#### Products/Services Offered

Our core competences include solutions for optical glass making, fiber drawing, fiber coating, fiber coloring, ribbon making, proof testing and fiber optic cable production. Our technology is used for producing telecom and specialty preforms and fibers.



OFC 40 Secondary Coating Line



OFC 05 Horizontal OVD Cladding & OFC 08 Clad Sintering System

[www.rosendahlnextrom.com](http://www.rosendahlnextrom.com)

Free Info at <http://info.hotims.com/72995-708>



Intro

Cov

ToC





**Diverse Optics Inc.**  
 10310 Regis Court  
 Rancho Cucamonga, CA 91730  
 Phone: 909-593-9330  
 Fax: 909-596-1452  
 E-mail: info@diverseoptics.com  
 www.diverseoptics.com

**Company Description**

Diverse Optics is the leader in diamond turning and precision injection molding of custom polymer optics. For over 25 years, we've manufactured the most challenging components and assemblies for leading defense, medical, and commercial applications. Whether it's prototypes or production molded optics, we'll show you how polymer optics are perfected.



**Target Markets**

Medical, Defense, Commercial

**Products/Services Offered**

We know that your optics are as unique as you are. For over 25 years, Diverse Optics has manufactured the most challenging components and assemblies for leading defense, medical, and commercial applications. We use our knowledge of injection molding and diamond turning processes to help you reduce cost, simplify design, and improve the performance of your optics. Whether it's prototypes or thousands of molded optics, trust us with everything from spheres, aspheres, domes, plano/convex, bi-convex, free-forms, diffractives, Fresnels, prisms, cylinders, collimators, combiners, TIR's, micro-optics, mirrors, parabolics, off-axis, ellipses, cylinders, and more! Let us show you how polymer optics are perfected.



[www.diverseoptics.com](http://www.diverseoptics.com)

Free Info at <http://info.hotims.com/72995-709>



**Spectrum Scientific, Inc.**  
 16692 Hale Ave  
 Irvine, CA 92606  
 Phone: 949 260 9900  
 Fax: 949 260 9902  
 E-mail: sales@ssioptics.com  
 www.ssiptics.com

**Company Description**

Spectrum Scientific, Inc (SSI) has been manufacturing high volume flat, aspheric and freeform reflective optics and holographic diffraction gratings since 2004. We primarily use the optical replication process in our manufacturing allowing us to supply high-fidelity, high-specification precision optics at a fraction of the cost of traditional manufacturing.

**Target Markets**

Life Sciences, Analytical Instrumentation, Spectroscopic Instrumentation, Telecommunications, Defense & Security, Test & Measurement, Aerospace & Space, Gas Sensing & Analysis, Industrial Process Control, Medical Devices, Photonics, Research.

**Products/Services Offered**

Our key capabilities include freeform mirrors, off-axis paraboloids and ellipsoid mirrors (with surface figures down to  $\lambda/10$  or better), plane, concave and convex holographic diffraction gratings (blazed and sinusoidal) with high UV efficiency and ultra-low stray light and high precision hollow retroreflectors with return beam accuracies to  $<2$  arcsec. We also manufacture miniature UV spectrometers available as standalone or OEM modules.

- Holographic Diffraction Gratings
- Aberration Corrected Concave Gratings
- Freeform Mirrors
- Off-axis Parabolic Mirrors
- Ellipsoidal Mirrors
- Miniature UV Spectrometers

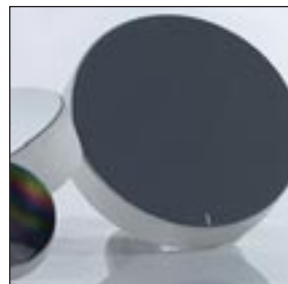

[www.ssiptics.com](http://www.ssiptics.com)

Free Info at <http://info.hotims.com/72995-710>





**Asphera Incorporated**  
 629 Center Street  
 Santa Cruz, CA 95060  
 Phone: 831-431-6801  
 E-mail: info@asphera.net  
 www.asphera.co

**Company Description**

Asphera Incorporated is the premier custom optical components and assembly provider. Since 2013, we have continued to help customers achieve results through diamond turning, CNC polishing and molding from prototype through production of complex micro to large glass, UV and IR optics.

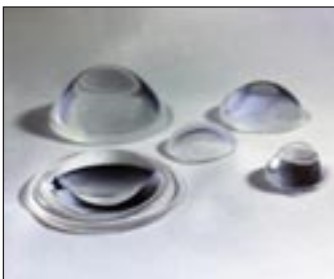

**Target Markets**

- Laser Industries
- Medical
- Semiconductor
- Biotech
- Research
- Commercial
- Space and Defense

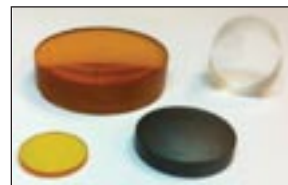

**Products/Services Offered**

What separates us from our competition is whether you need a glass molded micro-lens 0.8mm diameter with three aspheric sides, a CNC polished large 300mm asphere, or a IR diamond-turned optic, our teams have the engineering, speed, professionalism and pricing to achieve results. Our proven track record providing micro-optics, aspheres, collimators, spheres, parabolics, ellipsoids, plano-convex, and bi-convex complex shapes coupled with flat Sapphire, LiF, MgF2, CaF2, MgO windows and prisms proves we are a true one-stop shop that provides real integrated solutions for your application.

[www.asphera.co](http://www.asphera.co)

Free Info at <http://info.hotims.com/72995-781>

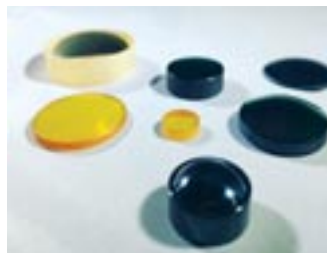

View our recent projects at [asphera.co](http://asphera.co)

**DEMANDING SCHEDULE?**

- Our customers chose Asphera Incorporated because we understand the drawbacks of timely custom optics manufacturing. We streamlined our spherical lens processing to offer 3 week expedited deliveries (as well as competitive 6 week typical delivery schedules).

**PROTOTYPES - PRODUCTION**

- Our customers chose Asphera Incorporated when they need a single-source provider for concept through production from our 3 methods of Custom Aspherical Lens Processing: Single-Point Diamond Turning, CNC Polishing, and Molding (0.8mm - 300mm Diameter capabilities).

**RELIABLE?**

- Our customers chose Asphera Incorporated because of our proven track record delivering complex custom optics since 2013.

**WHAT ELSE?**

- Research Laboratories and Universities around the world trust Asphera Incorporated's precision LiF, CaF2, MgF2, MgO, and Sapphire windows.

Call 831-431-6801 or Email [info@asphera.net](mailto:info@asphera.net)



# APPLICATION BRIEFS



## Optimizing Image Sensors for Security Cameras

Performance of image sensors for security cameras must be geared to low-light sensitivity, high signal to noise ratio, and high temperature performance. Security image sensors are typically mission-critical 24/7, often standing outside under sun, snow, wind, and other harsh environments. It's especially important that they can perform well at nighttime under dark conditions.

Although both CCD and CMOS sensors can be used for security and surveillance applications, CMOS is becoming the technology of choice. In the past CCD sensors have had superior performance in some areas, for example, good performance in low-light conditions, wide dynamic range, and low noise. However, in the last few years the performance of CMOS sensors has significantly improved to the point where they are matching or besting that of CCDs. A major factor in the rapid improvement in CMOS performance has been the research and development conducted by mass-market manufacturers. Their R&D has been motivated by the inherent benefits of CMOS, such as low power requirements, small size, simplified circuitry, and suitability for use in mobile telephone cameras. In addition, CMOS sensor chips are based on standard CMOS process technology for digital ICs, with some adaptation for imaging (e.g. pinned photodiodes) and are manufactured at foundries with the standard process technology typically used for all sorts of digital ICs. A CMOS imager converts charge to voltage at the pixel level, with voltage amplification integrated into the chip.

### Sensor Architecture

CMOS image sensors have historically been assembled with two different architectures: Frontside Illumination (FSI) —



Figure 1. Security image sensors are typically mission-critical 24/7, often standing outside under sun, snow, wind, and other harsh environments. (Photo: AliaksaB/Shutterstock)

the older, and Backside Illumination (BSI), the more recent.

A frontside illuminated sensor is constructed with a lens at the front and a matrix of photodetectors at the back. This arrangement is relatively simple to manufacture; however, it places the matrix and its wiring in a position to reflect back some of the light. This reflection reduces the available information in the incoming image signal.

In a BSI sensor, the wiring is placed behind the photocathode layer, which is reversed during manufacturing. The reverse side is then thinned so that light

can strike the photocathode layer without passing through the wiring layer. Because of this architecture, the chance of an input photon being captured and converted to an electron is increased from about 60% to over 90% — a significant advantage in low light security applications. The drawbacks to BSI have been problems such as cross-talk, which causes noise, dark current, and color mixing between adjacent pixels. Thinning also makes the silicon wafer more fragile.

### A New Approach

While BSI outperforms FSI overall, it's more complex, and therefore more expensive, to manufacture. You build the photodiode first and then you turn the wafer around, grind it, and place the metal on top of it. In addition to the increased number of steps, there are more mask layers — more stacks — than FSI, therefore it's costlier to manufacture. In addition, the time-to-market is usually 1.5 – 2× longer than FSI.

SmartSens Technology (Shanghai, China) has developed an advanced CMOS vision sensor designed specifically for the security/surveillance market. It benefits from the ease of manufacture of FSI, but has performance that exceeds what would have resulted from either FSI or BSI type alone, said Chris Yiu, Chief Marketing Officer. To distin-

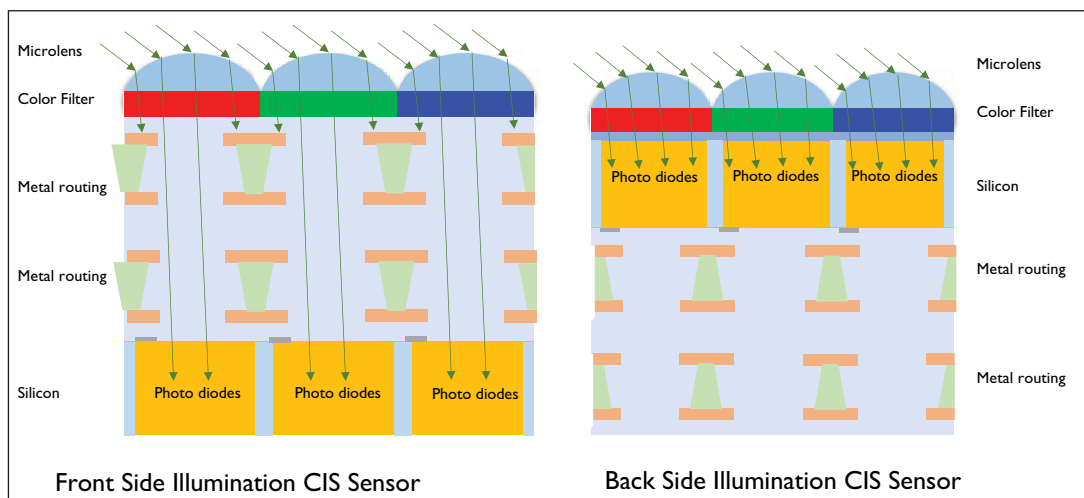

Figure 2. Frontside Illumination (FSI) and Backside Illumination (BSI) architectures. (Image: SmartSens Technology)

guish this new technology from the other sensors on the market, they have called their SmartSens DSI Technology. According to Yiu, its improved performance is the result of both pixel process and circuit design.

“Our DSI sensor uses FSI process technology, meaning that the photodiodes are laid underneath the metal layers in the process,” said Yiu. However, SmartSens DSI technology provides improvement in sensor performance based on several factors, she said. “We have improved the circuit design to reduce the noise generated by the system. We also use a pixel design architecture from the BSI world so that we can have the benefits of both technologies. The results exceed what we would have if we only used either type alone,” she added.

### Performance Results

SNRI was proposed by SONY in 2016 for the security market as an index to quantitatively evaluate picture quality at low illumination. Sensitivity to light is obviously important but it is not the only factor affecting performance. Noise has a major impact on the actual usable signal. Noise can be generated from background, which is a characteristic of CMOS, and also from pixel blooming or pattern noise generated by the system’s circuitry, both analog and digital. So, there’s a lot of random noise that can be generated. Therefore, in low light, where the light and signal levels stay low, the ratio between the actual meaningful signal and the random or pattern noise is critical.

SONY’s SNRI measure is an indicator of low light performance, but it is different from signal to noise ratio (SNR). It is a measure of the lowest illuminance level in lux, for which the signal is equal to the noise. Therefore, with SNRI, a lower number signifies better performance. The SNRI index, however, is limited to CMOS sensors and security applications.

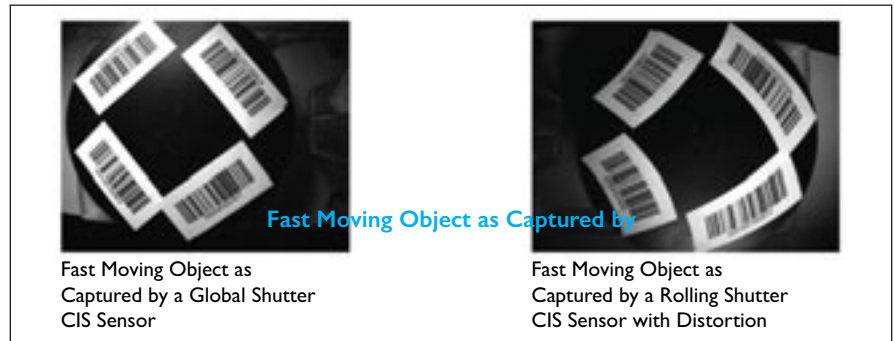

Figure 3. Comparison of global shutter CIS vs. rolling shutter CIS performance in capturing fast moving objects. (Photo: SmartSens Technology)

Another important measure of security sensor performance is dark current, which is the current generated by the sensor when there is no light impinging on it. This is an unavoidable characteristic of CMOS, and since it represents a signal error, it is a goal of CMOS sensor design to minimize dark current.

### Global vs Rolling Shutter

One of the important choices in selecting a surveillance camera is whether to use a global or rolling shutter. A rolling shutter scans line by line, whereas a global shutter outputs all of the image pixels at the same time.

This is a difficult choice, as both technologies have their pros and cons. For traditional surveillance applications, real-time video clips are generally captured, displayed, and then stored in the system archive. These systems are usually implemented with rolling shutter sensors, which are widely available in commercial markets in different resolutions and different price points. While there are issues with rolling shutters when objects are moving quickly, this is generally not a concern. Everyday surveillance systems are mostly cost sensitive so the higher price tags that come with the global shutter sensors are an impediment.

However, for security cameras used with AI or traffic control, moving objects are the main targets. In those cases, the motion artifacts caused by the slower moving rolling shutter are not desirable. These systems are mostly owned by authorized entities and inputting the data in the quickest and most accurate way will be more important than minimizing cost.

### Selecting the Right Camera Sensor is Key to Optimizing Security Systems

The important thing is to evaluate the requirements for your particular application and then to understand the variables: for example, should you look to FSI, BSI, or SmartSens’s new DSI architecture? To evaluate your needs, be careful to understand the different ratings, such as dark current and SNRI, as distinct from SNR. Reliability is a key concern, as is the ability to function over the anticipated temperature extremes. Also, decide whether you can minimize cost by using a rolling shutter or you need to optimize performance with a global shutter.

*This article was written by Ed Brown, Associate Editor of Photonics & Imaging Technology. For more information, visit <http://info.hotims.com/72995-222>.*

## Automotive Lidar Trends

*Lidar is becoming a full partner on the ADAS and autonomous vehicle teams.*

Real-time 3D lidar is poised to be the third leg of the trifecta of sensor technologies enabling both advanced driver-assistance (ADAS) and autonomous vehicles. The other two pieces are cameras and radar. David Hall, CEO of Velodyne Lidar, Inc., invented the HDL-64 Solid-State Hybrid real-time 3D lidar sensor in 2007

and Velodyne has continued to develop lidar systems for the automotive market ever since. I discussed the background of the technology and its current and future prospects with CTO, Anand Gopalan.

Lidar was developed in the 60s, shortly after the invention of the laser. It measures distance by illuminating a tar-

get with a pulsed laser beam and measuring the return time or phase shift of the reflected pulse.

The development of real-time 3D lidar was a major step forward for the technology. Initially it was just used to create human-readable high-definition maps of the world. At some point however, Google,



Figure 1. Retirement communities are a potential first location for truly driverless cars.

among others, realized that once you have this high definition map, you could use it for a variety of applications, such as autonomous driving. So, mapping and autonomy are very intricately linked. Autonomous vehicles are not just sensing, and avoiding, and reacting, to the environment, they're actually navigating through the world using a high definition map.

### Where is 3D Automotive Lidar Now — And Where is it Heading?

There are two types of automotive applications for lidar. The first is for developing fully autonomous vehicles — SAE level 4 and 5 systems. We will probably initially see them in mobility-on-demand (MOD) fleets, which are operated by ride-share companies like Uber or Lyft. Even some OEMs have expressed the desire to have their own autonomous vehicle ride-share services.

The other application, which is attracting a lot of interest, is for advanced driver assist systems (ADAS). Although initially these systems performed simple functions like emergency braking, lane-keep assist, and blind spot protection, they are moving toward more advanced features, such as highway autopilot and a limited set of autonomous features. According to Gopalan, lidar is necessary to achieve good level 2+ and level 3 ADAS systems. Research and development fleets have been on the road since 2017 and Gopalan expects that by 2020 or 2021 we will see production of consumer cars with lidar integrated into ADAS systems.

For the mobility on demand, fully autonomous vehicle fleet markets, Gopalan expects a move from small fleets of a few tens of vehicles to thousands in the next two to three years.

### Why Ride-Share Fleets?

I asked Gopalan why the initial market for autonomous vehicles will be for ride-share and mobility-on-demand fleets. He answered that there are a couple of different ways to think about it.

First, there is the economics and the business case. Especially in dense urban areas, ride-sharing is becoming well accepted. The cost of ownership of an autonomous vehicle, even an economical one, is high. However, with a ride-sharing service, the cost of ownership per mile dips below the total cost of ownership, especially in an urban environment.

For average consumers, it is becoming increasingly attractive to subscribe to an autonomous ride sharing service where you can have access to a wide variety of vehicles depending upon your needs, and they will be available at your beck and call. The average person uses a vehicle maybe three or four hours of the day, so in this model, for the rest of the time, the vehicle would be available for other people to use.

From a technology perspective, fleets can be maintained far more regularly — the vehicles can even be serviced on a daily basis if needed. This allows OEMs and ride-share operators to have much better control to make sure that their autonomous vehicles are functioning up to specifications.

I then asked about the safety of deploying an autonomous vehicle in a crowded urban environment. "This is obviously a problem. A lot of the autonomous vehicle technology companies, such as Waymo, Cruise, and Uber, have been working on it for a few years," said Gopalan. The key metric for determining the success of the technology, at least in the current and short term, is actually the speed of driving. Urban areas, even though they are denser and more complicated, tend to be lower speed environments. In the range of less than 40 miles per hour, those environments tend to be easier for autonomous systems to resolve than in a very high-speed environment like a highway. "So, I think that is the reason you're seeing a lot of the players focusing on low-speed urban environments, whether it's Waymo deploying in the streets of Phoenix, or Cruise testing in San Francisco, or Uber testing in Pittsburgh," he said.

### What Lidar Brings to the Sensor Trifecta

I asked Gopalan what 3D lidar can do that cameras and radar can't? "Cameras are relatively inexpensive and have high resolution, but they are a passive sensing technology. Since they are sensitive to ambient light, they don't perform uniformly for changing conditions, especially dawn to dusk to nighttime. So, since their performance is limited, you get a lot of variability in the results," he said. Also, with a stereo camera system you get derived, rather than direct, information. With standard stereo, there are two cameras spaced apart at a certain distance. Then based on these 2D images and the angles between them, you derive 3-D, information. The problem is that as you go further out in distance, small errors in the stereo camera system will lead to large errors in the measured distance because the angles are so extreme.

"Radar, on the other hand, is what I call an active sensor," he said. It senses the environment by sending and receiving electromagnetic waves. Since it is not sensitive to ambient light, it works well across any weather conditions. However, radar has limited resolution because of its wavelengths.

"Lidar is a really interesting technology because it sits in between the two other sensor modalities," said Gopalan. Since it's a light-based technology, it has much higher resolution than radar and can see colors, reflectivity, and lane markings. It can sense context similar to a camera, but since it brings its own light to the party, it's not at



all sensitive to ambient light conditions — it basically works the same whether it's dawn or dusk or night or daytime.

Lidar is also a direct, rather than a derived measurement of distance. It sends out a laser pulse and measures precisely when the pulse returns. Since the speed of light is constant, this is a direct and active measurement. The resolution is only limited by the wavelength of the light being used, which in the case of automotive lidar is the near infrared, with wave lengths in the range of hundreds of nanometers. That means you can easily resolve distances in the range of a millimeter or two. It's a very precise distance measurement, regardless of ambient light conditions or environmental noise.

### Sweeping the Environment

In order to be useful for autonomous driving, lidar has to sweep the environment to produce a useable 3D map. Velodyne has two different technologies for that. One is their Surround View platform, which achieves a 360° view around the sensor by using a solid-state electronic lidar engine, which is essentially rotated on a spindle.

The other platform is a small form factor embeddable lidar called Vellaray™, which uses frictionless beam steering that can be swept in two axes. Since it is not physically rotated however, its field of view is limited to 120° in the horizontal plane.

For both platforms, the vertical sweep angle is 40°. Looking forward, you want to be able to see a little bit higher than the horizon even if you're on an up or down slope. You also need to sense objects like road signs and overpasses. The general consensus in the industry is that about a 40-degree vertical field of view is more than adequate for these functions.

### Sensing the Environment

The resolution of modern lidar systems is good enough to distinguish between various objects, for example, a pedestrian vs. a bicycle. Besides distance, lidar can also probe the reflectivity of an object. Stop signs are high — the word "stop" is in white whereas the background is in red. Thus, the system cannot just detect the presence of a sign, but by virtue of the reflectivity, to determine its nature as well. Also, lane markings are more reflective than road surfaces, and so on.

This allows lidar to provide a view of the world independent of cameras and radar, although there will probably not be any attempt to replace them. There

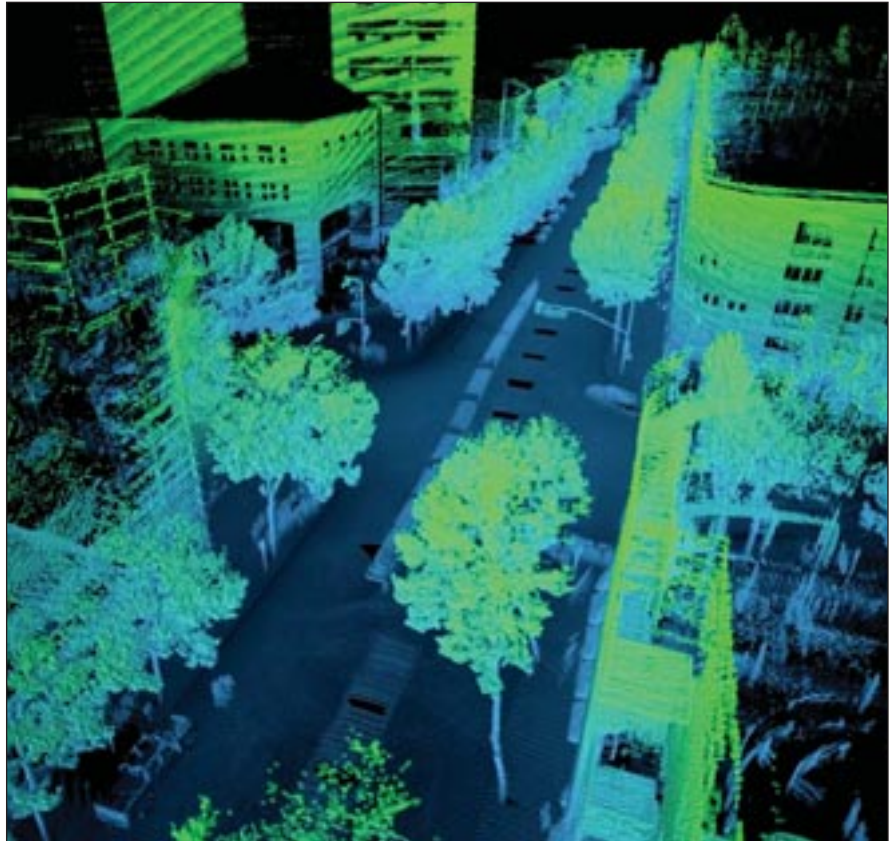

Figure 2. A lot of the players are focusing on low-speed urban environments, whether it's Waymo deploying in the streets of Phoenix, or Cruise testing in San Francisco, or Uber testing in Pittsburgh.

will always be a need for a redundant sensor modality as a backup in case the lidar system fails, to make sure that the vehicle is able to safely pilot itself or at least bring itself to a safe stop.

### Software

I then asked Gopalan about software. He replied that as the speed of autonomous vehicles increases, the code processing unit inside these systems, which is a pretty big computer at the moment, really has precious little time to crunch all the data and make decisions. Because of that, a greater amount of the processing will be done in the sensor itself. Rather than just providing raw data, in the future, analytics embedded in the lidar will directly provide location information. Gopalan also believes that most problems will continue to be solved with traditional algorithms rather than artificial intelligence. Since algorithms are deterministic, if a problem occurs the cause can be more easily traced.

### The Future

Autonomous vehicles and ADAS are poised to become standard technologies



Figure 3. Velodyne's Surround View platform achieves a 360° view around the sensor by using a solid-state electronic lidar engine, which is essentially rotated on a spindle.

in the next few years, thus increasing the need for improved sensing technologies. Lidar is becoming increasingly sophisticated and will be a major partner in automotive sensing along with cameras and radar.

*This article was written by Ed Brown, Associate Editor of Photonics & Imaging Technology. For more information, visit <http://info.hotims.com/72995-221>.*

## Revolutionary Camera Allows Scientists to Predict Evolution of Ancient Stars

University of Sheffield, UK

Scientists at the University of Sheffield have been working with HiPERCAM, a high-speed, multicolor camera, which is capable of taking more than 1,000 images per second, allowing experts to measure both the mass and the radius of a cool subdwarf star for the first time.

The findings have allowed researchers to verify the commonly used stellar structure model — which describes the internal structure of a star in detail — and make detailed predictions about the brightness, the color and its future evolution.

Scientists know that old stars have fewer metals than young stars, but the effects of this on the structure of stars was, until now, untested. Old stars (often referred to as cool subdwarf stars) are faint and there are few in the solar neighborhood. Up until now scientists have not had a camera powerful enough to be able to get precise measurements of their stellar parameters, such as the mass and the radius.

HiPERCAM can take one picture every millisecond as opposed to a nor-



For the first time scientists have been able to prove a decades old theory on stars thanks to a revolutionary high-speed camera. (Artist's impression of a binary star. Credit: Mark Garlick)

mal camera on a large telescope which usually captures only one picture every few minutes. This has given scientists the ability to measure the star accurately for the first time. The researchers have been able to measure the size of the star to confirm it is in line with stellar structure

theory. They say that these results would not have been possible with any other telescope. They have not only proved the stellar structure theory, but have also verified the potential of HiPERCAM.

HiPERCAM is mounted on the Gran Telescopio Canarias (GTC) — the world's largest optical telescope, with a 10.4-meter mirror diameter. The camera can take high-speed images of objects in the universe, allowing their rapid brightness variations — due to phenomena such as eclipses and explosions — to be studied in unprecedented detail. Data captured by the camera, taken in five different colors simultaneously, allow scientists to study the remnants of dead stars such as white dwarfs, neutron stars and black holes. The GTC is based on the island of La Palma, situated 2,500 meters above sea level, which is one of the best places in the world to study the night sky.

For more information, contact Emma Griffiths at [e.l.griffiths@sheffield.ac.uk](mailto:e.l.griffiths@sheffield.ac.uk).

## Integrated Silicon Photonic Switch Demonstrates Lowest Signal Loss Ever in High-Speed Data Transmission

University of California, Berkeley CA

Experimental photonic switches developed at UC Berkeley have shown promise toward the goal of fully optical, high-capacity switching for future high-speed data transmission networks. The switch developed and tested for this research demonstrated capabilities not seen before in photonic switches. Key to this success, is the scale-up of a  $240 \times 240$  integrated silicon photonic switch. The device is so-named because it accepts 240 optical communication input channels and sends them into 240 output channels.

The telecommunications industry long ago embraced fiber-optic technology as a better solution to meet exploding

demand for higher speeds and greater capacity data transmission than could be achieved with copper wires. Now a similar revolution is occurring at the points where the messages transmitted over long-haul fibers are sent and received. Instead of power-hungry electrical switches that require optical-electrical conversions and cause signal loss, researchers are developing and deploying photonic switches to improve transmission quality and link a single transmission to tens and sometimes thousands of servers.

Silicon-based photonic switches using advanced complementary metal-oxide

semiconductor (CMOS) technology are drawing attention from researchers as a powerful platform due to their low cost and high capacity. They have the potential to replace electrical switches, which will soon face scalability limits in performance and energy efficiency. In order to realize this potential, researchers are now working to overcome limitations related to the size of today's silicon photonic chips and improve their performance. Up to now, the physical size of a silicon photonic chip has been limited to 2 to 3 cm because of the limitations of the lithography tools necessary to etch the required geometric patterns on the sili-



Intro

Cov

ToC





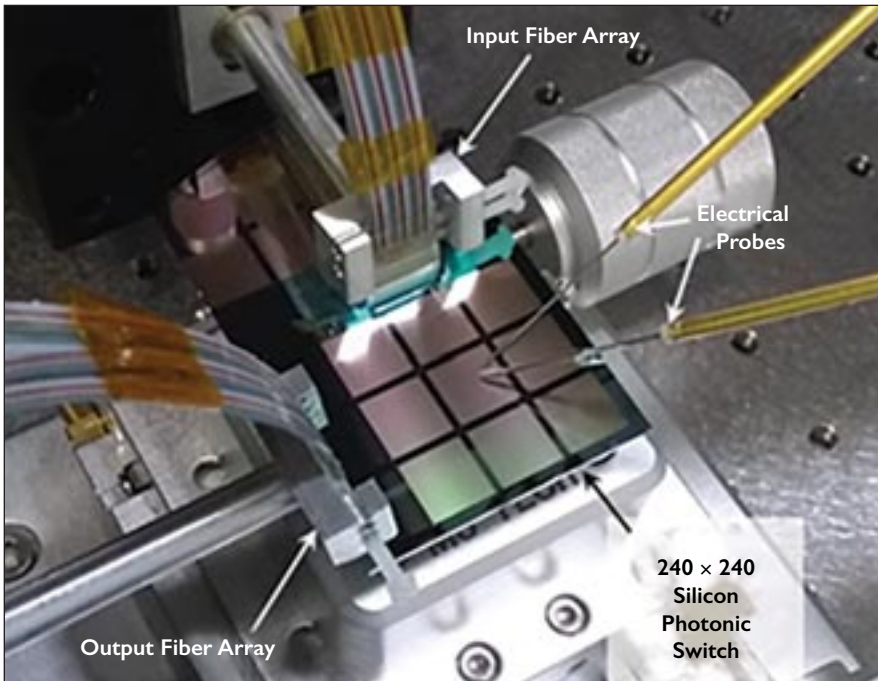

Photo of the fabricated  $240 \times 240$  silicon photonic switch on the characterization setup. (Photo courtesy of Tae Joon Seok)

con wafers used as a base for the integrated chips. The researchers overcame this limitation by using a process known as lithography stitching, creating a wafer-scale  $240 \times 240$  silicon photonic switch by stitching together nine  $80 \times 80$  switch blocks in a  $3 \times 3$  array, with three input and three output coupler blocks. The switches developed as part of the experiment coupled light coming in and out of the chip through grating couplers. The switch cells were actuated by electrical probes. The resulting switch area was  $4 \text{ cm} \times 4 \text{ cm}$  — nearly doubling the size of existing silicon photonic switches.

According to the researchers, the on-chip loss to port-count ratio (0.04 dB/port) is the lowest so far demonstrated. They went on to say that this technology can be applied not only to silicon photonic switches but also to any silicon photonics applications that require ultra-large-scale devices such as programmable photonic processors.

*For more information, contact Leah Wilkinson at [Leah@wilkinson.associates](mailto:Leah@wilkinson.associates).*

## Face-Tracking Robot

University of Cincinnati, Cincinnati, OH

A robot is being developed that tracks facial movements to perform human tasks. The robot resembles large, squiggly arms holding tiny cameras. Sitting in a rolling office chair across from one of the arms, the robot's developer, Nathan Huber, demonstrates how it works. Huber rolls from left to right, forward and back, and the robot's camera follows his movements. He programmed the robot to track objects in planes. First, it identifies the object and locates it on the X and Y axes. Then, with a spatial-tracking algorithm, the robot can determine how near or far an object is in order to grab it.

The computer screen connected to the robot displays the object it's following — in this case, Huber's face — outlined by a green box. "What he's trying to do is get the center of my face," says Huber. "Within the camera frame, the green box is what the desktop recognizes as a face. I calculate the center of that square, and I

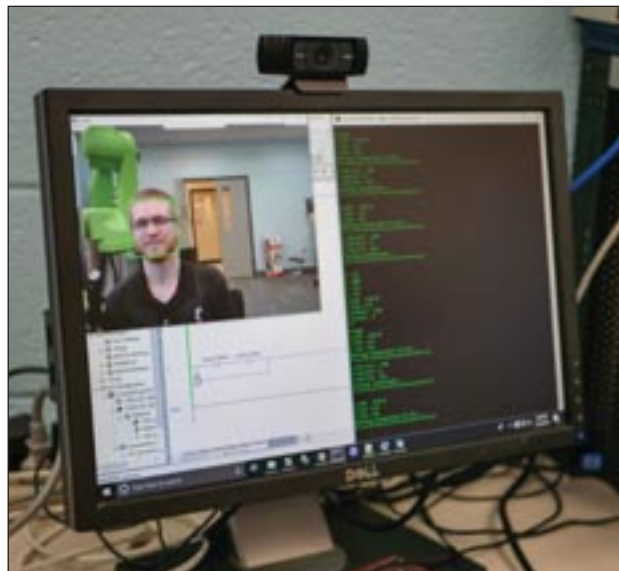

A monitor displays the face-tracking robot's field of vision. With a spatial-tracking algorithm, the robot can determine how near or far an object is. (Photo/Corrie Stookey/CEAS Marketing)

have the robot calculate where I'm in space in respect to the camera."

Applied commercially, Huber's work can advance virtual reality, like the technologies used in training pilots. Pilot training

typically takes place in a virtual reality that simulates a cockpit. A face-tracking robot can hold different parts of a physical cockpit, like a control panel or keyboard. As pilots-in-training look around the virtual interior of the cockpit, the robot can track these facial movements and move a control panel to their lines of sight. When a person reaches out to press a button or pull a switch, a control panel held by one of the robots will be right there.

In addition to virtual reality, this technology can be applied to healthcare, specifically an aging population. A robot like this could help someone who is in a nursing home and has trouble reaching for and holding different things. "It would be ideal if this robot is sitting next to a resident, and she looks over

at a cup of coffee, and the robot's able to recognize that, and is able to grab it and bring it to her," said Huber

*For more information, contact Brandon Pytel at [pytelbn@ucmail.uc.edu](mailto:pytelbn@ucmail.uc.edu).*

## Bringing Human-Like Reasoning to Driverless Car Navigation

Massachusetts Institute of Technology, Cambridge, MA

With the aim of bringing more human-like reasoning to autonomous vehicles, MIT researchers have created a system that uses only simple maps and visual data to enable driverless cars to navigate routes in new, complex environments.

Human drivers are exceptionally good at navigating roads they haven't driven on before, using observation and simple tools. We simply match what we see around us to what we see on our GPS devices to determine where we are and where we need to go. Driverless cars, however, struggle with this basic reasoning. In every new area, the cars must first map and analyze all the new roads, which is very time consuming. The systems also rely on complex maps — usually generated by 3-D scans — which are computationally intensive to generate and process on the fly.

In a paper presented at the International Conference on Robotics and Automation, MIT researchers described an autonomous control system that “learns” the steering patterns of human drivers as they navigate roads in a small area, using only data from video camera feeds and a simple GPS-like map. Then, the trained system can control a driverless car along a planned route in a brand-new area, by imitating the human driver.

Similarly to human drivers, the system also detects any mismatches between its map and features of the road. This helps the system determine if its position, sensors, or mapping are incorrect, in order to correct the car's course.

To train the system initially, a human operator controlled an automated Toyota Prius — equipped with several cameras and a basic GPS navigation system — to collect data from local suburban streets including various road structures and obstacles. When deployed autonomously, the system successfully navigated the car along a preplanned path in a different forested area, designated for autonomous vehicle tests.

“With our system, you don't need to train on every road beforehand,” says first author Alexander Amini. “You can download a new map for the car to navigate through roads it has never seen before.”

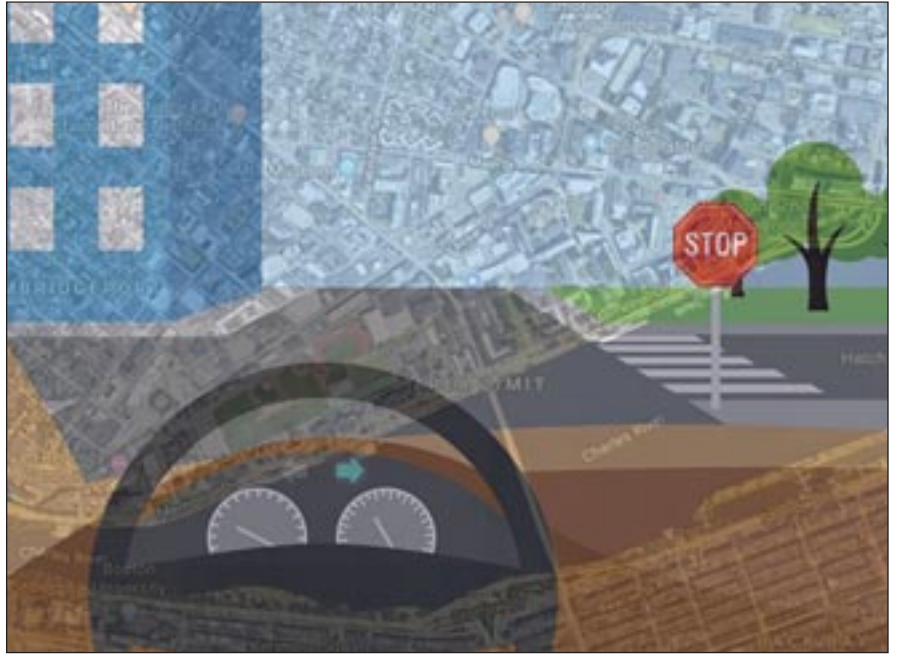

To bring more human-like reasoning to autonomous vehicle navigation, MIT researchers have created a system that enables driverless cars to check a simple map and use visual data to follow routes in new, complex, environments. (Image: Chelsea Turner)

“For example, if we train an autonomous vehicle to drive in an urban setting such as the streets of Cambridge, the system should also be able to drive smoothly in the woods, even if that is an environment it has never seen before,” said co-author Daniela Rus.

Traditional navigation systems process data from sensors through multiple modules customized for tasks such as localization, mapping, object detection, motion planning, and steering control. For years, Rus's group has been developing “end-to-end” navigation systems, which process inputted sensory data and output steering commands, without a need for any specialized modules. Until now, however, these models were strictly designed to safely follow the road, without any real destination in mind. In the new paper, the researchers advanced their end-to-end system to drive from start to destination, in a previously unseen environment. To do so, the researchers trained their system to predict a full probability distribution over all possible steering commands at any given instant while driving.

The system uses a machine learning model called a convolutional neural net-

work (CNN), commonly used for image recognition. During training, the system watches and learns how to steer from a human driver. The CNN correlates steering wheel rotations to road curvatures it observes through cameras and an inputted map. Eventually, it learns the most likely steering command for various driving situations, such as straight roads, four-way or T-shaped intersections, forks, and rotaries.

“Initially, at a T-shaped intersection, there are many different directions the car could turn,” Rus says. “The model starts by thinking about all those directions, but as it sees more and more data about what people do, it will see that some people turn left and some turn right, but nobody goes straight. Straight ahead is ruled out as a possible direction, and the model learns that, at T-shaped intersections, it can only move left or right.”

In testing, the researchers input the system with a map and a randomly chosen route. When driving, the system extracts visual features from the camera, which enables it to predict road structures. For instance, it identifies a distant stop sign or line breaks on the side of the road as signs of an upcoming inter-



section. At each moment, it uses its predicted probability distribution of steering commands to choose the most likely one to follow its route.

Importantly, the researchers say, the system uses maps that are easy to store and process. Autonomous control systems typically use LIDAR scans to create massive, complex maps that take roughly 4,000 gigabytes (4 terabytes) of data to store just the city of San Francisco, for example. For every new destination, the car must create new maps, which

amounts to tons of data processing. Maps used by the researchers' system, however, capture the entire world using just 40 gigabytes of data.

During autonomous driving, the system also continuously matches its visual data to the map data and notes any mismatches. Doing so helps the autonomous vehicle better determine where it is located on the road. And it ensures the car stays on the safest path if it's being fed contradictory input information. If, say, the car is cruising on a

straight road with no turns, and the GPS indicates the car must turn right, the car will know to keep driving straight or to stop.

"In the real world, sensors do fail," Amini says. "We want to make sure that the system is robust to different failures of different sensors by building a system that can accept these noisy inputs and still navigate and localize itself correctly on the road."

*For more information, contact Abby Abazorius at [abbya@mit.edu](mailto:abbya@mit.edu).*

## Breakthrough Could Enable Infrared Cameras for Electronics, Self-Driving Cars

University of Chicago, Chicago, IL

There's an entire world our eyes miss, hidden in the ranges of light wavelengths that human eyes can't see. But infrared cameras can pick up this light emitted as plants photosynthesize, as cool stars burn, and batteries get hot. They can see through smoke and fog and plastic.

But infrared cameras are much more expensive than visible-light ones; the energy of infrared light is smaller than visible light, making it harder to capture. A new breakthrough by scientists with the University of Chicago, however, may one day lead to much more cost-effective infrared cameras — which in turn could enable infrared cameras for common consumer electronics like phones, as well as sensors to help autonomous cars see their surroundings more accurately.

Today's infrared cameras are made by successively laying down multiple layers of semiconductors — a tricky and error-prone process that makes them too expensive to go into most consumer electronics.

Professor Guyot-Sionnest's lab instead turned to quantum dots — tiny nanoparticles just a few nanometers in size. At that scale they have odd properties that change depending on their size, which scientists can control by tuning the particle to the right size. In this case, quantum dots can be tuned to pick up wavelengths of infrared light.

This "tunability" is important for cameras, because they need to pick up different parts of the infrared spectrum. "Collecting multiple wavelengths



Photos taken by researchers testing a new method to make an infrared camera that could be much less expensive to manufacture. (Photo courtesy of Xin Tang)

within the infrared gives you more spectral information—it's like adding color to black-and-white TV," researcher Xin Tang explained. "Short-wave gives you textural and chemical composition information; mid-wave gives you temperature."

The researchers tweaked the quantum dots so that they had one formula to detect short-wave infrared and one for mid-wave infrared. Then they laid both together on top of a silicon wafer.

The resulting camera performs extremely well and is much easier to produce. "It's a very simple process," Tang said. "You take a beaker, inject a solution, inject a second solution, wait five to 10 minutes, and you have a new solution that can be easily fabricated into a functional device."

There are many potential uses for inexpensive infrared cameras, the scientists said, including autonomous vehicles, which rely on sensors to scan the road and surroundings. Infrared can detect heat signatures from living beings and see through fog or haze, so car engineers would love to include them, but so far cost has been prohibitive.

They would also come in handy for scientists. "If I wanted to buy an infrared detector for my laboratory today, it would cost me \$25,000 or more," Guyot-Sionnest said. "But they would be very useful in many disciplines. For example, proteins give off signals in infrared, which a biologist would love to easily track."

*For more information, contact Colleen Mastony at [cmastony@uchicago.edu](mailto:cmastony@uchicago.edu).*

# NEW PRODUCTS

## Fully Automated Beam Monitoring System

Ophir-Spiricon (North Logan, UT) has announced Ophir® BeamWatch® Integrated, a fully automated, non-contact laser measurement system designed to measure critical beam parameters in industrial production environments. BeamWatch Integrated is a patented, non-contact profiling system that captures and analyzes industrial lasers for wavelengths from 980nm - 1080nm and laser powers to 10 kW (30 kW, on request). The system provides real-time beam measurements of lasers that are typically too powerful for direct readings. Instead, it measures Rayleigh Scattering using a pass-through beam measurement technique that involves no contact between the instrument and the beam. Beam parameters measured include focus spot width and location, focal shift, centroid, M2, divergence, beam parameter product, Rayleigh length, beam tilt angle, and absolute power.

BeamWatch Integrated monitors high power YAG, fiber, and diode lasers in the 980-1080nm range. It charts all beam measurements over time in industrial material processing applications. High magnification optics measure beams with spot sizes down to less than 80 µm or less, allowing for smaller, more precise cuts with less waste of material.

**For Free Info Visit:** <http://info.hotims.com/72995-230>



## Low Profile XY Stage

The AU200-100 × 100-SC (Solid Core) Stage is the newest addition to the expanding line of precision XY stages from OES (Optimal-Engineering Systems, Inc.) (Van Nuys, CA). The linear travel of the X and Y axes is 100 mm × 100 mm (3.937 in. × 3.937 in.) and the resolution of the X and Y axes is 20 microns (non-micro-step) or 1 micron (20 micro-steps per step motor driver in use), the typical repeatability is 2 microns, and the typical positional accuracy is 3 microns. A low profile XY stage measuring just 80 mm (3.150 in.) high with a compact footprint (including the motors) of 348 mm × 348 mm (13.701 in. × 13.701 in.).

Preloaded V-groove and crossed roller bearings and ground 4 mm per-turn lead screws having just 2 microns of backlash, all contribute to the high precision and stiffness of the AU200-100 × 100-SC Stage. The table of XY stage measures 300 mm × 300 mm (11.811 in × 11.811 in.) and has a precision pattern of 21 drilled and threaded mounting holes to easily add special tooling or fixtures, and for easy integration into new and existing applications. Additional tooling plates are also available for custom and interchangeable applications.

**For Free Info Visit:** <http://info.hotims.com/72995-233>



## OPTICALLY CLEAR EPOXY for Bonding & Coating

### TWO PART EP37-3FLF

Very high flexibility  
Elongation 50-100%

Cryogenically serviceable  
down to 4K

Low viscosity  
600-1,100 cps

Excels in e-textile  
packaging

 **MASTERBOND®**  
ADHESIVES | SEALANTS | COATINGS

+1.201.343.8983 • [main@masterbond.com](mailto:main@masterbond.com)

[www.masterbond.com](http://www.masterbond.com)



## High-Speed Video Camera

Acies Image Technology (Simi Valley, CA) announced a new 40 gigapixel per second high-speed video camera called Acies, or ACS for short. The new MEMRECAM ACS comes fully equipped with 1280 × 800 (1 MP) resolution at 40,000 fps, over 500,000 fps at reduced resolution, and 50,000 ISO. The MEMRECAM ACS' superior capabilities include high resolution, high frame rates, high light sensitivity, fast data transfer rates, and user selectable bit depth.

ACS utilizes a proprietary CMOS global shutter, 28.16 mm × 19.71 mm, all active pixels. Image triggered by intensity shifts sensed at the minimum area of 21 × 16 pixel. Power is 20 - 32 VDC. Overall dimensions are 175 mm (W) × 175 mm (H) × 206 mm (D) and the camera weighs approximately 7.3 kg.

**For Free Info Visit:** <http://info.hotims.com/72995-232>

## UV Picosecond Laser

MKS Instruments, Inc. (Andover, MA) introduces its Spectra-Physics® IceFyre® 355-30, a high-power, industrial UV picosecond hybrid fiber laser featuring TimeShift™ ps programmable pulse flexibility, pulse-on-demand and position synchronized output (PSO) triggering. IceFyre 355-30 is the industry's smallest UV picosecond laser in its class and combines power supply and laser head in a rugged, compact package for easy integration into machine tools. The new laser is ideal for cold micromachining in high-throughput manufacturing of 5G flexible printed circuits (FPC), flat panel OLED displays, solar cells, ceramics, plastics, and other materials and devices.

Adding to the successful family of IceFyre picosecond lasers, IceFyre 355-30 delivers >30W average power and up to >60 µJ pulse energy typical at 355 nm with adjustable repetition rates from single shot up to 3 MHz. The new laser's TimeShift™ ps programmable pulse capability results in flexible burst mode operation with adjustable burst shape, pulse separation and number of pulses in a burst, all with high UV power available.

**For Free Info Visit:** <http://info.hotims.com/72995-234>



Intro

Cov

ToC



## 4-Channel Oscilloscope

Anritsu Company (Allen, TX) has introduced a 4-channel sampling oscilloscope option for its BERTWave™ MP2110A, creating a comprehensive single-instrument solution that integrates an oscilloscope and 100G BERT. With the option, the BERTWave can accurately evaluate the physical layer performance of 100G/400G optical transceiver modules, active optical cables (AOCs), direct attach cables (DAC), and high-speed optical devices used in data centers, core/metro networks, 4G/5G mobile backhaul, and 5G mobile fronthaul.

The BERTWave MP2110A, with the sampling oscilloscope option installed, supports various technologies, including NRZ/PAM4 signaling formats, as well as different wavelengths.

The built-in oscilloscope and BERT solution allows engineers to select 1, 2, or 4 channels, so it can be used during development and manufacturing of 100G/400G optical devices. The new sampling oscilloscope has best-in-class sensitivity supporting wide optical signal analysis from 25 Gbaud NRZ to 53 Gbaud PAM4 with a built-in clock recovery option.

**For Free Info Visit:** <http://info.hotims.com/72995-236>

## Vertical Displacement Microscope



Titan Tool Supply, Inc., Buffalo, New York, announces the introduction of its new model ZDM-3 vertical displacement microscope to measure minute variations in height. The Z-Axis electronic depth measuring

microscope features a built-in LED co-axial illuminator to allow the user to focus on the top or bottom of the part being inspected. The illuminator includes a green filter and is adjustable to control light, color, and intensity.

The new ZDM-3 is available with magnifications from 50 × to 400 × with a standard 10 × eyepiece and 100 × to 800 × magnifications with an optional 20 × eyepiece. Titan Tool states that the ZDM-3 can be fitted with a video adapter (Model TSTVA-12 available separately) to increase magnification range and to provide greater accuracy and ease of repeatability (from 0.0002-in. to 0.0003-in. or better). The use of the video adapter also relieves eye strain and allows for multi-viewing.

**For Free Info Visit:** <http://info.hotims.com/72995-237>

## Fiber-Optic Transmitters

TT Electronics, a global provider of engineered electronics for performance critical applications, is launching the OPF350A and OPF352A evolved fiber optic transmitter solutions based on 850nm LED technology. The OPF350A and OPF352A are equivalent alternatives to the existing OPF370A and OPF372A products and come with the same ST-style package. The new fiber optic transmitters also improve performance with up to 8% more optical power with various fiber sizes such as 50/125µm-200/300µm.

The OPF350A in TO-18 package is chosen for applications that demand high thermal stability across the industrial temperature range of -40°C to +100°C and offers a robust alternative to the OPF370A in addition to shorter lead times. The OPF352A in the ST-style receptacle is suitable for PCB or panel mounting. It is supplied pre-mounted, pre-tested with fiber to assure performance, and ready to use, with essential fixings and a protective dust cap included.

**For Free Info Visit:** <http://info.hotims.com/72995-238>



## Camera with CoaXPress 2.0 Interface

With the Basler boost series, Basler (Ahrensburg, Germany) is one of the first camera manufacturers on the market to expand its portfolio with a camera featuring the CoaXPress 2.0 standard and modern CMOS sensor technology. The camera delivers high resolutions and high frame rates with a cable length of up to 40m. Basler also offers a combination of camera and matching interface card from a single source in the form of the Basler boost bundle.

Thanks to the upcoming CoaXPress 2.0 standard (or CXP 2.0), the Basler boost cameras achieve a maximum bandwidth of up to 12.5 Gbps with a single CXP cable. The precise triggering with the CXP cable eliminates the need for a separate I/O cable, making a single-cable solution possible in combination with power-over-CXP (PoCXP).

Basler combines this advancement in interface technology with the best which the current CMOS sensor landscape has to offer: an optional Sony IMX253 or IMX255 sensor delivers resolutions of 12 or 9 megapixels respectively with maximum frame rates of 68 fps or 93 fps.

**For Free Info Visit:** <http://info.hotims.com/72995-239>



## Display Unit for Remote Spectral Detector



Gigahertz-Optik's CSS-45 Remote Spectral Detector can now be used with its new CSS-D display unit or operated by itself through PC connection under software control. Gigahertz-Optik's CSS-D Display Unit provides convenient hand-

held operation and control of a remote CSS-45 spectroradiometer head for the precise measurement of spectral irradiance (360-830nm), comprehensive photometric and colorimetric data as well as application specific data such as PAR PPF.

The CSS-45 Remote Spectral Detector can be used directly connected to PC under its own supplied software control, connected to the CSS-D Display Unit as a self-contained light-color-PAR-spectral meter or CSS-D plus CSS-D connected to PC using same software. An internal shutter normally found in the most advanced spectrometers automates dark level measurements, thereby facilitating accurate remote operation over extended periods.

**For Free Info Visit:** <http://info.hotims.com/72995-241>

## 500-Watt Blue Laser

NUBURU (Centennial, CO) announced the release of its new 500-Watt 450nm AO-500 industrial laser, bringing the power of blue light to deeper materials processing applications. Gold, aluminum, and copper are among the metals that absorb blue light much more than they do the infrared wavelengths of conventional industrial lasers. High power is only part of the story, however, because the efficiency and quality of materials processing applications are driven by power density. Increasing power density by a factor of four increases weld depth more than one-and-a-half times and increases the weld speed three to four times. The AO-500's beam parameter product is less than 30-mm-mrad, which enables rapid defect-free copper welding, and welding dissimilar metals with minimal formation of undesirable intermetallics in the joint.

**For Free Info Visit:** <http://info.hotims.com/72995-243>



Intro

Cov

ToC



# SINGLE PIVOT-POINT GALVANOMETER

An alternative to traditional two-mirror galvo scanners

- Larger field-of-view than 2D scanners simplifies processing of large parts
- Minimal spot distortion over the entire field-of-view minimizes processing variation for highest quality laser-processed parts
- Air and water cooling options improve thermal stability and long-term accuracy
- Mirror surface treatments for a variety of laser wavelengths



Visit [aerotech.com](http://aerotech.com) or Call 412-963-7470

Since 1970, Aerotech has designed and manufactured the highest performance motion control, positioning tables/stages, and positioning systems for our customers in industry, government, science, and research institutions around the world.

AF1218B-LPM

Free Info at <http://info.hotims.com/72995-712>



Intro

Cov

ToC

