



**Disclaimer: The systems, processes, and views described in this book reflect the judgments and interpretations of authors and editors, and do not necessarily represent the official policies or positions of the Headquarters, Department of the Army, the Department of Defense, or the United States Government. The text is a synthesis and interpretation of existing and developing National, Defense, Joint, and Army systems, processes, and procedures currently practiced, and is intended only for instructional purposes with the United States Army War College and Army Force Management School, and as an informal desk reference for their graduates and other interested organizations and project officers.**



DEPARTMENT OF THE ARMY  
UNITED STATES ARMY WAR COLLEGE AND CARLISLE BARRACKS  
CARLISLE, PENNSYLVANIA 17013-5210

January 29, 2020

Office of the Commandant

The U.S. Army War College (USAWC) School of Strategic Landpower is proud to present the 32nd edition of *How the Army Runs: A Senior Leader Reference Handbook, 2019–2020*. At a time when the Army is making critical decisions on force structure balance, readiness, and modernization in the midst of budget uncertainty and ambiguity regarding continuing conflicts throughout the world, this handbook is particularly relevant. It clearly describes the current Army systems and processes that support those critical decisions.

This edition is being released electronically on CD and on the USAWC website (<https://ssl.armywarcollege.edu/dclm/pubs/HTAR.pdf>). It is also being published in hard copy. The CD version includes the ability to link to the USAWC website where changes will be posted between the bi-annual updates.

*How the Army Runs* was prepared by the Army Force Management School under the direction of the USAWC Department of Command, Leadership, and Management faculty. It is intended for use in an academic environment to study the systems and processes used by Combatant Commanders in developing and sustaining combat forces. It is also a reference for personnel who use and “run” the organizations, systems, and processes described.

Every effort has been made to ensure the text accurately describes the systems and processes as they are. While there is no intent to advocate either the reform of the described systems or their continuance, the text does provide a foundation for those who are charged with developing potential reforms.

We look forward to your comments regarding the value of the handbook to you and your organization.

Sincerely,

A handwritten signature in black ink, appearing to read "J. Kem".

John S. Kem  
Major General, U.S. Army  
Commandant

## PREFACE

This text explains and synthesizes the functioning and relationships of numerous Defense, Joint, and Army organizations, systems, and processes involved in the development and sustainment of trained and ready forces for the Combatant Commanders.

It is designed to be used by the faculty and students at the U.S. Army War College (as well as other training and educational institutions) as they improve their knowledge and understanding of "How the Army Runs." It is also used extensively by participants in the processes as a reference book. We are proud of the value that senior commanders and staffs place in this text and are pleased to continue to provide it as a reference.

The text is revised every two years as we strive to capture the most up-to-date information available. This involves the synthesis of a wide array of published and unpublished references from a variety of sources. Necessarily, there is a point in time at which updates must stop.

This volume contains our best description of the systems, processes, and organizations as of November 2019; however, we caution the reader that there may be some inaccuracies as systems or processes evolve from the description in the text. We encourage all readers to contribute to its continued development and improvement. Please send your recommendations for changes, improvements, and additions to the Department of Command, Leadership, and Management, U.S. Army War College, Carlisle, Pennsylvania 17013-5240, ATTN: Editor, "How the Army Runs." To the maximum extent possible these changes will be posted to our Internet site pending the next complete update. The text can also be accessed over the Internet at <https://ssl.armywarcollege.edu/dclm/pubs/HTAR.pdf>.

We request that the text contained on this web site not be quoted, extracted for publication, or otherwise copied or distributed without prior coordination with the Department of Command, Leadership, and Management of the U.S. Army War College. You may contact us at commercial telephone number 717-245-4815.

The U.S. Army War College also extends its appreciation to the staff and faculty of the Army Force Management School and other contributing organizations for their efforts in the publication of this text.

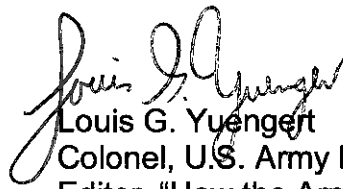
  
Louis G. Yuengert  
Colonel, U.S. Army Retired  
Editor, "How the Army Runs"

## U. S. Army War College Faculty Editors

| Chap # | Chapter Title  | Editor                                 | Phone #                          | E-Mail                                       |
|--------|--|--|----------------------------------|--|
| NA     | Executive Summary  | Prof Lou Yuengert<br>(Volume Editor)   | (717) 245-4790                   | louis.g.yuengert.civ                         |
| 1      | Introduction   | Prof Lou Yuengert                      | (717) 245-4790                   | louis.g.yuengert.civ                         |
| 2      | Strategy and Strategic Direction   | Prof Doug Douds                        | (717) 245-4414                   | douglas.g.douds.civ                          |
| 3      | Force Management   | Prof Ed Filiberti                      | (717) 245-3715                   | edward.j.filiberti.civ                       |
| 4      | Army Organization  | Prof Ed Filiberti                      | (717) 245-3715                   | edward.j.filiberti.civ                       |
| 5      | Army Mobilization and Deployment   | Prof Doug Waters                       | (717) 245-3821                   | douglas.e.waters.civ                         |
| 6      | Reserve Components   | COL Jocelyn Leventhal                  | (717) 245-4800                   | jocelyn.a.leventhal.mil                      |
| 7      | Force Readiness  | Prof Lou Yuengert                      | (717) 245-4790                   | louis.g.yuengert.civ                         |
| 8      | Army Planning, Programming, Budgeting, and Execution Process                                 | Prof Bob Bradford                      | (717) 961-2062                   | robert.d.bradford.civ                        |
| 9      | Resource Management  | COL Nick LaSala                        | (703) 692-5886                   | nicholas.j.lasala.mil                        |
| 10     | Capability Requirements and Materiel System Research, Development and Acquisition Management | Prof Lou Yuengert                      | (717) 245-4790                   | louis.g.yuengert.civ                         |
| 11     | Logistics  | COL Nate Hunsinger                     | (717) 245-4575                   | nathan.b.hunsinger.mil                       |
| 12     | Military Human Resource Management   | COL Don Stoner                         | (717) 245-4936                   | donald.w.stoner.mil                          |
| 13     | Civilian Human Resource Management   | Prof Julie Manta                       | (717) 245-4872                   | julie.t.manta.civ                            |
| 14     | Training and Leader Development  | Prof Lou Yuengert                      | (717) 245-4790                   | louis.g.yuengert.civ                         |
| 15     | Information Management and Information Technology  | Prof Lou Yuengert                      | (717) 245-4790                   | louis.g.yuengert.civ                         |
| 16     | Installation Management Community  | Prof Lou Yuengert                      | (717) 245-4790                   | louis.g.yuengert.mil                         |
| 17     | Army Health System   | COL Maurice Sipos                      | (717) 245-4795                   | maurice.l.sipos.mil                          |
| 18     | Civil Functions of the Department of the Army  | COL Dan O'Rourke<br>COL Silas Martinez | (717) 245-4083<br>(717) 245-4465 | morgan.d.orourke.mil<br>silas.g.martinez.mil |
| 19     | Public Affairs   | Prof Lou Yuengert                      | (717) 245-4790                   | louis.g.yuengert.civ                         |
| 20     | Defense Support of Civil Authorities   | COL Jocelyn Leventhal                  | (717) 245-4800                   | jocelyn.a.leventhal.mil                      |
| 21     | Foreign Military Sales   | Prof Lou Yuengert                      | (717) 245-4790                   | louis.g.yuengert.civ                         |
| 22     | Global Force Information Management  | Prof Lou Yuengert                      | (717) 245-4790                   | louis.g.yuengert.civ                         |

## Army Force Management School, HQDA, and Army Agency Authors

| Chap # | Chapter Title   | Author  | Phone #        | EEmail@mail.mil        |
|--------|---|---|----------------|------------------------|
| N/A    | Executive Summary   | COL(Ret) Ben Rivera, AFMS                             | (703) 805-4905 | bienvenido.rivera.ctr  |
| 1      | Introduction  | COL(Ret) Rick Garratón, AFMS ( <b>Volume Author</b> ) | (703) 805-2372 | ricardo.r.garraton.ctr |
| 2      | Strategy and Strategic Direction  | COL(Ret) Paul Melody, AFMS                            | (703) 805-5926 | paul.e.melody.ctr      |
| 3      | Force Management  | COL(Ret) Pete Colón, USAFMSA                          | (703) 805-4260 | pedro.j.colon12.civ    |
| 4      | Army Organization   | COL(Ret) Hershel Holiday, AFMS                        | (703) 805-3518 | hershel.l.holiday.ctr  |
| 5      | Army Mobilization and Deployment  | COL(Ret) John Dowdle, AFMS                            | (703) 805-2372 | john.h.dowdle.ctr      |
| 6      | Reserve Components  | COL(Ret) Todd Chamberlain, AFMS*                      | (571) 830-7395 | ricardo.r.garraton.ctr |
| 7      | Force Readiness   | Mr. Keith Bullock, DAMO-OD                            | (703) 693-9438 | keith.r.bullock.ctr    |
| 8      | Army Planning, Programming, Budgeting, and Execution Process                                  | COL(Ret) Kevin Vink, AFMS                             | (703) 805-1069 | kevin.j.vink.ctr       |
| 9      | Finance and Comptroller   | COL(Ret) Kevin Vink, AFMS                             | (703) 805-1069 | kevin.j.vink.ctr       |
| 10     | Capability Requirements and Materiel System Research, Development, and Acquisition Management | MAJ(Ret) Greg Hamlett (PhD), AFMS                     | (703) 805-2362 | gregory.l.hamlett.ctr  |
| 11     | Logistics   | COL(Ret) Tommie Hewitt, AFMS                          | (703) 805-4767 | tommie.hewitt2.ctr     |
| 12     | Military Human Resource Management  | COL(Ret) Tommie Hewitt, AFMS                          | (703) 805-4767 | tommie.hewitt2.ctr     |
| 13     | Civilian Human Resource Management  | COL(Ret) Todd Chamberlain, AFMS*                      | (571) 830-7395 | ricardo.r.garraton.ctr |
| 14     | Training and Leader Development   | Mr. Charles Scott, DAMO-TR                            | (703) 614-9816 | charles.r.scott18.ctr  |
| 15     | Information Management and Information Technology   | Mr. Keith Dean, HQDA CIO / G-6                        | (703) 545-1354 | keith.t.dean1.civ      |
| 16     | Installation Management Community   | Ms. Cherie Sands, DAMO-FMI                            | (703) 693-3139 | cheryl.sands.civ       |
| 17     | Army Health System  | LTC Karen Baimbridge, OTSG                            | (703) 681-8197 | karen.j.baimbridge.mil |
| 18     | Civil Functions of the Department of the Army   | COL Daniel Koprowski, USACE                           | (202) 761-0101 | daniel.c.koprowski.mil |
| 19     | Public Affairs  | MAJ Rob Lodewick, OSD PA                              | (301) 677-7274 | robert.l.lodewick.mil  |
| 20     | Defense Support of Civil Authorities  | COL(Ret) Todd Chamberlain, AFMS*                      | (571) 830-7395 | ricardo.r.garraton.ctr |
| 21     | Foreign Military Sales  | COL(Ret) George Dukes III, DASA (DE&C)                | (703) 545-4817 | george.l.dukes2.civ    |
| 22     | Emerging Concept: Global Force Information Management   | Ms. Lori Mongold, DAMO-FME                            | (703) 614-0505 | lori.l.mongold.civ     |

Note: If you cannot contact a Chapter Author, please contact the Volume Author.

\*COL (Retired) Todd Chamberlain does not have a military email account.

Table of Contents

**Executive Summary**.....viii

**Chapter 1—Introduction**

Section I—Fulfilling the Intent of Congress.....1-1

Section II—How The Army Runs—The Text .....1-4

Section III—Summary and References .....1-5

**Chapter 2—Strategy and Strategic Direction**

Section I—Introduction .....2-1

Section II—National-Level Strategy.....2-2

Section III—Defense-Level Strategy.....2-3

Section IV—Global Force Management .....2-4

Section V—Joint-Level Strategy .....2-7

Section VI—Joint Planning.....2-18

Section VII—Army-Level Strategy .....2-22

Section VIII—Summary, Key Terms, and References.....2-24

*Figures*

Figure 2-1. Joint Strategic Planning System.....2-8

Figure 2-2. Unified Combatant Commands .....2-17

Figure 2-3. Unified Action in Execution.....2-19

Figure 2-4. Joint Planning and Execution Community.....2-20

**Chapter 3—Force Management**

Section I—Introduction.....3-1

Section II—Force Development .....3-8

Section III—Force Development Phase I—Develop Capability Requirements .....3-9

Section IV—Force Development Phase II—Design Organizations .....3-17

Section V—Force Development Phase III—Develop Organizational Models .....3-20

Section VI—Force Development Phase IV—Determine Organizational Authorizations .....3-23

Section VII—Force Development Phase V—Document Organizational Authorizations .....3-29

Section VIII—Force Integration .....3-30

Section IX—Table of Distribution and Allowance Change Management Plan .....3-30

Section X—Force Generation and Sustainable Readiness .....3-35

Section XI—Summary, Key Terms, and References .....3-39

*Figures*

Figure 3-1. Army Force Management Model ..... Back of Book Fold-Out

Figure 3-2. Structure and Composition System .....3-4

Figure 3-3. Army Organizational Life Cycle Model .....3-6

Figure 3-4. Force Development Process.....3-8

Figure 3-5. Army Concept Framework.....3-11

Figure 3-6. Capabilities-Based Assessment Process.....3-14

Figure 3-7. Solutions Documents.....3-17

Figure 3-8. Force Design Update.....3-19

Figure 3-9. Modernization Over Time (Resource-Driven).....3-22

Figure 3-10. Total Army Analysis “End-to-End” Process .....3-24

Figure 3-11. Force Generation Phases.....3-36

Figure 3-12. Sustainable Readiness Modules .....3-39

**Chapter 4—Army Organization**

Section I—Introduction.....4-1

Section II—The Production Subsystem .....4-3

Section III—The Combat Subsystem.....4-8

# HOW THE ARMY RUNS

|   |      |
|---|------|
| Section IV—The Integrating Subsystem .....                          | 4-9  |
| Section V—Summary and References .....                              | 4-11 |
| <i>Figure</i>   |      |
| Figure 4-1. Headquarters, Department of the Army Organization ..... | 4-10 |

## **Chapter 5—Army Mobilization and Deployment**

|   |      |
|---|------|
| Section I—Introduction .....                                | 5-1  |
| Section II—Army Mobilization .....                          | 5-1  |
| Section III—Industrial Preparedness .....                   | 5-9  |
| Section IV—Summary and References .....                     | 5-12 |
| <i>Figures</i>  |      |
| Figure 5-1. Army Mobilization System Subsystems .....       | 5-4  |
| Figure 5-2. Reserve Component Utilization Authorities ..... | 5-6  |

## **Chapter 6—Reserve Components**

|  |      |
|--|------|
| Section I—Introduction .....                           | 6-1  |
| Section II—Reserve Service .....                       | 6-2  |
| Section III—Reserve Components Management .....        | 6-4  |
| Section IV—Training .....                              | 6-7  |
| Section V—Equipment .....                              | 6-8  |
| Section VI—Readiness and Mobilization Assistance ..... | 6-9  |
| Section VII—Summary and References .....               | 6-11 |
| <i>Figures</i>   |      |
| Figure 6-1. Reserve Service Categories .....           | 6-2  |
| Figure 6-2. State Partnership Program .....            | 6-8  |
| Figure 6-3. Reserve Component Access .....             | 6-8  |

## **Chapter 7—Force Readiness**

|   |      |
|---|------|
| Section I—Introduction .....                                      | 7-1  |
| Section II—Unit Readiness Reporting .....                         | 7-2  |
| Section III—Strategic Readiness .....                             | 7-5  |
| Section IV—Department of Defense Readiness Reporting System ..... | 7-10 |
| Section V—Summary, Key Terms, and References .....                | 7-11 |
| <i>Figures</i>  |      |
| Figure 7-1. Readiness Framework .....                             | 7-2  |
| Figure 7-2. Unit Readiness Fundamentals .....                     | 7-3  |
| Figure 7-3. Army Strategic Readiness Process .....                | 7-6  |
| Figure 7-4. Chairman’s Readiness System .....                     | 7-9  |

## **Chapter 8—Army Planning, Programming, Budgeting, and Execution Process**

|   |      |
|---|------|
| Section I—Introduction .....  | 8-1  |
| Section II—Department of Defense Planning, Programming, Budgeting, and Execution Process .....                      | 8-1  |
| Section III—The Army Planning, Programming, Budgeting, and Execution Process .....                                  | 8-8  |
| Section IV—Leading Army Planning, Programming, Budgeting, and Execution System Phases .....                         | 8-10 |
| Section V— Supporting Responsibilities in the Army for Planning, Programming, Budgeting, and Execution System ..... | 8-14 |
| Section VI—Allocation of Resources .....  | 8-26 |
| Section VII—Army Planning, Programming, Budgeting, and Execution Deliberative Forums .....                          | 8-29 |
| Section VIII—Army Planning, Programming, Budgeting, and Execution—Planning .....                                    | 8-34 |
| Section IX—Integrated Programming—Budgeting Phase .....   | 8-34 |
| Section X—Army Budget Execution Phase .....   | 8-41 |
| Section XI—Program Performance and Review .....   | 8-41 |
| Section XII—Summary, Key Terms, and References .....  | 8-41 |
| <i>Figures</i>  |      |
| Figure 8-1. Department of Defense Planning, Programming, Budgeting, and Execution Phases .....                      | 8-2  |
| Figure 8-2. Summary of Planning, Programming, Budgeting, and Execution Phases .....                                 | 8-2  |



## TABLE OF CONTENTS

|   |       |
|---|-------|
| Figure 8-3. Major Force Programs.....   | 8-4   |
| Figure 8-4. Future Years Defense Program.....   | 8-5   |
| Figure 8-5. Department of Defense Review / Decision-Making Bodies.....  | 8-7   |
| Figure 8-6. Management Decision Execution Package.....  | 8-27  |
| Figure 8-7. Fiscal Year 21-25 Program Objective Memorandum Management Decision Execution Package.....   | 8-28  |
| Figure 8-8. Planning, Programming, Budgeting, and Execution Decision Committees and Processes.....  | 8-31  |
| Figure 8-9. Program Evaluation Groups.....  | 8-32  |
| Figure 8-10. Program Evaluation Group Functions.....  | 8-33  |
| Figure 8-11. Army Resource Framework Hierarchy.....   | 8-36  |
| Figure 8-12. Program Objective Memorandum / Budget Estimate Submission Timeline.....  | 8-38  |
| Figure 8-13. Planning, Programming, Budgeting, and Execution Timeline.....  | 8-38  |
| Figure 8-14. Program and Budget Timeline.....   | 8-39  |
| <i>Tables</i>   |       |
| Table 8-1. Future Years Defense Programs and Subprograms with Army Proponents.....  | 8-5   |
| Table 8-2. Managers for Manpower and Force Structure Issues.....  | 8-10  |
| Table 8-3. Budget Activity Management Structure for Operation and Maintenance Appropriations.....   | 8-16  |
| Table 8-4. Budget Activity Management Structure for Operation and Maintenance Appropriations-Army Manpower-Only Activity Structure.....       | 8-19  |
| Table 8-5. Budget Activity Management Structure for Operation and Maintenance Appropriation-Base Operations Support.....                      | 8-19  |
| Table 8-6. Budget Activity Management Structure for Operation and Maintenance Appropriations-Sustainment, Restoration, and Modernization..... | 8-21  |
| Table 8-7. Budget Activity Management Structure for Operation and Maintenance Appropriations-Army National Guard.....                         | 8-22  |
| Table 8-8. Budget Activity Management Structure for Operations and Maintenance Appropriations-United States Army Reserve.....                 | 8-23  |
| Table 8-9. Army Appropriations-Managers for Functional Requirements and Program and Performance.....  | 8-24  |
| <br>  |       |
| <b>Chapter 9—Finance and Comptroller</b>  |       |
| Section I—Introduction.....   | 9-1   |
| Section II—Acquire Resources.....   | 9-4   |
| Section III—Budget Execution.....   | 9-5   |
| Section IV—Account for the Use of Resources.....  | 9-8   |
| Section V—Fiscal Stewardship.....   | 9-10  |
| Section VI—Financial Reform.....  | 9-12  |
| Section VII—Non-Appropriated Funds.....   | 9-15  |
| Section VIII—Summary, Key Terms, and References.....  | 9-16  |
| <i>Figures</i>  |       |
| Figure 9-1. Office of the Assistant Secretary of the Army (Financial Management and Comptroller).....   | 9-4   |
| Figure 9-2. Fund Distribution Process.....  | 9-6   |
| Figure 9-3. Cycle of Commitment and Review.....   | 9-13  |
| Figure 9-4. Cost-Benefit Analysis.....  | 9-15  |
| <br>  |       |
| <b>Chapter 10—Capability Requirements and Materiel System Research, Development, and Acquisition Management</b>                               |       |
| Section I—Introduction.....   | 10-1  |
| Section II—Army Modernization Enterprise and Army Futures Command.....  | 10-1  |
| Section III—Concept Development and Multi-Domain Operations.....  | 10-4  |
| Section IV—Capabilities Integration and Development.....  | 10-4  |
| Section V—Capability Requirement Documents.....   | 10-6  |
| Section VI—Materiel Requirements Review, Validation and Approval Process.....   | 10-12 |
| Section VII—Urgent and Emergent Operational Need Validation.....  | 10-19 |

## HOW THE ARMY RUNS

|   |       |
|---|-------|
| Section VIII—Materiel Systems Acquisition .....                                 | 10-23 |
| Section IX— Department of Defense Acquisition Organization and Management ..... | 10-26 |
| Section X—Operation of the Defense Acquisition System .....                     | 10-29 |
| Section XI—Acquisition Oversight and Review .....                               | 10-38 |
| Section XII—Major Sub-Processes.....  | 10-39 |
| Section XIII—Summary and References .....                                       | 10-44 |

### Figures

|  |       |
|--|-------|
| Figure 10-1. Key Elements in the Army Modernization Enterprise .....                               | 10-2  |
| Figure 10-2. Modernization: Cross-Functional Teams.....  | 10-3  |
| Figure 10-3. Army Futures Command’s Top-Down Futures Development Process .....                     | 10-3  |
| Figure 10-4. Three Joint Capabilities Integration and Development System Process Lanes.....        | 10-5  |
| Figure 10-5. DOTmLPF-P Change Recommendation.....  | 10-7  |
| Figure 10-6. Format for Initial Capabilities Document .....  | 10-7  |
| Figure 10-7. Components of the “IT Box” Construct in IS-ICDs .....                                 | 10-8  |
| Figure 10-8. Components of the “IT Box” Construct in IS-CDDs.....                                  | 10-9  |
| Figure 10-9. Format for Capability Development Document .....                                      | 10-10 |
| Figure 10-10. Joint Capabilities Integration and Development System Document Staffing Tracks ..... | 10-12 |
| Figure 10-11. Joint Requirements Oversight Council .....   | 10-13 |
| Figure 10-12. Joint Capabilities Board.....  | 10-14 |
| Figure 10-13. Functional Capabilities Board.....   | 10-15 |
| Figure 10-14. Army Requirements Oversight Council .....  | 10-24 |
| Figure 10-15. Combined AROC/JROC Staffing Process.....   | 10-18 |
| Figure 10-16. Army Capabilities Integration and Development System Process .....                   | 10-19 |
| Figure 10-17. HQDA Operational Needs Statement Process.....  | 10-21 |
| Figure 10-18. Army Requirements and Resourcing Board Organization .....                            | 10-22 |
| Figure 10-19. Technology Readiness Levels.....   | 10-26 |
| Figure 10-20. Army Acquisition Executive .....   | 10-20 |
| Figure 10-21. Department of Defense Acquisition Authority Chain .....                              | 10-21 |
| Figure 10-22. Defense Acquisition System, Model 1: Hardware Intensive Program.....                 | 10-30 |
| Figure 10-23. Model 2: Defense Unique Software Intensive Program .....                             | 10-31 |
| Figure 10-24. Model 3: Incrementally Deployed Software Intensive Program .....                     | 10-32 |
| Figure 10-25. Model 4: Accelerated Acquisition Program .....                                       | 10-33 |
| Figure 10-26. Model 5: Hybrid Program A (Hardware Dominant).....                                   | 10-34 |
| Figure 10-27. Model 6: Hybrid Program B (Software Dominant).....                                   | 10-27 |

## Chapter 11—Logistics

|   |       |
|---|-------|
| Section I—Introduction.....   | 11-1  |
| Section II— National Logistics Organization— Assistant Secretary of the Army (Acquisition, Logistics, and Technology); Headquarters, Department of the Army, Deputy Chief of Staff (DCS), G-4; DCS, G-8; Army Materiel Command; and Logistics Enterprise Support Agency ..... | 11-6  |
| Section III—National Logistics Organizations—Other .....  | 11-15 |
| Section IV—Summary, Key Terms, and References.....  | 11-19 |

### Figure

|  |       |
|--|-------|
| Figure 11-1. Foreign Military Sales Process..... | 11-10 |
|--|-------|

## Chapter 12—Military Human Resource Management

|  |       |
|--|-------|
| Section I—Introduction.....                        | 12-1  |
| Section II—The Structure Function .....            | 12-4  |
| Section III—The Acquisition Function .....         | 12-7  |
| Section IV—The Compensation Function.....          | 12-10 |
| Section V—The Distribution Function .....          | 12-11 |
| Section VI—The Development Function.....           | 12-18 |
| Section VII—The Sustainment Function .....         | 12-29 |
| Section VIII—The Transition Function .....         | 12-30 |
| Section IX—Summary, Key Terms, and References..... | 12-33 |

### Figures

## TABLE OF CONTENTS

|  |       |
|--|-------|
| Figure 12-1. Manpower Strength Relationships.....                                  | 12-5  |
| Figure 12-2. Enlisted Procurement .....  | 12-7  |
| Figure 12-3. Manning Programs .....  | 12-11 |
| Figure 12-4. Enlisted Automation Management System .....                           | 12-13 |
| Figure 12-5. Officer Distribution .....  | 12-17 |
| Figure 12-6. Warrant Officer Training and Education .....                          | 12-21 |
| Figure 12-7. Warrant Officer Promotion Timeline .....                              | 12-22 |
| Figure 12-8. Functionally Aligned Officer Personnel Management System Design ..... | 12-25 |
| Figure 12-9. Centralized Selection List Categories .....                           | 12-26 |
| Figure 12-10. IPPS-A Incremental Areas by Release .....                            | 12-34 |
| <i>Tables</i>  |       |
| Table 12-1. Warrant Officer Promotion Goals.....                                   | 12-22 |
| Table 12-2. Career Progression Pattern .....                                       | 12-27 |
| <br><b>Chapter 13—Civilian Human Resource Management</b>                           |       |
| Section I—Introduction.....  | 13-1  |
| Section II—Organization of Civilian Personnel Management.....                      | 13-4  |
| Section III—Civilian Human Resource Service Delivery.....                          | 13-8  |
| Section IV—Personnel Management at Installation / Activity Level .....             | 13-9  |
| Section V—Equal Employment Opportunity in the Army.....                            | 13-15 |
| Section VI—Executive and Senior Professional Personnel.....                        | 13-18 |
| Section VII—Defense Civilian Intelligence Personnel System .....                   | 13-19 |
| Section VIII—Army Personnel Transformation .....                                   | 13-21 |
| Section IX—Summary and References .....  | 13-22 |
| <i>Figures</i>   |       |
| Figure 13-1. Civilian Strength .....   | 13-2  |
| Figure 13-2. Differences Between the Military and Civilian Systems .....           | 13-3  |
| Figure 13-3. Civilian Expeditionary Workforce Model.....                           | 13-21 |
| <br><b>Chapter 14—Training and Leader Development</b>                              |       |
| Section I—Introduction.....  | 14-1  |
| Section II—Strategic Training Framework .....                                      | 14-1  |
| Section III—Operational Training .....   | 14-3  |
| Section IV—Institutional Training.....   | 14-8  |
| Section V—Military Functional Area and Skill Training.....                         | 14-15 |
| Section VI—Future of Army Training .....   | 14-15 |
| Section VII—Training Governance .....  | 14-16 |
| Section VIII—Leader Development.....   | 14-18 |
| Section IX—Civilian Training and Leader Development.....                           | 14-20 |
| Section X—Training Support.....  | 14-24 |
| Section XI—Policy, Requirements, and Resourcing Process.....                       | 14-27 |
| Section XII—Summary and References .....   | 14-29 |
| <br><b>Chapter 15—Information Management and Information Technology</b>            |       |
| Section I—Introduction.....  | 15-1  |
| Section II—Army Network Plan.....  | 15-3  |
| Section III—Army Enterprise Management.....  | 15-4  |
| Section IV—Army Chief Information Officer / G-6 Strategic Partnerships .....       | 15-8  |
| Section V—Summary, Key Terms, and References.....                                  | 15-11 |
| <br><b>Chapter 16—Installation Management Community</b>                            |       |
| Section I—Introduction.....  | 16-1  |
| Section II—Roles and Missions.....   | 16-3  |
| Section III—Initiatives and Programs.....  | 16-13 |
| Section IV—Summary, Key Terms, and References.....                                 | 16-15 |

# HOW THE ARMY RUNS

## Figures

|   |      |
|---|------|
| Figure 16-1. Installation Management Community Hierarchy..... | 16-3 |
| Figure 16-2. Installation Management Command.....             | 16-8 |

## Chapter 17—Army Health System

|   |       |
|---|-------|
| Section I—Introduction.....   | 17-1  |
| Section II—Army Medical Department Mission and Support to Commanders..... | 17-3  |
| Section III—Office of The Surgeon General.....                            | 17-5  |
| Section IV—Command and Management.....                                    | 17-7  |
| Section V—Summary and References.....                                     | 17-12 |

## Figures

|   |      |
|---|------|
| Figure 17-1. United States Medical Command Current Structure..... | 17-8 |
|---|------|

## Chapter 18—Civil Functions of the Department of the Army

|  |       |
|--|-------|
| Section I—Introduction.....                            | 18-1  |
| Section II—Civil Works Program.....                    | 18-4  |
| Section III—Support to Other Government Agencies.....  | 18-11 |
| Section IV—Engineer Overseas Activities.....           | 18-12 |
| Section V—Support to Unified Combatant Commanders..... | 18-14 |
| Section VI—Summary and References.....                 | 18-15 |

## Figure

|  |      |
|--|------|
| Figure 18-1. Where We Are: U.S. Army Corps of Engineers..... | 18-3 |
|--|------|

## Chapter 19—Public Affairs

|   |      |
|---|------|
| Section I—Introduction.....                         | 19-1 |
| Section II—Army Public Affairs Organizations.....   | 19-4 |
| Section III—Summary, Key Terms, and References..... | 19-7 |

## Figure

|   |      |
|---|------|
| Figure 19-1. Department of Defense Principles of Information..... | 19-2 |
|---|------|

## Chapter 20—Defense Support of Civil Authorities

|  |       |
|--|-------|
| Section I—Introduction.....  | 20-1  |
| Section II—Domestic Emergency Management Environment.....  | 20-4  |
| Section III—Federal Role in the National Response Process.....   | 20-7  |
| Section IV—Defense Support Process.....  | 20-12 |
| Section V—Defense Support of Civil Authorities Mission Category—Disasters and Declared Emergencies.....                  | 20-14 |
| Section VI—Defense Support of Civil Authorities Mission Category—Restore Public Health and Services and Civil Order..... | 20-18 |
| Section VII—Defense Support of Civil Authorities Mission Category—Special Events and Planned Periodic Support.....       | 20-18 |
| Section VIII—Summary and References.....   | 20-19 |

## Figures

|   |       |
|---|-------|
| Figure 20-1. National Response Plan (Stafford Act).....     | 20-5  |
| Figure 20-2. National Response Plan (Non-Stafford Act)..... | 20-6  |
| Figure 20-3. CBRN Response Enterprise.....                  | 20-16 |

## Table

|  |       |
|--|-------|
| Table 20-1. Federal Response Plan Emergency Support Functions..... | 20-10 |
|--|-------|

## Chapter 21—Foreign Military Sales

|  |       |
|--|-------|
| Section I—Introduction.....  | 21-1  |
| Section II—Foreign Military Sales Linkage to Department of Defense Through Security Cooperation and Security Assistance..... | 21-2  |
| Section II—Foreign Military Sales Authorities and Responsible Agencies.....  | 21-3  |
| Section IV—Army Foreign Military Sales.....  | 21-5  |
| Section V—Summary, Key Terms, and References.....  | 21-10 |

# TABLE OF CONTENTS

## *Figures*

|  |      |
|--|------|
| Figure 21-1. Responsible Agencies .....  | 21-4 |
| Figure 21-2. Pre-Letter of Request Process .....   | 21-5 |
| Figure 21-3. Letter of Request Process U.S. Army Corps of Engineers, Security Assistance<br>Training Field Activity, and U.S. Army Security Assistance Command ..... | 21-6 |
| Figure 21-4. Foreign Military Sales Delivery of Training Capability .....  | 21-7 |
| Figure 21-5. Foreign Military Sales Admin Fund Flow .....  | 21-8 |
| Figure 21-6. Foreign Military Sales Case Funds Flow .....  | 21-9 |

## **Chapter 22—Emerging Initiative: Global Force Information Management**

|   |       |
|---|-------|
| Section I—Introduction .....  | 22-1  |
| Section II—Deploy-to-Redeploy/Retrograde .....                              | 22-1  |
| Section III—Global Force Information Management Objective Environment ..... | 22-3  |
| Section IV—Global Force Management Data Initiative .....                    | 22-8  |
| Section V—Summary, Key Terms, and References .....                          | 22-20 |

## *Figures*

|  |       |
|--|-------|
| Figure 22-1. Deploy-to-Redeploy/Retrograde End-to-End Business Process .....   | 22-1  |
| Figure 22-2. Army Dynamic Force Structure Problem Statement Goals, Objectives, and Outcomes ...  | 22-6  |
| Figure 22-3. Army Global Force Information Management Required Capabilities .....  | 22-6  |
| Figure 22-4. GFIM OE “12 to 3 to 1” Hybrid Acquisition Approach .....  | 22-7  |
| Figure 22-5. How the Global Force Information Management Objective Environment<br>Supports Deploy-to-Redeploy/Retrograde .....               | 22-8  |
| Figure 22-6. GFM DI Provides Common Data Standard Across PPBES and Reporting<br>Systems to Support enterprise approach to D2RR and DFE ..... | 22-9  |
| Figure 22-7. Department of Defense Global Force Management Data Initiative Overview .....  | 22-10 |
| Figure 22-8. Organizational and Force Structure Construct Overview .....   | 22-11 |
| Figure 22-9. Organizational and Force Structure Construct Terminology and Components .....   | 22-11 |
| Figure 22-10. Organizational and Force Structure Construct Billet, TEMPLET, and<br>Personnel Accountability .....                            | 22-12 |
| Figure 22-11. Organizational and Force Structure Construct Organizational Tree<br>From DOD Down to Billet Level .....                        | 22-13 |
| Figure 22-12. Primary Organizational and Force Structure Construct Relations for Army<br>at Rest and Army in Motion .....                    | 22-14 |
| Figure 22-13. The Enterprise Force Structure Data Standard Enables Common Operating<br>Picture of the Total Army .....                       | 22-15 |
| Figure 22-14. Linking Personnel and Equipment to Force Structure .....   | 22-16 |
| Figure 22-15. Linking the Crewed Equipment (Tank IUID) to the<br>EOE (GFMID) that is Associated with the Crew .....                          | 22-17 |
| Figure 22-16. GFM DI Enterprise Force Structure Enables Dynamic Readiness at the<br>Lowest Employable Entity .....                           | 22-17 |
| Figure 22-17. Required Information and Data to Support DEF Decisions .....   | 22-18 |
| Figure 22-18. The Planned Integration of Capabilities in the Army GFIM OE .....  | 22-19 |

|                    |     |
|--------------------|-----|
| <b>Terms</b> ..... | T-1 |
|--------------------|-----|

|                       |     |
|-----------------------|-----|
| <b>Glossary</b> ..... | G-1 |
|-----------------------|-----|

### Executive Summary

*The Army of 2028 will be ready to deploy, fight, and win decisively against any adversary, anytime and anywhere, in a joint, multi-domain, high intensity conflict, while simultaneously deterring others and maintaining its ability to conduct irregular warfare. The Army will do this through the employment of modern manned and unmanned ground combat vehicles, aircraft, sustainment systems, and weapons, coupled with robust combined arms formations and tactics based on a modern warfighting doctrine centered on exceptional Leaders and Soldiers of unmatched lethality.*

#### *The Army Vision*

Since the publication of the 2017-2018 How the Army Runs Reference Handbook, the U.S. Army is transitioning its concepts, doctrine, and capabilities to a new strategy. This new strategy switches the focus of Army forces from counterinsurgency to large scale combat operations (LSCO) against a peer, or near-peer competitor. The Army responds to this fundamental change in strategy by establishing two very clear objectives in achieving the new strategy. The intermediate objective is to establish a multi-domain operations capable force (at least selected formations) by 2028 and an ultimate objective to grow that force into a multi-domain operations ready Army by 2035. This strategic environment creates opportunities and challenges across all Army functions. Army Force Managers will assist and enable Army Senior Leaders organize, man, train, equip, fund, station, and sustain the multi-domain operations capable force of 2028 rapidly, effectively, and efficiently. This edition of the How the Army Runs Reference Book informs you of the Army processes at the outset of this strategic transition.

Army Force Management enables Army leaders to generate lethal, modernized, trained, and ready forces for Combatant Commanders (CCDRs). Institutionally, this edition also captures emergent developments caused by the establishment of the Army Futures Command (AFC) in June 2018 across multiple chapters.

The ASLs follow the law, make prudent choices in strategy, approve and accelerate capabilities for the warfighter, carefully calibrate resources, and assess risk. This reference manual tells you, the Army leader, the details of how people, processes, and products come together to balance ends, ways, and means.

This reference book serves as a primer and ready reference to officers preparing to assume command, leadership, and management positions at the strategic level. At the time of publication, the volatile, uncertain complex, and ambiguous operational environment drives the Army to re-examine how it determines and approves requirements, re-cast how it achieves modernization rapidly and at reduced cost while

## HOW THE ARMY RUNS

maturing Sustainable Readiness. Through careful study and consideration of the chapters in this text, leaders will be able to:

- Explain the relationships of the force management systems and processes that build fielded force readiness while investing in future force readiness.
- Dissect strategy—at the National, Defense, Joint, and Army levels to understand how it impacts the Army.
- Recognize how Force Development translates requirements across Doctrine, Organization, Training, Materiel, Leadership, Personnel, Facilities and Policy domains into programs and structure.
- Examine how the Army uses three distinct subsystems: production; combat, and integration to produce versatile capabilities for global demands.
- Distinguish Army components (regular and reserve) which are uniquely optimized to sustain and expand capabilities to execute the range of military operations.
- Identify how the Army measures force readiness.
- Explore the sequential phases of the Planning, Programming, Budgeting, and Execution process, to align strategy with resources within timelines that support Executive and Legislative approval cycles.
- Examine the unification of the Future Force Modernization Enterprise in which the Joint Capabilities Integration and Development System and defense Acquisition System at Army level coalesce in AFC.
- Understand the Army's provision of logistics, personnel services, and health service support necessary to enable mission accomplishment globally.
- Know about the four components of readiness: manning, training, modernized equipment, and leader development.
- Identify the emergent efforts to create a modernization model for LSCO.
- Examine how the Army's information management and information technology support the broader and emergent cyber capability.
- Identify where Army readiness occurs at 154 permanent Army installations and over 1,100 community-based Army National Guard Readiness Centers and Army Reserve Centers worldwide.
- Know that the U.S. Army Corps of Engineers Civil Works program is focused on the development, protection, and restoration of the Nation's water and related land resources.
- Examine the Army's obligation to keep the American people informed, to foster confidence in the Army and its readiness to conduct multi-domain operations globally.
- Examine the laws, Presidential Directives, Executive Orders, and Defense Department policies for Defense Support to Civil Authorities.

Ultimately, the thoughtful and careful calibration of ends, ways, and means is at the heart of Force Management. The output of Army Force Management on behalf of the Secretary of the Army is the constant provision of trained, lethal, and modern forces for CCDRs when and where they need them.

**This page is intentionally left blank**



*Winning Matters. We win with our People doing the right things the right way. When we send the U.S. Army somewhere, we don't go to participate, we don't go to try hard, we go to win. There is no second place or honorable mention in combat.*

*Gen. James C. McConville, Chief of Staff of the Army*

## Chapter 1

### Introduction

#### Section I

#### Fulfilling the Intent of Congress

##### 1-1. Changing How We Manage Change

a. Today's Soldiers exemplify the legacy of the millions of Soldiers that came before them. The 190 campaign streamers that adorn the Army's flag are a testament to the moral commitment and personal courage of the Soldiers who stormed the beaches of Normandy, held fast on and off the shores of Okinawa, and fought through the rice paddies of Korea, jungles of Vietnam, sands of Iraq, and mountains of Afghanistan. America's adversaries have studied U.S. operations closely, and they know the American way of war well. The joint force excels in a way of war that emphasizes joint and combined operations; technological dominance; global power projection; strategic, operational, and tactical maneuver; effective joint fires; sustainment at scale; and mission command initiative. Simultaneously, emerging technologies like artificial intelligence, hypersonics, machine learning, nanotechnology, and robotics are driving a fundamental change in the character of war. As these technologies mature and their military applications become clearer, the impacts have the potential to revolutionize battlefields unlike anything since the integration of machine guns, tanks, and aviation which began the era of combined arms warfare. Strategic competitors like Russia and China are synthesizing emerging technologies with their analysis of military doctrine and operations. They are deploying capabilities to fight the U.S. through multiple layers of stand-off in all domains – space, cyber, air, sea, and land. The military problem facing the joint force is defeating multiple layers of stand-off in all domains to maintain the coherence in operations. Therefore, the American way of war must evolve and adapt. The Army's unique role as part of the joint force is to shape operational environments, prevent conflicts, conduct large-scale ground combat operations, and consolidate gains to achieve enduring national objectives. Only the Army is capable of mounting sustained large-scale combat operations. The Total Army, comprised of the Regular Army (RA), Army National Guard (ARNG), and Army Reserve (USAR), provides the nation with a land force unequalled in skill, adaptability, professionalism, and power.

b. Fulfilling the intent of Congress as well as the vision of national, defense, joint, and Army level leadership is a formidable task. The Army is a dynamic organization that must constantly adapt to emerging threats and their associated mission sets. Army professionals, especially leaders and force managers, must drive this change to ensure the Army is prepared to deploy, fight, and win the nation's wars. Further, the Army strives to implement orderly management of change while minimizing turbulence in organizations. Bringing about this change requires the continual adaptation and development of both materiel and non-materiel solutions across the Army's doctrine, organization, training, materiel, leadership and education, personnel, facilities, and policy (DOTMLPF-P) domains. A testament to this adaptation is the establishment of Army Futures Command (AFC) to lead the Army's future force modernization enterprise. The establishment of AFC marks a fundamental change in the Army's approach to modernization. The purpose of AFC is to improve future readiness by ensuring Soldiers have the weapons, equipment, and tools they need, when they need them, to deploy, fight, and win future conflicts.

c. Changing a large enterprise with well-developed cultures embedded in established bureaucracies is incredibly difficult. People in organizations like the Army with functioning, complex systems, and embedded processes tend to resist change or cause change to become more evolutionary. The Army

## HOW THE ARMY RUNS

has the internal challenge of ensuring that its processes remain flexible enough to facilitate and not impede change, while also inspiring creativity and rapidly incorporating technological, cognitive, and organizational innovations. This text provides a basis of understanding that empowers continued change in Army force management processes. From here, leaders must make informed decisions about force management processes and how they can be used or changed to better provide ready, lethal, and modern units to combatant commanders (CCDR).

d. The Army has made great progress in recent years, recovering from depleted levels of readiness following extended periods of sustained conflict and constrained defense spending. However, as the many demands on the nation's resources pressure the defense budget in the future, the Army will make difficult choices to meet national objectives. A continued commitment to strengthening alliances and building partnerships will help offset these challenges. To achieve the objectives of the 2018 Army Vision given the uncertainty of future budgets, the Army must continually assess everything it does, identify lower value activities to discontinue, and find ways to improve what it must do, to free up time, money, and manpower for top priorities. Trusting and empowering subordinate leaders will facilitate both reform and greater performance. The Army must develop smart, thoughtful, and innovative leaders of character who are comfortable with complexity and capable of improving the return on investment of taxpayer dollars by reforming its business practices to save money and reinvesting those savings into the Army modernization priorities.

### 1-2. Managing The Army

a. According to Army Regulation 71-32, Force management is the capstone process to establish and field mission-ready Army organizations. The process involves organization, integration, decision making, and execution of the spectrum of activities encompassing requirements definition, force development, force integration, force structuring, capability development, materiel development, training development, resourcing, and all elements of the Army Organizational Life Cycle Model (AOLCM). The focal point of force management is meeting the Secretary of the Army's statutory requirements to recruit, organize, supply, equip, train, service, mobilize, demobilize, administer, maintain, and station the Army.

b. The Army Force Management Model, Figure 3-1 (fold-out), is a system of systems approach to providing ready, lethal, and modern units to CCDRs. The model serves as a roadmap divided into seven distinct modules, each showing its relationship to the others as well as to the major Department of Defense (DOD) management processes. The modules include:

- (1) Determine strategic and operational requirements.
- (2) Develop required capabilities / DOTMLPF-P solutions.
- (3) Determine authorizations.
- (4) Determine structure (specifically, design organizations, develop organizational models, and document organizational authorizations).
- (5) Acquire materiel solutions.
- (6) Acquire, train, and distribute personnel.
- (7) Acquire and distribute materiel.

c. Although the Force Management (FM) Model depicts the flow of processes in a somewhat linear and sequential manner, the complexities of managing change may require otherwise. Depending on the level of importance and/or Army Senior Leader (ASL) emphasis, some initiatives may mandate that several of these FM processes occur simultaneously, in parallel, compressed in time, or in reverse order. Eventually, all FM processes and systems are employed to produce fully trained, equipped, and resourced operating and institutional force organizations.

### 1-3. The Army Posture

a. Each year, the SECARMY and CSA testify before Congress on the state of the Army. The statement describes where the Army is and what it has done over the last year to support the National Defense Strategy (NDS). Designed to reinforce this testimony and additional budget testimonies to the committees and subcommittees of the U.S. Senate and House of Representatives, the Army Posture Statement (APS) serves a broad audience as a basic reference on the state of the Army. The ARNG and USAR also publish annual posture statements to capture the posture of the Total Army. The APS is the primary vehicle to tell the Army story. As such, Soldiers, civilians, and contractors need to read and understand the APS to appreciate current challenges and future direction that the systems and processes described in this text must address.

b. The Army faces a global security environment that continually grows more competitive and volatile. The challenges are many: The reemergence of great power competition; a resilient but weakening post-World War II order; accelerating technological advancements empowering state and non-state actors; and persistent threats to the Homeland. The Army must be ready now and in the future to confront this challenging strategic environment. The Army must have forces prepared for high-intensity conflict, modernized to extend overmatch against near-peer adversaries, and trained to fight as part of the joint force alongside allies and partners, all while sustaining its ability to conduct irregular warfare.

c. The modern battlefield encompasses all domains – air, land, sea, space, and cyber-space – and is increasing in geographic scale. Near-peer competitors, like China and Russia, are aggressively pursuing modernization programs to erode American overmatch. They have developed sophisticated anti-access and area denial (A2/AD) systems, fires, cyber, electronic warfare, and space-based capabilities that generate layers of stand-off to disrupt the deployment of military forces, deny the build-up of combat power, and separate joint force capabilities in time and space. These capabilities may embolden more aggressive behavior in the conventional realm. China's military modernization program aims to transform the People's Liberation Army into a modern, mechanized, Information Age force in the next one to two decades and a world-class military capable of strategic force projection and warfighting by mid-century. Their military strategy seeks to protect Chinese interests outside of Asia and into Europe, the Middle East, and Africa. Furthermore, Russia is likely to threaten America's interests for the next 20 years as they attempt to regain control of historic spheres of influence and shape European economic and security structures in their favor. Although the U.S. may not face China and Russia directly, it is likely to face their systems and methods of warfare as they proliferate military capabilities to others.

d. Regional state adversaries, namely North Korea and Iran, also present significant challenges as they pursue advanced capabilities and weapons of mass destruction to gain regional influence and ensure regime survival. Additionally, transnational terrorist organizations continue to pose a threat to the Homeland and its interests, as well as its allies and partners. The Army must be prepared to defeat and deter highly capable adversaries while disrupting violent extremists and simultaneously defending the Homeland.

e. Today, the Army contributes to the Nation's efforts to counter these challenges by providing CCDRs over 179,000 Soldiers in more than 140 countries, including 110,000 Soldiers deployed on a rotational basis. This includes over 30,000 Soldiers supporting operations in the Middle East and Afghanistan; 8,000 Soldiers supporting NATO operations and the European Deterrence Initiative; and over 17,000 Soldiers providing a forward American presence on the Korean Peninsula. Additionally, Army forces remain prepared to respond to other contingency requirements, both abroad and at home. Concurrently, the Army is investing in the research and development of the next generation of weapons and equipment needed to stay ahead of the Nation's adversaries. Through a disciplined prioritization of resources, the Army will remain postured to defend the Nation in an increasingly dangerous world.

### **1-4. The Army in Transition**

a. Despite significant leadership transition across the DOD, the Army has remained focused on its missions in support of the NDS. Continuity of priorities and leadership focus is critical to achieve the 2018 Army Vision, which provides the strategic framework for guiding the Army into the next decade. Therefore, the Army's priorities – Readiness, Modernization, and Reform – are not changing.

(1) Readiness – The Army has increased its tactical readiness drastically, and will now expand its focus to improve strategic readiness – its ability to mobilize, deploy, and sustain the force. The Army must maintain a sustainable level of readiness to meet current demands while executing an aggressive modernization strategy to ensure the Total Army remains the most lethal ground combat force in the world.

(2) Modernization – The Army must modernize today or it could lose the next war. The Army must remain focused on delivering the 31 signature systems the eight cross-functional teams are developing in support of the six modernization priorities and ensure it can employ them the day they show up. To achieve this, the Army will integrate modernization efforts across doctrine, organizational designs, training models, leader development, personnel systems, facilities, and policies. Furthermore, the Army cannot maximize its Modernization Strategy without the Cloud, which is the backbone for artificial intelligence.

(3) Reforms – The Army will continue to ruthlessly prioritize resources and divest legacy programs through "Night Court" sessions, so it can scale new capabilities for low-rate initial production.

## HOW THE ARMY RUNS

Additionally, AFC is examining ways to adapt and advance the requirements generation process to achieve greater value at reduced cost and time.

b. The Army must follow through with these priorities while first taking care of PEOPLE - Soldiers, Family members, Department of the Army Civilians, and Soldiers for Life (retirees and veterans). The Army is a people oriented enterprise, and it is through them that the Army will deliver on readiness, modernization, and reform efforts.

### Section II

#### How The Army Runs—The Text

##### 1-5. Purpose

a. The purpose of the HTAR is fourfold. First, it describes how the Army runs, from strategy towards structure and, eventually, to resources, to provide ready, lethal, and modern units to CCDRs. Second, it addresses the systems and processes by which the Army runs in the context of national, defense, and joint level strategy, structure, and resources. Third, it serves as a handbook for officers preparing to assume command, leadership, and force management positions at the senior and strategic levels. Finally, it explains the relationships of the force management systems and processes that fill current CCDR requirements and predict, plan, and budget for requirements of the future.

b. While a key use of the HTAR is to support the U.S. Army War College (USAWC) resident and distance education curriculum, the text serves broader purposes to include: use by multi-component Army, sister service, and multi-national students attending force management courses at the Army Force Management School (AFMS) at Fort Belvoir, Virginia; use as a general reference for branch and service schools' professional military education (PME); and use as a primer for HQDA and the force management community of interest who seek to better understand the Army's organization and functions, along with its systems and processes.

##### 1-6. Scope

HTAR supports the USAWC curriculum, which promotes a better appreciation of the theory and practice of command, leadership, and management in the JIIM environment. Elihu Root founded the USAWC "not to promote war, but to preserve peace by intelligent and adequate preparation to repel aggression." He charged the faculty with directing "the instruction and intellectual exercise of the Army, to acquire information, devise the plans, and study the subjects indicated, and to advise the Commander-in-Chief of all questions of plans, armament, transportation, and military preparation and movement." That focus is addressed in the current USAWC mission statement: "The United States Army War College educates and develops leaders for service at the strategic level while advancing knowledge in the global application of landpower."

##### 1-7. Organization

The chapters of the HTAR are organized to describe in detail the seven modules of the force management model as well as the nine force integration functional areas (FIFA) considered within and across these modules. The nine FIFAs, as further described in the text, include structuring, manning, equipping, training, sustaining, deploying, stationing, funding, and readiness. This volume of the HTAR includes a new chapter on Foreign Military Sales and a chapter on an important emerging initiative regarding Global Force Information Management.

##### 1-8. Authorship

The production of this 2019-2020 volume of the HTAR would not have been possible without the loyal, detailed, and extensive work of military, civilian, and contractor subject matter experts at USAWC, AFMS, HQDA, and Army Publishing Directorate. Thank you all for your significant contributions to this improved handbook.

## Section III Summary and References

### 1-9. Summary

a. Force management is a critical operating function for the Army. It encompasses the many processes that generate future requirements and ensure the Army is efficiently and effectively organized, manned, equipped, trained, and sustained. Force Management provides ready, lethal, and modern forces to CCMDs now and in the future.

b. Force management is the behind the scenes and preliminary work that leads to tactical success whether commanding U.S. Army forces, international forces, or joint forces. It is also the important and difficult work that occurs following after action reviews. In an uncertain and unpredictable global security environment, it is never ending.

c. Success in force management is measured on the battlefield in the overmatch of U.S. adversaries and in the boardroom building programs of record to meet commanders' requirements.

d. HTAR is about the systems and processes that Army leaders and force managers must understand, embrace, and employ to ensure the Army remains as effective in service to the nation in the future as it has been in the past. This text helps its readers understand how the Army runs as influenced by the President, Congress, DOD, the Joint Chiefs of Staff (JCS), and the members of the Headquarters, Department of the Army (HQDA) Secretariat and Army Staff, as well as Army Commands (ACOM), Army Service Component Commands (ASCC), and Direct Reporting Units (DRU). Students and practitioners of the military art who use HTAR will more fully appreciate the truth in the words of General Harold K. Johnson, CSA from 1964-1968: "The Army is like a funnel. At the top you pour in doctrine, resources concepts, equipment, and facilities. And out at the bottom comes one lone Soldier walking point."

### 1-10. References

- a. Title 10, U.S.Code at <http://uscode.house.gov>.
- b. 2017 National Security Strategy.
- c. 2018 National Defense Strategy.
- d. 2018 Army Vision.
- e. 2019 Army Posture Statement, 26 March 2019.
- f. CSA Message to the Army Team, 12 August 2019.
- g. Secretary of the Army Message, 27 September 2019.
- h. DA GO 2018-10, Establishment of AFC.
- i. U.S. Army War College at <http://www.carlisle.army.mil>.

## HOW THE ARMY RUNS

**This page is intentionally left blank**

## Chapter 2

### Strategy and Strategic Direction

#### Section I Introduction

##### 2-1. Chapter Content

a. Strategic direction is the common thread that integrates and synchronizes the planning activities and operations of the Joint Staff (JS), combatant commands (CCMD), Services, combat support agencies (CSA), and other Department of Defense (DOD) agencies. Strategy provides purpose and focus to the planning for employment of military force. As an overarching term, strategic direction encompasses the manner, processes, and products by which the President of the United States (POTUS), Secretary of Defense (SECDEF), and Chairman of the Joint Chiefs of Staff (CJCS) provide strategic guidance to the joint force regarding long-term and intermediate objectives.

b. The purpose of the strategy module of the force management model—the first block in the top left corner—is to determine strategic and operational requirements which drive change through structure and resources to provide trained and ready units to combatant commanders (CCDR). This chapter will trace national, defense, joint, and Army level strategy, to include laws, leaders, processes, and documents, as well as establish the connections between each of these echelons of strategy as they influence how the Army runs.

##### 2-2. Strategy-Related Laws

The United States Code (U.S.C.) is a consolidation and codification by subject matter of the general and permanent laws of the United States (U.S.). The Office of the Law Revision Counsel of the United States House of Representatives prepares the U.S.C. The currency date for each section of the U.S.C. is displayed above the text of each section. If a section has been affected by any laws enacted after that date, those laws will appear in a list of "Pending Updates." If there are no pending updates listed, the section is current as shown. The U.S.C. sections related to strategy include—

a. Title 10—Armed Forces. Title 10—Armed Forces, includes—

- (1) Subtitle A—General Military Law.
- (2) Subtitle B—Army.
- (3) Subtitle C—Navy and Marine Corps.
- (4) Subtitle D—Air Force.
- (5) Subtitle E—Reserve Components.

b. Title 32—National Guard. Title 32—National Guard, includes Chapter 1—Organization, Chapter 3—Personnel, Chapter 5—Training, Chapter 7—Service, Supply, and Procurement, and Chapter 9—Homeland Defense Activities.

c. Title 50—War and National Defense. Title 50—War and National Defense, includes Chapter 44—National Security, Subchapter 1—Coordination for National Security, Section 3021. National Security Council and Section 3043. Annual National Security Strategy Report.

##### 2-3. National Defense Authorization Act (NDAA)

The National Defense Strategy (NDS) and the NDS Commission report established a comprehensive roadmap to bolster the U.S. national security in a new era of strategic competition. Last year's defense authorization legislation, the John S. McCain NDAA for Fiscal Year (FY) 2019, was the first NDAA to support the implementation of this strategy and resulted in readiness gains and improved capabilities. The 2020 NDAA keeps the Armed Forces on that trajectory, and builds on the recognition of strategic competition—strengthening U.S. forces, investing in innovation, and improving the combat effectiveness of the DOD.

## HOW THE ARMY RUNS

The Nation's military superiority can no longer be taken for granted and is not guaranteed. For too many years, the assumption that U.S. military equipment was unmatched has proven false. Increased investment improves capability and capacity, deters aggression, and precludes future or lasting national security damage. To meet urgent needs across operating domains, the NDAA aligns service resources with the NDS. This enables the Army to rebuild readiness, to optimize the force for innovation and effectiveness, and re-establish warfighting dominance. Therefore, the NDAA authorizes investments in critical equipment, weapons, and missile defense platforms to improve munitions that enhance lethality. It modernizes key capabilities and increases preparedness for war.

### **Section II National-Level Strategy**

#### **2-4. President of the United States (POTUS)**

The POTUS provides strategic guidance through the National Security Strategy (NSS), National Security Presidential Memorandums (NSPM), executive orders, and other strategic documents (such as guidance and refinements of the NSS from the National Security Council (NSC)).

#### **2-5. National Security Council (NSC)**

The NSC system, enabled by senior national security advisors, cabinet officials, executive departments and agencies, is the principal POTUS forum for deliberating, coordinating, developing, approving, and implementing national security and foreign policy. The NSC develops policy options, considers implications, coordinates interdepartmental perspectives and activities, develops recommendations for the POTUS, and monitors policy implementation. The NSC prepares national security guidance that, with Presidential approval, becomes national security policy, and when implemented, these policy decisions provide the direction for military planning and programming.

#### **2-6. National Security Strategy (NSS)**

- a. In accordance with Title 50, U.S.C., Section 3043 (50 U.S.C. 3043), Annual National Security Strategy Report, the President shall transmit to Congress each year a comprehensive report on the national security strategy of the United States on the date on which the President submits to Congress the budget for the next fiscal year and not later than 150 days after the date on which a new President takes office.
- b. Each national security strategy report shall set forth the national security strategy of the United States and shall include a comprehensive description and discussion of the following—
  - (1) The worldwide interests, goals, and objectives of the United States that are vital to the national security of the United States.
  - (2) The foreign policy, worldwide commitments, and national defense capabilities of the United States necessary to deter aggression and to implement the national security strategy of the United States.
  - (3) The proposed short-term and long-term uses of the political, economic, military, and other elements of the national power of the United States to protect or promote the interests and achieve the goals and objectives referred to in paragraph (1).
  - (4) The adequacy of the capabilities of the United States to carry out the national security strategy of the United States, including an evaluation of the balance among the capabilities of all elements of the national power of the United States to support the implementation of the national security strategy.
  - (5) Such other information as may be necessary to help inform Congress on matters relating to the national security strategy of the United States.

#### **2-7. Unified Command Plan (UCP)**

The UCP, prepared by the CJCS for the POTUS to issue, sets forth basic guidance to all CCDRs. The UCP establishes CCMD missions and responsibilities, delineates geographic areas of responsibility for geographic CCDRs, and specifies responsibilities for functional CCDRs. In accordance with 10 U.S.C., Chapter 6—Combatant Commands, Section 161: CCMDs: Establishment, requires the following—



## STRATEGY AND STRATEGIC DIRECTION

a. Unified and Specified CCMDs. The POTUS, with the advice and assistance of the CJCS, and through the SECDEF, shall: establish unified and specified CCMDs to perform military missions; and prescribe the force structure of those commands. (Note: There are two types of CCMDs: geographic and functional.

b. Periodic Review.

(1) The CJCS periodically (and not less often than every two years) shall: review the missions, responsibilities (including geographic boundaries), and force structure of each CCMD; and recommend to the President, through the SECDEF, any changes to such missions, responsibilities, and force structures as may be necessary.

(2) Except during times of hostilities or imminent threat of hostilities, the President shall notify Congress not more than 60 days after: establishing a new CCMD; or significantly revising the missions, responsibilities, or force structure of an existing CCMD.

### 2.8 Contingency Planning Guidance

Contingency Planning Guidance (CPG) serves the same purpose as did the now eliminated SECDEF Guidance for the Employment of the Force (GEF). The biggest change, aside from the title, is that it is a presidential/national level document. The CPG is a new document and there is not a lot written about it or how it is used.

## Section III

### Defense-Level Strategy

#### 2-9. Secretary of Defense (SECDEF)

For DOD, POTUS decisions drive strategic guidance promulgated by the Office of the Secretary of Defense (OSD). In accordance with 10 U.S.C. 113—Secretary of Defense, the SECDEF is the head of the DOD, appointed from civilian life by the President, by and with the advice and consent of the Senate. A person may not be appointed as SECDEF within seven years (unless Congress approves a waiver) after relief from active duty as a commissioned officer of a regular component of an armed force. The SECDEF is the principal assistant to the President in all matters relating to the DOD. Subject to the direction of the President and to this title and Section 2 of the National Security Act of 1947, the Secretary has authority, direction, and control over the DOD.

#### 2-10. Commission on the National Defense Strategy

a. With the passage of the 2017 NDAA, Congress repealed 10 U.S.C., Chapter 2—Department of Defense, Section 118 ending the requirement for a Defense Strategic Review (DSR). The DSR had replaced the Quadrennial Defense Review (QDR) based upon guidance from the 2015 NDAA.

b. In the 2017 NDAA, Congress directed the establishment of a Commission on the NDS for the United States. The Commission would be composed of 12 members appointed by the chair and ranking minority members of the Committee on Armed Services of the House of Representatives and Committee on Armed Services of the Senate.

c. The intent of the Commission was to review the current national defense strategy of the United States, including the assumptions, missions, force posture and structure, and strategic and military risks associated with the strategy. The Commission conducted a comprehensive assessment of the strategic environment, the threats to the United States, the size and shape of the force, the readiness of the force, the posture and capabilities of the force, the allocation of resources, and strategic and military risks and provided recommendations on national defense strategy for the United States.

d. One of the Commission's conclusions was to replace the QDR with the NDS.

#### 2-11. National Defense Strategy (NDS)

a. In accordance with 10 U.S.C. 113, the SECDEF in January every four years, and intermittently otherwise as may be appropriate, shall provide to the Secretaries of the military departments, the Chiefs of Staff of the armed forces, the commanders of the unified and specified CCMDs, and the heads of all Defense Agencies and Field Activities of the DOD and other elements of the Department and to the congressional defense committees, a defense strategy. Each strategy shall be known as the NDS and

## HOW THE ARMY RUNS

shall support the most recent NSS report of the President. Each national defense strategy shall include the following:

- (1) The priority missions of the DOD, and the assumed force planning scenarios and constructs.
- (2) The assumed strategic environment, including the most critical and enduring threats to the national security of the United States and its allies posed by state or non-state actors, and the strategies that the Department will employ to counter such threats and provide for the national defense.
- (3) A strategic framework prescribed by the Secretary that guides how the Department will prioritize among the threats described in clause (ii) and the missions specified pursuant to clause (i), how the Department will allocate and mitigate the resulting risks, and how the Department will make resource investments.
- (4) The roles and missions of the armed forces to carry out the missions described in clause (i), and the assumed roles and capabilities provided by other United States Government agencies and by allies and international partners.
- (5) The force size and shape, force posture, defense capabilities, force readiness, infrastructure, organization, personnel, technological innovation, and other elements of the defense program necessary to support such strategy.
- (6) The major investments in defense capabilities, force structure, force readiness, force posture, and technological innovation that the Department will make over the following five-year period in accordance with the strategic framework described in clause (iii).
  - b. Further, in accordance with 10 U.S.C. 113, the Secretary shall seek the military advice and assistance from the CJCS in preparing the NDS. This strategy will be presented to the Congressional committees in a classified form with an unclassified summary.
  - c. It provides direction to the Defense Planning Guidance (DPG).

### **2-12. Defense Planning Guidance (DPG)**

In accordance with 10 U.S.C. 113, the SECDEF, with the advice and assistance of the CJCS, shall provide annually to the Secretaries of the military departments, the Chiefs of Staff of the armed forces, the commanders of the unified and specified CCMDs, and the heads of all Defense Agencies and Field Activities of the Department written policy guidance for the preparation and review of the program recommendations and budget proposals of their respective components to guide the development of forces. Such guidance shall include—

- a. The national security interests and objectives;
- b. The priority military missions of the Department including the assumed force planning scenarios and constructs;
- c. The force size and shape, force posture, defense capabilities, force readiness, infrastructure, organization, personnel, technological innovation, and other elements of the defense program necessary to support the strategy;
- d. The resource levels projected to be available for the period of time for which such recommendations and proposals are to be effective; and
- e. A discussion of any changes in the defense strategy and assumptions underpinning the strategy.
- f. The DPG provides Service specific guidance for the Fiscal Year Defense Plan, or FYDP, which arrays programmed dollars, manpower, and force structure over a 5-year period beyond the current year of execution (for force structure, an additional 3 years).

## **Section IV Global Force Management**

### **2-13. Global Force Management (GFM) Overview**

The GFM process aligns force assignment, allocation, and apportionment methodologies in support of the DOD's strategic guidance. It provides DOD senior leadership with comprehensive insight into the global availability of forces and risk and impact of proposed force changes.

- a. In accordance with CJCSI 3100.01C, the GFM process provides near-term sourcing solutions while providing the integrating mechanism between force apportionment, allocation, and assignment. It informs DOD's assessment processes by identifying sporadic or persistent unsourced and/or hard to source (UHTS) forces and/or capabilities. Based upon information provided through the Joint Combat Capability

## STRATEGY AND STRATEGIC DIRECTION

Assessment (JCCA), the Global Force Management Board (GFMB) will proactively identify strategic and military risk along with mitigation options.

b. GFM will also enable the designated Joint Force Providers (JFP) to monitor force availability over time, identify risks to execute CCMD missions, forecast sourcing challenges to execute contingencies, and project Reserve Component unit mobilization and/or availability. The GFM system allows the SECDEF to strategically manage US Armed Forces to accomplish priority missions assigned to the CCDRs, enabling the DOD to meet the intent of the strategic guidance contained in the [NDS], NMS, UCP, CPG, and DPG. See the Global Force Management Implementation Guidance (GFMIG) and the current message for Joint Staff Force Sourcing Business Rules and SECDEF Orders Book (SDOB) Process.

c. The GFMIG provides SECDEF's direction for global force management (GFM) to manage forces from a global perspective. It provides the specific direction for force assignment, apportionment, and allocation processes enabling the SECDEF to make risk informed decisions regarding the distribution of US Armed Forces among the CCDRs. The CPG; GFMIG; and CJCSM 3130.06, Global Force Management Allocation Policies and Procedures, guide the GFM allocation process in support of CCMD force requirements. The assignment tables in the GFMIG and Forces for Unified Commands Memorandum serve as the record of force assignments.

### 2-14. Global Force Management Authorities

In accordance with Joint Publication 5-0, Joint Planning, Appendix E, GFM is a compilation of three related processes: assignment, allocation, and apportionment used to align U.S. forces—

a. Assignment. Fulfills the Military Departments 10 U.S.C. 162 responsibility to assign specified forces to CCDRs or to the US Element, North American Aerospace Defense Command (USELEMNORAD) as directed by SECDEF to perform missions assigned to those commands. CCDRs exercise combatant command (command authority) over forces assigned to them. Assignment of forces is conducted annually and documented in the GFMIG. This is published bi-annually on even years in the GFMIG and, in the years when the GFMIG is not updated, in a memorandum published separately.

b. Allocation. Pursuant to 10 U.S.C. 162 (3) a force assigned to a CCMD or the USELEMNORAD under this section may be transferred from the command to which it is assigned only by authority of the SECDEF; and under procedures prescribed by the SECDEF and approved by POTUS. Under this authority, the SECDEF allocates forces between CCDRs.

c. Apportionment. Apportioned forces provide an estimate of the Military Departments' capacity to generate capabilities that can reasonably be expected to be made available along general timelines. This estimate informs and shapes CCMD resource informed planning, but does not identify the actual forces that may be allocated for use if a plan transitions to execution. This informs senior leadership's assessment of plans based on force inventory, force generation capacity, and availability. The CPG and GFMIG provide strategic guidance with respect to the apportionment process.

d. Military Departments. Military Department forces required to execute Service institutional activities specified in 10 U.S.C. are considered "unassigned." The Military Departments are also tasked with providing trained and equipped force to the CCDRs via the allocation process. These forces are designated as "Service retained".

### 2-15. Global Force Management (GFM) Elements

In accordance with the GFMIG—

a. Global Force Management Board. The GFMB is a general officer/flag officer-level body organized by the JS to provide senior DOD leadership the means to assess operational effects of FM decisions and implement strategic planning guidance. The GFMB convenes periodically to address specific recurring tasks, and as required, to address emergent issues. The purpose of GFMB is to: implement the Department's strategic guidance and provide direction for developing force management options and recommendations; serve as a strategic-level review panel to address issues that arise on recommended GFM actions prior to forwarding to CJCS and SECDEF for decision; serve as a strategic-level review panel to annually assess forces/capabilities/individuals that are sporadically or persistently unsourced /hard to source (UHTS) and develop recommendations to address shortfalls; and serve as a strategic-level review panel to assess current GFM alignment with CPG priorities semiannually and develop recommendations to address imbalances. GFMB membership consists of general officer/flag officer or

## HOW THE ARMY RUNS

equivalent Senior Executive Service representation from the JS, CCMDs, the Military Department/Services, OSD agencies, the National Guard Bureau (NGB), and other Defense Agencies.

b. Joint Force Providers. CCDRs with assigned forces, the Secretaries of the Military Departments (MILDEP), DOD Agencies, and OSD organizations that provide force sourcing solutions to CCDRS force requirements are JFPs. They include—

(1) Joint Staff, J35. The CJCS, through the Director, J3 (DJ3), will serve as the JFP responsible for providing recommended sourcing solutions for all validated force and joint individual augmentee (JIA) requirements and as the JFP for conventional forces. DJ3 coordinates with the Secretaries of the Military Departments, CCDRs, JFPs, joint force managers (JFM), and DOD agencies to identify and recommend global conventional joint sourcing solutions (military and DOD civilian); coordinate force requests that include both general purpose forces (GPF) and special operations forces (SOF) capabilities; and to develop and recommend conventional JIA sourcing solutions for joint HQ, SECDEF-directed missions, and U.S. individuals contributions to North Atlantic Treaty Organization (NATO) Crisis Establishments.

(2) U.S. Special Operations Command (USSOCOM). USSOCOM serves as the JFP for SOF. USSOCOM coordinates with the Military Departments/Services, CCDRs, JFPs, and DOD Agencies to identify and recommend global SOF sourcing solutions. For force requests that include GPF and SOF capabilities, USSOCOM coordinates with its components, Military Departments/Services, and the JS to identify and recommend global sourcing solutions.

(3) U.S. Transportation Command (USTRANSCOM). USTRANSCOM serves as the JFP for mobility forces. Mobility forces are defined as personnel, equipment, and unique support required to execute command and control, and execute air and surface common user lift operations, including capabilities required for port opening, deployment, redeployment, and distribution activity. USTRANSCOM will coordinate with Military Departments/Services, CCDRs, JFPs, and DOD Agencies to identify and recommend global mobility sourcing solutions.

(4) U.S. Strategic Command (USSTRATCOM). USSTRATCOM serves as the JFM for intelligence, surveillance, and reconnaissance (ISR) and coordinates with Military Department/Services, CCDRs, and intelligence agencies to identify and recommend, through the JFCs, joint global ISR sourcing solutions including processing, exploitation, and dissemination (PED) capabilities. USSTRATCOM also serves as the JFM for integrated missile defense (IMD) and coordinates with Military Department/Services, CCDRs, and DOD agencies to identify and recommend, through the JFCs, global DOD missile defense sourcing solutions. The joint functional component command for ISR (JFCC ISR) and for IMD (JFCC IMD), are both assigned to CDRUSSTRATCOM.

(5) U.S. Cyber Command (USCYBERCOM). Section 923 of the 2017 NDAA required the President to establish a unified CCMD for cyber operating forces. A Presidential Memorandum to the SECDEF on 18 August 2017 directed that USCYBERCOM be established as a Unified Combatant Command and assigned all of the cyberspace-related responsibilities previously assigned to Commander, USSTRATCOM. The authorities and responsibilities for USCYBERCOM will be included in the next update to the UCP.

### **2-16. GFM Request for Forces and / or Request for Capabilities**

In accordance with the GFMIG, emergent requirements are requests from a CCDR, USELEMNORAD or NATO for units and capabilities that were not anticipated at the time of the CCDR's annual submission and cannot be met by the requesting HQ, its components, or their assigned and allocated forces. The CCDR submits request for forces (RFFs) via the Joint Capabilities Requirements Manager (JCRM) and record message (RMG) simultaneously.

a. Request for Forces Required Elements. RFF required elements include: unit capability (standard and non-standard); unit quantity; force tracking number (FTN); destination; deployment dates; deployment duration; mission justification; and special requirements.

b. Emergent RFF Staffing.

(1) ACOMs, ASCCs, and DRUs deployed in a CCMD or responsible for a named operation that is in need of a capability will "define" the emergent requirement.

(2) Joint Task Force (JTF) or component command staff will "review" the RFF.

(3) JTF CDR or component commander will "endorse" the RFF.

(4) The CCDR or designated representative (e.g., J3) will "approve" the RFF and assign an RFF identification number (RFFID).

## STRATEGY AND STRATEGIC DIRECTION

(5) The JS J3 will “validate” the RFF and “assign” the CPG priority and Joint Functional Commander (JFC) / JFP. JS J1 will “validate” emergent JIA requests to existing or approved Joint Manning Documents (JMD).

(6) The JFPs will “nominate” the best available sourcing solution from their forces.

(7) The JFC / JFP will “recommend” the best available JFP and force with an achievable latest arrival date (LAD).

(8) The SECDEF will “order” the sourcing recommendation in the SDOB and corresponding GFM Allocation Plan (GFMAP) modifications with an ordered LAD.

(9) The CCDR will “issue C2” language via deployment orders (DEPORD).

c. Emergent RFF Categories. There are three emergent RFF categories: routine, urgent, and immediate.

(1) Routine RFFs have LADs for requested forces that are 120 days or greater from the date time group (DTG) on the RFF message (e.g., “routine emergent” requests for JIAs).

(2) See the GFMIIG for classified descriptions of urgent and immediate RFF categories.

### 2-17. GFM Outputs

a. GFMAP. The GFMAP is the SECDEF deployment order, prepared by the CJCS, that authorized force allocations and deployment of forces in support of CCMD force and JIA requirements. The JS will seek SECDEF approval to deploy rotational and emergent forces in support of CCDR requests via GFMAP base DEPORD and subsequent modifications. Rotational forces are submitted annually. The DJ3 is responsible for developing the GFMAP, for briefing it to the SECDEF for approval, and for publishing the GFMAP once approved.

b. GFMIIG. The GFMIIG integrates complementary assignment, apportionment, and allocation information into a single GFM document. The GFMIIG provides a single reference for planners and leaders to integrate standing forces, rotational forces and potential contingency forces into comprehensive planning activities. The GFMIIG provides SECDEF direction for assigning forces to CCMDs to accomplish CCDRs’ assigned missions; outlines the allocation process that provides access to forces/capabilities when assigned mission requirements exceed the capacity and or capability of the assigned or allocated forces; provides apportionment guidance and force apportionment tables to facilitate planning and informs the Joint Force, structure, and capability assessment processes.

c. SDOB. The SDOB modifies the GFMAP base DEPORD. Non-urgent RFFs and alert / mobilizations that require SECDEF approval will be processed in a bi-weekly cycle.

d. Special Book. All time-sensitive requests for forces and alert / mobilizations will be staffed as a “special book” and briefed to the SECDEF upon completion of the standard, but expedited, staffing process.

### 2-18. GFM Interagency Process

In accordance with the GFMIIG, although GFM does not manage the entire collection capabilities in all branches of government, GFM interacts with the interagency process by providing a conduit to non-DOD agencies to meet CCDR capability requests, for both planned and executed operations. As other (non-DOD) instruments of national power are committed to support CCDR capability requests, the GFMAP provides a vehicle to inform the Joint Planning and Execution Community (JPEC) of the directed sourcing solution.

## Section V Joint-Level Strategy

### 2-19. Chairman of the Joint Chiefs of Staff (CJCS)

a. POTUS and DOD decisions and strategic guidance are influenced by the CJCS’s use of the Joint Strategic Planning System (JSPS). To carry out 10 U.S.C. statutory responsibilities, the CJCS uses the JSPS to provide a formal structure in aligning ends, ways, and means, and to identify and mitigate risk for the military in shaping the best assessments, advice, and direction of the Armed Forces when advising the POTUS and the SECDEF. In accordance with 10 U.S.C., Subtitle A—General Military Law, Part I—Organization and General Military Powers, Chapter 5—Joint Chiefs of Staff, Section 153. CJCS:

## HOW THE ARMY RUNS

Functions, Planning; Advice; Policy Formulation. Subject to the authority, direction, and control of the President and the SECDEF, the CJCS shall be responsible for the following—

(1) Strategic Direction. Assisting the President and the SECDEF in providing for the strategic direction of the armed forces.

(2) Strategic and Contingency Planning.

(3) Global Military Integration.

(4) Comprehensive Joint Readiness.

(5) Joint Capability Development

(6) Joint Force Development Activities.

(7) Other Matters.

b. Under the above categories two through seven, there are 28 specific responsibilities identified many of which are discussed later. Further, under Section 153 there are specific requirements on what the National Military Strategy (NMS) must address, when the CJCS must review or provide an update to the NMS, and how risk in the NMS needs to be assessed, all of which are discussed later in this chapter. There is also specific guidance on what needs to be in an annual report the CJCS provides to Congress on Combatant Command Requirements and when this report must be submitted.

### 2-20. JSPS

JSPS is the primary formal means the CJCS uses to meet his statutory responsibilities broadly identified in paragraph 2-19 and illustrated in Figure 2-1. Materiel that covers the JSPS is taken directly from the CJCS Instruction 3100.01C and from sections in 10 U.S.C.

a. 10 U.S.C. 113(g)(1), 113(g)(2), 151, 153, 161, 163, 165, 166, 181; 22 U.S.C.; and 50 U.S.C. direct the CJCS to provide independent assessments as principal military advisor to POTUS, the NSC, HSC, and the SECDEF; and to assist in providing unified strategic direction to the Armed Forces on behalf of the POTUS and SECDEF.

b. 10 U.S.C., Chapter 5, section 153 now requires the CJCS to perform six primary functions: provide strategic direction for the Armed Forces; conduct strategic and contingency planning; assess comprehensive joint readiness; manage Joint Force development; foster joint capability development; and advise on global military integration.

c. The JSPS is how the CJCS carries out his statutory responsibilities.

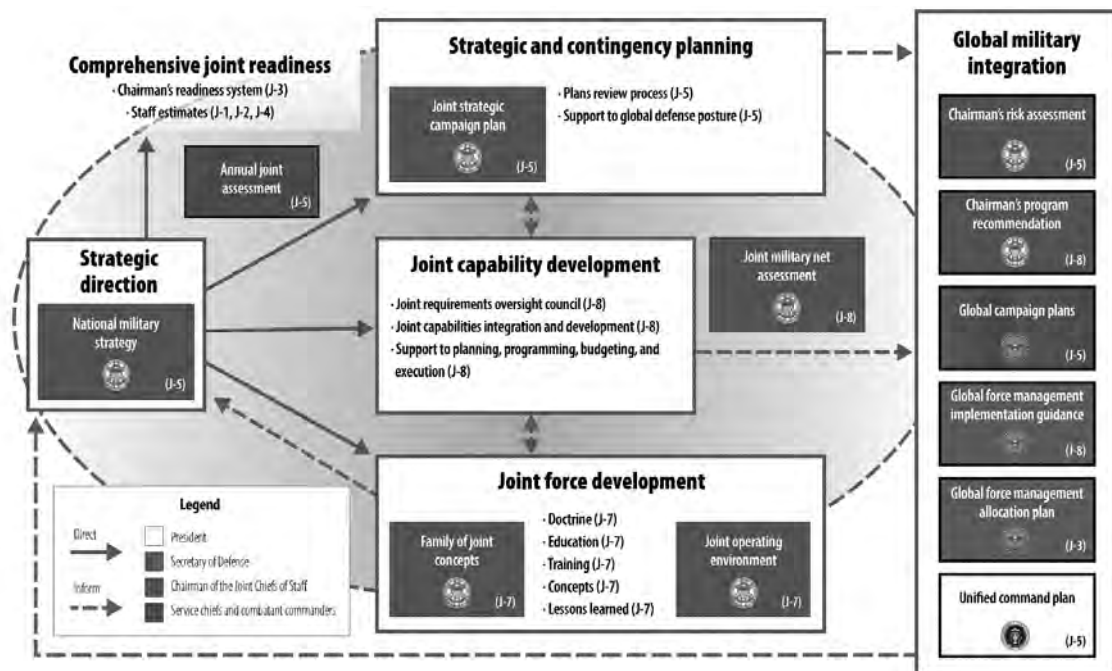

Figure 2-1. Joint Strategic Planning System

## STRATEGY AND STRATEGIC DIRECTION

### 2-21. Strategic Direction

- a. Overview. 10 U.S.C. 153(a)(1) directs the CJCS to assist POTUS and SECDEF “in providing for the strategic direction of the armed forces.” The JSPS document aligned with this function is the NMS.
- b. NMS. 10 U.S.C. 153(b)(1) directs that the CJCS shall determine for each even numbered year whether to prepare a new NMS or update an existing strategy.
- c. The Director for Strategy, Plans, and Policy, J-5, is responsible for developing, reviewing, and preparing the NMS for the CJCS’s signature.
- d. Three presidential guidance documents provide direction to the DOD. They are the NSS, UCP, and the CPG. The SECDEF provides strategic direction to the DOD and the Joint Force primarily through the NDS, the DPG, and force employment guidance. This strategic guidance provides the foundation for NMS development.
- e. The NMS is the CJCS’s central strategy and planning document. It translates policy guidance into Joint Force action and assists the SECDEF “in providing for the strategic direction of the armed forces” by providing guidance regarding plans, force employment, posture, and future force development. It provides the strategic framework for the prioritization of planning, resource allocation, and the distribution of risk. This classified military strategy serves as the starting point for all other JSPS actions and constitutes the CJCS’s military advice to the SECDEF and the President.
- f. 10 U.S.C. 153(b)(2) also directs a CJCS’s Risk Assessment to assess the risks associated with the most current NMS each year.

### 2-22. Strategic and Contingency Planning

- a. Overview. 10 U.S.C. 153(a)(2) directs the CJCS to develop strategic frameworks and plans “to guide the use and employment of military force and related activities across geographic regions and military functions and domains.” It further directs the CJCS to prepare “military analysis, options, and plans” to recommend to the President and the Secretary.” The CJCS is responsible for reviewing contingency plans and preparing joint logistic and mobility plans as well. The JSPS document aligned with this function is the Joint Strategic Campaign Plan (JSCP).
- b. Joint Strategic Campaign Plan
  - (1) The J-5, is responsible for developing, staffing, reviewing, and preparing the JSCP for the CJCS’s signature.
  - (2) The JSCP is a 5-year global strategic plan (reviewed every 2 years) that operationalizes the NMS. It is the CJCS’s primary document to guide and direct the preparation and integration of Joint Force campaign and contingency plans. The JSCP establishes a common set of processes, products, priorities, roles, and responsibilities to integrate the Joint Force’s global operations, activities, and investments from day-to-day campaigning to contingencies.
- b. The JSCP directs campaign, contingency, and support plans. It directs four types of campaign plans: Global Campaign Plans (GCPs), Regional Campaign Plans (RCPs), Functional Campaign Plans (FCPs), and Combatant Command Campaign Plans (CCPs).
  - (1) GCPs are an integral part of the revised JSPS. The Joint Staff prepares them for SECDEF approval.
  - (2) RCPs are assigned to geographic CCMDs. They are not part of the JSPS. RCPs address regional threats or challenges that require coordination across multiple CCMDs.
  - (3) FCPs are assigned to functional CCMDs. They are not part of the JSPS. FCPs address functional threats or challenges that are not geographically constrained and require coordination across multiple CCMDs.
  - (4) CCPs replace Theater Campaign Plans. They are the primary plans through which the CCMDs execute day-to-day campaigning. CCPs address theater objectives as well as objectives directed by GCPs, RCPs, and FCPs. CCPs are not part of the JSPS.
- c. The JSCP directs contingency planning consistent with the Contingency Planning Guidance (CPG). It expands on the CPG with specific objectives, tasks, and linkages between campaign and contingency plans. Related contingency plans are further integrated within an Integrated Contingency Plan. The JSCP also delineates support plans to foster Joint Force collaboration and coordination in time, space, and purpose.
- d. Global Campaign Plan (GCP) Concept
  - (1) To enable cohesive Joint Force actions in time, space, and purpose, the SecDef has designated the CJCS as the global integrator. As the global integrator, the CJCS determines which challenges

## HOW THE ARMY RUNS

require GCPs. The GCP addresses the most pressing transregional and multi-functional strategic challenges across all domains. GCPs look across geographic and functional Combatant Command boundaries.

(2) Each GCP has an assigned coordinating authority (CA) that is the Combatant Commander (CCDR) with the preponderance of responsibility for a GCP. The CA does not receive additional authority beyond that already assigned in 10 U.S.C. and the Unified Command Plan (UCP). As such, CAs cannot compel agreement or direct resource allocation between CCMDs and Services.

(3) The CA performs three key functions: planning, assessing, and recommending. CAs establish collaborative forums to support these functions.

(4) A collaborator is a Joint Force organization assigned in the JSCP to support integrated GCP planning. The collaborator works with the CA to develop and assess the viability of globally integrated plans.

e. Global Campaign Plan Review. CAs, collaborators, and the Joint Staff continuously assess and review the GCPs. Formal assessments are developed from inputs to the Annual Joint Assessment (AJA), CJCS's Readiness System, and Joint Chiefs of Staff (JCS) Tanks. The Joint Strategy Working Group (JSWG) and Joint Worldwide Planners Seminar (JWPS) review CA and Joint Staff issues and recommendations. The CJCS uses these inputs and assessments to formulate his military advice to the SECDEF on GCP resourcing, prioritization, posture, capabilities, risk, and risk mitigation measures.

f. Global Defense Posture. A key consideration of GCP and plan reviews is global defense posture. Foreign and overseas posture is the fundamental enabler of Joint Force activities. From a posture perspective, GCPs foster an integrated approach to requirements, trade-offs, and risk across three interdependent posture elements: forces, footprints, and agreements. The J-5, is the lead directorate for posture issues. In that role, the directorate coordinates closely with the J-3, J-4, and J-8 on global defense posture issues, such as force management and prepositioned equipment, and introduces posture recommendations to DOD's senior body overseeing global defense posture, the Global Posture Executive Council. The primary Joint Staff forum for reviewing posture issues and recommendations is the Operations Deputies Tank. As required, posture issues and recommendations are elevated for consideration in a Joint Chiefs of Staff Tank.

g. Cross-Functional Teams. Global integration requires information from across functions, domains, regions, and processes. To assist in the execution of the NMS and JSCP, the CJCS employs cross-functional teams (CFTs) to facilitate shared understanding and support the development of military advice. CFTs consist of Joint Staff functional and regional experts as well as representatives from CCMDs, OSD, and other U.S. government departments and agencies, as required. CFTs support globally integrated planning by contributing to NMS annexes on priority challenges as required and by assisting CCMDs in writing and managing GCPs. During a crisis or contingency, the CFTs may assist in developing a shared understanding of the strategic environment.

### **2-23. Comprehensive Joint Readiness**

a. In matters relating to comprehensive joint readiness, 10 U.S.C. 153(a)(4) directs the CJCS to accomplish the following interrelated actions:

(1) Evaluate the "overall preparedness" of the Joint Force to perform its responsibilities and respond to "significant contingencies."

(2) Assess risks to mission and force due to readiness shortfalls.

(3) Develop risk mitigation options.

(4) Advise the Secretary on "critical deficiencies and strengths" during the preparation and review of defense strategies and contingency plans.

(5) Advise the SECDEF on the missions and functions that are likely to require contractor or other external support.

(6) Maintain a uniform system to evaluate the preparedness of each Combatant Command and group of commands to carry out assigned missions.

b. Comprehensive joint readiness is the ability of the Joint Force to meet immediate contingency and warfighting challenges while preparing for future challenges. This shared understanding of readiness informs Strategic Direction, Strategic and Contingency Planning, Joint Force Development Activities, Joint Capability Development, and Global Military Integration Advice. For immediate contingency and warfighting challenges, comprehensive joint readiness evaluations consider the range of available



## STRATEGY AND STRATEGIC DIRECTION

capabilities, the speed and manner with which the Joint Force can employ these capabilities; the ability to sustain the Joint Force; and Joint Force resiliency. In anticipation of future challenges, readiness evaluations consider net assessments, wargames, and joint concepts.

c. The Joint Strategic Planning System (JSPS) elements aligned with this function are the Joint Military Net Assessment (JMNA), the Annual Joint Assessment (AJA), the Chairman's Readiness System (CRS), the Joint Personnel Estimate (JPE), the Joint Strategic Intelligence Estimate (JSIE), and the Joint Logistics Estimate (JLE).

(1) Net Assessments. As directed by the CJCS, the Director for Force Structure, Resources, and Assessments, J-8, collaborates with relevant CCMDs to produce net assessments that focus on a single adversary. These net assessments directly inform the JMNA.

(2) The Director for Force Structure, Resources, and Assessment, J-8, is responsible for developing, staffing, reviewing, and preparing the JMNA. It is the capstone Joint Staff assessment product.

(3) The JMNA is an annual integrated assessment of the Joint Force's ability to execute the NMS. It provides an overarching view of comprehensive joint readiness by benchmarking the Joint Force against selected adversaries and comparing the U.S. competitive trajectories within 5- years.

(4) The JMNA synthesizes existing JSPS assessments (primarily from the AJA and single adversary net assessments) and other studies to examine, in a military context, the competitive strategic environment. To that end, it identifies and analyzes current and future areas of military competition and presents options to the CJCS for addressing competitive area gaps. These options directly inform the annual Chairman's Program Recommendation (CPR). The CPR is the CJCS's direct input to the DPG and thus represents his advice to the SECDEF on capability investments.

d. AJA. The J-5, is responsible for developing, staffing, reviewing, and preparing the Annual Joint Assessment (AJA) survey.

(1) The AJA survey is the Joint Staff's central data collection and analytical mechanism for garnering Combatant Command and Service perspectives on the strategic environment, threats, challenges, opportunities, and risks. Each Joint Staff directorate actively participates in AJA survey development by generating survey questions that inform Joint Staff processes and products. The survey is issued to the CCMDs, Services, the NGB, and the Coast Guard.

(2) CCMDs, as part of the AJA, submit their priorities and requirements in the form of Integrated Priority Lists (IPLs). The J-8 prepares the Annual Report of Combatant Command Requirements (ARCCR) capturing the CJCS's perspective of the extent to which the Future Years Defense Program addresses Combatant Commanders' IPLs. The IPL Assignment Working Group develops initial alignment recommendations. IPLs that relate to capability development align to the Joint Requirements Oversight Council-led Capability Gap Assessment (CGA) process. IPLs that are unrelated to capability development are assigned to Joint Staff Directorates for further review and action.

(3) The AJA responses directly inform the CJCS's Risk Assessment (CRA), the JMNA, and the three staff estimates described in paragraph 5 of this enclosure.

e. CJCS's Readiness System. The Director for Operations, J-3, is responsible for the CRS. The CRS establishes a common framework for understanding the readiness of the Joint Force to execute the NMS. It provides uniform policy and procedures for assessing and reporting unit and strategic readiness.

f. The Joint Combat Capability Assessment (JCCA) within the CRS assesses strategic readiness for the CJCS. The JCCA includes two assessments: the Joint Force Readiness Review (JFRR) and the Integrated Contingency Plan (ICP) assessments.

(1) The JFRR is the principal strategic readiness assessment of the CRS, is completed twice per year, and directly informs the DOD's Quarterly Readiness Report to Congress. It combines and analyzes unit, Combatant Command, Service, and combat support agency (CSA) readiness data pulled from the Defense Readiness Reporting System (DRRS). DRRS is the primary unit readiness assessment tool that considers a unit's readiness to accomplish core tasks and execute named operations and top priority plans.

(2) ICP assessments measure a Combatant Command's ability to successfully execute plans selected as the highest visibility or the potential for the most severe consequences. ICP assessments consist of a data analysis of contingency sourcing of an integrated Time-Phase Force Deployment List developed by the owning CCMDs, a U.S. Transportation Command study of transportation feasibility, a logistics supportability analysis, and comprehensive CCMDs and Joint Force Provider risk analysis.

(3) The Joint Combat Capability Assessment Group (JCCAG) is the forum for strategic readiness issues. The JCCAG consists of an executive-level decision group, a general officer/flag officer steering

## HOW THE ARMY RUNS

group, and an O-6/GS-15-level working group. Participants include representatives from the Joint combat service support agencies. The JCCAG forwards JFRR summaries, ICP assessments, and other readiness data to the SECDEF.

g. Staff Estimates.

(1) Joint Personnel Estimate (JPE). The Director for Manpower and Personnel, J-1, prepares the annual JPE. The JPE is an independent assessment of the Joint Force's ability to support the NMS in a global, all-domain, and multifunctional environment from a joint personnel readiness perspective. The JPE assists the CJCS in formulating military advice through strategic documents such as the CRA and the JMNA, drawing data and analysis from the AJA, DRRS, and other inputs.

(2) Joint Strategic Intelligence Estimate (JSIE). The Director for Intelligence, J-2, prepares and publishes the annual JSIE to align with key JSPS products such as the AJA and JMNA. The JSIE defines and assesses the dynamic nature of the global threat environment – both the natural forces that are driving global changes to the international system in the coming decade and the immediate threat to U.S. Forces and interest posed by key challengers in the next two years. The JSIE includes several appendices that provide the perspectives of the CCMs and Services regarding the strategic environment and top intelligence priorities, as captured in their AJA survey responses.'

(3) Joint Logistics Estimate. The Director for Logistics, J-4, prepares the annual JLE. The JLE provides a globally integrated independent assessment of how well the Joint Force can project, support, and sustain itself through the FYDP and beyond, to enable the full range and number of missions called for in the NMS and JSCP. It describes sources of risk within logistics Joint Capability Areas (JCAs) and cross-cutting sources of risk across all JCAs. The JLE draws data and analysis from the AJA, DRRS, IPLs, and Combatant Command logistics supportability analyses. The JLE directly informs the CRA, the JMNA, and JFRR.

### 2-24. Joint Force Development Activities

a. 10 U.S.C. 153(a)(6) directs the CJCS to accomplish the following interrelated actions to develop the Joint Force: 1) Develop Joint Force doctrine; 2) Formulate policies, standards, and actions for the joint training of the armed forces; 3) Formulate policies for the military education of members of the armed forces; 4) Formulate Joint Force concept development and experimentation policies; 5) Gather, develop, and disseminate Joint Force lessons learned; 6) Advise the SECDEF on development of joint command, control, communication, and cyber capability.

b. Judgments about current and future areas of military competition play a significant part in identifying gaps in the U.S. military existing approaches and capabilities. Concepts, doctrine, training, education, and lessons learned contribute to developing the Joint Force and improving Comprehensive Joint Readiness. Lessons learned can inform capability development processes while concepts also drive future Joint Force capability development. Doctrine, education, and training can provide the tools necessary to prepare the Joint Force to use new or modernized materiel and non-materiel capabilities.

c. The Director for Joint Force Development, J-7, is responsible for the following Joint Strategic Planning System elements aligned with this function: the Joint Operating Environment (JOE), Family of Joint Concepts (FoJC), Joint Doctrine Development, Joint Professional Military Education (JPME), CJCS's Joint Training Guidance (CJTG), and the Joint Lessons Learned Program (JLLP).

d. The Director for Command, Control, Communications, and Computers (C4)/Cyber, J-6, provides inputs on "joint command, control, communication, and cyber capability" through the Joint Capabilities Integration and Development System (JCIDS), supports Planning, Programming, Budgeting, and Execution (PPBE), and indirectly informs Defense Acquisition System decisions.

e. JOE. The JOE provides a comprehensive view of the future operating environment and explores military implications of change to enable the Joint Force to anticipate and prepare for future operational challenges. It is an unclassified document that complements the classified Defense Intelligence Agency-produced Joint Strategic Assessment (JSA). The JOE also provides the operational context for the FoJC. It is published to coincide with the term of a new CJCS to incorporate his guidance.

f. FoJC. The FoJC extends the framework of the NMS, JSCP, and designated Global Campaign Plans by examining military problems and proposing solutions that describe how the Joint Force may operate within the context of the anticipated future security environment. Joint Concepts address current or envisioned real-world challenges and describe how a Joint Force commander might employ new or existing capabilities to meet these challenges and advance operational effectiveness into the future.

## STRATEGY AND STRATEGIC DIRECTION

Concepts can inform the strategic vision in the NMS, influence the development of future capabilities, inform service concepts, and thus catalyze significant change across the Joint Force.

g. The Joint Concept Development Program is governed by the CJCS.

(1) The Capstone Concept for Joint Operations (CCJO) describes the CJCS's vision for how the Joint Force will operate in the future operating environment and guide Joint Force development. The CCJO is published every four years to coincide with the term of a new CJCS. The CCJO is grounded in current strategic guidance, complements the NMS, and provides an understanding of the evolving security environment. It guides the development of challenge-specific Joint Operating Concepts (JOCs) that identify alternative approaches to operating in transregional, all-domain, and multi-functional environments and the capabilities needed to maintain a competitive advantage against emerging challenges. In this way, the CCJO aims to connect strategic guidance to subordinate concepts, force development guidance, joint capability development, and follow-on doctrine.

(2) Joint Operating Concepts (JOCs). The JOCs broadly describe how the Joint Force may execute military operations within a specific mission area in accordance with the NMS and the CCJO. The JOCs enhance the operational effectiveness of the Joint Force by providing a long-term look at how the future force will address operational challenges. Collectively, JOCs describe joint capabilities required to operate across the range of military operations and encourage further examination through wargaming, training, studies, experimentation, and analyses.

(3) Supporting Joint Concepts describe how the future Joint Force may conduct a subset of a JOC mission or apply joint functions across two or more JOC mission areas. Through Capability Based Assessments and other analyses, supporting Joint Concepts identify capability gaps crucial to executing a JOC's operational approach and support the refinement, documentation, and validation of non-materiel and materiel changes needed to achieve required capabilities.

(4) Doctrine, Education, Training, and Lessons Learned. The following nonmaterial elements directly influence comprehensive joint readiness along with strategic, and contingency planning by offering new doctrinal approaches, sharing lessons learned, and developing innovative Joint Force leaders.

(5) Joint Doctrine Development. Joint doctrine consists of the strategic principles and operational concepts that guide the employment of the Joint Force across the range of military options. Only those doctrinal publications approved by the CJCS and the J-7, will be referred to as Joint Publications.

(6) Joint Professional Military Education (JPME). The CJCS is responsible for formulating policies on the Joint Professional Military Education (JPME) of members of the Armed Forces. JPME is designed to promote the knowledge, skills, attributes, and behaviors of the Joint Force that define the profession of arms and produce leaders who think strategically. The Director, J-7, develops an annual list of up to six Special Areas of Emphasis, approved by the CJCS, and then distributed to the JPME institutions to educate the Joint Force.

(7) CJCS's Joint Training Guidance (CJTG). The CJTG is an annual notice signed by the CJCS that provides guidance to the Joint Force for the planning, execution, and assessment of individual and collective joint training for a 4-year period. The CJTG applies to CCMDs, Services, the NGB, the Joint Staff, and other joint organizations. The CJTG supports Joint Training Plan development.

(8) Joint Lessons Learned Program (JLLP). The JLLP is designed to enhance comprehensive joint readiness through the discovery, validation, integration, and evaluation of lessons learned from operations, events, and exercises across the full range of joint operations. Lessons learned that indicate capability gaps exist can also serve as the basis for capability requirements that are.

### 2-25. Joint Capability Development

a. 10 U.S.C. 153(a)(5) directs the CJCS to accomplish the following interrelated actions related to Joint Capability Development: 1) Identify new joint military capabilities; 2) Perform military net assessments; 3) Advise SECDEF on Combatant Command priorities; 4) Advise the SECDEF on how Service and Combatant Command program recommendations and budget proposals conform to priorities; 5) Advise SECDEF on new and alternative military capabilities, program recommendations and budget proposals; 6) Assess joint military capabilities to identify, approve, and prioritize gaps pursuant to the Joint Requirements Oversight Council (JROC); and 7) Recommend to the SECDEF appropriate trade-offs among life cycle costs, schedule, performance, and procurement quantity objectives in the acquisition of materiel and equipment.

b. The JSPS's Comprehensive Joint Readiness elements directly inform Joint Capability Development analysis and recommendations.

## HOW THE ARMY RUNS

c. The JSPS elements aligned with this function are the JROC and the Joint Capabilities Integration and Development System (JCIDS). JSPS also supports the Planning, Programming, Budgeting and Execution (PPBE) process. These three elements foster the horizontal integration of planning, resource prioritization, current readiness, and future Joint Force development. Additionally, these elements are responsive to Combatant Command high priority requirements, service and USSOCOM FYDP institutional strategies, and requirements beyond the FYDP.

d. Joint Requirements Oversight Council (JROC). 10 U.S.C., Chapter 181 establishes the Joint Requirements Oversight Council (JROC), which the Vice CJCS chairs. The JROC directly supports the CJCS's Joint Capability Development function per 10 U.S.C. 153(a)(5). Specifically, the JROC 1) Assesses joint military capabilities; 2) Identifies and prioritizes gaps; 3) Reviews and validates proposed capabilities intended to fill gaps, 4) Develops recommendations for program cost and fielding targets, 5) Establishes and approves joint performance requirements; 6) Reviews capability requirements for any existing or proposed solution; 7) Identifies new joint military capabilities based on advances in technology and concepts and alternatives to acquisition programs. Through these efforts, the JROC serves as the CJCS's global integration entity for Joint Capability Development.

e. Joint Capabilities Integration and Development System. The Director for Force Structure, Resources, and Assessment, J-8, is responsible for the Joint Capabilities Integration and Development System (JCIDS). The JCIDS is a needs-driven joint capability requirements validation process that directly supports the JROC in identifying, approving, and prioritizing joint military requirements and validating capability solutions to fulfill gaps in joint military requirements. It is an integrated collaborative process driven by the NMS. The objective is to develop Doctrine, Organization, Training, Materiel, Leadership and Education, Personnel, Facilities, and Policy (DOTMLPF-P) solutions that are affordable, militarily useful, operationally effective, and supportable in a technologically mature operational environment.

f. Capability Requirement Document. The JCIDS process provides the baseline for documentation, review, and validation of new capability requirements expressed in capability requirement documents. Requirement documents come from many sources and can reflect the translation of emerging Joint and Service concepts into new capability requirements. Examples of capability requirement documents include Initial Capabilities Documents, Joint DOTMLPF-P Change Recommendations (DCRs), Capability Development Documents (CDDs), and Joint Urgent and Emergency Operational Needs. JROC decisions on JCIDS capability recommendations are formalized in a JROC Memorandum (JROCM) signed by the Vice CJCS.

g. Capability Portfolio Review. The JROC has responsibility for monitoring ongoing activities affecting capability requirement portfolios. Capability portfolio reviews enable the JROC to manage and prioritize capability requirements within and across the capability requirement portfolios; inform other assessments, processes, and activities within the Joint Staff and across the DOD, and enable the JROC and CJCS to meet their statutory responsibilities.

h. Capability Gap Assessment. The Capability Gap Assessment (CGA) is an annual JROC-led capability portfolio review, coordinated by the Director for Force Structure, Resources, and Assessment, J-8, which examines Combatant Command Integrated Priority Lists submitted in the Annual Joint Assessment (AJA). The CGA assesses capability gaps in the current and planned force from various developmental perspectives. These gaps are assessed based on risk and ongoing efforts to close or mitigate the capability gap. Decisions to take action relating to each gap will be made at various levels. The JROC recommendation is formalized in a JROCM signed by the Vice CJCS. This JROCM is a key input to the JMNA. The JMNA, in turn, shapes the CJCS's Program Recommendation (CPR). The JMNA and CPR were introduced in Enclosure D.

i. Support to Planning, Programming, Budgeting, and Execution. The Planning, Programming, Budgeting, and Execution (PPBE) process is the SECDEF's institutional strategic planning system and his primary decision making process for translating strategic guidance into resource allocation decisions. Consistent with 10 U.S.C. direction, the CJCS and the Joint Staff interface with the PPBE process at all phases. The Directorate for Force Structure, Resources, and Assessments, J-8, is the Joint Staff focal point for PPBE support activities and the principal staff contact on these matters for the CCMDs, NGB, Services, and OSD. The CJCS's primary input to the PPBE process is the CPR. During the annual Programming and Budgeting Review (PBR), the Joint Staff participates in issue teams led by the Office of Cost Assessment and Program Evaluation (CAPE). Through these teams: 1) The Joint Force assesses the Services' programs; 2) Reviews Combatant Command and other agency issue nomination submissions; 3) Helps develop alternatives to address changes to the Service programs, and 4) adjudicates issue nominations.

## STRATEGY AND STRATEGIC DIRECTION

### 2-26. Global Military Integration

a. 10 U.S.C. 153(a)(3) directs the CJCS to provide “advice to the President and the Secretary in matters relating to global military strategic and operational integration.” Title 10 explicitly acknowledges the global “transregional, all-domain, and multifunctional threats” facing the Joint Force and directs the CJCS to provide to the SECDEF advice on the “allocation and transfer of forces among geographic and functional CCMDs.”

b. The CJCS, as global integrator, guides coordination across geographic, functional, and Service seams to ensure the Joint Force collectively expands its competitive advantages across a range of global challenges. To this end, the CJCS develops military advice on global posture, readiness, and risk. The broad concept of global integration is the conceptual foundation for all Joint Strategic Planning System (JSPS) functions.

c. The primary, formal military advice is the NMS. Beyond the NMS, the CJCS provides advice as the “principal military advisor” to the National Security Council, through formal memorandums such as: the Chairman’s Risk Assessment (CRA), Global Campaign Plans (GCP), the Chairman’s Program Recommendation (CPR), Global Force Management Implementation Guidance (GFMIG), Global Force Management Allocation Plan (GFMAP), and the Unified Command Plan (UCP).

(1) CRA. The Director for Strategy, Plans, and Policy, J-5, is responsible for developing, reviewing and preparing the Chairman’s Risk Assessment (CRA) for the Chairman’s signature. This classified assessment of risk fulfills multiple roles. 10, U.S.C. 153(b)(2) mandates the primary role of the CRA. Title 10 directs the CJCS to prepare an assessment of strategic risk to national interests and military risk to execution of the NMS.

(2) The CJCS submits the annual risk assessment through the SECDEF to Congress no later than 15 February. 10 U.S.C. further directs the SECDEF, when transmitting the risk assessment to Congress, to include a risk mitigation plan for all areas of significant risk.

(3) The CRA also informs NMS revisions and the Joint Military Net Assessment (JMNA).

(4) Primary inputs to the CRA are the Joint Staff Independent Risk Assessment and the Annual Joint Assessment (AJA) Combatant Command and Service responses.

(5) GCPs. The J-5, is responsible for developing, staffing, reviewing, and preparing Global Campaign Plans (GCP) for the CJCS’s and SECDEF’s approval. The GCPs are integrated plans that address the most pressing transregional, multi-functional strategic challenges across all domains. The CJCS, as the global integrator, determines which challenges require GCPs. As problem-focused plans, GCPs look across geographic and functional Combatant Command seams and simultaneously provide direction to the Combatant Commanders and military advice to the SECDEF. GCPs are the focal point for integrated assessment and resource decisions regarding prioritization, posture, capabilities, risk, and risk mitigation measures. The CJCS’s military advice, derived from GCP assessments, can take the form of a GCP memorandum focused on a single challenge or be contained within a broader JSPS product.

(6) CPR. The J-8, is responsible for developing, staffing, reviewing, and preparing the annual Chairman’s Program Recommendation (CPR) for the CJCS’s signature. The CPR represents the CJCS’s military advice to the SECDEF on capability investments. Each CPR is unique: there is no standard format or required contents. However, consistent with 10 U.S.C. 153(a)(5), a typical CPR provides a wide range of recommendations to improve comprehensive joint readiness. Thus, a typical CPR will recommend capabilities and approaches that could improve how the Joint Force employs and sustains the force and ensures the resiliency of critical capabilities. A CPR may also provide recommendations on allies and partners, posture, the defense industrial base, and force sizing. In consideration of the future competitive environment, CPRs recommend new approaches and capabilities.

(7) GFMIG. The Director for Force Structure, Resources, and Assessments, J-8, is responsible for developing, staffing, reviewing, and preparing the GFMIG for the CJCS’s review and the SECDEF’s approval every other year. The GFMIG describes how to implement a Global Force Management (GFM) model that accounts for strategic uncertainty by prioritizing the maintenance of capacity and capabilities for major combat, while providing options for proactive and scalable force employment. This ensures that resource allocation is aligned with strategy, and enables the Joint Force to meet Combatant Command requirements, while building readiness, ensures the ability to respond to the unexpected, and provides strategic predictably to U.S. Allies and unpredictability to U.S. adversaries. As such, it describes the CJCS’s advice on how the Department should execute the assignment, allocation, and apportionment of

## HOW THE ARMY RUNS

the Joint Force. When approved by the SECDEF, the GFMIG provides SECDEF direction for all aspects of GFM.

(8) GFMAP. The J-3, is responsible for developing, staffing, reviewing, and preparing the annual GFMAP for the CJCS's review and the SECDEF's approval. The GFMAP is the annual deployment order for the Joint Force and is modified to meet emerging or crisis-based requirements. Changes are captured and transmitted through the SECDEF's Orders Book (SBOB).

(9) UCP. The J-5, is responsible for developing, staffing, reviewing, and preparing the UCP for the CJCS's and the SECDEF's review and the President's approval. The UCP provides basic guidance from the President to the Combatant Commanders; establishes broad missions and responsibilities; delineates geographic boundaries; and, specifies functional Combatant Commander responsibilities. 10 U.S.C. 161(b) requires that the CJCS review, not less than every two years, the missions, responsibilities, (including geographic boundaries), and force structure of each Combatant Command. This review constitutes the CJCS's advice to the SECDEF and the President.

### 2-27 Combatant Commands (CCMDs)

a. In accordance with 10 U.S.C., Subtitle A—General Military Law, Part I—Organization and General Military Powers, Chapter 6—Combatant Commands, Section 162—Combatant Command Assigned Forces; Chain of Command, the Secretaries of the military departments shall assign specified forces under their jurisdiction to unified and specified CCMDs or to the USELEMNORAD to perform missions assigned to those commands. The SECDEF shall ensure that such assignments are consistent with the force structure prescribed by the President for each CCMD. A force not assigned to a CCMD or the USELEMNORAD shall remain assigned to the military department concerned with carrying out the responsibilities of the Secretary of the military department concerned. A force assigned to a CCMD or to the USELEMNORAD may be transferred from the command to which it is assigned only by authority of the SECDEF and under procedures prescribed by the SECDEF and approved by POTUS.

b. Except as otherwise directed by the SECDEF, all forces assigned to a unified CCMD shall be under the command of, the commander of that command. The preceding sentence applies to forces assigned to a specified CCMD only as prescribed by the SECDEF.

c. Unless otherwise directed by POTUS, the chain of command to a unified or specified CCMD runs from POTUS to the SECDEF; and from the SECDEF to the combatant commander (CCDR). The CCDR is responsible to POTUS and to the SECDEF for the performance of missions assigned to that command by the POTUS or by the SECDEF with the approval of POTUS. Subject to the direction of POTUS, the CCDR performs his duties under the authority, direction, and control of the SECDEF and is directly responsible to the SECDEF for the preparedness of the command to carry out missions assigned to the command.

d. CCDRs assist the CJCS by: providing information as requested through the CJA; including readiness reporting via the Joint Forces Readiness Review (JFRR) and DRRS processes as inputs to the JCCA process; providing assessments of capability gaps and excesses, policy and planning issue documents, as requested by the CJCS to the Joint Staff and participating in the CGA process; providing capability analysis and assessment on joint concepts through the CJA and providing participants to attend JROC forums.

e. CCDRs assist the CJCS by: developing and providing capability requirements documents as required in CJCSI 3170.01 and 3100.01D.

f. CCDRs assist the CJCS by: implementing the JSCP and other orders as directed and transmitted on behalf of the President or the SECDEF; implementing direction included with CJCS's funding of special programs; implementing procedures or policies as described in CJCSIs and CJCSMs.

g. CCDRs assist the CJCS in: leading current operations in response to EXORDs; participating in the GFM process; participating in JCIDS; and meeting Joint Strategic Capabilities Plan requirements.

h. There are currently six geographic and four functional CCMDs (see Fig 2-2).

(1) USAFRICOM. Responsible to the SECDEF for military relations with African nations, the African Union, and African regional security organizations. A full-spectrum CCMD, USAFRICOM is responsible for all DOD operations, exercises, and security cooperation on the African continent, its island nations, and surrounding waters.

(2) USCENTCOM. USCENTCOM's area of responsibility spans more than 4 million square miles and consists of the intersection of three continents and globally vital commercial sea lanes, flight

## STRATEGY AND STRATEGIC DIRECTION

corridors, pipelines and overland routes. The 20 nations of this AOR stretch from Northeast Africa across the Middle East to Central and South Asia.

(3) USEUCOM. Is one of the two forward-deployed geographical CCMDs, whose area of focus covers almost one-fifth of the planet, including all of Europe, large portions of Asia, parts of the Middle East, and the Arctic and Atlantic Oceans. The command is responsible for U.S. military relations with NATO and 51 countries on two continents with a total population of close to a billion people.

(4) USINDOPACOM. The USINDOPACOM area of responsibility encompasses about half the earth's surface, stretching from the waters off the west coast of the United States to the western border of India, and from Antarctica to the North Pole. There are few regions as culturally, socially, economically, and geo-politically diverse as the Indo-Pacific AOR. The 36 nations that comprise the Indo Pacific region are home to more than 50 percent of the world's population, 3,000 different languages, several of the world's largest militaries, and five nations allied with the U.S. through mutual defense treaties. Two of the three largest economies are located in this area along with 10 of the 14 smallest. This AOR includes the most populous nation in the world, the largest democracy, and the largest Muslim-majority nation. More than one third of Indo-Pacific nations are smaller, island nations that include the smallest republic in the world and the smallest nation in Asia.

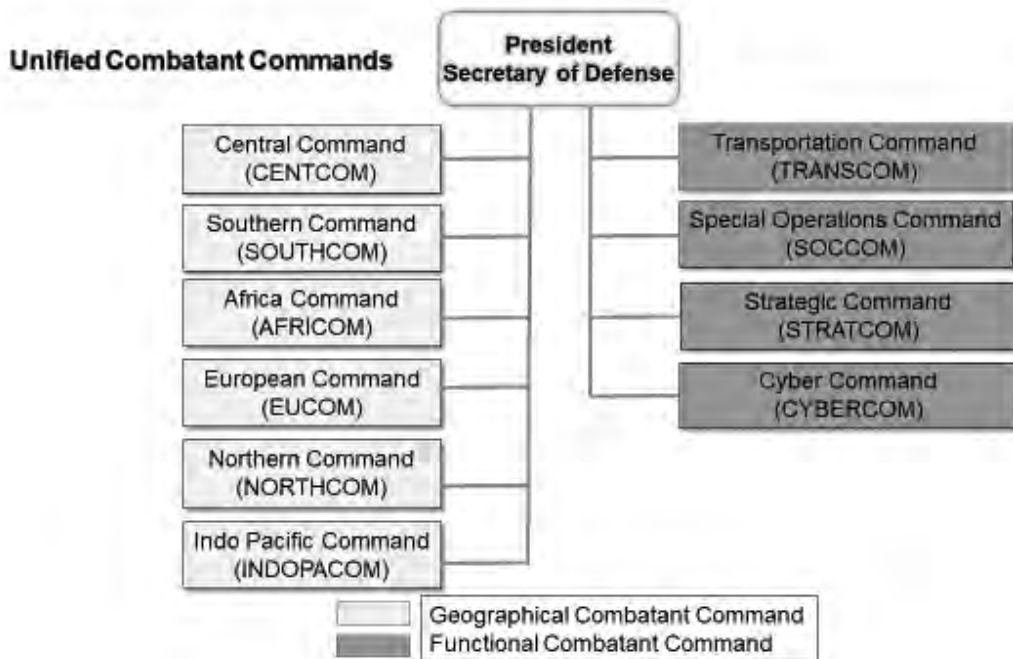

Figure 2-2. Unified CCMDs

(5) USSOCOM. Synchronizes the planning of Special Operations and provides SOF to support persistent, networked, and distributed Global CCMD operations to protect and advance the Nation's interests.

(6) USSOUTHCOM. Responsible for providing contingency planning, operations, and security cooperation in its assigned area of responsibility which includes Central America, South America, and the Caribbean (except U.S. commonwealths, territories, and possessions). SOUTHCOM is responsible for the force protection of U.S. military resources at these locations. SOUTHCOM is also responsible for ensuring the defense of the Panama Canal.

(7) USSTRATCOM. Integrates and coordinates the necessary command and control capability to provide support with the most accurate and timely information for POTUS, the SECDEF, other national leadership and CDRs. STRATCOM combines the synergy of the U.S. legacy nuclear command and control mission with responsibility for: space operations; global strike; global missile defense; and global command, control, communications, computers, intelligence, surveillance, and reconnaissance (C4ISR).

## HOW THE ARMY RUNS

This dynamic command gives national leadership a unified resource for greater understanding of specific threats around the world and the means to respond to those threats rapidly.

(8) USTRANSCOM. A unified, functional CCMD which provides support to the eight other U.S. CCMDs, the military services, defense agencies and other government organizations. USTRANSCOM provides full-spectrum global mobility solutions and related enabling capabilities for supported customers' requirements in peace and war.

(9) USNORTHCOM. Partners to conduct homeland defense, civil support, and security cooperation to defend and secure the United States and its interests.

USNORTHCOM's area of responsibility includes air, land and sea approaches and encompasses the continental United States, Alaska, Canada, Mexico and the surrounding water out to approximately 500 nautical miles. It also includes the Gulf of Mexico, the Straits of Florida, and portions of the Caribbean region to include the Bahamas, Puerto Rico, and the U.S. Virgin Islands.

(10) USCYBERCOM. USCYBERCOM has the mission to direct, synchronize, and coordinate cyberspace planning and operations to defend and advance national interests in collaboration with domestic and international partners. The command is charged with pulling together existing cyberspace resources, creating synergies, and synchronizing war-fighting effects to defend the information security environment.

### Section VI Joint Planning

#### 2-28. Joint Planning Overview

In accordance with JP 5-0, Joint Planning—

a. Joint planning is the deliberate process of determining how (the ways) to use military capabilities (the means) in time and space to achieve objectives (the ends) while considering the associated risks. Ideally, planning begins with specified national strategic objectives and military end states to provide a unifying purpose around which actions and resources are focused. At the combatant command (CCMD) level, joint planning serves two critical purposes:

(1) At the strategic level, joint planning provides the President and SECDEF options, based on best military advice, on use of the military in addressing national interests and achieving the objectives in the NSS and NDS.

(2) At the operational level, once strategic guidance is given, planning translates this guidance into specific activities aimed at achieving strategic and operational-level objectives and attaining the military end state.

b. Joint planning plays a fundamental role in securing the Nation's interests in a continuously changing operational environment (see Fig 2-3). Through structured review, assessment, and modification, plans are constantly assessed and updated by the JFC and reviewed by the broader JPEC and senior DOD leadership. The open and collaborative planning process provides common understanding across multiple levels of organizations and the basis for adaptation and change.

c. Joint planning begins when an appropriate authority recognizes potential for military capability to be employed in support of national objectives or in response to a potential or actual crisis. At the strategic level, that authority—the POTUS, SECDEF, or CJCS—initiates planning by deciding to develop military options. Presidential directives, NSS, UCP, CPG, JSCP, and related strategic guidance documents (e.g. strategic guidance statements) serve as the primary guidance to begin planning. Analyses of developing or immediate crises may result in the POTUS, SECDEF, or CJCS initiating military planning through a warning order or other planning directive.

#### 2-29. Joint Planning and Execution Community

In accordance with JP 5-0, Joint Planning, the headquarters, commands, and agencies involved in joint planning or committed to a joint operation are collectively termed the JPEC. Although not a standing or regularly meeting entity, the JPEC consists of the stakeholders shown in Figure 2-4.

#### 2-30. Adaptive Planning and Execution Enterprise

In accordance with JP 5-0, Joint Planning—



## STRATEGY AND STRATEGIC DIRECTION

a. Strategy and joint planning occur within adaptive planning and execution (APEX), the department-level enterprise of policies, processes, procedures, and reporting structures supported by communications and information technology used by the JPEC to plan and execute joint operations. APEX integrates the planning activities of the JPEC and facilitates the transition from planning to execution. APEX activities span many organizational levels, but the focus is on the interaction between SECDEF and CCDRs, which ultimately helps the POTUS and SECDEF decide when, where, and how to commit US military forces.

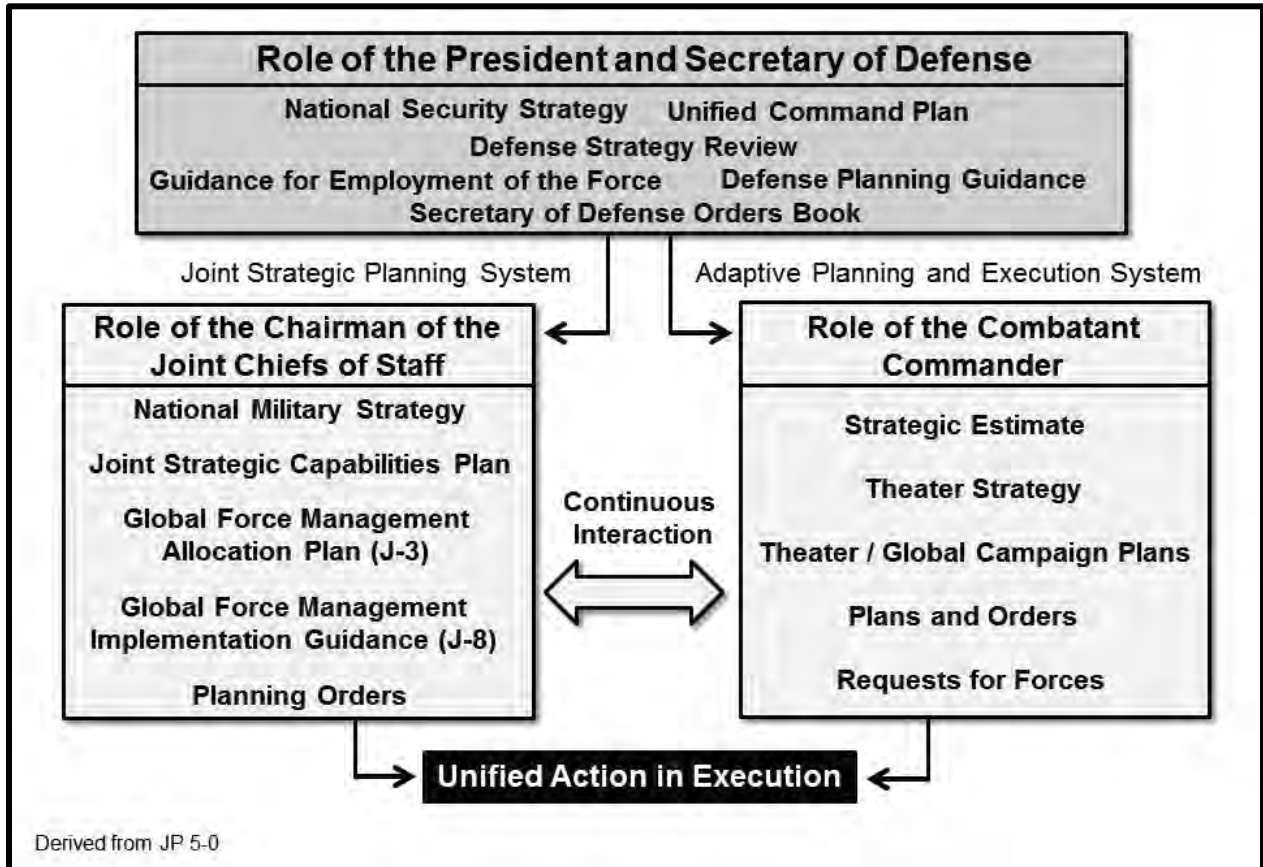

Figure 2-3. Unified Action in Execution

b. The JPEC uses the APEX system to monitor, plan, and execute mobilization, deployment, employment, sustainment, redeployment, and demobilization activities associated with joint operations. The APEX enterprise operates in a networked, collaborative environment, which facilitates dialogue among senior leaders, concurrent and parallel plan development, and collaboration across multiple planning levels.

### 2-31. Joint Planning Process

a. The JFC and staff develop plans and orders through the application of operational art and operational design in conjunction with Joint Planning Process. Refer to Joint Publication (JP) 5-0 for details.

b. The planning staff typically uses JPP to conduct detailed planning to fully develop options, identify resources, and identify and mitigate risk. Planners develop the concept of operations (CONOPS), force plans, deployment plans, and supporting plans that contain multiple courses of action in order to provide the flexibility to adapt to changing conditions and remain consistent with the JFC's intent and present acceptable options to civilian decision makers.

## HOW THE ARMY RUNS

c. JPP is an orderly, analytical set of logical steps to frame a problem; examine a mission; develop, analyze, and compare alternative courses of action (COAs); select the best COA; and produce a plan or order. JPP provides a proven process to organize the work of the commander, staff, subordinate commanders, and other partners, to develop plans that will appropriately address the problem. It focuses on defining the military mission and development and synchronization of detailed plans to accomplish that mission.

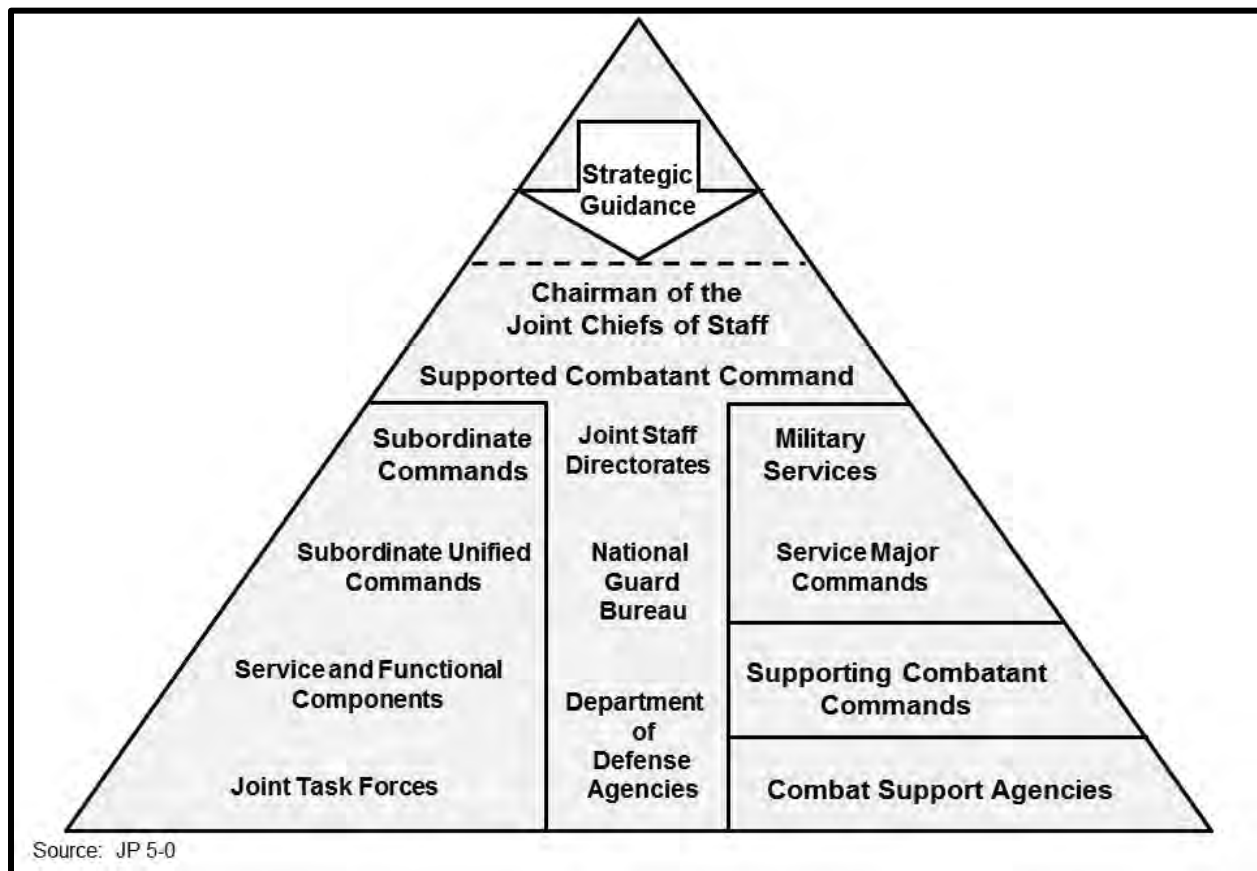

**Figure 2-4. Joint Planning and Execution Community (JPEC)**

### **2-32. Joint Planning Operational Activities**

In accordance with JP 5-0, Joint Planning, Joint planning encompasses a number of elements, including three broad operational activities, as follows (see Fig 2-5)—

a. Situational awareness addresses procedures for describing the operational environment, including threats to national security. This occurs during continuous monitoring of the national and international political and military situations so that CCDRs, JFCs, and their staffs can determine and analyze emerging crises, notify decision makers, and determine the specific nature of the threat.

b. Planning translates strategic guidance and direction into campaign plans, contingency plans, and operation orders (OPORDs). Joint planning may be based on defined tasks identified in the CPG and the JSCP. Alternatively, joint planning may be based on the need for a military response to an unforeseen current event, emergency, or time-sensitive crisis.

c. Execution begins when the President or SECDEF authorizes the initiative of a military operation or other activity. An execute order (EXORD), or other authorizing directive, is issued by the CJCS at the direction of the President or SECDEF to initiate or conduct military operations. Depending upon time constraints, an EXORD may be the only order a CCDR or subordinate commander receives. The EXORD defines the time to initiate operations and conveys guidance not provided earlier.

## STRATEGY AND STRATEGIC DIRECTION

### 2-33. Joint Planning Functions

In accordance with JP 5-0, Joint Planning, Joint planning encompasses a number of elements, including four planning functions. The four planning functions--strategic guidance, concept development, plan development, and plan assessment--are generally sequential, they often run simultaneously in order to deepen the dialogue between civilian and military leaders and accelerate the overall planning process.

a. Strategic Guidance. Strategic guidance initiates planning, provides the basis for mission analysis, and enables the JPEC to develop a shared understanding of the issues, OE, objectives, and responsibilities.

b. Concept Development. During planning, the commander develops several COAs, each containing an initial CONOPS that should identify major capabilities and authorities required and task organization, major operational tasks to be accomplished by components, a concept of employment and sustainment, and assessment of risk. Each COA may contain embedded multiple alternatives to accomplish designated objectives as conditions change (e.g., operational environment, problem, strategic direction).

c. Plan Development. This function is used to develop a feasible plan or order that is ready to transition into execution. This function fully integrates mobilization, deployment, employment, sustainment, conflict termination, redeployment, and demobilization activities through all phases of the plan. When the CCDR believes the plan is sufficiently developed to become a plan of record, the CCDR briefs the final plan to the SECDEF or a designated representative for approval.

d. Plan Assessment (Refine, Adapt, Terminate, Execute). Commanders continually review and evaluate the plan; determine one of four possible outcomes: refine, adapt, terminate, or execute and then act accordingly.

### 2-34. Joint Planning Products

In accordance with JP 5-0, Joint Planning, joint planning encompasses the preparation of a number of planning and execution-related products. While the planning process is the same for CCMD campaign, contingency, or crisis planning, the output or products may differ. Contingency and CCMD campaign planning encompasses the preparation of plans that occur in non-crisis situations with a timeline generally not driven by external events. It is used to develop plans for a broad range of activities based on requirements identified in the CPG, JSCP, or other planning directives.

a. Campaign Plans. CCMD campaign plans are the centerpiece of DOD's planning construct. They provide the means to translate strategic guidance into CCMD strategies and subsequently into executable activities. CCMD campaign plans provide the vehicle for linking current operations to contingency plans.

b. Contingency Plans. Contingency plans are branches of campaign plans that are planned for potential threats, catastrophic events, and contingent missions without a crisis at-hand, pursuant to the strategic guidance of the UCP, CPG, and JSCP, and of the CCDR. There are four levels of planning detail for contingency plans, with an associated planning product for each level (see Fig 2-5).

(1) Level 1 Planning Detail—Commander's Estimate. This level of planning involves the least amount of detail and focuses on producing multiple COAs to address a contingency. The product for this level can be a COA briefing, command directive, commander's estimate, or a memorandum with a required force list.

(2) Level 2 Planning Detail—Base Plan (BPLAN). A BPLAN describes the CONOPS, major forces, concepts of support, and anticipated timelines for completing the mission. It normally does not include annexes.

(3) Level 3 Planning Detail—Concept Plan (CONPLAN). A CONPLAN is an OPLAN in an abbreviated format that may require considerable expansion or alteration to convert it into a complete and detailed Level 4 OPLAN or an OPORD.

(4) Level 4 Planning Detail—OPLAN. An OPLAN is a complete and detailed plan containing a full description of the CONOPS, all applicable annexes to the plan including a time-phased force and deployment list (TPFDL), and a transportation-feasible notional TPFD. The OPLAN identifies the force requirements, functional support, and resources required to execute the plan and provide closure estimates for their flow into the theater.

c. Cross-AOR Planning. When the scope of contemplated military operations exceeds the authority or capabilities of a single CCDR to plan and execute, the President, SECDEF, or the CJCS, when designated by the President or SECDEF, identify a CCDR to lead the planning for the designated strategic challenge or threat.

## HOW THE ARMY RUNS

d. Supporting Plans. Supporting CCDRs, subordinate JFCs, component commanders, and CSAs prepare supporting plans as tasked by the JSCP or other planning guidance. Commanders and staffs prepare supporting plans in CONPLAN/OPLAN format that follow the supported commander's concept and describe how the supporting commanders intend to achieve their assigned objectives and/or tasks. Supporting commanders and staffs develop these plans in collaboration with the supported commander's planners.

### Section VII Army-Level Strategy

#### 2-35. Army Leaders

a. Secretary of the Army (SECARMY). In accordance with 10 U.S.C., Subtitle B—Army, Part 1—Organization, Chapter 303—Department of the Army, Section 3013, Secretary of the Army, the Secretary is the head of the Department of the Army (DA) and responsible for, and has the authority necessary to conduct, all affairs of DA, including the following functions: recruiting; organizing; supplying; equipping (including research and development); training; servicing; mobilizing; demobilizing; administering (including the morale and welfare of personnel); maintaining; the construction, outfitting, and repair of military equipment; and the construction, maintenance, and repair of buildings, structures, and utilities and the acquisition of real property and interests in real property necessary to carry out the responsibilities specified in this section. Subject to the authority, direction, and control of the SECDEF, the Secretary of the Army is also responsible to the SECDEF for: the functioning and efficiency of DA; the formulation of policies and programs by DA that are fully consistent with national security objectives and policies established by POTUS or the SECDEF; the effective and timely implementation of policy, program, and budget decisions and instructions of POTUS or the SECDEF relating to the functions of the DA; carrying out the functions of DA so as to fulfill the current and future operational requirements of the unified and specified CCMDs; effective cooperation and coordination between the DA and the other military departments and agencies of DOD to provide for more effective, efficient, and economical administration and to eliminate duplication; the presentation and justification of DA positions regarding DOD plans, programs, and policies along with the effective supervision and control of DA intelligence activities.

b. Chief of Staff of the Army (CSA). In accordance with 10 U.S.C., Subtitle B—Army, Part 1—Organization, Chapter 305—The Army Staff, Section 3033, Chief of Staff, the CSA performs duties under the authority, direction, and control of the SECARMY and is directly responsible to the Secretary. Subject to the authority, direction, and control of the SECARMY, the CSA shall: preside over the Army Staff (ARSTAF); transmit the plans and recommendations of the ARSTAF to the SECARMY and advise the Secretary with regard to such plans and recommendations; after approval of the plans or recommendations of the ARSTAF by the Secretary, act as the agent of the Secretary in carrying them into effect; exercise supervision, consistent with the authority assigned to commanders of unified or specified CCMDs, over such of the members and organizations of the Army as the Secretary determines, perform duties as prescribed as a member of the Armed Forces Policy Council; and also perform the duties prescribed as a member of the Joint Chiefs of Staff (JCS). To the extent that such action does not impair the independence of the CSA in the performance of these duties as a member of the JCS, the CSA shall inform the SECARMY regarding military advice rendered by members of the JCS on matters affecting the DA. Subject to the authority, direction, and control of the SECDEF, the CSA shall keep the SECARMY fully informed of significant military operations affecting the duties and responsibilities of the Secretary.

#### 2-36. The Army Plan

On 16 October 2014, the SECARMY and CSA published a memorandum entitled "Revisions to The Army Plan." The purpose of the revisions were to: ensure that the Army vision and strategy are well-aligned with Army plans and resources; better enable Army leaders to provide clear guidance, strategic focus, and programming priorities to the Army; and expand TAP to compose five separate documents that each successively builds upon the other while simultaneously serving to guide the Army's strategy and budget development. In accordance with this memorandum the five documents include—

## STRATEGY AND STRATEGIC DIRECTION

a. Army Vision (AV). The purpose of the AV, section I of TAP, is to capture the unified direction of the SECARMY and CSA and articulate the Army's "ends" in support of guidance from the National Command Authority (NCA).

(1) The AV articulates the desired end state of the SECARMY and CSA over a 10-year time horizon; at once, both challenging the Army and providing a "touchstone" to drive future change. It is the source document to which all other sections of the revised TAP are tethered and serves as the central document from which all other strategic communication documents (e.g., the Army Posture Statement) emanate. Although the AV informs the initial strategic choices that the Army Strategic Plan (ASP) outlines, the AV is primarily intended for external audiences (Office of the SECDEF-(OSD); Congress; the White House; think tanks; etc.).

(2) The AV's principal authors will be the personal staffs of the SECARMY and CSA, with assistance from the immediate staffs of the Under Secretary of the Army and Vice Chief of Staff, Army (VCSA), as appropriate. The Deputy Chief of Staff (DCS), G-3/5/7, provides additional support, as required.

(3) At a minimum, the AV should be reviewed or published every four years, in close proximity to the release of a new NDS. Although the AV is intended to endure across multiple Program Objective Memorandum (POM) cycles, some factors may necessitate more frequent changes or updates (e.g., radical shifts in the operational or fiscal environment; significant updates to the NCA guidance; significant changes to senior leader thinking, etc.).

b. Army Strategic Plan (ASP). The purpose of the ASP, section II of TAP, is to articulate a strategy that directs how the Army will fulfill its Title 10 responsibilities and additional statutory requirements over a 10-year time horizon. Its primary inputs are relevant NCA guidance (e.g., DSG; NSS; etc.) and the AV.

(1) Building on the AV and other senior leader guidance, the ASP re-emphasizes the Army's "ends" and defines and describes the strategic goals and objectives of senior leaders. Additionally, the ASP provides a strategic assessment of the operating environment, explicitly articulates key assumptions in its strategy formulation, and identifies key areas of risk. The ASP serves as the unifying document for all other Army strategic documents and plans (e.g., Army Modernization Strategy; Army Facility Strategy; etc.). Strategic guidance from the ASP directs planning and programming across multiple FYDP, including Total Army Analysis (TAA), and guides changes to Doctrine, Organization, Training, Materiel, Leadership and Education, Personnel, Facilities, and Policy (DOTMLPF-P). The ASP serves as the key linkage between strategy and budget and informs the Army's annual planning efforts as part of the Planning, Programming, Budgeting, and Execution (PPBE) process. Despite its budget and programming implications, the ASP is a strategic document not directly linked to any single POM or fiscal year.

(2) The DCS, G-3/5/7 serves as the proponent for the ASP, and coordinates with relevant HQDA Principal Officials, ACOMs, ASCCs, and DRUs at appropriate times throughout ASP development.

(3) The ASP is published not later than 120 days following the release of each NDS. Additionally, the ASP is reviewed every two years and republished when senior leaders determine an update is required.

c. Army Planning Guidance (APG). The purpose of the APG, section III of TAP, is to initiate the Army's annual PPBE process by identifying and providing guidance for key planning issues that require resolution or additional guidance before the POM build is complete. These planning issues may be identified from the previous year's POM, throughout program review, or as a result of decisions from other external actors (e.g., Congress; OSD; the White House; etc.).

(1) The APG will address near-, mid-, and far-term planning issues that apply to a specific budget year, later in the FYDP, or endure throughout it. The APG identifies each issue, provides a detailed description and applicable senior leader guidance, and identifies a responsible body for adjudication of that issue (e.g., the Army Management Action Group (AMAG); Planning Program Budget Committee (PPBC); Army Requirements Oversight Council (AROC); etc.). Additionally, the APG provides descriptive or prescriptive prioritization guidance addressing the hierarchy of functions for program development and budget execution. This prioritization guidance provides the ACOMs, DRUs, and Program Evaluation Groups (PEG) with initial senior leader guidance that remains applicable throughout the PPBE process, unless superseded by new guidance from the SECARMY and/or CSA. Finally, the APG designates those areas that the SECARMY and CSA have determined require centralized performance assessment management by the Army Campaign Plan.

(2) The DCS, G-3/5/7, serves as the proponent for the APG, and coordinates with the other co-chairs of the PPBC and members of the PPBC throughout the staff process.

## HOW THE ARMY RUNS

(3) The APG is published not later than 4 July of each year. Further updates and fragmentary orders (FRAGO) to the APG may be published as deemed necessary.

d. Army Program Guidance Memorandum (APGM). The purpose of the APGM, section IV of TAP, is to codify decisions made throughout the planning process in order to resolve each of the issues identified in the APG.

(1) The APGM signals the end of the Army's planning phase and beginning of the Army's programming phase for the annual PPBE process, and provides specific programming guidance that informs the POM build.

(2) The Director, PA&E (DCS, G-8) serves as the proponent of the APGM, and coordinates with the other co-chairs of the PPBC and other members of the PPBC throughout the staff process.

(3) The APG is published following the POM Off-site, but not later than mid-January, each year. Specific technical guidance will be published during the PPBE process, as required.

e. Army Campaign Plan (ACP). The purpose of the ACP, section V of TAP, is to establish and monitor annual priorities and initiatives from the SECARMY and CSA that require measurable end states or decision in the year of execution. Army Campaign Plan for Fiscal Year 2017 (ACP17) represents the current evolution of the ACP and supersedes ACP 14.

(1) The development of ACP17 is a collaborative effort across the Total Army. ACP17 derives from strategic documents within TAP along with published priorities of the Secretary of the Army and Chief of Staff of the Army. ACP17 reinvigorates Section V of The Army Plan as a powerful tool for driving transformational change within the Army. It consolidates several key decision-making activities into a single holistic process to drive Army Senior Leader decisions. ACP17 supports three essential purposes: drives Army Senior Leader decisions informed by risk; designates and integrates key Strategic Efforts that move the Army toward accomplishment of Army Senior Leader priorities; and assesses the Army's performance in execution of Army Senior Leader priorities: Readiness, Future Army, and Care of Troops.

(2) The DCS, G-3/5/7, serves as the proponent of the ACP. ACP17 applies to Headquarters, Department of the Army (HQDA), Army Commands, Army Service Component Commands, Direct Reporting Units, supporting agencies, and activities.

(3) The DCS, G-3/5/7 reviews this plan quarterly and updates it annually or as needed to ensure viability and relevancy

### Section VIII

#### Summary, Key Terms, and References

##### 2-37. Summary

There are several interrelated aspects within the strategy module of the Force Management Model – laws, leaders, processes, and documents – which influences how the Army runs. The laws, as designated in the U.S. Code and DOD, joint, and Army supporting documents to the U.S. Code, form the foundation of how strategic and operational requirements must be determined. The leaders at each echelon—national, defense, joint, and Army—develop their visions, assessments, advice, and direction based on how they want the strategic and operational requirements met. With every module impacted by strategy simultaneously and continuously, the processes at each echelon and further across the Army Force Management Model result in a structure within which resources can be applied to produce trained and ready units for CCDRs.

##### 2-38. Key Terms

The key terms were taken from Joint Pub 1-02, DOD Dictionary of Military and Associated Terms, August 2017.

a. Adaptive Planning and Execution A DOD enterprise of joint policies, processes, procedures, and reporting structures, supported by communications and information technology, that is used by the joint planning and execution community to monitor, plan, and execute mobilization, deployment, employment, sustainment, redeployment, and demobilization activities associated with joint operations. Also called APEX. (JP 5-0)

b. Assigned. Units or personnel assigned relatively permanently to a command or mission, where that organization controls and administers the units or personnel for the primary function, or greater portion of the functions, of the unit or personnel.

## STRATEGY AND STRATEGIC DIRECTION

- c. Allocation. Distribution of limited forces and resources for employment among competing requirements.
- d. Apportionment. The quantities of force capabilities and resources provided for planning purposes only, but not necessarily an identification of the actual force that may be allocated for use when a plan transitions to execution.
- e. Combatant Command. A unified or specified command with a broad continuing mission under a single commander established and so designated by the President, through the SECDEF and with the advice and assistance of the CJCS of the Joint Chiefs of Staff.
- f. Combatant Commander. A commander of one of the unified or specified CCMDs established by the President. Also called CCDR.
- g. Department of the Army. The executive part of the Department of the Army at the seat of government and all field headquarters, forces, Reserve Component, installations, activities, and functions under the control or supervision of the Secretary of the Army. Also called DA.
- h. Deployment Order. A directive from the SECDEF, issued by the CJCS, that authorizes the transfer of forces between CCMDs, Services and DOD agencies and specifies the authorities the gaining CCDR will exercise over the specific forces to be transferred. Also called DEPORD.
- i. Instruments of National Power. All of the means available to the government in its pursuit of national objectives. They are expressed as diplomatic, economic, informational, and military.
- j. Joint. Connotes activities, operations, organizations, etc., in which elements of two or more Military Departments participate.
- k. Joint Planning. Planning activities associated with military operations by CCDRs and their subordinate commanders.
- l. Joint Operations. Military actions conducted by joint forces and those Service forces employed in specified command relationships with each other, which of themselves, do not establish joint forces.
- m. Joint Staff. 1.) The staff of a commander of a unified or specified command, subordinate unified command, joint task force, or subordinate functional component (when a functional component command will employ forces from more than one Military Department), that includes members from the several Services comprising the force. 2) The Joint Staff under the CJCS that assists the CJCS and the other members of the Joint Chiefs of Staff in carrying out their responsibilities. Also called JS.
- n. Joint Strategic Planning System. One of the primary means by which the CJCS, in consultation with the other members of the Joint Chiefs of Staff and the CCDRs, carries out the statutory responsibilities to assist the President and SECDEF in providing strategic direction to the Armed Forces. Also called JSPS.
- o. Joint Task Force. A joint force that is constituted and so designated by the SECDEF, a CCDR, a subunified commander, or an existing joint task force commander. Also called JTF.
- p. Military Department. One of the departments within the DOD created by the National Security Act of 1947, which are the Department of the Army, the Department of the Navy, and the Department of the Air Force. Also called MILDEP.
- q. NMS. A document approved by the CJCS for distributing and applying military power to attain national security strategy and national defense strategy objectives. Also called NMS.
- r. National Security Council. A governmental body specifically designed to assist the President in integrating all spheres of national security policy. Also called NSC.
- s. NSS. A document approved by the President of the United States for developing, applying, and coordinating the instruments of national power to achieve objectives that contribute to national security. Also called NSS.
- t. Strategic Direction. The strategy and intent of the President, SECDEF, and CJCS in pursuit of national interests.
- u. Strategy. A prudent idea or set of ideas for employing the instruments of national power in a synchronized and integrated fashion to achieve theater, national, and/or multinational objectives.
- v. Unified Command. A command with a broad continuing mission under a single commander and composed of significant assigned components of two or more Military Departments that is established and so designated by the President, through the SECDEF with the advice and assistance of the CJCS. Also called unified CCMD.
- x. Unified Command Plan. The document, approved by the President, that sets forth basic guidance to all unified CCDRs; establishes their missions, responsibilities, and force structure; delineates the general geographical area of responsibility for geographic CCDRs; and specifies functional responsibilities for functional CCDRs.

## HOW THE ARMY RUNS

### 2-39. References

- a. CJCS Instruction 3100.01D, Joint Strategic Planning System, July 2018.
- b. Combatant Command websites, accessed June 2019—
  - (1) <http://www.africom.mil>.
  - (2) <http://www.centcom.mil>.
  - (3) <http://www.cybercom.mil>
  - (4) <http://www.eucom.mil>.
  - (5) <http://www.northcom.mil>.
  - (6) <http://www.indopacom.mil>.
  - (7) <http://www.socom.mil>.
  - (8) <http://www.southcom.mil>.
  - (9) <http://www.stratcom.mil>.
  - (10) <http://www.transcom.mil>.
- c. Global Force Management Implementation Guidance, 2017-2018.
- d. Joint Pub 1-02, Department of Defense Dictionary of Military and Associated Terms, January 2019.
- e. Joint Publication 1-0, Doctrine for the Armed Forces of the United States, 25 Mar 2013.
- f. Joint Publication 3-0, Joint Operations, 17 January 2017.
- g. Joint Publication 5-0, Joint Planning, 16 June 2017.
- h. Memorandum: Revisions to The Army Plan, 16 October 2014.
- i. National Security Strategy, December 2017.
- j. The Army Vision, 26 March 2018.
- k. Title 10, U.S.C. at <http://uscode.house.gov>.



## **Chapter 3**

### **Force Management**

#### **Section I Introduction**

##### **3-1. Chapter Content**

a. This chapter provides a holistic overview of the interconnected systems and processes used to identify requirements, develop capabilities, and manage change in the Army. During his initial message to the Army, then Secretary of the Army (SECARMY) Honorable Mark T. Esper outlined the top priorities for the service: Readiness, Modernization, and Reform. Reform being the driver in which the Army will change the way it conducts business, including how priorities are implemented, to make the Total Army more lethal, capable, and efficient. Reform also entails changing organizations, policies, processes, and tasks that consume time, money, or manpower to optimize efficiency and effectiveness while addressing the Army's top priorities. Army force management systems and processes guide and execute the entire life cycle of the Army from the earliest stages of conceptual development to the final disposition of people, equipment, and facilities.

b. This chapter discusses Force Management, the Army Force Management Model (AFMM), and the Army Organizational Life Cycle Model (AOLCM).

##### **3-2. Force Management**

a. Force Management is the capstone process that establishes and fields mission-ready Army organizations. The process involves organization, integration, decision-making, and execution of the spectrum of activities encompassing requirements definition, force development, force integration, force structuring, combat development, materiel development, training development, resourcing, and all elements of the AOLCM. The end-state is to assist and enable the SECARMY to accomplish his Title 10 statutory requirements to recruit, organize, supply, equip, train, service, mobilize, demobilize, administer, maintain, and station the Army.

b. Managing change in any large, complex organization requires the synchronization of many interrelated processes. The Army manages from an organizational life cycle perspective, developing operational organizations with highly trained personnel, led by confident leaders, with technologically advanced equipment, and providing that capability to the combatant commander (CCDR) for operational employment.

##### **3-3. Army Force Management Model (AFMM)**

a. The AFMM shown in Figure 3-1 (see the fold-out at the end of this book) is a "system of systems" approach to generating trained and ready units for CCDR employment. The AFMM is a roadmap divided into eight distinct modules, as follows:

(1) Determine Strategic and Operational Requirements. The strategy module includes analyses of national, defense, joint, and Army strategies, policies and congressionally mandated laws, key senior leader documents, approved Army concepts, and Global Force Management (GFM) demands and CCDR operational plans.

(2) Develop Required Capabilities / DOTMLPF-P Solutions. Uses the Joint Capabilities Integration and Development System (JCIDS) and the Capabilities-Based Assessment (C-BA) to identify capability shortfalls or gaps, provide recommended doctrine, organization, training, materiel, leadership and education, personnel, facilities, and policy (DOTMLPF-P) solutions for required capabilities.

(3) Design Organizations. This module centers on the Force Design Update process to help design and / or update organizations.

## HOW THE ARMY RUNS

(4) Develop Organizational Models. This module addresses the codification of the organization's personnel and equipment requirements through the development of Table of Organization and Equipment (TOE) and Basis of Issue Plan (BOIP) documents.

(5) Acquire Materiel Solutions. The Defense Acquisition System (DAS) is at the heart of this module.

(6) Determine Authorizations. This module includes Total Army Analysis (TAA) and the planning, programming, budgeting and execution (PPBE) Process.

(7) Acquire, Train, and Distribute Personnel.

(8) Acquire, Distribute, Sustain, and Dispose Materiel.

b. The AFMM shows the relationships of Army processes to each other and to the major Department of Defense (DOD) management processes. The underlying basis for this model is that force management, in its simplest context, is the management of change using many interrelated and complex processes. Although the model depicts the flow of processes in a somewhat linear and sequential manner, the complexities of managing change mandate that at any one time an initiative may be simultaneously in several of these processes at some level of maturity. As change management progresses, these processes may run sequentially, be compressed, run in parallel, or even run in reverse depending on the urgency, risk, and senior leader guidance on the issue. History has shown that, eventually, all of the steps must take place to produce a fully trained and equipped operational force at the right time and at the right place to support the CCDR.

c. In this model, strategic and senior leadership guidance, the processes for determining warfighting capabilities requirements, conducting research and development (R&D), and providing resources are all related activities within the force development process. The resulting products of force development, in turn, provide the basis for the force integration functions of acquiring and distributing materiel as well as acquiring, training, and distributing personnel. This widely used model highlights key aspects and relationships of force management.

### 3-4. Force Management Tools

The force management community uses a number of interrelated databases and systems to manage change across the Army.

a. Structure and Manpower Allocation System (SAMAS).

(1) SAMAS is the Army's automated force structure authoritative data source (i.e. database of record) for force accounting and manpower and unit programming. Deputy Chief of Staff (DCS), G-3/5/7 FM (DAMO-FMP) is the proponent for SAMAS.

(2) All approved units from TAA are entered into SAMAS to create the Program Objective Memorandum (POM) Force. The primary inputs to SAMAS are Operating Force (OF) organizations directed by the Army leadership, such as brigade combat teams, divisions, corps, Army Service Component Commands (ASCCs), armored cavalry regiments, Special Forces groups, and the forces required to support the combat structure. Generating Force (GF) organizations are allocated during TAA and their organizational structure is refined during the command plan (CPLAN) process or as updated by a Table of Distribution and Allowance (TDA) Change Management Plan (CMP).

(3) SAMAS has two primary outputs—

(a) The force structure file (commonly referred to as the "force file") reflects the approved (programmed and documented) force structure for each unit in the Army. The force file produces the Army's Master Force (MFORCE), which is the complete database of the entire Army's force structure. The MFORCE reflects the Chief of Staff of the Army (CSA) approved current, budgeted, and programmed force structure of the Army. It is the authoritative record of the total force over time. Throughout the year, periodic force reviews will adjust the MFORCE to reflect Army Senior Leader (ASL) decisions.

(b) The program and budget guidance (PBG) file (commonly referred to as the "budget file"). The budget file produces the manpower addendum to the PBG. Primary inputs to the budget file come from the annual CPLAN submissions of the Army commands, the TDA CMP, Program Budget Decisions (PBD), budget change proposals, program change proposals, and POM decisions.

(4) SAMAS contains the programmatic and force structure data used for the creation and approval of authorization documents.

(5) SAMAS retrievals permit detailed and summary analysis of the Army force structure to include organization, unit description, and strength data. Outputs are used across the Army staff to build detailed personnel, equipping, sustainment, installation, and training program data.

(6) The SAMAS database does not contain detailed personnel data or equipment information. It

## FORCE MANAGEMENT

does include more than 100 categories of unit information that can be extracted selectively for analysis. Key elements of information, in addition to required and authorized strengths, are the Unit Identification Code (UIC), Effective Date (EDATE), location, assignment code, Army management structure code (AMSCO), troop program sequence number (TPSN), and standard requirements code (SRC).

(7) SAMAS has both classified and unclassified data and applications.

(8) SAMAS conducts the three way synchronization among the force file, budget file, and authorization documents. This is commonly referred to as Automated Update Transaction System (AUTS). This process ensures authorization documents are matched to the planned structure and strengths programmed in SAMAS. A successful match will result in approval to publish and release an authorization document.

(9) SAMAS lock-point data is available through DCS, G-3/5/7 (DAMO-FMP) with approved access.

b. Army Force Management System (FMS).

(1) Army FMS is the information technology (IT) system for BOIP, TOE, Modified Table of Organization and Equipment (MTOE), and TDA development. It is the database of record for UIC, paragraph and line-level of detail for personnel and equipment. It aligns with the information in SAMAS.

(2) The U.S. Army Force Management Support Agency (USAFMSA) is the proponent for FMS. Access to FMS is limited to the force development community.

(3) Data contained in the Army's FMS will adhere to standards required by Department of Defense Manual (DODM) 8260.03, Volumes 1 and 2.

(4) FMS has both classified and unclassified data and applications.

(5) FMS data is distributed through Army Force Management System Web (FMSWeb) and the Army Organization Server (AOS).

c. Army Force Management System Web (FMSWeb).

(1) FMSWeb is a website that provides access to FMS data: TOEs, MTOEs, BOIPs, TDAs, CTA, JTA, and associated reference data and tools. FMSWeb is the repository for approved and in-staffing requirements and authorization documents. DA Pam 71-32 contains a detailed list of FMSWeb capabilities.

(2) USAFMSA is the proponent for FMSWeb and approves access to the website.

(3) Data from FMS may be viewed through the FMSWeb site, and provides retail level access to requirements and authorizations data and the Global Force Management Data Initiative (GFM-DI) digitally tagged hierarchical data. FMSWeb is available at <https://fmsweb.fms.army.mil/> or <https://fmsweb.army.mil/fmsweb>

d. Army Organization Server (AOS).

(1) The AOS is a data distribution hub that provides wholesale-level computer-to-computer access to authoritative past, current, and future GFM-DI formatted Headquarters, Department of the Army (HQDA) approved authorization data.

(2) USAFMSA is the designated proponent for the AOS.

(3) DODI 8260-03 - The Organizational and Force Structure Construct, February 19, 2014 -- and associated DODMs, DOD Instruction 8320.02 -- Sharing Data, Information, and Information Technology (IT) Services in the Department of Defense, August 5, 2013, and related documents require the Office of the Secretary of Defense (OSD), Joint Staff, Intelligence Community, and Armed Services to operate and maintain classified and unclassified GFM-DI organization servers.

e. Global Force Management Data Initiative (GFM-DI).

(1) The DOD has directed that all enduring automation systems consuming detailed force structure authorization data transition to the GFM-DI format.

(2) The GFM-DI is a Joint Staff and OSD initiative designed to standardize force structure representation, making it visible, accessible, and understandable across the DOD. Unique identifiers associate billets, crews, equipment, and chain of command links, enabling electronic manipulation across multiple systems. Through establishment of an information exchange data standard, GFM-DI enables DOD systems to exchange force structure data in a common format while exploiting the net-centric data environment.

(3) The central principle of GFM-DI is that force structure data is foundational for assessing and applying service capabilities in support of the National Military Strategy (NMS). GFM-DI facilitates the transformation of the processes used for global force management, readiness, command and control, manning, and logistics.

(4) USAFMSA is the designated proponent for GFM-DI authorization data.

## HOW THE ARMY RUNS

(5) Joint Staff J-8 Models and Analysis Support Division is the designated proponent for DOD implementation.

f. Structure and Composition Database (SACDB) (see Fig 3-2).

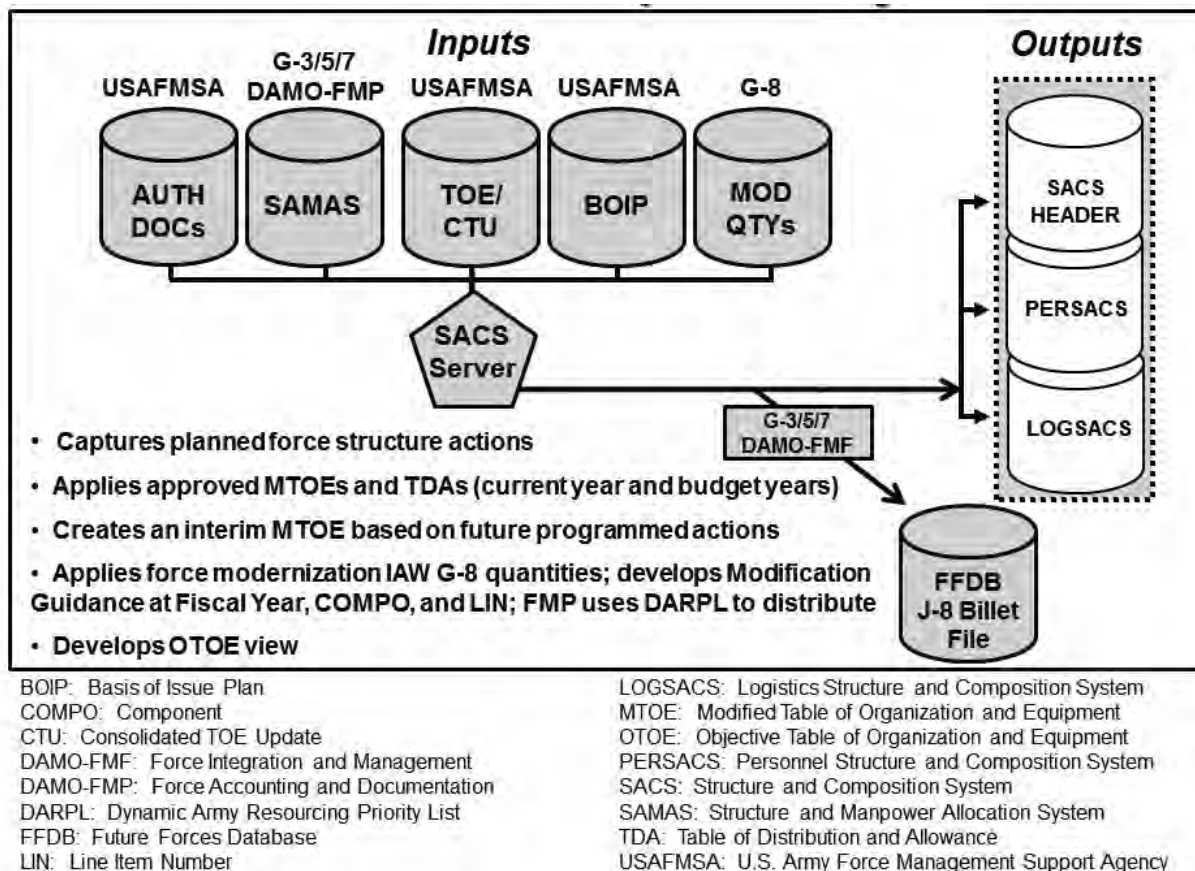

**Figure 3-2. Structure and Composition System**

(1) The SACDB report portrays the Army's time-phased demands for personnel and equipment over the current, budget and program years, and at OTOE levels. In this way, SACDB shows current levels of modernization, levels achieved at the end of the POM, and a fully modernized Army for planning purposes.

(2) The approved force lock (MFORCE or force review point (FRP)) is the key force structure input to initiate the SACDB cycle.

(3) SACDB combines and synchronizes information from BOIPs, TOEs, SAMAS force file, MTOEs, and TDAs within resource constraints.

(4) SACDB is operated and maintained by DAMO-FMP.

(5) SACDB is created after each force lock point, typically two to three times per year.

(6) SACDB reflects programmed force modernization changes using Army Equipping Enterprise System (AE2S) estimated line item number (LIN) quantities by COMPO, by FY provided by DCS, G-8 (DAPR-FD), and prioritized using the Dynamic Army Resourcing Priority List (DARPL).

(7) SACDB provide personnel and equipment requirement data to help build the Army sourcing lay-down for global requirements. SACDB outputs include—

(a) Personnel Structure and Composition (PERSAC) report. PERSAC report combines data from the SAMAS and TOE systems to tabulate and project military personnel requirements and authorizations for each unit in the force for the ten years of the SACDB. This data supports planning for personnel recruiting, training, promotions, requisition validation, and distribution. The personnel structure and

composition database, while a product of SACDB, is itself an input to other processes. The Personnel Management Authorization Document (PMAD), used by DCS, G-1 and Army Human Resources Command, provides personnel requirements and authorizations. PERSAC database summarizes the time-phased requirements and authorizations for personnel at the UIC, EDATE, Military Occupational Specialty (MOS), Grade, and quantity (QTY) level of detail for requirements and authorization for MTOE and TDA units. These are portrayed at summary, rather than paragraph and line level of detail.

(b) Logistics Structure and Composition (LOGSAC). LOGSAC combines data from the SAMAS, TOE, BOIP, and EQUIPFOR (EQ4) to tabulate and project equipment requirements and authorizations for each unit in the force for the current, budget, and POM years extended for a total of 10 years. LOGSACDB, while a product of SACDB, is itself an input to other processes. For example, the Total Army Equipment Distribution Program (TAEDP) uses equipment requirements and authorizations from LOGSACDB to plan equipment distribution. LOGSAC database summarizes the time-phased requirements and authorizations for equipment at the UIC, EDATE, LIN, equipment readiness code (ERC), and QTY level of detail for requirements and authorization for MTOE and TDA units.

g. Enterprise Management Decision Support System (EMDS). The EMDS system serves as the Army's common operating picture for integrated readiness, resourcing, deployment, and force generation analytics information. EMDS is a Secret Internet Protocol Router Network integrated, data-driven, commercial off-the-shelf (COTS) business intelligence system designed for the DA (military, government, and civilians). EMDS—

(1) Integrates authoritative data from multiple Army sources to provide visually driven analytic tools for personnel, equipment, training, deployment, and installations. EMDS analytic tools include customizable dashboards, table and chart views, and advanced discovery and search tools.

(2) Provides Army decision makers and their staff with the ability to conduct force planning in alignment with deployment schedules, readiness, and resourcing assessments.

(3) Provides this level of information for the Army's operating and generating forces (MTOE and TDA) units, U.S. Army Forces Command's (FORSCOM) Derivative UICs (DUICs), and Assistant Chief of Staff for Installation Management's (ACSIM's) installation reports.

(4) Provides DCS, G-3/5/7's force generation, resourcing, and readiness common operating pictures for all COMPOS.

(5) DCS, G-3/5/7 FM (DAMO-FME) is the proponent for EMDS.

(6) The EMDS portal is located at <https://emds.army.smil.mil> on the classified network.

h. Army Equipping Enterprise System (AE2S). AE2S is the Army's Web-based and common access card enabled knowledge management and decision support system for equipment modernization. It contains the Army's programmed force for the equipping program evaluation group (EE PEG) POM development, projected inventories based on equipment procurements and allocations to each of the components for equipment distribution transparency and BOIP application analysis.

(1) DCS, G-8 is the proponent for AE2S.

(2) AE2S contains the enhanced Army Flow Model that produces the TAEDP. It contains other allocation and distribution models to provide courses of action for investments, allocations, and distributions of existing and new equipment. The system combines data from authoritative sources and calculates the Total Army Requirement for equipment within capability groups; supports affordability analysis; and contains the Army acquisition and procurement objective for new and modifications of existing equipment. AE2S is accessible at <https://afm.us.army>.

### 3-5. Army Organizational Life Cycle Model (AOLCM)

a. The AOLCM graphically captures the continuous cycle of developing, employing, maintaining, and eliminating organizations. The Army force management approach recognizes the need to understand modernization and change as a complex adaptive system.

AOLCM provides a conceptual framework to both analyze and assess Army change efforts.

b. The AOLCM shown at Figure 3-3 reflects the stages that organizations and their personnel and equipment will experience at one time or another (and often concurrently) during their service in the Army. The functions performed in these stages develop, field, sustain, and modernize operational units and their supporting organizations; maintain their viability and effectiveness; and remove them or their assets (personnel and materiel) from the force as requirements change. Each individual asset (a Soldier, a civilian, or materiel) required by a unit or activity will be managed at some stage of the model beginning with the establishment of the need and entry into the Army to ultimate separation or disposal. The model

## HOW THE ARMY RUNS

details the critical stages through which an organizational resource will move, at some point, during its life span. Generally, the model depicts the life cycle of Army organizations from their development and their progression (clockwise around Figure 3-3) to separation. The dynamic of the model, displayed by the interconnecting lines, illustrates that the Army leadership must resource and manage all of the functions simultaneously, since Army assets will be in each functional stage at any one time. Any change to a resource in a functional stage will affect resources in most, if not all, of the other functional stages. In other words, if you influence or change something in one functional node the response will impact the entire model affecting other nodes to some degree.

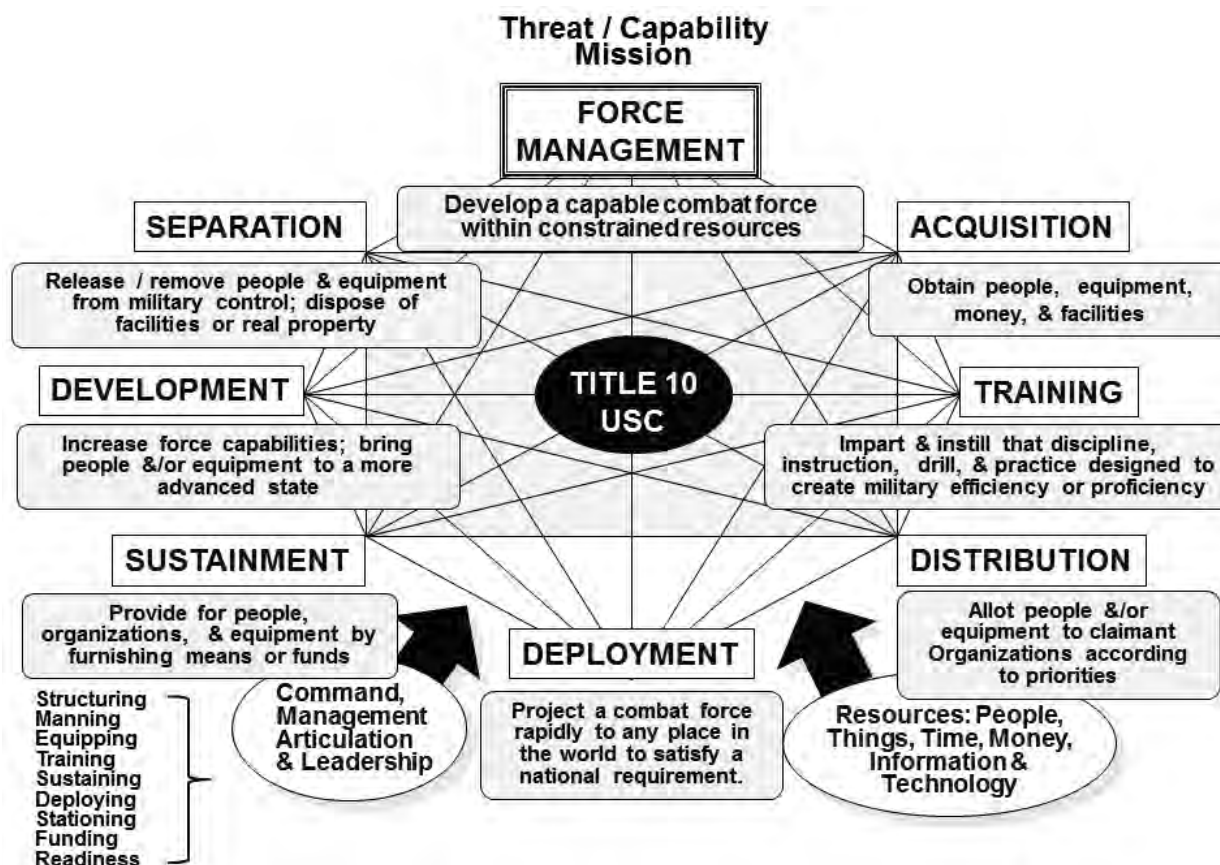

**Figure 3-3. Army Organizational Life Cycle Model**

c. Life cycle functions are listed below.

(1) Force Management. As the first phase of the organizational life cycle model, force management becomes the key activity underlying all other functions. The process involves decision-making and execution of activities encompassing conceptual development, capabilities requirements generation, force development, organizational development, force integration functions, and resourcing. Force management results in the development of a capable operational force within constrained resources.

(2) Acquisition. After the Congress authorizes and the DOD provides the budget and the End Strength (ES) guidance, the Army must then acquire the people and materiel specified in the requirements and authorizations documents necessary to accomplish specified missions. From a materiel acquisition perspective, the acquisition function extends beyond the principal item being fielded and must consider other essential requirements such as the availability of Associated Support Items of Equipment and Personnel (ASIOE/P), technical publications, repair parts, trained personnel, and facilities. From a human resource (HR) acquisition perspective, the acquisition function must consider recruiting and accession missions in concert with the overall manpower management program and the influences of personnel life cycle functions.

(3) Training. The training function encompasses the processes for transitioning recruits from civilian status to military service. In this context, the training function is somewhat different from what most Army leaders think of when discussing training. At this point in the life cycle, consider training from the aspect of initial entry training or the requirement to provide Soldiers with initial new equipment training or familiarization training on new or displaced equipment. In other words, this aspect of the training cycle imparts new skills to the Soldier or converts the civilian into a Soldier. It most often results in award of a MOS or Additional Skill Identifier (ASI). The training function also includes the transition of U.S. Military Academy (USMA), Reserve Officers Training Corps (ROTC), and Officer Candidate School (OCS) graduates into officers through the Basic Officer Leaders Course (BOLC). Traditional collective training and professional educational and leader development fall under the "development" phase of the AOLCM.

(4) Distribution. Having produced or procured the resources necessary to form and sustain units, they must be distributed according to established requirements, authorizations, and priorities. The distribution function includes the assignment of people from entry-level training to their initial unit and the delivery of new materiel from the wholesale level to the user. This activity is primarily managed and synchronized through the Army force generation process that focuses equipment and personnel distribution during the Prepare module of the Sustainable Readiness (SR) Process.

(5) Deployment. Deployment represents both a planning and operational function involving agencies on the Army Staff (ARSTAF), other levels of DOD, and the civilian transportation structure. Like many of other AOLCM activities, unit deployments are managed on a cyclical basis within the Army sustainable readiness module assignments. Once trained or prepared, units, individuals, packages, or materiel become available to support worldwide operations. An individual Soldier, civilian, unit, or item of equipment may be subject to some, if not all, of the mobilization, deployment, redeployment, demobilization, and reconfiguration processes of this function.

(6) Sustainment. In peace or war the presence of people and materiel in units establishes a requirement for sustainment. People, skills, capability, and equipment must be maintained to the standard set for mission accomplishment by replacement, rotation, repair, and training operations. From a personnel perspective this function covers Soldier reassignments throughout a career or obligation period, quality of life and well-being programs as well as other aspects of the personnel systems influencing retention. Repair parts and maintenance provide the sustainment process for materiel. Training in units covering the process of sustaining common Soldier skills that maintain individual proficiency falls under this function as well. The manning priority level, the Dynamic Distribution System (DDS), Dynamic Army Resourcing Priority List (DARPL), BOIP, ten classes of supply, the Authorized Stockage Lists, and Prescribed Load Lists (PLL) illustrate some of the systems or techniques used to manage authorizations and priorities within the sustainment function.

(7) Development. The Army must constantly develop and improve. The Army develops individuals through civilian, enlisted, and officer education programs that include character and leader development activities. Education and training programs range from individual self-development, including graduate-level degree programs, to the entire range of branch- and skill-related institutional training culminating at either the senior service college for officers and civilians or Sergeants Major Academy for enlisted Soldiers. Units develop through collective training processes that include individual training in units, home station training, and deployments for training. Examples are Collective Training Tasks (CTT), leader training, live fire and maneuver training, external evaluations such as those consistent with unit Combined Arms Training Strategy (CATS), deployment exercises, and training rotations to the Combat Training Centers (CTC).

(8) Separation. Finally, people and equipment separate from military service. People may separate voluntarily by not extending following completion of an obligated service period or by retiring. Involuntary separation may occur due to Reduction in Force (RIF) actions or qualitative reasons. The Army normally separates materiel through the Defense Reutilization and Marketing Office (DRMO) process or through Foreign Military Sales (FMS) actions.

d. There are two categories of external influences that affect the model,—

(1) The first category is the availability of resources. Resources include tangible assets in the form of funds, materiel, or personnel as well as intangible resources such as time, information, and technology.

(2) The second category is the influence of command, management, and leadership in planning, organizing, directing, controlling, and monitoring the multitude of inputs, decisions, and actions to ensure that functions at each stage of the model execute effectively and at the appropriate time. These command and management activities are synchronized within the Army force generation process to

## HOW THE ARMY RUNS

ensure the timely allocation of scarce resources and to maximize the availability of trained and ready Army forces to meet CCDR force requirements.

### Section II Force Development

#### 3-6. Force Development (FD) Overview

a. FD is the first of three major sub-processes within Force Management. It is a process that defines military capabilities, designs force structures to provide these capabilities, and produces plans and programs which, when executed through force integration (the second major sub-process), translate organizational concepts based on doctrine, technologies, materiel, manpower requirements, and limited resources into a trained and ready Army (see Fig 3-4).

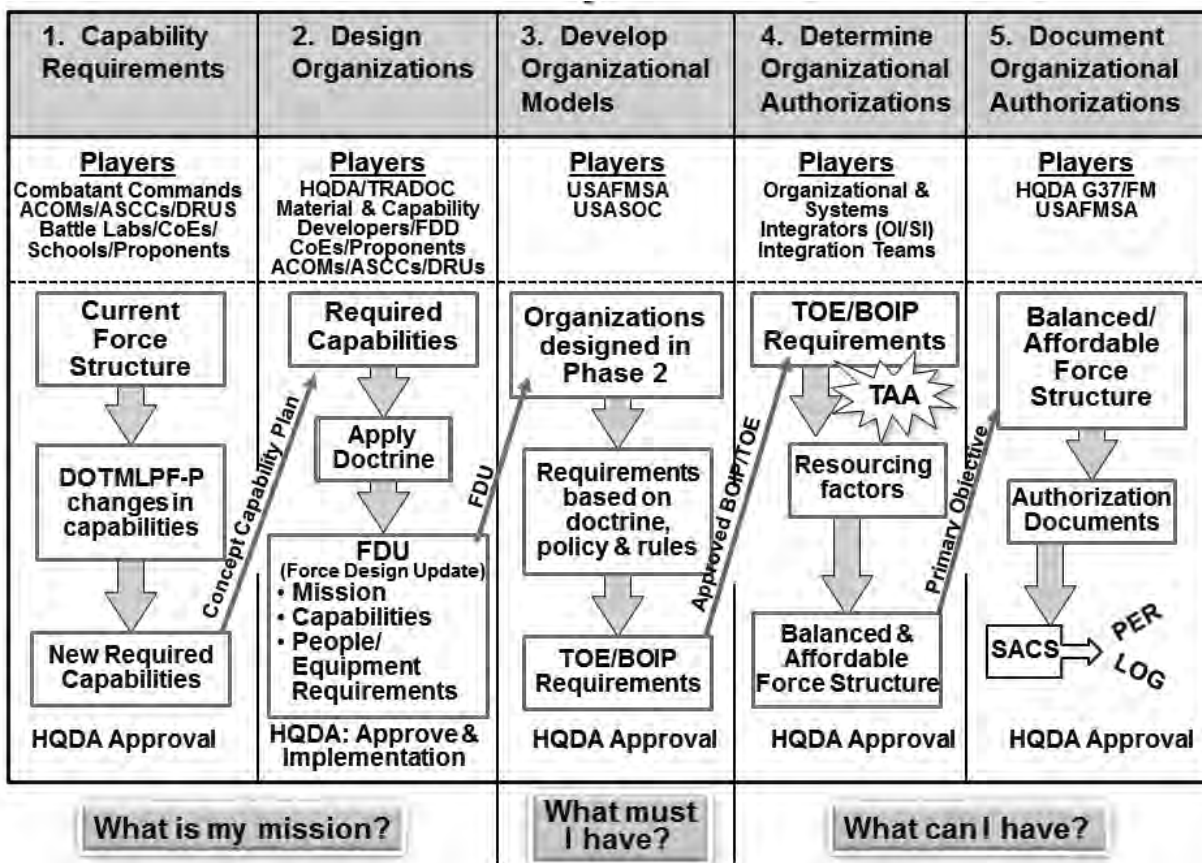

Figure 3-4. Force Development Process

b. The five-phased FD process includes—

- (1) Determine capabilities requirements.
- (2) Design organizations.
- (3) Develop organizational models.
- (4) Determine organizational authorizations.
- (5) Document organizational authorizations.

c. Force development starts with the operational capabilities desired of the Army as specified in national, defense, joint, and Army level strategies (see Chap 2, Strategy) as well as the needs of the CCDR. Strategic guidance identifies the Range of Military Operations (ROMO) that the Nation's leaders expect their military forces to perform, the effects they must achieve, the attributes those forces must



possess, where they must operate, and generally what kind and what size of force is expected to execute those operations. Strategic guidance is informed by the demands of the Operational Environment and Changing Character of Warfare (U.S. Army Training and Doctrine Command (TRADOC) Pam 525-92) and the projected future Joint Operating Environment-2035 (JOE-2035). These visualizations of the Operational Environment (OE) describe the composite of conditions, circumstances, and influences that affect the employment of military capabilities. They also serve as a foundation to synchronize service force development efforts around a common set of assumptions about the future joint operating environment.

d. The JOE provides the framework for the development of more specific concepts that are intended to accomplish the strategic objectives and decisively prevail within the JOE. These concepts, in turn, provide a visualization of how joint and Army forces will operate 10-20 years in the future, describe the capabilities required to carry out the range of military operations against adversaries in the expected OE, and how a commander, using military art and science, might employ these capabilities to achieve desired effects and objectives. Concepts enable the development of future capability descriptions within a proposed projection of future military operations. Each concept describes the operational challenges, the components of potential solutions, and how those components work together to address those challenges.

e. Similarly, the Army provides its own description of the Future Operational Environment with TRADOC Pam 525-92, The Operational Environment and the Changing Character of Warfare. The Pam was developed concurrently by TRADOC G2 and U.S. Army Futures Command (AFC). This Pamphlet further refines the vision of the future environment that will guide Army concept development efforts. The TP 525-92 postulates and describes a continuum of rapid and dynamic advances in science and technology accompanied with rapid societal changes that will occur in two distinct timeframes it terms as: “The Era of Accelerated Human Progress (2017-2035)” and the Era of Contested Equality (2035-2050). These two eras will pose different doctrinal and technological challenges for the U.S. Army in the near to mid future and will form the foundation for developing Future Army Concepts designed to prevail in this environment.

f. The force development process then determines Army DOTMLPF-P capabilities-based requirements and produces plans and programs that, when executed through force integration activities, brings together people and equipment and forms them into operational organizations with the desired capabilities for the CCDRs. Force development uses a phased process to develop operational and organizational plans, and then combines them with technologies, materiel, manpower, and constrained resources to eventually produce combat capability.

g. The force development process interfaces with the Joint Strategic Planning System (JSPS), the Defense Acquisition Management System (DAS), the Joint Operations Planning and Execution System (JOPES) and the DOD Planning, Programming, Budgeting, and Execution (PPBE) process.

h. The products of force development provide the basis for acquiring and distributing materiel and acquiring, training, and distributing personnel to achieve the ultimate goal of fielding an effective, balanced and affordable force.

### **Section III**

#### **Force Development Phase I—Develop Capability Requirements**

##### **3-7. Joint Capabilities Integration and Development System (JCIDS)**

See Chapter 10.

##### **3-8. Army Implementation of JCIDS Overview**

a. The Army FD process begins with capabilities-based requirements generation. Army JCIDS develops an integrated set of Army DOTMLPF-P requirements that support national-, defense-, joint-, and Army-level strategy and the operational needs of the combatant commands (CCMD). This process assesses joint and Army warfighting concepts in the context of the future joint operating environment to identify functional needs and solutions. The future operating environment describes the physical, demographic, political, economic, technological, and military conditions in which the Army will operate.

b. The Army portion of JCIDS is informed by the development of an Army Concept Framework (ACF). The ACF includes the Army Capstone Concept (ACC), Army Operating Concept (AOC) Multi-Domain Operations (MDO 1.5), Army Functional Concepts, and concepts directed by CG, AFC. These concepts

## HOW THE ARMY RUNS

provide an intellectual foundation for conducting Capabilities Based Assessments (C-BA) of the current force's ability to meet future operational challenges. Properly applied, Army JCIDS produces an integrated set of DOTMLPF-P solution approaches that collectively satisfy the identified required capabilities (RC). The Army JCIDS provides traceability of all Army system and non-system solutions back to the associated strategies and related concepts.

c. The C-BA identifies and documents capability gaps; determines the attributes of a capability or combination of capabilities that would fill the gaps; and identifies non-materiel and/or materiel approaches for possible implementation. The concepts-centric Army JCIDS process provides a robust analysis of warfighting capabilities required to prevail in the future operational environment. This process helps ensure the Army considers the most effective joint force capabilities and the integration of those capabilities early in the process. Appropriate component, cross-component, and interagency expertise; science & technology community initiatives; and wargaming and experimentation results are considered in the development of suitable DOTMLPF-P solutions.

d. Joint and Army JCIDS documentation—Initial Capabilities Document (ICD), Capability Development Document (CDD), CDD update if required, and the DOTMLPF-P Change Recommendation (DCR's are for a non-materiel capability)—provides the formal communication of related DOTMLPF-P capability developments between the user and the acquisition, test and evaluation, and resource management communities (see Chap 10 for more detail on the ICD, CDD, and DCR).

### 3-9. Capabilities Development and Integration

The Army's Futures and Concepts Center (FCC) assesses the threat and future OE; develops future concepts and the Army modernization strategy; and determines requirements to drive new capabilities and formations. It uses a collaborative approach to capabilities development and integration. Through the Cross Functional Teams (CFT), the AFC empowers and integrates teams of requirements, acquisition, science and technology, test and evaluation, resourcing, contracting, costing, and acquisition logisticians' expertise to maximize integration efforts using limited resources. Proponent led teams also use a collaborative approach for capabilities integration during the concept and capabilities developments cycle. These teams efficiently expedite the JCIDS and acquisition processes through the early involvement of key stakeholders and SMEs from different agencies and services. CFTs also demonstrate integration of the Future Force Modernization Enterprise (FFME), including U.S. Army Forces Command, other Army Service Component Commands, and leveraging of industry and academia.

### 3-10. Concept Development and Experimentation (CD&E)

CD&E supports current and future force development. Concepts, developed and refined through wargames and experiments, are the basis for determining the capabilities required for the future force. The translation of concepts into capabilities is an iterative process.

a. Concepts. Concepts are the centerpiece of the CD&E process. They establish the intellectual foundation for Army modernization and help Army leaders identify opportunities to improve future force capabilities. An operational concept is a generalized visualization of operations in the future environment. It describes a problem to be solved, the components of the solution to that problem, and the interaction of those components in solving the problem.

(1) Concepts serve as the foundation for architecture development and for generating capabilities-based DOTMLPF-P solutions such as: doctrine modification and development, organizational design changes, training initiatives, materiel solutions, leadership and education requirements, personnel changes such as creating a new MOS or new skill identifier, facilities renovation and/or design, and policy modification or formulation and adoption. The DOTMLPF-P solutions are created through an evolutionary development process that results in improved capabilities.

(2) Components of an operational concept include a description of the future joint operating environment and its associated range of operational challenges, a set of concepts that address the "how to" of countering and overcoming the challenges posed, and a corresponding set of required capabilities and initial force design principles needed to implement the concept.

b. Joint and Army Concept Development. Fundamental ideas about future concepts of military operations and their associated capabilities are documented in operational concepts. To maximize their future utility, concepts are broadly based and encompass both the art and science of future warfighting and are continually refined through wargaming, experimentation, assessment, and analysis.

## FORCE MANAGEMENT

(1) Joint concepts consists of a Capstone Concept for Joint Operations (CCJO), related Joint Operating Concepts (JOC) and Supporting Joint Concepts. These concepts address the period from just beyond the Future Years Defense Program (FYDP) out 20 years.

(a) CCJO. The CCJO is the vision of the Chairman of the Joint Chiefs of Staff (CJCS) and the overarching joint concept that guides joint force development and bridges strategy with operational concepts and future doctrine. The CCJO is approved by the CJCS. The CCJO articulates a high-order vision of how the future force will operate, describes the future operating environment, advances new concepts for joint operations, and suggests attributes that will define the future force. The CCJO aims to establish a bridge from strategic guidance to subordinate concepts, force development guidance, and follow-on doctrine. Service concepts and subordinate Joint Concepts (JCs) and Joint Capability Areas (JCAs) expand on the CCJO solution. The CCJO concludes by presenting risks and implications associated with the concept. The current CCJO is “globally integrated operations” with the following key elements: mission command; regional focus with global agility; leverage partners to maximize mutual advantage; flexible options in establishing joint forces—Active Component/Reserve Component (AC/RC) mix; cross-domain synergy; use of flexible, low signature capabilities; and threat discrimination.

(b) Joint Operating Concepts. JOCs link strategic guidance to the development and employment of future joint force capabilities and serve as “engines for transformation” that may ultimately lead to DOTMLPF-P changes. Collectively, JOCs describe required capabilities across the full range of military operations and encourage further examination through wargaming, joint training and a variety of studies, experimentation and analyses.

(c) Supporting Joint Concepts. Supporting Joint Concepts provides depth and detail to single and/or multiple JOCs by describing how the future Joint Force is expected to conduct a JOC mission or perform joint functions. Approved Supporting Joint Concepts drive the conduct of Capabilities-Based Assessments and other analyses designed to examine capability gaps and support the refinement and implementation of non-material and material solutions needed to achieve required capabilities and desired objectives specified in the concept.

(2) Army Concept Framework. The Army records its fundamental ideas about future joint operations in the ACF, promulgated in TRADOC 525-series pamphlets. The ACF consists of the ACC, the AOC MDO 1.5, the AFCs, and concepts directed by CG, TRADOC. Concepts facilitate the visualization and communication of the Army’s projections of future operations (see Fig 3-5).

(a) The ACC usually acts as the lead document of the ACF. However, TRADOC Pam 525-3-0, The U.S. Army Capstone Concept, was recently rescinded by AFC/FCC due to obsolescence and is under revision.

(b) The AOC, documented in TP 525-3-1, The U.S. Army Operating Concept, The U.S. Army in Multi-Domain Operations 2028, expands upon the ideas previously explained in Multi-Domain Battle: Evolution of Combined Arms for the 21st Century. It describes how the Army contributes to the Joint Force’s principal task, as defined in the unclassified Summary of the National Defense Strategy, to deter and defeat Chinese and Russian aggression in both competition and conflict. The U.S. Army in Multi-Domain Operations concept proposes detailed solutions to the specific problems posed by the militaries of post-industrial, information-based states like China and Russia. Although this concept focuses on China and Russia, the ideas also apply to other threats. The U.S. Army in Multi-Domain Operations 2028 concept is intended to guide the development of a comprehensive Army modernization strategy that is synchronized with a joint approach to force development; drive rapid, non-linear solutions in Army doctrine, organization, training, material, leadership and education, personnel, facilities, and policy; deepen the operational integration of both general purpose and special operations forces and also improve integration with U.S. allies and partners.

(c) The AFCs describe how the Army force will perform a particular military function across the full range of military operations 6-18 years in the future. AFCs support the ACC and AOC as well as joint concepts, and draw operational context from those documents. Organized along the lines of the classic functions of a military force, the seven AFCs are Fires, Intelligence, Mission Command, Movement and Maneuver, Protection, Sustainment, and Engagement. As an integrated suite of concepts, they describe the full range of land combat functions across the range of military operations. AFCs may include the details required to initiate the JCIDS Capabilities-Based Assessment.

## HOW THE ARMY RUNS

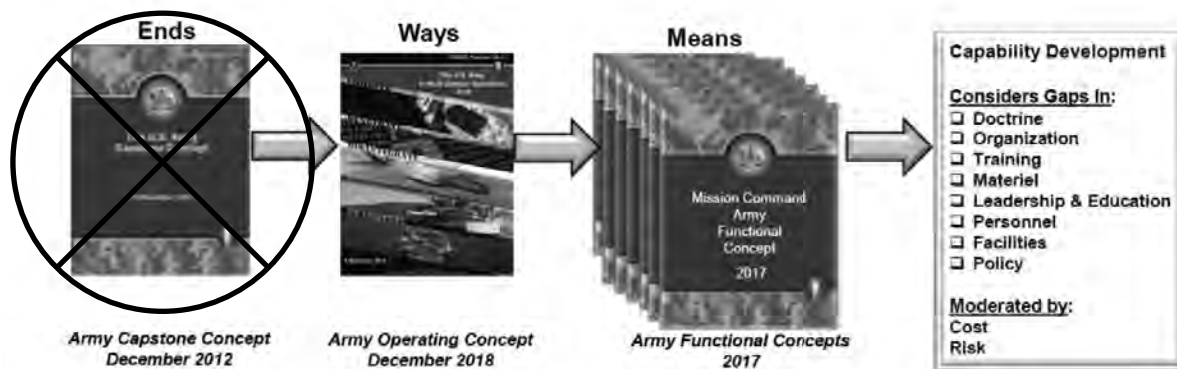

- The Army determines its required capabilities starting with concepts
- The Army Concept Framework provides the integrated vision of the future Army, to include Required Capabilities, necessary to support JCIDS (Joint Capabilities Integration and Development System) and capabilities development
- The Army organizes its concepts through warfighting functions:
  - Mission Command
  - Intelligence
  - Movement and Maneuver
  - Fire
  - Protection
  - Sustainment
  - Engagement
- Additional concepts address Learning and Training, Building Partnership Capacity, and the Human Dimension

**Figure 3-5. Army Concept Framework**

(d) An additional concept is devoted to improving the learning and training approaches to keep pace with the demands of the future environment. The Army Learning Concept for Training and Education (ALC-TE) provides the Army visualization of the future learning environment. It describes a continuous, adaptive learning enterprise that facilitates a career-long continuum of learning. The ALC-TE creates the conditions necessary for the Army to develop trained and capable Soldiers and Army civilians with the knowledge and skills needed to generate and sustain trained teams that improve and thrive under conditions of ambiguity and chaos.

c. Concept of Operations. A CONOPS is a verbal or graphic statement, in broad outline, of a commander's assumptions or intent in regard to an operation or series of operations. A CONOPS is designed to give an overall picture of the operation and provides a useful visualization of how a future operation would be conducted. It is frequently embodied in campaign and/or operational plans, particularly when the plans cover a series of connected operations to be carried out simultaneously or in succession. When used in concept development, a CONOPS is a tool to help describe how a particular operation is conducted in the future.

(1) For joint concepts and the ACF, CONOPS provide the overall understanding of an operation and the broad flow of tasks assigned to subordinate and/or supporting entities. It presents the joint force or land component commander's plan that maps capabilities to effects to accomplish the mission for a specific scenario eight to 20 years into the future. CONOPS focus on describing the end-to-end streams of activities and how the commander might organize and employ forces to accomplish those activities.

(2) The following two types of CONOPS may be used in the joint concepts and the ACF concept development process:

(a) Illustrative vignettes provide operational context to describe how a joint force commander might organize and employ forces eight to 20 years into the future. These vignettes are used to clarify and increase understanding of the concepts.

(b) Defense Planning Scenarios (DPS) and Army scenarios (based on DPS) are written eight to 20 years into the future, to facilitate experimentation and Capabilities-Based Assessment under JCIDS.

These scenarios have classified CONOPS that provide a high level of specificity and defined parameters to aid in robust analysis of capabilities and a comparison of alternate solutions.

(3) For near-term requirements, CONOPS have a different use. They are written to describe how a joint force and/or Army commander may organize and employ forces now through seven years into the future in order to solve a current or emerging military problem. These CONOPS provide the operational context needed to examine and validate current capabilities and examine new and/or proposed capabilities required to solve a current or emerging problem. There is no strict format for a CONOPS used to support capabilities development, but it should cover the following areas at a minimum: the problem being addressed; the mission; the commander's intent; an operational overview; functions or effects to be carried out/achieved; and the roles and responsibilities of affected organizations.

d. Force Operating Capabilities (FOCs).

(1) The FCC establishes required FOCs as the foundation upon which to base the JCIDS Capabilities-Based Assessment process. These critical, force-level, measurable statements of operational RC frame how the Army will realize future force operations as stated in the approved ACC, AOC, and AFCs. The FOCs help focus warfighting CD&E efforts. All warfighting capabilities-based requirements must have direct linkage through an FOC to an approved Army concept (capstone, operating, and functional) and The Army Plan (TAP). FOCs are listed TRADOC Pamphlet 525-66 and periodically updated.

(2) TRADOC Pamphlet 525-66 also guides Independent Research & Development (IR&D) efforts. By providing the private sector an unclassified, descriptive list of desired FOCs, the Army is able to tap into a wealth of information and new ideas on different means to achieve those capabilities. The Army encourages industry to share these ideas with the appropriate Capability Developer (CAPDEV) and Training Developer (TNGDEV) organizations.

e. Experimentation. Experimentation is the heart of JCIDS. Experimentation explores warfighting concepts to identify joint and Army DOTmLPF-P Change Recommendations (DCRs) and related capabilities needs. It provides insight and understanding of the concepts and capabilities that are possible given the maturity of specific technologies and capabilities that need additional research and development emphasis. The results of joint/Army experimentation help define the art-of-the-possible and support the identification of DOTmLPF-P solutions to provide new capabilities. Progressive and iterative mixes of high fidelity Live, Virtual, Constructive (LVC) and simulations using real Soldiers and units in relevant, tactically competitive scenarios provide joint/Army leaders with FOC insights. Warfighting experiments are conducted to gain an understanding about some aspect of future warfighting and serve as "way points" on the path to the future force.

(1) The Joint Staff, J-7 periodically publishes a joint development execution plan that examines joint development through experimentation. The plan provides a brief highlight of each experimentation project including its purpose, scope, end state, expected deliverables, and dates of completion.

(2) The Army also has an experimentation plan intended to examine future force development issues. It integrates Army CD&E in a coherent service and/or joint context to ensure the Army provides CCDRs with sustained land capabilities that are an indispensable, decisive component of the joint force. Correspondingly within the FCC, the Joint Modernization Command (JMC) plans, prepares and executes Joint Warfighting Assessments (JWA) and other concept and capability assessments, provides objective analyses and feasible recommendations to enhance functional capabilities and inform Army Modernization decisions. When required, it also conducts directed assessments in support of AFC's Cross Functional Teams. The objective is to validate Army concepts with the operational force prior to implementation, assess integration of significant, complex changes across the DOTMLPF-P spectrum, support the AOC central ideas; and through Army experimentation, provide Network Integrated Evaluations (NIE) with technology solutions ready for evaluation. Ultimately, the goal of CD&E is to reduce risk through learning, innovation, and pushing the limits of the possible. The Army experimentation plan is a holistic effort that inductively and deductively examines the future, supporting both current and future force development. Simply put, the Army experimentation plan is about what the Army must learn, when, and how. Army experimentation is hypothesis based, where the overarching hypothesis is that the future force capabilities will provide the joint force commander a means to prevail against adversaries by providing a much broader range of decisive capabilities.

f. Summary. In summary, a robust CD&E program can optimize return on investment while acknowledging that there are elements of the future that cannot be forecasted. Conducting a deliberate and coordinated CD&E program enables modernization by ensuring some resources are allocated to

## HOW THE ARMY RUNS

prototyping emerging concepts and capabilities which, in turn, enable robust and adaptive implementation of the related required capabilities.

### 3-11. Capabilities-Based Assessment Process

a. The Army C-BA is a structured JCIDS process. The three major phases of the Army C-BA are the Functional Area Analysis (FAA), Functional Needs Analysis (FNA), and Functional Solution Analysis (FSA) (see Fig 3-6).

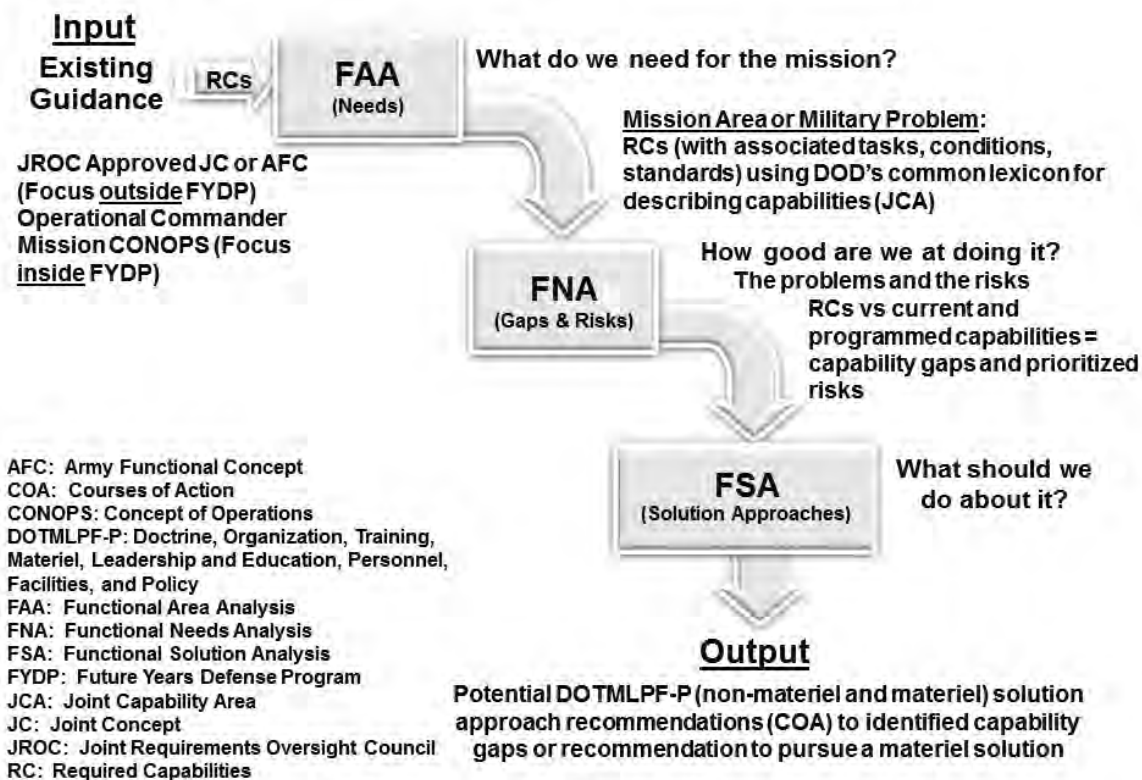

Figure 3-6. Capabilities-Based Assessment Process

b. Future JOE. The C-BA process begins with an analysis of the future joint operating environment. As outlined in paragraph 3-6 above, the JOE describes the physical, demographic, political, economic, technological, and military conditions in which the joint/Army force will operate during the next 25 years. This cohesive vision of the future joint operating environment provides the common underlying context for all services' development of their respective Operational Environments (OE). The JOE serves to help synchronize service modernization efforts based upon a common set of base assumptions regarding the context of future threats and opportunities and related service-specific roles, missions and functions. Consequently, the JOE and detailed service specific visions (TRADOC Pam 525-92, The Operational Environment and the Changing Character of Warfare) serve as the foundation for both joint and service concepts that, in turn, provide the framework for a more detailed Functional Area Analysis (FAA).

c. FAA. The FAA is the first analytical phase of the JCIDS-directed Capabilities-Based Assessment. Strictly a capabilities-based task analysis, the FAA provides the framework to assess Required Capabilities (RCs) in the follow-on Functional Needs Analysis (FNA).

(1) The input to the FAA is an approved Joint Capability Area (JCA), Army Functional Concept (AFC), or CONOPS that describes how the force will operate, the timeframe and environment in which it must operate, its RCs (in terms of missions and effects), and its defining physical and operational characteristics. The FAA must start with the military problem to be examined. The FAA isolates the RCs documented in the concept, identifies those tasks that the force must perform, the conditions of task

performance, and the required performance standards. The output is a list of RCs and associated tasks and attributes. Mapped to each RC, the tasks, conditions, and standards are developed to the level required for analysis against which current and programmed capabilities will be evaluated in the follow-on FNA. Not all warfighting concepts will necessarily generate an FAA.

(2) The FAA is based on professional military knowledge of established doctrine and standards and modified to account for the projected concept for future operations and organizations. The FAA employs operational analysis that is primarily qualitative in nature. The analysis must identify the tasks that must be performed to accomplish the mission or achieve the required effects, and the specific conditions (e.g., weather, terrain, threat) in which the tasks must be performed. The performance standards developed for required tasks are found in the Army Universal Task List, Universal Joint Task List, approved concepts, or based on operational experience.

d. FNA. The FNA is the second analytic phase in the Capabilities-Based Assessment. It assesses the ability of current and programmed Army capabilities to accomplish the tasks identified in the FAA, in the manner prescribed by the concept, under the full range of operating conditions, and to the prescribed standards. The FNA will identify any gaps and overlaps in capabilities and the risk posed by those gaps. The FNA determines which tasks identified in the FAA cannot be performed, performed to standard, performed in some conditions, or performed in the manner that the concept requires using the current or programmed force; and which of these gaps in capability pose sufficient operational risk to constitute needs that require a solution. Capability needs are defined as those capability gaps determined to present unacceptable risk. Following the FNA, the Director, FCC will direct the Center of Excellence (CoE) or proponent to proceed with an FSA for those needs considered critical to executing operations IAW the concept.

(1) The tasks, conditions, and standards identified in the FAA and a list of current and programmed capabilities are the inputs to the FNA. The initial output of the FNA is a list of all gaps in the capabilities required to execute a concept to standard. When these gaps are subjected to risk analysis, the final output is a list of prioritized gaps (needs), which are capabilities for which solutions must be found or developed. Not all capability gaps will be identified as needs.

(2) In its simplest form, the FNA is a comparison of RCs to existing and programmed capabilities and the identification of the corresponding gaps. It must accurately and fairly assess current and programmed solutions' ability to provide RCs when employed in the manner and conditions called for by the AfC and/or CONOPS. The FNA includes supportability as an inherent part of defining the capability needs. Emphasis will be placed on defining capabilities by functional domain, describing common attributes desired of subordinate systems, Family of Systems, or System of Systems and non-materiel solutions. Required capabilities must address joint and coalition warfare applications. The issue of determining whether the risk posed by specific capability gaps rises to the level of need, and to decide the relative priority of competing needs is a leadership decision. The FNA must provide the Army's leadership with an understanding of the operational effect of each identified capability gap at levels ranging from the simplest functional or tactical task to tasks of potentially operational or strategic impact.

e. FSA. The FSA is the third analytic phase in the Capabilities-Based Assessment. It is an operationally based assessment of potential non-materiel DOTmLPF-P and/or materiel approaches to solving or mitigating one or more of the capability needs determined from the FNA. The FSA describes the ability of each identified approach to satisfy the need. The FNA high-risk capability gaps are inputs to the FSA. The outputs of the FSA are the potential materiel and/or non-materiel approaches to resolve the capability needs. The FSA is composed of two sub-steps: ideas for non-materiel DOTmLPF-P approaches; and ideas for materiel approaches.

(1) Approaches proposed by an FSA must meet three criteria: first, they must be strategically responsive and deliver approaches when and where they are needed; second, they must be feasible with respect to policy, sustainment, personnel limitations, and technological risk; and third, they must be realizable in that DOD could actually resource and implement the approaches within the timeframe required.

(2) Sub-step 1: Ideas for non-materiel approaches. Potential non-materiel solution approach recommendations are sometimes called DOTmLPF-P or DOT\_LPF-P. The first sub step in the FSA identifies whether a non-materiel (DOTmLPF-P) or integrated DOTMLPF-P approach can address the capability gaps (needs) identified in the FNA. It first determines how the needed capability might be met by changes in DOTmLPF-P or existing materiel short of developing new systems. These include changes in quantity of existing materiel, improving existing materiel, adopting other services' materiel, or

## HOW THE ARMY RUNS

purchasing materiel from non U.S. sources. If the analysis determines that the capability can be partially or completely addressed by a purely DOTmLPF-P approach, a DCR is prepared and appropriate action is taken IAW the JCIDS Manual. If it is determined that DOTmLPF-P changes alone are inadequate and that product improvements to existing materiel, adoption of other service or interagency materiel, acquisition of foreign materiel, or a new materiel approach is required, the FSA process continues to sub step 2 below. Some capability proposals will involve combinations of DOTmLPF-P changes and materiel changes. Also, these proposals continue through the FSA process at sub step 2.

(3) Sub-step 2: Ideas for materiel approaches. Materiel approaches or courses of action are identified to provide the RCs. The collaborative nature of this effort is meant to develop potential joint solutions. The process brainstorms possible materiel approaches and always includes existing and future materiel programs that can be modified to meet the capability need. The DOTmLPF-P implications of a materiel solution must always be considered throughout the process.

f. Capabilities-Based Assessment Recommendations. A Capabilities-Based Assessment (C-BA) offers actionable recommendations for both non-materiel and materiel solution approaches (see Fig 3-7).

(1) Potential non-materiel solution approach recommendations include the following:

(a) Change policy.

(b) Change doctrine.

(c) Create new and/or modify existing organizations.

(d) Train and educate DOD personnel differently.

(e) Acquire commercial or non-developmental items.

(f) Acquire more quantities of existing items or commodities to include increases in manpower operational tempo, spare parts, and fuel supplies.

(g) Create new personnel MOS or ASIs.

(h) Create, move or realign infrastructure/facilities to address new mission areas.

(2) Materiel initiatives tend to fall into three broad categories (listed in terms of fielding uncertainty from low to high):

(a) Development and fielding of information systems (or similar technologies with high obsolescence rates) or evolution of the capabilities of existing information systems.

(b) Evolution of existing systems with significant capability improvement (this may include replacing an existing system with a newer more capable system, or simple recapitalization).

(c) Breakout systems that differ significantly in form, function, operation, and capabilities from existing systems and offer significant improvement over current capabilities or transform how the Army accomplishes the mission.

g. TRADOC tasks a CoE or proponent to develop the initial DOTMLPF-P capabilities document(s), such as the ICD and/or joint DCR. When documented, TRADOC submits DOTMLPF-P solution sets to HQDA G-3/5/7 for ARSTAF staffing and CSA, VCSA, and or CG, AFC validation and approval via the Army Requirements Oversight Council (AROC) validation process (see Chap 10).

h. Processes that may substitute for the C-BA. DOD and the Army have several processes in place that can be used in lieu of a formal C-BA or supplement those analyses—

(1) Joint Capabilities Technology Demonstration (JCTD). The Military Utility Assessment (MUA), which is completed at the end of the JCTD, may be a suitable replacement for the required analysis used as the basis for ICD preparation. MUAs that do not contain the critical elements of information presented in the ICD (description of the capability gap(s); associated tasks, conditions and operational performance standards/metrics; and how the materiel and non-materiel approaches and analyses from the JCTD addressed these factors), will be augmented with a final demonstration report to qualify the results as equivalent to an ICD. The MUA/final demonstration report will be used to support the development and subsequent AROC and/or JROC validation of the CDD or updated CDD if required. A CDD or updated CDD, as appropriate, will be developed for the JCTD to transition into a Defense Acquisition System Program of Record (DAS POR).

(2) Prototypes. Results of prototype projects and operationally validated quick reaction technology projects intended for direct transition to fielded capabilities may also be eligible for consideration as a potential solution approach. This consideration will be based on mission need validation and MUA processes as applied to the JCTDs.

(3) Joint Urgent Operational Needs Statement, Joint Emergent Operational Needs Statement, or Service's Urgent Needs Processes (see Chap 10).



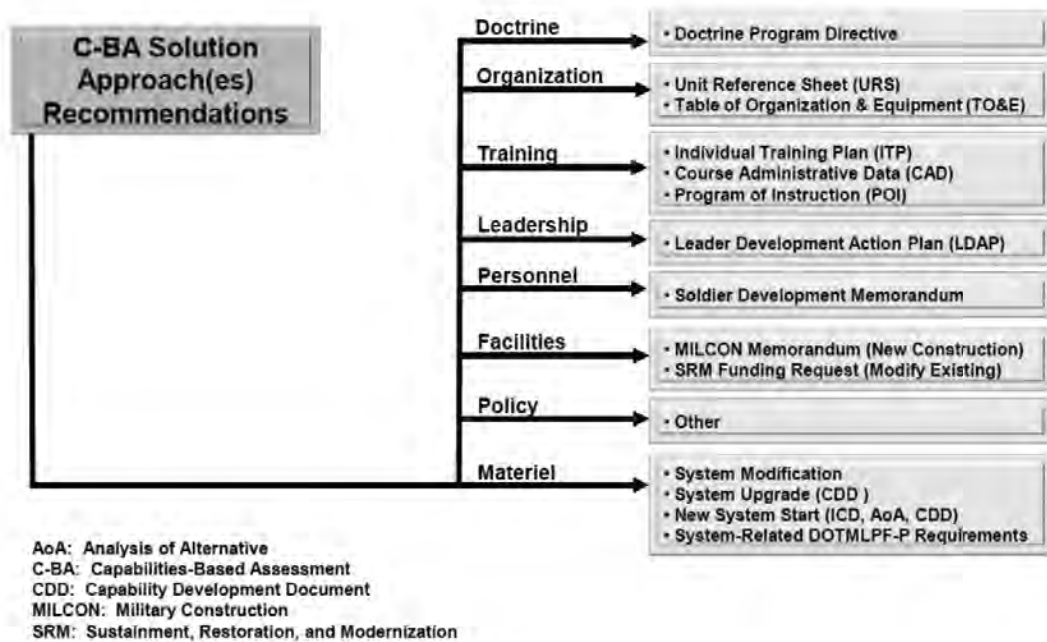

Figure 3-7. Solutions Documents

i. Overall, the capabilities-based Army JCIDS process examines the Army’s current capabilities, postulates what future capabilities will be required, estimates what risks are associated with not fielding those capabilities, and compares those risks with what those capabilities may cost. The Army learned many lessons from the wars in Iraq and Afghanistan and with the implementation of accelerated, or rapid, fielding processes used to develop the Stryker Brigade Combat Teams. These lessons have informed changes to how the Army generates current and future force structure requirements. Inserting an up-front and robust integrated analysis based on guidance from overarching joint and Army concepts allows informed decisions earlier in the process, producing refined DOTMLPF-P solution proposals and making it easier to synchronize development and fielding. In addition, this process allows requirements to be traced back to national strategies, concepts, and policies, thus helping to eliminate redundant capabilities within the Army and DOD.

**Section IV**  
**Force Development Phase II—Design Organizations**

**3-12. Organizational Design**

Organizational requirements flowing from the FSA determine whether a new or modified organization is required on tomorrow’s battlefield. Once identified, organizational requirements are documented through a series of connected organizational development processes, to include: Unit Reference Sheet (URS) development; Force Design Update (FDU) process; TOE development; BOIP development; and TAA. Every process may not always be required before organizational changes are made to the force structure and the process steps may occur out of sequence. For instance, phase III, Development of Organizational Models, may start before the end of Phase II, Designing Organizations.

**3-13. The Organizational Design Process**

a. Organizations have their beginnings in warfighting concepts. These provide the conceptual basis for the proposed organization and address its mission, functions, and required capabilities. The Combat Developers at TRADOC CoEs and other force modernization proponents develop new organizational designs or correct deficiencies in existing organizations. As previously indicated, the Director, FCC

## HOW THE ARMY RUNS

integrates and validates concepts developed for future force capabilities. These concepts normally address or influence:

- (1) Missions, functions, capabilities, and limitations.
- (2) Mission command linkages.
- (3) Individual, collective, and leader training requirements.
- (4) Sustainment in field and garrison.
- (5) Doctrinal impacts.
- (6) Impacts on materiel programs.

### 3-14. Force Design Update (FDU)

#### a. The FDU—

(1) Includes capabilities development, capabilities determination, requirements approval, and implementation decisions.

(2) Develops organizational design solutions to overcome identified capability shortfalls that cannot be accommodated by doctrine, training, leadership and education, facility, or policy solutions. As part of the solution development, AFC CDIDs, TRADOC CoEs force modernization proponents, and non-TRADOC force management proponents consider courses of action across DOTMLPF-P with the intent of deriving materiel, personnel, and organizational solutions as a last resort. Once an organizational solution becomes the recommendation, the force modernization proponent begins the integration process across the DOTMLPF-P domains.

(3) Includes Minimum Mission Essential Wartime Requirements (MMEWR) (personnel and equipment) for new or modified organizations.

(4) Is developed by CAPDEVs within AFC, TRADOC, MEDCOM, Space and Missile Defense Command, and U.S. Army Special Operations Command (USASOC).

(5) Is coordinated with other CAPDEVs and other Army organizations having a specific interest, including all Army Commands (ACOMs), ASCCs, Direct Reporting Units (DRUs), National Guard Bureau, Office of the Chief, Army Reserve, and Tactical Wheeled Vehicle Requirements Management Office (TWVRMO). After FDUs are approved by the TRADOC FDU process review board, they are available as source documents for TOE development. TOE development is accomplished in parallel with the FDU process (see Fig 3-8).

#### b. AFC —

(1) AFC assesses and integrates the future operational environment, emerging threats, and technologies to develop and deliver concepts, requirements, future force designs, and supports the delivery of modernization solutions.

(2) AFC uses these required capabilities and the JCIDS to create the Army's CNA database that includes capability gaps; FDUs address these CNA organizational capability gaps.

#### c. TRADOC—

(1) Develops and provides FDUs to DCS, G-3/5/7 (DAMO-FM) to develop new organizational requirements or changes to existing TOE organizations to meet current and evolving doctrinal requirements. DCS, G-3/5/7 (DAMO-FM) is the single point of entry to receive the FDU from TRADOC, staff the FDU with the ARSTAF in a Force Integration Functional Analysis (FIFA), and provide HQDA oversight of the FDU process.

(2) Submits FDUs to DCS, G-3/5/7 (DAMO-FM) semiannually. Special out-of-cycle (OOC) FDUs may be conducted to handle complex design issues or issues of special emphasis, such as those directed by HQDA. In addition, force modernization proponents can submit an FDU Junior issue at any time. FDU Junior issues involve minor adjustments that normally do not impact other proponents and do not cause personnel growth including Manpower Requirements Criteria (MARC) growth.

(3) Performs FDU cost benefit analysis (CBA) for submission to DASA-CE for validation (see Chap 10, Resource Management, for more details on the CBA). All FDUs and other force structure initiatives requiring an increase in resources must be offset to result in zero personnel growth (including grade) in the overall authorized force levels for each component. Any potential increase in equipment requirements must be reviewed for resourceability and supportability or include appropriate levels of funding to cover unbalanced growth.

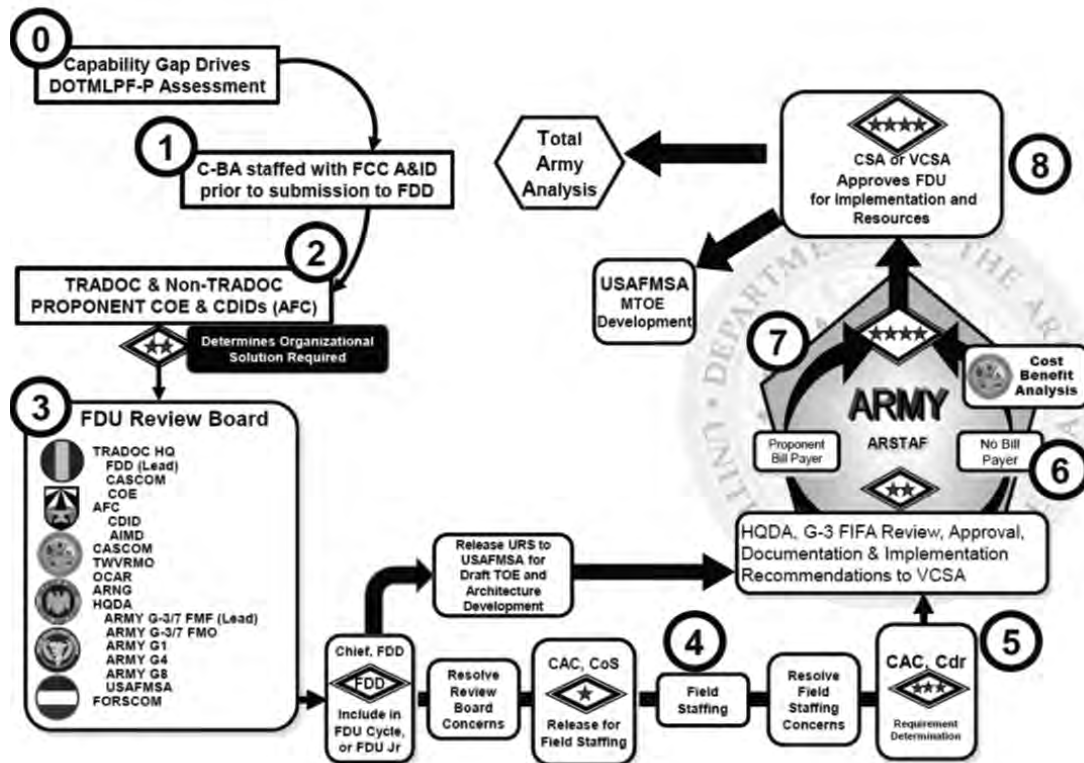

Figure 3-8. Force Design Update

### 3-15. Force Integration Functional Area Analysis (FIFA)

a. HQDA evaluates all proposed organizational changes by using a FIFA analysis to ensure designs are suitable, feasible, and acceptable. To be suitable, the proposed organizational design must accomplish the Army's mission and comply with VCSA and CSA guidance. To be feasible, the proposed organization design (unit, branch, echelon) must have the capability to accomplish the mission in terms of available resources. To be acceptable, the capability advantages gained by executing the organizational design must justify the increased cost in required resources.

b. The FIFA analysis reviews force structure issues and the impacts of force structure decisions on the Total Army. The FIFA determines the ability for the force to be structured, manned, equipped, trained, sustained, funded, and stationed. The FIFA analysis process analyzes the force to assess affordability, supportability, and sustainability. The FIFA analysis may provide alternatives based on prior initiatives, unalterable decisions from ASL, or program budget decisions.

c. FIFA can result in one of three recommendations—

- (1) Implement the change and find resources
- (2) Return to TRADOC for further analysis
- (3) Prioritize the issue of resourcing in the next TAA.

d. The nine FIFAs provide the basis for transitioning organizations from one level of capability to a higher level. FIFAs help force managers assign functional responsibility for issues and integrate the solutions. They are considered and/or applied against a draft TOE or URS. The nine FIFAs are—

(1) Structuring. An organization is properly structured to accomplish its doctrinal mission when the organization, its field maintenance and/or sustainment maintenance structure, and the support infrastructure, have accurate requirements documents, registered UICs, and HQDA-approved authorization documents.

(2) Manning. An organization is properly manned when the organization has assigned all authorized personnel by grade and skill.

(3) Equipping. An organization is properly equipped when the organization has the equipment authorized, including the following: major end items; TMDE; special tools and test equipment;

## HOW THE ARMY RUNS

maintenance floats.

(4) Training. An organization is properly trained when: all required Army training, including new equipment training is completed and evaluated according to mission essential task list standards; all authorized organizational training support materiel and training devices are in unit hands; all institutional training courses and training systems, training ammunition, and training facilities are available; and all doctrinal publications are on hand.

(5) Sustaining. An organization can be properly sustained when all authorized organization-level non-combat personnel are assigned; all support equipment, facilities, spares, and supplies are on hand; the field maintenance and/or sustainment structure and any support infrastructure is structured, equipped, trained, manned, sustained, stationed, and funded to sustain the supported organization; all support publications are on hand; and the organizations have valid DOD activity address codes.

(6) Funding. An organization is properly funded when: all costs associated with the organization and its field maintenance and/or sustainment structure have been identified, programmed, and resourced; and funds are available to support activation, reorganization, conversion, stationing, property turn-in or transfer, transportation, facility construction or renovation, and operational tempo.

(7) Deploying. An organization is deployable and/or employable when its field maintenance and/or sustainment structure, and associated units, are structured, equipped, trained, manned, sustained, stationed, and funded to operate as an element of an Army component command.

(8) Stationing. An organization is properly stationed when the organization and its field maintenance and/or sustainment structure have all required organizational facilities and support infrastructure in place. No degradation of quality of life, safety, or environmental standards can exist.

(9) Readiness. An organization is ready when its overall rating and commodity area category levels are consistent with current Army readiness standards in accordance with Army Regulation (AR) 220-1 and AR 525-30.

e. An approved FDU should support and accomplish each FIFA.

### Section V

#### Force Development Phase III—Develop Organizational Models

##### 3-16. TOE and BOIP Development

a. Organizations in the process of being designed in the preceding phase become the start point for the next phase. Following the first level of approval of the URS during the FDU process, the design goes to USAFMSA for documentation as a TOE. USAFMSA and USASOC develop TOEs and BOIPs codifying the input from the URS basic design.

b. TOEs and BOIPs are developed using FMS. FMS features a relational database for both requirement and authorization documentation and other information management systems as well.

c. Although the organization design phase and organizational model development phase are depicted as separate processes, they are closely related and frequently overlap. The proponent organization designers and the USAFMSA TOE developers work closely to ensure that the designs reflect requirements consistent with doctrine and policy and include all the elements necessary to provide an organization fully capable of accomplishing its doctrinal mission. The approved organization design should capture personnel and equipment requirements as accurately and completely as possible.

##### 3-17. Table of Organization and Equipment Description

a. TOEs provide a standard method for documenting the organizational structure of the Army. A TOE prescribes the doctrinal mission, required structure, and mission essential wartime manpower and equipment requirements for several levels of organizational options for a particular type unit. These organizational options provide models for fielding a unit at full or reduced manpower authorizations if resource constraints so mandate. A TOE also specifies the capabilities (and limitations or dependencies) for the unit.

b. TOEs provide the basis for developing authorization documents and provide input for determining Army resource requirements for use by force managers. These unit models establish increments of capability for the Army to develop an effective, efficient, and combat-ready force structure.

c. The TOE is a collection of related records in the database. There are a variety of records to include narrative information, personnel requirements, equipment requirements, paragraph numbers and titles,

and changes in the form of BOIP records to name a few. A TOE consists of Base TOE (BTOE) records and applicable BOIP records.

d. Document developers construct a TOE in levels of organization based on the manpower requirements necessary to achieve percentage levels such as level 1 (100%) MMEWR, or an organization partially manned by personnel other than Soldiers (level B). As TOE level 1 is the wartime requirement, it is what is reflected in the "required" column of the authorization document (MTOE).

e. FDU decisions, branch proponent input, and Army commands' issues, along with force design guidance developed during capabilities analyses, provide TOE developers with recommended TOE additions/modifications. Doctrine describes how each type of unit will perform its functions and details the mission and required capabilities. Policy and doctrine provide the missions and probable areas of employment of a unit. Policy includes guidance, procedures, and standards, in the form of regulations, on how to develop TOEs. Policy published in Human Resources Command's MOS Smartbook contains Standards of Grade (SG), duty titles, guidance for occupational identifiers (Area of Concentration (AOC), MOS, skill identifier, Special Qualification Identifier, and ASIs used in the development of requirement documents and other organizational plans.

f. TOE developers consider the unit mission and required capabilities when applying equipment utilization policies, MARC, SG, and BOIPs to develop the proper mix of equipment and personnel for an efficient organizational structure. Resource guidance limits the development of draft TOEs, as they must use resources available in the inventory.

### 3-18. BOIP Description

a. BOIP are requirements documents. BOIPs support equipment acquisition and materiel development by identifying and documenting both personnel and equipment requirements. They are developed for new or improved items of equipment, describing in detail the item, its capabilities, component major items of equipment, where the item is to be used, and the associated support items of equipment (ASIOE) and personnel. BOIPs may include personnel changes caused by the introduction of new items into the Army inventory, including the MOS needed to operate and maintain the equipment and any required Additional Skill Identifier (ASI). BOIP personnel changes may impact or be impacted by notifications of future changes. The BOIP includes the following elements: Army prepositioned stocks (APS) activity set, Army war reserve sustainment stocks, war reserve stocks for allies, repair cycle float, operational readiness float, operational projects stock, other TDA requirements and all other requirements.

b. The BOIP process begins in one of two ways: either as an initial submission or as an amendment. When the BOIP feeder data is submitted, reviewed, and accepted by stakeholders, USAFMSA develops/amends the BOIP.

c. The BOIP process identifies MMEWR for inclusion into organizations based on changes of doctrine, personnel, or materiel.

d. A BOIP provides:

- (1) Detailed description of the equipment.
- (2) Capabilities.
- (3) Where equipment is required (TOE/TDA institutional training bases).
- (4) When it is required.
- (5) Support equipment needed.
- (6) Support personnel needed, including operator and crew.
- (7) Equipment and personnel no longer needed.
- (8) Provides Army Acquisition Objective (AAO) elements.

e. There are two types of BOIPs:

- (1) Initial. The first BOIP developed for a new capability.
- (2) Amendment. A change to an already-approved BOIP.

f. The accepted BOIP feeder data (BOIPFD) submitted by the program manager in the Standard Study Number (SSN) Line Item Number (LIN) Automated Management and Integration System (SLAMIS) is the foundation for initial and amended BOIPs.

g. The approved BOIP is documented to the Objective TOE (OTOE) in applicable Standard Requirement Codes (SRCs) and is identified for TDAs to capture institutional and combat training facility requirements.

h. A BOIP is typically applied to unit MTOEs when recommended by the DCS, G-4, G-8, FD and approved by the DCS, G-3/5/7 via force modernization guidance or quarterly documentation guidance.

## HOW THE ARMY RUNS

i. Prior to fielding, the Army Materiel Command (AMC) lead materiel integrator, materiel developer and gaining commands must validate that the new materiel is reflected on an HQDA-approved authorization document and, if not, the PM must obtain and provide the gaining command a letter of authorization prior to fielding of new materiel.

j. BOIP Process.

(1) BOIP Feeder data (BOIPFD)

(a) Developing correct BOIPFD is the first step in the development of a BOIP. The BOIPFD is a compilation of information about a new or improved item of equipment.

(b) BOIPFD will be prepared by the MATDEV following an approved CDD and approved Milestone B decision and will support BOIP completion prior to the Milestone C decision. Prior to submission in SLAMIS, the materiel developer (MATDEV) develops BOIPFD in coordination with the product support management integrated process team (PSMIPT) and invites USAFMSA and other HQDA stakeholders in accordance with AR 700-127. This is intended to ensure timely and accurate submission of BOIPFD.

(c) The materiel developer summarizes information obtained from valid requirements documents and applicable information obtained from the product or project manager.

(d) BOIPFD is the foundation for initial and amended BOIPs and contains information on the functions, capabilities, intended use, initial cost estimate, BOI, personnel, and equipment requirements as well as other information necessary to supply, maintain, and transport the materiel and support requirements.

(e) The materiel developer initiates BOIPFD for initial and amended BOIPFD for changes to approved BOIPs and identifies systems required for institutional training locations

(f) The BOIPFD requires significant coordination by the materiel developer with the institutional schools, combat training facilities, and capability developers, to develop the data that will provide the necessary input for accurate documentation.

(e) BOIPFD will be prepared by the MATDEV and forwarded to USAFMSA within 60 days of the assignment of Developmental Line Item Number (ZLIN) for developmental items and within 30 days for a non-developmental item (NDI).

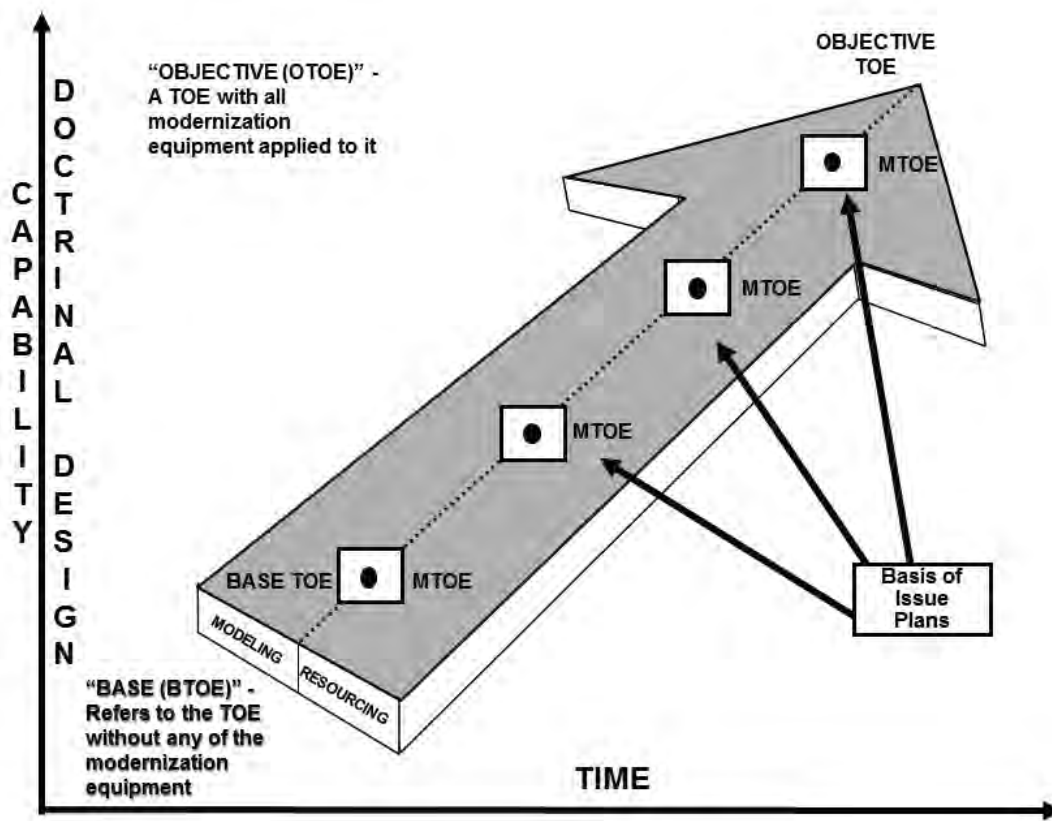

Figure 3-9. Modernization Over Time (Resource-Driven)

(f) When applicable, BOIPFD will include equipment modernization requirements for all schools in the One Army School System, both AC and RC, and in institutional training facilities.

(g) BOIPFD amendments will follow the same staffing process as initial submissions.

(h) Refer to ASA (ALT) policies and procedures for proposing and submitting BOIPFD.

k. BOIP Development and Staffing.

(1) The BOIP development process begins following the acceptance of BOIPFD in the Standard Study Number-Line Item Number Automated Management and Integrating System (SLAMIS). The appropriate USAFMSA branch chief, G-4 manager, and other interested parties (G-1, G-8, TWVRMO, and the Army MARC Maintenance Data Base (AMMDB) managers and other SMEs) participate in the review of the BOIPFD to ensure acceptability and affordability. If the BOIPFD is complete and error-free, the BOIP is accepted by G-37/FM and forwarded to USAFMSA to begin developing the BOIP. Following USAFMSA development of the BOIP, the BOIP is submitted to G-37FM for HQDA staffing.

(2) A HQDA-approved BOIP is required to establish Type Classification Standard (TC STD) designation and MS C decisions. Managers can submit waivers to continue the acquisition process without an approved BOIP through Commander, USAFMSA to DCS, G-3/5/7 (DAMO-FM) for Organizational Requirements Document Approval Briefing (ORDAB) General Officer Steering Committee (GOSC) decision.

(3) New or amended capability BOIPs (and MARC) are reviewed, validated, and approved by the ORDAB for all new or amended capability BOIPs (and MARC) to ensure correct basis of issue, personnel, materiel synchronization, and affordability. G-37/FM announces the decisions on BOIPs. The Council of Colonels (CoC) ORDAB is co-chaired by the Commander, USAFMSA, and the DCS, G-8 (DAPR-FDP) Resource Documentation Division Chief. The ORDAB GOSC is co-chaired by the DCS, G-37 (DAMO-FM), and DCS, G-8 (DAPR-FDZ). It comprises the following members: ASA (ALT); CIO/G-6; DCS, G-1; DCS, G-3/5/7 (DAMO-FM, DAMO-TR, DAMO-CI); DCS, G-4; DCS, G-8 (DAPR-FD); TRADOC; USAFMSA, Army National Guard (ARNG), U.S. Army Reserve (USAR), and other SMEs as required.

e. Application of BOIPs to TOEs, MTOEs, and select TDAs. During BOIP development, USAFMSA documents the BOIP on the TOE. Once a BOIP is accepted, USAFMSA documents the BOIP on the TOE as a draft record, and promotes them to Approval Level 3 in preparation for the ORDAB CoC. The application of the BOIP to MTOEs is done in accordance with the CPLAN cycle and adjusted as needed by DCS, G-3/5/7.

f. DCS, G-3/5/7 (DAMO-FM) announces BOIP decisions. A HQDA approved BOIP is required for ASA (ALT) to continue to TC/FRP at Milestone C.

## Section VI

### Force Development Phase IV—Determine Organizational Authorizations

#### 3-19. Determining Organizational Authorizations

a. The fourth force development phase, determining organizational authorizations, provides the proper mix of organizations, resulting in a balanced and affordable force structure. Force structuring is an integral part of the OSD management systems, PPBE and the JSPS. It is the resource-sensitive process portrayed in the “Determine Authorizations” section of the Army Force Management Model at Figure 3-1. This phase makes decisions on force structure authorizations in support of joint, strategic, and operational planning and Army planning, programming, and budgeting. Force structure decisions draw upon an understanding of the objectives, desired capabilities, and externally imposed constraints (e.g., dollars, total strength, roles, and missions).

b. The determination of the size and content of the Army force structure is an iterative, risk-benefit, trade-off analysis process, not all of which is exclusively within the purview of the Army.

c. TAA supports the evolving force structure transitions, providing the correct number and types of units over the POM period.

#### 3-20. Total Army Analysis (TAA)

TAA is a two phase force structure analysis process that defines the required Army force structure within end strength and accounts for the military and DA Civilian requirements and authorizations necessary to comply with DOD guidance. The TAA provides the basis for the Army's POM development and the

## HOW THE ARMY RUNS

establishment of the POM Force (see Fig 3-10). It is an integral part of the OSD PPBE and the Chairman, JCS's Joint Strategic Planning System. The TAA process develops a fiscally constrained force based on NMS objectives to be achieved and the dynamics of internal and external constraints. The fiscally constrained force is developed to achieve an affordable and effective force to support national objectives.

a. Operational Force (OF) TAA. OF TAA shapes Army force structure and determines the best mix of organizations which are required and resourced as a balanced and affordable force and examines the projected Army force through both quantitative and qualitative analysis. The DCS, G-3/5/7 continuously updates the information, modeling, and analyses used to develop the Army POM Force. TAA is an integral part of the OSD PPBE and the CJCS's JSPS and produces a balanced and affordable force projected to achieve strategic objectives within internal and external constraints.

b. Generating Force (GF) TAA. GF TAA determines the right size and composition of the GF to support the Army's future force structure requirements. This is accomplished through a yearly review of GF capabilities that addresses emerging capabilities growth, restructure initiatives, and rebalancing actions. GF TAA must—

(1) Review TDA structure manpower requirements focusing on military and DA Civilian requirements with the goal of reducing those requirements no longer valid within the current documented capability.

(2) Provide the ASL the opportunity to prioritize GF capabilities, capacity, and manpower mix.

(3) Provide a total Army programmed force and SACDB file as required to build a POM submission.

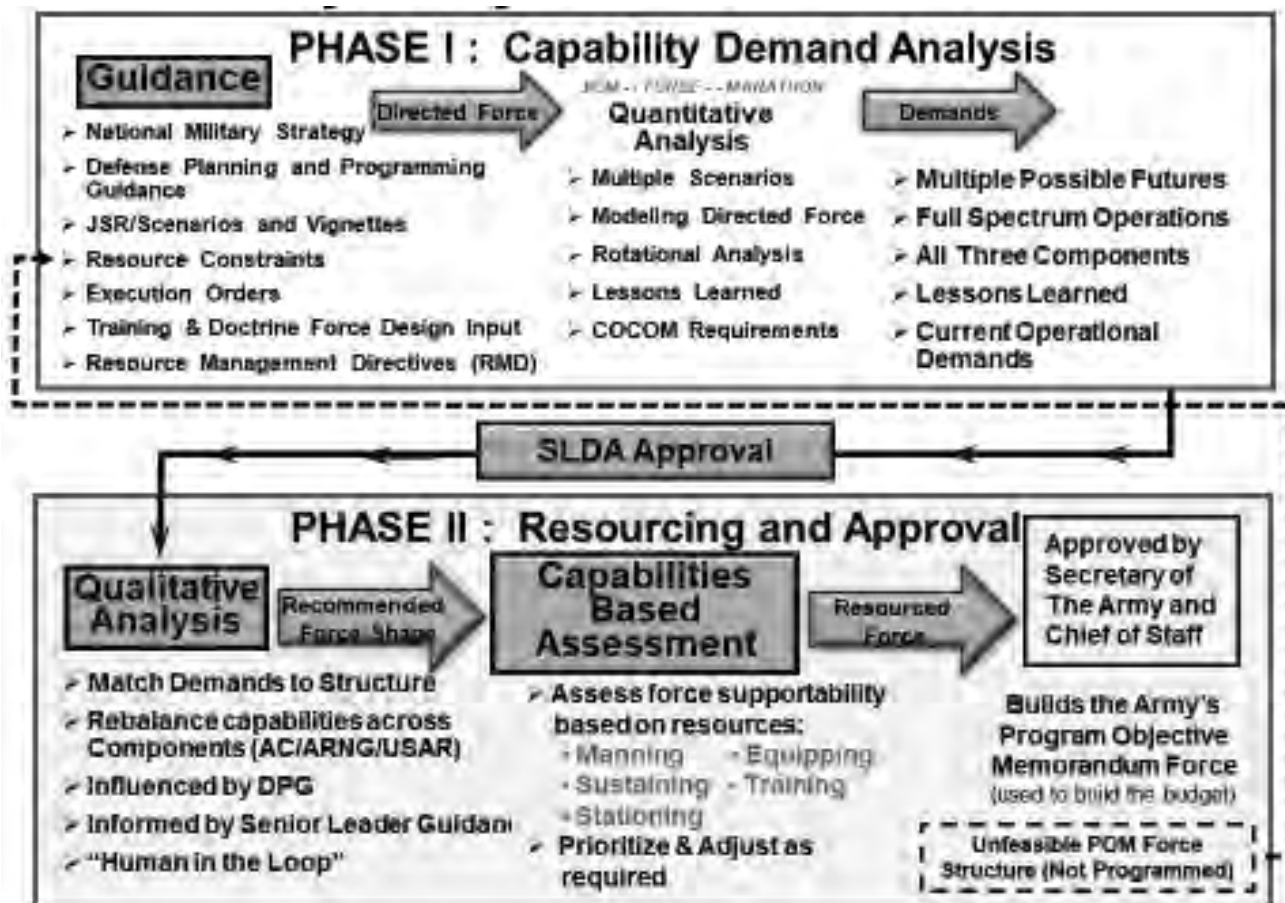

Figure 3-10. TAA "End-to-End" Process

c. TAA Objectives.

(1) Develop, analyze, determine, and justify a POM Force, aligned with OSD and/or joint staff (JS)



DPG and TAP. The POM Force is that force projected to be raised, equipped, sustained, and maintained within resources available during the FYDP.

(2) Provide analytical underpinning for the POM Force for use in dialogue among Congress, OSD, JS, CCDRs, and the Army.

(3) Assure continuity of force structure requirements within the PPBE processes.

(4) Provide program basis for structuring organizational, materiel, and personnel requirements and projected authorizations in SACDB.

(5) Conduct an annual analysis of force structure options for programming consideration that includes the mix of OF and GF capabilities between the Regular Army (COMPO 1) the ARNG (COMPO 2) and the USAR (COMPO 3) for the Secretary of the Army (SA) to consider and approve in support of the Army's future total force and Secretary of Defense planning objectives.

### **3-21. TAA Phase I—Capability Demand Analysis**

a. The Capability Demand Analysis (CDA) Phase consists of force guidance and quantitative analysis. DCS, G-3/5/7 derives force guidance from numerous sources to include the National Security Strategy (NSS), National Defense Strategy (NDS), National Military Strategy (NMS), and ASL guidance.

b. Force guidance and data inputs also include—

(1) Support for Strategic Analysis (SSA). OSD provides the directed scenarios, surge events (major campaigns) and vignettes within the support for strategic analysis. Primarily focused on strategic analysis of future force capabilities (force effectiveness and sufficiency).

(2) National strategy. Future force structure requirements are generated through updates to the National Security Strategy and National Defense Strategy.

(3) Force sizing and shaping. The Defense Planning Guidance provides guidance on which missions the Army is sized and shaped to perform.

(4) Scenarios. OSD approved scenarios are modeled by the Center for Army Analysis (CAA) incorporating parameters, planning and consumption factors, and assumptions. DCS, G-4; TRADOC; MEDCOM; U.S. Army Combined Arms Support Command (CASCOM); the theater commands; and other elements of the ARSTAF (CIO/G-6; DCS, G-1; DCS, G-3/5/7; DCS, G-4; and DCS, G-8) provide specific guidance, accurate and detailed consumption factors, planning factors, doctrinal requirements, unit level rules of allocation, network requirements, weapons and munitions data, and deployment assumptions. CAA then conducts a series of modeling and simulation (M&S) iterations that are analyzed to develop and define the total capability demands for logistical support necessary to sustain the combat force(s) and Army Support to Other Services (ASOS), foundational activities, and each major combat operation (MCO). Scenarios that are modeled are OSD approved and reflect a range of possible future mission requirements.

(5) Foundational activities. Foundational activities (FAs) develop force demands in support of a range of multiple, simultaneous operations at home and abroad (for example, stabilization, COIN, defeat regional aggressors(s), support to civil authorities in the United States, etc.) with the purpose of ensuring each capability is fully exercised across its projected full ROMO. OSD-approved vignettes are used to model foundational activity demand.

(6) Rules of allocation (ROA). Another critical step during the force guidance development is the review and updating of support-force rules of allocation used by the CAA during the modeling process (quantitative analysis). These rules of allocation, developed by TRADOC and the functional area proponents, and approved by the DCS, G-3/5/7, FM, represent a quantitative statement of doctrine for each type of unit (maneuver, fires, effects, support and sustainment). They are adjusted as necessary to incorporate theater-specific planning factors. The four basic types of rules are validated annually.

(a) Direct input (manual) rules are stand-alone requirements for OF or GF units in a theater (for example, BCTs, divisions, corps, and so on).

(b) Existence rules tie a requirement for one unit to another. The allocation of units is based on the existence of other units, or a function of a theater's physical or organizational structure (for example, for one large general purpose port—one each Harborcraft Company, requires one each Military Police Company, and so on).

(c) Workload rules tie unit requirements to a measurable logistical workload or administrative services in proportion to the volume of those services (for example, one each DS Maintenance Company per 375 daily man-hours of automotive maintenance or one each POL Supply Company per 2200 tons of bulk POL consumed per day).

## HOW THE ARMY RUNS

(d) Workload command and control rules capture the quantity of headquarters based on the number of subordinate elements (for example, one engineer battalion headquarters per 2–5 companies).

(e) Warfighting capability demands are determined in the quantitative analysis phase. CAA, through computer modeling and analysis, identifies the scenario generated requirements (OF only) for types of units needed to ensure success of the BCTs, support brigades and headquarters commands required in the different scenarios. CAA accomplishes the modeling through a series of analytical efforts and associated computer simulations. CAA uses the apportioned force provided in the OSD and Army guidance for employment in the MCO scenarios.

### c. Quantitative Analysis.

(1) The CAA develops the unconstrained (minimum risk) demand for enablers to ensure success of the BCTs in the war fight and provides rotational stress metrics for the resourcing phase. There are four primary outputs used in the TAA process—

(a) Joint Integrated Contingency Model. The Joint Integrated Contingency Model (JICM) re-creates combat forces to determine outcomes such as scenario time phasing, casualties, equipment destroyed, and ammunition consumed, which are used as inputs to the Force Generation model.

(b) Force Generation Model. The Force Generation Model (FORGE) uses inputs such as force designs and apportionment of units, scenario specific information from JICM and other sources, ROAs and planning factors to determine the enabling forces needed to support combat forces.

(c) Modeling Army Rotations at Home or Not. Marathon uses FORGE surge scenario output, foundational scenario force lists and SAMAS supply files to determine rotational demands under a set rotational policy.

(d) Early Deployer Time Phased Force Deployment Data (TPFDD) Analysis (EDTA). This model reviews the TPFDDs from multiple CCMD war plans to determine phased demand informed by limitations of strategic mobility.

(e) Staff Synchronization Rehearsal of Concept (ROC) Drill (SSRD). The SSRD is conducted early in the CDA phase. It is a forum by which TAA stakeholders provide additional information regarding the scenarios and vignettes required to inform the modeling process. It is not an opportunity to rewrite doctrine or doctrinal rules of allocation.

d. The Quantitative Analysis leverages OSD scenarios from Operational Availability (OA) series analytical work, and Integrated Security Constructs, to capture the Army's directed force (maneuver, fires and effects) Operating Force (OF) requirements. The scenarios are modeled and analyzed to develop the appropriate OF within the authorized end-strength necessary to accomplish the Unified Land Operations missions with minimum risk. Accurate planning, consumption and workload factors, threat data, and allocation rules ensure accurate computer-modeled demands. This demand list, combined with previous TAA scenario demand lists, CCMD War-plans and operational deployment data are used to help determine the best mix of forces for the Army within authorized end strength. It is not intended to be used to determine the size of the Army. Because of the scenario size and complexity required to ensure every capability is fully exercised across the full ROMO, the range of demands on OF capabilities far exceed the capabilities that can be resourced within the authorized end-strength.

### e. Phase I Capability Demand Analysis review and approval.

(1) The CoC/General Officers (GO) level reviews of the results of the range of demands produced for each capability (CAA modeling and analysis results, weighted and integrated with applicable TAA Scenarios, CCDR War plans and deployment data).

(2) The CoC/GO-level forums “review and approve” the warfighting capability as a fully structured and resourced force.

(3) The CoC/GO-level forums review and reach agreement on the force structure demands supporting Homeland Defense, ASOS and Foundational Activities and the appropriate level of inclusion of contractor support, use of strategic partners, joint capabilities, and other risk mitigation variables to appropriately scope the overall capability demands ensuring a focus on shaping the Army and not on sizing the Army.

(4) The GO-level review recommends approval of the capability demands to the ASL. The ASL reviews and approves the capability demands. The ASL's review and approval is the transition to Phase II of TAA (Resourcing and Approval Phase).

## 3-22. TAA Phase II—Resourcing and Approval

a. Resource determination consists of qualitative analysis and ASL review. Phase 2 develops force-

resourcing options within total end strength guidance for use in developing the POM Force. DCS, G-3/5/7 leads reviews of the POM Force at multiple levels, culminating in approval by the ASL. During Phase II, Resourcing and Approval, the determination must be made as to the level of acceptable risk to be taken for each capability. These capability demands are based on Army leadership directives, written guidance, risk analysis, the Army force generation approach and input from the Combatant Commander's Daily Operational Requirements (CCDOR). The qualitative analysis is the most difficult and contentious facet of the TAA process because the analysis results in the distribution of scarce resources, indirectly or directly impacting nearly every organization within the Army.

b. Emerging growth marks the beginning of Phase II and the merger of the GF and OF TAA process. Emerging growth is submitted to DCS, G -3/5/7 (DAMO-FM) for consideration of resourcing during the TAA process.

(1) Capabilities required to fill a critical gap may be submitted by any TAA stakeholder. Force Design Updates (FDUs) must be complete through the FIFA analysis stage, with an expectation of approval, in order to compete for resourcing.

(2) Emerging growth is prioritized using stakeholder voting results. The voting uses definitions ATP 5-19 of probability and severity of occurrences if the Army does not invest in the requested capability. The individual voting member scores are combined and averaged to produce a 1-N prioritized list of capabilities with "1" being the highest priority and "n" being the lowest. The submissions are prioritized within one of three categories.

(a) Directed. Those submissions already directed for resourcing by ASL.

(b) Compete. Submission competes for resourcing and ASL consideration.

(c) Do not compete. Submission is returned to originator without action.

(3) The emerging growth GOSC validates recommendations from the CoC and GF TAA GOSC and provides a prioritized emerging growth list for ASL consideration.

(4) The ASL approves select submissions for resourcing.

c. Qualitative Analysis. Qualitative analysis is conducted to develop the initial POM force, within total end strength limits, for use in the development of the POM. A series of resourcing forums, analyses, panel reviews, and CoC consider and validate the Capability Demand Analysis (CDA) phase demands. The qualitative analysis begins in the CDA Phase as risk mitigation measures are applied but prior to the resourcing panels. The qualitative analysis will continue until the resource constrained POM Force is approved by the ASL.

d. The resourcing CoC is held in two separate sessions, Organizational Integrator (OI) Panels and Resourcing CoC.

(1) OI Panels.

(a) HQDA action officers and their counterparts enter an intense round of preparations for the resourcing panels. Since the quantitative analysis only determined capability demands for doctrinally correct, fully resourced maneuver, fires, effects, support and sustainment units, the determination of a need for additional units and the allocation of resourced units to Components (RA, ARNG, and USAR), must all be accomplished during the OI Panels. HQDA bases force structuring options on an understanding of the objectives to be achieved, the desired capabilities and the constraints. The primary differences among various options are the extent to which risk, constraints and time are addressed. It is through the OI Panels that the "Art" of Force Management is applied to the "Science" introduced during the CDA Phase.

(b) The Resourcing CoC provides the opportunity for the ARSTAF, Army Commands, proponent representatives and staff support agencies to provide input, propose changes, and to surface issues related to the OI Panel recommendations. The issues focus on COMPO and center on resolving risk mitigation issues while balancing priorities. The AC/RC balance and total-strength concerns are key recommendation outputs of this CoC. It allows Army Service Component Commanders (ASCC) to verify that theater specific capability demands are satisfied by Army force structure assigned/apportioned to their commands to meet current CCDR OPLAN/CONPLAN warfighting requirements and CCDOR. The Resourcing CoC is typically a multi-day event chaired by the Director, Force Management (DFM), G-3/7.

(c) The resourcing CoC focuses on identifying and developing potential solutions for the wide range of issues brought to TAA. The OI and Force Integrators (FIs) are key individuals in this forum. The OIs have the responsibility to pull together the sometimes diverse guidance and opinions, add insight from a branch perspective, and establish the best course of action. The OIs pull all the relevant information together for presentation to the CoC. During these presentations, the OI reviews the Standard

## HOW THE ARMY RUNS

Requirements Codes (SRCs) of interest that fall under his/her area of responsibility, and presents recommendations on how to solve the various issues.

(d) The resourcing CoC integrates Generating Force issues and requirements, and reviews and resolves issues based upon sound military judgment and experience. The CoC forwards their recommendations and any unresolved issues to the resourcing GOSC.

(2) Force Feasibility Review. The FFR process is the vehicle to analyze force structure options developed during the TAA process. The ARSTAF further analyzes the force, initially approved by the GO resourcing conferences, via the FFR. The FFR process uses the results of the TAA resourcing conference as input, conducting a review and adjusting the POM force to assure it is affordable and supportable. At the macro level, within the limits of personnel, budgetary and timing constraints, the FFR determines if the POM force can be feasibly manned, trained, equipped, sustained, and stationed within the POM time frame. The FFR process identifies problems with the POM force and develops alternatives based on prior TAA initiatives, unalterable decisions from the Army leadership, or directed Program Budget Decisions (PBD). The alternatives are provided to the GOSC for determining the most capable force within existing or projected constraints. With the TAA/POM process on an annual schedule, the PEGs conduct the FFR each year while building the POM. Their feedback is injected back into the next OI Panel and Resourcing CoC.

(3) Resourcing GOSC. The qualitative phase culminates with the Resourcing GOSC. The GOSC reviews/approves the decisions of the Resourcing CoC and addresses remaining unresolved issues. The GOSC has evolved into a series of GO resourcing forums at the two- and three-star level. The GO forums review and approve the decisions of the resourcing CoC, and address remaining unresolved issues. The Resourcing GOSC approves the force that is then forwarded to the ASL for review and final approval.

(4) Leadership Review. After the resourcing conference, sequential GO resourcing reviews meet to resolve any contentious or outstanding issues. The SECARMY, Undersecretary of the Army, CSA, and VCOSA attend the ASL meetings. The SECARMY reviews and approves the POM force.

### 3-23. The Product of TAA

a. Army POM Force. The product of TAA is the Army's POM Force, the force recommended and supported by resource requests in the Army POM. The resulting POM Force includes the programmed structure for all Army components throughout the POM years and provides the basis for development of the Army POM submission. The POM Force meets the projected mission requirements with acceptable risk within anticipated total strength and equipment levels. Upon approval, the POM Force is released via the Army Structure Memorandum (ARSTRUC) and/or with the Structure and Manpower Allocation System (SAMAS) lock point file, and becomes the basis for development of the Army's POM submission. The POM Force meets the projected mission requirements with appropriate risk within anticipated total strength and equipment levels. The final output should result in an executable POM Force. The Army forwards the POM Force to OSD with a recommendation for approval. All approved units are entered into SAMAS to create the POM Force. Overall, TAA is the proven mechanism for explaining and defending Army force structure for budget submission.

b. ARSTRUC Memorandum. The product of the TAA and POM processes is the approved and funded force structure as specified in the ARSTRUC Memorandum. The ARSTRUC Memorandum is directive in nature. It is produced by Army G-37/FM and provides an authoritative record of Army's Senior Leadership final decisions made during the TAA process as well as captures changes made as part of the out-of-cycle process since the last ARSTRUC. The ARSTRUC Memorandum directs the commands to make appropriate adjustments to their force structure at the UIC level of detail during the next CPLAN. Commands record changes during the Command Plan process in the Structure and Manpower Allocation System (SAMAS), the official database-of-record for the Army. SAMAS, along with the BOIP and TOE files, provides the basis for Army authorization documentations (e.g., MTOEs and TDAs). Publication of the ARSTRUC Memorandum completes the TAA cycle.

c. The product of the TAA and POM processes is the approved force structure for the Army, which has been divided for resource management purposes into components:

- (1) COMPO 1—Regular Army.
- (2) COMPO 2—ARNG.
- (3) COMPO 3—USAR.
- (4) COMPO 4—Requirements to accomplish the Army's missions; not resourced.

- (5) COMPO 5---Not Matched Units
- (6) COMPO 6---Prepositioned Stock
- (7) COMPO 7—Direct Host-Nation Support.
- (8) COMPO 8—Indirect Host-Nation Support.
- (9) COMPO 9—Logistics Civil Augmentation, which comprise force structure offsets.

d. Host-nation support agreements guarantee the COMPO 7 and 8 resources. COMPO 9 is an augmentation, not an offset, and represents the contracts for additional support and services to be provided by domestic and foreign firms augmenting existing force structure.

### Section VII

#### Force Development Phase V—Document Organizational Authorizations

##### 3-24. Documentation Components Overview

a. The fifth and final phase of force development, the documenting of unit authorizations, can be viewed as the integration of organizational model development and organizational authorization determination. Battlefield requirements for specific military capabilities drive the development of organizational models. The results of this process are TOEs for organizations staffed and equipped to provide increments of the required capabilities. TOEs specify Army organizational requirements. Determining organizational authorizations, on the other hand, is a force structure process that documents resources (people, equipment, dollars and facilities) for each unit in the Army.

b. Because the Army is comprised of a complex mix of personnel, each with one or more of a variety of skills, and many millions of items of equipment, there must be an organized system for documenting what is required and how much is authorized. More important, as the Army moves forward with transformation, modularity, equipment modernization, application of new doctrines, and the modification and development of resulting organizations, the Army must have a way of keeping track of changes that are made so that they may be managed efficiently and with a minimum of turbulence.

c. Each unit in the Army has an authorization document, either an MTOE or a TDA, which identifies its mission, structure, personnel and equipment requirements and authorizations. These documents are essential at each level of command for the Army to function. A unit uses its authorization document as authority to requisition personnel and equipment and as a basis for readiness evaluations.

##### 3-25. Authorization Documents

Authorization documents align and integrate a specific organization's mission, functions, organizational structure, personnel and/or equipment requirements and authorization data in detailed and summary format. They provide the HQDA-approved authorizations to resource the organization's requirements.

a. MTOE. An MTOE is a UIC and EDATE specific, resource informed authorization document derived from a TOE through the application of HQDA directed guidance and personnel changes at individual billet and LIN level of detail. It establishes the personnel and equipment authorizations to resource MMEWRs to execute the organization's doctrinal mission, as documented in the TOE. USAFMSA builds and DCS, G-3/7 (DAMO-FM) approves MTOEs. USAFMSA publishes MTOEs for the current year, budget year, and first program year. MTOE organizations are primarily in the OF, but can also be in the GF.

b. Exception MTOE. Exception MTOEs deviate from the TOE and its applicable BOIPs. The DCS, G-3/5/7, Director, Force Management (DFM), is the approval authority for all exception MTOEs. These exceptions are re-validated every three years.

c. Equipment-Only MTOE. A set of equipment, pre-positioned for use by a rotational or deploying unit for a specific mission in a specific theater. This authorization document contains only equipment and does not provide requirements or authorizations for personnel. Current examples of equipment only MTOEs are Army pre-positioned stocks (APS), the European Activity Set (EAS), and the Korean Enduring Equipment Set (KEES).

d. TDA. A TDA is a UIC- and EDATE-specific authorization document that is not based on a TOE. It prescribes the organizational structure, the manpower and/or equipment requirements, and authorizations to perform a mission for which no TOE exists. TDAs can include military, civilian, and standard and commercial equipment. TDA manpower requirements are workload-based. Workload shall be in direct support of HQDA level directed missions and functions only. USAFMSA builds and DCS, G-3/5/7 (DAMO-FMZ) approves TDAs for the current year, budget year, and first program year. TDA organizations are primarily in the GF, but can also be in the OF.

## HOW THE ARMY RUNS

(1) Augmentation TDA (AUGTDA). The AUGTDA is a form of TDA that augments an MTOE unit. It establishes organizational structure, personnel, and equipment required for the unit to execute administrative and operational functions beyond the capabilities of the MTOE. The AUGTDA can include military, civilian, and standard or commercial equipment.

(2) Mobilization TDA (MOBTDA). The MOBTDA is a form of TDA that establishes the mission, organizational structure, personnel and equipment requirements and authorizations for units authorized under the non-deployment mobilization troop basis subsequent to a declaration of mobilization.

e. Joint Tables of Allowances (JTA). The JTA is an authorization document for equipment in support of joint organizations under the control of CCDRs and Standing Joint Force Headquarters. JTAs are applicable to all active elements of the Army, Navy, Air Force, Marine Corps, USASOC, and their supporting components and joint commands. USAFMSA creates and staffs JTAs for Commander, USAFMSA approval and HQDA publication, as necessary.

f. Common Table of Allowances (CTA). A CTA is an authorization document for items of materiel required for common Army-wide use by individuals or MTOE, TDA, or JTA organizations. USAFMSA builds, approves, and publishes CTAs.

g. Government-Owned, Contractor-Operated (GOCO) Equipment. Government-owned, contractor-operated equipment are listed on applicable authorization documents when they include nonexpendable equipment that the contractor requires to perform the contract (see Federal Acquisition Regulation, Part 45 (FAR 45.000); Defense FAR Supplement, Part 245 (DFARS 245.1); and Army Financial Acquisition Regulation Supplement, Part 5145 (AFARS 5145.1)). All government-furnished equipment, except for the categories listed in paragraph 7–17, will be documented in the appropriate TDA to compute replacement requirements.

### Section VIII Force Integration

#### 3-26. Force Integration Overview

a. Force Integration is the synchronized, resource-constrained execution of an approved force development program to achieve systematic management of change, includes the following:

(1) The introduction, incorporation, and sustainment of doctrine, organizations, and equipment in the Army.

(2) Coordination and integration of operational and managerial systems collectively designed to improve the effectiveness and capability of the Army.

(3) Knowledge and consideration of the potential implications of decisions and actions taken within the execution process.

b. Force integration encompasses processes, decision support mechanisms and products to manage change by:

(1) Assessing requirements for changes in capability.

(2) Ensuring consideration of growth alternatives.

(3) Developing suitable, feasible, and acceptable concepts to execute programs.

(4) Determining and recommending solutions.

(5) Preparing and executing detailed plans of action.

(6) Assuring feedback that validates or modifies actions and execution, as necessary.

(7) Considerations of facility requirements by location.

#### 3-27. Integrated Process Team

Integrated Process Teams (IPT) are used to discuss and seek solutions to implementation challenges of force management initiatives. These cross-functional working groups work complex issues faced by the accelerated pace of change in a manner superior to the linear and sequential methods used in the past. HQDA continues to use the team approach for force management. The three key staff officers that chair the major integrating working groups are the Requirements Staff Officer (RSO) assigned to the G-8, the Synchronization Staff Officer (SSO) assigned to the G-8, and the Department of the Army (DA) System Coordinator (DASC) assigned to the Assistant Secretary of the Army for Acquisition, Logistics and Technology (ASA (ALT)). They work with other team members including the G-3/5/7 Force Integrator (FI), the G-3/5/7 Organizational Integrator (OI), the G-8 Program Analysis and Evaluation (PA&E) action

officer, the Document Integrators (DIs), the Personnel System Staff Officer (PERSSO), command managers, and Resource Integrators (RI). As required, representatives from ACOMs, ASCCs, DRUs, Reserve Components, and other functional area and special interest representatives are included in IPTs and in the staffing of related force management issues.

### 3-28. Force Integrator (FI)

The FI assigned to G-3/5/7 represent the interests of functionally dissimilar force-level organizations (e.g., the entire force structure from Modular Brigade through Theater Army). They are horizontal force-level integrators and work with brigades, regiments, divisions, and corps and Theater Armies. Responsibilities of the FI include—

- a. Assesses ability of functional systems to support major organizations.
- b. Recommends prioritization of resources.
- c. Assesses impacts of organizational change, at the appropriate force level, on readiness.
- d. Facilitates integration of units into major organizations.
- e. Evaluates and analyzes impact of incorporating personnel, facilities, equipment, doctrine, structure, and capability changes into major organizations.
- f. Ensures major units are represented in force integration and force planning processes (e.g., TAA, FDU, etc.).
- g. Assesses impacts of mid-range and long-range planning on major units including new doctrine, structure, manning, equipment, technology, facilities, stationing, strategic policy, and resource strategies.
- h. Links organization requirements to resource allocation.

### 3-29. Organizational Integration

a. Organizational integration is the management of change in organizations. It is a part of force integration that focuses on organizations in the process of introducing, incorporating, and sustaining new structure, equipment, and doctrine into the Army. It manages the documentation, resourcing, fielding, and sustainment of assigned organizations as integrated packages of doctrinally aligned capabilities within resource constraints; focuses on increasing force capability while managing the organizational changes through prioritization of resources, management of information, synchronization of activities, and assessment of capabilities; and identifies how the force and equipment changes will effect facility requirements among others.

b. Organizational Integrator (OI). OIs are assigned to the G-3/7 FM Directorate and represent organizational interests of functionally similar organizations (e.g. Infantry, Military Police, etc.). OIs are branch assigned personnel who are the focal point for force accounting, documentation, resourcing, and readiness of assigned units; exercise resource controls for documentation; coordinate and recommend approval or disapproval of all branch specific actions and documentation. The duties of the OI include, but are not limited to, those listed below.

- (1) Analyzing, coordinating, refining, and developing recommendations on requirements.
- (2) Ensuring doctrinal linkage exists between organizational and current and emerging capabilities.
- (3) Coordinating approval of TOEs and BOIPs.
- (4) Participating in force management analysis reviews of all force management documentation.
- (5) Developing and coordinating the HQDA position on proposed TAA process changes.

c. Command Manager (CM). CMs assigned to the G-3/5/7 FM represent the organizational interests of an ACOM/ASCC/DRU by managing its TDA units, and serves as the FI for the command's MTOEs. The second focus of the CM is managing program budget guidance by ensuring that the manpower allocation for each ACOM/ASCC/DRU is accurately reflected in the SAMAS in compliance with Army leadership decisions and within manpower controls established by Office of the Secretary of Defense (OSD). Duties include the following:

- (1) Serving as point of contact for CPLANs and TDA CMPs.
- (2) Maintaining the documentation audit trail on all additions, deletions, and other changes to unit MTOEs and TDAs.
- (3) Producing manpower resource guidance for ACOM/ASCC/DRU PBG.
- (4) Managing command Force Structure Allowances (FSA)s.
- (5) Providing analysis and assessment of resource alternatives for organizational actions under consideration.

## HOW THE ARMY RUNS

(6) Documenting current and programmed personnel strength, applicable Joint Research, Development and Acquisition (RDA) programs, and organization force structure.

(7) “Cross-walking” analysis of Army programming decisions with those of the DOD, Office of Management and Budget (OMB), and Congress.

d. Document Integrator (DI). The DIs are assigned to the USAFMSA, a DCS, G-3/5/7 Field Operating Agency (FOA). The DI produces organizational requirement and authorization documents that implement approved Army force programs. Their duties include the following:

(1) Documenting the unit mission and required capabilities by applying equipment utilization policies, MARC, SG, and BOIP to develop the proper mix of equipment and personnel for an efficient organizational structure.

(2) Developing MARC that serves as HQDA approved standards for determining the MMEWR for staffing to accomplish maneuver support and maneuver sustainment functions in TOE and MTOE documents.

(3) Reviewing proponent-proposed or approved authorization documents to ensure compliance with manpower, personnel, and equipment policies and directives.

(4) Centrally building ACOM/ASCC/DRU authorization documents based on HQDA guidance, Command Plan, and input from the ACOM/ASCC/DRU.

e. ACOMs, ASCCs, and DRUs. Force management staffs at these echelons manage the planning and execution of the force integration mission.

(1) Document integration, including authorization document (MTOE and TDA) review, and database management.

(2) Systems integration, including requirements and authorization document review, the Materiel Fielding Plan (MFP) process, New Equipment Training Plan (NETP) review, and facilities support annex review.

(3) Organization integration, including the organizational assessment process, review of requirement and authorization documents, and doctrine review.

(4) Force structure management, including TDA manpower management and end-strength management.

(5) Force planning, including the TAA process, CPLAN process, force reduction planning and monitoring, and CONPLAN development.

f. Corps, division, regiment, separate brigade, and installation. Force management staffs at these levels continue to manage and oversee the force integration activities directed at the ACOM, ASCC, and DRU levels.

(1) Force structure management, including authorization document management, Commander’s Unit Status Report monitoring, and force structure review and analysis.

(2) Systems integration, including action plan development, distribution plans reviews, and facilities review.

(3) Organization integration, including organizational assessments, force structure review and analysis, and authorization document review process.

### Section IX

#### Table of Distribution and Allowance Change Management Plan

##### 3-30. TDA CMP

a. The TDA CMP replaces both concept plans and command implementation plans. This is the process used to request new organizations, updates and/or changes to all TDA and AUGTDA organizations in the Army regardless of COMPO and of whether the UIC is categorized as an operating or generating force unit.

b. The three categories that will drive the type of TDA CMP that is submitted by commands and their thresholds are defined below.

(1) Category 1.

(a) CAT1 submissions are used for requests that result in no programmatic changes (management decision package (MDEP), Army management structure code (AMSCO), civilian type (CTYPE), reimbursable source (REIMS), reimbursable command (REIMC), resource operating code (ROC), and no stationing actions). No HQDA staffing is required, with the exception of staffing changes to military



## FORCE MANAGEMENT

grades with HQDA G-1. Commands submit change requests to DCS, G-3/5/7 FM for analysis, processing, and out-of-cycle coordination.

(b) No Cost Benefit Analysis (CBA) or USAMAA review is required.

(c) A CAT1 change request is submitted via an email from the command headquarters O6/GS-15 level, or their designated representative. Submissions will not be accepted directly from the command's subordinate organizations.

(d) The submission must include a brief summation of the nature of the requested changes and a Section II personnel file formatted in the FMS 1.0 format from FMSWeb for submission to USAFMSA for documentation (contact USAFMSA for the current format). Approved position description (PDs) are required for civilian position title and grade changes.

(e) TDA documents must be changed to reflect these requests during the next available monthly out-of-cycle process, as per DCS, G-3/5/7 FM guidance.

(2) Category 2.

(a) A CAT2 request is used to internally realign structure within Command UIC(s), and between Command UICs so long as it has no programmatic impact (no request for new resourcing, no change to the current ROC, MDEP, AMSCO, CTYPE, REIMS, and REIMC and no nominative CSM branch codes (00Z)). Commands submit change requests to DAMO-FM for analysis, processing, and OOC coordination.

(b) It allows for changes to paragraph data, lift and shifts of requirements and authorizations, changes to position titles, changes to military and civilian grades, changes to branch, position code, MOS, and manpower mix criteria code.

(c) Lift and shift of requirements and/or authorizations is defined as moving a requirement and/or authorization from the current approved document within a UIC to another location without changing the programmatic elements of the position.

(d) A CAT2 submission must be submitted via an email and requires a command memorandum signed by an O6/GS-15 representative. The memorandum must define the changes requested.

(e) Submissions are not accepted directly from the command's subordinate organizations. The submission must include a brief summation of the nature of the requested changes. This submission requires limited HQDA staffing as determined by DCS, G-3/5/7 FM, such as DCS, G-1 or Assistant Chief of Staff for Installation Management (ACSIM), DCS, G-2, and so forth. No CBA submission or USAMAA review are required.

(f) If the requested changes occur between UICs a schedule 8 must be submitted to DCS, G-3/5/7, FM for review and to update the SAMAS. A TDA Excel crosswalk (contact USAFMSA for the current format) from FMSWeb is needed for submission to USAFMSA for documentation. Approved position description (PDs) are required for civilian position title and grade changes.

(3) Category 3.

(a) A CAT3 submission requests new manpower requirements. A CAT3 submission is used to request organizational changes to a TDA organization's mission or functions that result in placing increased demands on HQDA for resources, personnel, equipment, and/or facilities.

(b) This submission category is used to request new requirements to existing structure, add new structure requirements, add new structure requirements and authorizations with associated existing command bill payers, and change existing UIC, paragraph and line level of detail. These submissions require a wider level of HQDA staffing than CAT2 submissions. Commands must submit changes to DAMO-FM for staffing and coordination. The DAMO-FM force structure CM determines the appropriate staffing level.

(c) The command headquarters' designated O6/GS-15 representative will submit a CAT3 change request via an email. Submissions are not accepted directly from the commands subordinate organizations. The submission must contain a memorandum signed by a GO/SES that briefly describes and endorses the mission directive or mission mandate and the organizational change. Additionally, the submission must include an executive summary describing the nature of the requested changes, and validate that the requested requirements are work-load based. An FMSWeb TDA Excel crosswalk (contact USAFMSA for the current format) from FMSWeb, appropriate schedules 8, and approved position descriptions must accompany the submission.

(d) Any reprogramming of existing resources, to include transfers of manpower between commands must be linked with the requisite funding and be processed and approved through the PPBE process.

## HOW THE ARMY RUNS

(e) USAMAA Workload Analysis is required for command submissions that are for new or emerging concepts, or major directed reorganizations.

(f) A CBA is required if the dollar amounts and criteria are within the CBA thresholds as defined in the most current Army Program Guidance Memorandum. Submissions of \$10 million (or more) in any 1 year of the POM or \$50 million (or more) over the POM period require a CBA, unless approved by a HQDA PEG. The dollar amounts include but are not limited to all costs for manpower, equipment, supplies, training, facilities, construction, or contracts. Proposed reprogramming moves or realignments that cross appropriations require a CBA. Commands submit the CBAs via the Army Cost and Performance Portal at <https://cpp.army.mil>.

(g) Thresholds that will require a CAT3 CMP are: 1) Introduction of a new un-programmed TDA organization into the Army force structure. 2) A change to a TDA organization's mission or functions that involve placing increased demands on HQDA for personnel, equipment, funds and/or facilities. 3) Establishment or reorganization of an Army Management Headquarters Activity (AMHA) that leads to growth in the current programmed AMHA requirements or authorizations. 4) Movement of a mission, function, or unit from one command to another that is not addressed as an inter-command transfer during the POM schedule 8 submission. 5) Requests for additional paid parachute requirements and authorizations that exceed a command's existing ceiling. 6) For HQDA-directed increases in specified number of requirements and/or authorizations to support HQDA guidance or regulation (for example, equal opportunity advisors), TDA CMP submissions must be prepared by the HQDA proponent directing the increase. 7) The DCS, G-3/5/7 FM conducts a compliance and capability review prior to implementation and documentation. Depending on the nature of the HQDA guidance to add an Army wide capability, the Generating Force Working Group chaired by the DCS, G-3/5/7 FM may direct implementation and documentation of the change through the OOC process. 8) Requests for military technicians must be submitted and processed by USAR and ARNG, in accordance with AR 135-2.

### 3-31. Command Plan (CPLAN)

a. The CPLAN is the annual force management process designed to account for and document force structure decisions and directives. The CPLAN reviews the budget year and documents the first program year.

b. The DCS, G-3/5/7 (DAMO-FMP) is the proponent for CPLAN.

c. The CPLAN process is the primary process for disciplined management of organizational change in the Army. The CPLAN is designed to account for and document force structure decisions and directives from the Army leadership including those changes directed by OSD, submitted by the commands, or outlined in Congressional guidance. The CPLAN synchronizes organizational change with the delivery of resources, to react to changing requirements while minimizing organizational turbulence through a deliberate decision cycle. DAMO-FM publishes the CPLAN guidance memorandum that provides guidance and milestones for the CPLAN submission and describes the actions that must be accomplished.

d. During the CPLAN process, the DCS, G-3/5/7 (DAMO-FM) directs production of the appropriate authorization documents (MTOE and TDA).

e. The CPLAN process results in updated MTOE and TDA documents that provide personnel and equipment requirements and authorizations for the total force at the grade, MOS, LIN and quantity level of detail through the FMS.

f. All ARSTAF, ACOMS, ASCCs, or DRUs will brief the DCS, G-3/5/7 (DAMO-FM) on their CPLAN in accordance with published CPLAN guidance and in accordance with updated guidance from DAMO-FM.

g. The CPLAN culminates in the approval of the Army Master Force (MFORCE) and the release of HQDA approved authorization documents.

### 3-32. OOC Process

a. The documentation OOC process is a HQDA G-3/5/7 FM process that occurs between CPLANs. The OOC process is used for any document change to a given UIC that requires a matching SAMAS data value change for that UIC. The original HQDA-approved document is superseded by the OOC replacement document at the effective date of the OOC document.

b. There are three primary thresholds that warrant an OOC—

(1) Any change to a UIC's approved document information that is also reflected in the associated approved SAMAS subset. See DA Pam 71-32 for a list of SAMAS documented subset data elements.

- (2) Any change to an approved document that is directed as an OOC by the DFM.
- (3) A change originally proposed as an administrative change escalated for OOC consideration by the USAFMSA Commander.

### **3-33. Administrative Change Process**

- a. Documentation administrative changes are changes to a HQDA-approved authorization document that are outside of the mandatory criteria for implementation of the HQDA G-3/5/7 OOC documentation process.
- b. Documentation administrative changes must be approved by the USAFMSA Commander, with G-3/5/7 FM concurrence, prior to implementation.
- c. Details of the administrative change are annotated in MTOE or TDA Section 1.
- d. Monthly application of the Supply Bulletin 700-20 to HQDA approved requirements and authorization documents will be executed through the document administrative change process. These changes are not annotated in Section 1.
- e. There are three primary thresholds for an administrative change—
  - (1) Minor document corrective changes that do not correspond to SAMAS data elements.
  - (2) Application of previously codified HQDA guidance where the change does not constitute an OOC.
  - (3) Changes resulting in less than an aggregate \$100,000 equipment growth on the TOE will propagate to the associated MTOEs via the administrative change process.

## **Section X**

### **Force Generation and Sustainable Readiness**

#### **3-34. Force Generation and Sustainable Readiness**

a. Force Generation Overview. The new AR 525-29 Force Generation Process - Sustainable Readiness, provides a detailed description of the major processes and phases of Army Force Generation and describes its relationship with Sustainable Readiness (SR). Where practical, the provisions of the SAR were extracted verbatim or summarized and included below. Importantly, AR 525-29 differentiates the Army's Force Generation core process from the Sustainable Readiness (SR) process. Conceptually, the SR process and its internal SR model functions within and supports the overall Army Force Generation process. Overall, the Army builds readiness through the force generation and sustainable readiness processes to meet known demands while simultaneously retaining sufficient readiness within the total force to mitigate the risk of responding to likely contingencies. Units continue to build progressive readiness for known demands, but retain and sustain some of that readiness following deployments to help minimize the risk of responding to other possible contingency events. Units not deployed, build and sustain readiness and are resourced to attain affordable readiness levels in a measured band of excellence and are also prepared to respond to emerging contingencies. The cycling of known deployment requirements and contingency response responsibilities between units and COMPOs avoids the negative aspects of having units languish in extended periods of low "tiered" readiness and allows the Army to dynamically allocate resources, raise force-wide readiness levels and lower the risk of responding to emerging contingency requirements. Force Generation and Sustainable Readiness address known Global Force Management Plan force requirements as well as optimizes preparations to respond to on-demand contingency operations. Force Generation and Sustainable Readiness seeks to sustain the highest affordable readiness levels across the Army consistent with available resources, planned deployments and high priority contingency response requirements. It avoids wide variances in unit readiness levels associated with the previous wartime-driven Army Force Generation model that primarily focused resources on preparing rotational forces for wartime deployment and employment at the corresponding readiness expense of returning and non-deploying active and reserve units. Importantly, the Reserve Component (RC) provides the largest pool of surge capabilities for emerging contingencies, therefore, SR enables the selected operationalization of the RC by leveraging the unique capabilities of ARNG and USAR forces to support primarily mid- to late-deploying force requirements. SR extends the Army's readiness planning horizon by managing the Army's readiness levels to meet requirements in the execution year plus two to seven years into the future. This helps to synchronize readiness resource decisions with the development of the POM.

## HOW THE ARMY RUNS

b. The Force Generation process considers seven elements (Forces, Requirements, Resources, Demand, Readiness, Risk and Time) and encompasses four phases described sequentially from the projection of the Future Force (Phase I), working through the Program Force (Phase II) and the Current Force (Phase III) to the Past Force (Phase IV). (See Figure 3-11)

(1) In Phase I, the Army develops new concepts to provide the necessary data to develop program lines. This phase focuses on the Future Force through concept development of future capabilities and units to both define the desired military effect, the required force structure and equipment and to capture these in the budgetary and programmatic processes. At its conclusion, Phase I produces a defined and programmable concept of a ready and responsive capability (the Future Force).

(2) In Phase II, the Army prioritizes program lines across the FYDP (FY C–G) to submit a Budget to the Department of Defense, President and Congress. This phase focuses on the Program Force (Execution year plus two to seven years or FY C to G) by informing funding and resource allocation decisions within the budget build system. At its conclusion, Phase II enables the Army to submit a budget that sustainably provides ready and responsive forces.

(3) In Phase III, the Army executes the appropriation and prepares units in accordance with known requirements to provide ready and responsive forces, making it the main effort of Force Generation. This phase focuses on the Current Force by influencing and informing resourcing prioritization and synchronization in the near term. At its conclusion, Phase III produces ready and responsive forces provided in a sustainable manner through its linkages to the other phases through the Sustainable Readiness Process (SRP).

(4) In Phase IV, the Army evaluates the results of readiness decisions and reconciles readiness resource expenditures in order to meet statutory budgetary requirements and provide updated planning factors for Phases I–III. This phase focuses on the Army's Past Force by analyzing and assessing lagging indicators for readiness to validate resource allocation and funding level and the ability to build readiness and successfully execute ordered missions. At its conclusion, Phase IV produces updated planning factors for readiness decisions based on assessment of Past Force Readiness and an assessment of the Current Force Readiness for employment (Army forces, units, and capabilities that have fulfilled requirements that can be retrospectively assessed to validate current and future Readiness Objectives).

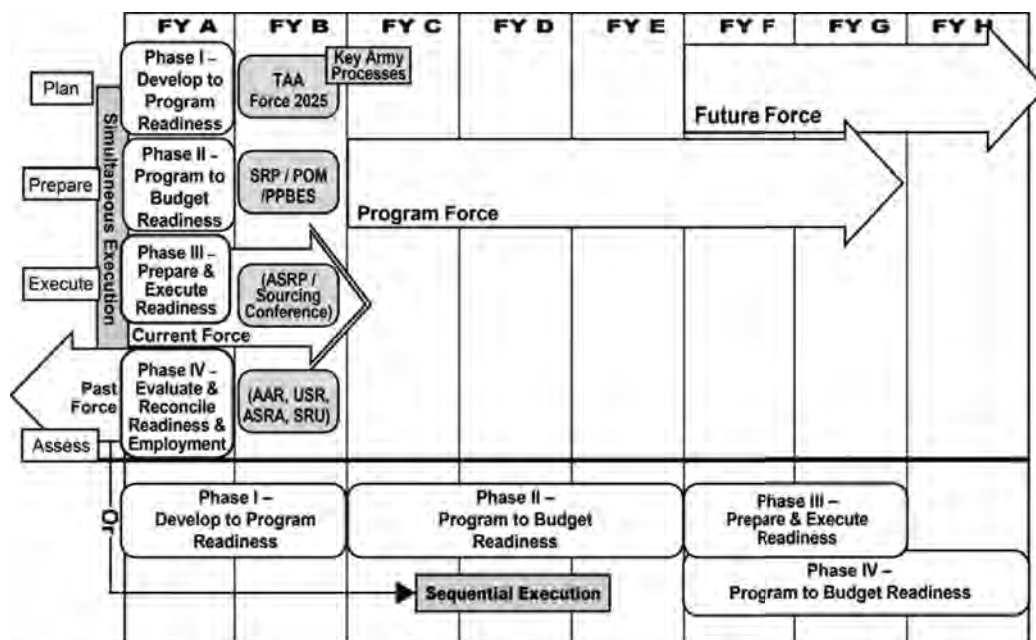

**Notes:** ASRA - Army Strat Readiness Assessment; ASRC - Army Synchtn & Resourcing Conf; ASRP - Army Synchtn & Resourcing Process; POM - Program Objective Memorandum; PPBES - Planning, Programming, Budgeting, & Execution System; SRP - Sustainable Readiness Process; SRU - Strat Readiness Update; TAA - Total Army Analysis; USR - Unit Status Report

Figure 3-11. Force Generation Phases

c. The SRP operates predominantly in Force Generation Phase II (the Program Force), but also supports both Force Generation Phase I and III. The SRP consists of four phases that are performed over a four-year timeframe but requires the quarterly conduct of readiness reassessments, synchronization and integration. SRP is managed through the existing forums such as the Army Synchronization and Resourcing Conference (ASRC), other appropriate Boards, Commissions, and Committees such as General Officer Steering Committees (GOSCs), and Senior Leader Readiness Forum (SLRF) (processes), enables Commander dialogue to set the conditions through policy adjustments for staffs at every level to expand current planning horizons and improve planning for budgeting, modernization, manning, equipping, and training in anticipation of known and unknown requirements.

(1) Sustainable Readiness Phase 1: Plan and Prepare Readiness Objectives. In Phase 1, the Army develops the overall requirements levied on the force as well as the readiness projections by unit type. These requirements and projections are compared with identified risks which forms the foundation for establishing readiness objectives for Phase 2. At its conclusion, Phase 1 establishes an initial draft of the Readiness Objectives (RO-I).

(2) Sustainable Readiness Phase 2: Establish Readiness Objectives. In Phase 2, the Army further analyzes the Readiness Objectives to inform the POM and coordinates with other commands and agencies that manage forces. At its conclusion, Phase 2 publishes the final Readiness Objectives (RO-F) through a HQDA Execution Order (EXORD).

(3) Sustainable Readiness Phase 3: Assess Projected Readiness. In Phase 3, the Army executes the appropriation and prepares units in accordance with Readiness Objectives and known requirements to provide ready and responsive forces. Commanders (Army Force Providers, installation, unit and organizational) prepare Readiness Projections, based on Readiness Objectives, the appropriated budget, and the missions their units have been aligned to according to the GFM and Army processes. The assessment of the expected attainment of Readiness Projections compared to Readiness Objectives enables the Army and Army Force Providers to systematically consider potential shortfalls and gaps in the desired readiness 12–24 months out. This assessment enables the reallocation of resources early enough to minimize overall disruption to readiness. It also enables the Army to refine its planning factors for the SR, POM, and the TAA process, while more effectively assessing the risks to readiness caused by unforeseen changes to missions or operational conditions. At its conclusion, Phase 3 produces ready and responsive forces provided in a sustainable manner.

(4) Sustainable Readiness Phase 4: Assess Achieved Readiness. In Phase 4, the Army evaluates the results of readiness decisions and reconciles readiness resource expenditures in order to provide updated planning factors for Phases 1–3. Commanders (Army Force Providers, installation, unit and organizational) support the assessment of the Readiness Achieved vice projected Readiness Objectives through the submission of the USR and providing feedback on the causes of deviations. This enables the Army and Army Force Providers to systematically consider adjustments to Readiness Objectives and Readiness Projections, as well as refining the planning factors and overall readiness standards and strategies that established them. This assessment enables improved decision-making for the initial allocation and in-stride reallocation of resources and alignment of missions to avoid readiness shortfalls. It also enables the Army to refine its planning factors for the SR, POM, and TAA processes, while more effectively assessing the risks to readiness caused by unforeseen changes to missions or operational conditions. At its conclusion, Phase 4 produces updated planning factors for readiness and force generation planning and allows related modifications to existing and future plans and programs.

d. The Sustainable Readiness Model (SRM). The SRM depicts forecasted levels of unit readiness through the first three years of each FYDP and beyond. It accomplishes this through the production of quarterly module presentations of every SRC in the Army from the current year through at least year three of the FYDP. These quarterly modules are depicted, one after another, to graphically display an individual unit's projected readiness and employment over a specified period of time. This grouping of SR modules for a single unit is termed the Unit Readiness Cycle (URC). In the SRM, a grouping of Unit Readiness Cycles (URCs) for all units associated with a particular SRC or capability with the associated forecasted known requirements is called known Demand Readiness Objectives (KDRO). SR modules and URCs are applied across the Army and are typically depicted at the parent unit (AA level) UIC reporting level when utilized by HQDA. Army forces report decisive action readiness using overall readiness ratings, which are assessed and reported through the Commander's Unit Status Report

## HOW THE ARMY RUNS

(CUSR). These readiness standards are reflected in SRM planning and execution through their incorporation in the unit module definitions.

(1) C-level ratings, which are an overall measure of a unit's training, personnel, and equipment assessments, reflect a unit's ability based on organizational design to provide core functional capabilities in performance of its wartime mission(s) for Unified Land Operations (ULO). When applied to the SRM, C-level ratings tied to module definitions will indicate different readiness ratings dependent upon the time of application. In the month of execution, C-level ratings reflect the reported readiness of the unit. Whereas, outside of the month of execution, C-level ratings tied to module definitions reflect a goal for planners and staffs to meet. Setting this goal enables staff sections with extended planning horizons to project the required resources needed to be allocated to achieve the goal. The process of allotting resources to modules and then assessing the feasibility of resources to stated goals is an important element of the SRP.

(2) For those units in receipt of an assigned mission, the Army reports projected unit ability to accomplish its mission using an A-level (assigned mission) rating in accordance with AR 220-1. A-level ratings assess three of the four measured areas (Assigned Mission Manning (AMM), Assigned Mission Equipping (AME), Assigned Mission Training (AMT)), where four measured areas are used to assess for C-levels (Personnel (P), Equipment and Supplies (S), On-hand/available Equipment Readiness/Serviceability (R), and Unit Training Proficiency (T)). For A-level determination, commanders evaluate training, personnel, and equipment availability carefully tailored to reflect the unique requirements of the assigned mission.

e. SRM modules. The SRM uses modules to organize and graphically depict unit readiness information and to signal resourcing requirements. The modules vary in length (from three months to several years for the RC) but are depicted and managed in a quarterly framework. This is to support the operational-level resourcing and training planning process, while staying integrated with the tactical-level execution of readiness preparation and execution. Each module represents a given unit's activity during the four quarters of a designated fiscal year of the six-year time horizon for planning. The SR modules provide a clear representation of a unit's preparedness for decisive action in support of ULO. There are three basic modules: Prepare, Ready, and Mission, with additional descriptive categories in the Prepare and Mission modules which assist planners and unit Commanders in synchronizing resource decisions and unit activities. Each module is color-coded for graphic representation in SRM planning. The SRP relies primarily on the Readiness and Mission modules, and uses the Availability Modules when assessing a unit's readiness against a specific requirement (Known, Emergent or Contingency). The two availability modules are Non-Available and Committed. The three basic SRM modules (see Figure 3-12) include:

(1) Yellow – Prepare. Red Letters for C4 transition or building readiness; Black Letters is building readiness at C3; Dark Green Letters is Maintaining readiness at C3 – primarily for the RC.

(2) Green – Ready. Dark Green for C1 level readiness/Light Green for C2 level readiness.

(3) Purple – Mission. Dark Purple for C1/C2 missions that require decisive action readiness, Light purple for missions not requiring C1/C2 decisive action readiness.

Similarly, the Availability Modules are only used when analyzing unit readiness against a specific known, emergent or contingency mission. Based on force alignment guidance, these modules identify those units that are not available due to Force Employment or Force Projection missions or tasks (Committed) or Force Generation (Non-Available). Determining if a unit is in a particular Availability Module depends on the requirement being analyzed. A Contingency Requirement necessitates a Decisive Action level of readiness and therefore would result in more units being considered Non-Available, whereas an Emergent Requirement for Defense Support to Civilian Authorities (DSCA) often has a lower level of required readiness and therefore would result in less units being assessed as Non-Available. Based upon mission suitability, modules would depict either orange or red.

(4) Orange – Committed. Availability assessment based on Force Employment or Force Projection considerations (on-going missions – known requirements). A unit assessed as Committed is not readily available due to its physical location (deployed in another CCMD AOR), it being deployed to or from an on-going Joint requirement, or not available due to SECDEF guidance concerning the priority of missions (emergent requirement that is not as high a priority as the Global Response Force requirement).

(5) Red – Non-Available. Availability assessment based on Force Generation considerations. A unit assessed as Non-Available is not readily available either a low mission or response readiness assessment or a failure to meet SECDEF's deployment policy. The low readiness is due to such Force

Generation issues as modernization, conversion, activation or inactivation. These conditions make it difficult for the unit to rapidly gain the readiness necessary (response readiness) to meet the specified requirement.

**Modules:** Three descriptive modules to categorize readiness by quarters

Aligns force generation with quarterly training and readiness processes

- Provides common standards across the Total Army
- Clear representation of a unit's preparedness for decisive action
- Synchronizes resource decisions and unit activities

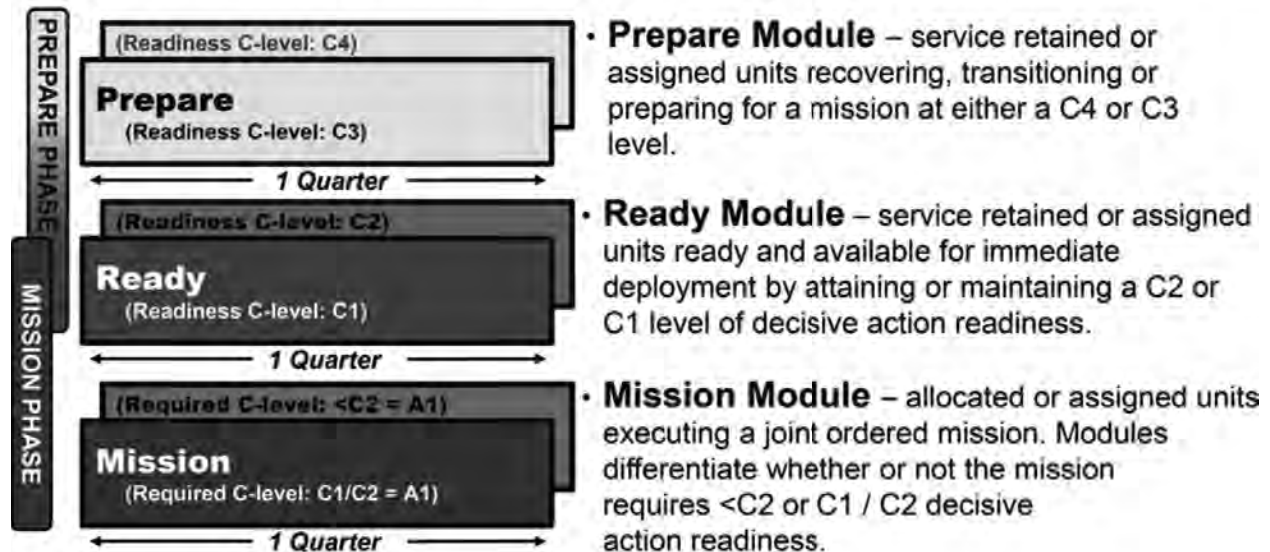

Figure 3-12. Sustainable Readiness Modules

f. Army Force Generation – Sustainable Readiness employs proven force generation methods that are measured and assessed through a comprehensive risk assessment directly linked to accomplishing national and CCDR missions and responding to emerging contingency requirements. The processes push readiness planning and management well into the HQDA resource planning windows to inform the budget and the POM. It provides the HQDA staff with a blueprint of readiness objectives for associated units that informs and prioritizes related resourcing, equipping, manning as well as unit training requirements. It also provides FORSCOM and the other force providers with a disciplined plan of unit readiness objectives that improves long range planning. Notwithstanding, it will not stop turbulence caused by unexpected changes to the operational and strategic environments. However, it will push planning timelines beyond the budget year and allow the force providers to prepare for known and projected demands over the FYDP and serve as a springboard to respond to changes. Finally, the readiness objectives distributed across every unit in the Total Army provide the Army with the means to project force-wide readiness and make readiness-informed resourcing and deployment/mission decisions.

**Section XI**

**Summary, Key Terms, and References**

**3-35. Summary**

a. In modern and complex organizations there is a cause and effect relationship involving almost every process and system. An appreciation of these interrelationships and knowledge of the individual systems that contribute to force management will in turn lead to an understanding of how the Army runs.

## HOW THE ARMY RUNS

The success of future senior Army leaders and managers depends on their understanding of the interrelations of the systems and subsystems as well as knowing the key players responsible for managing change. Senior leaders who can understand how these force management processes work, will certainly be more effective and efficient. Experience shows that successful senior leaders understand how the Army develops and sustains its part of the Nation's military capability and use this knowledge to make informed decisions on how to use or change the processes to improve that capability.

### 3-36. Key Terms

- a. Document Integrator (DI). Ensures that requirements and authorization documents meet approved Army force programs and link requirements, planned, or programmed force structure actions, and the documentation processes (FM 100-11, 15 Jan 98, RESCINDED).
- b. Force Development. The process of determining Army doctrinal, leader development, training, organizational, Soldier development, and materiel requirements and translating them into programs and structure, within allocated resources, to accomplish Army missions and functions (AR 71-32).
- c. Force Integration. The synchronized, resource-constrained execution of an approved force development program to achieve systematic management of change, includes the introduction, incorporation, and sustainment of doctrine, organizations, and equipment in the Army; coordination and integration of operational and managerial systems collectively designed to improve the effectiveness and capability of the Army; knowledge and consideration of the potential implications of decisions and actions taken within the execution process (AR 71-32).
- d. Force Integrator (FI). A manager of resourcing, documentation, fielding, and sustainment to assure doctrinal, operational, and technical integration of functionally dissimilar organizations. Responsible for the horizontal integration of large units such as brigades, regiments, groups, divisions and corps (FM 100-11, 15 Jan 98, RESCINDED).
- e. Force Management. The capstone process to establish and field mission-ready Army organizations. The process involves organization, integration, decision-making, and execution of the spectrum of activities encompassing requirements definition, force development, force integration, force structuring, combat developments, materiel developments, training developments, resourcing, and all elements of the AOLCM (AR 71-32).
- f. Force Modernization. The process of improving the Army's force effectiveness and operational capabilities through force development and integration (AR 5-22, 28 Oct 2015).
- g. Force Structure. The manpower and materiel composition, by number and type of organizations, of the current, planned, or programmed Total Army tasked to perform missions in peace and war (FM 100-11, 15 Jan 98, RESCINDED).
- h. Organization Integrator (OI). Manages TOE and/or MTOE units, by branch, to provide an operational view of change management. OIs are branch assigned personnel who are the focal point for force accounting, documentation, resourcing, and readiness of assigned units; exercise resource controls for documentation; coordinate and recommend approval or disapproval of all branch specific actions and documentation. The OI is the subject matter expert for branch issues and advises DCS, G-3/5/7 and G-3/7 FM on the disposition of branch actions at HQDA. The OI is the focal point for proponent and field access to the larger HQDA force management processes. (AR 71-32).
- i. System Integrator (SI). The coordinator for determining requirements, assuring operational and organizational documentation, coordinating, planning, programming fielding, and recommending resourcing priorities for designated functional areas or specific materiel systems (FM 100-11, 15 Jan 98, RESCINDED).
- j. Synchronization Staff Officer (SSO). Is charged with the synchronization of the JCIDS requirements process, DAS, PPBE, and equipment allocation processes. The SSO recommends an affordable equipment modernization investment strategy that best balances approved equipment modernization requirements and available fiscal resources to meet ACP directed equipping objectives. Facilitates informed HQDA decision making to equip the force to meet Army Title 10 mission requirements.

### 3-37. References

- a. AR 5-22, The Army Force Modernization Proponent System, 28 October 2015.
- b. AR71-32, Force Development and Documentation, 20 March 2019.
- c. Department of the Army Pamphlet 71-32, Force Development and Documentation Consolidated Procedures, 21 March 2019.



## FORCE MANAGEMENT

- d. CCJO, 10 September 2012.
- e. CJCSI 3010.02D, JCD&E, 22 November 2013.
- f. CJCSI 3170.01I, JCIDS, 23 January 2015.
- g. Department of the Army General Orders 2019-1, Assignment of Functions and Responsibilities Within Headquarters, Department of the Army, 15 May 2019.
- h. Department of the Army, General Orders 2018-10, Establishment of United States Army Futures Command, 4 June 2018.
- j. DODD 5000.71, Rapid Fulfillment of Combatant Commander Urgent Operational Needs, 24 August 2012.
- j. HQ TRADOC, TRADOC Regulation 25-36 C1, The TRADOC Doctrine Publication Program, 4 September 2012.
- k. Initial Message to the Force from the 23rd Secretary of the Army, SECARMY Hon Mark T. Esper, 21 November 2017.
- l. JCS J-8 Force Structure, Resources, and Assessments Directorate, Capabilities-Based Assessment Users Guide, Version 3, 01 October 2012.
- m. Public Law 99-433, DOD Reorganization Act of 1986.
- n. Public Law 103-62, Government Performance Results Act of 1993.
- o. Title 10, U.S. Code.
- p. TRADOC ARCIC, Capabilities-Based Assessment Guide, Version 3.1, 10 May 2010.
- q. TRADOC Pamphlet 71-20-3, TRADOC Concept Development Guide, 6 December 2011.
- r. TRADOC Pamphlet 525-3-0, The U.S. Army Capstone Concept, 19 December 2012.
- s. TRADOC Pamphlet 525-66 Force Operating Capabilities, 7 March 2008.
- t. TRADOC Regulation 71-20, Concept Development, Experimentation, and Requirements Determination, 28 June 2013.
- u. TRADOC Regulation 10-5, Organization and Functions, 21 April 2017.
- v. TRADOC Force Design Update (FDU) Writers Guide v.20 (DRAFT), 07 February 2019.
- w. AR 525-29, Force Generation – Sustainable Readiness, 1 October 2019.

## HOW THE ARMY RUNS

**This page is intentionally left blank**

*America's Army stands ready today to deploy, fight, and win our Nation's wars. The Army has made great progress in recent years, recovering from depleted levels of readiness following extended periods of sustained conflict and reduced defense spending. Our near-peer competitors, however, capitalized on this period to advance their own positions by modernizing their militaries and reducing the overmatch we held for decades. Aligned with the National Defense Strategy (NDS), the Army is pursuing a path to ensure we stay ahead of our competitors and remain ready and lethal into the future.*

## 2019 Army Posture Statement

### Chapter 4

#### Army Organization

##### Section I Introduction

##### 4-1. Chapter Content

a. The United States Army is a strategic instrument of national policy that has served the nation in peace and war for over two centuries. The Department of the Army (DA) is separately organized under the Secretary of the Army (SECARMY), Title 10 U.S. Code, Section 3011 (10 U.S.C. 3011). This chapter provides a discussion on how the Army is organized to perform its doctrinal tasks and how it responds to changes in its environment. The publications which provide the official description of Army organizations, as well as their roles, missions and functions, include the following: DA Pamphlet (DA PAM) 10-1, Organization of the United States Army; DA General Orders (DAGO) 2019-01, Assignment of Functions and Responsibilities Within Headquarters, Department of the Army; Army Regulation (AR) 10-87, Army Commands, Army Service Component Commands, and Direct Reporting Units; and AR 10-88, Field Operating Agencies, Office of Chief of Staff, Army (CSA). The Army web site provides links to the home pages of the Army Headquarters staff elements as well as four types of managing headquarters and supporting activities: the Army Commands (ACOM), Army Service Component Commands (ASCC), Direct Reporting Units (DRU), and Field Operating Agencies (FOA).

b. How the Army operates as a system within an organizational, operational, and strategic environment to carry out its Title 10 functions provides insight into how the Army allocates resources and effectively manages change. Through these processes, the Army is able to provide ready, lethal, and modern forces to the combatant commanders (CCDR) for prompt and sustained combat incident to operations on land. What follows is a discussion of the framework that describes the Army as an organization of headquarters, staffs, commands, and functional units.

##### 4-2. The Army Organizational System

a. The Army as an Open Organizational System.

(1) In terms of management theory, the Army can be considered an open organizational system with three distinct components: the production subsystem, the combat subsystem, and the integrating subsystem. Each of these components includes tasks to be accomplished, operates in a given environment, and requires and acquires resources. Because of the size and complexity of the Army and its tasks, its corresponding organizational structure must provide as much flexibility as possible, given resources and mission requirements, while also maintaining the mission command necessary to accomplish the following: develop forces; marshal, deploy, and employ those forces; and sustain operations in support of a national strategy.

(2) The Army's organizational design has evolved over time and is continuously being adapted to

## HOW THE ARMY RUNS

ensure a goodness-of-fit between its overall structure and the conditions of the external environment. In essence, the Army exists as an open system and thus must be structured and restructured in such a way as to allow the system to adapt to external factors in the appropriate manner. To facilitate adaptation, the Army organizational system is composed of a combination of decentralized functionally focused subordinate organizations empowered to adapt and make decisions to effectively and efficiently support or execute mission requirements. The Army system also has a centralized hierarchy designed to establish policies to effect coordination and cooperation between the sub-organizations and ensure cross functional integration and differentiation.

b. Integration and Differentiation. Every complex and open organization that is functionally organized to allow for decentralized sub-optimization is also challenged with ensuring both the integration of its suborganizational outputs and continued differentiation of those organizations as they adapt to the external environment. To manage integration and differentiation, organizations need to continuously scan their environment, both internally and externally, in order to best determine the following: the overall tasks and corresponding functional sub-tasks to be accomplished; the resource constraints placed on the organization; the extent of coordination that is needed within the organization in order to make effective and efficient decisions across all tasks and functional sub-tasks; whether accomplishment of new tasks or sub-tasks requires sufficiently unique skills, equipment, activities or management; whether the organization requires creation of a new sub-organization, or should or could be subsumed under an existing functional sub-organization; and the most effective and efficient overall organizational design needed to accomplish those tasks and, most important, to ensure the organization can rapidly adapt to future changes within and across the identified functional areas.

(1) Integration. The environments within which the Army competes require one primary output — mission-ready forces with a full range of operational capabilities. The Army is successful only to the extent that it produces such forces. The widely diverse operational environments also require a high degree of differentiation if the Army is to meet its multi-domain requirements. These two environmental demands—output and high differentiation—must be reconciled, and the Army must integrate many elements to produce mission-ready forces. One should expect that the greater the degree of differentiation in an organization, the more difficult it is to get the necessary coordination and integration. Generally, there are three approaches to integrating diverse organizational activities ranging from the simple to the highly complex: standard rules and procedures; plans, directives, and orders; and active management and directed integration. The use of each of these devices depends on a wide range of situational factors. Each of these devices is operating in any Army organization to some extent, and effective and complex organizations facing dynamic and diverse environments will use all of these integrative processes simultaneously.

(a) The simplest devices that can be used to deal with more certain environments are standard rules and procedures. In these cases, integration is achieved through adherence by the sub-organizations to the specified rules and procedures and active management is normally not required.

(b) Somewhat more complex devices are plans, directives, and orders. In these cases, integration is achieved through formulated guidance that specifies for the overall mission each organization's roles, responsibilities, and sub-tasks in time, space, and purpose. Coordination and integration is achieved through the coherency of the planning concept and the sub-organization's compliance to both the letter and intent of the plan.

(c) The most complex device is the process of active management and directed integration leading to mutual adjustment in which iterative communication is required within the management hierarchy or chain of command, and which could also entail the formation and use of cross-functional teams or individual integrators. A good example of the last process is the battalion task force approach to integrating and maneuvering the combined arms team after contact with the enemy. A project management organization also exemplifies integration by mutual adjustment.

(2) Differentiation. Organizations should be tailored in design to meet specific mission requirements and avoid unnecessary redundancy. For example, to demonstrate a forward presence in an area of vital interest to U.S. security, such as Europe, and to enhance relations with the Nation's allies, the Army has organized U.S. Army, Europe (USAREUR). Conversely, the U.S. Army Recruiting Command (USAREC), which is a major subordinate command of the U.S. Training and Doctrine Command (TRADOC), was established to deal with the Soldier acquisition task. To accommodate these different demands, the Army's systemic organizational response must be different. USAREUR would be as ineffective recruiting in the continental United States (CONUS) as USAREC would be in dealing with the Army's mission in

Europe.

(a) Task or functional specialization is both a dimension and a requirement of the structure of Army organizations. Such functions as personnel management; resource management (e.g., funds and manpower); operations, intelligence and security; logistics; and research and development are found separately identified in both the management staffs and subordinate commands.

(b) A major result of task specialization is that organizations tend to be designed and structured to fit the requirements of their sub-environments. Depending on the demands of the environment, organizations in one functional specialty tend to be differentiated from organizations in other specialties in the following manner: unique functionally-related mission focus; orientation on time and results (e.g., short-term, mid-term, long-term); degree of formality of the structure of organizations (e.g., rules, job descriptions, chain of command, process or procedural adherence); interpersonal orientation and ways of dealing with people (e.g., mission-oriented vs. relationship-oriented), etc.

## Section II

### The Production Subsystem

#### 4-3. Statutory Requirements

The Army's mission is to fight and win the nation's wars providing ready, prompt, and sustained land dominance by Army forces across the full spectrum of conflict as part of the joint force. This is accomplished through the following processes: executing Title 10 and Title 32 USC directives, to include organizing, equipping, and training forces for the conduct of prompt and sustained combat operations on land; accomplishing missions assigned by the President of the United States (POTUS), Secretary of Defense (SECDEF), and CCDRs; and changing the force to meet current and future demands.

#### 4-4. Production of Needed Resources

The production subsystem is the cornerstone of the process. This subsystem secures resources and raw materials for its many production efforts, to include the following: recruiting untrained personnel; searching for useable technology; and dealing with producers of outside goods and services. Its task, accomplished through its people and structure, is to convert the raw materials into the intermediate goods required by the combat system. To do this, the Army integrates Doctrine, Organization, Training, Materiel, Leadership and Education, Personnel, Facilities, and Policy (DOTMLPF-P) to produce the desired end state. Training centers and schools transform untrained people into tank crewmen, infantrymen, mechanics, and etcetera. Schools convert ideas and knowledge into doctrine, tactics, techniques, and training methods for the use of the combat subsystem. Laboratories, arsenals, and procurement and test organizations convert technology and contractor effort into weapons systems and equipment for the combat subsystem. Other parts of the production subsystem provide such sustaining support to the whole organizational system as health care, commissary support, and other services. The production subsystem serves primarily to meet the needs of the combat subsystem.

##### a. Army Futures Command (AFC).

(1) The mission of AFC is to lead a continuous transformation of Army modernization in order to provide future warfighters with the concepts, capabilities, and organizational structures they need to dominate a future battlefield. As the Army prepares for the future, it must modernized doctrine, equipment, processes, and organizational structures to maintain and extend overmatch against a range of competitors in any situation or domain.

(2) The Multi-Domain Operations (MDO) concept will guide this effort, which identifies future threats and challenges. The Army designed the AFC to develop capabilities needed for MDO using a completely modernized enterprise designed to achieve greater speed and efficiency AFC represents the most significant change in the Army in over 40 years. AFC will be an innovation hub allowing the commander to unite the functions of concept development, requirements, determination, organizational design, science and technology research, and solution development. Collocated within the innovation hub in Austin, Texas, AFC will have ready access to industry and academia.

(3) The Army will guide AFC using a clear set of modernization priorities that emphasize rapid maneuver, overwhelming fires, tactical innovation, and mission command. There are six priorities: 1) Long Range Precision Fires; 2) Next Generation of Combat Vehicles; 3) Future Vertical Lift; 4) Army Network; 5) Air and Missile Defense; and 6) Soldier Lethality.

## HOW THE ARMY RUNS

(4) Additionally, there are eight Cross Functional Teams (CFTs) aligned under AFC that will develop these six priorities. The CFTs match the six priorities with the addition of Assured Positioning, Navigation, and Timing CFT and Synthetic Training Environment CFT. These CFTs should serve to streamline the Army acquisition process, reducing the requirements process, shortening acquisition time, and engaging Soldiers early.

(5) The AFC's structure continues to develop based upon its mission. So far, the Army has reassigned the following commands to AFC:

(a) On 7 December 2018, TRADOC's Army Capabilities Integration Center (ARCIC) transitioned from TRADOC to AFC and changed its name to Futures and Concepts Center (FCC). The FCC's responsibility is to lead continuous transformation of Army modernization in order to provide future warfighters with the concepts, capabilities, and organizational structures they need to dominate a future battlefield.

(b) On 3 February 2019, the Research, Development, and Engineering Command (RDECOM) moved from TRADOC to AFC and was renamed the Combat Capabilities Development Command (CCDC).

(c) As the U.S. Army Medical Command reorganizes, one of its subordinate agencies, the U.S. Army Medical Materiel Activity (USAMMDA) will become part of AFC. Its mission and location will not change.

### b. TRADOC.

(1) TRADOC is the first of two major components of the production subsystem. TRADOC's roles include: develop, educate and train Soldiers, civilians, and leaders; support unit training; and design, build, and integrate a versatile mix of capabilities, formations, and equipment to strengthen the U.S. Army as America's force of decisive action. TRADOC is an ACOM consisting of HQ, TRADOC, and six major subordinate centers and commands. All TRADOC centers and schools are aligned under a major subordinate center or command, except the TRADOC Analysis Center (TRAC). The major subordinate centers and commands have direct authority over the centers and schools aligned under them, and are the linkage with non-TRADOC schools.

(2) TRADOC operates 32 Army schools organized under eight Centers of Excellence (CoE). Each school focuses on a separate area of expertise within the Army (e.g., Maneuver, Signal, etc.). These centers train nearly 600,000 Soldiers and service members each year (see Chapter 14 for a listing of TRADOC schools).

(3) The HQ TRADOC staff consists of a command group, personal staff, coordinating staff, and special staff.

(4) The HQ TRADOC staff provides staff management, facilitates external coordination, and assists the Deputy Commanding General/Chief of Staff (DCG/CofS) in the prioritization of resources. It ensures the coordination and integration of DOTMLPF-P initiatives and functions between external commands and organizations and the TRADOC major subordinate centers and commands, and special activities. The HQ, TRADOC staff is the primary interface with external agencies (e.g., DOD, Headquarters, Department of the Army (HQDA), joint organizations, other services, and other external agencies and organizations) to provide related Army positions and receive taskings and requests for TRADOC-related Army support.

(5) TRADOC's major subordinate centers and commands are also functionally aligned:

(a) Combined Arms Center (CAC). CAC designs, integrates and implements leader development and the Army Leader Development Program; synchronizes and delivers education; synchronizes branch and warfighting function proponent's doctrine, training, and leadership and education integration; develops and integrates doctrine; collects, analyzes, and disseminates Army lessons learned; manages the Army training support system enterprise; manages the Army training and education development enterprise and manages the Army combat training center program to build adaptive, innovative and agile Soldiers, leaders, and units in order to dominate and win in the conduct of unified land operations..

(b) Combined Arms Support Command (CASCOM) and Sustainment Center of Excellence (SCoE). CASCOM/SCoE trains, educates, and grows adaptive sustainment professionals; develops and integrates innovative Army and Joint sustainment capabilities, concepts, and doctrine to enable unified land operations.

(c) U.S. Army Center for Initial Military Training (CIMT). CIMT leads, trains, and mentors civilian volunteers and enables their development of knowledge, skills, abilities, and attributes into Soldiers who are competent in military skills, individuals of character, and committed to honorably serving the Nation. CIMT establishes standards and oversees training in core competencies and develops trusted

## ARMY ORGANIZATIONS

Soldiers/leaders who are grounded in the Army Ethic and are physically, mentally, and socially ready to assume duties in their first unit of assignment.

(d) U.S. Army Cadet Command (USACC). USACC partners with universities to recruit, educate, develop, and inspire Senior ROTC Cadets in order to commission officers of character for the Total Army. Additionally, USACC partners with high schools to conduct Junior ROTC in order to develop citizens of character for a lifetime of commitment and service to the nation.

(e) USAREC. USAREC is responsible for recruiting America's best volunteers to enable the Army to win in a complex world.

c. Army Materiel Command (AMC). The second major component of the production subsystem is AMC. AMC delivers logistics, sustainment, and materiel readiness from the installation to the forward tactical edge to ensure globally dominant land force capabilities. If a Soldier shoots it, drives it, flies it, wears it, eats it, or communicates with it, AMC provides it.

(1) AMC operates the following organizations: depots; arsenals; ammunition plants; and other facilities. AMC also maintains the Army Pre-Positioned Stocks (APS), both on land and afloat. The command is also the DOD Executive Agent for the chemical weapons stockpile and for conventional ammunition.

(2) To develop, buy and maintain materiel for the Army, AMC works closely with Program Executive Officers (PEO), the Army Acquisition Executive (AAE), industry and academia, the other services, and Other Government Agencies (OGA). AMC handles the majority of the Army's contracting including contracting services for deployed units and installation-level services, supplies, and common-use information technology hardware and software.

(3) AMC's main effort is to achieve the development, support, and sustainment of the current and future force. AMC is the key to supporting, sustaining, and resetting the current force. Its maintenance depots and arsenals restore weapon systems. The command's overhaul and modernization efforts enhance and upgrade major weapon systems—not just making them like new, but inserting technology to make them more operationally effective and reliable.

(4) AMC handles diverse missions that reach far beyond the Army. For example, AMC manages the multi-billion dollar business of selling Army equipment and services to friends and allies of the U.S. and negotiates and implements agreement for co-production of U.S. weapons systems by foreign nations. AMC also provides numerous acquisition and logistics services to the other components of DOD and many OGA.

(5) Continuing support across the full spectrum of operations plays a large role in maintaining combat readiness. No other Army organization is faced with such diversity and myriad cross-functional activities. Consequently, AMC is continuously adjusting its organizations to adapt to the changing operational and strategic environments, while ensuring both integration and differentiation of its subordinate organizations' roles, responsibilities and functions. AMC's Major Subordinate Commands (MSCs) include, but are not limited to the following:

(a) Army Sustainment Command (ASC). ASC functions to accomplish the following: manage APS; administer the Logistics Civil Augmentation Program (LOGCAP) and Logistics Assistance Program (LAP); oversee the timely retrograde of war materiel from the theater to Army depots for reset; and support Army operations in strategic locations around the world through seven assigned deployable Army Field Support Brigades (AFSB).

(b) Joint Munitions Command (JMC). JMC provides the conventional ammunition life-cycle functions of logistics sustainment, readiness and acquisition support for all U.S. military services, OGA, and allied nations as directed.

(c) U.S. Army Security Assistance Command (USASAC). USASAC is concerned with security assistance programs to include Foreign Military Sales (FMS).

(d) Army Contracting Command (ACC). ACC provides worldwide contracting support to the war fighter by acquiring equipment, supplies and services vital to our Soldiers' mission and well-being.

(e) U.S. Army Medical Command (MEDCOM) along with the Medical Research and Materiel Command (MRMC).

(f) U.S. Army Installation Management Command (IMCOM). IMCOM is accountable for effective installation management in the following areas: construction; barracks and family housing; family care; food management; environmental programs; well-being; Soldier and family morale, welfare, and recreation programs; logistics; public works; and installation funding. This evolution of the installation's role in the Army structure and its placement in the Army's organization has established it as

## HOW THE ARMY RUNS

a critical production subsystem of the Army.

(6) The AMC also coordinates directly with the Military Surface Deployment and Distribution Command (SDDC), concerned with ground transportation and port operations. The SDDC's CCMD is U.S. Transportation Command (USTRANSCOM) and serves as its ASCC. Concurrently, SDDC is also aligned as an MSC of AMC.

(7) AMC's four Life Cycle Management Commands (LCMC)—Aviation and Missile LCMC, Communications-Electronics Command (CECOM) LCMC, Joint Munitions and Lethality (JM&L) LCMC, and Tank-Automotive and Armaments Command (TACOM) LCMC—are commodity-oriented and perform life-cycle management over the initial and follow-on procurement and materiel readiness functions for items and weapon systems in support of the Army in the field (see Chapter 11 for more detail on LCMCs).

(8) AMC is headquartered at Redstone Arsenal, Alabama with a presence in all 50 states and 150 countries. Manning these organizations is a work force of more than 60,000 dedicated military and civilian employees, many with highly developed specialties in weapons development, manufacturing and logistics.

d. Installation Operations. Key to the production subsystem is the growing central role of Army installations. The subparagraphs below provide a general discussion and background for installations operations.

(1) The integration of installation organization and operations into the Army's overall organizational structure in the 1980s, both as a home station and training base, has proven to have a significant and positive effect on readiness. Installations are organized for and capable of training, mobilizing, deploying, sustaining, supporting, recovering, and reconstituting assigned and mobilized forces.

Additionally, activities on the installation receive installation support in accomplishing their missions. Examples of these activities are schools, hospitals, Reserve Component (RC) elements, and tactical HQ and their subordinate units. However, the traditional boundary between tactical and sustaining base activities are disappearing as the installation power projection platforms assume an increasing role in the sustainment, support, and welfare of deploying forces. This is also occurring because Information Technology (IT), rapid transportation, and improved management techniques are enabling more consolidated installation activities and reach-back to the installations for deployed forces.

(2) On 24 October 2006, the Army reorganized its structure for managing installations with the activation of U.S. Army Installation Management Command (IMCOM). The Army established IMCOM to reduce bureaucracy, apply a uniform business structure to manage U.S. Army installations, sustain the environment, and enhance the well-being of the military community. IMCOM's mission is to synchronize, integrate, and deliver installation services and sustain facilities in support of senior commanders in order to enable a ready and resilient Army.

(3) IMCOM transformed the Army's installation management structure into an integrated command structure.

e. Functional Commands.

(1) Not only is the installation operations task common to both the combat and production subsystems, but parts of the installation operations function have become recognizable specialty commands—and therefore part of the production subsystem—providing their goods and services usually to both the combat and production subsystems. For example, U. S. Army Medical Command (USMEDCOM) operates most Army medical activities in CONUS; and the U.S. Army Criminal Investigation Command (USACIDC) directs all criminal investigators.

(2) The principal reason for the establishment and continuation of functional commands is that the required degree of integration for their specialty activities differs substantially from those functions that are the responsibility of the installation commander. Each of the specialty functions is a goods or service provider that performs very different missions than those of the installation, whether it is force readiness or training. Mission performance does not require that telephone service, or commissary operations, or medical care delivery to be totally integrated with facilities or maintenance so that unit readiness or training objectives can be met. The same is not true of functions like maintenance or personnel support, which more directly affect installation goal achievement.

(3) Further, the conceptual model would suggest that achieving greater performance on the delivery or performance of these functions could best be accomplished by improving the degree of corresponding organizational differentiation. The functional organizational model appears to do just that. The central control reinforces the commitment by the local agency to do the following: high quality, efficient telephone service and medical care; good commissary support; meeting recruiting objectives; and



## ARMY ORGANIZATIONS

carrying out engineer construction projects. The process is successful because it emphasizes the uniqueness of the function and provides associated specialty career paths for employees.

f. HQDA Support Specialty Commands. Another secondary category of organizations within the production subsystem is the group of service producing, special-purpose organizations reporting to HQDA. This category includes, among others, Human Resources Command (HRC). It has tasks that do not require field units to produce the service, and therefore does not fall into the functional command category. HRC's services are used by the production and combat subsystems, as well as HQDA. Because of its specialty tasks, such agencies are directly linked to the HQDA staff, yet they are not classified as extensions to the staff because their functions are operational rather than policy generation. Most organizations operating in such manner are categorized as a FOA or a DRU. On the other hand, a Staff Support Agency (SSA) directly supports only an Army staff principal, usually with management information, analysis, or command and control support (Note: there are no SSAs currently designated).

(1) A FOA is an agency with the primary mission of executing policy that is under the supervision of HQDA, but not an ACOM, ASCC, or DRU. Listed below are the FOAs under the staff principal they support—

(a) Assistant Secretary of the Army (Manpower & Reserve Affairs): U.S. Army Diversity and Leadership; U.S. Army Manpower Analysis Agency; Army Review Boards Agency.

(b) The Army Auditor General — U.S. Army Audit Agency.

(c) Chief, Public Affairs: U.S. Army Public Affairs Center; U.S. Army Field Band.

(d) Administrative Assistant to the SECARMY: U.S. Army Resources and Programs Agency; U.S. Army Headquarters Services; U.S. Army Information Technology Agency; U.S. Army Center of Military History.

(e) The Inspector General — U.S. Army Inspector General Agency.

(f) Director of the Army Staff (DAS) — U.S. Army Combat Readiness/Safety Center.

(g) DCS, G-1: HRC; Civilian Training Student Education Detachment; Office of the Chief Army Enterprise Marketing.

(h) Office of the Army G-3/5/7: U.S. Army Force Management Support Agency; U.S. Army Command and Control Support Agency; U.S. Army Nuclear and Combating Weapons of Mass Destruction Agency.

(i) DCS, G-4 — U.S. Army Logistics Enterprise Support Agency.

(j) DCS, G-8 — U.S. Center for Army Analysis.

(k) Provost Marshal General: U.S. Army Corrections Command; Defense Forensics and Biometrics Agency.

(l) The Judge Advocate General: U.S. Army Legal Services Agency; The Judge Advocate General's Legal Center and School.

(2) A DRU is an Army organization comprised of one or more units with institutional or operational functions, designated by the SECARMY, providing broad general support to the Army in a normally, single, unique discipline not otherwise available elsewhere in the Army. DRUs report directly to a HQDA principal and/or ACOM and operate under the authorities established by the SECARMY. Listed below are the fifteen HQDA DRUs —

(a) Reporting to the CSA — U.S. Army Test and Evaluation Command; U.S. Military Academy; U.S. Military District of Washington; and U.S. Army War College.

(b) Reporting to the Executive Director Army National Military Cemetery—Arlington National Cemetery.

(c) Reporting to USAREC — Army Marketing and Engagement Brigade.

(d) Reporting to Assistant Secretary of the Army (Acquisition, Logistics, and Technology) (ASA (ALT)) — U.S. Army Acquisition Support Center.

(e) DCS, G-1: HRC; U.S. Army Civilian Human Resources Agency.

(f) Reporting to DCS, G-2—U.S. Army Intelligence and Security Command.

(g) Reporting to the Chief of Engineers — U.S. Army Corps of Engineers.

(h) Reporting to the Provost Marshal General — USACIDC.

(i) Reporting to the Assistant Secretary of the Army (Financial Management and Comptroller) (ASA (FM&C))—U.S. Army Financial Management Command.

(3) Comparison of DRUs and FOAs:

(a) DRUs are established by a Department of the Army General Order (DAGO) signed by the SECARMY with its responsibilities contained therein. A DRU is operationally oriented. It executes,

## HOW THE ARMY RUNS

instead of develops, policy provided by its HQDA principal. A DRU normally has a small headquarters and may lack a robust special staff inherent in an ACOM HQ (e.g., Inspector General (IG), Equal Employment Office (EEO), etc.). A DRU may have subordinate units that perform purely operational tasks. As stipulated in its DAGO, a DRU may be designated as an Operating Agency (OA) and exercise budget authority. Typically, a DRU submits resource/program requirements to its HQDA principal for programming/budget review and subsequently executes a program/budget approved by the HQDA principal. A DRU, in collaboration with its HQDA principal, develops appropriate input regarding the use of military and civilian manpower allocated directly by the Office of the ASA(FM&C), and performs its own internal personnel management functions (e.g., requisitions, civilian job classifications and announcements, officer and enlisted distribution plan management). A DRU's manpower and budget are not managed as a part of the HQDA Office of the Administrative Assistant (OAA). Because a DRU may perform some functions categorically defined as Management Headquarters Account (MHA) functions in DOD Directive (DODD) 5100.73, individual billets within the DRU headquarters may be classified as reportable Army MHA billets. A DRU is usually independent of OA 22, and therefore not under the management purview of the OAA.

(b) FOAs are agencies under the supervision of DA and, like a DRU, have a primary mission of executing policy. However, a FOA has relatively limited scope and responsibilities and does not operate under the authorities established by the SECARMY. FOA manpower and budget are managed as a part of the HQDA OAA. The DAS is the final approving authority for all recommendations to establish, discontinue, increase or decrease FOAs.

(4) Program Executive Offices (PEO) that fall under ASA (ALT) include—

- (a) PEO Ammunition.
- (b) PEO Intelligence, Electronic Warfare and Sensors.
- (c) PEO Aviation.
- (d) PEO Command, Control and Communications Tactical.
- (e) PEO Soldier.
- (f) PEO Missiles and Space.
- (g) PEO Combat Support and Combat Service Support.
- (h) PEO Simulation, Training and Instrumentation.
- (i) PEO Ground Combat Systems.
- (j) PEO Enterprise Information Systems.
- (k) Joint PEO Chemical and Biological Defense.
- (l) PEO Assembled Chemical Weapons Alternatives.

### Section III

#### The Combat Subsystem

##### 4-5. Products of the Combat Subsystem

The combat subsystem's major task is to convert the Army's intermediate products, obtained from the production subsystem, into mission-ready forces of units and organizations. Each element of its structure welds together individual Soldiers, equipment, doctrine, procedures, and training and produces combat readiness. The combat subsystem engages in a process of continued interaction with its resource environment, primarily the production and the integrating subsystems. Its task environment includes the enemy threat, the CCMDs, allied forces with whom it must deal, and, especially in peacetime, the Office of the Secretary of Defense (OSD) and Congress.

##### 4-6. The Army in the Field

a. This category of the Army's organizational structure consists of three ACOMs, including two of the commands previously addressed under the production subsystem and installation operations, and ten ASCCs.

(1) An ACOM is an Army force, designated by the SECARMY, performing multiple Army Service 10 U.S.C. 3013b across multiple disciplines. Command responsibilities are those established by the SECARMY. The four ACOMs are as follows—

- (a) AFC, Austin, Texas
- (b) TRADOC, Joint Base Langley-Eustis, Virginia.

- (c) AMC, Huntsville, Alabama.
- (d) FORSCOM, Fort Bragg, North Carolina.

(2) An ASCC is an Army force designated by the SECARMY, comprised primarily of operational organizations serving as the Army component for a CCDR. If designated by the CCDR, it serves as a Joint Forces Land Component Command (JFLCC) or a Joint Task Force (JTF). Command responsibilities are those established by the SECARMY. The ten ASCCs are as follows—

- (a) U.S. Army Africa/Southern European Task Force (USARAF/SETAF), Vicenza, Italy.
- (b) USAREUR, Wiesbaden, Germany.
- (c) U.S. Army, Central (USARCENT), Shaw Air Force Base, South Carolina.
- (d) U.S. Army North (USARNORTH), Fort Sam Houston, Texas.
- (e) U.S. Army South (USARSO), Fort Sam Houston, Texas.
- (f) U.S. Army Pacific (USARPAC), Fort Shafter, Hawaii.
- (g) U.S. Army Special Operations Command (USASOC), Fort Bragg, North Carolina.
- (h) Military Surface Deployment and Distribution Command (SDDC), Scott Air Force Base, Illinois.
- (i) U.S. Army Space and Missile Defense Command/Army Forces Strategic Command (USASMDC/ARSTRAT), Huntsville, Alabama.
- (j) U.S. Army Cyber Command (ARCYBER), Fort Gordon, Georgia.

b. In some respects, each command faces similar environments although they differ from each other in many ways. Several commands (e.g., FORSCOM, USAREUR, USARPAC, USASOC, and USARSO) have the principal task of providing mission-ready land forces—the primary output of the Army. As a result, each has developed an organizational structure reflecting its environment.

### **Section IV** **The Integrating Subsystem**

#### **4-7. Tasks of the Integrating Subsystem**

a. The integrating subsystem ties all of the subordinate subsystems together for the Army as a whole. Its tasks are to decide what is to be produced or accomplished by the whole system, and to see to it that the system performs as expected. It also acts as the source of funds for the subsystems, obtaining them from DOD, Office of Management and Budget (OMB), and Congress.

b. In any large organization, the HQ has the major function to direct the accomplishment of the overall mission and the major tasks of the organization. It is the most prominent integrating device in the organization. The challenge for the integrating subsystem is one of structuring the organization to accomplish the following tasks effectively:

(1) Determine the nature of current and future requirements from the strategic and operational environments (e.g., from strategic guidance from the Executive Branch and Congress, social trends, joint and other service developments, new or different external and domestic threats, technological opportunities, expanded or new domains (e.g., air, cyber, space, etc.), changes in the nature and form of war, increased resource constraints, etc.).

(2) Chart a course for the Army that will meet the projected demands/requirements.

(3) Secure the necessary resources (e.g., appropriations authority) for the Army.

(4) Allocate resources and assign responsibilities, objectives and performance requirements to the combat and production subsystems to address current requirements and to enable changes to meet future requirements.

(5) Evaluate the on-going performance of the subsystems' organizations in accomplishing current requirements and in their progress towards changing in time to meet anticipated future requirements.

(6) Adapt and manage change, whether evolutionary or revolutionary, to meet evolving or emerging national security requirements within acceptable risk and secured resources.

#### **4-8. Integration and Differentiation**

The exercise of these functions calls for both cross-functional integration and a high degree of differentiation within the HQ. Each function must relate to a similar functional group in OSD, to some extent to interested committees in Congress, and to members of the same specialist community in the combat and production subsystems. Figure 4-1 reflects the current HQDA Organization.

# HOW THE ARMY RUNS

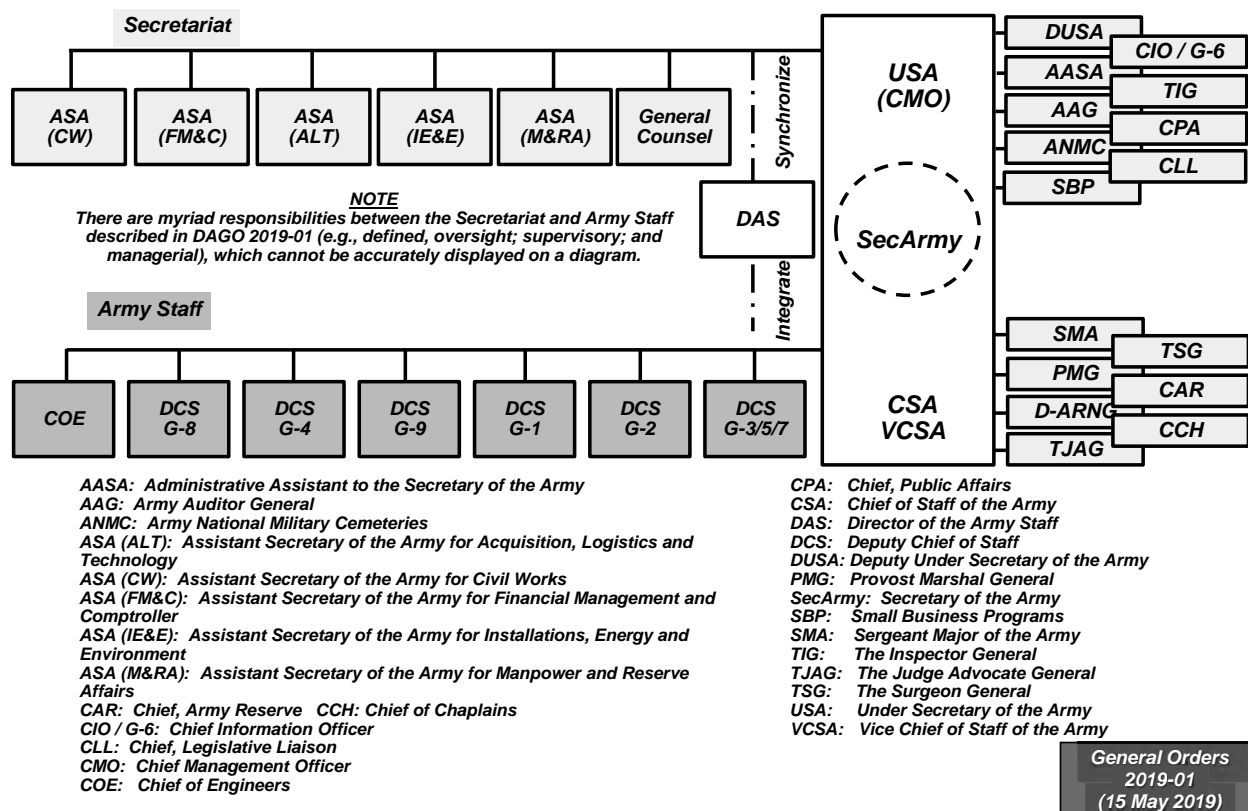

**Figure 4-1. HQDA Organization**

**a. Achieving Integration.**

(1) Integration is achieved in a formal series of meetings at the senior staff level within the Army Secretariat (ARSEC) and the Army Staff (ARSTAF). The heads of the staff agencies, the deputy chiefs of staff themselves, have a principal integrating role, serving more as a corporate management committee than as simply representatives of their own staff agencies. There are also many task forces, working groups, and committees with membership drawn from throughout the ARSEC and ARSTAF that serve as important knowledge-based integrators.

(2) Integration is also the primary function of the Army's senior leadership, to include: the SECARMY; Under Secretary of the Army (USA); CSA; and VCSA. This group decides on management strategies for stability, modernization of equipment, allocation of scarce resources, and force structure issues. These strategies, enunciated in the annual Army Posture Statement (APS), are unifying, integrating statements of objectives that relate directly to the dominant overall issue—maintaining mission-ready forces.

(3) The annual APS, available through the U.S. Army Home Page at <http://www.army.mil> is an unclassified summary of Army roles, missions, accomplishments, plans, and programs. Designed to reinforce the SECARMY and CSA posture and budget testimony before Congress, the APS serves a broad audience as a basic reference on the state of the Army.

**b. Achieving Differentiation.**

(1) Differentiation is achieved through the assignment of functional responsibilities to the HQDA directorates and the HQDA special and personal staff sections. It is within the directorates that assigned tasks such as recruiting, planning, or budgeting are managed, goals are formulated, timing coordinated, and sub-organizational hierarchy and protocols established. The directorates possess knowledge and experience sufficient for most decisions that concern their task environments.

(2) It is important at HQDA that the requirements of the associated functional environments are

## ARMY ORGANIZATIONS

communicated and analyzed. This includes both upward relationships—with OSD, OMB, and congressional committee staffers—and downward relationships with the subordinate organizations. The senior leadership of the Army has a large influence on goal-setting and performance evaluation for the whole functional or specialty community within the Army and a similar influence on getting the needed resources from OSD, OMB, and Congress.

### c. Horizontal Differentiation in HQDA.

(1) Part of the past debate on HQDA reorganization was the belief that the structure of HQDA actually complicates the achievement of the required differentiation and performance. The criticism focused on the functional parts of the ARSEC and ARSTAF directorates which seemed to perform duplicate activities or have overlapping responsibilities. The Goldwater-Nichols DOD Reorganization Act of 1986 required the integration of the two staffs into a single HQDA comprised of a Secretariat focused on managing the business of the Army and the CSA and deputy chiefs of staff responsible for planning, developing, executing, reviewing, and analyzing Army programs. The Army has continued to increase the integration of HQDA with the creation of the Executive Office of the HQDA, subsequently re-designated as Army Senior Leaders (ASL), which increased administrative oversight by the DAS of both the ARSEC and ARSTAF and required closer staff relationships.

(2) To achieve greater differentiation in acquisition management, Congress directed and placed into law that the service acquisition executive functions be placed within the service secretariats. Accordingly, the SECARMY appointed the ASA (ALT) as the AAE to centrally manage this function.

(3) The Army differentiates functions and tasks vertically. Efficiency and effectiveness demand that organizations eliminate any level that does not perform essential and unique tasks or perform critical integrating functions. The Army executes unique Title 10 functions and tasks and produces value-added outputs at the strategic, operational and tactical levels.

## Section V

### Summary and References

#### 4-9. Summary

a. This chapter presents a theoretical construct for the organizational design and structure of the Army by looking at the Army as an open organizational system composed of a production, combat, and integrating subsystem.

b. This chapter presents the details of each subsystem's major components, organizations, roles, missions, and functions, to include the ACOMs, ASCCs, DRUs, and FOAs.

c. Finally, this chapter examines the two defining characteristics of functional differentiation and integration.

#### 4-10. References

- a. Army Green Book 18-19.
- b. 2019 Army Posture Statement, 26 March 2019.
- c. AR 10-87, ACOMs, ASCCs, and DRUs, 11 December 2017.
- e. AR 570-4, Manpower Management, 8 February 2006.
- f. TRADOC Regulation (TR) 10-5, Organization and Functions.
- g. DAGO 2019-01, Assignment of Functions and Responsibilities Within HQDA, 15 May 2019.
- h. DOD Reorganization Act of 1986 (Goldwater-Nichols).
- i. DOD Dictionary of Military and Associated Terms, January 2020.
- j. <http://www.army.mil/info/organization/>.

## HOW THE ARMY RUNS

**This page is intentionally left blank**

## Chapter 5

### Army Mobilization and Deployment

#### Section I

##### Introduction

##### 5-1. Chapter Content

This chapter covers Army mobilization and deployment planning systems. The focus is on how the Army mobilizes forces to respond to the requirements of the Combatant Commanders (CCDRs). Also discussed are the Department of Defense (DOD) objectives for improving industrial preparedness in the United States and the Army industrial preparedness program.

#### Section II

##### Army Mobilization

##### 5-2. Army mobilization definition

Army mobilization is the core competency of bringing the Army to a state of readiness for war, contingency, or national emergency. This includes activating all or part of the Reserve Component (RC), assembling and organizing Army resources such as personnel, supplies, and materiel for war, extending terms of service, and surging the Army training operational bases.

##### 5-3. Framework for Army Mobilization Planning

a. Army participation in joint operations planning and Army planning for mobilization must be integrated. Joint Publication (JP) 4-05, Joint Mobilization Planning, facilitates integration of these processes by identifying the responsibilities of the Joint Staff (JS), Services, Combatant Commands (CCMD), transportation component commands, and other agencies engaged in mobilization planning. The mobilization annex of the Joint Strategic Capabilities Plan (JSCP) guides the Army and CCMDs in preparing mobilization plans. Global Force Management (GFM) is the Department of Defense Process used for aligning, force assignments, apportionment, and allocation processes in support of the National Defense Strategy, joint force availability requirements, and joint force assessments

b. Army Regulation (AR) 500-5, Army Mobilization, incorporates DOD and Chairman of the Joint Chiefs of Staff (CJCS) mobilization planning guidance in a single Army publication. It lists Army mobilization responsibilities and requirements for mobilization planning and system execution, and identifies the list of commands required to provide and maintain a mobilization plan. It recognizes the close relationship between operations planning and mobilization planning. It provides the means, within the Army, to accomplish both in a coordinated manner.

c. The mobilization plans of Army commands (ACOM), Army agencies, and Army Service Component Commands (ASCC) together with those of Headquarters, Department of the Army (HQDA), constitute the Army Mobilization Plan. The Army Mobilization System (AMS) is the vehicle by which all components of the Army plan and execute actions to provide and expand Army forces and resources to meet the requirements of CCMDs. AMS serves as the Army supplement to the adaptive planning and execution system (APEX). It provides the interface between the Army's plans to provide forces and resources and the CCDR's plans to deploy and use them. It also provides a standard set of guidelines for developing these plans and an integrated structure for the planning products.

##### 5-4. Army Mobilization System (AMS) Overview

a. The AMS ensures that the Army plans and executes actions necessary to provide the forces and resources to meet requirements of the CCDR. It covers a wide range of general functions covering the full course of a military action, conflict, or war. These functions include training, exercises, mobilization,

## HOW THE ARMY RUNS

deployment, employment, and sustainment, expansion of forces beyond the approved force structure, redeployment, demobilization, and reconstruction of Army forces. The goal of AMS is to ensure that the Army can adequately support all future combat operations of the CCMD, as opposed to concentrating only on getting forces into the theater of operations. AMS is also adaptable for planning military operations in a peacetime or permissive environment. The system is not just a planning system, but also an execution system. The use of the operations plan (OPLAN) format, with functional annexes and appendices, emphasizes the operational nature of the system.

b. HQDA Execute Order (EXORD) 088-19 supports AR 500-5 and the Army Mobilization Plan. It provides primary guidance for the Army to plan, resource, and execute global force management allocation plan operations and large scale combat operations. It applies to the Regular Army (RA), the Army National Guard (ARNG), and the United States Army Reserve (USAR). EXORD 088-19 establishes a common operational framework to scale and rapidly execute Army mobilization.

### 5-5. Mobilization Planning Responsibilities

a. Deputy Chief of Staff (DCS), G-3/5/7. The DCS, G-3/5/7 is responsible for developing Army mobilization and operations policy and guidance, developing priorities for mobilization of RC units, directing the call-up of RC units, and preparing them for deployment as well as establishing, publishing, and maintaining AMS. The AMS responsibilities include the following: coordinating the structure and content of AMS with ARSTAF, ACOM, and other Army activities; tasking agencies and commands to prepare appropriate portions of AMS; reviewing agency and command mobilization plans; ensuring AMS guidance, policies, and products satisfy applicable Office of the Secretary of Defense (OSD) and CJCS guidance; and ensuring AMS guidance, policies, and products are updated biennially, as a minimum, but not later than 45 days after publication of the JSCP. The DCS, G-3/5/7 also schedules and chairs all General Officer Mobilization Reviews (GOMRs).

b. Principal Department of the Army (DA) Officials and Army Staff Agencies. Each principal DA official and agency is responsible for assisting the DCS, G-3/5/7, in developing and maintaining those portions of AMS pertaining to their respective areas of interest and for mobilization and operational planning activities within their respective functional areas. They disseminate additional guidance to staff support agencies and field operating agencies (FOA) on related matters in development of mobilization, deployment, redeployment, demobilization, reconstitution plans and other matters. They review and approve mobilization plans of their respective staff support agencies and FOA.

c. ACOMs. Each ACOM is responsible for assisting the DCS, G-3/5/7 in developing and maintaining those portions of the AMS pertaining to their respective mission areas. ACOMs are also responsible for mobilization and operations planning within their respective mission areas and for publishing a command mobilization plan as a volume of the Army mobilization plan. Such plans will be submitted to HQDA for review and approval prior to publication. ACOMs are also responsible for compliance with the guidance and procedures published in the AMS.

d. Specific Responsibilities.

(1) U.S. Army Forces Command (FORSCOM) is the DA executive agent for continental U.S. (CONUS) unit mobilization, deployment, redeployment, demobilization, and reconstitution planning and execution.

(2) U.S. Army Special Operations Command (USASOC), ARNG, and U.S. Army Reserve Command (USARC) are responsible for the alert notification of RC special operations forces (RCSOF) units to include mobilization, validation, deployment, redeployment, and demobilization for wartime or other assigned missions. USASOC provides follow-on personnel and equipment to sustain RCSOF units and individual replacements provided to the CCMDs.

(3) U.S. Army Training and Doctrine Command (TRADOC) acts as the HQDA executive agent for CONUS replacement center (CRC) operations. TRADOC establishes and operates CRCs that receive and prepare individuals and replacement personnel for onward movement. TRADOC establishes procedures and ensures the training base infrastructure can be rapidly expanded to support contingency operations. TRADOC also ensures that individual ready reserve (IRR) Soldiers are properly assessed, trained and processed for onward movement in time of crisis.

(4) ACOMs and ASCCs support HQDA in developing and maintaining AMS, and assist FORSCOM units to ensure plans to mobilize, deploy, re-deploy, demobilize, and reconstitute are sound and workable.

e. Mobilization Planning. Mobilization, under the concept of graduated mobilization response, is a tool provided to the President of the U.S. (POTUS) and Secretary of Defense (SECDEF) to respond in varying



## ARMY MOBILIZATION AND DEPLOYMENT

degrees to crises as they occur. Army mobilization is the process the Army to a state of readiness for war, contingency, or national emergency. This includes activating all or part of the RC as well as assembling and organizing personnel, supplies, and materiel. This section provides an overview of the mobilization process within the framework of the AMS, the types of mobilization, and the interface with non-DOD agencies.

(1) AMS Major and Functional Subsystems. The primary objective of the Army mobilization process is to mobilize, deploy, and sustain the theater force. The major subsystems involved are theater force units, military manpower, and materiel. Supporting these subsystems are a number of interrelated CONUS-based functionally oriented subsystems, which include: power projection platforms (PPP)/power support platforms (PSP); the training base; the logistics structure; the medical structure; and transportation support. These subsystems are interrelated as shown in Figure 5-1 and described in more detail below.

(2) Theater Force. The theater force consists of theater force units, military manpower (e.g., individuals), and materiel apportioned for deployment to the theater of operations. The objective of the theater force units subsystem is to ensure the orderly and timely availability of Army units at ports of embarkation (e.g., air and sea) for deployment as prescribed in war plans or as directed by the JS. It also may include new or un-resourced units that would be activated on order.

(a) JSCP. If deployed or designated to support one or more OPLANs by the JSCP and Annex A of AMS, the JS alerts CONUS-based active units through FORSCOM channels (e.g., through the U.S. Indo-Pacific Command (USINDOPACOM) CCDR channels for Hawaii and Alaska-based units) when an emergency arises. RA units do not require mobilization. Instead, they are either forward positioned or pre-positioned (PREPO) units which deploy by air to link up with PREPO equipment. Units with organic equipment load their equipment and move either to an air- or sea-port of embarkation. PREPO units turn in equipment that will remain behind, load equipment to accompany troops, load equipment not authorized pre-positioning (NAP) and items that may be short in PREPO, and then move to a designated airport of embarkation. PREPO shortages may be shipped by air and/or sea as required by the time-phased force and deployment data (TPFDD). Units may be deployed from an ongoing smaller contingency operation location to a higher priority large contingency operation at the direction of the POTUS or SECDEF.

(b) ARNG. The Director, ARNG (DARNG) on behalf of the Chief, National Guard Bureau (CNGB), assists DCS, G3/5/7 to develop functional areas specifics to mobilize Army forces. They provide general officer (GO) or senior executive service (SES) support as required to general officer mobilization reviews, colonel support to council of colonel mobilization working groups, and action officer mobilization working groups. On behalf of the CNGB, the DARNG coordinates with state, territory, and district adjutants general (TAGs) as required. In peacetime, the preparation of ARNG units for mobilization is the responsibility of the state Governor. Guidance is issued to the Governor by HQDA through the CNGB, and by FORSCOM and U.S. Army Pacific (USARPAC) to the TAGs of the states within their areas of operation. The state Governor commands ARNG units until they are federalized. Once federalized, ARNG units become RA units under the appropriate ACOM.

(c) USAR. Per Title 10, Section 10171 (10 U.S.C. 10171), during peacetime, the preparation of all assigned USAR units for mobilization is the responsibility of the CG, United States Army Reserve Command (USARC); the Commander, USARPAC; and the Commander, USAREUR. USAR units are usually apportioned to one or more OPLANs or designated to support the CONUS sustaining base. Selected later-deploying units may receive interim assignments to augment a particular element in the CONUS base.

(d) Human Resources Command (HRC), St. Louis, Missouri is responsible for the management and continued training of the IRR and retired reserve. These groups provide the largest resource of pre-trained Soldiers. The CG, USARC assists DCS, G3/5/7 to develop functional areas specifics to mobilize Army forces. They provide GO or SES support as required to general officer mobilization reviews, colonel support to council of colonel mobilization working groups, and action officer mobilization working groups.

(e) Un-Resourced and New Units. FORSCOM prepares, in coordination with each supported CCMD, a proposed unit activation schedule for each major planning scenario identified in the JSCP. Considerations in the development of the proposed unit activation schedule (UAS) include the following: changes emanating from the CCDR's response to biennial JSCP guidance (e.g., a TPFDD shortfall); Total Army Analysis (TAA) determinations of which units in the required force structure will be un-

## HOW THE ARMY RUNS

resourced; and structure changes reflected in program objective memorandum (POM) development. The prioritized activations include additional support units required to sustain the current force. In preparing the UAS, close attention is given to recognized equipment availability constraints, particularly major weapon systems. The composition of the proposed UAS and the recommended priorities will be reviewed and approved by HQDA.

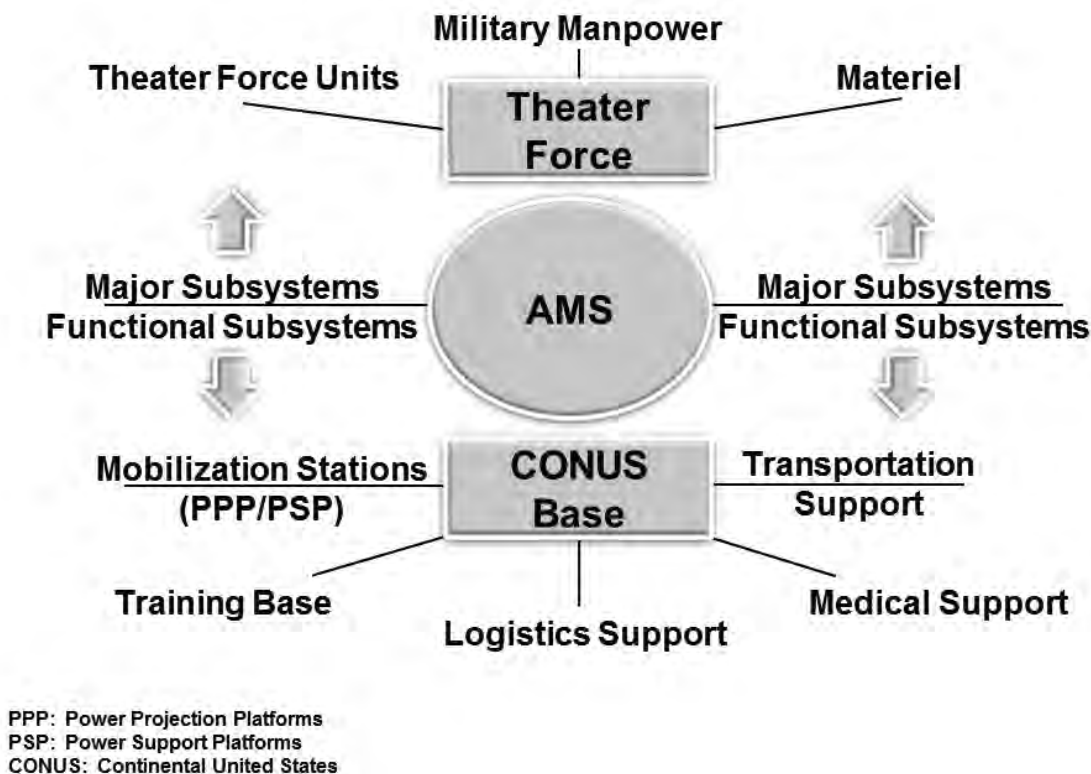

**Figure 5-1. Army Mobilization System Subsystems**

f. Types of Mobilization. Generally, the magnitude of the emergency governs the type of mobilization. As authorized by law or congressional resolution and when directed by the POTUS, DOD mobilizes all or part of the RC as shown in Figure 5-2. Concurrently, the DOD and other federal agencies marshal national resources in order to sustain the mobilized force.

(1) Selective Mobilization. For domestic emergencies, the POTUS may order expansion of the active armed forces by activation of RC units and/or individual reservists to deal with a situation where the armed forces may be required to protect life, federal property, or to prevent disruption of federal activities. A selective mobilization would not be associated with a requirement for contingency plans involving external threats to national security.

(2) PRC. The POTUS may augment the active forces by an involuntary call-up of units and individuals of the Selected Reserve or any member of the IRR designated as essential up to 200,000 persons from all services for up to 365 days to meet an operational requirement. No more than 30,000 of the 200,000 may be members of the IRR. The POTUS must notify Congress whenever this authority to call-up the RC is exercised.

(3) Partial Mobilization. In time of national emergency declared by the POTUS, or when otherwise authorized by law, an authority designated by the Service Secretary concerned may, without the consent of the persons concerned, order any unit, and any member not assigned to a unit organized to serve as a unit, in the Ready Reserve under the jurisdiction of that Secretary to active duty for not more than 24 consecutive months. Not more than 1,000,000 members of the Ready Reserve may be on active duty, without their consent, under partial mobilization at any one time.

## ARMY MOBILIZATION AND DEPLOYMENT

(4) Full Mobilization. In time of war or national emergency declared by Congress, or when otherwise authorized by law, an authority designated by the Service Secretary concerned may, without the consent of the persons affected, order any unit, and any member not assigned to a unit organized to serve as a unit, of a RC under the jurisdiction of that Secretary to active duty for the duration of the war or emergency and for six months thereafter.

(5) Total Mobilization. Total mobilization involves expansion of the active armed forces beyond the approved force structure by organizing and/or activating additional units to respond to requirements of the emergency. All national resources, to include production facilities, needed to sustain additional forces will also be mobilized. Congressional authorization is required for these actions.

(6) 12304a and 12304b. 2012 National Defense Authorization Act (NDAA) Section 12304a provides the SECDEF with the authority to order any unit, and any member not assigned to a unit organized to serve as a unit, of the USAR, Navy Reserve, Marine Corps Reserve, and Air Force Reserve to active duty without their consent for a continuous period of not more than 120 days to respond to a Governor's request for federal assistance regarding a major disaster or emergency. Section 12304b provides the Secretary of a Military Department the authority to order any unit of the Selected Reserve, without the consent of the members, to active duty for not more than 365 consecutive days when the Secretary determines that it is necessary to augment the active forces for a preplanned mission in support of a CCMD. To exercise this authority, the manpower and associated costs of such active duty must be specifically included and identified in the defense budget materials for the fiscal year or years in which such units are anticipated to be ordered to active duty. Additionally, budget information on such costs must include a description of the mission for which such units are anticipated to be called to active duty and the anticipated length of time involuntarily on active duty. Not more than 60,000 members of the RC may be on active duty under this section at one time.

g. Mobilization Authority.

(1) The authority to order mobilization resides with the POTUS, Congress, SECDEF, and the Secretaries of the Military Departments as outlined in the types of mobilization above. The POTUS or Congress will declare a national emergency depending upon the type of mobilization invoked.

(2) The National Emergencies Act of 1976 provides that when the POTUS declares a national emergency, the declaration or subsequent executive order must specify the authorities being invoked. The POTUS's powers are limited to those invoked until the subsequent announcement of the invoking of additional specific authorities. Once the POTUS declares a national emergency for a specific purpose, the national emergency will remain in effect for one year, unless sooner rescinded or extended. Under the Federal Administrative Procedure Act of 1946, all executive orders must be published in the federal register.

(3) The SECDEF, with the advice and recommendation of the CJCS and the Service Secretaries, recommends to the POTUS and the Congress the mobilization authority required to support a given contingency, OPLAN, or national emergency. The SECDEF directs mobilization of RC units and manpower through the military departments.

h. Peacetime Planning. The Army plans and prepares for mobilization in peacetime. It participates in war planning to establish Army forces and the requirements for their augmentation. It programs and budgets resources and acts to man, equip, and train the Army and to prepare for its employment during a war or other national emergency. Planning is accomplished in accordance with the provisions of the joint operations planning and execution system (JOPES) and AMS. This peacetime planning essentially consists of war planning intended to develop the OPLANs for the conduct of operations and mobilization planning.

i. DOD Mobilization Planning Process.

(1) Mobilization planning, primarily a service responsibility, is based on guidance from OSD and the Joint Chiefs of Staff (JCS). OSD guidance is included in the Defense Planning Guidance (DPG) and Guidance for Employment of the Force (GEF). JS guidance is contained in the JSCP. In addition, JP 4-05, Joint Mobilization Planning, assigns general responsibilities and procedures for mobilization. The JS coordinates the mobilization plans of the services and ensures the interface of these plans with deployment (see Chap 2, Strategy).

(2) Within the Army, mobilization is the process of assembling and organizing Army resources for war or other emergency to include activating all or part of the Reserve Component, extending terms of service, and surging the Army operational training bases (EXORD 088-19).

## HOW THE ARMY RUNS

|                     | Legal Authority                       | Purpose of Duty                              | Applies To               | Type of Duty |             |  |
|---------------------|---------------------------------------|--|--------------------------|--------------|-------------|--|
| <b>Training</b>     | 10 USC 10147                          | Annual Training (AT)/Drill Requirement       | Reserve Only             | AD/IDT       | Involuntary |  |
|                     | 10 USC 12301(B)                       | Annual Training                              | Reserve & National Guard | AD/IDT       | Involuntary |  |
|                     | 10 USC 12301(d)                       | Additional/Other Training Duty               | Reserve & National Guard | AD/IDT       | Voluntary   |  |
|                     | 32 USC 502(a)                         | Annual Training (AT)/Drill Requirement       | National Guard Only      | FTNGD/IDT    | Involuntary |  |
|                     | 32 USC 502(f)(1)(A)                   | Additional Training Duty                     | National Guard Only      | FTNGD        | Involuntary |  |
|                     | 32 USC 502(f)(1)(B)                   | Additional/Other Training Duty               | National Guard Only      | FTNGD        | Voluntary   |  |
| <b>Support</b>      | 10 USC 12301(d)                       | AGR Duty/Operational Support/Additional Duty | Reserve & National Guard | AD           | Voluntary   |  |
|                     | 10 USC 12304b                         | Preplanned/Preprogrammed CDR Support         | Reserve & National Guard | AD           | Involuntary |  |
|                     | 32 USC 502(f)(1)(B)                   | AGR Duty/Operational Support/Additional Duty | National Guard Only      | FTNGD        | Voluntary   |  |
|                     | 32 USC 502(f)(1)(A)                   | Other Duty                                   | National Guard Only      | FTNGD        | Involuntary |  |
| <b>Mobilization</b> | 10 USC 12301(a)                       | Full Mobilization                            | Reserve & National Guard | AD           | Involuntary |  |
|                     | 10 USC 12302                          | Partial Mobilization                         | Reserve & National Guard | AD           | Involuntary |  |
|                     | 10 USC 12304                          | PRC  | Reserve & National Guard | AD           | Involuntary |  |
|                     | 10 USC 12304a                         | Emergencies and Natural Disasters            | Reserve Only             | AD           | Involuntary |  |
|                     | 14 USC 712                            | Emergencies and Natural Disasters            | USCGR Only               | AD           | Involuntary |  |
|                     |                                       |  |                          |              |             |  |
| <b>Other</b>        | 10 USC 12503                          | Funeral Honors                               | Reserve & National Guard | ID           | Voluntary   |  |
|                     | 32 USC 115                            | Funeral Honors                               | National Guard Only      | ID           | Voluntary   |  |
|                     |                                       |  |                          |              |             |  |
|                     | 10 USC 12319                          | Muster Duty                                  | Reserve & National Guard | ID           | Involuntary |  |
|                     |                                       |  |                          |              |             |  |
|                     | 10 USC 12301(h)                       | Medical Care                                 | Reserve & National Guard | AD           | Voluntary   |  |
|                     | 10 USC 12322                          | Medical Evaluation and Treatment             | Reserve & National Guard | AD           | Voluntary   |  |
|                     | 10 USC 12323                          | Pending LOD for Response to Sexual Assault   | Reserve & National Guard | AD           | Voluntary   |  |
|                     |                                       |  |                          |              |             |  |
|                     | 10 USC 688                            | Retiree Recall                               | Reserve & National Guard | AD           | Involuntary |  |
|                     | 10 USC 802(d)                         | Disciplinary                                 | Reserve & National Guard | AD           | Involuntary |  |
|                     | 10 USC 10148                          | Unsat Participation (up to 45 days)          | Reserve & National Guard | AD           | Involuntary |  |
|                     | 10 USC 12301(g)                       | Captive Status                               | Reserve & National Guard | AD           | Involuntary |  |
| 10 USC 12303        | Unsat Participation (up to 24 months) | Reserve & National Guard                     | AD                       | Involuntary  |             |  |
| 10 USC 12402        | Duty at National Guard Bureau         | National Guard Only                          | AD                       | Voluntary    |             |  |
|                     |                                       |  |                          |              |             |  |
| 10 USC 331          | Insurrection                          | National Guard Only                          | AD                       | Involuntary  |             |  |
| 10 USC 332          | Insurrection                          | National Guard Only                          | AD                       | Involuntary  |             |  |
| 10 USC 12406        | Insurrection                          | National Guard Only                          | AD                       | Involuntary  |             |  |

AD – Active Duty  
CCDR – Combatant Commander  
ID – Inactive Duty

IDT – Inactive Duty Training  
FTNGD – Full Time Natl Guard Duty  
PRC – Presidential Reserve Call-up

Table taken from DoDI 1215.06, including change 1, effective May 19, 2015

**Figure 5-2. RC Utilization Authorities**

j. Mobilization planning in other federal departments and agencies. In addition to DOD, approximately 50 federal departments and agencies have emergency planning responsibilities. The Federal Emergency Management Agency (FEMA) is the federal government coordinator of these emergency management activities in both peace and war. FEMA's responsibilities include policy guidance and planning to ensure that the government at all levels is able to cope with and recover from emergencies. FEMA assesses national civil mobilization capabilities and develops concepts, plans, and systems for management of national resources. It identifies actual and potential shortages in natural, industrial, economic, and other resources, develops plans to mitigate their national security impacts, and fosters programs to reduce national vulnerability to such resource shortages. FEMA is the principal respondent to military requirements for civilian sector resources during mobilization, coordinates the response of the civilian agencies to defense needs, and ensures that national resources are used to meet both the military and the essential civilian needs of the nation.

k. The Army Mobilization Strategy (AMS) incorporates the guidance of the DPG, JSCP, and JP 4-05, and specifies the planning process used to develop HQDA and ACOM mobilization plans. The FORSCOM mobilization plan details the time-phased flow of mobilizing RC units from home stations to their mobilization stations. The TRADOC Mobilization and Operation Planning and Execution System provides installations and training base augmentation units in the USAR with guidance on training base expansion activities.

l. Army Mobilization Planning. The Army Mobilization Plan (AMP) is a collection of mobilizations plans from ACOMs, ASCCs, DRUs, and other Army elements consolidated over 26 volumes (XXVI). Part of Army mobilization planning provides the resources required to support various OPLANs. This includes incorporating mobilizing the units, manpower, and materiel required for immediate implementation of an OPLAN as well as the resources required to sustain the operation. Per EXORD 088-19., the AMP is conducted in 3 Phases:

## ARMY MOBILIZATION AND DEPLOYMENT

(1) Phase 1: Begins with the Army Mobilization Forum (AMF) and ends with the publication HQDA Mobilization Plan EXORD.

(2) Phase 2: Begins with the publication of the HQDA Plan EXORD and ends with the publication of supporting mobilization plans.

(3) Phase 3: Begins with the publication of the supporting Command Mobilization Plans and ends with the major revision of AR 500-5.

m. Relationships of War Planning and Mobilization Planning. AMS provides the linkage between war planning under JOPES and mobilization planning as directed by DOD and the JS. AMS establishes the who, when, what, where, why and how of mobilization and further prescribes the Army crisis action system for managing the execution of mobilization and OPLANS. The principal products of AMS are prepared executable plans, supporting information, and databases prepared and maintained for use during national crises. Mobilization plans incorporate the specific actions and responsibilities that must be accomplished both in peacetime and upon the order to mobilize. HQDA and ACOM mobilization plans that constitute the Army mobilization plans are based on guidance contained in AMS and other documents. Most mobilization plans are oriented toward full mobilization. However, the Army has developed partial mobilization plans for selected contingencies.

n. Peacetime Preparation. Preparation for mobilization proceeds concurrently with planning. The Army programs, budgets, and funds resources to overcome the shortfalls and limiting factors identified from a continuing analysis of the various operation plans. Concurrently, the Army trains units and individuals. Within its capabilities, it identifies and pre-assigns augmenting manpower and prepositions materiel to support those plans.

o. Alert, Mobilization, and Deployment. There are four phases of individual or unit mobilization as outlined in HQDA EXORD 088-19: Phase I is pre-mobilization; Phase II is alert; Phase III is mobilization; Phase IV is demobilization. The Force Generation process is designed to effectively and efficiently generate trained and ready forces for CCDRs at sustainable and predictable rotational levels.

(1) Phase I-Pre-Mobilization. Pre-Mobilization consists of tasks and planning factors to enable effective mobilization and deployment of RC forces. This includes RC unit selection and notification of sourcing (NOS) to allow RC units to begin planning. RC units pre-identified to support large scale combat operations should receive specific HQDA resourcing (certain classes of supply, material, training days) to enhance unit readiness for the notification pre-mobilization period. Primary responsibility in Phase I lies in the RC with support from the mobilization authorities to enable RC units to conduct home station activities to build readiness on their designated C-level. Phase I ends when a unit receives an official HQDA alert order.

(2) Phase II-Alert. Phase II begins with the signing of the SECDEF Orders Book (SDOB). HQDA then publishes an alert order for RC units. FORSCOM, USASOC, USARPAC, or USAREUR then publish deployment orders for assigned and RA and RC units with specific mission requirements and current deployment data as applicable. Phase II is the responsibility of the unit commander supported by mobilization authorities. RC units then conduct mission specific training, plan sustainment, and prepare for formal mobilization. Phase II end on the mobilization date (M-date) or on the effective date of a HQDA de-alert order.

(3) Phase III-Mobilization. Mobilization begins on the M-date documented on the HQDA mobilization order and corresponding Continental US Army (CONUSA) order. First Army publishes the CONUSA level mobilization order for the continental US (CONUS), US Virgin Islands, Puerto Rico, and based RC forces not assigned to INDOPACOM, USEUCOM, and USSOCOM. USASOC publishes mobilization level orders for USOCOM RC forces. USARPAC publishes CONUSA level mobilization orders for INDOPACOM assigned RC forces. USAREUR publishes the CONUSA mobilization level orders for EUCOM assigned RC forces. Deploying RC forces will assemble at home station and on order move to the designated Mobilization Force Generation Installation (MFGI). Upon completion of post-mobilization training and validation, units will deploy in sufficient time to meet the latest arrival date (LAD). Upon arrival in the Joint Operations Area (JOA) the unit is placed under operationally control of the gaining CCDR, or upon arrival at the designated location for the mobilization support force (MSF), or the CONUS support base mission (CSB). Phase III ends when the unit is released by the CCDR or designated CDR, attached to First Army, or aligned ASCC, or upon departure from the JOA, or from the CSB mission location enroute to the designated MFGI.

(4) Phase IV-Demobilization. Phase IV begins when the unit arrives at the port of debarkation (POD) from outside CONUS deployments or the designated demobilization station for CSN mobilizations.

## HOW THE ARMY RUNS

Phase IV is the responsibility of FORSCOM, First Army, associated unit Corp/Division HQ, USASOC, USARPAC, and USAREUR. RC units will conduct demobilization at MFGIs. Phase IV ends on the effective date of HQDA demobilization order and units return to RC control.

p. FORSCOM Mobilization Planning.

(1) FORSCOM mobilization planning is based on FORSCOM Regulation 500-5-1.

(2) FORSCOM coordinates with USASOC, TRADOC, Medical Command (MEDCOM), U.S.

Transportation Command, Surface Deployment and Distribution Command (SDDC), Army Materiel Command (AMC), and NGB in preparing data. The Global Combat Service Support System – Army mobilization planning line includes scenario-dependent data for RC deploying and redeploying modified table of organization and equipment and table of distribution and allowance units in the Army status of resources and training system. The mobilization planning line includes the following data for these units, as applicable:

(a) Unit description, component, and home station.

(b) Power projection platform data.

(c) Unit mobilization data (notional).

(d) Ready-to-load dates.

(e) Deployment data for the applicable TPFDD(s).

q. Mobilization Flow. Mobilization execution is decentralized to commands. FORSCOM, USARPAC, and USAREUR are the principal commands that command mobilizing RC units. Other commands (USASOC, TRADOC, MEDCOM, AMC, and SDDC) assume command of designated non-deploying units. Upon receiving the order to mobilize, most RC units move to one of 15 PPPs and 12 PSPs within the First Army area and the USARPAC area to train before deploying or augmenting the CONUS base. Cross-leveling of equipment and personnel assets required to make units mission-capable takes place primarily at PPPs. AMC provides wholesale management for materiel. Human Resources Command (HRC) serves in a similar management role for personnel. MEDCOM expands medical support services and facilities. The U.S. Army Corps of Engineers (USACE) expands troop housing, training, industrial, and other facilities.

### **5-6. Department of the Army Mobilization Processing System (DAMPS)**

DAMPS is a system that automates the business processes of military forces mobilization. DAMPS is a web-based system that provides the workflow business process for the alert, notification and orders for Army RC units and individuals ordered to active duty. DAMPS produces and maintains unit mobilization orders. These orders provide instructions and authority for a mobilized unit to move from home station to the mob station based on the mobilization station assignments. Once the order is issued, RC commands can issue the individual mobilization orders for the members of the unit. DAMPS is the cornerstone of the concept to address a fundamental need for the Army to transform reserve mobilization into an agile, information based core business process. As Army level orders are generated, information is passed from DAMPS through intermediate commands to Army personnel systems, enabling the lashing of requirements to individual orders and enabling systems to track soldiers through the entire mobilization cycle. DAMPS provides significant gains in efficiency: enables surge, reduces man hour costs by decreasing labor needed to move requests through the validation process, and reduces processing times by more than half. Data reconciled through the integration of DAMPS and other Army systems provides the basis for the Army's enterprise approach to mobilization - the Mobilization Common Operating Picture (MOBCOP).

### **5-7. Mobilization Common Operating Picture (MOBCOP)**

The MOBCOP is a system of record comprised of an integrated enterprise collection of Authoritative Data Systems (ADS) that provides a common operating picture for functions related to mobilization of individuals and units. MOBCOP provides access through fully integrated interfaces to authoritative personnel and service data on RC Soldiers; tools to automate the Army's sourcing, mobilization and tracking functions; and procedures that approve and generate orders for mobilizing and deploying Army units and Soldiers.

## Section III Industrial Preparedness

### 5-8. The Need for Industrial Preparedness

In the post-Cold War era when global conflicts between nation states were unlikely, the U.S. needed to maintain a viable industrial base to replenish expenditures of critical war materiel following regional conflicts, or military operations in a peacetime or permissible environment, in a timely manner. Future conflicts will still largely be “come as you are” actions. However, the rise of peer/near-peer threats makes industrial base issues more critical. The industrial base may now be called upon to increase capacity while also sustaining deployed forces, and will likely need to expeditiously replace losses in order to continue operations and be prepared for another contingency.

### 5-9. DOD Industrial Base Policy Objectives

a. The defense industrial base (DIB) is comprised of a diverse and dynamic set of companies, DOD organic facilities, and nonprofit institutions as shown in Table 1. The DIB provides products and services, directly and indirectly, to DOD to support national security objectives. DOD relies on an industrial base that is global, commercial, and financially complex. Partnerships between government, industry, and academia within the defense industrial base allow DOD to:

- (1) Sustain production, maintenance, repair, and logistics for military weapons.
- (2) Maintain advanced research and development activities to provide weapon systems.
- (3) Improve development, production, and integration of information technology.
- (4) Maintain critical design skills to ensure technological superiority.
- (5) Ensure reliable sources of material.
- (6) Reduce the presence of counterfeit parts.
- (7) Provide critical services.

b. U.S. manufacturing trends dictate the nation’s ability to compete in global markets and support the domestic economy. Globalization, the rapid pace of technology development and integration in manufacturing are challenging the U.S. position as a dominant global manufacturer. Although recent efforts focused on advanced manufacturing have helped to level off the decline in manufacturing jobs during the past few years, manufacturing’s share of employment and gross domestic product remain at historic lows. This has led to a growing shortage of well-trained and capable manufacturing workers. Manufacturing industry chief executive officers (CEOs) have underscored this need in a Manufacturing Institute study stating that “the manufacturing industry is projected to fall a startling 2 million workers short of its needs” in the coming years. It is imperative that the U.S. defense industrial base understand and adapt to these manufacturing trends. DOD continues to expand several programs that speed technology transition into defense systems and gain access to the innovation centers of the country, such as Defense Unit Experimental (DIU), the Strategic Capabilities Office (SCO), and the eight DOD Manufacturing USA Institutes.

### 5-10. DOD-Level Industrial Preparedness Management

a. It is DOD policy to maintain a state of industrial preparedness by working with private industry to produce, maintain, and repair materiel that meets mobilization requirements. Where it is determined that required mobilization items cannot be provided by the private sector, then government-owned facilities and equipment are acquired and maintained to produce them.

b. Overall responsibility for managing the defense industrial base is vested in the Deputy Assistant SECDEF for Industrial Policy. The mission of the office of Industrial Policy is to ensure robust, secure, resilient, and innovative industrial capabilities upon which the DOD can rely to fulfill warfighter requirements.

c. The Industrial Policy office supports OSD and Service Acquisition Executives by providing detailed analyses and in-depth understanding of the increasingly global, commercial, and financially complex industrial supply chain essential to national defense, and recommending or taking appropriate actions to maintain the health, integrity and technical superiority of that supply chain. Industrial Policy is DOD’s lead in all matters relating to mergers, acquisitions, and dissolutions of national security-related business.

d. The office of Industrial Policy addresses innovation within supply chain sectors and supports responsible investment to advance industrial productivity through a variety of authorities and programs,

## HOW THE ARMY RUNS

including the Defense Production Act and Manufacturing Technology (ManTech). The challenges of critical and fragile elements of the base are also analyzed to identify systemic and fundamental issues that can be resolved through engagement across the public and private sectors.

### **5-11. The Defense Priorities and Allocations System**

a. This regulatory system (15 Code of Federal Regulations (CFR) 700), administered by the Department of Commerce (DOC), is used to ensure the timely availability of industrial resources to meet approved national defense and emergency preparedness program requirements and to provide an operating system to support rapid industrial response in a national emergency.

b. The authority for this regulatory system is found in Title I of the Defense Production Act (50 U.S.C., App. 2061, et seq.), which authorizes the POTUS to require:

(1) The priority performance of defense contracts and orders over all other contracts and orders.

(2) The allocation of materials, services, and facilities necessary and appropriate to promote the national defense.

c. The DPAS establishes two levels of contract priority: "DX" (highest national urgency); and "DO" (critical to national defense). DX priority rated contracts and orders take precedence over DO priority rated contracts and orders; and DO rated contracts and orders take precedence over un-rated / commercial contracts and orders. The DPAS requires that—

(1) Contractors and suppliers capable of their performance accept all priority rated contracts and orders.

(2) Precedence is given to priority rated contracts and orders as necessary to achieve timely delivery.

(3) Contractors extend the priority rating to contracts and orders placed with their vendors and suppliers.

d. Although the DPAS is self-executing, in the event of a problem involving acceptance, scheduling, production, or any situation that would interfere with timely delivery of a priority rated contract or order, special priorities assistance may be requested. DOC may take official action under the DPAS to resolve the problem.

### **5-12. The National Defense Stockpile**

a. The Strategic and Critical Materials Stock Piling Act (50 U.S.C. 98 et seq.) provides for the acquisition and retention of stocks of certain strategic and critical materials and encourages the conservation and development of sources of such materials within the United States. The acquisition and retention of stocks will decrease and preclude, when possible, a dangerous and costly dependence upon foreign sources or a single point of failure of such materials during and immediately following a national emergency. Such materials when acquired and stored constitute and are collectively known as the National Defense Stockpile (NDS or the "stockpile").

b. By Executive Order, the SECDEF is designated as the NDS Manager, with management responsibilities delegated to the Under SECDEF for Acquisition and Sustainment. The operational activities of the NDS are delegated to the Director of the Defense Logistics Agency (DLA). DLA Strategic Materials was established as a field activity to manage the operations of the NDS program, including the acquisition, storage, management, and disposal of materials.

### **5-13. DOD Key Facilities List (KFL)**

A register of selected command installations and industrial facilities of primary importance to the support of military operations and military production programs. KFL is a list of facilities of such importance that loss through sabotage, subversion, terrorism, or other hostile acts would seriously impair the national defense posture of the United States. FORSCOM uses the KFL in fulfilling its responsibility for CONUS land defense planning. It is prepared under the policy direction of the JCS.

### **5-14. Army Industrial Base Process**

The DOD-level management philosophy applies to the Army's Industrial Base Process per AR 700-90:

a. AR 700-90 implements Army objectives and policies regarding national policy on the national technology and industrial base. This regulation focuses on the manufacturing industrial base and policies associated with assessing its ability to effectively support operation, surge, and sustainability.

b. Overarching industrial base strategy.



## ARMY MOBILIZATION AND DEPLOYMENT

(1) In the acquisition of materiel, the Army should employ life cycle strategies that effectively use market research of worldwide capabilities and capacities to achieve a responsive, innovative and efficient industrial base.

(2) Recognize the inherent advantages of competition and commercial capability and capacity to meet the Army's materiel needs to the maximum extent practicable. Establish organic core depot-level maintenance and repair capacity as an essential component to meet national defense requirements. Focus organic industrial capability on mitigating the risk associated with reliance on private sector capacity. An essential nucleus of organic capacity will be established and sustained in compliance with statutory mandates and readiness requirements.

(3) Utilize public-private partnering, as permitted by statutes, when appropriate to ensure a healthy, capable and efficient industrial base.

(4) Provide a comprehensive and continuous program for the future safety and for the defense of the United States by providing adequate measures whereby the private sector and an essential nucleus of Government-owned industrial activities and depots can supply the needs of the armed forces in time of national emergency. This essential nucleus is mandated by several statutes, most notably 10 U.S.C. 2535, that states the intent of Congress to maintain a comprehensive and continuous program to provide for such defense measures. The statute establishes that to the maximum extent practicable, reliance will be placed upon private industry for support of defense production, yet it is necessary to maintain industrial manufacturing capability for production of critical items to provide production capacity not available in private industry or to assist private industry in time of national disaster

c. Management tools available include the following:

(1) Industrial Preparedness Planning (IPP). IPP is conducted to ensure that an adequate industrial base is established, maintained, and retained to be responsive to military materiel requirements in the event of an emergency. It involves the assessment of the capability of the industrial base to support peacetime and emergency operations, and planning with industry to ensure adequate procurement, production, and maintenance capabilities to meet support requirements.

(2) DA Critical Items List (DACIL). The DACIL is prepared by the DCS, G-3/5/7. They provide biennially a priority list of items required to sustain warfighting for either an indefinite or surge contingency. They also provide stable mobilization requirements to support planning with industry. The DACIL are the basic documents from which IPP is conducted.

(3) Industrial Preparedness Planning List (IPPL). Prepared by AMC from the DACIL, the IPPL consists of critical items having long lead-time components. The IPPL is comprised of items and components identified by Program Executive Officers (PEOs) and as recommended by the AMC commodity managers as necessary to either monitor or take action to ensure sufficient capacity for operational, combat, and contingency requirements. Many of these components require special manufacturing skills or present other production challenges requiring detailed planning. The aggregate IPPL should include Class VII end items identified by the DACIL, as well as Class II, Class V, Class VIII, and Class IX items and components identified by the PEOs and recommended by the AMC commodity managers

(4) Industrial Capability Assessment (ICA). When market research reveals a problem with supplying Warfighter's needs, an ICA will be accomplished. This assessment will address both public and private sources. The Assistant Secretary of the Army (Acquisition, Logistics and Technology) provides programming guidance to PEOs and/or Program Managers (PMs) and item managers for ICAs based on priorities that are validated by DCS, G-3/5/7 and DCS, G-4. The PEOs and/or PMs and item managers will base their budget and program objective memorandum (POM) submissions to DCS, G-8 on this guidance and the industrial base's ability to successfully execute.

(5) Industrial Preparedness Measures (IPM). These actions aid industry to overcome production deficiencies in the Army's industrial base. IPMs are designed to shorten production lead-time, increase production or repair capacity, and reduce inspection time. IPMs for accelerated production will only be used when they are cost-effective alternatives to stockpiling.

# HOW THE ARMY RUNS

## Section IV Summary and References

### 5-15. Summary

The utility of the Army to the nation depends on whether its forces can be rapidly and effectively mobilized, deployed, employed, and sustained. The process of planning for contingencies or for emergencies is a continuous, all-encompassing process. It incorporates all aspects of Army management including manpower procurement, training, materiel development, and fiscal assets and constraints. Central to the task of reinforcing active forces is the ability to mobilize RC assets and to deploy them with the least possible delay.

### 5-16. References

- a. AR 500-5, Army Mobilization, 16 April 2015.
- b. HQDA EXORD 088-19 ISO Army Mobilization Plan dated 032142Z June 19.
- c. HQDA EXORD 252-17, for Chief of Staff, Army Korea Warplan, dated 21 July 2017.
- d. HQDA EXORD 114-18, Army Mobilization Enterprise Staffing, dated 12 April 2018.
- e. Frago 3 to HQDA EXORD 125-17, Army Implementation Guidance for the DOD Global Force Management Data Initiative, dated 10 March 2017.
- f. HQDA EXORD 140-17, Mobilization Command and Support Relationships, dated: 3 January 2018.
- g. AR 700-90, Army Industrial Base Process, 18 Jun 2018.
- h. AR 525-93, Army Deployment and Redeployment, dated 12 November 2014.
- i. ATP 3-35, Army Deployment and Redeployment, Change 2, dated 10 October 2018.
- j. CJCSM 3122.05. Operating Procedures for Joint Operation Planning and Execution System; 15 December 2011.
- k. CJCSM, 3500.03C, Joint Training Manual for the Armed Forces of the United States, 15 January 2011.
- l. CJCS Instruction (CJCSI) 3100.01D Joint Strategic Planning System, 20 July 2018.
- m. DODI 1235.12, Accessing the Reserve Components (RC): 7 June 2016 Incorporating Change 1, Effective 28 February 2017.
- n. FORSCOM Regulation 55-1, Unit Movement Planning, 1 June 2006.
- o. FORSCOM Regulation 500-35-1, FORSCOM Mobilization and Deployment (DRAFT).
- p. JP 1, Doctrine for the Armed Forces of the United States (Change 1), 12 July 2017.
- q. JP 4-05, Joint Mobilization Planning, 23 October 2018.
- r. JP 5-0, Joint Operation Planning, 16 June 2017.
- s. JP 6-0, Joint Communications System, 10 Jun 2015.
- t. U.S. Army War College, Department of Military Strategy, Planning and Operations, Campaign Planning Handbook, 2019.
- u. U.S. Department of Commerce, Defense Priorities and Allocations System (DPAS) Regulation (CFR, Title 15, Chapter VII, Part 700), 2009.
- v. U.S. DOD, DOD Annual Industrial Capabilities Report to Congress, March 2018.
- w. Army Mobilization and Deployment Reference (AMDR), 27 August 2018.
- x. 10 U.S.C. 12304, Presidential Selected Reserve and certain Individual Ready Reserve Member; Order to Active Duty other War or National Emergency.
- y. 10 U.S.C. 1230A, Military Reserve Emergency Activation.
- z. 10 U.S.C. 12304B, Selected Reserve; Order to Activate Duty for Preplanned Mission in Support of the Combatant Commands.
- aa. Fiscal Year 2017 Annual Industrial Capabilities Report to Congress, March 2018.

## Chapter 6

### Reserve Components

#### Section I Introduction

##### 6-1. Chapter Content

This chapter addresses the role, organization, structure, and contributions of the Reserve Components (RC) of the Army.

##### 6-2. Reserve Components (RC)

There are seven federal RC in the Department of Defense (DOD): the Army National Guard of the United States (ARNGUS), the U.S. Army Reserve (USAR), the U.S. Navy Reserve (USNR), the U.S. Marine Corps Reserve (USMCR), the Air National Guard of the United States (ANGUS), the U.S. Air Force Reserve (USAFR), and the U.S. Coast Guard Reserve (USCGR). The USCGR, although a naval force, belongs to the Department of Homeland Security (DHS) in time of peace, just like the active Coast Guard. Upon declaration of war, or when directed by the President of the U.S. (POTUS), the Coast Guard reverts to the Department of the Navy. In their DHS role, the Coast Guard can and does participate in law enforcement.

##### 6-3. RC Statutory Foundation

Section 10102 of Title 10, U.S. Code (10 U.S.C. 10102) identifies the RC purpose as follows: to provide trained units and qualified persons available for active duty in the armed forces, in time of war or national emergency, and at such other times as the national security may require, to fill the needs of the armed forces whenever more units and persons are needed than are in the regular components.

##### 6-4. RC Chain of Command

In many ways, the ARNGUS and ANGUS are very similar to the USAR and USAFR. The primary difference lies with the level of government in which they fall. The USAR and USAFR are subordinate to the federal government while the state National Guard units (ARNG or ANG) are subordinate to the various state or territorial governments, except when called into federal service by the POTUS, or as provided for by law.

##### 6-5. RC Force Structure Mix, Roles, and Size

a. The RC provides operational capabilities and strategic depth to meet U.S. defense requirements across the full range of military operations. Over half of the Army's total deployable forces are in the ARNGUS and USAR. The Army's principal force management goal is to meet the requirements of the defense strategy at the least risk to the nation's security and Soldiers. By law, the Army's force mix will comprise capabilities and capacity from the Regular Army (RA), ARNG, and USAR.

b. In general terms, the Regular Army (RA) is best suited for emergent and frequent deployments and dealing with complex operational environments and unexpected contingencies. The RC is best suited for predictable and infrequent deployments and providing Title 10 and Title 32 support to state and local authorities, as well as operational and strategic depth. The Army trains and employs its RC as part of the Army's total force to support the regional combatant commanders (CCDR) through planned, predictable, and programmed rotational cycles and to support the nation in defense support to civil authorities (DSCA).

c. Ideally, the Army RA forces are sized and organized to accomplish the following: Provide the large majority of forces to conduct early deploying contingency operations; Sustain service day-to-day enduring forward presence, training, readiness, and generating force requirements; Provide sufficient capacity for

## HOW THE ARMY RUNS

complex, critical, and/or multipurpose capabilities whose readiness cannot be quickly replicated by RC units; and Provide rotationally available forces to meet less predictable requirements.

d. The Army RC forces are sized and organized to accomplish the following: Provide select immediate response forces when limitations on the size of the RA require acceptance of some level of risk; Supplement and/or complement early deploying RA forces across a full range of military operations; Provide rotationally available forces to meet more predictable requirements; Provide follow on forces to allow RA forces to regenerate readiness and prepare for next mission; and Provide forces and units for CONUS disaster response. The RCs are best able to leverage civilian acquired skills – those skills, often of a technical nature, that would be too onerous to demand of rotating RA soldiers. These positions would include various medical specialties and those jobs needing special advanced degrees, licenses, training or certifications.

e. Common references to components (COMPO) are as follows: RA is COMPO 1; ARNGUS is COMPO 2; and USAR is COMPO 3.

f. Multi-COMPO Units (MCU). An MCU combines personnel and/or equipment from more than one COMPO on a single authorization document. The intent of MCU is to maximize integration of RA and RC resources. MCUs have unity of command and control (C2) similar to that of single-COMPO units.

### Section II Reserve Service

#### 6-6. Reserve Service Categories

There are three major categories of reserve service: the Ready Reserve; the Standby Reserve; and the Retired Reserve (see Fig 6-1).

#### Ready Reserve

- **Selected Reserve**
  - **Troop Program Units (TPU)**
  - **Active Guard/Reserve (AGR)**
  - **Individual Mobilization Augmentees (IMA) (USAR only)**
- **Individual Ready Reserve (IRR) (USAR only)**
- **Inactive National Guard (ING) (ARNG only)**

#### Standby Reserve

#### Retired Reserve

USAR: U.S. Army Reserve  
ARNG: Army National Guard

Figure 6-1. Reserve Service Categories

## RESERVE COMPONENTS

### 6-7. The Ready Reserve

The Ready Reserve has three subcategories: Selected Reserve; Individual Ready Reserve (IRR); and Inactive National Guard (ING).

a. Selected Reserve. The Selected Reserve consists of the following: ARNG units (e.g., drilling personnel), USAR troop program units (TPU); Title 32 and Title 10 Active Guard/Reserve (AGR); Title 10 personnel; USAR Individual Mobilization Augmentee (IMA). IMAs and Drilling IMAs (DIMAs) are included in RA table of distribution and allowances (TDA) units and are funded by USAR funds.

b. IRR. The IRR consists of personnel with remaining obligations and control groups (e.g., USAR only).

(1) Human Resources Command (HRC) exercises mission command over the IRR, Standby Reserve, and Retired Reserve. For strength accountability purposes, the IRR consists of pre-trained individual Soldiers assigned to various groups for control and administration. The IRR is available for mobilization in time of war or national emergency declared by Congress or the POTUS, and a portion of the IRR is available under Presidential Reserve Call-Up (PRC) authority.

(2) The IMA program (AR 140-145) serves to pre-assign qualified members of the Army's Selected Reserve to required mobilization positions that have been specifically designated and documented to augment Regular Army units and/or other authorized agencies of the U.S. Government. Assigning soldiers as IMAs allows these individuals to be used as augmentation or replacements for RA units without "breaking" a USAR unit to fill the need and streamlines the mobilization process. Soldiers assigned to the IMA program are volunteers who are readily and immediately available to meet individual mobilization requirements and contingency operational needs. IMA positions are identified on the RA unit's MOBTDA and are usually focused on manning requirements needed in wartime that are not present in peacetime, such as an increased number of instructors to handle an emergency influx of trainees. The IMA program also allows qualified Soldiers to continue to serve, even though they do not reside near a USAR unit.

(3) The IRR constitutes the largest category of the pre-trained individual manpower. These personnel provide the majority of filler personnel required to bring both the RA and Selected Reserve units to their wartime required personnel strength in the event of mobilization and initial casualty replacements and/or fillers in fighting theaters.

c. ING.

(1) The ING provides a means for individuals who are otherwise unable to participate in an active status to continue in a military status in the ARNG. While in the ING, individuals retain their federal recognition and Reserve of the Army status as members of ARNG units. Subject to immediate involuntary mobilization with their assigned units in time of federal or state emergency, personnel transferred to the ING normally are attached to their former ARNG units and are responsible to participate in an annual muster with their unit.

(2) Individuals assigned to the ING are included in the Ready Reserve strength of the Army.

### 6-8. Standby Reserve (USAR Only)

a. The Standby Reserve consists of Soldiers who want to maintain their military affiliation without being in the Ready Reserve or Retired Reserve. Membership is limited to those Soldiers having mobilization potential, but who are not normally subject to immediate mobilization.

b. The Standby Reserve is composed of an active list and an inactive list. Those assigned in an active status are authorized to participate in Ready Reserve training at no expense to the government. Such participation includes training to earn retirement points or to qualify for promotion. Individuals assigned in an inactive status are normally not authorized to participate in USAR training.

### 6-9. Retired Reserve

a. The Retired Reserve includes those individuals who: are eligible for and who have requested transfer to the Retired Reserve; are entitled to retiree pay from the armed forces because of prior military service; have completed 20 or more qualifying years of service in the RC (e.g., ARNG or USAR) and/or active service for which retirement benefits are not payable until age 60; are ARNG and/or USAR officers and warrant officers who are drawing retired pay after completing 20 or more years of active federal service; and are RA enlisted personnel retired after 20, but less than 30, years of active service until they have completed 30 years of service.

b. Members of the Retired Reserve are not provided any form of training and are not available for military service except in time of war or a congressionally declared national emergency. However,

## HOW THE ARMY RUNS

service Secretaries may recall retired personnel with 20 or more years of active service to active duty at any time in the interest of national defense.

### Section III RC Management

#### 6-10. Governance

All three COMPOs of the Army are governed by Congress and affected by recommendations of the Office of the Secretary of Defense (OSD) and Headquarters, Department of the Army (HQDA).

#### 6-11. Congress

a. Committees. The House Armed Services Committee (HASC) and Senate Armed Services Committees (SASC) establish end strength authorizations and other matters concerning the ARNG and USAR. Establishing and approving the annual paid end strength authorizations are the most significant congressional actions. Each year, end strength ceilings are authorized to support appropriations for reserve pay and allowances. The defense subcommittees of both the House Appropriations Committee (HAC) and Senate Appropriations Committee (SAC) prepare the appropriation acts that allow funding.

b. Uniform Services Employment and Reemployment Rights Act (USERRA). This congressional legislation protects RC Soldiers' rights for reemployment after military service or training. This act does not replace the Service members Civil Relief Act (SCRA), but codifies and clarifies 50 years of case law and court decisions. The USERRA entitles reserve Soldiers to return to their civilian employment with the seniority, status, and pay they would have attained had they been continuously employed. Among other protections, it expands health care and employee benefit pension plan coverage.

#### 6-12. OSD

a. Assistant Secretary of Defense for Manpower and Reserve Affairs (ASD (M&RA)). ASD (M&RA) has overall responsibility for all RC issues at the OSD level.

b. Reserve Forces Policy Board (RFPB). Per 10 U.S.C. 10301, the RFPB is an independent adviser to the Secretary of Defense (SECDEF) to provide advice and recommendations on strategies, policies, and practices designed to improve and enhance the capabilities, efficiency, and effectiveness of the RC. The RFPB consists of 20 members including the following: a civilian chairman; two active or Retired Reserve officers or enlisted members from each of the Army, Navy, and Air Force military departments (MILDEP); one active or Retired Reserve officer or enlisted member of the Coast Guard; 10 U.S. citizens who have significant knowledge of and experience in policy matters relevant to national security and RC matters appointed or designated by the SECDEF; a general or flag reserve officer from the Army, Navy, Air Force, or Marine Corps to serve as military adviser to the chair, as military executive officer of the board, and as supervisor of the operations and staff of the board; and a senior enlisted member of a RC to serve as enlisted military adviser to the chair. The SECDEF is formally associated with the RC community through the RFPB. The SECDEF is required by 10 U.S.C. 113 to submit an annual report to the POTUS and Congress prepared by the RFPB on any RC matter that the RFPB considers appropriate to include in the report.

c. Employer Support of the Guard and Reserve (ESGR). In operation since 1972, the ESGR, a DOD program, is dedicated to improvement of relations between civilian employers and local ARNG and USAR units. The program has successfully resolved many employer and/or employee misunderstandings arising from RC service. It operates on an informal basis with the goal of ensuring that individuals have the freedom to participate in training without employment obstacles or loss of earned vacations. In FY 1979, state chairmen were appointed to work with the national chairman. The use of state committees provides widespread support for the program.

#### 6-13. Joint Chiefs of Staff (JCS)

The Chief, National Guard Bureau (CNGB) is a member of the JCS in accordance with 10 U.S.C. 151(a), as amended by the 2012 National Defense Authorization Act (NDAA). As a member of the JCS, the CNGB has specific responsibility of addressing matters involving non-federalized National Guard forces in support of homeland defense and civil support missions.

### 6-14. HQDA

a. Assistant Secretary of the Army for Manpower and Reserve Affairs (ASA (M&RA)). The ASA (M&RA) has overall responsibility for the RC.

b. Reserve Component Coordination Council (RCCC). Established in 1976, the RCCC reviews progress on RC matters related to readiness improvement, examines problem areas and issues, coordinates the tasking of issues to the Army Staff (ARSTAF), and reviews staff efforts. The RCCC is chaired by the Vice, Chief of Staff, U.S. Army (VCSA), includes selected general officers from the ARSTAF, Chief of the Army Reserve, Director of the ARNG, the U.S. Army Forces Command (FORSCOM) Chief of Staff, and the Deputy ASA (M&RA).

c. Army Reserve Forces Policy Committee (ARFPC). The ARFPC reviews and comments to the Secretary of the Army (SECARMY) and the Chief of Staff, U.S. Army (CSA) on major policy matters directly affecting the RC and the mobilization preparedness of the Army. Membership of the committee, which is appointed by the SECARMY, consists of five RA general officers on duty with the ARSTAF, five ARNGUS general officers, and five USAR general officers. There are also five alternate members appointed from the ARNG and five alternate members appointed from the USAR. RC principal members are appointed for a three-year term and RA members are appointed for the duration of their assignment to the ARSTAF. The ASA (M&RA), ARNG, OCAR, U.S. Army Training and Doctrine Command (TRADOC), and FORSCOM also provide liaisons. The Director of the Army Staff (DAS) serves as adviser to the ARFPC. The committee chairman is selected from the RC members and serves a two-year term. The Goldwater-Nichols DOD Reorganization Act of 1986 reassigned the committee from the office of the CSA to the office of the SECARMY. The ARFPC Chairman reports directly to the SECARMY. The act also modified the nomination procedures. The committee normally meets in March, June, September, and December.

### 6-15. National Guard Bureau (NGB)

a. The NGB is a DOD joint activity and the legally designated channel of communication between the Departments of the Army and Air Force and the states, territories, and Washington, District of Columbia (DC) as established by 10 U.S.C. 10501 and DOD Directive 5105.77, NGB. The CNGB is a principal advisor to the SECDEF, through the Chairman of the Joint Chiefs of Staff (CJCS), on matters involving non-federalized National Guard forces and on other matters as determined by the SECDEF and the principal advisor to the SECARMY and the CSA, and to the Secretary of the Air Force and the Chief of Staff of the Air Force, on matters relating to the National Guard, the ARNGUS, and the Air National Guard of the United States in accordance with 10 U.S.C. 10502, as amended by the 2008 NDAA.

b. The NGB consists of: the Office of the CNGB; the National Guard joint staff; Office of the Director, Army National Guard (DARNG); and Office of the Director, Air National Guard. The DARNG and his staff, the ARNG Directorate, assist the CNGB in carrying out the functions of the NGB as they relate to the Army.

c. The CNGB works directly with the State Adjutants General. Although the CNGB has no command authority in these dealings, cooperation is facilitated through control and coordination of funds, end strength, equipment, force structure programs, and by authority to develop and publish regulations pertaining to the ARNG when not federally mobilized.

d. The CNGB is appointed to a four-year term by the POTUS, with the advice and consent of the Senate.

### 6-16. OCAR

According to 10 U.S.C. 7038, the Chief, Army Reserve (CAR) holds the grade of lieutenant general. 10 U.S.C. 10171 states that the United States Army Reserve Command (USARC) is a separate command of the Army commanded by the CAR. Except as otherwise prescribed by the SECDEF, the SECARMY shall prescribe the chain of command for the USARC. Except for Outside of the Continental United States (OCONUS) units commanded by the U.S. Army Europe (USAEUR) and U.S. Army Pacific (USARPAC), almost all Army Reserve troop program units (TPU) are commanded by the USARC.

a. The OCAR provides direction for USAR planning to accomplish the mission of providing trained units and individuals to support Army mobilization plans. The CAR is appointed by the POTUS with the advice and consent of the Senate and holds office for four years. The CAR may succeed himself one time and holds the rank of lieutenant general for the duration of the appointment. The CAR also serves as Commanding General (CG), USARC. The duties of the CAR include—

## HOW THE ARMY RUNS

- (1) Commander, USARC.
- (2) Adviser to the CSA on USAR matters.
- (3) Directly responsible to the CSA for matters pertaining to the development, readiness, and maintenance of the USAR.
- (4) Responsible for implementation and execution of approved USAR plans and programs.
- (5) USAR representative in relations with governmental agencies and the public.
- (6) Adviser to the ARSTAF agencies in formulating and developing DA policies affecting the USAR.
- (7) Assists in development of USAR mobilization policy and plans.
- (8) In coordination with other appropriate ARSTAF agencies, develops, recommends, establishes, and promulgates HQDA policy for USAR training.
- (9) Appropriation sponsor for three USAR appropriations (e.g., pay and allowances, operations and maintenance, and construction).
- (10) Member of HQDA and OSD committees, as required.

### **6-17. State Adjutants General (National Guard)**

a. ARNG units are located in each of the 50 states, Washington, DC, Guam, Puerto Rico, and the Virgin Islands. In addition, Guam and American Samoa signed a memorandum of agreement (MOA) in 2010 whereby American Samoans are able to serve in the Guam ARNG. Command of the ARNG, when not in active federal service, is vested with the Governors of the states and territories who exercise command through The Adjutant General (TAG). 32 U.S.C. 314 requires each state and territory to have a TAG who shall perform the duties prescribed by the laws of that jurisdiction. TAG is either an ARNG or ANG officer who is appointed by the Governor in all states and territories except for Vermont and Washington, DC. Vermont's TAG is elected by the state legislature, whereas the POTUS appoints the CG of Washington, DC. TAG is also a state official whose authority is recognized by federal law. The authorized TAG grade is normally major general.

b. TAGs and their management staffs, which include both state and federal employees, manage federal resources to build combat-ready units. Under TAG, ARNG commanders lead their combat-ready units in training during peacetime.

c. A Joint Forces Headquarters-State (JFHQ-State) is organized within each state. The JFHQ-State is responsible to maintain trained and equipped ARNG and ANG forces, and to provide C2 of these forces during pre-mobilization. As directed by FORSCOM and First Army and as coordinated by NGB, the JFHQ-State is responsible for providing increased levels of support to federalized units and moving federalized units to the mobilization station or port of embarkation. The JFHQ-State is also capable of providing some installation support, family support, and mobilization support to other RC units within the state upon declaration of a national emergency. For domestic operations, the JFHQ-State must provide operational information, through NGB, to the DOD, and through a State JTF, to the commander of Federal military forces operating in their respective States to ensure unity of effort. The JFHQ-State must be prepared to provide one or more joint task force (JTF) command elements (or to serve as component elements of a (larger) JTFs that might be established by proper authority) able to exercise command and control of military forces to execute assigned missions. The JFHQ-State continues to provide support to non-federalized ARNG units within the state. Upon mobilization, the gaining numbered Army or Combatant Command (CCMD) assumes C2 of federalized ARNG units. If the JFHQ-State is federalized for a domestic homeland defense, homeland security or domestic support to civil authorities (DSCA) mission, it will fall under the C2 of the respective geographic CCMD.

d. The U.S. Property and Fiscal Officer (USPFO) is a colonel in the ARNG or ANG ordered to active duty under the provisions of 10 U.S.C. 10503(7) and 32 U.S.C. 708, and assigned to the NGB with duty in the state supporting the state TAG. The USPFO receives and accounts for all federal funds and property, and provides financial and logistical resources for the maintenance of federal property provided to the state. The USPFO manages the Army and Air Force federal logistics support systems for the state and, upon mobilization of a supported unit, provides the support necessary for the unit to transition to active duty status. Additionally, the USPFO functions as a federal contracting officer responsible for federal procurement activities within the state. The USPFO is also responsible for certifying the accuracy of federal payrolls.

e. 10 U.S.C., Chapter 1803 facilities for RC, provides for federal support of construction of ARNG facilities. This law permits construction of facilities on sites furnished by states at no cost to the federal government or on federal property licensed to the state specifically for ARNG purposes. Funding for



## RESERVE COMPONENTS

approved armory construction is normally 75% federal funds and 25% state funds with 100% federal support for other construction such as administrative, logistics support, and training facilities in direct support to sole federal functions. Operations and maintenance costs for these facilities are funded via cooperative agreements between the federal government and the state military departments. The federal government provides all funding for construction and maintenance of facilities for the USAR.

### Section IV Training

#### 6-18. Training Goals

At current RA force levels, the chances are very high for employment of those land forces in the ARNG and USAR as currently organized, trained, equipped, and prepared. The ability to mobilize quickly and effectively with the proper identification and resourcing of RC capabilities is a key hedge against uncertainty. To have RC formations properly trained, equipped, and prepared for rapid introduction into contingencies or major combat will require higher states of readiness and leader preparation, as well as changes to current mobilization processes. The goals for RC training can be found in the Army Training Strategy.

#### 6-19. Training Challenges

a. The same training standards apply to the RC that apply to the RA. One key factor to understanding RC training challenges is comprehending the distinct differences between RC and RA training. Unlike RA units, which have military occupational specialty (MOS)-qualified Soldiers assigned to them by HRC, RC units usually recruit Soldiers from the local area. Whether initial entry or prior service, these Soldiers are assigned to the unit and then must attend MOS qualification training to match the needs of the unit. Qualification training, sustainment training, additional duty training, and professional development education are often conducted in lieu of scheduled UTAs and AT, and in some cases require more than a year to complete. Even though these RC Soldiers are counted against the unit's assigned strength, they are not available to participate in collective training.

b. Another training challenge is that RC Soldiers and units must meet the same standards as RA units in a fraction of the time. Non-directed mission essential task list (DMETL) training, non-core mission essential task list (CMETL) training, and other events, such as Army physical fitness tests (APFT), weapons qualification, mandatory training, inventories, and physicals have a greater impact on the RC because they take the same time as RA units within fewer available days to accomplish them.

c. A third training challenge is the geographic distance between Reserve units. A typical armory or reserve center is comprised of a single company-sized unit. Battalion and large size units can have their sub-units spread across large distances and across state lines. These geographic distances create a challenge for collective training and demonstrate the value that the Army Synthetic Training Environment (STE) will provide to the Reserve Components, allowing them to conduct geographically and temporally separated live, virtual, constructive, and gaming training.

#### 6-20. Unit Training Assemblies

ARNG and USAR units, as elements of the Selected Reserve, are normally authorized 48 IDTs and a two-week (e.g., 14-17 days) annual training (AT) during the training year, which starts on 1 October and terminates on 30 September of the following year. The general trend is to consolidate UTAs during the year so that four UTAs (four each 4-hour IDT blocks, totaling 16 hours) are accomplished during a single weekend. This MUTA-4 configuration provides continuity for individual and crew training, qualification firing, field training, and refresher training.

#### 6-21. Collective Tasks

AT is directed primarily toward collective pre-mobilization tasks. Individual training and weapons qualifications are typically performed during IDT. Soldiers and units train to established pre-mobilization levels of proficiency. Combat maneuver units generally train to individual-, crew-, and platoon-levels of proficiency. CS and/or CSS units are generally required to train to company-level proficiency.

## HOW THE ARMY RUNS

### 6-22. State Partnership Program (SPP)

National Guard units conduct military-to-military engagements directly with selected nations in support of defense security goals but also leverage whole-of-society relationships and capabilities to facilitate broader interagency and corollary engagements spanning military, government, economic and social spheres. The SPP has been building relationships for over 25 years and has expanded to 78 unique security partnerships involving 85 nations around the globe. SPP links a unique component of the DOD – a state's National Guard – with the armed forces or equivalent of a partner country in a cooperative, mutually beneficial relationship. The SPP evolved from a 1991 U.S. European Command decision to set up the Joint Contact Team Program in the Baltic Region with RC Soldiers and Airmen. A subsequent NGB proposal paired U.S. states with three nations emerging from the former Soviet Bloc and the SPP was born, becoming a key U.S. security cooperation tool that facilitates cooperation across all aspects of international civil-military affairs and encouraging people-to-people ties at the state level. This low-cost joint DOD program is administered by the NGB, guided by State Department foreign policy goals, and executed by the state adjutants general in support of combatant commander and U.S. Chief of Mission security cooperation objectives and DOD policy goals (see figure 6.2).



Figure 6-2 State Partnership Program

## Section V Equipment

### 6-23. Equipment Policy

The Army accepted risk during the Cold War by not fully fielding force modernization equipment to authorized levels in the RC. The RC was characterized as a strategic reserve and was not expected to immediately deploy in the event of a crisis. The global strategic environment has changed dramatically over the past two decades and, in order to meet the nation's national security demands today, the RC functions as an operational reserve. In their operational reserve role, the RC' deployment timeline has shortened considerably with the expectation that it will continue to move further away from the Cold War paradigm of mobilize, train, deploy, and closer toward the RA model of train, deploy. As a result, DA

policy today distributes equipment to units in first-to-fight and/or first-to-support sequence. Later deploying units are provided the minimum-essential equipment required for training and to achieve acceptable readiness levels. The COMPO to which a unit belongs, with the exception of specified programs (e.g., National Guard and Reserve Equipment Appropriation (NGREA)) is not a factor in equipment distribution. This policy ensures units employed first in time of crisis have the necessary equipment to accomplish the mission. Under this policy, the ARNGUS and USAR have received substantial amounts of modern equipment in recent years and are programmed to receive more in future years. Each Service provides an estimate as to how much equipment will be procured for each of their RCs, within their Service procurement appropriations for inclusion in the future-years defense program using the P-1R budget exhibit as required by 10 U.S.C. 10543.

### **6-24. National Guard and Reserve Equipment Appropriation (NGREA)**

NGREA was created by Congress in 1981 in response to RA budget priorities and was intended to supplement the Services' base procurement appropriations for the RC. NGREA is not meant to relieve the RA from the appropriate funding and equipping of their respective National Guard and Reserve components. NGREA is a special 3-year appropriation designated for the acquisition of equipment for the RC to improve readiness. Congress may further provide guidance as to the use of these funds for the purchase of specific items of equipment which they will describe in each year's Congressional budget language. Additionally, Congress requires the Services to submit a list of all the equipment they intend to buy with NGREA to the Legislative Defense Committees for their review and approval. NGREA funds complement the service appropriations, which primarily fund force modernization, thereby improving training and readiness in the RC. Until the Army is able to support total Army modernization, the continued programming of NGREA funding will allow the ARNGUS and USAR to procure critical modernization equipment in order to improve survivability and interoperability.

### **6-25. National Guard and Reserve Equipment Report (NGRER)**

10 U.S.C 10541 requires the SECDEF to submit a report to Congress each year concerning the equipment of the National Guard and the RCs. This requirement reflects Congressional interest in ensuring a well-equipped and robust RC capability within the Armed Forces. The NGRER identifies major items of equipment in the RC inventories that are important to the Services, DOD, and Congress. The report outlines how that equipment is being acquired and disposed of by the RC for the budget year and the two succeeding years.

## **Section VI Readiness and Mobilization Assistance**

### **6-25. Background**

In 1973, the Army leadership recognized the potential of many types of RC units for early deployment. Accordingly, the affiliation program was conceived to improve the mobilization and deployment readiness of selected RC units and provide added combat power earlier in the execution of contingency plans. As more structure and missions were added to the RC in the mid-to-late 1970s, the Army instituted several programs to facilitate achievement of higher training readiness levels for the RC. These included the RA/RC partnership program which aligned selected combat and Special Forces RC units with RA units, the counterpart program that aligned ARNG attack helicopter units with RA counterparts, and the corps and division training coordination program (CORTRAIN) that associated RA/RC combat units with a CONUS corps for command post exercises. Together, these programs provided resources and opportunities for RC unit leaders and Soldiers to work closely and share their experiences with their RA counterparts.

### **6-26. Training Support Organizations**

The ARNG Combat Readiness Reform Act of 1992 required the Army to assign not less than 5,000 RA personnel to RC units to provide training and readiness advice and support. The Army developed five USAR-flagged training support divisions aligned with First and Fifth Armies composed of RA, ARNG, and USAR personnel to provide collective training support for RC units. Additionally, a portion of the 5,000 personnel were embedded in RC units as full-time support (FTS) personnel. An Army transformation campaign plan realigned the First and Fifth Armies into two different mission areas. Effective July 2006,

## HOW THE ARMY RUNS

Fifth Army became Army Forces North (ARNORTH), the Army Service Component Command (ASCC) providing support to United States Northern Command (USNORTHCOM) for HD and DSCA missions. Effective October 2006, First Army assumed the CONUS mission of mobilizing, training, validating, and deploying RC units. First Army is organized with two divisions (First Army-East and First Army-West) which command training support brigades along with associated ARNG and USAR elements provide exercise support, pre-mobilization training, and post-mobilization validation capability for RC units to ensure Army standards and doctrinal mission capabilities are achieved prior to deployment.

### **6-27. Overseas Deployment Training (ODT)**

The overseas deployment training (ODT) program provides RC units the opportunity to exercise their skills in a realistic environment with the added benefits of reducing RA operating tempo (OPTEMPO) and providing needed operational support to CCDRs. As part of Army force generation, selected units from may be designated to train in JCS exercises and in non-exercise mission training that enhances their awareness of mobilization and/or deployment processing. The ODT program has provided training opportunities to an increasing number of companies and battalions. ODT reduces mobilization and deployment timelines, enhances readiness, and promotes unit cohesion.

### **6-28. Full Time Support (FTS)**

a. The FTS program was directed by Congress to increase the readiness of ARNGUS and USAR units. The majority of FTS personnel work in ARNGUS and USAR units. The FTS staff performs the day-to-day support functions for the unit to operate including personnel, administration, training, operations, maintenance, and supply which enables Troop Program Unit (TPU) reservists to use their limited training time (e.g., 39 days annually) to concentrate on their wartime tasks instead of sustainment functions.

b. The FTS program consists of AGR Soldiers, military technicians (both dual-status and non-dual status), DA civilians, and RA Soldiers. AGR Soldiers are traditional ARNG and USAR Soldiers who are on active duty. Military technicians and DA civilians are full-time civilian employees. Dual-status military technicians have the distinction of also being RC Soldiers who must maintain their reserve status as a condition of employment. The RA assigns Soldiers to support RC units and these Soldiers are considered part of the FTS program. ARNG and USAR technicians provide full-time, day-to-day assistance and support and act as the representative for their commanders during non-UTA periods. Technicians ensure continuity in administration, supply, maintenance, and training and their services are critical to mobilization preparedness. Both ARNG and USAR technicians are federal civil service employees. The USAR technicians are governed by the provisions of the Civil Service System. ARNG technicians are governed by the same provisions except as modified by Public Law 90-486, National Guard Technician Act of 1968, as well as 32 U.S.C. 709, and regulations prescribed by the NGB. As a provision of employment in the military technician program, dual-status technicians must also be members of the ARNG or USAR. Many technicians are employed in the same unit to which they are assigned. AGR Soldiers serve on active duty in support of the RC. 10 U.S.C. AGR personnel are available for worldwide assignment whereas 32 U.S.C. AGR personnel receive assignments within their state, territory, or Washington, DC.

### **6-29. The Army School System**

See Chapter 14, Training and Leader Development.

### **6-30. RC Access**

All of the DOD services access the RC using authorities outlined in Figure 6-3, in conjunction with DOD policies. Access is defined as the requisite authority in concert with the necessary funding. The authority used to mobilize RC soldiers will significantly impact mission cost and affect service member benefits and entitlements. The RC provides operational capabilities and strategic depth to meet US defense requirements across the full spectrum of conflict. The RC can augment capabilities primarily found in the RA or provide the sole or primary source of a capability not resident in the RA. In their operational roles, elements of the RC participate in a full range of missions according to their services' force generation plans. Units and individuals participate in missions in an established cyclic or periodic manner that provides predictability for the CCMDs, the services, service members, their families, and employers. Preplanned mobilization support per 10 U.S.C. 12304b gives the MILDEP Secretaries the authority to activate their Selected Reserves up to 365 days to augment the active forces for preplanned missions in

## RESERVE COMPONENTS

support of a CCMD, thus utilizing the RC as an operational reserve with cyclical predictability. In their strategic reserve role, RC units and individuals train or are available for missions in accordance with the national defense strategy. As such, the RC provides strategic depth and is available to transition to operational reserve roles as needed.

| Statute  | Utilization Process  | Intended Use  | Limits   |
|--|--|---|--|
| <b>INVOLUNTARY</b>   |  |   |  |
| <b>10 USC 12301(a)<br/>Full Mobilization</b>                       | Congressional declaration of war or national emergency   | Rapid expansion of armed forces to meet an external threat to national security   | - No personnel limitation<br>- Duration plus 6 months<br>- Applicable to all reservists (inactive & retired)   |
| <b>10 USC 12301(b)<br/>15-Day Statute</b>                          | Service Secretary authority to order to active duty without member's consent   | Annual training or operational mission  | - 15 days active duty once per year<br>- Governor's consent required for National Guard  |
| <b>10 USC 12302<br/>Partial Mobilization</b>                       | Presidential declaration of national emergency, typically Secretary of Defense-approved force tracking numbers / Department of the Army Execution Order      | Manpower required to meet external threat to national emergency or domestic emergency   | - Max 1M Ready Reservists on active duty<br>- Not more that 24 consecutive months<br>- Used for Iraq / Afghanistan contingency operations                              |
| <b>10 USC 12304 (a/b)<br/>Presidential Reserve Call-Up</b>         | President's signature  | Other than during war or national emergency   | - 200K Selected Reserve<br>- Max 30K Individual Ready Reserve<br>- 365 days  |
| <b>10 USC 12304a<br/>Reserve Emergency Call Up</b>                 | Secretary of Defense can involuntarily mobilize reserve forces for disaster response; Governor requests assistance; No National Guard or Coast Guard Reserve | Response to major disaster / emergency<br>C2: Typically an appointed commissioned officer as a dual-status commander serving on active duty and duty in or with the National Guard of a State | - Ready Reserve (no cap)<br>- 120 continuous days  |
| <b>10 USC 12304b<br/>Reserve Pre-Planned Call Up<br/>ISO CCMDs</b> | President's authorization required for operational mission   | Preplanned mission in support of Combatant Command  | - Ready Reserve<br>- 60K Cap / 365 days<br>- Identified in Defense Budget for FY(s)  |
| <b>VOLUNTARY</b>   |  |   |  |
| <b>10 USC 12301(d)<br/>Active Duty for Operational Support</b>     | Service Secretary authority to order to active duty with member's consent  | Operational missions (volunteers)   | - Applicable to Ready Reserve<br>- Active duty for operational support limits duty to 3 years out of 4 (1095 Rule)<br>- Governor's consent required for National Guard |

**Figure 6-3. Reserve Component Access**

### 6-31. Uniform Code of Military Justice (UCMJ)

The UCMJ was extended to RC members as of 14 Nov 1986, when President Reagan signed into law the Military Justice Amendment of 1986 as part of the 1987 NDAA. Under these changes, USAR Soldiers are subject to the UCMJ while in an IDT status. The military can now recall a Soldier to active duty for trial for crimes committed while performing ADT or IDT. The decision to activate a Soldier for trial must be approved through the USAR chain of command to the SECARMY if confinement is contemplated. In other cases, the RA General Court Martial Convening Authority (GCMCA) is the final decision authority. National Guard personnel are subject to UCMJ authority when in federal service. When in state service, they are subject to their state military code, which is generally patterned after the UCMJ.

## Section VII

### Summary and References

#### 6-32. Summary

Over half of the Army's total deployable forces are in the ARNG and USAR. The management of these forces is of paramount importance. The structure for RC management includes Congress, DOD, HQDA, ACOMs, states, and units. Two key managers at HQDA are the NGB and OCAR. At the ACOM level, FORSCOM and its subordinate First Army as well as the USARC have a leading role in preparing RC forces for mobilization and deployment.

## HOW THE ARMY RUNS

### 6-33. References

#### a. Publications.

- (1) 5 U.S.C. Part III, Civil service; Armed Forces (e.g. Federal GS technicians, DA/DAF/DON civilians).
- (2) 10 U.S.C., Chapter 47 (Section 801-941), Uniform Code of Military Justice.
- (3) 10 U.S.C., Subtitle E (Section 10001-18501) – Reserve Components
- (4) 10 U.S.C. 10141, Ready Reserve.
- (a) 10 U.S.C. 10143, Selected Reserve.
- (b) 10 U.S.C. 10144, Individual Ready Reserve.
- (5) 10 U.S.C. 10151-10153, Standby Reserve.
- (6) 10 U.S.C. 10154, Retired Reserve.
- (7) 10 U.S.C. 10201, Assistant Secretary of Defense for Manpower and Reserve Affairs.
- (8) 10 U.S.C. 10216-10217, Dual status and Non-Dual status technicians.
- (9) 10 U.S.C. 10301, Reserve Forces Policy Board.
- (10) 10 U.S.C. 10302, Army Reserve Forces Policy Committee.
- (11) 10 U.S.C., Chapter 1011 (Section 10501-10508), National Guard Bureau.
- (12) 10 U.S.C. 12301(a), Full mobilization.
- (13) 10 U.S.C. 12301(b), Annual training.
- (14) 10 U.S.C. 12301(d), Voluntary active duty.
- (15) 10 U.S.C. 12302, Partial mobilization.
- (16) 10 U.S.C. 12304, Presidential Reserve Call-Up.
- (17) 10 U.S.C. 12304a, Army Reserve, Navy Reserve, Marine Corps Reserve, Air Force Reserve: order to active duty to provide assistance in response to a major disaster or emergency.
- (18) 10 U.S.C. 12304b, Preplanned mission in support of Combatant Command.
- (19) 10 U.S.C. 12310, Reserves: for organizing, administering, etc. reserve components.
- (20) 10 U.S.C. 12310(c), Operations relating to defense against weapons of mass destruction and terrorist attacks.
- (21) 10 U.S.C., Chapter 1211 (Section 12401-12408), National Guard Members in Federal Service.
- (22) 10 U.S.C. Chapter 1803 (Section 18231), Facilities for Reserve Components (page 5000)
- (23) 32 U.S.C. 109, Maintenance of other troops.
- (24) 32 U.S.C. 314, Adjutants general.
- (25) 32 U.S.C. 328, Active Guard and Reserve duty: Governor's authority.
- (26) 32 U.S.C. 315, Detail of regular members of Army and Air Force to duty with National Guard, note: Delegation of Authority to permit an Active Component dual-status commander.
- (27) 32 U.S.C. 317, Command during joint exercises with Federal troops, note: dual-status commander usual and customary arrangement for DSCA.
- (28) 32 U.S.C. 502, Required drills and field exercises (48 individual training assemblies, 15 days annual training).
- (29) 32 U.S.C. 502(f), Training or other duty.
- (30) 32 U.S.C. 708, Property and fiscal officers.
- (31) 32 U.S.C. 709, Technicians: employment, use, status.
- (32) 32 U.S.C., Chapter 9, Homeland Defense Activities.
- (33) DODD 1200-17, Managing the Reserve Components as an Operational Force, 29 October 2008.
- (34) DODD 4270.5, Military Construction, w.Chg 1, 31 August 2018.
- (35) DODD 5105.77, National Guard Bureau, w/Chg 1, 10 October 2017.
- (36) DODD 5105.83, National Guard Joint Force Headquarters – State (NG JFHQs-State), w/Chg 1, 30 September 2014.
- (37) DODD 5124.10, Assistant Secretary of Defense for Manpower and Reserve Affairs, 14 March 2018.
- (38) DODI 1200.18, The United States Property and Fiscal Officer (USPFO) Program, 7 June 2012.
- (39) DODI 1205.18, Full-Time Support to the Reserve Components, 12 May 2014.
- (40) DODI 1205.22, Employer Support of the Guard and Reserve (ESGR), 6 February 2017.
- (41) DODI 1225.06, Equipping the Reserve Forces, w/Chg 1, 30 November 2017.
- (42) DODI 1225.08 Reserve Component (RC) Facilities Program and Unit Stationing, w/Chg 1, 1 December 2017.

## RESERVE COMPONENTS

- (43) DODI 1235.09, Management of the Standby Reserve, 12 February 2014.
  - (44) DODI 1235.11, Management of Individual Mobilization Augmentees (IMAs), 24 May 2007.
  - (45) DODI 1235.12, Accessing the Reserve Components, w/Chg. 1, 28 February 2017.
  - (46) DODI 1235.13, Administration and Management of the Individual Ready Reserve (IRR) and the Inactive National Guard (ING), 18 October 2013.
  - (47) DODI 1352.01, Management of Regular and Reserve Retired Military Members, 8 December 2016.
  - (48) DODI 4140.58, National Guard and Reserve Equipment Report (NGRER), 8 January 2010.
  - (49) DODI 4165.70, Real Property Management, w/Chg 1, 31 August 2018.
  - (50) DODI 4165.71, Real Property Acquisition, w/Chg 1, 31 August 2018.
  - (51) AR 5-10, Stationing, 20 August 2010.
  - (52) AR 135-5, Army Reserve Forces Policy Committee, 08 December 2014.
  - (53) AR 135-18, The Active Guard Reserve Program, 29 September 2017.
  - (54) AR 135-200, Active Duty for Missions, Projects, and Training for Reserve Component Soldiers, 26 September 2017.
  - (55) AR 140-145, Individual Mobilization Augmentation Program, 21 March 2016.
  - (56) AR 140-483, Army Reserve Land and Facilities Management, 24 July 2007.
  - (57) AR 350-9, Overseas Deployment Training (ODT), 08 November 2004.
  - (58) AR 500-5, Army Mobilization, 16 April 2015.
  - (59) AR 525-29, Army Force Generation, 14 March 2011.
  - (60) CNGBI 1001.01, National Guard Joint Force Headquarters-State, 29 June 2016.
  - (61) CNGBI 1302.01, Guidance for Members Performing Duty Under the Authority of 32 U.S.C. 502(f), 23 April 2013.
  - (62) NGR 130-6/ANGI 36-2, United States Property and Fiscal Officer Appointment, Duties, and Responsibilities, 1 July 2007.
  - (63) NGR 614-1, Inactive Army National Guard, 18 March 2010.
  - (64) NG Pam 415-5, Army National Guard Military Construction Program Execution, 31 July 2003.
- b. Useful Links.
- (1) <http://www.asamra.army.mil>.
  - (2) <http://www.nationalguard.mil>.
  - (3) <http://www.usar.army.mil>.
  - (4) <http://www.ang.af.mil>.
  - (5) <https://afreserve.com>.
  - (6) <http://www.public.navy.mil/nrh/Pages/default.aspx>.
  - (7) <http://www.marforres.marines.mil>.
  - (8) <http://www.reserve.uscg.mil>.

## HOW THE ARMY RUNS

**This page is intentionally left blank**



## **Chapter 7**

### **Force Readiness**

#### **Section I**

#### **Introduction**

##### **7-1. Chapter Content**

a. This chapter describes the updated and emerging changes to readiness and capabilities reporting systems throughout the Department of Defense (DOD). To make the decisions necessary for achieving and maintaining a quality Army with joint and expeditionary capabilities, the DOD, the Joint Chiefs of Staff (JCS), and the Department of the Army (DA) have developed reporting systems to assist the leadership at all levels in managing force readiness.

b. This chapter discusses the methods used for measuring force readiness and the systems and procedures used to respond to force readiness issues. It provides insights regarding the processes qualitatively and quantitatively defining and describing force readiness at the tactical and strategic level. Further, it provides an executive overview of the Chairman's Readiness System (CRS) which establishes a common framework for assessing Unit readiness using force readiness reporting and strategic readiness using the Joint Combat Capability Assessment (JCCA). The JCCA process is used to provide the Chairman of the Joint Chiefs of Staff (CJCS) a strategic readiness assessment of DOD's ability to meet the demands of the National Military Strategy (NMS). Finally, the readiness levels and capability assessments of Army organizations are reported in the Defense Readiness Reporting System (DRRS). The Army component of this DOD system is DRRS-Army (DRRS-A).

c. This chapter provides an overview of the ways in which tactical and strategic Army readiness inform Army leaders as well as the Joint Staff (JS) and DOD level readiness reporting requirements and systems.

##### **7-2. Maintaining Readiness**

a. Force readiness is an integral function supporting the Army's strategic imperatives to provide modernized and ready, tailored land force capabilities, develop leaders to meet the challenges of the 21st Century, adapt the Army to more effectively provide land power, and enhance the All-Volunteer Army. The Army's readiness reporting process supports requirements established by the National Defense Authorization Act (NDAA), Office of the Secretary of Defense (OSD), DRRS, CRS and the Army's current force generation process.

b. As the Army continues operating in the 21st century, it confronts the major challenge of maintaining readiness to meet current operational demands in a time of insufficient resources. Maintaining readiness requires critical and often difficult decisions by the Army leadership, for they must strive for the proper balance between maintaining current readiness and resourcing future capability requirements.

##### **7-3. Readiness Framework and Reporting**

a. Readiness Framework. Title 10 and Title 32 U.S. Code (U.S.C.), in conjunction with the annual NDAA, form the statutory requirement for all DOD readiness reporting requirements. The Services and Combatant Commands fulfill these requirements using DRRS to fulfill multiple quarterly and annual readiness assessments to Congress.

b. Readiness Reporting. The Army frames readiness reporting through a wide range of diverse inputs into the process (e.g., programs, procedures, doctrine, senior leader guidance, and venues) to address readiness at the unit and Service strategic levels (see Fig 7-1). The venues in which readiness is discussed are—

(1) Weekly Strategic Readiness Assessment Group (SRAG). An O6/Action Officer-level venue to discuss and work through various readiness reporting issues.

## HOW THE ARMY RUNS

(2) Monthly Strategic Readiness Update (SRU). An update to the VCSA with all ACOMs, ASCCs, and ARSTAF in attendance to highlight any issues raised from the SRAG or other topics as directed by the Army Leadership.

(3) Army Readiness Council of Colonels. As required, a council held in the Pentagon with representation of all ACOMs, ASCCs, DRUs, and ARSTAF to review and provide recommendations to the Army Senior Leaders on readiness reporting policy or procedure changes.

(4) Readiness Working Groups. Working groups are established at varying times throughout the year to work readiness reporting specific issues.

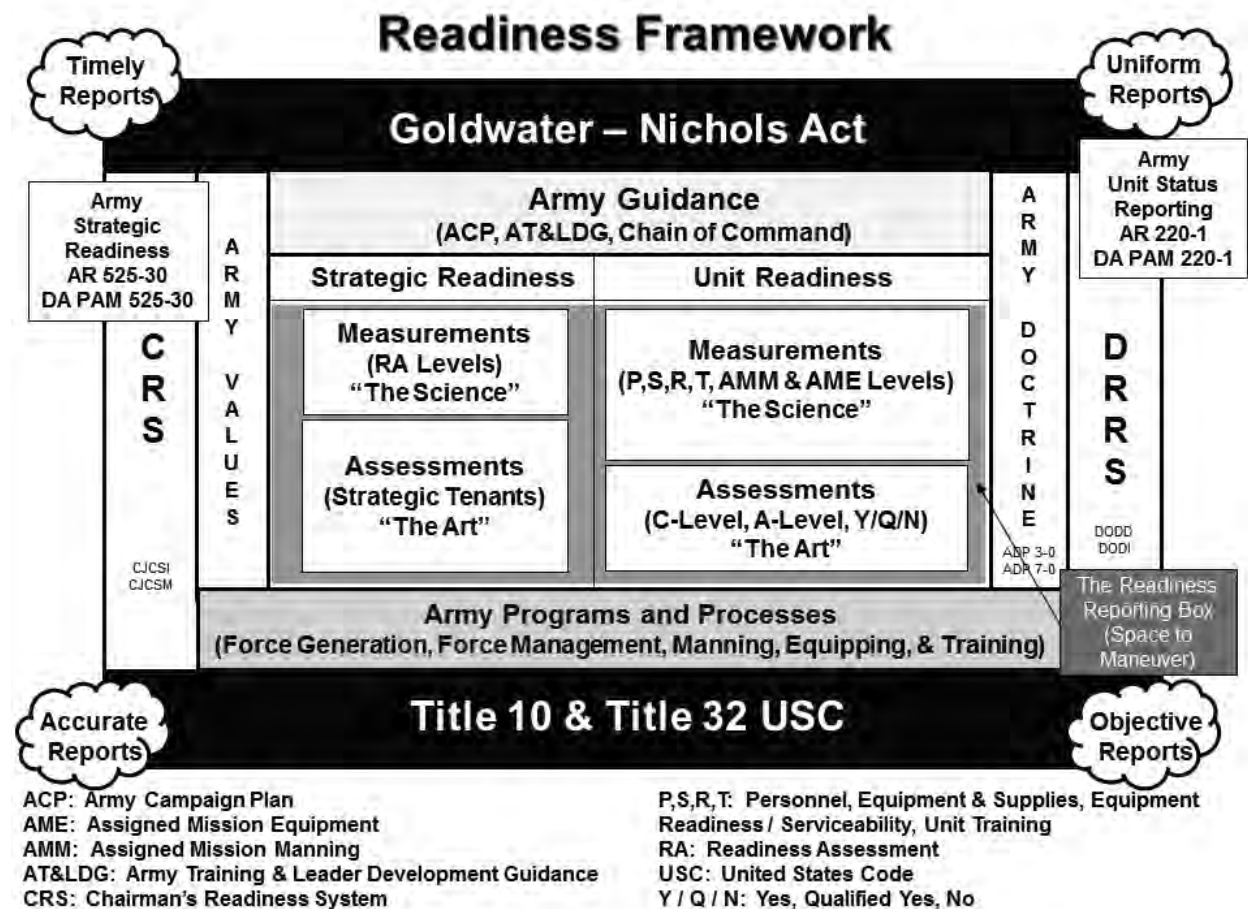

Figure 7-1. Readiness Framework

## Section II

### Unit Readiness Reporting

#### 7-4. Unit Status Reporting Purpose

Net-Centric Unit Status Report (NetUSR) is the software application used by commanders of Army units to provide readiness input to DRRS-A. The primary purpose of the reports prepared by commanders using NetUSR is to provide the POTUS, SECDEF, JCS, HQDA, and all levels of the Army's chain of command with the current status of U.S. Army units and necessary information for making operational decisions. The NetUSR application enables commanders to measure and report on the status of resources and the training level in their units at a given point in time. The reports should not be used in isolation to assess overall Army unit readiness or the broader aspects of Army force readiness. The reports provide a timely single source document for assessing key elements of a unit's status according to the unit commander. It does not provide all the information necessary to manage resources at a

strategic level. Army Regulation (AR) 220-1, Army Unit Status Reporting and Force Registration-Consolidated Policies governs the production and submission of unit status reporting.

**7-5. Unit Status Reporting Procedures**

a. Commanders of all reporting units are required to determine and report their assessment of their units' ability to accomplish the core missions for which the units are designed (C-Level), an Assigned Mission Level (A-Level) that reflects their assessments of their units' ability to accomplish their primary directed missions, and also a Chemical-Biological Defense Readiness Training (CBDRT) Level indicating their units' readiness to perform their core mission under chemical or biological conditions. The C-Level, A-Level, and the CBDRT Level are overall levels that are described in AR 220-1. There are four measurements (personnel, equipment and supplies on-hand/available, equipment readiness/serviceability, and unit training level proficiency) that support the C-Level determination. Two measurements, Assigned Mission Manning (AMM) and Assigned Mission Equipment (AME), support the A-Level determination. Two measurements (Equipment and supplies and training) support the CBDRT Level determination. These resource and training status measurements are determined using a four tier rating scale. Analysis of these resource and training measurements provides insight into the measured unit's tactical-level capability (see Fig 7-2).

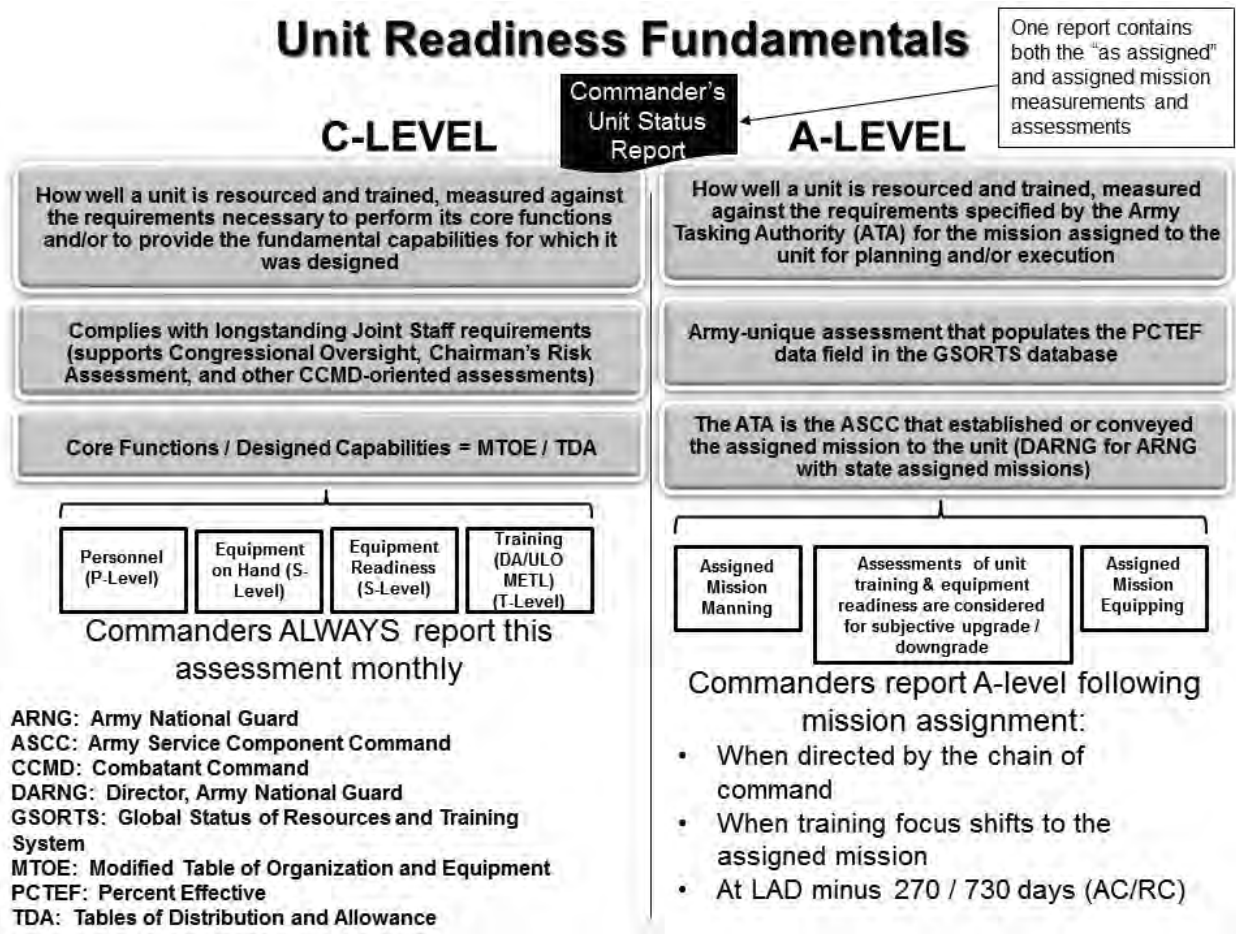

**Figure 7-2. Unit Readiness Fundamentals**

b. Status levels are determined for each of these measured areas to support the overall assessments required. Measured area levels are determined by applying the specific resource or status criteria and metrics. Commanders cannot subjectively upgrade or downgrade the level of a measured area.

## HOW THE ARMY RUNS

c. In general, reporting units will report readiness status against their currently effective Modification of Organization and Equipment (MTOE)/Table of Distribution and Allowances (TDA) document. However, in certain circumstances, units can report early against a future document. AR 220-1, Chapter 7 provides detailed instructions for determining the requirements document.

### d. Measured Area Levels.

(1) Personnel Level (P-Level). Army units will measure personnel readiness using three metrics for personnel fill percentages that are based on the unit's strength requirements for its core functions/designed capabilities: 1) Total deployable personnel strength divided by the required strength; 2) Assigned Military Occupational Specialty (MOS) skills match strength of qualified Soldiers assigned and or attached by duty position divided by the required strength; 3) The deployable senior grade composite level determined by comparing the available and required strength in each of five senior grade categories. The applicable MTOE or TDA that reflects the unit's core functions/designed capabilities is the authoritative source for the unit's required strength. While Army units also are required to determine and report additional personnel data (for example the assigned strength percentage, turnover percentage, and so on), the personnel level is determined solely based on the results of these three P-Level metrics.

(2) Equipment and Supplies On-Hand (S-Level). Army units determine and report an S-Level by determining by Line Item Number (LIN) the on hand/availability status of designated critical equipment items (pacing items/Equipment Readiness Code (ERC-P)) and the on-hand/availability status of the other mission essential equipment items (Equipment Readiness Code (ERC) A) that are listed on the unit's MTOE or TDA. Substitute items prescribed by HQDA via Sustainment Brigade (SB) 700-20 and In Lieu Of (ILO) substitutions directed by HQDA or determined by the commander are applied in accordance with AR 220-1. Note that for this S-Level measurement, the on hand/availability status of equipment items is based solely on those equipment items currently in the unit's possession, under its control or, when applicable, available to it within 72 hours for mission execution. The S-Level measurement is not based solely on property accountability records, and it does not consider the operational readiness/serviceability of the equipment items. A discrete measurement is accomplished at the LIN Level of detail by comparing the equipment items currently in the unit's possession, under its control or available to it within 72 hours, to the equipment items required to accomplish its core functions/designed capabilities, and an S-Level rating is determined for each measurement. The applicable MTOE or TDA that reflects the unit's core functions/designed capabilities is the authoritative source for the unit's equipment requirements. The unit's S-Level rating is determined in accordance with a methodology that considers each of these by LIN S-Level measurements.

(3) Equipment Readiness/Serviceability (R-Level). Army measured units will measure the operational readiness or serviceability of the critical equipment items that are in their possession, under their control or available to them within 72 hours, and that are designated by HQDA via the Maintenance Master Data File (MMDF) as reportable for maintenance. Separate measurements will be accomplished for each maintenance reportable pacing item and for all maintenance reportable equipment currently in the unit's possession (aggregate). An R-Level rating is determined for each measurement, and, subsequently, the unit's R-Level rating is determined in accordance with a methodology that considers each of these R-Level measurements.

(4) Training proficiency and training readiness level (T-level). The unit assessment of training (T-Level) is the fourth of the four measured areas that are the primary factors in determining a unit's overall C-level. The T-level reflects the commander's assessment of their unit's trained proficiency in the METs associated with its core functions/designed capabilities. The T-level metric relies on the values derived from the unit's MET proficiency assessments.

e. Determining the Unit's C-Level. To determine the overall C-Level, the commander reviews the status levels attained in the four measured resource areas. The overall unit C-Level will normally be the lowest level recorded in any of the unit's individually measured resource areas of personnel, equipment and supplies on-hand, equipment readiness/serviceability, and unit training level proficiency. There may be circumstances in which commanders may subjectively upgrade or downgrade a unit's C-Level based on mission evaluation, but the status level computed for each individually measured area must be reported without adjustment.

(1) Overall Levels. The overall category level (C-1, C-2, C-3, C-4, C-5) indicates the degree to which a unit has achieved prescribed levels of fill for personnel and equipment, the training status of those personnel, and the maintenance status of the equipment required to perform its wartime mission(s) as determined by the unit's organizational design and core function capability. The four areas for which

specific levels are calculated to support the C-Level determination are described in paragraph d. above. These measured area levels reflect the status of the unit's resources and training measured against the resources and training required to undertake the wartime mission for which the unit is organized or designed. Category levels do not project a unit's combat ability once committed to action. The overall unit category level will be based only upon organic resources and training under the actual control of the reporting unit or its parent unit. The C-Level categories follow. When assigned a current operational requirement, units also report an A-Level to indicate their readiness level for the current assigned mission. The reporting commander reports the unit's primary assigned mission using the four tier rating scale A-Level assessment, any additional assigned missions are assessed with a three tier rating scale.

(a) C-1. The unit possesses the required resources and is trained to accomplish or provide the core functions and fundamental capabilities for which it was designed or to undertake the mission it is currently assigned. The status of resources and training in the unit does not limit flexibility in methods to accomplish core functions or assigned missions nor increase vulnerability of unit personnel and equipment. The unit does not require any compensation for deficiencies.

(b) C-2. The unit possesses the required resources and is trained to accomplish or provide most of the core functions and fundamental capabilities for which it was designed or to undertake most of the mission it is currently assigned. The status of resources and training in the unit may cause isolated decreases in the flexibility of choices to accomplish core functions or currently assigned missions. However, this status will not increase the vulnerability of the unit under most envisioned operational scenarios. The unit will require little, if any, compensation for deficiencies.

(c) C-3. The unit possesses the required resources and is trained to accomplish or provide many, but not all, of the core functions and fundamental capabilities for which it was designed or to undertake many, but not all, portions of the mission it is currently assigned. The status of resource and training in the unit will result in significant decreases in flexibility to accomplish the core functions or the assigned missions and will increase vulnerability of the unit under many, but not all, envisioned operational scenarios. The unit will require significant compensation for deficiencies.

(d) C-4. The unit requires additional resources or training to accomplish or provide the core functions and fundamental capabilities for which it was designed or to undertake the mission currently assigned; however, the unit may be directed to undertake portions of the assigned mission with resources on hand (available).

(e) C-5. The unit is undergoing a HQDA-directed resource action and/or is part of a HQDA-directed program and is not prepared to accomplish or provide the core functions or fundamental capabilities for which it was designed. Units report C-5 in accordance with the policy and procedures established in AR 220-1. Level 5 is not applicable to A-Level reporting. C-5 units are restricted to: 1) Units undergoing activation, inactivation, conversion, or other HQDA directed resource action; 2) Units that have their levels for authorized personnel and/or equipment established so that, even when filled to the authorized level, the established level does not allow the unit to achieve level 3 or higher; 3) Units that are not manned or equipped but are required in the wartime structure.

f. Determining the Unit's A-Level. The A-Level is an overall readiness assessment that reflects the unit's ability to accomplish the assigned mission that it is preparing for, has been ordered to execute and/or is executing. Similar to the C-Level, the A-Level contains measured resource areas that indicate the availability status of resources (personnel and equipment) measured against the assigned mission requirements that have been established or conveyed by the Army Tasking Authority. If the core mission is directed for execution, then the A-Level and C-Level will coincide.

g. NetUSR data is transmitted through Administrative Control (ADCON) channels. Reporting units are required to submit a unit status report covering their specific resource and training status levels, their overall C-Levels, and their individual and overall MET assessments.

### **Section III Strategic Readiness**

#### **7-6. Strategic Readiness Reporting Purpose**

a. Strategic Readiness is the assessment of the Army and its Army Commands (ACOM), Army Service Component Commands (ASCC) and Direct Reporting Units' (DRU) ability to meet its current and future Title 10 responsibilities in support of the NMS. The Army Strategic Readiness Assessment (ASRA) is a

## HOW THE ARMY RUNS

quarterly comprehensive analysis of the Army's strategic readiness levels across the total force necessary to inform the Army's senior leaders, the Joint Staff, OSD, and Congress on the status of the Service to meet the demands of the NMS. This assessment combines objective, quantitative, empirical, qualitative, and subjective strategic measures and indicator assessments to portray a holistic view of current and projected strategic readiness. The ASRA is the Army's source document to meet readiness reporting requirements of the JFRR and the QRRC. It also assists senior leaders in congressional hearing preparation, questions for the record (QFR) responses, the comprehensive Joint assessment (CJA), chairman's risk assessment (CRA), and the Secretary of Defense (SECDEF) Risk Mitigation Plan. Figure 7-3 visually depicts the relationship of unit reports, the Army's strategic readiness tenets (SRT), and Joint Staff criteria used to develop the ASRA.

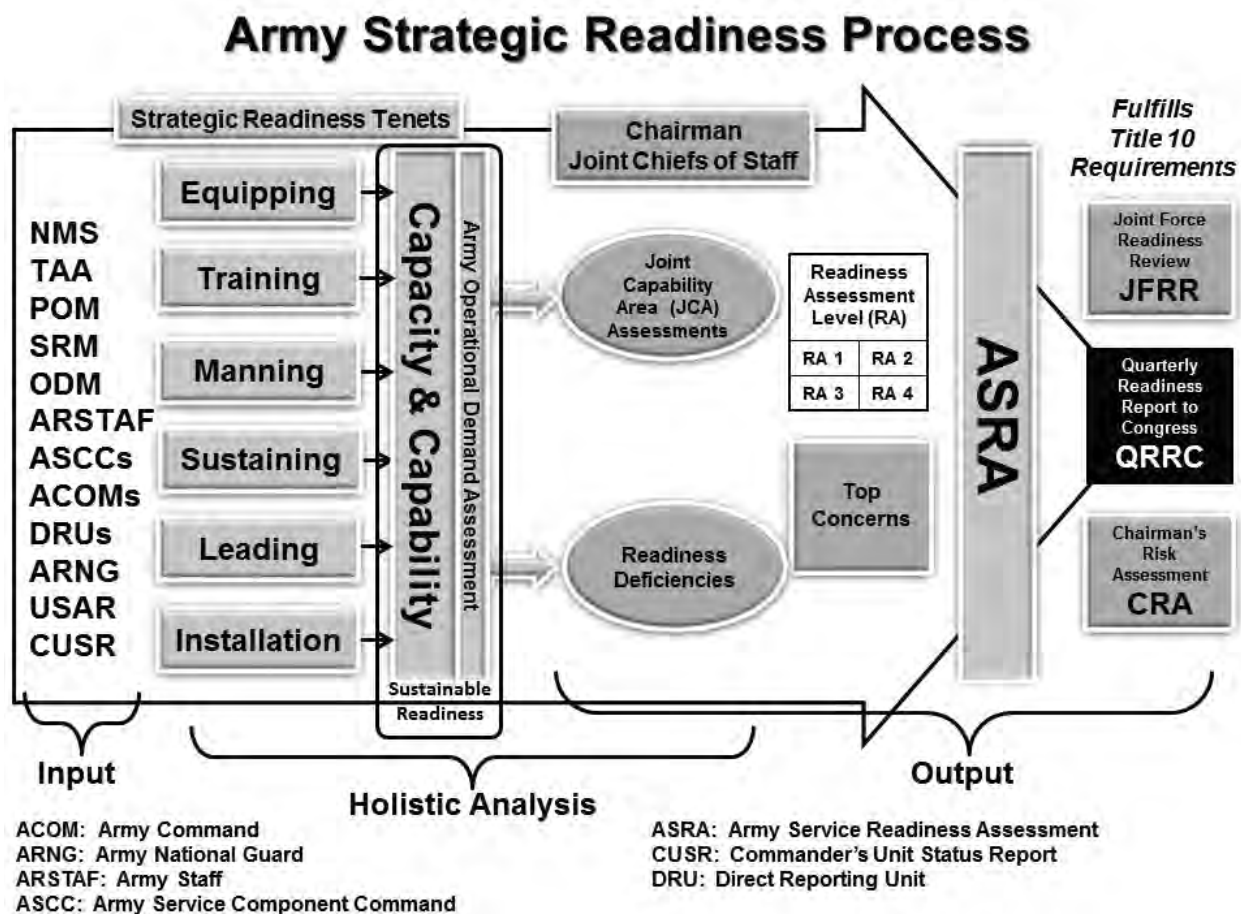

Figure 7-3. Army Strategic Readiness Process

b. The ASRA process includes determining, analyzing, assessing, and reporting Army strategic readiness in accordance with the three Joint Staff criteria (JCAs, Army plan assessment, and readiness deficiencies) and seven Army strategic readiness tenets (manning, equipping, sustaining, training, leading, installations, and capacity and capability). The ASRA prepares the analysis by criteria, key indicators, and measures and develops the assessment through the Strategic Readiness Assessment Group (SRAG). The ASRA is then delivered quarterly to the Army's senior leaders and the information within is used for the computation of the JFRR, QRC, and CRA.

### 7-7. Joint Staff Criteria

The Army uses four strategic readiness criteria to determine the ASRA. In accordance with CJCSI 3401.01E, three criteria are mandated by the Joint Staff (paragraph 7-8 explains the fourth remaining Army criteria). They are JCA assessments, Army plan assessments, and overall readiness deficiencies.

These three joint staff criteria incorporate the Army's Title 10 U.S.C. "man, train, equip" responsibilities and demonstrate how they directly affect joint operations in support of the NMS.

a. Joint Capability Areas (JCA). The nine JCA assessments are the first of the three mandatory Joint Staff criteria that inform the ASRA. JCAs are collections of like DOD capabilities functionally grouped to support capability analysis, strategy development, investment decision making, capability portfolio management, and capabilities-based force development and operational planning. JCA assessments are given a score based on the Joint Staff readiness metric, as follows:

(1) Yes (Y). The organization can accomplish the task to established standards and conditions.

(2) Qualified Yes (Q). The organization can accomplish all or most of the task to standard under most conditions. The specific standards and conditions, as well as the shortfalls or issues impacting the unit's task, must be clearly detailed in the Mission Essential Task (MET) assessment.

(3) No (N). The organization is unable to accomplish the task to prescribed standard and conditions at this time.

b. Army Plans Assessment. The Army plans assessments are a reflection of the Army's ability to source combatant command (CCMD) operational plans (OPLANS) and assessments of the Army's METs and are composed of Joint combat capability assessment-plan assessments (JCCA-PA), time phased deployment data (TPFDD) readiness analysis, apportionment table readiness analysis, and the ASCC's MET analysis.

c. Army Readiness Deficiencies. Readiness deficiencies are submitted by ACOMs ASCCs, DRUs, ARNG, and USAR. Readiness deficiencies are defined in CJCSI 3401.01E as a shortfall of resources to meet the requirements of a reporting organization's assigned mission, plan, or other documented responsibility. They provide the commanders of the various stakeholders with an opportunity to highlight the specific issues that most affect their units.

### 7-8. Army Criteria

The Army criteria are composed of seven Strategic Readiness Tenets (SRT), including manning, equipping, sustaining, training, installation, and capacity and capability. SRTs are quantitative and qualitative measures that provide leading indicators of future Army readiness.

a. Manning. The manning tenet assesses the Army's ability to provide qualified personnel on time to meet the needs of the Army and the CCDRs in support of the NMS. The manning tenet covers human resource functions from the tactical to the strategic level.

b. Equipping. The equipping tenet of readiness assesses the Army's ability to properly equip and modernize forces to meet the needs of the Army and the CCDRs in support of the NMS. Any trend or issue that affects the ability of the Army to equip the force is relevant to this analysis.

c. Sustaining. The sustaining tenet of readiness assesses the Army's ability to project and sustain forces to meet the needs of the Army and the CCDRs in support of the NMS. The sustainment tenet covers logistics functions from the tactical to strategic level.

d. Training. The training tenet of readiness assesses the Army's ability to properly develop leaders, train individuals, and train units to meet the needs of the Army and the CCDRs in support of the Army training strategy, Army leader development strategy, and the NMS.

e. Leading. The Army's ability to provide leadership as the multiplying and unifying element of combat power in executing the requirements of the NMS. The preparation of Army leaders to operate globally, across the range of military operations, and within the JIIM environment is achieved through training, education, and experience.

f. Installation. The installation tenet of readiness assesses the Army's ability to achieve mission excellence through streamlined processes, strategic partnerships, and good stewardship of resources that address Army priorities and meet the mission requirements of senior commanders. This translates into the ability to provide a growing and transforming Army with the infrastructure and support services it needs to remain a highly effective, expeditionary and campaign-quality force, today, and in the future.

g. Capacity and Capability. The capacity and capability tenet assesses the ability of the total force to provide Army forces with sufficient capacity and the capability (readiness) to execute current operations, projected operational demand, and surge requirements established in strategic documents including the Defense Strategic Guidance (DSG), Global Employment of the Force (GEF), and the Global Force Management Allocation Plan (GFMAP).

## HOW THE ARMY RUNS

### 7-9. Readiness Assessment

a. In order to develop an overall assessment and to ensure common language when assessing the cumulative effects of readiness assessments across all readiness tenets and criteria, it is essential that assessments are conducted within a common framework. The Army's overall strategic assessment will follow the existing CRS, as outlined in CJCSI 3401D. This will allow a seamless transition of the Army assessment to the CRS. The Army will use the readiness assessments (RA) outlined in CJCSI 3401.01E in the overall assessment of each strategic readiness tenet, as follows—

(1) RA-1. Issues and/or shortfalls have negligible impact on readiness and ability to accomplish assigned mission(s) in support of the NMS as directed in the Global Employment of the Force (GEF) and Joint Strategic Capabilities Plan (JSCP).

(2) RA-2. Issues and/or shortfalls have limited impact on readiness and ability to accomplish assigned mission(s) in support of the NMS as directed in the GEF and JSCP.

(3) RA-3. Issues and/or shortfalls have significant impact on readiness and ability to accomplish mission(s) in support of the NMS as directed in the GEF and JSCP.

(4) RA-4. Issues and/or shortfalls preclude accomplishment of assigned mission(s) in support of the NMS as directed in the GEF and JSCP.

### 7-10. Chairman's Readiness System

a. The CRS was implemented in 1994. While it has been incrementally modified since then, it was significantly revised in 2002, 2004, 2007, and then most recently in November of 2010. The CRS provides a common framework for conducting commanders' readiness assessments, blending unit-level readiness indicators with Combatant Command (CCMD), Service, and Combat Support Agency (CSA) (collectively known as C/S/A) subjective assessments of their ability to execute the NMS. Title 10 U.S.C., section 117d (10 U.S.C. 117d), requires the CJCS to conduct, on a quarterly basis, a joint review to measure the level of current military readiness based upon the reporting of the capability of the armed forces to carry out their wartime missions. The quarterly JCCA does this through the Joint Force Readiness Review (JFRR) which compiles the Services', CCMDs', and CSA's readiness assessments. Additionally, plans assessments, a readiness deficiency assessment and a quarterly readiness report to Congress are performed. The CRS, through JCCA, provides the means to meet the CJCS's statutory requirements while supporting a process that provides timely and accurate reporting to the DOD leadership.

b. The CJCS is responsible for assessing the strategic level of readiness of the Armed Forces to fight and meet the demands of the full range of operations required by the military strategy. Readiness at this level is defined as the synthesis of readiness at the joint and unit levels. It also focuses on broad functional areas, such as intelligence and mobility, to meet worldwide demands. Joint readiness is the responsibility of the CCDRs. It is defined as the commander's ability to integrate and synchronize combat and support forces to execute assigned missions. Unit readiness is the primary responsibility of the Services and the United States Special Operations Command (USSOCOM). Unit readiness is defined as the ability to provide the capabilities required by CCDRs to execute their assigned missions. The CSAs are responsible for providing responsive support to the operating forces in the event of war or threat to national security. These definitions are considered key because they delineate the responsibilities of the CJCS, Service Chiefs, CCDRs, and CSA directors in maintaining and assessing readiness (see Fig 7-4). The forum within the CRS for the assessment of joint, unit, and CSA readiness is the JFRR.

### 7-11. Chairman's Readiness System Outputs

a. The outputs of the CRS are synchronized to inform, through the Comprehensive Joint Assessment (CJA), other Joint Staff and OSD processes to include: J-5's CJCS's Risk Assessment (CRA); J-8's Annual Report on CCDR Requirements and OSD's Quarterly Readiness Report to Congress. Through these informative relationships, the CRS does the following.

(1) Ensures senior leaders and staffs are operating off a common readiness picture.

(2) Supports the development of coordinated strategic documents.

(3) Is synchronized to facilitate timely senior leader decision making.

(4) Helps the SECDEF and CJCS fulfill their statutory requirements under 10 U.S.C.



## Chairman's Readiness System

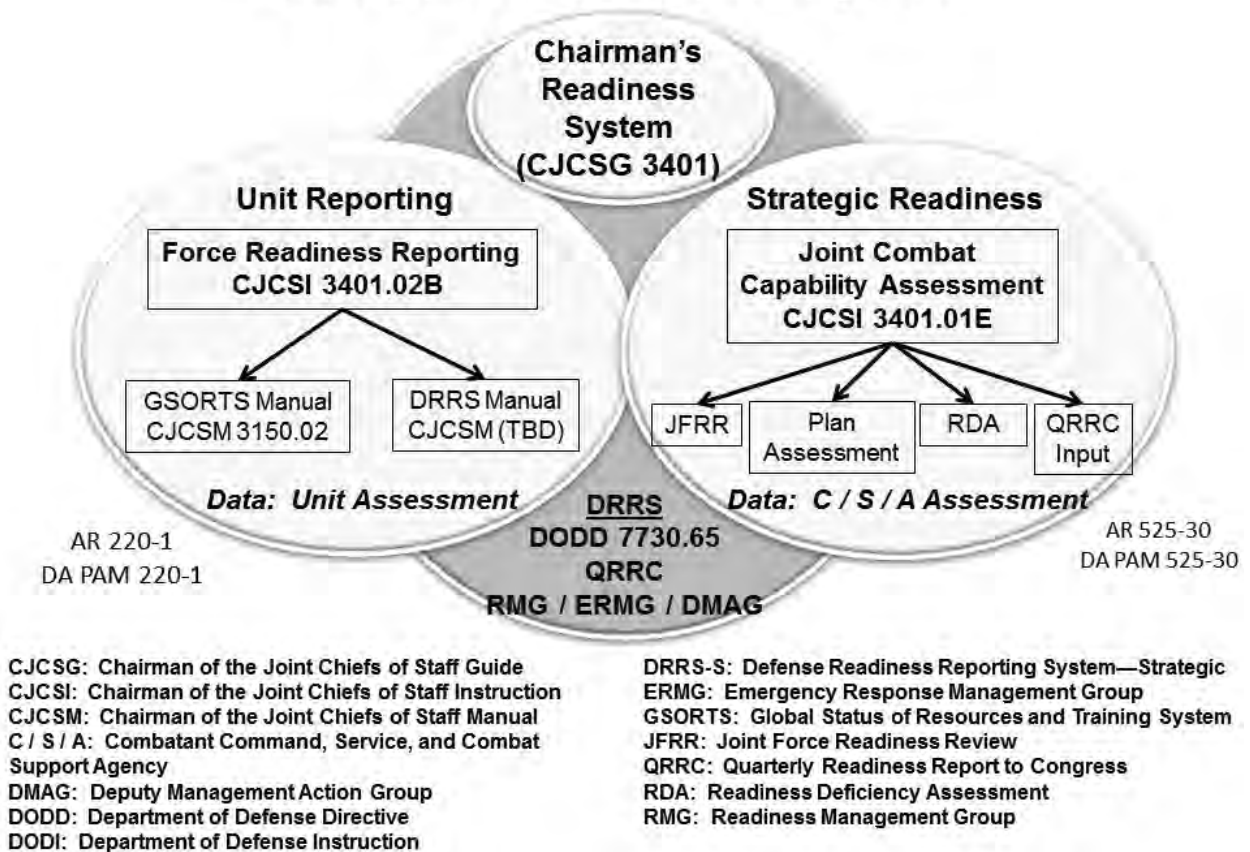

Figure 7-4. Chairman's Readiness System

b. The strategic documents mentioned above and discussed in greater detail below help align ends, ways, means, and risks to accomplishing the NMS and enable the CJCS to provide the best military advice to the President of the United States (POTUS) and the SECDEF.

(1) CRA. In accordance with 10 U.S.C. 153 (b)(1), "the CJCS shall submit to the SECDEF a report providing the CJCS's assessment of the nature and magnitude of the strategic and military risks associated with executing the missions called for in the NMS." To help fulfill this statutory requirement, the JCCAG will forward to the J-5, annually, the Joint Combat Capability Assessment and the results of Plans Assessments to inform the CRA.

(2) Annual Report on CCDR Requirements. In accordance with 10 U.S.C. 153 (c)(1), "the CJCS shall submit to the congressional defense committees a report on the requirements of the CCMDs." In addition to consolidating the combatant command integrated priority lists, the report will "address each deficiency in readiness identified during the joint readiness review" (10 U.S.C. 117 (d)(1)(a)). To help fulfill this statutory requirement, the JCCAG will forward to the J-8, annually, the Readiness Deficiency Assessment identifying the following.

- (a) CCMD readiness deficiencies reported over the fiscal year.
- (b) CCMD readiness deficiencies closed over the fiscal year.
- (c) The status of CCMD readiness deficiencies not yet closed.

(3) Quarterly Readiness Report to Congress. 10 U.S.C. 482 requires that within 45 days following the end of each calendar quarter a report be sent to Congress based on military readiness. The QRRC is reviewed and approved by the SECDEF and forwarded to Congress and fulfills this requirement.

# HOW THE ARMY RUNS

## Section IV Department of Defense Readiness Reporting System

### 7-12. DOD Readiness Reporting System Overview

DRRS establishes a mission-focused, capabilities-based application that provides DOD users a collaborative environment to facilitate operational decision-making via readiness evaluation of U.S. Armed Forces in support of assigned missions. DRRS is a unique network of applications identifying the capabilities of military forces. The information in DRRS goes well beyond the standard resource accounting approach of traditional readiness reporting by providing assessments of each organization's ability to conduct assigned tasks either in the context of their core mission or other assigned operations. In addition, DRRS improves the efficiency of readiness reporting by merging previously unrelated stovepipe data into a single integrated, authoritative source. DRRS establishes a common language of tasks, conditions, and standards to describe capabilities essential to the completion of assigned missions. The valuable data within DRRS is used to provide timely, accurate readiness information including overall mission readiness and individual task readiness.

### 7-13. Department of Defense Readiness Reporting System Army (DRRS-A) Overview

DRRS-A is the Army-Specific Implementation of the DOD DRRS.

a. DRRS-A was developed by HQDA G-3/5/7 to accommodate the ongoing development and implementation of additional and/or revised readiness status reporting and force registration requirements by the SECDEF, the CJCS, and the Secretary of the Army/the Chief of Staff of the Army to meet their responsibilities under 10 U.S.C. It is a family of related and supporting systems that includes: the DRRS-A database; the Net-Centric Unit Status Report (NetUSR) application; the Force Registration application; the Force Projection application; and the Army Readiness Management System (ARMS). DRRS-A also supports the evolution of Army force generation concepts and processes for manning, equipping, and training and the reporting of the progressive readiness of Army forces for unified land operations. The DRRS-A database is the Army's official readiness reporting database and the authoritative database of record and central registry for all currently existing and approved Army units, organizations, and installations. The DRRS-A database replaced the Army Status of Resources and Training System (ASORTS) database during FY 2008.

b. DRRS-A Key Applications.

(1) The NetUSR Application. A web-based readiness status data input tool that imports data from designated authoritative sources for reference to support required commander readiness status assessments. The NetUSR replaced the Personal Computer-Army Status of Resources and Training System (PC-ASORTS) application as the Army's official readiness status data input tool in October 2006.

(2) The Force Registration Application. A web-based force management data input tool used by Army force registration officials and Unit Identification Code Information Officers (UICIO) to formally register currently existing and approved Army organizations and to update Basic Identity Data Elements (BIDE) in the DRRS-A database.

(3) The Army Readiness Management System (ARMS) Application. The official DRRS-A business intelligence and output tool that provides visibility to selected Army readiness status and force registration data and information contained in the DRRS-A database and facilitates the detailed analysis of readiness status trends and force registration issues.

(4) The Force Projection Application. This application provides execution information for the mobilization of Reserve Component forces in support of ongoing operations. Additionally, Force Projection provides mobilization and execution data to the Joint Operations Planning and Execution System (JOPES) in support of deployment operations to include validation requirements, strategic airlift schedules, and status of the deployment flow in conjunction with the Computerized Movement Planning and Status System (COMPASS).

c. The Army developed the DRRS-A to accommodate the evolution of DRRS and to provide the readiness reporting flexibility necessary to support the current Army force generation process for manning, equipping, training, and readiness. The DRRS-A is a capabilities-based, adaptive, near-real-time readiness reporting system that ensures seamless coordination between the Army, OSD, and the CCDRs. It is linkage to the Army authoritative databases for personnel, medical, logistics, installations, training, and force management.

### 7-14. Use of DRRS-A Data at Headquarters, Department of the Army

a. At HQDA, DRRS-A data is part of a larger readiness picture compiled from many functional reports and sources. It alerts senior leaders to unit readiness issues, helps identify potential strategic readiness trends, and assist in determining if leader decisions are having the desired effect across the Army. The appropriate management actions or the required assistance can be exercised. DA uses DRRS-A data in conjunction with other personnel and logistics reports to improve resource management of people, equipment, and the programming of facilities and training areas to increase the combat effectiveness of subordinate elements.

b. Unit commanders prepare their status reports using the NetUSR application and submit them through their major commands into the DRRS-A database. Subsequently, the Office of the Deputy Chief of Staff (ODCS), G-3/5/7 compiles the reports and provides them to Global Status of Resources and Training Systems (GSORTS) and the DOD DRRS. ODCS, G-3/5/7's ARMS allows all DA Staff elements and other ARMS users to access for analysis via Secure Internet Protocol Router Network (SIPRNet) all unit reports in the DRRS-A database.

c. The Vice Chief of Staff, U.S. Army (VCSA) receives a monthly Strategic Readiness Update (SRU) from the ODCS G3/5/7, with significant input and analysis from the ODCS G-1, ODCS G-4, ODCS G-8, and other Army Staff (ARSTAF) elements. The current readiness status and trend analysis of major units is provided as well as the Army's continual strategic readiness posture.

d. Each principal DA Staff element uses the information provided by the ODCS, G-3/5/7 to influence resource allocation. Aggregate data in DRRS-A also serves as a yardstick to measure how well the functional management system for personnel, logistics, and training are performing.

## Section V

### Summary, Key Terms, and References

#### 7-15. Summary

Readiness is a primary mission of military forces. Recognizing that readiness is highly situational and subjective, it is, nevertheless, a yardstick for programming and budgeting. The Army's readiness strategy entails maximizing readiness within available resources to meet the operational demands resulting from expeditionary requirements and contingency force requirements. The more accurately the Army captures and quantifies readiness, the better the Army can articulate resource needs to the DOD and the Congress.

#### 7-16. Key Terms

a. Overall Category Level 1 (C-1). The unit possesses the required resources and is trained to accomplish or provide the core functions and fundamental capabilities for which it was designed or to undertake the mission it is currently assigned. The status of resources and training in the unit does not limit flexibility in methods to accomplish core functions or assigned missions nor increase vulnerability of unit personnel and equipment. The unit does not require any compensation for deficiencies.

b. Overall Category Level 2 (C-2). The unit possesses the required resources and is trained to accomplish or provide most of the core functions and fundamental capabilities for which it was designed or to undertake most of the mission it is currently assigned. The status of resources and training in the unit may cause isolated decreases in the flexibility of choices to accomplish core functions or currently assigned missions. However, this status will not increase the vulnerability of the unit under most envisioned operational scenarios. The unit will require little, if any, compensation for deficiencies.

c. Overall Category Level 3 (C-3). The unit possesses the required resources and is trained to accomplish or provide many, but not all, of the core functions and fundamental capabilities for which it was designed or to undertake many, but not all, portions of the mission it is currently assigned. The status of resource and training in the unit will result in significant decreases in flexibility to accomplish the core functions or the assigned missions and will increase vulnerability of the unit under many, but not all, envisioned operational scenarios. The unit will require significant compensation for deficiencies.

d. Overall Category Level 4 (C-4). The unit requires additional resources or training to accomplish or provide the core functions and fundamental capabilities for which it was designed or to undertake the mission currently assigned; however, the unit may be directed to undertake portions of the assigned mission with resources on hand (available).

## HOW THE ARMY RUNS

e. Overall Category Level 5 (C-5). The unit is undergoing a HQDA-directed resource action and/or is part of a HQDA-directed program and is not prepared to accomplish or provide the core functions or fundamental capabilities for which it was designed. Units report C-5 in accordance with the policy and procedures established in paragraph 4–8 of AR 220-1. Level 5 is not applicable to A-Level reporting. C-5 units are restricted to the following: units undergoing activation, inactivation, conversion, or other HQDA directed resource action; units that have their levels for authorized personnel and/or equipment established so that, even when filled to the authorized level, the established level does not allow the unit to achieve level 3 or higher; and units that are not manned or equipped but are required in the wartime structure.

f. Readiness Assessment Level 1 (RA-1). Issues and/or shortfalls have negligible impact on readiness and ability to accomplish assigned mission(s) in support of the NMS as directed in the Global Employment of the Force (GEF) and Joint Strategic Capabilities Plan (JSCP).

g. Readiness Assessment Level 2 (RA-2). Issues and/or shortfalls have limited impact on readiness and ability to accomplish assigned mission(s) in support of the NMS as directed in the GEF and JSCP.

h. Readiness Assessment Level 3 (RA-3). Issues and/or shortfalls have significant impact on readiness and ability to accomplish mission(s) in support of the NMS as directed in the GEF and JSCP.

i. Readiness Assessment Level 4 (RA-4). Issues and/or shortfalls preclude accomplishment of assigned mission(s) in support of the NMS as directed in the GEF and JSCP.

### 7-17. References

- a. AR 220-1, USR and Force Registration - Consolidated Policies.
- b. AR 525-30, Army Strategic Readiness.
- c. AR 700-138, Army Logistics Readiness and Sustainability.
- d. Chairman of the Joint Chiefs of Staff (CJCS) Guide 3401D, CJCS Guide to the CRS.
- e. CJCS Instruction (CJCSI) 3401.01E, CRS.
- f. CJCSI 3401.02B, Force Readiness Reporting.
- g. CJCS Manual 3150.02, Global Status of Resources and Training System.
- h. Department of Defense Directive (DODD) 5149.2, Senior Readiness Oversight Council (SROC).
- i. DODD 7730.65, DRRS.
- j. "Initial Message to the Army," General Mark A. Milley, 26 August 15.
- k. OSD Personnel and Readiness (P&R), DRRS Primer for Senior Leaders.

# ARMY PLANNING, PROGRAMMING, BUDGETING, AND EXECUTION PROCESS

## Chapter 8

### Army Planning, Programming, Budgeting, and Execution Process

#### Section I Introduction

##### 8-1. Chapter Content

- a. This chapter describes how the Department of Defense (DOD) and Army Planning, Programming, Budgeting, and Execution (PPBE) processes acquire, allocate, and manage resources for military functions. Prescribed by Army Regulation (AR) 1-1, the Army PPBE process is a component of the DOD PPBE process governed by DOD Directive (DODD) 7045.14.
- b. This chapter, as well as chapter 9, details the responsibilities of Army officials for overseeing Army PPBE, managing the several phases of the Army PPBE process, and performing PPBE-related operational tasks.
- c. Finally, this chapter highlights principal forums and other key characteristics of the DOD and Army PPBE processes, provides a graphic representation of the processes' recurring events and organizational structure, and concludes with a phase-by-phase discussion of the annual PPBE process.

#### Section II Department of Defense Planning, Programming, Budgeting, and Execution Process

##### 8-2. Purpose

The DOD PPBE process aligns strategy with resources. Its main purpose is to allocate resources to allow DOD to execute actions in support of the national strategy. The DOD executes PPBE in the context of the annual federal budgeting process. PPBE has two main outputs, DOD input to the annual President's Budget and the Future Years Defense Program (FYDP), a five year database containing the resource allocations to support the strategy. The President's Budget is the basis for Congressional authorizations and appropriations. When effective, PPBE aligns dollars and manpower to capabilities and operations in support of the national strategy. PPBE resources capabilities and operations worldwide

##### 8-3. Process and Structure

- a. PPBE consists of four phases, Planning, Programming, Budgeting, and Execution. Each phase has specific tasks and documents associated with it (see Figure 8-1).
  - (1) Planning Phase – DOD determines its priorities and publishes strategic documents to support prioritization of resource allocation to support the national security strategy. These documents include the national defense strategy, the national military strategy, and the annual defense planning guidance that gives direction to DOD components to guide their program development.
  - (2) Programming Phase – The Programming phase results in the services and agencies Program Objective Memorandums, their contribution to the FYDP. It is within this phase that major decisions are made regarding priorities and tradeoffs. Along with aligning resources with strategy, the purpose of this phase includes providing a balance (across all Joint Capability Areas) of capabilities in the DOD portfolio.
  - (3) Budgeting Phase – This phase refines the POMs and puts them into the format required for the President's Budget (PB) submission. It moves from a focus on programs to a focus on budget elements. Another major output from this phase is the justification materials that are transmitted to Congress.
  - (4) Execution Phase – This phase begins when Congress appropriates funds to DOD and ends when appropriated funds are obligated, spent and tracked by Service and OSD comptrollers. It includes re-allocation of funds during the year of execution based on changing events and priorities and the transmission of re-programming requests to Congress as needed.

# HOW THE ARMY RUNS

|                 |   |
|-----------------|---|
| <b>Planning</b> | National Security Strategy (NSS)—reviewed/updated with President's Budget (PB)—White House<br>National Defense Strategy (NDS)—after the NSS—at SecDef discretion<br>National Military Strategy (NMS)—at CJCS discretion<br>Defense Planning Guidance (DPG)—OSD<br>The Army Plan (TAP)—Headquarters, Department of the Army (HQDA)—Consists of:<br>• Army Vision (AV)—with NDS—Secretary of the Army / Chief of Staff of the Army<br>• Army Strategic Plan (ASP)—after AV—HQDA, G-3/5/7 DAMO-SS<br>• Army Planning Guidance (APG)—HQDA, G-3/5/7, DAMO-ZR<br>• Army Program Guidance Memorandum (APGM)—Jan after POM Offsite—G-8 PA&E<br>• Army Campaign Plan (ACP)—HQDA, G-3/5/7, DAMO-ZT<br>Research, Development, and Acquisition Plan (RDAP)—HQDA<br>Total Army Analysis (TAA)—HQDA |
|                 | Chairman's Program Recommendation (CPR)—CJCS<br>Technical Guidance Memorandum (TGM)—HQDA<br>Fiscal Guidance (FG)—OSD<br>Program Objective Memorandum (POM) / Budget Estimate Submission (BES)—HQDA<br>Issue Papers—OSD  |
|                 | Resource Management Decision (RMD)—Sept to Nov—OSD<br>Major Budget Issue (MBI)—Dec—OSD<br>Department of Defense Budget (DOD (B))—Dec—OSD<br>PB— Feb—White House   |
|                 | Authorization / Appropriation—HQDA—Oct 1st<br>Execution—HQDA<br>Assessment—HQDA   |

Figure 8-1. DOD PPBE Phases

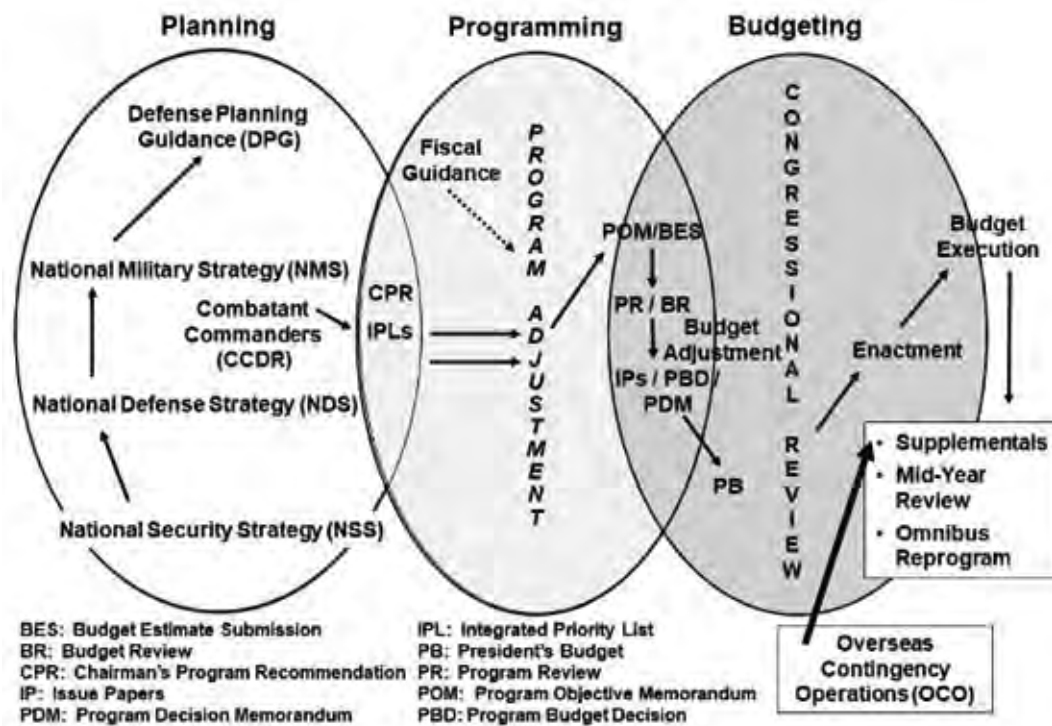

Figure 8-2. Summary of PPBE Phases

## **ARMY PLANNING, PROGRAMMING, BUDGETING, AND EXECUTION PROCESS**

b. The concurrent nature of PPBE phases is an important characteristic. The Department is never just one phase, it is always planning two-twenty years out, programming one to seven years out, budgeting for the next year, and executing up to five years of appropriations. This concurrent nature makes it important to properly identify the fiscal year or program being discussed and which phase you are in when making specific resource allocation decisions.

### **8-4 Guidance.**

a. Presidential Guidance. The President signs the National Security Strategy (NSS), which provides important direction for the PPBE process. The NSS outlines the major objectives for the nation, addresses how the U.S. plans to deal with other nations, and provides top-level guidance related to the capabilities required to implement the NSS. See Chapter 2, Strategy, for more detail on the NSS.

b. Office of the Secretary of Defense Guidance. Office of the Secretary of Defense (OSD) planning also drives the PPBE process. OSD publishes the National Defense Strategy (NDS) to provide specific guidance for how the military will prepare to accomplish the NSS. OSD examines the military posture of the U.S. in comparison to national security objectives and resource limitations. The NDS provides overarching guidance for force development and force employment. OSD publishes annual Defense Planning Guidance to give specific guidance to components to support their POM development. The DPG prioritizes resource allocation and capability development, and describes risk tolerance. It contains more specifics than the NDS and is updated annually. See Chapter 2, Strategy, for more detail on defense-level strategy, to include the Defense Planning Guidance (DPG) and Contingency Planning Guidance (CPG).

c. Joint Strategic Planning System Guidance. The Joint Strategic Planning System (JSPS) is used by the Chairman of the Joint Chiefs of Staff (CJCS) to provide strategic direction to the armed forces and defense policy, programs, and budgets and is described in detail in Chapter 2, Strategy. Two key documents from JSPS inform PPBE: The National Military Strategy (NMS) and the Chairman's Program Recommendation (CPR). The NMS provides some detail on force employment and force design and development to support the NDS. The Chairman's Program Recommendation (CPR) is a classified document that compares planning guidance and objectives with current and projected resource profiles from the most recent PB and related FYDP. The CPR focuses on recommendations that will enhance joint readiness, promote joint doctrine and training, and better satisfy joint warfighting requirements. It is prepared for the Chairman to provide to the Secretary of Defense. It is not widely disseminated around the Department in its final form. Importantly, the CPR influences the DPG which provides direction to DOD components as they build their POMs. The CJCS solicits ideas from the combatant commanders (CCDRs) and the services in the preparation of the CPR.

### **8-5. Future Years Defense Program**

a. The FYDP officially summarizes forces and resources for programs developed within the DOD PPBE process and approved by the SECDEF. The FYDP specifies force levels and lists corresponding to Total Obligation Authority (TOA) and manpower. For example, in addition to historical data, the FYDP for the FY 2020 budget would show projected costs through FY 2024 as follows—

- (1) Records totals for each resource group by:
  - (a) Prior Year (PY), in this case FY 2018.
  - (b) Current Year (CY), in this case FY 2019.
  - (c) Budget Year (BY), in this case FY 2020.
- (2) Extends TOA and manpower totals four years beyond the FY 2020 budget to FY 2024.

b. The FYDP comprises 12 major force programs as shown in Figure 8-3.

Table 8-1 shows these force programs with their corresponding subprograms with Army proponent agencies. Each program consists of an aggregation of program elements (PE) that reflect a DOD force or support mission. PEs identify specific activities, projects, or functions and contain the fiscal and manpower resources needed to achieve an objective or plan. PEs permit cross-service analysis by OSD and congressional staff members.

c. HQDA submits the Army portion of the FYDP database to OSD at least twice each year.

- (1) The first submission, forwarded in August, records the position of the combined Army POM/BES.
- (2) The second submission, forwarded in late January or early February, records the position of the

PB.

d. For each FYDP position, OSD publishes a Summary and PE Detail volume.

## HOW THE ARMY RUNS

e. As prescribed by 10 U.S.C 221(a), OSD provides the PB version of the FYDP to Congress each year at or about the time the PB is submitted to Congress.

f. OSD's Director of Cost Assessment and Program Evaluation (CAPE) manages the PE data structure and serves as the approval authority for any changes to that structure.

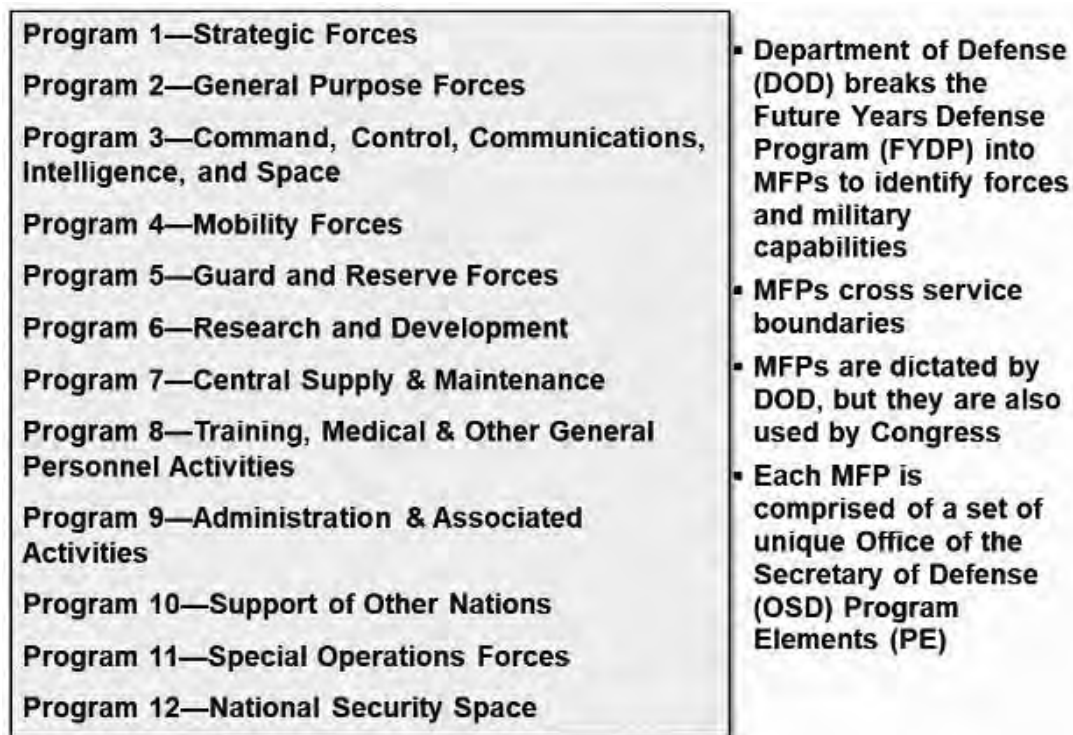

Figure 8-3. Major Force Programs

### 8-6. Resource Recording Structures

The FYDP accounts for the total of all resources programmed by the DOD. Using OSD PEs, DOD apportions decisions on dollars and manpower among the FYDP's 12 major force programs. See Figure 8-4 for the FYDP.

### 8-7. Key Participants

DOD key participants assisting the SECDEF in the PPBE process include the following:

a. Deputy Secretary of Defense (DEPSECDEF). The DEPSECDEF assists the SECDEF in overall DOD leadership. He exercises authority delegated by the SECDEF and conducts the day-to-day operation of DOD. The DEPSECDEF manages the PPBE process.

b. CJCS. The CJCS serves as the principal military adviser to the President and SECDEF and helps them provide strategic direction to the armed forces. Shouldering responsibilities for planning, advising, and policy formulation, the CJCS participates in DOD's senior councils, where he speaks for the Joint Chiefs of Staff (JCS) and CCDRs.

c. Vice CJCS (VCJCS). The VCJCS, who is the second-ranking member of the armed forces, acts for the CJCS in his absence and chairs the Joint Requirements Oversight Council (JROC).

d. Service Secretaries. The service secretaries convey the service perspective on DOD matters to the SECDEF and DEPSECDEF and, as key advisers, provide them with candid personal views.

e. Under Secretary of Defense for Acquisition and Sustainment (USD (A&S)). The USD (A&S) exercises responsibility for all matters relating to defense acquisition and sustainment and serves as the Defense Acquisition Executive (DAE).



# ARMY PLANNING, PROGRAMMING, BUDGETING, AND EXECUTION PROCESS

**Table 8-1. Future Years Defense Programs and Subprograms with Army Proponents**

| Nr  | Major Defense program                                      | Proponent <sup>1</sup>   |
|-----|--|--------------------------|
| 1.  | Strategic Forces   | G-3/5/7                  |
| 2.  | General Purpose Forces                                     | G-3/5/7                  |
| 3.  | Command, Control, Communications, Intelligence, and Space: |                          |
|     | Communications   | CIO-/G-6                 |
|     | Intelligence   | G-2/G-3/5/7 <sup>2</sup> |
|     | Space  | SMDC <sup>3</sup>        |
| 4.  | Mobility Forces  | G-3/5/7                  |
| 5.  | Guard and Reserve Forces:                                  |                          |
|     | Army National Guard  | DARNG                    |
|     | Army Reserve   | CAR                      |
| 6.  | Research and Development                                   | ASA (ALT)                |
| 7.  | Central Supply and Maintenance                             | ASA (ALT)                |
| 8.  | Training, Medical, and Other General Personnel Activities: |                          |
|     | Training   | G-3/5/7                  |
|     | Medical  | TSG <sup>4</sup>         |
| 9.  | Administration and Associated Activities                   | G-1                      |
| 10. | Support of Other Nations                                   | G-3/5/7                  |
| 11. | Special Operations Forces                                  | G-3/5/7                  |
| 12. | National Security Space                                    | SMDC                     |

**Note:**

1. Within each applicable program, Assistant Chief of Staff for Installation Management (ACSIM) serves as proponent for base operations and real property services and G-1 serves as proponent for management headquarters and manpower functions.
2. G-2 is the resource proponent for operational and strategic intelligence. G-3/5/7 is the resource proponent for tactical intelligence.
3. U.S. Army Space and Missile Defense Command.
4. The Surgeon General.

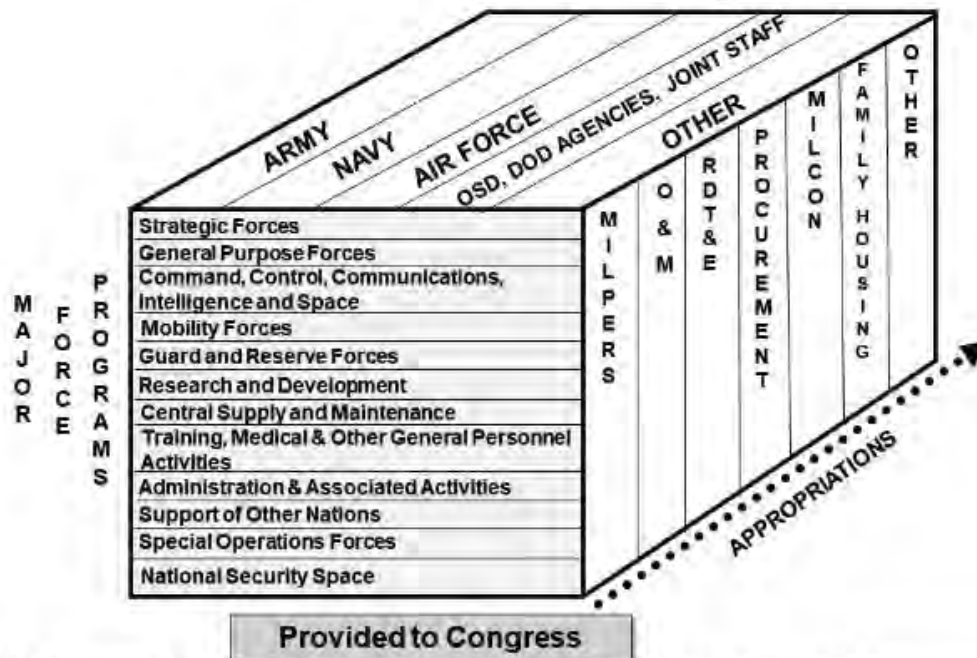

DOD: Department of Defense    MILPERS: Military Personnel    OSD: Office of the Secretary of Defense  
MILCON: Military Construction    O&M: Operations and Maintenance    RDT&E: Research, Development, Test and Evaluation

**Figure 8-4. Future Years Defense Program**

## HOW THE ARMY RUNS

f. Under Secretary of Defense for Policy (USD (P)). The USD (P) represents DOD on foreign relations and arms control matters and serves as the principal adviser to the DEPSECDEF for the PPBE planning phase (and strategy development).

g. Under Secretary of Defense (Comptroller) / Chief Financial Officer (USD (C)/CFO). The USD (C) exercises responsibility for all budgetary and fiscal matters (lead in budget and execution phases).

h. Under Secretary of Defense (Personnel and Readiness) (USD (P&R)). The USD (P&R) exercises responsibility for all matters relating to total force management as it concerns readiness, National Guard and Reserve Affairs, health affairs, training, and personnel requirements and management.

i. Director, CAPE. The Director, CAPE serves as the principal staff assistant to the SECDEF for cost assessment and program evaluation (lead in programming phase).

### 8-8. Decision Making Bodies

Several groups have been organized to assist the SECDEF in making PPBE resource decisions as shown in Figure 8-5. These groups counsel the SECDEF in applying sound business practices in the military departments, DOD agencies, and other DOD components. When determined by the chair, heads of other DOD components participate as appropriate. For example, the chair may invite officials to participate from other departments and agencies of the executive branch, including the Office of Management and Budget (OMB) and the NSC. The groups are—

a. Secretary's Senior Leadership Council (SSLC). The SSLC is the senior information exchange body in the DOD resource management system. The SECDEF chairs the SSLC. Membership includes the Deputy's Management Action Group (DMAG) principals and CCDRs.

b. Senior Leader Review Group (SLRG). The SLRG is the senior decision-making body assisting the SECDEF and DEPSECDEF in making major program decisions. The SECDEF chairs the SLRG with the CJCS serving as vice chairman. The DEPSECDEF designates other OSD principals to participate in deliberations as necessary. SLRG members include—

(1) From OSD: DEPSECDEF; USD (C); USD (P); USD (A&S); USD (P&R); Under Secretary of Defense for Intelligence (USD (I)); Director, CAPE; Assistant Secretaries of Defense for Legislative Affairs, Public Affairs and Networks and Information Integration, and CCDRs.

(2) From the Joint Staff (JS) and services: CJCS; VCJCS; Director, JS; secretaries of the military departments (MILDEPS) who are normally accompanied by service chiefs; and Chief of the National Guard Bureau (CNGB). Considering broad policy and developing guidance on high-priority objectives, the SLRG helps promote long-range planning and stability in the defense program.

(3) Among other functions, the SLRG—

(a) Reviews guidance for planning and programming.

(b) Evaluates high-priority programs.

(c) Considers the effect of resource decisions on baseline cost, schedule, and performance of major acquisition programs and aligns the programs with the PPBE process.

(d) Helps tie the allocation of resources for specific programs and forces to national policies.

(e) Reviews the program and budget.

(f) Reviews execution of selected programs.

(g) Advises the SECDEF on policy, PPBE issues, and proposed decisions.

(4) When the SLRG meets to deliberate major issues on DOD-funded intelligence programs, it expands to include representatives of appropriate intelligence agencies. The DEPSECDEF and Director of Central Intelligence co-chair this expanded SLRG (ESLRG).

(5) The Director, CAPE, acts as executive secretary for both the SLRG and ESLRG. In this capacity, the director manages the program review process and, with the chairs of the ESLRG, the intelligence program review. The Director, CAPE, also manages the preparation of issue papers (IP) to formulate service-level issues which challenge the service program requests and the Intelligence Resource Management Decisions (IRMD) that reflect the SECDEF's program decisions.

c. Deputy's Management Action Group (DMAG). The DMAG facilitates the development of the NDS, monitors its implementation, and addresses other subjects as required. The DMAG participates in the program review process and comments on the IPs resulting from the program review of the POM. The DEPSECDEF and VCJCS co-chair the DMAG.

(1) DMAG membership is as follows:

(a) From OSD: USD (A&S); USD (C); USD (P&R); and USD (I); Deputy Undersecretary for Policy; Assistant Secretary Defense Network Integration / CIO; Director and Principal Deputy Director, Cost

## ARMY PLANNING, PROGRAMMING, BUDGETING, AND EXECUTION PROCESS

Assessment & Program Analysis; Deputy Chief Management Officer (DCMO); Assistant Secretary of Defense, Legislative Affairs; and the General Counsel.

(b) From the JS and Services: service undersecretaries and vice chiefs; Director, JS; Director, J-8; Director, J-5; Director, National Guard Bureau; and Deputy Commander, U.S. Special Operations Command (USSOCOM). CCDRs or their deputies are welcome when issues are being considered that impact their regional or functional responsibilities.

(2) The DMAG generally meets weekly to consider ongoing and cyclic issues including:

- (a) Capability portfolio development and management.
- (b) Defense planning scenarios and related analytical efforts.
- (c) Program and budget reviews.
- (d) IPs resulting from the OSD staff and other players.
- (e) Strategy and policy development including periodic reviews.
- (f) Regional and functional challenges.
- (g) Transformation.

d. The OSD 3-star programmers group analyzes major issues and develops decision options during program review. It forwards issues sufficiently significant to warrant action by the SLRG to that body for consideration. Supporting the endeavor, OSD principal staff assistants conduct a series of Strategic Portfolio Reviews (SPR). As directed by the SLRG, assessments address topics or decisions that will influence the next POM and subsequent program review. Prepared in coordination with other OSD principal assistants, representatives of the CJCS, and service chiefs, the assessments are briefed to the 3-star group. As appropriate, they are also briefed to the DEPSECDEF or SLRG. The Director, Cost Assessment and Program Analysis, chairs the 3-star group. Adding other OSD principals to participate in sessions as appropriate, the 3-star group includes the following members:

(1) From OSD: Representatives from the Deputy Under Secretary of Defense (Comptroller, Policy, Intelligence, and Acquisition & Sustainment) and the Assistant Secretaries of Defense for Force Management Policy, Health Affairs, and Manpower & Reserve Affairs, the Principal Deputy Assistant Secretary of Defense for Networks and Information Integration, the Director of Operational Test and Evaluation and Commander USSOCOM.

(2) From the JS: Director for Force Structure, Resources, and Assessment (J-8).

(3) From the services: HQDA DCS G-8; Deputy Chief of Naval Operations (Resources, Warfare Requirements and Assessments); Marine Corps Deputy Commandant (Programs and Resources); and Air Force, DCS (Plans and Programs).

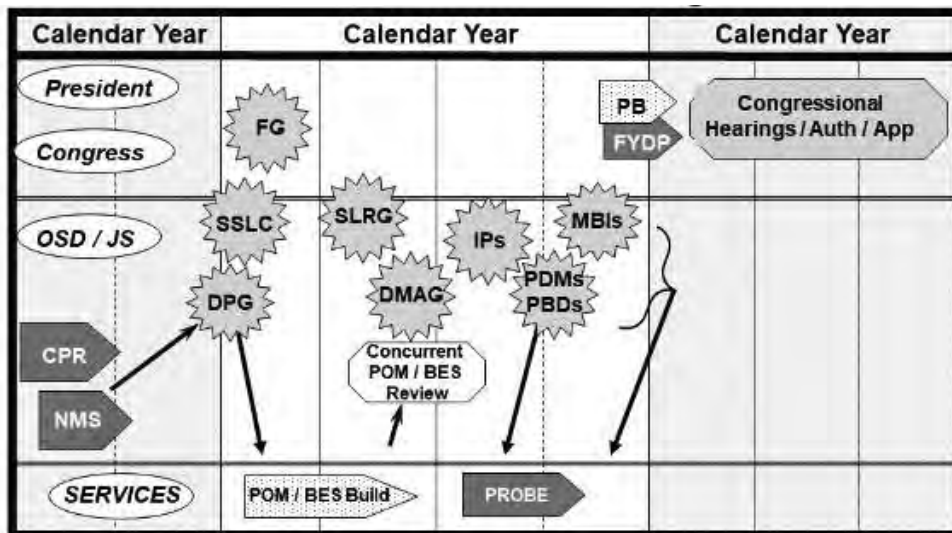

Figure 8-5. DOD Review / Decision-Making Bodies

## HOW THE ARMY RUNS

### 8-9. Intelligence Program Review Group

- a. The Intelligence Program Review Group (IPRG) identifies opportunities to advance the U.S. Government's intelligence strategy. It evaluates potential program changes from a mission perspective, considers tradeoffs, and forwards issue analyses to the ESLRG for consideration.
- b. The Director, CAPE, and the Executive Director for Intelligence Community Affairs co-chair the IPRG. Members include representatives of all executive branch organizations that manage or oversee intelligence capabilities.

### Section III

#### The Army Planning, Programming, Budgeting, and Execution Process

### 8-10. Army's Primary Resource Management System

The PPBE process serves as the Army's primary resource management process. A major decision-making process, PPBE interfaces with joint strategic planning and with planning conducted by OSD. Linking directly to OSD programming and budgeting, the PPBE process develops and maintains the Army portion of the defense program and budget. PPBE supports Army planning, program development, and budget preparation at all levels of command. Similarly supporting program and budget execution, it provides feedback to the planning, programming, and budgeting processes.

### 8-11. Planning, Programming, Budgeting, and Execution Concept

- a. The PPBE process ties strategy, program, and budget all together. It helps build a comprehensive plan in which budgets flow from programs, programs from requirements, requirements from missions, and missions from national security objectives. The patterned flow from end purpose to resource cost defines requirements in progressively greater detail.
- b. Long-range planning creates a vision of the Army 10-30 years into the future. In the 2- to 10-year mid-term, long-range macro estimates give way to a specified size, composition, and quality of operational and support forces. Derived from joint strategic planning and intermediate objectives to achieve long-range goals, this operational and support force provides the planning foundation for program requirements.
- c. In the mid-term, guided by force requirements, the integrated program-budget process distributes projected resources. It seeks to support priorities and policies of the senior Army leadership while achieving balance among Army organizations, systems, and functions. For the 0- to 2-year near-term, the integrated process converts program requirements into budget requests for manpower and dollars. When enacted into appropriations and manpower authorizations, these resources become available to carry out approved programs.
- d. By formally adding execution to the traditional emphasis on planning, programming, and budgeting, the Army emphasizes concern for how well program performance and financial execution apply allocated resources to meet the Army's requirements.
- e. Documents produced within the PPBE process support defense decision-making, and the review and discussion that attend their development help shape the outcome. For example—
  - (1) The Army helps prepare the SECDEF's Defense Planning Guidance (DPG) and planning documents produced by the Joint Strategic Planning System (JSPS). Army participation influences policy, strategy, and force objectives considered by the SECDEF and the CJCS, including policies for development, acquisition, and other resource-allocation issues.
  - (2) ACOM commanders, PEOs, and heads of other operating agencies similarly influence positions and decisions taken by the SECARMY and CSA. Commanders and heads of agencies develop and submit force structure, procurement, and construction requirements as well as assessments and data to support program and budget development. Through periodic commanders' conferences held by the CSA, they also make their views known on the proposed plan, program, and budget.
  - (3) CCDRs influence Army positions and decisions through ACOM commanders serving as commanders of ASCCs, who integrate operational requirements of the CCMD into their program and budget submissions. CCDRs also highlight capability shortfalls in their Integrated Priority List submission (IPL) that receives close review during program development.

# ARMY PLANNING, PROGRAMMING, BUDGETING, AND EXECUTION PROCESS

## 8-12. Planning, Programming, Budgeting, and Execution Objectives

The main objective of the PPBE process is to establish, justify, and acquire the fiscal and manpower resources needed to accomplish the Army's assigned missions in executing the NMS. Phase by phase objectives follow—

- a. Conduct planning to size, structure, man, equip, train, and sustain the Army force to support the NMS.
- b. Analyze integrated programming and budgeting, to—
  - (1) Allocate and distribute projected manpower, dollars, and materiel among competing requirements according to Army resource allocation policy and priorities, making sure that requirements get resourced at defensible, executable levels.
  - (2) Convert resource allocation decisions into requests for congressional authorization and appropriations.
- c. Execute programs to apply resources to achieve approved program objectives, and adjust resource requirements based on execution feedback.
- d. Oversee budget execution, to manage and account for funds to carry out approved programs.

## 8-13. Control of Planning, Programming, and Budgeting Documents

- a. Papers and associated data sponsored by the DOD PPBE process give details of proposed programs and plans. The proposals often state candidate positions and competing options that remain undecided until final approval.
- b. Access to such tentative material by other than those directly involved in planning and allocating resources would frustrate the candor and privacy of leadership deliberations. Moreover, access by private firms seeking DOD contracts would imperil competition and pose serious ethical, even criminal, problems for those involved. For these reasons, DOD closely controls documents produced through the DOD PPBE process and its supporting databases. Thus, OSD restricts access to DOD and other governmental agencies directly involved in planning, programming, and budgeting Defense resources, primarily OMB.
- c. Exceptions to the limitations described require SECDEF approval. After coordination with the General Counsel, Army proponents may request an exception, but only for compelling need. Statutes and other procedures govern disclosure of information to Congress and the General Accountability Office (GAO).
- d. Guidance in DODD 7045.14 gives the secretaries of the MILDEPS, CJCS, the Under Secretaries and Assistant Secretaries of Defense, Director, CAPE, and the Director, Operational Test and Evaluation designation as the approval authorities for disclosing PPBE documents and data outside the DOD and to other government agencies directly involved in the defense planning and resource allocation process. This disclosure authority is restricted to PPBE documents and data generated by the offices and organizations they oversee.
- e. Major PPBE and PPBE-related documents and material requiring restricted access include--
  - (1) Planning Phase:
    - (a) Defense Planning Guidance (DPG)
    - (b) Contingency Planning Guidance (CPG)
    - (c) The Army Plan (TAP)
  - (2) Programming Phase:
    - (a) Fiscal Guidance.
    - (b) POM.
    - (c) FYDP documentation including FYDP annexes.
    - (d) IPs (for example, major IPs, and cover briefs).
    - (e) Proposed MILDEP program reductions (or program offsets).
    - (f) Tentative issues in the form of draft IPs process at OSD.
    - (g) Program Decision Memorandum (PDM), loosely known as Resource Management Decisions (RMD), which are implementing instructions from the SECDEF on his final decisions on programs.
  - (3) Budgeting Phase:
    - (a) FYDP documents for the BES and PB, including procurement, RDT&E, and construction annexes.
    - (b) Program Budget Decisions (PBD), along with PDM are loosely called RMDs.

## HOW THE ARMY RUNS

- (c) Automated Program and Financing Statements.
- (d) Reports generated by the automated Comptroller Information System (CIS).
- (e) DD Form 1414, Base for Reprogramming Actions.
- (f) DD Form 1416, Report of Programs.
- (g) Congressional data sheets.

### Section IV

#### Leading Army Planning, Programming, Budgeting, and Execution System Phases

##### 8-14. Secretarial Oversight

- a. Responsible for PPBE oversight and Army-wide policy development, the Assistant Secretary of the Army (Financial Management and Comptroller) (ASA (FM&C))—
  - (1) Oversees the PPBE process and develops and issues Army-wide PPBE policy.
  - (2) Serves as appropriation sponsor for all appropriations (funds) except Army National Guard (ARNG) and U.S. Army Reserve (USAR) appropriations, whose sponsors are the Director of the Army National Guard (D, ARNG) and Chief, Army Reserve (CAR).
- b. Functional Oversight. Principal officials of the Office of the Secretary of the Army (OSA) oversee operation of the PPBE process within assigned functional areas and provide related policy and direction.

##### 8-15. System Management

ASA (FM&C) manages the PPBE process, with the HQDA DCS G-3/5/7, Director, Program Analysis and Evaluation (DPAE), and Military Deputy for Budget and Execution acting as advisers. The Assistant Deputy Chief of Staff (ADCS) G-3/5/7, the DPAE, and the DAB manage functional phases of the process, each establishing and supervising policies and procedures necessary to carry out phase functions.

##### 8-16. Planning Phase

- a. HQDA DCS G-3/5/7. Responsible for operations and planning functions with the Assistant Deputy G-3/5/7, as follows—
  - (1) Manages the PPBE planning phase.
  - (2) Co-chairs the Planning Program Budget Committee (PPBC) with the DPAE and DAB.
  - (3) With the Military Deputy for Budget, OASA (FM&C) and the G-8, co-chair the Three-Star Budget, Requirements, and Program board (BRP).
  - (4) Guides the work of Program Evaluation Groups (PEG) on planning and readiness matters to include requirements determination, prioritization, and the integration of security cooperation issues per the Army International Activities Plan (see Table 8-2).

**Table 8-2. Managers for Manpower and Force Structure Issues**

| Issue   | Manager       |
|---|---------------|
| Force structure/Unit Identification Code (UIC)/Resource Organization (Command) Code (ROC) | G-3/5/7       |
| Military Manpower (Active)  | G-1           |
| Army National Guard Manpower  | Director ARNG |
| U.S. Army Reserve Manpower  | Chief AR      |
| Civilian (End Strength and Full Time Equivalents)   | G-1           |
| Individuals Account   | G-1           |
| Army Management Headquarters Activities (AMHA)  | G-1           |
| Joint and Defense Accounts  | G-1           |

The functional proponents outlined above and their supporting PEGs bear responsibility for setting the funding level of validated military requirements and validating and funding nonmilitary requirements generated by new equipment for unit set fielding, force modernization, or other new mission or doctrine.

## **ARMY PLANNING, PROGRAMMING, BUDGETING, AND EXECUTION PROCESS**

- (e) Assesses capabilities, deficiencies, and risks of the POM force at the end of the current POM.
- (2) Serves as the principal adviser to the Chief of Staff, Army (CSA) on joint matters, NSC matters, and the politico-military aspects of international affairs, as follows—
  - (a) Provides HQDA with strategic analysis pertaining to national security issues involving international and regional arms control treaties, agreements, and policies.
  - (b) Plans for employment of Army forces to meet strategic requirements and shape Army forces for the future.
  - (3) Serves as overall integrator of Army transformation, as follows—
    - (a) Makes sure that military requirements reflect future Army Strategic Plan (ASP), other planning guidance, and policy, and that the capability and applicability of total Army forces remain synchronized with the NSS, national defense strategy, and National Military Strategy (NMS).
    - (b) Provides the HQDA focal point for the organization, integration, and synchronization of decision making, as well as for requirements definition, force structuring, training developments, and prioritization.
  - (4) Prepares the Army Vision (AV), ASP, Army Planning Guidance (APG), and Army Campaign Plan (ACP) sections of The Army Plan (TAP); coordinates the publication of the Army Program Guidance Memorandum (APGM) with the DPAE. In addition—
    - (a) Defines Army planning assumptions.
    - (b) Sets requirements and priorities based on guidance from the SECDEF, Secretary of the Army (SECARMY), and CSA and priorities of the CCDRs.
    - (c) Sets objectives to meet requirements and overcome shortfalls.
  - (5) Monitors and reports on current operations as follows—
    - (a) Develops and coordinates policy, programs, and initiatives to achieve directed levels of individual, leader, and unit training readiness for the Army.
    - (b) Oversees Army readiness reporting requirements and the reporting of Army readiness to provide an accurate picture for prioritization and resource allocation decisions within HQDA and externally.
    - (c) Assesses and coordinates support to CCDRs and, through the Army Service Component Command (ASCC), provides the operational link between each combatant command (CCMD), HQDA, and the JS.
  - (6) Performs all mobilization functions.
  - (7) Provides the HQDA focal point for executing military support to civil authorities.
  - (8) Executes the Continuity of Operations Program (COOP) for HQDA and OSD, the Army Infrastructure Assurance Program, and the Domestic Preparedness Program which provides support for special events.
    - (9) Provides support for special events.
    - (10) Provides the vision and strategy and manages the development of models and simulations.
    - (11) Develops policy and acts as the principal adviser to the CSA for information operations.
    - (12) Serves as proponent of the Training PEG.
    - (13) Serves as proponent of programs within the FYDP, including: 1-Strategic Forces, 2-General Purpose Forces, 4-Mobility, 10-Support of Other Nations, and 11-Special Operations Forces.
    - (14) Serves as resource proponent for tactical intelligence, Army subprogram 3-Intelligence and proponent of Army subprogram 8-Training.
    - (15) Manages force structure issues and manages functional requirements and program and performance for designated accounts of the Operation and Maintenance, Army (OMA) appropriation (see Tables 8-3 through 8-8).
- b. HQDA DCS G-8. Responsible for the execution of approved materiel requirements, as follows—
  - (1) Provides the HQDA focal point for program development, materiel integration, and assessments like the NDS.
  - (2) With the ASA (ALT), prepares the Research, Development, and Acquisition Plan (RDAP), which is represented by the database for the FYDP.
  - (3) Prepares the Army's Equipment Modernization Strategy (AEMS), the Army Equipment Program in support of the PB, the Army Equipping Guidance and helps prepare Army input to OSD's Defense Program Projection.
  - (4) Serves as proponent of the Equipping PEG.
  - (5) With the Military Deputy for Budget, OASA (FM&C) and the G3/5/7, co-chair the Three-Star Budget, Requirements, and Program (BRP) Board.

## HOW THE ARMY RUNS

(6) Manages functional requirements for Research, Development, Test, and Evaluation (RDT&E) and procurement appropriations.

### **8-17. Integrated Programming and Budgeting Phase**

The DPAA and DAB jointly manage the integrated programming and budgeting phase to produce a combined POM and Budget Estimate Submission (BES).

a. DPAA. The Army DPAA takes the lead on programming matters and—

(1) Provides the SECARMY and CSA with independent assessments of program alternatives and priorities.

(2) Provides analytical and administrative support for PPBE forums.

(3) Co-chairs the PPBC and the Two-Star BRP with the ADCS G-3/5/7 and the DAB.

(4) Exercises overall responsibility at HQDA for Army program development in support of the POM and FYDP.

(5) With the ADCS G-3/5/7 and DAB, guides and integrates the work of PEGs throughout the PPBE process.

(6) With functional proponents—

(a) Prepares Army responses to OSD programming guidance documents.

(b) Structures the APGM and Technical Guidance Memorandum (TGM) to articulate direction and guidance from the DPG and senior Army leadership.

(c) Develops the Army program, including review of CCDR integrated priority lists (IPL) and program submissions of the Army Commands (ACOM), Program Executive Offices (PEO), and other operating agencies.

(7) Codifies and submits to OSD the approved Army program in the POM.

(8) Serves as HQDA point of contact for the POM and FYDP within HQDA, and with OSD and the JS.

(9) Manages the Management Decision Execution Packages (MDEP) architecture.

(10) Serves as host activity manager of the PPBE enterprise system in coordination with ASA (FM&C), appropriation sponsors, manpower managers, the OSD Comptroller, OSD Director, CAPE, and Department of the Treasury, and—

(a) Through the PPBC, establishes a PPBE Strategic Automation Committee (PSAC) to implement configuration management of the PPBE enterprise system and oversee long-term plans for investing in information technology (IT) to improve the performance of PPBE functions.

(b) Maintains the resource management architecture for automated support of PPBE processes and information systems and their integration into a common PPBE database. In particular: hosts the web services that provide coordination for the common data architecture, including PEs, Army PE (APE), resource organization (command) codes, the SSN-LIN Automated Management and Integrating System (SLAMIS) and, in coordination with the Defense Finance and Accounting Service (DFAS), the Army Management Structure Code (AMSCO); maintains an integrated data dictionary of data elements in the PPBE data element structure and disciplines its use without re-keying by database users and component databases; and controls data entry and makes sure that PPBE data elements are consistent not only internally for programming, budgeting, and execution but, also externally with reporting requirements of the Standard Data Collection System (SDCS), Service Support Manpower System (SSMS), and Comptroller Information System (CIS) or their successors.

(c) Maintains the official database position for Army Program and Budget Guidance (PBG) and through the SDCS, SSMS, and CIS, or their successors, updates OSD resource management databases with data that reflect the POM, BES, and the PB. Affected data includes the Army BES for manpower, Army appropriations, and Army-managed defense appropriations.

(d) Ensures that the Army portion of FYDP submissions to OSD includes defense appropriations managed by the Army and that force structure and manpower information match positions in the force structure and accounting databases for the Active Army, ARNG, USAR, and civilian work force.

(e) Issues the PBG to the Army Commands, PEOs, PMs, and other operating agencies and Direct Reporting Units (DRUs) after each PPBE phase.

(11) Provides feedback to each CCDR as to the resource status of the command's issues on forwarding the combined POM / BES to OSD.

b. DAB. The DAB takes the lead on budgeting matters and:'

(1) Co-chairs the PPBC and the Two-Star BRP with the ADCS G-3/5/7 and DPAA.

(2) Establishes budgeting policy and processes.



## **ARMY PLANNING, PROGRAMMING, BUDGETING, AND EXECUTION PROCESS**

- (3) Guides and integrates the work of the PEGs on budget matters.
- (4) Reviews and consolidates the ARNG and USAR budgets with the Active Army budget.
- (5) Provides feedback to each CCDR on major budget issues (MBI) affecting the command's resource requirements.
- (6) Justifies the Army budget before OSD, OMB, and Congress.
- (7) Maintains liaison and acts as point of contact with Congressional appropriations committees except for civil works issues.
- (8) With the DPAE and data proponents, performs system and data management functions.
- (9) Serves as proponent of FYDP program 6-Research and Development and program 7-Central Supply and Maintenance.
- (10) Manages functional requirements and program and performance for designated appropriation accounts.
- (11) Manages the data architecture of APE and elements of resource (EOR).
- (12) Maintains and issues TOA controls for Army appropriations for the BES and the PB cycles.
- (13) Translates final budget decisions into program changes, posting PEs, Army PEs (APE), MDEPs, and command distributions, as required, updating the PPBE database to produce the PB position submitted to OSD and Congress.
- (14) Manages the issue cycle to formulate IPs challenging the Service program requests and MBI processes. The IPs from the SECDEF challenge the service program requests with suggested changes.
  - (a) Maintains coordination between the USD (C) and HQDA.
  - (b) Makes sure that adjustments to fiscal controls are correct on all records for each IP (verifying corresponding manpower controls, however, is a HQDA DCS G-1 responsibility).
- (15) Gives special attention to any IP under appeal since the DEPSECDEF may, on review, revise pending adjustments.
- (16) When the SECDEF makes his final decision on change to the Service programs he issues PDMs or PBDs (collectively called RMDs) which directs the Services to change their programs to comply with his resourcing decisions.
  - c. ADCS G-3/5/7. The ADCS G-3/5/7 ensures the optimal allocation of army resources by evaluating the integrated programming-budgeting phase for compliance with The Army Plan (TAP) and Army priorities. Additionally, Co-chairs the PPBC and the Two-Star BRP with the DAB and DPAE.

### **8-18. Execution Phase**

- a. Military Deputy for Budget and Execution. For the ASA (FM&C), the Military Deputy for Budget and Execution—
  - (1) Reviews program performance and, specifically, oversees Cost and Performance Measures designed to provide the senior Army leadership with a corporate view of business efficiencies and program accomplishment.
  - (2) Applies funds appropriated by Congress to carry out authorized programs.
  - (3) Through the DAB, manages the PPBE execution phase.
- b. DAB. The DAB manages the PPBE Execution phase and, during financial execution—
  - (1) Establishes funding policy and processes.
  - (2) Supervises and directs financial execution of the congressionally approved budget.
  - (3) Allocates funds appropriated by Congress and monitors their execution
  - (4) Oversees accounting for and reporting on use of Army-managed funds to OSD and Congress by appropriation. As applicable to each appropriation, includes FYDP program, PEs, APEs, project number, budget line item number (BLIN), Standard Study Number (SSN), quantities, budget activity groups (BAG), activity groups (AG), budget sub-activity groups (SAG), element of resource (EOR), and financing data. Also as applicable to an appropriation, accounts for and reports on the use of the manpower-by-manpower category.
    - (5) With functional proponents and within stated restrictions and specified dollar thresholds, reprograms funds as required to meet unforeseen requirements or changes in operating conditions.
    - (6) With the Defense Finance and Accounting Service (DFAS):
      - (a) Oversees the development and maintenance of standard Army systems in support of financial accounting; and oversees implementation of the same standard Army systems in support of distribution, accounting, and reporting of funds.
      - (b) Makes sure that execution reports meet HQDA management information needs.

## HOW THE ARMY RUNS

c. DPAE. During programmatic execution, the DPAE monitors how programmed resources are applied to achieve approved objectives to gain feedback for adjusting resource requirements.

d. The ADCS G-3/5/7. The ADCS G-3/5/7 ensures the optimal allocation of Army resources by evaluating the execution phase for compliance with TAP and Army priorities.

### Section V

#### Supporting Responsibilities in the Army for Planning, Programming, Budgeting, and Execution System

##### 8-19. Headquarters Department of the Army Principal Officials

a. The Assistant Secretary of the Army (Acquisition, Logistics, and Technology) (ASA (ALT))—

(1) Represents the Army on the DAB, the Nuclear Weapons Council Standing Committee, and the Conventional Systems Committee.

(2) Integrates the development and acquisition of materiel into all phases of the PPBE process.

(3) With the HQDA DCS G-8, helps prepare the Research, Development, and Acquisition Plan (RDAP).

(4) Manages functional requirements and program and performance for RDT&E and procurement appropriations, the Chemical Agents and Munitions Destruction, Army appropriation, and designated miscellaneous accounts, as well as the contract operations account of the Operation and Maintenance, Army (OMA) appropriation.

b. The Assistant Secretary of the Army (Installations, Energy and Environment) (ASA (IE&E)) exercises responsibility for, and oversees, all matters and policy related to installations, housing, installation-related-military construction, real estate and environment, safety, and occupational health.

c. The Assistant Secretary of the Army (Manpower and Reserve Affairs ((ASA (M&RA))—

(1) Oversees Army manpower requirements determination and resource allocation for all Army components across all major Army Commands (ACOM) and separate agencies (Active, Guard, Reserve, Joint, and Defense).

(2) Reviews policies and programs pertaining to readiness, resource allocation, training, force structure, and professional and leader education and development.

d. Administrative Assistant to the Secretary of the Army (AASA)— Plans, programs, budgets, and accounts for the execution of resources for HQDA and its field operating and staff support agencies.

e. Chief Information Officer and Army G-6 (CIO / G-6)—

(1) Serves as Program Integrator for IT.

(2) Serves as proponent of the Army FYDP subprogram 3-Communications.

(3) Makes sure through advice and technical assistance that Army acquires IT and manages information resources in a manner that implements the policies, procedures, and goals of the Army Knowledge Management Strategic Plan.

(4) Validates IT requirements and monitors the performance of IT programs throughout all phases of the PPBE process.

(5) Develops, maintains, and facilitates the IT architecture, the Army Knowledge Enterprise Architecture (AKEA), across the Army.

f. HQDA DCS G-1—

(1) Develops human resource programs, budgets, and activities to execute life-cycle functions of manning, well-being, personnel technologies, Soldier-oriented R&D, and personnel transformation.

(2) Serves as proponent of the Manning PEG.

(3) Serves as proponent of FYDP program 9-Administration.

(4) Manages issues related to Army manpower accounts except for ARNG and USAR manpower and manages functional requirements and program and performance for the military pay, Army appropriation, and for designated personnel accounts and manpower-only accounts of the OMA appropriation.

g. HQDA DCS G-2—

(1) Prepares, justifies, and submits the program and budget for the Army portion of the National Foreign Intelligence Program (NFIP) per the policy, resource, and administrative guidance of the Director of Central Intelligence and DOD NFIP Program Managers. The Director of Central Intelligence is also responsible under statute and presidential order to do the following: develop, approve, and present to POTUS an annual budget for the NFIP for inclusion in the PB for transmittal to Congress pursuant to

## **ARMY PLANNING, PROGRAMMING, BUDGETING, AND EXECUTION PROCESS**

OMB guidance; and participate in the development by the SECDEF of the annual budgets for the Joint Military Intelligence Program (JMIP) and the Tactical Intelligence and Related Activities (TIARA).

(2) Serves as Army Staff lead for integrating intelligence, surveillance, and reconnaissance (ISR) matters into all phases of the PPBE process.

(3) Serves as the resource proponent for operational and strategic intelligence of Army FYDP subprogram 3-Intelligence.

(4) Manages functional requirements and program and performance for Security Programs of the OMA appropriation.

(5) Serves as PEG Program Integrator for national and military intelligence program matters

h. HQDA DCS G-4—

(1) Develops and resources Army-wide logistics operation programs for strategic mobility, supply, maintenance, war reserves and prepositioning, aviation, munitions, transportation, distribution, readiness, and integrated logistics support (ILS).

(2) Integrates and balances between acquisition and logistics the sustainment functions of readiness, supply, services, maintenance, transportation, aviation, munitions, security assistance, and related automated systems.

(3) On behalf of the Army Acquisition Executive (AAE)—

(a) Develops policies for, and oversees, the PPBE of ILS.

(b) Makes sure that PEOs have programmed and incorporated supportability requirements into the acquisition and fielding of new systems.

(4) Serves as proponent of the Sustaining PEG.

(5) Manages functional requirements for the Procurement of Ammunition, Army appropriation and the Army Working Capital Fund and manages functional requirements and program and performance for Logistics Operations accounts of the OMA appropriation, including those for base operations.

i. Assistant Chief of Staff for Installation Management (ACSIM)—

(1) Develops and directs planning, programming, and budgeting of installation management functions and the funding of installation-related military construction, housing, environmental protection, and facilities operation and sustainment.

(2) Provides ACSIM validation of requirements for managing and funding Army installations.

(3) Serves as proponent of the Installations PEG.

(4) Manages functional requirements and program and performance for military construction appropriations and environmental restoration as well as Installation Management Operations and Maintenance appropriations.

j. Chief of Engineers (COE)—

(1) Supports and promotes resource requirements of the engineer regiment.

(2) Represents and promotes resource requirements of the U.S. Army Corps of Engineers (USACE).

(3) Acts for SECARMY in executing SECARMY Executive Agent responsibilities for military construction to include construction for the Air Force, Navy, National Aeronautics and Space Administration (NASA), and selected DOD activities and foreign nations.

(4) Manages functional requirements and program and performance for the Homeowners Assistance Fund, Defense.

k. The Surgeon General (TSG)—

(1) Represents and promotes resource requirements of the U.S. Army Medical Department.

(2) Manages functional requirements and program and performance for reimbursable medical manpower of the OMA appropriation.

l. Chief, National Guard Bureau (CNGB). Through the Director of the Army National Guard (DARNG)—

(1) Plans and administers the budget of the ARNG and serves as appropriation sponsor for ARNG appropriations.

(2) Serves as proponent of the ARNG subprogram, FYDP program 5-Guard and Reserve Forces.

(3) Manages ARNG manpower issues and manages functional requirements and program and performance for ARNG appropriations and ARNG accounts of the Operation and Maintenance, Army National Guard appropriation.

(4) Serves as Program Integrator for the statutory, defense, and Army requirements of the ARNG.

(5) Provides technical assistance to Title 10 PEGs and monitors actions to integrate into all phases of the PPBE processes the statutory, defense, and Army requirements of the ARNG.

(6) Tracks ARNG program performance during budget execution.

## HOW THE ARMY RUNS

### m. CAR—

- (1) Plans and administers the budget of the USAR and serves as appropriation sponsor for USAR appropriations.
- (2) Serves as proponent of the USAR subprogram, FYDP program 5-Guard and Reserve Forces.
- (3) Manages USAR manpower issues and manages functional requirements and program and performance for USAR appropriations and USAR accounts of the Operation and Maintenance, U.S. Army Reserve appropriation.
- (4) Serves as Program Integrator for the statutory, defense, and Army requirements of the USAR.
- (5) Provides technical assistance to Title 10 PEGs and monitors actions to integrate into all phases of the PPBE processes the statutory, defense, and Army requirements of the USAR.
- (6) Tracks USAR program performance during budget execution.

### 8-20. Army Commanders

- a. Commanders of ACOMs, ASCCs, DRUs, PEOs, and heads of other operating agencies:
  - (1) Plan, program, and budget for assigned missions, responsibilities, and functions.
  - (2) Document manpower in their subordinate organizations per allocated manpower levels.
  - (3) Execute the approved ACOM or agency program within allocated resources, applying the inherent flexibility allowed by law and regulation.
  - (4) Assess ACOM or agency program performance and budget execution and—
    - (a) Account for and report on use of allocated funds by appropriation and MDEP. As applicable to each appropriation, include FYDP program, Army Management Structure Code (AMSCO), Army Program Element (APE), project number, BLIN, SSN, BA, BAGs, AGs, SAGS, and EOR. Also account for and report on use of allocated manpower by unit identification code (UIC).
    - (b) Use manpower data and financial data from budget execution in developing future requirements.
    - (c) Make sure that below threshold reprogramming remains consistent with Army priorities.
- b. Commanders of ASCCs. ASCC commanders identify and integrate with their other missions and operational requirements, the requirements of the CCMD.

### 8-21. Staff Managers and Sponsors for Congressional Appropriations

The Military Deputy for Budget and Execution, the DARNG, CAR, and designated functional managers manage and control Army resources. One set of functional managers addresses manpower and force structure issues. Another set of functional managers assists appropriation sponsors. Tables 8-3 through 8-9 list assignments of appropriation sponsors and functional managers.

**Table 8-3. Budget Activity Management Structure for Operation and Maintenance Appropriations**

| Code                   | Description                        | Manager <sup>1</sup>                            |  |
|------------------------|------------------------------------|---|--|
| BA 1: Operating forces |                                    |   |  |
| 11                     | Land forces                        | G-3/5/7 Collective Training Division (DAMO-TRC) |  |
| 111                    | Combat Forces                      | G-3/5/7 Collective Training Division (DAMO-TRC) |  |
| 112                    | Combat Support Forces              |   |  |
| 113                    | Echelons Above Brigades (EAB)      |   |  |
| 114                    | Theater Level Assets               |   |  |
| 115                    | Land Forces Operations Support     |   |  |
| 116                    | Aviation Assets                    |   |  |
| 12                     | Land Forces Readiness              |   |  |
| 121                    | Force Readiness Operations Support |   |  |
| 122                    | Land Forces System Readiness       |   | G-3/5/7 Training Simulations Division (DAMO-TRS) |
| 123                    | Land Forces Depot Maintenance      |   | G-4 Directorate of Sustainment (DALO-SM)         |
| 13                     | Land Forces Readiness Support      |   | ACSIM Resources Division (DAIM-ZR)               |
| 131                    | Base Operations Support            |   |  |

**ARMY PLANNING, PROGRAMMING,  
BUDGETING, AND EXECUTION PROCESS**

| Code                                | Description   | Manager <sup>1</sup>   |
|-------------------------------------|---|--|
| 132                                 | Facilities Sustainment, Restoration, and Modernization  | ACSIM Resources Division (DAIM-ZR)   |
| 133                                 | Management and Operational Headquarters                 | G-1 Manpower Policy, Plans, and Program Division (DAPE-PRA)  |
| 134                                 | Combatant Commands Core Operations                      | G-3/5/7 Resources and Programming Division (DAMO-TRP)  |
| 135                                 | Additional Activities                                   |  |
| <b>BA 2: Mobilization</b>           |   |  |
| 21                                  | Mobility Operations                                     | G-3/5/7 Collective Training Division (DAMO-TRC)  |
| 211                                 | Strategic Mobility                                      | G-3/5/7 Collective Training Division (DAMO-TRC) <sup>2</sup><br>G-4 Directorate for Force Projection/Distribution (DALO-FP) <sup>3</sup> |
| 212                                 | Army Prepositioned Stocks                               | G-3/5/7 Collective Training Division (DAMO-TRC) <sup>2</sup><br>G-4 Directorate for Force Projection/Distribution (DALO-FP) <sup>3</sup> |
| 213                                 | Industrial Preparedness                                 | G-3/5/7 Collective Training Division (DAMO-TRC) <sup>2</sup><br>G-4 Directorate for Force Projection/Distribution (DALO-FP) <sup>3</sup> |
| 214                                 | Prepositioned Materiel Configured to Unit Sets (POMCUS) | G-3/5/7 Collective Training Division (DAMO-TRC) <sup>2</sup><br>G-4 Directorate for Force Projection/Distribution (DALO-FP) <sup>3</sup> |
| <b>BA3: Training and Recruiting</b> |   |  |
| 31                                  | Accession Training                                      |  |
| 311                                 | Officer Acquisition                                     | G-3/5/7 Institutional Training Division (DAMO-TRI)   |
| 312                                 | Recruit Training  | G-3/5/7 Institutional Training Division (DAMO-TRI)   |
| 313                                 | One Station Unit Training                               | G-3/5/7 Institutional Training Division (DAMO-TRI)   |
| 314                                 | Senior Reserve Officer Training Corps                   | G-3/5/7 Institutional Training Division (DAMO-TRI)   |
| 315                                 | Service Academy Base Support                            | ACSIM Resource Division (DAIM-ZR)  |
| 316                                 | Sustainment Restoration, and Modernization              | ACSIM Resource Division (DAIM-ZR)  |
| 32                                  | Basic Skill and Advance Training                        | G-3/5/7 Institutional Training Division (DAMO-TRI)   |
| 321                                 | Specialized Skill Training                              |  |
| 322                                 | Flight Training   | G-3/5/7 Institutional Training Division (DAMO-TRI)   |
| 323                                 | Professional Development Education                      | G-3/5/7 Institutional Training Division (DAMO-TRI)   |
| 324                                 | Training Support  | G-3/5/7 Institutional Training Division (DAMO-TRI)   |
| 325                                 | Base Support  | ACSIM Resource Division (DAIM-ZR)  |
| 326                                 | Sustainment, Restoration, and Modernization             | ACSIM Resource Division (DAIM-ZR)  |
| 33                                  | Recruiting, Other Training and Education                | G-1 Resource Division (DAPE-PRR)   |
| 331                                 | Recruiting and Advertising                              |  |
| 332                                 | Examining   |  |

## HOW THE ARMY RUNS

| Code   | Description   | Manager <sup>1</sup>  |
|--|---|---|
| 333  | Off Duty and Voluntary Education                            | G-1 Resource Division (DAPE-PRR)  |
| 334  | Civilian Education and Training                             | G-1 Resource Division (DAPE-PRR)  |
| 335  | Junior Reserve Officer Training Corps                       | G-1 Resource Division (DAPE-PRR)  |
| 336  | Base Support-Recruiting and Examining                       | ACSIM Resource Division (DAIM-ZR)   |
| <b>BA 4: Administration and Service Wide Support</b> |   |   |
| 41   | Security Programs   | G-2 Directorate for Resource Integration (DAMI-RI)  |
| 411  | Security Programs   | G-4 Directorate for Sustainment (DALO-SM)<br>G-4 Directorate for Force Projection/Distribution (DALO-FP)      |
| 42   | Logistics Operations  |   |
| 421  | Service Wide Transportation                                 | R/P-G-1 Manpower Policy, Plans, and Programs Division (DAPE-PRA)<br>P-CIO/G-6 Program Execution Div (SAIS-ZR) |
| 422  | Central Supply Activities                                   |   |
| 423  | Logistics Support Activities                                |   |
| 424  | Ammunition Management                                       |   |
| 43   | Service Wide Support  |   |
| 431  | Management Headquarters                                     |   |
| 432  | Service Wide Communications                                 |   |
| 433  | Manpower Management   | G-1 Resource Division (DAPE-PRR)  |
| 434  | Other Personnel Support                                     | Various   |
| 435  | Other Service Support                                       | TJAG  |
| 436  | Army Claims and Administrative Support Activities           | ACSIM Resource Division (DAIM-ZR)   |
| 437  | Real Estate Management                                      | ACSIM Resource Division (DAIM-ZR)   |
| 438  | Base Support  | None  |
| 439  | Defense Environmental Restoration Account (DERA) (FY 18-19) | G-3/5/7 international Plans, Policy, Programs, and integration Division (DAMO-SSI)                            |
| 44   | Support of Other Nations                                    | None  |
| 441  | International Military Headquarters                         | None  |
| 442  | Miscellaneous Support of Other Nations                      | None  |
| 45   | Closed Account  | None  |
| 49   | Defense Environmental Restoration Account (DERA) (FY96)     | None  |

### Legend

Army Manpower and TOA

n BA

nn Activity Group (01 level)

nnn Budget Sub Activity

Records resources for Army Management Structure Code (AMSCO) nnn\*\*\*, where nnn shows budget sub activity (see Chaps. AO-2020a-d, h, and j, DFAS-IN Manual 37-100-\*\*\* for further information)

Also see DOD Financial Management Regulation (FMR) 7000.14R, current edition.

### Note:

5. Manager for functional requirements and program and performance except as noted.

6. Manager for functional requirements

**ARMY PLANNING, PROGRAMMING,  
BUDGETING, AND EXECUTION PROCESS**

**Table 8-4. Budget Activity Management Structure for Operation and Maintenance Appropriations-Army Manpower-Only Activity Structure**

| Code   | Description  | Manager <sup>1</sup>  |
|--|--|---|
| Category 8: Medical activities, manpower only-reimbursable labor |  |   |
| 84   | Medical manpower-reimbursable  | TSG Manpower and Programming Division (DASG-PAE-M) <sup>2</sup>   |
| 841  | Examining activities   |   |
| 846  | Training medical spaces  |   |
| 847  | Care in Army medical centers   |   |
| 849  | Defense medical spaces   |   |
| Category 9: Other-manpower only                                  |  |   |
| 91   | Special operations forces manpower-reimbursable                          | G-1 Manpower Policy, and Program Division (DAPE-PRA) <sup>3</sup> |
| 92   | Defense agency manpower (military only)                                  |   |
| 93   | Outside DOD  |   |
| 94   | Trainees, Transients, Holdees, and Students operating strength deviation |   |

**Legend**

**Manpower-only activity structure**

The PPBE database generates categories 8 and 9 to meet manpower-reporting requirements. Category 8 records resources for AMSOC 84n\*\*\* where n=1, 6, or 7 shows the budget sub activity, category 9 records resources for AMSCO 9n\*\*\*\*, where n=1, 2, 3, or 4 shows the 0-1 level structure.

**Note:**

7. Manager for functional requirement and program except as noted.
8. Manager for functional requirements.
9. Manager for program and performance.

**Table 8-5. Budget Activity Management Structure for Operation and Maintenance Appropriation-Base Operations Support**

| Code         | Account  | Manager <sup>1</sup>              |
|--------------|--|-----------------------------------|
| —            | ****19, ****20<br>Child develop services, family centers   | ACSIM Resource Division (DAIM-ZR) |
| AMSCO        | ****53, ****54, ****56<br>Environmental conservation, pollution prevention, environmental compliance | ACSIM Resource Division (DAIM-ZR) |
| AMSCO        | ****75<br>Ant-terrorism/Force protection   | ACSIM Resource Division (DAIM-ZR) |
| AMSCO<br>.J0 | ****79 (Real Property Services)<br>Operation of utilities  | ACSIM Resource Division (DAIM-ZR) |
| *.M0         | Municipal Services   | ACSIM Resource Division (DAIM-ZR) |

## HOW THE ARMY RUNS

| Code  | Account  | Manager <sup>1</sup>   |
|-------|--|--|
| .N0   | Facilities engineering services  | ACSIM Resource Division (DAIM-ZR)  |
| .P0   | Fire and emergency response services   | ACSIM Resource Division (DAIM-ZR)  |
| AMSCO | ****90<br>Audio visual and visual information production, acquisition, and support | P-CIO/G-6 Program Execution Div (SAIS-ZR) <sup>2</sup><br>ACSIM Resource Division (DAIM-ZR) <sup>3</sup> |
| AMSCO | ****95<br>Base communications  | P-CIO/G-6 Program Execution Div (SAIS-ZR) <sup>2</sup><br>ACSIM Resource Division (DAIM-ZR) <sup>3</sup> |
| AMSCO | ****96 (Base Operations Support) (BASOPS(-))                                       |  |
| .A0   | Real estate leases   | ACSIM Resource Division (DAIM-ZR)  |
| .B0   | Supply operations and management   | G-4 Directorate for Sustainment (DALO-SM)  |
| .C0   | Materiel maintenance   | G-4 Directorate for Sustainment (DALO-SM)  |
| .D0   | Transportation services  | G-4 Directorate for Sustainment (DALO-SM)  |
| .E0   | Laundry and dry-cleaning services  | G-4 Directorate for Sustainment (DALO-SM)  |
| .F0   | The Army food service program  | G-4 Directorate for Sustainment (DALO-SM)  |
| .K0   | Civilian personnel management  | R/P-G-1  |
| .L0   | Morale, welfare, and recreation  | ACSIM Resource Division (DAIM-ZR)  |
| .M0   | Military personnel support   | R/P-G-1  |
| .Q0   | Reserve component support  | ACSIM Resource Division (DAIM-ZR)  |
| .U0   | Financial management   | ASA (FM&C)   |
| .V0   | Management analysis  | ASA (FM&C)   |
| .W0   | Contracting operations   | ASA(ALT) Plans, Programs and Resources Directorate (SAAL-RI)   |
| .X0   | IT, management and planning  | P-CIO/G-6 Program Execution Div (SAIS-ZR) <sup>2</sup><br>ACSIM Resource Division (DAIM-ZR) <sup>3</sup> |
| .Y0   | Administrative services  | P-CIO/G-6 Program Execution Div (SAIS-ZR) <sup>2</sup><br>ACSIM Resource Division (DAIM-ZR) <sup>3</sup> |
| .10   | Provost Marshal  | G-3 Security, Force Protection, and Law Enforcement (DAMO-ODL)   |
| .20   | Staff Judge Advocate   | ACSIM Resource Division (DAIM-ZR)  |
| .30   | Chaplain   | ACSIM Resource Division (DAIM-ZR)  |
| .40   | Public affairs   | ACSIM Resource Division (DAIM-ZR)  |
| .50   | Inspector General  | ACSIM Resource Division (DAIM-ZR)  |



**ARMY PLANNING, PROGRAMMING,  
BUDGETING, AND EXECUTION PROCESS**

| Code | Account                                    | Manager <sup>1</sup>              |
|------|--|-----------------------------------|
| .60  | Installation management                    | ACSIM Resource Division (DAIM-ZR) |
| .70  | Operations                                 | ACSIM Resource Division (DAIM-ZR) |
| .90  | Unaccompanied personnel housing management | ACSIM Resource Division (DAIM-ZR) |

**Legend**

**Base Support**

Base Operations Support (BOS) applies to sub activity groups 131, 315, 325, 336, and 438

Base support refers to the resources to operate and maintain Army installations (major, minor, stations, other). It comprises two sub activity groups: Base Operations Support (BOS) and Sustainment, Restoration, and Modernization (SRM). Resources are recorded in Army Management Structure Code (AMSCO) and nnn\* yy, where nnn shows budget sub activity group (SAG) and yy designates specified subdivisions. Sometimes, resources are recorded as nnn\*yy.z0, where .z0 refers to letter accounts, as below for BASOPS (-) and SRM. (See chap A9-BSSPT, DFAS-IN Manual 37-100-\*\*\*\* for further information and DOD FMR 7000.14R.)

**Note:**

- 10. Manager for functional requirements and program and performance.
- 11. Manager for functional requirements.
- 12. Manager for program and performance.

**Table 8-6. Budget Activity Management Structure for Operation and Maintenance Appropriations-Sustainment, Restoration, and Modernization**

| Code | Account  | Manager <sup>1</sup>              |
|------|--|-----------------------------------|
| AMSC | ****76   |                                   |
| O    |  |                                   |
| .L0  | Minor construction   | ACSIM Resource Division (DAIM-ZR) |
| AMSC | ****78 (Maintenance and Repair)  |                                   |
| O    |  |                                   |
| .10  | Surfaced areas (including bridges and other appurtenances)               | ACSIM Resource Division (DAIM-ZR) |
| .20  | Airfields, paved and unpaved (including bridges and other appurtenances) | ACSIM Resource Division (DAIM-ZR) |
| .40  | Railroads (including bridges and other appurtenances)                    | ACSIM Resource Division (DAIM-ZR) |
| .50  | Utility systems  | ACSIM Resource Division (DAIM-ZR) |
| .A0  | Maintenance and production facilities                                    | ACSIM Resource Division (DAIM-ZR) |
| .B0  | Training and operations facilities                                       | ACSIM Resource Division (DAIM-ZR) |
| .C0  | RDT&E facilities   | ACSIM Resource Division (DAIM-ZR) |
| .D0  | Supply and storage facilities  | ACSIM Resource Division (DAIM-ZR) |
| .E0  | Administrative facilities (including IT facilities)                      | ACSIM Resource Division (DAIM-ZR) |
| .F0  | Unaccompanied personnel housing facilities                               | ACSIM Resource Division (DAIM-ZR) |

## HOW THE ARMY RUNS

| Code      | Account   | Manager <sup>1</sup>              |
|-----------|---|-----------------------------------|
| .G0       | Other unaccompanied personnel housing facilities        | ACSIM Resource Division (DAIM-ZR) |
| .H0       | Dining facilities                                       | ACSIM Resource Division (DAIM-ZR) |
| .Q0       | Other facilities without facility category groups (FCG) | ACSIM Resource Division (DAIM-ZR) |
| .R0       | Airfield facilities                                     | ACSIM Resource Division (DAIM-ZR) |
| .S0       | Training/instruction support facilities                 | ACSIM Resource Division (DAIM-ZR) |
| .T0       | Ports   | ACSIM Resource Division (DAIM-ZR) |
| .U0       | Medical and hospital facilities                         | ACSIM Resource Division (DAIM-ZR) |
| .V0       | Grounds   | ACSIM Resource Division (DAIM-ZR) |
| .W0       | Community support                                       | ACSIM Resource Division (DAIM-ZR) |
| .X0       | Family housing  | ACSIM Resource Division (DAIM-ZR) |
| AMSC<br>O | ****93<br>Demolition of real property                   | ACSIM Resource Division (DAIM-ZR) |

Note:

13. Manager for functional requirements and program and performance

**Table 8-7. Budget Activity Management Structure for Operation and Maintenance Appropriations-Army National Guard**

| Code | Description  | Manager <sup>1</sup> |
|------|--|----------------------|
|      | BA 1: Operating forces                               | DARNG <sup>1</sup>   |
| 11   | Land Forces  |                      |
| 111  | Combat Forces  |                      |
| 112  | Combat Support Forces                                |                      |
| 113  | Echelons Above Brigade (EAB)                         |                      |
| 114  | Theater Level Assets                                 |                      |
| 115  | Land Forces Operations Support                       |                      |
| 116  | Aviation Assets                                      |                      |
| 12   | Land Forces Readiness                                |                      |
| 122  | Land Forces System Readiness                         |                      |
| 123  | Land Forces Depot Maintenance                        |                      |
| 13   | Land Forces Readiness Support                        |                      |
| 131  | Base Operations Support                              |                      |
| 132  | Facility Sustainment, Restoration, and Modernization |                      |
| 133  | Management and operational headquarters              |                      |
| 135  | Weapons of mass destruction                          |                      |
|      | BA 4: Administration and service wide activities     | DARNG <sup>1</sup>   |
| 43   | Service wide support                                 |                      |
| 431  | Staff management                                     |                      |

**ARMY PLANNING, PROGRAMMING,  
BUDGETING, AND EXECUTION PROCESS**

| Code | Description                            | Manager <sup>1</sup> |
|------|--|----------------------|
| 432  | Information management                 |                      |
| 433  | Readiness and personnel administration |                      |
| 434  | Recruiting and advertising             |                      |

Legend

Army National Guard

n BA

nn Activity Group (01 level)

nnn Budget Sub Activity

Note:

14. Budget Formulation Branch (NGB-ARC-BF): Manager for functional requirements and program and performance.

15. Budget Branch (DAAR-CFM): Manager for functional requirements and program and performance

**Table 8-8. Budget Activity Management Structure for Operations and Maintenance Appropriations-United States Army Reserve**

| Code | Description  | Manager <sup>1</sup> |
|------|--|----------------------|
|      | BA 1: Operating forces                               | CAR <sup>2</sup>     |
| 11   | Land forces  |                      |
| 111  | Combat Forces  |                      |
| 112  | Combat Support Forces                                |                      |
| 113  | Echelons Above Brigade (EAB)                         |                      |
| 114  | Theater Level Assets                                 |                      |
| 115  | Land Forces Operations Support                       |                      |
| 116  | Aviation Assets                                      |                      |
| 12   | Land Forces Readiness                                |                      |
| 121  | Force Readiness Operations Support                   |                      |
| 122  | Land Forces System Readiness                         |                      |
| 123  | Depot Maintenance                                    |                      |
| 13   | Land Forces Readiness Support                        |                      |
| 131  | Base Operations Support                              |                      |
| 132  | Facility Sustainment, Restoration, and Modernization |                      |
| 135  | Additional activities                                |                      |
|      | BA 4: Administration and service wide activities     | CAR <sup>2</sup>     |
| 43   | Service wide support                                 |                      |
| 431  | Administration                                       |                      |
| 432  | Service wide communications                          |                      |
| 433  | Personnel/financial administration                   |                      |
| 434  | Recruiting and advertising                           |                      |

Legend

U.S. Army Reserve

n BA

nn Activity Group (01 level)

nnn Sub Activity Group

Note:

16. Budget Formulation Branch (NGB-ARC-BF): Managers for functional requirements and program and performance.

17. Budget Branch (DAAR-CFM): Manager for functional requirements and program and performance.

## HOW THE ARMY RUNS

**Table 8-9. Army Appropriations-Managers for Functional Requirements and Program and Performance**

| Resource Identification Code | Appropriation (Fund) <sup>1</sup>                                  | Manager for Functional Requirements (R)<br>Manager for Program and Performance (P)  |
|------------------------------|--|---|
| RDT&E                        | Investment<br>Research, Development,<br>Test, and Evaluation, Army | R-G-8 Programs and Priorities (DAPR-FDR)<br>P-ASA(ALT) Plans, Programs and Resources<br>Directorate (SAAL-RI)   |
| ACFT (APA)                   | Aircraft Procurement, Army   | R- G-8 Programs and Priorities (DAPR-FDR)<br>P-ASA(ALT) Plans, Programs and Resources<br>Directorate (SAAL-RI)  |
| MSLS<br>(MIPA)               | Missile Procurement, Army  | R- G-8 Programs and Priorities (DAPR-FDR)<br>P-ASA(ALT) Plans, Programs and Resources<br>Directorate (SAAL-RI)  |
| WTCV                         | Procurement of Weapons and<br>Tracked Combat Vehicles,<br>Army     | R- G-8 Programs and Priorities (DAPR-FDR)<br>P-ASA(ALT) Plans, Programs and Resources<br>Directorate (SAAL-RI)  |
| AMMO<br>(PAA)                | Procurement of Ammunition,<br>Army                                 | R- G-8 Programs and Priorities (DAPR-FDR)<br>R-G-4 Directorate for Sustainment (DALO-SM)<br>P-ASA(ALT) Plans, Programs and Resources<br>Directorate (SAAL-RI) |
| OPA                          | Other Procurement, Army  | R- G-8 Programs and Priorities (DAPR-FDR)<br>P-ASA(ALT) Plans, Programs and Resources<br>Directorate (SAAL-RI)  |
|                              | OPA 1  | R- G-8 Programs and Priorities (DAPR-FDR)<br>P-ASA(ALT) Plans, Programs and Resources<br>Directorate (SAAL-RI)  |
|                              | OPA 2  | R- G-8 Programs and Priorities (DAPR-FDR)<br>P-ASA(ALT) Plans, Programs and Resources<br>Directorate (SAAL-RI)  |
|                              | OPA 3  | P-CIO/G-6 Program Execution Div (SAIS-ZR)<br>R- G-8 Programs and Priorities (DAPR-FDR)<br>P-ASA(ALT) Plans, Programs and Resources<br>Directorate (SAAL-RI)   |
|                              | OPA 4  | R- G-8 Programs and Priorities (DAPR-FDR)<br>P-ASA(ALT) Plans, Programs and Resources<br>Directorate (SAAL-RI)  |
| MCA                          | Military Construction, Army <sup>2</sup>                           | R-ACSIM Facilities Division (DAIM-FD)<br>P-ACSIM Resources Division (DAIM-ZR)   |
| MCNG                         | Military Construction, Army<br>National Guard <sup>2</sup>         | R-DARNG Engineering Directorate (NGB-AEN)<br>P-ACSIM ACSIM Resources Division (DAIM-<br>ZR)   |
| MCAR                         | Military Construction, Army<br>Reserve <sup>2</sup>                | R-CAR Army Reserve Engineer Directorate<br>(DAAR-EN)<br>P- ACSIM Resources Division (DAIM-ZR)   |
| CHEM                         | Chemical Agents and<br>Munitions Destruction, Army                 | R- G-8 Programs and Priorities (DAPR-FDR)<br>P-ASA(ALT) Plans, Programs and Resources<br>Directorate (SAAL-RI)  |
| AFHC                         | Family Housing, Army<br>(Construction)<br>Operations               | R/P- ACSIM Facilities Division (DAIM-FD)  |

## ARMY PLANNING, PROGRAMMING, BUDGETING, AND EXECUTION PROCESS

| Resource Identification Code | Appropriation (Fund) <sup>1</sup>                            | Manager for Functional Requirements (R)<br>Manager for Program and Performance (P) |
|------------------------------|--|--|
| ERA                          | Environmental Restoration, Army and Formerly Used Test Sites | R/P-ACSIM Environmental Division (DAIM-ED)   |
| BRAC                         | Base Realignment and Closure                                 | R/P-ACSIM BRAC Office (DAIM-BO)  |
| AFHO                         | Family Housing, Army (Operations)                            | R/P- ACSIM Facilities Division (DAIM-FD)   |
| OMA                          | Operation and Maintenance, Army                              | See Tables 8-3 through 8-9   |
| OMNG                         | Operation and Maintenance, Army National Guard               | See Table 8-7  |
| OMAR                         | Operation and Maintenance, Army Reserve                      | See Table 8-8  |
| MPA                          | Military Personnel, Army                                     | R/P- G-1 Manpower Policy, Plans, and Program Division (DAPE-PRA)                   |
| NGPA                         | National Guard Personnel, Army                               | R/P-DARNG Budget Formulation Branch (NGB-ARC-BF)                                   |
| RPA                          | Reserve Personnel, Army                                      | R/P-CAR Budget Branch (DAAR-CFM)   |
| HAF-D                        | Homeowners Assistance Fund Defense                           | R/P-COE  |

Appropriation sponsors and functional managers' general responsibilities are as follows—

a. Manager for manpower and force structure issues. The managers for manpower and force structure issues work together to maintain a continuous exchange of information and collaboration during each PPBE phase. As appropriate, they—

(1) Coordinate instructions to the field, and the processing of requests from the field, for manpower or force changes.

(2) Align and balance manpower and unit information among such PPBE database systems as the Structure and Manpower Allocation System (SAMAS), the PPBE Enterprise System and the FYDP.

(3) Provide lead support on manpower issues to PEG chairs.

(4) Verify manpower affordability.

b. Manager for functional requirements. The manager for functional requirements—

(1) Determines the scope, quantity, and qualitative nature of functional requirements for planning, programming, and budgeting.

(2) Checks how commands and agencies apply allocated manpower and dollars to make sure their use fulfills program requirements.

(3) Prioritizes unfunded programs submitted by ACOMs, PEOs, and other operating agencies.

(4) Using Army PBG and priorities, resolves conflicts involving unfunded requirements or decrements on which ACOMs, PEOs, and other operating agencies fail to reach agreement in developing the program or budget.

(5) Recommends to the PPBC the allocation of available resources, unfunded programs, and offsetting decrements.

(6) During program and budget reviews, and throughout the process, coordinates resource changes with agencies having responsibility for affected MDEPs and with the appropriate appropriation sponsor for relevant resources.

c. Manager for program and performance. The manager for program and performance—

(1) Represents the functional program and monitors its performance during each PPBE phase.

(2) As required, helps perform the duties of the appropriation sponsor.

(3) Translates budget decisions and approved manpower and funding into program changes and makes sure that data transactions update affected MDEPs and, in coordination with the appropriation sponsors, affected appropriations.

## HOW THE ARMY RUNS

- (4) Checks budget execution from the functional perspective.
- (5) For investment appropriations:
  - (a) Operates and maintains databases in support of the PPBE Enterprise System.
  - (b) During budget formulation, determines how changes in fiscal guidance affect budget estimates and reviews and approves the documentation of budget justification.
  - (c) During review of the budget by OSD and OMB and by Congress, serves as appropriation advocate, helps prepare the Army response to OSD IPs which are the result of IP proposals, and prepares congressional appeals.
  - (d) During execution determines fund recipients, monitors execution, performs decrement reviews, plans reprogramming, and controls below threshold reprogramming. On RDT&E and procurement matters and otherwise as required, testifies before OSD and Congress.
- d. Appropriation Sponsor. The appropriation sponsor—
  - (1) Controls the assigned appropriation or fund.
  - (2) Serves as Army spokesperson for appropriation resources.
  - (3) Helps resource claimants solve manpower and funding deficiencies.
  - (4) Issues budget policy, instructions, and fiscal guidance.
  - (5) During budget formulation:
    - (a) Bears responsibility for updating the PPBE database.
    - (b) Prepares and justify budget estimates, coordinating with functional and manpower representatives to make sure appropriate exhibits and database systems match.
  - (6) Testifies before Congress during budget justification.
  - (7) Manages financial execution of the appropriation and reprograms allocated manpower and funds to meet unforeseen contingencies during budget execution.

### Section VI

#### Allocation of Resources

##### 8-22. Recording Resources

- a. The Army MDEP serves as a key resource management tool. Collectively, MDEPs account for all Army resources. They describe the capabilities programmed over a multi-year period for the Active Army, Guard, Reserve, and civilian work force.
- b. Recording the resources needed to gain an intended outcome, an individual MDEP describes a particular organization, program, or function and applies uniquely to one of the following areas for resource management—
  - (1) Missions of Modified Tables of Organization and Equipment (MTOE) units.
  - (2) Missions of Tables of Distribution and Allowances (TDA) units.
  - (3) Acquisition, fielding, and sustainment of weapon and information systems (with linkage to organizations).
  - (4) Special Visibility Programs (SVP).
  - (5) Short-Term Projects (STP).
- c. In short, the MDEP specifies the military and civilian manpower and dollars associated with a program undertaking; displays needed resources across relevant Army commands (ACOM) and relevant appropriations; and justifies the resource expenditure.
- d. HQDA uses the MDEP to help develop programs to support the requirements, carry-out approved programs, and check program results.
- e. HQDA uses the MDEP to link decisions by the SECARMY and CSA and their priorities to:
  - (1) FYDP accounts that record Service positions in OSD.
  - (2) AMSCO accounts that record funding transactions in Army activities and installations.
- f. HQDA uses the MDEP also to link key systems within the PPBE Enterprise System, for example:
  - (1) The Structure and Manpower Allocation System (SAMAS).
  - (2) The Army Training Requirements and Resources System (ATRRS) whose product, the Army Program for Individual Training (ARPRINT), shows valid training requirements and associated training programs.
  - (3) Depot maintenance programs.

## ARMY PLANNING, PROGRAMMING, BUDGETING, AND EXECUTION PROCESS

g. For investment accounts, managers for construction, RDT&E, and procurement first allocate program and budget resources by AMSCO, APEs, project number, and BLIN. They then distribute the resources to MDEPs within the resource management areas.

### 8-23. Program and Budget Years Covered by the MDEP

a. The MDEP records manpower and TOA over the nine fiscal years (FY) needed to display the program and budget. Which program year (PY) or which BY each FY addresses, depends on whether interest in the MDEP centers on the program or budget. Figure 8-6 shows the definition and functions of an MDEP. Figure 8-7 shows the FY structure of an MDEP as applied to the FY 21-25 PB, and considers the complementary way that programmers and budgeters view resource requirements. The display shows from left to right the manpower and dollars needed to carry out missions and functions. From top to bottom, the display shows how these requirements are distributed among Army programs to form appropriation requests to Congress.

b. The MDEP shifts forward one year in the annual POM / BES submission. At the start of the cycle for the next annual POM / BES, the PPBE database drops the earliest year from the database and adds one new year. The first of the preceding years is the PY. It records resources spent in executing the budget the year before the CY. The CY shows resources in the budget being executed. The last preceding year is called the BY. It lists resources requested in the PB being reviewed by Congress.

#### Definition:

- A stand-alone functional package that describes a particular organization, program, or function capturing total resources over a 9-year period

#### Functions:

- What capability is resourced?
- How much is resourced?
- Why resource this capability?
- Who is responsible?
- When are resources available?

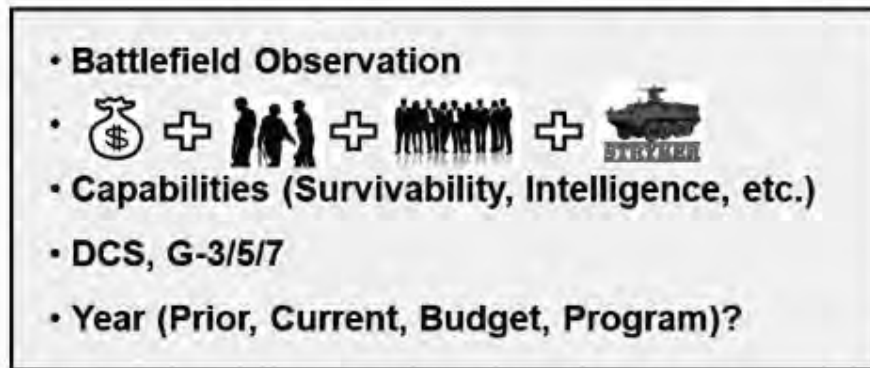

**The MDEP is an Army Programming Tool**

Figure 8-6. Management Decision Execution Package

## HOW THE ARMY RUNS

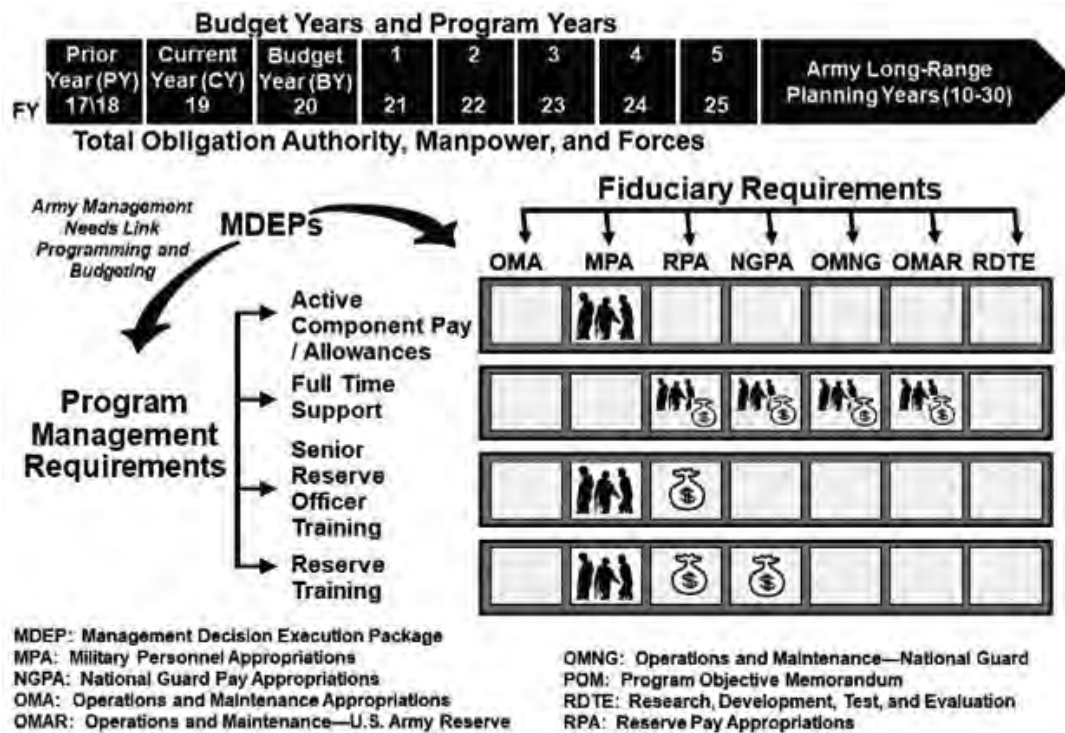

**Figure 8-7. FY 21-25 Program Objective Memorandum MDEP**

### 8-24. Extent that Manpower and Dollars can be redistributed in the Management Decision Execution Package

- a. The MDEP, as just described, has both BY and PY increments. The two increments differ primarily by the flexibility the Army has with manpower and funds.
- b. During the program or POM years, HQDA is constrained by Congress on total military end strength and by FG. HQDA determines and approves civilian work year levels by balancing workload and available funding. Similarly, HQDA restricts program dollars only by TOA, not by individual appropriation. The distinctions allow redistributing previously programmed manpower and dollars to meet changing requirements. In later POM or budget submissions, for example, HQDA can, as needed, move PY resources between MDEPs, appropriations, and APEs.
- c. Once HQDA sends the BES to OSD, OSD must approve any changes to manpower and dollars. Even tighter controls govern changes in manpower and funding in the BYs after the PB has gone to Congress.

(1) HQDA can redistribute previously budgeted manpower and dollars between MDEPs or commands and agencies, but must leave current budgeted dollars unchanged until CY appropriations become law.

(2) Some flexibility during execution permits financing unbudgeted requirements to meet unforeseen needs or changes in operating conditions. Even so, Congressional rules and specified dollar thresholds severely restrict spending for purposes other than those originally justified and approved. In addition, during execution, HQDA can transfer military and civilian manpower within appropriations without a corresponding transfer of funds.

### 8-25. How Flexibility Affects the Management Decision Execution Package

- a. **Frequent Change in MDEP Resources.** Competition at each stage of program development and budget formulation can produce frequent change in an MDEP's resource levels. Decisions resulting from OSD review of the POM/BES will further change amounts initially approved. Sometimes decisions may even affect requests in the PB already before Congress. Authorization and appropriation decisions by Congress often change amounts requested in the PB. Budget execution sometimes results in different rates and quantities of expenditure from those planned, and, at times, it results in different purposes.



# ARMY PLANNING, PROGRAMMING, BUDGETING, AND EXECUTION PROCESS

b. Keeping MDEP Resources Current. Program and budget analysts continually update MDEPs through their respective feeder systems to reflect the position of the last program or budget event. The kinds of changes described require that resource managers continually weigh how the stream of program and budget actions affect the MDEP and how a change in the PY or BY portion of the package may affect the out years. Managers continually ask, “In what ways do the changes: alter MDEP resource levels; shift resources between years; and affect resources in related MDEPs?”

c. Army Management Structure (AMS). The AMS serves as a second major resource recording structure. Based on congressional appropriations, the AMS relates program dollars and manpower to a standard classification of activities and functions per DFAS-IN Manual 37-100-\*\*\*\* (where \*\*\*\* stands for the CY, e.g., 2019). AMSCO help record the data in the detail needed for budgeting, execution, and accounting. See DOD FMR 7000.14R.

## 8-26. Other Structures

Other fiscal management structures include the 01 level BA structure for operation and maintenance appropriations shown in Tables 8-3 through 8-8, SSN and BLIN for weapon systems, and project numbers for military construction automated support. The automated Army PPBE System supports Army PPBE functions and DOD PPBE data submissions to OSD, OMB, and Congress. Known simply as the PPBE database, it encompasses forces, funds, and manpower and serves as the database of record for Army resources.

a. PPBE Database. The PPBE database organizes and registers nine years of dollar and manpower data used in the process, and 12 years of forces data. It gathers manpower and dollar data through keys tied to the MDEP, appropriation, PEs, APEs, and other identifiers including the command or resource organization code. HQDA uses the database to—

- (1) Support user analysis.
- (2) Build and record the combined POM / BES.
- (3) Prepare the Army portion of the FYDP to reflect the POM / BES and later the PB.
- (4) Report consistent Army resource positions to OSD through the Select and Native Programming (SNaP) Data Collection System, SDCS, SSMS, and CIS.
- (5) Issue ACOMs PBG reflecting the FYDP resource position after each FYDP update.
- (6) Provide MDEP execution and expenditure information.

b. Future System Enhancement. The Planning, Programming and Budgeting (PPB) Business Operating System (BOS) standardizes and better integrates the transactional automated information systems used in the HQDA level programming and budgeting processes. These systems are core to the PPBE business processes of the headquarters for gathering programmatic requirements, balancing resources and delivering the Army's program budget to OSD. The BOS streamlines programming and budgeting business processes and significantly improves strategic analysis capabilities. The BOS provides architecting, reengineering, and consolidating of HQDA systems, feeder database systems, and the business processes associated with them. BOS has improved capabilities, eliminated redundancies and reduced overall costs of operations.

## Section VII

### Army Planning, Programming, Budgeting, and Execution Deliberative Forums

#### 8-27. Army Decision Committees and Processes

a. Program Budget Assessment Team (PBAT) is a working-level forum that meets throughout the PPBE process. The PBAT will assist the PPBC Council of Colonels and the PEGs by disposing of low-level resource issues, within its authority. The PBAT will—

- (1) Review resource change requests (accepted during the PEG process), Concept Plans, and other changes to resources within its authority, with a particular focus on manpower issues.
- (2) Prepare and coordinate resource recommendations on those issues selected for presentation to the PPBC Council of Colonels for action.
- (3) Monitor the activities of the other PPBE decision forums.
- (4) The PBAT will have four co-chairs from the following organizations:
  - (a) Chief Budget Formulation Division, Management and Control Directorate, ASA (FM&C)

## HOW THE ARMY RUNS

- (b) Chief Resource Development Branch, Resource Division, DCS G-1 Programs and Resources
- (c) Chief Program Budget Guidance Branch, Force Accounting and Document Division, DCS G3/5/7 FM

(d) Deputy Division Chief, Program Development Division, PA&E

b. The PPBC Council of Colonels is co-chaired by the Chief, Resource Analysis and Integration Division, G-3/5/7; Chief Program Development Division, PAED; and the Chief, PPBE Integration, ASA (FM&C). The PPBE Council of Colonels, also called the PEG Executives / Appropriation Sponsors (PE/AS), is a continuing forum that meets throughout the PPBE process. This forum represents the PPBC and serves as the normal entry point for all resourcing issues presented to them for decision, either at their level or at a higher level. The PE/AS will –

- (1) Act as a gatekeeper for other issues with resourcing implications.
- (2) Package proposals, frames issues and recommendations, and coordinates all issues with resourcing implications to be presented to higher-level decision forums.
- (3) Oversee implementation of senior level PPBE decisions and guidance within HQDA and may issue additional guidance to ensure prompt and proper implementation.
- (4) Monitor the activities of the other PPBE decision forums.
- (5) Membership of the PPBC Council of Colonels includes COL/GS15 Secretariat and Army Staff representatives from the PEGs and PEG integrators. Other Secretariat and Army Staff representatives attend as required to ensure synchronization and transparency of the PPBE process.
- (6) The co-chairs of the PPBC Council of Colonels also co-chair Colonel Budget Requirements and Program (O-6 BRP) board or forum.

c. Planning, Program, Budget Committee (PPBC) has three co-chairs, one of whom presides over the forum depending upon the subject matter under consideration - the ADCS G-3/5/7 for planning, the DPAE for programming, and the DAB for budgeting and execution. The PPBC serves the PPBE process in both a coordinating and executive-advisory role. It provides a continuing forum in which planning, program, and budget managers review, adjust, and recommend courses of action on relevant issues. The PPBC may return the results of committee deliberations to the Army Staff or Secretariat for action. It may pass them, in turn, to the SRG for review or approval. Among its responsibilities, the PPBC:

- (1) Maintains overall discipline of the PPBE process.
- (2) Oversees the PPBE schedule, with each chair controlling the chair's respective portion of the schedule.
- (3) Monitors force management and preparation of TAP, POM/BES, and PB.
- (4) Makes sure that Army policy remains internally consistent and that program adjustments remain consistent with Army policy and priorities.
- (5) Maintains the PPBE Strategic Automation Committee to implement configuration management of the PPBE Enterprise process and to oversee long-term plans for investing in IT to improve the performance of PPBE functions.
- (6) As required, set up other standing committees or working groups to resolve issues that arise in managing the program or budget.
- (7) Membership of the PPBC includes Secretariat and Army Staff representatives from the PEGs and PEG integrators. Other Secretariat and Army Staff representatives attend as required to ensure synchronization and transparency of the PPBE process.
- (8) The co-chairs of the PPBC also co-chair 2-Star Budget Requirements and Program forum.

d. Colonel Budget, Requirements, and Programs (BRP) are gatekeepers for issues with year of execution resourcing implications and packages proposals, frames issues, and coordinates matters that go before the 2-Star and 3-Star BRP.

e. 2-Star BRP serve in an executive-advisory role enforcing discipline of resourcing process and ensuring resourcing decisions align with Army priorities. The 2-Star BRP recommends POM / BES solutions to the 3-Star BRP.

f. 3-Star BRP resolves resource allocation issues, synchronizes decisions with POM / BES, and serve as the key 3-Star level forum for working time-sensitive issues. The 3-Star BRP is co-chaired by the Military Deputy to the ASA (FMC), the DCS G3/5/7 and the G-8. 3-Star BRP membership includes 3 Star GO/SES level representatives from the Secretariat and ARSTAF.

g. Senior Review Group (SRG) serves as the senior Army leadership decision making forum and is chaired by the SECARMY and the CSA with representation from all the Secretariat and ARSTAF organizations and the ACOMS. The SRG:

# ARMY PLANNING, PROGRAMMING, BUDGETING, AND EXECUTION PROCESS

- (1) Sets policy and approves guidance and priorities.
- (2) Reviews and approves the Army POM/BES
- (3) Approves prioritization of Army programs. See Figure 8-8 for Army Decision Committees and Processes

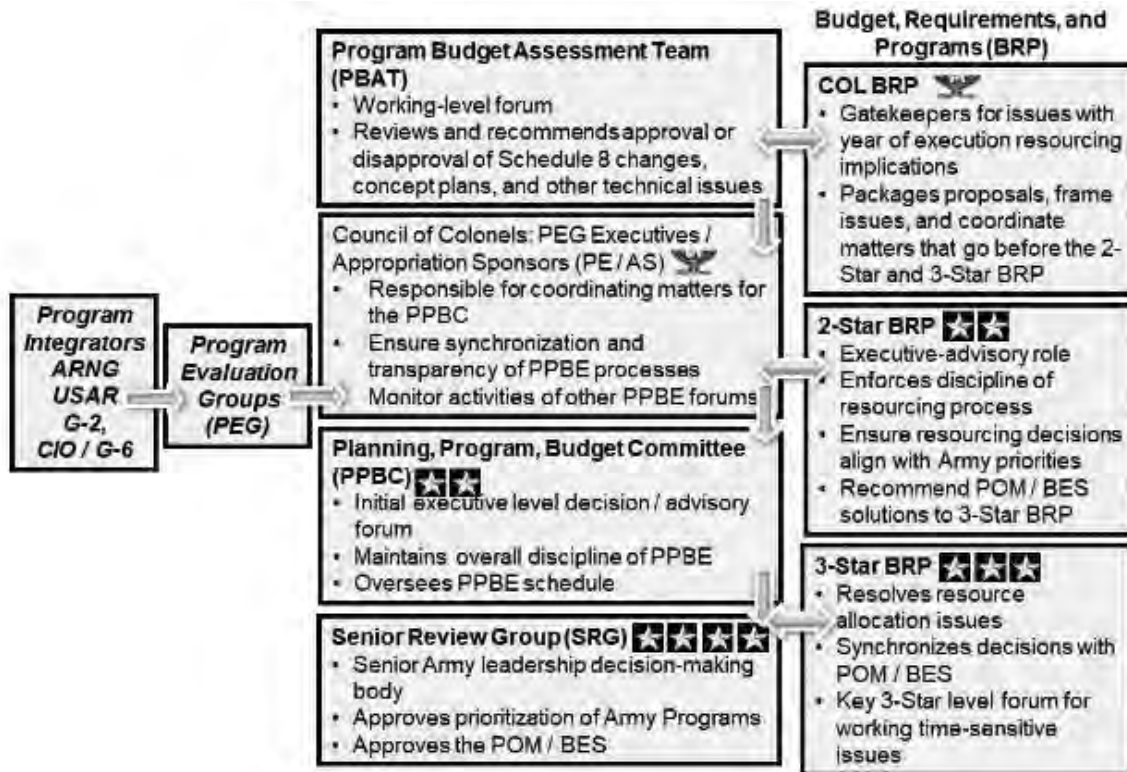

**Figure 8-8. PPBE Decision Committees and Processes**

## 8-28. The Program Evaluation Groups (PEGs)

a. Program Integrators. The ARNG, USAR, G-2, and CIO / G-6 serve as program integrators to the PEGs. Program integrators provide technical assistance and monitor actions to integrate priorities and statutory, defense, and Army requirements for the ARNG, AR and IT programs into the Army's overall program.

b. PEGs. HQDA uses five PEGs to support PPBE (see Figs 8-9 and 8-10). Each PEG is co-chaired by a representative of the Secretariat and a representative of the PEG's proponent, who provide the PEG with executive and administrative support. Permanent members include representatives of ASA (FM&C) appropriation sponsors, G-3/5/7 program prioritizers and requirements staff officers (RSO), and G-8 PAE program integrators.

(1) PEGs program and monitor resources to perform Army functions assigned by 10 USC, Subtitle B, Army, and to support the CCMDs and OSD-assigned executive agencies. Each PEG administers a set of MDEPs within one of the following functional groupings: Manning (MM), Training (TT), Equipping (EE), Sustaining (SS), and Installations (II).

(2) Each PEG, subject to existing PBG, sets the scope, quantity, priority, and qualitative nature of resource requirements that define its program. They monitor PEG resource transactions and, as required, make both administrative and substantive changes to assigned MDEPs. MDEP proponents, subject matter experts, and, as appropriate, representatives of commands and agencies participate in PEG deliberations.

(3) PEGs, assisted by program integrators, help HQDA functional proponents—

(a) Build TAP and the Army program and help convert the program into budget-level detail.

(b) Maintain program consistency, first during planning and later when preparing, analyzing, and defending the integrated program-budget.

## HOW THE ARMY RUNS

- (c) Track program and budget performance during execution.
- (d) Keep abreast of policy changes during each phase of the PPBE process.

| PEG Name           | Co-Chair Secretariat | Co-Chair for Commands | Management / Daily Operations | Appropriation Sponsor* | Program Integrator |
|--------------------|----------------------|-----------------------|-------------------------------|------------------------|--------------------|
| Manning (MM)       | ASA (M&RA)           | TRADOC CDR            | DCS G-1                       | ASA (FM&C)             | G8 PA&E, G-3/5/7   |
| Training (TT)      | ASA (M&RA)           | FORSCOM CDR           | DCS G-3/5/7                   |                        |                    |
| Equipping (EE)     | ASA (ALT)            | AFC CDR               | DCS G-8                       |                        |                    |
| Sustaining (SS)    | ASA (ALT)            | AMC CDR               | DCS G-4                       |                        |                    |
| Installations (II) | ASA (IE&E)           | AMC and IMCOM CDR     | ACSIM                         |                        |                    |
|                    |                      |                       |                               |                        |                    |

ACSIM - Assistant Chief of Staff for Installation Mgmt.  
 AFC - Army Futures Command  
 ALT - Acquisition, Logistics & Technology  
 AMC - Army Material Command  
 ASA - Assistant Secretary of the Army  
 DCS - Deputy Chief of Staff  
 FM&C - Financial Mgmt. and Comptroller  
 FORSCOM - Forces Command

G-1 (Personnel); G-4 (Logistics); G-8 (Programs)  
 G-3/5/7 (Operations, Plans, Training)  
 IE&E - Installations, Environment & Energy  
 IMCOM - Installations Management Command  
 M&RA - Manpower & Reserve Affairs  
 PA&E - Program, Analysis & Evaluation  
 TRADOC - Training & Doctrine Command

\* Includes Chief, National Guard Bureau (CNGB) and Chief, Army Reserve (CAR)

Figure 8-9. Program Evaluation Groups

## ARMY PLANNING, PROGRAMMING, BUDGETING, AND EXECUTION PROCESS

|   |   |
|---|---|
| <p><b>Manning (MM)</b></p> <ul style="list-style-type: none"> <li>• Provides the Active Army, Army National Guard (ARNG) and U.S. Army Reserve (USAR) with authorized personnel by grade and skill</li> <li>• Integrates the personnel authorizations for the ARNG and USAR</li> </ul>  | <p><b>Equipping (EE)</b></p> <ul style="list-style-type: none"> <li>• Provides resources for the integration of new doctrine, training, organization, and equipment for developing and fielding warfighting capabilities for the Active Army, ARNG and USAR</li> <li>• Focuses mainly on materiel acquisition which comprises Research, Development, Test &amp; Evaluation (RDT&amp;E) and procurement of weapons and equipment</li> <li>• Considers operating and support costs to field weapons and equipment, as well as the cost of combat development</li> </ul>   |
| <p><b>Training (TT)</b></p> <ul style="list-style-type: none"> <li>• Provides resources for Active Army, ARNG and USAR unit readiness (to include medical units) and unit collective training (ground OPTEMPO and the flying hour program, fixed wing aircraft operation and maintenance, combat training centers (CTC), mobilization, theater security cooperation (TSC) activities and military contingency operations</li> <li>• Provides for collective training, institutional training (initial entry training, leader development, professional development, functional training), and officer acquisition (United States Military Academy (USMA), Reserve Officer Training Corps (ROTC), Officer Candidate School (OCS))</li> <li>• Supports multi-national force compatibility through integrated training, military exercises, and command control exchanges with allies and coalition partners</li> <li>• Deals with programs, systems, and activities to satisfy intelligence requirements of the President of the United States (POTUS) and Secretary of Defense (SECDEF) as well as those of the senior leadership; these are requirements funded in the Army portion of the National Foreign Intelligence Program (NFIP) under Program 31 and intelligence support to national agencies under Program 9 (Equipping PEG manages most requirements for tactical intelligence and related activities (TIARA) managed by G-8 FD under Program 2, and 4 through 10, as well as acquisitions to meet other intelligence and electronic warfare (IEW) requirements</li> </ul> | <p><b>Sustaining (SS)</b></p> <ul style="list-style-type: none"> <li>• Provides resources to sustain operations of the Active Army, ARNG and USAR, stressing worldwide readiness.</li> <li>• Scope embraces strategic mobility, reserve stocks, industrial preparedness, central supply, and internal operations of depots' materiel maintenance</li> <li>• Includes measures to assure the quality and timeliness of strategic logistics systems, manage weapons systems, provide security assistance, conduct logistical long-range planning, and reshape logistics</li> <li>• Addresses measures to streamline business operations, improve information management structure, further the integration, sharing, standardization, and interoperability of information systems</li> </ul> <p><b>Installations (II)</b></p> <ul style="list-style-type: none"> <li>• Provides resources to support Active Army, ARNG and USAR installations—the operational and service support centers where Soldiers, families and civilians work, live, and train</li> <li>• Plans and programs installation funding for base support, military construction, family housing, base realignment and closure, and environment restoration programs</li> <li>• Base support is provided in two parts:             <ul style="list-style-type: none"> <li>✓ Base operations support (BOS) consisting of base operations (BASOPS), anti-terrorism, force protection, family programs, environment, and audio visual base communications</li> <li>✓ Sustainment, restoration and modernization providing for maintenance, demolition, improvement or replacement of facilities and infrastructure</li> </ul> </li> <li>• Provides for minimal essential workforce in support of installation management and continuously seeks to leverage current strength by converting non-core military to civilian employees for contract, where appropriate</li> </ul> |

Figure 8-10. Program Evaluation Group Functions

# HOW THE ARMY RUNS

## Section VIII

### Army Planning, Programming, Budgeting, and Execution—Planning

#### 8-29. The Army Plan

See Chapter 2, Strategy.

#### 8-30. Required Capability Determination

a. See Chapter 10, Capability Requirements and Materiel System Research, Development, and Acquisition Management, for details on the Joint Capabilities Integration and Development System (JCIDS).

b. Beginning in October and November, in the early stages of program development, requirements staff officers (RSO) work with PEGs to ensure that funded programs have a clearly definable and documented link to military requirements or leadership designated capabilities. Together, PEGs and their RSOs attempt to strengthen linkages of programs meeting this criterion and to terminate those failing to do so. From January, when formal preparation of the program gets under way, through April, these efforts continue during deliberations to approve the individual MDEPs that make up each PEG program. The aim is to make sure the unfolding PEG program links to validated military requirements and leadership-designated capabilities.

c. If unresolved at the PEG level, a program earmarked for termination is forwarded through the ADCS G-3/5/7 to the PPBC for decision.

#### 8-31. Army Research, Development, and Acquisition Plan

The G-8 with the ASA (ALT) prepares the Army Research, Development, and Acquisition Plan (RDAP) to analyze requirements for battlefield and infrastructure capabilities and rank those requirements in priority order. The RDAP matches the requirements to materiel solutions, that is, to RDT&E and procurement programs.

a. The RDAP is a 15-year plan for developing and producing technologies and materiel to advance Army modernization. Imposing mandatory TOA controls, the plan restricts modernization to those efforts that are both technically and fiscally achievable. The process truncates requirements developed through unconstrained planning into an RDA program that, within limited resources, maximizes warfighting capabilities and supporting infrastructure.

b. The RDAP is represented by the G-8 RDA database called Force Development Investment Information System (FDIIS). FDIIS provides information to the RDA program as a required set of MDEPs arrayed in 1-n order by G-8 and ASA (ALT). Each MDEP describes a program, function, or organization and the dollars and system quantities needed.

c. A continuous process, the RDAP focuses on periodic revisions to the RDA database. Revisions typically occur during preparation of the CY combined POM / BES (Feb to Aug) and the PB (Sep to Jan). During these periods, HQDA adjusts the FYDP years, or first 5 years of the RDAP. Then, the Army's RDA community adjusts the final 9 years making sure progression from POM / BES to the PB is not only affordable, but also executable.

d. Each December, TRADOC provides HQDA its recommendations on materiel requirements, arriving at the recommendations through a Capability Needs Analysis (CNA). The process takes into account such guidance as the NMS and the TAP, the AEMS, and IPLs of the CCDRs. The CNA compares future capabilities required by the total force against the fiscally constrained budgeted force. The comparison determines force modernization needs that TRADOC rank orders according to their contribution to mission accomplishment.

## Section IX

### Integrated Programming-Budgeting Phase

#### 8-32. Army Programming and Budgeting

An integrated decision process, Army programming-budgeting produces a combined POM / BES. In conjunction with OSD review, Army integrated programming and budgeting supports development of the

## **ARMY PLANNING, PROGRAMMING, BUDGETING, AND EXECUTION PROCESS**

PB. Once the PB goes to Congress, the Army presents and defends its portion of the budget in congressional hearings.

### **8-33. Guidance**

- a. The primary product of the OSD planning phase is the DPG which provides key strategy, policy and limited programmatic guidance to the services and defense agencies.
- b. TGM. G-8's DPAE complement the APGM with a TGM outlining program intent with respect to allocating resources to attain the Army vision. The TGM also provides coordinating instructions to guide PEGs during the POM / BES build. Additional, PEG-by-PEG guidance lays out programming priorities for specific programs set by the SECARMY and CSA and, for some programs, specifies a particular level of funding.
- c. FG. Before completion of the POM / BES build, OSD issues FG establishing the Army's TOA over the PYs. DPAE then apportions the TOA to the PEGs for building their portion of the program. The guidance includes inflation factors and other administrative instructions.
- d. PBG. DPAE issues PBG typically twice each year, after forwarding the combined POM / BES to OSD for review and after the PB is forwarded to Congress. An enterprise product, the PBG is produced jointly by ASA (FM&C)'s Budget Formulation Division (SAFM-BUC-F) and the G-8's Program Budget Data Management Division (DAPR-DPI) in coordination with G-3/5/7's Force Accounting and Documentation Division (DAMO-FMP). The PBG provides resource guidance to major ACOMs, PEOs, and other operating agencies. Narrative guidance instructs commands and agencies, in addressing resource requirements, such as those related to flying hours, ground operating tempo (OPTEMPO), and rates for fuel, inflation, and foreign currency. A related automation file reflects the resource status of each command and agency. Commands and agencies use their PBG resource information to update their databases for the forthcoming PPBE cycle.
- f. Integrated Program-Budget Data Call. HQDA publishes a multivolume Resource Formulation Guide (RFG) to facilitate the PPBE process. Issued in the fall, RFG volume 3 (Integrated Program-Budget Data Call) describes the data ACOMs, PEOs, and other operating agencies must submit to HQDA to prepare the POM / BES. Commands and agencies may propose changes to their resources over the PYs. Volume 3, however, requires that changes remain zero-sum within the command or agency.
- g. Programming Data Requirements. Before each POM submission, OSD updates a web-based manual entitled Programming Data Requirements (PDR). The PDR provides instructions for preparing and submitting data, requirements, and program justifications to support component POMs. Prescribing formats and exhibits, its instructions describe programming data requirements and some budgeting data, which components submit using OSD's SNaP Data Collection System.
- h. POM Preparation Guidance. As required, HQDA issues RFG volume 4 augmenting OSD PDR with additional guidance for preparing the POM.
- i. BES Preparation Guidance. Two OSD budget guidance documents affect content of the BES. Volume 2 of the DOD Financial Management Regulation prescribes various exhibits and displays to be used in presenting the budget. The Annual Budget Call Memorandum provides supplemental information such as current rate and pricing guidance. Complementing these documents, ASA (FM&C) also issues administrative instructions for preparing the Army's BES.

### **8-34. Army Resource Framework**

The Army Resource Framework Hierarchy shown in Figure 8-11 is designed to organize the Army's resources in a consistent manner to facilitate resource decision-making in all PPBE cycles.

### **8-35. Program Objective Memorandum Preparation**

- a. Start-Up. The annual integrated programming-budgeting phase of the process starts in Oct as OSD reviews the recently forwarded change proposals. In developing the Army program, programmers translate planning decisions, OSD programming guidance, and congressional guidance into a comprehensive allocation of forces, manpower, and funds. In doing this they integrate and balance centrally managed programs for manpower; operations; research, development, and acquisition; and stationing and construction. Concurrently, they incorporate requirements presented by ACOMs, PEOs, and other operating agencies for manpower, operation and maintenance, housing, and construction.
- b. Initial Programmatic Review. From October through December, HQDA-

## HOW THE ARMY RUNS

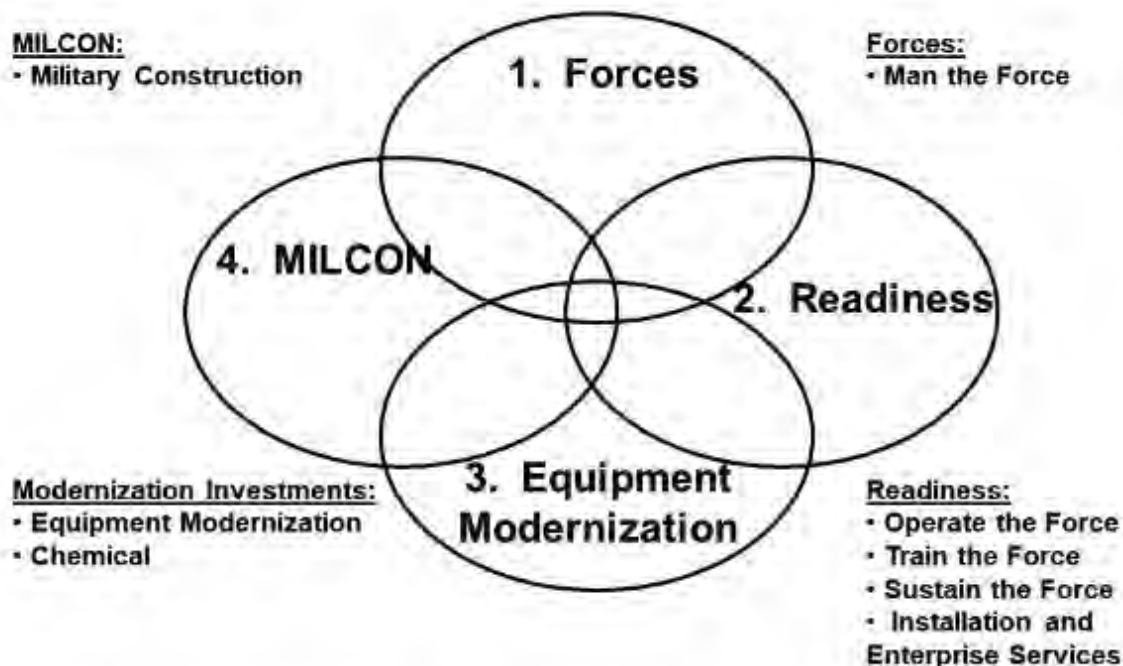

Source: Command Program Guidance Memorandum (CPGM), 27 June 2019

**Figure 8-11. Army Resource Framework Hierarchy**

- (1) Reviews the existing program to determine program deficiencies.
  - (2) Sorts existing MDEPs by PEGs.
  - (3) Establishes force structure and civilian manpower authorizations.
  - (4) Responds to changes recorded in and IPs generated by the OSD program and budget review.
- c. Preparing the Database.
- (1) Formal preparation of the POM / BES starts once the PB goes to Congress. This usually occurs after the first Monday in January but not later than the first Monday in February. As a start point, DPAE establishes a base file in the PPBE database that reflects the PB resource position. Afterwards, in a series of zero-sum adjustments that leave resource levels in the PB unchanged for the BYs, HQDA revises the database. The adjustments—
    - (a) Update earlier estimates with new information and revise them for inflation.
    - (b) Move resources between and among current AMSCO and MDEP structures.
    - (c) Consolidate or otherwise restructure individual programs through rolls and splits to make the overall Army program more manageable.
    - (d) Re-price existing programs as needed and, when required by modified resource levels, identify offsetting deductions as bill payers.
  - (2) Figures 8-12, 8-13, and 8-14 show timelines for POM / BES, PPBE, and Program & Budget.
- d. Command participation. ACOMs participate in the PPBE process as do PEOs, which report through the Army Acquisition Support Center (ASC). These and other operating agencies make mission and operating requirements known through Commander's Narratives, Command-Requested Changes, and additional data submissions prescribed by RFG volume 3. ACOM commanders serving as commanders of ASCCs integrate operational requirements of the CCMD into their program and budget input. In addition, CCDRs highlight their pressing requirements in an IPL that receives close review during program development by HQDA, the JS, and OSD.
- e. Use of PEGs.



## **ARMY PLANNING, PROGRAMMING, BUDGETING, AND EXECUTION PROCESS**

(1) As mentioned, HQDA packages program requirements into MDEPs, each associated with one of six resource management areas. HQDA then assigns each MDEP to a PEG to help build and track the Army POM that forms the Army portion of the DOD FYDP.

(2) PEG POM-building activity begins in the fall and peaks March through May of the following year.

(3) PEGs administer assigned MDEPs. They set the scope, quantity, priority, and qualitative nature of resource requirements that define each PEG program. They monitor PEG resource transactions, making both administrative and substantive changes to their MDEPs as required. In the process, PEGs review assigned MDEPs in terms of TOA guidance. They review command and agency requested requirements submitted via Schedule 1s and their POM. At the same time, PEGs review IPLs of the CCMDs as well as resource needs expressed by the supporting ASCC. PEGs relate these command operating requirements to HQDA guidance as well as to existing MDEPs and new initiatives.

(4) Meanwhile, program integrators provide technical assistance to the PEGs and monitor actions to integrate priorities and statutory, defense, and Army requirements for their respective programs.

(5) Based on review of military requirements related to their Title 10 area of responsibility, each PEG builds an executable program characterized by affordability, continuity, and balance. In the process, the PEG—

(a) Validates requested changes submitted by ACOMs, PEOs, and other operating agencies.

(b) Reconciles conflicts involving unfunded requirements or decrements on which commands fail to reach agreement.

(c) Recommends the allocation of available resources and offsetting decrements to support approved unfunded programs.

(d) Rank orders validated programs as PEG input to G-3/5/7's overall POM 1-n prioritized program list.

(e) Evaluates HQDA, command, and other agency zero-sum realignments that reallocate programmed resources to meet existing shortfalls and changed requirements.

(f) Coordinates resource changes with appropriate Service, DOD, and non-DOD agencies when required.

(g) Makes sure that proposed reallocations conform to legal restraints and Army policy and priorities, avoid imprudently high risk, and maintain the ability to execute mandatory programs and subprograms.

(h) Prices programmatic decisions that the Army can defend during review by OSD, OMB, and the Congress.

f. Internal Program Review. The PPBC meets periodically throughout the POM / BES build to review and adjust the developing program, devising courses of action and recommendations on relevant issues as appropriate. The Senior Review Group (SRG), in turn, convenes early in the process to approve guidance and, at key stages, to ratify PPBC decisions.

g. POM. The annual POM, which documents the program decisions of the SECARMY as influenced by the CSA's recommendations, presents the Army's proposal for a balanced and integrated allocation of its resources within specified OSD fiscal and manpower constraints. POM subject matter remains relatively constant from cycle to cycle, but varies as required to address special issues. The FY 2017-2021 POM included an introduction and discussion of forces, investment, operations and support, infrastructure-environmental, infrastructure-defense agencies, manpower and personnel, Defense Working Capital Fund, and CCDR IPLs.

# HOW THE ARMY RUNS

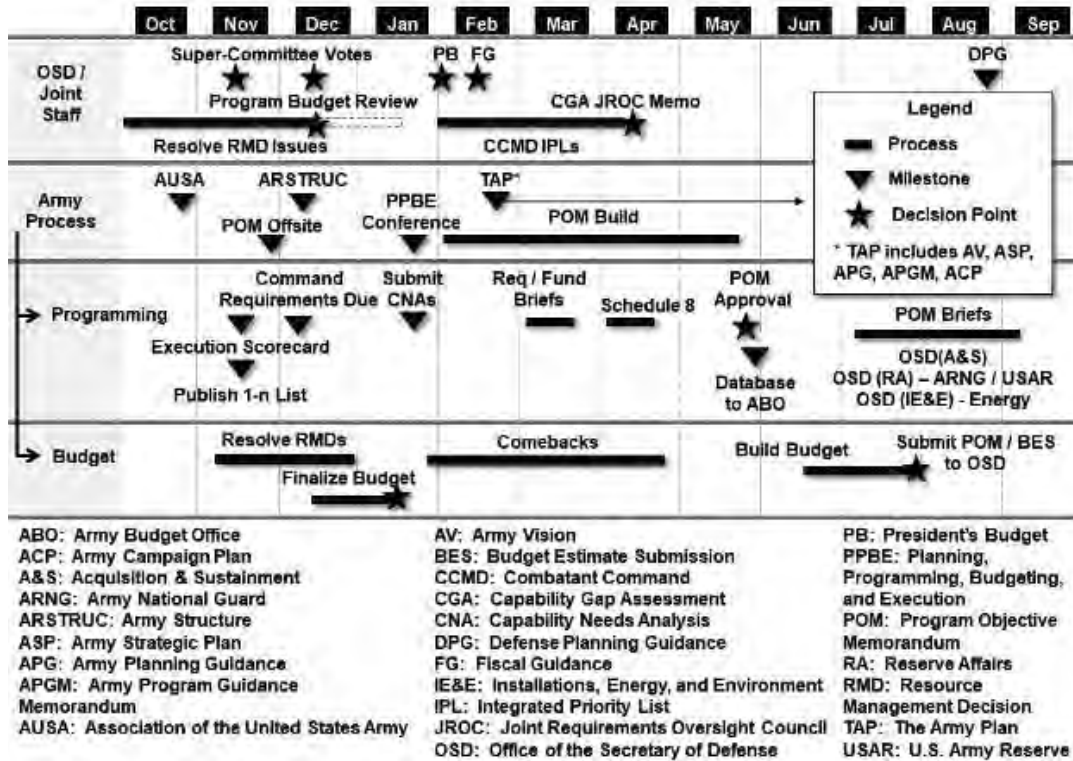

Figure 8-12. Program Objective Memorandum / Budget Estimate Submission Timeline

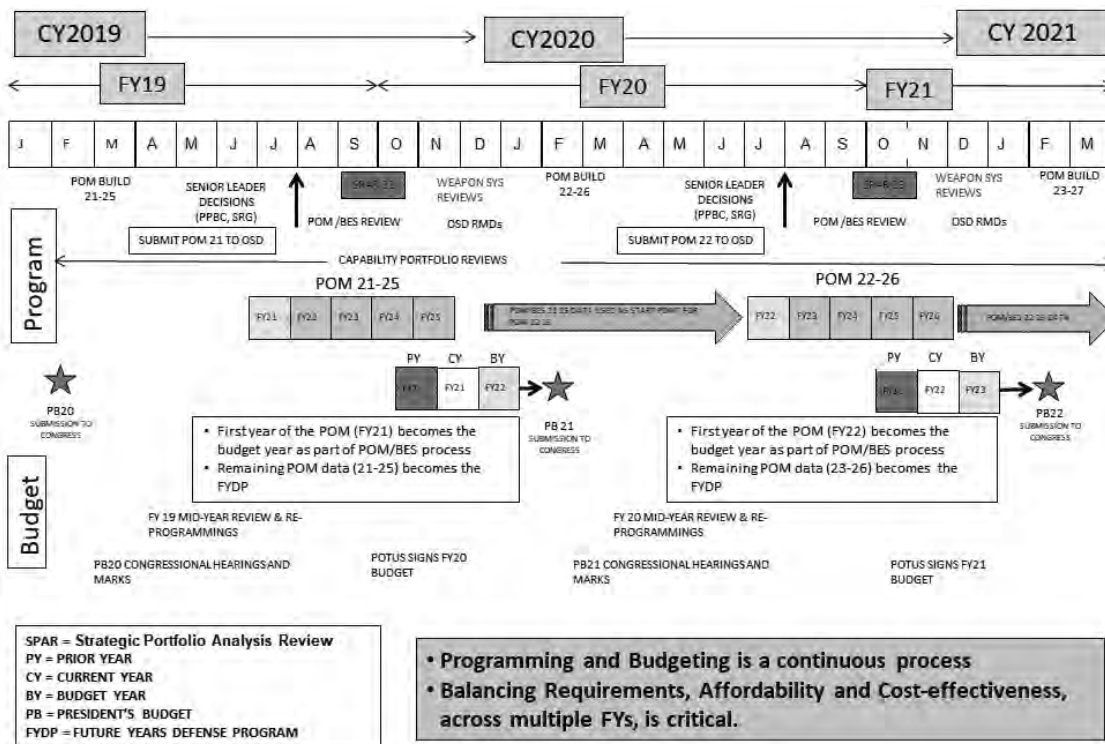
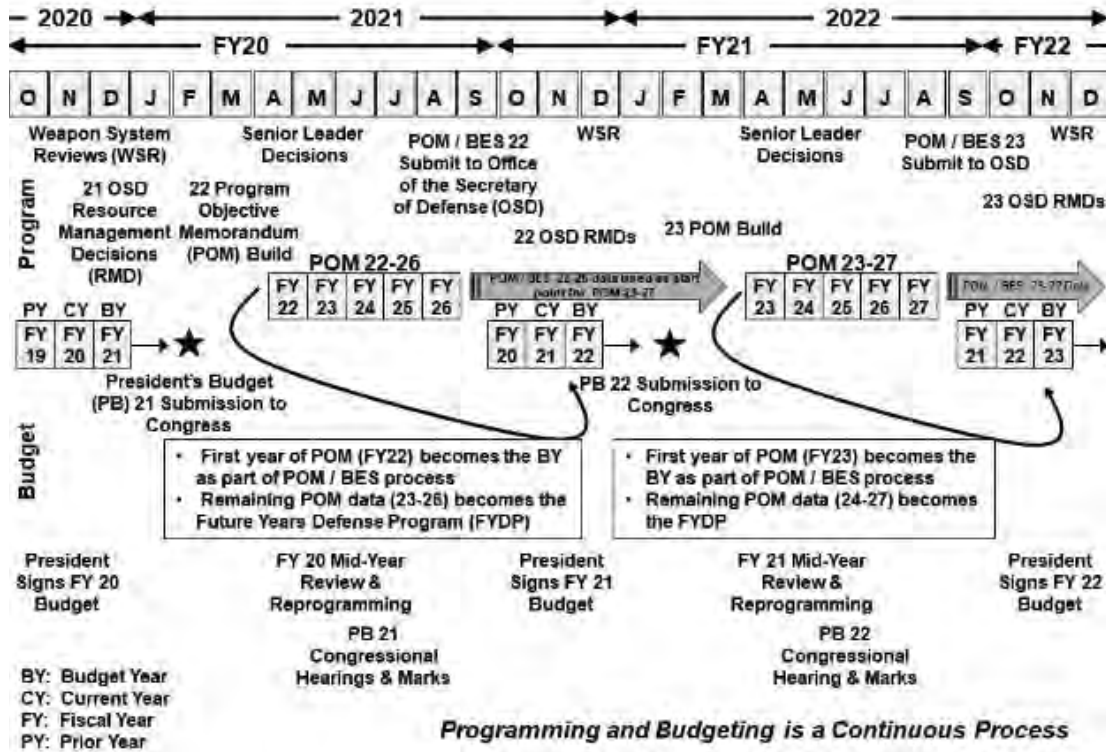

Figure 8-13. PPBE Timeline

# ARMY PLANNING, PROGRAMMING, BUDGETING, AND EXECUTION PROCESS



**Figure 8-14. Program & Budget Timeline**

### 8-36. Program and Budget Correlation

The POM defines what the Army intends to do over the five-year program period. It uses the MDEP to package required resources by mission, function, and other program objectives. Throughout program development, however, both programmers and budgeters make sure that programmatic decisions receive proper costing and that Army resource decisions can be defended during budget reviews conducted by OSD, OMB, and Congress. Working closely together, programmers and budgeters help the senior Army leadership consider all relevant information before the leaders make resource allocation decisions. The approach precludes the need, later in the integrated process, to revisit most issues. Moreover, it presents a near seamless transition from program to budget.

### 8-37. Budget Estimate Submission (BES) Preparation

a. ASA (FM&C) prepares the BES concurrently with the POM, historically submitting the combined POM / BES to OSD in August every year. The first year of the program, approved by the SECARMY and CSA, becomes the basis for the BES.

b. Since the first year of the POM was created 18 months prior to submission of the BES, adjustments are often required. Adjustments can be directed or 'fact-of-life'. Directed changes can come from Congress or OSD. Fact-of-Life changes are often the result of rate and price changes for the Army Working Capital Fund, Military and Civilian pay, fuel, or inflation.

### 8-38. Office of the Secretary of Defense Program and Budget Reviews

OSD begins review of the combined POM / BES soon after their submission. The Program Review is conducted until Oct-Nov followed by the Budget Review which continues until late December. The review concludes when the administration makes final PB decisions.

a. Issues center on compliance with the DPG, the overall balance of service programs, and late-breaking significant issues.

## HOW THE ARMY RUNS

b. As issues arise, representatives of HQDA principal officials meet with their OSD counterparts. The Army representatives present the Army position and try to clarify the issue. If possible, the issue is resolved at this level.

c. Upon completion of the Program Review, after review officials have debated and decided program issues, the DEPSECDEF issues one or more RMDs directing specific changes to program positions of the submitted POM. After the Budget Review and before completing the budget, if it is needed, the DEPSECDEF publishes a Summary RMD along with a memorandum describing the disposition of programmatic issues.

d. Budget issues are decided through draft IPs. Focusing on proper pricing, reasonableness, and program execution, an IP may be based on errors or on strength of justification. It may result from analytical disagreement or, it may be motivated by cost savings or changes in policy. After reviewing the IP responses, the SECDEF issues RMDs which are final decisions directed by the SECDEF telling the services to change their program requests to align them with the SECDEF's decisions.

e. After the DEPSECDEF or USD (C) has signed the RMDs, each service selects as MBIs certain adverse resource decisions. Army MBIs center on decrements to specific initiatives or broad issues that would significantly impair its ability to achieve its program intentions. An MBI addresses the adverse impact that would occur if the decrement were to prevail. At the end of the process, the SECARMY and CSA meet with the SECDEF and DEPSECDEF on MBI. After the meeting, the SECDEF decides each issue, if necessary meeting with the OMB or the President to request additional funds or recommend other action.

### 8-39. President's Budget (PB)

a. In December, OSD issues a final RMD, an OSD memorandum incorporating any changes from deliberations on MBI, thus completing the review process.

b. After implementing the final resource distribution at the BA and object class level, Army sends the information to OSD. OSD forwards the information as the Army's portion of the Defense budget to OMB and OMB incorporates the Defense budget into the PB. The PB covers prior year obligations and updated resource estimates for the current year. During the annual POM/BES cycle, the PB covers Total Obligation Authority (TOA) estimates for the budget year.

### 8-40. Justification

a. Congressional Budget Hearings.

(1) During budget justification, the Army presents and defends its portion of the PB before Congress. The process proceeds formally and informally under the staff supervision of the Chief of Legislative Liaison and ASA (FM&C).

(2) After the President formally submits the budget, the Army provides detailed budget justification to the authorization and appropriations committees. First, however, appropriation sponsors will have prepared material in Army justification books to conform to decisions of the President and SECDEF and congressional requirements for formats and supporting information. Justification books undergo internal Army review by ASA (FM&C) and are then sent to OSD for final review.

(3) The Senate Armed Services Committee (SASC) and House Armed Services Committee (HASC) conduct authorization hearings for the various programs and appropriations. Concurrently, the Army's budget request goes before the Senate Appropriations Committee (SAC) and House Appropriations Committee (HAC). In these hearings, the SECARMY and CSA normally testify first. Then with assistance from ASA (FM&C)'s Budget Liaison Office and the Office, Chief of Legislative Liaison (OCLL), appropriation sponsors and functional proponents present and defend the details of the budget.

b. Legislative approval and enactment.

(1) When Congressional committees complete their review, the Senate and House vote on the committee bills. Differences between the Senate and House versions are resolved in joint conference.

(2) Budget justification ends when the President signs the authorization and appropriation bills for the coming FY. Enacted into law, Army appropriations provide the legal authority to incur obligations and make payments.

c. Continuing Resolution Authority (CRA). When Congress fails to pass an appropriation by the end of September, it may pass a continuing resolution. CRA derives from emergency legislation that authorizes the funding of government operations in the absence of appropriations. A temporary measure, the CRA usually restricts funding to the PY level and prohibits new initiatives. HQDA separately publishes specific

# ARMY PLANNING, PROGRAMMING, BUDGETING, AND EXECUTION PROCESS

policy on how the Army will operate under the CRA. Failure to pass either an appropriation or CRA could result in a temporary shutdown of government operations. Normally, however, until an appropriation or CRA is enacted, DOD would continue minimum essential operations based on national defense requirements.

## **Section X** **Army Budget Execution Phase** **See Chapter 9.**

## **Section XI** **Program Performance and Review**

### **8-41. Program Implementation**

ACOMs, PEOs, and other operating agencies carry out the approved program within manpower and funds provided. They review budget execution and account for and report on the use of allocated funds by appropriation and MDEP. As applicable to each appropriation, they include FYDP program and subprogram, AMSCO, APE, project number, BLIN, SSN, BA, BAG, and EOR. They also account for use of allocated manpower by UIC. The manpower and financial data obtained help commands and agencies develop future requirements.

### **8-42. Performance Assessment**

a. ASA (FM&C) oversees the Cost & Performance Portal (CPP) which collects Army financial and performance data from disparate Army data systems, centralizes the data into a single data warehouse, and displays analytic information through various reports and graphical displays. The CPP is accessible to all Army users including resource managers, functional experts, and senior leaders through web-based interfaces with the ability to login via the Army cost accounting codes (CAC).

b. The CPP provides real-time, relevant, accurate and transparent financial and performance information to senior leaders and HQDA staff to support decision-making.

### **8-43. Review of Selected Acquisition Systems**

The means for checking system program performance include milestone reviews of designated acquisition programs conducted by ASA(ALT) using the ASARC and Major Automated Information Systems Review Council (MAISRC).

### **8-44. Joint Reconciliation Program**

This program applies the skills of those responsible for various aspects of financial management. The skills include those of accountants, budget and program analysts, contracting professionals, logisticians, and internal review auditors. The program applies these combined skills to verify the validity of un-liquidated obligations, contractor work in progress, billing status, and the continued need for goods and services not yet delivered. The program achieves dollar savings by identifying and canceling obligations for goods and services no longer needed or duplicative. The program also reconciles current appropriations to verify the correctness of amounts obligated. In addition, the program assures the liquidation of appropriations to be canceled by the end of the FY.

## **Section XII** **Summary, Key Terms, and References**

### **8-45. Summary**

The PPBE process ties strategy, program, and budget all together. It helps build a comprehensive plan in which budgets flow from programs, programs from requirements, requirements from missions, and missions from national security objectives. The patterned flow from end purpose to resource cost defines requirements in progressively greater detail.

## HOW THE ARMY RUNS

### 8-46. Key Terms

- a. Program Objective Memorandum (POM). The final product of the programming process within the DOD, the DOD Component's POM displays the resource allocation decisions of the Military Departments in response to and in accordance with planning and programming guidance (DODD 7045.14).
- b. Future Years Defense Program (FYDP). Program and financial plan for the DOD as approved by the Secretary of Defense. The FYDP arrays cost data, manpower, and force structure over a 5-year period (force structure for an additional 3 years), portraying this data by major force program for DOD internal review for the program and budget review submission. It is also provided to the Congress annually in conjunction with the President's budget (DODD 7045.14).

### 8-47. References

- a. DODD 7045.14, Implementation of the Planning, Programming, and Budgeting System.
- b. CJCS Instruction 3100.01B, Chairman's JSPS.
- c. AR 1-1, PPBE Process.

*The Nation's fiscal situation will continue to discipline the defense budget, forcing the Army to make difficult choices about how to spend our finite resources. It is imperative we implement aggressive reforms by 2020 to free up time, money, and manpower for our highest priorities and to empower subordinate commanders to make more timely and effective decisions.*

*The Army Strategy 2018-2028*

*Stewardship programs pay for themselves over and over again; optimizing purchasing power, enhancing readiness and lethality, and ensuring the Army achieves and sustains auditability.*

*LTG Thomas A. Horlander, Military Deputy and Army Comptroller  
ASA(FM&C)*

## **Chapter 9**

### **Finance & Comptroller**

#### **Section I Introduction**

##### **9-1. The Need for Finance and Comptroller (FC)**

a. The Finance and Comptroller capability is grounded in the Constitution. Article 1 firmly establishes the roll of the Congress in generating revenues, raising and supporting Armies, making appropriations for drawing funds from the U.S Treasury, and the need to provide an accounting of those funds – which is the role of Finance and Comptroller professionals.

(1) Section 7 establishes that “All bills for raising Revenue shall originate in the House of Representatives;...”

(2) Section 8 establishes that “The Congress shall have the Power To lay and collect Taxes, Duties, Imposts and Excises, to pay the Debts and provide for the common Defense...”; “To coin Money”; and “To raise and support Armies, but no Appropriation of Money to that Use shall be for a longer Term than two Years;...”.

(3) Section 9 establishes that “No Money shall be drawn from the Treasury, but in Consequence of Appropriations made by Law; and a regular Statement and Account of the Receipts and Expenditures of all public Money shall be published from time to time.”

(4) Congress has prescribed more detailed laws in the U.S. Code and through Annual Appropriations and Authorizations to guide the specifics of what funding can be used and the durations of those funds. Additionally, the Department of Defense, the Army, and a variety of other entities have promulgated regulations, policies, and procedures to guide spending and account for every public dollar spent. This legal and regulatory environment requires specifically trained and organized individuals, staffs, and units to assist Army commanders and leaders ensure they spend their budgets properly. Their Comptrollers help to translate their intent and guidance into action through funding operational requirements while balancing the constraints of the law.

b. Implicit in this mission is the proper stewardship of public funding. The Comptroller understands that ultimately it is the commander who is responsible for proper execution of the budget; however, the

## HOW THE ARMY RUNS

Comptroller's role is in knowing their responsibility to help the commander navigate this complex environment. Through their knowledge of the legal and regulatory landscape, the unit's mission, and the commander's intent, they assist commanders and the staff development a detailed plan of execution from budget formulation through disbursement of funds from the Treasury. Due to legal and regulatory separation of duties requirements, the Comptroller cannot disburse funds from the Treasury. This requires an Agent of the U.S. Treasury, which is the role of the Finance side of the profession. Together, the Army's Finance and Comptroller capability enables the commander to steward the funds entrusted to them to accomplish assigned missions.

### 9-2. Key Players in the Process

a. Congress. The Congressional role is central, and their Constitutional authority is described above. How they accomplish that role follows:

(1) Appropriations. Each house of the Congress has a sub-committee for Defense Appropriations; the Senate Appropriations Committee-Defense (SAC-D) and the House Appropriations Committee-Defense (HAC-D). These are the starting points of all Defense Appropriations. Committee members and their professional staffs work closely with the Army to understand the funding needs and the National Defense requirements supporting those amounts. They do the work of transforming the Annual President's Budget Request into an Appropriation (known as the Appropriations Act) which details the amounts the Army can spend from the Treasury. The HAC-D/SAC-D submit their versions of the Defense Bill to the larger House and Senate Appropriations Committee for inclusion into what is traditionally known as the discretionary spending requirements of the Federal Government. (Mandatory spending programs are not a normal part of the annual appropriations activity as they usually have automatic annual spending amounts written into the original text of the legislation.) The annual Appropriations Bill is divided into 12 separate appropriations: Defense; Military Construction and Veterans Affairs; Transportation; Housing and Urban Affairs; Energy and Water; Homeland Security; Agriculture; Interior; Labor and Education; State and Foreign Affairs; Commerce and Justice; and Financial Services.

(2) Authorizations. In addition to the sub-committees for appropriations, each chamber has a committee which authorizes the actions and activities of the Army; the Senate Armed Services Committee (SASC) and the House Armed Services Committee (HASC). Committee members and their staffs work closely with the Army to understand the legislative authority the Army needs to accomplish its mission. This legislation is commonly known as the National Defense Authorization Act (NDAA). Examples of legislative authority found in the Act include authority to fund training of foreign forces, use of funding for new unique purposes not already in law (CERP, ISFF, ASFF), and the caps on micro-purchase limits for the government purchase card. Both an appropriation AND an authorization are required for expenditure of funds.

b. President of the United States (POTUS). In addition to signing the above legislation into law, the President is required to submit an annual budget request to the Congress in February of each year. The President's Budget (PRESBUD) contains the amounts required to operate all Federal Agencies. The PRESBUD is built from the earliest POM Year.

c. Office of Management and Budget (OMB). OMB assists the POTUS in overseeing the preparation of the federal budget and in supervising its administration in federal agencies. It evaluates, formulates, and coordinates management procedures and program objectives within and among federal departments and agencies. It provides POTUS with recommendations regarding budget proposals and relevant legislative proposals. Additionally it plans, conducts, and promotes evaluation efforts to assess federal program's objectives, performance, and efficiency. OMB also oversees and coordinates the Administration's procurement, financial management, information, and regulatory policies (for details on OMB, visit <https://www.whitehouse.gov/omb/>).

d. U.S. Treasury. After POTUS signs the appropriations bill(s), the U.S. Treasury issues appropriations warrants to establish bank accounts on the books of the U.S. Treasury for each appropriation. The Treasury Warrant is a financial controlling mechanism and gives the Army the authority to disburse funds from those accounts. Without this authority, the Army cannot make any payments citing the non-warranted appropriation.

e. Under Secretary of Defense - Comptroller (USD (C)) - CFO. Within the OSD there is an USD(C) who advises and assists the Secretary of Defense (SECDEF) in exercising budgetary and fiscal responsibilities and fills the role of the DoD Chief Financial Officer. The Comptroller is the principal advisor to the Secretary of Defense for budgetary and fiscal matters including financial management,



## FINANCE & COMPTROLLER

accounting policy and systems, management control systems, budget formulation and execution, contract and audit administration, and general management improvement programs. The office of the Comptroller consists of the following organizations; Budget and Appropriations Affairs, the Deputy CFO, Program and Budget, Resource Issues, and Human Capital and Resource Management. The office establishes and supervises the execution of policies and procedures relating to expenditure and collection of funds.

Additional details can be found at; <https://comptroller.defense.gov/About-OUSD-C/functionalStatements/>

f. Secretary of the Army (SECARMY). In accordance with (IAW) Title 10, U.S. Code (U.S.C.), Section 7013 (10 U.S.C. 7013), and subject to the authority, direction, and control of the SECDEF, the SECARMY is responsible for, and has the authority necessary to conduct all affairs of the Department of the Army (DA), including the following functions: the functioning and efficiency of the department; the effective and timely implementation of policy, program, and budget decisions and instructions of POTUS or the SECDEF relating to functions of HQDA; and the performance of the functions of the HQDA so as to fulfill the current and future operational requirements of the unified Combatant Commands. This broad authority gives the secretary direct input into the resourcing needs of the force and makes this a key position in the process of building and executing Army funding.

g. Assistant Secretary of the Army for Financial Management & Comptroller -ASA (FM&C). IAW 10 U.S.C. 7016 and 7022 the principal responsibility of the Assistant Secretary shall be the exercise of the comptroller functions of the Department of the Army, including financial management functions and shall be responsible for all financial management activities and operations of the Department of the Army and shall advise the Secretary of the Army on financial management. Integral in building the POM and translating it into the Budget Estimate Submission (BES) and ultimately to distribution and execution of the budget through to the production of auditable financial statements. The Assistant Secretary executes these roles through five entities. (Fig 9-1 for the organization)

(1) Military Deputy (MILDEP). The Military Deputy to the ASA-FM&C serves as the primary military advisor to the Assistant Secretary and is the functional representative for the Finance and Comptroller military profession of the Total Army. The MILDEP functions as the Comptroller of the Army.

(2) Director of the Army Budget (DAB). The DAB is responsible for budget formulation, the presentation and defense of the budget through the Congressional appropriation process, budget execution and analysis, reprogramming actions, and appropriation fund control/distribution. The DAB provides the ASA(FM&C) and the Army Staff budgetary assessments and impacts of implementing future Army plans and programs.

(3) Deputy Assistant Secretary of the Army - Financial Operations (DASA-FO). DASA-FO is responsible for policies, procedures, programs and systems pertaining to finance and accounting activities and operations, Army financial management systems and data integration activities, production and audit of Army's Financial Statements, Army programs for internal control, internal review and audit compliance, the Army Travel Charge Card, fraud, waste, and Abuse and other management evaluation activities.

(4) Deputy Assistant Secretary of the Army - Cost and Economics (DASA-CE). The DASA-CE is responsible to provide the Army decision-makers with cost, performance and economic analysis in the form of expertise, models, data, estimates and analyses at all levels.

(5) Deputy Assistant Secretary of the Army - Financial Information Management (DASA-FIM). The DASA-FIM is responsible for ensuring the Army financial management systems and processes are modernized and integrated to provide a complete range of financial and cost information needed for Army to conduct Business transactions, to provide accountability to the public, support audit, and enhance performance reporting and decision making.

h. Commanders of Army Commands (ACOM), Army Service Component Commands (ASCC), & Direct Report Units (DRU). Commanders are responsible for developing, justifying, presenting, and defending programs supporting their assigned missions and responsibilities. Further, they are accountable for ensuring approved program budgets are properly executed and certified. This responsibility includes ensuring accounting and fund status reporting for appropriated and non-appropriated funds is accomplished in accordance with fiscal law and governing regulations and policies.

# HOW THE ARMY RUNS

## Section II Acquire Resources

### 9-3. Building the Army's Budget

- a. The Army builds the Annual Budget from the first year of the POM.
- b. "Four A's" model:

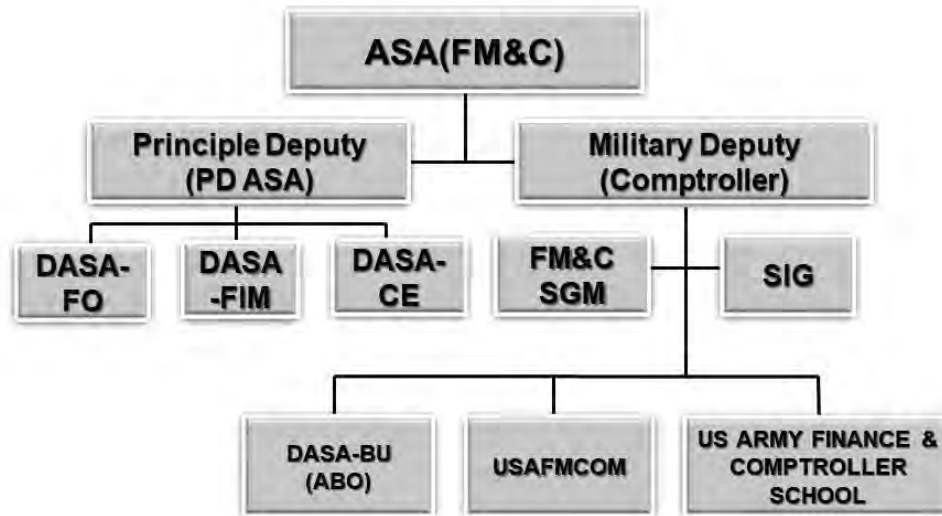

DASA – Deputy Assistant Secretary of the Army; FO – Financial Operations, FIM – Financial Information Management, CE – Cost & Economics  
BU – Budget, SGM – Sergeant Major, SIG – Strategic Initiatives Group, ABO – Army Budget Office. USAFMCOM – US Army Financial Management Command

**Figure 9-1. Office of the ASA (FM&C)**

- (1) Acquire resources – part of formulation and development.
  - (2) Allocate or distribute those resources according to the priorities generally considered in terms of dollars and manpower.
  - (3) Account for those resources with a system that provides a decision support and tracking capability for the program and budget functions, and a system that performs accounting for fiscal compliance required by statutes.
  - (4) Analyze the execution of those resources and implement course corrections as required.
- c. These functions—acquire, allocate, account, analyze—are performed in a closed-loop process. Though it is recognized that there are other models that describe the elements of financial management, for this discussion the “4-A’s” model is sufficient. The building of the budget and the BES are parallel processes that are synchronized with development of the POM.

### 9-4. Defending the Army's Budget

Described in detail in Chapter 8, the Planning, Programming, Budgeting, and Execution (PPBE) process provides the means by which the Army builds (or acquires) and defends (or justifies) its resources from Congress. After authorization and appropriations acts are signed into law, several interrelated functions are performed by OMB, the U.S. Treasury, the Office of the Under Secretary of Defense (Comptroller) (OUSD (C)) and OASA (FM&C) to acquire the Army's financial resources and allocate or distribute them to the field for execution. Figure 9-2 graphically portrays this process.

- a. Apportionment.

(1) An apportionment requires a specific request. Using SF 132, Apportionment and Reapportionment Schedule, the ASA (FM&C) Funds Control Officer prepares the request within five days of the availability of an appropriations act or in response to approved reprogramming requests, supplemental appropriations, or rescissions. OSD approves or revises the apportionment requests and submits them to the OMB for approval. OMB approves, changes, or disapproves the requests and returns apportionments through OSD to the Army for entry into GFEBs. OMB apportions the following:

(a) Operating Accounts-Operation & Maintenance (O&M), Military Personnel (MILPERS), and Army Family Housing, Operations (AFHO)-on a fiscal quarterly basis.

(b) Investment accounts-RDT&E, Procurement, Military Construction (MILCON), and Army Family Housing (Construction) (AFHC))-at the start of the FY rather than on an incremental basis, funding the entire amount of the appropriation.

(2) The apportionment determines the Budget Authority (BA) available in GFEBS. For the operating accounts-even after releasing the entire program to the command-it is the cumulative amount of BA issued to commands and agencies by quarter that determines the execution level for the appropriation.

(3) Apportionment requests. Apportionment is a process for the administrative control of appropriations and funds. It is also a distribution of a specified amount of Obligation Authority (OA) in an appropriation / fund that is available for specified time periods (for example, fiscal quarter), activities, projects or a combination thereof as approved by the OMB. The amounts so apportioned limit the obligations that may be incurred by the Army. After Congress passes an appropriation bill and POTUS signs it into law, the OASA (FM&C) submits an apportionment of funds request through OUSD (C) to OMB. OMB reviews the request, adjusts the amounts as may be necessary based on their analysis of prior Army spending patterns, approves the request, and transmits the approved request back down through OUSD (C) to the OASA (FM&C). Within OASA (FM&C), the HQDA Funds Control Officer loads the approved apportioned amounts into the GFEBS. GFEBS is the official funds control management system of the DOD and is used throughout the Army financial management community to control the fund distribution process (see Fig 9-2).

b. Program documents. In addition to the approved apportionment mentioned above, OUSD (C) may issue further restrictions by withholding amounts for specific programs. These restrictions come to HQDA via an OA letter (for Operations and Maintenance (O&M), Military Personnel (MILPERS), and Army Family Housing Operations (AFHO) appropriations), a DD Form 440 (for Procurement and Research, Development, Test, and Evaluation (RDT&E) appropriations), or a DD Form 460 (for the MILCON appropriations).

### **Section III Budget Execution**

#### **9-5. Treasury Warrants**

After POTUS signs the appropriations bill(s), the U.S. Treasury issues appropriations warrants to establish bank accounts on the books of the U.S. Treasury for each appropriation. The Treasury Warrant is a financial controlling mechanism and gives the Army the authority to disburse funds (e.g., write a check to pay for an obligation) from those accounts. Without this authority, the Army cannot make any payments citing the non-warranted appropriation.

#### **9-6. Fund Distribution and Control**

Passing funds through command channels and making the commander responsible for their control is the basic tenet by which the Army's funding distribution system operates. In this case the use of the term "funds" implies that the authority to create obligations, for which the U.S. Government (USG) has to pay, has been granted. Distribution of funds is any documented action that makes funds available for obligation.

a. The Distribution Procedure. After obtaining OA from OMB and OUSD (C), HQDA directs major commands and other subordinate operating agencies to execute their approved budgeted programs (see Fig 9-2). Using the GFEBS, the HQDA Funds Control Officer in the OASA (FM&C) allocates program authority and OA to ACOMs, ASCCs, DRUs and operating agencies based upon guidance from the appropriation sponsors. ACOMs and operating agencies in turn sub-allocate or allot to the appropriate subordinate organization (for example, installation, major unit, PM, and so forth) where the program will actually be executed by obligating for such things as payroll, travel orders, contracts, purchase orders, etc.

b. Funding Guidance. Along with program authority, HQDA issues specific spending guidance at the beginning of the FY. This annual funding guidance acts as an administrative control mechanism to either restrict action or provide specific guidance on how to report obligations. The annual guidance acts much like annual training guidance as it tells Comptrollers how they are expected to manage, report, and

## HOW THE ARMY RUNS

account for funding IAW higher commander guidance and intent. It addresses such items as the requirement to submit Spend Plans and when to update them as well as when key budget battle rhythm events will occur throughout the year – e.g. Mid-Year Review and Quarterly Program and Budget Advisory Councils (PBAC). Units may then issue any additional funding guidance to their subordinate commanders and activities to further control the execution of their programs and budgets.

### 9-7. Fund Authorization Document (FAD)

This documented process is generally referred to as the FAD, or Funding Authorization Document. Funding is said to be 'FADed' to units down to the Level 4 within GFEBS. The FAD process is critical as it represents the formal subdivision of funds and is the guide for where Anti-Deficiency Act (ADA) violations can actually occur. As a rule, any violations of Purpose-Time-Amount (PTA) below a formal subdivision of funds cannot generate an ADA. The FAD provides the specifics of PTA and any additional instructions to the receiving unit such as reporting requirements, additional restrictions, and transfer limitations associated with the funding.

### 9-8. Delegation of Funding Authority

Commanders have the inherent authority to expend government resources. Commanders to whom funds are made available may delegate their authority to their comptroller or other official designated to execute their budget. As with every aspect of a commander's inherent authority, while they can delegate that authority, they never relinquish the responsibility for the proper stewardship of those funds.

a. Delegation of authority must be in writing (verbal or telephonic authorizations should only occur in emergency circumstances and must be confirmed in writing as soon as possible).

b. Authority may be delegated to a named individual or a position as long as the authority is vested in a readily identifiable person at all times.

c. Delegation of authority does not relieve commanders of their fiscal responsibilities under the law.



Figure 9-2. Fund Distribution Process

**9-9. Availability of Appropriations for Obligations**

The Constitution and Congress determine the length an appropriation is available for new obligations. Most appropriations have a limited time period for which new obligations can be made against them.

Note: Congress can legislate exceptions.

a. Annual Appropriations. Appropriations with a one-year period of availability, include:

(1) Operations and Maintenance appropriations like Operations and Maintenance-Army (OMA), Operations and Maintenance-National Guard (OMNG), Operations and Maintenance-Army Reserve (OMAR), and Army Family Housing Operations (AFHO).

(2) Military personnel appropriations like MPA, NGPA, and RPA.

b. Multi-Year Appropriations. Appropriations having more than one year of availability include:

(1) RDT&E appropriation is available for two years.

(2) Procurement appropriations (e.g., Aircraft Procurement, Army; Missile Procurement, Army; Procurement of Weapons and Tracked Combat Vehicles (WTCV), Army; Procurement of Ammunition, Army; and Other Procurement, Army (OPA)) are available for three years.

(3) MCA; MILCON, National Guard (MCNG); MILCON Army Reserve (MCAR); and Army Family Housing Construction (AFHC) are available for five years.

c. "No-year" Appropriations. These appropriations and funds have an unlimited period of availability. Examples include the appropriation for Base Realignment and Closure (BRAC) and the Army Working Capital Fund (AWCF). These funds are appropriated with the phrase "until expended".

d. Expired Appropriations. When an appropriation's period of availability is over it is considered "expired" and maintains this status for 5 years. As an example, the FY 18 OMA appropriation has a period of availability for obligation from 1 October 2018 through 30 September 2019. The appropriation has a five-year expiration period from 1 October 2018 through 30 September 2022. Appropriations in an expired status are generally not available to incur new obligations without specific authority; however, they can be used to make adjustments. An example could be for travel executed at the end of the FY when the voucher is settled in the new FY and is for a greater amount than the obligated amount on the Authorization. In this case, Comptrollers are free to make adjustments to the expired account because the original obligation (the travel) was a bonafide need of that fiscal year. Adjustments to amounts this late after the initial obligation may seem farfetched; however, by law, vendors have 6 years to bill the government so it is not unusual to receive a final bill for services rendered 3 to 5 years afterward.

e. Cancelled Appropriations. After the fifth year of expiration an appropriation is considered canceled by the U.S. Treasury. The appropriation is no longer available for any purpose, for example, accounting adjustments. Using the FY 18 OMA example above, it would cancel on 30 September 2022. If any further adjustments are required from the canceled appropriation, such as a final settlement to a disputed contract, then payment is made out of the activity's current year appropriation subject to several limitations. One limitation is the total amount cannot exceed 1% of the current appropriation and cannot exceed the un-liquidated balance of the initial, now cancelled, appropriation.

**9-10. Special Classified Programs**

Classified programs may be compartmentalized for security reasons. Specific funding distribution procedures have been created to accommodate the unique security requirements of such programs. Generally, the VCSA must approve the use of the procedures.

**9-11. Emergency and Extraordinary Expenses**

Congress gives the Services specific authority to be used for emergency and extraordinary expenses from within the O&M appropriation. These authorities are described in Army Regulation (AR) 37-47, Representation Funds of the Secretary of the Army. The utilization of these authorities are closely monitored and fall under audit responsibilities of the Army Audit Agency to ensure funds used under these authorities are solely for the purposes intended and approved by the SECARMY. The rules for using the authorities are very specific and exceptions to deviate should be obtained from higher headquarters.

# HOW THE ARMY RUNS

## Section IV

### Account for the Use of Resources

#### 9-12. Legally Using the Resources to Accomplish the Mission

31 U.S.C. 1301(a) states that "Appropriations shall be applied only to the objects for which the appropriations were made except as otherwise provided by law." The act, generally referred to as the Purpose Statute was initially enacted in March 1809 to limit the discretion of the executive branch in spending appropriations. To preclude the misappropriation/mispending of funds, a body of laws, regulations, court decisions, and rules has evolved over many years to direct how fiscal resources will be used to accomplish the Army's missions and tasks. Because Congress provides funds in specific amounts for specific purposes through the enactment of public law, the expenditure of those funds must be within the boundaries established by the law. The term "administrative control of funds," as required by law is used to identify those actions, events, or systems that are required to ensure essentially three things:

- a. Funds are used only for the purposes for which they were intended.
- b. Amounts of funds in excess of that available, are neither obligated, neither disbursed nor further distributed.
- c. The agency head is capable of fixing responsibility in the event of violations of either of the first two.

#### 9-13. Properly Obligating the Resources

An obligation is the action taken to establish a liability against the USG that will ultimately result in a disbursement from the U.S. Treasury. There are several principles that must be followed in executing and accounting for obligations. The foundations for these principles are contained in 31 U.S.C. Money and Finance. While only the most important "obligating" principles are outlined here, the entire listing is provided in the DOD Financial Management Regulation 7000.14-R.

- a. Bonafide need of the current FY. A determination must be made that supplies or services required pursuant to contracts entered into or orders placed obligating an annual appropriation are intended to fill a bona fide need of the current FY. There are provisions when lead-time is an important factor to obligate funds in the current year for a subsequent year delivery.
- b. Intent of Performance. Contracts entered into or placed for supplies or services are executed only if there is a bonafide intent on the part of the contractor (or other performing activity) to commence work promptly or to perform the contract in accordance with its terms and conditions (to include beginning date).
- c. Assure Availability. The responsible official must ensure that proper funds are available before binding the USG in an agreement with a second party, which will result in an obligation for which the Government is required to pay.
- d. Documentary Evidence. Each obligation recorded in the official record must be supported by proper documentary evidence. These may be originals, duplicates, or copies of appropriate documents so long as signatures are visible. A memorandum of telephone conversation or an electronically received written message may be used temporarily until the actual document is received.
- e. Charge Immediately. Obligations, when incurred, must be charged immediately to the applicable account. The recording of obligations incurred cannot be deferred until additional funds are received. The obligation must be recorded even if there are insufficient funds to cover it, thereby incurring a statutory violation, which must then be reported through command channels. Failure to record an obligation will not obviate a suspected violation of the ADA statute.
- f. Prompt Adjustment. Any adjustment to previously recorded obligations, either as an increase or decrease, must be entered in the accounts as soon as the necessity for an adjustment is evident and the amount can be determined.

#### 9-14. Anti-Deficiency Act (ADA)

Chapters 13 and 15 of 31 U.S.C. contain prohibitions with respect to the legal use of funds and establish punitive provisions in the event there are violations. When the ADA was codified into the U.S.C., its provisions were incorporated into a number of sections of 31 U.S.C. The sections that are most frequently cited are sections 1341, 1342, and 1517.

- a. How Anti-deficiency Act Violations Occur. Generally, ADA violations may occur when:

(1) Funding authority is issued in excess of the amount available and the excess amount is obligated or expended.

(2) There are violations of the special and recurring statutory limitations or restrictions on the amounts for which an appropriation or fund may be used.

(3) There are violations of statutory or regulatory limitations on the purposes for which an appropriation or fund may be used.

(4) Obligations are authorized or incurred in advance of funds being available.

(5) Obligations or expenditures of funds do not provide for a bona fide need of the period of availability of the fund or account and corrective funding is not available.

b. Administrative and criminal penalties for ADA violations. The person who caused the violation may be subject to discipline, to include suspension without pay or removal from office (31 U.S.C. 1349 and 1518). If an action is taken knowingly and willfully and results in a conviction for violating the ADA, the person may be fined up to \$5000, imprisoned for not more than two years, or both (31 U.S.C. 1350 and 1519).

### 9-15. Accounting for the Obligation

a. Legal Mandate to Account for Funds. By law the DOD is required to maintain accounting systems that provide:

(1) Complete disclosure of the financial results of the Department's activities.

(2) Adequate financial information the Department needs for management purposes.

(3) Effective control over, and accountability for, assets for which the Department is responsible.

(4) Reliable accounting results that will be the basis for:

(a) Preparing and supporting the Department's budget requests.

(b) Controlling the Department's budget execution.

(c) Providing financial information POTUS requires.

(d) Suitable integration of the Department's accounting with the central accounting and reporting responsibilities of the Secretary of the Treasury.

b. Defense Finance Accounting System (DFAS). The majority of the Army's accounting is performed by DFAS. DFAS consists of a headquarters located in Washington, D.C., five centralized sites located in Indianapolis, Cleveland, Columbus, Denver, Kansas City, and 20 field sites or Operating Locations. The Army pays approximately \$500M for DFAS services on an annual basis. In contingency or combat operations, Soldiers of the Finance and Comptroller Branch perform the accounting and disbursing functions on the battlefield. In some instances in Theaters where Finance and Comptroller elements are forward stationed (Korea, Hawaii, Germany); they will execute the accounting and disbursing of funds associated with Theater exercises.

c. The principal accounting system used is GFEBS. Other accounting systems are used by the Research, Development and Acquisition activities, the U.S. Army Corps of Engineers, and the Army National Guard.

### 9-16. Year-End Certification of Accounts

Commanders who receive FADs are required to certify their annual obligations as of 30 September of that FY. In most instances the Comptroller, as part of their delegated authority, will certify the accounting report.

a. DFAS will provide the command a certified record of their accounting with the following statement: "I hereby certify that the attached reports and associated schedules include all transactions received which have been properly recorded and are supported by subsidiary accounting records."

b. The Commander or designated representative, will make the following certification: "I hereby certify that the attached reports and schedules include all known transactions. Those meeting the criteria of 31 U.S.C. 1501(A) have been obligated and are so reported. All reports and schedules for all transactions for the fiscal year ended September 30, \_\_\_\_\_, are correct and are supported by subsidiary accounting records. All individual upward obligation and open allotment disbursement adjustments in excess of \$100,000 of expired appropriations have been properly approved and are on file for audit purposes."

c. Certifications are required for all appropriations and for any reimbursable activity performed by the command or agency. The ASA (FM&C) certifies all Army appropriations to the U.S. Treasury.

# HOW THE ARMY RUNS

## Section V Fiscal Stewardship

### 9-17. Overview

The Secretary and Chief of Staff, U.S. Army charged Army leaders with the responsibility to be better stewards of the fiscal resources they receive from the American Taxpayer. Army Senior Leaders (ASL) determined that if the Army received an adequate budget, on time, it could not go back to the American Taxpayer for additional money until it reformed how it spent the money on hand. Thus, stewardship of all resources is the responsibility of the commander or senior leader of the agency to ensure resources are optimized. These leaders leverage their Comptroller on the budget execution end and the Comptroller coordinates with Finance units to assist in accounting and disbursing the obligations made. As the majority of Army expenditures are for contracts, transportation and supplies, close coordination with Sustainment and Contracting professionals is critical. There are a number of tools available to leaders to evaluate and analyze the effectiveness of their budget execution.

### 9-18. Command Accountability and Execution Reviews (CAER)

a. Established on 24 April 2018, CAER was created to optimize the purchasing power of Army O&M funding. Analysis of historical execution (using FY12 as the basis for that analysis), the Army found that it only uses about 95% of its O&M funding. While at the close of the FY obligation rates were around 100%, over the course of the five expired years, nearly 5% would be sent back to the Treasury as unspent. The Army thought they had spent those dollars on readiness; however, due to a number of factors, those dollars were excess to need.

b. CAER puts commanders back into the decision making and oversight of their budgets. CAER helps the Army and subordinate commanders see their fiscal health better and isolate the root causes of issues to focus limited time and effort on the most important issues.

(1) The three primary de-obligation problems areas for the Army are:

- (a) Contracted Services
- (b) Transportation of People and Things
- (c) Supply Chain

(2) To get after the root causes of these drivers the program addresses three echelons:

- (a) Headquarters Department of the Army
- (b) ACOM, ASCC, and DRU Commands
- (c) The DoD Enterprise

(3) To ensure the proper level of visibility of issues the program gathers three groups of leaders:

- (a) Commander briefings to the Under Secretary of the Army and Vice Chief of Staff (CAER-C)
- (b) Enterprise working groups with key Army and DoD entities to bring about enterprise solutions

(CAER-E)

(c) Quarterly updates to SECARMY and the CSA on progress and to receive guidance (CAER-S)

c. The program provides commanders with a number of analytical tools, leveraging Army data across accounting, supply chain, contracting, travel, and training systems to provide commanders with a comprehensive understanding of their cost drivers, de-obligation risks, and overall budget execution performance to build readiness. In addition to CAER, ASLs, instituted a comprehensive review of all programs to find efficiencies for application to critical modernization needs.

### 9-19. Budget Reviews

The most significant review is at the mid-year mark of the FY – usually in April. This review will analyze execution of budgets over the first 6-months of the FY, which is a good indicator of how the second half of the FY will perform. It allows Army leaders to make in stride changes to the budget plan and to identify amounts for reprogramming requests to Congress and to build the Unfunded Requirements (UFR) list in preparation for the last quarter of the FY. The Army may also conduct quarterly reviews of performance depending on the appropriation type, complexity of the FY, and/or the number of changing missions and requirements. The Army Budget Office (ABO) is responsible for the conduct of these reviews.

### 9-20. Analyzing Execution; The Joint Reconciliation Program

The Joint Reconciliation Program is an effort combining the skills and expertise of accountants, budget analysts, contracting professionals, logisticians, internal review auditors, and DFAS personnel for the



purpose of verifying the validity of un-liquidated obligations, contractor work in progress, billing status, and validating the continued need for goods and services that have not yet been delivered. The JRP is what happens below the CAER level of visibility and works the detailed analysis and actual work of adjusting the accounting of the organization. When performed properly, and in the current year of execution, the JRP will result in real dollar savings through the identification of obligations in excess to need and for use on other requirements. As a result of performing effective joint reconciliation, commands increase their purchasing power which directly enhances mission accomplishment. Additionally, effective JRP increases the Army's stewardship credibility with Congress and the taxpayer.

### **9-21. Shifting Resources**

In general, the annual budget is created almost 18-months before the first dollar is spent. In order to be effective Stewards of public funds the Congress recognizes and allows for flexibility during the execution year to make adjustments to emerging needs or changing priorities. Examples include; emerging contingency operation, storm damage to an installation, changes in fuel prices, acceleration of procurement programs to achieve an economic savings, or any other unforeseen mission or task.

a. Reprogramming actions are governed by limits imposed by the Congressional committees and manifest themselves in either the Appropriations of Authorization Act. Actions below established thresholds are considered 'Below Threshold Reprogramming (BTR); and those above thresholds as 'Above Threshold Reprogramming (ATR) Requests to transfer above an established threshold require approval or announcement to the Congressional committee who set the threshold.

b. Other flexibility is obtained through existing US Code or language included in a law. The OASA (FM&C) manages the reprogramming process for Army appropriations.

## **Section VI Financial Reform**

### **9-22. Efforts to Reform**

Since the early 1980s, major legislative and Army management initiatives have introduced an unprecedented focus on performance and results. These initiatives all point to the transition to more outcome-oriented program management and performance budgeting. Currently, Reform is Line of Effort 3 of the Army Strategy - 2028.

### **9-23. Federal Manager's Financial Integrity Act of 1982**

a. The FMFIA requires all federal agencies to establish and maintain effective accounting and administrative controls to provide "reasonable assurance" that agency management controls are reasonable and, where they are not, material weaknesses are identified and corrective actions are taken.

### **9-24. Chief Financial Officer Act of 1990**

a. The CFO Act was enacted to implement more effective financial management practices in the federal government. Its key purpose is to provide more accurate, timely, and reliable financial information for decision-makers through improved accounting systems, integrated functional and financial management, and strengthened internal controls.

b. A major provision of the Act mandated the preparation of audited annual financial statements for revolving funds, trust funds, and substantially commercial activities. The Army and DoD completed its first full financial audit in 2018. The department is working to improve processes and procedures identified as deficient during the audit. A successful audit starts at the squad-leader level and requires engaged leadership at each echelon.

### **9-25. Government Management Reform Act of 1994**

a. GMRA implements the requirements for audited annual financial statements "covering all accounts and associated activities of each office, bureau, and activity of the agency" for all federal agencies. Beginning in 1998, and annually thereafter, the Secretary of the Treasury, in coordination with the Director of the OMB, is required to submit to POTUS and Congress government-wide audited financial statements that cover all accounts and associated activities of the executive branch of the federal government. With the end of the CFO Act pilot project and full implementation of reporting under the Act,

## HOW THE ARMY RUNS

the Army continues working to implement the letter and the spirit of the legislation and to improve all aspects of Army financial management and stewardship.

### **9-26. Government Performance and Results Act of 1993**

a. The GPRA is major management reform legislation and a critical step in the inevitable transition to more outcome-oriented program management and performance budgeting. The purpose of the GPRA is to increase public confidence in the federal government and improve program effectiveness and public accountability by systematically holding agencies accountable for achieving program results.

b. Through its PPBE process, the Army reviews and monitors its strategic plans and mission objectives. The PPBE process supports the Army's implementation of the GPRA by using The Army Plan (see Chapter 2, Strategy).

### **9-27. Federal Financial Management Improvement Act of 1996**

This law builds upon and compliments the acts discussed above. It requires auditors to report as part of their report on agencies' annual financial statements whether the agencies' financial management systems comply substantially with requirements. These three requirements are critical for ensuring that agency financial management activities are consistently and accurately recorded, and timely and uniformly reported throughout the federal government:

- a. Federal financial management systems requirements;
- b. Applicable federal accounting standards; and
- c. The USG Standard General Ledger at the transaction level.

### **9-28. Management Controls**

a. Management controls are the procedures established to ensure accomplishment of objectives and guard Army resources against fraud, waste, and abuse. Numerous audit and inspection reports, however, continue to find serious management control deficiencies in DOD and the Army. This damages the Army's reputation as stewards of public resources and hinders its ability to compete effectively in Congress for additional resources. Congress has made clear that their emphasis on management controls will continue.

b. Army Regulation 11-2, Management Control, establishes policies and guidelines for implementing the provisions of the Federal Financial Management Improvement Act. It describes the Army's current management control process which was restructured effective in FY 95 to reduce the administrative burden, to provide commanders and managers with greater flexibility in scheduling and conducting their evaluations, and to make them directly accountable for the effectiveness of their management controls. The restructured process requires management control evaluations only for the most critical controls (the "key management controls") and encourages commanders and managers to use existing review and oversight processes wherever possible to accomplish evaluations.

### **9-29. Cost Management**

a. CM must play a critical role in support of decision-making in order to maintain the maximum number of well-trained and properly equipped forces possible. CM allows the Army to maintain the maximum capability possible in the face of the constant reduction of dollars available to resource the force. This is an unfamiliar war, fought on an unfamiliar battleground by commanders and leaders generally new to the weapons needed to win. CM, focused on the activities necessary to produce the products or services required for mission success, is the most important war-fighting doctrine available for employment. Given full understanding of the potential of CM and complete knowledge and use of its working parts, the cost war can be won.

b. The Army has chosen to implement Activity Based Costing (ABC) as a tool to assist the local manager in maximizing scarce resources and as a means of continuous process improvement. The Army Implementation Plan mandates CM / ABC implementation in the Army's eleven support business areas. These business areas are Acquisition, BASOPS, Civilian Human Resources (CHR), Contracting, Depot Maintenance, Information Support, Institutional Training, Ordnance, R&D Laboratories, Supply Management, and Test & Evaluation.

c. CM principles offer commanders greater flexibility in mission execution by providing more information in the decision-making process. Planning and the ABC model provide the foundation for CM. Use of the model in the commitment and review cycle enables commanders and other senior leaders to conserve

resources within individual operations (see Figure 9-3). By reducing the costs of individual operations, the manager has flexibility with funds during the execution year. These available funds must be identified early in the FY to enable execution of other priority missions. CM / ABC provides a mechanism for accomplishing the mission within the funds provided.

**9-30. Cost Modeling**

CM / ABC focuses managerial skills and action at all levels on the results of a cost modeling process that presents useful, accurate cost data based on the activity (a product or service) that the manager wishes

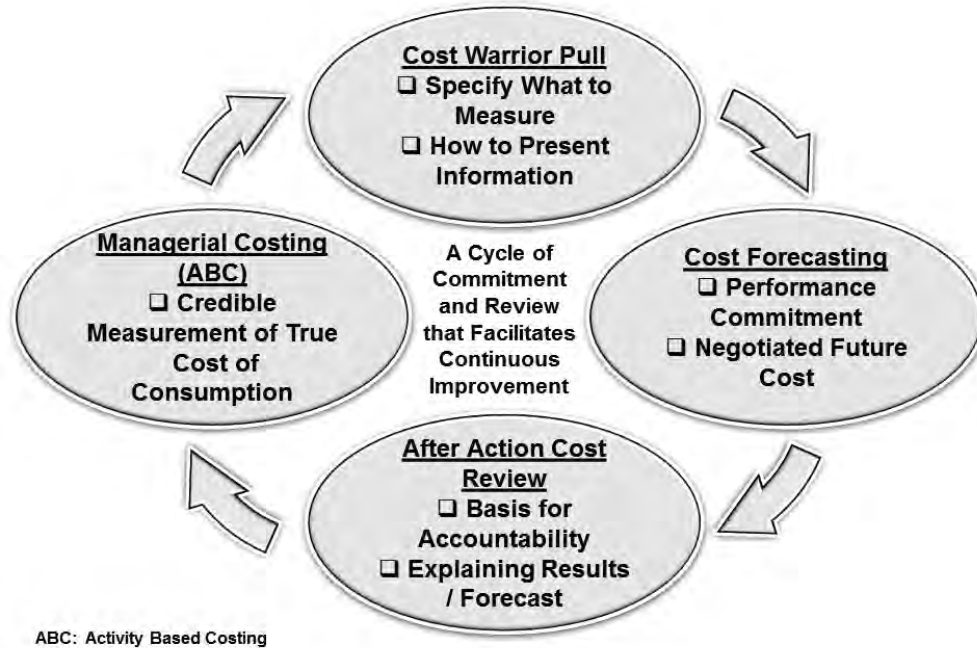

**Figure 9-3. Cycle of Commitment and Review**

to accomplish. Traditional cost accounting systems and processes in DOD do not provide the same focus. Instead, they focus cost models on bags of money that are available to accomplish grossly defined categories of expenditures. Amounts of money are allocated to the bag by passing down a limit or budget, then managers at all levels use up the money until someone tells them that the budget is exhausted. This is and has been the conventional way of operating. In fact, using up the entire budget allocated down to low levels in the organization has generally been viewed as a good thing. The budget has come to be thought of as an entitlement to spend. This is far from a desirable way to operate at a functional level. The objective should be to use as little money as possible to achieve a defined level of quality and thereby have as much money as possible available to allocate to other command priorities. These available funds must be identified early in the FY to enable execution of other priority missions.

**9-31. Building an Activity Based Costing Model**

a. An ABC model is needed because the traditional cost accounting system used by the DOD does not allow the assignment of all relevant costs to a product or service (activity). For example, a commander should know the total cost of activities under his control (e.g. the cost of overhauling a tactical vehicle, or training a Soldier in a new Military Occupational Specialty, or renovating a set of family quarters). More importantly, the manager that has the power to influence costs must know and understand them. By analyzing them and the process that produces them, the effective manager is prompted to discover numerous changes that will affect costs.

b. A useful model is built by allowing the people who do the work to build their model using a simple question and answer walk-through of what they do each day in performing their mission. All relevant costs are then allocated to the product or service that the tasks produce. No salary or other relevant expense can be left out. Managerial tasks commonly referred to as overhead and other costs have to be

## HOW THE ARMY RUNS

considered. On the other hand, precision, carried to an extreme, can overly complicate the process and diminish usefulness of the results. This outcome has been observed in many initial attempts at creating a useful cost model. Together, CM and the ABC model give the manager a structure to be as cost effective as possible.

### 9-32. Using the Activity Based Costing Model

a. Once a model is built and is repetitively presenting unit cost results, a managerial process to use the data has to be implemented. Leaders with power to change the way things function must view the unit cost data, be presented with managers' analyses, and approve or create new work processes and direct their implementation.

b. A regularly scheduled performance review and planning meeting can be the single vehicle to do all these things. The manager is presented with the data, preferably by the individuals responsible for spending the money to produce the product, and its correctness is evaluated. The best results are usually reached if the first line manager is the person explaining what the costs are and why his planned resource needs were either exceeded or improved upon. Since the overall goal is to reduce unit costs without sacrificing performance, that discussion ensues. It is important to remember that this same manager previously presented his spending plan, using his ABC model as the basis, for the quarter that is now being reviewed.

c. The commander or senior manager should be the leader at the review as this is the person who has the ultimate authority to implement procedural changes that result in cost reductions in the process under scrutiny. The commander is also the one that will reallocate the savings produced to higher priorities. An integral part of the overall methodology must be to provide incentives for managers at all levels to think and work smarter.

### 9-33. Cost Benefit Analysis—A Key Decision-Making Tool

a. Cost Benefit Analysis (CBA) is a structured methodology for forecasting and comparing the anticipated costs and benefits of alternative courses of action in order to identify the optimum solution for achieving a stated goal or objective. The goal is to produce a strong value proposition—a clear statement that the benefits more than justify the costs, risks, and bill payers (see Figure 9-4).

b. In today's resource-constrained environment, the Army must exercise wise stewardship of every dollar it manages. A key element in that stewardship is to develop and use sound CBA practices throughout all requirements / resourcing processes. For every proposed program, initiative, or decision point that is presented to decision makers, it is important to provide an accurate and complete picture of both the costs to be incurred and the benefits to be derived.

### 9-34. Enterprise Resource Planning

The OSD-level Enterprise Funds Distribution (EFD) system is a web-based system which combines congressional tracking with funds distribution to the Army and contains specific instructions on funds control. EFD has standardized funding authorization documents (e.g., Obligation Authority (OA) letters, DD440 documents, DD460 documents and annual operating budget for Working Capital Funds appropriated funding).

### 9-35. General Fund Enterprise Business System

a. The GFEBS is a Chief Financial Officers Council certified commercial off the shelf (COTS) Enterprise Resource Planning (ERP) system designed to provide the Army relevant, reliable, and timely financial information across the full spectrum of its operations. GFEBS is helping the Army standardize and streamline its financial business processes to provide continuous access to financial information, as well as contribute an important element in the development of an Army integrated enterprise-wide system.

b. The three Army ERP systems—GFEBS, the Logistics Modernization Program, and the Global Combat Support System-Army provide the Army an integrated enterprise-wide system to provide decision-makers with data for better informed decision making and to comply with legal and mandatory reporting requirements. As "mixed systems," these three systems perform financial management functions to better support their primary missions and system functions.

c. GFEBS Business Process Areas. GFEBS is organized into six functional business process areas related to Funds Management.

- (1) Funds Management (Budget Execution and Budget Formulation) – includes General Fund management, budget execution, and budget formulation below HQDA level.
- (2) Property, Plant and Equipment – includes real property management and maintenance, materials management, equipment and asset management, and environmental liabilities.
- (3) Spending Chain – includes initiating purchase requisition, checking funds, recording obligations, managing goods and services receipts, and logistics integration and inventory management.
- (4) Cost Management – includes full costing, and payroll and travel interfaces.

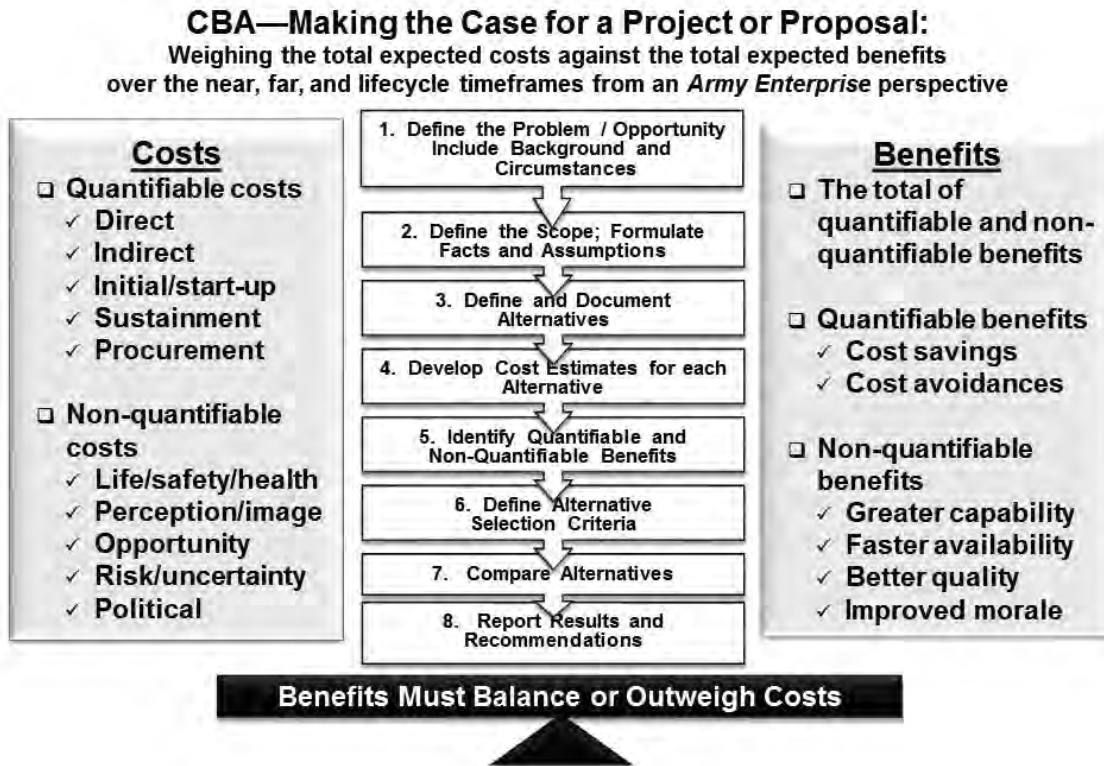

**Figure 9-4. Cost Benefit Analysis**

- (5) Financials – includes U.S. Standard General Ledger accounting (USSGL), workflow journal voucher approval process, financial statements, and month end and year-end closing processes. Also includes sub-processes of reimbursable management and accounting.
- (6) Reimbursables – includes reimbursable order processing and debt management.

**Section VII  
Non-Appropriated Funds**

**9-36. Non-Appropriated Funds (NAF) Definitions**

- a. NAF are cash and other assets that are not appropriated by Congress. NAF come primarily from the sale of goods and services to authorized patrons, DOD military and civilian personnel and their family members, and are used to support MWR programs for the collective benefit of authorized patrons who generate them. NAF are government funds, but they are separate and apart from APF that are recorded on the books of the U.S. Treasury.
- b. Non-Appropriated Fund Instrumentality (NAFI). A NAFI is a USG fiscal entity that performs an essential government function. It acts in its own name to provide, or assist other DOD organizations in providing, MWR, and other programs for military personnel, their families, and authorized civilians.

## HOW THE ARMY RUNS

### 9-37. Non-Appropriated Funds Instrumentality Management (10 U.S.C. 2783)

a. Every NAFI is legally constituted as an “instrumentality of the United States.” Funds in NAFI accounts are USG funds and NAF property including buildings and real estate is USG property. NAF are not commingled with APF and are managed separately, even when supporting a common program or activity. This means that:

(1) Each NAFI operates under the authority of the USG in accordance with applicable federal laws and departmental regulations.

(2) Because NAFIs operate under the authority of the federal government, they are entitled to the same sovereign privileges and immunities as the USG accorded by federal law.

(3) Applicable DOD directives and implementing Army regulations have the force and effect of law.

b. A NAFI is administered and managed by military or civilian personnel acting in an official capacity. The NAFI is generally immune from federal taxes and exempt from most direct state, local, and host country taxes. It must account for and report financial operations through command and department channels. NAFI operations are subject to review by Congress. AR 215-1, Military Morale, Welfare, and Recreation Programs and Non-appropriated Fund Instrumentalities, provides more information on management of Army NAFIs.

### 9-38. Management of Morale, Welfare, and Recreation and Non-Appropriated Funds

a. Morale, Welfare, and Recreation (MWR) and NAF are managed by a Board of Directors (BOD). Members of the BOD are the four-star commanders, the Sergeant Major of the Army, and the ASA (M&RA). The senior military member chairs the BOD. The MWR BOD develops goals and objectives, approves financing strategies, monitors performance, prioritizes NAF major construction requirements, and ensures fiduciary responsibility for MWR.

b. An Executive Committee (EXCOM) reports to the MWR BOD. The EXCOM is chaired by the G-1. The BOD structure also includes Strategic Planning, Finance, and Audit Committees that report to the EXCOM. An Investment Subcommittee reports to the Finance Committee.

c. Individual responsibility. There is an individual fiduciary responsibility to use NAF properly and prevent waste, loss, mismanagement, or unauthorized use. This responsibility extends to all DOD personnel to include members of the Armed Forces and appropriated funded and non-appropriated funded civilian employees.

d. The ASA (FM&C) oversees NAF by participating on the Morale, Welfare, and Recreation (MWR) Board of Directors. The DASA (FO) is a voting member of the MWR EXCOM. In addition, the Principal Deputy Assistant Secretary of the Army (FM&C) chairs the Audit Committee, and the Chief Resource Analysis and Business Practices serves on the Investment Subcommittee. Through these positions, the ASA (FM&C) influences virtually all aspects of MWR financial policy. As part of the responsibility of overseeing NAF, the ASA (FM&C) presents NAF issues to the SECARMY and CSA for decision.

## Section VIII

### Summary, Key Terms, and References

#### 9-39. Summary

a. The roles and missions of Finance and Comptroller continues to evolve. New legislation, new requirements, new management initiatives, new missions, new doctrine and the proliferation of cryptocurrencies and electronic banking require a continual focus on developing new approaches to Army money. Advances in data analytics brings about a new level of analysis which requires training in new areas to provide decision makers at all levels with powerful tools to maximize the allocation and application of resources.

b. Real success lies in a well-trained workforce who understands commander’s intent, the unit mission and the legal and regulatory complexities of the fiscal environment. This requires commanders and peer staff officers to understand the capability finance and comptrollers bring to the unit and how to properly integrate that capability into every aspect the of the unit’s operations.

c. This chapter summarized the more pertinent features of finance and comptroller systems using a minimum of the complex terms associated with the process. This chapter identified the major players, the major steps they must take, and the various controls that guide their actions in the RM process particularly during the execution stage.

### 9-40. Key Terms

a. Asset leverage. The combination of government assets with private sector knowledge, expertise, equity and or financing in a venture (partnership) which results in long term benefit to the government.

b. Budget Authority (BA). BA is the authority to incur a legal obligation to pay a sum of money from the U.S. Treasury. BA is not “money.” The U.S. Treasury actually disburses cash only after an agency (e.g., DFAS) issues a U.S. Treasury check withdrawing money from the Treasury and thus disburses the money to pay a previously incurred obligation.

c. Comptroller. The Comptroller is a key member of the commander’s staff with primary responsibility to execute the command’s funding. They provide analysis, recommendations and accounting of appropriated funds allocated to the unit to accomplish its mission. The Comptroller is often referred to as the Director of Resource Management or its staff moniker – S/G/J8. (At the Army/HQDA level the DA G8 has the responsibility of working Programming functions, e.g. the POM and not the execution of the budget).

d. Congressional Appropriation. A law passed by the Congress and signed by POTUS that provides BA for the specific purpose(s) stated in the law. In the case of the annual DOD appropriations act (e.g., Public Law 111-118, Department of Defense Appropriations Act, 2015) BA is provided for a number of appropriations (e.g., OMA; Military Personnel, Army (MPA); RDT&E,A; MCA) for a specified period of time for the Army to incur legal obligations as it executes the programs authorized by Congress and other laws that guide Army operations.

e. Congressional Authorization. A law passed by the Congress and signed by POTUS that establishes or continues a federal program or agency, and sets forth guidelines to which it must adhere. Generally for every FY, the Congress passes an NDAA (e.g., Public Law 111-383, Ike Skelton National Defense Authorization Act for Fiscal Year 2015), which directs by law what can be purchased, what manpower resource levels each service can have, and how many weapon and other materiel systems can be bought. It also provides additions and changes to 10 U.S.C. that, among other laws, guide the management of the Army and the other activities of the DOD. An authorization act does not provide the BA to draw funds from the U.S. Treasury to pay an obligation.

f. Cost-Benefit Analysis (CBA). A structured methodology for forecasting and comparing the anticipated costs and benefits of alternative courses of action in order to identify the optimum solution for achieving a stated goal or objective. The goal is to produce a strong value proposition—a clear statement that the benefits more than justify the costs, risks, and bill payers.

g. Disbursement. Payment of an obligation of the USG.

h. Fiscal Year (FY). The FY is the government’s accounting period. For the federal government, it begins on 1 October and ends on 30 September. The FY is designated by the appropriation year Congress is legislating (usually the same as the calendar year in which it ends. For example, FY 2015 begins on 1 October 2014 and ends on 30 September 2015).

i. Obligation. Any act that legally binds the USG to make a payment. From the central concept of “obligating the USG to make a payment” springs forth the foundation of the Nation’s fiscal law and the legal parameters under which the Army must operate as a part of the USG. The obligation may be for a service rendered by a contractor, the acquisition of materiel items (e.g., a tank), the construction or repair of a facility, or salary for a Soldier or civilian.

j. Outlays. Outlays are the amount of money the Government actually disburses in a given FY.

### 9-41. References

a. U.S.C. Titles from <http://uscode.house.gov/> as follows:

- (1) Title 5 U.S.C., Government Organization and Employees.
- (2) Title 10 U.S.C., Armed Forces.
- (3) Title 31 U.S.C., Money and Finance.
- (4) Title 32 U.S.C., National Guard.
- (5) Title 41 U.S.C., Public Contracts.

b. DOD Financial Management Regulation (FMR), 7000.14-R;  
<https://comptroller.defense.gov/FMR.aspx>.

c. ASA (FM&C): <https://www.asafm.army.mil/>.

d. Office of Management and Budget: <https://www.whitehouse.gov/omb>.

## HOW THE ARMY RUNS

- e. AR 11-2, Managers' Internal Control Program, 4 January 2010 with a Rapid Action Revision (RAR) 001, 26 March 2012.
- f. AR 215-1, Military Morale, Welfare, and Recreation Programs and Non-Appropriated Fund Instrumentalities, 24 September 2010.
- g. DFAS 37-100. <https://www.asafm.army.mil/DFAS-Guidance/DFAS-IN-Manual-37-100/FY-2019/>.
- h. AR 10-87. Army Commands, Army Service Component Commands and Direct Report Units, 11 December 2017.
- i. General Order # 2019-01. Assignment of Functions and Responsibilities within Headquarters, Department of the Army.



# CAPABILITY REQUIREMENTS AND SYSTEM RESEARCH, DEVELOPMENT, AND ACQUISITION MANAGEMENT

## Chapter 10

### Capability Requirements and System Research, Development, and Acquisition Management

#### Section I Introduction

##### 10-1. Department of Defense and U.S. Army Capabilities Development and System Acquisition Management

This chapter describes Department of Defense (DOD) and U.S. Army management, key roles, missions, functions, and processes/systems used for Capability Requirements and System Research, Development, and Acquisition (RDA) Management of materiel systems across the Army Modernization Enterprise (AME). The AME can view these systems as a combination of structure, process, and culture.

- a. Structure is the sum of regulatory guidance, policy, or process, and the organization provided to accomplish the RDA management functions.
- b. Process is the interaction of the structure in producing the output.
- c. Culture is the cumulative sum of past practices and their impact on interpretation of guidance and attitude toward institutional changes to the system.

##### 10-2. Primary Purpose

This chapter provides a systematic way for the joint warfighter to acquire an Army capability when required. This translates into supporting the Army's primary responsibility to field properly trained, equipped, and sustained military units to execute missions in support of the National Defense Strategy (NDS), National Security Strategy (NSS), and the National Military Strategy (NMS). This strategic guidance enables the Army to develop and acquire needed warfighting capabilities that are both operationally effective and affordable to meet stated objectives. To facilitate an understanding of these processes, this primer will begin by highlighting some critical aspects of Joint Capabilities Integration and Development System (JCIDS), the Defense Acquisition System (DAS), and established policy for the management of all acquisition programs across the AME.

#### Section II Army Modernization Enterprise (AME) and Army Futures Command (AFC)

##### 10-3. AME and AFC

The AME provides the foundation from which the Army will deliver solutions to warfighters and formations. The AME will continuously integrate processes and entities, and will revolutionize and improve the means by which the Army develops and delivers overmatch in the future and across multiple domains. Army leaders recognized that emerging threats from near-peer competitors require a new and integrated approach to conceive, develop, and deliver the right solutions to ensure overmatch and success of the Army's Future Force.

- a. New ideas and recommendations for modernization efforts could now be an outcome from subsequent AME engagements and interactions using an Open Innovation Process Model (Figure 10-1). In this model, ideas, concepts, science, and technologies can come from both internal and external sources. This model is more in line with the purpose of the AME enterprise because it allows multiple pathways into and out of the AME to find, develop, integrate, and deliver the best ideas, concepts, science and technologies, and complete doctrine, organization, training, materiel, leadership and education, personnel, facilities, and policy (DOTMLPF-P) solutions. Using this model enables constructive dialog, circulates information to stimulate ideas and create early touchpoints for AME

## HOW THE ARMY RUNS

development and requires diverse Army commands, organizations, industry, government and agencies to work together, which will bring about the full potential of the AME. Therefore, the Open Innovation Process Model will enable the Army to leap ahead of future threats and rapidly exploit new opportunities. AFC leads the AME efforts for the Army.

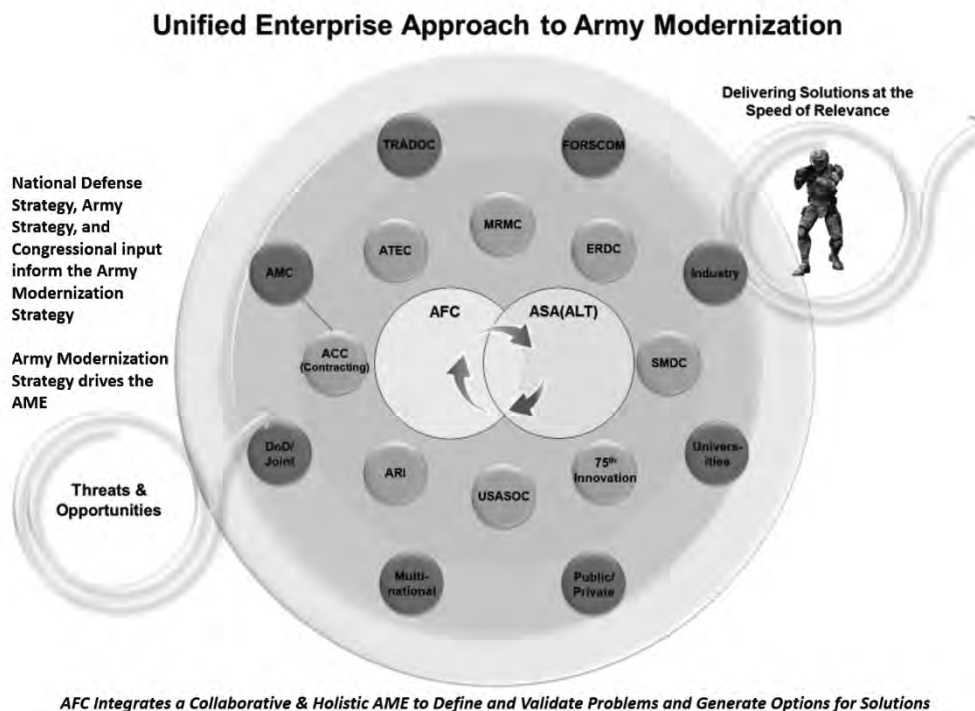

**Figure 10-1. Key elements in the AME (Open Innovation Process Model)**

b. The formation of AFC recognizes the modernization challenges the Army faces. AFC's focus is on driving the Army to the future (General Order 2018-18, 4 June 2018). AFC's mission is to lead a continuous transformation of Army Modernization to provide future warfighters with the concepts, capabilities, and organizational structures needed to dominate on the future battlefield. AFC assesses and integrates emerging threats and technologies to develop and deliver concepts, requirements, and future force designs to provide modernization solutions and strategic direction for the AME. The principles of being strategic, effective, innovative, agile, unified, and faster are the basis for the establishment of AFC. AFC creates a culture that unifies talent, capabilities, and infrastructure across the AME to strategically and effectively develop and deliver the future force.

c. AFC established Cross-Functional Teams (CFTs) which underpin the focus on strategic priorities in line with the Army Modernization Strategy (Figure 10-2). Eight CFTs champion initiatives related to the Army's current modernization priorities: 1) Long-Range Precision Fires; 2) Next Generation of Combat Vehicles; 3) Future Vertical Lift; 4) Network (Position, Navigation and Timing); 5) Air and Missile Defense; and 6) Soldier Lethality (Synthetic Training Environment). The CFTs are working to ensure the Army achieves the required capabilities in their respective areas. In addition, the CFTs have the flexibility and authority to stimulate action, break down barriers, and move ideas forward as they leverage the industrial, academic, requirements, acquisition, logistics, science and technology, contracting, testing, and resourcing communities. Overall, CFTs demonstrate the integration of the AME.

d. A holistic solution or approach is required to overcome the Army's modernization challenges. AFC accomplishes its modernization reform objectives through another component called the Army's Top-Down Futures Development Process (Figure 10-3). The Top-Down Futures Development Process

# CAPABILITY REQUIREMENTS AND SYSTEM RESEARCH, DEVELOPMENT, AND ACQUISITION MANAGEMENT

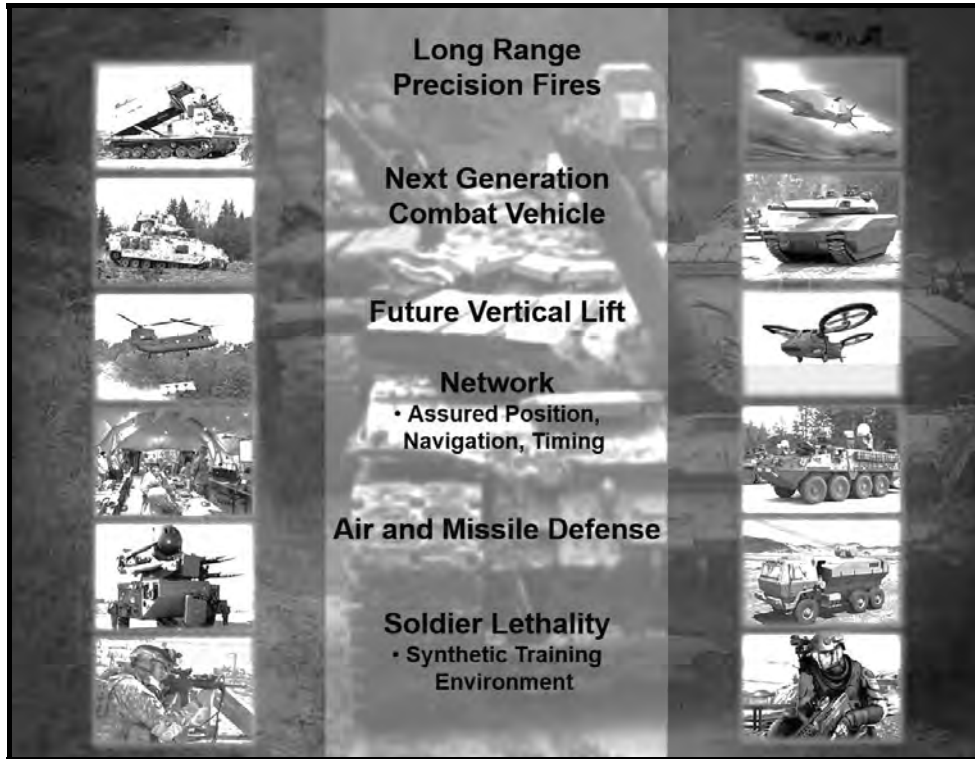

Figure 10-2. Modernization: Cross-Functional Teams

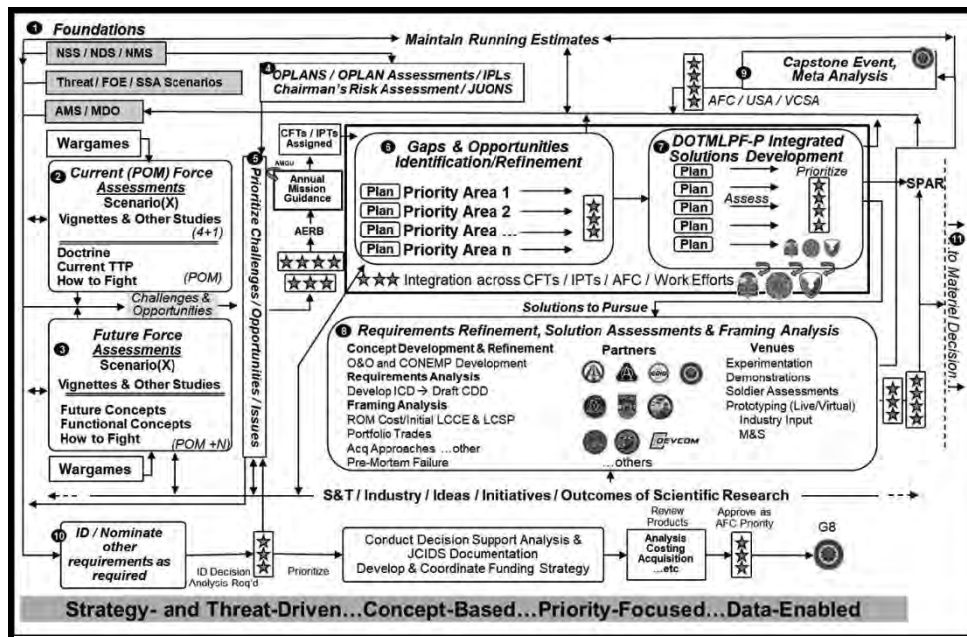

Figure 10-3. AFC's Top-Down Futures Development Process

leverages recent legislative authorities such as Middle-Tier Acquisition (MTA) for rapid prototyping and rapid fielding, and integrates with the JCIDS Process and DAS, capitalizing on existing avenues for accelerated acquisition through these processes. This process enables the examination of modernization solutions across the DOTMLPF-P to achieve a more efficient and effective effort.

## HOW THE ARMY RUNS

e. Based on multiple sources and insights from capabilities development and materiel development subject matter experts, the AFC Top-Down Futures Development Process was developed to mitigate these modernization challenges and enhance reform efforts. This process adheres to strategy-driven, threat-driven, concept-based, priority-focused, and data-enabled activities as their guiding principles. The Top-Down Futures Development Process addresses AME activities prior to the Materiel Development Decision (MDD) or a decision to implement a DOTmLPPF-P Change Recommendation (DCR). It establishes a common foundation to modernize the Army and enables better senior leader decision-making, resulting in the delivery of quality solutions to the warfighter.

f. Figure 10-3 depicts a set of eleven tasks that captures this scientific method. The information gained in one task informs the next task and so forth. In addition, continuous feedback loops enable the AME to measure its progress towards addressing modernization challenges. The information or data captured during this process is stored in an accessible repository for use across the AME.

### Section III

#### Concept Development and Multi-Domain Operations (MDO)

##### 10-4. Multi-Domain Operations (MDO)

To win tomorrow, the Army must evolve how it is organized and integrated as part of the Joint Force. To do this, the Army will: 1) Continue to refine a warfighting concept that provides an azimuth to the future – The U.S. Army in MDO 2028 is that concept; 2) Develop a comprehensive Army modernization strategy linked to this concept and synchronized with a joint approach to force development; 3) Drive rapid, non-linear solutions in Army DOTMLPF-P; and 4) Deepen the operational integration of general purpose and special operations forces with allies and partners. MDO is a dynamic concept intended to be the foundation for building the Army of 2028 with the intent to update and improve the concept over time based on lessons learned and extensive experimentation. The Army must evolve its force and operations, around the three core tenets of MDO. The first tenet is “calibrated force posture” – a combination of forward presence, expeditionary capability, and access to joint, national, and partner capabilities. The second tenet is the use of “multi-domain formations” that have capacity, capability, and endurance to maneuver and choreograph effects across multiple domains. The final tenet is “convergence” – the ability to rapidly converge effects from multiple domains, simultaneously and nearly continuously, using multiple forms of attack and redundant sensor-to-shooter networks enabled by robust mission command. Underpinning these tenets are mission command and disciplined initiative at all warfighting echelons.

### Section IV

#### Capabilities Integration and Development

##### 10-5. Policy

The Chairman of the Joint Chiefs of Staff Instruction (CJCSI) 5123.01H provides policy for the Charter of the Joint Requirements Oversight Council (JROC) and Implementation of the JCIDS and supporting JCIDS Manual for procedural guidance. The Army supports JCIDS through Army -Capabilities Integration and Development (A-CIDS) to be incorporated in Army Regulation (AR) 71-9 (being updated); and Training and Doctrine Command (TRADOC) Regulation 71-20.

##### 10-6. Joint Capabilities Integration and Development System (JCIDS)

a. The JCIDS, the DAS, and the Planning, Programming, Budgeting, and Execution (PPBE) process form the DOD’s three primary decision support systems/processes for shaping military forces to support strategic guidance documents. JCIDS is a capabilities-based approach to identify current and future capability gaps in the joint force’s ability to carry out joint warfighting missions and functions. When the JCIDS process determines that DOD needs to develop new materiel solutions, the JCIDS capability requirements process interacts with the DAS and the PPBE process to provide effective solutions. The procedures established in JCIDS support the Chairman, Joint Chiefs of Staff (CJCS), and the JROC in advising the Secretary of Defense (SECDEF) in identifying, assessing, and prioritizing joint military capabilities-based requirements (needs).

# CAPABILITY REQUIREMENTS AND SYSTEM RESEARCH, DEVELOPMENT, AND ACQUISITION MANAGEMENT

b. JCIDS is a needs driven joint capabilities-based requirements generation process. The objective is to develop a balanced and synchronized DOTMLPF-P solution approach that is affordable, militarily useful/operationally effective, supportable by outside agencies, and based on mature technology demonstrated in a laboratory, relevant, or operational environment. JCIDS implements an integrated, collaborative process, based on top-level strategic direction, to guide development of new capabilities through changes in DOTMLPF-P. This integrated, collaborative approach requires a process that uses Joint/Services concepts and integrated architectures to identify prioritized high-risk capability gaps and integrated joint DOTMLPF-P approaches (materiel and non-materiel) to resolve those capability gaps. The traditional route to identifying capability gaps characterizes the deliberate process and proposed solutions – the results of the Capabilities-Based Assessment (C-BA) placed within an Initial Capabilities Document (ICD) and/or DCR, and proceeding to an MDD and an Analysis of Alternatives (AoA) to support a materiel and/or non-materiel solution decision. Prototyping, design, development, production, fielding, and sustainment follows the materiel and/or non-materiel solution decision.

c. Urgent Threat Timeline. Planning for ongoing contingency operations may identify urgent operational needs (UON) which represent potential for critical mission failure or unacceptable loss of life if not satisfied by a rapidly acquired capability solution. These capability requirements may qualify for submission as Joint UONs (JUON) or DOD Component UONs for expedited validation and rapid acquisition efforts.

d. Emergent Threat Timeline. Planning for anticipated contingency operations may identify operational needs which represent potential mission failure or unacceptable loss of life once operations commence, if not satisfied by a rapidly acquired capability solution. These capability requirements may qualify for submission as Joint Emergent Operational Needs (JEON) or DOD Component UONs for expedited validation and rapid acquisition efforts.

e. Deliberate Planning. The traditional route to identifying capability gaps and proposed solutions characterizes the deliberate planning process – the C-BA process, documenting the C-BA in an ICD and/or DCR, and proceeding to an MDD and an AoA to support a materiel solution decision. See Figure 10-4 for a depiction of the three JCIDS process lanes from the JCIDS Manual.

**Validation:** The review and approval of capability requirement documents by a designated validation authority

“Keep right, except to pass”

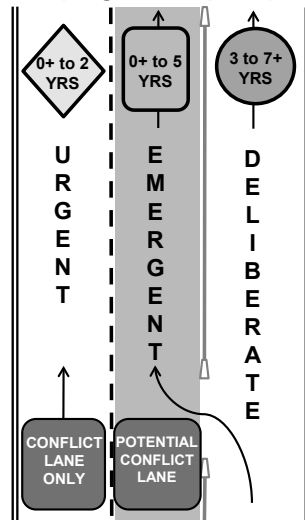

## • Deliberate Requirements

- Sponsor Driven (CCMD / Service / Other Component)
- ICDs, CDDs, CDD Update, Joint DCRs
- Traditional route for capability requirements that require significant technology development and/or are not urgent in nature
- JCB / JROC validates, or delegated to Sponsor

## • Emergent Requirements (New)

- CCMD driven (JEONs / “Fast Lane”)
- Supports accelerated acquisition of capabilities needed for an anticipated or pending contingency operation
- VCJCS verifies; JCB or JROC validates

## • Urgent Requirements (Institutionalized)

- COCOM driven (JUONs) Sponsor driven (UONs)
- Urgent and compelling to prevent loss of life and/or mission failure during current operations
- Require little technology development and can be resolved in less than two years
- J-8/DDR validates JUONs; Sponsor validates UONs

CDD: Capability Development Document  
CCMD: Combatant Command  
DDR: Deputy Director of Requirements (J-8)  
ICD: Initial Capabilities Document  
JCB: Joint Capability Board

JEON: Joint Emergent Operational Need  
JROC: Joint Requirements Oversight Board  
JUON: Joint Urgent Operational Need  
UON: Urgent Operational Need  
VCJCS: Vice Chairman Joint Chiefs of Staff

**Figure 10-4. Three JCIDS Process Lanes**

f. Rapid acquisition includes activities to develop and implement capability solutions in a shorter timeframe than typical of deliberate DAS processes. Rapid acquisition activities may also include expedited procurement of COTS, GOTS, and NDI solutions, or modification/ acceleration of existing

## HOW THE ARMY RUNS

development programs initiated under the deliberate process. The Milestone Decision Authority (MDA) determines the specific acquisition process each validated capability requirement will follow.

### 10-7. Capabilities-Based Assessment (C-BA)

Organizing and executing a successful JCIDS C-BA is a significant challenge. For the Army, the C-BA has three phases: Functional Area Analysis (FAA), or required capabilities and associated tasks, conditions, and standards; Functional Needs Analysis (FNA), or high risk/high priority capability gaps; and Functional Solutions Analysis (FSA), or potential DOTMLPF-P approaches, recommendations, solutions to mitigate or eliminate the capability gap(s).

a. Needs – A capability required to meet an organization's roles, functions, and missions in current and future operations.

b. Gaps – An operational assessment of the current and programmed force is conducted to identify the capability requirements (based on specified operational tasks that must be performed, under what conditions, and to what standards). If a capability solution does not satisfy a capability requirement, there is an associated capability gap. Gaps are assessed in terms of risk to the mission, risk to the force (potential losses), and other important considerations such as resourcing and effects on allies.

c. Solutions – Solutions include accepting risk and/or doing nothing, identifying non-material approaches to wholly or partially mitigate any of the identified capability gaps, and if needed, recommended materiel approaches, or a combination of non-materiel and materiel approaches. Ranking and timing of the needed solution(s) are important for resourcing and planning. The Capabilities Based Assessment is an analytic basis to identify capability requirements and associated capability gaps. Other forms of studies, analyses, or assessments may be used, but may need refinement to ensure sufficient data to properly generate capability requirement documents.

## Section V

### Capability Requirement Documents

#### 10-8. Generating and Documenting Capabilities Based Materiel Requirements

Capability Requirement Documents (e.g., an ICD /or Joint DCR) document the C-BA results. The ICD demonstrates the need for a materiel acquisition program, how the materiel will be employed, and what the materiel must be capable of doing. As the acquisition program progresses, statements of required performance and design specifications become more and more specific. The functional area focused ICD is the document that initiates the DAS. The Capability Development Document (CDD) and the CDD Update (if required) are the documents that define the system capabilities needed to satisfy an approved materiel need (high-risk capability gap).

#### 10-9. Joint DOTmLPP-P Change Recommendation (DCR)

Joint DCRs are referred to as "non-materiel solutions" and used to apprise the Joint Staff of a recommendation for a major DOTmLPP-P change (Figure 10-5). These recommendations may have an impact across the DOD and may create a need for the Joint Staff and DOD to take actions to reprogram or obtain resources to implement the Joint DCRs that are recommended. Examples of non-materiel solutions that may eliminate or mitigate the gap include the following: change of DOD/Service policy; change in doctrine; reorganization or force structure changes; train and educate personnel differently; acquire more quantities of an existing commercial off the shelf (COTS) or non-developmental item; add or reassign personnel to mission areas; or move/realign facilities to support new mission areas. DCRs consist of an Executive Summary plus 30 pages according to the JCIDS Manual.

#### 10-10. Initial Capabilities Document (ICD)

The ICD is the most common starting point for new capability requirements. The ICD is a broad statement of a materiel capability (need) that can possibly support more than one developmental system. It documents the need for a non-materiel and/or materiel solution approaches to resolve a specific high-risk capability gap derived from the C-BA process. It describes capability gaps that exist in warfighting functions. The capability gap is defined in terms of the functional area, the relevant range of military operations, and timeframe under consideration (Figure 10-6).

## CAPABILITY REQUIREMENTS AND SYSTEM RESEARCH, DEVELOPMENT, AND ACQUISITION MANAGEMENT

- Document proposes non-materiel capability solutions only as an alternative to, or complement of materiel capability solutions
- By definition, Joint DCRs have impact to the Joint Force and are assigned a Joint Staffing Designator of JROC Interest or JCB Interest
- Sponsors may use (or not) a DCR in support of non-materiel capability solutions or as enablers of materiel capability solutions IAW policies and processes of that organization

**EXSUM & 30 Pages**

- JCIDS Manual (31 August 2018)  
- DCR v1.6 (15 March 2019)

A. Cover Page...Joint DOTmLPF-P Change Recommendation for.....

B. Validation Page...Signed JROCM indicating validation of the document.

Executive Summary... will not exceed 1 page

1. Operational Context... Contributions to missions and activities of the Joint Force; Operational Concept Graphic (Include OV-1, OV-3, OV-4, and OV-5a).
2. Threat Summary ...Threat Assessment, Expected Operational Environment.
3. Capability Requirements Discussion...Outline the results of related studies or analysis performed..
4. Change Recommendations.....Outline recommendations that enable solutions to satisfy the gaps.
5. Implementation Plans...Outline plan for recommended DOTmLPF-P changes, cost data.

Appendices: A. References; B. Acronym List; C. Glossary; D. Classified (Optional)

**Figure 10-5. DOTmLPF-P Change Recommendation (DCR)**

- Documents the capability gap (high risk, high priority need) for required non-materiel / materiel capability identified in JCIDS Capabilities-Based Assessment (C-BA)
- Summarizes the results of the JCIDS C-BA, to include the DOTMLPF-P analysis
- Makes the case for materiel / non- materiel approaches (COAs) to resolve the identified capability gap (need)
- The Building Code "The What," not "The How"

**EXSUM & 10 Pages**

- Writer's Guide (15 March 2019), v3\_4  
- JCIDS Manual (31 August 2018)

Executive Summary... limited to one page or less.

1. Operational Context... Range of Military Operations, IOC & FOC Timeframe, Required Operational Outcome, Operational Concept Graphic (Include OV-1), Key Intelligence Support Capabilities Required
2. Threat Summary ...Threat Assessment Citation, Expected Operational Environment, Threat Capabilities in the expected operational environment
3. Capability Requirements and Gaps/Overlaps...Capability Requirements Overview, Summary Table
4. Final Recommendations...DOTmLPF-P Recommendations part of a materiel solution, DOTmLPF-P Recommendations independent of a materiel solution, Materiel Approach, Affordability

Appendices: A. References; B. Acronym List; C. Glossary; D. Classified Annex; E. Cyber Survivability Risk Categories (CSRC)

IOC – Initial Operational Capability  
FOC – Final Operational Capability  
OV – Operational View

**Figure 10-6. Format for Initial Capabilities Document (ICD)**

a. The ICD summarizes the results of the C-BA analysis and identifies any changes in U.S. or Allied doctrine, operational concepts, tactics, organization, and training that were considered in satisfying the identified high risk capability gap. The ICD describes why non-materiel changes were judged inadequate in addressing the complete capability. It further proposes a recommended materiel approach based on analysis and describes how the recommended approach best satisfies the desired required capability.

## HOW THE ARMY RUNS

b. Once validated, an ICD is archived in the Joint Staff, J-8 Knowledge Management/Decision Support (KM/DS) tool database, so that all validated documents are maintained in a single location (via SIPRnet). The ICD is limited to 10 pages and the format and detailed content instructions are provided in the JCIDS Manual. An ICD is not always required before creating successor documents (i.e., CDDs or Joint DCRs), especially if alternative studies or documentation sources make the ICD redundant (i.e., Lessons Learned, UONs, or Joint Capability Technology Demonstrations (JCTDs)). In cases where the sponsor proposes to proceed directly to a successor document, the general content of the ICD, including capability requirement and capability gap tables will be provided in the successor document. In cases where the sponsor proposes to proceed directly to a CDD, they will request an ICD waiver through the Joint Staff J-8 Gatekeeper. The Joint Staff J-8 Gatekeeper, in coordination with the MDA and validation authority, may approve an ICD waiver, and the MDA may direct the development of this capability to be abbreviated or eliminated, and further development of a capability solution start directly at Milestone A (MS A), Milestone B (MS B), or Milestone C (MS C). If the MDA determines a program start at MS B or beyond, a CDD is required in support of the milestone decision. Sponsors can update a validated CDD and provide a “CDD Update” to the validation authority for any changes that are deemed significant between MS B and MS C.

### 10-11. Information System ICD (IS-ICD)

For capability requirements likely to be addressed by Information Systems (IS) solutions – software development, and off-the-shelf hardware, if required – sponsors should consider the IS-ICD variant detailed in Figure 10-7. For capability requirements likely to be addressed by a mix of IS and non-IS solutions, sponsors must use the regular ICD format and consider an IS-CDD and ICD validation to streamline the IS portion of solution development.

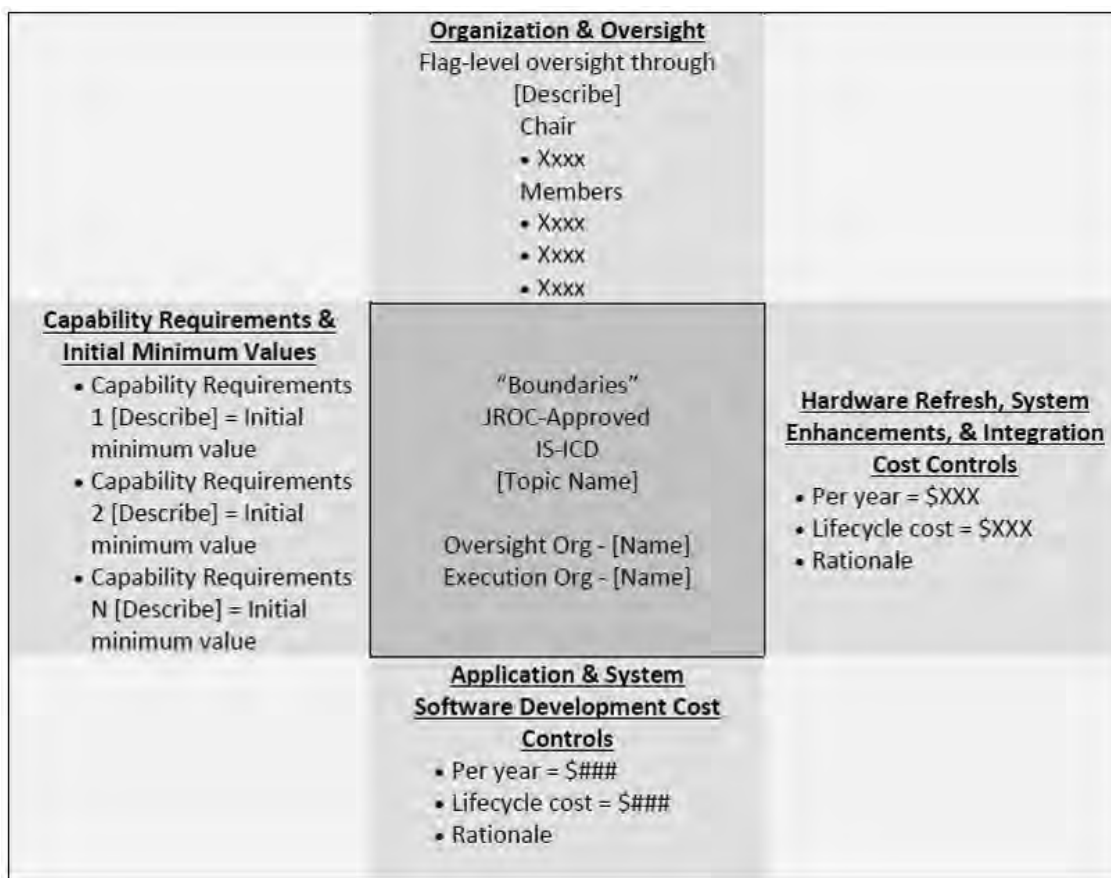

Figure 10-7. Components of the “IT Box” Construct in IS-ICDs



## CAPABILITY REQUIREMENTS AND SYSTEM RESEARCH, DEVELOPMENT, AND ACQUISITION MANAGEMENT

a. The purpose of an IS-ICD is to facilitate efficient and timely software development efforts; IS-ICDs are not appropriate for hardware development efforts or capturing capability requirements that span a broad scope of hardware, software, and/or DOTMLPF-P efforts. IS-ICDs are appropriate when it is clear from the C-BA that an IS solution is the only viable approach to be considered. All hardware associated with an IS-ICD must be COTS/GOTS.

b. The IS-ICD is a variant of the regular ICD, implementing the “IT Box” model outlined in this section. Approaches where the capability solution involves research, development, and/or acquisition of applications systems software, and the projected lifecycle costs exceed \$15 million. IS-ICDs with lifecycle costs less than \$15 million may be submitted for review and validation if validated requirements are needed to support budgetary requests or other purposes. The “IT Box” construct calls for fewer iterations of validating capability requirements documents through the JCIDS process by describing the overall IS program and delegating validation of detailed follow-on requirement and solution oversight to a flag-level organization other than the JROC or Joint Capabilities Board (JCB).

### 10-12. Information System CDD (IS-CDD)

a. The purpose of an IS-CDD (Figure 10-8) is focused on facilitating more efficient and timely software development efforts, and are not appropriate for hardware development efforts or capturing capability requirements which span a broad scope of combined hardware, software, and/or DOTMLPF-P efforts.

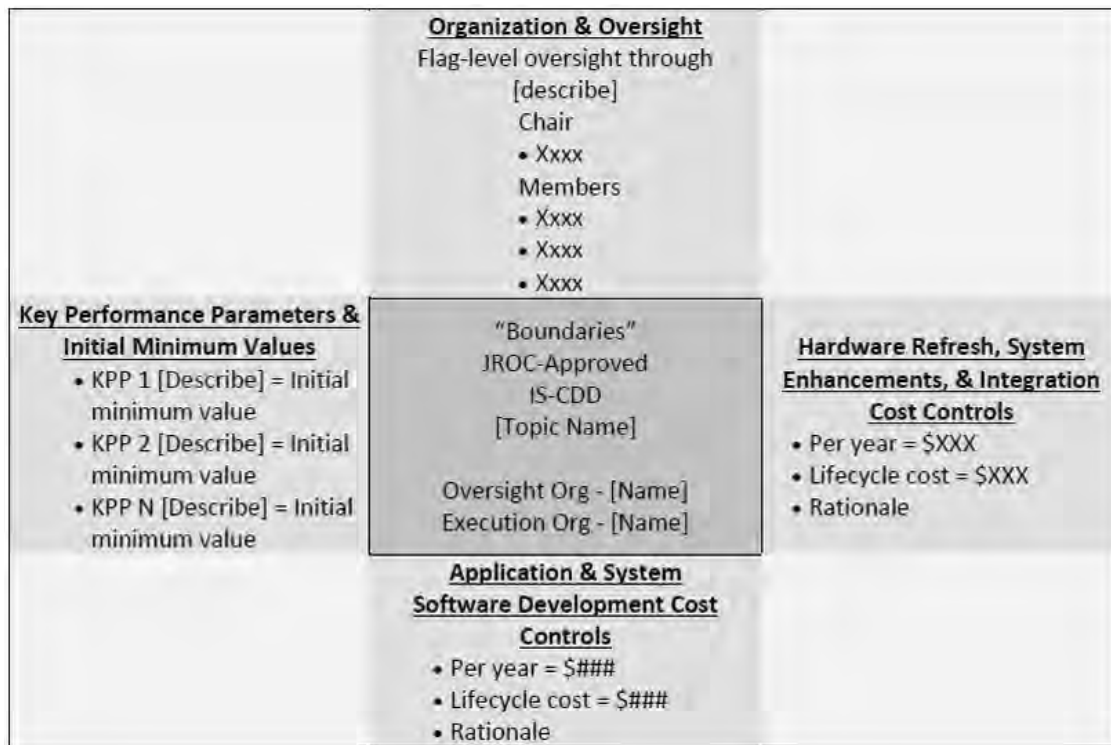

**Figure 10-8. Components of the “IT Box” Construct in IS-CDDs**

b. The IS-CDD is a variant of the regular CDD, implementing the “IT Box” model outlined in the IS-ICD section. IS-CDDs streamline the requirements process relative to IS efforts by delegating requirements oversight for subsequent documents as identified in the IS-CDD. This provides IS programs greater flexibility to incorporate evolving technologies and achieve faster responses from requirement validation processes than is typical for other kinds of materiel or non-materiel solutions. In general, the IS-ICD is the preferred method for implementing the “IT Box” model, but IS-CDDs may be used in cases where a validated ICD contains capability requirements which can be addressed by a combination of IS and non-IS capability solutions and the IT Box construct is applicable to the IS portion of the capability solution(s).

## HOW THE ARMY RUNS

### 10-13. Capability Development Document (CDD)

The CDD is the warfighter's primary means of defining authoritative, measurable, and/or testable capabilities for the Engineering and Manufacturing Development (EMD) phase of an acquisition program. While the CDD is guided by the ICD, its primary basis is the approved AoA that identifies the best set of operationally effective and affordable system attributes. The CDD captures the information necessary to deliver an affordable and supportable capability using mature technology within a specific increment of an Acquisition Strategy (AS) – the framework (roadmap) for planning, directing, and managing an acquisition program to satisfy a validated materiel requirement.

a. A draft CDD is generated during the Materiel Solution Analysis (MSA) Phase and the final CDD is generated during the Technology Maturation & Risk Reduction (TMRR) phase of the acquisition process prior to MS B (program initiation). The CDD describes a technically mature and affordable increment of militarily useful/operationally effective capability that was demonstrated in a relevant environment. The CDD supports entry into the EMD phase.

b. The CDD (Figure 10-9) describes the operational capability; threat; integrated architectures; required capabilities; program support; supportability; force structure, DOTmLPP-P impact, and constraints; schedule; and program affordability for the system. The CDD identifies the operational performance attributes (testable or measurable characteristics), in threshold-objective (minimum-desired) format, necessary for the acquisition community to design a proposed system and establish an Acquisition Program Baseline (APB). The CDD states performance attributes, including Key Performance Parameters (KPP) that guide the development, demonstration, and testing of the current increment. These parameters provide the "trade space" for the system as it goes through development and testing. The performance attributes and KPPs apply only to the current increment.

|   |   |
|---|---|
| <ul style="list-style-type: none"> <li>• System specific - Defines authoritative, measurable, and testable capabilities needed by warfighters</li> <li>• Outlines an affordable, single increment of military useful and technically mature capability demonstrated in a relevant environment</li> <li>• Identifies operational performance and support attributes (characteristics) and KPPs for the increment described in terms of objectives and minimum acceptable requirements or thresholds that define system (increment) capabilities to satisfy the validated materiel need articulated in the ICD</li> <li>• Validated CDD required to initiate an acquisition program (MS B) and enter EMD (Milestone B)</li> </ul> |   |
| <p><b>Format: 45 Pages</b></p>  |   |
| <p style="text-align: center;">-Writer's Guide (15 March 2019), v3_8<br/>-JCIDS Manual (31 August 2018)</p>   |   |
| <p>Executive Summary (No more than one page)</p> <ol style="list-style-type: none"> <li>1. Operational Context</li> <li>2. Threat Summary</li> <li>3. Capability Discussion</li> <li>4. Program Summary</li> <li>5. Development Performance Parameters (KPPs, KSAs, and APAs)</li> <li>6. Other System Attributes.</li> <li>7. Joint Interoperability</li> </ol>  | <ol style="list-style-type: none"> <li>8. Spectrum Requirements</li> <li>9. Intelligence Supportability</li> <li>10. Weapon Safety Assurance</li> <li>11. Technology Readiness</li> <li>12. DOTmLPP-P Considerations</li> <li>13. Program Affordability</li> </ol> <p>Appendix A: References<br/>Appendix B: Acronym List<br/>Appendix C: Glossary<br/>Appendix D: Classified Annex</p> |

**Figure 10-9. Format for Capability Development Document (CDD).**

c. The CDD page limit is 45 pages, and the format and detailed content instructions are provided in the JCIDS Manual. When validated, CDDs bring the desired capability specified in the ICD into the DAS EMD phase. The CDD can only be changed by the validation authority to carry the program and its increments through the acquisition process.

# CAPABILITY REQUIREMENTS AND SYSTEM RESEARCH, DEVELOPMENT, AND ACQUISITION MANAGEMENT

## **10-14. Army Futures Command (AFC) Abbreviated Capability Development Document (A-CDD)**

An A-CDD capability requirement document supports Army Modernization efforts. A-CDDs were developed to provide the technical, operational, analytical and programmatic depth beyond what was needed to meet urgent/emergent requirements short of the full burden of information required in a JCIDS document in support of the DAS. The A-CDD is used to establish the Army's position on development of an Army materiel capability. A-CDDs are a more robust and refined capability requirement document that conveys the Army's position, which establishes a need to accomplish probable military objectives prior to an acquisition MDD. Approval of the A-CDD will not support an acquisition milestone decision. A-CDDs can be used as the source requirement to execute rapid experimentation and prototyping efforts prior to program initiation. An A-CDD equates to an approved requirement. All of the CDD paragraphs must be accounted for, however, the content of each section/paragraph of the A-CDD does not have to be at the maturity required for a final CDD. To transition the capability into the DAS, an A-CDD converts into a formal JCIDS requirement document.

## **10-15. Capability Requirement Document Performance Characteristics**

a. The CDD states the operational and support-related performance attributes of a system that provides the capabilities required by the Soldier – attributes so significant, they need verification by testing or analysis. Whenever possible, attributes are stated in terms that reflect the operational capabilities necessary to operate in the full range of military operations and the environment intended for the system. These statements guide the acquisition community in making trades decisions between the threshold and objective values of the stated attributes. Operational Testing (OT) assesses the ability of the system to meet the production threshold and objective values.

b. Key Performance Parameters (KPP) are those system attributes considered most essential for an effective military capability. The CDD contains four required KPPs that capture the minimum operational effectiveness and suitability attributes (testable or measurable characteristics) needed to achieve the overall desired capabilities for the system during the applicable increment. Failure to meet a CDD KPP threshold can result in the reevaluation of the selected system, program reassessment, or termination. The following KPPs are mandatory and required in the CDD:

(1) Force Protection KPP. This attribute is a required KPPs for all manned systems and systems designed to enhance personnel survivability in an asymmetric threat environment. The Joint Staff Protection Functional Capabilities Board (FCB), in coordination with the lead FCB, assess this KPP and its applicability for JCB Interest and JROC Interest CDDs and make a recommendation to the JCB or JROC on validation. The sponsoring component validates the KPP for non-JCB/JROC Interest CDDs.

(2) System Survivability KPP. Survivability attributes are those that contribute to the survivability of a manned system. This includes attributes such as speed, maneuverability, detectability, and countermeasures that reduce a system's likelihood of being engaged by hostile fire, as well as attributes such as armor and redundancy or critical components that reduce the system's vulnerability if it is hit by hostile fire. The Joint Staff FCB, in coordination with the lead FCB, assess this KPP and its applicability for JCB Interest and JROC Interest CDDs and make a recommendation to the JCB or JROC on validation. The sponsoring component validates the KPP for non-JCB/JROC Interest CDDs.

(3) Sustainment KPP. A sustainment KPP (materiel availability) and two mandatory supporting Key System Attributes (KSA) (materiel reliability and O&S cost) are developed for all JROC Interest programs involving materiel solutions. For non-JCB/JROC Interest programs, the sponsor determines the applicability of this KPP.

(a) Materiel Reliability KSA is a measure of the probability that the system will perform without failure over a specific interval. Reliability must be sufficient to support the warfighting capability needed. Materiel reliability is generally expressed in terms of a Mean Time Between Failure (MTBF).

(b) Operations and Support (O&S) cost KSA provides balance to the sustainment solution by ensuring that O&S costs associated with materiel readiness are considered in making decisions.

(4) Energy Efficiency KPP. This KPP includes fuel efficiency considerations for fleet purchases and operational plans consistent with mission accomplishment. Life-cycle cost analysis will include the fully burdened cost of fuel during the AoA; subsequent analyses and acquisition program design trades.

c. The following KPPs are not required or mandatory in the CDD, but are addressed as stated below:

(1) System training KPP is no longer a required or mandatory KPP (training is still addressed, but captured elsewhere in the capability requirements document).

## HOW THE ARMY RUNS

(2) NET-Ready KPP is addressed as a part of the Joint Interoperability section of the CDD.

d. Key System Attribute (KSA). KSAs are those system attributes considered most critical or essential for an effective military capability, but not selected as a KPP. KSAs provide decision-makers with an additional level of capability prioritization below the KPP, but with senior sponsor leadership control (authority is system dependent designated by the Acquisition Executive).

### 10-16. Capability Production Document (CPD)

The CPD is no longer required. Sponsors can update a validated CDD and provide a CDD Update to the validation authority for any changes deemed significant at MS C.

## Section VI

### Material Requirements Review, Validation and Approval Process

#### 10-17. Joint Requirements Review, Validation and Approval Process

a. The process of obtaining validation of JCIDS documents begins with the submission of a requirements document proposal into the Joint Staff, J-8 Knowledge Management/Data System (KM/DS) tool, and continues until the document is validated by the appropriate authority. Services, Combatant Commands (CCMDs), and other DOD organizations conducting JCIDS CBA analyses may generate ideas and concepts leading to draft ICDs, CDDs, and joint DCRs. As the initiative develops into proposed DOTLmPF-P or materiel solutions to provide the desired capabilities, an FCB may task a lead Service or component with sponsoring the initiative. Further development of the proposal becomes the responsibility of the sponsor.

b. All JCIDS documents (ICDs, CDDs, and DCRs) are submitted into the JS, J-8 KM/DS tool by the sponsoring component. Submission of the document to the KM/DS tool triggers the JS and the gatekeeper to determine whether the document has joint implications or is sponsor unique. Normally, the document has undergone an appropriate sponsor staffing process before submission.

c. The JS J-8 Deputy Director for Requirements for Capabilities Development (DDRCD), serves as the JCIDS process gatekeeper. The gatekeeper, with the assistance of the JS J-8 Joint Capabilities Division (JCD), reviews and evaluates all JCIDS documents submitted through the J-8 KM/DS tool database.

(1) To determine if the proposal affects the joint force.

(2) Based on the content of the submission, the gatekeeper assigns a Joint Staffing Designator (JSD) of JROC Interest, JCB Interest, and Joint Information to the ICD, CDD, or DCR submitted via the KM/DS (Figure 10-10).

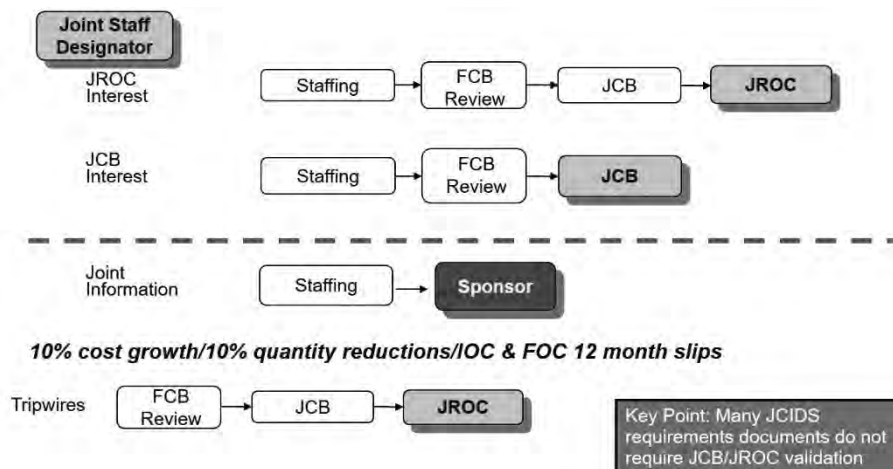

**Figure 10-10. Joint Capabilities Integration and Development System Document Staffing Tracks**

(a) JROC Interest. This designation applies to all potential information assurance programs where the capabilities have a significant impact on joint warfighting or have a potential impact across Services or

# CAPABILITY REQUIREMENTS AND SYSTEM RESEARCH, DEVELOPMENT, AND ACQUISITION MANAGEMENT

interoperability in allied and coalition operations. All joint DCRs are designated as JROC Interest. Capability documents designated as JROC Interest are staffed through the JROC for validation.

(b) JCB Interest. This designation applies to programs where the capabilities and/or systems associated with the document affect the joint force and an expanded joint review is required.

(c) Joint Information. This designation applies to programs that have interest or potential impact across the Services or defense agencies, but do not have significant impact on the joint force and do not reach the threshold for JCB Interest or JROC Interest. Once designated Joint Information, staffing is required for informational purposes only and the FCB may review the document. The sponsoring component validates the Joint Information documents.

(3) The JCIDS process now deletes the requirement for all Acquisition Category (ACAT) I programs to automatically be given a JSD of JROC Interest. The JROC is not tied directly to cost, but instead tied to joint equities as defined under the Joint Performance Requirements (JPRs).

(4) JCIDS delegates Certifications/Endorsements to the Sponsor unless joint interoperability is clear or there are multi-service equities.

(5) The JS J-8, using the KM/DS tool, maintains a database of JCIDS documents processed through the gatekeeper function. The database helps to ensure consistency of staffing as JCIDS proposals progress through the JCIDS process. The document moves into the staffing and validation process upon JSD assignment.

## 10-18. Joint Requirements Primary Review Boards/Forums

a. The Vice Chairman of the Joint Chiefs of Staff (VCJCS) chairs the JROC (Figure 10-11). CCDRs have a standing invitation to attend JROC sessions in an advisory role when matters related to their area of responsibility or functions are considered. Historically, the JROC has consisted of the VCJCS, the Vice Chiefs of Staff of the Army and Air Force, Vice Chief of Naval Operations, and the Assistant Commandant of the Marine Corps.

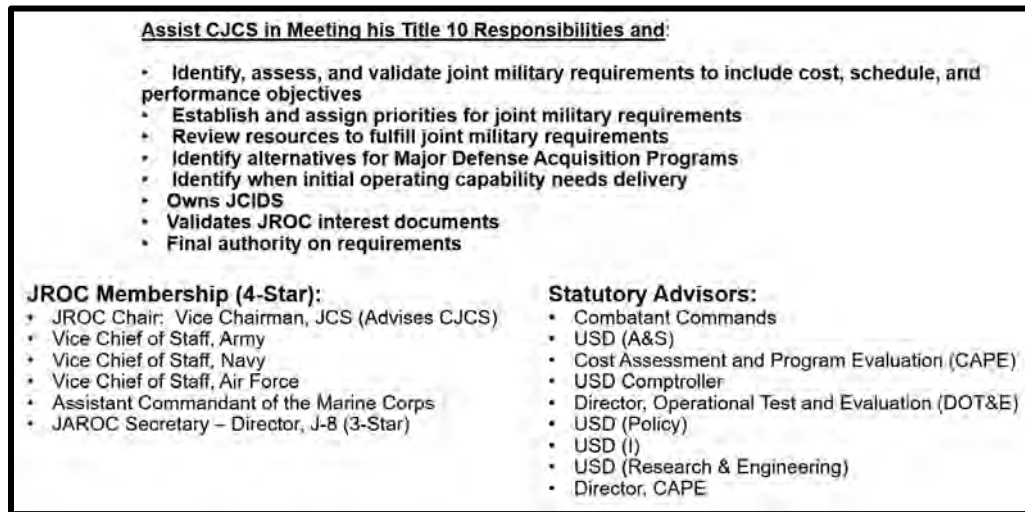

Figure 10-11. Joint Requirements Oversight Council (JROC)

b. The following DOD civilian officials serve as advisors to the JROC on matters of their authority and expertise:

- (1) The Under Secretary of Defense (Comptroller).
- (2) The Under Secretary of Defense for Acquisition and Sustainment (A&S).
- (3) The Director of Cost Assessment and Performance Evaluation (CAPE).
- (4) The Under Secretary of Defense for Policy.
- (5) The Director of Operational Test and Evaluation.
- (6) Other civilian officials within DOD can also advise the JROC as designated by the SECDEF.
- (7) FCB participating organizations have a standing invitation to attend JROC-related meetings in an advisory role to the JROC Chairman.

## HOW THE ARMY RUNS

c. The CJCSI that covers this organization's functions and membership is 5123.01H. This instruction identifies key Title 10 functions associated with the CJCS with which they assist, thus enabling him to execute these specific responsibilities as well as other duties.

d. The JROC has continued to broaden its strategic focus to include providing top-down guidance in defining military capabilities from a joint perspective and integrating this advice within the planning, programming, and budgeting process. The JROC oversees the JCIDS and provides advice on acquisition programs. Additionally, the JROC focuses on interacting with CCDRs on the full range of warfighting requirements and capabilities as well as engaging DOD senior leaders who are now advisors to this council. Assessment teams that examine those requirements and capabilities or working groups are organized within the established FCBs.

e. The JROC chartered the JCB to serve as an executive-level advisory board to assist it in fulfilling its many responsibilities. The JCB consists of the Director, J-8, and appropriate Service and CCMDs designated general officer or civilian equivalent representatives (Figure 10-12). The Chief, Joint Capabilities Division in the J-8 serves as the JCB Secretary. The JCB assists the JROC in overseeing the JCIDS process.

**Assists the JROC in Executing its Responsibilities:**

- **Assists in oversight of the Joint Capabilities integration and Development System (JCIDS) process**
- **Reviews and endorses documents and adjudicates lower level issues prior to JROC review for decision**
- **Reviews and adjusts prioritization from FCBs**
- **Approves documents with Joint Staffing Designator of JCB Interest; assists JROC**

**JCB Membership:**

- JCB Chair, Director, J-8 (3-Star)
- Director, Joint & Integration (HQDA G-8) (1-Star)
- Director, Assessment Division (Navy) (1-Star)
- Director for Joint Matters (USAF) (1-Star)
- ADCS, Programs & Resources (USMC) (1-Star)
- JCB Secretary – Chief Joint Capabilities Division J-8 (COL)
- CCMD Representatives can participate

**Figure 10-12. Joint Capabilities Board (JCB)**

f. The FCB (Fig 10-13) is an advisory body to the JCB and the JROC for JCIDS initiatives assigned with JSDs of JCB Interest or JROC Interest. The FCBs serve as the points of entry for the JROC's actions related to the JCAs. Additionally, the FCBs, under the leadership of a Joint Staff or Functional CCMD flag officer or senior executive service civilian, serve as integrators of joint capability development and ensure that major programs are fully integrated into joint architectures from the outset. The JROC and its associated sub-organizations continue to evolve to remain focused on strategic issues and concepts. As an example of this strategic focus and desire to directly influence future systems and capabilities, each of the organizations within the JROC process has become more involved in developing operational concepts and operational architectures, as well as developing strategic guidance to influence capabilities. The overall intent is to provide more upfront guidance to ensure capabilities and systems are focused more on joint interdependency and resolve capability gaps while reducing redundancy.

### **10-18. Army Requirements Oversight Council (AROC)**

a. Mission. The AROC advises the CSA on approval of capabilities required to support warfighting commanders. This advice provides linkage and synchronization between, and recommended prioritization of, required capabilities and re- sources.

# CAPABILITY REQUIREMENTS AND SYSTEM RESEARCH, DEVELOPMENT, AND ACQUISITION MANAGEMENT

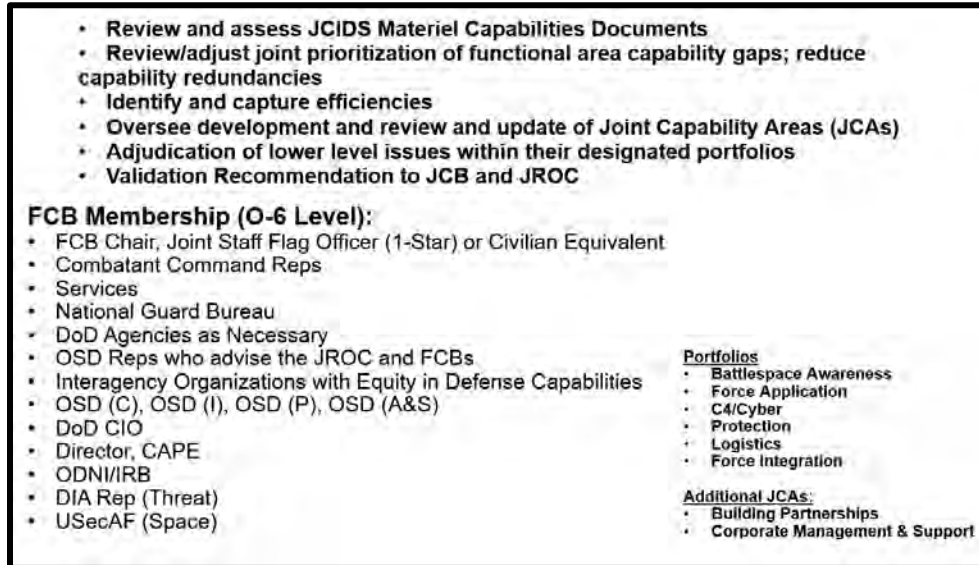

**Figure 10-13. Functional Capabilities Board (FCB)**

b. Purpose. The AROC approves modernization requirements consistent with Army strategic priorities. The CSA uses the AROC forum to concur with acquisition milestone certifications and Configuration Steering Board changes to cost, schedule and performance. The AROC supports CSA assessment and prioritization of integrated capabilities to balance near-term and future force readiness.

c. Validation and approval. Validation entails review of a capability proposal by operational and functional authorities other than the originator to confirm the feasibility, acceptability, and supportability of the proposal. Approval indicates acceptance of the proposal and commitment of resources to execute. The validation of the capability proposal, KPPs, and DOTmLPF-P requirements, and approval to resource within established priority, must address:

(1) Military need and risk. The AROC will review and provide decisions and guidance on the capability gaps identified in documentation presented for validation and approval. This ensures identified gaps link with modernization investment priorities essential for maintaining land force dominance.

(2) Synchronization with Army and Joint modernization strategies. The AROC will validate the recommended approaches to resolve capability gaps, including associated DOTMLPF-P changes, which are consistent with Army modernization strategies. Proposals must contribute to a balanced and synchronized modernization program. The AROC will also review how the recommended approaches fit into related Joint Concepts, force modernization strategies and investment portfolios to ensure interoperability synergy.

(3) Estimated program affordability. The AROC will review the affordability, based on cost estimates, of all proposed solutions to capability gaps and programs presented to ensure that, if pursued, they are within programming limits for development, procurement and sustainment. The granularity of the affordability data will be tied to the maturity of the proposal. The AROC will consider trade-offs of capability and/or performance versus cost to ensure only affordable solutions are pursued. Affordability will include potential long-term supportability requirements for the concept or system. Proposals presented to the AROC will address Joint development and procurement considerations.

(4) Capability definition. The AROC will ensure the operational definition of the capability gap and the proposed solution are clear and consistent with Army and Joint warfighting concepts. Key performance gap and the proposed solution must be clear and consistent with Army and Joint warfighting concepts. Key performance parameters serve as the fulcrum for AROC risk deliberations on operational improvements sought versus technical maturity and costs to field for a capability at the appropriate time and in the appropriate quantities. Opportunities to integrate other Service programs or technologies to improve Joint interoperability, shorten acquisition timelines, and reduce developmental and sustainment costs.

d. The AROC membership consists of (Figure 10-14):

## HOW THE ARMY RUNS

(1) Chair. The CSA chairs the AROC. The VCSA or CG, AFC will chair the AROC as directed.

(2) Principals. DCS, G-8 (Secretariat); Assistant Secretary of the Army (Acquisition, Logistics, and Technology); Assistant Secretary of the Army (Financial Management and Comptroller); CG, U.S. Army Materiel Command; CG, U.S. Army Forces Command; CG, AFC (when not chairing the AROC), CG, TRADOC; CG, U.S. Army Cyber Command; CG, U.S. Army Test and Evaluation Command (ATEC).

(3) Advisors. DCS, G-1; DCS, G-2; DCS, G-3/5/7; DCS, G-4; CIO/G-6; Chief, Army Reserve; the Chief, National Guard Bureau (CNGB) or the Director, Army National Guard if so delegated by the CNGB; Commander U.S. Army Research, Development and Engineering Command; Military Deputy, Assistant Secretary of the Army (Acquisition, Logistics, and Technology); Assistant Secretary of the Army (Financial Management and Comptroller) Deputy for Cost and Economics; Director of the Army Staff; DCS, G-8, Director, Programs, Analysis and Evaluation; DCS, G-8, Force Development; General Council; The Judge Advocate General; Director, Congressional Legislative Liaison; CGs of Centers of Excellence; TRADOC Capabilities Managers; Program Executive Officers/Program Managers; and other ARSTAF, Army Secretariat offices or commands/agencies as appropriate for topic or issue.

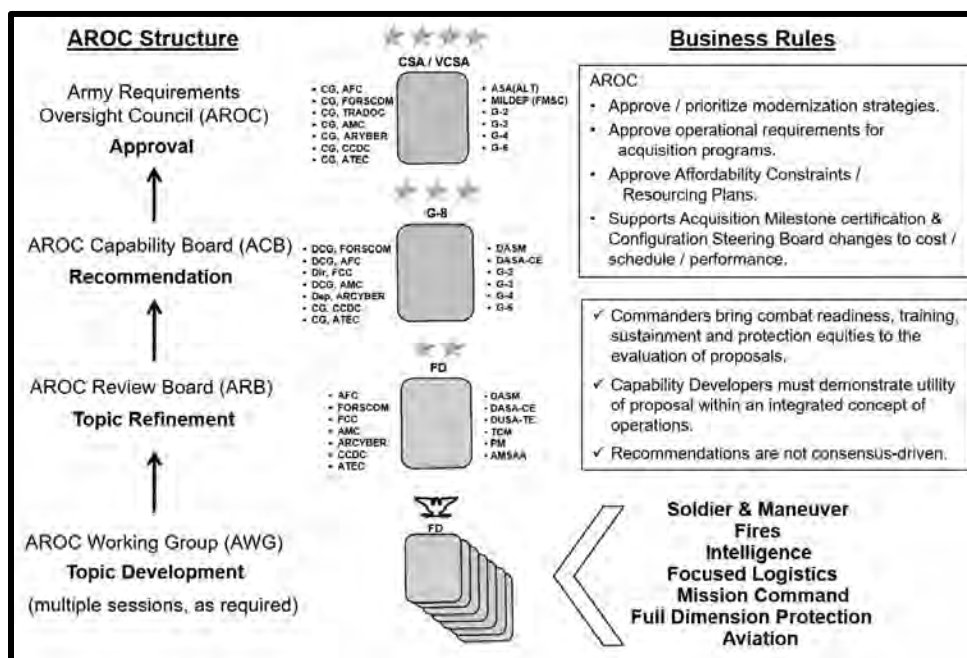

Figure 10-14. Army Requirements Oversight Council (AROC) Structure

f. Roles.

(1) AROC principals and advisors. The AROC principals and advisors will advise the CSA in assessment and prioritization of DOTMLPF-P integrated capabilities, validate and approve proposals for rapid insertion of technologies to address current capability needs when solution extends into the POM, and advise on strategies to resolve capability gaps and resultant changes to modernization programs and plans. The AROC will validate JCIDS documents in support of CSA approval prior to submission for JROC community review. This will encompass all JCIDS efforts including Army Annexes to Joint and other Service documents, those where an Army proponent has been designated as a Joint Combat Developer, and Army Annexes required for Army but not JROC community validation.

(2) AROC Secretariat. The AROC Secretariat coordinates and synchronizes all requirements and calendars for AROC meetings. The Secretariat will publish calendar information to AROC Principals and Advisors on the meeting, topic, and any special information directed by the DCS, G-8 or VCSA and publish AROC minutes. The Secretariat also schedules and runs the requirements integration synchronization meetings (RISMs) and serves as the AROC Capabilities Board (ACB) and the AROC Review Board (ARB) Secretariats.

(3) Requirements integration staff officer. The RISO is the DCS, G-8 DOTMLPF-P functional



## **CAPABILITY REQUIREMENTS AND SYSTEM RESEARCH, DEVELOPMENT, AND ACQUISITION MANAGEMENT**

integrator for specific focus areas (aligned with Directorate of Materiel (DOM) Divisions), responsible for coordination and integration of functional proposals in the capability and AROC management system (CAMS) assigned to them by the Army Gatekeeper. The RISO is the Army's functional point of contact for coordination and integration of all proposals entering the AROC staffing process and assists the sponsor with staff coordination of pre-briefs for AROC topics. The RISO makes recommendations on comment acceptance, partial acceptance, or rejection in conjunction with the requirements staff officer (RSO) assigned to the DCS, G-8 Force Development (FD) DOM divisions. Once the RSO closes out the staffing, the RISO then forwards the comments matrix to AFC for adjudication.

(a) Army Gatekeepers. Army Gatekeepers are usually RISOs assigned to the Requirements Integration and Assessment Division who oversee and manage all documents submitted for Army and Joint staffing. While there are two Army Gatekeepers (one primary and one alternate) for managing the CAMS database, all RISOs are gatekeepers in CAMS for staffing execution and management of the documentation in their functional area.

(b) RSO. The RSO is the DCS, G-8 capability subject matter expert within the Directorate of Materiel in Force Development. The subject matter experts identified within an organization provide expertise on the document subject and comments as a guest user in CAMS. The subject matter expert is responsible for inputting comments for themselves and others in their organization on the document coordination comment matrix, and having the required level of general officer or senior executive service equivalent comment approval. RSOs are also responsible for reviewing all comments entered into CAMS for a document staffing and recommending acceptance, rejection or change to the comment and deleting improperly provided or irrelevant comments prior to closing out the document staffing.

(c) AFC. The JCIDS document sponsor is an Army force modernization proponent responsible for executing the capabilities determination process and coordinating with the AFC Gatekeeper to facilitate Army and Joint staffing of a document through the AROC and JROC processes. The proponent develops JCIDS documents and submits them through the AFC Gatekeeper to DCS, G-8 via CAMS.

### **10-19. Army Requirements Review, Validation, and Approval Process**

a. While the Army may exercise independent validation (review and approval) authority for capability requirements, the ultimate validation authority resides with the VCJCS as the Chairman of the JROC. Accordingly, the Army has a specific process to internally review and submit capability requirements for Joint Staff consideration. If a submitted Army requirement is not designated a JPR, then the Army exercises independent validation authority. This Army process is Army- Capabilities Integration and Development System (A-CIDS). A-CIDS is the Army's capabilities determination and approval process. A-CIDS nest with JCIDS and the AROC is the decision forum that supports the A-CIDS process. Alternatively, if the DDRCD assigns a JSD of JCB Interest or JROC Interest, then the Joint Staff retains validation authority.

b. The lead organization within the Army for the management of the A-CIDS process in coordination with the CG, AFC is the DCS, G-8. The DCS G-8 serves as the AROC Secretariat, recommends requirements prioritization, executes the Army Modernization Strategy, and executes the annual Strategic Portfolio Analysis Review (SPAR). AFC will lead the Army Materiel Requirements Enterprise, approve capability requirements, chairs the AROC approves prioritization of requirements, develops Army Modernization Strategy, and leads the annual SPAR analysis. Within the DCS G-8, Requirements Staff Officers (RSOs) and Requirements Integration Staff Officers (RISOs) are directly responsible for leading HQDA staff integration and coordination efforts for all Army and joint DOTMLPF-P requirements. The RSO/RISO coordinates with the HQDA DCS, G-8 counterpart, the Synchronization Staff Officer (SSO), to facilitate the transition from capabilities-based requirements development and validation to requirements solutions (execution and resourcing).

c. The process for obtaining validation of requirements documents at HQDA begins with the submission of a proposal by the AFC Futures and Concepts Center (FCC) JCIDS gatekeeper, into the Capabilities and AROC Management System (CAMS) database. CAMS is the HQDA DCS, G-8 authoritative database driven knowledge management decision support information technology system that supports AROC document staffing and commenting from numerous users and organizations within the Army into a centralized database repository. CAMS ensures version control/transparency of changes and comments. CAMS allows for flexible staffing assignments and timelines. The system allows users to view document information and monitor document progress through AROC validation until submission to the Joint Staff staffing and validation process.

## HOW THE ARMY RUNS

d. All JCIDS proposals are entered into CAMS by the AFC FCC gatekeeper. The gatekeeper acts as the entry and exit point for all JCIDS capability documents and other Service capability documents sent to AFC FCC for review. The gatekeeper manages the staffing of the JCIDS capability documents and loads validated capability documents into the CAMS database for AROC/JROC validation. Submission of the proposal will trigger the Army gatekeeper process. The JCIDS proposal will be submitted for HQDA staffing and coordination. All proposals undergoing the review process are considered draft until they are validated by the designated validation authority.

e. All Army sponsored JCIDS proposals are submitted for HQDA JCIDS gatekeeper review to determine accuracy and completeness. Based on the content of the proposal, the gatekeeper will assign the proposal to the functional RSO and initiate Army staffing utilizing CAMS as the staffing tool.

f. At the conclusion of the AROC review process, the Army JCIDS gatekeeper submits the document to the Joint Staff (via the JS J-8 Knowledge Management /Decision Support –KM/DS) for staffing.

g. The HQDA JCIDS gatekeeper signals completion of Army and joint staffing and validation (Figure 10-15) by publishing the approval memorandum with a Catalog of Approved Requirement Documents (CARDS) reference number. The CARDS reference number signifies an approved (official) Army materiel requirement.

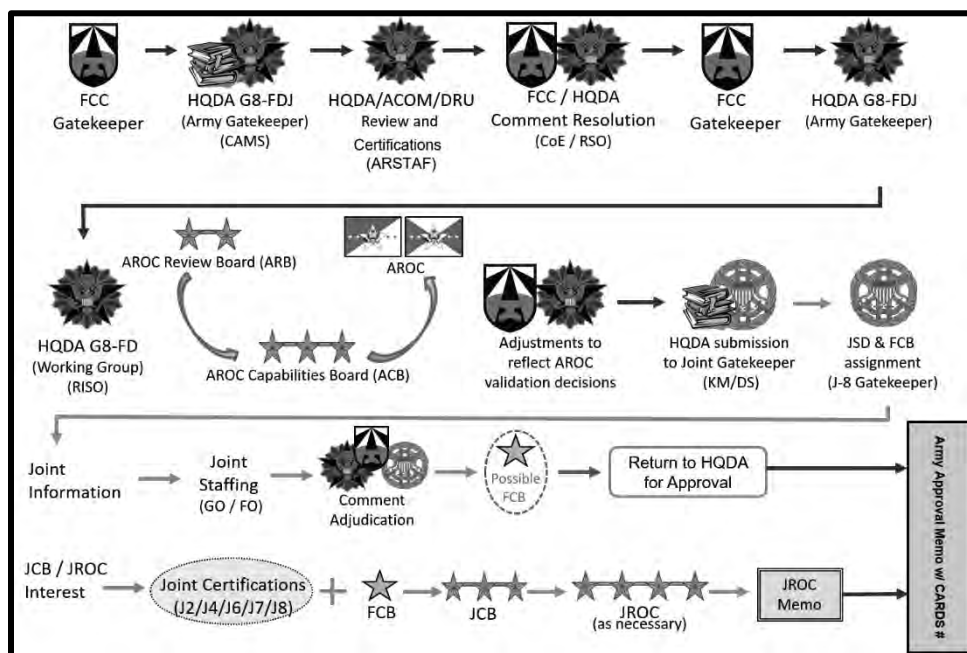

Figure 10-15. Combined AROC/JROC Staffing Process

### 10-20. AROC process decision forums

The AROC requirements approval process is conducted through four levels of review boards. The AROC, the ACB, the ARB, and the AROC Working Groups (AWGs) are supported by a number of Army organizations as well as the ARSTAF:

a. Army Requirements Oversight Council (AROC) description: Advisory body that reviews/validate selected capability requirement documents and recommends final disposition to the CSA/VCSA/CG, AFC.

b. ACB Description. The ACB is a three-star board one level below the AROC. It advises the AROC on issues within and across the capability portfolios.

c. ARB Description. The ARB is a one-/two-star board one level below the ACB and advises the ACB and AROC on issues within and across the capability requirement portfolios, and performs other activities at the direction of the ACB or AROC. The ARB is also the delegated approval authority for all Requirements Definition Packages that are derived from Information Technology (IT) Box capability documentation.

d. AWGs. AWGs are O-6/General Schedule (GS)-15-level boards one level below the ARB and advise the ARB, ACB, and AROC on issues within a respective capability requirement portfolio (or portfolios). AFCs perform other activities at the direction of the ACB or AROC Chairs. There are seven standing

# CAPABILITY REQUIREMENTS AND SYSTEM RESEARCH, DEVELOPMENT, AND ACQUISITION MANAGEMENT

AWGs corresponding to the Materiel Divisions in DCS, G8–FD.

## 10-21. Requirements Integration Synchronization Meeting (RISM)

a. The RISM is chartered to bring key stakeholders together to prioritize topics for AROC presentation. This prioritization will facilitate alignment of requirement document approval and acquisition milestones. The primary output of the RISM is a prioritized list of requirements documents, staffing strategy for each open requirement document, and an approved AROC calendar.

b. Purpose. The purpose of the RISM is to prioritize and synchronize Army requirements document approval, ensuring integration of acquisition, and JCIDS processes to deliver timely and affordable capabilities to the Joint Force.

## 10-22. A-CIDS Process

As of 1 October 2019, the A-CIDS Process (Figure 10-16) is under consideration to become the new Army requirements process. If approved, it will include the following:

a. Deliberate Staffing Process. The traditional route for capability requirements that require significant technological development for solutions that are not urgent – required in the next six years.

b. Quick Fire Staffing Process. A condensed, flexible review process for high priority capability needs which will allow for experimentation/prototyping and will not lead to a milestone decision.

c. Operational Needs Statement (ONS) Staffing Process. Support to operational commanders in current or pending operations. This process is for urgent and compelling needs to prevent loss of life and/or mission failure during current or pending operations.

d. Capability Needs Statement Staffing Process. Providing operational commanders a way to get Army Senior Leaders visibility of operational needs. Emergent threat within next 2-5 years.

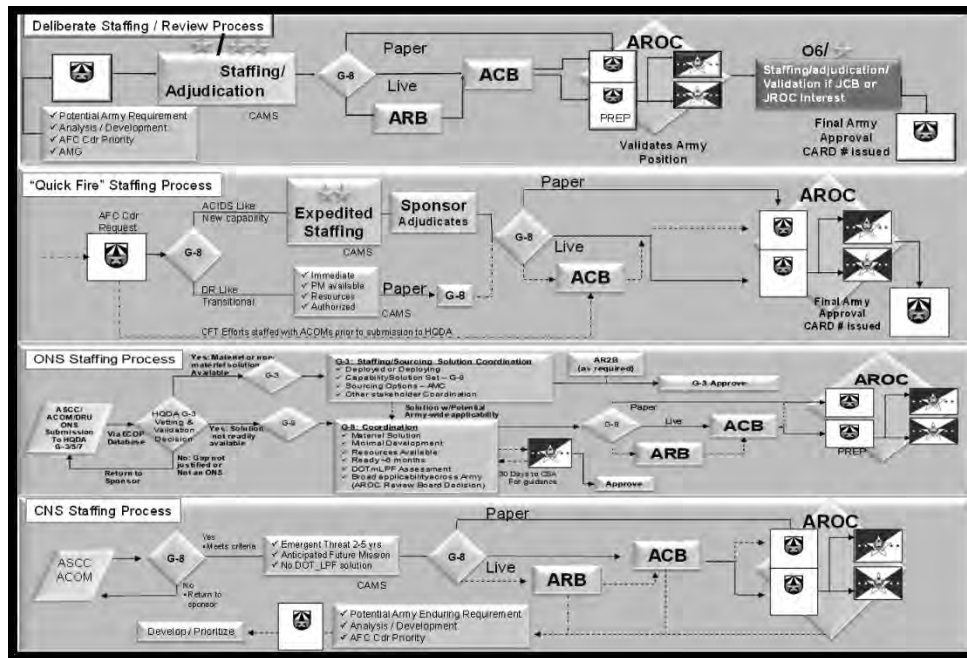

Figure 10-16. A-CIDS Process

## Section VII Urgent and Emergent Operational Need Validation

### 10-23. Urgent and Emergent Operational Needs Requirements

a. An UON encompasses capability requirements that are identified by a DOD Component as impacting an ongoing or anticipated contingency operation. If left unfulfilled, the resulting capability gaps can potentially cause loss of life or critical mission failure. Different DOD Components may use different

## HOW THE ARMY RUNS

terms to describe a UON.

b. DOD and the Army continue to improve and adapt their capabilities and materiel developments processes in response to Combatant/Operational Commanders urgent needs. The deliberate JCIDS and DAS processes acquire weapons systems using traditional DOD processes, usually taking five to seven years even when the system uses maximum streamlining. Sometimes, the warfighter needs a new capability as soon as possible. When operational commanders, in a conflict or crisis, report situations that put life at risk or risk mission failure, every military Service has responded with its own rapid response approach. When the situation is a joint, theater-wide problem, the JUON/JEONS processes apply.

c. A JUON is an urgent operational need identified by a Combatant Commander (CCDR) affecting two or more DOD components involved in an ongoing overseas contingency operation. The JUON purpose is to identify and subsequently gain a Joint Staff (JS) validation and resourcing solution, usually within days or weeks, to meet a specific high priority CCDR need. Rapid validation and resourcing of a JUON is a time-sensitive process in support of a CCDR involved in a combat-related ongoing operation. The JUON rapidly validates resources and fields urgent operational solutions that fall outside of the established Service processes. This process is not intended to compete with any of the current Service processes, but rather to complement them. In addition, it is not intended to replace any other JS process.

d. A JEON is identified by a CCDR as inherently joint and impacting an anticipated or pending contingency operation. The scope of a JUON/JEON will be limited to addressing urgent operational needs that fall outside of the established Service processes; and most importantly, if not addressed immediately, will seriously endanger personnel or pose a major threat to ongoing operations. They should not involve the development of a new technology or capability; however, the use of "off-the-shelf" items or the acceleration of a science and technology JCTD or minor modification of an existing system to adapt to a new or similar mission is within the scope of the JUON/JEON validation and resourcing.

(1) The validation authority will make one of the following decisions:

(a) Validate the JUON/JEON. The validation authority validates that the urgency of satisfying the identified capability requirements to support ongoing or anticipated contingency operations precludes the use of the deliberate requirements validation process. Validation of the JUON/JEON allows the JRAC to proceed with assigning a solution Sponsor to rapidly fund, develop, and field a capability solution.

(b) Validate part of the JUON/JEON. If it is clear that the Sponsor's capability requirement is best validated through a mix of urgent and deliberate requirements validation processes, the validation authority will validate part of the capability requirement as a JUON/JEON, and recommend the Sponsor resubmit the remainder of the capability requirement for validation in the deliberate requirements validation process.

### **10-24. Joint Rapid Acquisition Cell (JRAC)/Senior Integration Group (SIG)**

a. Joint Rapid Acquisition Cell (JRAC). The JRAC is chartered to break through the institutional barriers of providing timely, effective support to operational commanders. The cell is not attempting to introduce a new acquisition/procurement process. However, it is attempting to push critical JUONs/JEONs through the existing DOD process. The USD (A&S) and the USD (Comptroller) established the JRAC based on Deputy Secretary of Defense (DEPSECDEF) guidance. Membership consists of 1-Star-level or senior executive representatives from the Joint Staff, CCMDs, and each of the Services, empowered to go back to their organizations and carry out the JRAC's decisions.

b. The cell works directly with the CCMDs to meet certified operational critical DOTMLPF-P (primarily materiel and logistics) requirements. The cell selects and focuses on high priority JUONs/JEONs. The goal is to act on requests within 48 hours so that a contract is awarded and goods and services are delivered within two years or less. All incoming requests for an urgent operational need must be validated and prioritized by the CCMD before forwarding to the JS via SIPRNET. The cell tracks how quickly the military responds and reports directly to the SECDEF through the DEPSECDEF and the Warfighter SIG.

c. Senior Integration Group (SIG). Building on the previous establishment and success of the JRAC to resolve requests from operational forces for urgently needed capabilities, OSD, in August 2012, formally established the Warfighter SIG. The Warfighter SIG is responsible for leading the response to CCDR UONs, and must recognize, respond to, and mitigate the risk of operational surprise associated with ongoing or anticipated near-term contingency operations. There is an expectation that the SIG will help speed up the process of developing ways to fill JUONs/JEONs, focusing on solutions that are capable of

# CAPABILITY REQUIREMENTS AND SYSTEM RESEARCH, DEVELOPMENT, AND ACQUISITION MANAGEMENT

being fielded within two years. The DEPSECDEF serves as the chair of the Warfighter SIG, with the director of the JRAC serving as executive secretary.

d. DOD's highest priority is to provide warfighters involved in conflict or preparing for imminent contingency operations with the capabilities urgently needed to overcome unforeseen threats, achieve mission success, and reduce risk of casualties.

e. The Co-Chairs of the Warfighter SIG will prioritize and direct actions to meet urgent requirements and to integrate DOD-wide efforts to manage the institutional response to operational surprise.

f. CCDRs will use the JUONs/JEONs processes to identify operational vulnerabilities that require resources and/or capabilities beyond those available through the global force management process and more rapidly than the traditional PPBE and DAS allow.

## 10-25. Component Urgent Operational Need: Army ONS & Army Requirements and Resourcing Board (AR2B)

Services use various methods to shorten acquisition timelines to meet urgent and compelling needs during crisis and conflict (e.g., Air Force UON); Marine's Urgent Universal Need statement (UUNS), Navy's UONS; and USSOCOM's Combat-Mission Need Statement). The ONS is the Army's UON process and approach.

a. An Army capability request to HQDA constitutes a request for a materiel and/or non-materiel solution to correct a deficiency or to improve a capability that impacts upon mission accomplishment. These capability requests come to HQDA via the SIPRNET-based Army Equipment Common Operating Picture (ECOP) database and fall into two general categories: Authorized pre-validated Equipment Sourcing Document (ESD) and the ONS (Figure 10-17). The AR2B determines the final validation and prioritization decision for these capability requests.

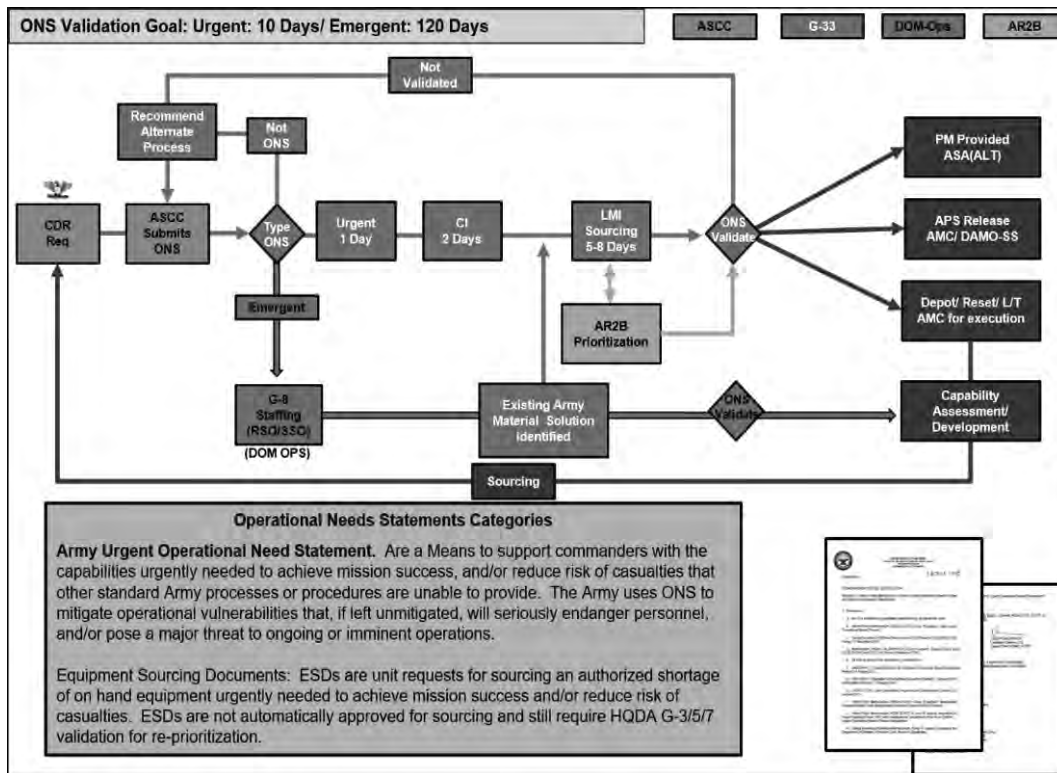
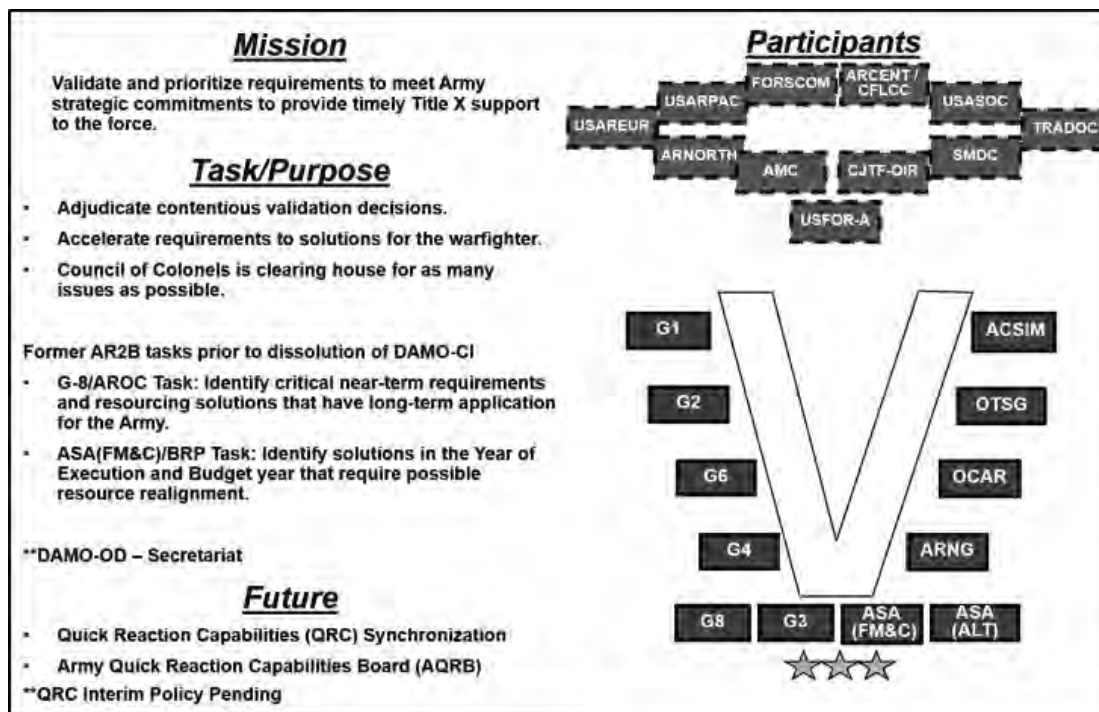

**Figure 10-17. HQDA Operational Needs Statement (ONS) Process**

b. The AR2B (see Fig 10-18) is the mechanism (forum) for validating and prioritizing critical operational needs (ONSs and ESDs) for rapid senior leadership decision-making (accelerated fielding solutions) in support of an OCO named operation. The AR2B identifies solutions in the year of execution and/or

## HOW THE ARMY RUNS

budget year that require possible resource realignment. Established in December 2004, the AR2B replaced the Army Strategic Planning Board and Setting the Force Task Force.



**Figure 10-18. Army Requirements and Resourcing Board (AR2B) Organization**

c. Authorized/pre-validated equipment sourcing requests (unit shortages or pre-approved items authorized by HQDA). Deployed and deploying units or other HQDA designated high priority units, may submit ESDs for authorized/pre-validated equipment (e.g., Modification Table of Organization and Equipment (MTOE) and/or Basis-Of-Issue Plan shortages, or other equipment shortages already validated by HQDA).

d. ONS. Operational field commanders use an ONS to document the urgent need for a materiel and/or non-materiel solution to correct a deficiency or to improve a capability that impacts upon mission accomplishment in overseas contingency operations.

(1) The ONS provides an opportunity for the operational field commander (O6 level) to initiate the HQDA AR2B process via the Army ECOP database.

(2) Response to an ONS varies depending on the criticality of the need for the proposed item. HQDA may not consider an ONS for a variety of reasons, including conflicting needs, higher priorities for funding, existence of a similar system, or non-concurrence of the criticality of the need. HQDA AR2B determines validity of the need and the availability of technology to fill the requirement. If the need is determined as critical and can be resourced, a directed requirement may result.

(3) If validation of the ONS indicates that the concept has the potential for Army-wide application, the development of a new system maybe appropriate.

### 10-26. Directed Requirements (DRs)

a. If operational analysis and assessment of an ONS or JUON solution or results of an Advanced Technology Demonstration (ATD) or Joint Capability Technology Demonstration (JCTD), indicate a specific, limited but necessary, urgent need exists, HQDA, DCS G-8 may prepare and issue a directed requirement for a capability having application within the Army. Directed requirements must be approved by the VCSA or HQDA, DCS G-8. While JCIDS capabilities compete in the Army prioritization process for program funding, the DCS G-8 will specify the funding source and priority for a directed requirement. DRs are not recognized by the DAS as a requirements document. A DR is designed to produce information in support of early acquisition and programming decisions.

# CAPABILITY REQUIREMENTS AND SYSTEM RESEARCH, DEVELOPMENT, AND ACQUISITION MANAGEMENT

b. The scope of a directed requirement will be limited to addressing urgent operational needs that, fall outside of the established JCIDS process, and if not addressed immediately, will seriously endanger personnel or pose a major threat to the success of ongoing operations. A directed requirement should not involve the development of a new technology or capability; however, the acceleration of an ATD or JCTD (previously discussed), is within the scope of the directed requirements process.

## **10-27. Rapid Acquisition Authority (RAA)**

This is a Secretary of Defense signed determination made in response to a documented deficiency following consultation with the Joint Staff. The RAA should be considered when, within certain limitations, a waiver of a law, policy, directive, or regulation will greatly accelerate the delivery of effective capability to the warfighter in accordance with section 806(c) of P.L. 107-314.

## **Section VIII**

### **Matériel Systems Acquisition**

## **10-28. Department of Defense System Acquisition Policy**

The DOD DAS establishes a management process to translate user needs (broadly stated functional high risk capability gaps developed in the JCIDS or business needs responding to new ways of doing business) and technological opportunities (developed or identified in S&T), into reliable and sustainable systems that provide capability to the user.

a. The basic policy is to ensure that acquisition of Defense systems is conducted efficiently and effectively to achieve operational objectives of the U.S. Armed Forces in their support of national policies and objectives within the guidelines of The Defense Acquisition System (certified current as of 20 Nov 2007); and DOD Instruction 5000.02 (Operation of the Defense Acquisition System (31 August 2018, Change 4). DODI 5000.02 (Change 4) continues to emphasize “Tailoring” of program structures, content, and decision points to the product being acquired. The things that have to be done in defense acquisition are the following:

- (1) Identify a need or desire for a new product.
- (2) Reduce the technical risk to an acceptable level.
- (3) Develop and test the product.
- (4) Field the product.
- (5) Sustain and dispose of the product overtime.

b. Army Regulation (AR) 70-1 (10 August 2018) provides Army Acquisition policy for matériel and information systems. AR 70-1 governs research, development, acquisition and life-cycle management of Army matériel to satisfy validated Army requirements.

c. An acquisition program is defined as a directed, funded effort designed to provide a new, improved or continuing weapon system or IT system capability in response to a validated operational need. Acquisition programs are divided into four Acquisition Categories (ACATs), which are established to facilitate decentralized decision-making, execution, and compliance with statutory and regulatory requirements. Acquisition phases provide a logical means of progressively translating broadly stated mission needs into well-defined system-specific requirements and ultimately into operationally effective, suitable, and survivable systems. An acquisition program can enter the system at any phase or Milestone (MS), based on the maturity of the needed technology or the demonstrated viability of possible matériel solutions under consideration. All the tasks and activities needed to bring the program to the next MS occur during acquisition phases. A MS is the major decision point that initiates the next phase of an acquisition program.

## **10-29. Department of Defense Science and Technology**

Since World War II, owning the technology advantage has been a cornerstone of U.S. national security strategy. Maintaining this technological edge has become even more important as high technology weapons have become readily available on the world market. In this environment, it is imperative that joint forces possess technological superiority to ensure success and minimize casualties across the broad spectrum of engagements. Similarly, today’s investments in S&T will substantially determine the warfighting capabilities 10 to 15 years from now.

## HOW THE ARMY RUNS

### **10-30. Research, Development, Testing, and Evaluation (RDT&E) Appropriation Activities**

To assist in the overall planning, programming, budgeting, and managing of the various R&D activities, the RDT&E appropriation is divided into seven R&D budget activities. These categories are used throughout DOD. The current RDT&E budget activities are as follows:

- a. Budget Activity 6.1 – Basic Research. Basic research includes all efforts and experimentation directed toward increasing fundamental knowledge and understanding in those fields of the physical, engineering, environmental, and life sciences related to long term national security needs.
- b. Budget Activity 6.2 – Applied Research. This activity translates promising basic research into solutions for broadly defined military needs, short of development projects. This type of effort may vary from systematic mission-directed research, which is beyond that in Budget Activity 1, to sophisticated breadboard hardware, study, programming, and planning efforts that establish the initial feasibility and practicality of proposed solutions to technological challenges. These funds are normally applied during the MSA phase of the DAS life-cycle.
- c. Budget Activity 6.3 – Advanced Technology Development. This activity includes all efforts that have moved into the development and integration of hardware for field experiments and tests. The results of this type of effort are proof of technological feasibility and assessment of operability and production rather than the development of hardware for Service use. These funds are normally applied during the TMRR phase of the DAS life-cycle.
- d. Budget Activity 6.4 – Advanced Component Development and Prototypes. This budget activity includes all efforts necessary to evaluate integrated technologies in as realistic an operating environment as possible, to assess the performance or cost reduction potential of advanced technology. These funds are normally applied during TMRR, but could be applied throughout the acquisition life-cycle.
- e. Budget Activity 6.5 – System Development and Demonstration. This budget activity includes those projects in system development and demonstration, but not yet approved for Low Rate Initial Production (LRIP) at MS C. These funds are normally applied during the EMD phase of the DAS life-cycle.
- f. Budget Activity 6.6 – RDT&E Management Support. Includes efforts directed toward support of RDT&E installations or operations required for use in general R&D and not allocable to specific R&D missions. Included are technical integration efforts, technical information activities, space programs, major test ranges, test facilities and general test instrumentation, target development, support of operational tests, international cooperative R&D, and R&D support.
- g. Budget Activity 6.7 – Operational System Development. This activity includes R&D efforts directed toward development, engineering, and test of changes to fielded systems or systems already in procurement which alter the performance envelopes. Operational system development may include OT costs.

### **10-31. Army Science and Technology**

The Army's S&T investments support Army unified land operations focusing on the future force while, at the same time, seeking opportunities to provide advanced technology to the current force. This dual strategy requires a dynamic technology investment portfolio that is strategically aligned with the Army's future operational capability needs and that maintains an awareness of the lessons learned from current overseas contingency operations. Fundamentally, Army S&T programs are seeking to provide solutions that enable faster, lighter, and smarter systems. The Army may be challenged by a convergence of factors, including technology advances that change how we fight.

- a. The S&T program supports Army unified land operations in three ways. First, Soldiers benefit today from technologies that emerged from the Army's past investments. Second, S&T exploits transition opportunities by accelerating mature technologies derived from ongoing efforts. Finally, Army S&T leverages the expertise of our scientists and engineers to develop solutions to unforeseen problems encountered during current operations.
- b. The ultimate goal of the Army's S&T program is to provide the Soldier with a winning edge on the battlefield. The accelerating pace of technological change continues to offer significant opportunities to enhance the survivability, lethality, deployability, and versatility of Army forces. It is the Army Futures Command (AFC) that will lead this effort.
- c. Army S&T programs are an integral part of capabilities development and system acquisition management. The S&T program consists of three stages (corresponding with the first three budget activities as explained in 10-30): Basic research (6.1); Applied Research (6.2); and Advanced Technology



## CAPABILITY REQUIREMENTS AND SYSTEM RESEARCH, DEVELOPMENT, AND ACQUISITION MANAGEMENT

development (6.3). The 6.1, 6.2, and 6.3 identifiers are commonly used for identifying funds, but they are also used as a shorthand technique by members of the Research and Development (R&D) community to identify levels of research development. The 6.1, 6.2, and 6.3 stages are known as the “tech base.” Basic research (6.1) includes all efforts of scientific study and experimentation directed toward increasing knowledge and understanding in those fields related to long-term national security needs. Applied research (6.2) includes all efforts directed to the solution of specific military problems, short of major development projects. Advanced technology development (6.3) includes all efforts directed toward projects, which have moved into the development of hardware for testing of operational feasibility.

d. A mainstay of the Army strategy for military technology is a viable in-house research capability. The Combat Capabilities Development Command (CCDC) within AFC and its laboratories are the key organizations responsible for technical leadership, scientific advancements and support for the capabilities development and system acquisition management processes. Technology insertion into systems is accomplished via the flow of patents, data, design criteria, and other Advanced Technology Demonstrations (ATDs) and JCTDs, new designs, and fielded systems.

### 10-32. Army Technology Transition Strategy

The basic strategy of the S&T program is to transition mature technologies into operational systems that satisfy validated warfighting capabilities-based materiel requirements. The key to this strategy is demonstrations. ATDs, and JCTDs exploit technologies derived from applied research (6.2), which in turn build on new knowledge derived from basic research (6.1) programs. These ATDs and JCTDs provide the basis for new systems, system upgrades, or advanced concepts which are further out in time. The critical challenge is to tie these programs together in an efficient and effective way. The scope and depth of the TDs, and the increased importance of their role in the capabilities development and system acquisition management processes, brings about increased emphasis on user involvement to permit an early and meaningful evaluation of overall military capability. The following sections provide an explanation of technology maturity, ATDs and JCTDs as well as systems/system upgrades.

a. Technology Maturity. Technology maturity measures the degree to which proposed critical technologies meet program objectives. Technology maturity is a principal element of program risk. A Technology Readiness Assessment (TRA) examines program concepts, technology requirements, and demonstrated technology capabilities to determine technological maturity.

(1) TRAs for critical technologies occur prior to DAS Milestone Decision Review (MDR) MS B and C to provide useful technology maturity information to the acquisition review process.

(2) The Deputy Assistant Secretary of the Army (Research and Technology) (DASA(R&T)), directs the TRAs; and for Major Defense Acquisition Programs (MDAPs), submits the findings to the AAE, who submits the report to the Deputy Under Secretary of Defense for Science and Technology DUSD(S&T) with a recommended Technology Readiness Level (TRL) for each critical technology. In cooperation with the DASA(R&T), the DUSD(S&T), evaluates the TRAs and after concurrence, forwards the findings to the DOD Overarching Integrated Product Team (OIPT) leader and Defense Acquisition Board (DAB).

(3) TRLs (Figure 19) are a measure of technical maturity that enables consistent, uniform, discussions of technical maturity, across different types of technologies. Decision authorities must consider the recommended TRLs when assessing program risk.

b. Technology Demonstrations (TD). The primary focus of TDs is to demonstrate the feasibility and practicality of a technology for solving specific military requirements. They are incorporated during the various stages of the 6.2 and 6.3 development process and encourage technical competition. They are most often conducted in a non-operational (laboratory or field) environment. These demonstrations provide information that reduces uncertainties and subsequent engineering cost, while simultaneously providing valuable development and requirements data.

c. Advanced Technology Demonstrations (ATD). ATDs are typically integrated demonstrations that are conducted to demonstrate the feasibility and maturity of an emerging technology. They provide a relatively low-cost approach for assessment of technical risks and uncertainties associated with critical technologies prior to the incorporation of these technologies into a system entering the formal acquisition process. They are conducted at the Service and DOD agency level with internal funding. They focus on evolving a specific element of technology nominally at the 6.3 advanced technology development point (typically TRL 5-6) to reduce its risk of implementation by an acquisition program or to feed into a JCTD.

## HOW THE ARMY RUNS

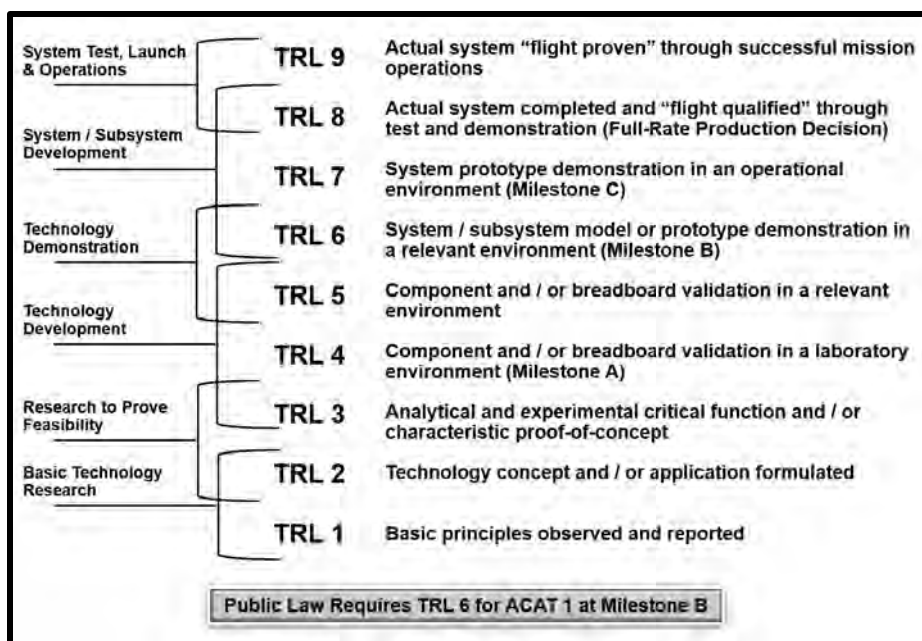

Figure 10-19. Technology Readiness Levels (TRLs)

d. JCTDs. DOD initiated the JCTD process to permit the early and relatively inexpensive evaluation of mature advanced technologies. The Soldier evaluates JCTDs to determine military utility of the technologies and to develop the Concept of Operations (CONOPS) that will optimize effectiveness. JCTDs are structured and executed so that, when successful, DOD can proceed rapidly into formal acquisition systems.

### Section IX

#### Department of Defense Acquisition Organization and Management

##### 10-33. DOD System Acquisition Management

a. The USD(A&S), is the senior procurement executive and the principal staff assistant and adviser to the SECDEF and takes precedence in DOD for all matters relating to the DAS: Research and development; Test and evaluation; Production; Logistics; Communications and intelligence activities related to acquisition, Military construction, and Procurement.

b. The USD(A&S) serves as the Defense Acquisition Executive (DAE) with responsibility for supervising the performance of the entire DAS in accordance with the laws, Congressional guidance and direction, and OMB Circular No. A-11, part 3. The DAE establishes policy for all elements of DOD for acquisition. The basic policies of the DAE are established and implemented by DODD 5000.01 and DODI 5000.02 (Change 4, 31 August 2018). The DAE serves as the chairman of the DAB, assisted by the OIPTs that relate to the acquisition process. As the DAB chairman, the DAE recommends to the SECDEF acquisition resource matters and other acquisition management matters required to implement acquisition MS decisions. While the DAE, as DAB chairman, makes recommendations whether to proceed with plans to acquire major materiel systems, the Senior Leader Review Group (SLRG), chaired by the DEPSECDEF, makes budgetary recommendations on the same programs. Acquisition program decisions are made within the parameters established by the SLRG and the SECDEF through the PPBE process.

##### 10-34. Army System Acquisition Management (Research, Development, and Acquisition Goals)

a. The SECARMY is responsible for functions necessary for the research, development, logistical support and maintenance, preparedness, operation, and effectiveness of the Army. The SECARMY

# CAPABILITY REQUIREMENTS AND SYSTEM RESEARCH, DEVELOPMENT, AND ACQUISITION MANAGEMENT

supervises all matters relating to Army procurement. The SECARMY executes his acquisition management responsibilities through the AAE.

b. Stability of materiel acquisition programs is a matter of utmost interest, especially after the system passes the DAS MS B program initiation decision. Reliability, Availability, and Maintainability (RAM) goals; Human Systems Integration (HSI); Integrated Product Support (IPS); survivability; effectiveness; safety; and product quality are incorporated into system performance objectives.

## 10-35. Army Acquisition Executive

The Assistant Secretary of the Army (Acquisition, Logistics, and Technology) (ASA(ALT)) is the AAE (Figure 10-20). The AAE is designated by the SECARMY as the Component Acquisition Executive (CAE)/or Service Acquisition Executive (SAE) and the senior procurement executive within HQDA. When serving as the AAE, the ASA(ALT) is assisted by a Principal Military Deputy (MILDEP).

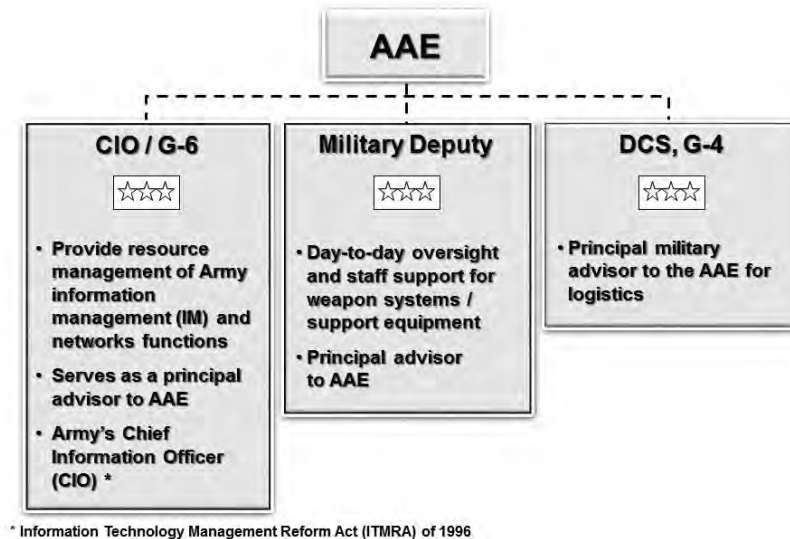

Figure 10-20. Army Acquisition Executive (AAE)

a. The MILDEP is assigned to the Office of the ASA(ALT) and provides staff support to the AAE in managing the R&D, Developmental Test (DT), and materiel acquisition for all Army weapon and support systems.

b. Similar to the Defense Acquisition Executive (DAE), the AAE develops Army acquisition policies and procedures and manages the Army's production base support and industrial mobilization programs. The AAE, acting with the full authority of the SECARMY, is responsible for administering acquisition programs according to DOD policies and guidelines, and exercises the powers and discharges the responsibilities as set forth in DODD 5000.01 for CAEs/SAEs. In addition, the AAE:

- (1) Appoints, manages and evaluates Program Executive Officers (PEOs) and direct-reporting PMs.
- (2) Coordinates with the Office of the DCS, G-8, to establish policy and guidance for the AoAs for ACAT I and II programs; designates the organization responsible for performing system engineering trades analyses for the AoA; and provides issues and alternatives to the DCS, G-8 for inclusion in the AoA tasking document.
- (3) Carries out all powers, functions, and duties of the SECARMY with respect to the acquisition work force within the Army, subject to the authority, direction, and control of the SECARMY.
- (4) Formulates Army-wide S&T base strategy, policy, guidance, and planning; establishes and validates Army technology base priorities throughout the PPBE process.
- (5) Develops and promulgates acquisition, procurement, and contracting policies and procedures.
- (6) Chairs the Army System Acquisition Review Council (ASARC).
- (7) Directs the Army Science Board (ASB).
- (8) Serves as the MDA for ACATs IC, IAC, selected ACAT II programs, and assigns the MDA for ACAT III and IV programs to the PEOs. If designated, a PM can be an MDA at the ACAT IV level.

## HOW THE ARMY RUNS

c. The Federal Acquisition Regulation (FAR) is the primary contracting regulation. It is the first regulatory source to which DA acquisition personnel refer. The ASA(ALT) issues the Army Federal Acquisition Regulation Supplement (AFARS) to supplement the FAR and the Defense Federal Acquisition Regulation Supplement (DFARS); and to establish uniform policies and procedures for use in the Army.

d. HQDA System Coordinator (DASC). The DASC is the primary acquisition staff officer at HQDA. The DASC is responsible for the day-to-day support of assigned programs and serves as the PM's representative and primary Point of Contact (POC) within the Pentagon. The DASC reports to the ASA(ALT), Deputy for Acquisition and Systems Management. The DASC is responsible for keeping the acquisition chain of command informed of the status of assigned acquisition programs. In addition, the DASC assists the PM with issue resolution at HQDA and OSD levels. The DASC is the "eyes and ears" of the PM at the Pentagon and ensures that the PM is advised of any actions or circumstances that might negatively impact their program.

### 10-36. Program Executive Officer

a. The PEO system structure was implemented by the Army in 1987, in response to requirements established by the Goldwater-Nichols Reorganization Act of 1986; and the recommendation of the Packard Commission, under President Reagan, that was approved and then ordered by the National Security Decision Directive (NSDD) 219 (Figure 10-21).

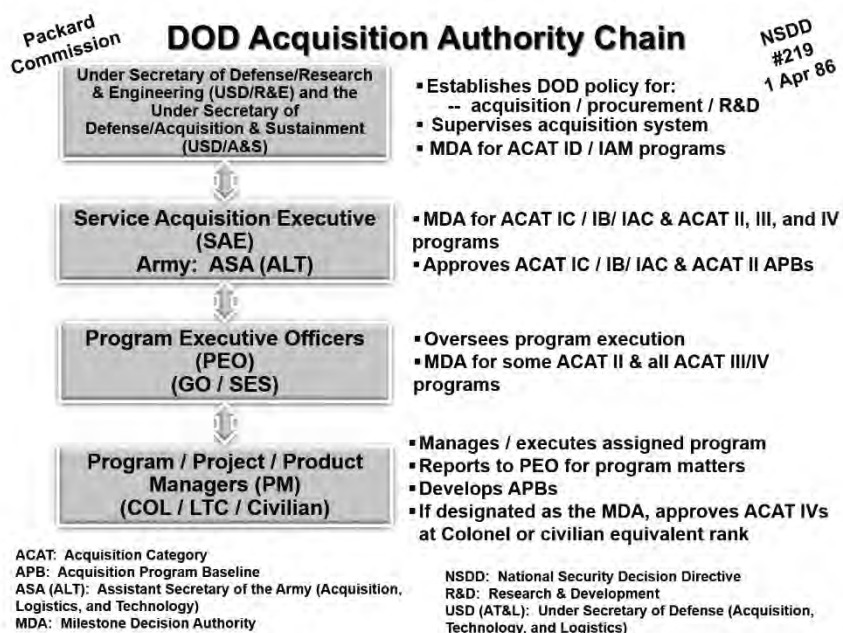

**Figure 10-21. Department of Defense Acquisition Authority Chain**

b. The PEO, administering a defined number of AAE assigned MDAPs, major and/or non-major programs, is responsible for programmatics (materiel acquisition cost, schedule, and total system performance) and for the PPBE necessary to guide assigned programs through each DAS MS. In addition, the PEO provides program information to the AAE, HQDA, DOD, and Congress; and participates in the development of data to support AAE programmatic decisions in the PPBE. Other PEO and direct-reporting PM responsibilities include assisting the CAPDEV and TNGDEV in developing capability requirements documents, by providing technical, availability, performance, anticipated materiel acquisition cost, and schedule type information as required.

c. The PEO, administering a defined number of AAE assigned MDAPs, major and/or non-major programs, is responsible for programmatics (materiel acquisition cost, schedule, and total system performance) and for the PPBE necessary to guide assigned programs through each DAS MS. In addition, the PEO provides program information to the AAE, HQDA, DOD, and Congress; and participates in the development of data to support AAE programmatic decisions in the PPBE. Other PEO and direct-

## **CAPABILITY REQUIREMENTS AND SYSTEM RESEARCH, DEVELOPMENT, AND ACQUISITION MANAGEMENT**

reporting PM responsibilities include assisting the CAPDEV and TNGDEV in developing capability requirements documents, by providing technical, availability, performance, anticipated materiel acquisition cost, and schedule type information as required.

d. The AAE has 12 PEOs: Missiles and Space; Aviation; Command, Control, Communications – Tactical; Intelligence, Electronic Warfare and Sensors (IEWS); Ground Combat Systems; Combat Support/Combat Service Support Systems; Simulation, Training, and Instrumentation; Assembled Chemical Weapons Alternatives Program; JPEO Armaments and Ammunition; Soldier; Enterprise Information Systems; and JPEO, Chemical and Biological Defense – responsible for the intensive management of RDA weapons and information systems.

### **10-37. Program/Project/Product Manager**

The PM has authority and responsibility for all programmatic decisions (cost, schedule, performance, and life-cycle sustainment) to execute the assigned program within the approved APB and subject to functional standards established by regulation, secretarial direction, or law. Generically, all PMs are program managers, but they are chartered as a program manager, a project manager, or product manager generally based on the value and importance (visibility) of the program they manage. The criteria established for designation of a program manager are generally the same as those which cause a system acquisition to be designated as a MDAP, major, or non-major program—high defense priority, high dollar value, or major Congressional or OSD interest. Since 2001, all Army acquisition programs, regardless of ACAT, are managed by a PM, overseen by a PEO or directly reporting to the AAE. All PEOs report directly to the Defense Acquisition Executive (ACAT ID programs) or to the SAE (for ACAT IC and below). Project managers report to a PEO or the AAE. All product managers report to a project manager. This distinction between PMs is unique to the Army, and does not apply to the other Services. The PM must be certified in acquisition unless a waiver is granted by the DAE or AAE.

## **Section X**

### **Operation of the Defense Acquisition System**

#### **10-38. Department of Defense Instruction 5000.02 (31 August 2018, Change 4)**

DODI 5000.02 instructs the MDA, the designated individual with responsibility for a program, to be accountable for cost, schedule, and performance reporting to higher authorities, to include Congress. This document authorizes the MDA to tailor the regulatory requirements and acquisition procedures in DODI 5000.02 to more efficiently achieve program objectives, consistent with statutory requirements. The instruction provides the detailed procedures that guide the operation of the system. Successful defense acquisition depends on careful thinking and sound professional judgments about the best acquisition strategy to use for a particular product. DODI 5000.02 contains several program structure models. These models, are not alternatives from which a Program Manager must choose; they are examples and starting points that can and should be tailored to the actual product being acquired. MDAs have been given broad authority to tailor program acquisition strategies. The following Defense Acquisition Program Models are as follows: Model 1 (Hardware Intensive Program); Model 2 (Defense Unique Software Intensive Program); Model 3 (Incrementally Deployed Software Intensive Program); Model 4 (Accelerated Acquisition Program); Model 5, Hybrid Program A (Hardware Dominant); and Model 6, Hybrid Program B (Software Dominant). DAS Models 1-6 are shown in Figures 10-22 through 10-27.

#### **10-39. Materiel Development Decision (MDD)**

a. The MDD is based on a validated initial requirements document (an ICD or equivalent requirements document) and the completion of the Analysis of AoA Study Guidance and the AoA Study Plan. This decision directs execution of the AoA, and authorizes the DOD Component to conduct the Materiel Solution Analysis Phase. This decision point is the entry point into the acquisition process for all defense acquisition products; however, an “acquisition program” is not formally initiated (with the accompanying statutory requirements) until Milestone B, or at Milestone C for those programs that enter directly at Milestone C.

b. At the Materiel Development Decision, the DCAPE, (or DOD Component equivalent) will present the AoA Study Guidance, and the AoA lead organization will present the AoA Study Plan. Additionally, the

## HOW THE ARMY RUNS

Component will provide the plan to staff and fund the actions that will precede the next decision point (usually Milestone A) including, where appropriate, competitive concept definition studies by industry.

c. If the MDD is approved, the MDA will designate the lead DOD Component; determine the acquisition phase of entry; and identify the initial review milestone, usually, but not always, a specific milestone as described in one of the program models. MDA decisions will be documented in an ADM. The approved AoA Study Guidance and AoA Study Plan will be attached to the ADM.

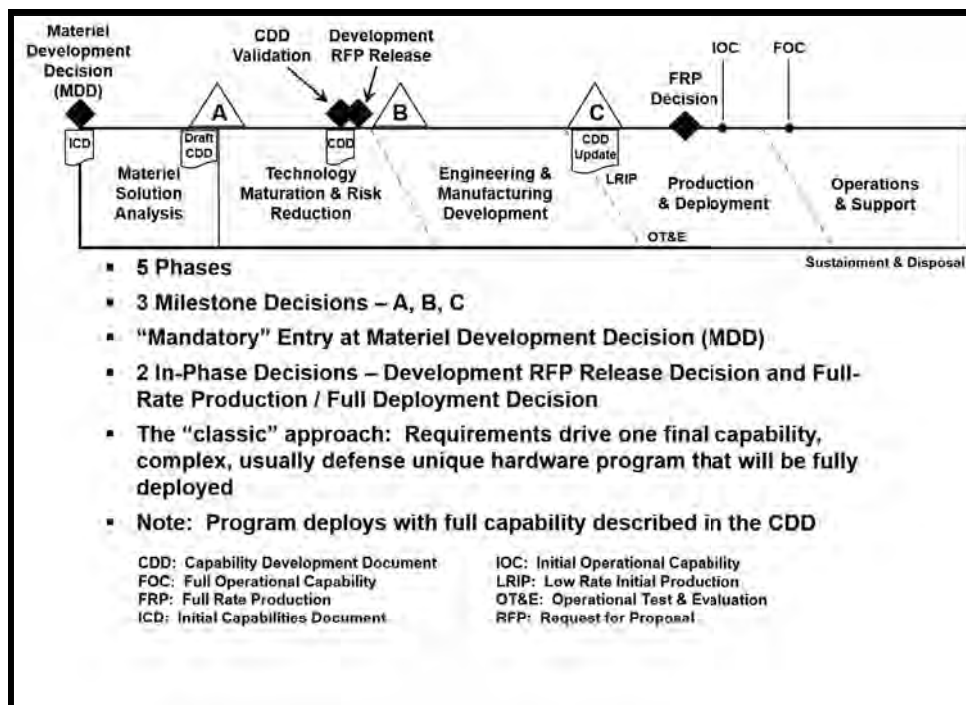

Figure 10-22. Defense Acquisition System, Model 1: Hardware Intensive Program

### 10-40. Materiel Development Decision (MDD) Review

a. At the MDD review, the validated ICD is presented to the MDA. The ICD documents the need for non-materiel and/or materiel solution approaches to resolve a specific high risk capability gap derived from the JCIDS CBA process. The ICD includes: the preliminary CONOPS; a description of the needed capability; the operational risk; and the basis for determining that non-materiel approaches will not sufficiently mitigate the capability gap. The OSD Director, Cost Assessment & Program Evaluation (D, CAPE), (or Service equivalent), proposes study guidance for the MS AoA. The purpose of the AoA is to assess the potential system-level materiel solutions to satisfy the selected materiel concept (approach) documented in the validated ICD. The AoA identifies a best set of system attributes, that are both operationally effective and affordable, and provides the analytical basis for the CDD.

b. Following approval of the study guidance, the organization conducting the AoA immediately prepares an AoA study plan to assess preliminary materiel solutions, identify key technologies, and estimate life-cycle costs. Following the MDD, the MDA may authorize entry into the DAS at any point consistent with phase-specific entrance criteria and statutory requirements. Progress through the DAS depends on obtaining sufficient knowledge to continue to the next phase of development. The MDD review is the formal entry point into the DAS and is mandatory for all potential acquisition programs. The MSA phase begins with the MDD review.

# CAPABILITY REQUIREMENTS AND SYSTEM RESEARCH, DEVELOPMENT, AND ACQUISITION MANAGEMENT

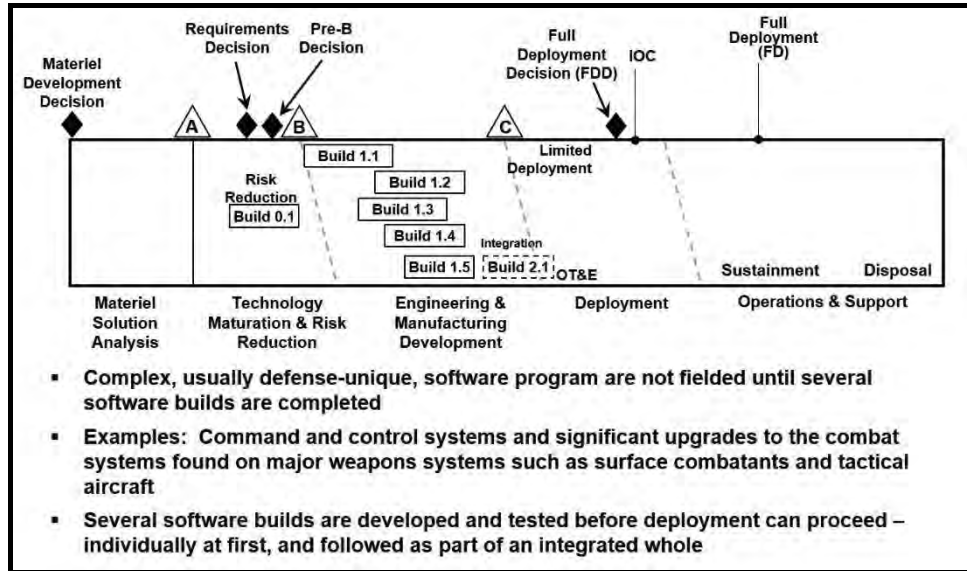

**Figure 10-23. Model 2: Defense Unique Software Intensive Program**

## 10-41. Materiel Solutions Analysis Phase

The purpose of this phase is to conduct the analysis and other activities needed to choose the concept for the product that will be acquired, to begin translating validated capability gaps into system-specific requirements including the Key Performance Parameters (KPPs) and Key System Attributes (KSAs); and to conduct planning to support a decision on the acquisition strategy for the product. AoA solutions, key trades among cost, schedule, and performance, affordability analysis, risk analysis, and planning for risk mitigation are key activities in this phase.

## 10-42. Milestone A

a. Minimum funding required for this phase is normally that needed to analyze and select an alternative for materiel development, and to complete the activities necessary to support a decision to proceed to the next phase; technology development and concept analysis and design efforts may also be funded in this phase.

b. The analysis will be conducted to focus on identification and analysis of alternatives; measures of effectiveness; key trades between cost and capability; total life-cycle cost, including sustainment; schedule; concepts of operations; and overall risk. The AoA will inform and be informed by affordability analysis, cost analysis, sustainment considerations, early systems engineering analyses, threat projections, and market research.

c. Prior to the completion of this phase, the DOD Component capabilities developer will prepare a CONOPS/Operational Mode Summary (OMS)/Mission Profile (MP) that will include the operational tasks, events, durations, frequency, operating conditions and environment in which the recommended materiel solution is to perform each mission and each phase of a mission. The CONOPS/OMS/MP are provided to the Program Manager and will inform development of the plans for the next phase including acquisition strategy, test planning, and capability requirements trades. It will be provided to industry as an attachment for the next acquisition phase RFP.

d. This phase ends when a DOD Component has completed the necessary analysis and the activities necessary to support a decision to proceed to the next decision point and desired phase in the acquisition process. The next phase can be Technology Maturation and Risk Reduction (TMRR), EMD, or P&D, depending on the actions needed to mature the product being acquired. Each of these phases has associated decision points to authorize entry.

e. Program Office Establishment and Next Phase Preparation. During the Materiel Solution Analysis Phase, the CAE will select a Program Manager and establish a Program Office to complete the necessary actions associated with planning the acquisition program with emphasis on the next phase. Prior to preparation and release of a final RFP for the planned next phase, the Program Manager should

## HOW THE ARMY RUNS

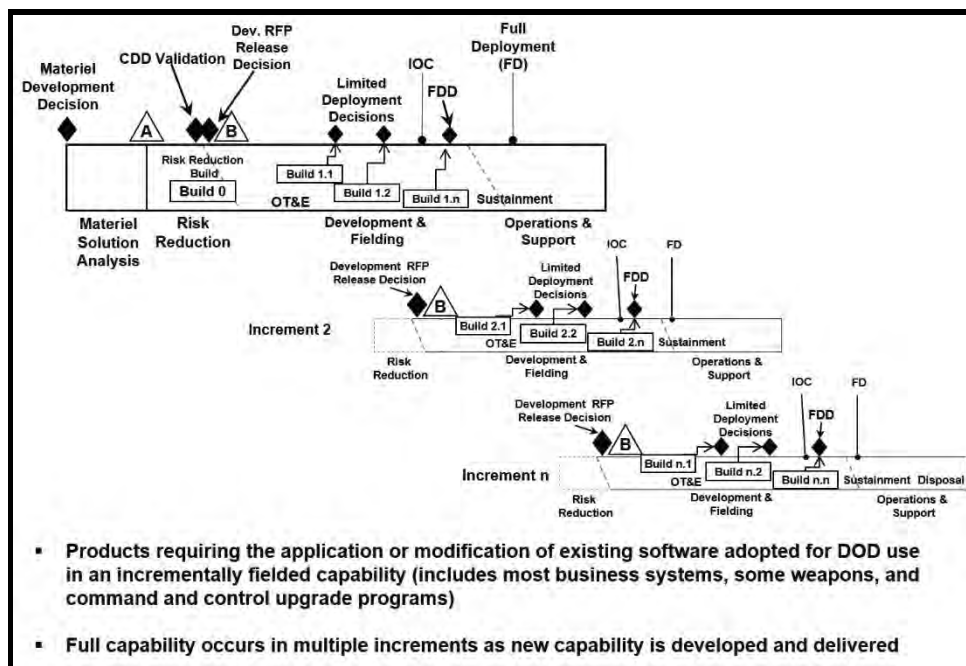

**Figure 10-24. Model 3: Incrementally Deployed Software Intensive Program**

complete and submit the Acquisition Strategy and obtain MDA approval. An approved Acquisition Strategy will inform development of the final RFPs for the next phase of the program.

### 10-43. Milestone A Review

a. The Program Manager will present the approach for acquiring the preferred materiel solution including: the Acquisition Strategy, the business approach, framing assumptions, an assessment of program risk and how specific technology development and other risk mitigation activities will reduce the risk to acceptable levels, and appropriate “Should Cost” management targets.

b. The DOD Component will present an affordability analysis and proposed affordability goals based on the resources that are projected to be available to the DOD Component in the portfolio(s) or mission area(s) associated with the program under consideration. The analysis will be supported by a quantitative assessment of all of the programs in the prospective program’s portfolio or mission area that demonstrates the ability of the Component’s estimated budgets to fund the new program over its planned life cycle. Affordability analyses are not intended to produce rigid, long-range plans; their purpose is to inform current decisions about the reasonableness of embarking on long-term capital investments at specific capability levels. The affordability analysis will support the Component’s proposed affordability goals for unit production and sustainment costs for MDA approval and inclusion in the Milestone A ADM.

c. Demonstrate that the program will be fully funded within the FYDP at Milestone A.

d. If Milestone A is approved, the MDA will make a determination on the materiel solution, the plan for the TMRR Phase, release of the final RFP, and specific exit criteria required to complete TMRR and enter EMD. The MDA will document these decisions in an ADM.

### 10-44. Technology Maturation & Risk Reduction (TMRR) Phase

a. The purpose of this phase is to reduce technology, engineering, integration, and life-cycle cost risk to the point that a decision to contract for EMD can be made with confidence in successful program execution for development, production, and sustainment.

b. This phase should include a mix of activities intended to reduce the specific risks associated with the product to be developed. This includes additional design trades and requirements trades necessary to ensure an affordable product and executable development and production programs. Capability requirements are matured and validated, and affordability caps are finalized during this phase. The TMRR Phase requires continuous and close collaboration between the program office and the requirements



# CAPABILITY REQUIREMENTS AND SYSTEM RESEARCH, DEVELOPMENT, AND ACQUISITION MANAGEMENT

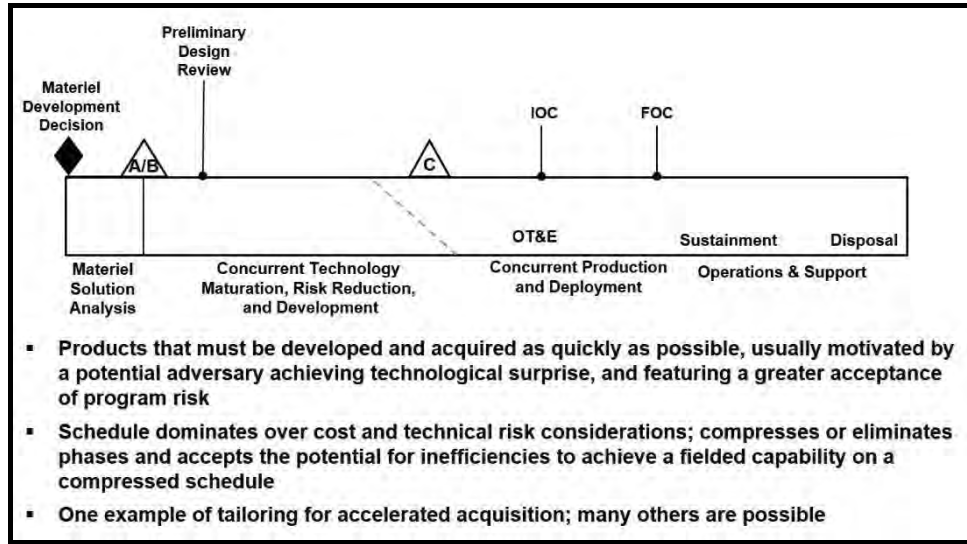

**Figure 10-25. Model 4: Accelerated Acquisition Program**

communities and authorities. During this phase, any realized Should Cost management savings should normally be used to further reduce program risk and future program costs.

c. This phase normally includes competitive sources conducting technology maturation and risk reduction activities and preliminary design activities up to and including a Preliminary Design Review (PDR) prior to source selection for the EMD Phase.

d. Risk reduction prototypes will be included if they will materially reduce engineering and manufacturing development risk at an acceptable cost. Risk reduction prototypes can be at the system level or can focus on sub-systems or components.

e. A competitive prototype, or if this is not feasible, a single prototype or prototyping of critical subsystems prior to Milestone B is statutorily required to be part of the Acquisition Strategy for MDAPs and is a regulatory requirement for all other programs.

f. There are a number of ways to structure this phase which should be tailored to reduce the specific risks associated with the product being acquired. TRLs should be used to benchmark technology risk during this phase; however, these are rough benchmarks, and not conclusive about the degree of risk mitigation needed prior to development. Deeper analysis of the actual risks associated with the preferred design and any recommended risk mitigation must be conducted and provided to the MDA.

g. The Acquisition Strategy will guide this phase. Multiple technology development demonstrations, defined in the acquisition strategy, may be necessary before the operational user and material developer can substantiate that a preferred solution is feasible, affordable, and supportable; satisfies validated capability requirements; and has acceptable technical risk. Planning for EMD, production, developmental and operational test, and life-cycle sustainment of proposed products will occur during this phase.

h. During this phase, and timed to support CDD validation (or its equivalent), the Program Manager will conduct a systems engineering trade-off analysis showing how cost and capability vary as a function of the major design parameters. The analysis will support the assessment of refined KPPs/KSAs in the CDD. Capability requirements proposed in the CDD (or equivalent requirements document) should be consistent with program affordability goals.

i. Subsequent to CDD validation, the Program Manager will conduct additional requirements analysis including: requirements decomposition and allocation, definition of internal and external interfaces, and design activities leading to a PDR. Unless waived by the MDA, the PDR will occur prior to Milestone B.

j. During the TMRP Phase, the Program Manager will plan the balance of the program, prepare for subsequent decision points and phases, and submit an updated Acquisition Strategy for MDA approval. The updated Acquisition Strategy will describe the overall approach to acquiring the capability to include the program schedule, risks, funding, and the business strategy. The business strategy will describe the rationale for the contracting approach and how competition will be maintained throughout the program life cycle, and detail how contract incentives will be employed to support the Department's goals.

## HOW THE ARMY RUNS

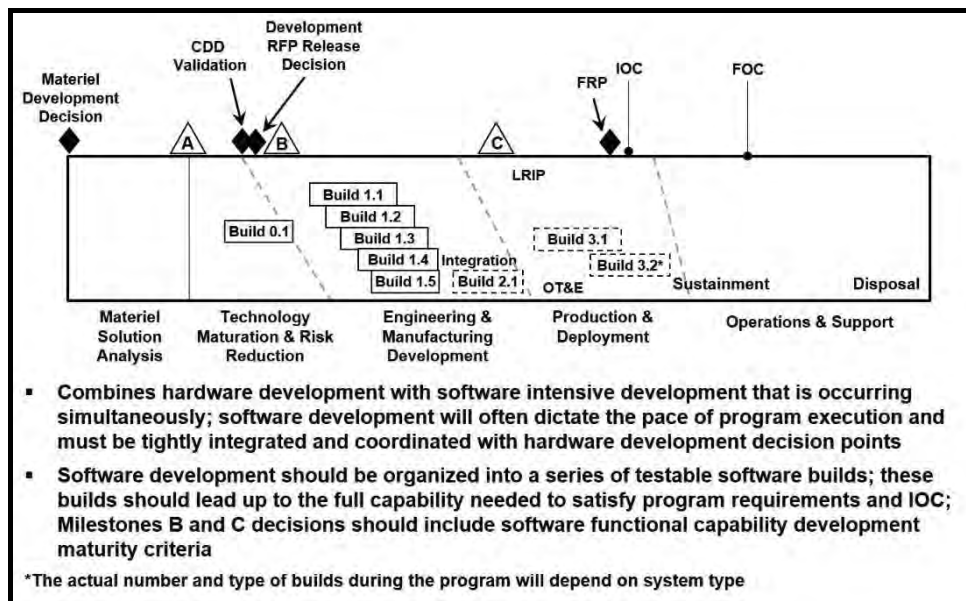

Figure 10-26. Model 5: Hybrid Program A (Hardware Dominant)

### 10-45. Milestone B

a. This milestone provides authorization to enter into the EMD Phase and for the DOD Components to award contracts for EMD. It also commits the required investment resources to the program. Most requirements for this milestone should be satisfied at the Development RFP Release Decision Point; however, if any significant changes have occurred, or if additional information not available at the Development RFP Release Decision Point could impact this decision, it must be provided at the Milestone B. Milestone B requires final demonstration that all sources of risk have been adequately mitigated to support a commitment to design for production. This includes technology, engineering, integration, manufacturing, sustainment, and cost risks. Validated capability requirements, full funding in the FYDP, and compliance with affordability goals for production and sustainment, as demonstrated through an independent cost estimate (ICE), are required.

b. Milestone B is normally the formal initiation of an acquisition program with the MDA's approval of the APB. The APB is the agreement between the MDA and the Program Manager and his or her acquisition chain of command that will be used for tracking and reporting for the life of the program or program increment. The APB will include the affordability caps for unit production and sustainment costs. Affordability caps are established as fixed cost requirements equivalent to KPPs.

c. At the milestone, the MDA will finalize the following, if not already completed:

- (1) The Low Rate Initial Production (LRIP) quantity or the scope of limited deployment, as applicable.
- (2) The specific technical event-based criteria for initiating production or making deployment decisions.
- (3) Document decisions in an ADM.

### 10-46. Engineering & Manufacturing Development Phase

a. The purpose of the EMD Phase is to develop, build, and test a product to verify that all operational and derived requirements have been met, and to support production or deployment decisions.

b. General. EMD completes all needed hardware and software detailed design; systemically retires any open risks; builds and tests prototypes or first articles to verify compliance with capability requirements; and prepares for production or deployment. It includes the establishment of the initial product baseline for all configuration items.

c. Design. The system design effort usually includes a standard series of design reviews prior to test article fabrication and/or software build or increment coding. Multiple design iterations may be necessary to converge on a final design for production. The SEP provides the basis for design activities.

# CAPABILITY REQUIREMENTS AND SYSTEM RESEARCH, DEVELOPMENT, AND ACQUISITION MANAGEMENT

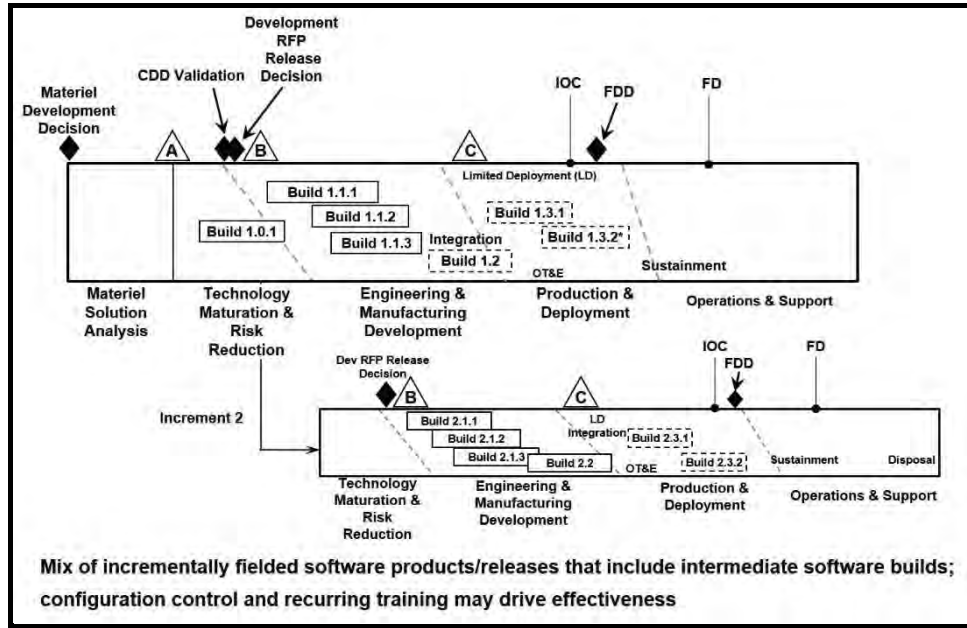

**Figure 10-27. Model 6: Hybrid Program B (Software Dominant)**

d. Post-Milestone B PDR. If a PDR prior to Milestone B has been waived, the Program Manager will plan for a PDR as soon as feasible after program initiation.

e. Developmental Test and Evaluation (DT&E). Developmental testing and evaluation provides feedback to the Program Manager on the progress of the design process and on the product's compliance with contractual requirements. DT&E activities also evaluate the ability of the system to provide effective combat capability, including its ability to meet its validated and derived capability requirements, including the verification of the ability of the system to achieve KPPs and KSAs, and that initial system production and deployment and Operational Test and Evaluation (OT&E) can be supported. The effort requires completion of DT&E activities consistent with the Test and Evaluation Master Plan (TEMP). Successful completion of adequate testing with production or deployment representative prototype test articles will normally be the primary basis for entering LRIP or Limited Deployment.

f. Developmental and operational test activities should, to the extent feasible, be planned in conjunction with one another to provide as efficient an overall test program as possible.

g. During EMD, the Program Manager will finalize designs for product support elements and integrate them into a comprehensive product support package. Early in the EMD Phase, the Program Manager's initial product support performance requirements allocations will be refined based on the results of engineering reviews.

h. The MDA conducts a formal program assessment following system-level Critical Design Review (CDR). The system-level CDR provides an opportunity to assess design maturity as evidenced by measures such as: successful completion of subsystem CDRs; the percentage of hardware and software product build-to specifications and drawings completed and under configuration management; planned corrective actions to hardware/software deficiencies; adequate DT; the identification of key system characteristics; the maturity of critical manufacturing processes; and an estimate of system reliability based on demonstrated reliability rates. The PM provides a post-CDR report to the MDA that provides an overall assessment of design maturity and a summary of the system-level CDR results.

i. The EMD Phase will end when:

- (1) The design is stable.
- (2) The system meets validated capability requirements demonstrated by developmental and initial operational testing as required in the TEMP.
- (3) Manufacturing processes have been effectively demonstrated and are under control.
- (4) Software sustainment processes are in place and functioning.
- (5) Industrial production capabilities are reasonably available.

## HOW THE ARMY RUNS

(6) The system has met or exceeds all directed EMD Phase exit criteria and Milestone C entrance criteria. EMD will often continue past the initial production or fielding decision until all EMD activities have been completed and all requirements have been tested and verified.

### 10-47. Milestone C

a. Milestone C and the Limited Deployment Decision are the points at which a program or increment of capability is reviewed for entrance into the P&D Phase or for Limited Deployment. Approval depends in part on specific criteria defined at Milestone B and included in the Milestone B ADM. The following general criteria will normally be applied: demonstration that the production/deployment design is stable and will meet stated and derived requirements based on acceptable performance in developmental test events; an operational assessment; mature software capability consistent with the software development schedule; no significant manufacturing risks; a validated Capability Development Document (CDD), CDD Update, or equivalent requirements document; demonstrated interoperability; demonstrated operational supportability; costs within affordability caps; full funding in the FYDP; properly phased production ramp up; and deployment support.

b. In making Milestone C and Limited Deployment Decisions, the MDA will consider any new validated threat environments that were not included in the CDD and/or CDD Update and might affect operational effectiveness, and will consult with the requirements validation authority as part of the production decision making process to ensure that capability requirements are current.

c. MDA decisions at Milestone C and Limited Deployment Decisions will be documented in an ADM following the review.

### 10-48. Production & Deployment (P&D) Phase

a. The purpose of the P&D Phase is to produce and deliver requirements-compliant products to receiving military organizations. In this phase, the product is produced and fielded for use by operational units. The phase encompasses several activities and events: LRIP, Limited Deployment, OT&E, and the Full-Rate Production Decision or the Full Deployment Decision followed by full-rate production or full deployment. During this phase, the appropriate operational authority will declare IOC when the defined operational organization has been equipped and trained and is determined to be capable of conducting mission operations. During this phase, Should Cost management and other techniques will be used continuously to control and reduce cost.

b. LRIP establishes the initial production base for the system or capability increment, provides the OT&E test articles, provides an efficient ramp up to full-rate production, and maintains continuity in production pending OT&E completion. While this portion of the phase should be of limited duration so that efficient production rates can be accomplished as soon and as economically as possible, it should be of sufficient duration to permit identification and resolution of any deficiencies prior to full-rate production. Limited Deployment for software developments is principally intended to support OT&E and can, consistent with the program strategy, be used to provide tested early operational capability to the user prior to full deployment.

c. The appropriate operational test organization will conduct operational testing in a realistic threat environment. The threat environment will be based on the program's Validated On-Line Life-Cycle Threat Report (VOLT) and appropriate scenarios. For MDAPs, MAIS programs, and other programs on the Director, Operational Test and Evaluation (DOT&E) Oversight List, the DOT&E will provide a report providing the opinion of the DOT&E as to whether the program is operationally effective, suitable, and survivable before the MDA makes a decision to proceed beyond LRIP

. For programs on the DOT&E Oversight List, operational testing will be conducted in accordance with the approved TEMP and operational test plan.

d. LRIP is intended to result in completion of manufacturing development to ensure adequate and efficient manufacturing capability and to produce at least the minimum quantity necessary to provide production configured or representative articles for IOT&E; establish an initial production and training base for the system; and permit an orderly increase in the production rate for the system, sufficient to lead to full-rate production upon successful completion of operational (and live-fire, where applicable) testing. Deficiencies encountered in testing prior to MS C are resolved prior to proceeding beyond LRIP (at the FRP decision review) and any fixes verified in IOT&E. LRIP may be funded by RDT&E appropriation or by procurement appropriation, depending on the intended usage of the LRIP systems.

## **CAPABILITY REQUIREMENTS AND SYSTEM RESEARCH, DEVELOPMENT, AND ACQUISITION MANAGEMENT**

e. The DOT&E determines the LRIP quantity for MDAPs and major systems at MS B, and provides rationale for quantities exceeding 10 percent of the total production quantity documented in the Acquisition Strategy. Any increase in quantity after the initial determination, must be approved by the DOT&E.

### **10-49. Full-Rate Production Decision Review**

a. An acquisition program may not proceed beyond LRIP without approval of the MDA at the FRP decision review. Before making the full-rate production and deployment decision, the MDA considers:

- (1) Economic analysis.
- (2) The manpower estimate (if applicable).
- (3) The results of operational and live fire test (if applicable).
- (4) Compliance certification and certification for MAISs.
- (5) C4I supportability certification.
- (6) Interoperability certification.

b. The MDA approves the AS prior to the release of the final RFP, the production APB, and the ADM. The decision to continue beyond low-rate to full-rate production, or beyond limited deployment of MAISs or software-intensive systems with no developmental hardware requires completion of IOT&E, submission of the Beyond LRIP Report for DOT&E oversight programs, and submission of the Live-Fire Test and Evaluation (LFT&E) Report (where applicable) to the USD (A&S), to the SECDEF, and to Congress. This work effort delivers the fully funded quantity of systems and supporting materiel and services to the users. During this work effort, units attain initial operational capability (IOC). The IOC is the first attainment of the capability by a MTOE unit and supporting elements to operate and maintain effectively a production item or system provided the following: 1) The item or system has been type classified as standard or approved for limited production; 2) The unit and support personnel have been trained to operate and maintain the item or system in an operational environment; 3) The unit can be supported in an operational environment in such areas as special tools, test equipment, repair parts, documentation, and training devices.

### **10-50. Operations & Support Phase**

The objective of this activity/phase is the execution of a support program that meets materiel readiness and operational support performance requirements and sustains the system in the most cost-effective manner over its total life-cycle. When the system has reached the end of its useful life, it must be disposed of in an appropriate manner. Planning for this phase begins prior to program initiation and is documented in the Life-Cycle Sustainment Plan (LCSP). The O&S phase has two major work efforts – life-cycle sustainment and disposal.

a. The life-cycle sustainment program includes all elements necessary to maintain the readiness and operational capability of deployed systems. The scope of support varies among programs, but generally includes supply, maintenance, transportation, sustaining engineering, data management, configuration management, manpower, personnel, training, habitability, survivability, safety (including explosives safety), occupational health, protection of Critical Program Information (CPI), anti-tamper provisions, IT (including National Security System (NSS)) supportability and interoperability, and environmental management functions. The PM works with the CAPDEV to document performance and sustainment requirements in performance agreements specifying objective outcomes, measures, resource commitments, and stakeholder responsibilities. The PM employs effective performance-based life-cycle product support planning, development, implementation, and management. Performance-Based Logistics (PBL) offers the best strategic approach for delivering required life-cycle readiness, reliability, and ownership costs.

b. At the end of its useful life, a system must be demilitarized and disposed of in accordance with all legal and regulatory requirements and policy relating to safety (including explosives safety), security, and the environment. During the design process, PMs document hazardous materials contained in the system, and estimate and plan for demilitarization and safe disposal. The demilitarization of conventional munitions (including any item containing propellants, explosives, or pyrotechnics) shall be considered during systems design.

## HOW THE ARMY RUNS

### 10-51. Middle-Tier Acquisition (MTA) Policy

a. Rapid Prototyping shall provide for the use of innovative technologies to rapidly develop prototypes to demonstrate or evaluate new capabilities, operational concepts or meet emerging military needs. The objective of acquisition efforts under the rapid prototyping pathway is to field a prototype that can support these purposes in a real or simulated operational environment and provide for a residual operational capability within five years of the development of an approved requirement.

b. Rapid Fielding shall provide for the use of proven technologies, to include through Rapid Prototyping, to field production quantities of new or upgraded systems with minimal development required. The objective of acquisition efforts under the rapid fielding pathway is to begin production within six months and complete fielding of an Army Requirements Oversight Council (AROC) defined capability increment within five years of the development of an approved requirement.

c. Not subject to the Joint Capabilities Integration and Development System Manual and Department of Defense Directive 5000.01. Term "major defense acquisition program" does not include an acquisition program or project that is carried out using the rapid fielding or rapid prototyping acquisition pathway. Request for authority to implement Section 804 (National Defense Authorization Act of 2016) will be submitted through the Deputy for Acquisition & Systems Management (DASM) to the Army Acquisition Executive (AAE).

d. Component or Service Acquisition Executive (CAE/SAE) must provide notice of programs being approved as MTA NLT 30 days before any funding is released.

c. Office of the Secretary of Defense (OSD) can disagree and direct program to follow traditional acquisition authorities under DODI 5000.02.

## Section XI

### Acquisition Oversight and Review

#### 10-52. Defense Acquisition Board (DAB)

The DAS is controlled by decisions made as the result of various acquisition programs MDRs conducted by appropriate management levels at program MSs. The reviews are the mechanism for checking program progress against approved plans and for developing revised APBs. Approval of APBs and plans in these reviews do not constitute program funding approval; and allocation of funds in the PPBE process is required.

a. The function of the DAB is to review DOD ACAT ID programs to ensure that they are ready for transition from one DAS program phase to the next. The DAB is the DOD senior-level acquisition forum for advising the USD (A&S), as the DAE, on critical decisions concerning ACAT ID programs. DAB reviews focus on key principles to include interoperability and demonstrated technical maturity. The DAB is composed of DOD senior-level officials. The board is chaired by the USD(A&S). Other executive members include: The VCJCS; Under Secretary of Defense (Comptroller); Under Secretary of Defense (Policy); Under Secretary of Defense (Personnel & Readiness); DOD Chief Information Officer; Director, Cost Assessment and Program Evaluation; Director, Operational Test and Evaluation; and the Secretaries of the Military Departments. The Director, Acquisition Resources and Analysis serves as the DAB Secretary; and additional advisors as required.

#### 10-53. Army Systems Acquisition Review Council (ASARC)

a. The ASARC is the Army's senior-level acquisition advisory body for ACAT IC, IAC, and selected ACAT II programs, ACAT ID programs (DAB managed) prior to a DAB, and ACAT IAM programs prior to an ITAB. The ASARC convenes at formal MSs to determine a program or system's readiness to enter the next phase of the materiel acquisition cycle, and makes recommendations to the AAE on those programs for which the AAE is the MDA. An ASARC may be convened at any time to review the status of a program. The ASARC is chaired by the AAE.

b. ASARC membership includes: Vice Chief of Staff, Army (VCSA); ASA(ALT) Principal DASA; ASA(ALT) Principal MILDEP; Deputy Under Secretary of the Army – Test and Evaluation; Assistant Secretary of the Army (Financial Management and Comptroller); Assistant Secretary of the Army (Installations, Energy, and Environment); Assistant Secretary of the Army (Manpower and Reserve Affairs); CG, Army Materiel Command; CG, Training and Doctrine Command; Office of the General Counsel; DCS, G-1; DCS, G-2; DCS, G-3/5/7; DCS, G-4; CIO/G-6; DCS, G-8; Office of Small

# CAPABILITY REQUIREMENTS AND SYSTEM RESEARCH, DEVELOPMENT, AND ACQUISITION MANAGEMENT

Business Programs; Office of the Chief, Army Reserve; Army National Guard/National Guard Bureau; CG, ATEC; and other ASA(ALT) representatives and organizations are invited to attend, if a significant issue is identified within their area of responsibility.

## **10-54. In-Process Review (IPR)**

a. The IPR is a formal acquisition review forum for ACAT III and IV programs. Reviews are conducted at MSs and at other times deemed necessary by the MDA. The MDA, usually the assigned PEO, chairs the IPR.

b. The IPR brings together representatives of the MATDEV, the CAPDEV, the trainer, the logistician, and the independent evaluators for a joint review and decision on proceeding to the next phase of development. Their purpose is to provide recommendations, with supporting rationale, as a basis for system concept, system development, type classification, and production decisions by the appropriate level of authority. They are the forums where agencies responsible for participating in the materiel acquisition process can present their views and ensure that those views are considered during development, test, evaluation, and production. Participation is extended to the appropriate testing agencies, HQDA representatives, and to others as designated by the IPR chairman.

## **10-55. Configuration Steering Board (CSB)**

Section 814 of the 2009 National Defense Authorization Act (NDAA) requires the Secretary of each military department to establish a CSB for DAS post MS B ACAT I and IA programs for cost and requirements. The CSB reviews all proposed requirement changes and any significant technical configuration changes for programs in development that have the potential to result in cost and schedule impacts to an acquisition program during DAS Engineering and Manufacturing Development (EMD) Phase. The CSB is designed to monitor programs and avoid requirements creep. As of 26 June 2018, Major Defense Acquisition Programs (MDAPs) are no longer required to conduct an annual CSB, if the AAE determines that there have been no changes to the program requirements during the preceding year and no changes are anticipated for the current year. PEOs may nominate programs meeting the above criteria for exemption from the annual CSB requirement through the Director, Acquisition Reporting and Assessments (ARA). If a program has been granted an exemption, and subsequently, an event occurs necessitating a requirements change, a trigger CSB may be executed. (Section 826 of the NDAA 2018, Public Law 115-91).

## **Section XII**

### **Major Sub-Processes**

#### **10-56. Test and Evaluation Process/Products**

There are several major sub-processes that support the DAS. One of those major sub-processes is Testing and Evaluation (T&E). The Director of Operational Test and Evaluation (DOT&E) and ATEC are two major players with important roles in the Test and Evaluation Process.

a. DOT&E. The appropriate operational test organization will conduct operational testing in a realistic threat environment. The threat environment will be based on the program's System Threat Assessment Report and appropriate scenarios. For MDAPs, MAIS programs, and other programs on the DOT&E Oversight List, the DOT&E will provide a report providing the opinion of the DOT&E as to whether the program is operationally effective, suitable, and survivable before the MDA makes a decision to proceed beyond LRIP. For programs on the DOT&E Oversight List, operational testing is conducted in accordance with the approved TEMP and operational test plan. If LRIP is not conducted for programs on the DOT&E Oversight List, fully production-representative articles must nonetheless be provided for the conduct of the required operational testing.

b. ATEC. The CG, ATEC is responsible for management of the Army's OT, DT, and System Evaluation (SE) processes. Their evaluations of materiel and IT systems' operational effectiveness, suitability and survivability are independent of the CAPDEV/MATDEV and are reported directly to the MDA. CG, ATEC is a member of the ASARC, AROC, and chairman of the Test Schedule and Review Committee (TSARC). The TSARC is the HQDA centralized management forum for user (operational) testing and resources. ATEC provides advice and assistance to the CSA, the VCSA, other members of the ARSTAF, and other elements of HQDA in regard to Army T&E. Other responsibilities include:

## HOW THE ARMY RUNS

(1) Reviewing all draft capability requirements documents for T&E implications.

(2) Assisting TRADOC ARCIC in developing evaluable, operationally relevant, and totally system focused Critical Operational Issues and Criteria (COIC). Provide advice concerning methods and measures to evaluate the system against the COIC and advise on the resources and ability to test and evaluate the system.

(3) Preparing and approving all ATEC Capabilities & Limitations Reports in support of rapid fielding.

(4) Supporting the TRADOC JWA program, Network Integration Evaluation (NIE), and Concept Experimentation Program (CEP).

c. All Army acquisition programs must be supported by a TEMP, that reflects an adequate and efficient T&E program. T&E is the principal tool with which progress in system development and acquisition is measured. T&E is structured to support the DAS and user by providing essential information to decision-makers, assessing attainment of technical performance parameters, and determining whether systems are operationally effective, suitable, and survivable for intended use. The primary reasons for conducting T&E are to facilitate learning, assess technical maturity and interoperability, facilitate integration into fielded forces, and confirm performance. In addition, T&E can assess and reduce program risk (e.g., cost, schedule, technical feasibility, technical obsolescence, and software management). The primary product of the T&E sub-process is information (hard facts), plus an independent evaluation of all the credible data on a system, so that the MDA can make informed decisions.

d. The planning, programming, and budgeting for T&E begins early in the acquisition process, concurrent with coordination of the validated ICD. Early T&E integration is accomplished through the independent evaluator's involvement in the ICDT and the planning of the acquisition team within the T&E WIPT. The primary purpose of the T&E WIPT is to optimize the use of the appropriate T&E expertise, instrumentation, targets, facilities, simulations, and models to implement test integration, thereby reducing costs and decision risk to the Army. The primary product of the T&E WIPT is the TEMP. The Army Test and Evaluation Executive, within the office of the DUSA, is the TEMP approval authority for all ACAT I/IA, ACAT II, and any programs on the OSD T&E Oversight List prior to final OSD approval. The MDA approves TEMPs for ACAT II, III and IV programs not on the OSD T&E Oversight List.

e. Continuous Evaluation is used to provide a continuous flow of information and data to decision-makers, MATDEV, and CAPDEVs. The data generated in early development phases is visible and maintained as the system moves into formal testing, thereby avoiding duplication of testing. Continuous evaluation continues through a system's post-deployment, to verify whether the fielded system meets or exceeds demonstrated performance and support parameters.

### 10-57. Developmental Testing (DT) and Operational Testing (OT)

a. DT encompasses models, simulation, and engineering tests that are used to verify that design risks are minimized, system safety is certified, achievement of system technical performance is substantiated, and to certify readiness for OT. DT generally requires instrumentation and measurements, and accomplished by engineers and technicians, is repeatable, may be environmentally controlled, and covers the complete spectrum of system capabilities. The PM designs DT objectives applicable to each phase and MS.

b. OT is a field test of a system (or item) under realistic operational conditions with users who represent those expected to operate and maintain the system (or item) when fielded or deployed. Examples of key OTs are:

(1) IOT&E. It is conducted before the FRP decision and is structured to provide data to determine the operational effectiveness, suitability, and survivability of a system operated by typical users under realistic conditions (e.g., combat and representative threat).

(2) FOT&E. FOT&E may be necessary during (or after) production to refine the estimates made during the IOT&E, provide data to examine changes, and verify that deficiencies in materiel, training, or concepts have been corrected. A FOT&E provides data to ensure that the system continues to meet operational needs and that it retains its effectiveness in a new environment or against a new threat.

c. The Army's TSARC is a high-level centralized management forum that reviews and coordinates the resource commitment (e.g., personnel, instrumentation, and equipment), required to support the tests included in the Army's Five-Year Test Program (FYTP). The TSARC is chaired by CG, ATEC and operates under AR 73-1. When approved for inclusion in the FYTP, a program's TRP becomes the authority for tasking in the current and budget years. The TRP is the acquisition system's formal T&E resource planning and tasking document.



# CAPABILITY REQUIREMENTS AND SYSTEM RESEARCH, DEVELOPMENT, AND ACQUISITION MANAGEMENT

## 10-58. Integrated Product Support (IPS) Process

Another major sub-process in support of DAS is Integrated Product Support (IPS).

a. IPS is a disciplined, unified, and interactive approach to the management and technical activities necessary to integrate logistics support into system and equipment design. IPS is the process used by the Army to implement the mandatory life-cycle logistics policies and procedures and includes all elements of planning, developing, acquiring, and supporting Army materiel throughout its life-cycle.

b. PBL is the preferred Product Support Strategy (PSS) for weapon systems that employs the purchase of support as an integrated performance package designed to optimize system readiness. PBL objectives include optimizing total system availability while minimizing cost and logistics footprint. PBL is implemented on all Army ACAT programs where it is operationally and economically feasible. PBL will meet performance goals for the system through a support structure based on performance agreements. These agreements must contain clear lines of authority and responsibility, delineate outcome performance goals of weapon systems, ensure that responsibilities are assigned, provide incentives for attaining these goals, and facilitate the overall life-cycle management of system reliability, supportability, and total ownership costs. The PBL strategy must be addressed at each MDR and is tailored for each individual acquisition system with specific performance goals, roles, responsibilities that will be detailed in Performance-Based Agreements (PBA) prior to system fielding.

c. LCSP documents the PM's plan for the sustainment strategy of an acquisition program. The LCSP is based upon the IPS framework (IPS elements). The LCSP is a standalone document which is submitted for MDA approval. The PM will also include a summary of the LCSP in the main body of the AS. The initial LCSP is prepared by the CAPDEV IPS lead for the system during the Materiel Solution Analysis Phase and is provided to the PM's IPSPM or PSM upon establishment of the PM SIPT.

(1) The purpose of the LCSP is to methodically gather and review relevant logistics data (Supportability Analysis (SA)), assess alternative system design and support concepts using the SA, document decisions, coordinate plans, and execute the selected logistics support concept. The LCSP will serve as the official record to document the actions taken during the development and implementation of the IPS management process.

(2) The LCSP is used to maintain an audit trail of changes that affect:

- (a) Support planning.
- (b) Support budgets, including the LCC estimate and reduction in total ownership costs initiatives.
- (c) Support concepts, support-related goals, and thresholds (including changes in definition).
- (d) Impacts or changes on system readiness objective (SRO), support costs, and IPS objectives.
- (e) Strategy to achieve type classification-standard and Full Materiel Release (FMR) by FRP

decision.

(3) The MDA manages and approves the LCSP for all ACAT levels. The SIPT utilizes the acquisition strategy for its foundation to ensure supportability is integrated into the acquisition.

(4) The LCSP is updated by the PM; coordinated with CAPDEV, supporting LCMCs, Army Acquisition Logistician, the technical and operational testers/evaluators, and other program participants; and will be available 60 days prior to MS B.

(a) When no PM exists prior to MS B, the PEO, who is assigned system responsibility, will lead the effort to develop the LCSP.

(b) In cases where there is no CAPDEV IPS lead, the PEO (or PM if assigned) will develop the initial LCSP.

(c) Programs past MS B that do not have a LCSP will require one prior to MS C to address the IPS planning during development, production, fielding, and sustainment.

(5) For Joint Service acquisition programs for which the Army has lead responsibility, the IPSPM or PSM will develop an LCSP in coordination with all participating Services. For other programs, the Army representative on the SIPT will coordinate Army input to the LCSP.

(6) The LCSP will include the details of the plan, exit criteria, and the timeline to achieve all program decision points, key events, and MSs to include Type Classification and FMR (see AR 700-142).

## 10-59. Army Human System Integration (HSI)

Another major sub-process in support of the DAS is the Army HSI program. HSI is the Army's application of the DOD HSI requirements in systems acquisition (DODD 5000.01 and DODI 5000.02), in compliance with Title 10. HSI, described in detail in AR 602-2, is the Army's program to ensure that Soldier

## HOW THE ARMY RUNS

performance is the central consideration in system design, development, and acquisition. HSI is now an organization within AFC, specifically under AFCs CCDC. HSI systematically considers the impact of materiel design on soldiers throughout the system development and design process. HSI optimizes total system performance; reduces life cycle costs; minimizes risk of soldier loss or injury; ensures usability, suitability, maintainability and sustainability; eliminates reliance on external human support; and extends weapon system life. The HSI methodology “fits the equipment to the soldier – not the soldier to the equipment.” HSI is the technical process of integrating the seven interdependent HSI elements/domains:

- a. Manpower. The number of military and civilian personnel required and potentially available to operate, maintain, sustain and provide training for systems.
- b. Personnel. To establish and enforce requirements for individuals and unit physical environments, personnel services, and living conditions, to prevent or mitigate risk conditions that adversely impact performance, quality of life and morale, or degrade recruitment or retention.
- c. Training. Provides instruction, education, and on the job training required to provide personnel and units with their essential job skills, knowledge, values, and attitudes.
- d. Human factors engineering. Human factors engineering is the integration of characteristics into system definition, design, development and evaluation to optimize human-machine performance.
- e. Safety & Occupational Health. Considers environmental, safety and occupational health in determining system design characteristics to enhance job performance and minimize risks of illness, disability, injury and death to operators and maintainers.
- f. Force Protection & Survivability. The impact of system design (e.g., egress, survivability) to protect individuals and units from direct threat events and accidents, including chemical, biological, and nuclear threats.
- g. Habitability. The cognitive and physical capabilities required to train, operate, maintain and sustain materiel and information systems.

### 10-60. Training Development (TD)

Training development is another major sub-process in support of the DAS.

- a. Training development (TD) is a vital component of TRADOC’s mission to prepare the Army for war. TRADOC is responsible for developing training and providing support for individual and unit training. This responsibility includes determining requirements for range, ammunition, and training devices and facilities, as well as education/training courses, products, and programs.
- b. The Army’s Training and Education Development Process (TEDP) is a systematic approach to making training/education decisions about collective, individual, and self-development training for the Army. The TEDP involves five training related phases: Evaluation; Analysis; Design; Development; and Implementation. Evaluation is continuous throughout the TEDP process and the entire process must operate within a given set of resources.
- c. The Army’s implementation of the DAS is a complex and lengthy process embedded with training development throughout. Training impacts and costs are vital to system performance. Close and continuous coordination between the CAPDEV, MATDEV, and TNGDEV is required to develop and field a complete material system that meets the CDD requirements.
- d. The System Training Plan (STRAP) is the master training plan for a new, improved, or displaced materiel system. It establishes a basis for determining resources (manpower, equipment, and facilities) to ensure training can be adequately conducted and supported. It outlines the development of the total training strategy for integrating a new system into the training base and gaining units; plans for all necessary training support, training products, and courses; and sets MSs to ensure the accomplishment of the training strategy. In addition, the STRAP supports development and validation of the system capability requirements documents and establishes MSs for managing training development.
- e. The proponent TNGDEV develops the STRAP. The commanding general of the proponent TRADOC or non-TRADOC CoE approves the STRAP.
- f. AR 350-1 provides policy and procedures and assigns responsibilities for the planning and execution of new systems training. The regulation provides a process for the expeditious integration of equipment into the force structure through NET, Displaced Equipment Training (DET), Doctrine and Tactics Training (DTT), and Sustainment Training (ST).

(1) NET supports force integration and modernization through identification of personnel, training, and training devices required to support new or improved equipment. NET comprises the planning for the orderly transfer of knowledge from the MATDEV to the trainer, user, and supporter by documenting

## **CAPABILITY REQUIREMENTS AND SYSTEM RESEARCH, DEVELOPMENT, AND ACQUISITION MANAGEMENT**

requirements in New Equipment Training Plans (NETP) and the deployment of New Equipment Training Teams to train Soldiers to operate, maintain, and provide instruction on modernized equipment.

(2) DET applies to systems replaced by new equipment, but remain in the inventory. Planning for and executing DET is similar to the NET process.

(3) DTT occurs in conjunction with NET or DET. DTT provides commanders, staffs, operators, and trainers with a doctrinal basis for employment of new or displaced materiel.

(4) ST is a command responsibility. The training base shares the responsibility for ST by assuring that a pool of trained replacements is available to support the sustainment effort. The ultimate responsibility for ST, however, remains with the commander.

g. Training Aids, Devices, Simulators and Simulations (TADSS) are developed and acquired to support training at the unit and/or Combat Training Centers (CTC) and within the institutional training base. Training aids are instructional aids to enable trainers to conduct and sustain task-based training in lieu of using extensive printed material or equipment. TADSS is either system or non-system:

(1) System TADSS are designed for use with a system, family-of-systems or item of equipment, including sub-assemblies and components. They may be stand-alone, embedded, or appended. They are funded (HQDA DCS, G-8, Equipping Program Evaluation Group (PEG)) and documented as part of the weapon system they support. The weapon system PM is responsible to procure the system TADSS.

(2) Non-Standard Training Aids, Devices, Simulations, and Simulators (NSTD) support general military training and non-system specific training requirements. They are funded (HQDA DCS, G-3/5/7, Training PEG) and documented as a separate program under the Training Mission Area. The PEO Simulation, Training, and Instrumentation is normally responsible to procure and develop non-system TADSS.

### **10-61. Contracting**

As defined in 10 U.S.C 2545, the DAS exists to manage the investments of the United States in technologies, programs, and product support necessary to achieve the national security strategy prescribed by the President pursuant to section 108 of the National Security Act of 1947 (50 U.S.C. 3043) and to support the United States Armed Forces. The Armed Forces use contracting to acquire quality supplies and services that satisfy user needs with measurable improvements to mission capability and operational support at a fair and reasonable price. The Federal Acquisition Regulation (FAR) establishes the codification and publication of uniform federal contracting policies and procedures for acquisition by all executive agencies, from acquisition planning through contract closeout. The FAR is a prepared, issued and maintained system prescribed jointly by the Secretary of Defense, the Administrator of General Services, and the Administrator, National Aeronautics and Space Administration, under their several statutory authorities. The FAR is supplemented by: 1) Defense Federal Acquisition Regulation (DFARS) – A supplement to the FAR that provides DOD specific acquisition regulations that DOD government acquisition officials and those contractors doing business with DOD must follow in the procurement process for goods and services; 2) Army Federal Acquisition Regulation (AFARS) – Implements and supplements the FAR, the Defense FAR Supplement (DFARS), and the DFARS procedures, guidance, and information to establish uniform policies for Army acquisition. It does not restrict the exercise of good business judgment or stifle innovation.

a. Key contracting contributors include the Contracting Officer (KO) and the Contracting Representative (COR).

(1) The KO has the authority to enter into, administer, and terminate contracts and make related determinations and findings. The KO is responsible for ensuring performance of all necessary actions for effective contracting, ensuring compliance with the terms of the contract, and ensures the requests for approval of acquisition plans are in accordance with the thresholds identified at DFARS 207. The KO can bind the Government to a specific dollar amount.

(2) The COR is the primary Government official responsible for ensuring compliance with contractual agreements. The KO designates and authorizes the COR in writing to perform specific technical or administrative functions (FAR 2.101). The COR has no authority to make any commitments or changes that affect price, quality, quantity, delivery, or other terms and conditions of the contract nor in any way direct the contractor or its subcontractors to operate in conflict with the contract terms and conditions. The COR should have extensive knowledge of the goods and services being procured.

b. The preferred types of contracts are Fixed Price and Cost Reimbursement (Cost Plus).

## HOW THE ARMY RUNS

(1) Fixed Price. Requirements (products & services) well defined; preferred type under NDAA FY17; contractor assumes higher cost risk; and total price for work is set.

(2) Cost Reimbursement (Cost Plus). Requirements (products & services/R&D) not well defined; Government assumes higher cost risk; Government buys contractors best effort; contractor entitled to recover allowable costs; and allows government flexibility.

c. Indefinite Delivery Contracts can be used to acquire supplies and/or services when the exact times and/or exact quantities of future deliveries are not known at the time of contract award. Orders for services or supplies are accomplished after award through a delivery order or task order. The three types are Definite Quantity Contracts; Requirements Contracts; and Indefinite Quantity Contracts.

d. The Multi-Year Contracting issued to acquire up to 5 years requirements in one contract; funded annually as appropriations permit; and if a contract is canceled, the contractor is entitled to recoup start-up costs up to cancellation ceiling; exception to DOD full funding policy; approved by Congress; and rationale reviewed by GAO.

e. Other Transactional Authority (OTA) are legally binding instruments that may be used to engage industry and academia for a broad range of research and prototype projects directly related to enhancing/improving the mission effectiveness of military personnel and platforms, systems, components, or materials proposed to be acquired or developed by the DOD. This includes the option to extend to production and sustainment of a successful prototype project. OTAs are: Not standard procurement contracts, grants, or cooperative agreements; Not subject to the federal laws and regulations that apply to government procurement contracts (e.g., FAR/DFARS); Codified by Section 815 of the FY2016 NDAA; Congress has provided the authority to link a sole-source, FAR-based production contract or transaction to an OTA for prototypes when the OTA is competitively awarded and successfully completed; and It is limited to \$250M threshold for individual OTAs and the USD(A&S) must provide authorization to proceed.

### Section XIII

#### Summary and References

##### 10-62. Summary

a. This chapter provided a basic introduction to the management process, organization, and structure of the JCIDS and system acquisition management process. Through the chapter description, the reader should have gained an appreciation of the logic of the process, its organization and management, including recent changes. This chapter highlights the current basic DOD and Army policies for capabilities development, materiel systems acquisition, and descriptions of capabilities development and system acquisition managers.

b. Difficult decisions, overseas contingency operations, a scarcity of dollar resources, and honest differences of opinion cause disruptions and delays. It is unlikely that there will be total agreement on the best technical approach to satisfy a need – or, indeed, on the need itself. The annual budget cycle and budget constraints almost ensure that some projects will not receive funding at the level desired, if at all. Tests are not always successful. Estimates of time, costs, effectiveness, and technical feasibility are often “wide of the mark” for complex systems. After all, they are estimates projected well into the future based on vague data. These real-world problems reinforce the fact that capabilities development and system acquisition management are complex processes of great importance to national defense. Capabilities development and system acquisition can be a host of new and effective weapons systems, where effective management and professionalism can make the difference in overseas contingency operations. As with any activity involving the use of scarce resources to meet organizational goals and objectives, the people involved – the capability developers, acquisition managers and the Soldier users and maintainers – constitute the most vital link to mission accomplishment.

##### 10-63. References

- a. 2013 Army Strategic Planning Guidance.
- b. Army Materiel Command Logistics Support Activity (LOGSA) Pamphlet 700-3, Total Package Fielding (TPF).
- c. Army Regulation 700-127, Integrated Product Support, 7 October 2014.
- d. Army Regulation 700-142, Type Classification, Materiel Release, Fielding, and Transfer, January 2013.

## **CAPABILITY REQUIREMENTS AND SYSTEM RESEARCH, DEVELOPMENT, AND ACQUISITION MANAGEMENT**

- e. Army Regulation 70-1, Army Acquisition Policy, 22 July 2011.
- f. Army Regulation 71-9, Warfighting Capabilities Determination, 28 December 2009.
- g. Army Regulation 73-1, Test and Evaluation Policy, 1 August 2006.
- h. Army Standard Operating Procedures (SOP) for Agile Capabilities Life-cycle Process, 7 August 2012.
- i. Capstone Concept for Joint Operations (CCJO), Joint Forces 2020, 10 September 2012.
- j. CJCS Capability Development Tracking and Management (CDTM) User Manual, version 1.3, June 2011.
- k. CJCSI 3010.02C, Joint Concept Development and Experimentation (JCD&E), 15 January 2012
- l. CJCSI 5123.01H, Charter of the Joint Requirements Oversight Council (JROC) and Implementation of the Joint Capabilities Integration and Development System (JCIDS) Manual, 31 August 2018.
- m. DA Pamphlet 700-142, Instructions for Type Classification, Materiel Release, Fielding, and Transfer, July 2014.
- n. DA Pamphlet 70-3, Army Acquisition Procedures, 28 January 2008.
- o. DA Pamphlet 73-1, Test and Evaluation in Support of Systems Acquisition, 30 May 2003.
- p. Defense Acquisition University (DAU), Introduction to Defense Acquisition Management, 10th Edition, August 2010.
- q. Defense Strategic Guidance (DSG), January 2012.
- r. DOD Directive 5000.01, The Defense Acquisition Management System, 12 May 2003 (certified current as of 20 November 2007).
- s. DOD Directive 5000.52, Defense Acquisition Education, Training and Career Development Program, 25 October 1991.
- t. DOD Directive 5000.71, Rapid Fulfillment of CCDR Urgent Operational Needs, 24 August 2012.
- u. DOD Directive-Type Memorandum (DTM) 09-027, Implementation of the Weapon Systems Acquisition Reform Act of 2009 (Public Law 111-23), 4 December 2009.
- v. DOD Instruction 5000.02, Operation of the Defense Acquisition System, 7 January 2015.
- w. DODD 7045.20, Capability Portfolio Management, 25 September 2008.
- x. Federal Acquisition Streamlining Act of 1994, 13 October 1994.
- y. HQ TRADOC, ARCIC Memorandum, Subject: Implementing Cost-Benefit Analysis (CBA) Guidance for JCIDS Capabilities Documents, 15 June 2012.
  
- z. HQDA (G37 DAMO-CIC), Capabilities and AROC Management System User's Guide, 23 March 2010.
- aa. HQDA DCS, G-3/5/7, ECOP User's Guide, version 2.3, 20 July 2011.
- bb. HQDA DCS, G-8 Army Equipping Strategy, 27 July 2011.
- cc. HQDA G-3/5/7, The 2012 Army Campaign Plan, 1 June 2012.
- dd. HQDA, 2010 Army Science and Technology Master Plan, 14 July 2010.
- ee. HQDA, 2013 Army Posture Statement.
- ff. HQDA, 2013 Weapon Systems Handbook.
- gg. HQDA, Assistant Secretary of the Army for Financial Management and Comptroller (ASA(FM&C)) Memorandum, Subject: Cost-Benefit Analysis Guidance and Training, 1 February 2010.
- hh. HQDA, Deputy Assistant Secretary of the Army Cost and Economics (DASA(CE)) Memorandum, Subject: U.S Army Cost-Benefit Analysis Guide, version 1.0, 12 January 2010.
- ii. HQDA, The United States 2014 Army Equipment Modernization Plan, 13 May 2013.
- jj. "Initial Message to the Army," General Mark A. Milley, 26 Aug 15.
- kk. JCS J-8 Force Structure, Resources, and Assessments Directorate, Capabilities-Based Assessment (C-BA) User's Guide, version 3, March 2009.
- ll. JROC Memorandum (JROCM), Subject: JROC, and JCIDS Changes, 3 February 2012.
- mm. National Defense Strategy (NDS), 16 June 2008.
- nn. National Military Strategy (NMS), 8 February 2011.
- oo. National Security Strategy (NSS), May 2010.
- pp. Office of the Under Secretary of the Army and Vice Chief of Staff, Army Memorandum, Subject: Cost-Benefit Analysis to Support Army Enterprise Decision Making, 30 December 2009.
- qq. SECARMY Memorandum, Subject: Army Directive 2010-07, Non-Standard Equipment Interim Policy, 4 August 2010.
- rr. The Defense Acquisition Workforce Improvement Act (DAWIA), Title 10 USC Sections 1701-1764, Defense Acquisition Workforce Improvement Act of 1990, as amended by Section 808, Public Law (PL)

## HOW THE ARMY RUNS

No. 106-398, National Defense Authorization Act for Fiscal Year 2001, 30 October 2000: Section 824, PL No. 107-107, 28 December 2001.

ss. TRADOC Army Capabilities Integration Center (ARCIC), Capabilities-Based Assessment Guide, Version 3.1, 10 May 2010.

tt. TRADOC Pamphlet 525-3-0, The U.S. Army Capstone Concept (ACC), 19 December 2012.

uu. TRADOC Pamphlet 525-3-1, The U.S. Army Operating Concept (AOC) 2016-2028, version 1.0, 19 August 2010.

vv. TRADOC Regulation 350-70, Army Learning Policy and Systems, 8 December 2011.

ww. TRADOC Regulation 71-20, Concept Development, Capabilities Determination, and Capabilities Integration, 23 February 2011.

xx. U.S. Army War College, How the Army Runs: A Senior Leader Reference Handbook, 2017-2018.

yy. USD(AT&L) Memorandum, Subject: Configuration Steering Boards, 30 July 2007.

zz. USD(AT&L) Memorandum, Subject: Prototyping and Competition, 19 September 2007.

aaa. Weapon Systems Acquisition Reform Act of 2009 (Public Law 111-23), 22 May 2009.

bbb. DA PAM 700-127 Integrated Product Support Procedures, 8 October 2014.

## Chapter 11

### Logistics

#### Section I Introduction

##### 11-1. Chapter Content

This chapter provides an executive overview of the nature and structure of the Army's national and theater logistics systems and includes: key concepts and definitions; the principles of logistics; selected logistics terms; and the Army's national logistics organizations' roles and responsibilities – Assistant Secretary of the Army (Acquisition, Logistics, and Technology) (ASA (ALT)); Headquarters, Department of the Army (HQDA) Deputy Chief of Staff (DCS), G-4; HQDA DCS, G-8; Army Materiel Command (AMC); and Logistics Enterprise Support Agency (LESA). The chapter underscores other national logistics organizations and Department of Defense (DOD) agencies that directly impact Army sustainment: U.S. Army Corps of Engineers (USACE); U.S. Army Combined Arms Support Command (CASCOM); the Army and Air Force Exchange Service (AAFES); Defense Logistics Agency (DLA); and the Defense Contract Management Activity (DCMA).

##### 11-2. Key Concepts and Definitions

a. Fundamentals of Sustainment. For the Army, sustainment is the provision of logistics, personnel services, and health service support necessary to maintain operations until successful mission completion Army Doctrine Publication (ADP) 4-0, Sustainment. This is accomplished through the integration of national and global resources and ensures Army forces are physically available and properly equipped, at the right place and time, to support the Combatant Commander (CCDR). The concept leverages multinational and Host Nation Support (HNS), Operational Contract Support (OCS), and other available capabilities to minimize overburdening of military resources while maintaining a quality Army. Army sustainment is based on an integrated process (e.g., people, systems, materiel, health services, and other support) inextricably linking sustainment to operations. The concept focuses on building a combat ready Army, delivering capabilities to the CCDR as part of the joint force, and sustaining combat power across the depth of the operational area with unrelenting endurance.

b. Logistics. Logistics is planning and executing the movement and support of forces. Logistics involves both military art and science. Knowing when and how to accept risk, prioritizing a myriad of requirements, and balancing limited resources all require military art while understanding equipment and system capabilities and limitations incorporates military science. Logistics integrates strategic, operational, and tactical support of deployed forces while scheduling the mobilization and deployment of additional forces and materiel. Army logistics include the following:

(1) Maintenance. Maintenance is all actions taken to retain materiel in a serviceable condition or to restore it to serviceability. The Army's two levels of maintenance are field maintenance and sustainment maintenance (Army Techniques Publication (ATP) 4-33, Maintenance Operations). Maintenance is necessary for endurance and performed at the tactical through strategic levels of war.

(a) Field maintenance is repair and return to user and is generally characterized by on-(or near) system maintenance, often utilizing line replaceable unit, component replacement, battle damage assessment, repair, and recovery (ATP 4-33). It is focused on returning a system to an operational status. Field level maintenance is not limited to removal and replacement of materiel, but also provides adjustment, alignment, and fault/failure diagnoses. Additionally, Field maintenance includes battlefield damage and repair tasks performed by either the crew or support personnel to maintain a system in an operational state.

## HOW THE ARMY RUNS

(b) Sustainment maintenance is generally performed to accomplish commodity-oriented repairs on all supported items to one standard that provides a consistent and measurable level of reliability. Off-system maintenance consists of overhaul and manufacturing activities designed to return components, modules, assemblies, and end items to the supply system or to units, resulting in extended or improved operational life expectancies.

(2) Transportation Operations. Army transportation units play a key role in facilitating endurance. Transportation units move forces, equipment, and supplies from ports to points of need and retrograde materiel as required. Transportation operations encompass the employment of a wide range of capabilities needed to allow joint and Army commanders to conduct operations. Important transportation functions are movement control, intermodal operations (terminal and mode), and container management.

(a) Movement control is the dual process of committing allocated transportation assets and regulating movements according to command priorities to synchronize distribution flow over ground, air, and sea lines of communications (LOCs) to sustain land forces. Movement control balances requirements against capabilities and requires continuous synchronization to integrate military, host nation, and commercial movements by all modes of transportation to ensure seamless transitions from the strategic through the tactical level of an operation. It is a means of providing commanders with situational awareness to control movements in their operational area. Movement control responsibilities are imbedded in an infrastructure that relies on planning and execution coordination to ensure transportation assets are used efficiently while ensuring LOCs are de-conflicted to support freedom of access for military operations.

(b) Intermodal operations is the process of using multiple modes (air, sea, highway, rail) and conveyances (truck, barge, containers, pallets) to move troops, supplies, and equipment through expeditionary entry points and the network of specialized transportation nodes to sustain land forces. It uses movement control to balance requirements against capabilities and capacities to synchronize terminal and mode operations ensuring an uninterrupted flow through the transportation system. It consists of facilities, transportation assets, and material handling equipment required to support the deployment and distribution enterprise. Terminal operations consist of the receiving, processing, and staging of passengers; the receipt, transit storage and marshalling of cargo; the loading and unloading of transport conveyances; and the manifesting and forwarding of cargo and passengers to a destination (JP 4-01.5). Terminal operations are a key element in supporting operational reach and endurance. They are essential in supporting deployment, redeployment and sustainment operations. There are three types of terminals: air, water, and land. Mode operations are the execution of movements using various conveyances (e.g., truck, railcar, and aircraft) to transport cargo. It includes the administrative, maintenance, and security tasks associated with the operation of the conveyances.

(c) Container management is the process of establishing and maintaining visibility and accountability of all cargo containers moving within the Defense Transportation System (DTS). In theater, container management is conducted by commanders at the operational and tactical levels. The Theater Sustainment Command (TSC) distribution management center coordinates intermodal operations with the movement control battalion at transportation, storage, and distribution nodes. The TSC maintains information on the location and status of containers and flat-racks in the theater. The movement control battalion provides essential information on container location, use, flow, and condition. They assist with control of containers by identifying that they are ready for return to the distribution system. The distribution management center sets priorities for container shipment and diversion.

(3) Supply. Supply provides the materiel required to accomplish the mission and is essential for enhancing Soldiers' quality of life. Supply includes the following classes:

(a) Class I—Subsistence, including ice, water and health and welfare items.

(b) Class II—Clothing, individual equipment, tents, tool sets and tool kits, hand tools, administrative, and housekeeping supplies and equipment (including maps). This includes items of equipment, other than major items, prescribed in authorization/allowance tables and items of supply (not including repair parts).

(c) Class III—Petroleum, Oils, Lubricants. Petroleum and solid fuels, including bulk and packaged fuels, lubricating oils and lubricants, petroleum specialty products; solid fuels, coal, and related products.

(d) Class IV—Construction Materials, to include installed equipment and all fortification/barrier materials.

(e) Class V—Ammunition of all types (e.g., small arms, bombs, explosives, tank and artillery rounds, mines, fuses, detonators, pyrotechnics, missiles, rockets, propellants, and other associated items).



(f) Class VI—Personal Demand items (e.g., nonmilitary sales items).

(g) Class VII—Major End items. A final combination of end products which is ready for its intended use: (principal item) (e.g., launchers, tanks, mobile machine shops, vehicles).

(h) Class VIII—Medical Materiel, including uniquely medical repair parts.

(i) Class IX—Repair Parts and components, including kits, assemblies and subassemblies, repairable and non-repairable, required for maintenance support of all equipment.

(j) Class X—Materiel to support nonmilitary programs such as, agricultural and economic development, not included in Class I through Class IX.

(4) Field Services. Field services maintain unit combat strength by providing for basic needs and promoting health, welfare, morale, and endurance. Field services provide life support functions.

(a) Shower and Laundry. Shower and laundry capabilities provide Soldiers a minimum of one weekly shower and up to 15 pounds of laundered clothing each week (comprising two uniform sets, undergarments, socks, and two towels). The shower and laundry function does not include laundry decontamination support.

(b) Field Feeding. Food preparation is a basic unit function and one of the most important factors in Soldiers' health, morale, and welfare. The standard is to provide Soldiers at all echelons three quality meals per day (Army Regulation (AR) 30-22, Army Food Program). Proper refuse and waste disposal is important to avoid unit signature trails and maintain field sanitation standards.

(c) Water Production and Distribution. Water production and distribution are essential for hydration, sanitation, food preparation, medical treatment, hygiene, construction, and decontamination. The Water production is both a field service and a supply function. Quartermaster supply units normally perform purification in conjunction with storage and distribution of potable water.

(d) Clothing and Light Textile Repair. Clothing and light textile repair is essential for hygiene, discipline, and morale purposes. Clean, serviceable clothing is provided as far forward as the brigade area.

(e) Aerial Delivery. Aerial delivery includes parachute packing, air item maintenance, and rigging of supplies and equipment. This function supports airborne insertions, airdrop and air land resupply. It is a vital link in the distribution system and provides the capability to supply forces when land LOCs have been disrupted or terrain is too hostile, thus adding flexibility to the distribution system. See Filed Manual (FM) 4-20.41, Aerial Delivery Distribution in The Theater of Operations for details.

(f) Mortuary Affairs. Mortuary affairs is a broadly based military program to provide for the necessary care and disposition for the remains of deceased personnel. The Army is designated as the Executive Agent for the Joint Mortuary Affairs Program (Joint Publication (JP) 4-06, Mortuary Affairs).

(5) Distribution. Distribution is the primary means to prolong endurance. Distribution is the operational process of synchronizing all elements of the logistics system to deliver the "right things" to the "right place" at the "right time" to support the Geographic Combatant Commander (GCC). Distribution is more than just transportation; it is the integration of supply stockade, transportation resources, and materiel management. Additionally, it is also the process of assigning military personnel to activities, units, or billets (JP 4-0). The distribution system consists of a complex of facilities, installations, methods, and procedures designed to receive, store, maintain, distribute, manage, and control the flow of military materiel between point of receipt into the military system and point of issue to using activities and units.

(a) Global Distribution. The Joint segment of the distribution system is referred to as global distribution. It is defined as the process that synchronizes and integrates the fulfillment of joint requirements with the employment of joint forces (JP 4-09). It provides national resources (personnel and materiel) to support the execution of joint operations.

(b) Theater Distribution. The Army segment of the distribution system is referred to as theater distribution. Theater distribution is the flow of equipment, personnel, and materiel within theater to meet the CCDR's mission. The Theater segment extends from the ports of debarkation or source of supply (in theater) to the points of need (units and Soldiers). It is enabled by a distribution management system that synchronizes and coordinates facets of multiple networks (physical, communications, information, and resources) with operational and tactical sustainment functions to provide responsive support to operational requirements. Distribution management includes the management of transportation and movement control, warehousing, inventory control, order administration, site and location analysis, packaging, data processing, accountability for equipment (materiel management), people, and communications. See Army Tactics, Techniques, and Procedures (ATTP) 4-0.1, Army Theater Distribution for details. The distribution management of medical materiel is accomplished by a support

## HOW THE ARMY RUNS

team from the Medical Logistics Management Center (MLMC). The MLMC support team collocates with the Distribution Management Center (DMC) of the TSC/Expeditionary Sustainment Command (ESC) to provide the Medical Command (MEDCOM) Direct Support (DS) with visibility and control of all Class VIII.

(c) In-Transit Visibility (ITV). In-transit visibility is the ability to track the identity, status, and location of DOD units, non-unit cargo (excluding bulk petroleum, oils, and lubricants) passengers, patients, and personal property from origin to consignee, or destination across the range of military operations (JP 3-35). This includes force tracking and visibility of convoys, containers/pallets, transportation assets, other cargo, and distribution resources within the activities of a distribution node. ITV provides the distribution manager the ability to assess how well the distribution process is responding to supported force needs. Distribution managers gain and maintain visibility (items, personnel, units, transition hubs, and transport modes) at the earliest practical point in the management process. This allows managers to operate with timely information to effectively assess the status of resources, adapt and rapidly respond to immediate distribution requirements.

(d) Retrograde of Materiel. Another aspect of distribution is retrograde of materiel. Retrograde of materiel is the return of materiel from the owning/using unit back through the distribution system to the source of supply, directed ship-to location, and/or point of disposal (ATTP 4-0.1). Retrograde includes turn-in/classification, preparation, packing, transporting, and shipping. To ensure these functions are properly executed, commanders must enforce supply accountability and discipline and use the proper packing supplies. Retrograde of materiel can take place as part of theater distribution operations redeployment operations. Retrograde of materiel must be continuous and not be allowed to build up at supply points/nodes. Early retrograde planning is essential and necessary to preclude the loss of materiel assets, minimize environmental impact, and maximize use of transportation capabilities. Planners must consider environmental issues when retrograding hazardous material. Contractor or HNS may be used in the retrograde of materiel. This support is planned for and negotiated early in the operation. HNS must be identified early enough to ensure personnel are properly screened and present no security risk. Leaders at all levels are responsible for the adherence to all policies and safety measures by contractors and HNS. Retrograde materiel flows through the distribution system from the tactical to strategic levels. Retrograde materiel is consolidated at the lowest supply support activity and reported up through the support operations for distribution instructions. When released by the maneuver commander, AMC assumes responsibility for providing disposition instructions, accounting, and shipping of retrograde materiel from the theater. An approved military customs inspection program must be in place prior to redeployment to pre-clear, not only redeployment materiel, but also the shipment of battle damaged equipment out of theater. The Theater Army is responsible for establishing the customs inspection program to perform U.S. customs preclearance and United States Department of Agriculture (USDA) inspection and wash down on all materiel retrograded to the United States in accordance with Defense Transportation Regulation (DTR) 4500.9-R.

(6) Operational Contract Support (OCS). OCS is the integration of commercial sector support into military operations (JP 4-10, ATP 4-10, AR 715-9). While contracting officers play a key and legally binding role, OCS is commander's business with equities across all primary and certain special staff functions.

(a) The desired end-state of properly planned and integrated OCS actions include: enhanced operational flexibility and sustainability through alternative sources of support; increased effectiveness, efficiencies, and cost avoidance of the contracting effort; increased visibility and ability to properly integrate contractor personnel and their equipment into military operations; ability of the commander to properly plan, integrate, and control the civil military impacts, both good and bad, of operational contract support actions; and decreased and/or mitigated contract fraud.

(b) Types of contracted support. There are three types of contracted support: theater support; external support; and system support. Theater support contracts are a type of contingency contract awarded by contracting officers deployed to the area of operation (AO) serving under the command and contracting authority of the contracting support brigade in support of that particular operation. These contracts, sometimes executed under expedited contracting authority (reduced time frames for posting of contract solicitations; allowing for simplified acquisition procedures for higher dollar contracts, etc.), provide goods, services, and minor construction mostly from locally available commercial sources. Also important from a contractor management perspective are local national employees that often make up the bulk of the theater support contractor workforce. External support contracts are awarded by contracting organizations outside of the AO. External support contracts provide a variety of logistics and other

noncombat related services and supply support. External support contracts normally include a mix of U.S. citizens, host nation, and local national contractor employees. Examples of external support contracts are: service (Air Force, Army, and Navy) civil augmentation programs; special skills contract (staff augmentation, linguists, etc.); DLA prime vendor contracts; and the largest and most commonly known Army external support contract is the Army's Logistics Civil Augmentation Program (LOGCAP). LOGCAP can provide a complete range of logistics services, including supply services (e.g., storage, warehousing, distribution, etc.) for the nine classes of supplies, but does not include the actual provisioning of these commodities. System support contracts are prearranged contracts associated with acquisition program executive officers (PEOs) and project/product management (PM) officers. These centrally funded contracts provide technical, maintenance and, in some cases, Class IX support for a variety of Army weapon and support systems. System support contracts are routinely put in place to provide support to newly fielded weapon systems, including aircraft, land combat vehicles, and automated command and control information systems. System support contractor employees, made up mostly of U.S. citizens, provide support both in garrison and in deployed operations. Operational commanders generally have less influence on the execution of system support contracts than other types of contracted support.

(c) Individual training. There are three primary operational contract support courses available from the joint staff and the Army Logistic University (ALU). Contracting Officer Representative (COR) training is a 40-hour ALU course certified Soldiers and civilians to be level B CORs. This course is offered as both, a resident class at Fort Lee and via mobile training teams to various Army installations world-wide. Operational Contract Support Course is a two week course that awards the 3C additional skill identifier and is designed to prepare military and government civilians to function in assignments that involve tactical level operational contract support planning and integration functions. Students learn: the latest OCS doctrine; how to integrate contract support requirements into the military decision making process; how to build acquisition ready requirements (known as requirements review board packets) to include performance work statement development and independent government estimates; how to integrate contract requirements into the overall unit spend plan process; how to set up and build contract management files; how to build quality assurance surveillance plans and manage CORs; and how to avoid common pitfalls customarily associated with outsourcing requirements. The graduate of the OCS course will provide the unit commander and staffs with the expertise necessary to properly and pro-actively manage contracts and contract requirements. Like the COR course, this course is offered as both a resident class at Fort Lee, Virginia and via mobile training teams to various Army installations world-wide. Joint Operational Contract Support Planning and Execution Course (JOPEC) is a two week long joint course is similar to the ALU course except it focuses at the theater strategic and operational levels. This Joint Staff J-4 controlled course is available to Army officers serving on theater army, field army, corps, divisions, and theater level support headquarters staff. JOPEC is offered via mobile training teams to various locations worldwide.

(d) Organizations: Army Contracting Command (ACC) at Rock Island Arsenal, Illinois is the main element within the Army to provide OCS. Contracting Support Brigades are subordinate units to ACC and are located in each Army Service Component Command (ASCC) area of responsibility (AOR). These Brigades provide the contracting support to the ASCC commander and requiring activities. These brigades have Contracting Battalions and Senior Contingency Contracting Teams that can be dispersed in the AOR as needed. A newly developed Contingency Contracting Team is allocated to each brigade combat team (BCT) for contracting needs of the units.

(e) Requiring Activity Responsibilities: It must be remembered that ACC and subordinate units do the contracting work to provide the goods or services to the requiring activity. The Requiring activity is responsible for managing the work of the contractor in accordance with the Quality Assurance Surveillance Plan and Performance Work Statement; developing the Statement of Work (what is required in detail for the contractor to perform) and providing the COR; designating funds for operations of the contract to include contract closeout; and providing and recovering any government furnished property needed by the contractor.

(7) Operational Energy. As the Army operates across the spectrum of missions, it must conserve energy and reduce risk. Energy consumption is a burden on the unit, with significant funding and resource implications. Most importantly, it increases operational vulnerability. Every time Soldiers deliver fuel or batteries on the battlefield they are at risk. As volumes increase, more storage is required, thereby increasing the demand on the Brigade Support Battalion (BSB) or making forward operating bases larger

## HOW THE ARMY RUNS

and harder to protect. The Army is examining all possible ways to be more effective in energy usage, to employ renewable resources, and lower energy costs. All of this will reduce the number of convoys on the roads. But it requires the Army to change its behavior. When Soldiers start thinking, “How can I use energy smarter?” then the Army will be on its way. Soldiers have speed, agility, endurance, and a lethal edge on the battlefield thanks to Operational Energy, but it comes at a cost. Today, it takes more than 20 gallons of fuel per day to sustain each Soldier in combat. Every Soldier in an Infantry squad carries 23 batteries just to power equipment on a 72-hour mission. The Army must learn to use energy smarter. Just as consumers check fuel economy of cars and energy performance of appliances before buying them, the Army too must make more energy-informed decisions. Only then will the Army grow its operational capabilities, while reducing risks to Soldiers and the costs of providing that energy. Operational Energy touches every aspect of the Army from the factory to the foxhole. Successful missions require us to consider energy from planning through execution. Operational Energy efforts are already enabling the Army to Prevent, Shape, and Win (Operational Energy White Paper).

(8) General Engineering Support. The Army has a broad range of diverse engineer capabilities, which commanders can use to accomplish various tasks for various purposes. One such purpose is to provide support to ground force commanders that enables logistics. To accomplish this purpose, engineers combine and apply capabilities from all three engineer disciplines (combat, general, and geospatial engineering) to establish and maintain the infrastructure necessary for sustaining military operations in the AO. This involves primarily general engineering tasks that consist largely of building, repairing, and maintaining roads, bridges, airfields, and other structures and facilities needed for Aerial Port of Debarkations (APODS), Sea Port of Debarkations (SPODS), main supply routes, and base camps. Depending on the range of military operations, other tasks include the planning, acquisition, management, remediation and disposition of real estate, supplying mobile electric power, utilities and waste management, environmental support and firefighting (see FM 3-34.400). Although engineering tasks that enable logistics are primarily considered general engineering tasks, engineers also use capabilities from the other engineer disciplines for the same purpose. Similarly, although general engineering tasks are often used to enable logistics, engineers also use capabilities from the general engineering discipline for other purposes and to support other warfighting functions. FM 3-34 provides additional information about all three engineer disciplines and how they are used for various purposes and to support all the warfighting functions.

### Section II

**National Logistics Organization— Assistant Secretary of the Army (Acquisition, Logistics, and Technology) (ASA (ALT)); Headquarters, Department of the Army (HQDA) Deputy Chief of Staff (DCS), G-4; HQDA DCS, G-8; Army Materiel Command (AMC); and Logistics Enterprise Support Agency (LESA)**

#### 11-3. ASA (ALT)

The ASA (ALT) is the principal adviser to the Secretary of the Army (SECARMY) on all matters relating to acquisition, logistics and technology. The ASA (ALT) is responsible for the overall supervision of the acquisition, logistics and technology matters of DA and has sole responsibility for performing the acquisition function within HQDA. The ASA (ALT) is designated as the Army Acquisition Executive (AAE), Senior Procurement Executive and Senior Official responsible for the management of acquisition of contract services, Science Adviser to the SECARMY and senior research and development official for DA. The ASA (ALT) is responsible for setting the strategic direction for and ensuring that DA policies, plans and programs related to acquisition, logistics, technology, procurement, the industrial base, materiel related security cooperation (including security assistance and armaments cooperation), and the Army's portion of the Chemical Demilitarization Program are executed consistent with law, regulation and policy. The Office of the ASA (ALT) is designated the single office for the acquisition function in HQDA and, subject to the authority, direction and control of the SECARMY, provides the Chief of Staff of the Army (CSA) such staff support for acquisition matters as the CSA considers necessary to perform his duties and responsibilities. The ASA (ALT) is assigned responsibility for—

a. Establishing strategic direction for aspects of the Planning, Programming, Budgeting, and Execution (PPBE) process within the ASA (ALT)'s assigned functions and responsibilities, including acquisition, logistics, technology, procurement and associated resource allocation decisions and policies and, when

appropriate, coordinating and integrating that direction with the ASA Financial Management and Comptroller (FM&C); Chief Information Officer (CIO); DCS, G-4; DCS, G-3/5/7; DCS, G-8; and other DA officials and organizations.

b. Providing strategic guidance and supervision for policies and programs for any procurement, logistics and technology initiatives executed by DA officials, organizations and commands.

c. Exercising sole authority for providing materiel solutions to equipment modernization requirements.

d. Developing and executing the Army's acquisition function and the acquisition management system, including Army acquisition programs and Army acquisition policy. Chairs the Army Systems Acquisition Review Council (ASARC) and Configuration Steering Board.

e. Supervising the research and development function for DA and directing the Army Science Board (ASB).

f. Executing, as the AAE and consistent with DA requirements for appointing executive or senior professionals, the functions and duties of the SECARMY with respect to the acquisition workforce, including managing the Army Acquisition Corps and Army Acquisition Workforce; appointing those personnel below the executive level; and managing and evaluating acquisition program executive officers and direct-reporting program, project and product managers.

g. Executing the authorities of the agency head for contracting procurement matters pursuant to laws and regulations.

h. Supervising logistics, including acquisition fielding, sustainment and disposal logistics management, and administering life cycle logistics support planning and execution.

i. Supervising the development, coordination and implementation of policy and programs for the Army's materiel related security cooperation activities, to include Foreign Military Sales (FMS), foreign military training (FMT), allocation of Excess Defense Articles (EDA) to foreign countries, armaments cooperation, technology transfer, direct commercial sales, and munitions case processing.

j. Providing export policy supervision and chairing and directing the Technology Transfer Security Assistance Review Panel.

k. Director, U.S. Army Chemical Materials Agency and the activities of the Army portion, including chemical stockpile emergency preparedness efforts.

l. Representing the Army in relevant matters to DOD and non-DOD partners.

m. Co-chair of the Sustaining Program Evaluation Group (SS PEG) (see sec 9-37 for more information).

#### **11-4. DCS, G-4**

The DCS, G-4 is the principal military adviser to the CSA and ASA (ALT) for logistics and sustainment. The DCS, G-4 is also the principal military adviser to the ASA (IE&E) for operational energy and contingency basing and is the process champion for all logistics end-to-end business processes. The DCS, G-4 assists in the development of Army strategy, policies, and programs for logistics and sustainment; plans and supervises the execution of those policies and programs; and reviews and assesses the execution of Army logistics policies and programs. The DCS, G-4 is assigned responsibility for:

a. Collaborating on logistics operations in support of security cooperation and representing the Army on coalition sustainment standardization actions.

b. Maintaining current logistics operations, contingency plans and resource programs that support Army-wide logistics operations.

c. Executing staff prepotency for the logistics civil augmentation program and coordinating the development of multinational interoperability policy and practice for the use of allied civil augmentation programs.

d. Serving as proponent for Army equipment safety and Army airworthiness.

e. Advising on and monitoring the Army's materiel readiness to determine Army-wide readiness trends.

f. Ensuring that supportability requirements are incorporated into acquisition and fielding requirements for new systems.

g. Assisting in the supervision of the execution of Army logistics policies, programs, budgetary inputs and activities.

h. Coordinating with and supporting the ASA Installations Energy and Environment (IE&E) on issues, policies and programs related to energy security, including operational and tactical energy, and contingency bases.

i. Supporting the ASA (ALT) in the Army's organic industrial base matters and activities.

## HOW THE ARMY RUNS

- j. Ensuring sustainment functions and related logistics automated information systems management are fully integrated and properly balanced between acquisition and sustainment.
- k. Co-chair of the SS PEG (see sec 9-37 for more information).

### 11-5. DCS, G-8

The DCS, G-8 is the principal military adviser to the CSA and ASA (FM&C) for the PPBE programming phase. The DCS, G-8 coordinates with the ASA (ALT) on all proposed programming and process recommendations related to ongoing and future acquisition programs and science and technology initiatives. The DCS, G-8 coordinates with Army Futures Command (AFC) for program funding for all elements of the future force materiel modernization enterprise. The DCS, G-8 is the principal ARSTAF adviser to the CSA on all materiel requirements and the prioritization, integration, and programming of Army and joint materiel capabilities for integration into the overall prioritization of capabilities by the DCS, G-3/5/7. The DCS, G-8 is assigned responsibility for:

- a. Supervising the Director, Program Analysis and Evaluation, who is—
  - (1) Responsible for developing and defending the Army Program under the guidance and direction of the ASA (FM&C) and the DCS, G-8. This includes managing the programming phase of PPBE to facilitate the development and defense of the Army Program and the Future Years Defense Program, developing and maintaining the Army's authoritative resource position database and ensuring the coordination of the programming and budgeting phases of PPBE and an effective transition to an Army budget estimate.
  - (2) Directly responsible to the SECARMY and CSA, including for developing and providing an independent assessment of the Army Program.
- b. Managing the Center for Army Analysis (CAA) and other HQDA studies and providing analytic support to HQDA.
- c. Developing plans, in coordination with the ASA (ALT), for equipping the future Army through programming, materiel integration and studies.
- d. Coordinating Army input and participation in joint requirements matters considered by DOD bodies and supporting the CSA and VCSA in their related responsibilities.
- e. Co-chair of the Equipping PEG (see sec 9-37 for more information).

### 11-6. AMC

AMC is the Army's principal provider of materiel readiness – acquisition support, materiel development, logistics power projection, and sustainment – to the total force, across the spectrum of joint military operations. If a Soldier shoots it, drives it, flies it, wears it, eats it or communicates with it, AMC provides it. AMC is headquartered at Redstone Arsenal, Alabama, and impacts or has a presence in all 50 states and 150 countries. Manning these organizations is a work force of more than 190,000 dedicated military and civilian employees, many with highly developed specialties in weapons development, manufacturing, and logistics. To develop, buy, and maintain materiel for the Army, AMC works closely with PEOs, the AAE, industry, academia, and other related agencies. The command's complex missions range from development of sophisticated weapons systems and cutting-edge research, to maintenance and distribution of spare parts. The command's maintenance depots and arsenals overhaul, modernize, and upgrade major weapons systems – not just making them like new, but inserting technology to make them better and more reliable. AMC operates depots; arsenals; ammunition plants; and other facilities; and maintains the Army's Prepositioned Stocks (APS), both on land and afloat. The command is the DOD Executive Agent for the chemical weapons stockpile and for conventional ammunition. AMC includes global surface transportation experts who provide the Warfighter with a single surface distribution provider for adaptive solutions that deliver capability and sustainment on time. AMC also handles the majority of the Army's contracting including a full range of contracting services for deployed units and installation-level services, supplies, and common-use information technology hardware and software. It operates a network of Army field support brigades and battalions, logistics support elements, and brigade logistics support teams, all of which identify and resolve equipment and maintenance problems, and materiel readiness issues for combatant commands. AMC handles diverse missions that reach far beyond the Army. For example, AMC manages the multibillion-dollar business of selling Army equipment and services to friends and allies of the United States and negotiates and implements agreements for co-production of U.S. weapons systems by foreign nations. AMC provides numerous acquisition and

logistics services to the other components of the DOD and many other government agencies. The AMC subordinate commands are:

a. U.S. Army Chemical Materials Activity (CMA). CMA is responsible for the safe and effective storage, treatment, and disposal of U.S. chemical weapons safely and effectively. The activity develops and uses technologies to safely store and eliminate chemical weapons at seven stockpile sites while protecting the public, its workers and the environment. CMA also has the storage mission at the Nation's final two stockpile sites.

b. U.S. Army Security Assistance Command (USASAC). (See Chapter 21, Foreign Military Sales)

(1) USASAC is responsible for managing security assistance programs and Foreign Military Sales (FMS) for the Army. USASAC serves as the primary entry point for U.S. Army materiel-and service-related FMS requirements. Its mission is leading the AMC Security Assistance Enterprise, developing and managing security assistance programs and FMS cases to build partner capacity, supporting Combatant Command (CCMD) engagement strategies, and strengthening U.S. global partnerships. USASAC is responsible for Army security assistance information management and financial policy; provides policy, procedure, and guidance to the Army security assistance community; and manages the Army's co-production program. The U.S. Army Security Assistance Training Management Organization (USASATMO) is a subordinate command of USASAC that can deploy teams throughout the world to provide training tailored to a country for equipment purchased through FMS. Locations: Headquarters, Redstone Arsenal, Alabama; New Cumberland, Pennsylvania; Washington Field Office, Fort Belvoir, Virginia; U.S. Army Security Assistance Training Management Organization, Fort Bragg, North Carolina; Office of the Program Manager, Saudi Arabian National Guard Modernization Program (SANG), Riyadh, Saudi Arabia; Liaison Officers at each Combatant Commands (CCMD), Kuwait and Afghanistan.

(2) Security assistance is a national program supervised and directed by the State Department. In conjunction with the White House, Congress, and the Treasury Department, military security assistance programs are executed by the DOD. The FMS program (see Fig 11-1) is the U.S. government's program for transferring defense articles, services and training to other sovereign nations and international organizations. Under FMS, the U.S. government procures defense articles on behalf of the foreign customer. The President of the United States designates countries and international organizations eligible to participate in FMS. The Department of State makes those recommendations and approves individual programs on a case-by-case basis. Countries approved to participate in this program may obtain defense articles and services by paying with their own national funds or with funds provided through U.S. government-sponsored assistance programs. In certain cases, defense articles, services and training may be obtained on a grant basis. The Defense Security Cooperation Agency (DSCA) administers the FMS program for DOD. USASAC implements approved U.S. Army security assistance programs, including FMS of defense articles and services to eligible foreign governments. In carrying out the Army security assistance mission, USASAC calls on all AMC Life Cycle Management Commands (LCMC), as well as other DOD agencies and U.S. industry. Each sale of equipment to overseas customers comprises the same "total package" of quality materiel, facilities, spare parts, training, publications, technical documentation, maintenance support, and other services that AMC provides to U.S. Army units. USASAC is responsible for life cycle management of FMS cases, from letter of request, development, execution, and closure.

c. Aviation and Missile Command (AMCOM) LCMC. Aviation and Missile LCMC, unites all of the organizations that work to design, acquire, integrate, field, and sustain Army aviation, missile, and unmanned aircraft weapon systems. Headquartered at Redstone Arsenal, AL, the Aviation and Missile Materiel Enterprise is comprised of the Aviation and Missile Command (AMCOM), the Army Contracting Command-Redstone, the Program Executive Officer (PEO) Aviation, and the PEO Missiles and Space. AMCOM also supports PEO Aviation and the PEO Missiles and Space as they execute their missions of acquiring and managing the Army's aviation and missile systems. The Development and Engineering Center (AMRDEC) now reports to AFC. AMCOM performs several steps in the life cycle of Army aviation and missile systems, including procurement of spare parts, flight safety, maintenance and overhaul, Foreign Military Sales, and, eventually, retirement or demilitarization. AMCOM provides depot-level support to the Army's aviation and missile systems at Corpus Christi Army Depot (CCAD) and Letterkenny Army Depot (LEAD). Depot support comprises specialized, complex maintenance and overhaul activities. Recapitalization and resetting equipment, along with repairing crash and battle-damaged aircraft, are key missions performed at AMCOM's depots.

## HOW THE ARMY RUNS



**Figure 11-1. Foreign Military Sales Process**

d. Communications-Electronics Command (CECOM) LCMC. CECOM is responsible for life cycle support of communications-electronics systems and equipment. CECOM's mission is to develop, acquire, provide, and sustain world-class Command, Control, Computers, Intelligence, Surveillance and Reconnaissance (C4ISR) systems and battle command capabilities for the joint Warfighter. As an LCMC, CECOM conducts training missions; provides field support for equipment and systems modifications and upgrades; and provides logistical expertise to ensure the on-time delivery of equipment, services, and capabilities to the Warfighter. CECOM also plays an integral part in the establishment and optimization of the Army's C4ISR Materiel Enterprise and C4ISR Center of Excellence (CoE), also located at Aberdeen Proving Ground (APG), MD. The C4ISR Materiel Enterprise is co-chaired by AMC and the ASA (ALT). Together, these organizations develop, acquire, provide, field, and sustain world-class C4ISR systems and battle command capabilities for the joint Warfighter. CECOM is comprised of approximately 8,500 military, civilian, and contract personnel. CECOM provides depot level support at Tobyhanna Army Depot (TYAD), Tobyhanna, PA. TYAD is the Army's premier depot providing maintenance, manufacturing, integration, and fielded repair to C4ISR systems worldwide, including more than 80 forward repair activities. TYAD accomplishes maintenance, fabrication, and system integration for Army, Navy, and Air Force C4ISR systems.

e. Joint Munitions and Lethality (JM&L) LCMC. JM&L LCMC manages research, development, production, storage, distribution, and demilitarization of all conventional ammunition and the personnel, organizations, infrastructure, and processes required for effective life cycle management of conventional ammunition within the DOD. JM&L LCMC is headquartered at Picatinny Arsenal, New Jersey, with major components located at Rock Island Arsenal (RIA), Illinois, and at Picatinny. While the objectives of the JM&L LCMC are to facilitate product responsiveness, minimize life cycle costs, and enhance the effectiveness and integration of munitions and lethality acquisition, logistics, and technology, its overarching objective is to deliver the best munitions to the right place, at the right time, and at the right cost. The JM&L LCMC brings together the resources and expertise of its three component organizations: the Program Executive Office for Ammunition located at Picatinny Arsenal, Joint Munitions Command (JMC) at Rock Island, and the Armament Research, Development and Engineering Center (ARDEC) now reports to AFC, also at Picatinny. It also oversees a nationwide network of installations and facilities that produce and store conventional ammunition under the direction of JMC. JMC manages the Army's



ammunition plants and depots and serves as the logistics arm of the LCMC. JMC installations produce, store, issue, and demilitarize conventional ammunition for all U.S. military services, and for other U.S. agencies and allied nations as directed. JMC manages the Army's 14 ammunition production plants and storage depots and the Defense Ammunition Center, a technical center for munitions where the next generations of civilian ammunition specialists are trained. JMC also serves as the logistics and readiness arm of the LCMC, ensuring that munitions are delivered at the right place and time to support unit training and deployments.

f. Tank and Automotive Command (TACOM) LCMC. The TACOM LCMC, headquartered in Warren, Michigan, unites all of the organizations that focus on Soldier and ground systems throughout the entire life cycle. The TACOM LCMC mission is to develop, acquire, field, and sustain Soldier and ground systems or America's warfighters. The TACOM LCMC consists of the Integrated Logistics Support Center, Program Executive Office (PEO)-Combat Support and Combat Service Support, PEO-Ground Combat Systems, and PEO-Soldier. The TACOM LCMC is also aligned with several business partners: U.S. Army Tank Automotive Research, Development and Engineering Center; Army Contracting Command-Warren; U.S. Army Armaments Research, Development and Engineering Center now falls under AFC; Edgewood Chemical and Biological Center; Joint Program Executive Office for Chemical and Biological Defense; and System of Systems Integration Directorate. Successful execution of TACOM LCMC's mission requires effective communication and coordination among the acquisition, logistics, and technology (ALT) organizations that are part of the TACOM LCMC and the Army's Materiel Enterprise. TACOM's arsenal and depots are: Watervliet Arsenal (WVA), Watervliet, New York; Anniston Army Depot (ANAD), Anniston, Alabama; Red River Army Depot (RRAD), Texarkana, Texas; and Sierra Army Depot, Herlong, California.

g. Military Surface Deployment and Distribution Command (SDDC). SDDC is headquartered at Scott Air Force Base (AFB), Illinois. SDDC's mission is to provide expeditionary and sustained end-to-end deployment and distribution to meet the Nation's objectives. SDDC is the ASCC of the U.S. Transportation Command (USTRANSCOM). This relationship links USTRANSCOM's Joint Deployment and Distribution Enterprise and AMC's Materiel Enterprise. The command also partners with the commercial transportation industry as the coordinating link between DOD surface transportation requirements and the capability industry provides. SDDC's success in deploying and redeploying the Defense Department's personnel and assets is achieved by coordination and leveraging the capability of the commercial transportation industry and other military assets to create an efficient flow of materials worldwide. SDDC averages about 20 million square feet of deployment and redeployment cargo movements each year or roughly 314 vessel operations per year. SDDC operates 24 ports spread throughout the continental U.S. and the world. Their support teams are able to deploy to virtually any port in the world. SDDC manages and coordinates all surface moves in support of door-to-door container and break bulk cargo movements around the globe and provides domestic routing services for rail and highway movements in the continental U.S., including arms, ammunition and explosives. SDDC also manages the assets of the Defense Rail Interchange Fleet and the Army's Containerized Ammunition Distribution System. In addition, SDDC manages household goods, privately owned vehicles and bus charters for Soldiers.

i. ACC. ACC's Soldiers, civilians, and contractors support Soldiers worldwide by acquiring equipment, supplies, and services vital to Soldiers' mission and well-being. ACC ensures contracting support as mission requirements emerge and as the Army transforms and moves within the continental United States and throughout the globe. Headquartered at Redstone Arsenal, Alabama, ACC has two subordinate commands – the Expeditionary Contracting Command (ECC) (for locations outside the continental United States) and the Mission and Installation Contracting Command (MICC) – and six major contracting centers that provide support to AMC's life cycle management commands and MSCs. These centers also provide contracting support to several program executive offices and program managers supporting the Army's major acquisition programs. The ECC provides effective and agile contracting service across the full spectrum of military operations for ASCC commanders in support of Army and joint operations as well as to other defense organizations at locations outside the continental United States. ECC accomplishes this vital mission through seven contracting support brigades, eight contingency contracting battalions, and 83 contingency contracting teams throughout the world. The MICC provides contracting support across Army commands, installations, and activities located throughout the continental United States, Alaska, and Puerto Rico. Its customers include the U.S. Army Installation Management Command, U.S.

## HOW THE ARMY RUNS

Army Forces Command, U.S. Army Training and Doctrine Command (TRADOC), U.S. Army North, U.S. Army Reserve Command, and U.S. Army Medical Command.

j. U. S. Army Medical Research and Materiel Command (USAMRMC). The USAMRMC is the Army's medical materiel developer, with responsibility for medical research, development, and acquisition and medical logistics management. The USAMRMC's expertise in these critical areas helps establish and maintain the capabilities the Army needs to fight and win on the battlefield. Ensuring the Nation's armed forces remain in optimal health and are equipped to protect themselves from disease and injury, particularly on the battlefield, is the job of the USAMRMC. USAMRMC is headquartered at Fort Detrick, Maryland, with 12 subordinate commands located throughout the world. USAMRMC now reports to AFC.

k. U.S. Army Installation Management Command (IMCOM). IMCOM supports the Army by handling the day-to-day operations of Army installations around the globe. Army garrisons are communities that provide many of the same types of services expected from any small city. IMCOM was formerly a direct reporting unit of the HQDA. On 8 March 2019, IMCOM became a major subordinate command of AMC. IMCOM is headquartered in Fort Sam Houston, San Antonio, Texas.

l. U.S. Army Sustainment Command (ASC). The ASC organizes, trains, and sustains a quality deployable force and integrates materiel and services to the Soldier. Rock Island Arsenal, ASC, provides support through the Lead Materiel Integrator (LMI) program, Materiel Management, the LOGCAP Program Management Office, APS, and the Directorates of Logistics. Major ASC responsibilities include:

(1) LMI. The AMC effectively and efficiently distributes and redistributes materiel to support the generation of trained and ready force. As AMC's executing agent for LMI, ASC is the single integrator to ensure Soldiers have the right equipment at the right time to accomplish their missions. Materiel Management: ASC provides materiel readiness visibility and management, including property accountability and source of repair work loading. The Distribution Management Center works contracting requirements, supply management, Army Force Generation equipping strategy, and Directorate of Logistics realignment.

(2) LOGCAP Program Management. The purpose of the LOGCAP is to augment deployed Army forces and other designated organizations with sustainment support services as required by mission specific factors. LOGCAP is a DA regulatory program (AR 700-137) that includes pre-planned, logistics and general engineering/ minor construction support augmentation executed through pre-awarded contracts to selected LOGCAP performance contractor companies. LOGCAP's unique power is related to the operational commander's ability to leverage the designated performance contractor's existing global and regional commercial resources through these pre-selected performance contractors to sustain operations in any environment and during any operational phase. LOGCAP is designed to support preplanned sustainment support during peacetime and execution of that support through contract task orders for deployed forces performing combatant command directed missions. LOGCAP is an immensely capable program that leverages commercial capabilities to provide augmentation for most Army sustainment functions (per ADRP 4-0) in support of Army missions. LOGCAP can also be utilized to provide support for some common support functions not currently found in existing Army force structure. LOGCAP has been designated a strategic source for Logistics Management Services by the ASA (ALT). By design, the program reduces the need for the requiring activity and supporting contracting activities to develop individual contract solutions. Use of LOGCAP vice other contract solutions can reduce the requiring activities and supporting contracting activity burden very significantly by leveraging the LOGCAP Program Management Office, part of ASC at Rock Island, Illinois, and its deployable support elements, especially in large scale operations. Individual sustainment requirement sets are integrated across the LOGCAP footprint to achieve economy of scale and other efficiencies without compromising effectiveness, based on established in law, policy and doctrine. While best known for operations in support of US Forces during Operation Enduring Freedom (OEF)/ Operation Iraqi Freedom (OIF), LOGCAP, when authorized by HQDA, is capable of supporting all Service components, allies, coalition forces, and even other governmental agencies across the range of military operations.

(3) Army Prepositioned Stocks (APS). ASC maintains, accounts for, and cares for stocks in storage worldwide and issues stocks to deploying units worldwide. These stocks include combat equipment and supplies (CL I, IV, III(P), V, VIII, and IX), and humanitarian mission stocks, at land- and sea-based positions strategically located in the continental United States, Italy, Korea, Germany, Japan, Kuwait, Qatar, Afghanistan, and ships at sea. There are currently 6 APS sets: APS-1 located in CONUS that maintains the supplies for Days 61-180; APS-2 is located in Italy and Germany (the set mainly consists of the European Activity Set – a BDE set used both for training and available for warfighting contingencies);

APS-3 is located afloat on container and LMSR leased vessels from Military Sealift command (maintenance and sustainment of the equipment is done at the Charleston Support Activity); APS-4 is located in Japan and Korea; APS-5 is located in Kuwait and Qatar; and APS-6 for SOUTHCOM located at Guantanamo Bay, Cuba. APS maintains Operational projects in each APS location. These are special requirements above unit MTOE authorizations that are pre-staged in the AOR as needed. Examples of Operational Projects are supplies to build an Enemy Prisoner of War Camp, Bridging materiel, Hot and Cold Weather gear and other items specifically requested by the ASCC commander. Activity Sets are a new category of APS. These serve a dual purpose. These are owned and maintained by AMC but can be issued for training purposes.

(4) Directorates of Logistics (DOL). Transferring all functions and responsibilities of the DOLs around the globe from the Installation Management Command to AMC, with full operational control in fiscal year 2013 to ASC's Army Field Support Brigades, aligns logistics support with core competencies. The objective is to provide as good or better service at the best value, by increasing quality, efficiency, and standardizing performance across the materiel enterprise. This transfer essentially places the Army's field-level maintenance and supply capabilities under the command and control of one single command structure, the ASC. To more effectively describe the efficiencies realized by aligning all DOL services under one command and contracting strategy, these installation logistics providers are now named Logistics Readiness Centers (LRC).

### 11-7. LESA

LESA is a field operating agency of the DCS, G-4 headquartered at Fort Belvoir, Virginia. LESA's mission is to assess and integrate innovative logistics solutions, policies, processes, and programs across the Army Logistics enterprise. LESA provides a U.S. Army Headquarters level perspective on any/all issues related to new applications of logistics-related technologies, policies, process enhancements, and business practices. The LESA's mission is to assess and integrate innovative logistics solutions, policies, processes, and programs in support of the CSA and DCS, G-4 priorities. LESA has six core functions and operates across four focus areas.

#### a. Six Core Functions:

(1) Connected Logistics Enterprise and Sense & Respond Logistics (S&RL). The DCS, G-4's vision for how Army Logisticians will support the future fight is based on the transformative potential of the "Connected Logistics Enterprise." The centerpiece of this vision is the Global Combat Support System – Army (GCSS-A), the largest Enterprise Resource Planning (ERP) in DOD. LESA's role in attaining the Connected Logistics Enterprise is the exploration and integration of Sense and Respond Logistics (S&RL) network technologies and processes that will capture data at the "edge." This includes the automated capture of operational and readiness data from asset platforms, sensed equipment items, material in storage and transit, and via handhelds and tablets, the capture of accountability and transactional data from supply, maintenance and distribution events.

(2) Logistics Assessments. Assess logistics enterprise policies, processes, and programs, in support of DCS, G-4 priorities. Key functions: Provide qualitative/quantitative assessments to inform G-4 planning, policy and programming decisions. Conduct business case and cost-benefit assessments of potential enablers to improve logistics operations. Assess and improve Army logistics processes through use of continuous process improvement techniques.

(3) Logistics Audit Readiness Compliance. In support of the DCS, G-4 and in coordination with the ASA (FM&C), LESA's Audit Readiness and Compliance Team conducts "Transaction Level Verification" to enable the institutionalization of logistics audit readiness across the Army. The team conducts existence and completeness (E&C) testing of controls and business processes for General Equipment (GE), Army Working Capital Fund (AWCF) Inventory, Operating Materials and Supplies (OM&S), and Government-Furnished Property (GFP). LESA also conducts follow-on testing to ensure the remediation of units not meeting standard.

(4) Science and Technology Advocacy and Innovation. LESA advises the DCS, G-4 on the Army's Science and Technology (S&T) program, focusing on two major areas. First, LESA provides expertise to the DCS, G-4 as the logistics advisor to the ASA (ALT). Second, LESA supports the sustainment enterprise by managing the logistics optimization strategy, which is documented in the DCS, G-4's Logistics Strategic Planning Guidance.

(5) Second Destination Transportation. In support of the DCS, G-4, LESA manages the G-4's Second Destination Transportation - Centrally Managed Allotment (SDT-CMA) program, Army Third Party

## HOW THE ARMY RUNS

Payment System (TPPS), and Army Transportation Account Code (TAC) that will improve stewardship, achieve auditability, and comply with statutory, DoD, and Army internal control requirements for Army transportation funding. LESA manages the Army G-4's SDT-CMA program, which is a centrally funded, de-centrally executed transportation operation for global movement of select Army material. TPPS Management is a DOD-directed program that allows carriers to be paid in a timely manner. LESA oversees the creation and management of over 4,400+ active Army TACs, which consists of a four character code that is associated with a valid Line of Accounting and identifies the funding account to be charged for transportation.

(6) Studies and Audits Synchronization. In January 2016, LESA took over responsibility for managing DCS, G-4 studies and audits. LESA's mission is to manage and synchronize study and audit-related actions to reduce duplication of effort and maximize the utility of studies and audits focused on issues of high importance to Army logistics.

b. Four Focus Areas:

(1) Business Case Analysis (BCA). LESA is conducting a BCA to identify a preferred Enterprise Ammunition Management and Accountability (AMA) solution for the Army and to provide justification for investment. This BCA is required to support the acquisition milestone decision, and will compare AMA alternatives based on economic viability, costs/savings, requirements satisfaction, operational benefits, and risk. Conditioned Based Maintenance Plus (CBM+) Store and Forward (SaF) BCA. The CBM+ and SaF BCA's purpose is to identify a preferred CBM+ Data SaF solution for the Army, which will inform future acquisition milestone decisions. CBM+ Data SaF is a gap in the Army End-to-End process, and is needed to interface CBM+ enabled assets and deliver their data to maintenance and fleet management support systems. This effort will be comparing alternatives based on economic viability, costs/savings, requirements satisfaction, operational benefits, and risk.

(2) Logistics Business Mission Area (BMA) Integration. LESA's Logistics BMA Integration Team provides "Process" innovation within the enterprise architecture discipline. The BMA Team documents the high-level processes as described by Army policies and regulations, HQDA process owners and subject matter experts. Primarily, the BMA Team assists the DCS, G-4 in collaboratively standardizing the operational processes for Plan-to-Stock (inventory management of all classes of supply) and Service Request-to-Resolution (both field and sustainment maintenance) End-to-Ends to maximize GCSS-A and the U.S. Army Logistics Modernization Program (LMP) Enterprise Resource Planning (ERP) functionality.

(3) Log Integration Capstone (LogIC) Implementation. The DCS, G-4 and the ASA (ALT) partnered on an effort to demonstrate powerful mobile and network technologies that are available in the commercial logistics marketplace and are having transformative effects on process effectiveness and efficiencies. The DCS, G-4 directed LESA, in coordination with ASA (ALT), to investigate these capabilities and process enhancements, and demonstrate those that had the potential to enhance legacy Army sustainment processes.

(4) Sustainment Life Cycle Costing (LCC). Improve sustainment costing and resourcing through more accurate LCC estimates, requirements determination, and risk identification associated with program change decisions. This includes the following lines of effort:

(a) Developed and Enhancing the Program Assessment Tool (PAT). Provides cost impact forecast(s) due to potential/planned program changes such as Reliability, Density, operational tempo, etc. The PAT is registered within the DOD Modeling & Simulation Catalog.

(b) Automate the Affordability Estimate Analysis (SS PEG). Develop an automated process to analyze the affordability of weapon systems for the SS PEG, to include depot maintenance, divestiture, transportation, and SSTS costs.

(c) Standardize & Automate O&S Cost. Standardize and automate the Operating & Support (O&S) cost computations. Ensure process is captured within Army Policy.

### 11-8. Theater Sustainment (TSC)

a. The TSC serves as the senior Army sustainment HQ (less medical) for the Theater Army. The TSC provides mission command of support units assigned, attached, or under operational control (OPCON) to the theater. The mission of the TSC is to provide mission command for operational level logistics within an assigned AOR (less medical) (FM 4-94). The TSC is capable of planning, preparing, executing, and assessing logistics and human resource support for Army forces in theater. It provides support to unified land operations. As the distribution coordinator in theater, the TSC leverages strategic partnerships and joint capabilities to establish an integrated theater-level distribution system that is responsive to Theater

Army requirements. It employs sustainment brigades to execute theater opening (TO), theater sustainment, and theater distribution operations. The TSC includes units capable of providing multifunctional logistics: supply, maintenance, transportation, petroleum, port, and terminal operations. Other specialized capabilities, such as mortuary affairs (MA), aerial delivery, human resources, sustainment to internment/resettlement operations, and financial management, are available from the force pool. The combination of these capabilities gives the TSC commander the ability to organize and provide tailored support.

b. The Expeditionary Sustainment Commands (ESC) are force pooled assets. They are normally under the mission command of the TSC. The ESC provides mission command of sustainment units (less medical) in designated areas of a theater. The ESC plans, prepares, executes, and assesses sustainment, distribution, theater opening, and reception, staging, and onward movement operations for Army forces in theater. It may serve as a basis for an expeditionary command for joint logistics when directed by the Geographical Combat Commander (GCC) or designated multinational or joint task force commander. It normally deploys when the TSC determines that a forward command presence is required. This capability provides the TSC commander with the regional focus necessary to provide effective operational-level support to Army or JTF missions.

c. The Sustainment Brigade (SB), when deployed, is a subordinate command of the TSC, or by extension the ESC. The sustainment brigade is a flexible, multifunctional sustainment organization, tailored and task organized according to mission, enemy, terrain and weather, troops and support available, time available, and civil considerations (METT-TC). It plans, prepares, executes, and assesses sustainment operations within an area of operations. It provides mission command of sustainment operations and distribution management.

d. The Army Field Support Brigade (AFSB) is assigned to the ASC, and when deployed, is placed OPCON to the supported Theater Army. This OPCON relationship is normally delegated to the supporting TSC or ESC as appropriate. An AFSB provides materiel readiness focused support to include coordination of acquisition logistics and technology actions, less theater support contracting and medical, to Army operational forces. AFSBs serve as ASC's link between the generating force and the operational force. AFSBs are also responsible to integrate LOGCAP support into contract support integration plans, in coordination with the theater Army G-4 and the supporting CSB (ATP 4-91).

e. The Combat Sustainment Support Battalion (CSSB) is a flexible and responsive unit subordinate to the Sustainment Brigade that executes logistics throughout the depth of an area of operations including transportation, maintenance, ammunition, supply, mortuary affairs, airdrop, field services, water, and petroleum. The CSSB is attached to a sustainment brigade and is the building block upon which the sustainment brigade capabilities are developed. The CSSB is tailored to meet specific mission requirements. Employed on an area basis, the CSSB plans, prepares, executes, and assesses logistics operations within an area of operations. The CSSB also supports units in or passing through its designated area. The CSSB may operate remotely from the sustainment brigade and therefore must maintain communications with the sustainment brigade. The CSSB establishes voice communications to support mission command and convoy operations as well as to monitor, update, and evaluate the logistics posture.

f. The BSB is an organic component of BCT, fires, and maneuver enhancement brigades. The BSB is tailored to support the particular brigade to which it is organic. For example, the BSB of an armor brigade combat team (ABCT) has more fuel distribution capabilities and maintenance than does a fires brigade BSB. The BSB provides supply, maintenance, motor transport, and medical support to the supported brigade. The BSB plans, prepares, and executes, logistics operations in support of brigade operations (FM 4-90).

g. The Aviation Support Battalion (ASB) is the primary aviation logistics organization organic to a Combat Aviation Brigade (CAB) and the Theater Aviation Brigade. The ASB performs the BSB mission. It provides aviation and ground field maintenance, brigade-wide satellite signal support, replenishment of all supplies, and medical support to the aviation brigade. The ASB has been optimized to support the CAB's forward support companies, aviation maintenance companies, and the brigade HQ and HQ Company (FM 3-04.111).

h. The Human Resources Sustainment Center (HRSC) functions as a staff element of the TSC. The HRSC provides theater-level support to the ASCC G-1 and enables the TSC Commander to plan, integrate, and execute HR support to the theater. The TSC is the key linkage between the ASCC G-1 who provides the policy, direction, and guidance for HR support to the theater and the HRSC, which

## HOW THE ARMY RUNS

executes the HR support mission for postal, casualty, reception, replacement, return to duty, redeployment, rest & recuperation and personnel accounting and strength reporting. The HRSC has a defined role to ensure that the theater HR support plan is developed and then supported with available resources within the TSC. The HRSC is the technical link to HR organizations which execute postal, reception, replacement, redeployment, return to duty rest & recuperation, casualty operations, and personnel accountability support functions.

i. The Financial Management Center (FMC) functions as a staff element of the TSC and asserts technical coordination over all Army financial management companies and detachments in theater. The FMC Director, in coordination with the TSC G-8 or Support Operations, is the principal advisor to the ASCC commander and ASCC G-8 on all aspects of financial management operations. The FMC provides technical oversight of all Army financial management operations in the theater to include negotiations with Host nation banking facilities, advising unit commanders on the use of local currency, and coordination with national providers (US Treasury, Defense Finance and Accounting Service (DFAS), ASA (FM&C), and United States Army Finance Command) to establish financial management support requirements. The FMC sustains Army, joint and multinational operations by providing timely contractual and procurement payments and a theater disbursing capability.

j. The Contracting Support Brigade (CSB) is assigned to the ACC, but allocated to each ASCC. The CSB provides theater support contracting services, along with contracting advice and assistance, primarily to Army forces and to joint forces when directed, and is organized along functional lines. CSBs are more than just a contracting services provider; they provide key operational contracting support capabilities to include contracting support planning assistance, contracting oversight and fraud, waste and abuse prevention. CSB primary tasks include—

- (1) Planning and executing theater support contracting services.
- (2) Providing contract support related advice and planning assistance.
- (3) Coordinating and de-conflicting common contracting support actions.

k. SDDC Transportation Brigades are GCC aligned and provide single port management functions in an area of operations. SDDC serves as the ASCC of USTRANSCOM and is a major subordinate command to AMC. The brigade works with commercial transportation industry as a coordinating link between DOD surface transportation requirement to move equipment to and from home station to point of need or retrograde of materiel from deployed locations to home station.

l. In an environment of rapid change and limited resources, the military must respond quickly and efficiently to situations around the world. To deal with this, USTRANSCOM developed Joint Task Force – Port Opening (JTF-PO) in 2005 to rapidly open and establish ports of debarkation and initial distribution networks to support joint operations and multinational operations. The command is stationed at Fort Eustis, Virginia and assigned to USTRANSCOM with OPCON or TACON to the GCC upon employment.

### Section III

#### National Logistics Organizations—Other

##### 11-9. Other Logistics–Related Organizations

a. The Sustainment CoE (CASCOM), is a subordinate command of TRADOC. CASCOM trains, educates, and develops Sustainment professionals while generating, synchronizing, and integrating innovative Sustainment capabilities, concepts, and doctrine to sustain Large Scale Combat Operations (LSCO). CASCOM's three core competencies are to:

- (1) Execute Initial military training for sustainment Soldiers and civilians.
- (2) Prepare the Army to sustain LSCO in a Joint Interagency Intergovernmental Multinational environment.
- (3) Design, develop, and integrate sustainment capabilities into warfighting requirements, foster innovation, and lead change for the future force.

b. U.S. Army Forces Command (FORSCOM). FORSCOM is responsible for the administrative control of all Army forces in CONUS.

c. ASCC. Logistics in a theater of operations is tailored to support the Joint Force Commander's (JFC) requirements for each situation. Consideration is given to the variety of missions, which tend to make each logistics requirement different in terms of amounts and types of supplies, maintenance, transportation, and services needed. Consequently, organizations are tailored to each theater to cover a

full spectrum of possibilities ranging from a large theater of operations comprised of one or more corps to support levels required by a division or separate brigade. The ASCC is responsible for providing administrative control (that includes logistics support) to all Army units and contractors in the theater. This responsibility is executed through the TSC or a functional command such as personnel, transportation, medical, or engineer commands. The Army commander manages theater logistics support by establishing broad policies, allocating critical supplies, and assigning missions in concert with the JFC's guidance. Additionally, the Army theater commander manages and controls supply, maintenance, and other logistics services through the TSC and provides for centralized movements control for U.S. Army forces through the Theater Movement Control Agency (TMCA).

d. Army and Air Force Exchange Service (AAFES). AAFES is the provider of supply Class VI (personal demand items) for the Army and Air Force. It is a joint command of the Departments of the Army and Air Force. The AAFES commander is responsible to the AAFES Board of Directors (BOD). In turn, the BOD is responsible to the Secretaries of the Army and Air Force through their respective chiefs of staff. Primarily a civilian-run organization under military leadership, AAFES employs about 52,400 people, and operates approximately 1,500 facilities worldwide. AAFES worldwide headquarters is located in Dallas, Texas and two subordinate headquarters manage operations within the Europe and Pacific Regions. The mission of AAFES is to provide merchandise and services of necessity and convenience to authorized patrons at uniformly low prices, and to generate funds to supplement Appropriated Funds (APF) for the support of MWR programs. AAFES does this in peace and wartime. To accomplish its mission, AAFES:

(1) Operates retail, food, personal service, vending centers, theaters, automotive facilities, and Army military clothing sales stores on military installations.

(2) Provides basic exchange support to military personnel engaged in contingency operations or field exercises by establishing military-run tactical field exchanges (TFEs) where regular AAFES operations are not possible. Class VI support in the field can be limited to basic health and hygiene needs or expanded to include food, beverages, and other comfort items based upon the requested needs of the theater commander.

(3) Generates earnings that support MWR programs. AAFES pays dividends to the Army, which in turn allocates funds to specific MWR programs on installations. The Army MWR BOD, which is formed under the Army Community and Family Support Center (CFSC), controls the allocation of AAFES-generated MWR funds within the Army.

e. General Services Administration (GSA). The GSA provides general supplies and services that are common to more than one department of the Government. The GSA has multi-mission responsibility to manage the varied business activities of the Federal Government. GSA provides an extensive amount of supply support to the DOD for such commonly used items as leased commercial-style vehicles, office furniture and supplies, machine and hand tools, photo supplies, etc.

### **11-10. Defense Logistics-Related Organization**

a. Defense Logistics Agency (DLA).

(1) As America's combat logistics support agency, the Defense Logistics Agency provides the Army, Marine Corps, Navy, Air Force, other federal agencies and partner nation armed forces with a full spectrum of logistics, acquisition and technical services. DLA sources and provides nearly all of the consumable items America's military forces need to operate – from food, fuel and energy to uniforms, medical supplies and construction material. DLA also supplies nearly 90 percent of the military's spare parts, manages the reutilization of military equipment, provides catalogs and other logistics information products, and offers document automation and production services to a host of military and federal agencies. Headquartered at Fort Belvoir, Virginia, DLA is a global enterprise – wherever the United States has a significant military presence, DLA is there to support.

(2) The DLA's primary activities are—

(a) DLA Land and Maritime, Columbus, Ohio. Manages weapons system supply chains and is the largest Inventory Control Point (ICP). DLA Land and Maritime's core functions include monitoring inventory levels, maintaining technical data, and assuring quality of more than two million spare and repair parts. DLA Land and Maritime manages more than two million different items for approximately \$5 billion in annual sales. DLA Land manages wheeled, tracked and heavy vehicle parts; vehicle maintenance kits, power transmission, engine, suspension components, tires, batteries and small arms parts.

## HOW THE ARMY RUNS

(b) DLA Aviation, Richmond, Virginia. DLA Aviation operates in 18 stateside locations, supporting more than 1,900 major weapon systems, with focused support to 143 major weapon systems and is the U.S. military's integrated materiel manager for more than 1.1 million repair parts and operating supply items in support of all fixed- and rotor-wing aircraft, including spares for engines on fighters, bombers, transports and helicopters; all airframe and landing gear parts; flight safety equipment; and propeller systems. DLA Aviation industrial support activities are positioned alongside its military customers at Robins AFB, Georgia; Tinker AFB Oklahoma; Hill AFB, Utah; Marine Corps Air Station Cherry Point, North Carolina; Naval Air Station North Island, California; and NAS Jacksonville, Florida. DLA Aviation also manages depot-level repairable procurement operations at Robins, Tinker, and Hill AFBs; Naval Supply Systems Command (NAVSUP) Weapon Systems Support, Philadelphia, Pennsylvania; and at Redstone Army Arsenal, Alabama. DLA Aviation also operates an industrial plant equipment repair facility at NAVSUP Weapon Systems Support, Mechanicsburg, Pennsylvania. DLA Aviation also operates the federal government's only industrial plant equipment facility at Navy Inventory Control Point, Mechanicsburg, Pennsylvania.

(c) DLA Troop Support, Philadelphia, Pennsylvania. DLA Troop Support supplies and manages food, clothing and textiles, pharmaceuticals, medical supplies, and construction and equipment supplies in support of America's warfighters worldwide and their eligible dependents. Other customers include America's school children participating in federal school lunch programs, and other non-Defense Department customers. DLA Troop Support supports nearly every contingency operation, humanitarian relief effort, and every theater of operation.

(d) DLA Energy, Ft. Belvoir, Virginia. DLA Energy provides the DOD and other government agencies with comprehensive energy solutions and is designated as the executive agent for bulk fuel. DLA Energy's mission continues to expand, incorporating emerging areas of renewable and alternative methods for satisfying customers' energy needs. Its mission is expanding beyond the role of traditional fuel and energy support as it leverages new technologies. Its business units continue to pursue solar power, hydrogen power, synthetic fuels and other alternative fuel and renewable energy sources as new procurement, research and development initiatives materialize.

(e) DLA Distribution, New Cumberland, Pennsylvania. DLA Distribution is a combat support agency and the Lead Center for Distribution. DLA Distribution's 26 sites around the world are responsible for the receipt, storage, issue, packing, preservation and transportation of more than four million items.

(f) DLA Disposition Services, Battle Creek, Michigan. In support of the DLA mission, DLA Disposition Services disposes of excess property received from the military services. The inventory changes daily and includes thousands of items: from air conditioners to vehicles, clothing to computers, and much more. That property is first offered for reutilization within the DOD, transfer to other federal agencies, or donation to state and local governments and other qualified organizations. Reutilization means big savings. In the past four years more than \$2.2 billion worth of property was reused each year. Every dollar's worth of property reutilized is a tax dollar saved. DLA Disposition Services also supports disaster relief at home, and humanitarian assistance and foreign military sales programs. DLA Disposition Services' (formerly known as the Defense Reutilization and Marketing Service) mission is to support customers through the reuse, transfer, donation, sale or disposal of excess property.

(g) DLA Strategic Materials, Fort Belvoir, Virginia. DLA Strategic Materials is the U.S. leading agency for the analysis, planning, procurement and management of materials critical to national security. They are responsible for providing safe, secure and environmentally sound stewardship for strategic and critical materials in the U.S. National Defense Stockpile (NDS). The stockpile of materials is intended to decrease dependence upon foreign sources of supply during national emergency. DLA Strategic Materials stores 28 commodities with a current market value of over \$1.4 billion at 15 locations in the U.S. Commodities range from base metals such as zinc, cobalt, and chromium to the more precious metals such as platinum, palladium, and iridium. The U.S. Congress has authorized DLA Strategic Materials to sell commodities that are excess to DOD needs. Since 1993, DLA Strategic Materials sales have totaled approximately \$6.6 billion. Sales of excess NDS materials produce revenue for the Treasury General Fund and a variety of defense programs such as the FMS program, military personnel benefits, and the buy-back of broadband frequencies for military use. The sale revenues also fund DLA Strategic Materials operations to make it a self-sustaining organization.

(h) DLA Logistics Information Services, Battle Creek, Michigan. DLA Logistics Information Service provides interoperable, integrated, quality logistics data and enterprise IT solutions for the Military Services, the DOD, and other federal agencies. DLA Logistics Information Services Cataloging



Directorate is the centralized and consolidated cataloging activity for all DOD cataloging. It performs all 12 DOD cataloging functions and provides direct cataloging services in support of Warfighters, all DOD agencies (both at the wholesale and retail levels), and approximately 50 NATO and other allied nations. It is responsible for operational assignment, life cycle maintenance and collaboration with each of the Services for the 7.4 million National Stock Numbers and all the descriptive data associated with each item of supply.

(i) DLA Document Services, Mechanicsburg, Pennsylvania. DLA Document Services provides a full portfolio of document services ranging from traditional offset printing, through on-demand output to on-line document services. Further, DLA Document Services is recognized as a transformation agent actively moving the DOD toward the use of on-line documents and services. Initiatives include an on-line customer eBusiness interface, Electronic Document Management CoEs for customer shared capability, Distribute and Print services (e.g., distribution of a digital file to multiple production facilities and print on demand), Equipment Management Solutions (e.g., best-value document support equipment in customer workspaces), and document conversion services (e.g., one of the largest providers in the federal government).

(j) DLA Transaction Services, Wright-Patterson AFB, Ohio. DLA Transaction Services receives, edits, and routes logistics transactions for the military services and federal agencies for standard Military Supply (MILS) transactions and provide information about anything, anywhere, anytime, to anyone in the DOD and Federal Logistics Community.

(k) DLA Distribution, New Cumberland, Pennsylvania is the leading provider of global distribution support to America's military including receiving, storing and issuing supplies as well as providing other tailored services to increase warfighter readiness. DLA Distribution offers best value supply chain solutions through a broad range of services including storage, distribution, customized kits, and specialized packaging as well as transportation support and technology development. DLA Distribution's customers include U.S. Army, Marine Corps, Navy, Air Force and other agencies. More than 10,000 employees provide timely distribution services to customers around the globe. In fiscal year 2013, DLA Distribution processed nearly 16 million receipts and issues supporting customer requirements worldwide, to include Operation New Dawn and Operation Enduring Freedom, numerous humanitarian assistance missions and a multitude of military exercises to ensure warfighter readiness.

b. Defense Contract Management Agency (DCMA). DCMA is the DOD component that works directly with Defense suppliers to help ensure that DOD, Federal, and allied government supplies and services are delivered on time, at projected cost, and meet all performance requirements. DCMA provides Contract Administration Services to the DOD Acquisition Enterprise and its partners to ensure delivery of quality products and services to the warfighter; on time and on cost. These services include: Acquisition Planning Support, Contract Management, Financial Services, Engineering Support Services, Property Management, Quality Assurance and Product Acceptance, Software Acquisition Management, Small Business, and Specialized Safety Support. DCMA professionals serve as "information brokers" and in-plant representatives for military, federal, and allied government buying agencies -- both during the initial stages of the acquisition cycle and throughout the life of the resulting contracts. Before contract award, DCMA provides advice and information to help construct effective solicitations, identify potential risks, select the most capable contractors, and write contracts that meet the needs of the Army's customers in DOD, federal, and allied government agencies. After contract award, DCMA monitors contractors' performance and management systems to ensure that cost, product performance, and delivery schedules are in compliance with the terms and conditions of the contracts

c. The Defense Contract Audit Agency (DCAA) provides audit and financial advisory services to DOD and other federal entities responsible for acquisition and contract administration. DCAA operates under the authority, direction, and control of the Under Secretary of Defense (Comptroller)/Chief Financial Officer. DCAA, while serving the public interest as its primary customer, shall perform all necessary contract audits for the DOD and provide accounting and financial advisory services regarding contracts and subcontracts to all DOD components responsible for procurement and contract administration. These services shall be provided in connection with negotiation, administration, and settlement of contracts and subcontracts to ensure taxpayer dollars are spent on fair and reasonable contract prices. DCAA shall provide contract audit services to other Federal agencies as appropriate.

## HOW THE ARMY RUNS

### 11-11. Department of the Army Systems

a. LMP. The LMP provides a comprehensive, modernized logistics solution that allows AMC to provide world class logistics readiness. Operational since July 2003, LMP delivers a fully-integrated suite of software and business processes that streamlines the Maintenance, Repair, and Overhaul (MRO), planning, finance, acquisition, and supply of weapon systems, spare parts, services, and materiel. Today, LMP is operational at all the AMC LCMCs, ASC, DFAS, and other Army locations. The program manages a multi-billion dollar inventory with tens of thousands of vendors and integrates with more than 70 DOD systems. Now fully fielded, LMP operates at more than 50 locations worldwide with approximately 25,000 users.

b. GCSS-A. GCSS-A oversees the implementation of the tactical logistics and financial ERP program to integrate business processes and offer an Army-wide view of logistics information from the battlefield. GCSS-A allows commanders to anticipate, allocate, and synchronize the flow of resources across all areas of operations. GCSS-A replaces aging, stove-piped tactical logistics systems and associated financial capabilities and interface with applicable Army C2 systems and Joint systems as a follow-on initiative. This Web-based system, supported by laptops and Automatic Identification Technologies (AIT) devices, provides functionality for limited disconnected operations and for connected operations using robust deployable communications to connect to a centralized database for all users at all echelons.

c. Army Enterprise Systems Integration Program (AESIP). The Army continues to modernize its ERP business systems to simplify operations, optimize processes, and provide an accurate, Enterprise view of business information to all users. AESIP is a key component of this initiative. AESIP integrates business processes and systems by serving as the Enterprise hub for the Army's logistics and financial ERP business systems, to include: LMP, the national logistics system; GCSS-A, the tactical logistics system; and General Fund Enterprise Business System, the Army's financial system. AESIP enables integration by linking business processes and data across existing IT systems. This integration optimizes business processes and supports Enterprise level information requirements. AESIP has successfully delivered a Web-based solution for the creation and management of customer and vendor master data and implemented an optimized messaging and hub services capability. AESIP houses and enables the Army Enterprise material master which provides the Army a single authoritative source for material data supporting all Army constituent (modernized and legacy) systems. This Army Enterprise material master provides the catalyst to manage, control, create, change, archive, and validate data, while providing a single global view of material thus, providing the basic building blocks for Product Lifecycle Management/Weapon System Management. Implementation of the Enterprise material master has enabled inventory management, accountability, pricing, accounting functions, and Material Requirements Planning (MRP) operations to be seamlessly integrated into the Army Enterprise vision.

d. The LMI Decision Support Tool (DST). DST is the Army's collaborative tool used to synchronize the distribution and redistribution of materiel IAW Army priorities and directives. DST receives information from the Logistics Information Warehouse (LIW), which is the Army's single authoritative materiel data repository. In order to help provide a common operating picture for distribution and redistribution actions, LIW receives data from sources such as Property Book Unit Supply Enhanced, GCSS-A, LMP, Army War Reserve Deployment System, Force Management System Website, and the Army Equipping Enterprise System. Materiel Managers across the Enterprise are able to obtain near real-time asset visibility, develop equipping plans, and project unit readiness.

## Section IV

### Summary, Key Terms, and References

#### 11-12. Summary

Army sustainment processes, organizations, and management enterprises continue to transform to meet the Nation's challenges and provide unique logistics support to the Joint Force Commander; enabling freedom of action across the range of military operations. Logisticians provide the essential capabilities to enable the force to deploy, fight and win the Nation's wars by providing ready, prompt, and sustained land dominance by Army forces across the full spectrum of conflict as part of the Joint Force.

## 11-13. Key Terms

- a. Anticipation. The ability to foresee events and requirements and initiate necessary actions that most appropriately satisfy a response without waiting for operations orders or fragmentary orders.
- b. Container Management. The process of establishing and maintaining visibility and accountability of all cargo containers moving within the DTS.
- c. Continuity. The uninterrupted provision of sustainment across all levels of war.
- d. Directive Authority for Logistics. The CCDR's authority to issue directives to subordinate joint force commanders of service component commanders for as many common support capabilities required to accomplish the assigned mission (JP 3-33).
- e. Economy. Providing sustainment resources in an efficient manner that enables the commander to employ all assets to the greatest effect possible.
- f. Improvisation. The ability to adapt sustainment operations to unexpected situations or circumstances affecting a mission.
- g. Integration. Combining all of the sustainment elements within operations assuring unity of command and effort.
- h. Intermodal Operations. The process of using multiple modes (e.g., air, sea, highway, rail) and conveyances (e.g., truck, barge, containers, pallets) to move troops, supplies and equipment through expeditionary entry points and the network of specialized transportation nodes to sustain land forces.
- i. Logistics. Planning and executing the movement and support of forces. It includes those aspects of military operations that deal with: design and development, acquisition, storage, movement, distribution, maintenance, evacuation, and disposition of materiel; acquisition or construction, maintenance, operation, and disposition of facilities; and acquisition or furnishing of services.
- j. Mode Operations. The execution of movements using various conveyances (truck, lighterage, railcar, aircraft) to transport cargo.
- k. Movement Control. The dual process of committing allocated transportation assets and regulating movements according to command priorities to synchronize distribution flow over lines of communications to sustain land forces.
- l. Personnel Services. Sustainment functions that man and fund the force, maintain Soldier and Family readiness, promote the moral and ethical values of the nation, and enable the fighting qualities of the Army.
- m. Port Opening. The ability to establish, initially operate and facilitate throughput for ports of debarkation (POD) to support unified land operations.
- n. Responsiveness. The ability to react to changing requirements and respond to meet the needs to maintain support.
- o. Simplicity. Relates to processes and procedures to minimize the complexity of sustainment.
- p. Sustainment. The provision of logistics, personnel services, and health service support necessary to maintain operations until successful mission completion (ADP 4-0).
- q. Sustainment Preparation of the Operational Environment. The analysis to determine infrastructure, physical environment, and resources in the operational environment that will optimize or adversely impact friendly forces means for supporting and sustaining the commander's operations plan.
- r. Sustainment Warfighting Function. The related tasks and systems that provide support and services to ensure freedom of action, extended operational reach, and prolong endurance (ADRP 3-0).
- s. Theater Closing. The process of redeploying Army forces and equipment from a theater, the drawdown and removal or disposition of Army non-unit equipment and materiel, and the transition of materiel and facilities back to host nation or civil authorities.
- t. Theater Distribution. The flow of equipment, personnel, and materiel within theater to meet the CCDR's mission.
- u. Theater Opening. The ability to establish and operate ports of debarkation (air, sea, and rail), establish a distribution system and sustainment bases, and to facilitate port throughput for the reception, staging, onward movement and integration of forces within a theater of operations.

## 11-14. References

- a. Publications. Field manuals and selected joint publications are listed by new number followed by old number.
  - (1) Joint Publications. Most joint publications are available online: <http://www.dtic.mil/doctrine/-->
  - (a) JP 1, Doctrine for the Armed Forces of the United States, 25 March 2013.

## HOW THE ARMY RUNS

(b) JP 1-02, Department of Defense Dictionary of Military and Associated Terms, 8 November 2010 (amended 15 Jun 2015).

(c) JP 1-06, Financial Management Support in Joint Operations, 2 March 2012.

(d) JP 2-03, Geospatial Intelligence Support to Joint Operations, 31 October 2012.

(e) JP 3-0, Joint Operations, 11 Aug 2011.

(f) JP 3-08, Inter-organizational Coordination during Joint Operations, 24 June 2011.

(g) JP 3-28, Civil Support, 31 Jul 2013.

(h) JP 3-33, Joint Task Force Headquarters, 30 July 2012.

(i) JP 3-34, Joint Engineer Operations, 30 June 2011.

(j) JP 3-35, Deployment and Redeployment Operations, 31 January 2013.

(k) JP 4-0, Joint Logistics.

(l) JP 4-01, Joint Doctrine for the Defense Transportation System, 6 June 2013.

(m) JP 4-01.5, Joint Terminal Operations, 6 April 2012.

(n) JP 4-02, Health Service Support, 26 July 2012.

(o) JP 4-06, Mortuary Affairs, 12 October 2011.

(p) JP 4-08, Logistics in Support of Multinational Operations, 21 February 2013.

(q) JP 4-09, Distribution Operations, 19 December 2013.

(r) JP 4-10, Operational Contract Support, 16 July 2014.

(s) JP 5-0, Joint Operation Planning, 11 August 2011.

(2) Army Publications. Most Army doctrinal publications are available online:

<http://www.apd.army.mil/-->

(a) ADP 3-0 (FM 3-0), Unified Land Operations, 10 October 2011.

(b) ADP 4-0 (FM 4-0), Sustainment, 31 July 2012.

(c) ADP 5-0, The Operations Process, 17 May 2012.

(d) ADP 6-0, Mission Command, 17 May 2012 with Changes 1 and 2.

(e) ADRP 1-02, Operational Terms and Graphics, 2 February 2015 (replaced FM 1-02).

(f) ADRP 3-0, Unified Land Operations, 16 May 2012.

(g) ADRP 4-0, Sustainment, 31 July 2012.

(h) ADRP 5-0, The Operations Process, 17 May 2012.

(i) ADRP 6-0, Mission Command, 17 May 2012, with changes 1 and 2.

(j) AR 10-25, United States Army Logistics Innovation Agency, 5 April 2012.

(k) AR 11-1, Command Logistics Review Program, 27 November 2012.

(l) AR 11-2, Managers' Internal Control Program, 26 March 2012.

(m) AR 27-10, Military Justice, 3 October 2011.

(n) AR 30-22, The Army Food Program, 24 July 2012.

(o) AR 700-8, Logistics Planning Factors and Data Management, 15 March 2011.

(p) AR 700-80, Army IN-Transit Visibility, 24 September 2008.

(q) AR 700-131, Loan, Lease, and Donation of Army Materiel, 23 August 2004.

(r) AR 700-137, Logistics Civil Augmentation Program (LOGCAP), 28 December 2012.

(s) AR 702-6, Ammunition Stockpile Reliability Program, 23 June 2009.

(t) AR 710-2, Supply Policy Below the National Level, 28 March 2008.

(u) AR 711-6, Army Participation in the Defense Logistics Agency Weapon System Support Program, 15 May 2009.

(v) AR 715-9, Operational Contract Support Planning and Management, 20 June 2011.

(w) AR 735-5, Property Accountability Policies, 10 May 2013.

(x) AR 750-1, Army Materiel Maintenance Policy, 12 September 2013.

(y) ATP 4-0.1, Army Theater Distribution, 29 October 14.

(z) ATP 4-90, Brigade Support Battalion, 2 April 2014.

(aa) ATP 4-91, Army Field Support Brigade, 15 December 2011.

(bb) ATP 4-92, Contracting Support to Unified Land Operations, 15 October 2014.

(cc) ATP 4-94, Theater Sustainment Command, 28 June 2013.

(dd) ATP 4-15, Army Watercraft Operations, 3 April 2015.

(ee) ATP 4-33, Maintenance Operations, 14 April 2014.

(ff) ATP 4-42 – General Supply and Field Services Operations, 14 July 2014.

(gg) FM 1-0, Human Resources Support, 1 April 2014.

(hh) FM 1-04, Legal Support to the Operational Army, 18 March 2013.

- (ii) FM 1-05, Religious Support, 5 October 2012.
  - (jj) FM 1-06, Financial Management Operations, 15 April 2014.
  - (kk) FM 3-04.111, Aviation Brigades, 7 December 2007.
  - (ll) FM 3-05, Army Special Operations Forces, 9 January 2014.
  - (mm) FM 3-05.40, Special Operations Sustainment, 3 May 2013.
  - (nn) FM 3-28, Civil Support Operations, TBP.
  - (oo) FM 3-34, Engineer Operations, 2 April 2014.
  - (pp) FM 3-35.1, Army Prepositioned Operations, 1 July 2008.
  - (qq) FM 4-02.1, Army Medical Logistics, 8 December 2009.
  - (rr) FM 4-02.7, Multiservice Tactics, Techniques, and Procedures for Health Service Support in a Chemical, Biological, Radiological, and Nuclear Environment, 15 July 2009.
  - (ss) FM 4-02, Army Health System, 26 August 2013.
  - (tt) FM 4-20.41, Aerial Delivery Distribution in the Theater of Operations, 29 August 2003.
  - (uu) FM 4-95 Logistics Operations, 1 April 2014.
  - (vv) FM 27-10, The Law of Land Warfare, 18 July 1956.
  - (ww) PAM 735-5, Financial Liability Officer's Guide, 9 April 2007.
  - (xx) HQDA General Order 2012-01, Assignment of Functions and Responsibilities within Headquarters, Department of the Army, 11 June 2012.
- (3) Other Publications—
- (a) Allied Land Publication 4.2, (Standardization Agreement 2406), Land Forces Logistics Doctrine, 4 February 2010.
  - (b) DODD 5100.1, Functions of the Department of Defense and its Major Components, 21 December 2010.
  - (c) DODD 5101.9, DOD Executive Agent for Medical Materiel, 23 August 2004.
  - (d) DTR 4500.9-R, Defense Travel Regulation, [http://www.transcom.mil/dtr/part-i/dtr\\_part\\_i\\_toc.pdf#search=4500.9&zoom=100](http://www.transcom.mil/dtr/part-i/dtr_part_i_toc.pdf#search=4500.9&zoom=100), November 2010.
  - (e) Military Justice (Preamble, Manual for Courts-Martial), [http://www.loc.gov/rr/frd/Military\\_Law/pdf/MCM-2012.pdf](http://www.loc.gov/rr/frd/Military_Law/pdf/MCM-2012.pdf).
  - (f) NATO Logistics Handbook, 3rd Edition, Chapter 7, NATO Principles and Policies for Logistics <http://www.nato.int/docu/logi-en/logist97.htm>, October 1997.
  - (g) Title 10 United States Code (U.S.C.), Armed Forces.
  - (h) Title 32 U.S.C., National Guard.

**This page is intentionally left blank**

## Chapter 12

### Military Human Resource Management

#### Section I

#### Introduction

##### 12-1. Military Human Resource Management

The term Human Resource Management (HRM) has been accepted by the Army leadership and, over time, has been integrated into policy and doctrine formerly used to describe the functions of personnel management and personnel administration. In the most general sense, HRM is a series of integrated decisions about the employment relationship that influences the effectiveness of employees and organizations. Military Human Resource Management (MHRM) is the major component of the Army's overall HRM operations. It has evolved from a supporting role to that of a strategic enabler for the Army. Today's challenges require informed decisions on force structure requirements, recruiting and retention programs, well-being programs, and personnel readiness from both individual and unit perspectives. HR leaders must possess professional and specialized skills to meet these challenges and manage the programs that comprise the functions and integrating systems of the HR life cycle model.

##### 12-2. Military Human Resource Life Cycle Functions

In a broad sense, MHRM describes the process of managing people by performing the essential functions of planning, organizing, directing, and supervising effective procedures necessary in administration and operation of personnel management. The life cycle HR management functions are derived from the Army's life cycle, as follows.

- a. Personnel Structure. The HR portion of the Army's force development function where personnel requirements and authorizations are determined and documented.
- b. Acquisition. This function ensures the Army is staffed with the correct grades and skills in numbers sufficient to satisfy force requirements, and has three components.
  - (1) Manpower Management. The process of linking accession, retention, and promotion targets to Army requirements as measured against the military manning program in the Planning, Programming, Budgeting, and Execution (PPBE).
  - (2) Accession and Retention Management. The process that converts manpower targets to missions and oversees execution.
  - (3) Training Integration. The establishment of a demand for training programs and a system to control input and tracking of trainees and students.
- c. Distribution. The function of assigning available Soldiers to units based on Army requirements and priorities.
- d. Development. This function begins with accession training and continues throughout a Soldier's entire period of service. It includes institutional training, self-development, leader development, and supporting programs such as the voluntary education, evaluation, promotion, and command selection systems.
- e. Deployment. This function enables the Army to transition from the "prepare mode" to the "conduct of military operations" mode. Deployment includes mobilization, deployment, redeployment, demobilization, reset, non-combatant evacuation, and repatriation.
- f. Compensation. This function encompasses the management of all pay, allowances, benefits, and financial entitlements for Soldiers, retirees, and annuitants. The dollars involved exceed one-third of the Army's total obligation authority.
- g. Sustainment. This function involves the management of programs to maintain and advance the well-being of Soldiers, civilians, retirees, and family members.

## HOW THE ARMY RUNS

h. Transition. As individuals leave the RA for either of the Reserve Components (RC) or civilian life, this function provides assistance to Soldiers, Army civilians, and family members.

### 12-3. Human Resource Leadership

a. Assistant Secretary of the Army (Manpower and Reserve Affairs) (ASA(M&RA)) has principal responsibility for the overall supervision of manpower, personnel, and RC affairs.

b. The Deputy Chief of Staff, G-1 (DCS, G-1), as the Army's personnel proponent, determines the broad objectives of the military personnel management system. The DCS, G-1 establishes policy for and exercises Army staff (ARSTAF) proponent supervision of the system's functions and programs.

c. The Commanding General (CG), U.S. Army Human Resources Command (HRC) is the Army's functional proponent for the military personnel management system and operates the Army's military HR systems within the objectives set by the DCS, G-1. The CG, HRC also supports the MHRM system's automation requirements in the design, development, and maintenance of personnel databases and automation systems.

d. The CG, U.S. Army Soldier Support Institute (USASSI) develops and coordinates operational concepts, materiel requirements, organization and force design requirements, and integrates training into courses of instruction at the Adjutant General School.

### 12-4. Key Military Human Resource Publications

a. Army Regulation (AR) 600-8, Military Personnel Management. This regulation establishes the military personnel management system. It describes the functional structure of the system and sets forth the organizational structures that direct, integrate, and coordinate the execution of the system. The AR 600-8 series addresses specific subjects within the military personnel management arena.

b. Field Manual (FM) 1-0, Human Resource Support. This field manual describes the Army's personnel doctrine and how it fits into the Army's operational concept across the full spectrum of conflict, as well as how it supports unit commanders and Soldiers. It provides a common understanding of HR support and encompasses the management concepts of personnel information and readiness; replacement, casualty, and postal operations; personnel accounting and strength reporting; mobilization and demobilization; and other essential personnel services.

c. AR 600-3, The Army Personnel Proponent System.

(1) HRC manages the personnel proponent system, designating personnel proponents, assigning their basic responsibilities, and defining the personnel life cycle management functions. The objectives of the personnel proponent system are as follows.

(a) Identify a single agent (proponent) responsible for all personnel matters for each career field (officer, warrant, enlisted, and civilian).

(b) Fix responsibility for all career field-related matters.

(c) Ensure the civilian work force is integrated into the personnel proponent system.

(d) Ensure personnel management policies and programs established by Headquarters, Department of the Army (HQDA) incorporate career field-related considerations.

(e) Foster awareness and achievement of the objectives of the Officer Personnel Management System (OPMS), the Total Warrant Officer System (TWOS), the Enlisted Personnel Management System (EPMS), and the Civilian Integration into the Personnel Proponent System (CIPPS).

(2) The functions of personnel proponentcy are accomplished through approximately 54 personnel proponent offices in conjunction with HRC. Together the proponents assist the DCS, G-1 in all personnel-related matters.

(3) The framework for proponentcy consists of the eight life cycle management functions. The personnel proponent system serves as the honest broker, ensuring fairness, completeness, accuracy, and timeliness of all aspects of the personnel system.

### 12-5. Military Occupational Classification and Structure System (MOCS)

a. The MOCS system translates manpower requirements into specific skills and grade levels. System policy is set forth in AR 611-1, Military Occupational Classification and Structure Development and Implementation. Department of the Army Pamphlet (DA PAM) 611-21, Military Occupational Classification and Structure, contains the procedures and detailed officer, warrant officer (WO), and enlisted classification and structure guidance. AR 611-1 publication is available as an electronic



## MILITARY HUMAN RESOURCE MANAGEMENT

publication on the U.S. Army Publishing Agency (USAPA) web site ([www.usapa.army.mil](http://www.usapa.army.mil)). DA PAM 611-21 is available on the milSuite website (<https://www.milsuite.mil/book/groups/smartbookdapam611-21>).

b. Changes to occupational identifiers within the MOCS are generally driven by the requirements determination process. Personnel proponents submit proposed changes to the system in accordance with responsibilities in AR 600-3 for recommending classification criteria. The Personnel Occupational Specialty Code Edit (POSC-Edit) System, an automated system maintained by DCS, Personnel (DAPE-PRP), is the official military occupational edit file used to edit and update data on authorized automated personnel systems. The file is updated based on approved revisions to the MOCS. It contains a listing of all authorized commissioned officer, WO, and enlisted identifiers; grades associated with those identifiers; and other personnel information.

### 12-6. Interrelated Documents and Systems at the Heart of Human Resource Process

a. The Active Army Military Manpower Program (AAMMP). The manpower program is produced as monthly updates and as decision programs for the Program Objective Memorandum (POM), Office of the Secretary of Defense (OSD) budget submission, and President's Budget. It is the report produced by the Enlisted Grades (EG) Model. Using a linear program, the EG Model operates within constraints such as end strengths, man years, and recruiting capability to develop an OS that matches the force structure allowance (FSA) as closely as possible. It also carries up to seven years of historical loss behavior to use as a projective (predictive) database. Inputs are the latest available strength, gains, and loss data. Vital data for the AAMMP comes from (or will come from) several manpower systems, most of which are discussed later in this chapter. These systems include the suite of forecasts that constitute the Officer Forecasting Model (OFM); Enlisted Specialties Model; the Individual Account (IA) Model; and the Army Training Requirements and Resources System (ATRRS). The AAMMP records and/or projects strength of the Army; losses and gains; FSA; training inputs; officer, cadet, and female programs; and the TTHS account.

b. Total Army Personnel Database (TAPDB). An automated, standardized database containing military personnel data to fully support manning and sustaining functions during peacetime and under mobilization required by HRC and the National Guard Bureau (NGB). It consists of integrated but physically distributed databases (Active Officer (TAPDB-AO), Active Enlisted (TAPDB-AE), United States Army Reserve (USAR), Army National Guard (ARNG), and Core). TAPDB core contains selected data elements from each component database needed to support mobilization.

c. Electronic Military Personnel Office (eMILPO). This web-based automated personnel information system is the Army's database of record and primary HR system. eMILPO provides commanders with management information reports; performs automated field records maintenance; and provides automated personnel information to TAPDB (AE, AO), the Enlisted Distribution and Assignment System (EDAS), Active Enlisted (AE), and Total Officer Personnel Management Information System (TOPMIS) (AO). eMILPO is web based, uses a centralized database and provides near real-time, Army-wide visibility on personnel information.

d. Enlisted Specialties Model. This is part of the HQDA decision support system. It is personnel planning optimization model that computes recommended Military Occupational Specialty (MOS) and grade mix, enlisted accessions, training to support accessions, and in-service reclassification/reenlistment and promotions to maintain force alignment through the POM cycle.

e. OFM. The OFM uses time-series forecasting techniques to demonstrate the aggregate impact of current proposed manpower policies. It maintains force alignment by minimizing the difference between the desired and projected OS in each competitive category and grade. The major inputs are authorizations data, inventory data, loss rates, and promotion targets. The model provides output data that can be imported into spreadsheets or word processing documents for analysis and reporting. The OFM outputs support program and budget development, policy analysis, and other management activities and serves as an input or constraint into EG.

f. Active Army Strength Forecaster (A2SF). This system developed and used by DCS, G-1, replaced several legacy systems used in forecasting officer and enlisted strengths, gains, losses, and force manning. Using updated methodologies, the object-oriented design of this system provides more accurate and timely forecasting, as well as significantly enhanced detail (rates for specific populations, gender, etc.) to support DCS, G-1 decisions. It draws upon TAPDB for personnel source data and produces the AAMMP as one of its primary reports.

## HOW THE ARMY RUNS

g. ATRRS. ATRRS is the Army's system of record for training. It is an automated information system that provides personnel input to training management information for HQDA, commands, schools, and training centers during both peacetime and mobilization operations. The system contains information at the course level of detail on all courses taught by and for the Army. A major product of ATRRS is the Army Program for Individual Training (ARPRINT).

h. ARPRINT. The ARPRINT is a mission document that provides officer and enlisted training requirements, objectives, and programs for the RA, Army RC, and Department of the Army (DA) civilians, other U.S. Services, and foreign military. Training is planned and executed on a fiscal year (FY) basis and the goal is to train sufficient numbers in each MOS/branch and functional area to equal the projected authorizations as of the end of the FY.

### Section II

#### The Structure Function

##### 12-7. Military Manpower Management

In Chapter 3, we addressed unit structure and force planning, describing how the force is sized and configured and how that force is accounted for in the documentation system. This paragraph, which should be viewed as an extension of Chapter 3, will focus on how the Army manages manpower and personnel once the force is configured and sized.

a. Manpower management at the macro level is the function of determining requirements, obtaining manpower, and allocating resources. It includes the determination of minimum-essential requirements, alternative means of providing resources, and policies to be followed in utilization of manpower. It involves the development and evaluation of organizational structure and review of utilization. It includes Soldiers in the RA, ARNG, and USAR, Army civilian manpower assets, and certain contractor assets when a requirement is satisfied by contractual services rather than by Army military or civilian personnel.

b. Manpower managers deal with HR requirements from the perspective of the organizational structure in which they will be most efficiently and economically used. First, they focus on requirements demanding explicit grades and skills to perform specific tasks. Then, they focus on determining which requirements will be supported with authorizations (spaces). Finally, they combine force structure authorizations with requirements in the TTHS Account, also referred to as the IA, to determine the needs of the Army by grade and skill within constraints that exist. Simultaneously, HR managers focus on supporting requirements through the acquisition, training, and assignment of personnel (faces) to authorized positions.

c. The Congress, the Office of Management and Budget (OMB), OSD, and the Office of the Secretary of the Army (OSA) are not directly involved in the management of individual military personnel. They do, however, establish policies that prescribe the availability of this resource and the management latitude available to those involved in personnel management. For example, policies which limit Permanent Changes of Station (PCS), establish tour lengths, set officer grade limitations, or place a ceiling on the hire of local national personnel affect the flexibility of personnel managers. OSD and, to a more limited extent, OMB, are involved in the force-structuring process. Managers, above the DA level, are concerned primarily with the management of spaces, while at descending levels below HQDA, they are increasingly concerned with the management of people and their associated costs. Much of the work at the departmental level involves decisions dealing with the aggregate of the force structure and inventory rather than the subsets of grade and skill. At lower levels, the HR process turns its focus more toward the faces and the management of people. Whenever the force structure changes, there is a significant cause and effect relationship on the many systems that support manpower planning and HR management.

##### 12-8. Manpower Management at HQDA

a. In managing military manpower at the macro level, the key measurement used by HR managers is the Operating Strength Deviation (OpSD). OpSD is a measurement of how much the OS (faces) is deviating from the FSA (spaces). The OS must not be confused with the FSA. The anticipated size of the OS, however, gives a good idea as to how large a structure can realistically be manned. Throughout the year there can be many causes for these deviations, such as unpredicted changes in retention rates and seasonal surges in acquisitions. Personnel managers must constantly monitor the OpSD and adjust personnel policies to ensure the Army has an optimum match of faces to spaces. At the same time, the



## HOW THE ARMY RUNS

e. By knowing the TTHS and total strength projections, manpower planners can easily determine the size of the OS and use that as a basis for developing a FSA for building authorized units. TTHS, FSA, and OSD projections are all contained in the AAMMP.

f. The number of personnel in the TTHS is often directly attributable to the personnel policies in effect. Soldier casualties, fill of projected deploying units, and training requirements and policies are but a few examples of policies which affect the size of TTHS. Since TTHS has a direct effect on the faces available for FSA manning, these same policies have a direct impact on the number of units and organizations which the Army can field. Thus, manpower and personnel managers face a constant challenge to ensure a balance exists between the use of authorized spaces and the acquisition, training, and distribution of personnel assets to meet the needs of the Army. The stated personnel needs of the Army as expressed in its various organizational documents change on a daily basis as different units and organizations are activated, inactivated, or changed. However, the process of providing personnel to meet these changing needs is much slower.

### **12-9. Personnel Management Authorizations Document (PMAD) and Updated Authorizations Document (UAD)**

a. The PMAD and UAD are the Army's documents of record for active component military authorizations. The PMAD and UAD provide authorizations data at the Unit Identification Code (UIC), MOS, and grade level of detail for the current year through the end of the program. The PMAD and UAD support the distribution of personnel, strength forecasting, programming, budgeting, accessions, promotions, and training.

b. The primary inputs to the PMAD and UAD are built from annual updates of the force structure files reflected in the HQDA DCS, G-3/5/7 Force Management Division, to include: Structure and Manpower Allocation System (SAMAS) and Army authorization documents files. A PMAD is based on a locked SAMAS file. A normal year sees two locked SAMAS files and two corresponding PMADs. In between command plans, decisions are often made which cause significant changes to authorizations. A UAD which makes adjustments to PMAD authorizations is produced periodically to capture such changes. The Army will publish UADs to capture emerging changes to personnel structure. A normal year sees the publication of two UADs. The personnel community uses PMAD and its most current UAD as the sole source of RA authorizations to UIC, MOS, grade, and Additional Skill Identifier (ASI) level of detail for the current and budget years. The focus of the PMAD and UAD is on detail for near-term distribution. The PMAD is the basis for decisions regarding accessions, training, force alignment, promotions, and distribution of personnel. Throughout this text the term PMAD refers to the PMAD itself or its most current UAD.

### **12-10. Notional Force System**

As needed the Army may also publish a NOF. A NOF provides the same authorizations data as a PMAD or UAD—active component military authorizations at the UIC, MOS, and grade level of detail for the current year through the end of the program. The difference is that a NOF reflects force structure or personnel structure decisions that have not received approval. The purpose of a NOF is to support analysis only and its distribution is limited.

### **12-11. Military Force Alignment**

Force alignment is managing changing faces and spaces simultaneously by grade level and Career Management Field (CMF)/MOS—reshaping a force today to also meet tomorrow's needs. The always changing AAMMP, PMAD, and budget are intensively managed monthly for the PPBE six-year cycle; ensuring military personnel strength is skill-qualified and available for distribution. Force alignment strives to synchronize military personnel programs: promotions, recruiting, accessions, training, reenlistment, reclassification, and special and incentive discretionary pay. Simultaneously, every effort is made to provide professional career development consistent with Army force manning levels for qualified Soldiers. Management forums are the Functional Review (FR), personnel functional assessment (PFA), Structure Manning Decision Review (SMDR), Monthly Military Personnel Review (M2PR), Training Resources Arbitration Panel (TRAP), and CMF reviews. Representation in shaping the officer and enlisted forces involves the entire personnel community in varying degrees of programming and execution. Enlisted Strength Model is a major planning tool for enlisted force alignment analysis. The goal: to achieve a PMAD grade-CMF/MOS match to OS for the current year, budget year, and program years.

**Section III**  
**The Acquisition Function**

**12-12. Enlisted Procurement**

a. Based on input from the PMAD (authorizations by skill and grade), TAPDB-AE (skills and grades on hand), and the AAMMP (projected accessions in the aggregate), the Enlisted Specialties Model projects the numbers and training requirements for the various MOSs. This in turn is used to develop the annual program (ANNPRO) and the ARPRINT and feeds the personnel input to the ATRRS which is linked to the Recruit Quota Enlistment System (REQUEST) and the Reenlistment/Reclassification System (RETAIN) (Figure 12-2).

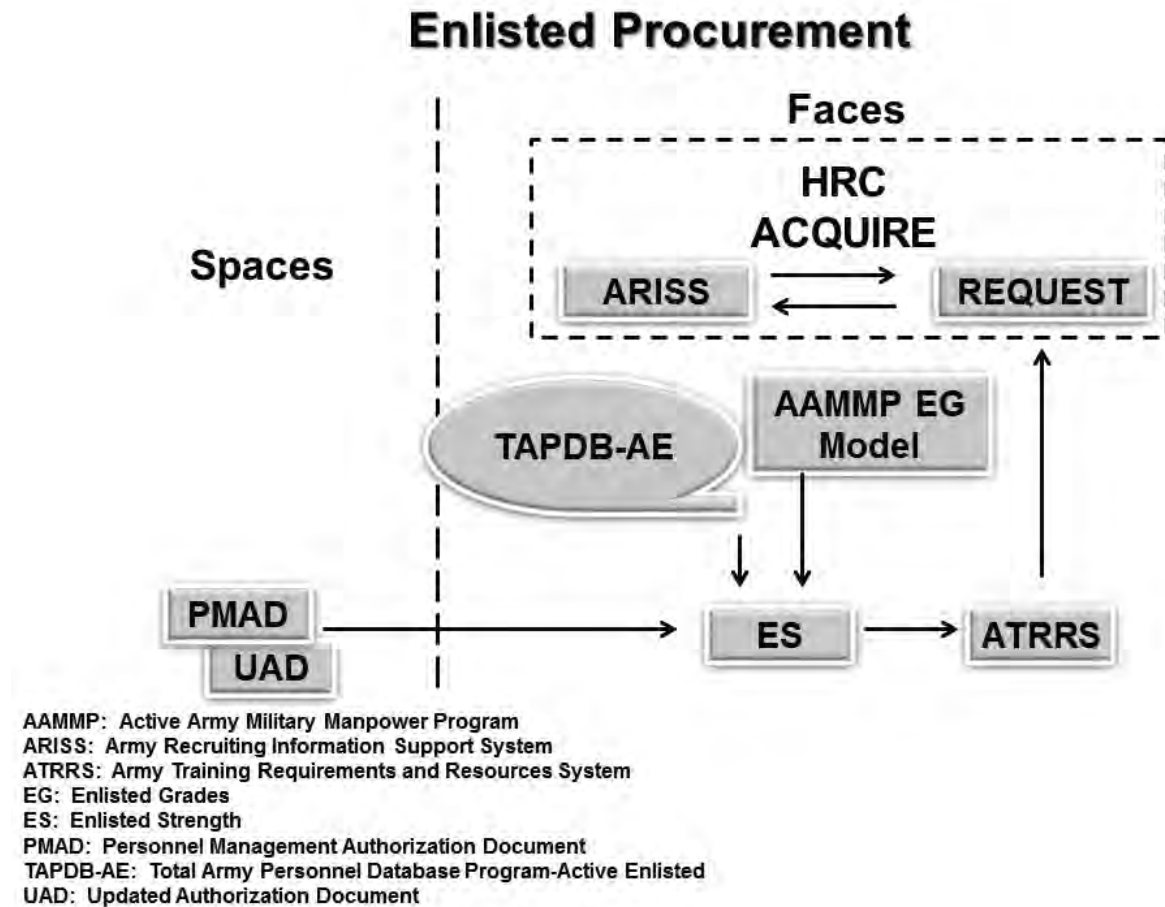

**Figure 12-2. Enlisted Procurement**

b. The mission of the U.S. Army Recruiting Command (USAREC) is to obtain the quantity and quality of recruits to meet both RA and USAR requirements. RA enlistment options provide the vehicle by which Army applicants are attracted. The option packages vary and contain such incentives for applicants as training guarantees, unit/station of choice assignments (used primarily for prior service applicants), and payment of bonuses or education incentives. Additionally, the length of the enlistment period varies for certain options and skills.

(1) Quality Constraints. The recruiter is constrained by quality standards, which must be met. A potential enlistee is classified as a result of an Armed Services Vocational Aptitude Battery (ASVAB) which has 10 aptitude areas. ASVAB results place individuals into test score categories and determine both basic enlistment and specific MOS eligibility. Both law and Army policy constrain the number of certain test categories the recruiting force may enlist. The Army Non-Prior Service (NPS) accession

## HOW THE ARMY RUNS

quality program seeks to maximize the number of high school diploma graduates and those in the upper test score categories, with a ceiling established for the lower test score categories.

(2) MOS Training Targets. All new Soldiers receive a minimum of 12 weeks of Initial Entry Training (IET) prior to becoming available for deployment. All new Soldiers recruited by USAREC contract for a specific MOS, which is supported by a resourced training seat. Using projections from Enlisted Specialties Model, HRC projects annual IET requirements for new Soldiers in the ANNPRO for each MOS. These requirements then feed into the ATRRS. In ATRRS, IET requirements combine with professional development and other training requirements and are presented at the SMDR for resourcing. Once approved by the Army leadership, all training requirements and approved training programs are identified in the ARPRINT.

(3) Management of Recruiting Objectives. REQUEST is an automated enlistment and training space management system designed to support the Army's recruiting and RC retention missions. The system is a worldwide, real-time, interactive system and is the controlling element for recruiters and RC retention Noncommissioned Officers (NCO) in translating aggregate mission objectives to the MOS needs of the Army. It uses a worldwide telecommunications network with remote data terminals accessing a common data bank containing the Army's training programs determined by the ARPRINT and modified in the year of execution by TRAPs which either increase or decrease the SMDR ANNPRO to meet current requirements. ATRRS provides class schedules and quota allocations to REQUEST, which becomes visible to Army recruiters to enlist Soldiers to fill those quotas. The system provides reservation processing for enlistment options, accession controls, and management information reports from remote data terminals.

(a) REQUEST, designed to enhance the efficiency of Army recruiting, provides the Army with a means of allocating training resources to accessions. Enlistment options during periods of non-mobilization result from a review of the applicant's qualifications based on the ASVAB, physical testing, individual preference, and Army MOS requirements. An automated matching algorithm aligns the applicant's qualifications, desires, and aptitudes to the Army's needs. Qualification checks and other features of the system preclude erroneous enlistments into skills for which the applicant does not qualify.

(b) The REQUEST Unit Distribution Program (RUDIST) adds a unit vacancy and distribution guidance file to the REQUEST System. A portion of the training spaces for MOSs available under an enlistment option guarantees a first assignment is allocated to specific units and stations. Allocations of first assignment are based upon projected unit requirements and distribution policies. This is primarily used for Prior Service Soldiers. For Non-Prior Service applicants, the majority are contracted as uncommitted, providing maximum flexibility to the distribution system to assign them to a unit where they best meet an Army requirement.

(c) The REQUEST System is the controlling element for recruiters in translating aggregate recruiting objectives to the MOS needs of the Army.

(4) Military Entrance Processing Station (MEPS).

(a) The MEPS is a jointly staffed Service activity charged with aptitude testing, medical examination, moral evaluation, and administrative processing of applicants for the Armed Forces. DA is the Department of Defense (DOD) Executive Agent for the MEPS. The Military Entrance Processing Command (MEPCOM) commands and controls the MEPS.

(b) Once the recruiter has determined the applicant's desire to enlist and his or her areas of interest, he or she can administer an enlistment screening test which gives an informal indication of how the applicant might fare on the ASVAB. If the applicant continues his or her interest, he or she goes to MEPS for processing.

### 12-13. Warrant Officer (WO) Procurement

a. WOs are highly specialized officers, appointed based on technical competence and leadership abilities. USAREC procures WO candidates for the RA. DCS, G-1 develops a recruiting goal by MOS for each FY. USAREC uses this and an internally created lead refinement list, to direct recruiting efforts, especially for hard-skill MOSs with existing or projected critical shortages. Applicants come from the best of the NCO ranks, outside the Army (primarily aviation applicants), other in-service sources such as other Services, commissioned officers, and members of the RC.

b. Applications of all eligible individuals are evaluated by a HQDA selection board. USAREC conducts the board which is composed of a field grade officer president and WO members from each branch with applicants to be considered. Those recommended by the board on an order of merit list are slated to

## MILITARY HUMAN RESOURCE MANAGEMENT

attend the Warrant Officer Candidate School (WOCS), in a candidate status, as procurement openings present themselves. Each new WO1 then attends the appropriate Warrant Officer Basic Course (WOBC) to complete certification training.

c. The recruitment, application processing, and selection of WOs for the USAR is performed in a similar manner as the RA. However, USAREC recruits WO candidates against specific USAR unit vacancies. In addition, USAREC accepts and processes applications for Active Guard Reserve (AGR), Individual Mobilization Augmentee (IMA), and Individual Ready Reserve (IRR) vacancies. The USAR uses boarding and school-slating procedures similar to those used by the RA. The ARNG solicits applications through announcement of vacancies via an internal recruiting effort. The boarding and school-slating procedures are as determined by each individual State Adjutant General. All RC WO applicants attend WOCS and WOBC. RC versions for many WOBCs are available.

### 12-14. Commissioned Officer Procurement

a. The PMAD is the authoritative source for officer requirements. Authorizations are defined by unit, by Area of Concentration (AOC), and by grade for all grades except WO1. There are no authorizations for WO1s in the U.S. Army. Procurement each year is based on an analysis of the current inventory and the losses projected by the DCS, G-1. This annual procurement number is then disaggregated by HRC into an allocation for each branch. The G-1 then distributes an allocation of branches to each commissioning source. Sufficient officers must be procured each year to ensure an adequate number of trained individuals by grade, AOC, and skill is available for utilization in the future. There are constraints associated with the management of officer end-strength contained in Title 10 United States Code (10 U.S.C.). There is no specific force structure allowance for the officer corps within the authorized end strength of the Army. However, for field grade officers, 10 U.S.C. restricts the number of officers serving at each grade as a proportion of the size of the officer corps. Training constraints limit the number of officers that can be procured in each branch.

b. Officer Sources. The sources of officer procurement for the basic branches are Officer Candidate School (OCS), Reserve Officers' Training Corps (ROTC), and United States Military Academy (USMA). Requirements are determined by the DCS, G-1 and filled through the various commissioning programs and special branch programs. To supplement these appointments, recall of reserve officers, recall of retired officers, direct appointments, and inter-service transfers are also used. The inter-service transfer program allows the Army to access members of the Air Force, Navy, Marine Corps, or Coast Guard to fill shortages in the mid-grade ranks and has proven effective as the other services have been decreasing officer strength. All commissioned officers incur a statutory eight-year Military Service Obligation (MSO), which may be supplemented by concurrent or consecutive obligations like those described in AR 350-100. Officers may serve their MSO in a variety of ways depending on the source of their commission as outlined below.

(1) The OCS.

(a) OCS at Fort Benning, Georgia, trains and commissions officers for both the RA and RC. RA OCS graduates incur a three-year Active Duty Service Obligation (ADSO) and may serve the remainder of their eight-year MSO on active duty or in the RC. RC graduates receive a reserve appointment and return to reserve status after completing their initial officer training requirements such as Basic Officer Leaders Course (BOLC), Airborne, or Ranger School. RC graduates not only incur the statutory MSO, but must serve six years of that in a Troop Program Unit (TPU) as a drilling reservist.

(b) In-service candidates are enlisted Soldiers serving on active duty. Semi-annual selection boards at HRC select qualified Soldier applicants for OCS. Branches are assigned based on the needs of the Army and candidate's preferences. In-service candidates incur a three-year ADSO within their eight-year MSO.

(c) Enlistment option candidates are qualified college graduates who elect to enlist in the Army in order to attend the OCS. These candidates enlist in the Army and attend basic training followed by the 12-week OCS course. Enlistment option candidates incur a three-year ADSO within their eight-year MSO.

(d) Additionally, each state runs a National Guard OCS to commission officers into the RC.

(2) ROTC. The ROTC trains and commissions officers for both the RA and the RC. Branching is accomplished through Cadet Command and HQDA boards based on the needs of the Army and the cadet's qualifications, standings on the Order of Merit List, and individual preferences.

## HOW THE ARMY RUNS

(a) RA. Upon accession, scholarship cadets incur a four-year ADSO within their eight-year MSO, while non-scholarship cadets incur a three-year ADSO with their eight-year MSO. The remainder of any MSO may be served in the RA or in the RC.

(b) RC. Scholarship cadets must serve in a TPU all eight years of their MSO, while non-scholarship cadets must serve at least six years in a TPU. The remainder of the MSO may be spent in the IRR.

(3) USMA. The USMA trains and commissions officers for the RA. A formal branch selection process matches the needs of the Army with cadet preferences based on a strict order of merit list. The active duty service obligation for USMA graduates is five years and the remainder of the MSO may be spent in the RA or RC.

(4) Special Branches. The special branches—Judge Advocate General's Corps (JAGC), the medical branches, and the Chaplains Corps—procure officers through their individual programs, and service obligations vary depending upon the program. Procurement for most medical officers and Chaplains has been assigned to USAREC while JAGC is responsible for its own recruiting.

### Section IV

#### The Compensation Function

##### 12-15. Compensation Overview

a. Compensation is a relatively recent addition to the military HR life cycle. Over one third of the Army's total obligation authority relates to compensation and only through controlling the cost drivers (number, grade, and skill of Soldiers) can the Army manage the dollars appropriated by Congress.

b. The Army's personnel assets are centrally managed as are Army resources tied to these assets. The Army pays against the inventory (assigned strength), but authorizations and personnel policies are the cost drivers.

c. Personnel management policies, force structure decisions, and content of the force influence the Military Personnel, Army (MPA) appropriation requirement. Among these cost drivers are the following.

- (1) Pay rates
- (2) Retirement rates, including number of medical retirements vice normal retirements, and early retirements (less than 20 years of service)
- (3) Cost of food
- (4) Social Security and Medicare rates
- (5) Basic Allowance for Housing (BAH), including programs similar to
- (6) Residence Communities Initiative (RCI), privatize housing, privatize barracks
- (7) Military Health Care
- (8) Stationing plans and manpower.
- (9) Clothing bag
- (10) Entitlements
- (11) Special Pays (Medical, Aviation, Special Duty Assignment Pay, etc.)
- (12) Assignment Incentive Pay
- (13) Enlistment bonuses
- (14) State of the Economy
- (15) Reenlistment rates/bonuses
- (16) Separation Pays
- (17) Marital status
- (18) Size of the Army Outside of the Continental United States (OCONUS) and overseas station allowances
- (19) Tour lengths
- (20) Force changes
- (21) Grade and skill content
- (22) Active Duty Operational Support (ADOS)
- (23) Unemployment Compensation
- (24) ROTC pay/scholarships
- (25) Junior ROTC (JROTC) support

d. The MPA account pays the force, moves the force, subsists the force, and supports the force. Pay includes pay and allowances for officers, enlisted, and cadets. Movement is managed under the PCS



# MILITARY HUMAN RESOURCE MANAGEMENT

account, which is sub-divided into accessions, separations, training, operational, rotational, and unit moves. Subsistence provides payment for the basic allowance for subsistence and subsistence in kind. Finally, support comes in other military personnel costs such as education, adoption, unemployment, death gratuities, and survivor benefit programs.

## 12-16. Manning Program Evaluation Group (MMPEG)

At the departmental level, all personnel-related programs are contained within the MM PEG. The MM PEG has responsibility to determine the valid requirements for those programs in Figure 12-3. All should come together in providing the right skills, at the right place and time.



Figure 12-3. Manning Programs

## Section V

### The Distribution Function

#### 12-17. Enlisted Distribution and Assignment

a. Distribution Challenge. In theory, the distribution planning and assignment processes place the right Soldier with the right skills at the right place at the right time. In fact, the system does a very credible job for those MOSs and grades which are nearly balanced, those for which the overseas-to-sustaining base ratio is supportable, and for those in which there is a high density of personnel in substitutable skills. The problem arises in the MOSs where these conditions do not exist, and a sharing of shortages is required for all commands. When certain commands, or organizations, are exempted from "shortage-sharing" based upon special guidance, it compounds shortages to be shared by the organizations lower in priority. The readiness cost of this compounded shortage-sharing comes to light when each organization must

## HOW THE ARMY RUNS

assess its mission capable status in the monthly readiness reporting. The personnel component of the report involves several calculations, but its principal factors are assigned strength, available strength, available senior grade personnel (Sergeant (SGT) and above), and MOS qualification.

(1) Enlisted personnel distribution is a very complex business, replete with pitfalls and shortcomings because of the rapidly changing variables that exist—force structure changes, recruiting success, training attrition rates, retention rates, military personnel authorizations, dollar constraints, and most of all, the unpredictability of the individual Soldier, his or her health, and his or her family. All of these variables point up the critical factors which govern successful distribution—the accuracy and timeliness of the databases being used for analysis. Authorizations not approved and posted expeditiously to PMAD and individual change data not properly reported for posting on the TAPDB-AE make the already complicated distribution system less responsive.

(2) Soldiers have the ability to influence their assignment in several ways. One is by submitting an assignment preference. They do so via a web-based application called Assignment Satisfaction Key (ASK), which allows the Soldier to update his/her assignment desires and volunteer for valid requirements directly with HRC in real time.

b. Distribution Planning and Priorities. The basic document that defines priorities for the distribution of enlisted personnel to all units/activities is the FY HQDA Manning Guidance. DCS, G-1 publishes and distributes this guidance to HRC and to Army commands (ACOMs) for implementation after the Chief of Staff of the Army (CSA) approves it. The guidance provides responsibilities at all levels for manning units and expected level of fill commands can expect. Distribution is driven by requirements to fill approved authorizations documented in PMAD/UAD, Directed Military Overstrength (DMO), and overstrengths in specific high priority units. Distribution is affected by recruiting and retention goal achievement; unprogrammed losses; and fiscal constraints affecting promotions, PCS movements, and end strength. Special priorities are based on operational and training requirements for special skills, such as Ranger qualifications and linguists. (Current DMO policy is under review)

c. Enlisted Distribution Target Model (EDTM).

(1) The EDTM is an automated system that creates enlisted distribution targets by MOS, grade, and UIC. The model fills each UIC reflected in the PMAD with projected available inventory from the Enlisted Specialties Model in accordance with the DCS, G-1 distribution policy. This results in an optimum distribution of scarce resources consistent with distribution policy fill priorities. The EDTM constrains the assignment process to coincide with the projected OS targets. It represents the assets the Army realistically expects to be available for distribution.

(2) The EDTM is maintained by the Enlisted Readiness Division, Enlisted Personnel Management Directorate (EPMD), HRC. The targets are produced monthly with EDTM targets for grade bands E1-4, E5-8, and E9. Current Month (CM) through CM+18 are visible to field personnel managers via Personnel Network (PERNET) using the EDAS.

d. Management Systems. HRC uses several automated data-processing systems to distribute, manage, and develop active duty enlisted personnel. These systems are described below and reflected in Figure 12-4.

(1) TAPDB is the heart of the overall system. It consists of three logical components containing personnel, requisition, and organizational data. The Personnel (Component of TAPDB) (PER DB) contains personnel information on every active duty Soldier. HRC and DCS, G-1 use this information to determine Army readiness, strength, promotion eligible, re-assignable personnel, and training requirements. The Requisition (Component of TAPDB) (REQ DB) contains information on requirements to move individuals and information on those who have been directed to move (assignments). The Organization (Component of TAPDB) (ORG DB) contains information on location and status of Army units; it does not contain any authorization or unit strength information.

(2) HRC Enlisted Personnel Data Update System (PEPDUS) is one of the major systems used to update the data on the TAPDB. It consists of two components, a batch component and an online, interactive component that allows managers worldwide to query and update personnel data.

(a) The batch component receives transactions daily from other systems. The primary source is eMILPO, but other sources such as the Centralized Promotion System and the EDAS submit transactions. PEPDUS is also designed to support mobilization. During a mobilization scenario it is able to process over 500,000 transactions daily. As PEPDUS updates the TAPDB, it also creates transactions that are passed back to eMILPO (receipt notices, update transactions, DA error notices, etc.), in order to update the TAPDB-Mobilization (TAPDB-MOB), and provide feedback to other systems.

## Enlisted Automation Management System

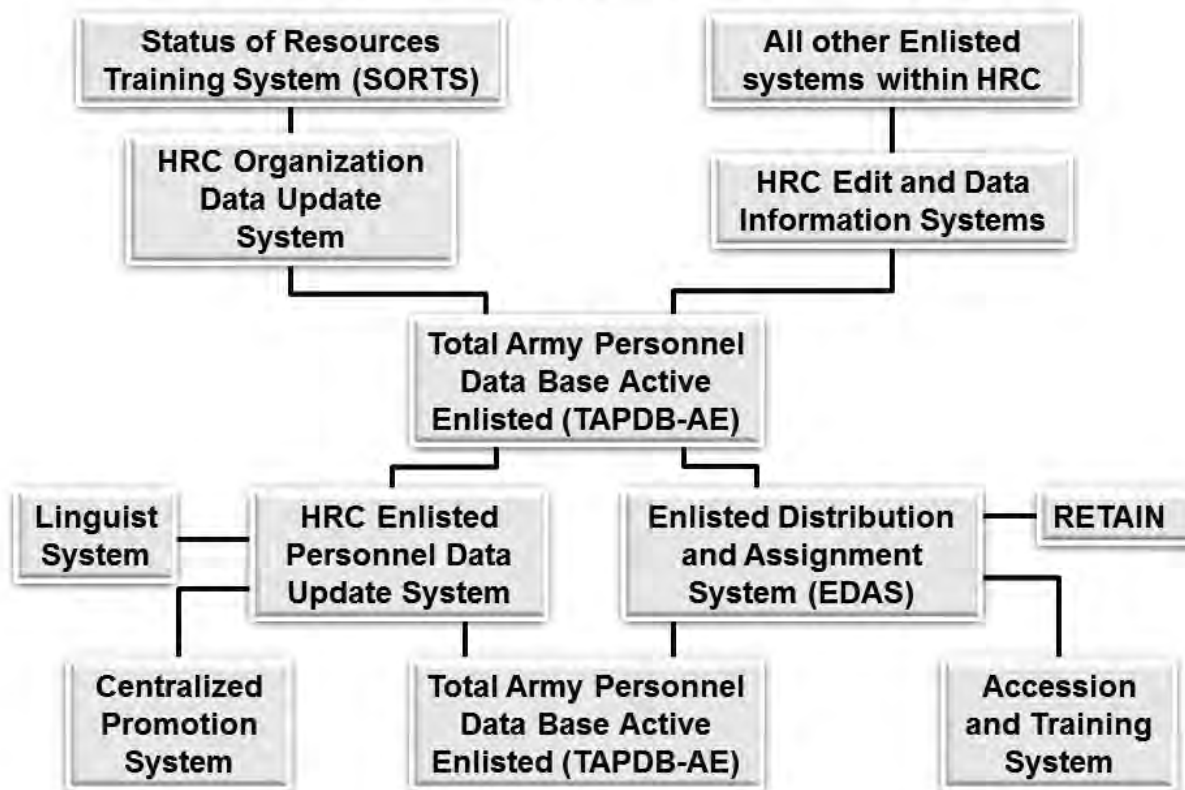

Figure 12-4. Enlisted Automation Management System

(b) The on-line interactive component allows EPMD managers to update data items on the PER DB. Some examples are Continental United States (CONUS) and OCONUS assignment preferences, assignment eligibility, and Date Eligible for Return from Overseas (DEROS). As EPMD managers update, PEPDUS updates the eMILPO Personnel File.

(3) EDAS is an on-line system which allows EPMD managers to create, review, and update requisition and assignment data. It also provides reports for those managers for strength management of the force. It has several batch programs that exchange information with external systems. EDAS allows EPMD distribution and assignment managers to work with one collection of information on the same computer. Under previous systems, updates to information occurred only during the weekend; updates are now instantaneous. Consequently, decisions made by one manager are immediately available to all other managers. Moreover, EDAS provides field users the capability to view and in some cases update the same information that distribution and assignment managers use to make decisions. Finally, EDAS reduces the time to validate a requirement, select a Soldier to fill the requirement, and transmit the assignment instructions to the field. A more detailed explanation on how EDAS is used in distributing and assigning Soldiers is presented in a subsequent section.

(4) Assignment of Newly Trained Personnel.

(a) Permanent unit assignments are based on input to HRC from basic and advanced individual training centers via the Student/Trainee Management System-Enlisted (STRAMS-E), a module within the ATRRS. Information is passed by ATRRS to EDAS which processes newly trained personnel for assignment.

(b) If an individual has an enlistment agreement for a unit in an area, he or she is assigned according to the enlistment contract upon satisfactory completion of training. Soldiers who have no unit/area options are assigned against requirements in accordance with a distribution plan prepared by HRC.

## HOW THE ARMY RUNS

Assignment instructions are generated by EDAS and sent directly to losing commands. The transaction is processed through EDAS and is posted to the TAPDB. EDAS advises the gaining command of the assignment.

e. Enlisted Distribution Management. HRC Enlisted Readiness Division manages the strengths of major overseas commands, ACOMs, and special management and functional commands worldwide. HRC established a direct requisition authority to each of the brigade combat team or armored cavalry regiment to ensure projected gains to those organizations were not diverted by installation strength managers. Under modularity and brigade centric organizations, brigades with organic military HR assets requisition and receive replacements directly from HRC. Strength managers at HRC project the assigned strength of an activity ranging from the current month's strength out to 12 months, and determine how many Soldiers are needed each month to ensure the commands meet targets established by the FY enlisted distribution policy. These aggregate totals (arranged by individual rank and rank bands, i.e., private-specialist, sergeant-staff sergeant, sergeant first class-master sergeant, and sergeant major) are the basis for transition into individual MOS requirements. These top-of-the-system strength managers then determine how many requisitions for replacements should be placed in EDAS, by either directly building the requisitions or coordinating with field commanders.

f. Overseas Requisitions. Requirements for Korea, U.S. Army, Europe (USAREUR), and U.S. Army, Pacific (USARPAC) are analyzed 10 months into the future (eight months for USARPAC). Using the EDTM targets, distribution managers allocate requisitions to each command at the four-character MOS level, allowing commands two weeks to submit requisitions at the nine-character MOS level, including any other special requirements.

g. CONUS Requisitions.

(1) For CONUS installations, requisitioning is partially constrained through a process known as Requisition Allocation Plan-CONUS (RAP-C). Since fill of vacancies in CONUS commands is partially based on eligible overseas returnees, RAP-C keys on DEROS data in the TAPDB-AE and calculates the number of Soldiers in an MOS and grade who are expected to return to CONUS in a requisition month (two months after DEROS month). CONUS requisitions are normally validated 12 months out. Distributors at HRC, using the EDTM, allocate these Soldiers. If the EDTM requires more requisitions than Soldiers returning from overseas, additional requisitions are loaded, which will require CONUS-to-CONUS moves.

(2) The next effort for HQDA distribution managers is validation, whether for CONUS or OCONUS. If an apparent over or under requisitioning exists, the manager attempts to resolve the discrepancy with the command/installation prior to making a decision to validate, or not validate, requisitions. Discrepancies in the two projections may be caused by a proponent-approved authorization change at the unit level not yet recorded in the Personnel Structure and Composition System, or by more current authorizations data available to HRC through the use of the PMAD, or by more current gain and loss data. The problem is resolved prior to the submission of the validated requisitions for assignment processing in the EDAS.

(3) Distribution managers continually monitor command and installation strength projections and adjust accordingly. Deletions, authorization changes, and other variables may create need for top loading or canceling requisitions.

h. EDAS. EDAS consists of several major subsystems: management information, requisition, policy, assignment, and personnel.

(1) EPMD distribution managers use the management information subsystem to determine an organization's authorized, assigned, and projected strength. Managers can obtain this information by MOS, skill, CMF, grade, Special Qualification Identifier (SQI), ASI, language, Distribution Management Level/Sub-Level (DML/DMSL), location (installation, state, and country), command, requisition activity code, Troop Program Sequence Number (TPSN), and/or UIC. This information is used to determine the number of valid requisitions needed to maintain that organization at an acceptable strength level.

(2) After the distribution managers determine the number of valid requisitions, the assignment managers must fill them. The policy and nomination subsystems assist assignment managers by recommending which Soldier should be assigned to each requisition and also provide alternate recommendations.

(3) The policy subsystem allows EPMD managers to enter assignments into EDAS that are in accordance with current policies. For example, Soldiers with Home base/Advanced Assignment Program (HAAP) agreements can only be recommended for assignments which fulfill HAAP agreements.

## MILITARY HUMAN RESOURCE MANAGEMENT

(4) In addition to making assignments, the assignment subsystem provides the capability to delete or defer Soldiers. If field users have the authority to approve a deletion or deferment, they can complete the action interactively through the assignment subsystem as an alternative to submitting it through eMILPO. If field users do not have the authority to approve the action, they can request a deletion or deferment electronically through EDAS. Throughout this entire process, the field user can interactively monitor the current status of the request.

(5) One important aspect of EDAS is that the system tightly controls access and what the user can do in the system. Some modules allow users to query data, while others allow updates. EDAS controls access by individual user and provides system managers with audit trails which can be used to determine who accessed or changed data in the system. Additionally, EDAS controls which records a user can query and/or update.

(6) The EDAS promotion points update module allows field personnel managers to post promotion point data for Soldiers in grades E4 and E5 directly to the TAPDB. This function allows personnel managers to review and update the information that is resident on the TAPDB. This information is then used by HRC to determine the numbers of promotions for each month by MOS. By using the promotion subsystem, field managers can see those Soldiers, by name, who were considered eligible for promotion when the calculations were performed. If the data on the Soldiers is incomplete or in error, field managers use the EDAS promotion point update and promotion update functions to update the data, promote the Soldier, or alert HRC managers as to why Soldiers will not be promoted. EDAS returns the promotion on the Soldier to eMILPO which then updates local databases and the Defense Finance and Accounting Service (DFAS).

(7) EDAS fully supports mobilization scenarios. The policy subsystem can store and maintain any number of scenarios (peace, limited mobilization, full mobilization, etc.) and the user can invoke any one of the scenarios in seconds. The system can also evaluate "what if" questions.

i. The Army Automated RETAIN. RETAIN is a real-time automated system that identifies and reserves training spaces or assignment vacancies for potential re-enlistees and determines MOS availability for Soldiers undergoing reclassification based upon the individual's qualifications and the needs of the Army. It is also used to process enlisted Soldiers for reenlistment or reclassification assignments.

(1) If the Soldier is requesting a MOS training space, RETAIN accesses the REQUEST system to determine if there are any RA in-service quotas available for the school the Soldier desires. If the seat is available, it allows the retention NCO or reclassification authority to make a reservation and puts the record on the RETAIN wait list for an ultimate assignment in the new MOS upon completion of training. The wait list manager is required to give the Soldier an ultimate assignment 120 days prior to the start date of the school. RETAIN is also used to process potential re-enlistees for assignments. RETAIN will determine if there are any vacancies available for the installation/overseas area the Soldier desires. If a vacancy exists, it will be offered to the Soldier. If a vacancy does not exist, the Soldier may elect to be put on the RETAIN wait list.

(2) The RETAIN wait list is for those Soldiers desiring an installation/overseas area which was not available and no other area/location was available at the time of entry into RETAIN. Weekly, the RETAIN system attempts to match Soldiers on the wait list to the place they desire to go.

(3) RETAIN is a valuable tool that commanders, career counselors, and personnel service centers use in counseling Soldiers for reenlistment and reclassification. Since RETAIN is a real-time automated system it can provide current, accurate information to the potential reenlistee or Soldier involved in reclassification.

j. Reclassification. RETAIN also addresses reclassification. Reclassification is a process which provides for migration from one MOS to another. It supports policies and goals to reduce MOS over strength and alleviate shortages. In addition to individual voluntary requests, mandatory reclassifications are necessary when a Soldier loses qualification, for example, loss of security clearance, or disqualifying medical condition. Special reclassification programs, such as Fast Track, realign MOS overages through reenlistment and reclassification. Soldiers possessing the over strength MOS may be allowed to reclassify or reenlist for retraining without regard to Expiration of Term of Service (ETS).

### **12-18. Officer Distribution and Assignment**

The Army continues to adapt and change its officer assets by branch, functional area, and grade equal the sum total found in authorization documents, taking into consideration Professional Military Education (PME) schools and training programs for each branch and functional area.

## HOW THE ARMY RUNS

a. Distribution Planning. The officer distribution (see Fig 12-5) planners and managers at HRC are influenced by three principal factors: officer assets (inventory), authorizations, and priorities. All three are in a constant state of change. Therefore, there is a need for a master distribution plan that will ensure that all commands, agencies, and activities receive, according to priority, an appropriate share of the available officer assets/inventory. The foundation of this master plan is a management tool known as the Dynamic Distribution System (DDS), formerly the Officer Distribution Plan (ODP), and also formerly the Officer Distribution System (ODS). The DDS brings assets/inventory, authorizations, and priorities into balance and is one of the Army's most important systems for officer distribution planning. DDS allows the Army to be more flexible during times of war and transformation, as DDS allows us to shift with the Army's changing priorities.

b. The DDS Process. If available officer assets matched the requirements identified through the PMAD, by branch, functional area, and grade, officers would simply be assigned against authorizations. However, this is rarely the case. As with most resources, there is generally a greater demand than there is a supply, and officer shortages in certain units is a result. Some system of priorities is needed to help manage these shortages. After the available officer inventory has been compared with the authorizations in the PMAD, a computer system, Statistical Analysis Software runs a program model to determine officer needs based on current Army Manning Guidance initiatives and any special distribution guidance as determined by HQDA (Figure 12-5). Under DDS, an available officer fits into one of two categories: non-discretionary or discretionary. An important concept to keep in mind is what defines an available officer. An available officer is defined differently for each type of unit. Generally speaking, a deploying brigade needs a non-dwell restricted, deployable, PME graduate that needs key development time. The opposite is true for the National Training Center which needs a Key Developmental complete officer with recent deployment experience. A non-discretionary move includes those moves that involve hard dates in an officer's career, e.g., a DEROS from an overseas assignment, a report date to a professional school, a graduation date from a school, a command selection, a Personnel Management System selection, a joint tour completion, a sequential assignment report date, or a retirement date. These can generally be determined from data analysis from TOPMIS. A discretionary move includes those moves that are triggered by an assignment officer working to ensure an officer continues appropriate career development e.g., an officer needs a new skill set (Joint or Army Staff), an officer's skills are no longer applicable to the current assignment, or where an officer is pre-positioned for a career enhancing position (Command, Schools, etc.). Moves driven by the individual needs of the officer are also included in this category e.g. Exceptional Family Member Program, joint domicile, and compassionate reassignments and personal preference.

c. Officer Requisition System. The officer requisition system is designed to fill the officer requirements of all commands and activities.

(1) TOPMIS. This is a fully integrated management information system that supports the officer management process within HRC and at worldwide requisitioning activities. TOPMIS is composed of seven operational modules:

(a) The control module provides security of access and updating, creates individual user profiles, and provides on-line electronic mail service to all TOPMIS users.

(b) The strength module displays operating and projected strength down to the CMF level for requisitioning activities in various report formats.

(c) The goaling and monitoring module displays assignment goals for the FY by grade and CMF. It is also used to plan the DDS and monitor its progress.

(d) The requisition module allows distribution managers and the requisition activity managers to generate, edit, validate (based on the DDS), and update requisitions. This module generates and maintains requisitions based on projected strength. The final product is a list of requisitions for career managers to fill.

(e) The asset/Officer Record Brief (ORB) module provides an online version of the ORB and the capability for on-line updating of ORB fields by career managers. This module also provides access to by-name reports of officers assigned and/or on orders.

(f) The assignment module provides access to personnel, requisition, and organization data; provides online extract/update capability from the TAPDB-AO via TOPMIS; and processes assignments generated by HRC managers in the Officer Personnel Management Directorate (OPMD). Assignment instructions are transmitted electronically on a daily basis to the gaining and losing requisition activity.

## Officer Distribution

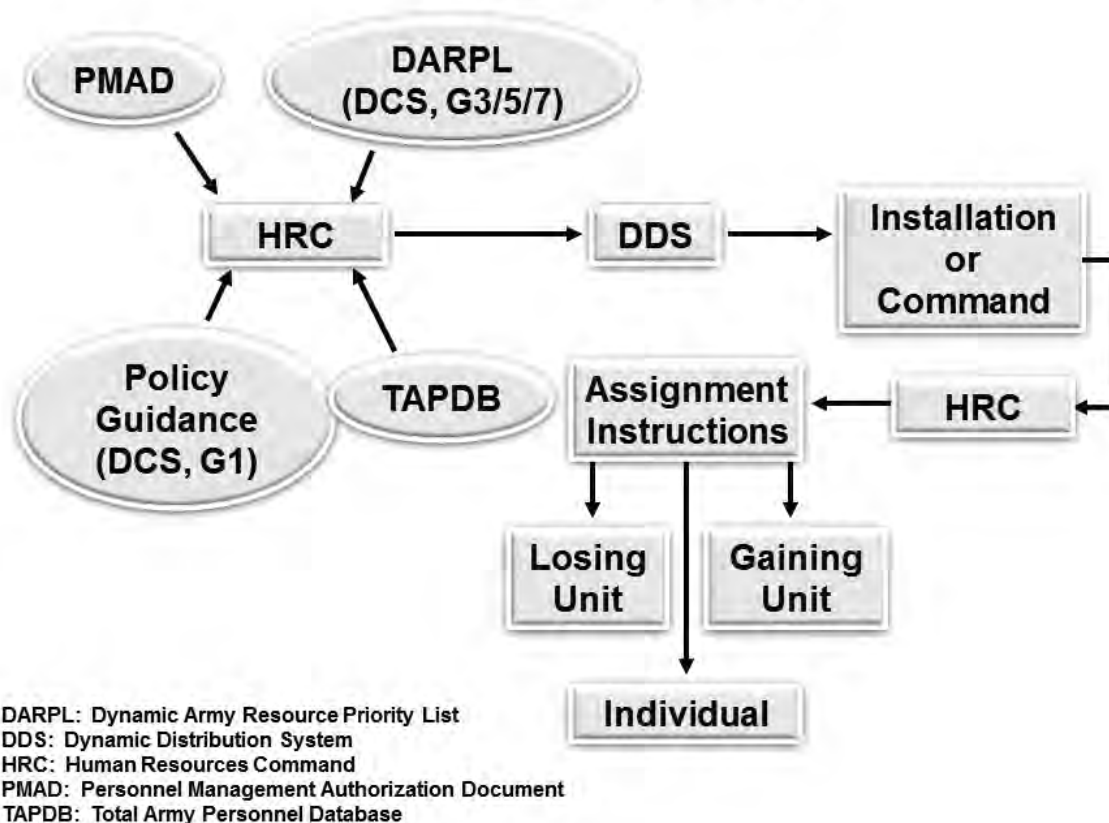

Figure 12-5. Officer Distribution

(g) The user assistance module allows users to review data name definitions and tables of valid codes used in officer management.

(h) TOPMIS interacts with the TAPDB-AO and is used by assignment and distribution managers of the basic branches, medical department branches, the Chief of Chaplains, and JAG offices. Worldwide requisition/officer management activities can access TOPMIS through the Defense Data Network (DDN) or a variety of host-to-host systems.

(2) Requisition Cycles. Officer requisitions are generated on an alternating bimonthly basis for either overseas or CONUS. As a general goal, requisitions are validated so that officers will arrive 12 months after validation, which also allows a 12-month notification to the officer concerned. As a normal rule, overseas returnees, school requirements and units preparing to deploy drive the assignment system because these officers must move on time and deploying units must have necessary officer assets. Overseas returnees and various school requirements are largely due to tour length policies and graduation dates respectively. Others are assigned to replace these personnel and the cycle continues.

(3) Assignment Challenge. Assignment officers within the divisions and branches of OPMD must take into consideration a wide variety of competing factors in the process of identifying the right officers to fill valid requisitions. Some, but by no means all, of these factors are listed below. They are in no particular order, because each assignment action is unique—

- (a) Army requirements.
- (b) Gaining and losing organizations' requirements.
- (c) Tour equity (CONUS vs OCONUS).
- (d) Time-on-station and Dwell time.

## HOW THE ARMY RUNS

- (e) Professional development.
- (f) Officer preference.
- (g) Joint domicile.
- (h) Compassionate situations.
- (i) CTC experience.
- (j) Joint duty.

### Section VI

#### The Development Function

##### 12-19. Enlisted Development

There must be a way of developing leadership, evaluating, and rewarding those who do well, and eliminating those who do not measure up. This section will address some of the programs designed to accomplish these tasks and to create an environment which will motivate men and women to become career Soldiers.

##### 12-20. Enlisted Personnel Management System (EPMS)

a. The EPMS provides a logical career path from private to sergeant major, career-long training, and performance-oriented evaluation. Additionally, it is designed to eliminate promotion bottlenecks, provide all Soldiers with promotion opportunities, make assignments more flexible, and provide greater challenge by making MOSs more multi-functional.

b. A key feature of EPMS is to associate five standardized skill levels for the enlisted ranks, with privates and specialists having skill level 1 and master sergeants and sergeants major having skill level 5. EPMS skill levels were selected so that the vital middle-grade NCOs would be distinct and visible for management purposes.

c. Another major feature of EPMS is the Noncommissioned Officer Professional Development System (NCOPDS). EPMS and NCOPDS are part of the same continuum.

##### 12-21. Enlisted Evaluation System (EES)

At the heart of EPMS is the EES. It is used to assist in the identification of Soldiers for assignment, promotion, reenlistment, reclassification, special training, elimination, and other personnel management actions. The EES consists of Academic Evaluation Reports (AER) and a NCO Evaluation Report (NCOER) for sergeant and above. Both reports serve as the official evaluation of duty performance and academic success and provide a record of each individual NCO's potential.

##### 12-22. The NCO Leader Self-Development Career Model

a. The NCO Leader Self-Development Career Model provides enlisted Soldiers a guide in the selection of self-development activities recommended by CMF proponents. Career models have been developed by subject matter experts for each CMF and are published in DA PAM 600-25.

b. The career models correspond to the Army's leader development process relating self-development activities to institutional training and operational assignments. The models can help Soldiers establish planned, progressive, and sequential self-development programs, which enhance and sustain military competencies as well as required Skills, Knowledge, and Attributes (SKA). The career models also contain CMF-proponent recommended goals, e.g., licensure, certification, or academic degree, and allow Soldiers to combine experience and training with self-development activities for career progression as well as goal achievement.

c. Activities and goals are recommendations, not requirements, and do not preclude mission assignments and training. Completion does not guarantee advancement. The career models are tools for use by supervisors and professional education counselors to help guide Soldiers in their professional and personal growth. They also may be used to help Soldiers prepare for NCOPDS and NCO functional resident courses.

d. The elements in the leader development process—education, training, experience, assessment, feedback, and reinforcement—create a dynamic synergy to prepare Soldiers for increasing responsibilities. Self-development is the only aspect of that process over which the Soldier has direct control. The career model can stimulate involvement in this vital imperative, which should be the goal of every career Soldier.



## MILITARY HUMAN RESOURCE MANAGEMENT

To foster this desire requires close cooperation between commanders, supervisors, education counselors, and the Soldier.

### **12-23. Enlisted Promotions**

a. The objectives of the enlisted promotion system are to ensure advancement of the best qualified Soldiers, to provide career incentive, to promote Soldiers based on potential rather than as a reward for past service, and to identify and preclude promotion of Soldiers who are nonproductive and ineffective. Three programs make up the promotion system: the decentralized program which controls advancements from private through specialist; the semi-centralized program which controls promotions to SGT and Staff Sergeant (SSG); and the centralized program which controls promotions to Sergeant First Class (SFC) through Sergeant Major (SGM)/Command Sergeant Major (CSM).

b. Under the decentralized program, authority to appoint and promote Soldiers is delegated to local commanders, but there must be compliance with standard policies and procedures established by HQDA. Promotion boards are not required.

c. Authority to promote Soldiers under the semi-centralized program is delegated to field commanders who are serving in an authorized lieutenant colonel or above command position in accordance with guidance from HQDA. In this case, eligible Soldiers compete Army-wide on the basis of relative standings by points attained on a standardized point system. Soldiers recommended for promotion are required to appear in person for evaluation by a selection board. Names of Soldiers recommended for promotion by the board are placed on a locally maintained recommended list and grouped by MOS in an order of merit based on the total points attained under the point system. HQDA controls the number of Soldiers who can be promoted in each MOS by establishing cut-off scores according to the needs of the Army. Soldiers whose scores equal or exceed the announced cut-off scores are promoted without regard to assignment. Those not immediately promoted remain on the recommended list until promoted, unless they are removed for administrative reasons or for cause. Soldiers on a recommended list may request reevaluation to improve their standing.

d. Promotions to sergeant first class through sergeant major are centralized and a board, convened by HQDA, makes selections. Selections are based on the whole person concept. No one single factor should be considered disqualifying but rather an individual's entire record is given careful consideration. Selections are made on a best-qualified basis in conjunction with Army needs.

e. Army Directive 2019-15 (Enlisted Centralized Selection Boards) revises Army Policy for enlisted Soldiers in the RA and USAR Active Guard Reserve Program as it pertains to the conduct of enlisted centralized selection boards. (See Army Directive 2019-15)

### **12-24. Command Sergeants Major Program**

This program ensures the selection and assignment of the best-qualified sergeants major, first sergeants, and master sergeants for command sergeant major positions. These positions are the principal enlisted assistants to commanders of organizations with enlisted troop strength equivalent to a battalion or higher level and commanded by a lieutenant colonel or above. Boards convened by HQDA make selections. A list of those selected is published and maintained within HRC for use in appointing personnel to fill vacancies. Command sergeants major are assigned only to positions that have been designated by the DCS, G-1.

### **12-25. Total Army Retention Program**

This program consists of the RA Retention and RC Transition Programs and is responsible for assisting in manning the force with quality Soldiers by achieving and maintaining a balanced career content in the regular Army enlisted force. The retention program also focuses on improving quality through the retention of trained, qualified, and experienced enlisted Soldiers in the correct MOS and grade. Those not retained in the RA, being otherwise qualified, are recruited to serve in USAR or ARNG units. RA retention and RC transition program objectives are assigned to commands by DCS, G-1 while HRC provides overall program and personnel management of the programs. Personnel and fiscal support of the RC Transition Program is provided by the ARNG and USAR.

### **12-26. Qualitative Management Program**

a. This program was developed as a means of enhancing the quality of the career enlisted force, selectively retaining the best qualified Soldiers and denying continued service to nonproductive Soldiers.

## HOW THE ARMY RUNS

b. NCOs whose performance, conduct, and/or potential for advancement do not meet Army standards, as determined by the approved recommendations of HQDA centralized selections boards responsible for QMP screening, will be denied continued service. NCOs who are not promoted to the next grade because of their failure to complete the next appropriate level of the NCO Professional Development System (NCOPDS) training for the next higher grade are subject to the denial of continued service through the QMP. The QMP is not intended as a substitute, and does not relieve commanders of the responsibility for initiation of separation proceedings under other provisions of AR 635-200 when required or appropriate. Regularly scheduled, centralized promotion/selection boards for staff sergeant through command sergeant major select individuals for promotion or retention in grade, as well as those Soldiers to be barred. These boards consider the Soldier's entire record using the whole person concept, not just his or her current job or term of service. Soldiers separated with a DA bar receive a reenlistment eligibility code of 3 (individual is not qualified for continued Army service, but the disqualification is waivable. Ineligible for enlistment unless a waiver is granted.). Effective 1 October 2016 the bar to reenlistment was re-designated as the bar to continued service. A bar to continued service places a Soldier on notice that his or her continued service may not be in the Army's best interest. Applicable to all enlisted ranks regardless of the established RCP/maximum for each rank, a bar to continued service limits continued service to Soldiers of high moral character and personal competence. Accordingly, Soldiers who currently serve under the NCO Career Status Program, including Soldiers transitioning from the RA to a reserve component, may be barred from continued service. Reenlistment is deemed a privilege and not a right. It is the responsibility of commanders, at all levels, to ensure that only those Soldiers of high moral character, personal competence, and demonstrated performance are allowed to reenlist in the Army. Reenlistment should be denied Soldiers who, by their performance, conduct, and potential indicate further service will be non-progressive and unproductive.

c. Under the Army Mobilization Operation Plan, Annex E, Personnel, the QMP program can be suspended for the period the Army is under partial mobilization.

### 12-27. WO Development

a. The implementation of TWOS in 1986, the WO Management Act (WOMA) of 1991, the WO Leader Development Action Plan (WOLDAP) in 1992, the WO Education System (WOES) in 1993, and the Army Training and Leader Development Panel (ATLDP) decisions in 2002, have had a major impact on the management and professional development of WOs. The Army's current goal is to recruit WOs earlier in their careers, train them better, and retain them longer. About half of all WOs retire after 23 years of combined (enlisted and WO) active federal service. Under WOMA, decisions on promotions, training, and assignments are based on years of WO Service (WOS). A careerist will have an opportunity to serve up to 30 years of WOS unless twice non-selected for promotion to the next higher grade.

b. Every RA WO position in authorization documents is classified by rank based on the skills, knowledge, abilities, and experience needed in that position. Formerly there was no rank differentiation in WO positions.

### 12-28. WOMA

a. WOMA provided a comprehensive and uniform personnel management system, similar to Defense Officer Personnel Management Act (DOPMA), for WO appointments, promotions, separations, and retirements. The key provisions of WOMA include the following.

(1) Authorized the grade of CW5, to include pay and allowances. Maximum number of CW5s on active duty is limited to 5% of the total number of WOs on active duty.

(2) Eliminated the dual promotion system and established a DOPMA-style promotion system for WOs.

(3) Established minimum Time in Grade (TIG) requirement for consideration for promotion.

(4) Established authority to convene Selective Retirement Boards (SRB) to consider retirement eligible WOs for involuntary retirement.

(5) Established the management of WOs by years of WOS rather than by Active Federal Service (AFS). A WO may serve for 30 years of WOS. Retirement eligibility at 20 years AFS remains unchanged.

(6) Established selective continuation for WOs twice non-selected for promotion (very limited use and normally in shortage skills).

# MILITARY HUMAN RESOURCE MANAGEMENT

(7) Modified the involuntary separation date from 60 days to the first day of the seventh month after board results are approved. This provision applies to WOs twice non-selected for promotion and those selected for involuntary retirement.

b. WOMA modernized WO life cycle management, offers all WOs the potential for a full career, provides tools to shape the force, and enhances readiness by providing the Army with a highly qualified and experienced WO cohort.

## 12-29. WO Education System

WO education is integrated within the Officer Education System (OES). WO specific courses are depicted in Figure 12-6. Chapter 14 provides additional information on these courses and other WO training and education.

## Warrant Officer Training and Education

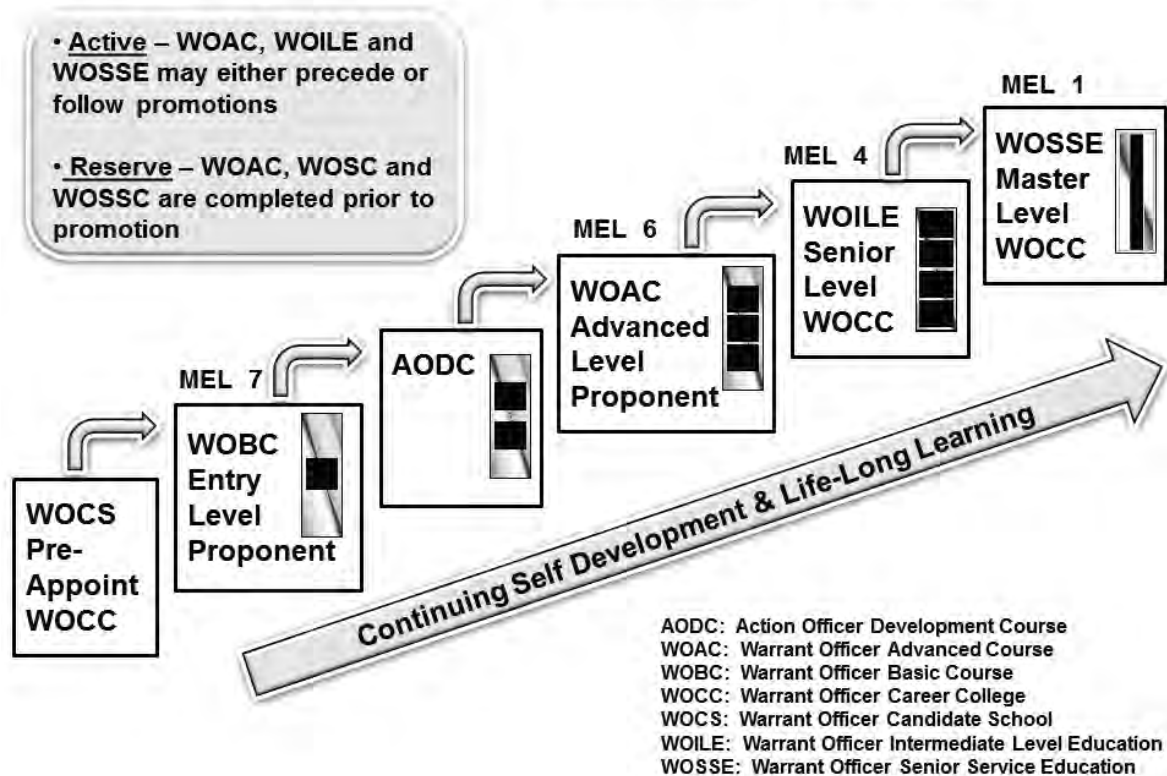

b. Figure 12-6. Warrant Officer Training and Education

a. The WOBBC is the first course encountered by all newly appointed WO1s. WOBBC certifies the new WO1 within his branch and specialty.

b. The WO Advanced Course (WOAC) is a combination of common core and MOS proponent training that prepares WOs to serve in CW3 level positions. WOAC is provided in a non-resident common core phase and a resident phase, which includes a common core module and a MOS-specific module.

Completion of the Action Officer Development Course (AODC) is a prerequisite for WOAC attendance

c. The WO Intermediate Level Education (WOILE) provides senior CW3s and new CW4s with the intermediate-level education and influential leadership skills necessary to apply their technical expertise in support of leaders on tactical and operational level Joint, Interagency, Intergovernmental, and Multinational (JIIM) staffs during unified land operations.

d. The WO Senior Service Education (WOSSE) is the capstone for WO PME conducted at the Warrant Officer Career Center (WOCC), Fort Rucker, Alabama. WOSSC provides senior CW4s and new CW5s

## HOW THE ARMY RUNS

with the senior level education, knowledge, and influential leadership skills necessary to apply their technical expertise in support of leaders on strategic level JIIM staffs during unified land operations.

e. The WOCC serves as the Training and Doctrine Command (TRADOC) executive agent for WO common core education. The WOCC evaluates common core instruction within the proponent specific program of instruction for WOBC and WOAC.

### 12-30. WO Promotions

WOs are promoted under a single permanent promotion system similar to the commissioned officer system.

a. Promotions to CW3, CW4, and CW5 for WOs on the Active Duty List (ADL) are administered at HQDA. Promotion authority to CW2 is delegated to commanders in the rank of lieutenant colonel and above. WOs may be promoted to CW2 after completion of 24 months in the grade of WO1 under current policy. WOMA allows CW2 promotion consideration after 18 months in grade. Time in grade for promotions to CW3, CW4, and CW5 are depicted in Figure 12-7 and Table 12-1, but vary with Army requirements.

b. WOs twice non-selected for promotion to the next higher grade will be discharged or retired, if eligible, unless selectively continued on active duty to meet a valid Army requirement.

**Table 12-1. Warrant Officer Promotion Goals**

| To grade | Promotion opportunity | Years AWOS |
|----------|-----------------------|------------|
| W2       | Fully qualified       | 2          |
| W3       | 80%                   | 7-8        |
| W4       | 74%                   | 12-14      |
| W51      | 44%                   | 17-20      |

Note: 1. By law the number of CW5s is limited to 5% of the WO force.

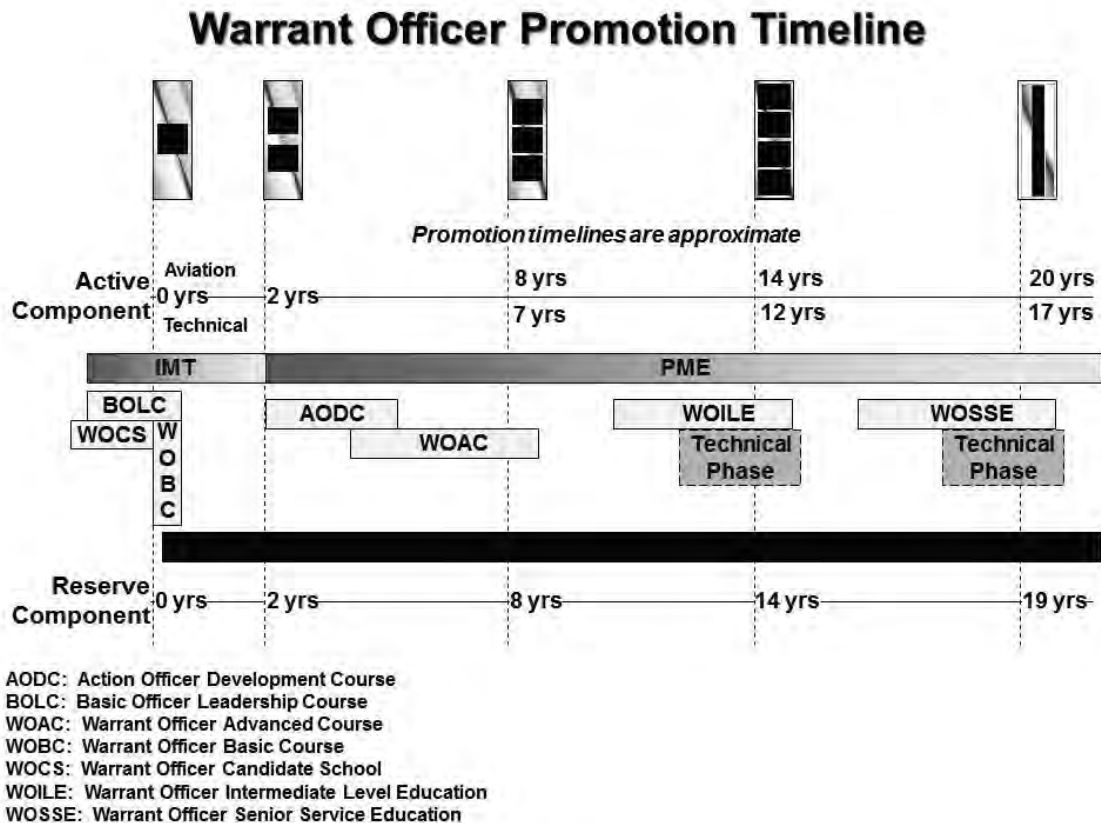

**Figure 12-7. Warrant Officer Promotion Timeline**

## MILITARY HUMAN RESOURCE MANAGEMENT

### 12-31. WO Retention Programs

a. RA integration and commissioning is concurrent with promotion to CW2. Officers who decline regular Army integration will not be promoted and shall be separated 90 days after the declination date or upon completion of any active duty service obligation, whichever is later.

b. Separate regular Army integration boards were discontinued during the Army drawdown. Future boards are planned to only consider exceptions; for example, a USAR CW3 who requests and is called to active duty to fill a valid requirement.

c. WOs are released from active duty after being twice non-selected for promotion to the next higher grade unless they are selectively continued.

### 12-32. Officer Development

The OPMS provides a framework for developing the required number of officers with the necessary skills and for managing the careers of all commissioned officers, except those assigned to the special branches (Army Medical Department (AMEDD), JAG, and Chaplain Corps). This framework consists of all OPMS functional categories, with each one being a grouping of duty positions whose skill, knowledge, and job requirements are mutually supportive in the development of officers to successfully perform in the functional category. Each functional category contains sufficient duty positions to support progression to the grade of colonel. Military and civilian educational opportunities are also geared to the officer's functional category. Army requirements and an individual's qualifications and preference are the major considerations in determining the designation of functional categories. OPMS consists of three major and interrelated subsystems: strength management, professional development, and evaluation.

### 12-33. Officer Professional Management System

In May 1997, the CSA approved implementation of several changes in OPMS as a result of the recommendations of the OPMS XXI Task Force. During 2002, the DCS, G-1 changed the name to OPMS III (vice OPMS XXI) to reflect the system as progressive and evolving to support emerging needs for the 21st century. In 2006, the DCS, G1 eliminated the numerical designation in recognition that OPMS was designed to be a continual evolution.

a. Historical Perspective.

(1) OPMS exists to balance the needs of the Army with the aspirations and developmental requirements of the officer corps. OPMS was instituted in 1972 as a result of the U.S. Army War College Study on Military Professionalism and a follow-on analysis directed by the DCS, G-1. After passage of the DOPMA by Congress in 1981, the CSA ordered a major review to examine the impact of the legislation on OPMS policies. As a result, OPMS II was developed in 1984 to accommodate the changes brought about by DOPMA, including the creation of functional areas, dual tracking and regular Army integration. In 1987, the CSA directed a review of officer leader development to account for the changes in law, policy, and procedures that had occurred since the creation of OPMS II. As a result of the study, the leader development action plan was approved for implementation in 1989.

(2) During the last decade plus, the Army has undergone significant changes with widespread effect on the officer personnel system, brought about by the drawdown at the end of the Cold War and by major legislative initiatives. The DOD Reorganization Act of 1986 (Goldwater-Nichols) required the Services to improve interoperability and provided the statutory requirements for joint duty assignments, joint tour credit and joint military education. In 1986, Congress also passed Public Law 99-145, which specified the acquisition experiences and education necessary for an officer to be the project manager of a major weapons system. This law later led to the creation in 1990 of the Army Acquisition Corps (AAC). The Defense Acquisition Workforce Improvement Act (DAWIA) of 1990 placed additional requirements on Acquisition Corps officers and directed them to single track in their functional area. Congressional Title VII (1992) and XI (1993) legislation placed additional officer requirements on the RA in their support of the RC. The Reserve Officer Personnel Management Act (ROPMA) of 1996 brought the RC officer promotion systems in synchronization with the RA. This legislation established a best-qualified promotion system for RC officers, thereby replacing the fully qualified system previously used.

b. Initiation of OPMS III.

(1) In 1994, a team of senior field grade officers was assembled to examine a series of OPMS-specific issues and to determine whether a general review of the OPMS was warranted. This OPMS XXI Precursor Study Group ultimately reviewed more than 60 individual issues. Based on the collective body of these issues, the OPMS XXI Task Force convened in July 1996 to review and revise the personnel management system as necessary to ensure its viability for meeting future challenges. The Task Force

## HOW THE ARMY RUNS

focused on the development and career management of officers of the Army Competitive Category (ACC). The special branches (Chaplain, JAG, and the branches of the AMEDD) were not specifically addressed although some OPMS XXI issues and solutions dealing with education, officer evaluation, and general promotion policies will apply to them as well.

(2) The Task Force linked its work with other ongoing Army planning efforts: Force XXI for the near-term, Army XXI initiatives for the mid-term, and Army after next projections for the long-term planning environment. In designing the personnel system for the future, the CSA directed the task force to also create a conceptual framework that integrated OPMS with the leader development system, ongoing character development initiatives and the then new officer evaluation report.

(3) The task force concluded that, in order for OPMS III to work effectively, three sets of strategic recommendations for change must be jointly addressed.

(a) The first recommendation called for the creation of an Officer Development System (ODS) as part of an overall Army development system. ODS will encompass and integrate officer leader development, character development, evaluation, and personnel management.

(b) The second recommendation recognized the need to adopt a holistic, Strategic Human Resource Management (SHRM) approach to officer development and personnel management for the 21st Century.

(c) The final strategic recommendation by the task force called for the creation of an officer career field-based management system composed of four career fields: Operations, Operational Support, Institutional Support, and Information Operations. Under OPMS III, officers are designated into a single career field after selection for major and serve and compete for promotion in their designated career field from that point on.

(d) The results of these strategic recommendations, approved by the CSA in December 1997, formed the basis for the changes to OPMS until 2005.

(e) In 2005, the CSA directed that OPMS be reviewed to determine if the system met the developmental needs of the officer corps for the future. After study by a new OPMS task force, and a vetting process for recommendations with subject matter experts, a Council of Colonels representing all stakeholders, and General Officer Steering Committees, many changes have been approved or are under consideration at this writing. Driving many of the changes is the Army leadership's view that the future officer corps needs to be more multi-skilled and afforded assignment and educational opportunities that foster this end. Among the changes approved was changing the four career fields to three functional categories as depicted in Figure 12-8. The new design is considered more conducive to bringing balance to the officer corps—breadth and depth, was less prescriptive, and provided multiple career paths. There have been some changes to this initial construct as functional areas were eliminated or consolidated (e.g. Comptroller, HR) and other created (e.g., Logistics Corps).

(f) In 2017, a fourth functional category was added, Information Dominance. This category includes the new Cyber branch as well as Information Operations and Electronic Warfare.

### 12-34. Fundamentals of Officer Management

The Army needs, and will continue to need, the finest officers imbued with the warfighting ethos and with the right skills, knowledge and experience to effectively meet any challenges. Further, the Army continues to be a values-based organization, steeped in core principles and beliefs that set the muddy boots Soldier apart as a unique professional. In order to grow an Officer Corps with the right SKA to respond to evolving future challenges—to remain ready not only today but also tomorrow—OPMS changed many aspects of how officers are managed, developed, and promoted.

a. Functional Category Based Management. Officers are developed in only one branch, and the branch remains primary for approximately the first 6-8 years of an officer's career (an exception exists for those officers being branch detailed as a new lieutenant and a small number of officers in selected functional areas). Functional category designation begins after the fourth year of service. Officer preference is a key factor in terms of board selection criteria in the functional category designation process, but Army requirements are always paramount.

b. Functional Areas. Functional areas are not directly related to any specific branch. Incorporating what are referred to as non-accession specialties, functional areas provide a management and development system to effectively use the vast talents of a diverse officer corps and meet Army requirements.

## Functionally Aligned OPMS Design

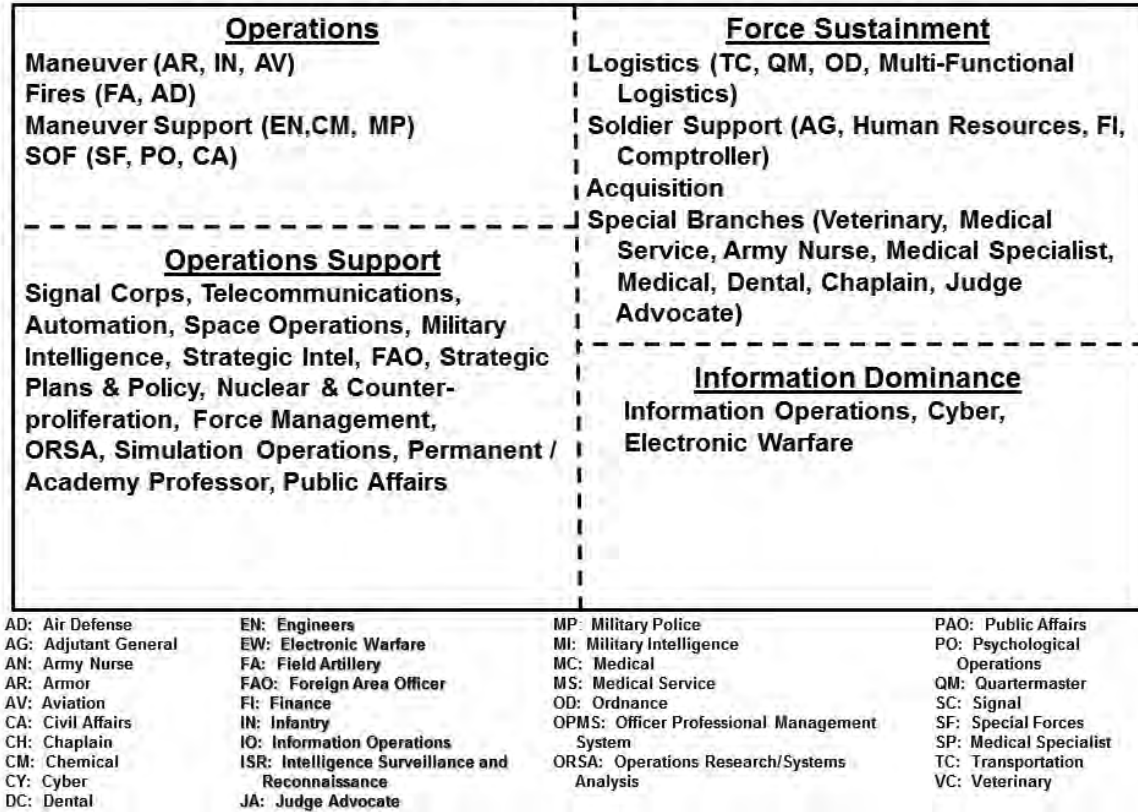

Figure 12-8. Functionally Aligned Officer Personnel Management System Design

### 12-35. Functional Categories

Officers compete for promotion only with other officers in the same functional category. Each functional category, or branch or functional area within a functional category, has its own unique characteristics and development track for officers that reflects the readiness requirements of the Army today and into the 21st century. DA PAM 600-3 outlines all aspects of OPMS, officer training, education and development. Officers from every branch and functional area will also fill officer generalist and combat arms generalist (O1A/O2A) positions across the Army. Functional categories are depicted in Figure 12-8.

### 12-36. Functional Category Assignment

The functional designation process determines in which specialty officers will continue their development; either in their accession branch or in a different FA. Management of officer development in functional categories recognizes the need to balance specialization of the officer corps with the inherent requirement for officers to gain more breadth in an increasingly complex environment. Officers have periodic opportunities after the 4th year of officer service to transfer to a different branch or FA. The process is known as the Voluntary Transfer Incentive Program (VTIP) and is managed by HRC to balance inventories with Army requirements and to leverage individual officer preferences and demonstrated abilities. VTIP panels are conducted two to three times a year and are announced via military personnel (MILPER) message describing procedures and specialties to be considered for cross leveling. VTIP allows HRC to identify and target officers with critical skills early in their development, allowing them to get additional training and experience to bring those skills to bear as quickly as possible. The VTIP balances the force across the four functional categories. The intent of the VTIP panel is to fill requirements and provide the FAs enough time to send their officers to school and training prior to utilization. The VTIP process ensures that the needs of the Army are met for future field grade officer requirements in each functional category. Each functional category has its own unique characteristics and development model for officers, which reflects the readiness requirements of the Army today and into the

## HOW THE ARMY RUNS

21st century. Officers in all functional categories are assigned across the Army in TOE and TDA organizations.

### 12-37. Centralized Selection for Command and Key Billet Positions

The Centralized Selection List (CSL) emphasizes the preference-based approach to an officer's career pattern. The CSL includes four functional categories of commands and key billets as depicted in Figure 12-9. The CSL commands include all Lieutenant Colonel (LTC) and Colonel (COL) command positions approved by the Army. The list of centrally selected command positions changes regularly. In FY 2004 key division staff positions (G1, G2, and G6) were added to the list of centrally selected positions. Prior to convening each command selection board, officers being considered will be given the opportunity to indicate the functional category (or categories) in which they desire to compete for selection. The board selects officers for command within the given categories and HRC conducts the slating process and recommends the specific unit or organization for the officer to command. The CSA has the final decision on the command slate.



Figure 12-9. Centralized Selection List Categories

### 12-38. Officer Evaluation System

a. The Officer Evaluation System is the Army's method of identifying those officers most qualified for advancement and assignment to positions of increased responsibility. The system includes assessments of officer performance and potential accomplished in the organizational duty environment; in an academic environment, both military and civilian; and at joint and departmental levels.

b. The potential assessment of an officer is a subjective judgment as to the officer's capability to perform at a specified level of responsibility, authority, or sensitivity. Although potential is normally associated with the capability to perform at a higher grade, judgments are also made by DA on retention and increased responsibility within a specified grade. The assessment is based on three major factors: the Army's officer requirements, the individual officer's qualifications, and a summation of the individual officer's performance.

c. The performance assessment by DA differs significantly from that accomplished in the organizational duty environment. Whereas the organizational duty assessment involves a personal knowledge of the



# MILITARY HUMAN RESOURCE MANAGEMENT

situations surrounding a specific period of time, DA assessment is accomplished by an after-the-fact assessment of a series of reports on performance over a variety of duty positions and covering the officer's entire career.

## 12-39. Officer Evaluation Report (OER) System

a. The OER System is a subsystem of the Officer Evaluation System. It includes the methods and procedures for organizational evaluation and assessment of an officer's performance and an estimation of potential for future service based on the manner of that performance. The official documentation of these assessments is the OER and the AER.

b. The primary function of the OER System is to provide information from the organizational chain to be used by DA for officer personnel decisions. The information contained in the OER is correlated with the Army's needs and individual officer qualifications providing the basis for personnel actions such as promotion, elimination, retention in grade, retention on active duty, reduction in force, command designation, school selection, assignment, and functional category designation.

c. A secondary function of the OER System is to encourage the professional development of the officer corps. To enhance this, emphasis is placed on the responsibility of senior officers to counsel their subordinates. While this has always been a major aspect of leadership, continual reemphasis is necessary. The OER System contributes significantly by providing a natural impetus to continual two-way communication between senior and subordinate. It is through this communication that the rated officer is made aware of the specific nature of his or her duties and is provided an opportunity to participate in the process. The rater uses the communication to give direction to and develop his or her subordinates, to obtain information as to the status and progress of his or her organization, and to plan systematically for the accomplishment of the mission. The senior/ subordinate communication process also facilitates the dissemination of career development information, advice, and guidance to the rated officer. This enables the rated officer to take advantage of the superior's experience when making functional category or assignment-related decisions.

## 12-40. Officer Promotions

As of 15 September 1981, the DOPMA amended Title 10 for officer promotions. DOPMA, as implemented, is applicable to all officers on the ADL. It does not apply to WOs. The act provides for a single promotion system for all officers (regular Army and Other than Regular Army (OTRA)), thus eliminating the previous dual (Army of the United States (AUS)/RA or AUS/USAR) system of promotions. The intent is for promotions to be made within fairly uniform promotion timing and opportunity goals, as vacancies occur. Eligibility for consideration for promotions is based on minimum TIG and Time in Service (TIS) with the below-the-zone selection rate established at a maximum of 10% (or 15% when so authorized by the Secretary of Defense (SECDEF)) of the list for any grade above captain. Goals for promotion opportunity and phase point (i.e., TIS when most officers are promoted) are listed in Table 12-2, as found in DOD Instruction (DODI) 1320.13 dated 30 October 2014 (Actual promotion percentages and TIG/TIS may vary considerably).

**Table 12-2. Career Progression Pattern**

| To grade           | Promotion opportunity | DOPMA phase point         |
|--------------------|-----------------------|---------------------------|
| First Lieutenant   | Fully Qualified       | 18 MOS TIS/TIG min        |
| Captain            | 90%                   | Not less than 2 years TIG |
| Major              | 80%                   | 10 +/-1 year              |
| Lieutenant Colonel | 70%                   | 16 +/-1 year              |
| Colonel            | 50%                   | 22 +/-1 year              |

Note: Opportunity and TIS are set by policy. TIG for promotion to 1LT and CPT is set by law.

## 12-41. Officer Quality Management

a. The goal of the officer management program is to ensure that only those individuals demonstrating satisfactory performance and possessing acceptable moral and professional traits be allowed to serve on active duty, retain their commissions, and remain on DA promotion lists.

b. Commanders and DA agencies are continually striving to maintain the quality of the officer corps by identifying and processing for involuntary separation those officers whose performance or professional or moral traits are deficient. To this end, the records of officers are screened continually to identify those

## HOW THE ARMY RUNS

whose degree of efficiency and manner of performance and/or misconduct, moral, or professional dereliction require separation.

c. Whenever an officer is identified to show cause, the officer is afforded the opportunity to resign in lieu of undergoing the entire process. Similarly, DA agencies are tasked to review promotion lists and CSLs to ensure that no officer is promoted or allowed to command who has become mentally, physically, morally, or professionally disqualified after being selected. The records of officers whose fitness for promotion or command has become suspect are referred to a DA Promotion/Command Review Board, which will recommend to the SECARMY whether the officer should be retained on or removed from the promotion/CSL.

d. The promotion system also serves as a qualitative management tool through the mandatory separation from active duty of officers who fail to be selected for promotion to certain grade levels. However, an officer non-selected for promotion may be selectively continued in his current rank upon recommendation by the DA promotion board that non-selected him for promotion.

e. No person has an inherent right to continue service as an officer. The privilege of service is his or hers only as long as he or she performs in a satisfactory manner. Responsibility for leadership and example requires officers accomplish their duties effectively and conduct themselves in an exemplary manner at all times.

### 12-42. Officer Strength Management

When manpower reductions are necessary, the Army has several programs that may be applied to reduce the number of officers on active duty. When possible, reductions are accomplished through normal attrition and voluntary release programs coupled with reduced officer accessions. In the past, Congress directed the Services to include senior as well as junior officers when implementing officer strength cuts, Selective Early Retirement Boards (SERB) and Reductions-in-Force (RIF) may be implemented when required. RIFs target all officers by year while SERBs select a fixed number of retirement-eligible officers for involuntary early retirement. RIFs and SERBs are quantitative measures that are qualitatively administered.

### 12-43. Defense Officer Personnel Management Act (DOPMA)

DOPMA evolved from the continued inability of the Officer Personnel Act (OPA) of 1947, as changed by the Officer Grade Limitation Act (OGLA) of 1954, to meet the changing requirements for a modern and equitable officer management system for the active forces. The intent of DOPMA was to provide all Services with an equitable, effective, and efficient system to manage their officer corps below the brigadier general level.

a. The management objective is to provide consistent career and promotion opportunities across all Services in order to attract and retain high-caliber officers, and promote them at a point in service conducive to effective performance. The integration into a single promotion and grade authorization system of the dual-track Regular Army/Reserve system mandated by OGLA and OPA provided a more favorable environment in which to achieve this goal.

b. The provisions for selective continuation of captains and majors, combined with the capability to instruct promotion boards on skill needs, provides a mechanism through which specialty needs can be filled, while enhancing an officer's opportunity to stay on active duty until retirement. Under DOPMA, a first lieutenant who twice fails to be selected for promotion to captain is involuntarily released from active duty. By law, captains and majors may be selectively continued to remain on active duty until 20 and 24 years respectively. DOPMA establishes uniform, general constructive provisions for all Services, thus recognizing that special skills acquired are essential for effective performance in special branches. This provision impacted AMEDD, Chaplain, and the JAG accessed after the effective date of the act.

### 12-44. DOD Reorganization Act of 1986 (Goldwater-Nichols)

The congressional goal of this act was to improve the performance of officers in joint duty positions by establishing management procedures for their selection, education, assignment, and promotion. Key provisions of the law are listed below.

a. Assignments. The qualifications of officers assigned to joint duty assignments will be such that they are expected to meet certain specified promotion rates comparable to their Service headquarters and the overall board selection rate. Officers assigned to joint duty assignments will be assigned in anticipation that they will serve the prescribed tour length for their grade: two years for general officers and three

## MILITARY HUMAN RESOURCE MANAGEMENT

years for others. Assignments for officers possessing critical occupational specialties, which for the Army are defined as the combat arms branches, may be curtailed to a minimum of 24 months under certain conditions. All graduates of professional joint education (e.g., National War College and The Dwight D. Eisenhower School for National Security and Resource Strategy formally known as Industrial College of the Armed Forces who are designated as Joint Specialty Officers (JSO), and a high proportion (greater than 50%) of those graduates not designated as JSO, will be assigned to a joint duty assignment immediately following graduation.

b. Promotions. Selection boards considering officers serving in, or who have served in, joint duty assignments will include at least one officer designated by the Chairman of the Joint Chiefs of Staff (CJCS) who is currently serving in a joint duty assignment. The letter of instruction for selection boards includes the following guidance: "You will give appropriate consideration to the performance in joint duty assignments of officers who are serving in, or who have served in such assignments." Prior to approval by the Secretary of the Military Department, the results of selection boards considering officers who are serving in, or who have served in, joint duty assignments will be forwarded by the Secretary to the CJCS. The CJCS will review the results to determine whether appropriate consideration was given to performance in joint duty assignments.

c. Reports. Each Secretary of a Military Department must provide periodic progress reports on their promotion rates in relation to the promotion objectives specified above.

d. General/flag officer actions. In the absence of a waiver (waiver authority was eliminated in the 2007 NDAA) by the SECDEF, officers selected to the grade of O-7 subsequent to 1 January 1994 must have completed a full joint duty assignment before selection or their first assignment as a general/flag officer will be in a joint duty assignment. A capstone military education course has been created and all newly promoted general/flag officers must attend this course within two years after selection, unless such attendance is waived by the SECDEF.

### Section VII

#### The Sustainment Function

##### 12-45. Sustainment Function Overview

The sustainment function includes a broad range of activities that are focused on the well-being of Soldiers, retirees, and their families. The range includes but is not limited to quality of life activities, awards, and decorations, casualty and memorial affairs, housing, morale, recreation, personnel actions, and Soldier readiness.

##### 12-46. Army Continuing Education System (ACES)

a. ACES is a critical element in the recruitment and retention of a quality force. ACES exist to ensure Soldiers have opportunities for personal and professional self-development. Education opportunities are offered through education centers, regional and state education offices, and learning centers located worldwide. Educational programs include the following.

- (1) On-duty functional academic skills training, which provides job-related instruction in the academic areas of reading, mathematics, and English grammar at no cost to the Soldier or adult family member.
- (2) High school completion programs for Soldiers without a high school diploma.
- (3) Undergraduate and graduate college courses and programs which provide financial assistance, such as the Tuition Assistance Program.
- (4) Foreign language programs for qualified Army linguists assigned overseas.
- (5) Skill development programs to prepare non-commissioned officers for NCOES training.
- (6) Counseling to establish challenging yet attainable short and long-term goals
- (7) Academic testing through the Defense Activity for Non-Traditional Education Support.
- (8) Army personnel testing, and training support for skill specific and unit training, leaders' self-development and language and computer laboratories.

b. In addition, the Service members Opportunity College Army degree system of college and university networks promoting credit transferability and the Joint Service Transcript documenting recommended credit for Soldier training and experience help Soldiers earn degrees despite frequent transfers and rotations. The ACES, focused on Soldiers, family members, and available to DA civilians, represents a primary family covenant program.

## HOW THE ARMY RUNS

c. To further enable Soldiers to continue their education, the Army has implemented a web-based portal, GoArmyEd.com, so that Soldiers and family members have anytime, anywhere access to education programs and services. Soldiers use GoArmyEd to request funding for college level courses wherever they are in the world. GoArmyEd.com provides Soldiers maximum flexibility to continue to pursue their individual educational goals.

### **12-47. Equal Opportunity (EO) Program**

a. Army's Military Equal Opportunity (MEO) Program formulates, directs, and sustains a comprehensive effort to maximize human potential and to ensure fair treatment for all persons based solely on merit, fitness, and capability in support of readiness. This program strives to eliminate incidents of discrimination based on race, color, sex, religion, national origin, and sexual orientation and provide an environment free of unlawful discrimination or discriminatory behavior to include hazing and bullying. The Army Equal Opportunity Program is resonant in leadership that is rooted in taking care of Soldiers and is crucial to unit cohesion, readiness, and mission accomplishment. Ensuring Soldiers are treated with fairness, justice, and equity is central to an Army culture dedicated to the highest professional and personal standards and to sustaining our most important resource-people.

b. Commanders are assisted in sustaining MEO goals and objectives by an Equal Opportunity Program Manager (EOPM) at division level and above, Equal Opportunity Adviser (EOA) at brigade level and above, and an EO leader (EOL) collateral duty at battalion and company level. These MEO practitioners assist the commander in EO training, reporting and continuously assess the command climate to identify indicators of individual and institutional barriers. Soldiers volunteer or selected as EOPMs and EOAs receive 11 weeks of intensive training at Defense Equal Opportunity Management Institute (DEOMI), receive an ASI of "T" for officers and a SQI of "Q" for NCOs, and serve a 24 month tour as an EOPM or EOA. EOL receives 80 hours of training at the installation-level. The EO practitioner provides the commander a valuable subject matter resource for sustaining a positive EO climate, training, and developing remedies to eliminate practices or treatment, which affects readiness

### **12-48. The Army Casualty System**

a. The casualty operations functions include casualty reporting, notification, assistance, and fatal accident family brief program. Casualty reporting is the source of information provided to the Next of Kin (NOK) concerning a casualty incident. It is of the utmost importance to provide that information accurately, promptly, and in as much detail as possible so that the NOK receive as full an accounting as possible of the casualty incident.

b. Defense Casualty Information Processing System (DCIPS) provides casualty, mortuary affairs, personal effects tracking and processing, remains tracking, Line of Duty, and Freedom of Information Act (FOIA) management capability for casualties from current and prior conflicts for all Services. DCIPS is the DOD required system for casualty management (DODI 1300.18). All information contained in the DCIPS data base is classified For Official Use Only (FOUO). This information is governed under the Privacy Act Laws and should not be discussed with those not having a need to know.

## **Section VIII**

### **The Transition Function**

#### **12-49. Transition Function Overview**

The transition function includes a broad range of activities focused on ensuring Soldiers and their families are treated with dignity and respect and assisted in every way possible as they transition from the RA to a RC and/or civilian status. Selected transition activities are described in greater detail below.

#### **12-50. The Soldier for Life — Transition Assistance Program (SFL-TAP)**

a. The SFL-TAP orchestrates a broad spectrum of programs and services designed to assist Soldiers in making critical career and transition decisions. SFL-TAP provides transition services to Soldiers, DA civilians, retirees, and their family members. RC personnel are also eligible to receive SFL-TAP services upon serving a minimum of 180 consecutive days of active duty immediately prior to separation.

b. SFL-TAP is not a job placement service but instead a program through which a wide range of services are made available to users through a combination of DOD, Department of Labor, Department of

## MILITARY HUMAN RESOURCE MANAGEMENT

Veteran Affairs, U.S. Army, and contractor provided services. Transition counseling and career planning are the cornerstone services that assist the user to properly focus on their career path and the value of their experience should they remain on active duty or transition to civilian life. Individuals using SFL-TAP services have access to an abundance of reference materials and a wealth of information about benefits, civilian employment opportunities, career planning and services available through many federal, state, and local government agencies.

c. Participation in SFL-TAP is mandatory for all active duty Soldiers who are separating or retiring. Retirees and their families are eligible to use SFL-TAP services for life on a space available basis. Referral to SFL-TAP is mandatory for civilians who are departing because of force alignments, RIFs, or base closures. SFL-TAP participation is optional for transition of family members and eligible RC Soldiers.

d. SFL-TAP establishes a strong partnership between the Army and the private sector, creates a recruiting multiplier, improves employment prospects for transitioning personnel, reduces unemployment compensation costs to the Army, and allows career Soldiers to concentrate on their mission. SFL-TAP is an enduring program, institutionalized into the Army culture and life cycle functions.

### **12-51. The Soldier for Life — Army Retirement Services Program**

a. The Army Soldier for Life Retirement Services Program provides assistance to Soldiers and their Families preparing for and transitioning to retirement, Families of Soldiers who die on active duty and Retired Soldiers, surviving Spouses and their Families. Through a network of Retirement Services Officers (RSOs) at major Army installations, National Guard State Headquarters, and Army Reserve Regional Support Commands worldwide, they: 1) provide counseling to these groups on their rights, benefits and entitlements, 2) assist with Survivor Benefit Plan (SBP) elections, and 3) keep the retiree population informed of law and benefit changes.

b. The HQDA Retirement Services Office provides policy guidance and program oversight to the installation RSOs and develops Army policy and procedures for the Survivor Benefit Plan (SBP) program; publishes Echoes, the newsletter for Retired Soldiers and surviving spouses and their families; develops policy for the operation of the Army Retirement Services Program; and administers the Army Chief of Staff's (CSA) Retiree Council.

### **12-52. Separation**

Separation includes voluntary and involuntary release from active duty, discharge, non-disability retirement, and physical disability retirement. Because the type of discharge and character of service are of such great significance to the Service member, it must accurately reflect the nature of service performed. Eligibility for veterans' benefits provided by law, eligibility for reentry into service, and acceptability for employment in the civilian community may be affected by these determinations.

### **12-53. Enlisted Separation**

a. An enlisted Soldier may be separated upon ETS or prior to ETS by reason of physical disability, sentence of general or special court-martial, or one of the administrative separation programs prescribed in AR 635-200. Both voluntary and involuntary administrative separation actions are outlined in AR 635-200.

b. Voluntary separations are initiated by the Soldier. Reasons include hardship/dependency, surviving family members, acceptance into an ROTC program, orders to active duty as an officer or WO, defective enlistment, pregnancy, for the good of the service in lieu of trial by court-martial, and early separation when denied reenlistment. Soldiers who have tested positive for the Human Immunodeficiency Virus (HIV) antibody may request discharge under Secretarial authority. Soldiers may also be allowed to separate early to further their education.

c. Commanders may initiate involuntary separation proceedings for parenthood, personality disorder, concealment of an arrest record, fraudulent or erroneous entry, alcohol or drug abuse rehabilitation failure, failure to meet body composition/weight control standards, entry-level performance and conduct, unsatisfactory performance, or misconduct. To separate a Soldier involuntarily, the unit commander must notify the Soldier in writing. Any involuntary separation action involving a Soldier with six or more years of total active and reserve military service entitles the Soldier to a hearing by an administrative separation board. If the Soldier has 18 or more years, the board is mandatory and cannot be waived. Administrative discharges of Soldiers with 18 or more years of AFS must be approved at the Army Secretariat level.

## HOW THE ARMY RUNS

d. Discharge certificates are furnished only to Soldiers who are honorably discharged or discharged under honorable conditions. All Soldiers leaving active duty are issued a Department of Defense (DD) Form 214, Certificate of Release or Discharge from Active Duty. The DD Form 214 documents the characterization of service, except when a Soldier is separated while in an entry-level status. Entry-level separations normally have service described as uncharacterized. Honorable, general, and under other than honorable conditions characters of service are assigned administratively. Bad conduct and dishonorable discharges are issued upon conviction by a court-martial.

### **12-54. Enlisted Non-Disability Retirement System**

To qualify for voluntary retirement, an enlisted Soldier must be on active duty and have completed 20 or more years of AFS on the retirement date. A Soldier who has completed 20 years, but less than 30 years AFS and who has completed all required service obligations may be retired at his or her request. Enlisted Soldiers who have completed 30 years AFS have the vested right under law to retire and may not be denied unless other provisions of law are invoked (e.g., stop loss). DA policy requires that all service obligations incurred by promotion, schooling, or PCS be completed prior to approval of voluntary retirement of Soldiers with less than 30 years' service. However, a Soldier may request waiver of a service obligation, and approval would depend upon whether the best interests of the Service are involved or whether a substantial hardship might exist should retirement be denied. Enlisted retirements are normally approved by field commanders of general officer rank.

### **12-55. Officer Non-Disability Retirement System**

a. There are two types of retirement—voluntary and mandatory. To qualify for voluntary retirement, officers must have completed at least 20 years AFS on their retirement date. All service obligations incurred must be completed unless waived by HQDA. Mandatory retirement dates are established by law and only in very rare cases are individuals retained on active duty beyond these dates. Majors, lieutenant colonels, and colonels may remain until 24, 28, and 30 years of Active Federal Commissioned Service respectively, unless involuntarily retired through the SERB process.

b. While majors and below must have served six months in their grade to retire at that grade, lieutenant colonels and colonels must serve three years in grade to retire in that grade unless waived by HQDA. Some programs like the Voluntary Early Release and Retirement Program can waive one year of the three-year obligation, subject to limitations and provisions imposed by Congress. Officers who are selected by SERB retain their grade regardless of time held.

### **12-56. Physical Disability Separation**

The laws governing physical disability separation from the Army provide for the medical retirement or separation of a Soldier who is determined to be unfit by reason of physical disability when the physical/mental condition(s) significantly interferes with their ability to perform the duties of his or her office, grade, rank, or rating. The severity of the condition(s) determines eligibility for disability benefits, disability retirement, and severance pay. It is possible to receive a non-disability separation and still have physical disabilities, which could affect potential for civilian employment and retirement benefits. Disability compensation for any medical condition that affects a Soldier's quality of life may be determined by Department of Veteran Affairs and is separate from the service separation.

### **12-57. Integrated Pay and Personnel System-Army (IPPS-A)**

IPPS-A is the Army's future web-based HR solution to provide integrated HR capabilities across all Army Components. IPPS-A will be launched incrementally in five phases, or "releases," over the coming years. Each release will build upon the system's previous release, starting with IPPS-A's first release. The first release interfaced with 15 personnel systems and built the foundational database of trusted personnel data for all future releases. In addition, this release provided each Soldier access to the Soldier Record Brief, an eventual replacement for the Officer and Enlisted Record Briefs, DA Form 2-1, and nine multi-Component reports for HR Professionals. Release 1 was deployed to the Army in three waves by Component in 2014, including a trusted database. This included the ability for RA, ARNG, and USAR Soldiers to view and retrieve their SRB as well as the ability for Leaders, Commanders and administrators to access nine-predefined queries. Release 2 will provide the National Guard with the capabilities that are currently supported by SIDPERS-ARNG. Release 3 will provide the capabilities currently supported by the major field systems for the USAR and RA. Pay capabilities will then be introduced to all

# MILITARY HUMAN RESOURCE MANAGEMENT

Components in Release 4 and Release 5 will provide the remaining essential personnel services not previously supported. This approach ensures IPPS-A meets the needs of all its users. IPPS-A will ultimately subsume 45 HR and Pay systems currently in use. Before any system's functions are subsumed, the Army will conduct an analysis to ensure that each subsumed system's functions can be accomplished with IPPS-A or other systems.

## Section IX Summary, Key Terms and References

### 12-58. Summary

a. The primary purpose of the MHRM system is to satisfy valid Army requirements and, insofar as practicable, accommodate the legitimate needs of its members. The system is a complex, dynamic, multifaceted mosaic of interacting subsystems, which interface in a variety of ways with all other major Army systems. It must keep up with the rate of change occurring in the Army so that Soldiers are properly supported, and commanders have timely, relevant information on which to base operational decisions.

b. The processes designed to structure, acquire, train, educate, distribute, sustain, professionally develop, and separate Soldiers must be continuously evaluated and refined to ensure they support current and future Army requirements. The subsystems within these processes must have flexibility to meet the needs of the Army. Whether the Army is reducing or expanding, there are a few critical operating principles to guide decision makers as they choose between difficult, challenging options in either scenario: maintain force readiness at the prescribed levels; maintain quality in recruiting, retention, and development programs; make changes in a balanced and orderly way throughout all grades and specialties, both officer and enlisted; maintain current board selection functions to continue to build on the best; rely on RC; protect well-being; and, finally, in order to reduce uncertainty, ensure there is an understandable, comprehensive plan.

c. This chapter was designed to provide a broad overview of major personnel management systems. During the next several years, the policies, functions, and processes within every one of the subsystems will be continuously challenged to ensure Army requirements are satisfied and to care for its most important resource: People.

### 12-59. Key Terms

a. End Strength. The total number of personnel authorized by the Congress to be in the Army on the last day of the Fiscal Year (FY) (30 September). This is normally provided in the NDAA.

b. Force Structure Allowance (FSA). The sum of authorized spaces contained in all Modification Tables of Organization and Equipment (MTOE) units and Table of Distribution and Allowances (TDA) type organizations.

c. Total Strength. The total of all personnel serving on active duty in the Army, including Soldiers in units and organizations and those in the individuals account.

d. Operating Strength (OS). Those Soldiers available to fill spaces in MTOE units and TDA organizations, sometimes referred to as the distributable inventory.

e. Individuals Account. This account, often referred to as the Trainee, Transient, Holdees, and Student (TTHS) account, is comprised of those personnel unavailable to fill spaces in units. The six sub-accounts are trainees, officer accession students, transients, holdees (short explanation needed), students, and USMA cadets.

### 12-60. References

a. Regulations:

- (1) AR Series Title 600, Personnel—General.
- (2) AR Series Title 601, Personnel Procurement.
- (3) AR Series Title 614, Assignments, Details, and Transfers.
- (4) AR Series Title 621, Education.
- (5) AR Series Title 623, Evaluations.
- (6) AR Series Title 624, Promotions.
- (7) AR Series Title 635, Personnel Separations.

## HOW THE ARMY RUNS

(8) AR Series Title 680, Personnel Information Systems.

(9) Field Manual 1-0, Human Resources Support.

b. Useful Links:

(1) <http://www.army.mil>.

(2) <http://www.armyg1.army.mil>.

(3) <http://www.asamra.army.pentagon.mil>.

(4) <http://www.usarec.army.mil>.

(5) <http://www.goarmy.com>.

(6) <https://www.hrc.army.mil>.

(7) <https://www.goarmyed.com>.



# CIVILIAN HUMAN RESOURCE MANAGEMENT

*I am an Army Civilian—a member of the Army team.  
I am dedicated to our Army, our Soldiers and Civilians.  
I will always support the mission.  
I provide stability and continuity during war and peace.  
I support and defend the Constitution of the United States and consider  
it an honor to serve our nation and our Army.  
I live the Army values of loyalty, duty, respect, selfless service, honor,  
integrity, and personal courage.  
I am an Army Civilian.*

*Army Civilian Corps Creed*

## Chapter 13

### Civilian Human Resource Management

#### Section I

#### Introduction

##### 13-1. Chapter Content

a. Civilians have been an important component of the Army since the Revolutionary War. They are an integral part of the force used to accomplish today's multiple complex missions. On 19 June 2006, the Secretary of the Army (SECARMY) established the Army Civilian Corps and the Army Civilian Corps Creed. This name unifies the Army Civilian service and embodies the commitment of the dedicated individuals who serve as a fundamental part of the Army team. Army Civilians serve in all theaters and are deployed worldwide to support the Army mission and Overseas Contingency Operations. The purpose and role of the Army Civilian is defined by the Army Civilian Corps Creed.

b. The Army Civilian Corps includes both Appropriated Fund (APF) and Non-Appropriated Funds (NAF) employees, as well as foreign or local national employees (see Fig 13-1 for details). These Civilians are employed in over 530 different occupations with the highest concentrations in logistics, research and development and Base Operations (BASOPS) functions. Civilians are excluded from positions by law requiring military incumbents but are increasingly being used in combat service support functions when former military positions are converted to Civilian occupancy.

c. An understanding of the types of employees and the rules and regulations that govern each of them is necessary to understand the management and administrative environment within which Civilian personnel management systems operate. The laws, regulations, personnel policies, and practices differ for Army Civilian employees based on their source of funding.

##### 13-2. Categories of Civilian Personnel

a. APF Civilians. The term appropriated funds refers to those funds provided by Congress, normally in annual Defense Appropriations Act legislation. U.S. citizens and eligible U.S. aliens are paid from APFs and are managed within a structure of federal civil service laws. APF employees are further divided into two categories based on the nature of work performed. Military-function Civilians perform support duties associated directly with the Army's National Military Strategy (NMS) objectives. Civil-function Civilians perform duties associated with the Army's civil works program administered by the Army Corps of Engineers. Civil works includes planning, design, construction, operation and maintenance of projects that improve the nation's water resource infrastructure (e.g., navigation, flood control, and hydroelectric power, plus other civil functions prescribed by law). The laws governing APF employees are administered by the U.S. Office of Personnel Management (OPM) and are discussed in more detail in subsequent sections of this chapter.

## HOW THE ARMY RUNS

| <b>Appropriated Fund Military Function Civilians</b>   | <b>Strength</b> |
|--|-----------------|
| US Direct Hire in Military Function                    | 199,272         |
| National Guard Techs                                   | 27,573          |
| Foreign National (FN) Direct Hire in Military Function | 6,421           |
| FN Indirect Hire in Military Function                  | 13,777          |
| <b><i>Sub-Total Military Function</i></b>              | <b>247,043</b>  |
| <b>Appropriated Fund Civil Function Civilians</b>      |                 |
| US Direct Hire in Civil Function                       | 25,054          |
| US Direct Hire Cemeterial Function                     | 183             |
| <b><i>Sub-Total Civil Function</i></b>                 | <b>25,237</b>   |
| <b><i>Total Appropriated Fund in All Functions</i></b> | <b>272,280</b>  |
| <b><i>Total Non-Appropriated Fund</i></b>              | <b>27,145</b>   |
| <b><i>Total Civilian Strength</i></b>                  | <b>299,425</b>  |

Figure 13-1. Civilian Strength as of June 2019 – Source: SF113A

### 13-3. Categories of Civilian Personnel

a. APF Civilians. The term appropriated funds refers to those funds provided by Congress, normally in annual Defense Appropriations Act legislation. U.S. citizens and eligible U.S. aliens are paid from APFs and are managed within a structure of federal civil service laws. APF employees are further divided into two categories based on the nature of work performed. Military-function Civilians perform support duties associated directly with the Army's National Military Strategy (NMS) objectives. Civil-function Civilians perform duties associated with the Army's civil works program administered by the Army Corps of Engineers. Civil works includes planning, design, construction, operation and maintenance of projects that improve the nation's water resource infrastructure (e.g., navigation, flood control, and hydroelectric power, plus other civil functions prescribed by law). The laws governing APF employees are administered by the U.S. Office of Personnel Management (OPM) and are discussed in more detail in subsequent sections of this chapter.

#### b. NAF Civilians.

(1) NAF employees are paid from funds generated from sales, fees, and charges to authorized patrons. This category is comprised of U.S. Civilians, foreign nationals (usually from the local labor market), and enlisted service personnel working part time during off-duty hours. All compete for employment on the basis of merit.

(2) NAF employees play an important role in providing Family and Morale, Welfare and Recreation (FMWR) services to military personnel and their family members. Army clubs, Army lodging, child care centers, craft shops, bowling centers, swimming pools, gymnasiums, and other NAF activities employ a considerable number of employees at most Army installations and contribute to the overall quality of life.

c. Foreign/Local National Civilians. The Army also employs foreign and local nationals in both APF and NAF positions in overseas areas. The Status of Forces Agreement (SOFA) in effect with a given host country forms the basis of the employment systems for these employees. Within this framework, employee administration must be consistent with host country practice, U.S. law, and the management

## CIVILIAN HUMAN RESOURCE MANAGEMENT

needs of the Army. In some cases, the host government may reimburse the salary and associated personnel costs in whole or in part.

### 13-4. Army Workforce Mix

a. The Army's fighting environment has changed, causing the Army to transform. The number and scope of the missions the Army must perform has grown significantly since the end of the Cold War. Following the post-Cold War drawdown that ended in 1999, the number of Army Civilian employees increased modestly through Fiscal Year (FY) 2004. During FY 2005 to FY 2010, the numbers increased significantly due to migration of Overseas Contingency Operations missions to base missions, Grow the Army budget initiatives such as increases for base support functions, contractor to Civilian conversions, military pay re-capitalization, and conversion of military billets to Civilian positions. Civilian increases are not likely to continue into the future considering budget and deficit reduction deliberations currently underway.

b. The Army is undergoing a fundamental change in how it defines its total manpower. The challenge is achieving the right balance of Civilian employees, contractors, and Soldiers in the Army.

### 13-5. Decentralized Management

The systems for recruiting, utilizing, developing, and sustaining Department of the Army Civilians (DAC) are predominantly decentralized. Decentralized management of Civilians is very different from the centralized management of military personnel (Figure 13-2). Most authorities for the supervision and management of Civilians have been delegated through the chain of command to the lowest practicable level. Certain Civilian personnel functions are performed on a regional, command-wide, or Army-wide basis when doing so results in more efficient operations (e.g., the Army Benefits Center-Civilian (ABC-C) at Fort Riley, Kansas provides counseling to individual employees across the Army on their benefits and automated support for benefits changes) or when a managerial perspective above the local level is required to meet program objectives (e.g., Headquarters, Department of the Army (HQDA) manages the intake and training of interns in DA career programs). The management of Senior Executive Service (SES) employees is also centralized at HQDA level.

| Category                 | Military   | Civilian   |
|--------------------------|--|--|
| Statute                  | Title 10, United States Code   | Title 5, United States Code  |
| Authority                | Rank in Person   | Rank in Job  |
| Acquisition              | Fill based on structure and authorizations; managed by United States Army Recruiting Command, United States Military Academy, Cadet Command, Human Resources Command, Army G-1 | Fill based on position vacancy; managed by supervisor, Commander, Civilian Personnel Advisory Center, Career Program Manager, Assistant Secretary of the Army for Manpower & Reserve Affairs |
| Individual Training      | Hierarchy of schools for military and leadership skills  | Functional training primarily occupation-related   |
| Distribution             | Mandatory movement to meet worldwide requirements  | Voluntary mobility (generally)   |
| Deployment               | Involuntary (based on Army requirements)   | Voluntary (unless part of job criteria)  |
| Professional Development | Central selection and management   | Heavy decentralized management   |
| Transition               | Contractual obligation and forced separation / retirement  | More individual choices and longer tenure  |

Figure 13-2. Differences Between the Military and Civilian Systems

# HOW THE ARMY RUNS

## Section II Organization of Civilian Personnel Management

### 13-6. Merit System Principles

a. The Merit System Principles are nine basic standards governing the management of the executive branch workforce. The principles are part of the Civil Service Reform Act of 1978 and can be found at Title 5 U.S. Code, Section 2301 (5 U.S.C. 2301). The following merit principles govern all personnel practices.

(1) Recruitment should be from qualified individuals from appropriate sources in an endeavor to achieve a workforce from all segments of society. Selection and advancement should be determined solely on the basis of relative ability, knowledge and skills after fair and open competition which assures all receive equal opportunity.

(2) All employees and applicants for employment should receive fair and equitable treatment in all aspects of personnel management without regard to political affiliation, race, color, religion, national origin, sex, marital status, age, or handicapping condition (sic - the preferred term is disability), and with proper regard for privacy and constitutional rights.

(3) Equal pay should be provided for work of equal value, with appropriate consideration of both national and local rates paid by employers in the private sector, and appropriate incentives and recognition should be provided for excellence in performance.

(4) All employees should maintain high standards of integrity, conduct, and concern for the public interest.

(5) The federal work force should be used efficiently and effectively.

(6) Employees should be retained on the basis of adequacy of their performance. Inadequate performance should be corrected. Employees should be separated who cannot or will not improve their performance to meet required standards.

(7) Employees should be provided effective education and training in cases in which such education and training will result in better organizational and individual performance.

(8) Employees should be protected against arbitrary action, personal favoritism, or coercion for partisan political purposes, and prohibited from using their official authority or influence for the purpose of interfering with or affecting the result of an election or a nomination for an election.

(9) Employees should be protected against reprisal for the lawful disclosure of information which an employee reasonably believes evidences a violation of any law, rule, or regulation, or evidences mismanagement, a gross waste of funds, an abuse of authority, or a substantial and specific danger to public health or safety.

b. Twelve prohibited personnel practices are defined by law at 5 U.S.C. 2302(b). Any employee who has authority to take, direct others to take, recommend, or approve any personnel action, shall not, with respect to such authority -

(1) Discriminate for or against an employee or applicant for employment—

(a) On the basis of race, color, religion, sex, or national origin, as prohibited under section 717 of the Civil Rights Act of 1964 (42 U.S.C. 2000e-16);

(b) On the basis of age, as prohibited under sections 12 and 15 of the Age Discrimination in Employment Act of 1967 (29 U.S.C. 631, 633a);

(c) On the basis of sex, as prohibited under section 6(d) of the Fair Labor Standards Act of 1938 (29 U.S.C. 206 (d));

(d) On the basis of handicapping condition, as prohibited under section 501 of the Rehabilitation Act of 1973 (29 U.S.C. 791); or

(e) On the basis of marital status or political affiliation, as prohibited under any law, rule or regulation.

(2) Solicit or consider employment recommendations based on factors other than personal knowledge or records of job-related abilities or characteristics.

(3) Coerce the political activity of any person (including the providing of any political contribution or service) or take any action against any employee or applicant for employment as a reprisal for the refusal of any person to engage in such political activity.

(4) Deceive or willfully obstruct anyone from competing for employment.

(5) Influence anyone to withdraw from competition for any position so as to improve or injure the employment prospects of any other person.

## CIVILIAN HUMAN RESOURCE MANAGEMENT

(6) Give an unauthorized preference or advantage to anyone so as to improve or injure the employment prospects of any particular employee or applicant.

(7) Engage in nepotism (i.e., hire, promote, advance, or advocate the hiring or promotion of relatives to a civilian position).

(8) Engage in reprisal for whistle blowing (i.e., take, fail to take, threaten to take or fail to take a personnel action with respect to any employee or applicant because of any disclosure of information by the employee or applicant that he or she reasonably believes evidences a violation of a law, rule or regulation; gross mismanagement; a gross waste of funds; an abuse of authority; or a substantial and specific danger to public health or safety (if such disclosure is not barred by law and such information is not specifically required by Executive Order (EO) to be kept secret in the interest of national defense or the conduct of foreign affairs—if so restricted by law or EO, the disclosure is only protected if made to the Special Counsel, the Inspector General, or a comparable agency official)).

(9) Take, fail to take, threaten to take or fail to take a personnel action against an employee or applicant for exercising an appeal, complaint, or grievance right; testifying for or assisting another in exercising such a right; cooperating with or disclosing information to the Special Counsel or to an Inspector General; or refusing to obey an order that would require the individual to violate a law.

(10) Discriminate based on personal conduct which is not adverse to the on-the-job performance of an employee, applicant, or others.

(11) Take or fail to take, recommend, or approve a personnel action if taking or failing to take such an action would violate a veterans' preference requirement.

(12) Take or fail to take a personnel action, if taking or failing to take action would violate any law, rule or regulation implementing or directly concerning merit system principles at 5 U.S.C. 2301.

### **13-7. United States Office of Personnel Management (OPM)**

a. OPM is the personnel agency of the executive branch charged with the mission to administer most federal laws and EOs dealing with all aspects of Civilian personnel management and administration in the federal sector. Some laws and EOs place certain personnel management responsibilities directly on agency and department heads, subject to OPM policy and review. In other cases, OPM retains the authority to establish specific program standards and regulate and control the means of carrying out major aspects of agency or departmental personnel management operations.

b. OPM develops proposals for federal personnel legislation and EOs and develops and publishes specific policies, procedures and regulations implementing federal personnel laws and EOs. OPM also provides testing, evaluation, and referral of job applicants to agencies; evaluates agency personnel management systems; provides advice and assistance to agencies in the development of effective personnel management programs; provides oversight on Department of Defense (DOD) evaluations and assessments of human capital policies, programs, and practices. In addition, OPM develops standards by which jobs are classified (i.e., pay systems, title, job series, and grades); administers retirement, health, and life insurance programs; and adjudicates position classification appeals.

c. OPM executes, administers, and enforces civil service rules and regulations through audits, reviews and inspections. Failure on the part of agencies to observe the prescribed standards, requirements, and instructions may result in the withdrawal of personnel management authority delegated by OPM.

d. NAF employees are not legally deemed to be employees of the Federal Government for the purposes of most laws administered by the OPM, therefore the policies, procedures, and entitlements relating to employees paid from appropriated funds and those relating to NAF employees are different. There are, however, instances where legislation not applicable to NAF employees has been administratively adopted.

### **13-8. Other Agencies with Federal Government-Wide Authority**

In addition to OPM controls and procedures, four separate independent federal agencies also provide oversight to ensure agencies adhere to principles of merit, labor relations guarantees, and equal employment rights:

a. U.S. Merit Systems Protection Board (MSPB). The MSPB is an independent, quasi-judicial agency in the executive branch that serves as the guardian of federal merit systems. The board's mission is to protect federal merit systems and the rights of individuals within those systems. NAF employees are not covered under MSPB. MSPB carries out its statutory responsibilities and authorities primarily by

## HOW THE ARMY RUNS

adjudicating individual employee appeals and by conducting merit systems studies. In addition, MSPB reviews significant actions by the OPM to assess the degree to which those actions may affect merit.

(1) Cases arising under the MSPB jurisdiction include the following:

(a) Employee appeals of agency adverse actions, including removals, suspensions of more than 14 days, reductions in grade or pay, furloughs of 30 days or less, reduction-in-force actions, and denials of within grade salary increases.

(b) OPM suitability determinations.

(c) OPM determinations in retirement matters.

(d) Disciplinary actions brought by the Office of Special Counsel (OSC) alleging violations of the Hatch Act (coercion of government employee political activity).

(e) Corrective and disciplinary actions brought by the OSC against agencies or federal employees who are alleged to have committed certain prohibited personnel practices or alleged to have violated certain civil service laws, rules, and regulations.

(f) Requests for stays of personnel actions alleged by the OSC to result from certain prohibited personnel practices.

(g) Requests for review of regulations issued by OPM or of implementation of OPM regulations by an agency.

(h) Informal hearings in cases involving proposed performance-based removals from the Senior Executive Service.

(2) The MSPB also has jurisdiction over allegations of employment discrimination in connection with actions otherwise appealable to the MSPB and certain employee allegations subject to a negotiated grievance procedure covering actions otherwise appealable to the MSPB.

b. Office of Special Council (OSC). The OSC is an independent federal investigative and prosecutorial agency. OSC's authority comes from four federal statutes: the Civil Service Reform Act (CSRA), the Whistleblower Protection Act, the Hatch Act (legal restrictions on government employee political activity), and the Uniform Services Employment and Reemployment Rights Act (USERRA). OSC's primary mission is to safeguard the merit system by protecting federal employees and applicants from prohibited personnel practices, especially reprisal for whistle blowing. Sexual orientation and parental status employment discrimination are designated as prohibited personnel practices by EO. Allegations of employment discrimination on these bases may be filed with and subject to investigation by the OSC.

c. Federal Labor Relations Authority (FLRA). The FLRA is an independent administrative federal agency which adjudicates federal employee collective bargaining disputes, including resolving complaints of unfair labor practices, determining appropriateness of units for labor organization representation, adjudicating exceptions to arbitrator's awards, adjudicating legal issues relating to duty to bargain and negotiability, and resolving impasses during negotiations.

d. The Equal Employment Opportunity Commission (EEOC). EEOC is an independent federal agency responsible for enforcing federal laws which prohibit employment discrimination in both the private and public sector based on race, color, national origin, sex, age (40 and older), religion, genetic information, mental or physical disability or in reprisal for engaging in protected activity such as opposing discrimination or participating in a discrimination complaint or lawsuit. The EEOC provides oversight and coordination of all federal sector equal employment opportunity regulations, practices and policies, and submits an annual report on the federal workforce to the President of the United States (POTUS), Congress, and appropriate congressional committees. The EEOC's regulation implementing the federal sector Equal Employment Opportunity (EEO) program (29 Code of Federal Regulations (CFR) 1614), requires each federal agency to implement and maintain effective EEO programs. The EEOC Administrative Judges (AJ) play an adjudicative role in formal federal sector EEO complaints as well as at the appellate level of the administrative complaint process. EEOC findings of discrimination are not appealable by agencies in federal court.

### 13-9. Department of Defense (DOD)

Under EO 9830, the POTUS has delegated authority to agency heads, including the Secretary of Defense (SECDEF) to act in Civilian human resource matters in accordance with applicable policies, program requirements, standards, and instructions.

a. Office of the Secretary of Defense (OSD). Within OSD, the Under Secretary of Defense (Personnel and Readiness) (USD(P&R)) and the Deputy Assistant Secretary of Defense (Civilian Personnel Policy) (DASD(CPP)) have responsibility for DOD-wide Civilian Human Resource (CHR) policy. The

## CIVILIAN HUMAN RESOURCE MANAGEMENT

DASD(CPP) develops plans, policies, and programs to manage the DOD Civilian workforce, including NAF and local national employees in coordination with the services and within the framework established by federal law, EOs, and government-wide regulations. Through its Defense Civilian Personnel Advisory Service (DCPAS), the DASD(CPP) also provides certain Civilian human resource services on a DOD-wide basis.

b. DOD Investigations and Resolutions Division (DOD IRD). The IRD investigates and facilitates the resolution of EEO complaints and formal employee grievances not covered by negotiated grievance procedures. In a complex formal grievance of a NAF employee, or a formal grievance of an APF employee under the Administrative Grievance System, the deciding official may elect to retain the services of the IRD to review the facts and make recommendations.

### **13-10. Assistant Secretary of the Army for Manpower and Reserve Affairs (ASA (M&RA))**

a. DA authority for Civilian personnel management is further delegated by the SECDEF to the SECARMY. The SECARMY in turn has delegated some of the Civilian personnel management responsibilities including responsibility for personnel policy, programming, and oversight to the ASA (M&RA) through General Order No. 2019-01, 15 May 2019. The SECARMY retains appointing and pay setting authority for Civilian Executive and Senior Professional (ESP) personnel (except for those appointed by the POTUS or other higher level authority). This includes positions in the SES, Defense Intelligence Senior Executive Service (DISES), Scientific and Technical (ST) Professionals, Senior Level (SL), and Defense Intelligence Senior Level (DISL), as well as Highly Qualified Expert (HQE) positions. By memo dated 3 August 2009, the SECARMY delegated to the ASA (M&RA) authority, direction, and control over missions, functions, and personnel of the Civilian Senior Leader Management Office (CSLMO). The Deputy Chief of Staff, G-1 (DCS, G-1) is the responsible official to the ASA (M&RA) in developing, coordinating, and implementing programs and policies directly associated with accession, development, distribution, and sustainment of military and Civilian personnel. The Assistant G-1 for Civilian Personnel (AG-1 CP) has responsibility for supervision of Civilian personnel policy, management, and related Civilian personnel functions in the Army.

b. Appointing authority, which is the authority to approve personnel actions, is delegated to the Commanders of the Army Commands, the Commanders of the Army Service Component Commands, the Commanders/Superintendent of the Direct Reporting Units and the Administrative Assistant to the SECARMY. In order to streamline the execution of the DA's Civilian personnel management program, the Army's Civilian Human Resources Agency (CHRA), through the CHRA Regional Directors or their designees, authenticates Civilian personnel actions for their serviced organizations. Such personnel officials will act for the appointing authorities in authenticating actions. Authenticating officials may electronically approve a personnel action only after the responsible management official has approved the action, determined it's in accordance with law and regulation, and exercised appropriate fiduciary responsibility to ensure fiscal soundness. The authenticating official is responsible for ensuring personnel actions are in compliance with applicable Civilian personnel laws, rules, regulations and governing policies before processing the actions and thus serves as the appointing official. An example is provided to illustrate the act for relationship: whenever the regional processing center approves and processes an official personnel action (such as the appointment of someone to a position), it does so on behalf of the commander of the serviced organization, thus exercising that commander's personnel management authority. Regional and Civilian Personnel Advisory Center (CPAC) directors are directly responsible to each of the commanders they service for the proper exercise of this authority.

### **13-11. Other Army Organizations with Civilian Personnel Responsibilities**

a. Installation Management Command (IMCOM) G-9. IMCOM G-9's mission is to develop and administer systems and programs for the Army family and community activities under the general heading of Family and Morale, Welfare, and Recreation (FMWR). IMCOM G-9, in conjunction with the Talent Management Program, is responsible for filling specified MWR managerial jobs (both APF and NAF) and administration of a benefits program for all Army NAF employees.

b. Intelligence Personnel Management Office (IPMO). The IPMO is a subordinate element of the Office, DCS G-2, HQDA. It serves as the focal point in the Army for policy and management of the Defense Civilian Intelligence Personnel System (DCIPS) and reports jointly to the Army DCS G-2 and the ASA (M&RA). The IPMO maintains liaison with the rest of federal intelligence activities on Civilian personnel management issues, develops policies and programs, and develops and provides training and guidance.

## HOW THE ARMY RUNS

The IPMO also provides personnel management advice and assistance to CPACs that, in turn, provide Civilian personnel management support to intelligence organizations or those with DCIPS employees.

### Section III Civilian Human Resource Service Delivery

#### 13-12. Civilian Personnel Advisory Centers

a. Advisory functions requiring face-to-face interaction between Human Resources Specialists, managers and employees typically reside at the CPAC (installation/activity level). Action processing, record keeping, and database management functions are centralized at regional processing centers. The Army has established geographically based Regional Offices and Civilian Personnel Records Centers. The Regional Offices provide oversight and guidance to CHRA's CPACs throughout the world which are responsible for providing comprehensive operational lifecycle HR services, advice, and support to installations/activities and their employees. Each CPAC is typically located at or near the installation(s) to which it provides advisory services.

b. Specific responsibilities of the CPACs are as follows:

(1) Provide the Civilian personnel service and assistance necessary to obtain, compensate, develop, use, and retain an effective Civilian workforce as well as to maintain the order and discipline of the Civilian force.

(2) Promote equality of opportunity in the organizational units serviced.

(3) Coordinate personnel management requirements and needs of the organizations serviced.

(4) Provide information and staff assistance and guidance to managers and supervisors to assist them in obtaining the most effective use of Civilians through improved management.

(5) Assist commands at the installation and activity level in establishing labor management relationships focused on supporting and enhancing the Army's national security mission and creating and maintaining a high-performance workplace that delivers the highest quality products and services at the lowest possible cost. Such relationships should be committed to pursuing solutions that promote increased quality and productivity, customer service, mission accomplishment, efficiency, quality of life, employee empowerment, organizational performance, and military readiness. Consensual means of resolving disputes, such as alternate dispute resolution and interest based bargaining, should be sought.

c. NAF HR Offices are fully functional HR operations and are located within the CPAC. All HR functions are performed in the NAF HR Office.

#### 13-13. Automation Tools

a. It is DOD policy that Information Technology (IT) investments will be managed as portfolios to: ensure IT investments support the Department's vision, mission, and goals; ensure efficient and effective delivery of capabilities to support the warfighter; and maximize return on investment to the enterprise. The enterprise portfolio consists of Civilian Human Resources Management Information Technology (CHRM-IT) systems providing capabilities across the spectrum of the end-to-end human resources (HR) life cycle. Reference DOD Instruction (DODI) 1400.25, Volume 1100.

b. The DOD has a single enterprise-wide mandated CHRM-IT solution consisting of a set of CHRM-IT systems. This includes the Defense Civilian Personnel Data System (DSPDS) that uses a standard configuration for personnel action processing, reporting, and data retrieval. Army continues to use Army-specific systems in addition to existing enterprise-wide systems, until enterprise-wide solutions are acquired or developed. Below are a few of the systems used to accomplish the Civilian HR mission:

(1) DCPDS. DCPDS contains the world's largest relational database, housing and processing all of DOD's civilian HR data. The system is designed to support APF, NAF, and local national HR operations. DCPDS offers a comprehensive array of state-of-the-art personnel processing capabilities. Managers can access organizational, historical, and employee data through a variety of reports and individual screens. Features include MyBiz+, Employment Verification, Personnel Actions, and Personnel Information.

(2) Civilian Personnel On-Line (CPOL) and CPOL Portal. CPOL contains policy and guidance documents on the management and administration of the Army Civilian workforce including newsletters, bulletins, operating manuals, directives, forms, per diem rates, and salary schedules. CPOL Portal is a



## CIVILIAN HUMAN RESOURCE MANAGEMENT

one-stop secure site which provides Army Civilian employees, managers and HR Specialists access to a private portal with a complete set of employment-related resources, links and web-based applications.

(3) Automation Innovation Center (AIC) and AutoNOA. As a strategic CHR partner, AIC and AutoNOA continue to make positive, visionary differences in maximizing CHRA's ability to meet the needs of an evolving workforce while increasing quality and quantity of automated output in overall support of the Army Soldier.

(4) Business Objects. The Business Objects Xi (BOXi) is a web based, user friendly report building system used to view and create reports on Army Civilian Personnel data.

(5) Electronic Official Personnel Record (eOPF). The eOPF contains official benefit, personnel action, and position related documents spanning an employee's Federal career.

(6) Government & Retirement Benefits (GRB) Platform (formerly EBIS) is an automated, secure, self-service web application providing employees online access to view and change their Civilian benefits, such as health and life insurance.

(7) Fully Automated System For Classification (FASCLASS). FASCLASS is a centralized system that delivers position classification and position description information to the customer's desktop. It provides online access to active position descriptions and organizational information.

(8) Defense Enterprise Hiring Solution (DEHS): USA Staffing and USAJOBS. USAJOBS is the federal government's official source for federal job listings and employment opportunity information. Job seekers can access thousands of job opportunities across hundreds of federal agencies and organizations, allowing agencies to meet their legal obligation (5 U.S.C. 3327 and 5 U.S.C. 3330) of providing public notice for federal employment opportunities. Once a job seeker locates a vacancy of interest, USAJOBS passes the applicant to one of several approved talent acquisition systems for application intake, evaluation, referral, and selection. USA Staffing is the DEHS talent acquisition system.

### Section IV

#### Personnel Management at Installation / Activity Level

##### 13-14. Personnel Management Responsibility and Authority

The responsibility for providing day-to-day leadership of Army Civilians resides primarily at installation and activity level with the supervisor, manager, and commander. The SECARMY has delegated personnel management authority, except for management of ESP resources, to commanders with authority to further delegate to commanders of independent field activities. Thus, the actual management of DACs, including professional development, incentive awards, discipline, evaluation, labor relations, and most other life cycle personnel functions is decentralized to installation and activity commanders, and local managers and supervisors. The CPAC assists the chain of command in exercising this responsibility. In the case of ESPs, centralized management is the responsibility of CSLMO.

##### 13-15. Commander Responsibilities

Installation commanders are responsible for leading and managing Civilian employees and are held accountable for effectively employing their HR assets. Responsible commanders develop, empower and use subordinate supervisors, managers and the CHR staff to establish a work environment for positive employee motivation and high performance. Specific command responsibilities are to carry out Civilian personnel management policies, procedures and programs as set forth in Title 5 U.S.C. Government Organizations and Employees; Title 5 Code of Federal Regulations Administrative Personnel; and DOD 1400.25-M DOD Civilian Personnel Manual; 5 CFR Parts 410 and 412, Training; Supervisory, Management and Executive Development, and other applicable laws and regulations, consistent with applicable negotiated agreements.

##### 13-16. Supervisor Responsibilities

a. Commanders generally delegate authority for leading and managing Civilian employees to subordinate managers and supervisors. This carries with it specific responsibilities to do the following.

- (1) Maintain accurate position descriptions.
- (2) Recruit, select, assign, and set pay for employees.
- (3) Evaluate employee performance, and train and develop employees.
- (4) Administer award and incentive programs.

## HOW THE ARMY RUNS

- (5) Maintain management-employee communications.
  - (6) Communicate employee expectations, administer constructive discipline, and promptly address employee performance deficiencies.
  - (7) Maintain a positive labor-management relations program.
- b. Supervisor responsibilities in each of these areas and the functional systems established to assist in carrying out these responsibilities are described below.
- c. The Army has an informal Civilian mentoring program for mentoring Civilians. The Army Mentorship Program was created to reemphasize, reinvigorate, and increase mentorship throughout the Army.
- (1) Supervisors should motivate employees to seek mentors through the Army's Mentorship Resource Center.
  - (2) DA pamphlet 690-46 Mentoring for Civilian Members of the Force provides further guidance.

### 13-17. Position Classification and Pay

- a. Position Classification and Pay for APF Positions.
- (1) Position classification authority is delegated to managers and supervisors within the Army, who may further delegate to CHRA for day to day operation. Individual positions are classified by comparison with the appropriate classification standards or guides. These are established by OPM or DOD based on comprehensive occupational studies of representative work found in the federal service. Army regulations assign responsibility for maintaining accurate job descriptions to supervisors. Differences in grades and pay must be attributed to differences in the difficulty, responsibility, and skill requirements of jobs.
  - (2) Most positions are covered by the following pay systems: the General Schedule (GS); Personnel demonstration projects (which cover white-collar workers in professional, administrative, technical, clerical, and protective occupations); and the Federal Wage System (FWS), which covers workers in trades, crafts, labor, and similar occupations. Salary rates for most GS positions, including locality pay, are based on surveys of private sector salary rates conducted by the Department of Labor. FWS wage rates are established based on local surveys of private sector rates conducted by federal agencies in accordance with OPM policies. Personnel demonstration projects operate under broad pay band systems rather than the GS. The National Security Personnel System (NSPS) covered some workers, but was repealed by the National Defense Authorization Act (NDAA) for FY 2010, and it is no longer in use as of 1 January 2012.
  - (3) Personnel demonstration projects authorized by the 1995, 1996, and 1998 NDAs operate under broad pay band systems rather than the GS schedule. Classification authority in these systems is delegated only to appropriate management officials. These officials classify positions by a comparison of duties and responsibilities with the appropriate broadband or factor-level descriptors as outlined in the demonstration projects' federal register notices. Typically occupations with similar characteristics are grouped together into career paths, such as Engineering/Science, Business / Technical and General Support. Depending on the demonstration project, each career path may have two to six pay bands. Pay bands allow managers flexibility in setting pay within a band. Salary rates for personnel demonstration project employees generally include staffing supplements, which are usually administered in the same manner as locality pay for GS. Employees progress through pay bands according to job performance. Management officials may also use recruitment, retention and relocation incentives as well as other pay flexibilities as discussed in paragraph 14-17 below.
- b. Position Classification and Pay for NAF Positions.
- (1) The DOD NAF uses a pay band system for position classification and pay. Pay banding involves the establishment of several broad salary bands and allows managers to set individual salaries within an established pay band. This enables NAF managers to provide high-performing NAF employees with greater compensation short of a promotion action or performance award. The DOD pay band system includes NAF clerical, administrative, sales, technical, managerial, executive, professional, and personal service positions exclusive of childcare giving and crafts and trades positions.
  - (2) There are six pay bands, referred to as pay levels and identified using codes NAF NF-1 through NF-6. They have overlapping minimum and maximum pay rates. The minimum and maximum rates for the first two levels and minimum level for NF-3 are determined by locality-based wage surveys of comparable private sector jobs. The maximum rates for NF-3 and the rates for NF-4 through NF-6 are related to the GS and SES pay range.

## CIVILIAN HUMAN RESOURCE MANAGEMENT

(3) Child caregiving pay band positions are covered by a separate pay band system implemented in consonance with the DA Caregiving Personnel Pay Program (CPPP). There are two pay bands, also referred to as pay levels, and they are distinctly identified through use of the terms Pay Band I or Pay Band II. The range in pay for child care giving pay band positions is equal to the hourly rate of pay for a GS-2, Step 1, through GS-5, Step 10, and pay rates prescribed for GS child care giving positions also apply. The DA CPPP was expanded in February 1999 to include positions in Youth Services having similar duties and responsibilities. The current Child and Youth Personnel Pay Program (CYPPP) follows the same guidelines established for the CPPP.

(4) Crafts and trades positions are not affected by pay banding. Pay is determined through the prevailing rate system used for those positions covered under the FWS.

c. Position Classification and Pay for Foreign National Positions. These positions are generally not included in either of the pay systems described above. Employees in these positions are paid under local host-nation pay scales and conditions.

### **13-18. Recruitment, Selection, and Assignment**

a. Management has the right to consider candidates from all appropriate sources, including but not limited to merit promotion, reinstatement and transfer eligibles, Veterans Employment Opportunity Act (VEOA) eligibles, individuals with severe physical or mental disabilities, family member eligibles under EO 12721 and 13473, and those certified as eligible for appointment by OPM or under a delegated examining authority. In deciding which sources to tap, management should consider sources expected to produce candidates who will meet the agency's mission requirements, contribute new ideas and viewpoints and meet the agency's affirmative action and special employment programs. Recruitment sources also encompass the Pathways Programs created under Executive Order 13562, Recruiting and Hiring Students and Recent Graduates. The Pathways Programs includes the Internship Program, Recent Graduates Program and the Presidential Management Fellows Program and are described below. Persons with statutory or priority placement rights to a vacancy must be given appropriate consideration before the normal recruitment process may proceed.

(1) Recent Graduates Program. This program targets recent graduates of trade and vocational schools, community colleges, universities, and other qualifying institutions. To be eligible, applicants must apply within two years of degree completion (except for veterans precluded from doing so due to their military service obligation, who will have six years after degree completion). Successful applicants will be placed in a 1 or 2-year career development program. Those who successfully complete the program may be considered for noncompetitive conversion to career/career conditional appointments.

(2) Internship Program. The program provides students in high schools, community colleges, four-year colleges, trade schools, career and technical education programs, and other qualifying educational institutions and programs with paid opportunities to work in agencies and explore federal careers while still in school. Students who successfully complete the program may be eligible for noncompetitive conversion to career/career conditional appointments.

(3) Presidential Management Fellows Program. This program aims to attract to the federal service outstanding men and women from a variety of academic disciplines at the graduate level who have a clear interest in, and commitment to, the leadership and management of public policies and programs. Successful completion may lead to noncompetitive conversion to a career/career conditional appointment. Personnel selection decisions must be based solely on merit based and job-related reasons.

b. In recent years, DA, like other employers, has found the recruitment and retention of highly skilled employees a challenge, particularly for jobs in shortage occupations or in locations with an especially tight labor market. Due to an anticipated wave of retirements, and the recent downsizing of the federal government DA anticipates difficulty in filling mission critical vacancies in a highly competitive environment. It is important that supervisors and managers are aware of the special incentives available for staffing positions with unusual recruitment and retention problems. These incentives may include recruitment relocation, and retention incentives, superior qualifications appointments (appointment at a rate above the minimum for the GS grade because of superior qualifications or a special need for the candidate's services) and special salary rates (minimum rates and rate ranges above those of the GS). In addition, activities may identify local shortage positions for purposes of paying first duty station and pre-employment interview travel expenses for permanent positions. Information about these and other incentives is available in the Personnel Management Information and Support System (PERMISS). Army

## HOW THE ARMY RUNS

employment also offers attractive leave, insurance and retirement benefits and typically provides a family friendly environment, meaningful public service work, and good opportunities for training and advancement based on merit. These are important tools in marketing the Army as an employer.

### **13-19. Evaluation of Employee Performance and Administration of Awards / Incentives Programs**

a. Administering the evaluation and performance incentive functions of Civilian personnel management requires managers and supervisors to exercise both leadership and fiscal responsibilities. It also requires an appreciation of the workplace environment and an understanding of individual needs for counseling, recognition, and reward. The Civilian incentive awards program includes monetary and honorary awards. Civilian incentive award decorations and award approval authority are aligned with the military awards system to the extent practicable. The following Army Civilian performance management programs are detailed in regulations, pamphlets, and DOD and OPM guidance listed in the reference section of this chapter.

(1) Performance planning and evaluation programs for ESPs, white-collar, blue-collar, and NAF employees.

(2) Base pay adjustment policy and procedures for all Civilian employees (ESP pay increases; GS and FWS within-grade increases; and NAF pay increases).

(3) Cash and honorary award programs to recognize significant individual and group contributions (SES performance bonuses; GS, NAF, and FWS performance awards; GS quality step increases; and time-off and honorary awards).

(4) Policy and procedures for dealing with employees who fail to meet performance expectations.

(5) Personnel demonstration projects and ESPs use systems that reward high performance or contributions to mission and place less emphasis on longevity for pay and retention.

b. As with the military performance evaluation systems, the Civilian evaluation process is designed to enhance supervisor/employee communications and day-to-day relationships to improve overall performance. At the beginning of each rating period, the rating supervisor and the employee determine job requirements and develop a performance plan for the year. The performance plan should reflect the organization's mission and goals and the duties and responsibilities of the employee in concert with individual position descriptions. The performance plan may change during the year when the mission requires a re-ordering of responsibilities and priorities. At least once during the performance cycle (usually at the midpoint of the rating period) the rating official must conduct an in-progress review of employee performance. The in-progress review typically involves a discussion of employee achievements, any changes to performance expectations and ways to improve performance. At the end of the rating period, the rating chain compares the individual's contributions to the requirements in the performance plan and renders a rating of record. The rating of record is used to make promotion/pay increase and training decisions, document justification for performance-based cash awards and honorary awards, and give additional credit for reduction-in-force/workforce shaping purposes. The evaluation process is also used to assist employees who experience performance problems. Performance counseling sessions may be used to help employees improve to an expected level or the evaluation can serve to support removal from the position if employees fail to meet standards. The keys to successful performance management are frequent, two-way communication and timely, appropriate action to either recognize significant contributions or correct performance which fails to meet expectations.

### **13-20. Training and Development of Employees**

On 10 December 2009, significant federal changes governing the training, supervisory, management, and executive development of employees went into effect. These changes were published by OPM in the federal register and pertain to 5 CFR Parts 410 and 412 (Training; Supervisory, Management, and Executive Development). Based on these new requirements, the Army is developing and maintaining training programs to include all training activities in support of organizational missions and to support the first of the federal requirement to regularly evaluate Army training programs and plans with respect to accomplishing the agency's specific performance plans and strategic goals. Organizational managers and supervisors are required to develop, coordinate and administer their training and development programs. Army executives, managers and supervisors are required to define their training requirements in support of the life cycle management of employee development through competency-based training.

a. Training Programs. Training categories cover from executive and management courses to adult basic education. Training is classified as either short or long-term (more than 120 days). The actual

## CIVILIAN HUMAN RESOURCE MANAGEMENT

training can be delivered through on-the-job training at local activities, Army schools, DOD schools, CHRA locations, interagency schools, formal schools, and a host of other government and non-government sources as well as online sources. Civilians may also compete for attendance in formal training programs such as Senior Service Colleges. The Army Regulation (AR) 215 series of documents establishes training requirements for both APF and NAF employees in MWR activities. This training is met largely through courses sponsored and/or conducted by the Installation Management Academy.

### b. Career Management System.

(1) To establish basic policies and program requirements for the intake, assignment, training, and development of employees in designated occupations, the Army developed The Army Civilian Training, Education and Development System (ACTEDS) as outlined in AR 690-950, Career Management. These systems support supervisors in recruiting candidates for long-term career opportunities and ensure a steady flow of capable, fully qualified, and trained personnel for Army positions in 31 Civilian career professional, technical, and administrative fields.

(2) The career management system provides clear lines of progression to successively more responsible positions and a coordinated training and development program for occupational specialties, using both Army and outside facilities. Procedures are provided for counseling employees, planning individual development programs and appraising employee competencies. New employees participate in planned work or rotational assignments designed to develop technical and leadership competencies to prepare for future managerial responsibilities. The ACTEDS is the DA-wide program by which these objectives are accomplished and funded.

(3) For higher-grade positions, typically for promotion to grades GS-13 through GS-15, candidates are considered on an Army-wide basis. Application procedures depend on the particular career program.

(4) The above procedures apply to APF personnel, including those working in MWR programs.

### 13-21. Workers' Compensation Program

#### a. Appropriated Funds (AF)

(1) Federal employees who are injured or become ill as a direct result of their employment are entitled by the Federal Employees Compensation Act (FECA) to medical care and salary replacement (compensation) while they are not working. Benefits are also available for a surviving spouse and dependents if the death is job related. Additionally, employees are entitled to a lump sum payment if there is a permanent loss or impairment of a body part because of their employment. The Workers' Compensation program is costly to the Army, both in dollars and in lost human potential. The majority of the cost stems from workers who never return to Army employment and continue to draw a salary replacement for their lifetimes.

(2) To maintain control of these costs, each installation is required to have a FECA working group established by the Senior Commander, who chairs the group. The FECA working group will also include the Injury Compensation Specialist (ICS), representatives of management, medical, safety, and investigative service staff. The working group is required to meet at least quarterly to analyze trends and develop cost-containment initiatives. The ICS located in the CPAC has the lead in administering the installation level workers' compensation program. An employee who does not return to productive employment is entitled to salary replacement (compensation) for the employee's lifetime. The ICS and supervisor are also responsible for ensuring questionable claims of injury or illness are challenged so the Army is not charged for undue expenses. The ICS should be in frequent contact with all injured employees and ensure each treating physician understands the Army is eager to offer light duty or modified employment.

(3) Managers and supervisors have several obligations in the FECA program:

(a) To ensure all workplaces are as safe as possible, employees are trained on safe work practices and issued appropriate safety equipment, and constantly enforce safety standards. All workplace injuries and illness should be investigated by the supervisor and by the safety office to correct the cause of the injury or illness.

(b) To ensure employees are aware of reporting procedures, if injured.

(c) To advise employees of their right to seek medical care for the injury.

(d) To work with the employee and ICS to adjust work assignments, in accordance with medical restrictions, to allow employees to return to work as soon as medically feasible.

b. Non-Appropriated Funds (NAF). NAF employees are entitled to worker's compensation benefits established under provisions of the Non-Appropriated Funds Instrumentalities (NAFI) Act of 1958 (5

## HOW THE ARMY RUNS

U.S.C. 8171-8173), which extends the provisions of the Longshore and Harbor Workers Compensation Act (LHWCA) (33 U.S.C. 901 et seq.). Worker's compensation provides benefits to NAF employees who are disabled because of job-related illness or injury or to the surviving spouse and dependents in cases of death from job-related causes. Benefits apply to employees of NAFI/entities employed inside the continental United States or employees of NAFI/entities who are U.S. citizens, permanent residents of the U.S., a territory, or possession of the U.S. and employed OCONUS. Benefits do not apply to active duty military personnel employed by NAFI/entities or local Civilians employed by NAFI/entities overseas. AR 215-3, N Personnel Policy and AR 215-1, Morale, Welfare, and Recreation Activities and Non-Appropriated Instrumentalities outline established processes and procedures related to Worker's Compensation for NAF employees.

### **13-22. Communication, Discipline, and Labor-Management Relations**

Supervisors are responsible for striving to develop a cooperative labor-management relationship; administering labor-management agreements; communicating management objectives, decisions, and viewpoints to their subordinates; and communicating their subordinates' views to higher-level management. Supervisors must analyze problems, develop solutions, and evaluate the results of decisions. The CPAC is responsible for assisting management in the day-to-day business of employee performance, discipline, individual adverse actions, effective use of recognition and awards, labor-management-employee relations, administration of leave and hours of work, and monitoring health and safety conditions.

a. If an employee believes his or her rights have been denied, improper procedures have been followed, or an action taken by management is unwarranted, he or she may use appropriate forums for relief. Such forums may include but are not limited to Administrative Grievance Procedures, Negotiated Grievance Procedures, Alternative Dispute Resolution (ADR), the MSPB, the OSC and EEO channels. Adverse actions may be appealed to the MSPB (except in cases of a short suspension defined as 14 days or less). Short suspensions and reprimands may be contested through the Administrative Grievance System or Negotiated Grievance Procedures. Subsequently the courts may also be used.

b. The grievance procedures (both in policy and through negotiated agreements) specify steps to be followed for resolving employee dissatisfaction with any aspect of working conditions, working relationships or employment status. Army policy encourages timely resolution at the lowest level practical. However, grievances can escalate up the chain of command, or, if under a negotiated grievance procedure, lead to binding arbitration.

c. Negotiated grievance procedures are outlined in labor contracts which are jointly developed by management and the local labor union granted exclusive recognition to represent all bargaining member employees (whether or not the employees are union members). The legal basis for the labor-management relations program for federal employees is 5 U.S.C. Chapter 71. It states that labor organizations and collective bargaining in the civil service are in the public interest. The rights and obligations of employees, unions and agency management are also established in AR 215-3 which provides the framework for addressing labor-management relations for NAF employees.

d. Supervisors are obliged to maintain a willingness to bargain collectively with labor organizations. Despite earnest efforts, there may be a time when an impasse will result, and if both parties fail to resolve their differences, the law provides for a neutral third party to resolve the impasse. This is the job of the Federal Mediation and Conciliation Service (FMCS) and the Federal Service Impasses Panel (FSIP). The FMCS assists the parties in reaching a voluntary agreement. Failing this, the FSIP may impose a settlement on the parties.

e. Management should strive to ensure non-adversarial labor-management relationships are nurtured so mission accomplishment is enhanced rather than inhibited by the labor relations process. Management is also responsible for the following:

(1) Negotiating in good faith regarding conditions of employment (e.g., personnel policies, practices, and matters affecting working conditions).

(2) Furnishing official time to union representatives for negotiating collective-bargaining agreements and for other representational purposes as provided for by negotiated agreement.

(3) Deducting union dues from the pay of eligible employees who authorize such deductions and allotting those deductions to recognized unions.

(4) Notifying recognized unions and giving them the opportunity to be present at formal discussions between management and one or more employees.

## CIVILIAN HUMAN RESOURCE MANAGEMENT

(5) Allowing the union an opportunity to be represented at any examination of an employee pursuant to an investigation if the employee reasonably believes the examination may result in disciplinary action and if the employee requests representation (this is called the Weingarten Rights).

f. Certain ground rules are established to safeguard the basic intent of the law. The FLRA is an independent administrative agency presided over by three members appointed by the POTUS. The FLRA is the central policymaking body of the federal labor-management relations program. It decides representation questions (whether a union is eligible to represent certain groups of employees or whether particular employees fall within the certified bargaining unit), adjudicates negotiability disputes (whether there is an obligation to negotiate on specific proposals), adjudicates Unfair Labor Practices (ULP) (i.e., a violation of the provisions of Title VII) and decides appeals to arbitrators' awards.

g. Responsibilities of CPAC Directors. The CPAC Director is the designee of the installation/activity commander and, as head of the CPAC, is responsible for administering the Civilian personnel program. Note that the commander retains overall responsibility for managing and leading the Civilian work force. The CPAC director has responsibility for implementing, maintaining, and evaluating local personnel programs designed to assist supervisors with their personnel management responsibilities and achieve activity mission objectives. The CPAC Director interprets personnel policies and regulations and provides guidance and assistance in personnel matters in his or her assigned areas of responsibility. The CPAC Director must seek to ensure management actions affecting Civilian employees will enhance the Army's reputation as a good and fair employer, ensure employee productivity, support EEO and maintain effective community relations. The CPAC Director also has oversight of the local NAF personnel program. The CPAC director is assisted in the administration of the NAF discipline and labor relations programs by a NAF Human Relations Officer as well as the NAF personnel program in general.

h. Executive Order 13522, Creating Labor-Management Forums to Improve Delivery of Government Services (9 December 2009). Among other responsibilities, this EO provides for establishing labor-management councils at the level of recognition and other appropriate levels agreed to by labor and management. Labor-management councils are intended to help identify problems and propose solutions to better serve the public and the agency mission. In addition to councils, the EO provides for employees and their union representatives to have pre-decisional involvement in all workplace matters to the fullest extent practicable. The CPAC can provide additional guidance and instruction on the local implementation of the provisions of EO 13522.

### **13-23. Army Civilian Wellness Program**

The Army's Civilian Wellness program helps employees enhance mental and physical well-being, prevent health problems, engage in health promoting behaviors and find assistance and support in times of need. Studies show that on average, employees who are healthy, and personally and professionally satisfied, are more productive, spend fewer days away from work due to illness, and are more engaged in their work. The Army's Wellness Vision statement is as follows: To improve the health and well-being of DA employees' lives through health education and activities that encourage and support positive lifestyle and healthy living changes thereby resulting in improved employee productivity and morale and healthcare cost savings for the Army. The wellness program is covered by AR 600-63, Army Health Promotion.

## **Section V Equal Employment Opportunity in the Army**

### **13-24. EEO and Diversity in the Army**

a. Discrimination in the workplace negatively affects employee morale, productivity and teamwork, increases employee absenteeism and turnover and takes focus away from mission readiness.

b. To ensure full implementation and intent of the law, the DA willfully complies with requirements set forth in, to include but not limited to: Title VII of the Civil Rights Act of 1964, as amended; 29 CFR Part 1614; The Rehabilitation Act of 1973, as amended; Sections 501, 504, 508 of Title VI, The Equal Pay Act of 1963, as amended; The Age Discrimination in Employment Act of 1967, as amended; The Architectural Barriers Act of 1968, as amended; The Genetic Information Nondiscrimination Act (GINA) 42 U.S.C. 2000; and all applicable implementing instructions from the DOD, the EEOC, and the OPM.

c. The Policy of DA is to provide equal opportunity in employment for all persons, to prohibit discrimination in employment because of race, color, religion, sex, national origin, age, disability, or

## HOW THE ARMY RUNS

genetic information, and to promote the full realization of EEO, diversity and inclusion principles in managing all human resources. No person shall be subject to retaliation for opposing any practice made unlawful or for participating in any stage of an administrative or judicial proceeding under these statutes.

d. The EEOC has authority and oversight for the federal sector EEO program and provides federal agencies instruction and direction about how to obtain model EEO programs, practices and processes through affirmative employment planning models, identifying barriers that prevent employment and implementing strategies for diversity and inclusion. EEOC also provides for the EEO Complaint Process which encourages and enables opportunities to resolve allegations of employment discrimination quickly and administratively. The Army's authority to administer, manage and direct the Army's EEO & Diversity Programs is delegated to the Deputy Assistant Secretary of the Army for Diversity and Leadership (DASA DL).

e. Within the Office of the DASA DL, the Policy and Programs Directorate is responsible for the administrative oversight of the Army's EEO and Diversity Program and is the proponent for AR 690-12.

f. Responsibility for EEO, Affirmative Employment, Diversity, Inclusion, Education and Training programs extends from the Secretary of the Army to the ASA (M&RA), to the Deputy Assistant Secretary of the Army for Diversity and Leadership to Commanders and Leaders at all levels. The Army's EEO & Diversity Programs focus on evaluating and assessing Army workforce (Civilian and military) demographics compared to appropriate labor force statistics, trends and/or barriers to employment and less than expected participation rates of groups in order to develop and implement strategies that address both internal training and development as well as external outreach to create a motivated talent pool capable of accomplishing the mission. The Army documents progress, strengths and weaknesses annually in the federal EEO Progress Report - Management Directive 715, The State of the Agency Briefing and through the administration of the 31 Army Career Programs.

g. The ASA (M&RA) serves as the Agency Director for EEO with responsibility for EEO, Diversity, and EEO Compliance and Complaints Review/Adjudication Policy.

h. The DASA DL develops, directs and implements Army wide EEO, Diversity, EEO Compliance and Complaints policy and program evaluation and reporting requirements.

i. Commanders are responsible and accountable for effectively executing EEO programs and creating a climate where it is clear to Soldiers and Civilians that unlawful discrimination and harassment (sexual/non-sexual) will not be tolerated. All allegations of discrimination will be dealt with seriously, swiftly and effectively in accordance with all applicable laws, regulations, and procedures. Commanders will sign EEO policy statements expressing support of Army EEO and diversity policy upon assumption of command and disseminate them annually. The Commander serves as the senior rater of the EEO Official in the performance evaluation and review process.

j. The EEO Official is a member of the Commander's personal/special staff. EEO Officials are a part of the management team, not an advocate for employees, and serve as an advocate for leadership, federal civil rights, due process, employee's rights, the EEO complaints process, and strategic management of human capital. A reporting structure will be maintained that provides the EEO Official direct access to the Commander and senior leaders as a trusted and confidential advisor for effective management and resolution, reporting, compliance, efficiency, and resources for the EEO Program. The EEO Official and staff will be used as a valued partner/advisor on all matters in the management and implementation of the CHR programs and decision making models and processes within the command.

### **13-25. The Equal Employment Opportunity Complaints Program and Process**

a. Within the office of the DASA DL, the Equal Employment Opportunity Compliance and Complaints Review (EEOCCR) Directorate is responsible for the administrative oversight of the Army's EEO Complaints Program, and is the proponent lead for AR 690-600, Equal Employment Opportunity Discrimination Complaints which implements the complaints program. DL-EEOCCR monitors Army compliance with laws, statutes, and regulations governing EEO complaint processing, reports the Army's compliance status to the EEOC annually, and is the complaint records custodian for the Army. DL-EEOCCR is also the Army's adjudicator of the merits of formal EEO complaints when final agency decisions are requested or required.

b. EEO offices generally have one of two roles: operational and administrative. Operational EEO offices are responsible for processing EEO complaints and providing training and information to the workforce. Many operational EEO offices are located on Army installations and provide services to tenant commands on the installations as well as their own commands. Administrative EEO offices are



## CIVILIAN HUMAN RESOURCE MANAGEMENT

responsible for monitoring complaint activity within their area of responsibility but generally do not process EEO complaints themselves. Army Commands (ACOM), Army Service Component Commands (ASCC), and Direct Reporting Units (DRU) headquarters EEO offices are generally administrative. Some administrative EEO offices have oversight and support responsibilities for operational EEO offices.

c. On behalf of the Commander, the EEO Officer is charged with the duty to impartially execute the EEO Complaints Program and ensure that due process is preserved. Commanders should be briefed on the status of current complaints within the command, the use of ADR, the timeliness of complaint processing, the office complaint load overall (if the EEO office processes complaints for tenant organizations as well as the command), and trends in complaints that impact the command. Other senior leaders should also be briefed on the status of complaints within their area of responsibility as appropriate.

d. The Complaints Process. Army employees, former employees, applicants for employment, and contractors who believe they have been discriminated against by the Army with respect to a term, condition, or benefit of employment on the basis of race, color, national origin, religion, sex, age (40 and over), mental or physical disability, genetic information, or in reprisal or retaliation for having engaged in protected EEO activity have the right to initiate an EEO complaint with the Army. Examples of employment actions that may give rise to a complaint include, but are not limited to, hiring and promotion decisions, performance evaluations, reassignments, disciplinary actions, and harassment.

e. Individuals must contact the EEO office, or anyone reasonably connected to EEO, to initiate a precomplaint. Contact must be made within 45 calendar days from the date the individual knew or should have known about the alleged discrimination. An employee from the EEO office will conduct a precomplaint interview with the individual, called the aggrieved, and document the claim and the narrative information. An EEO Counselor will be assigned to conduct a limited inquiry into the claims alleged. When deemed appropriate by the EEO officer, and after coordination with Labor and Management Employee Relations (LMER), legal officials, and Army management, ADR may be offered to the aggrieved as a means of resolving the complaint. If resolution of the complaint is reached at any point in the process, the terms of the resolution will be documented in a written negotiated settlement agreement. Commanders and other senior leaders can promote ADR programs and encourage managers and supervisors in their organizations to participate in ADR. If the complaint cannot be resolved, the aggrieved will receive a Notice of Right to File a Formal Complaint of Discrimination, and will have 15 calendar days from the date of receipt of the notice to file a formal complaint.

f. Upon receipt of a written formal complaint, the EEO officer will determine whether the claim(s) alleged can be dismissed for procedural reasons provided in 29 CFR 1614 and AR 690-600. A claim(s) that cannot be dismissed will be accepted. The EEO officer will issue a letter accepting and/or dismissing claims identified in the complaint within 15 calendar days of receipt of the formal complaint. If a claim is accepted, a formal investigation is arranged and ADR may be offered again. The EEO office will request the assignment of an investigator from the DOD IRD. IRD charges a flat administrative processing fee for requests for investigators. The activity where the discrimination is alleged to have occurred is responsible for paying the IRD fee and identifying the activity Point of Contact (POC) who will make the payment. Once an investigator is assigned, the EEO office will coordinate the investigation. IRD investigations are conducted via Fact Finding Conference (FFC), the Army's preferred method of investigation. The FFC is attended by the investigator, the complainant and complainant's representative, and any responding management officials, witnesses, agency representatives, and a certified court reporter. Commanders and other senior leaders are required to ensure that their organizations cooperate with any request from an EEO for documentation or the testimony of a Soldier or Civilian within the command identified as a witness. Testimony is taken under oath and on the record from the complainant, the responding management official, and other witnesses. The activity where the discrimination is alleged to have occurred is also responsible for paying for a certified court reporter to take a verbatim transcript of the investigation. The investigator will use the verbatim transcript and complaint documents to draft a Report of Investigation (ROI). The ROI is a compilation of facts and evidence taken under oath to be used to make a decision on the merits of the complaint at a later time. The Army is responsible for ensuring that investigations are completed within 180 calendar days of the formal filing date or within 120 calendar days where the complaint involves an issue appealable to the MSPB. The investigation officially ends when the EEO office receives the ROI.

g. Once the EEO office receives the ROI, a copy is sent to the complainant, along with a Post-Investigative Options Notice. This notice provides the complainant the option of either requesting a

## HOW THE ARMY RUNS

hearing before an EEOC Administrative Judge (EEOC AJ) or requesting a Final Agency Decision (FAD) from the EEOCCR. If the complainant fails to select an option, the EEO office will request a FAD on the complainant's behalf. If the complaint involves an issue appealable to the MSPB, the complaint will be sent to the EEOCCR for a FAD. If the complainant elects to request a hearing, the hearing request, along with a copy of the complaint file, is sent to the appropriate EEOC regional or field office and the EEOC AJ is appointed to hear the complaint. Once the hearing is scheduled, witnesses will be required to attend and provide sworn testimony at the hearing. The activity where the discrimination is alleged to have occurred is also required to pay for the services of a court reporter to take a verbatim transcript of the hearing. After the hearing, the EEOC AJ will issue a decision stating whether discrimination was or was not found to have occurred. The EEOC AJ decision is forwarded to the Army (EEOCCR) for issuance of a Final Agency Action (FAA) implementing the AJ's decision. The complainant has the option of appealing a FAA or a FAD to the EEOC Office of Federal Operations (OFO) or filing suit in federal court. The Army may choose to appeal an EEOC AJ's finding of discrimination to the EEOC OFO instead of issuing a FAA.

h. Failure to cooperate with the complaint process places the Army at risk. A finder of fact, such as an EEOC AJ or EEOCCR, may determine the failure to cooperate constitutes sufficient grounds to presume that unlawful discrimination occurred. This is called an adverse inference, and essentially means a prima facie case of discrimination is established and the agency bears the burden of providing evidence to rebut the adverse inference. When a finder of fact determines that discrimination occurred, the activity where the discrimination occurred is responsible for providing any relief the complainant is deemed entitled to, such as funding monetary damages (including attorney fees), initiating personnel actions and conducting a culpability study of management officials found to have discriminated to determine what, if any, disciplinary action(s) should be taken. A management official found to have discriminated against an employee may be subject to discipline, including termination in accordance with AR 690-700, Chapter 751 Table of Penalties. A finding of discrimination may also prevent a management official from being eligible for certain awards and prevent an officer from promotion into or up through the General Officer ranks.

### Section VI

#### Executive and Senior Professional Personnel

##### 13-26. Executive and Senior Professional (ESP) Structure and Composition

a. Civilian senior leadership is crucial to the support of military operations in a wide range of functions necessary for the Army to achieve battlefield success. This includes roles in procurement, logistics, research and development, finance, and human capital management. Executive and Senior Professional (ESP) positions are above the GS-15 level and salaries may range as they do for general officers. OPM establishes the regulations and allocations for ESP positions. DA requests allocations through OSD. Army's authorized ESP positions include a broad range of occupational series spanning across the U.S. and overseas. However, almost half of the Army's ESP positions are located in the National Capital Region.

b. On 9 August 2010, the SECARMY signed the Executive Resources Board (ERB) Charter. The ERB plays an active, robust role in formulating policies for and in the management, governance and oversight of Army ESP programs. The ERB also reviews and renders decisions or opinions on certain actions affecting ESP members and positions, including ESPs assigned to combatant commands (COCOM) to which the Army provides administrative and logistical support. The ERB advises the SECARMY on matters relating to the hiring, training and development, utilization, performance evaluation, and compensation of the Army's ESP workforce, which includes career SES, SL, ST, DISES, and DISL personnel. The ERB may also provide advice on, and oversight of, matters relating to other Army executive-level positions.

##### 13-27. Qualifications of Senior Executive Service Members

a. There are five Executive Core Qualifications (ECQ) all potential SES members must demonstrate prior to selection. They are:

## CIVILIAN HUMAN RESOURCE MANAGEMENT

(1) **Leading Change.** This core qualification involves the ability to bring about strategic change, both within and outside the organization to meet organizational goals. Inherent to this ECQ is the ability to establish an organizational vision and to implement it in a continuously changing environment.

(2) **Leading People.** This core qualification involves the ability to lead people toward meeting the organization's vision, mission, and goals. Inherent to this ECQ is the ability to provide an inclusive workplace that fosters the development of others, facilitates cooperation and teamwork, and supports constructive resolution of conflicts.

(3) **Results Driven.** This core qualification involves the ability to meet organizational goals and customer expectations. Inherent to this ECQ is the ability to make decisions that produce high-quality results by applying technical knowledge, analyzing problems and calculating risks.

(4) **Business Acumen.** This core qualification involves the ability to manage human, financial and information resources strategically.

(5) **Building Coalitions.** This core qualification involves the ability to build coalitions internally and with other federal agencies, state and local governments, nonprofit and private sector organizations, foreign governments, or international organizations to achieve common goals.

b. The executive development of employees in GS-14 and 15 grade levels or equivalent is an important command responsibility. ESP members are expected to possess leadership competencies that parallel those of Army general officers. Therefore, attendance at a Senior Service College program is a highly desirable experience for Civilians who aspire to ESP positions. Appointment to the ESP marks achievement of the highest nonpolitical Civilian executive position. These positions are given protocol precedence equivalent to lieutenant general, major general or brigadier general.

c. For more information on ESP positions go to <http://www.opm.gov/ses/index.asp>.

### **Section VII**

#### **Defense Civilian Intelligence Personnel System (DCIPS)**

##### **13-28. Structure and Composition of the Defense Civilian Intelligence Personnel System**

a. DCIPS employees are U.S. citizens paid from APFs. Unlike other APF Civilians, they are managed through a statutorily based excepted personnel service administered by the OSD for the DOD Intelligence Community.

b. There are approximately 6,800 Civilians in the Army under this personnel system. The Army includes in DCIPS all employees in series and specialties with clear ties to the intelligence arena wherever they are found. Some examples are intelligence specialists in the 132 series and intelligence assistants in the 134 series regardless of function as well as security specialists in the 080 series and security assistants in the 086 series where 51 percent or more of their duties are intelligence related (not law enforcement related). DCIPS coverage by series/function has resulted in most major commands having at least some DCIPS employees. The Army has also included in DCIPS all employees (except local nationals) in commands having a primary intelligence mission. Many of the administrative, technical, and support series, and a few wage grade employees in DCIPS, as well as the Army's intelligence and security professionals, are found in such commands as the U.S. Army Intelligence and Security Command (INSCOM).

##### **13-29. Relationship of DCIPS to the Army Civilian Personnel Program**

a. DCIPS is considered a part of the Army's overall Civilian personnel program and has tested innovative personnel management features for the Army and DOD. As a statutory alternative personnel system, DCIPS is exempt from Title VII job classification provisions and has adopted the use of the National Security Agency's (NSA) classification system to better align grades with the rest of the intelligence community. DCIPS is also exempt from many OPM hiring provisions and can directly consider applications from non-government employees through its own merit system. In 2009, DOD revised DCIPS to encompass all of DOD's intelligence community, not just the military services.

b. Civilian personnel service support for CONUS intelligence activities are consolidated at the Fort Huachuca CPAC and West Regional Processing Center at Fort Huachuca, Arizona. This consolidation improved HR understanding and system expertise and increased personnel service effectiveness and efficiency.

## HOW THE ARMY RUNS

c. DCIPS was implemented in FY 1990, first as a tri-service system known as the Civilian Intelligence Personnel Management System (CIPMS), and then evolving into DCIPS when a provision of the DOD Authorization Act of 1997 (known as the DOD Civilian Intelligence Personnel Policy Act of 1996) combined Civilian personnel management systems for DOD intelligence components into one broad excepted service system. DCIPS legislation and supporting initiatives continually strive to achieve a broad common architecture of policies, systems and standards while protecting individual Service and agency prerogatives. Common employment and compensation architectures are planned along with inter-community rotational and development programs. Common senior executive and leader programs have also been developed. These include the DISES for intelligence executives and the DISL program for senior experts in the Section VIII Civilian Expeditionary Workforce (CEW).

### 13-30. Civilian Expeditionary Workforce

a. DOD issued a new Directive-type Memorandum (DTM), 17-004, DOD Expeditionary Civilian Workforce on 25 January 2017. This new directive reissued the previous DODD 1404.10, DOD Civilian Expeditionary Workforce (dated 23 January 2009) to establish the policy through which an appropriately sized subset of the DOD Civilian workforce is pre-identified to be organized, trained, and equipped in a manner that facilitates using their capabilities for operational requirements. These requirements are typically away from the normal work locations of DOD Civilians, or in situations where other Civilians may be evacuated to assist military forces where the use of DOD Civilians is appropriate. These employees are collectively known as the DOD Expeditionary Civilians (DoD-EC). The DTM 17-004 also superseded any conflicting portions of other DOD issuances. Members of the DoD-EC are to be organized, trained, cleared, equipped, and ready to deploy in support of DOD operations by the military to include combat operations, contingencies, emergency operations, humanitarian missions, disaster relief, restoration of order, drug interdictions, and stability operations in accordance with DODD 3000.05.

b. Force Integration. DOD's civilian workforce capabilities are integrated into DOD Total Force planning processes. Civilian manpower requirements are sourced and designated consistent with the manpower policy and procedures in DODI 1100.22 (Policy and Procedures for Determining Workforce Mix). DoD-EC requirements are included in the DOD Global Force Management process.

c. Implementing the DoD-EC program in the Army requires commands to identify and designate a portion of their workforce as DoD-EC. Additionally, Commanders of major commands are responsible for ensuring all designated DoD-EC employees are properly trained, equipped, and ready to deploy. This also includes ensuring all employees returning from a deployment complete the required Post Deployment Health Assessments (e.g., 30 and 90 to 180 days after deployment). To aid Commanders in ensuring the readiness of their designated DoD-EC employees, Army employees are processed through the CONUS Replacement Center (CRC) located at Fort Bliss, Texas.

e. CEW Designations and Definitions.

(1) Emergency Essential (E-E). Position-based designation to support the success of combat operations or the availability of combat-essential systems in accordance with 10 U.S.C. 1580 and designated as key.

(2) Non Combat Essential (NCE). A position-based designation to support the expeditionary requirements in other than combat or combat support situations and designated as key.

(3) Capability Based Employee Volunteers (CBV). An employee who may be asked to volunteer for deployment, to remain behind after other Civilians have evacuated, or to backfill other DOD Civilians who have deployed to meet expeditionary requirements to accomplish critical expeditionary requirements that may fall outside or within the scope of an individual's position.

(4) Capability-Based Former Employee Volunteer Corps. A collective group of former (including retired) DOD Civilian employees who agree to be listed in a database as individuals who may be interested in returning to federal service as a time-limited employee to serve expeditionary requirements or who can backfill for those serving other expeditionary requirements.

(5) Key Employees. DOD Civilian employees in positions designated as E-E and/or NCE are to be designated key in accordance with DODD 1200.7.

## CIVILIAN HUMAN RESOURCE MANAGEMENT

### Features:

- Designated subset of employees to respond within 72 hours to 30 days of notification
  - **EE—Emergency Essential:** a position-based designation to support combat operations or combat-essential systems in a combat zone (10 U.S.C. 1580). Deployability required as condition of employment
  - **NCE—Non-Combat Essential:** a position-based designation to support non combat missions. Deployability required as condition of employment
  - **CBV—Capability Based Employee Volunteers:** a personnel-based designation to support voluntary identification of capabilities outside scope of an employee’s position for EE and NCE requirements
  - **Reserve Team—Inventory of Former or Retired DOD Employees:** prepared to support backfill or deployed requirements

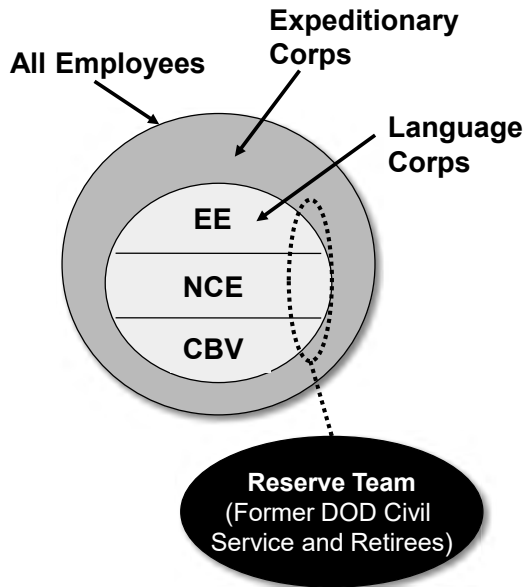

Figure 13-3. Civilian Expeditionary Workforce Model

### Section VIII Army Personnel Transformation

#### 13-31. Current and Transforming Civilian Human Resource Administration

The current CHR force is vital to the Army’s mission. Each CPAC staff member is a strategic partner with serviced commands, managers and supervisors. Today, the Army faces significant challenges as it transforms to a more agile and technology-based force. The CHR community will use process improvement methodologies to redesign business processes and delivery services and reinvest those savings into the organization to continue providing world-class customer service.

#### 13-32. Career Management

In 2011, the Army undertook transformation initiatives to expand career program coverage to encompass 100 percent of its Civilian population, both APF and NAF, except for National Guard Bureau technicians and indirect hire foreign nationals. Functional Chief and Functional Chief Representative roles and responsibilities were expanded to exercise an evolving strategic and competency-based, life-cycle management planning environment and to address occupational and career program management matters across command lines.

#### 13-33. Hiring Reforms

Army’s HR community will continue to support recruitment and hiring reform objectives developed to improve the quality and speed of the hiring process. In addition, these hiring reforms require managers and supervisors to assume a greater responsibility and accountability in the planning, recruitment and selection of the employees under them.

# HOW THE ARMY RUNS

## Section IX Summary and References

### 13-34. Summary

a. The purpose of the Army Civilian Personnel Management System is to provide a motivated and technically qualified work force to meet Army requirements. The Civilian workforce is an integral part of the Army team. Army Civilians play an important role in all Army missions and share in the Army's accomplishments. The Army employs Civilians because they possess unique skills, ensure operational continuity, are economical and permit military personnel to perform military duties. The Civilian personnel management system and its supporting policy and service organizations contribute significantly to the Army's overall mission.

b. More than half of Army Civilian positions are bargaining unit positions represented by labor unions. Army leaders, both Civilian and Military, must accept their labor-management responsibilities. The efficiency of Army operations cannot be allowed to fail due to an unhealthy labor climate where leaders did not accept their obligations to advise, consult, and bargain as the law requires.

c. As the force downsized and underwent initiatives to convert former military positions to Civilian occupancy, more Civilians assumed key roles in headquarters and support activities, schools and training centers, and BASOPS. For many of these important positions it may not be possible to hire people with the necessary skills. Therefore, the Army must develop Civilians from within its current ranks.

d. This chapter provided a brief overview of the Civilian Personnel Management System to describe how the major processes are designed to support Army leaders. It is important to understand the legal basis for the federal civil service, how the Army's system works within the federal system, and also the regulatory basis and practices for the Army's NAF Personnel System. Furthermore, commanders and managers at all levels must have a clear understanding of the nature of the Civilian personnel structure, programs and mission, and their responsibilities to provide effective leadership and management. DACs are part of an Army team comprised of a diverse workforce dedicated to doing the best job possible to ensure Army missions are accomplished effectively. The Army and DOD Civilian personnel web sites contain a great deal of helpful information and may be accessed at [www.cpol.army.mil](http://www.cpol.army.mil) and [www.cpms.osd.mil](http://www.cpms.osd.mil), respectively. The CSLMO also has a secure web site which may be accessed by those holding a CAC registered with AKO at <https://www.cslmo.army.mil>.

### 13-35. References

- a. 5 CFR Parts 410 and 412, Training; Supervisory, Management, and Executive Development.
- b. Age Discrimination in Employment Act of 1967.
- c. Americans with Disabilities Act of 1990.
- d. Architectural Barriers Act of 1968.
- e. AR 10-89, U.S. Army Civilian Personnel Evaluation Agency.
- f. AR 215-1, Morale, Welfare, and Recreation Activities and Non-Appropriated Fund Instrumentalities.
- g. AR 215-3, Non-Appropriated Funds Personnel Policy.
- h. AR 570-4, Manpower Management.
- i. AR 600-3, The Army Personnel Proponent System.
- j. AR 600-7, Nondiscrimination on the Basis of Disability in Programs and Activities Assisted or Conducted by the Department of the Army.
- k. AR 600-63, Army Health Promotion.
- l. AR 672-20, Incentive Awards.
- m. AR 690-11, Use and Management of Civilian Personnel in Support of Military Contingency Operations.
- n. AR 690-12, Equal Employment Opportunity Program and Affirmative Action.
- o. AR 690-13, CIPMS - Policies and Procedures.
- p. AR 690-400, Chap 432, Reduction in Grade and Removal Based on Unacceptable Performance.
- q. AR 690-400, Chap 4302, Total Army Performance Evaluation System (TAPES).
- r. AR 690-600, Equal Employment Opportunity Discrimination Complaints.
- s. AR 690-700, Chap 751, Discipline.
- t. AR 690-900, Chap 920, Senior Executive Service.
- u. AR 690-950, Career Management.

## CIVILIAN HUMAN RESOURCE MANAGEMENT

- v. Civil Rights Act of 1991.
- w. Civil Service Reform Act of 1978.
- x. DA Pamphlet 672-20, Incentive Awards Handbook.
- y. DA Pamphlet 690-11, Guide to Civilian Personnel Management.
- z. DA Pamphlet 690-46, Mentoring for Civilian Members of the Force.
- aa. DA Pamphlet 690-47, DA Civilian Employees Deployment Guide.
- bb. DOD Civilian Intelligence Personnel Policy Act of 1996.
- cc. DOD Authorization Act of 1997.
- dd. DOD Manual 1400.25 Subchapter 920, Executive and Senior Professional Pay and Performance.
- ee. DOD 1400.25-M, Civilian Personnel Manual.
- ff. DODI, 1400-25, DOD Civilian Personnel Management Systems: Volume 250, Civilian Strategic Human Capital Planning (SHCP).
- gg. Directive-type Memorandum (DTM), 17-004, DOD Expeditionary Civilian Workforce.
- hh. Equal Employment Opportunity (EEO) Act of 1972.
- ii. Equal Employment Opportunity Commission Management Directive 715 (EEOC MD 715).
- jj. Equal Pay Act of 1963.
- kk. Executive Order 9830, Amending the Civil Service Rules and providing for Federal personnel administration.
- ll. Executive Order 12721, Eligibility of Overseas Employees for Noncompetitive Appointments.
- mm. Executive Order 13473, To Authorize Certain Noncompetitive Appointments in the Civil Service for Spouses of Certain Members of the Armed Forces.
- nn. Executive Order 13522, Creating Labor-Management Forums to Improve Delivery of Government Services.
- oo. Executive Order 13562, Recruiting and Hiring Students and Recent Graduates.
- pp. Federal Anti-Discrimination and Retaliation Act of 2002.
- qq. Genetic Information Nondiscrimination Act of 2008.
- rr. Hatch Act of 1939.
- ss. HQDA General Orders No. 3, 9 July 2002, and amendment No. 2002-03.
- tt. Longshore and Harbor Worker's Compensation Act (33 U.S.C. 901 et seq.).
- uu. Management Directive 715 State of the Agency Report.
- vv. Non-Appropriated Fund Instrumentalities Act of 1958 (5 U.S.C. 8171 – 8173).
- ww. Rehabilitation Act of 1973.
- xx. Title 5 U.S.C., Government Organizations and Employees.
- yy. 10 U.S.C. 1580: Emergency Essential Employees: Designation.
- zz. Title 33 U.S.C., Navigable Waters.
- aaa. Uniformed Services Employment & Reemployment Rights Act of 1994.
- bbb. Whistleblower Protection Act of 1989.

## HOW THE ARMY RUNS

**This page is intentionally left blank**



## Chapter 14

### Training and Leader Development

#### Section I Introduction

##### 14-1. Chapter Contents

- a. This chapter covers Army training and leader development. Included are descriptions of the Army training domains, organizations, governance, support systems, management, policy, requirements, and munitions.
- b. It details operational and institutional training, individual and collective training, unit training and training enablers. It complements the Military and Civilian Resource Management chapters of this publication by further describing how training, education, and leader development are tailored for Army officers, warrant officers (WO), non-commissioned officers (NCO), Civilians, and Soldiers.
- c. Army Regulation (AR) 350-1 prescribes policies, procedures, and responsibilities for developing, managing, and conducting Army training and leader development. AR 350-52 provides policy for the Army Training Support System. AR 350-50 provides policy for the Combat Training Center Program.

#### Section II Strategic Training Framework

##### 14-2. Overview

The Army has six strategic objectives derived from the Army Vision for 2028: Man, Organize, Train, Equip, Lead and Doctrine. In more detail, the strategic objective for training as stated in the Army Vision is to focus training on high-intensity conflict, with emphasis on operating in dense urban terrain, electronically degraded environments, and under constant surveillance. Training must be tough, realistic, iterative, and dynamic. Continuous movement, battlefield innovation, and leverage of combined arms maneuver with the Joint Force, allies, and partners must be its hallmarks. This training will require capabilities down to the company level to enhance Soldier and team lethality.

##### 14-3. Army Mission and Training

The Army Mission is to deploy, fight, and win the Nation's wars by providing ready, prompt, and sustained land dominance by Army forces across the full spectrum of conflict as part of the Joint Force. To achieve the Army Mission, readiness is the number one priority. Training is a key component of readiness. Therefore, all training must contribute to accomplishing the mission and achieving the vision.

##### 14-4. Army Training Strategic Ends

- a. Army Training directly supports the Army Vision. Training applies across the Total Force—all components—for an Army that is fully-trained, capable, and ready to achieve the vision. The Army's intent is to develop smart, discerning, and innovative leaders of character who are comfortable with complexity and capable of operating from the tactical to the strategic level. The Army is building a new talent management-based personnel system that leverages the knowledge, skills, behaviors, and preferences of its officers and noncommissioned officers to align talent with unit needs to enhance training readiness. This will be accomplished through leader development as a shared responsibility between the institutional Army (education or training institutions), the operational force (OF) (organizations or units), and the individual. The operational Army and the institutional Army work together to ensure synergy in support of combatant commanders (CCDR).
- b. Army Training Strategic Ends: A Ready (Trained) Army.

## HOW THE ARMY RUNS

(1) Train the Total Force to rapidly deploy, fight, sustain itself, and win against complex state and non-state threats in complex environments (e.g., the expeditionary mindset). The Total Army will increase its expeditionary mindset through Emergency Deployment Readiness Exercises (EDRE) across all echelons, to include division level EDREs.

(2) Train to ensure the right mix of operationally ready and responsive forces and capabilities to rapidly meet emergent combatant command (CCMD) requirements while maintaining an operational and strategic reserve.

(3) The Army must sustain readiness for large-scale combat operations while modernizing and simultaneously training and developing leaders for multi-domain operations (MDO). MDO is the Army's foundational concept for establishing overmatch against adversaries. The Army will use the MDO concept to drive capability development and force design to build a more lethal and capable ground combat force for the future. The Army will incorporate MDO into all levels of Army leader development, training, and education.

(4) Conduct tough, realistic multi-echelon home station training using the integrated training environment (ITE) consisting of live, virtual, gaming, and constructive capabilities fielded by the Army's training support system (TSS) to replicate high fidelity, complex operational environments (OE) in order to develop agile and adaptive leaders and versatile units. By 2021, the Army will begin fielding the Synthetic Training Environment, which will integrate virtual, constructive, and gaming training environments into a single platform to increase home-station training repetitions in a variety of scenarios.

(5) Train to leverage multi-echelon joint and multinational command post exercises (CPX), staff rides, simulations, and the Mission Command Training Program (MCTP) to produce a regionally capable Joint Force Land Component Commander (JFLCC) and Joint Task Force (JTF) headquarters.

(6) Ensure that Army units are trained and prepared for current, emerging, and evolving missions in areas such as homeland defense, Defense Support of Civil Authorities, space, cyberspace, missile defense, countering weapons of mass destruction, and weapons of mass destruction-elimination.

(7) Leverage the expertise and competency of the Department of the Army Civilian (DAC) component. This is key and essential to the success of Soldiers on the battlefield and to building a flexible, streamlined and responsive global force.

(8) Reinforce Army values and ethical leadership throughout all unit and institutional training, leader development programs, and professional military education (PME).

(9) Educate and develop all Soldiers and civilians to grow the intellectual capacity to understand the complex contemporary security environment to better lead Army, Joint, Interagency, Intergovernmental, and Multinational (JIIM) task forces, and teams.

(10) Open previously closed positions and occupational specialties to women while maintaining the Army's combat effectiveness. The initiative seeks to remove as many barriers as possible and allow talented people, regardless of gender, to serve in any position they are capable of performing to standard.

### 14-5. The Training Challenge

The Army's training challenge is to optimize, synchronize and support training in schools, training and education in units, and self-development training to produce forces and leaders capable of responding across the range of military operations. Internal to unit training, the greatest challenge is managing the broad array of commander responsibilities and requirements in relation to the time available to train and conduct unit activities resulting in better overall unit readiness. Prioritization of activities and requirements is imperative. Army Doctrine Publication (ADP) 7-0, Army Doctrine Resource Publication (ADRP) 7-0 and Field Manual (FM) 7-0 provide the Army's doctrinal foundation for how units train to build training readiness. Unit Combined Arms Training Strategies (CATS) are Mission Essential Task List (METL) - based training strategies which support readiness reporting requirements. They are designed to train a unit to perform its missions, employment, capabilities and functions and contain all the collective tasks designed to train the unit. Training events in the CATS provide recommendations of the methods that can be employed to train those tasks. Training events are often designed to suggest a progressive training path so that commanders can select the appropriate level of event difficulty to match the unit's level of proficiency at executing the collective tasks associated with that task set. CATS are nested crew-level to brigade combat team (BCT) or functional/multi-functional brigade, and corps, integrate Department of the Army Pamphlet (DA Pam) 350-38 and provide recommendations on who, what, how and the frequency to train. They provide recommendations on the use of training aids, devices, simulators, and simulations (TADSS), training gates, multi-echelon training, resources and provide a base

# TRAINING AND LEADER DEVELOPMENT

line purpose, outcome and execution guidance for each event. A unit commander has two major training responsibilities: prepare the unit to accomplish the designed or assigned mission and develop Soldiers/leaders for future responsibilities. The commander will use METL-based CATS to prepare the unit to perform those missions the unit was doctrinally designed to execute across the range of military operations. Assignment of a deployment mission allows leaders, in dialogue with their higher headquarters commander and with guidance from the ASCC commander, to focus their training on those METL tasks that support the deployment mission. The process for METL task development for emerging tasks and assigned missions can be found in FM 7-0.

## **Section III Operational Training**

### **14-6. Training by Operational Units**

Training prepares forces to conduct operations as doctrinally designed, or for an assigned mission. Training develops the teamwork, trust, and mutual understanding that commanders need to exercise MC and that forces need to achieve unity of effort. Training does not stop when a unit deploys. If the unit is not conducting operations or recovering from operations, it is preparing for future operations.

### **14-7. Leader Responsibility**

Leaders are responsible for the readiness of their units and the training to accomplish it. The operational domain encompasses training activities executed by operational units, whether by the entire unit, by sub-elements of the unit, or for leaders and individuals at the unit. These activities include: training conducted by unit leaders at home station and other regional/national/international training areas/facilities; training conducted for the unit at Army-sponsored training venues like Combat Training Center (CTC) rotations, Army National Guard (ARNG) exportable combat training capability lanes, and U.S. Army Reserve (USAR) combat support training exercises; and training exercises (e.g., multinational, joint, and/or service-sponsored exercises) executed by the unit.

### **14-8. Force Generation**

a. Globally Responsive Army. The Army must create and sustain a ready and capable Total Army that provides joint and combined forces with expeditionary and enduring land power for the range of military operations. This globally responsive Army will feature unique competencies such as operational leadership, mobility, command and control, and theater logistics at all echelons. It will also rapidly deploy, fight, and win whenever and wherever the Nation's interests are threatened. The globally responsive Army will maintain a responsive force posture and effective network of installations and capabilities at home and abroad to protect U.S. interests and those of its Allies, while aggressively pursuing improvements to deployment processes to eliminate institutional impediments and expediting movement of ready forces in response to Geographic Combatant Command (GCC) requirements. Finally, the Global Response Force will support the joint force with critical enablers such as aviation, intelligence, engineers, logistics, medical, signal, and special operations, both while en route to, and operating within, expeditionary environments alongside unified action partners.

b. Regional Alignment. Army forces may be aligned with a GCC. Regional alignment provides deployable and scalable, regionally-focused Army forces, that are task-organized for direct support of geographic and functional CCDR and joint requirements. A regionally engaged Army shapes and sets theaters for regional commanders while employing unique Total Army characteristics and capabilities to influence the security environment, build trust, develop relationships, and gain access through rotational forces, multilateral exercises, military-to-military engagements, coalition training, and other opportunities. A regionally engaged Army assures the readiness of forward deployed and rotational forces in support of defense strategy, and deepens regional understanding of Soldiers, leaders, and units to sharpen tactical, operational and strategic planning and operations.

c. Force Generation Process. The Army uses a deliberate process to meet operational requirements for Army forces. U.S. Army Forces Command (FORSCOM) manages force generation for the Army and ensures mission requirements are assigned to unit(s) and ensures units have training support needed to prepare for mission success (e.g., a scheduled CTC rotation). U.S. Army Special Operations Command (USASOC) manages Special Operations Force generation for the Army, ensures mission requirements

## HOW THE ARMY RUNS

are assigned to units, and ensures units have training support needed to prepare for mission success (e.g., a scheduled CTC rotation).

d. Sustainable Readiness (SR). SR is the Army's force generation concept adapted to the needs of a contingency force that is globally responsive and regionally engaged. SR sustains optimized levels of readiness throughout the Total Force to satisfy both current Global Force Management Plan requirements as well as War Plan demands; provides Army leaders with appropriate mitigation strategies consistent with available resources; operationalizes the Reserve Component (RC); leverages the unique capabilities of ARNG and USAR forces to support early and mid-deploying forces; extends the Army's planning timeline by analyzing its ability to meet requirements four years into the future; and synchronizes readiness resource decisions with program objective memorandum (POM) development.

e. Force Readiness Objectives. HQDA manages the readiness posture of the Army by directing Army force providers to achieve and maintain specified readiness levels (Readiness Objectives) for their assigned and Service-retained forces.

f. Objective T-level establishes objective means for Army units (Regular Army (RA), ARNG, USAR) to assess training readiness. This includes objective criteria in training and evaluation outlines for evaluating task proficiency, a metric for unit individual/crew-served/platform qualification, a metric for unit collective live fire proficiency, and also re-establishes an Army task framework that is hierarchical, includes all unit types and echelons, and allows for clear task cross-walks from individual through higher level collective tasks. It re-invigorates a common understanding of training-to-standard through improved Training and Evaluation Outlines. Objective T improves stewardship and optimizes training resources, establishing links between training activities, their cost, and the readiness generated.

### 14-9. Planning and Conducting Training in Units

a. Unit leaders plan and conduct training in accordance with Army training management doctrine.

b. ADP 7-0 and Field Manual 7-0, describe Army training management practices and embrace the operations process as the accepted model for planning not only operations, but also unit training and leader development. Concepts such as long-range planning and short-range planning are based on the military decision-making process and troop leading procedures as defined by ADRP 5-0, The Operations Process, and Army Tactics, Techniques, and Procedures 5-0.1. Both ADP 7-0 and ADRP 7-0 support the idea that training a unit is not fundamentally different from preparing a unit for an operation. Learning the concepts, ideas, and terminology of the operations process as units train makes the transition from training to operations a more seamless effort for both leaders and their units.

### 14-10. Troop Schools

Troop Schools help to support training execution and training management at the command or Army installation level. Commanders will use Troop Schools as part of their unit training strategy to acquire, enhance, sustain, and supplement individual military skills or pre-command education not readily available through the institutional training base. Soldiers should acquire these military skills early enough in the unit's force generation cycle to optimize their contribution to the unit. These military skills include, but are not limited to, Air Assault Operations, Arms Room Security, Mine Resistant Ambush Protected Vehicle Tactical Driving, Air Load Planning, Company Commander First Sergeant Course, etc.

### 14-11. Army Support of Unit Training

a. Army Training Management System (ATMS). Units record and manage training using the web-based resources provided by ATMS, which is comprised of the Army Training Network (ATN), the CATS development tool, and the Digital Training Management System (DTMS).

b. ATN provides units with access to online Army training doctrine, products, techniques and downloadable resources. ATN is accessed at: <https://atn.army.mil>.

c. CATS. CATS are developed for company-level and higher table of organization and equipment (TOE) units and for identified Functional Capabilities (Stability, Mission Command, etc.). CATS provide a task-based, event-driven strategy that identifies a progressive sequence of training events that can be used by the unit to develop a Unit Training Plan (UTP) to train either for their unit capabilities as reflected by their HQDA Standardized METL (see FM 7-0), or for an assigned mission. Training events in CATS range from individual, crew, and squad levels through company, battalion, brigade, division and corps levels, and provide a crawl, walk, run methodology to enable a unit to progressively build higher levels of readiness on tasks the unit is doctrinally designed to perform. CATS provide recommendations on

## TRAINING AND LEADER DEVELOPMENT

methods that can be employed to train tasks in events using Live, Virtual, or Constructive training environments. CATS are nested crew- to BCT-level, integrate the weapons training strategies listed in DA Pam 350–38, Standards in Training Commission, and provide recommendations on who, what, how, and when to train. CATS also provide recommendations on use of TADSS, training gates, multi-echelon training, resources, and provide a base-line purpose, outcome, and execution guidance for each event. CATS provide a strategy from which leaders can develop a UTP to develop mission-essential task proficiency for readiness reporting.

d. DTMS. DTMS provides support for the doctrinal training processes described in ADP/ADRP/FM 7-0. DTMS allows unit leaders to view their unit's HQDA standardized METL. DTMS is designed to assist unit leaders to plan training and record task proficiency in the individual training record (ITR) and unit training record (UTR). The ITR records an individual Soldier's accomplishment of training conducted to include records of HQDA mandatory training, and other records of training governed by AR 350-1, Army Training and Leader Development. The UTR consists of unit-level accomplishment of training conducted. Commanders use DTMS to continuously assess unit training performance in order to improve task proficiencies.

### 14-12. Army Training Models

a. Army Training Models are a family of interrelated models that support the planning, programming and budgeting system. Currently there are three primary models: Training Resource Model (TRM), Aviation Training Resource Model (ATRM), and Institutional Training Resource Model (ITRM). These models provide the basis for training resource requirements development for Headquarters, Department of the Army (HQDA) and provide rapid adjustment/assessment of changing Army inputs (e.g., force structure, training strategies, MTOE authorized equipment, cost factors, student loads, etc.). TRM, ATRM, and ITRM have been designated as authoritative data sources. The Training Resource Management Information System (TRMIS) is a web-based tool that pulls together output from TRM, ATRM, and ITRM to provide the Army Staff (ARSTAF) and Army commands with access to training resource information.

b. The Cost of Training Readiness review is an Army initiative to capture costs and measure unit readiness generated using Objective T-rating standards. The Army must be able to optimally fund units and activities needed to achieve readiness objectives. The data analysis reflects what events were executed, the density and usage of the vehicles for each training event, the readiness generated against Objective T-rating standard, and the costs associated with the unit training. Results are fed back into the training resource models to synchronize funding to readiness objectives specified for all unit types in the sustainable readiness force generation process.

### 14-13. Combat Training Centers (CTCs)

a. Vision. The Army's CTC Program remains the cornerstone of an integrated strategy that builds trained and proficient combat-ready units and leaders to conduct operations as part of the Joint Force. The CTC Program develops leaders and trains BCTs with Unified Action Partners to conduct MDO in a Decisive Action Training Environment (DATE). CTCs provide a crucible experience for units and are designed to replicate combat by stressing every Warfighting Function with operations against tough, freethinking, realistic hybrid threats under the most difficult conditions possible. The end state will be units and leaders prepared to deploy worldwide, fight with confidence, and win against any adversary, anytime, under any conditions.

b. Program Objectives. The CTC program objectives are to: increase unit readiness; develop battlefield leaders; embed doctrine; provide feedback on unit tactical effectiveness to participants; and provide data to improve Doctrine, Organization, Training, Materiel, Leadership and Education Personnel, Facilities, and Policy (DOTMLPF-P) input to the combat and training development processes. AR 350-50, The CTC Program, establishes Army policies for the management of the CTC program. The CTC program provides realistic joint and combined arms training in accordance with Army and joint doctrine, and approximates actual combat. The CTC program:

- (1) Focus on a METL with training for combat operations as part of the Joint team.
- (2) Train for MDO in a DATE and unified land operations missions including: offense, defense, stability, defense support of civil authorities, and Electronic Warfare/Cyber/Space.
- (3) Stress realistic, sustained, multi-echelon, and fully integrated collective MDO in a DATE and Unified Land Operations training for BCTs and enablers, Theater Support Commands, Expeditionary Support Commands (ESCs), sustainment brigades, functional and multi-functional support brigades,

## HOW THE ARMY RUNS

Special Operations Forces (SOF); division, corps and Army service component commands (ASCCs) as operational Army, JFLCC, or JTF capable headquarters.

(4) Focus on performance-oriented training for MDO in a DATE based scenario assessed against established tasks, conditions, and standards.

(5) Support achieving and sustaining leader development and unit warfighting readiness using a combination of integrated live, virtual, and constructive (LVC) simulations.

(6) Facilitate commanders' readiness assessment through live-fire, force-on-force, and computer-simulated exercises that integrate all aspects of lethal and nonlethal effects, tailored to the operational environment from platoon to corps-level and that are based on unit warfighting focus within CTC capabilities.

(7) Include instrumented urban operations training experience during the rotation.

(8) Incorporate reception, staging, onward movement, and integration operations, regeneration, and deployment training.

(9) Fully integrate decisive actions, including small-scale chemical weapons of mass destruction, injects incorporating SOF/Conventional Force handover coordination.

(10) Execute mission rehearsal exercises (MREs) for brigades and below, and mission readiness exercises (MRXs) for divisions and above, as required.

(11) Conduct training as a multi-component team, implementing Total Army Force Policy by incorporating RA, ARNG, and USAR Soldiers, leaders, and units at every echelon and opportunity.

c. Rigor. During a CTC experience, commanders will train with the equipment they would expect to take to war, to the extent possible. In order to provide a realistic training environment, each CTC will—

(1) Provide a MDO DATE in which rotational unit commanders can train to established standards (for example, METL, Combined Arms Training Strategy, and approved training guidance).

(2) Capture Operational Environment (OE) complexities within various OE assessments to replicate (not duplicate) the OE of the theater to which the unit will likely deploy.

(3) Conduct doctrinally based after action reviews focused on observed performance that enables Soldiers and leaders to discover for themselves what happened, why it happened, and how to sustain strengths and overcome weaknesses.

(4) Stress all warfighting functions in decisive air-ground unified land operations where both lethal and nonlethal solutions could be employed.

(5) Provide a freethinking, capabilities-based, opposing force (OPFOR) with an equal chance to win.

(6) Develop tactical or operational level of war scenarios where the outcome is not assured and that promote initiative-oriented warfighting skills for commanders.

(7) Ensure consequences of military decision making are allowed to fully develop in order to show cause and effect.

(8) Dedicate a portion of the rotation to retraining those tasks the commander deems essential for their unit to increase proficiency. (Retraining is not an indication of failure).

(9) Execute training in compliance with applicable safety regulations, sustainability/environmental regulations (for example, AR 385-10, AR 385-63, AR 200-1, DA Pam 385-30).

d. CTCs. The CTC Program includes the MCTP; Joint Multinational Readiness Center (JMRC); Joint Readiness Training Center (JRTC); and the National Training Center (NTC). JMRC, JRTC, and NTC are collectively referred to as the maneuver CTCs or dirt CTC sites.

(1) The MCTP, located at Fort Leavenworth, Kansas, is the Army's primary CTC for mission command training using constructive simulations as portrayed by a professional OPFOR. MCTP supports Army unit readiness, force generation processes, mission preparation progression, and other Army requirements. MCTP conducts or supports training that simulates unified land operations in the OE at worldwide locations. The MCTP provides training events for ARNG BCTs, multifunctional support brigades, functional support brigades, Expeditionary Support Commands (ESCs), divisions, Theater Support Commands (TSCs), corps, ASCCs, Special Operations Joint Task Forces, Combined Joint Special Operations Task Force, and JFLCCs. MCTP provides training in coordination with Joint Staff J7 to commands and/or staffs that are designated to serve as a JTF. The MCTP creates training experiences that enable the Army's senior mission commanders to develop current, relevant, and campaign-quality, Joint and expeditionary mission command instincts and skills.

(2) The JMRC, in a forward deployed environment at Hohenfels and Grafenwoehr, Germany, trains BCTs by conducting force-on-force and live-fire training in a joint scenario across the range of conflict, using an LVC training model, as portrayed by a professional OPFOR, controlled by an expert, and

## TRAINING AND LEADER DEVELOPMENT

experienced JMRC operations group (OPS GRP). Training occurs under tough, realistic, combat-like conditions across a wide range of likely tactical operations and MREs capable of full integration into higher-level exercises and scenarios. In support of Army unit readiness and force generation processes, JMRC will normally focus on collective training events supporting U.S. Army Europe (USAREUR) BCTs. JMRC conducts one CTC Program BCT rotation per year, with the ability to surge to four rotations per year, at the Hohenfels-Grafenwoehr complex and associated maneuver rights areas. When directed, JMRC also supports non-CTC Program events, such as North Atlantic Treaty Organization (NATO) Response Force (NRF), European Rotational Force (ERF) and Regionally Aligned Force (RAF) training using theater supplied assets and funding while leveraging CTC facilities and ITADSS when appropriate. Use of the CTC facilities and ITADSS for non-CTC events will include theater reimbursement for any sustainment or repair costs.

(3) JRTC at Fort Polk, Louisiana and NTC at Fort Irwin, CA train Army BCTs by conducting force-on-force and live-fire training in a Joint scenario across the range of conflict using a LVC training model as portrayed by a professional OPFOR and controlled by an expert and experienced OPS GRP. Training occurs under tough, realistic, combat-like conditions across a wide range of likely tactical operations and MREs capable of full integration into higher-level exercises and scenarios. In support of Army unit readiness and force generation processes, JRTC and NTC will normally focus on collective training events supporting BCTs achieving decisive action proficiency. However, JRTC and NTC may also be tasked to execute focused rotations in support of BCT mission preparation progression when required by Global Force Management allocation demands.

### **14-14. Chief of Staff of the Army (CSA), Army CTC Huddle**

a. The CSA convenes a CTC Huddle to discuss and decide CTC Program issues with a select group of Army senior leaders including the Vice Chief of Staff; Director of the Army Staff, Sergeant Major of the Army, the DA G-3/5/7; FORSCOM CG; USAREUR CG; U.S. Army Training and Doctrine Command (TRADOC) CG; the Army Material Command CG; the Chief of the Army Reserve; the Director, ARNG; CG, USASOC; CG Combined Arms Center (CAC) and DCG, CAC-Training (CTC-T); CG 7th Army Training Command; CG JRTC; CG NTC; Commander MCTP; DCS, G-3 Director of Training (DOT); and Director, CTC Directorate. Other leaders are involved as required.

b. The HQDA DCS, G-3/5/7 DOT is the lead office for scheduling, agenda development, meeting preparation, execution and coordinating the official record of the CTC Huddle. The CTC Directorate supports the DOT in this activity. The two-hour huddle is normally scheduled in conjunction with another senior leader event (ex: 4-Star Conference, Senior Leader Readiness Forum) to reduce impact on leader calendars and temporary duty (TDY) costs.

### **14-15. Army Total Force Policy (ATFP)**

The Army implements the ATFP to provide predictable, recurring, and sustainable capabilities to support the National Military Strategy (NMS) and Army commitments worldwide. The intent of the ATFP is to seamlessly blend RA, ARNG, and USAR units into a globally available, regionally aligned, multi-component Army that synergistically supports the NMS.

### **14-16. Unified Action (Joint, Interagency, Intergovernmental, and Multinational (JIIM))**

a. The Army builds forces capable of ULO, able to operate effectively with JIIM partners across the range of military operations, and provides those capable and ready forces to CCDRs in support of the National Security Strategy (NSS) and national defense strategy. JIIM partners provide access to capabilities and authorities not resident within the Army and serve as effective combat multipliers if properly included in the planning and conduct of operations.

b. Army formations must prepare to operate with JIIM partners. HQDA G-37 Training (TR) works with Office of the Secretary of Defense (OSD) Personnel and Readiness and Joint Staff (JS) J-7 to bring joint context to priority Army training venues, like CTC. Additionally, HQDA G-37 TR works with CCDRs and ASCCs to support Army participation in joint exercises. Incremental funds, costs over normal training funds, and transportation funds to move personnel and equipment to joint exercises are provided by OSD. (see AR 350-28).

# HOW THE ARMY RUNS

## Section IV Institutional Training

### 14-17. Overview

The Army institutional training and education system provides Soldiers, leaders, and Army Civilian Corps with attributes and competencies required to successfully operate in combat and at home station. Institutional training supports every Soldier and Army civilian in the force throughout his or her Army career.

### 14-18. The Army School System (TASS)

TASS is a composite school system made up of RA, USAR, ARNG, and Army civilian institutional training systems. TASS conducts Initial Military Training (IMT) (e.g., BCT, One Station Unit Training (OSUT), Advanced Individual Training (AIT), and Basic Officer Leaders Course (BOLC B); reclassification training [e.g., Military Occupational Specialty (MOS) and officer branch qualification]; officer, WO, NCO, and Army civilian professional development training and education (e.g., Officer Education System (OES), NCO Education System (NCOES), and Civilian Education System (CES); and functional training (e.g., Additional Skill Identifier (ASI), Skill Qualifications Identifier (SQI), Skill Identifier (SI), Language Identification Code. These training requirements are completed using standard resident and Distributed Learning (dL) courses. The RC TASS units are functionally aligned and linked to appropriate training proponents.

a. RA Training Institutions. Serves as a link to the RC schools to ensure equivalency, quality assurance (QA), instructor certification, The Army Training System (TATS) courseware availability, use of the Analysis, Design, Development, Implementation, and Evaluation curriculum design method, and a dL strategy. The TATS courseware ensures that all Army Soldiers, regardless of component, receive the same critical task instruction, regardless of which TASS institutions conduct the training or education.

(1) TRADOC. Largest Active training institution in the United States Army. TRADOC oversees 34 Army schools (see list below) organized under eight Centers of Excellence (Aviation, Cyber, Fires, Intelligence, Maneuver, Maneuver Support, Mission Command, and Sustainment (Combined Arms Sustainment Command)). Each one focuses on a separate area of expertise within the Army (such as Maneuver and Signal). These Centers train over 500,000 Service members each year.

(2) TRADOC Centers of Excellence (CoE). The designated command or organization within an assigned area of expertise that:

(a) Executes assigned responsibilities for one or more TRADOC core functions.

(b) Provides TRADOC the ability to develop and integrate DOTMLPF-P capabilities within and across the Army warfighting functions.

(c) Performs force modernization proponent responsibilities for the Army where assigned.

(3) TRADOC Centers and Schools. There are 35 TRADOC Centers and Schools:

(a) Adjutant General School, Fort Jackson, South Carolina.

(b) Airborne School, Fort Benning, Georgia.

(c) Air Defense Artillery Center/School, Fort Sill, Oklahoma.

(d) Armor Center/School, Fort Benning, Georgia.

(e) Army Logistics University, Fort Lee, Virginia.

(f) Army Management Staff College, Fort Leavenworth, Kansas.

(g) Army Medical Department Center and School, Fort Sam Houston, Texas.

(h) Cyber Center/School, Fort Gordon, Georgia.

(i) Aviation Center/School, Fort Rucker, Alabama.

(j) Aviation Logistics School, Fort Eustis, Virginia.

(k) Chaplain School, Fort Jackson, South Carolina.

(l) Chemical School, Fort Leonard Wood, Missouri.

(m) Command and General Staff College, Fort Leavenworth, Kansas.

(n) Drill Sergeant Schools, Fort Jackson, South Carolina.

(o) Electronic Warfare School, Fort Huachuca, Arizona.

(p) Engineer School, Fort Leonard Wood, Missouri.

(q) Field Artillery Center/School, Fort Sill, Oklahoma.

(r) Finance School, Fort Jackson, South Carolina.

(s) Infantry Center/School, Fort Benning, Georgia.



## TRAINING AND LEADER DEVELOPMENT

- (t) Intelligence Center/School, Fort Huachuca, Arizona.
  - (u) Irregular Warfare School, (location TBD)
  - (v) Military Police School, Fort Leonard Wood, Missouri.
  - (w) Officer Candidate School, Fort Benning, Georgia.
  - (x) Ordnance Mechanical Maintenance School, Fort Lee, Virginia.
  - (y) Ordnance Munitions and Electrics Maintenance School, Redstone Arsenal, Alabama.
  - (z) Physical Fitness School, Fort Benning, Georgia.
  - (aa) Quartermaster Center/School, Fort Lee, Virginia.
  - (bb) Ranger School, Fort Benning, Georgia.
  - (cc) Recruiting and Retention School, Fort Jackson, South Carolina.
  - (dd) School of Advanced Military Studies, Fort Leavenworth, Kansas.
  - (ee) School of Information Technology, Signal Center, Fort Gordon, Georgia.
  - (ff) School of Military Packaging Technology, McAlester, Oklahoma.
  - (gg) Sergeants Major Academy, Fort Bliss, Texas.
  - (hh) Signal School, Fort Gordon, Georgia.
  - (ii) Transportation Center/School, Fort Eustis, Virginia.
  - (jj) Warrant Officer Career Center, Fort Rucker, Alabama.
  - (kk) BLC, FORSCOM, USAREUR, Eighth U.S. Army, USASOC, and multiple locations within TRADOC, ARNG, and USAR.
- (4) Non-TRADOC Schools include—
- (a) Army Force Management School, Fort Belvoir, Virginia.
  - (b) Army Inspector General School, Fort Belvoir, Virginia.
  - (c) John F. Kennedy Special Warfare Center and School, Fort Bragg, North Carolina.
  - (d) United States Military Academy (USMA), West Point, New York.
  - (e) Criminal Investigation Laboratory, Fort Gillem, Georgia.
  - (f) Defense Ammunition Center and School, McAlester, Oklahoma.
  - (g) Army Management Engineering College, McAlester, Oklahoma.
  - (h) Corps of Engineers Professional Development Support Center, Huntsville, Alabama.
  - (i) Prime Power School, Fort Leonard Wood, Missouri.
  - (j) Army Safety Center, Fort Rucker, Alabama.
  - (k) University of Foreign Military and Cultural Studies (Red Team), Fort Leavenworth, Kansas.
  - (l) U.S. Army War College (USAWC), Carlisle Barracks, Pennsylvania.
  - (m) Reserve TASS (Army School System), various Continental U.S. (CONUS) and outside CONUS (OCONUS) locations.
  - (n) ARNG TASS (81 schools, including 54 Regional Training Institutions), various CONUS and OCONUS locations.
  - (o) Cadet Command controls hundreds of University and College Reserve Officers' Training Corps (ROTC) sites and Basic Officer Leader Course (BOLC) A.
- b. RC Training Institutions.
- (1) USAR. Provide component infrastructure organized into training commands with brigades and battalions. These elements deliver institutional training at multiple geographic resident and dL locations using courseware approved and distributed by the Army training proponents through the U.S. Army Reserve Command (USARC). The USAR TASS unit, the 80th Training Command (TC) conducts MOS reclassification, NCOES, OES, ASI/SQI, and functional courses. With an MOA between their parent headquarters, the USARC, and with TRADOC, the 80th TC is tasked to manage planning and execute the assigned Army Program for Individual Training (ARPRINT) as directed by HQDA G-1/G-3/5/7 from the Structure and Manning Decision Review (SMDR) and as coordinated by TRADOC; report school execution trends, report forecast mission conflicts, and identify forecasted constraints; update TRADOC TASS Readiness Reporting System (TTRRS) monthly as required; participate in the Total Army Centralized Individual training Solicitation (TACITS) process in support of the One Army School System; participate in the program of instruction (POI) development process at the proponent level; and, augment TRADOC proponent schools with Quality Assurance Officers, instructors, and support personnel (note: through the approval of Army Campaign Plan Decision Point 74, the CSA directed TRADOC to take OPCON of the 80th TC (TASS) on 1 October 2009).
  - (2) The ARNG. TASS is missioned to train Officer Candidate School (OCS), Warrant Officer Candidate School (WOCS), MOS reclassification, NCOES, ASI and functional courses in leadership;

## HOW THE ARMY RUNS

maneuver, fires and effects (MFE); operations support; and force sustainment training lanes. ARNG shares leadership, operations support and force sustainment lanes with USAR TASS schools. TASS divides the CONUS and territories into six regions based on geographic and demographic data (RA and RC force structure). Based on mission training requirements, each region includes officer education (OCS, WOCS, officer professional development), enlisted education (MOS reclassification training, NCOES), functional, ASI and SQI courses. TASS training battalions, subordinate to the brigades/regiments, align with the proponents for each career management field. Battalions manage instructor groups. Each instructor group has multiple teaching sites that ensure the availability of decentralized instruction for all Soldiers. Respective states have ARNG TASS training regiments aligned within the state, but provide similar regional coverage for training of Soldiers of all components.

### 14-19. Joint PME (JPME) and Training Institutions

a. Joint education institutions prepare officers and Department of Defense (DOD) civilians for assignments at Joint or combined headquarters/commands. JPME is governed by the Chairman Joint Chiefs of Staff Instruction (CJCSI 1800.01E) Officer Professional Military Education Policy (OPMEP). JPME is a subset of PME; it begins at pre-commissioning institutions and weaves through General Officer education. JPME provides the body of knowledge to enhance performance of duties consistent with Joint Matters and in the context of joint functions – command and control, intelligence, fires, movement and maneuver, protection and sustainment. JPME is that portion of PME that supports fulfillment of the educational requirements for joint officer qualification (see Title 10 U.S. Code, Chapter 38, Section 661(c) (10 U.S.C. 661 (c)) and DOD Instruction (DODI) 1300.19, DOD Joint Officer Program for joint officer qualifications). The education generally prepares students to accomplish Joint command and staff functions and to perform strategic and operational planning.

b. The Army's accredited JPME institutions are the Command and General Staff School (JPME I), the Advanced Strategic Leadership Studies Program (JPME II), the U.S. Army War College Resident Program (JPME II), and the Distant Education Program (JPME I and JPME II). Other JPME institutions include: Sister Service Command and Staff level institutions (JPME I), National Intelligence University (JPME I), Sister Service War Colleges (JPME II), National Defense University (NDU), at Ft McNair, Washington, District of Columbia, programs include the National War College (JPME II), The Eisenhower School (JPME II), the College of International Security Affairs (JPME II senior program only), and the College of Information and Cyberspace (JPME II senior program only) as well as the Joint Forces Staff College, Norfolk, VA, that include the Joint Advanced Warfighting School (JAWS, JPME II), Joint and Combined Warfighting School (JCWS, JPME II) and Joint and Combined Warfighting School-Hybrid Course (JCWS-H, Primarily for RC Only, JPME II).

c. Specialized courses focused on a particular command or multi-national audiences, such as the NATO, are also available. The NATO School Oberammergau, Germany (see website at <https://www.natoschool.nato.int/>) offers the NATO Staff Officer's Orientation Course; this course is mandatory for all RA and Active Guard and Reserve (AGR) officers in the grade of O-4 through O-6 selected for an initial assignment to a NATO staff position. The course acquaints students with NATO missions, organizations, and procedures, preparing graduates for their NATO Assignments and ensuring effective interaction with their allied colleagues.

### 14-20. Institutional Leader Training and Education Categories

Much of the OES, WOES, NCOES, and civilian curriculums are complementary in that they support the development of leaders for utilization at specific organizational levels. It is the foundation upon which leaders realize their maximum potential. Training and education usually precede significant new and higher levels of operational assignments. It consists of branch-specific courses and functional training. The courses identified below correspond to the organizational levels listed.

a. Officer Pre-Commissioning Programs educate and train cadets, officer candidates, and WO candidates and assess their readiness and potential for commissioning as second Lieutenants or as WO1s. Pre-commissioning programs prepare the individuals for progressive and continuing development. Chapter 2 of AR 350-1 covers the U.S. Army and ARNG. Pre-Commissioning programs are as follows: BOLC Phase A, WOCS, ROTC, USMA, OCS, Direct Commissioning (detailed information reference Pre-commission Training is in AR 350-1, pg 68, paragraph 3-32). WOCS is a branch-immaterial course that prepares enlisted Soldiers to serve as a WO1 in the RA, ARNG, and USAR. WOCS incorporates a high stress environment designed to challenge the warrant officer candidate from

## TRAINING AND LEADER DEVELOPMENT

day one. Candidates attend training at the Warrant Officer Candidate Course, Fort Rucker, Alabama. ARNG and USAR candidates who are eligible may alternatively attend WOCS at a State Regional Training Institute. Special Forces Warrant Officer Candidates attend WOCS at Fort Bragg, North Carolina, as part of the Warrant Officer Technical and Tactical Training Course (WOTTC).

b. IMT provides an orderly transition from civilian to military life. It is the first step to transforming civilians into Soldiers. It teaches Soldier the tasks and supporting skills and knowledge needed to be proficient in required skills at the first unit of assignment. IMT consists of Basic Combat Training (BCT), Advanced Individual MOS Training (AIT)/OSUT and BOLC-B.

c. Initial Entry Training (IET) produces technically and tactically competent Soldiers who exemplify Army values, live Warrior Ethos, and are prepared to take their place in the ranks of the Army. For enlisted Soldiers, it includes traditional BCT, AIT, one station unit training, or other formal Army individual training received prior to entry.

d. PME. Refer to Section IX, Leader Development, for detailed information pertaining to PME.

e. MOS-T Reclassification Training is intended to qualify an individual in a new MOS. Upon satisfactory completion of the training the new MOS will be awarded to the Soldier and designated as the Primary MOS. Soldiers attending MOS-T training for reclassification are afforded the same privileges as permanent party members of equal grade. MOS-T (reclassification) courses have non-MOS-specific (e.g., common core) tasks removed by the proponent, as Soldiers attending these courses have already completed IMT and do not need to repeat basic Soldiering training. RA Soldiers may attend training at TASS BNs if the BN is accredited and teaching TATS-C delivered in active duty for training status mode (see detailed information on MOS-T in AR 350-18, pg. 24, paragraph 3-6).

f. Functional Training provides qualified Soldiers and Army Civilians for skill specific training to duty positions that require specific functional skills (e.g., ASI, SQI, or SI) and knowledge, such as Airborne and Ranger training. It may provide training that qualifies Soldiers for award of an ASI, SQI, or SI, produce ASI/SQI-trained and qualified Soldiers, and provide other functional training required for a specific deployment (Mission Readiness) and follow-on assignments.

g. Civilian Education System (CES). See Section IX, Civilian Training and Leader Development.

### 14-21. Conduct/Method of Instruction

Some TASS institutions and units focus on education as the primary method of instructions while others may focus on training. Many TASS units use a combination of both methods of instructions through a variety of courses.

a. Resident training is conducted at centralized training sites with required ranges, facilities (classrooms, housing, subsistence, and so forth) and equipment to support all training requirements (for example, Army schools and training centers). Priority for conducting resident training will be determined by the training Army Command (ACOM).

b. Nonresident training is individual training distributed to students for completion without the presence of an on-site instructor/facilitator, small group leader or otherwise designated trainer.

(1) dL is the delivery of standardized individual, collective and self-development training to Soldiers, Army Civilians, units, and organizations at the right place and right time using computer based technologies. dL may involve both synchronous (in real time—for example, via two-way audio/video television) and asynchronous (non-real time—for example, via CBT) student-instructor interaction. It may also involve self-paced student instruction without benefit of access to an instructor (for example, correspondence programs). For additional information on dL development requirements Reference the Web site for TRADOC administrative publications: <http://www.tradoc.army.mil/tpubs/> and/or the CAC Web site for current guidelines for dL requirements.

(2) Mobile Training Teams consist of one or more U.S. military or civilian personnel sent on temporary duty, often to a foreign nation, to give instruction. The mission of the team is to train indigenous personnel to operate, maintain, and employ weapons and support systems, or to develop a self-training capability in a particular skill. The Secretary of Defense may direct a team to train either military or civilian indigenous personnel, depending upon host-nation requests.

(3) Video Tele-Training (VTT). Fiscal constraints and lower TDY budgets pose challenges for training Soldiers for combat and other missions. The Army has established a program that reduces the need for TDY and allows one instructor to teach many Soldiers at different locations by using the VTT program. The U.S. Army VTT program broadcasts training courses to Soldiers whether they are in a classroom at Fort Benning, Georgia, or at a point of delivery site such as a digital training facility in

## HOW THE ARMY RUNS

Wiesbaden, Germany. The Army Training Support Center (ATSC) at Fort Eustis, Virginia administers the VTT program and is part of a wider initiative to take training and education outside classroom walls that fits well with the Army Learning Model (ALM) 2015, which is changing the Army's individual learning methods and processes.

(4) Train the Trainer courses are created to deliver specific learning objectives and how they should be taught to selected individuals who will return to their units and pass the information along. These new trainers typically do not have any additional duties beyond conducting and recording the training. This is not the same as creating unit Subject Matter Experts or Additional Duty personnel who, along with conducting the training, have additional administrative and advisory duties to conduct for the commander. As an example, the recent training for the new NCO Evaluation Report document was conducted via Train the Trainer to deliver the information to the units. Whereas the Sexual Harassment /Assault Response & Prevention training or Master Gunner training produces personnel who conduct additional duties and responsibilities in addition to providing training to the unit.

(5) On the Job Training (OJT) is a formal training program with specific learning objectives conducted by a trainer when the learner is performing the duties being trained. OJT is limited to the immediate performance of short-term duties.

d. Army Training Requirements and resources System (ATRRS). ATRRS is the Army's Management Information System of record for student input to training. The on-line system integrates work force requirements for individual training with the process by which the training base is resourced and training programs execution is recorded. This automation support tool contains: training requirements; training programs; class schedules; class quotas; student reservations; and student input and graduation data. It supports numerous Army processes to include SMDR. The product of the SMDR is the ARPRINT, the mission document and input factor for resourcing the institutional training base during peacetime and mobilization. ATRRS supports the Training Requirements Division of the Office of the Deputy Chief of Staff (DCS), G-1 in its Army-wide mission of integrating all phases of input to training management, during peacetime and mobilization. The system supports the planning, programming, and budgeting processes.

### **14-22. Development of the Army Individual Training Requirements**

a. General. The development of individual training for the RA begins with the identification of force structure authorizations from the Personnel Management Authorizations Document (PMAD) and Active Army Military Manpower Program (AAMMP). The Army G-1 produces the PMAD semiannually, usually in August and January. PMAD displays authorizations at the MOS and grade level. The Army G-1 also produces the AAMMP on a monthly basis. It contains manning data such as RA end strength, monthly recruiting requirements, and inputs to training for seven Fiscal Years (FYs).

b. MOS Level System (MOSLS). Using the PMAD, the MOSLS process predicts RA (enlisted) skill requirements. MOSLS compares MOS and grade inventory, aged to the FY under consideration by applying gain, loss, and promotion factors. The difference between the authorizations and the aged (to the FY) inventory constitutes the number of trained Soldiers, by skill that the training base must produce (output). Applying training attrition rates at the skill level provides the number of Soldiers required to begin training (input).

c. Other training requirements. Human Resources Command (HRC) identifies other training requirements for officer and enlisted in-service personnel who require training and education to support professional development, reenlistment or reclassification programs, and mission requirements. The Army G-1 identifies training requirements for Army civilians. Additionally, HRC solicits in-service training requirements from other ACOMs, ASCCs, DRUs, States' Adjutant Generals, and other services and agencies via the TACITS. HRC conducts the TACITS survey annually. The accession-driven, in-service, and other task-based training requirements are combined as total raw training requirements within the ATRRS. The ATRRS' automated databases include a list of Army task-based training courses that includes length, capacity, frequency, and location. It also includes other services' courses attended by Army personnel. The task-based requirements are translated into course requirements and become the Army's training requirements at the course level of detail by component and FY.

d. Training program development for each MOS/AOC. After the training requirements for courses are developed, the next major task in the process is the development of the training program for each MOS/AOC. The first step in establishing a training program is the SMDR, co-chaired by ODCS, G-1 and ODCS, G-3. It includes representatives from: ODCS (G-1, G-3/5/7, and G4); OTSG; TRADOC; Army

## TRAINING AND LEADER DEVELOPMENT

Materiel Command; U.S. Army Medical Department Center and School; HRC; FORSCOM; NGB; OCAR; USAREC; Office of the Chief of Engineers (OCE); other services; Foreign Military Sales; International Military Education and Training; and the individual proponent schools. The purpose of the SMDR is to reach a consensus within the Army for the ITP for the first and second POM years and any major changes for the upcoming budget year. Additionally, the SMDR validates training requirements (Soldiers and civilians to be trained in formal education/training courses), compares training requirements with schoolhouse current resource capabilities (facilities, billeting, manpower), and adjusts training requirements or training resources to form recommended training programs. The SMDR is conducted annually in September/October. Individual training requirements are initially established for the third POM year, validated for the second POM year (the primary focus of the SMDR), and fine-tuned for the first POM year.

e. SMDR categorization by course. The SMDR categorizes each course. The first category is composed of those courses where the total training requirement can be trained with available resources. The second category consists of courses where the requirements exceed the resourced capability of the training base. In the second category, resources can be provided or requirements reduced to the resourced level without significant impact on the manning program. The third category represents those courses where the requirements exceed the capacity, requires significant resources, and cannot be reduced without significant impact on the manning program. These courses are termed constrained. The results of the SMDR are briefed to a Council of Colonels (CoC) which attempts to confirm category two adjustments/resources and move as many courses as possible from category three to category two.

f. General Officer Steering Committee (GOSC). The courses in categories two and three are then referred to a GOSC co-chaired by the DOT and the Director of Manpower and Personnel Management. At this meeting, GOs take action on the recommendations of the CoC. Each course remaining constrained is reviewed as to current authorizations, projected operating strength, training requirements, training capability, source of constraint, resources required to eliminate the constraint, availability of required resources, and a recommended course of action. That review results in a resourced training requirement that is called an approved training program for each course for that FY.

g. ARPRINT. After the GOSC is completed, the ODCS, G-1, Training Requirements Division publishes both the training requirement and the training program in the ARPRINT. The ARPRINT is a mission document for the training base as well as the Army in terms of recruitment and professional development education. The ARPRINT identifies, by FY, projected individual training requirements for established courses and for task-based courses for new course requirements. Based on identified training requirements, subsequent actions are taken to provide resources (work force, money, facilities, ammunition, and equipment) to train the required number of Soldiers' Army civilians, sister Services' personnel, and international military personnel (FMS). The desired flow of Soldiers into the schools and training centers aids in development of class schedules to support the ARPRINT-approved training requirements for each course. The class schedules are entered into ATRRS. TRADOC reviews the class schedules to ensure they support the ARPRINT requirement and TRADOC scheduling policy.

h. Mobilization Planning System (MPS). The MPS is a subsystem of ATRRS. It provides training managers, at or above installation level, prompt access to information necessary to plan for implementation of the mobilization of the Army training base. The MPS helps produce the Mobilization (MOB) ARPRINT that provides a projection of trainee and student inputs, by task-based course, to satisfy post mobilization requirements for trained work force as determined by Mobilization Manpower Planning System.

### **14-23. Management of the Army Individual Training Requirements and Resources**

a. The SMDR is the forum that validates Army training seat requirements and subsequently reconciles those requirements to an affordable, acceptable, and executable training program. Training requirements are initially established for the third POM year, validated for the second POM year (the primary focus of the SMDR), and fine-tuned for the first POM year. Where possible, achievement of the fine-tuning goal is based on the funded capabilities of the training activities (see AR 350-10).

b. The Training Resources Arbitration Panel (TRAP) addresses unprogrammed training-seat changes to the ARPRINT during the execution and budget years. These changes can generate unprogrammed resource requirements such as additional manpower, base operations (facilities, meals, lodging), equipment, ammunition, and funding, for which commands may require resourcing through HQDA. If unprogrammed resourcing through HQDA is required, the TRAP helps HQDA determine whether to

## HOW THE ARMY RUNS

approve the unprogrammed training-seat changes or disapprove and accept risk. HQDA, DCS, G-3/5/7 and HQDA, DCS, G-1 co-chair the TRAP. Detailed guidance on the TRAP process is included in AR 350-10.

c. The Analysis of Change Cell is a forum that addresses issues influencing training in the budget and execution years, too complex to address in the TRAP or SMDR. Its role is to develop recommendations to resolve critical issues affecting inputs to programmed training. Issues include, changes in training loads generated by changes in current authorization documents, Army policies, current manpower inventory, projected gains and losses, training attrition rates, training strategies and availability of resources. Policy guidance on the analysis and change cell is included in AR 350-10.

d. The TACITS is a module in the ATRRS database, which federal and DOD agencies, the total Army, other services, Security Assistance Training Field Activity (foreign military training requirements), and civilian agencies use to submit their individual training seat requirements to compete for validation during the SMDR.

e. Training Requirements and Resources Governance. The Input to Training Management (ITM GOSC) role is to approve the ARPRINT and to resolve critical issues that influence the Army's individual, institutional training missions. The offices of the DCS, G-1 and the G-3/5/7 co-chair the ITM GOSC.

### 14-24. The Army University

a. The Army reorganized its educational enterprise into a university structure in order to maximize educational opportunities for Soldiers by providing valid academic credit for the education and experience they receive while on active duty. This effort was intended to provide a cost savings to the Army in tuition assistance and unemployment expenses, and improve a Soldier's ability to transition into quality employment opportunities after their service. The Army University encompasses all TRADOC schools, provides the force with a single point of contact for all Army education matters, and addresses the educational needs of the Army while providing individual Soldiers and civilians the opportunity to accomplish their own respective academic goals. In addition, Army University will work closely with the USAWC at Carlisle, Pennsylvania; the WOCS at Fort Rucker, Alabama; the Command and General Staff College at Fort Leavenworth, Kansas; and the TRADOC CoEs to leverage capabilities for training and research. The purpose of Army University is to: provide professional degree and credentialing opportunities; communicate the value the Army places on education; gain national recognition as an accredited educational institution; increase partnering with public and private universities; and identify talent and integrate best practices across the education system. The Army University integrates all of the schools across TRADOC into a single educational structure modeled after many of the state university systems seen across the Nation. This includes all elements of officer, warrant officer, non-commissioned officer and civilian education systems. It includes educational programs in the RA, the RC, and the ROTC pre-commissioning program.

b. USAWC. The USAWC will serve as the focal point and enterprise coordinator for strategic education and research in the Army University construct while remaining a separately accredited and governed graduate college. As such, it retains a unique status as a direct reporting unit to the CSA. The USAWC Commandant will be dual-hatted as the Army University's Vice Chancellor for Strategic Education, responsible to educate strategic leaders, provide enterprise level guidance on strategic education across the Army, and conduct research for the Army senior leadership. The USAWC will receive direct guidance on its missions and strategic educational requirements from the CSA, maintain independent budget authority (including over any gifts received from its 501(c) (3) foundation), and operate under the oversight of a separate Board of Visitors. The USAWC will also continue to participate in all working groups and boards associated with the Army and Joint educational requirements. The second driver for this unique status within the Army University is the statutory requirement for the USAWC to grant a master's degree. In order to award the master's degree required by United States Code, the USAWC must meet the standards of their regional accrediting body, the Middle States Commission on Higher Education, which is a different regional accrediting body than that of the Army University. The Middle States Commission requires the USAWC to control the academic governance of their institution through their Commandant and Provost in order to retain their regional accreditation. Likewise, the USAWC is accredited by the Joint Staff for its award of JPME II and thereby responds to the Military Education Coordination Council and J-7. Finally, the USAWC Commandant has recently been tasked to execute and coordinate all Army GO education from Brigadier through Lieutenant General. Therefore, the

## TRAINING AND LEADER DEVELOPMENT

USAWC must retain its unique status within the Army University and its direct report status with the Office of the CSA.

### **Section V Military Functional Area and Skill Training**

#### **14-25. Overview**

Functional courses prepare Army personnel for assignment to special units or specific duty positions and increase their value to the Army. These courses provide Soldiers an opportunity to acquire duty position-required skills and knowledge that cannot be obtained by attending other institutional courses. The courses may provide training that qualifies Soldiers for award of an ASI, SQI, or SI. The ATRRS course catalog has a complete listing of functional and skill-qualification courses.

a. The CG, HRC will assign RA personnel other than chaplains, Army Medical Department (AMEDD), and Judge Advocate General's Corps (JAGC) personnel to attend specialty courses in a TDY en-route status in conjunction with a permanent change of station (PCS) or officer accessions. Soldiers on a PCS status attend courses or a combination of courses totaling 20 weeks at one location. Each proponent with training responsibilities develops course prerequisite qualifications specified in the ATRRS course catalog ([www.atrrs.army.mil](http://www.atrrs.army.mil)).

b. ACOMS, ASCCs, and DRUs will assign RA personnel to attend specialty courses in a TDY and return status.

c. The Defense Acquisition University (DAU) is a corporate university that provides mandatory training for all acquisition, technology and logistics workforce members. DAU also provides a full range of basic, intermediate, and advanced curriculum training, as well as assignment-specific and continuous learning opportunities to support the goals and professional development of the DOD Acquisition, Technology, and Logistics (AT&L) workforce.

#### **14-26. Joint Education and Training Institutions**

Joint education institutions prepare officers and civilians of all services for assignments at joint or combined headquarters or commands. The education generally prepares students to accomplish joint command and staff functions and to perform strategic and operational planning. Joint education institutions may offer specialized courses focused on particular joint or combined assignments. The NATO Staff Officers Orientation Course is an example of this type of course. The NDU presents the course various times throughout the year. Attendance at the NATO Staff Officers Orientation Course is mandatory for all RA and AGR officers in the grade of O-4 through O-6 selected for an initial assignment to a NATO staff position. The course acquaints students with NATO missions, organizations, and procedures, preparing graduates for their NATO assignments and ensuring effective interaction with their allied colleagues.

### **Section VI Future of Army Training**

#### **14-27. Overview**

Army education and training is changing from the traditional classroom, instructor presented lessons to a combination of resident, dL, and unit training. This approach leverages automation technologies to improve the efficiency of producing, distributing, and implementing instruction. This change affects individual and collective training. The automation network serves as the conduit for producing and distributing learning material to Soldiers, leaders, and units to meet their specific needs to train and prepare for a broad spectrum of global contingencies. The use of automation technologies does not change performance standards expected of Soldiers, Civilians, and units. Reliance on traditional training methods will continue; however, the availability and communications power of the commercial world-wide web, internet, and other information transfer systems will enhance training. To attain this vision, the Army launched a number of projects to provide a solid education and training information foundation. ATRRS is the means to register for Army education and training to include dL courses. Beginning in FY14, registration for training and education for Army civilians was accomplished using GoArmyEd, a system

## HOW THE ARMY RUNS

currently in use by the Army Continuing Education System for Soldier tuition assistance. ATRRS facilitates student enrollment, class scheduling, registration, tracking of training records, and financial tracking for most training and education courses used by Army civilians.

a. Learning Environment. Classroom learning is shifting from instructor-centered, lecture-based methods, to a learner-centered, experiential methodology. Knowledge and comprehensive learning objectives and individual learning activities occur outside the classroom. This includes self-paced technology-delivered instruction and research. Students and trainees will participate in discussion, collaborative learning activities, problem identification, and small-group problem solving. Engaging the learner in collaborative practical and problem-solving exercises relevant to their work environment provides an opportunity to develop critical competencies—initiative, critical thinking, teamwork, and accountability, in addition to specific knowledge content.

b. dL. To meet the challenge of the future, the Army is implementing dL to deliver education and training to the Soldier whenever and wherever needed. Types of dL include interactive multimedia instruction (individualized self-paced instruction), video teleconferencing, web-managed instruction, and simulations. Army dL does not fundamentally change the way the Army trains; it enhances training by using current and emerging technologies for management and delivery of training to the Soldier at the point of need. Exploiting these technologies takes the classroom to the unit, and the unit to the classroom, providing training in a worldwide virtual training environment. Soldiers in the field, in units, at institutions, and at home can train by accessing the informational databases through the Army Knowledge Online website. Units can select training options (resident and non-resident) based upon their need, time available to train, distance from the “on-site” training site, and other resource constraints. The dLS uses an integrated learning management support system, which automates student enrollment, scheduling, and training records. The dLS delivers digital courseware to include real-time VTT, video and audio recordings, web- and computer-based training materials, and simulations. Army dL documents and related materials are available on the internet at <http://www.atsc.army.mil/tadlp/index.asp>. Types of dL include:

(1) Army Learning Management System (ALMS). ALMS is the heart of the Army’s dLS. ALMS streamlines, consolidates, and provides overall direction to the Army’s training processes. ALMS is a web-based information system that: delivers training to Soldiers; manages training information; and provides training collaboration, scheduling, and career planning capabilities in both resident and non-resident training environments. The ALMS also assists Army trainers and training managers in conducting and managing the training of Soldiers and Army civilians throughout their careers.

(2) Digital Training Facilities (DTF). DTFs provide training access for the Army’s Soldiers and civilians at RA installations and USAR training sites.

(3) Deployed Digital Training Campus (DDTC). The DDTC is a deployable-networked classroom that delivers proponent-approved dL training using satellite communications (SATCOM), wireless connectivity, and VTT equipment. SATCOM provides linkage to deployed forces worldwide through the following: VTT; video teleconference (VTC); worldwide web (WWW); non-classified internet protocol router network (NIPRNET); and schoolhouse resources not reachable through other means.

(4) ARNG dL Classrooms (dLC) and Mobile dLC (MdLC). The ARNG dL program is a component of the Army dL program. It provides multiple dL methods and technology-enabled standardized individual and collective training relevant to the readiness requirements of Soldiers and units throughout the ARNG.

(5) TRADOC Enterprise Classroom Program. The program includes Classroom XXI, MC Art and Sciences Program (MCASP), BCT/OSUT, and the Institutional Training Technology Program. Enterprise classroom programs sustain instructional capabilities that support approved training requirements and priorities that enable ALM 2015.

### Section VII Training Governance

#### 14-28. Training General Officer Steering Committee (TGOSC)

a. Structure. The TGOSC governs and provides vision, goals, objectives, and direction to the Training Enterprise, as well as provide critical input to the Army Planning, Programming, Budgeting, and Execution (PPBE) process. The TGOSC encompasses an annual management process at three levels – council of colonels, 1- /2-Star TGOSC and 3-Star TGOSC – to recommend improvements in training policy,



## TRAINING AND LEADER DEVELOPMENT

strategy, and capabilities needed to provide trained and ready Soldiers, leaders, Army Civilians, and units to the combined, joint, interagency, and multinational forces of CCDRs. In addition, the TGOSC ensures Army training portfolios (operational, mission, institutional, network and training support systems) can sustain requisite Soldier, leader, Army Civilian, and unit readiness, as well as support Army and DOD transformation requirements.

(1) The HQDA DCS, G-3/5/7 chairs the TGOSC, with the DOT or Deputy Director of Training (DDOT) serving as chair in his absence. The DCS, G-3/5/7 DOT and the DCS, G-1, Director of Military Personnel Management, represent the ARSTAF as voting members. Other ARSTAF may be invited. Representatives of the Army Secretariat are invited to participate and provide oversight.

(2) Primary TGOSC members are also voting members and include general officers (GO) or Senior Executive Service (SES) members from each ACOM, ASCC, and DRU, ARNG, and USAR who are responsible for training and leader development. The TGOSC chair may invite other HQDA and Joint Staff GOs or SES to attend based on the issues being presented.

(3) Generally, each 1-2-star TGOSC is followed by a 3-star TGOSC secure video teleconference (SVTC) to address key emerging issues, decisions, or contentious topics that cannot be resolved at the 1-2-star TGOSC. The 3-star TGOSC provides a back brief to the Army senior leaders concerning the outcome from the TGOSC cycle. Annually, or as required, a 4-Star Executive Session will review TGOSC recommendations as well as a summary of issues not brought forward for 4-Star consideration.

(4) Meeting Frequency. The TGOSC meets as required, either in a SVTC or in a conference setting. At least two physical meetings are generally conducted in the Fall (1st Quarter of the fiscal year) and Winter (2d Quarter) with a Summer (4th Quarter) SVTC. The TGOSC meets in the 3rd Quarter by exception, as efforts that quarter are instead directed at planning and executing the annual Army Senior Leader Readiness Forum (SLRF) for the CSA. A number of councils of colonels meet as needed to support the TGOSC by developing and framing training-related issues for TGOSC consideration and Army leaders' decisions.

(5) Purpose. The TGOSC provides a management process to identify and resolve issues, determine priorities, and make decisions in support of Army training and leader development in order to develop synchronized and integrated strategic recommendations for the CSA in support of Army Transformation and Force Readiness. All TGOSC recommendations will consider policy implications, influence if not adopted, general resource requirements, and general priority in relationship to other Army training and leader development initiatives. Each TGOSC forum will have a different focus, synchronized with other Army processes and priorities.

(a) Fall TGOSC. The Fall TGOSC has a two-fold purpose: First, to provide comprehensive guidance to the Training Program Evaluation Group (TT PEG) in order to shape the POM plan to maximize training balance and readiness. Second, to incorporate key stakeholder input to provide the opportunity to prioritize their requirements. Key inputs include: Short Range Training Requirements Analysis; Non-System Training Devices; Strategic Portfolio Analysis Review (SPAR); SMDR; Execution Assessment; SLRF Task status; and Army Profession Leader Development Forum initiatives; and by exception, directed requirements. A combined CoC and associated Integration Forum precedes the Fall TGOSC. Key outputs include a balanced TT PEG assessment and prioritization and an updated CTC Huddle Agenda. The Fall TGOSC is targeted to occur annually NLT 15 November.

(b) Winter TGOSC. The Winter TGOSC has a two-fold purpose: First, to provide the adjusted POM Plan in order to review and approve PEG balance and risk; second, to build and influence mid-year review (MYR) for the current FY. Key inputs include: the PEG Guidance Adjustment and the Commander's Narrative Assessment Concerns. The Combined Council of Colonels (CoC) and Integration Forum will precede the Winter TGOSC. Key outputs include the Adjusted POM Plan and Technical Guidance Memorandum (TGM) shaping guidance. The Winter TGOSC is targeted to occur annually NLT 28 February.

(c) Spring TGOSC. The Spring TGOSC is by exception. When necessary, the Spring TGOSC may accomplish the following: Review the MYR for the current fiscal year in order to identify and attempt to mitigate risk and shape new initiatives for future decision in order to examine and assess initiatives. When scheduled, a Combined CoC and associated Integration Forum will precede the Spring TGOSC. Key outputs include the MYR, Way Ahead and Prioritization, SLRF Agenda, and Decision Point for Summer TGOSC. The Spring TGOSC is targeted to occur annually NLT 30 May.

(d) Summer TGOSC. The Summer TGOSC has several priorities: (1) to address guidance and decisions from the June SLRF; (2) to assess the next FY budget for balance and risk and to gain

## HOW THE ARMY RUNS

understanding of immediate risk and resource challenges; (3) to assess the upcoming Budget Estimation Submission (BES) (first year of preceding POM) in order to gain understanding of upcoming risk and resource challenges; (4) to confirm new initiatives for inclusion in the TT PEG guidance; and (5) to validate and prioritize emerging requirements for the TT PEG. The CoC and associated Integration Forum precedes the Summer TGOSC. The key output is the decision on new initiatives and/or policy changes. The Summer TGOSC informs the September meeting of the Army Synchronization Resource Council (ASRC). The Summer TGOSC is targeted to occur annually NLT EOM August.

**14-29. TGOSC Integration Forum.** The Integration Forum's primary function is to prepare the TGOSC agenda by integrating supporting CoCs to ensure the presentations of recommendations are in the context of an Army-wide training and leader development requirement. The HQDA DCS, G-3/5/7 Training Directorate Chief of Staff, or designated colonel/GS-15 level representative, chairs the Integration Forum. Integration Forum participants consist of the HQDA DCS, G-3/5/7 Training Directorate Colonel/GS-15 chairs from each of the supporting CoCs. The HQDA DCS, G-3/5/7 Training Directorate Chief of Staff may invite ACOM, ASCC, DRU, ARNG, USAR, selected Army Staff, and other representatives (subject matter experts (SME) when needed. The TGOSC chair will establish and provide guidance to supporting CoC, such as: Operations CoC, Mission CoC, Institutional CoC, and Training Support System CoC; other CoCs may be established as required; such as the Army Munitions Requirement CoC. The chairperson for each CoC will determine work groups as required based on TGOSC guidance, voting members for each CoC, and publish a charter under which they will operate (approved by the DOT).

### **14-30. Senior Leader Readiness Forum (SLRF)**

The SLRF, formerly known as the Army Training and Leader Development Conference, is an annual senior leader forum that provides the CSA the opportunity to facilitate an informative dialogue among senior commanders and Army trainers on changes necessary to support Army training and leader development policies and resourcing matters. The SLRF focuses on current and future strategic training and leader development issues for the current and future warrior leader. Primary SLRF members are general officers responsible for training and leader development from each ACOM, ASCC, DRU, the ARNG, the USAR, Army Divisions, and Army Schools.

## **Section VIII**

### **Leader Development**

#### **14-31. Leader Development**

a. Leader development is the deliberate, continuous, sequential, and progressive process, grounded in Army values, that grows Soldiers and Army Civilians into competent and confident leaders capable of decisive action. Leader development is achieved through the life-long synthesis of the knowledge, skills, and experience gained through the development of institutional, operational, and self-development. Leader development is a purposeful, continuous, and progressive activity, as well as a process where the synthesis of one's training, education, and experiences over the course of time creates growth. Development can be amplified through quality developmental relationships (superior, peers, and subordinates). Leader development is a mutually shared responsibility between the Generating Force, the Operating Force, and the individual. The three components of leader development (training, education, and experience) reside in each of these three developmental domains. No domain has exclusive rights to any one or more of the three leader development components, nor can any of the domains abdicate their responsibility for any particular leader development component to another. The Army Leader Development Model portrays the framework and its major components. The Army advocates seven leader development imperatives described in the Army Leader Development Strategy (ALDS) 2013, which guide policy and actions to develop leaders to meet the challenges of the 21st Century. The ALDS is available at [www.usacac.army.mil](http://www.usacac.army.mil) or <http://usacac.army.mil/cac2/cal/repository/ALDS5June%202013Record.pdf>. These imperatives serve as guiding principles for the deliberate, continuous, and progressive process of developing leaders:

- (1) Commitment to the Army Profession, life-long learning, and development.
- (2) Balance the Army's commitment to the Training, Education, and Experience Components of leader development.
- (3) Manage military and civilian talent to both benefit the institution and the individual.

## TRAINING AND LEADER DEVELOPMENT

(4) Select and develop leaders with positive leader attributes and proficiency in core leadership competencies for responsibility at higher levels.

(5) Prepare adaptive and creative leaders capable of operating within the complexity of the operational environment and the entire range of military operations.

(6) Embed mission command principles in leader development.

(7) Value a broad range of leader experiences and developmental opportunities.

b. PME. PME is one element in the deliberate, continuous, sequential, and progressive process of developing leaders who demonstrate the Army's essential leader attributes and competencies and who are prepared to lead Soldiers.

(1) NCOES. The NCOES provides noncommissioned officers (NCO) with progressive and sequential leader, technical, and tactical training that prepares them to lead and train Soldiers, and execute unit missions. The DA Pam 600-25, NCO Professional Development Guide offers a timeline that identifies a typical Army career. Some individual Career Management Fields vary based on structure and design. The timeline's intent is to show a correlation between training, education, and experiences over time, synchronized to foster development of a professional corps of NCOs. The NCOES includes:

(a) Basic Leader Course (BLC) (formerly Warrior Leader Course); basic, branch-immaterial, leadership training.

(b) Advanced Leader Course (ALC); leader training and basic, branch-specific, squad, and platoon-level training.

(c) Senior Leader Course (SLC); advanced, branch-specific, platoon, and company-level training.

(d) Master Leader Course (MLC); fills a gap between advanced and senior-level education focused on strategic, operational, and critical thinking; problem-solving; and effective communication (oral and written).

(e) Sergeants Major Course (SMC); senior-level, branch-immaterial, staff training.

(f) Senior Leader Seminar (SLS); for Command Sergeant Major (CSM)/SGM.

(g) Executive Leaders Course; for nominative CSMs for 1 to 2-star headquarters/agencies.

(2). OES. The OES prepares officers and warrant officers (WO) for increased leadership, responsibilities, and performance at progressively higher levels. The OES includes:

(a) Primary Level Education (2LT – CPT, WO1-CW3): BOLC (e.g., BOLC A pre-commissioning/pre-appointment training to qualify to serve as officers and BOLC B officer initial entry and branch qualification training); WO Basic Course (WOBC) (e.g., BOLC A (pre-commissioning/appointment) and BOLC B (branch specific technical training); Captains Career Course (CCC) (e.g., tactical, technical, and leader knowledge and skills to lead company-size units and serve on battalion and brigade staffs); and WO Advanced Course (WOAC) (e.g., common core and branch-specific training that builds upon skills, knowledge, and experience).

(b) Intermediate Level Education (ILE) (MAJ, CW4): Command and General Staff Officer Course (CGSOC) (e.g., education and training to conduct decisive actions in a JIIM environment); WO Intermediate Level Education (WOILE) (e.g., branch-immaterial intermediate level staff officer and leadership skills); and School of Advanced Military Studies (SAMS) (e.g., advanced education in military arts and science for selected ILE graduates, preparing officers to plan and conduct future operations across the range of military operations).

(c) Senior Level Education (LTC – COL, CW5): Pre-Command Course (PCC) (e.g., command preparation that provides focused leader development opportunities for the Army's future senior leaders); WO Senior Service Education (WOSSE) (e.g., capstone course for WO military education focusing on senior level staff officer and leadership skills required to serve at brigade and strategic levels); Army War College (AWC)—resident, distance education, and fellowships (e.g., educates and develops leaders for service at the strategic level while advancing knowledge in the global application of landpower); SLS; and Advanced Strategic Leadership Studies Program (ASLSP) conducted at SAMS (e.g., develops theater-level leaders for positions of significant responsibility including strategic thinkers and planners at CCMD, JTF, and other four-star headquarters).

(d) GO Education (BG-LTG): The Army Strategic Education Program (ASEP) located at Carlisle Barracks, PA, plans, coordinates, and executes professional military education for the entire population of Army GOs across the Total Force. The ASEP executes the rigorous, mandatory education of over 400 general officers annually, through five core courses attended at key milestones in their careers: ASEP-Basic, ASEP-Advanced, ASEP-Advanced (RC), ASEP-Senior, and GO Transition Course. The ASEP

## HOW THE ARMY RUNS

also coordinates and funds attendance to additional courses executed by Army, Joint, International, corporations, and civilian institutions of higher education.

c. Self-Development. Self-development is planned, goal-oriented learning that reinforces and expands the depth and breadth of an individual's knowledge base, self-awareness, and situational awareness. Self-development complements what is learned in the classroom and on the job, enhances professional competence, and helps individuals meet personal objectives. There are three types of self-development:

(1) Structured Self-Development (SSD) is required learning that continues throughout a career and is closely linked to, and synchronized with, classroom and experiential learning, and is a prerequisite for attendance to NCOES courses. SSD is intended to bridge the operational and institutional domains and, by ensuring that learning is continuous and enduring, set the conditions for continuous personal and professional growth. SSD is a centrally managed set of specified content that must be completed within specified career points as a prerequisite for attendance at NCOES courses, but is both an individual and first-line leader responsibility. Soldiers become eligible for SSD upon completion of BCT/OSUT, and subsequent completion of BLC, ALC, SLC, MLC, and SMC.

(2) Guided Self-Development is recommended, but optional learning that helps keep personnel prepared for changing technical, functional, and leadership responsibilities throughout their career.

(3) Personal Self-Development is self-initiated learning where the individual defines the objective, pace, and process, such as pursuing college education and/or advanced degree programs.

d. Culture, Regional Expertise, and Language (CREL). Competent and confident leaders capable of decisive action must understand today's complex operational environment. While some specialties require leaders have language proficiency, all must be culturally aware and regionally informed to achieve mission success. This is why the Army includes elements of cross-cultural competency and regional understanding in both pre-deployment training and professional military education. Another key CREL function for the Army is DOD Executive Agent (EA) for the Defense Language Institute Foreign Language Center (DLIFLC). As DLIFLC EA, the Army is responsible for programming, resourcing, and providing foreign language training to leaders and specialists from all Services. This EA function can present challenges to the training enterprise. Although DLIFLC falls under the TT PEG like other TRADOC institutions, its funding comes from the Military Intelligence Program (MIP). Utilization must be managed in accordance with DOD directives governing MIP resources. Changes to DLIFLC funding require coordination thru HQDA DCS, G-2 and approval from the DOT, DAMO-TR, HQDA G-3/5/7, in order to ensure compliance.

### Section IX Civilian Training and Leader Development

#### 14-32. Overview

Training and development of the Army Civilian Corps is required to sustain a mission-ready Army. 5 U.S.C. 4101 provides the authority to train Army Civilian employees. Like their uniform counterparts, Civilian employees must be functionally proficient and technically competent leaders who are fully capable, adaptable, and committed to the Army's mission. Training and leader development is a shared responsibility between Army career program managers, supervisors, and employees. Leaders are developed through a combination of training and education, and experience and self-development over the course of the civilian career. The professional attitudes and beliefs that characterize the DAC are found in the Civilian Creed (ADRP 6-22).

#### 14-33. The CES

The CES program is the Army's leader development program for all Army Civilians. It provides progressive and sequential education for Civilians at key positions throughout their careers. Courses of instruction are provided through blended learning - dL and resident instruction. HQDA G-37-TRV is the Army's proponent for CES. The Army Management Staff College, located at Fort Leavenworth, Kansas, executes CES. CES courses are the core leader development courses for most Army Civilians based on grade and equivalent pay band level as they progress through their careers. All course registration is completed through the Civilian Human Resource Training Application System (CHRTAS), a part of ATRRS. Each enrollee must establish a profile in order to register for all CES courses.

## TRAINING AND LEADER DEVELOPMENT

a. Responsibility. Commands are responsible for determining and forecasting their requirements for CES based on their Civilian population. These requirements are entered into the TACITS on an annual basis for the future years. The commands attend the SMDR each year to validate their training requirements so they can be translated into quotas for the CES courses.

b. Registration. Registration for CES courses is done by employees in CHRTAS. Command quotas are managed by the Command Quota Source Manager typically located in the G-1 or the G-3 of the organization. CES courses are centrally funded for most Army Civilians. The prioritization of resident seats is: first, supervisors, managers and team leaders; second, non-supervisors, managers and team leaders; and third non-Army employees and military supervisors of Civilians. Priority 3 employees must be funded by their command or organization. Detailed instructions and additional information can be found in AR 350-1.

c. Core Leader CES Courses.

(1) The Foundation Course goal is to provide DACs with an orientation to leader development concepts build their careers and become an Army Civilian leader. The course objectives are to: understand U.S. Army leadership doctrine; increase self-awareness as it relates to their profession; understand team building, group dynamics, and effective communication; assess individual values and how they relate to professional ethics; understand how to manage professional advancement and leverage career potential; and complete administrative requirements expected of Army Civilians.

(2) The Basic Course (BC) develops Army Civilians to lead small teams and manage projects. The primary option is a 100% online course (Basic Course dL). This course is offered continuously and space is readily available for all prospective students. Prospective students may also request to attend a two-week resident course (Basic Course Resident) that takes place in a university setting encompassing a classroom environment and small group seminars. The BC is the required leader development course for all Army Civilians in grades GS-01 through GS-09 or equivalent pay band.

(3) The Intermediate Course (IC) target population is mid-level leaders who by necessity are more agile, innovative, self-aware, and prepared to effectively lead and care for personnel and manage assigned resources. Training and developmental exercises focus on mission planning, team building, establishing command climate, and stewardship of resources. The IC is conducted through blended learning - DL and three weeks resident training. Resident training is taken after successful completion of the dL and takes place in a university setting encompassing a classroom environment and small group seminars. The Intermediate Course is the required leader development course for all Army Civilians in grades GS-10 through GS-12 or equivalent pay band.

(4) The Advanced Course focus is on Army Civilians skilled in leading a complex organization in support of national security and defense strategies; integrating Army and joint systems in support of the joint force; inspiring vision and creativity; implementing change; and managing programs. The Advanced Course is conducted through blended learning - dL and four weeks resident training. Resident training is taken after successful completion of the dL and takes place in a university setting encompassing a classroom environment and small group seminars. The Advanced Course is the required leader development course for all Army Civilians in grades GS-13 through GS-15 or equivalent.

(5) The Continuing Education for Senior Leaders (CESL) courses provide the continuing education sustainment program that brings senior level Civilian leaders together to discuss current and relevant issues facing the Army. The program's intent is for leaders to return to the program continuously to refresh and receive updates on current Army issues and initiatives (two years are recommended between each CESL attendance). The CESL course is conducted through blended learning - dL and four and a half days resident training. The dL consists of reading materials and written assignments. CESL resident training consists of both small and large group activities. The course structure is a combination of guest speakers and interactive exercises. It is open to Army Civilians at the GS-14/15 or equivalent level, and RA LTC, COL, CW4-5, and SGM.

(6) The Supervisor Development Course (SDC) is the Army's single source for providing mandatory supervisory training and refresher/sustainment training. The SDC is a web-based course with lessons that focus on supervising civilian employees and is required for all civilian and military personnel who supervise Army Civilians. The SDC must be completed within the first year of placement in a supervisory position in accordance with the one-year supervisory probationary period. By law, supervisors are required to complete this course as refresher training every three years. SDC is available to all Army employees as a self-development tool.

## HOW THE ARMY RUNS

(7) The SDC for Executives (SDC-EX) is required for experienced senior leaders (SES/GO) who have previously supervised Civilians. The purpose of this course is to meet the requirements of the National Defense Authorization Act (NDAA) 2010. This course is a guide and presents Army, DOD and OPM provisions those critical areas designated in the NDAA, including: merit systems principles/prohibited personnel practices; performance management; counseling, coaching, and mentoring; hostile work environment; valuing a diverse workforce; management and labor relations; and leader development and Civilian education system programs.

(8) The Action Officer Development Course (AODC) is a web-based course with a focus on “staff work” practices in the Army. AODC covers organization and management; conducting completed staff work; managing time and priorities; conducting meetings and interviews; solving problems and making decisions; communications; writing to the Army standard; coordinating; conducting briefings; and ethics. The AODC is a required course for all Army interns. The AODC is available to all Army Civilians as a self-development tool. The course is available to military and Civilian employees to take at any point in their careers.

(9) The Manager Development Course (MDC) is a web-based course with lessons that focus on managing and leading people. The MDC includes modules in: organizational culture; time management; objectives and plans; problem-solving and decision-making; planning, programming and budgeting; manpower management; communications; information technology applications; the Army Environmental Program; equal employment opportunity; professional ethics; internal management control; and Army family team building. The MDC is available as a self-development tool for all Army employees and is recommended for Army Civilians in supervisory or managerial positions.

### d. Competitive Professional Development.

(1) The Competitive Professional Development Program is a planned, systematic, and coordinated program of professional development that supports the Army’s organizational goals and mission. It encompasses functionally tailored developmental opportunities that occur in academic environments, business/industrial settings, or in other strategically planned career-enhancing developmental assignments that have been identified in an approved Career Program Master Training Plan or IDP. Training instances may be short- or long-term and funded from various sources.

(2) HQDA centrally managed courses include the Army Congressional Fellowship Program, Leadership for a Democratic Society at the Federal Executive Institute, Harvard University Program for Senior Executive Fellows, Senior Manager Course in National Security Leadership, Senior Leader Seminar, and Senior Leader Development Course. Academic Degree Training (ADT) is included in this category of professional development and central management. The proponent for these courses is the HQDA G-3/7 DAMO-TRV, Civilian Training and Leader Development Division.

(3) Army Career Program Proponency provides structured plans, processes, and activities directing and supporting the systematic organizational, occupational, and individual growth of Army Civilians in designated career programs throughout the civilian human capital life cycle. It entails progression through a series of training, education, and professional development (TE&PD) programs and assignments involving broader knowledge, improved skills, and/or greater responsibility. The CPP provides each Army Civilian with the capability to define career goals by identifying career developmental paths and competency-based training plans.

(4) Civilian Training and Leader Development centrally managed programs are covered in AR 350-1. Career Program management is covered in detail in AR 600-950, Civilian Personnel Career Management. Career maps with training plans are found in Army Career Tracker. Career Maps are continuously updated by the Career Program managers to reflect ongoing career program development.

(5) All course enrollment for Career Program training and education, as well as all ADT, must be completed in GoArmyEd, an automated training application system. Each employee and supervisor must establish an account in GoArmyEd in order to apply for and approve training.

e. The Senior Enterprise Talent Management (SETM) and Enterprise Talent Management (ETM) Programs are structured Army Civilian professional development system designed to meet the Army’s long- term performance needs in a productive and efficient way. SETM and ETM are the means by which the Army prepares its senior Army Civilians to assume duty positions of greatest responsibility across the Army. These programs are designed to afford selected GS–12–15 and equivalent Army Civilians an exceptional professional development, senior-level educational or experiential learning opportunity. SETM and ETM programs operate under the overall supervision and oversight of the Assistant Secretary of the Army for Manpower and Reserve Affairs (ASA (M&RA)), and executed by the Civilian Service

## TRAINING AND LEADER DEVELOPMENT

Leader Management Office (CSLMO). SETM and ETM are comprised of eight components: Project-Based SETM TDY Assignments; Senior Service College (SSC); Defense Senior Leader Development Program (DSLDP); Army Senior Civilian Fellowships (ASCF); Command and General Staff Officers Course (CGSOC); Executive Leader Development Program (EDLP); Project-Based ETM TDY Assignments; and Leadership Shadowing Experiences.

f. SSC. SSC is at the apex of Civilian education and prepares Army Civilians for positions of greater responsibility in DOD. Army Civilians in the GS-14/15 grades and equivalent levels are eligible to apply. SSC provides advanced-level educational opportunities for leaders who require an understanding of complex policy and operational challenges and increased knowledge of the national security mission. Attendance is a competitive process and selections are made by a HQDA SETM Board. SSC participants are moved from their organizational TDAs, assigned to the Civilian Personnel Training Account and required to sign the SSC/Graduate Placement Program (GPP) mobility agreement to be placed in a new permanent position. Placement will occur immediately after graduation. Participants are required to serve in the DOD a minimum of three times the length of the program.

g. DSLDP. The DSLDP is the premiere executive development program for senior defense civilians. The DSLDP provides joint leadership academic experience through: non-Army senior-level professional military education; defense-unique leadership seminars from an enterprise-wide perspective; and opportunities for individual development based on the participant's IDP. It is a 2-year program, including attendance at a sister service's resident SSC. Application for the DSLDP is through the SETM process. Army Civilians in the GS-14/15 grades and equivalent levels are eligible to apply. DSLDP applicants who attend SSC during their program are moved from their organizational TDA, assigned to the Civilian Personnel Training Account and required to sign the SSC/Graduate Placement Program (GPP) mobility agreement to be placed in a new permanent position. Participants are required to serve in the DOD a minimum of three times the length of the program.

h. ETM. The ETM is designed to provide board selected GS-12/13, and equivalent pay plan/band civilians, professional and leader development opportunities. The program is operated under the supervision of the ASA (M&RA) and execution of the CSLMO. It consists of four components: Leadership Shadowing Experience; ETM-TDY Assignments; DOD Executive Leader Development Program; and CGSC.

i. Defense Executive Leadership Development Program (DELDP). DELDP is a unique and challenging opportunity for DOD employees to gain insight, training, and exposure to the missions and complex role of the war fighters. Participants train with each military service, as well as combined and allied forces around the world. Civilian employees at the GS-12/13/14 and equivalent levels are eligible to attend.

j. SES Education, Training, and Development. The DA SES members are the Army Civilian equivalent to GOs, and include top executive, managerial, supervisory and political appointment positions. The SES members are individuals who are highly agile and skilled in their function, who can successfully lead a wide spectrum of operations and who are adaptive to challenges. SES members demonstrate technical expertise, confidence, integrity, critical judgment and adaptability. Army Senior Executives can: operate in complex and fluid environments; build teams amid technological changes; provide vision and direction; and solve problems creatively. SES members require a broad core of executive qualifications or abilities in addition to professional, technical and program knowledge and skills. The Office of Personnel Management validated five executive core qualifications required of SES members: leading change, leading people, results driven, business acumen, and building coalitions. The CSLMO, Office of the ASA (M&RA), provides centralized life-cycle management and administration for the Army SES personnel. The CSLMO plans, manages and executes the Army's SES Education, Training and Development Program with the advice and support of the Army's Executive Resource Board (ERB). The goal of the program is to foster a culture of continuous learning that enhances leadership competencies through education, training and experiences in department, joint, interagency, intergovernmental and multinational environments. The SES Education, Training and Development Program is comprised of: Mandatory Foundation Training, Position Based Training, Advanced Continuing Education, Joint Qualifying Training, Talent and Succession Management (TSM), and ERB results. The Secretary of the Army (SECARMY) TSM Board enables the Army's senior leadership to target SES members for competency enhancing developmental assignments. The TSM ensures that an Executive's potential is developed through career opportunities and that skills and talent are utilized to meet Army enterprise challenges, both today and in the future. The ERB may identify SES members for developmental assignments, reassignment or further

## HOW THE ARMY RUNS

education or training. ERB directed education or training takes precedence when prioritizing applicants for constrained course allocations.

### Section X Training Support

#### 14-34. Training Support System (TSS)

a. The TSS provides the foundation on which Army training runs. As described in AR 350-1 and AR 350-52, it is the system of systems that provides networked, integrated, and interoperable training support capabilities that are necessary to enable operationally-relevant training for Soldiers, units, and Army civilians anytime and anywhere. The TSS includes products (Training IT Systems and non-systems TADSS), services (training support operations and manpower) and facilities (ranges, simulation centers, mission training complexes, training support centers) that are necessary to create the conditions to portray realistically the operational environment and enable operational, institutional and self-development training strategies. TSS enablers underpin the operational training leading to sustainable readiness and institutional POIs by providing commanders with tools to execute Soldier, leader, mission command, and unit collective training to standard at home station, CTCs, TRADOC Schools/CoEs, to include self-development.

b. The TSS consists of five programs organized around three lines of effort (LOE): Live, Synthetic, and Integration. The LOEs complement each other and together generate the Army's TSS capability. The programs include: 1) Sustainable Range Program (SRP); 2) CTC Modernization (CTC MOD) program; 3) Mission Command Training Support Program (MCTSP); 4) Soldier Training Support Program (STSP); and the 5) Training Information Infrastructure (TII) program. Each TSS program is defined by supporting functions or components that include program policy and procedures, manpower and TDA structure, modernization strategy, operations functions and resources, connectivity, and management support systems.

c. Live LOE.

(1) The SRP is the Army's approach for improving the design, management, use, and long-term sustainability of ranges. SRP is defined by its two core programs: first, the Range Program includes range modernization and range operations; and second, the Training Land Program focuses on land management and maintenance through the Integrated Training Area Management (ITAM) process, training land acquisition, and SRP Outreach, which provides support to both SRP core programs. ITAM provides a Geospatial Information System (GIS) capability that supports range modernization, range operations, and land management.

(2) CTC MOD and life cycle technology refreshment of the maneuver CTCs (NTC, JRTC and JMRC) in support of changing Army doctrine includes OPFOR, Instrumentation/TADSS, and facilities to provide a realistic training environment for BCTs in force-on-force and live fire scenarios. CTC MOD ensures CTCs remain relevant by providing joint context to the operational environment and provides the doctrinally-based feedback, facilitating leader and unit training dictated in the sustainable readiness training models. Resultant training capability output produces trained and ready combat units, leaders, and Soldiers prepared for the spectrum of conflict in a contemporary OE against a hybrid threat wide-area security/combined-arms maneuver.

d. Synthetic LOE.

(1) The MCTSP program provides the staff and trainers, facilities, infrastructure, and other resources necessary to support MC training of Army, USAR, and ARNG formations. Of note, the MCTSP provides resources for the development of the Synthetic Training Environment, part of the Army's six modernization priorities, managed by one of its eight Cross Functional Teams (CFTs). The MCTSP provides virtual and constructive training environments in support of combined arms training that replicates Army operations across the spectrum of conflict. This program supports MC training for individuals and for units ranging from company to corps, and at levels from tactical to JTF and ASCC levels of command. The MCTSP creates training that helps Army leaders develop current, relevant MC instincts and skills. It supports Army MC System training and battle command essential capabilities that empower individuals and small units and that allow junior leaders to prevail during decentralized operations. The MCTSP includes MTC operations and facilities, collective virtual and constructive TADSS, Army Games for Training (GFT), and the live, virtual, and constructive ITE.



## TRAINING AND LEADER DEVELOPMENT

(2) The STSP includes individual Soldier through crew level virtual and live TADSS management and Training Support Center (TSC) and Virtual Training Facility (VTF) operations. STSP manages TADSS fabrication of training devices, and the issuance of TADSS and provides instructors/operators for specific virtual TADSS and other TADSS support that enable commanders to execute individual and operational and institutional training.

e. Integration LOE.

(1) The TII program consists of two primary components: the Army Training Information System (ATIS); and point of delivery systems for dL. ATIS includes the integration of Army training information systems and provides an integrating architecture for training management, scheduling, development and content management. Point of delivery systems maintain and upgrade home station, deployable and institutional systems and infrastructures.

(2) The TADSS Maintenance Program enables Army operational and institutional training by funding a centralized, Army-wide contract for sustainment, maintenance, movement, supply, and limited operations of both systems (e.g., Longbow Crew Trainer) and non-systems TADSS (e.g., Instrumentable-Multiple Integrated Laser Engagement System) at Home Stations, CTCs, and institutions.

(3) TSS Management Program enables training in the Operational and Institutional training domains by providing training support management below HQDA level in the following areas:

(a) TADSS acquisition oversight by the Program Executive Office Simulation, Training, and Instrumentation (PEO STRI) operations costs for PEO STRI, and associated program management offices, including base operations, infrastructure, and IT support.

(b) TSS management, integration, and analysis at TRADOC, CAC-T, and ATSC.

(c) Management of USAREUR training services and support at 7th Army Training Command, including all aspects of multi-national integration training support.

(d) Management of U.S. Army Pacific (USARPAC) training services and support in Hawaii, Alaska, Japan, and Republic of Korea including all aspects of multi-national integration training support and the Joint Pacific Multinational Readiness Capability.

(e) Training management, ammo management, and troop school personnel in Installation Management Command (IMCOM) Garrisons.

### 14-35. Training Support System Governance and Management

a. The DCS, G-37 Training Simulations Division (DAMO-TRS) provides overall management and policy for TSS plans, programs, and resources. TSS governance is achieved through an enterprise consisting of HQDA G-37 TRS, TRADOC CAC-T, and the Army Futures Command's Synthetic Training Environment (STE) CFT and supported by PEO STRI and PEO Enterprise Information Systems. TRADOC provides lead agent support, to include TSS requirements validation for non-STE TSS products in order to integrate TSS with CTC capabilities. The IMCOM garrisons execute TSS in coordination with the TSS Enterprise. The IMCOM HQ and Directorates oversee TSS execution in CONUS (other than at Fort Irwin/NTC and Fort Polk/JRTC) in support of the RA and USAR. Supported commands are FORSCOM, TRADOC, USARC, MEDCOM, USMA, and Military District of Washington. USAREUR, USARPAC, and the ARNG execute TSS on their installations and within the ASCC's AORs. FORSCOM executes TSS at Fort Irwin and Fort Polk. The ACOMs, ASCCs, and DRUs that are responsible for operational and institutional training maintain a staff that validates and prioritizes TSS needs from their subordinate commands.

b. Enterprise Organization. The organizations listed below represent the core of the TSS Enterprise and support DAMO-TRS in the following areas: policy development and dissemination; requirements development; integration validation and prioritization; resource allocation; and execution oversight and tasking.

(1) HQDA G-37 TRS provides Army-wide policy and resources.

(2) TRADOC training support for the Army and designates lead agents for TSS. It manages the TSS Master Plan and database, and provides analytical support capability.

(3) TRADOC Capability Managers (e.g., live, OPFOR, integrating, synthetic, and training information) are aligned with, and across, the major TSS programs to identify program requirements and support the planning, programming, budgeting, development and acquisition of products, facilities, and services to the field.

(4) TRADOC Schools/CoEs develop requirements that support their institutional/school POI training, and, as a proponent, identify TSS requirements to support operational unit training.

## HOW THE ARMY RUNS

c. Management Process. The TSS Management Process includes periodic Management Reviews and Modernization Reviews to ensure TSS planning, programming, and execution is synchronized with current and future training needs.

d. TSS Capability Assessment. The TSS undergoes continuous assessment to ensure capabilities support Army training strategies and the Army Campaign Plan (ACP).

(1) Assessment Metrics include:

(a) Mission Essential Requirements (MER) are products, services, facilities, and sustainment identified by the major TSS programs. The MERs define what is needed to support training strategies.

(b) Use Cases define the level of MER delivered to each location where TSS is executed. Each TSS major program sets the parameters by which use cases are determined.

(c) Bench Marks are derived from the ACP and reflect applicable PPBE cycles, normally by the FY in which the MER is required at each Use Case.

(d) The SPAR is used to manage the lifecycle of non-systems TADSS from a holistic approach over a 30-year period and seeks to synchronize requirement, acquisition and resource planning across the modernization, sustainment, training and installation communities.

(e) The STE CFT conducts prototyping and develops requirements for STE components.

(f) Programs accomplished through the processes and constraints prescribed by the TT PEG Co-Chairs.

(2) Assessment Process entails:

(a) Biennial ASCC/CMD level Theater IPR.

(b) Major assessments conducted biennially to support POM development. They are done by conducting TSS Theater In-Process Reviews (IPRs) to determine TSS requirements based on the above metrics.

### 14-36. Training Ammunition

a. Training ammunitions requirements process.

(1) The Army develops munitions requirements in support of Army weapons training annually, by FY.

(2) Munitions resourcing is approved for all Army weapons training strategies through the Army Munition Requirements Working Group and Army Munition Requirements Counsel of Colonels (AMRWG/COC) process. Only munitions resourcing approved through the AMRWG/COC is published in DA Pam 350–38 and TRADOC POIs.

(3) The standard lead time to program for, procure, produce, and distribute munitions in support of a COC-approved weapons training strategy is a minimum of 4 years. It is imperative that munitions resourcing strategies be presented to the AMRWG/COC early in the acquisition and training strategy development processes. Proponents may present a draft resourcing strategy once the initial development plan for a course has been approved, or, for new capabilities, as early as completion of MS A, the technology development phase.

(4) No later than 90 days following AMRWG/COC-approval of munitions resourcing for any weapons training strategy, TRADOC proponents will submit their approved strategy to the TRADOC Live Training Directorate Standards in Training Commission (STRAC) Office, for review and forwarding to DCS, G-3/5/7 (DA G-37/TRA) (Training Ammunition Manager), for final validation and posting to Total Ammunition Management Information System (TAMIS).

b. Home station training.

(1) DA Pam 350–38 provides commanders with the DCS, G-3/5/7-approved individual, crew, and collective weapons training strategies and identifies the munitions and TADSS resources required to execute the strategies. It provides the basis for determining unit training ammunition requirements. All weapons training strategies in DA Pam 350–38 are published and maintained in TAMIS. Chapter 1, glossary, and appendix A of DA Pam 350–38 will continue to be published through the Army Publishing Directorate.

(2) Each TRADOC proponent school develops the Army-wide training strategies for all individual and crew certification training on individual and crew-served weapons for which it is the proponent.

(3) TRADOC schools that are the proponent for a collective training event will determine the collective training strategies for all crew-served weapons and weapons platforms involved in that training.

(4) TRADOC, with coordination and input from the commands that own a combined training center (CTC), is responsible for developing all weapons training strategies to support collective training at the

## TRAINING AND LEADER DEVELOPMENT

CTCs. Strategies must include resourcing for opposing forces training support requirements and will use standard Army munitions.

(5) TRADOC proponent schools will develop all Army weapons training strategies in accordance with approved Army doctrine.

(6) ACOMs that have enduring (lasting 3 years or more) command-unique weapons training requirements will present strategies for those training requirements to the AMRWG/COC for approval. ACOMs must coordinate command-unique strategies with the appropriate TRADOC proponent school(s) prior to presenting the strategies in the AMRWG/COC for approval. Approved command-unique strategies will be included in DA Pam 350–38.

(7) DA Pam 350–38 is updated annually and officially published on 1 October in the FY of execution. Thus, the DA Pam 350–38 for execution in FY 20x1 is published on 1 October 20x0.

(8) TRADOC proponents will explicitly identify and incorporate all TADSS into all weapons training tables where Army TADSS are part of the weapons training strategy.

(9) All units will use TAMIS to calculate their munitions requirements for home station and CTC weapons training. TAMIS extracts personnel and weapons densities information from the Army organization server (AOS), the DCS, G–3/5/7 (DA G–3/5/7) FM system of record for management of TOEs and/or TDAs. TAMIS pulls force data from AOS in accordance with appendix B. Unit authorization documents change continuously. Occasionally units will have TOE and/or TDA-authorized weapons and personnel on-hand that are not reflected in TAMIS (or vice versa). The munitions requirements for these on-hand, properly authorized weapons and personnel are valid requirements but must be manually entered into the TAMIS Requirements Module until the TOE and/or TDA data is updated in AOS and imported into TAMIS. To enable validation of these requirements, units will provide DCS, G–3/5/7 (DA G–37/TRA) a copy of the letter of acceptance (LOA) or the TOE and/or TDA that shows that the weapons or personnel are authorized to the unit.

(10) Units may have requirements that are “above-STRAC.” These include requirements for non-enduring (fewer than three years) training events that are not in DA Pam 350–38. Units must manually enter these requirements in the TAMIS requirements module and provide justification to support their approval. Justification must include:

- (a) Name of the event.
- (b) A description of the event.
- (c) Frequency of the event.
- (d) Number of weapons in the event.
- (e) Number of rounds per weapon to support the event.
- (f) Why resourcing in DA Pam 358–38 is insufficient to support the requested training.

(11) Command ammunition managers are responsible for ensuring that only valid requirements are submitted to DCS, G–3/5/7 (DA G–37/TRA) for approval and resourcing. Commands will support above-STRAC and above-POI requirements with their existing authorizations, when possible.

### **Section XI Policy, Requirements, and Resourcing Process**

#### **14-37. General**

The TT PEG provides guidance, implements decisions and defends the resourcing for training readiness requirements within five portfolios (Institutional, Operational, Mission, Network, and Training Support Services) in accordance with the Army Training Strategy and Army Senior Leadership guidance as directed. It plans, programs, manages, and defends the training resources that support the Army's ability to provide Training Readiness within the PPBE process. Input is provided by manpower models, force structure changes, and resourcing actions. Training activities receive the largest portion of funding in Operation & Maintenance, Army (OMA) appropriation which is sub-divided into five budget activities (BAs): BA-1 Operating Forces; BA-2 Mobilization; BA-3 Training and Recruiting; BA-4 Administrative and Service-wide Activities; and BA-5 Cyber. Other contributing appropriations include: Operations and Maintenance, National Guard (OMNG); Operations and Maintenance, Army Reserve (OMAR); Military Construction, Army (MCA); Missiles (MSLS); Other Procurement, Army (OPA); and Research Development Test and Evaluation (RDT&E).

## HOW THE ARMY RUNS

### 14-38. Organization

The DCS, G-3/5/7 combines the functions of institutional and unit training, missions and network support, and training support systems. The DCS, G-3/5/7 approves and manages Army military individual, collective, Army Civilian training, and education programs. It provides the Army a single point of entry for issues that influence training. The DCS, G-3/5/7 develops, coordinates, and resource policies and strategies for training and leader development programs and initiatives to achieve directed levels of individual, leader, and unit training readiness to support the force generation process, and to enable the Army to support the National Military Strategy.

a. ASA (M&RA). ASA (M&RA) has a training division to assist in the development, implementation, and review of policies and programs related to achieving the Army goal of effective and efficient training and education for the Army. The ASA (M&RA) advises the SECARMY on all matters relating to human resources and reserve affairs, to include, readiness and training.

b. Assistant Secretary of the Army (Financial Management & Comptroller) (ASA (FM&C)). ASA (FM&C) formulates the Army budget, issues manpower and dollar guidance, distributes funds to commands and agencies, and monitors obligation rates and reprogramming actions.

c. Assistant Secretary of the Army for Acquisition, Logistics, and Technology (ASA (ALT)). ASA (ALT) manages the life cycle of materiel and non-materiel items used by individuals and units in mission performance. The ASA (ALT) provides policy and guidance to research, develop, and procure system and non-system TADSS and other approved requirements for training support materials. Additionally, the ASA (ALT) funds and coordinates new equipment training (NET).

d. Assistant Secretary of the Army for Installations, Energy, and Environment (ASA (IE&E)). ASA (IE&E) provides secretariat-level management for the formulation, execution, and review of policies, plans, and programs relating to the following: the Range and Training Land Program (RTLTP); environment, safety and occupational health concerns or requirements; the National Environmental Policy Act; and Land Use Requirements Studies.

e. DCS, G-1. The DCS, G-1 is responsible for integrating personnel readiness and training, and manages ATRRS, the system that supports the ARPRINT management process. The DCS, G-1 manages execution-year training program change requests driven by personnel readiness requirements through the TRAP. The DCS, G-1 also manages the administration of the manpower requirements of the pre-commissioning programs for officers (USMA, ROTC, and OCS); and training for equal opportunity, and alcohol and drug abuse.

f. HRC. The Army HRC projects training requirements, by fiscal year FY based on training spaces allocated by the G-3/5/7 for RA officers and enlisted personnel. The DCS, G-3/5/7 allocates training spaces for AC based on projected unit requirements and distribution policies informed by the Army force generation cycle.

g. HRC-Army Reserve (AR). HRC commands and controls all Individual Ready Reserve (IRR) members. HRC also provides individual training management to the IRR, officers and enlisted (see Chap 6). It is responsible for the Officer Professional Management System (OPMS)-USAR and the Enlisted Professional Management System (EPMS)-USAR, and projects officer and enlisted training requirements for the USAR by FY. The HRC allocates training spaces for USAR officers and enlisted based on projected training requirements and in accordance with applicable Army force generation cycles.

h. DCS, G-9 Installations. The DCS, G-9 provides the following: policy and guidance for facility engineering programs and environmental compliance, restoration, pollution prevention, conservation, environmental program management, and real property master planning; direction and assistance in land acquisition in support of the RTLTP; utility and manpower infrastructure facility support for installation Training Support Centers (TSC) operations.

i. DCS, G-2. The DCS, G-2 is responsible for the OPFOR program and assisting the DCS, G-3/5/7 on intelligence training policy and management of the Defense Foreign Language Program.

j. DCS, G-4. The DCS G-4 is responsible for logistics readiness of Army forces, to include supportability/maintainability of equipment (to include training assets) in troop units.

k. The Army Chief Information Officer (CIO)/G-6. The CIO/G-6 provides policy and procedural guidance for Army visual information and multimedia support.

l. The DCS, G-8 is responsible for integrating Army funding, fielding, and equipping actions with the OSD, Joint, and Army Staff (ARSTAF) organizations and processes for the purpose of meeting current and future force requirements of the Joint Force. The DCS, G-8 is the principal military advisor to ASA (FM&C) and advises VCSA on Joint Requirements Oversight Council issues as well. The DCS,

## TRAINING AND LEADER DEVELOPMENT

G-8 also serves as a member of Joint Capabilities Board, Army Requirements and Resourcing Board, Army Requirements Oversight Council, and Army-Marine Corps Board.

m. The Inspector General (IG). The IG conducts Army-wide assessments of training development and training management to evaluate the implementation of training policy and impacts of training on readiness, sustainability, and units' ability to fight and win. Assessments focus on training resources and provide feedback to commanders in order to promote efficiency in training.

n. Office of The Surgeon General (OTSG). The OTSG projects training requirements and allocates course spaces internal to the AMEDD.

o. Chief, National Guard Bureau (CNGB). The CNGB promulgates training policy for ARNG units through ARNG Regulation 350-1. The CNGB also programs the resources for ARNG training and allocates training spaces to each state, territory, and the District of Columbia. ARNG unit commanders are responsible for their units' training. FORSCOM establishes training criteria and supervises training of ARNG units. Policy and guidance are contained in FORSCOM/ARNG Regulation 350-2.

p. Chief, Army Reserve (CAR). The CAR programs training resources for the USAR and monitors USAR training activities. The CAR manages professional development training for USAR officers, WOs, and senior NCO through HR.

### 14-39. Requirements and Resourcing Process

a. TTPEG. As one of the Army's five Title 10 PEGs, the TT PEG in coordination with the Training Enterprise, Integrators and Stakeholders, program resources across the FYDP.

b. Management Decision Packages (MDEP). The TT PEG manages all aspects of training dollars within components, units and down to individual training. TT PEG has 100 MDEPs divided into five portfolios: Institutional Training, Missions, Network, Operational Training, and Training Support Services. The DDOT, ODCS, G-3/5/7 and the ASA (M&RA) co-chair the TT PEG. MDEP managers articulate and defend resource requirements to the PEG during the POM. The MDEP managers use various costing models to determine and create requirements.

c. PPBE. The PEG uses the PPBE process to build the Training PEGs portion of the Army's POM. A variety of systems and models provide input into this process such as the manpower model, force structure model, training models, costing models and resourcing actions.

## Section XII

### Summary and References

#### 14-40. Summary

All training and leader development actions occur within the Army culture which embraces values and ethics, the Warrior Ethos, standards, and enduring principles and imperatives. Training builds confidence and competence, while providing essential skills and knowledge. Training results in individual and unit readiness. Unit commanders are responsible for scheduling and conducting training. Leader development is the deliberate, continuous, sequential, and progressive process founded in Army values that grows Soldiers and Army Civilians into competent and confident leaders capable of decisive action.

#### 14-41. References

- a. Publications—
- (1) ADP 3-0. Unified Land Operations, October 2011.
  - (2) ADP 7-0, Training Units and Developing Leaders, August 2012.
  - (3) ADRP 3-0, Unified Land Operations, May 2012.
  - (4) ALDS 2013.
  - (5) AR 5-13, Total Army Munitions Requirements Process and Prioritization System, December 2009.
  - (6) AR 12-15, Joint Security Cooperation, Education and Training, January 2011.
  - (7) AR 25-1, Army Information Technology, June 2013.
  - (8) AR 25-30, The Army Publishing Program, June 2015.
  - (9) AR 220-1, Army Unit Status Reporting and Force Registration, April 2010.
  - (10) AR 350-1, Army Training Leader Development, August 2014.
  - (11) AR 350-2, Operational Environment and Opposing Force Program, May 2015.

## HOW THE ARMY RUNS

(12) AR 350-10, Management of Army Individual Training Requirements and Resources, September 2009.

(13) AR 350-19, The Army Sustainable Range Program, August 2005.

(14) AR 350-38, Policies and Management for Training Aids, Devices, Simulators, and Simulations, March 2013.

(15) AR 350-50, Combat Training Center Program, April 2013.

(16) AR 525-29, Army Force Generation, March 2011.

(17) AR 600-100, Army Leadership, March 2007.

(18) AR 600-8-19, Enlisted Promotions and Reductions, February 2015.

(19) AR 600-8-29, Officer Promotions, February 2005.

(20) Army Training Strategy, October 2012.

(21) DA Pamphlet (Pam), 350-38, Standards in Training Commission, October 2014.

(22) DA Pam 600-3 Commissioned Officer Professional Development and Career Management, December 2014.

(23) DA Pam 600-25, U.S. Army Noncommissioned Officer Professional Development Guide, September 2015.

(24) Draft Army Training Strategy, December 2019.

(25) Rivera, Francis A., CP26, "Investing in Force Management," Manpower and Force Management Career Program Bulletin, spring 2014, pp 10-11.

(26) TRADOC Regulation 350-18, The Army School System (TASS), July 2010.

(27) TRADOC Regulation 350-70, Systems Approach to Training Management, Processes, and Products, Mar 1999.

(28) U.S. Army Training Concept 2012-2020, 23 November 2010.

(29) ALM 2015, 14 September 2010.

(30) DODD 5160.41E Defense Language, Regional Expertise, and Culture (LREC) Program dated 21 August 2015.

(31) DODD 5205.12 Military Intelligence Program (MIP) dated 14 November 2015.

(32) DODI 5160.70 Management of the Defense Language, Regional Expertise, and Culture (LREC) Program dated 30 December 2016

(33) AR 11-6 Army Foreign Language Program dated 18 February 2016.

(34) AR 350-20 Management of the Defense Foreign Language Program dated 17 January 2018.

### b. Useful Links—

(1) <http://tradoc.army.mil>.

(2) <http://apd.army.mil>.

(3) <http://dls.army.mil>.

(4) <https://www.atn.army.mil>.

(5) <https://www.atrrs.army.mil>.

(6) <http://usacac.army.mil>.

(7) <https://www.us.army.mil/suite/portal/index.jsp>.

(8) [www.dliflc.edu](http://www.dliflc.edu).

## Chapter 15

### Information Management and Information Technology

#### Section I Introduction

##### 15-1. Chapter Content

This chapter provides an executive overview of how the Army conducts business regarding information management (IM) and information technology (IT). The key concepts are: the IM and IT roles as well as responsibilities of the Chief Information Officer (CIO) / G-6; Army Network Plan (ANP); Army enterprise management; and partnerships with the CIO / G-6. The last section of this chapter provides a list of key terms and references.

##### 15-2. CIO / G-6 Roles and Responsibilities

The CIO / G-6 is a senior Army official with dual roles regarding Army business for IM and IT. The duties and responsibilities of the CIO role differ in scope and authority from the duties and responsibilities of the G-6 role. The next two sections will separately describe the duties and responsibilities of the Army CIO and the G-6.

##### 15-3. CIO Duties and Responsibilities

The CIO is the principal adviser to the Secretary of the Army (SECARMY) on the strategy, policy, and execution of IM and IT for the Army. The CIO is also responsible for: advising the SECARMY on the effect of IM and IT on warfighting capabilities; creating, managing, and maintaining the Army Enterprise Architecture (AEA); developing information sharing policy; maintaining Army resource management processes; and ensuring the synchronization of the Army's network activities. This chapter organizes these responsibilities into four main categories: Strategy / Policy; Architecture and IT standards; IT Financial Management; and Implementation Oversight.

###### a. Strategy / Policy.

- (1) Develop Headquarters, Department of the Army's (HQDA) IM strategy.
- (2) Develop and implement the IM and IT capital planning and investment control strategy.
- (3) Establish strategic direction for aspects of the Planning, Programming, Budgeting, and Execution (PPBE) for IM resources.
- (4) Develop IM policies and guidance that are in compliance with laws.
- (5) Set policy for the acquisition of IM, IT, and information resources to maximize the value of IT investments.
- (6) Develop policy for information sharing standards.
- (7) Develop policies and guidance for Army cybersecurity activities including key infrastructure, common access card, and other technology programs.
- (8) Coordinate with and provide input to the Chief Management Officer's (CMO) strategic guidance on business operations, policy development, procedures, and planning documents to obtain alignment and integration with IM and IT data strategies and directives.
- (9) Manage the electromagnetic spectrum in Department of Defense (DOD), Service, Joint, National, Host-Nation, and International spectrum management activities.

###### b. Architecture and IT Standards.

- (1) Develop, implement, and maintain the AEA.
- (2) Develop, implement, and maintain the Enterprise Information Environment Mission Area (EIEMA).
- (3) Develop information sharing standards and architecture.
- (4) Develop cybersecurity standards and architecture.

## HOW THE ARMY RUNS

- (5) Validate compliance of interoperability and standards implementation.
- c. IT Financial Management.
  - (1) Review budget requests for all IT national security systems.
  - (2) Promote the effective and efficient design and operation of all major information resources management processes.
  - (3) Report the Army's IT budget to Congress.
- d. Implementation Oversight.
  - (1) Develop, coordinate, and implement an assessment process for Army IM programs, including compliance with IM policies, guidance, standards, and monitoring.
  - (2) Advise and assist the Assistant Secretary of the Army (Acquisition, Logistics and Technology) (ASA (ALT)) on the acquisition of IM, IT, and information resources in order to ensure that IT resources are acquired and managed in a manner that implements the policies and procedures defined by the CIO.
  - (3) Chair the Army CIO Executive Board (EB) and represent HQDA on IM issues and concerns.
  - (4) Develop, implement, and maintain infrastructure and portals.
  - (5) Supervise the execution of information sharing standards.
  - (6) Supervise the execution and compliance with cybersecurity requirements.
  - (7) Conduct IT portfolio management by identifying opportunities, validating requirements, screening business cases, providing guidance on and monitoring implementation of IM capabilities and dependencies in business process initiatives and programs.
  - (8) Conduct IT investment performance management and advise the SECARMY regarding continuing, modifying, or terminating an IM or IT program or project.
  - (9) Ensure that HQDA has a sufficient number of trained information resource management and information security personnel and make sure those personnel meet requirements for ensuring the performance of activities to achieve goals established for information resource management.
  - (10) Ensure that IT and national security systems are in compliance with standards of the Federal Government and DOD.
  - (11) Develop policy to manage Internal Use Software (IUS) and ensure controls are in place to enable compliance with IUS reporting.

### 15-4. Deputy Chief of Staff, G-6 (DCS, G-6)

The Army Signal, DCS, G-6, function is fulfilled by providing advice to the Chief of Staff, Army (CSA) for IM / IT and communications issues and their impact on warfighting capabilities from a network functional perspective. G-6 responsibilities are organized into four main categories: Strategy / Policy; Standards / Architecture; IT Financial Management; and Implementation Oversight.

- a. Strategy / Policy.
  - (1) Develop the ANP.
  - (2) Develop strategy and policy for—
    - (a) Information and signal operations.
    - (b) Army signal force structure.
    - (c) Equipping and employment of signal forces.
  - (3) Provide policy and guidance for the Army's communications needs for all network layers, including Top Secret and higher levels of security and access to coalition networks.
- b. Architecture and IT Standards. Develop and maintain Army Network architecture in conjunction with Army Cyber Command.
- c. IT Resource Management.
  - (1) Formulate and defend resources necessary to provide command, control, communications, and computers (C4) and IT solutions to the warfighter.
  - (2) Translate warfighter IM, IT, and information resources requirements into funding requirements.
  - (3) Resource the Army's communications needs for all network layers, including Top Secret and higher levels of security and access to coalition networks.
- c. Implementation Oversight.
  - (1) Develop, coordinate and implement an assessment process for Army communications programs, including compliance with IM policies, guidance, standards, and monitoring.
  - (2) Assess the effects of IM-related strategy, policies, plans, services, and programs on the warfighter.
  - (3) Monitor the implementation of IM requirements.



- (4) Guide and monitor the implementation of the Army global enterprise network.
- (5) Execute the Army's data and information sharing plan.
- (6) Implement CIO policy and guidance for Army cybersecurity activities.
- (7) Supervise Army-wide activities in C4, satellite-enabled information networks, enterprise-wide integration of Army information and IT, and IM-related aspects of business continuity, disaster recovery, and contingency support.
- (8) Supervise the implementation of other Army-wide communications programs, including those for Army spectrum management and electromagnetic spectrum operations (ESMO), non-intelligence space and joint military satellite communications programs and projects, and visual information.
- (9) Act as the Enterprise Information Environment Mission Area (EIEMA) lead for the functional area of communications, and conduct IT portfolio management by identifying opportunities, validating requirements, screening business cases, providing guidance on, and monitoring implementation of IM capabilities and dependencies in business process initiatives and programs.

### **Section II**

#### **Army Network Plan (ANP)**

##### **15-5. The Army Network**

The Army's portion of the Department of Defense Information Network (DODIN-A) is comprised of tactical and enterprise hardware, software, and data links and includes network operations, cybersecurity, and the people and contracts that support it. DODIN-A must be a survivable, unified, end-to-end network that enables leaders to prepare, lead, and fight in high-intensity conflict with Unified Action Partners against any adversary, anywhere, anytime to win decisively in all domains. To achieve this, it has to be simple and intuitive, available, reliant, and resilient, expeditionary and mobile, standards-based, protected, dynamic, upgradeable, and function as a weapons system.

a. The CIO / G-6 leads the Army's network modernization effort to deliver timely, trusted, and shared information. The CIO / G-6 mission includes creating an environment where innovation empowers the Army and mission partners through an agile, responsive, collaborative, and trusted information enterprise.

b. Network Modernization. The network must be treated as a single entity, unified from the DOD Information Network (DODIN) to the installation and to the farthest tactical edge. It must provide a common operating environment from home station to expeditionary, as well as en route. The ultimate goal is to enable mission command (MC) to defeat the Nation's adversaries with unmatched lethality, protection, and situational awareness in Multi-Domain Operations as part of the Joint Force. Achieving multi-domain dominance requires an overarching network architecture that connects all echelons from squad through Joint Task Force (JTF) to ensure that leaders have the right information at the right time to make the best possible decisions. The Army must design, develop, acquire, and field the network in a comprehensive, synchronized manner. The Army CIO / G-6, in coordination with key stakeholders from across the Army, industry, and academia will modernize the Army Network in support of the Army Cloud Strategy that establishes an Artificial Intelligence (AI) ready, hybrid, commercially provided cloud hosting environment as a part of the DOD enterprise cloud first eco-system that will protect Army's data, increase lethality at echelon, and generate reinvestment opportunities that enable future modernization. The Army's Enterprise Computing Environment (ECE) capability is a component of the Army's Common Operating Environment (COE) community. The Army ECE will provide for application hosting and hoteling services as a commercially provided virtual on-premises or off-premises cloud service offering, Defense Information Systems Agency (DISA) provided commercial cloud service offering (CSO); and additionally application hosting and cloud integration requirements for Army Enterprise Data Centers (AEDC) in the Continental United States (CONUS) and outside of the Continental United States (OCONUS). These reforms will support the vision of a single, secure, standards-based network that supports the Joint Information Environment (JIE), Mission Partner Environment (MPE), and Multi-Domain Operations.

c. End-to-End Capability. The Army network is comprised of tactical, enterprise, and installation communications, computing, network operations, and security components. Over the last decade, the Army invested heavily in augmenting and integrating tactical solutions. During this same period, the enterprise and installation components of the network have remained relatively stagnant, fostering significant disparities. As the Army shifts to a CONUS-based fighting force, the requirement to train with

## HOW THE ARMY RUNS

the same technology and procedures used in theater, and the requirement for a smaller footprint in the area of operations, mandate transformation of DODIN-A's institutional components. The Army must rebalance DODIN-A into an end-to-end network while maintaining readiness, guaranteeing interoperability, and minimizing cost.

d. The ANP. Following the successful capability set approach used in the MC domain, the Army will incrementally upgrade the institutional component of DODIN-A while synchronizing solutions with the operational network. These upgrades, often transparent to end users, will provide significant service improvements for Army leaders, data center operations, network users, and network operators, while enhancing the security posture of the network. The ANP will increase effectiveness (for example, single sign-on access to applications and data repositories, and robust and always available collaborative solutions), efficiency (for example, command and control (C2) of the network through centralized network operations and synchronized network funding), and security (for example, assured identity and access management, and continuous monitoring and risk assessment of the network and data center security posture).

### 15-6. Network Transformation

The ANP supports the Army Campaign Plan (ACP) and the Army Operating Concept (AOC). The ANP supports mission readiness by providing the vision and direction that set conditions for multi-domain dominance by unifying efforts to provide a modern network that meets the Army's warfighting, intelligence, and business needs, today and tomorrow. The ANP is comprised of two documents, which are intended to be used together to achieve the overall vision. The ANP Framework (ANPF) is an overarching document that supports The Army Plan (TAP) by establishing the framework for achieving the future state of the network and focusing the efforts of Army IT stakeholders as they execute their roles and responsibilities. The Army Network Implementation Plan (ANIP) operationalizes the framework and describes the key strategic tasks that must be executed to achieve the future state. Together, these documents guide resource planning and shape the Program Objective Memorandum (POM).

a. Network Capability Sets (NCS). The Army will use a capability set management construct for the network that will cut across functional areas. To realize the full operational capabilities of DODIN-A 2020 and Beyond, it is essential that NCS integrate operational and institutional requirements defined as Operational Capability Sets (OCS) and Institutional Capability Sets (ICS) respectively. OCS are defined as MC hardware, applications, communication transport, and services that support units and organizations while deployed. ICSs are defined as the hardware, applications, services, and communications transport that support the Army business, installation management, and Army units and organizations. The ICS supports both Generating Forces (GF) and Operating Forces (OF) as they train, prepare to deploy, and deploy. The OF receive responsive support, while en route and forward deployed, from solutions resident across various Army / DOD installations.

b. Lines of Effort (LOE). The CIO / G-6 executes the duties and responsibilities of the offices via specified LOE. The LOE are defined in the ANP.

## Section III

### Army Enterprise Management

#### 15-7. Standardizing Enterprise Information Technology Management

The Army is moving toward DODIN-A 2020 and the JIE. As it moves toward this holistic enterprise concept, the CIO / G-6 synchronizes requirements and delivers solutions to the enterprise, ensuring DODIN-A 2020 provides capability to the edge. As solutions are delivered, the Army collapses local systems and delivers enterprise services bringing the full complement of DODIN-A to the edge.

#### 15-8. Army Information Technology Governance

The Army CIO / G-6 hosts two primary governance boards that support both the CIO and G-6 responsibilities: the CIO Executive Board (EB); and the CIO / G-6 Army Enterprise Network Council (AENC).

a. The CIO EB serves as a platform to share Army CIO / G-6 strategies, policies, actions, and guidance with Army Commands (ACOM), Army Service Component Commands (ASCC), Direct Reporting Units (DRU), and HQDA, as well as receive feedback and questions from the field. In addition, the CIO EB is a

platform used to socialize and discuss the AENC decision recommendations. Board membership consists of General Officers, Senior Executive Service, and other senior-level participants from the Army Staff (ARSTAF), ACOMs, ASCCs and DRUs.

b. The AENC is chaired by the Army CIO. The AENC serves as a senior decision-making forum for the CIO and G-6 functions, ensuring that the strategic objectives of Army EIEMA support DOD's JIE. The AENC ensures that validated requirements are traceable to, and fully support, the required capabilities of the Warfighting Mission Area (WMA) and Business Mission Area (BMA). The AENC is a three-tiered structure with two subcommittees: a 1/2-Star Council; and a Council of Colonels. The AENC provides strategic guidance and enables the operational solutions of, and recommends decisions, encompassing three areas: network security; Army Core Enterprise Services; and building network capacity. The AENC conducts portfolio reviews in order to align requirements with the PPBE process. During the portfolio reviews, portfolio managers will validate requirements against adherence to and compliance with strategic priorities, architecture integration, Clinger-Cohen Act (CCA) criteria, capability gap and / or redundancy analysis, cost-benefit analyses, and / or other criteria. These reviews will inform processes such as Joint Capability Integration and Development System (JCIDS), Defense Acquisition System (DAS), or other processes for appropriate action.

c. CIO Responsibilities for IT/IM Implementation Oversight. The Army must adhere to federal regulation and policy found in the Federal Information Security Act (FISMA) and OMB Circular A-123 which include compliance to National Institute of Science and Technology (NIST) Special Publication 800-53. Review Business Mission Area (BMA) systems for compliance with NIST, DODI and Army regulations using inputs from audits, DOD and Army automated business intelligence systems and inspection results. Identify potential cybersecurity vulnerabilities from these sources and notify system owners. The Army CIO works across HQDA staff, ASA (ALT), and combatant commands to support remedial action and reduce IT risk to these systems, insuring compliance with all federal, DOD, and Army standards.

### **15-9. C4 / Information Technology Investment Strategy**

The efficient and effective use of IT resources has a direct effect on the Army's ability to perform its missions. The Army CIO / G-6 manages IT investments and develops a coordinated, consolidated investment strategy across all Mission Areas. The IT planning process develops the IT Investment Strategy, recommending a prioritized list of IT investments and / or whether to continue, modify, or terminate an IT program / project in accordance with CCA Authorities (Titles 10, 40, and 44 of the U.S. Code (U.S.C.)). The recommended prioritization listing is a reference and support tool within Program Evaluation Groups (PEG) throughout the PPBE and acquisition processes. The prioritization process addresses capability gaps, investment risks, IT interdependencies, and timing issues across all areas of IT investments. This helps the Army maximize how limited IT investment funding is used and ties investments to strategic priorities.

### **15-10. Core Enterprise Services**

The EIEMA is focused on delivering core enterprise services to the end-users of the Warfighting, Business, and Intelligence Mission Areas supporting both the current and future force. Enterprise services allow the widespread use of standardized solutions (for example, services, tools, or applications) to facilitate end-to-end linkage of the Army's operational and institutional processes. The CIO / G-6 is responsible for overseeing the Army's integrated approach to delivering Enterprise services. CIO / G-6 integrates plans, policy, and resources to ensure the business and warfighting requirements of the Army are met. Enterprise services provide an array of critical enablers for executing the Army's mission. These include general-use services, services for specific functional communities, and services to support Army missions' mission-partner environments.

a. CIO / G-6 serves as an integrator for enterprise services while ensuring compliance with applicable law, federal, DOD, and joint guidance. The CIO is required by statute to perform management, integration, and accountability for use of IT resources in performing Army missions and functions. Consistent with the ANP, the Army will deploy enterprise services as a part of capability set fielding.

b. The Army's network modernization efforts include investments in enterprise services that support implementation of the JIE. Managing IT solutions as enterprise services reduces the total cost of ownership through bulk buying capacity and reduces security risks related to managing multiple individual solutions. Modernization investments include enterprise email, enterprise content management, and

## HOW THE ARMY RUNS

collaboration services, and enterprise resource planning investments such as the General Fund Enterprise Business System (GFEBS).

### **15-11. Army Enterprise Service Management Framework**

a. The AESMF is the IT Service Management (ITSM) model the Army CIO / G-6 has implemented to help guide the design, implementation, and maintenance of quality enterprise services for Army customers. This requires integration with other Army management processes, such as JCIDS and PPBE. The AESMF is a process-based approach for delivering enterprise IT services aligned with Army's strategic and operational goals. Based on industry best business practices, AESMF is aligned with both the Defense Enterprise Service Management Framework (DESMF) and DOD Directive (DODD) 8000.01, Management of the Department of Defense Information Enterprise.

b. AESMF relies on people, processes, functions and technology to effectively deliver IT services within a well-defined governance structure. The AESMF currently applies to all IT services listed in the Army C4 and Information Management (C4IM) Services List. Following the AESMF lifecycle approach (for example, Strategy, Design, Transition, Operations, and Continual Service Improvement) will provide the Army with effective, secure, and efficient IT services that meet Army operational mission requirements. Further information about Army Enterprise Service Management (AESM) is found in the AESM Concept of Operations (CONOPS), and the AESM Reference Architecture.

### **15-12. Army Enterprise Architecture (AEA) Overview**

a. The purpose of an AEA is to integrate and synchronize all of the architecture produced across the Army so that it can be used to consistently provide decision-makers with timely, accurate and relevant information, enabling repeatable decisions to be made. Repeatability is important as it ensures accurate traceability in decision-making which leads ultimately to accountability of appropriated funding.

b. Although architecture is widely used within the Army, there is not currently anything that can be called an AEA. The vast majority of architecture produced today is used to support specific requirements such as the JCIDS or other acquisition-based processes. This means that decision-makers at the GO/SES level are unable to access these single-use architectural products to make repeatable, enterprise-wide decisions.

c. The Army CIO / G-6 intends to rectify this situation by implementing a true AEA. To do this, the following elements will be put in place:

(1) Policy, rules and guidance governing an AEA, including the meta-model that ensures the coherency and consistency of data between architectures.

(2) A mechanism for integrating all architectures based around the mission of the Army. The intention is not for CIO / G-6 to 'architect the Army' but to provide a mechanism for the Army to architect itself.

(3) Processes for ingesting architecture data from authoritative sources and storing it in an AEA repository.

(4) A means to access and visualize the data in the AEA repository. This requires the creation of an analytics application that is cloud-based and Common Access Card (CAC)-enabled and ensures access for not just architects but all Army users.

d. When considered as a complete capability the holistic benefit of the AEA is the transformation of access to timely, accurate and relevant information. Any Army user who needs access to data captured in architecture will be able to use the AEA to find it quickly and easily, reducing data calls, avoiding ambiguity around sources of authoritative data, and shortening information-gathering timelines.

Additionally:

(1) The AEA will enable the alignment of investments with The Army Plan and provide a cohesive view of the Army Enterprise. The AEA links operational, business, and functional capabilities in a data-driven investment and portfolio management analytics application and enables integration and synchronization of portfolios across the Army. This transformative effort will enable and support congressional, Federal, DOD, and Army mandates to better manage and oversee investments across all Army functions.

(2) The AEA will integrate and synchronize the Army's warfighting, intelligence, and business processes. It will be used to guide and inform decision-making across all doctrine, organization, training, materiel, leadership and education, personnel, facilities, and policy (DOTMLPF-P) domains and to appropriately allocate resources throughout the Army's decision cycles of the Defense Planning, PPBE

system, DAS, and the JCIDS. It will also inform and optimize support to the senior governance forums (for example, Army Requirements Oversight Council (AROC), Strategic Portfolio Analysis Review (SPAR), IT Oversight Council (ITOC), etc.).

(3) One of the inherent features of the AEA is that it will act as the Rosetta Stone for the Army by aligning disparate yet commonly used DOD and Army taxonomies (Joint Capability Areas (JCAs), Joint Functions, Army Mission Essential Functions (MEF), Army Universal Task List (AUTL), etc.) and their definitions. This alignment will provide a transitive relationship across taxonomies effectively normalizing how the army categorizes its functional activities. This will ensure the Army can understand its constituent parts regardless of the language being used for portfolio management.

d. The AEA can also be a mechanism for greater Joint Service Integration. Mapping US Law to DOD functions to MEF/Army Specific Functions/Common Service Functions (CSF) not only supports the integration of the Army's Total Force but provides an ideal starting point for integration discussions with the other Services. If they were to conduct similar mappings of DOD Functions to MEF/CSF and their Service specific functions then the interoperability touch points would become readily apparent.

### **15-13. Army Data Management - DODIN-A 2020 and the Joint Information Environment**

Data is a strategic asset and managed as such. In accordance with Title 44, U.S.C., Subsection 3520 (44 U.S.C. 3520), Chief Data Officers (CDO), SECARMY will designate the CDO. The Army CDO will be responsible for lifecycle (origination to destruction) data management to include standardization of data format, sharing of data assets and publication of data assets in accordance with applicable law and policy. The Army CDO must work closely with the Army CIO to effect changes within IT and Information Resource Management (IRM) policy. Through the Office of the Secretary of Defense, the Army will receive support, guidance and direction on data policies, practices, and priorities.

a. The Army Data Strategy, aligned to the DOD Data Strategy, guides the Army toward ensuring data and information are visible, accessible, understandable, trusted (to include protection, assurance, and security), and interoperable throughout the data life-cycle to any authorized DOD consumer or mission partner to the maximum extent allowed by law and policy. The Army Data Strategy will provide guidance to data producers to maximize information availability to authorized consumers. This will allow commanders and their organizations to have broad and efficient access to data-reducing duplication of efforts by leaders / Soldiers and their joint / multinational partners. It will also increase interoperability among systems and reduce development costs. The Army Data Strategy includes the following components—

(1) Army Information Architecture (AIA). The AIA provides the foundation to accelerate Army transformation to net-centric information sharing in two ways. The first is design and development guidance for enabling information sharing. The second is a set of compliance requirements for assessing the level to which systems meet net-centric information sharing objectives.

(2) Authoritative Data Sources (ADS). This allows commanders, decision makers, and stakeholders to target recognized systems for obtaining specific trusted information such as social security numbers and unit readiness, without having to choose from several systems for the correct data.

(3) Information Exchange Specifications (IES). Enables efficient exchange of information between systems and saves resources, with agreed upon definitions and formats, for reuse by a larger group of systems. In other words, it will be easier for systems to exchange data because they speak the same language.

(4) Governance. In large enterprises such as the Army, data is produced by many different organizations, directed toward their specific needs and requirements. However, when data needs to be shared across the enterprise, as is certainly the case for the Army, there are considerations beyond the specific needs of the organization. These include issues of trust, security, policy, understandability, quality, and so on. Data governance is the means to address these issues. Army Regulation (AR) 25-1 references the Army Data Board (ADB) structure, positions, responsibilities, and other information on governance. In compliance with AR 25-1, Army Information Technology, the CDO has developed a governance approach that provides a collaborative environment with active participation from across the Army. The CDO recognizes that the individual proponents, as identified by the SECARMY, ACOMs, and Deputy Chiefs of Staff, are responsible for the operational success of their areas and are ideally suited to identify how data can best be exploited to support them in achieving mission success.

b. Army Data Management Program (ADMP). The ADMP establishes requires policies and procedures for the production of data standards to ensure enterprise-wide machine process ability of Army

## HOW THE ARMY RUNS

information resources and interoperability for all pertinent data exchanges among Army information systems. The ADMP addresses the creation and implementation of data standards applicable to automated systems, software applications, data exchanges, databases, record and document management, and information presentation within and across warfighting and business systems. The ADMP facilitates the dissemination and exchange of information among organizations and ISs throughout the Army, DOD, and the federal government. The ADMP implements the information standards portion of the DOD Information Technology Standards Registry (DISR) and supplements the DOD Net-Centric Data Strategy. Net-centricity is dependent upon the ability to locate and retrieve information and services regardless of where they are stored. A common data management strategy is essential to allowing authorized users to access required information.

### **15-14. Cybersecurity**

Cyber attacks threaten the Army Network and its information every day, putting operations and personnel at risk. Commanders require operational freedom to maneuver in cyberspace with the ability to identify vulnerabilities while minimizing risk. Network security and cybersecurity are therefore paramount for protecting and safeguarding Army information and communications systems ensuring the integrity of operational Warfighting networks and business information systems critical to Army mission success.

a. The Army CIO / G-6 is responsible for overseeing and managing the Army Cybersecurity program. The Army Information Assurance program protects information and its critical elements, including the systems and hardware that use, store, and transmit that information by identifying, measuring, and mitigating risk. Cybersecurity incorporates functions from Operations Security, Communications Security, Transmission Security, Information Security, personnel security, and physical security to protect and safeguard Army IT and communication technologies as well as Army warfighting and business solutions.

b. Cybersecurity is everyone's responsibility. Leaders must incorporate cybersecurity into their risk management programs, make certain their personnel are accountable for their daily practices that put Army information and communication technologies at risk, and link cybersecurity to readiness. All personnel must be aware of the potential risks they present and take proper precautions to protect the information entrusted to them.

### **15-15. Army Spectrum Management**

The electromagnetic spectrum (EMS) is a limited resource and considered a maneuver space essential to controlling the operational environment that affects military operations. Today, military operations and training are executed in an environment complicated by increasingly challenging demands and constraints on the EMS. The relationship between range of military operations (ROMO) and electromagnetic spectrum operations (EMSO) are best visualized as a continuum. As ROMO transitions from peacetime (regulatory) to wartime (superiority), EMSO provides a set of coordinated military actions executed in order to exploit, attack, protect, and manage the electromagnetic environment. EMSO is important to the Army and Joint Forces to ensure readiness, modernization, and shaping the force and becomes an enabler to the Army's cyberspace electromagnetic activities (CEMA). The CIO / G-6 -

a. Is responsible for the Army's Spectrum Management (SM) policy at the strategic level, and prepares the Army's input to the Defense EMS Management Strategic Plan. In addition, coordinates the Army's response to the National Spectrum Strategy that incorporates current and future spectrum requirements.

b. Serves as the principal Army negotiator representing Army requirements in U.S. spectrum national and international regulatory and policy discussions through the International Telecommunications Union (ITU).

## **Section IV**

### **Army Chief Information Officer / G-6 Strategic Partnerships**

#### **15-16. Army Partnerships**

Given the cross-cutting missions of CIO / G-6 to provide an integrated, secure, standards-based information environment that address the mission needs of the Army, internal and external partnerships are critical. Partnerships are required to accurately define, develop, execute, and share critical information securely to meet the changing needs of the Army, DOD, other federal agencies and mission partners.

## Information Management and Information Technology

a. Principal HQDA officials. Within their respective areas, principal HQDA officials serve as the proponent for information requirements and associated DOTMLPF-P solutions within their assigned functional areas of responsibility. As the proponent, the principal official manages functional processes within their respective portfolio areas to maximize the efficiency of enterprise processes and improve effectiveness of information systems. The principal official requests and defends the resources needed to support the development, deployment, operation, security, logistics support, and modification of IT investments through the PPBE process.

b. Army Futures Command (AFC). Support to AFC is a CIO / G-6 priority. The Army's Network Cross-Functional Team (N-CFT) is tasked with narrowing capability gaps in the Army's Mission Command Network through experimentation, assessments, and technical demonstrations. The outcomes of these processes rapidly transition leader-approved capabilities into the Army Acquisition System. CIO / G-6 support to AFC extends beyond the N-CFT into all of Army's modernization priorities, focused not only on delivering network and space-based capabilities, but to support readiness goals across all modernization efforts.

c. ASA (ALT). Army CIO / G-6 and ASA (ALT) are strategic partners in delivering standardized, compatible, interoperable, secure, and resourced solutions to the Warfighter. Working with CIO / G-6, ASA (ALT) serves as the source selection authority for acquiring IT solutions. In addition, ASA (ALT) oversees project managers and Program Executive Offices (PEO) to ensure that IT and National Security System (NSS) systems successfully meet Army IT requirements. CIO / G-6 works closely with the PEOs on IT related programs, including—

(1) PEO Enterprise Information Systems (EIS). PEO EIS provides joint and Army organizations with information dominance by developing, acquiring, integrating, deploying, and sustaining net-centric knowledge-based IT and business management systems, communications, and infrastructure solutions through leveraged commercial and enterprise services. The PEO EIS oversees the management of Computer Hardware, Enterprise Software Solutions (CHESS), MilTech Solutions, and Army Knowledge Online (AKO).

(a) The CHESS office provides a full range of IT, IT infrastructure, and information systems (hardware, software, peripherals, networking, and infrastructure support services) to Army, DOD, foreign military, Soldiers, and federal agencies consistent with DOD and HQDA policy.

(b) AKO is the Army's current enterprise portal for accessing information (see para 15-8); however, as the Army transitions to enterprise services, like enterprise email, the approved enterprise solutions and tools will change.

(2) PEO Command Control Communications-Tactical (C3T). PEO C3T provides the computer systems, radios and communications networks required to fight and win the Nation's wars. PEO C3T oversees the management of the MilTech Solutions and the Warfighter Information Network-Tactical (WIN-T).

(a) MilTech Solutions provide web-based tools and technologies that improve workforce collaboration and enable faster, more effective support to the Warfighter. MilSuite, provides a behind-the-firewall version of familiar social media sites.

(b) Program Manager (PM) WIN-T provides the communications network (satellite and terrestrial) and services that allow the Soldier to send and receive information to execute the mission. WIN-T incrementally develops and delivers products that simplify network initialization and management and significantly increase capabilities.

d. DCS, G-2. DCS, G-2, as the functional lead for the Army intelligence community, works with CIO / G-6 to ensure that IT investments in that community align with Army IT investment strategies.

e. DCS, G-3/5/7. CIO / G-6 and DCS, G-3/5/7 are strategic partners in delivering Warfighter-required capabilities. DCS, G-3/5/7 validates, synchronizes, and prioritizes Army Network requirements to meet current, emerging, and future needs of operational commanders. DCS, G-3/5/7 ensures that all network-related requirements fit within the Army's enterprise network as part of the DODIN-A capabilities set.

f. DCS, G-8. CIO / G-6 and DCS, G-8 work closely to develop and defend Army IT programs. CIO / G-6 collaborates with DCS, G-8 in the development of C4, intelligence, surveillance, and reconnaissance (C4ISR) positions presented to relevant governance boards. In addition, Army Portfolio Management Solution (APMS) (a CIO / G-6 system) is housed in the G-8 data warehouse to enable closer alignment with GFEBs.

g. Army Cyber Command. ARCYBER reports to U.S. Cyber Command. ARCYBER is the single authority for the operation, management, and defense of the DODIN-A. As the single C2 authority for all

## HOW THE ARMY RUNS

collateral top secret and below Army Network operations, ARCYBER works closely with CIO / G-6 to establish the vision, direction, and architecture of the Army Network.

h. U.S. Army Network Enterprise Technology Command (NETCOM). As directed by ARCYBER, NETCOM serves as the Designated Approving Authority for the Army enterprise. NETCOM is the Army IT integrator advising the end-to-end management of the Army's enterprise service area to ensure the CIO / G-6 achieves a single, virtual enterprise network.

i. Assistant Secretary of the Army (Manpower & Reserve Affairs) (ASA (M&RA)). Army CIO / G-6 and ASA (M&RA) are strategic partners within the Army Civilian Career Program Proponency system, providing structured plans, processes, and activities that support the systematic organizational, occupational, and individual growth of the Army IT / Cyber workforce throughout the civilian human capital lifecycle.

### 15-17. External Partnerships

a. Federal CIO Council. The CIO / G-6 serves as a member of the Federal CIO Council. The Federal CIO Council, in partnership with all federal agencies, serves as a forum for CIOs to improve practices in the design, use, sharing and performance of federal information resources and cross-agency challenges.

b. DOD CIO. The DOD CIO is the principal staff assistant and advisor to the Secretary of Defense (SECDEF) on information resources management. The DOD CIO sets the vision and strategic goals, and provides direction to DOD in executing policies and practices to deliver agile and secure information capabilities to enhance decision-making and combat mission needs. The DOD CIO and the Army CIO / G-6 are partners in addressing DOD-wide IM, IT business, and Warfighting information capabilities essential for enterprise-wide solutions and operational effectiveness. CIO / G-6 is a member of the DOD CIO EB and Military Department CIO Executive forums to advise the DOD CIO on strategic direction, requirements, and implementation strategies to meet Army's critical information mission needs.

c. Other DOD Partnerships. The Army CIO / G-6 also has an information capability delivery partnership with other DOD components such as the DISA, the Joint Staff, and the other military department CIOs to address cross-cutting information and service delivery requirements to enable communication, collaboration and sustaining of secure trusted environments. This includes how information will be made available and how to develop and deliver enterprise service solutions.

d. Industry. Industry partners play an important role in supporting the mission of the CIO / G-6. These businesses offer technology and strategy consulting that provide IT solutions for current and future forces. In addition, CIO / G-6 works with industry partners to develop and implement enterprise licenses that use the Army's buying power to realize cost savings and efficiencies.

### 15-18. Cultural Changes

a. In the current economic climate, the Army expects significant budget cuts while potential threats to national security continue to evolve. At the same time, the Army is becoming primarily CONUS-based, while the threat environment demands the ability to deploy globally with little-to-no notice. To fulfill the U.S.' national security objectives, the Army must be agile and prepared to fight upon arrival in Multi-Domain Operations. Further, the Army must create a smaller footprint in theater while providing every type of required support to the Soldier at the tactical edge, and it must be capable of operating with all mission partners. While the Army transitions to an expeditionary Army that is smaller and yet more capable, the network is the core of that smaller, capable Army.

b. The Army is supporting network modernization efforts through participation in the development and maturation of the DOD JIE. JIE is DOD's construct to provide a single, secure, reliable, timely, effective, and agile C4 enterprise information environment for use by joint forces and non-DOD mission partners across the full spectrum of operations, at all echelons, and in all operational environments. The CIO / G-6 has aligned its top IT initiatives to support the JIE effort, without being dependent on it.

c. Other key modernization efforts include—

(1) Modernizing the network as a platform by improving governance, enforcing compliance, implementing agile IT acquisition, and ensuring transparent IT spending.

(2) Standardizing a basic architecture called the common operating environment (COE)—a centrally approved, commercially-based set of computing technologies and standards to which the network itself and all applications and systems riding the network must adhere.

(3) Updating and consolidating network infrastructure.

(4) Consolidating and securing networks.



- (5) Moving to a capability set management construct to foster end-to-end network modernization.
- (6) Building a comprehensive IT / Cyber workforce development strategy and implementation plan to maximize Soldier and civilian personnel management.

### **Section V Summary, Key Terms, and References**

#### **15-19. Summary**

- a. Army transformation will enhance the Service's ability to conduct operations. The goal of the CIO / G-6 is to provide the data infrastructure to enable better and faster decisions than U.S. adversaries.
- b. IT / IM strategy provides for the integration and the interoperability of processing, storing, and transporting information over a seamless network, allowing access to universal and secure Army knowledge across the enterprise. As the Army moves toward building a single, secure, standards-based network that ensures access at the point of need and enables global collaboration, current operational systems are examined for the results they achieve and benefits they provide to the Army. If the systems do not contribute to a world-class net-centric knowledge system, they face elimination or migration to systems that do.
- c. The CIO / G-6 commits to meeting the challenges that come with transforming the Army into a force that is strategically responsive and dominant. To that end, the CIO / G-6 is investing in today's technology to stimulate the development of doctrine, organizational design, and leader training to improve the future force. Doing so will extend the Army's technological overmatch.

#### **15-20. Key Terms**

- a. Capital Planning and Investment Control. The management process for ongoing identification, selection, control, and evaluation of investments in information resources. The process links budget formulation and execution, and is focused on agency missions and achieving specific program outcomes.
- b. Commercial Cloud Services. CSOs are cloud services offered by a commercial Cloud Service Provider (CSP). Examples: Infrastructure-as-a-Service (IaaS), Platform-as-a-Service (PaaS), Software-as-a-Service (SaaS), storage, compute processing, security, access.
- c. Communications. JP 6.0 describes a joint communications system as one that is comprised of the networks and services that enable joint and multinational capabilities. The objective of the joint communications system is to assist the JFC in C2 of military operations. Effective C2 is vital for proper integration and employment of capabilities. The HQDA's end-to-end communications system supporting the JFC is called the DODIN-A. The DODIN conceptually unifies DOD's information systems and networks into a real-time information system of systems that provides increased information capabilities to the joint force. Communications systems are more than electronic boxes, wires, and radio signals, and the DODIN is more than a collection of information networks. The interdependence of the parts, as well as the processes, policy, and data on those systems, permeate daily life, and preparation for and execution of operations. An effective communications system helps commanders maintain the unity of effort to apply their forces' capabilities at critical times and places to achieve objectives.
- d. Cyberspace operations. CO includes offensive cyberspace operations (OCO), defensive cyberspace operations (DCO), and DODIN operations.
- e. DODIN-A. DODIN-A is the portion of the DODIN operated by the Army. DODIN-A is the set of information solutions, and associated processes that collect, process, store, disseminate, and manage information on demand to warfighters, policy makers, and support personnel, whether interconnected or stand-alone, including owned and leased communications and computing systems and services, software (including applications), data, security services, other associated services, and national security systems.
- f. Electromagnetic spectrum operations. Coordinated military actions to exploit, attack, protect, and manage the electromagnetic spectrum.
- g. Enterprise Computing Environment. The ECE is one of the six Computing Environments (CEs) in the Army Common Operating Environment (COE). The COE includes technologies and standards for enabling capability development, delivery and interoperability across the six CEs. When and where appropriate, the CEs will connect to the ECE via the DODIN.
- h. IM. The planning, budgeting, manipulating, and controlling of information throughout its life cycle.

## HOW THE ARMY RUNS

i. IRM. IRM is the process of managing information resources to accomplish agency missions. The term encompasses both information itself and the related resources, such as personnel, equipment, funds, and information technology.

j. IT. Any equipment or interconnected system or subsystem that is used in the automatic acquisition, storage, manipulation, management, movement, control, display, switching, interchange, transmission, or reception of data or information by an executive agency (EA). For purposes of the preceding sentence, equipment is used by an EA if the equipment is used by the EA directly or is used by a contractor under a contract with the EA which: one, requires the use of such equipment; or two, requires the use, to a significant extent, of such equipment in the performance of a service or the furnishing of a product. The term "information technology" includes computers, ancillary equipment, software, firmware, and similar procedures, services (including support services), and related resources. The term "information technology" does not include any equipment that is acquired by a federal contractor incidental to a federal contract. The term "information technology" does not include national security systems as defined in the CCA of 1996 (40 U.S.C. 1452).

k. Internal Use Software. Software that includes applications and operating system programs, procedures, rules, and any associated key supporting documentation pertaining to the operation of a computer system or program, and are developed to meet the Army's internal or operational needs. IUS is an integral part of overall system(s) having interrelationships between software, hardware, personnel, procedures, controls, and data.

l. Spectrum Management. The management of how electromagnetic spectrum resources are used. The goal of Army spectrum management is to support telecommunications, weapons systems, and electronic warfare requirements. This goal will be accomplished through the acquisition of spectrum resources, the efficient use of those resources, and the attainment of Electromagnetic Compatibility.

### 15-21. References

- a. AR 5-12, Army Use of the Electromagnetic Spectrum.
- b. AR 10-87, Army Commands, Army Service Component Commands, and Direct Reporting Units.
- c. AR 25-1, Army Information Technology.
- d. AR 25-2, Army Cybersecurity.
- e. AR 70-1, Army Acquisition Policy.
- f. CIO / G6 Enabling Success <http://ciog6.army.mil/>.
- g. Department of the Army Pamphlet 25-1-1, Army Information Technology Implementation Instructions.
- h. General Order 2019-01, Assignment of Functions and Responsibilities Within the Headquarters, Department of the Army.
- i. General Order 2002-05, Establishment of the U.S. Army Network Enterprise Technology Command / 9th Army Signal Command; Transfer and Re-designation of the Headquarters and Headquarters Company, 9th Army Signal Command; Discontinuance of the Communications Electronics Services Office and the Information Management Support Agency.
- j. Joint Doctrine Note 3-16, Joint Electromagnetic Spectrum Operations.
- k. Joint Publication 6-0, Joint Communications System.
- l. Office of the Chairman of the Joint Chiefs of Staff. Joint Information Environment White Paper. Washington D.C.: Joint Chiefs of Staff, 2013.
- m. SECARMY, "Information Technology Management Reform (ITMR) Implementation Plan," Washington, D.C.: Office of the SECARMY, 2013.
- n. OMB's Data Center Optimization Initiative (DCOI) <https://www.whitehouse.gov/wp-content/uploads/2019/06/M-19-19-Data-Centers.pdf>.
- o. Federal Information Technology Acquisition Reform Act (FITARA) (Redirected from Federal Information Technology Acquisition Reform Act (H.R. 1232; 113th Congress)).
- p. DOD Cloud Strategy, December 2018 <https://media.defense.gov/2019/Feb/04/2002085866/-1/-1/1/DOD-CLOUD-STRATEGY.PDF>.
- q. DOD Digital Modernization Strategy <https://media.defense.gov/2019/Jul/12/2002156622/-1/-1/1/DOD-DIGITAL-MODERNIZATION-STRATEGY-2019.PDF>.
- r. 2019 Federal Cloud Computing Strategy — Cloud Smart; <https://cloud.cio.gov/>.
- s. 44 U.S.C. 3520.
- t. DOD Data Strategy, 2003.

## Chapter 16

### Installation Management Community

#### Section I Introduction

##### 16-1. Chapter Content

This chapter provides history, hierarchy, roles and missions, programs, and initiatives of organizations in the Installation Management Community (IMC). Installations remain a big business. The Program Integration Division of the Deputy Chief of Staff, G-9 Installations (DCS, G-9) is the resource integrator and administrator for the Installation Program Evaluation Group (II PEG). The II PEG is one of Headquarters, Department of the Army's (HQDA) PEGs that support Army planning, programming, and budgeting and is Co-Chaired by the Assistant Secretary of the Army for Installations, Energy and Environment (ASA (IEE)) and the Commanding General (CG), Army Materiel Command (AMC). The IIPEG plans, programs, and budgets the installation portfolio in excess of \$16.9 billion. Installations cover over 13.5 million acres of land, more than the combined acreage of the states of Maryland, Connecticut, and Rhode Island. Installations maintain well over 158,000 buildings covering more than one billion square feet. Army facilities represent a replacement value of more than \$460 billion. Installations are home to the Force and home to the Army Family - where the Army lives, works, trains, deploys, sustains, and prepares to meet tomorrow's challenges. Army posts and surrounding communities are home to well over one million Service members and their Families. Installations house approximately one-third of Army Families and can house nearly 200,000 permanent party single Soldiers. Army installations are where a quarter of a million Civilian employees and nearly 150,000 contract employees come to work every day.

##### 16-2. History

a. In the 1980s and early 1990s, findings from a host of inspections, studies, and surveys determined that installations should and could be managed far more effectively and efficiently. As a result, Army leadership took the following actions to integrate widely diverse, and often competing, installation management functions to better prepare commanders for increasingly complex and important work of running Army and Department of Defense (DOD) installations:

- (1) Established ACSIM in 1993.
- (2) Established centrally selected garrison commanders (GCs) in 1993.
- (3) Published Field Manual 100-22, Installation Management in 1994.

b. On 1 October 2002, the Installation Management Agency (IMA) was established to support Transformation of Installation Management in an effort to standardize its garrisons. Using an enterprise approach, IMA shifted base support away from 15 major commands. This brought more uniformity to facilities and services of 184 installations worldwide - and by 2006, this was accomplished with \$4.5 billion less than in 2003.

c. After proven success, the Army transformed the agency into U.S. Army Installation Management Command (IMCOM). On October 2006, the U.S. Army Environmental Command (USAEC) joined IMCOM as a subordinate command. Today, as it has for more than 40 years, USAEC provides knowledge, tools, and programs supporting ready and resilient Soldiers, installations, and commands by balancing military training with sound environmental practices. Also in October 2006, the Family and Morale, Welfare and Recreation Command (FMWRC) was established with the activation of IMCOM. In June 2011, FMWRC became the G-9 directorate of IMCOM. This integration ensured commitment to the Community Covenant, a program that is designed to foster and sustain effective state and community partnerships with the Army to improve quality of life for Soldiers and their families, both at their current duty stations and as they transfer to other states. It is a formal commitment of support by state and local communities to Soldiers and Families of the Army – Regular Army (RA), Army National Guard (ARNG),

## HOW THE ARMY RUNS

and U.S. Army Reserve (USAR). While the Community Covenant is an Army program, it extends to other Military Services as well, recognizing that many community efforts support all Service Members and their Families regardless of the uniform they wear. This makes Army garrisons the platforms of readiness and resilience for Soldiers, Families, and Civilians they are today, complete with programs and services enhancing the mind, body, and spirit of those who always answer the Nation's call. Just months later, the 2005 Base Realignment and Closure round brought all the elements; relocating from Aberdeen Proving Ground, Maryland, and Crystal City and Alexandria, Virginia; to a single campus at Joint Base San Antonio, Texas. On October 2012, IMCOM transferred its Directorates of Logistic (DOL) to U.S. Army Materiel Command (AMC).

d. On October 2015, IMCOM became a separate three-star Direct Reporting Unit (DRU) to the Chief of Staff of the Army (CSA) and was no longer dual-hatted as the ACSIM. USAEC remains a major subordinate command of IMCOM. On 1 November 2016, IMCOM realigned from geographical regions and established five functionally-aligned directorates: IMCOM-Readiness, co-located with U.S. Army Forces Command (FORSCOM); IMCOM-Training, co-located with U.S. Army Training and Doctrine Command (TRADOC); IMCOM-Sustainment, co-located with AMC; IMCOM-Europe; and, IMCOM-Pacific. The directorates are organized to be more efficient and improve mission command through unity of purpose, a smaller number of garrisons to manage, and similar demographics of communities. The directorates solve functional challenges for GCs, coordinate Headquarters, IMCOM (HQ IMCOM) support, and drive/assess garrison execution of service delivery. HQDA Execute Order (EXORD) 094-19, dated 11 February 2019, reassigned IMCOM from a DRU of the CSA to a Major Subordinate Command (MSC) of AMC effective 1 March 2019.

e. The Army's installations have been significantly reshaped by five rounds of BRAC authorized by Congress: 1988, 1991, 1993, 1995, and 2005.

(1) The Army is currently saving approximately \$1.04 billion per year from closures and realignments of the 2005 BRAC round, and approximately \$943M per year from four prior BRAC rounds.

(2) Each BRAC round affords the Army opportunity to comprehensively review its real estate portfolio, reassess how it calculates military value, examine where its missions are currently located, and optimize missions to ensure they are being performed in the right locations. The result of five BRAC rounds is nearly \$2 billion in annual reoccurring savings and a better alignment of force structure, military value, and infrastructure.

(3) DoD requested BRAC authority from FY13-FY18; all six requests were rejected by Congress. The Administration did not request BRAC in its FY19 and FY20 budget submissions.

(4) 2005 BRAC Recommendation #146 directed realignment of 26 Army, Navy, Air Force, and Marine Corps installations into 12 joint bases by 15 September 2011. A lead Military Service, referred to as "Supporting Component", is responsible for management and provision of installation support services for two or more installations that comprise a joint base. Other Military Services at joint base are referred to as "Supported Component(s)." All installation support functions (unless explicitly excluded) transferred from the Supported Component to the Supporting Component to include the Supported Component's associated real property and installation support funding, personnel, and equipment. The primary joint basing policy document is the Joint Base Implementation Guidance (JBIG). The 12 joint bases and designated lead agency are as follows:

- (a) Joint Base Anacostia-Bolling, Washington, District of Columbia, Navy.
- (b) Joint Base Andrews-Naval Air Facility, Washington, Maryland, Air Force.
- (c) Joint Base Charleston, South Carolina, Air Force.
- (d) Joint Base Elmendorf-Richardson, Alaska, Air Force.
- (e) Joint Base Langley-Eustis, Virginia, Air Force.
- (f) Joint Base Lewis-McChord, Washington, Army.
- (g) Joint Base McGuire-Dix-Lakehurst, New Jersey, Air Force.
- (h) Joint Base Myer-Henderson Hall, Washington, District of Columbia, Army.
- (i) Joint Base Pearl Harbor-Hickam, Hawaii, Navy.
- (j) Joint Base San Antonio, Texas, Air Force.
- (k) Joint Expeditionary Base Little Creek-Fort Story, Virginia, Navy.
- (l) Joint Region Marianas, Guam, Navy.

# INSTALLATION MANAGEMENT COMMUNITY

## 16-3. IMC Hierarchy

The Army develops and implements strategies, policies, programs, and resources through an effective network of installations and support capabilities referred to as the IMC. The key levels of efforts by commands and staffs within the IMC are shown in Figure 16-1.

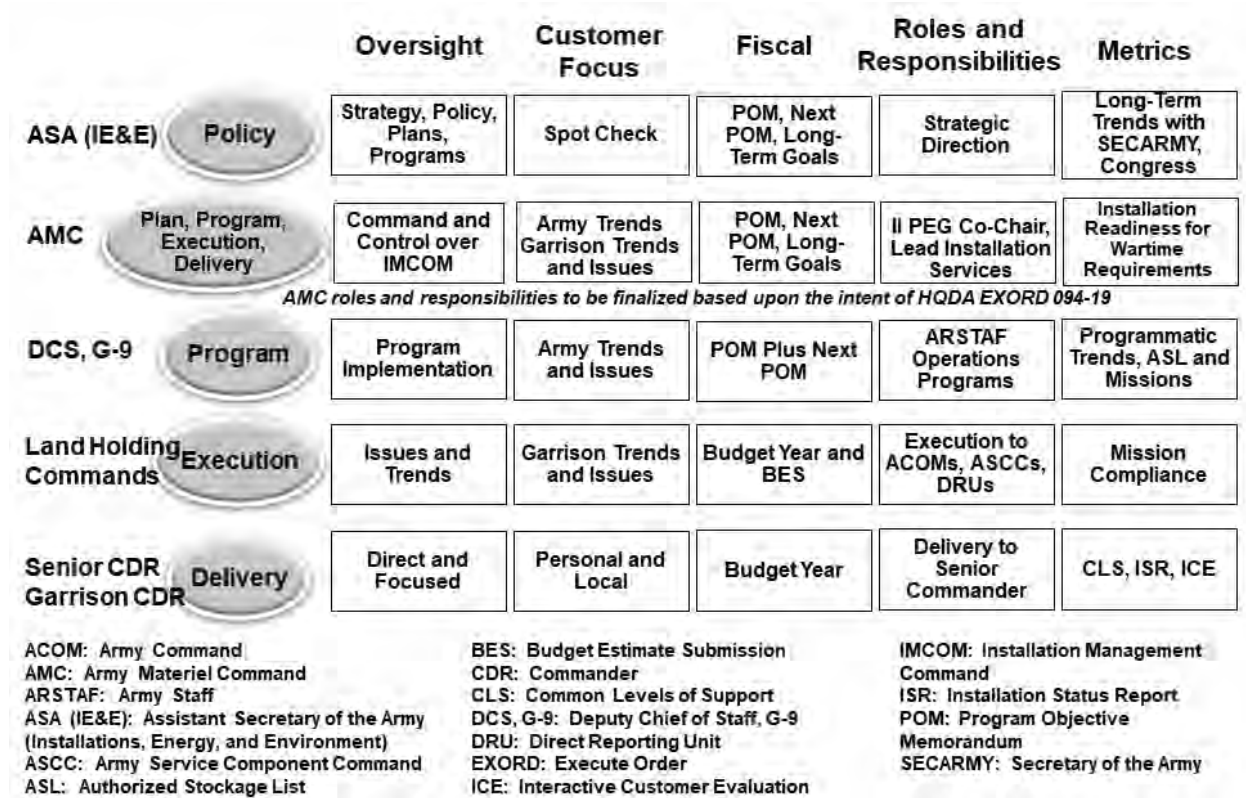

Figure 16-1. Installation Management Community Hierarchy

## Section II Roles and Missions

### 16-4. Assistant Secretary of the Army (Installations, Energy and Environment) (ASA (IEE))

a. The ASA (IEE) is the principal adviser to the Secretary of the Army (SECARMY) on matters related to Army installations; energy and water security and sustainability; and the Army's impact and compliance with environment, safety, and occupational health standards. ASA (IEE) sets the strategic direction for installation programs and ensures Army efforts are executed consistent with law, regulations, and policy. The ASA(IEE) tri-chairs the Installation Readiness Board of Directors (IRBOD) with the Assistant Secretary of the Army for Manpower and Reserve Affairs (ASA (M&RA)) and the Vice Chief of Staff of the Army (VCSA) to address policy and other installation matters affecting the IMC and its stakeholders. The ASA (IEE) is a Senate-confirmed, appointed position, and has responsibility for:

(1) Establishing strategic direction for the Planning, Programming, Budgeting, and Execution (PPBE) process within the ASA (IEE)'s areas of responsibility, including facilities investment, military construction, installations, Army real estate, energy and water security, operational energy, sustainability, the environment, safety and occupational health, and associated resource allocation decisions and policies. Coordinating and integrating direction with the Assistant Secretary of the Army (Financial Management and Comptroller) (ASA (FM&C)); Chief Information Officer (CIO); DCS, G-3/5/7; DCS, G-4; DCS, G-8; DCS, G-9; and other Department of the Army (DA) officials and organizations. The ASA (IEE) serves as Co-Chair with the Commander, Army Materiel Command for the II PEG.

## HOW THE ARMY RUNS

(2) Providing strategic guidance and supervision for policies, plans, and programs for facilities investments, military construction, energy and water security, operational energy, overseas bases, and environmental initiatives executed by the Army Staff (ARSTAF), including ACSIM; DCS, G-4; other DA officials, organizations and commands, including U.S. Army Corps of Engineers (USACE).

(3) Supervising and facilitating development and management of Army installations, including facilities investments to support readiness, design, construction, physical security and critical infrastructure protection of installations to ensure continuity of operations, energy and water security, environmental, safety and occupational health; and advising the SECARMY and the CSA on installations' suitability for stationing.

(4) Supervising development and implementation of policies and programs for Army real property, including acquisition, management, disposal, exchanges, public domain withdrawals, condemnation, and donations. Setting policy for and supervising management of historic properties owned or leased by the Army and the Army homeowners' assistance program.

(5) Developing policies for and ensuring implementation of policies for BRAC, stationing, planning and utilization, reuse and economic adjustment programs.

(6) Supervising Army privatization initiatives and their implementation.

(7) Supervising and developing policies and budget requests for Army military construction, including overseas military construction agreements, and ensuring consistency with statute, regulation, and Army and DOD policy.

(8) Supervising Army energy and water security and sustainability, including development of strategy and policy, coordination of initiatives, supervision of HQDA councils and committees and representation of Army environmental and sustainability interests in coordination with Federal regulatory agencies and State and local governments.

(9) Supervising and developing policies and programs for Army environmental efforts, including environmental compliance; pollution prevention; environmental impact analysis; stewardship of natural, cultural and historic resources; and environmental cleanup and restoration, including Formerly Used Defense Sites (FUDS).

(10) Coordinating with the Assistant Secretary of the Army (Acquisition, Logistics, and Technology) (ASA(ALT)) to ensure that environmental, safety, health, energy and water security and resilience, operational energy efficiency, green procurement, and installation management issues are appropriately addressed by materiel developers; integrated into acquisition program planning and documentation; and addressed as risk areas during milestone decision reviews.

(11) Providing policy and supervising Army-wide safety, occupational and environmental health risk management, including sanitation and hygiene.

(12) Supervising development of Army policy for environmental, safety and occupational health aspects of DOD's Chemical Demilitarization Program and, in coordination with the ASA (ALT) and DCS, G-3/5/7, serving as the Army's Chemical, Biological, Nuclear, and Conventional Treaty Verification and Compliance Official.

b. Principal Deputy Assistant Secretary of the Army (PDASA). The PDASA (IEE) is the senior Deputy Assistant Secretary of the Army (DASA) reporting directly to the ASA (IEE) and is responsible for integrating ASA (IEE) activities within the Army secretariat and HQDA staff. The PDASA is an appointed (but not Senate confirmed) position.

c. The ASA (IEE) has four DASAs, all of whom are career Senior Executive Service (SES) positions.

(1) DASA (Energy & Sustainability) (DASA (E&S)) is the Senior Energy Executive for the Army. This office provides strategic leadership, policy guidance, program oversight, and outreach for energy and sustainability throughout the Army enterprise to enhance current installation and operational capabilities, safeguard resources, and preserve future options. DASA (E&S) also oversees climate change adaptation for installations, third-party financing for energy and water projects, and the Office of Energy Resilience.

(2) DASA (Environment, Safety and Occupational Health (ESOH)) provides policy, programming and oversight of the Army's ESOH programs; oversees all Army environmental programs; provides technical assistance on explosives, munitions and chemical warfare materiel response; provides recommendations to milestone decision authorities on Army materiel regarding ESOH concerns; executes the Army's arms control program; and serves as the Executive Agent for several DOD programs. In addition, DASA (ESOH) is the proponent for Army safety and occupational health policy and programs.

(3) DASA (Installations, Housing and Partnerships (IHP)) provides worldwide policy, programming and oversight of the SECARMY's Title 10 U.S. Code (10 U.S.C.) responsibilities in the areas of real estate,

## INSTALLATION MANAGEMENT COMMUNITY

military construction, engineering, housing, and BRAC. DASA-IHP represents the Army's business interests in privatization/partnership projects (i.e., Residential Communities Initiative (RCI), Privatization of Army Lodging (PAL), and Intergovernmental Support Agreements (IGSA)). In addition, DASA-IHP provides oversight reviews, approvals, congressional testimony and notifications as required by statutes in the responsible areas. The organization coordinates Infrastructure Analysis and Evaluation of real property as well as stationing.

(4) DASA (Strategic Integration (SI)) is lead official for integration and coordination of installation initiatives into Army-wide policies and plans. In this capacity, DASA (SI) serves as the ASA (IEE) representative in development of Army strategic plans and guidance including the Army Campaign Plan (ACP). The office develops strategy, executes business transformation at the secretariat level and conducts day-to-day operations for the ASA (IEE) in the II PEG.

### 16.5 AMC

a. The Commanding General (CG), AMC shares II PEG co-chair responsibility with the CG, IMCOM in accordance with AR 1-1.

b. AMC develops Logistics Readiness Center (LRC) requirements including cost estimates for future unit stationing across posts, camps, and installations. The LRC is the single AMC face to the field on an installation through which AMC capabilities can be accessed, integrated, and synchronized to support Senior Commanders and units.

c. The CG, AMC will exercise all authority, direction, command, and control over IMCOM, to include prescribing IMCOM missions, functions, and responsibilities. All personnel, equipment, and other resources (for example, contracts and budgeted funds) assigned or allocated to IMCOM and its components are transferred and reassigned under the authority, direction, and C2 of the CG, AMC.

### 16-6. Deputy Chief of Staff, G-9

a. The DCS, G-9 is the principal military adviser to the ASA (IEE) on a broad array of programs, including management of facilities and infrastructure, environmental programs, housing, installation logistics, public and private partnerships, and energy and water security and resilience. The DCS, G-9 is the principal ARSTAF adviser to the CSA on installation and Family support matters and assists the CSA in acting as the agent of the SECARMY in carrying into effect approved plans and recommendations. The DCS, G-9 is also the principal military adviser to the ASA (M&RA) and ASA (FM&C) for Family and Morale, Welfare and Recreation, Non-appropriated Fund Instrumentalities (NAFIs), and Soldier and Family readiness programs. Under supervision of the ASA (IEE), ASA (FM&C), and ASA (M&RA) the DCS, G-9 plans, develops, implements, resources, oversees, and evaluates execution of plans and programs for delivery of installation services and infrastructure to support readiness. The DCS, G-9 serves as the Executive Secretary for the II PEG and the IRBOD. The DCS, G-9 has responsibility for:

(1) Supervising and coordinating development, implementation and evaluation of policies, plans and strategies for military facilities investment requirements, housing, privatization, installation, environmental, water management and energy security and sustainability programs.

(2) Supervising and coordinating development, validation and execution programs for resourcing of environmental programs, housing, privatization, water management and energy security and sustainability programs on assigned Army installations.

(3) Developing standards and metrics to evaluate installation and base operations infrastructure and service requirements, including compliance with environmental requirements and energy efficiency.

(4) Serving as the proponent for installation management doctrine.

(5) Serving as the ARSTAF proponent and execution authority for Army wide installation-related environmental programs and for installation environmental programs assigned to the Army by DOD.

(6) Ensuring execution of approved operational programs for reorganization, realignment and closure of installations under supervision of the ASA (IEE).

(7) Developing infrastructure and monitoring execution of programs for installation services and management that support readiness and enhance well-being of Soldiers and Families.

(8) Assisting and supporting the ASA (M&RA) in planning, development, budgeting, implementation and evaluation of installation morale, welfare and recreation programs and NAF instrumentalities.

(9) As the authority having jurisdiction for Army Fire & Emergency Services, responsibility for policy development and interpretation, MDEP management, and execution oversight of the Fire & Emergency Services program. This includes, but is not limited to, responsibility to determine necessary personnel,

## HOW THE ARMY RUNS

funding, vehicles, scopes of service and service delivery performance objectives and standards. Additionally, the DCS, G-9 has responsibility to approve deviations from minimum level of service objectives and other minimum requirements.

b. DCS, G-9 is supported by four directorates; Installation Services, Information Technology, Operations, and Resources:

(1) Installation Services Directorate interprets strategic guidance, provides policy, and creates priorities for resources in order to create a supportive and sustainable environment through world class housing, environmental stewardship, responsive logistics, collaborative partnerships, and enhanced quality of life programs for Soldiers, Civilians, and their Families. The directorate consists of four divisions. The Housing Division focuses on providing quality Soldier and Family housing facilities, programs and services, including community housing advocacy, the Army Barracks Management Program, General/Flag Officer quarters, housing furnishings, and developing barracks buyouts/upgrades and modernization programs. The Career Program 27 Proponency Office, led by a senior Housing Specialist directly reporting to the Director of Installation Services, Office of the Assistant Chief of Staff for Installation Management (ODCS, G-9), is the proponent for all career matters affecting all members of the Army's Housing Management Team. The goal of the proponency office is to provide support to all members regarding education, training, professional development, and future advancement. Privatized Housing and Lodging Branch is the DCS, G-9 center of excellence for privatization and Partnerships ensuring maximization and sustainability of Army assets and services through partnerships with private sectors. Key programs are the Residential Communities Initiative, Privatization of Army Lodging, and Privatized Enlisted & Officer Unaccompanied Housing Initiative. The Logistics and Services Division works to reduce greenhouse gas emissions; develops implementation guidance to optimize the Non-Tactical Vehicle (NTV) fleet; alternative fuel vehicles, and charging stations for the NTV fleet; serves as the Army systems administrator and help desk for the Federal Motor Vehicle Registration System and UNICOR's License Plate database; develops implementation guidance, programming and oversight for Municipal Services which includes, but not limited to: Solid Waste Management, Pest Management, Grounds Maintenance, Custodial Services, Wildfire Prevention, and Pavement Clearance. Laundry, Dry Cleaning, and Civilian Inmate Labor; provides implementation guidance, programming, oversight and processes that provide for flexible Fire & Emergency Services in an all-hazards environment; including developing funding lines and authorities, execution oversight of the Fire & Emergency Services program, standardized firefighter qualifications and position descriptions, qualification standards, vehicle recapitalization and procurement methodology, training and education requirements to include career development and progression, and represent the Army with other services and both government and non-government emergency services organizations. Soldier and Family Readiness Division provides policies, resources, and strategies that promote Soldier and Family readiness, adaptability, and self-reliance, to include Army Community Service; Child, Youth and School Services; Community Recreation and Business programs; NAFIs; and senior leader initiatives such as Total Army Strong. The Environmental Division manages Army environmental programs in support of the Operating and Generating Forces, plans and programs resources; establishes program execution priorities and approves work plans; develops regulations and program guidance for the Army.

(2) Information and Technology Directorate sets strategic direction and provides effective information technology (IT) and information management (IM) capabilities that enable the ODCS, G-9 business areas to support Soldiers, civilians and their families. The directorate is comprised of three divisions: Integration Division, Business Systems Technical Support Division, and Portfolio Management and Architecture Division. The Integration Division provides an objective and standardized governance structure with supporting processes to ensure IT investments are visible, selected, monitored and compliant with laws and regulations. This division also provides IT/Cyber support to the Army Facility Related Control System (FRCS) Cybersecurity initiative, strategic sourcing, and Freedom of Information Act (FOIA) support. The Business Systems Technical Support Division provides defense business system application support services for development and sustainment of ODCS, G-9 business systems. This division also provides Information Assurance Program Manager (IAPM), Operational Security (OPSEC), Risk Management Framework (RMF) support to ensure appropriate levels of confidentiality, integrity, authentication, non-repudiation, and availability of installation management data, information and knowledge. This division also provides integrated information technology support for desktop, network and enterprise managed IT requirements and services in coordination with the HQDA IT service provider. The division operates and maintains the ODCS, G-9 website and Knowledge Portal used for



## INSTALLATION MANAGEMENT COMMUNITY

knowledge sharing and collaboration. The Portfolio Management and Architecture Division manages the IEE Domain within Headquarters Army Business Mission Area. The division supports Army and Installation Management business transformation and priorities by leading the Army Installation Business Enterprise Architecture (BEA), Capital Planning and Investment Management (CPIM) and Portfolio Management (PFM) Programs. The division provides critical portfolio and certification support to IEE Domain stakeholders through the Defense Business Systems (DBS) Management Council (DBSMC) investment management process to ensure IEE DBS investments in the IEE portfolio support business needs while minimizing risks and achieving DOD and federal strategies for business systems. This division is also the process champion for Acquire to Retire (A2R) Real Property, Service Request to Resolution (SR2R) and Environmental Liability (EL) End to End (E2E) business processes.

(3) Operations Directorate oversees development and coordination of program requirements, plans, guidance, and reporting requirements pertaining to facilities, energy, water, military construction, and real property that support Army objectives and improves quality of life for Soldiers, Civilians, and Families. The Directorate has five divisions: BRAC, Construction Integration, Energy and Facilities Engineering, Real Property Asset Management, and Plans and Operations. The BRAC Division continues to be ready for potential future BRAC rounds and executes cleanup and transfer of BRAC and assigned non-BRAC excess Army property. The Construction Division plans, programs, and executes the Army military construction (MILCON) program and provides interface for the Non-appropriated Fund (NAF) construction program. The Construction Division provides oversight and participates in regular updates from USACE on execution of the Army construction program. The Energy and Facilities Engineering Division manages the Army energy and water programs. This division manages the Utilities Privatization (UP) Program under delegated authorities from ASA (IEE). This division also manages the Army Facilities Standardization Committee, operates the Army Energy and Water Report System, and manages roads, airfields, railroad tracks, bridges, dams, and waterfront structures. It increases readiness of Army facilities with security and resilience guidelines and technology transfer. The division manages resourcing and oversight for utilities services and commodities, third party investments, energy and water security, and cybersecurity of facility related control systems. The Real Property Asset Management Division, organized into two branches, performs functions to provide guidance, synchronize real property management, and deliver high quality, enterprise-level systems employed across the Army to visualize installations' status, establish facility requirements, and guide decision-making. The Installation Systems Branch interfaces the Army installation systems of record with all other Army and external systems, and manages the Army systems of record, including: Real Property Planning and Analysis System (RPLANS), Headquarters Installation Information System (HQIIS), Installation Status Report (ISR), Installation Geospatial Information and Services (IGI&S), and the Army Stationing and Installation Plan (ASIP). The effect of this effort is timely and accurate reporting of the Army Real Property Inventory and enhanced support to decision-making and programming efforts. The Real Property Asset Management Branch guides Army efforts to effectively and efficiently manage and account for all real property. The branch provides program oversight of facility sustainment, restoration and modernization (SRM), leasing, and demolition programming for RA and Reserve Components (ARNG and USAR), and guides Army master planning activities that ensure effective management of real estate and real property. The Plans and Operations Division is the DCS, G-9 connection to the DCS, G-3/5/7 and the ACP. The division assesses readiness of Army installations through Army Strategic Readiness Assessments and Strategic Readiness Updates. The division also coordinates force structure, stationing, and joint basing requirements. The division integrates and synchronizes support to the annual Facilities Investment Guidance (FIG).

(4) The Resources Directorate is the resource proponent for the Army's Installation Management portfolio across all Components (RA, ARNG, and USAR). As the II PEG Executive Secretary, its mission is to integrate and defend resources for installation infrastructure, services, and programs in support of Army Readiness. The directorate also reviews, integrates and implements Army financial management policy and procedures; ensures financial and performance systems reliability and data accuracy; provides training and support on various databases of record, data sets, costing techniques and formulaic interpretations; ensures audit recommendations pertaining to installation management are completed and synchronized with guidance from audit agencies; maintains Army Regulation (AR) 5-9; and, administers the ODCS, G-9 Manager's Internal Control (MIC) Program. Serves as the DCS, G-9 representative for ASA(FM&C) coordination. Assists in building the DCS, G-9 portions of budget requests and provides

## HOW THE ARMY RUNS

post-submission, explanatory responses to Congressional inquiries. The Resources Directorate consists of three divisions: Resource Analysis, Requirements Modeling and Financial Management.

### 16-7. IMCOM and other Land Holding Commands

a. Land Holding Commands are commands with real property maintenance responsibilities that execute installation management and base operations activities. These Commands manage installations and include IMCOM, ARNG, USAR, and Arlington National Cemetery.

b. IMCOM is the primary active land holding command in providing installation management services and support at over 71 garrisons, joint bases, communities, and sites throughout the continental United States (CONUS) and outside CONUS in Europe and the Pacific. In addition, although not currently the land holding command, IMCOM provides various installation management services and support at several USAR, Air Force, and Navy owned and managed installations/locations through Army Support Activities. Future Force redesign initiatives will eventually designate IMCOM as the single Land Holding Command for ARNG and USAR Installations. ARNG installation management will be in accordance with state and federal law limitations.

(1) HQ IMCOM is located at Joint Base San Antonio, Texas. IMCOM is accountable to AMC for effective garrison support of mission activities and serves as the active Army's primary provider of base support services. The five IMCOM directorates are each led by an SES government employee serving as an IMCOM Directorate Director reporting directly to the IMCOM commander. IMCOM's mission is to integrate and deliver base support to enable readiness for a globally-responsive Army. HQ IMCOM, directorates, and garrisons provide comprehensive installation analysis to DCS, G3/5/7 for feasible unit stationing in accordance with AR 5-10.

(2) IMCOM Directorates implement, direct, and oversee policy and program execution. They support garrisons by being responsible for enforcing Army-wide standards and ensuring equity among installations, adopting best business practices, identifying and implementing efficiencies and partnerships, and interfacing directly with ACOMs, Army Service Component Commands (ASCCs), DRUs, and other Services and/or agencies.

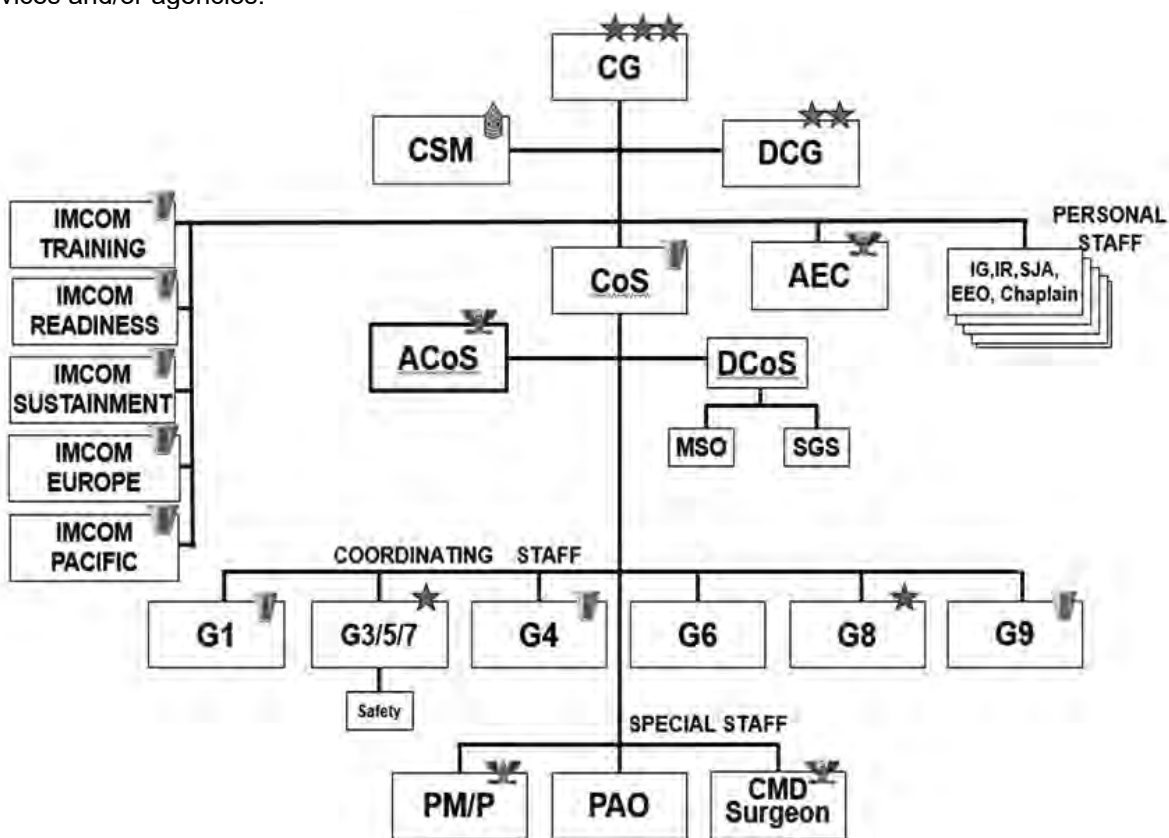

Figure 16-2. Installation Management Command

## INSTALLATION MANAGEMENT COMMUNITY

(3) Each Army installation has a garrison command reporting to an IMCOM Directorate. GCs support and enable Senior Commanders (SC). The GC integrates and synchronizes garrison services, following command and control, by providing installation and base support services to all local units, tenants and customers.

(4) IMCOM garrisons provide the full range of installation support services with the exception of Base Operations Support (BASOPS) logistics services.

(5) The GC roles and duties are described in AR 600-20 and further described below as it relates to the SC. The GC is supported by the Deputy GC, retained as a civilian position, to provide continuity for the garrison and its supported population.

d. **SC/GC Roles and Responsibilities.** The SC is normally, but not always, the senior General Officer (GO) at the installation. The SC's mission is to care for Soldiers, Families, and Civilians, and enable unit readiness. While delegation of senior command authority is directed from HQDA, the SC will routinely resolve installation issues with IMCOM and, as needed, the associated ACOM, ASCC, or DRU. The SC's higher headquarters (i.e., ACOM, ASCC, or DRU), on behalf of HQDA, will maintain oversight of the SC while executing installation missions. The SC uses the garrison command as the primary organization to provide services and resources to customers in support of accomplishing this mission. All applicable commands support the SC in execution of SC responsibilities; therefore, the SC is the supported commander by IMCOM, other installation Service providers, and tenants. The SC is responsible for synchronizing and integrating Army priorities, initiatives and sustainable readiness at the installation. On IMCOM-managed installations there is a requirement for a strong collaborative relationship between the SC and IMCOM Director (IMCOM-Training, IMCOM-Readiness, IMCOM-Sustainment, IMCOM-Pacific, and IMCOM-Europe). The SC commands the installation but funding of almost all BASOPS activities flows through IMCOM.

e. The GC is a military officer, lieutenant colonel (LTC/O-5) or colonel (COL/O-6), selected by HQDA. The GC commands the garrison, is the SC's senior executive for installation activities, is rated by the IMCOM Director, and is senior rated by the SC. The GC is responsible for day-to-day operation and management of installations and base support services. The GC ensures that installation services and capabilities are provided in accordance with (IAW) HQDA-directed programs, SC guidance, CLS, and IMCOM guidance. The GC provides additional service support IAW HQDA directives and provides reimbursable services in accordance with memorandum of understanding (MOU) or memorandum of agreement (MOA) and/or installation support agreements. The GC is responsible to deliver Family and installation programs, coordinates and integrates delivery of support from other Service providers, and obtains SC approval of the installation master plan. The GC may be appointed by the SC as a Summary Courts-Martial Convening Authority or Special Courts-Martial convening authority for the installation and its support area; in rare cases the GC may be appointed as GCMCA. In some cases, the senior official on an installation may be the garrison manager. A garrison manager (Civilian equivalent of a GC) has the same responsibility and authority as the military counterpart with exception of UCMJ and command authority. Prior to the appointment of garrison manager, command and UCMJ authorities for the garrison will be specified. The GC responsibilities are as follows:

- (1) Represents the Army and installation in the surrounding community as directed by the SC.
- (2) Approves and issues garrison policies in accordance with respective Army regulations, or installation level policies involving tenant units as directed by the SC.
- (3) Implements policies for the IMCOM Civilian workforce.
- (4) Develops and implements an Integrated Protection Plan incorporating functional elements of the Army Protection Program (anti-terrorism, critical infrastructure risk management, emergency management, physical security, law enforcement, fire and protection services, and continuity of operations).
- (5) Supports mobilization station requirements.
- (6) Integrates all installation services on the installation by all Service providers.

f. The ACOM, ASCC, or DRU commanders on IMCOM-managed installations:

- (1) Provide to IMCOM a prioritized list of military construction, Army/military construction, Army Reserve projects and requirements that impact subordinate units to support development of the military construction program and the program objective memorandum (POM).
- (2) Provide IMCOM with subordinate mission priority requirements for military construction and base operations.
- (3) Identify to IMCOM, through the CLS process and other requirements development processes, the required levels of garrison support needed to meet mission requirements. Also, identify to IMCOM any

## HOW THE ARMY RUNS

support requirements not included in CLS services. Collaborate with IMCOM in developing garrison support requirements that are applicable to all garrisons.

(4) Evaluate the effectiveness of installation services and support and participate in prioritization of these services and support.

(5) Responsible for mobilization of subordinates as specified in AR 10–87 and HQDA EXORDs.

(6) Provide prioritization requirements for information technology and training enabler support to IMCOM.

(7) Commands with personnel residing on installations, whether on a permanent or temporary basis, will support and comply with FP actions of the garrison as directed by the SC.

(8) Will follow command responsibilities for the Total Army Sponsorship Program as stated in AR 600–8–8 and related official guidance.

(9) Provide IMCOM with critical infrastructure function, criticality, and protection requirements of critical infrastructure located on IMCOM installations and critical infrastructure needed for support located off IMCOM installations.

g. Installation Readiness.

(1) Installation Readiness is achieving mission excellence through streamlined processes, strategic partnerships, and good stewardship of resources that address Army priorities and meet mission requirements of SCs. It translates into the ability to provide a growing and transforming Army with infrastructure and support services it needs to remain a highly effective, expeditionary and campaign-quality force, today and in the future.

(a) Installations are readiness platforms that enable Commanders to project power and mobilize forces in support of the National Military Strategy (NMS). As readiness platforms, installations provide support to the warfighter through facilities and services that allow the Army to exercise mission command, collect/process intelligence, train, maintain, arm, protect, house, mobilize, deploy, and receive forces to fight and win. The CSA directed revision of the Army Strategic Readiness Assessment (ASRA) to assess the Army's ability to meet NMS demands through seven tenets. The ODCS, G-9 established readiness measures and indicators to assess Installation Tenet readiness risk through three Lines of Effort (LOE): Mission Readiness, Soldier and Family Readiness, and Installation Capacity. The first assessment focus on facility readiness is achieved through a collaborative approach between HQDA and commands to identify poor and failing facilities that most drive readiness in order to inform Senior Leader policy and resourcing decisions.

(b) The Facility Readiness Drivers (FRD) framework was established in 2017 and enables the Army to focus readiness reporting and optimize facility investments based upon commanders input. The FRD seeks to close a long-standing gap in understanding how facilities (and how deficiencies in the right quantities, quality, or functionality of a facility) translate into unit readiness and the Defense Readiness Reporting System-Army (DRRS-A). HQDA EXORD 265-17, dated 3 August 2017, is a three-phased effort directing ACOMs, ASCCs, and DRUs identify poor and failing facilities by relative impact to readiness. FRDs tier identification will be maintained in an Army system of record that supports installation readiness reporting. The FRD framework will give Army Senior Leaders an enhanced view of installation readiness that informs resourcing and policy decisions. Future development will enable installations to articulate readiness risk in Installation Capacity and Soldier and Family Readiness.

(2) Resilience is a major facet of installation readiness. Today, interdependence between mission excellence, energy and water security, environmental stewardship and community relations has never been more important. The installation community has produced an Energy Portfolio, Water Portfolio, and Environmental Portfolio which recognizes successes at installations in each of these areas. The community has issued environmental sustainment guidance for everyday actions to include education, incentives and alternatives. IMCOM collaborates with industry and ACOMs to establish installations that are capable of sustaining energy and water critical to missions during extended outages and are more energy efficient and self-sustaining than in the past. IMCOM continues to work with community partners as it pursues sustainability in long range goals, addresses encroachment issues and reaffirms installations as valued neighbors. IMCOM will continue to modernize installation training facilities to support unified land operations training. IMCOM supplies training areas and facilities that provide Soldiers with realistic experiences, thoroughly preparing them for all contingencies. IMCOM will continue to focus attention on current and emerging technologies, leveraging opportunities to conserve energy, promote water conservation, reduce waste, preserve natural resources, enhance training realism, and reduce supply chain vulnerability.

## INSTALLATION MANAGEMENT COMMUNITY

(3) SCs, GCs, leaders, and staff at installations understand their local circumstances in order to make decisions regarding all hazards and threat assessments, risk management, protection and response planning, training, exercising; and, assessing allocation of protection-related resources at their installations. The Army Protective Posture (APP) management structure consists of APP Board of Directors (APPBOD), APP General Officer Steering Committee (APPGOSC), APP Council of Colonels (APPCoC), and associated working groups. At the HQDA level, the APP expands program oversight, ensures senior leader accountability, and facilitates informed decision making and resource allocation. DCS, G-9 and IMCOM have representatives attending each of the APP bodies. IMCOM, through the Provost Marshal/Protection Division, supports APP operational objectives which serve as the primary means for the Army to support execution of the DOD Mission Assurance Strategy as it applies to installations. The APP is comprised of the following non-war fighting functional elements and associated enabling functions found on Army installations: Antiterrorism, Continuity of Operations, Critical Infrastructure Risk Management, Emergency Management, Fire & Emergency Services, Law Enforcement, Physical Security, Information Assurance and OPSEC. DCS, G-9, while a member of the APP, remains the proponent responsible for policy, MDEP management, and execution oversight of the Fire & Emergency Services Program.

h. Establishing Standards. The Army's installation long-range plan conveys direction for installation management during the next 20-plus years. The plan identifies efficiency programs, determines funding requirements, and describes metrics used to measure success. The goal of the plan is to provide quality, cost-effective, and efficient mission-ready installations that are the right size, in the right place, and available when needed. Management planning for installations focuses on streamlining, realigning and standardizing services and the workforce, recapitalizing investments and reducing costs. For this purpose, DCS, G-9 acts for and exercises authority of the CSA in dissemination of policy and integration of doctrine pertaining to the operation of Army installations. The DCS, G-9 is responsible for establishing performance metrics and implementing Army-wide standards for installation management and BASOPS.

i. MILCON.

(1) A viable standard process for determining Mission/Base Operations military construction projects is a fundamental condition for the success of managing installations to standards. The streamlined components of this process include the following actions—

(a) GC forwards the SC's prioritized listing of all projects to IMCOM Directorates.

(b) IMCOM Directorates prioritizes all BASOPS projects within their span and forwards to HQ IMCOM.

(c) HQ IMCOM prioritizes all BASOPS projects and forwards to DCS, G-9.

(d) ACOM, ASCC, DRU prioritize their mission projects and forward prioritizations to DCS, G-9.

(e) ACOM, ASCC, DRU may offer their suggested prioritization of BASOPS projects for installations where the SC reports to the ACOM, ASCC or DRU. This suggested prioritization would be forwarded to DCS, G-9 and IMCOM.

(2) Upon receipt of prioritized project listing from ACOMs, ASCCs, DRUs, and HQ IMCOM and using guidance provided by Senior Army Leadership, DCS, G-9 and DCS, G-3/5/7 co-chair the MILCON Integrated Programming Team (IPT) which builds the recommended Army prioritized project list. DCS, G-9/DCS, G-3/5/7 provides the recommended prioritized project list to the Undersecretary of the Army (USA) and the VCSA for approval. MILCON projects are funded within available fiscal constraints.

j. USAR.

(1) The USAR is the land-holding command for all USAR facilities, assets, and land located on three Operations and Maintenance Reserve (OMAR) funded installations (Fort Buchanan, Fort Hunter Liggett and Fort McCoy), two Reserve Forces Training Areas (RFTAs) (Parks RFTA, Devens RFTA), community-based facilities throughout CONUS via four USAR Readiness Divisions (RD), and responsible for funding services provided by the Army Support Activity at Joint Base McGuire-Dix-Lakehurst. Additionally, the USAR provides Base Support for overseas USAR facilities located on American Samoa, Saipan, Puerto Rico, and Hawaii.

(2) For facilities that are imbedded within communities in CONUS (i.e. Army Maintenance Support Activities (ASA), Equipment Concentration Sites, and Reserve Centers) the USAR subdivides their land-holding command and base support responsibilities on an area support basis using the following structure: 99th RD-northeast region; 81st RD- southeast region; 88th RD- west/midwest region, 63d RD west/ southwest region. The RDs provide both BASOPS and facility management as "virtual installations" to geographically dispersed organizations within their regions to ensure readiness and soldier/family

## HOW THE ARMY RUNS

support. The RDs essential mission of providing customer care and services “virtually” enables commanders and operational units the ability to focus on their training objectives and mission, while complimenting support requirements that are unique to the Army Reserve.

(3) OMAR funded installations to include both RFTAs and the ASA, function as the training platform for all USAR units based on the mission and training objective set forth by the Chief of the Army Reserve. These organizations are primarily OMAR funded in order to support the training and readiness of stationed USAR military personnel, transient training soldiers and units, tenants, and off post USAR units.

(4) The Army Reserve Installation Management Directorate (ARIMD) located within both Office of the Chief of the Army Reserve and U.S. Army Reserve Command function as the headquarters entity responsible for providing fully integrated and comprehensive Base Support programs both at the regional and installation level. ARIMD coordinates, synchronizes, and disseminates guidance and resources to all 10 BASOPS organizations in order to meet the needs of the Army.

k. ARNG executes installation management separately from IMCOM and it occurs at the State-level (e.g., the 50 States, District of Columbia, Puerto Rico, Guam and the Virgin Islands). The federal government has agreements with each state, district, and territory to support the ARNG federal mission by providing services and facilities. This support is provided through cooperative agreements, whereby the federal government funds the state to provide services in support of the federal share of the mission; the state is responsible for funding their share of costs. The organizational interface between the federal government and the State is provided through the National Guard Bureau (NGB). Each state has an assigned NGB, Title 10 Officer (United States Property and Fiscal Officer – USPFO) who works closely with the state’s leadership to assure proper federal reimbursement for state-provided services. Further, each state assigns a Construction and Facility Management Officer (CFMO) that generally manages the state’s ARNG facilities and related services.

### **16-8. Installation Readiness Board of Directors (IRBOD)**

a. The IRBOD is an advisory body that makes recommendations regarding major strategic initiatives, policies, plans, and programs pertaining to Army facilities, installation infrastructure, installation services (including military construction, exchange and commissary services, logistic services, training support, medical support, information technology, and housing and lodging) and Morale, Welfare, and Recreation programs. The IRBOD is responsible to the SECARMY and CSA for identifying required policy, programming, and resourcing changes for ARSTAF development and approval. It replaces the function of the MWRBOD to include integration and synchronization of all programs, policies, and initiatives pertaining to Army installations. The IRBOD is tri-chaired by the VCSA, ASA (M&RA), and ASA (IEE). The tri-chairs will assess whether installation and MWR programs critical to Soldier and Family readiness receive appropriate emphasis and oversight. The IRBOD recommends decisions including, but not limited to, the following issues:

(1) Establishing strategic goals, objectives, and standards for programs and operations.

(2) Establishing strategic guidance and investment priorities that define effective performance, enable installation readiness, and optimize resources and programs needed to implement and monitor the strategic plan.

(3) Establishing, monitoring, and influencing performance measures for programs and operations that address critical readiness shortfalls and optimize installation programs, policies, and performance.

(4) Reviewing and approving, or endorsing, BASOPS actions and proposals that have Army-wide impact. These actions include but are not limited to determining new standards for service delivery and/or changes to types and amount of services provided.

(5) Approving and prioritizing, within available funding levels, non-appropriated fund (NAF) construction projects for inclusion in the annual DOD Report to Congress on the NAF major construction program.

(6) Providing fiduciary oversight for Army MWR and all non-appropriated fund instrumentalities.

(7) Reviewing, endorsing, and conducting inter- and intra-agency coordination of those actions that cannot be resolved within the Army (e.g., non-Army tenants on installations).

b. The IRBOD is intended to incorporate and broaden functional responsibility of the chartered Morale, Welfare, and Recreation Board of Directors (MWRBOD) and the unchartered Services and Infrastructure Core Enterprise (SICE) Board, providing a single forum to address all installation readiness functional components. The MWRBOD was established in 2011 to function as a governing body to review and approve major management strategies, plans, and programs pertaining to Moral, Welfare, and Recreation

## INSTALLATION MANAGEMENT COMMUNITY

(MWR) programs and non-appropriated fund instrumentalities. The SICE Board replaced the Soldier and Family Readiness Board (SFRBOD) in 2010.

c. The IRBOD is a principal official-level body (3- and 4-Star) and includes a supporting General Officer Steering Committee (GOSC) (2- and 3-Star deputies or equivalent) and supporting Council of Colonels (CoC). IRBOD tri-chairs may adjust membership as necessary. Additional ARSTAF representation is requested as appropriate, or when agenda dictates.

d. The IRBOD meets twice a year, in the September and February timeframes, with CoC's and GOSCs leading up to the IRBOD, vetting topics and potential decisions.

### Section III Initiatives and Programs

#### 16-9. Major Installation Management Initiatives and Programs

a. The Service Culture Initiative (SCI) is a continuous campaign that IMCOM utilizes to instill a culture (shared value) of service excellence within all facets of IMCOM services. IMCOM determined that a service culture is vital to help the Army adapt to a changing environment characterized by reduced resources to maintain or enhance readiness requirements. The SCI indoctrinates a culture of service excellence through leader and workforce engagement, an on-boarding program that welcomes and fully integrates all newly assigned Soldiers and Civilians to IMCOM, an employee recognition program that effectively furthers missions, goals, and values of the Army, and a standardized customer service training implemented garrison-wide. The SCI, and its pillars, help IMCOM carry out its unique mission in support of the Chief of Staff of the Army's effort to adjust Army culture; focusing on the Army as a profession, individual self-reliance, empowerment, commitment to service, community well-being, and taking care of each other.

b. Common Levels of Support (CLS) is IMCOM's enterprise platform by which IMCOM delivers, tracks, and reports performance measures with a singular focus on achieving the highest levels of readiness and with the greatest efficiency IAW the Army Business Strategy. CLS defines common BASOPS support services, subtasks (Service Support Programs), and performance targets establish standards for service delivery and measure performance against Army established standards. CLS provides the SC and GC the ability to:

- (1) Deliver the right level of service with a capability to predict required resources; and a method to plan, execute, track and compare performance.
- (2) Articulate definitive performance guidance to garrisons for the execution of core services delivered to Army standards, based on available funding.
- (3) Distribute available resources among installations to execute guidance.
- (4) Measure garrison performance to ensure expected performance is being achieved.
- (5) Inform customers on levels of support they can expect from Garrisons across the Army.

CLS is built on the principle that IMCOM installations will provide non-reimbursable BASOPS to Army customers across all its installations. This support will be standard but adaptable to local realities for the installation (e.g., requirements of mission, demography, or geography). Garrisons are required to deliver installation management support services IAW with the Army's ISR - Services program, which specifies content and pacing measures for each service component. The total dollar requirement for garrisons to deliver these services is calculated to fund the full scope of service as defined in the ISR. However, garrisons historically do not receive 100 percent of required dollars for each service. Garrisons therefore cannot deliver the full scope of services, and must have some way of determining which service components can be delivered with the dollars available. CLS provides an approach for making this decision across the Army, in a way that will lead to quality, consistency, and predictability.

c. Installation Service Standards (ISS). The effort to develop Army Baseline Standards performance-based measures initially focused on those ISR services where the quality of the service provided was key to determining required resources and so potential performance measures could easily be identified. For these services, quality played a significant role and required supplemental data from Army Standard Service Costing (SSC) - a model to capture the cost of base operations at the service level - to facilitate development of good cost estimating relationships (CER) for resource program development purposes. This ongoing effort will result in performance measures and standards for all 95 standard services developed by the Army Baseline Standards Task Force appointed by the DCS, G-9 in fiscal year 2015.

## HOW THE ARMY RUNS

The intended result is a Published Installation Services Directory identifying services and providers, to include established baseline standards, applicable regulations, performance and pacing measures (cost drivers) that provide for common service expectations; clearly defined non-reimbursable service standards that more accurately inform POM requirements (valid and defensible).

d. ISR. The ISR Program assists Army leadership in making informed and responsible decisions required to sustain or improve management of installation facilities, mission support capabilities, and services. The program provides HQDA, ACOMs, ASCCs, DRUs, and leadership of reporting installations with executive level information focused on the installation's real property assets, and installation support services. The ISR is comprised of three components:

(1) ISR Infrastructure. The purpose of ISR infrastructure is to document and display an ISR reporting installation's infrastructure status by assessing the quantity of facilities available for installation requirements and comparing the quality of installation facilities to established Army standards.

(2) ISR Mission Capacity (ISR-MC) focuses on energy and water security and resilience. It is designed to provide leaders at all levels with a decision support tool to assess the current energy and water security and resilience posture of an installation and track progress toward mitigating risk to mission.

(3) ISR Services focuses on evaluating quality, efficiency, and availability of services provided on an installation. Since July 1993, ODCS, G-9 has used ISR Services performance and cost data as the basis for developing BASOPS requirements. The ISR program provides an overall picture of an installation's status and shows how deficiencies in installation condition affect the mission performance. It provides information which links installation conditions, priorities and resources to readiness. While serving the needs of different customers—HQDA, ACOMs, ASCCs, DRUs, and installations—the ISR is also the installation commander's opportunity to prioritize installation requirements. The ISR provides a common standard and language for the Army to speak with one voice. Details concerning the ISR are contained in AR 210-14, Installation Status Report Program. Additionally, ISR data supports HQDA decisions on funding for the ASRA.

e. The Facility investment framework is a holistic approach to improve facility quality which includes investments to sustain enduring facilities, improve existing facility conditions particularly energy and utility efficiencies, to demolish facilities no longer needed, and to build to address critical shortfalls. The Army will use all forms of facility investment to include Unspecified Minor Military Construction, Army (UMMCA), O&M (R&M) and expend MILCON when MILCON is the best alternative. The Army will use the ISR and RPLANS to measure investment results.

f. Core Capabilities.

(1) Installation Services. The Army will provide a quality of life commensurate with the quality of service provided by Soldiers and their Families. Additionally, the Army will plan for a future of delivering facilities and services that are flexible and adaptive to support the Operating and Generating Forces. Army-wide standards for service delivery will be customer-driven, leverage successful partnerships with communities and the private sector, enable mission accomplishment by SCs, and enable well-being and readiness for Service members and Families. Services will be provided based on an enterprise business model and reflect enterprise standards, priorities, and funding strategies intended to eliminate redundancies.

(2) Installation Infrastructure. The Army will provide infrastructure to enable the Army to accomplish its mission on a global scale and achieve Army standards for quality and capacity at the lowest cost. In 2028, Army installation infrastructure should be secure and sustainable. Energy and environmental programs will be models for surrounding communities across the globe. Army facilities will enable a quality of life commensurate with the quality of service provided by its Soldiers and their Families, and help to mitigate the stress of repeated operational deployments on people, equipment, and infrastructure. The Army will work as an enterprise to properly station the force and adjust the Army's global infrastructure to enable the Army to fulfill its training and operational mission, and execute requirements of the National Defense Strategy.

(3) Installation Synchronization—People, Processes, and Tools. Installation leaders will seek to use innovative approaches built on lessons learned and institutionalize best practices of benchmark organizations within and outside of Army and DOD. Installation leaders will use performance management, geo-spatial, financial management, and communications tools to meet Army requirements and facilitate enterprise management. Internal installation functions will be streamlined and focus on core competencies of installation services and installation infrastructure. Installations will work within the Army Management system, pursue vigorously public-public and public-private partnership opportunities, and



# INSTALLATION MANAGEMENT COMMUNITY

will employ processes that develop and sustain the workforce and create a true Installation Profession. Installations will have many organizations responsible for providing services as an enterprise, and installation leaders will coordinate and synchronize all service providers to ensure integrated, balanced and efficient service delivery.

## Section IV Summary, Key Terms, and References

### 16-10. Summary

The IMC concept provides effective Army-wide installation management through use of best corporate business models, development of relevant standards and comprehensive adherence to Army standards, and partnership with ACOMs, ASCCs, and DRUs, senior and mission commanders, who receive focus on their unique issues, while geographic efficiencies are realized through economies of scale. The concept cares for people while ensuring readiness is not compromised; it positions installations for Army and DOD transformation initiatives and represents the Army's commitment to improve installations, preserve the environment, enable well-being of Soldiers, civilians and family members, and support mission readiness of all stakeholder units.

### 16-11. Key Terms.

a. Army Installation. An Army installation constitutes the following:

(1) An installation is defined as an aggregation of contiguous or near contiguous, real property holdings commanded by a centrally selected commander. Installations represent management organizations. An installation may be made of one or more sites.

(2) A site is a physically defined location which can be supported by a legal boundary survey which closes a polygon. It can be owned, leased, or otherwise possessed or used. A site may exist in one of three forms: land only, facility or facilities only, or land and all the facilities on it. A site is the sum of all real property at a specific location.

b. Stationing. Stationing is the process of combining force structure and installation structure at a specific location to satisfy a specific mission requirement. As such, it includes all forms of realignment or relocation and includes those actions that determine the authorized population (military and civilian) at a particular installation. Each stationing action is composed of a force component and an installation component. The force component consists of the personnel (military and civilian) and equipment of an organization. The installation component deals with all the facilities required to support the unit. Both components must be considered as part of the stationing process. The desired end of this process is a force that is based in a manner that ensures effective and efficient mission accomplishment. The ways used to accomplish stationing include transfer, consolidation, or relocation of a function, manpower, or personnel; activation or inactivation; or reduction or increase of civilian personnel. The means to execute these actions are encompassed in the procedures used to manage directed actions (for example, those actions mandated by Congress, BRAC, and discretionary actions resulting from ACOM, ASCC and/or DRU requests, HQDA direction, or directed actions requiring additional actions not originally specified).

### 16-12. References

a. Publications—

- (1) AR 1-1, Planning, Programming, Budgeting, and Execution System, 23 May 2016.
- (2) AR 5-1, Management of Army Business Operations, 12 November 2015.
- (3) AR 5-9, Installation Agreements, 4 April 2018.
- (4) AR 5-10, Stationing, 20 August 2010.
- (5) AR 10-87, Army Commands, Army Service Component Command, and Direct Reporting Units, 4 September 2007.
- (6) AR 58-1, Management, Acquisition, and Use of Motor Vehicles, 3 April 2019.
- (7) AR 115-11, Geospatial Information and Services, 28 August 2014.
- (8) AR 200-1, Environmental Protection and Enhancement, 13 December 2007.
- (9) AR 210-14, Installation Status Report Program, 19 July 2012.
- (10) AR 210-20, Real Master Planning for Army Installations, 16 May 2005.
- (11) AR 210-35, Civilian Inmate Labor Program, 12 May 2006.

## HOW THE ARMY RUNS

- (12) AR 210-130, Laundry and Dry Cleaning Operations, 2 February 2005.
  - (13) AR 405-70, Utilization of Real Property, 12 May 2006.
  - (14) AR 405-90, Disposal of Real Estate, 10 May 1985.
  - (15) AR 420-1, Army Facilities Management, 12 February 2008 (Rapid Action Revision Chapter 25, 24 August 2012).
  - (16) AR 420-41, Acquisition and Sales of Utilities Services, 3 March 2015.
  - (17) AR 600-3, The Army Personnel Development System, 26 February 2009.
  - (18) AR 600-8-8, The Total Army Sponsorship Program, 4 April 2006.
  - (19) AR 600-20, Army Command Policy, 6 November 2014.
  - (20) DA General Order 2017-01, Assignment of Functions and Responsibilities within Headquarters, Department of the Army, 5 January 2017.
  - (21) DA General Order 2019-13, Reassignment of the U.S. Army Installation Management Command as a Major Subordinate Command of U.S. Army Materiel Command, 15 February 2019.
  - (22) DA Pamphlet 5-13, Procedures for Army Stationing, 3 June 2015.
  - (23) DA Pamphlet 210-9, Laundry and Dry Cleaning Operations, 15 March 2001.
- b. Useful Links—
- (1) Deputy Under Secretary of Defense for Energy, Installations & Environment:  
<http://www.acq.osd.mil/eie>.
  - (2) ASA (IEE): <http://www.army.mil/asaiee>.
  - (3) AMC: <http://www.amc.army.mil>.
  - (4) DCS, G-9: <http://www.DCS, G-9.army.mil/index.html>.
  - (5) IMCOM: <http://home.army.mil/imcom>.

## **Chapter 17**

### **Army Health System**

#### **Section I Introduction**

##### **17-1. Chapter Content**

This chapter covers the Army Medical Department (AMEDD) mission and support to commanders, the Army Health System's (AHS) key elements, relationships, responsibilities, and command and management within the AMEDD, the Medical Command, and Regional Health Commands (RHCs), as of 1 July 2019. In support of Army transformation, Army Medicine is transforming to align medical operations with the National Defense Strategy in order to sustain the readiness of Soldiers and deploying a medical force that is trained and ready to support the Army in high-intensity conflict and any directed mission. Senior leaders are currently evaluating several courses of action to reorganize or restructure Army Medicine to best support a Medically Ready Force and a Ready Medical Force. To date, Army Leadership realigned the U.S. Medical Research and Materiel Command (USAMRMC) to Army Materiel Command (AMC). USAMRMC was renamed the U.S. Army Medical Research and Development Command (USAMRDC), and the headquarters and research and development mission aligned under Army Futures Command (AFC). During the transition, the medical logistics capabilities remained with AMC. Army Leadership also realigned the U.S. Army Medical Center of Excellence (MEDCoE) to the U.S. Army Training and Doctrine Command (TRADOC). The military Medical Treatment Facility transition was directed in the 2017 and 2019 National Defense Authorization Acts (NDAA) and is intended to transform the Military Health System (MHS) into an integrated system. It focuses on the transfer of management and administration of military treatment facilities (MTFs) from the Military Departments to the Defense Health Agency (DHA). This chapter will be updated in its entirety following the completion of medical reform.

##### **17-2. The Evolution in Military Medicine**

The strategic environment is one of complex interdependence and contains two major parts. First, the environment in general includes various political, economic, and social forces that are not unique to Army Medicine or the federal government. Second, the Army Medicine organizational context includes both the Army and the Military Health System (MHS). Healthcare in the U.S. is at a critical juncture, and there is an opportunity for Army Medicine to lead the Nation away from the status quo. Advances in technology not only provide promise for improving the efficacy and delivery methods of healthcare, but new methods of communication will redefine how individuals connect with one another, with partners, and with patients. Additionally, increased data-collection and analysis provides new opportunities for intervention and understanding. The Army Medicine Campaign Plan (AMCP) 2018, which supersedes AMCP 2017, expresses the comprehensive organizational strategy for U.S. Army Medical Command USAMEDCOM and the Office of The Surgeon General (OTSG) to fulfill the Army Medicine Vision. AMCP 2018 outlines an operational approach that portrays the broad actions that Army Medicine must take to transform current conditions into those desired at the end state. Army Medicine will operate on the following four lines of effort (LOE) to achieve its desired end state—

a. LOE 1, Readiness and Health. Army Medicine must be agile, adaptive, flexible, and responsive to Warfighter requirements. Properly postured to deploy healthy individuals and organizations in support of the world's premier combat force.

b. LOE 2, Healthcare Delivery. From the battlefield to the garrison environment, Army Medicine will support the operational requirements of Combatant Commanders (CCDRs) while also ensuring the delivery of the healthcare benefit to all beneficiaries.

## HOW THE ARMY RUNS

c. LOE 3, Force Development. Army Medicine must rapidly develop scalable and rapidly deployable medical capabilities that are responsive to operational needs, and able to effectively operate in a Joint/Combined environment characterized by highly distributed operations and minimal, if any, pre-established health service infrastructure.

d. LOE 4, Take Care of Ourselves. Take care of the Army's Soldiers for Life, DA Civilians, and Families. Army Medicine will continue to take care of the Force, Soldiers for Life, Service Colleagues, DA civilians, and service members' Families.

### 17-3. Scope of the Army Medical Department (AMEDD)

The AMEDD encompasses those Army specialty branches that are under the supervision and management of The Surgeon General (TSG). Specifically, these specialty branches are the Medical Corps (MC), Dental Corps (DC), Veterinary Corps (VC), Medical Service Corps (MS), Army Nurse Corps (NC), and Army Medical Specialist Corps (SP). The AHS, as part of the Military Health System, is one of the world's largest health systems and includes all roles of medical, dental, veterinary, and other related healthcare from policy and decision-making to the combat medic in the field. These functions are under active analysis as part of the overall redesign of the OTSG, Public Health, Dental, and Warrior Transition enterprises as a result of the 2017 and 2019 NDAAs.

a. TSG of the Army is dual-hatted as a principal staff officer of the Headquarters, Department of the Army (HQDA) and as the Commanding General (CG) of the Army's largest active duty direct reporting unit USAMEDCOM.

b. TSG advises the Chief of Staff of the Army (CSA) on the development, policy direction, organization, and overall management of the AHS.

c. TSG also monitors and manages health services Army-wide through the OTSG, the AMEDD-element of the Army Staff (ARSTAF). Hand-in-hand with other Army management processes (Total Army Analysis (TAA); Planning, Programming, Budgeting, and Execution (PPBE)), the AMEDD conducts various programs specifically designed to meet the force modernization, unit readiness, research and development, preventive medicine, and patient care missions for the armed forces.

d. The USAMEDCOM CG possesses command authority over healthcare personnel and hundreds of generating force health readiness organizations and platforms.

e. Through the Warrior Transition Command (WTC), the AMEDD is responsible for every aspect of the Army's Warrior Care and Transition Program which provides a holistic patient and family-centered approach to recovery, rehabilitation, and reintegration of wounded, ill, and injured Soldiers.

### 17-4. AHS Support

The AHS and Army medical and dental benefits are an important element of overall military compensation. Providing comprehensive and quality healthcare to military personnel is required by law. Other eligible Army Medicine beneficiary categories, such as retirees and family members, are entitled to medical and dental care subject to availability of space, facilities, and medical and dental staff as defined by Title 10 of the United States Code (10 U.S.C.) and other regulatory requirements. Health services are essential to recruiting and retaining a quality force. Soldiers' confidence and performance on the battlefield are enhanced knowing that they and their family members are supported by a superb health readiness system. As the Army looks towards obtaining a Multi-Domain Operations capable force by 2028, it is projected that the Army will be regionally aligned and globally engaged. To meet the 2019 Army's Modernization Strategy, there is an essential requirement to optimize human performance to bolster the Soldier Lethality. The Army understands that leader and Soldier development must incorporate the ability to train, adapt, and execute in very fluid and challenging environments. To better meet this requirement, Army Medicine recognized the need to facilitate health readiness and resilience by optimizing physical, emotional, social, spiritual, and family fitness of the Total Army. This is achieved, not just through high quality healthcare delivery, but through a System for Health; a proactive "system" of integrated and synergistic initiatives, programs, relationships and policies designed to empower individuals to take decisive action with their own health and well-being to optimize and sustain a state of personal health readiness. It is a proactive approach to partner with Army and Department of Defense entities to influence strategic, operational, and tactical policy and environments. Such an integrated system improves, strengthens and maintains health readiness and wellness for all Service Members. Service Members, Soldiers for Life, and their Families are fully integrated with the Army's Holistic Health and Fitness Program coupled with the DOD's Total Force Fitness efforts.

## Section II

### Army Medical Department Mission and Support to Commanders

#### 17-5. Mission of the AMEDD

Army Medicine's mission is to provide sustained health services and research in support of the Total Force to enable readiness and conserve the fighting strength while caring for the Army's Soldiers for Life and Families. This mission is accomplished by AMEDD personnel assigned across the Army around the world, 24 hours a day, 365 days a year. While Army Medicine directly enables the Army's service responsibilities outlined in 10 U.S.C., it is also foundational to the joint force in the execution of Globally Integrated Health Services. This mission relates directly to Army combat readiness. The AMEDD is responsible for maintaining the clinical, technical, and combat readiness of medical units and personnel to support forces in the theater of operations. As a component of the MHS, the AHS is responsible for operational management of the health service support and force health protection missions for training, pre-deployment, deployment, and post deployment operations. It includes all mission support services performed, provided, or arranged by the AMEDD to support health service support and force health protection mission requirements for the Army and as directed, for joint, intergovernmental agencies, coalition, and multinational forces. The AHS includes all mission support services performed, provided, or arranged by the AMEDD to support Health Service Support (HSS) and Force Health Protection (FHP) mission requirements for the Army and as directed, for joint, intergovernmental agencies, coalition, and multinational forces.

a. HSS is defined as all support and services performed, provided, and arranged by the AMEDD to promote, improve, conserve, or restore the mental and physical well-being of personnel in the Army and as directed in other services, agencies, and organizations. This includes casualty care, medical evacuation, and medical logistics, which encompass a number of AMEDD functions—organic and area medical support, hospitalization, the treatment aspects of dental care and behavioral health and/or neuropsychiatric treatment, clinical laboratory services, and the treatment of Chemical, Biological, Radiological, and Nuclear, (CBRN) patients.

b. FHP is defined as measures to promote, improve, or conserve the mental and physical well-being of Soldiers. These measures enable a healthy and fit force, prevent injury and illness, and protect the force from health hazards. This includes the prevention aspects of a number of AMEDD functions, as follows: preventive medicine, such as medical surveillance and occupational and environmental health surveillance; veterinary services, including the food inspection and animal care missions; the prevention of zoonotic diseases transmissible to man; combat and operational stress control; dental services (e.g., preventive dentistry); and laboratory services (e.g., area medical laboratory support).

(1) The deployable medical units of the Army carry out FHP, with a heavy reliance on the Reserve Components (RC) medical capabilities. These units are apportioned to combatant commands (CCMDs) around the world.

(2) The AMEDD is also chartered to deliver healthcare to Soldiers and family members at Medical Centers (MEDCEN), community hospitals, and medical clinics, dental clinics, and veterinary services; medical research and development; education and training, rehabilitative care and training; and health promotion and preventive medicine. Fixed installation Table of Distribution and Allowance (TDA) medical units directly support operational units on an area basis as it relates to medical equipment and training of assigned medical personnel.

(3) The recruitment and retention of healthcare professionals and sustainment of their skills are central to the maintenance of a high-quality medical force. Deploying the medical force is one of the AMEDD's primary missions. In peacetime, the vast majority of healthcare professionals and technical support personnel who deploy with medical units are employed within the Army's fixed hospitals, MEDCENs, and other healthcare facilities. The day-to-day practice of healthcare professionals and their support staff in these environments is the basis for maintaining the clinical skills and teamwork necessary to care for sick and wounded Soldiers during operations.

c. Beneficiary Care and TRICARE. The second, but equally important, aspect of the AMEDD mission is to help maintain the personnel readiness of the Total Army by maintaining the health of individual Soldiers and their Families.

(1) Quality healthcare for Soldiers, retirees, and their families is an essential and valuable benefit. Physical readiness, good health, and the knowledge that family members will be cared for, contribute to the ability of each Soldier to deploy and perform their mission in the operational environment (OE).

## HOW THE ARMY RUNS

(2) To meet readiness requirements and serve Soldier and family health needs better, Congress directed the DOD to develop and implement a new model for military healthcare that would improve patients' access to healthcare, assure high quality of care, and control rising healthcare costs. The result, TRICARE, is now the medical program for active duty service members and their family members, retirees and their families, and eligible survivors of all uniformed Service Members. TRICARE relies on inter-service and civilian-military sharing of medical resources to improve accessibility of care and achieve efficiencies. A DOD program under the oversight of the Assistant Secretary of Defense for Health Affairs (ASD (HA)), it is managed by the military in partnership with civilian contractors. Each TRICARE region has an Army, Navy, or Air Force lead agent (usually the commander of an MTF or RHC) responsible for the program. Details for each TRICARE program is available at <https://www.tricare.mil>.

### **17-6. AMEDD Support to Commanders**

a. Commanders are responsible for the health and physical fitness of their Soldiers. The AMEDD supports commanders by acting as the proponent for medical doctrine, advising commanders in all health related matters of the AHS. The AMEDD:

(1) Advises the command of measures to assure the health, fitness, and vigor of all members of the Army.

(2) As directed, acts as the proponent to provide those measures needed to assure health and fitness.

(3) Develops, trains, and maintains forces necessary for medical FHP to the Army in an OE.

(4) Conducts routine comprehensive health surveillance to identify leading injury and disease trends affecting Soldier's readiness and health.

(5) Conducts field investigations of outbreaks of potential health threats from disease, environmental hazards and injuries.

b. The importance of the AHS in the OE is paramount. It supports the prevention of disease and non-battle injury to ensure maximum operational capability. When casualties occur, the medical system provides rapid initial treatment, stabilization and evacuation to medical treatment facilities.

### **17-7. AMEDD Support to Emergency Management and Installation Commanders**

a. AMEDD supports the National Preparedness Goal (NPG) to achieve "a secure and resilient nation with the capabilities required across the whole community to prevent, protect against, mitigate, respond to, and recover from the threats and hazards that pose the greatest risk." TSG / USAMEDCOM provides overarching policy on the medical and human health aspects of Army installation activities and operations associated with the Army Installation Preparedness (IP) and Emergency Management Program (EMP), including consideration of potential and residual all-hazards contamination. TSG is responsible for ensuring all medical headquarters develop applicable Emergency Management plans that are compliant and interoperable with the National Incident Management System (NIMS) and Joint Commission, when applicable.

b. USAMEDCOM provides integrated and comprehensive Emergency Management Health Service Support to protect beneficiaries and mission capabilities from all hazards in an implementable and sustainable manner to support the Army EMP.

d. Emergency Management operational plans address a series of integrated planning frameworks that will be used to govern shaping, mitigation, preparedness, response, and recovery; build upon scalable, flexible, and adaptable coordinating structures to align key roles and responsibilities; and be coordinated using a common terminology and approach. Coordinating activities address detailed concepts of operations, a description of critical tasks and responsibilities, detailed requirements (e.g. personnel, equipment, and training), and specific provisions for rapid integration. Plans identify resource guidance, such as arrangements enabling the ability to share personnel, equipment guidance aimed at nationwide interoperability, and guidance for national training and exercise programs.

## Section III Office of The Surgeon General

### 17-8. Key Elements

a. TSG/OTSG. TSG is the principal military adviser to the Secretary of the Army (SECARMY) and the CSA on the health and medical aspects of manning, training, and equipping the Army; assists and supports the Assistant Secretary of the Army (Manpower and Reserve Affairs) (ASA (M&RA)) in the development and oversight of policies and programs related to health affairs and is responsible for the planning and supervision of the execution of those policies and programs; and ASD (HA) and Defense Health Agency health affairs policies and programs. TSG is responsible for:

(1) Assisting the ASA (M&RA) in developing policies and programs for the Army system for health and planning and supervising the execution of those policies and programs.

(2) Representing the Army on health policies, military health readiness requirements, and safety of members of the Army to DOD, executive departments, Congress, and nongovernmental organizations.

(3) Providing technical advice and assistance to the Secretariat and ARSTAF for matters regarding public health, readiness of the force, warrior transition care, medical force structure and equipping, force development, medical materiel and research and development, medical training and education, medical evacuation, and medical military construction.

(4) Developing and directing the Army's PPBE process for the Defense Health Program.

b. Health Services. Health services are all services performed, provided, or arranged for (regardless of location) which promote, improve, conserve, or restore the physical or behavioral health of individuals or groups, and those services which contribute to the maintenance or restoration of a healthy environment. Health services include, but are not limited to: preventive, curative, and restorative health measures; medical doctrine; medical aspects of CBRN defense; health promotion and injury prevention; assessment of health threats and countermeasures; medical operations planning; medical intelligence; health professional education and training; health-related research; transportation of the sick and wounded; selection of the medically fit and disposition of the medically unfit; administration; medical logistics; medical equipment maintenance; medical facility life cycle management; and the delivery of medical, nursing, dental, veterinary, laboratory, optical, and other specialized services.

c. Programming and Budgeting. Since 1991, military funding was secured through the DOD Unified Medical Program and the Defense Health Program (DHP) Appropriation, rather than the Services' budgets. The ASD (HA) issues policy guidance and TRICARE manages and monitors service execution of the DHP Appropriation and the DOD Unified Medical Program. The DHP appropriation consists of: operation and maintenance; research, development, test, and evaluation; and procurement funds designed to finance the non-military personnel requirements of the MHS. In FY 2003, the Department implemented the DOD Medicare Eligible Retiree Healthcare Fund, an accrual-type fund to pay for healthcare provided to Medicare eligible retirees, retiree family members, and survivors.

(1) The OTSG / USAMEDCOM Staff (see paragraph 17-10) programs and funds manpower using both the DHP and Army appropriations. DHP funds provide for most peacetime healthcare operations in TDA units such as Army MEDCENs and community hospitals and for TRICARE Managed Care Support Contracts. The vast majority of AMEDD manpower is funded by the DHP. Army funding supports deployable medical Table of Organization and Equipment (TOE) units and medical readiness missions.

(2) The OTSG / USAMEDCOM Staff programs for Army funds and provides its input to the Army's Program Objective Memorandum (POM). It programs for DHP funds and provides input to the DHP POM through TRICARE. Military personnel costs are programmed by TRICARE in the DHP POM and the programmed total obligation authority transfers to the MPA appropriation when the budget estimate submission (BES) is prepared. Civilian personnel costs are reimbursable from DHP Operations and Maintenance Defense funds during the year of execution. Authorizations for both military and civilian personnel are on Army manpower documents.

### 17-9. Staff Relationships and Responsibilities

a. Office of the ASD (HA) has statutory responsibility for overall supervision of health affairs within DOD and is the principal staff assistant and adviser to SECDEF for all DOD health policies, programs, and activities.

(1) Defense Health Agency (DHA). DHA is a joint, integrated Combat Support Agency that enables the Army, Navy, and Air Force medical services to provide a medically ready force and ready medical

## HOW THE ARMY RUNS

force to Combatant Commands in both peacetime and wartime. The DHA supports the delivery of integrated, affordable, and high quality health services to Military Health System (MHS) beneficiaries and is responsible for driving greater integration of clinical and business processes across the MHS. DHA administers and manages the TRICARE health plans and administers, manages, and monitors service execution of the DHP appropriation and the DOD Unified Medical Program.

(2) The DHA TRICARE Health Plan (THP) Division coordinates healthcare within the various geographic health service regions. Each region has a contractor that administers and helps coordinate the healthcare services available through military treatment facilities and a network of civilian hospitals and providers. The THP—

- (a) Provides oversight of regional operations and health plan administration at the regional level.
- (b) Manages the contracts with regional contractors.
- (c) Supports MTF Commanders.
- (d) Develops business plans for non-MTF areas (e.g., remote areas).
- (e) Funds regional initiatives to optimize and improve delivery of healthcare.

b. OTSG has the following ARSTAF responsibilities—

(1) Assisting the SECARMY and the CSA in discharging 10 U.S.C. responsibility to synchronize and integrate health services for the Army and other agencies and organizations entitled to military health services.

(2) Developing doctrine, policy, and regulations for the AHS, health hazards assessment, the establishment of health standards, and medical materiel.

(3) Representing the Army to the executive branch, Congress, DOD agencies, and other organizations on all health policies affecting the Army.

(4) DOD focal point for North Atlantic Treaty Organization (NATO) Medical Chemical, Biological, Radiological, and Nuclear (CBRN) actions. Provides U.S. Head of Delegation for the NATO CBRN Medical Working Group and Biomedical Panel.

(5) Managing all aspects of Army medical CBRN defense programs in coordination and support to the joint Chemical and Biological Defense Program.

(6) Advising and assisting the SECARMY and CSA and other principal officials on all policy issues pertaining to health and military health service support to include—

- (a) Policies and regulations concerning the health aspects of Army environmental programs.
- (b) Health professional education and training for the Army, to include training programs for all medical, nursing, dental, and veterinary specialty areas.
- (c) Research and development activities for nutrition and wholesomeness in support of DOD Food Service.
- (d) Medical materiel life-cycle management.
- (e) Medical materiel in the Army War Reserves Program.
- (f) Medical materiel concepts, requirements, validity and viability.
- (g) Technical review and evaluation of medical and nonmedical materiel to determine the existence of possible health hazards.
- (h) Program management for Army healthcare automation.
- (i) Electronic health records.
- (j) Army execution of the Defense Medical Systems Support Center (DMSSC).
- (k) Medical aspects of the Security Assistance Program.
- (l) Program sponsor for Operations and Maintenance, Army - Program 84 (Medical).
- (m) Executive Agent (EA) of the SECARMY for all DOD veterinary services.
- (n) Medical facility life cycle management.
- (o) Field medical support concepts, doctrine, training and leader development programs and user test.
- (p) Medical intelligence training.
- (q) Medical mobilization training.



## Section IV Command and Management

### 17-10. AMEDD Organization

a. In 1998, TSG directed the implementation of the One Staff concept, consolidating the staffs at OTSG and Headquarters, USAMEDCOM, Fort Sam Houston, Texas. Personnel at both locations now function as a single staff with one set of leaders who coordinate ARSTAF functions, along with Army command functions (see Fig 17-1). In 2011, TSG directed a Bottom Up Review (BUR) which resulted in an increase in AMEDD General Officer presence in the National Capital Region (NCR); reduction in key leader span of control; better alignment of OTSG / USAMEDCOM headquarters staff with HQDA staff; and transforming HQ USAMEDCOM to an Operating Company Model aimed at decreasing variance across staff and standardizing headquarters processes. Additionally in 2015, USAMEDCOM initiated the USAMEDCOM Transformational Concept aimed at better integration of medical, dental, public health, and Warrior care within HQ USAMEDCOM, while elevating patient safety and quality of care to the forefront within the One Staff. The USAMEDCOM Transformational Concept resulted in merging the following MSC HQs into the HQ USAMEDCOM One Staff: Public Health Command (PHC) became the HQ USAMEDCOM Deputy Chief of Staff (DCS) for Public Health; WTC became the HQ USAMEDCOM DCS for Warrior Care Transition; and DENTCOM became the HQ USAMEDCOM DCS G-3/5/7 Dental Directorate. All subordinate O-6 (COL) Public Health Command Regions (PHCR) and Regional Dental Commands (RDC) were renamed Public Health Commands (PHC) and Dental Commands (DENTCOM), respectively. These organizations were then realigned under each RHC.

b. The consolidation of worldwide medical assets under the USAMEDCOM in 1996 greatly enhanced command and control efficiency to meet the needs of the Army of the 21st Century. Implementation of the One Staff concept to achieve the most efficient and effective MC structure underscored the AMEDD's commitment to continuous quality improvement and poised the AMEDD for its role in the Army Transformation.

c. The One Staff is responsible for AMEDD policy, planning, and operations worldwide, with a focus on strategic planning. Its mission is to:

- (1) Provide the vision, direction, and long-range planning for the AMEDD.
- (2) Develop and integrate doctrine, training, leader development, organization, materiel, and Soldier support for the AHS.
- (3) Allocate resources, analyze health services utilization, and conduct assessments of performance worldwide.
- (4) Coordinate and manage graduate medical education programs at the Army MEDCENs.
- (5) USAMEDCOM is designated by the Chairman, Joint Chiefs of Staff (CJCS) as the Theater Lead Agent for Medical Materiel (TLAMM) to U.S. Northern Command.

### 17-11. U.S. Army Medical Command (USAMEDCOM)

a. USAMEDCOM represents the Generating Force (GF) elements of the AMEDD. As part of the previously mentioned 2015 USAMEDCOM Transformational Concept, USAMEDCOM initiated an overarching reorganization of HQ USAMEDCOM and its assigned Major Subordinate Commands (MSC). Figure 17-1 depicts USAMEDCOM's current state with subordinate headquarters elements of DENTCOM, PHC, and WTC as principal staff elements within the USAMEDCOM headquarters to improve the integration, synchronization, and oversight of health readiness at the strategic level.

b. Additionally, USAMEDCOM has the following MSCs—

- (1) Regional Health Command-Europe (RHC-E).
- (2) Regional Health Command-Central (RHC-C).
- (3) Regional Health Command-Atlantic (RHC-A).
- (4) Regional Health Command-Pacific (RHC-P).

c. RHCs oversee day-to-day operations of the health readiness platforms, PHCs and Regional Dental Commands within their regions. Aligned Public Health and Dental assets under the MC of RHCs, are the single point of accountability for health readiness to Continental United States (CONUS) Army Corps and Outside of the CONUS (OCONUS) Army Service Component Commands (ASCCs).

## HOW THE ARMY RUNS

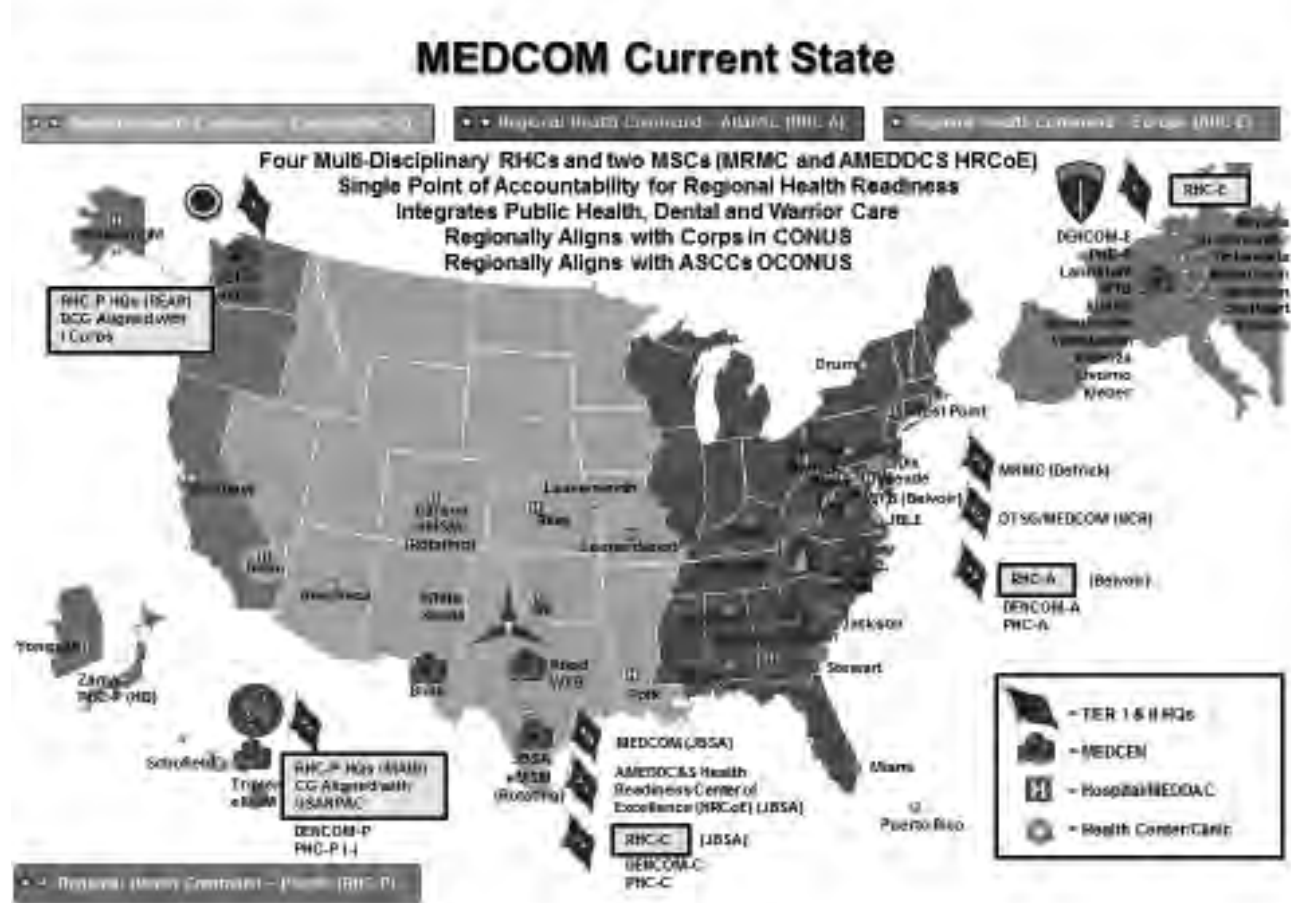

**Figure 17-1. United States Medical Command Current Structure**

### 17-12. Regional Health Commands

a. RHCs are the key operational element for the delivery of healthcare services for geographical regions within USAMEDCOM. RHCs are MSCs operating under the supervision of the commander. Mission responsibilities include:

- (1) Regional MC of an affordable, multidisciplinary, customer-focused, quality military health service system.
- (2) Supporting the health readiness requirement of the Army.
- (3) Developing and sustaining technical healthcare and leader skills in support of USAMEDCOM readiness goals.
- (4) Allocating resources, analyzing utilization, and assessing performance across the RMC.

b. As the primary integrator of health readiness, the RHC is responsible for:

- (1) Daily utilization of assigned and attached medical assets, integrating active and reserve training, and development of mobilization requirements.
- (2) Budgeting, defending, and allocating readiness costs and funding.
- (3) Preplanning health readiness platform professional backfill requirements during deployment by expanding network coverage, shifting RHC assets, and coordinating RC coverage.
- (4) Ensuring that Army health readiness requirements are fully integrated into the activities of DOD healthcare regions.
- (5) Conducting training exercises in health readiness platform mobilization, professional backfill activities, and deployment actions.
- (6) Providing medical planning and preparation programs for worldwide contingency operations;
- (7) Sponsoring readiness-based clinical research.

- (8) Providing responsive and reliable oral health services, which include:
  - (a) Serving as the proponent for meeting the dental health needs of the Army and eligible beneficiaries.
  - (b) Providing MC of RDCs, Dental Activities (DENTAC), Dental Clinic Commands, and Dental Treatment Facilities worldwide.
- (9) Promoting health and preventing disease, injury, and disability of Soldiers and retirees, their families, and Department of the Army civilian (DAC) employees; and assuring effective execution of full spectrum veterinary services for Army and DOD Veterinary missions.

### **17-13. U.S. Army Medical Research and Materiel Command (USAMRMC)**

- a. The USAMRMC is the Army's medical materiel developer with responsibility for medical research, development, acquisition, and medical logistics management transitioned to the AMC, effective 1 October 2018. The USAMRMC Research, Development, Testing and Evaluation (RDTE) transitioned to the U.S. Army Medical Research and Development Command (USAMRDC) and transferred the medical research, development, and acquisition elements of USAMRMC to AFC on 1 June 2019.
- b. Six medical research laboratory commands execute the science and technology program to investigate medical solutions focusing on various areas of biomedical research, including military infectious diseases, combat casualty care, military operational medicine, medical chemical and biological defense, and clinical and rehabilitative medicine. The Command manages a large extramural research program with numerous contracts, grants, and cooperative research and development agreements to provide additional science and technology capabilities from leading academic, private industry, and other government organizations.
- c. Six additional commands focus on medical materiel advanced development, strategic and operational medical logistics, and medical research and development contracting, to complete the full life cycle of medical materiel acquisition.

### **17-14. United States Army Medical Department Center and School, Army Health Readiness Center of Excellence (AMEDDC&S HRCoE)**

- a. General. The AMEDDC&S HRCoE transferred to TRADOC on 8 October 2018. The transfer facilitates the alignment of health services, functional and branch proponent efforts, operational medical capabilities, the requirements determination processes, and force development. The transfer also aligns Army Medicine training, education, professional development, and DOTMLPF-P integration functions. Moving AMEDDC&S under TRADOC standardizes initial military training, promotes professional development, and enhances the Army's ability to generate and sustain ready medical forces and provide operational support to CCDRs. AMEDDC&S was re-designated the MEDCoE effective 15 September 2019.
- b. Mission. Envision, design, train, educate and inspire the world's premier military medical force to enable readiness and strengthen America's Army.
- c. Functions.
  - (1) Develops, integrates, coordinates, implements, evaluates, and sustains training/training products for Active and Reserve medical forces worldwide IAW AR 350-1, Army Training and Leader Development.
  - (2) Develops, integrates, analyzes, tests, validates, and evaluates concepts, emerging doctrine medical systems, and doctrine and training literature.
  - (3) Conduct all AMEDD officer, enlisted and civilian proponent functions, personnel inventories and life-cycle management of career fields.
  - (4) Develops concepts, systems, and forces structure for combat health services support.
  - (5) As the integration center for doctrine and training requirements, systematically develops courses, training devices, manuals and sustainment materials for readiness.
  - (6) Provides training, education, and evaluation of AMEDD personnel.
  - (7) Tests and evaluates new and replacement items of medical equipment.
  - (8) Serves as proponent for Force Health Protection (FHP) in theaters of operation.
  - (9) Conducts healthcare studies to improve the efficiency and effectiveness of the AMEDD.
  - (10) Provides statistical and analytical consultation to the AMEDD, with secondary support to subordinate organizations within the USAMEDCOM; provides decision support expertise to AMEDD senior leadership; promotes data quality, integrity, and standardization across the AMEDD.
  - (11) Maintain evaluation and quality assurance program. Conduct efficient and effective internal and external evaluations/quality assurance program to improve training; sustain readiness level and control or

## HOW THE ARMY RUNS

reduce cost.

(12) Facilitate successful development and fielding of AMEDD and other supporting information management/information technology (IM/IT) systems.

(13) Execute applicable force design updates in support of Army transformation.

(14) Serve as AMEDD agent for management of military individual education through Army training requirements and resources system (ATRRS) in accordance with AR 350-1.

### 17-15. AMEDD Role in Sustainment Units

a. In addition to its fixed MTFs, the Army has medical units within deployable commands that support the sustainment and protection warfighting function. These medical units work in concert with logistics and personnel units to form the sustainment core for Army forces. The deployable medical assets consist of TOE units in both the Regular Army (RA) and Reserve Component (RC). CONUS RA medical units are assigned to U.S. Army Forces Command. OCONUS medical units are assigned to the ASCC. Deployable medical units range in size, scope of mission, and capacity from medical detachments to theater hospitals. Collectively, they establish an integrated continuum of medical evacuation and treatment from point of injury on the battlefield, to the echelons above corps, and eventually to specialized treatment in CONUS.

b. In the event of mobilization, AMEDD RC medical units will often be among the earliest deploying forces. With approximately 68 percent of the medical force in the RC, the AMEDD truly exemplifies the Total Army. Well-trained and combat ready RC medical units are absolutely essential for ensuring that the FHP missions of the Army are accomplished during periods of mobilization. Senior Army leaders have begun reassigning Army Medicine assets to increase efficiencies and better align organizations within the Army and directed the realignment of Professional Filler System (PROFIS) personnel from assignment to MTF generating force TDA units to assignment to Modified Tables of Equipment (MTOE) for operating force units. These MTOE Assigned Personnel (MAP) are now assigned to their MTOE unit "with duty at" MTFs. The key objective of MAP include: 1) Align authorization transfers from MTFs co-located with MTOE units; 2) Maintain co-located positions at remote and OCONUS locations; 3) Maintain wartime skill currency/ sustainment for trauma, surgical, and intensivist positions.

c. A key operational enabler is the Medical Communications for Combat Casualty Care (MC4). MC4 integrates a medical information management system for Army tactical medical forces, enabling a comprehensive, lifelong electronic medical record for all service members, and enhancing medical situational awareness for operational commanders. MC4 integrates Theater Medical Information Program (TMIP); the Battlefield Medical Information-Theater (BMIS-T); Armed Forces Health Longitudinal Application (AHLTA); the U.S. Transportation Command (TRANSCOM) Regulating and Command and Control Evacuation System (TRAC2ES); the Defense Medical Logistics Standard Support (DMLSS); and the Defense Medical Surveillance System (DMSS). MC4 integrates the global medical network with a fully integrated operational architecture and a Global Information Grid (GIG) infrastructure. MC4 will enable commanders to effectively synchronize medical care on any battlefield, worldwide.

### 17-16. Staff Surgeons

The senior AMEDD officer present for duty with a headquarters (other than medical) will be officially titled:

a. The "Command Surgeon" of the ACOM and ASCC.

b. The "Surgeon" of the field command (e.g., corps).

c. The "Director of Health Services (DHS)" at the installation level.

d. The surgeon and DHS are responsible for the staff supervision of all health matters and policies, except dental and veterinary matters. The DHS and the Director of Dental Services (DDS) will serve on the installation commander's staff. Normally, the commander of the MEDCEN or medical department activity (MEDDAC) is the DHS, and the commander of the Army dental activity (DENTAC) is the DDS.

### 17-17. Health Service Logistics

a. Health service logistics is integral to the AHS and is managed by the AMEDD as a core functional area of MHS. This gives the command surgeon the ability to influence and control the resources needed to save lives. TSG establishes medical logistics policies and procedures within the framework of the overall Army logistics system. Health service logistics includes the management, storage, and distribution of medical materiel (to include medical gases), blood and blood products, optical fabrication, medical material war reserves, and medical equipment maintenance which are inherent to the provision of

healthcare. The medical commodity (Class VIII) has characteristics that make it distinctly different from other classes of supply. Medical materiel includes pharmaceuticals, narcotics, and blood products that are potency and shelf life (dated) that require special handling and security. Most items are subject to the regulations and standards of external agencies such as the Food and Drug Administration (FDA), the Environmental Protection Agency, the Drug Enforcement Agency, and The Joint Commission. Medical logisticians have extensive knowledge of those requirements as they relate to health service support.

b. The Single Integrated Medical Logistics Manager (SIMLM) mission designates a single organization or ASCC to manage and provide health service logistics support to joint forces operating in the theater. Blood is the only medical material not directly under control of the SIMLM. Blood supplies are coordinated and managed by the Joint Blood Program Officer in each of the CCMDs.

c. The TLAMM provides a single theater medical materiel distribution and supply chain management, providing the intensive management required for the medical commodity in close concert with FHP operations and industry partners at the national level.

d. USAMEDCOM established Medical Equipment Reset operations for medical equipment and sets for re-deploying units and Theater Provided Equipment (TPE)-Medical. Redeploying units conduct field-level reset operations at home station in coordination with the RMCs and their Installation Medical Supply Activities. Sustainment Reset (Depot Level) activities occur at one of three depot locations: Hill Air Force Base (AFB), Utah; Tracy Army Depot, California; and Tobyhanna Army Depot, Pennsylvania. TPE-Medical Reset is provided to units in theater in order to reduce equipping requirements for deploying units and to maintain continuity of care in support of operations. High utilization and harsh conditions result in increased maintenance requirements and accelerated wear-out rates. TPE-Medical is owned by theater and life-cycle managed by theater stakeholders in partnership with USAMEDCOM.

e. Army Medical Logistics Enterprise (AMLE). In 2009, TSG established the AMLE comprised of generating and operating force Medical Logistics (MEDLOG) organizations that work within a collaborative and networked framework to meet the medical logistics needs of the AHS in delivering medical support to the Army and/or JFC.

f. PO 171-003 reassigned all USAMRDC and the remaining medical logistics elements to the U.S. Army Medical Logistics Command (AMLC) under AMC with an IOC date of 1 June 2019, and an FOC date of 1 October 2019 in order to provide AMC a capability to manage and execute medical logistics globally in support of Army Operations. As a subordinate of AMC, the AMLC is integrated within the Army's primary logistics and sustainment command to capitalize on the expertise inherent within the command and create efficiencies that benefit Soldiers through effective resource management. Medical logistics remains functionally linked to the medical product development and program management process, to ensure fielded medical solutions are sustainable and affordable over their lifecycle.

### **17-18. SECARMY's Executive Agent Representative for DOD Executive Agencies**

a. Executive Agent (EA) representative. An EA is the Head of a DOD Component (e.g., SECARMY) to whom the SECDEF or the Deputy SECDEF (DEPSECDEF) has assigned specific responsibilities, functions, and authorities to provide defined levels of support for operational missions, or administrative or other designated activities that involve two or more of the DOD Components. The DOD EA may delegate, to a subordinate designee within that official's Component (e.g., TSG), the authority to act on that official's behalf for any or all of those EA, functions, and authorities assigned by the SECDEF or the DEPSECDEF. TSG is responsible for the following EAs:

- (1) Armed Services Blood Program Office.
- (2) Medical Research for Prevention, Mitigation, and Treatment of Blast Injuries.
- (3) Persian Gulf War Exposure Registry.
- (4) U.S. Army Medical Research Unit-Georgia (Lugar Center).

b. In addition to the DOD EAs embedded in AMEDD MSCs, TSG serves as the Lead Component (LC) or Support Agent representative for other essential joint medical agencies, to include:

- (1) Extremity Trauma & Amputee Center of Excellence.
- (2) Investigational New Drugs-Force Health Protection.
- (3) Accession Medical Standards Analysis and Research Activity.
- (4) Armed Forces Pest Management Board.
- (5) Civilian Employee Occupational Health and Medical Services Program.
- (6) Combat Dental Research.
- (7) DOD Nutrition Research Program.

## HOW THE ARMY RUNS

- (8) DOD/VA Clinical Practice Guidelines Development.
- (9) DOD Pharmacoeconomic Center.
- (10) Gulf War Illness Research Program.
- (11) MEPCOM-Medical.
- (12) Military Infectious Disease Research Program.
- (13) Multi-Drug Resistance Organism and Repository Surveillance Network.
- (14) Nutrition Standards and Education Program.
- (15) Peer Review Medical Research Program.

### Section V

#### Summary and References

##### 17-19. Summary

This chapter discussed the mission, organization, functions, and staff relationships of the AMEDD. The AHS encompasses all roles and/or levels of medical, dental, veterinary, and other related from the policy and decision-making level to the combat medic in the field. Health services within the Army are directed and monitored by TSG through USAMEDCOM and the OTSG. TRICARE has markedly altered the peacetime military health system and continues to evolve to ensure the provision of world class healthcare to all beneficiaries. The AHS continues to transform in order to meet the needs of the Army and the Nation.

##### 17-20. References

- a. Army Doctrine Publication (ADP) 3-37, Protection.
- b. ADP 3-0, Operations.
- c. ADP 4-0, Sustainment.
- d. Army Doctrine Reference Publication (ADRP) 3-0, Unified Land Operations.
- e. ADRP 3-37, Protection.
- f. ADRP 4-0, Sustainment.
- g. Army Medicine Campaign Plan 2018, dated 1 March 2018.
- h. Army Regulation (AR) 10-87, Organization and Functions Army Commands, Army Service Component Commands, and Direct Reporting Units.
- i. AR 40-1, Composition, Mission, and Functions of the Army Medical Department.
- j. AR 40-4, Army Medical Department Facilities/Activities.
- k. AR 40-61, Medical Logistics Policies.
- l. Army Tactics, Techniques, and Procedures 4-02, Army Health System.
- m. Call to Action: 43rd Surgeon General, United States Army, 2012.
- n. DOD Directive (DODD) 5101.1, DOD Executive Agencies.
- o. DODD 5136.1, (ASD (HA)).
- p. MEDCOM Memorandum 10-2, Organizations and Functions, Headquarters.
- q. MEDCOM/OTSG Regulation 10-32.
- r. MEDCOM Regulation 10-1, Organization and Functions Policy.
- s. U.S. Army Medical Department Website, [www.cs.amedd.army.mil](http://www.cs.amedd.army.mil).
- t. FM 4-02, Army Health, dated 26 August 2013.
- u. Military Treatment Facility Transition Communication Strategy (DRAFT), dated 26 July 2019.
- v. Military Reform Communication Strategy (DRAFT), dated 26 July 2019.

# CIVIL FUNCTIONS OF THE DEPARTMENT OF THE ARMY

*I am firmly convinced that, but for the existence of the Corps of Engineers peacetime organization and its resources of men, methods, training and supply and its close association with the military through the years, the history of the Pacific area in World War II would have been written more in blood than in achievement.*

*GEN Dwight D. Eisenhower, Chief of Staff, U.S. Army Testimony before the House Armed Services Committee on H.R. 3830, 1947*

## Chapter 18

### Civil Functions of the Department of the Army

#### Section I

#### Introduction

##### 18-1. Chapter Content

In addition to its military mission, the Department of the Army (DA) carries out an extensive program in support of the United States' economic development and environmental stewardship. This concept goes back to President Thomas Jefferson, who envisioned a force capable of conducting missions "of a civil nature" as well as military activities. In that spirit, he founded the U.S. Military Academy at West Point, with an engineering curriculum emphasis that continues to this day. The largest of the civilian-oriented missions is the Civil Works Program carried out by the U.S. Army Corps of Engineers (USACE) under the oversight of the Assistant Secretary of the Army (Civil Works) (ASA (CW)). This program primarily revolves around water resources, dating from the Army's earliest involvement in navigation improvement in 1824. Over the years, as the Army's expertise grew, Administrations and Congresses assigned other water-related missions - flood risk management, water supply, hydropower, recreation, aquatic ecosystem restoration, emergency management, and more. Today, Civil Works is a \$6 billion a year program, funded outside the Defense appropriation. This program provides a more than 12-to-1 return on investment, delivering \$89 billion a year in benefits to the Nation in the form of flood damages prevented, transportation through ports and inland waterways, low-priced and nonpolluting hydropower, recreational opportunities, water supply for cities and farms, etc. Although not familiar to many in the Army, the rangers at Corps of Engineers recreation areas come into contact with more members of the public than any other members of the DA. This chapter will describe civil functions definitions, authorizations, relationships, leaders, organizations, activities, research, and development (R&D), support to other government agencies, overseas activities, and support to combatant commanders (CCDRs).

##### 18-2. Civil Functions Defined

A number of non-military activities traditionally carried out by the DA are commonly referred to as civil functions. The most extensive of these is the Civil Works Program managed by the USACE. The Civil Works Program focuses on sustainable development, protection, and restoration of the Nation's water and related land resources. Civil Works projects are implemented and operated for commercial navigation, flood risk management, environmental remediation/restoration, hydroelectric power, recreation, and municipal and industrial water supply. Infrastructure built by the Corps over the years in support of the Civil Works mission has an estimated value today of about \$273 billion. Civil functions also include programs to regulate, by permit, dredging, construction, and similar activities in navigable waters of the United States and dredging and fill material discharge activities in waters of the United States, including many wetlands; preparedness activities for all types of natural disasters, and response and recovery activities; and engineering and construction support to non-defense-related activities of the federal government, states, local agencies, and USACE overseas activities not exclusively in support of U.S. forces.

## HOW THE ARMY RUNS

### 18-3. Leadership and Organization

a. ASA (CW). Through specific statutory provisions, General Orders from the Secretary of the Army (SECARMY), and internal DA regulations, the ASA (CW) has been assigned responsibilities for the civil functions. Congress established the position of the ASA (CW) in Section 211 of the Flood Control Act of 1970, Public Law (PL) 91-611, and reaffirmed it in Section 501 of the Goldwater-Nichols Department of Defense Reorganization Act of 1986, PL 99-433. The Goldwater-Nichols Act specifies that the ASA (CW) duties include overall supervision of DA programs for conservation and development of water resources, including flood risk management, navigation, environmental restoration and stewardship, and related purposes. The ASA(CW) reports directly to the SECARMY.

b. USACE. Most of the Army's civil functions are executed by USACE, an executive branch agency within DOD and a Major Command within the Army consisting of more than 800 military and 36,000 civilians. USACE is the world's largest public engineering, design, and construction management agency. USACE also provides real estate services; conducts research & development; and designs and builds military facilities for the Army, Air Force, other federal agencies, and foreign governments. Approximately 280 military personnel and 22,100 civilian employees in USACE are involved in civil functions.

c. The Chief of Engineers. The Chief of Engineers holds positions as both a principal Headquarters, Department of the Army (HQDA) Staff officer and as commander of the USACE. The Chief of Engineers, the Corps' Deputy Commanding General for Civil and Emergency Operations (DCG-CEO), and the civilian Director of Civil Works report to the ASA (CW) on the Civil Works Program.

d. Divisions and Districts. Under the Chief's command are nine divisions, eight of which have Civil Works missions. Under the divisions are 43 districts, 38 of which are within the United States. Division and district boundaries for the Civil Works Program within the Continental U.S. (CONUS) generally follow watersheds and drainage basins, as shown in Figure 18-1. These delineations reflect the water resources mission of USACE. Military Construction (MILCON) districts, on the other hand, generally follow State boundaries, and not all stateside districts have a MILCON mission.

e. Overseas Offices. USACE also includes a number of overseas offices with missions in construction in support of U.S. forces, assistance to other countries and international organizations, and support to other U.S. agencies.

(1) The Pacific Ocean Division, headquartered in Honolulu, Hawaii includes subordinate districts in Japan and Korea as well as Hawaii and Alaska.

(2) The North Atlantic Division includes the Europe District as well as five stateside districts.

(3) The Transatlantic Division, with headquarters in Winchester, Virginia includes one subordinate district in Afghanistan, and one responsible for USACE activities elsewhere in the Middle East and Africa.

(4) Mobile District's mission also includes support of U.S. Southern Command (USSOUTHCOM).

f. Other United States Army Corps of Engineers Organizations. There are several other organizations within the Corps of Engineers:

(1) The U.S. Army Engineer Research and Development Center (ERDC), headquartered in Vicksburg, Mississippi consists of seven laboratories. (See Paragraph 18-8.)

(2) The U.S. Army Engineering and Support Center, Huntsville, Alabama provides engineering and technical services, program and project management, construction management, and contracting initiatives for programs that are national or broad in scope or not normally provided by other Corps of Engineers elements. Huntsville is also USACE's major training center.

(3) The Institute for Water Resources, Civil Works Directorate, headquartered at Fort Belvoir, Virginia supports the Civil Works Directorate and Corps of Engineers commands by developing and applying new planning evaluation methods, polices and data in anticipation of changing water resources management conditions. Subordinate to the Institute are the Hydrologic Engineering Center in Davis, California are: the Waterborne Commerce Statistics Center in New Orleans, Louisiana; the Risk Management Centers in Lakewood, Colorado, Pittsburgh, Pennsylvania, and Louisville, Kentucky, and at Fort Belvoir, Virginia; the International Center for Integrated Water Resources Management; the Navigation and Civil Works Decision Support Center; and the Conflict Resolution and Public Participation Center of Expertise. The Institute also provides support to the Civil Works Directorate with the U.S. Section of the World Association for Waterborne Transport Infrastructure (PIANC-USA). PIANC USA works with members from 40 other nations to address policy, engineering and environmental issues for the advancement of waterborne transportation.



## CIVIL FUNCTIONS OF THE DEPARTMENT OF THE ARMY

(4) The USACE Finance Center, Millington, Tennessee provides operating finance and accounting functions throughout the Corps of Engineers.



Figure 18-1. Where We Are: U.S. Army Corps of Engineers

(5) The USACE Logistics Activity, Millington, Tennessee provides logistics support to the Corps including supply, maintenance, readiness, materiel, transportation, travel, aviation, facility management, integrated logistics support, management controls, and strategic planning.

(6) The Marine Design Center, Philadelphia, Pennsylvania provides planning, engineering, and shipbuilding contract management in support of Corps, Army, and national water resource projects in peacetime, and augments the military construction capacity in time of national emergency or mobilization.

(7) Humphreys Engineer Center Support Activity, Fort Belvoir, Virginia provides administrative and operational support for USACE Headquarters and various field offices.

(8) USACE's Enterprise Infrastructure Services (EIS) designs information technology standards for the Corps, including automation, communications, management, visual information, printing, records management, and information assurance. EIS outsources the maintenance of its Information Technology

## HOW THE ARMY RUNS

(IT) services, forming the Army Corps of Engineers Information Technology (ACE-IT). ACE-IT is made up of both civilian government employees and contractors.

(9) USACE's Deployable Tactical Operations System (DTOS) provides mobile mission command platforms in support of the quick ramp-up of initial emergency response missions for the Corps. DTOS is a system designed to respond to any district, division, national, and international events.

(10) The 249th Engineer Battalion (Prime Power) generates and distributes prime electrical power in support of warfighting, disaster relief, stability, and support operations as well as advice and technical assistance in all aspects of electrical power and distribution systems. It also maintains Army power generation and distribution war reserves.

(11) The 911th Engineer Company provides specialized technical search and rescue support for the National Capital Region. It is also a vital support member of the Joint Force Headquarters National Capital Region, which is charged with the homeland security of the United States Capital Region.

(12) The 412th Theater Engineer Command (TEC) is headquartered in Vicksburg, Mississippi.

(13) The 416th TEC is headquartered in Darien, Illinois. The 412th and 416th TECs are operational & functional commands of the U.S. Army Reserve, providing trained, ready, and available Soldiers in support of the Army's mission at home and abroad. On order, the two-star command conducts theater-level engineer operations in support of U.S. Army Pacific; U.S. Army Europe; U.S. Army Africa; and Eighth U.S. Army, Korea.

### 18-4. Relationship to Warfighting Competencies

The civil functions complement and augment the Army's warfighting competencies, providing the capability to respond to a variety of situations across the spectrum of conflict by maintaining a trained and ready engineer force at virtually no additional expense to the DOD military budget and at minimum expense to personnel allocations. More than 10,000 Corps of Engineers employees in jobs funded by the Civil Works Program have deployed for short tours in Iraq, Afghanistan, and other overseas areas. Expertise resident in the Civil Works program is also made available through USACE's "Reachback" programs, which link CCDRs with subject matter experts within the government, private industry, and academia to obtain engineering solutions to complex problems.

### 18-5. Private Sector Capabilities and Partnerships

The partnership between the USACE and the private sector represents a force multiplier of several hundred thousand architects, engineers, and builders, ready to support the Nation in times of emergency. The private sector is an essential element of the Civil Works team. Private construction firms carry out practically all construction work, employing about 300,000 people at any time on Corps activities. USACE also employs private architectural, engineering, and construction firms for over half of its design work. In Fiscal Year (FY) 2013, the USACE let about \$4.86 billion in contracts for Civil Works activities. Of this amount, \$1.77 billion (36.3 percent) went to small businesses, including \$676 million (13.8 percent) to small disadvantaged firms.

## Section II Civil Works Program

### 18-6. Authorization, Congressional Oversight, and Funding

Although they differ from other Army programs in financing and oversight, the civil functions are an integral part of the overall mission of the Army and the service it provides to the Nation. Financial and personnel resources associated with the Civil Works Program are principally authorized under Water Resources Development Acts (WRDAs) and funded separately by annual Energy and Water Development Appropriations Acts, not the Defense appropriation. Program funding under these acts is approximately \$7 billion a year. These funds are used for studies of water resources problems in the Federal interest where Civil Works projects might be appropriate, design and construction of projects authorized and funded by Congress, operation and maintenance of completed projects, and funds for emergency management, regulatory activities in waters of the U.S., the Formerly Utilized Sites Remedial Action Program (FUSRAP) for former nuclear sites, and headquarters and division expenses. Additional funds may be provided through Supplemental Appropriation Acts. For example, in FY 2018 congress provided \$17.4B in supplemental funding for disaster relief and recovery activities. The WRDA of 1986

## CIVIL FUNCTIONS OF THE DEPARTMENT OF THE ARMY

and subsequent WRDAs also require increased cost-sharing contributions from state and local government project sponsors for most Civil Works activities; these contributions typically come to about \$753 million a year. USACE support activities for other, non-defense agencies are reimbursed by those agencies - to include emergency response activities funded by the Federal Emergency Management Agency (FEMA). Congressional committees like the Subcommittee on Water Resources and Environment of the House Transportation and Infrastructure Committee or the Subcommittee on Transportation and Infrastructure of the Senate Environment and Public Works Committee provide legislative oversight and authorizing legislation, while the Energy and Water Development Subcommittees of the House and Senate Appropriations Committees provide funding.

### 18-7. Civil Works Program Activities

a. The Program. The Civil Works Program provides nationwide development and management of water and related land resources, including the planning, design, construction, rehabilitation, operation and maintenance of flood risk management (to include coastal storm risk), navigation, ecosystem and other environmental restoration, and multiple-purpose water resource projects. The Civil Works Planning function is the foundation of the overall program in the development and authorization of new water resources projects. In addition to the project purposes listed above, completed Corps projects may include hydroelectric power, water supply, recreation, and natural and cultural resource management. Collectively, they include approximately 12 million acres (18,800 square miles) of land and water. In addition to this direct federal investment program, the Civil Works Program includes an important regulatory mission in which the Corps regulates construction in navigable waters under the Rivers and Harbors Act of 1899. The Corps also regulates the deposit of dredged and fill material in waters of the United States, including many wetlands, under the Clean Water Act of 1972. In addition, the Civil Works Program includes emergency flood fighting, recovery operations, and repair and restoration of flood control works -- all performed under the USACE's own authority as specified in Public Law 84-99 (PL 84-99, Section 5 of the Flood Control Act of 1941). USACE also carries out DOD's responsibilities under the National Response Framework (NRF) (see Chap 20) as the lead planning and operating agent for public works and engineering (Emergency Support Function #3) (see Chapter 20), in support of the FEMA and other federal agencies.

#### b. Economic Infrastructure.

(1) USACE has been the Nation's major contributor to the development, construction, and maintenance of a sound water resources infrastructure since its first navigation project was undertaken in 1824. Commercial navigation and flood risk management are long-standing missions of the Civil Works Program. Coastal storm risk is part of the overall flood risk program. The navigation function includes improvement and maintenance of harbors handling all of the Nation's seaborne commerce and that of the Great Reservoirs. With funds from the Harbor Maintenance Trust Fund, USACE maintains navigability in 186 harbors handling more than 250,000 tons of cargo per year, and 881 smaller harbors. With more than 15 million American jobs dependent on U.S. import and export trade, the Nation's commercial ports are vital to the economic security of the United States. USACE has built an intracoastal and inland commercial waterway network of 12,000 miles, and operates 239 lock chambers at 193 sites. Major improvements to inland waterway facilities are financed in part by the Inland Waterway Trust Fund. More than 600 million tons of commerce moves every year on these waterways – at half the cost per ton-mile of transportation by rail, and 1/10 the cost of transportation by truck. Maintaining the system of ports and inland waterways involves removing more than 185 million cubic yards of dredged material each year.

Major segments of this network include:

- (a) The Lower Mississippi River (1,015 miles).
- (b) The Upper Mississippi River (936 miles).
- (c) The Ohio River (981 miles).
- (d) The Tennessee River (785 miles).
- (e) The Missouri River (735 miles).
- (f) The Arkansas and White Rivers (706 miles).
- (g) The Columbia-Snake River System (468 miles).
- (h) The South Atlantic Coast (1,111 miles).
- (i) The Gulf Intracoastal Waterway (GIWW)-West (Brownsville, Texas to St. Marks, Florida) (1,501 miles).
- (j) GIWW-East (Clearwater to Fort Myers, Florida) (431 miles).

## HOW THE ARMY RUNS

(2) USACE shares with the U.S. Department of Homeland Security's (DHS) FEMA both the expertise and mandate to address the Nation's vulnerabilities to flood related disasters and damages. USACE has been involved in flood risk management activities, largely on the Ohio and Mississippi Rivers, since the 19th Century. This involvement was ramped up with the Mississippi River and Tributaries Flood Control Project in 1928, in the aftermath of widespread flooding in the Mississippi Basin the year before. The Flood Control Act of 1936 established a nationwide federal role in flood risk management, and since then USACE's responsibilities have expanded to include structural and non-structural solutions to managing flood risks, inspecting the condition of existing flood risk management infrastructure, technical and planning support to States and communities, advance emergency measures to alleviate impending flooding, and rehabilitating levees and other flood risk management infrastructure damaged by flooding. The Nation's investment in flood risk management has prevented almost nine dollars in flood damage reduction for each dollar invested, even after adjusting for inflation. This represents a tremendous return on investment for taxpayers and businesses. In 2012, the USACE completed reconstruction of the New Orleans Hurricane and Storm Damage Risk Reduction System (HSDRRS) to the "100 year" level of protection (able to withstand a storm with a one percent chance of happening in a given year). HSDRRS was highly successful in preventing damage and loss of life during Hurricane Isaac in August 2012 – the \$14.7 billion spent to build system prevented about \$90 billion in damages – a 6 to 1 return on investment in the first year. Flood risk management efforts range from small, local protection projects to large dams. Prior to the WRDA of 1986, the partner provided land, easements, rights-of-way, relocation, and disposal areas. Since the passage of the WRDA of 1986, most of these projects have been constructed as joint ventures between the federal government and non-federal sponsors. USACE operates and maintains most of its dams, but most other projects, once built, including about 14,700 miles of levees in USACE's Levee Safety Program, are operated and maintained by local sponsors.

(3) USACE can provide flood management assistance through a wide variety of authorities and programs. For example, through its Flood Plain Management Services Program (FPMS), USACE can provide information, technical assistance and planning guidance (paid for by the federal government) to States and local communities to help them address flood risk management issues. Typical focus areas are flood hazard evaluation, flood warning preparedness, flood plain management, and much more. In cases where the risk of flooding is imminent in a specific area, USACE is authorized to take immediate advance measures to protect life and property, such as temporary flow restriction structures and removing log debris blockages. The responsibility for managing the Nation's flood risks, however, does not lie exclusively with federal agencies such as USACE and FEMA. Rather, it is shared across multiple federal, State, tribal, and local government agencies with a complex set of programs and authorities, including private citizens and private enterprises such as banking and insurance firms and developers. Both, USACE and FEMA have programs to assist states and communities reduce flood damages and promote sound flood risk management. However, the authority to determine how land is used within floodplains and enforce flood-wise requirements is entirely the responsibility of State and local government. Floodplain management choices made by state and local officials can impact the effectiveness of federal programs to mitigate flood risk and the performance of federal flood risk reduction projects. However, the federal investment is protected by the execution of agreements between federal and non-federal partners. For example, the Silver Jacket Programs team local, state, and federal personnel to review and reduce the risk of flooding by capitalizing on the knowledge and expertise of each member.

(4) In November 2007, the Corps established a Levee Safety Program, an important step to ensure the public is aware of the risks associated with levees in USACE programs. The mission is to assess the integrity and viability of levee systems and recommend actions to ensure these systems do not pose unacceptable risks. The main objectives are to hold public safety paramount, reduce adverse economic impacts, and develop reliable and accurate information. Within the program, a National Levee Database has been created to facilitate and link activities which include flood risk communication, levee certification, levee inspection, floodplain management, and risk assessments. The database presently includes levees within a USACE program or FEMA's National Flood Insurance Program (NFIP). The WRDA of 2007 extended USACE authority and allows the inclusion of all nonfederal levees on a voluntary basis. A methodology for technical risk assessments of existing levee infrastructure is being used to evaluate levees nationally. Additional activities within this program include national teams to develop new policies concerning levee safety, such as inspections of existing levee systems, verification or establishment of existing geodetic control, minimum standards for new levee systems and interim risk reduction measures. Key policy issues in which close collaboration between USACE, FEMA, and other stakeholders is

## CIVIL FUNCTIONS OF THE DEPARTMENT OF THE ARMY

necessary relate include mapping the flood hazard, inspection and assessment of levees, operation and maintenance of levees, and emergency response and evacuations.

(5) USACE operates 75 power plants, which represent almost one fourth of the Nation's hydroelectric capacity or two percent of the Nation's total electric power generating capacity. Dams built by the USACE provide storage for municipal (including drinking water) and industrial water supply, irrigation, and fish and wildlife habitat. Additionally, 402 of the 716 dams (mostly reservoirs) are developed for recreational use. These projects accommodate nearly 250 million visits a year. USACE estimates that one in ten Americans visit a civil works project at least once a year. Visitors to these recreation areas generate 189,000 private and public sector jobs. USACE is one of the Nation's largest provider of outdoor recreation, hosting fifteen percent of visits to federal recreation areas on two percent of federal land.

(6) The transportation infrastructure developed in the Civil Works Program plays a role in national defense. Ports and waterways maintained by USACE serve the Navy and Coast Guard, and are vital logistics links when large volumes of materiel and personnel must be moved around the country and around the world. USACE works with the Surface Deployment and Distribution Command (SDDC) and local port authorities to ensure that ports are ready to support movement of military equipment and supplies when needed. This partnership was especially effective in moving nearly all the Army's equipment and supplies necessary for Operations Enduring Freedom and Iraqi Freedom. Waterways built and operated and maintained by the USACE similarly have direct military uses for strategic mobility. Units of the Texas, Oklahoma, and Arkansas National Guard have conducted successful movements over the Arkansas, Mississippi, and Illinois Rivers to their summer training sites, and the 101st Air Assault Division has conducted movements by waterway from Fort Campbell, Kentucky, to Louisiana saving weeks of rail travel and \$1M. USACE flood risk management projects also contribute to force projection by protecting important highway and railway links. Thus, through activities as diverse as facilitating the movement of materiel to protecting vital infrastructure, the Civil Works Program contributes to National security.

### c. The Environment.

(1) Project Activities. The Civil Works Program makes important contributions to the Nation's environmental goals by constructing projects for restoration of ecosystems. The objective of ecosystem restoration is to restore degraded ecosystem structure, function, and dynamic processes to a less degraded. Among the largest such projects underway (and amount funded in FY 2019) were South Florida Ecosystem Restoration (\$105 million), Columbia River Fish Mitigation (\$46 million), Poplar Island, MD (\$21 million), Upper Mississippi River Restoration (\$33 million), Missouri River Fish and Wildlife Recovery (\$30 million), and Mud Mountain Dam, WA (\$84 million). Much of this work proceeds in partnership with other federal and state agencies or recognized Native American tribes, Alaska Natives, and local communities. In 2002, the Corps entered into a partnership with The Nature Conservancy, the Sustainable Rivers Program, to improve the management of rivers under Corps management for restoration purposes while maintaining the projects' authorized purposes. Lastly, the Corps has agreements with the National Fish and Wildlife Federation, the National Audubon Society, and Ducks Unlimited to advance restoration of important ecological resources.

### (2) Project Authorities.

(a) The WRDA of 1990 established environmental restoration and protection as one of the primary missions in the planning, design, construction, operation, and maintenance of water resources projects – equivalent to navigation and flood risk management. This new direction stimulated the Corps and its non-federal project sponsors to plan and implement new projects with environmental restoration as a primary project purpose.

(b) Like other major Corps projects, Congress must authorize large restoration projects. In one of the largest environmental restoration and protection projects ever undertaken, the Departments of the Army and the Interior have been cooperating with the State of Florida to restore the hydrologic regime of the Everglades in South Florida. Congress approved the Corps' Comprehensive Everglades Restoration Plan in Title VI of the WRDA of 2000, PL 106-541. The first feasibility study for a component of this project requiring specific authorization was completed in 2002.

I The Corps and the State of Louisiana are working together to restore and protect that State's shrinking coastal wetlands and stem an ongoing loss of 25 to 35 square miles per year. This ecosystem is vital to the Nation's environmental health for naturally filtering out water pollution and for providing critical winter habitat for 70 percent of the Nation's waterfowl. This ecosystem is also vital to the Nation's

## HOW THE ARMY RUNS

economy as the home of a major seafood industry. The wetlands and barrier islands also protect inland urban, industrial, and agricultural areas – including New Orleans and dozens of other communities that are home to a culture unique in America – from hurricanes and coastal storms. Work in Coastal Louisiana took on added urgency after Hurricane Katrina focused national attention on the role of coastal wetlands in attenuating storm surge and wave action.

(d) In addition to specifically authorized projects such as the Everglades and Coastal Louisiana restoration projects described above, environmental restoration is accomplished through three programmatic authorities for small projects. Under Section 1135 of the WRDA of 1986 (PL 99-662), the USACE is authorized to modify projects it constructed earlier in the interest of making them “greener.” Section 1135 also authorizes the USACE to accomplish environmental restoration when the original Corps project contributed to environmental loss. Section 204 of the WRDA of 1992 provided authority for beneficial uses of dredged material. This authority allows the USACE to use material from the dredging of navigation projects for environmental restoration. The third authority is Section 206 of the WRDA of 1996. This provision establishes a program for Aquatic Ecosystem Restoration under which small projects may be constructed with no link to an existing Corps project required. Working toward a national goal of “no net loss of wetlands,” the Civil Works Program is undertaking projects to restore existing wetlands and create new ones.

### (3) Regulatory Program.

(a) The USACE’s regulatory program has a long history of protecting the Nation’s waters. The Rivers and Harbors Act of 1899 authorizes the USACE to regulate, by permit, structures and/or work, including dredging and filling activities, in navigable waters of the United States. A principal objective of this program is to ensure that the navigable capacity of waterways is maintained for commercial and recreational navigation users. Over time, the Corps’ “public interest review” has become an important part of the decision process used by Corps district commanders in issuing, issuing with conditions, or denying permit applications.

(b) In 1972, Section 404 of the Clean Water Act authorized USACE to regulate, by permit, dredging and fill material discharge activities in waters of the United States, including many wetlands. This Act expanded the Corps’ regulatory responsibilities beyond those in the Rivers and Harbors Act of 1899 to all waters of the United States. Also, other environmental laws that were enacted in the late 1960s and early 1970s, including the National Environmental Policy Act, the Endangered Species Act and the National Historic Preservation Act, require federal decision makers to consider and take responsibility for the effects of their actions.

I Section 103 of the Marine Protection, Research and Sanctuaries Act of 1972, as amended, authorizes the USACE to issue permits for the transportation of dredged material for ocean disposal. In its determination, the Corps ensures that the dumping will not unreasonably degrade or endanger human health, welfare, or amenities, or the marine environment, ecological system, or economic potentialities.

(d) Rulings of the Supreme Court, including its Solid Waste Agency of Northern Cook County (SWANCC) decision in 2001 and the Rapanos decision in 2006 have concluded that USACE regulatory jurisdiction does not extend to all waters. These decisions have resulted in challenges to determining the limits of waters of the United States that are subject to the Corps Clean Water Act regulation, including the need to determine if particular waters have a significant nexus to traditional navigable waters. In 2015, the Environmental Protection Agency and USACE issued a new “Waters of the United States” regulation, specifying which bodies of water were and weren’t covered under Sec. 404 of the Clean Water Act. However, this regulation was never implemented, and in February 2017 President Trump ordered a review of the regulation. The tension between federal and state authority is a constant factor in the unique mission set that the Corps executes.

I Permit decisions are made in the regulatory program by evaluating the effects of activities within the Corps control and evaluating benefits and detriments of the proposal on the public interest. The evaluation process promotes the balancing of environmental protection with responsible economic growth. In FY 2016, the Corps worked with project proponents to evaluate tens of thousands of activities in the Nation’s waterways and wetlands, coordinating and consulting with other agencies, tribes and the public in many cases. A total of nearly 55,000 nationwide or regional general permit verifications were completed for activities in waters with minimal effects. For those projects that required individual permit (IP) evaluation because they did not meet the terms and conditions of any general permit, the Corps issued Ips for 3,200 activities, including special conditions as necessary, and denied permits for 87 activities.

## CIVIL FUNCTIONS OF THE DEPARTMENT OF THE ARMY

(4) Stewardship. The Corps is steward for about 12 million acres (18,831 square miles) of land and water in 42 States. Conservation of forests, range wildlife habitat, fisheries, and soils involves multiple uses of resources and sound ecosystem management principles. The USACE accomplishes this through a mix of its own management capabilities, partnerships with State and local governments, volunteers, and working agreements with a wide range of interest groups.

(5) Compliance. The Corps conducts compliance assessments at all of its projects on a five-year cycle through the environmental compliance assessment program. The Environmental Review Guide for Operations (ERGO), the tool used to conduct assessments, is a checklist containing federal and state environmental statutes and USACE requirements. Project and facility managers, as well as external organizations, use ERGO to systematically locate and correct environmental deficiencies.

(6) Nonstructural Flood Risk Management. In recent years the Corps has placed an increasing emphasis on nonstructural approaches to flood management. Nonstructural alternatives focus on addressing development in the floodplain. Alternatives include floodplain zoning, participating in the National Flood Insurance Program (NFIP), developing and implementing flood warning systems (coordinated with the National Oceanic and Atmospheric Administration's flood warning program) and emergency evacuation plans, and flood proofing individual structures as well as removing structures from extreme flood hazard areas.

(7) Civil Environmental Activities' Relationship to Army Missions. Environmental activities in the Civil Works Program are essential elements of the Army's Environmental Strategy for the 21st Century. People who learn their specialties in Civil Works missions that concern natural and cultural resources, water quality, flood plain management or hazardous waste management help the Army go "beyond compliance" to take on a leadership role in natural resources stewardship. Civil Works expertise helped the Army develop such tools as the Environmental Compliance Assessment System (ECAS) and Integrated Training Area Management (ITAM). The Civil Works Program is responsible for about half the Army's land holdings and is familiar with balancing preservation of the natural environment with human use – a major issue facing the Army. This program is also the Army's reservoir of cultural resources expertise, which the Army has used on several priority missions.

### d. Emergency Preparedness and Disaster Response.

(1) The USACE responds to the Nation's needs in case of natural or man-made disasters and emergencies. The USACE programs provide a wide variety of assistance to protect human life and improved property, reduce human suffering, help communities recover from the effects of disasters, and mitigate damage and future threats. Response and recovery activities supplement State and local efforts. When disasters occur, USACE teams and other resources are mobilized from across the country to assist USACE local districts and offices to deliver response missions. USACE has more than 50 specially-trained response teams supported by emergency contracts to perform a wide range of public works and engineering-related support missions. USACE uses pre-awarded contracts that can be quickly activated for missions such as debris removal, temporary roofing, and generator installation. Every year, USACE, as part of the federal government's unified national response to disasters and emergencies, deploys hundreds of people to provide technical engineering expertise and to promote capacity development at home and abroad. In 2018, USACE had 2,125 personnel deployments in response to one or more of 52 disaster events.

(2) Under PL 84-99, the USACE undertakes planning and preparedness activities for all types of natural disasters and provides response and recovery activities necessitated by floods and coastal storms. The Flood Control and Coastal Emergencies (FCCE) appropriation funds all PL 84-99 activities. Included in these preparedness and response efforts are: disaster preparedness measures; advance measures to alleviate high potential flood threats; flood fighting activities; preservation of threatened federally-constructed shore protection projects; and life-saving rescue operations.

(3) Recovery and mitigation measures include repair and rehabilitation of damaged flood control works and shore protection projects or nonstructural projects. PL 84-99 also authorizes the USACE to provide emergency supplies of clean water to localities whose water source has been contaminated, and to drought-affected areas. In addition, the USACE is authorized to provide essential services and restore essential public infrastructure for a period of up to 10 days in any area victimized by a natural disaster for which the Governor of a State has requested federal assistance under the Stafford Act authority.

(4) Under the Robert T. Stafford Disaster Relief and Emergency Assistance Act (42 USC 5121 et seq.), FEMA, under the DHS, has developed the National Response Framework (NRF), which coordinates the execution of response and recovery operations of the 28 federal signatory departments

## HOW THE ARMY RUNS

and agencies. USACE uses its engineering expertise and its response and recovery capabilities to carry out DOD's responsibilities under the NRF. DOD has delegated its responsibility for Emergency Support Function (ESF) #3, Public Works and Engineering, to the USACE.

(5) As the lead DOD (and federal) agency for ESF #3, the USACE has a number of standing missions, to include provision of emergency power, debris removal, temporary housing, and temporary roofing. Other missions in the Public Works and Engineering area are assigned by the FEMA to the USACE as needed. All of these missions are tailored to the needs of and coordinated with the impacted state or territory. FEMA funds all of these missions under a reimbursable agreement with an approved mission assignment. Each mission assignment is based on the capabilities of the USACE, including its significant and responsive contracting capability. The Joint Staff, J-3, Joint Directorate of Military Support (JDOMS), coordinates DOD requirements outside of ESF #3 missions.

e. Homeland Security. The Corps has developed in-depth anti-terrorism/protection warfighting function expertise, including many skilled engineers with experience on Khobar Towers in Saudi Arabia, the Murrah Federal Building in Oklahoma City, Oklahoma, the World Trade Center in New York City, New York, the Pentagon, Washington, District of Columbia, and other sites. It leverages that expertise to protect critical water resources infrastructure from terrorists. Over past few years the Corps has been working with other agencies, including the Bureau of Reclamation, Department of Energy, TVA, EPA, and FBI to develop comprehensive security assessment processes to identify risks to critical facilities such as locks, dams and hydropower facilities

### 18-8. Research and Development

a. The Engineer Research and Development Center (ERDC) is the Corps' premier research organization, solving the toughest challenges faced by the Nation and the military today. Its unmatched force protection technologies save lives, both Soldiers and Civilians, overseas and at home. ERDC innovations allow USACE forces to quickly deploy anywhere in the world for military and humanitarian missions. ERDC solutions help USACE Soldiers move faster, stay safer, and dominate the battlefields of today and tomorrow. Advanced R&D also addresses national environmental and water problems that affect the Nation's lives in flood control, threatened and endangered species, contaminants, navigation, infrastructure, hurricane and storm protection, and other diverse areas. Unique, world-class equipment and facilities, ranging from the world's fastest supercomputers to one-of-a-kind physical models, give USACE R&D an innovative edge. ERDC's biggest strength is its people—internationally recognized engineers, scientists, physicists, mathematicians, technicians, and support personnel (2,500 strong) – all helping to make the world a safer and better place through innovative solutions to solve the Nation's toughest challenges.

b. The Army Corps of Engineers Civil Works Program pursues an R&D effort to take advantage of rapidly developing technologies and techniques that will promote significant monetary savings and greater reliability, safety, enhanced efficiency and environmental sustainability of its civil works activities. The R&D program is formulated to support each of the assigned Civil Works missions and their supporting core of technical competencies, environmental restoration and stewardship, economics and decision support, cold regions engineering and dredged sediment management. Technology infusion is pursued, in conjunction with Regional Business Centers USACE Divisions and established Centers of Expertise as part of the overall efforts to maintain a trained and ready engineering force capable of responding to a wide range of contingency situations.

c. The Corps conducts Civil Works-related R&D through its Engineer Research & Development Center (ERDC) and its Institute for Water Resources (IWR). The ERDC is headquartered at the Waterways Experiment Station facility, Vicksburg, Mississippi. It consists of seven individual research laboratories:

- (1) Coastal and Hydraulics Laboratory, Vicksburg, Mississippi.
- (2) Cold Regions Research and Engineering Laboratory, Hanover, New Hampshire.
- (3) Construction Engineering Research Laboratory, Champaign, Illinois.
- (4) Information Technologies Laboratory, Vicksburg, Mississippi.
- (5) Geospatial Research Laboratory, Alexandria, Virginia.

d. The IWR, headquartered at Fort Belvoir, Virginia, provides economic and decision support-related R&D support. Its Hydrologic Engineering Center is located in Davis, California.



# CIVIL FUNCTIONS OF THE DEPARTMENT OF THE ARMY

## Section III Support to Other Government Agencies

### 18-9. Overview

The USACE provides engineering and construction support to about 70 non-DOD federal agencies, plus numerous States, local, tribal and foreign governments under the Interagency and International Services (IIS) Program. Funds for this program are provided by the agencies receiving support. USACE IIS includes support to the DHS by managing the design and construction of border control and detention facilities for the Customs and Border Protection Agency and emergency management assistance to the Federal Emergency Management Assistance Agency, construction of facilities for the State Department, and renovation of health care facilities for the Department of Veterans Affairs. The USACE also supports programs and projects of other federal agencies designed to meet important national environmental objectives. These include the Superfund Program of the U.S. Environmental Protection Agency (EPA). These support activities in support of the Nation's domestic stakeholders totaled \$1.04 billion in expenditures in FY16, an increase of \$381M from FY15. Some key domestic stakeholders in terms of overall program execution include the Department of Veterans Affairs (\$311M), U.S. Customs and Border Protection (\$86M), National Aeronautics and Space Administration (\$63M), Department of Energy (\$34M), Federal Emergency Management Agency (\$34M), Department of Interior (\$30M), U.S. Agency for International Development (\$12M), Millennium Challenge Corporation (\$7M), and the Department of State DoS (\$5M).

### 18-10. Agencies Supported

a. Department of Energy (DOE): In FY16, USACE signed new five-year Memorandum of Agreements (MOA) with the National Nuclear Security Administration (NNSA), the DoE Office of Environmental Management, and the DOE Office of Project Assessments. In addition, USACE and NNSA signed an Enterprise Program Management Plan that provides the framework for supporting NNSA's design and construction program.

b. United States Agency for International Development (USAID). Significant FY16 accomplishments include continued technical assistance and capacity development for water resource management in Pakistan, assessment of the USAID water reservoir program in Honduras to reduce the impact of drought, continued construction of cyclone shelters and other infrastructure in Bangladesh.

c. Department of State (DoS). In FY16, in support of the U.S. Embassy Baghdad Chief of Mission, USACE and the Government of Iraq (GOI) signed a new agreement under the Foreign Assistance Act to serve as the GOI's Engineer and provide construction oversight of a contract to perform grouting operations for Mosul Dam. Work was completed by in June 2019. Under an FY15 agreement, a USACE advisor was assigned to the Embassy Baghdad and continues to provide support to DoS on Mosul Dam related matters. The Corps also continued leveraging its extensive knowledge of river basin management, disaster preparedness and response, and collaborative planning to support the Department of State's Lower Mekong Initiative (LMI) to enhance regional cooperation and sustainable development in the Mekong region of Southeast Asia.

d. Department of Interior (DOI). USACE and DOI signed a new MOA covering the full range of support that USACE provides to DOI. The new agreement replaces separate MOAs with each of the DOI Bureaus and agencies.

e. Millennium Challenge Corporation (MCC): USACE signed three new interagency agreements for engineering and environmental services projects to support the MCC mission. Additionally, four existing interagency agreements were extended to continue to provide assistance in several countries in Africa as well as in Jordan and the Philippines.

f. Nuclear Regulatory Commission (NRC). An Interagency Agreement was signed with the NRC in FY13 to provide technical expertise in assessing flood risk to downstream nuclear power plants from USACE and other dams. The work is part of flood hazard reevaluations required by NRC following the 2011 accident at the Fukushima Dai-ichi nuclear power plant in Japan. Eight different USACE districts have performed flood hazard analyses for 10 different nuclear power plants. The final analysis was completed in September 2016, and USACE is now providing follow up support to NRC as they review submittals from their nuclear power plant licensees.

g. Department of Veterans Affairs (DVA): USACE's partnership with the Department of Veteran's Affairs resulted in formal agreements for design and construction oversight of fourteen Major Medical

## HOW THE ARMY RUNS

Facilities in eight states valued at approximately \$6B. In FY16, USACE and DVA's Office of Construction and Facilities Management jointly developed an Enterprise Program Management Plan (EpgMP) as a framework for program execution. A Program Management Office (PMO) was established in the IIS Division and staffed with two full-time Program Managers. Future PMO staffing will include additional dedicated Engineering and Construction Division personnel and dedicated positions at USACE Division with DVA medical construction projects.

h. Customs and Border Protection (CBP): USACE has a long-established relationship with U.S. Customs and Border Protection, including supporting the completion of the border fence with real estate acquisition, environmental services, design, construction, maintenance, repair and replacement supporting the execution of Secure Fence Act mandates in 2006-2008. USACE currently provides programmatic support to Customs and Border Protection in their mission to construct a physical wall along the southern border in accordance with the Executive Order for Border Security and Immigration Enforcement Improvement. USACE accepted the mission to support the DHS Border Infrastructure Program. USACE is planning, designing, acquiring, and constructing border protection measures along the southern border of the U.S. from California to Texas in support of the Department of Homeland Security, U.S. Customs and Border Protection's (CBP) efforts to implement Executive Order: Border Security and Immigration Enforcement Improvements dated 25 January 2017 (EO 13767) for the purpose of achieving complete operational control of the border.

This program anticipates \$18B of border infrastructure construction, using both Design-Build (DB) and Design-Bid-Build (DBB) commercial construction delivery methods. Requirements include a mix of steel bollard wall, concrete wall, levee-wall, gates, patrol roads, access roads, lights, drainage improvements, and other related construction, repairs, and alterations.

i. Task Force Southwest Border led by the Commander, Southwestern Division, in partnership with the Commander, South Pacific Division leverages USACE enterprise-wide expert planning, engineering, construction, and real estate support to execute this border infrastructure program. Headquarters USACE, led by the Chief, International and Interagency Services provides enterprise-level executive coordination with the Office of the Commissioner, CBP and Office of the Secretary, DHS.

j. A Border Infrastructure – Program Management Office (BI-PMO) has been established in the Fort Worth District in Texas that reports directly to the Commander and CBP Program Executive, Southwest Division to synchronize delivery of the program with the CBP Program Management Office and executing USACE Districts. The desired outcome is USACE delivery of border infrastructure projects on-time and within budget to permit CBP to achieve complete operational control of the southern border and to further strengthen the existing USACE / CBP interagency partnership.

k. Funding for initial USACE planning was provided in FY17. The FY17 appropriation of \$415M provides funding for construction of 20 miles of primary fence replacement (\$290M), 35 gates in the existing Rio Grande Valley fence (\$49M), and patrol roads (\$76M). The FY18 appropriation of \$1.375B provides funding for construction of levee-wall and steel bollard wall in the Rio Grande Valley (\$641M), secondary steel bollard wall in San Diego (\$251M), primary fence replacement (\$445M), and out-year project planning (\$38M). At the time of this writing, it is unclear exactly how the recent Emergency Declaration and reprogramming of MILCON resources will affect funding to CBP support in future years.

### Section IV Engineer Overseas Activities

#### 18-11. Overview

The USACE conducts a broad range of foreign activities. Many are exclusively in support of U.S. forces overseas, but others are considered part of the civil functions of the Army. In coordination with the of Strategy Office, Plans, & Policy (Army G3/5/7), the ASA(CW) provides program direction to the foreign activities of the Corps, except those which are exclusively in support of U.S. military forces overseas. In FY 2018, the Corps supported U.S. foreign policy in more than 100 countries. The largest of the Corps overseas programs was in Afghanistan, where USACE was involved in the construction of roads and other civilian infrastructure as well as facilities for the new Afghan Army. USACE support overseas includes Humanitarian Assistance (HA) projects (schools, clinics, water wells, etc.) for the Combatant Commands (CCMD), assisting the Millennium Challenge Corporation with major infrastructure projects and support to the U.S. Agency for International Development. The USACE also supports U.S. objectives

## CIVIL FUNCTIONS OF THE DEPARTMENT OF THE ARMY

by using its water resources expertise for capacity development for developing nations. Examples of this activity include technical advice and consensus building for the Mekong River Commission and strategic water resources engagement with the Brazilian Army Engineers.

### **18-12. Foreign Military Sales**

As the DOD Construction Agent in many parts of the world, the Corps provides international security assistance to eligible foreign nations as an instrument of the National Security Strategy (NSS) and DOD Policy. Under the authorities of the FMS Program, the Corps provides reimbursable design and construction services for defense infrastructure to eligible foreign nations as approved by the Deputy Assistant Secretary of the Army (Defense Exports and Cooperation) (DASA(DEC)) and authorized by the Defense Security Cooperation Agency (DSCA). USACE continues to effectively support current partners while establishing new relationships by developing cases in countries throughout the globe, including Korea, Paraguay, Maldives, Guatemala and Ukraine.

a. U.S. Central Command (CENTCOM): 71 active cases with a total program value of \$2.5B. USACE's projects in the region include support facilities to the Qatar Apache helicopter and Patriot defense program.

b. U.S. European Command (EUCOM): 58 active cases with a total program value of \$1B. USACE's North Atlantic Treaty Organization (NATO) SHAPE school renovation is one USACE's most important projects within the region.

c. U.S. Indo-Pacific Command (INDOPACOM): Four active cases with a total program value of \$315M. The C-17 India case continues to be USACE's largest FMS effort in the INDOPACOM region

d. U.S. Africa Command (AFRICOM): 18 active cases with a total program value of \$16.5M. Typically warehouses, vehicle maintenance, and hangars are provided under the 1206/2282 Building Partner Capacity Program.

e. U.S. Northern Command (NORTHCOM): One active case with a total program value of \$10M. USACE's core competencies are used in the program, including USACE's geospatial technical expertise for USACE's C4ISR case in Canada.

f. U.S. Southern Command (SOUTHCOM): Three active cases with a total program value of \$16.2M. USACE is involved in facilitating enhanced commercial navigation for Brazil through the technical assistance in water resource master planning.

### **18-13. Civil-Military Emergency Preparedness**

USACE executed 24 international disaster preparedness events in support of Geographic Combatant Command (GCC) FY16 security cooperation objectives. These activities assist the countries in building capacity for "All-Hazards" preparedness and consequence management. Focused on NATO, other partners, and countries in the SOUTHCOM area of responsibility; USACE conducted 24 events (an increase of eight from FY15) and received funds of \$1.5M from the Wales Initiative Funds (WIF), Defense Environmental International Cooperation (DEIC), and Traditional COCOM Activities (TCA) sources.

### **18-14. Engineer Engagements**

USACE continued to receive international delegations seeking best practices and information exchange on various technical and engineering issues, including establishing a Corps of Engineers-like capability, consequence management, and integrated water resource management. In FY16, USACE hosted delegations from Afghanistan, Pakistan, Taiwan, Korea, China, the Brazilian Chief of Engineers, and the Lower Mekong River Commission. USACE also hosted groups from Chile, Egypt, Israel, Hungary, Laos, Mexico, Mongolia, Morocco, Nepal, Palestine, Paraguay, China, Peru, Russia, Tajikistan, Tanzania and Vietnam under the State Department's International Visitor Leadership Program. In FY19, USACE conducted extensive engagements with the Mekong River Commission on water resource management for Laos, Cambodia, Vietnam, and Thailand. Through the Engineer and Science Exchange Program, USACE created a new exchange program with the Japanese Ministry of Defense to further their knowledge of US Anti-Terrorism/Force Protection protocols. USACE continues to embed Engineer Liaison Officers with each of the GCCs, several Army Service Component Commands (ASCCs), with USAID, and other agencies.

## HOW THE ARMY RUNS

### **18-15. Theater Security Cooperation and Shaping (XISQ MDEP)**

The Army established security cooperation (SC) as an enduring mission to meet the intent of using steady-state security cooperation as a means of effectively and efficiently achieving National Security Strategy, National Defense Strategic Guidance, National Military Strategy, and Combatant Commanders (CCDRs) objectives. This mission is codified in documents such as the Army Vision; Army Operating Concept; Army Strategic Guidance for Security Cooperation; AR 11-31, Army Security Cooperation Policy; and DA PAM 11-31, Army Security Cooperation Handbook. USACE is distinctively postured to shape the security environment. USACE obligated over \$606K of the XISQ Security Cooperation Funds to support engagements in India, Viet Nam, China, Taiwan, Laos, Mongolia, Colombia, Honduras, Swaziland, and Mexico addressing challenges of national and global significance related to water resources, disaster preparedness, infrastructure development, and environmental protection. Regionally aligned and globally present, USACE employs its unique array of interagency and international partnerships, authorities, acquisition tools, and expertise to address a broad range of technical and engineering needs that enables the US Government to maintain influence and access, strengthens relationships and integration across the Joint, Interagency, Intergovernmental, and Multinational (JIIM) community, and builds partner capacity. As the momentum for conducting security cooperation activities has grown, there has been a corresponding increase in the recognition of need and demand for USACE capabilities within the Army, CCMDs, and interagency as integral and essential to their respective national and theater security cooperation strategies. The following examples highlights how USACE capabilities are being employed to shape the security environment:

- a. Assisting strategic partners to address critical water and environmental security challenges in the Mekong region of Southeast Asia, the Baltics and Eastern Europe, the Paraguay and São Francisco River Basins in South America, and the Nigerian Waterway and Senegal Basin in Africa by leveraging USACE's JIIM partnerships, extensive knowledge of river basin management, risk management, and disaster preparedness and response, and collaborative planning approaches to enhance regional cooperation, sustainable development practices, and resiliency (supports multiple INDOPACOM LOEs including China, Allies and Partners, and All Hazards, SOUTHCOM LOEs 4, Humanitarian Assistance/Disaster Relief and 6, Critical Access and Relations, EUCOM's Disaster Preparedness and Environmental Security LOAs, and AFRICOM LOEs).
- b. Assisting in key partner nation Army Engineer transformation initiatives through bilateral exchanges in countries such as Brazil, Colombia, Chile, Peru, Angola, Kenya, and Liberia (supports SOUTHCOM LOE 5, Defense and Security Sector Reform/Defense Institution Building and all AFRICOM LOEs).
- c. Responding to the Brazilian water agency request for assistance to assess and recommend water quality monitoring and sediment management solutions to address the recent mine breaches in the Minas Geras region and impacted portions of the Rio Doce (supports SOUTHCOM LOEs 4, Humanitarian Assistance/Disaster Relief and 6, Critical Access and Relations).
- d. Maintaining critical access and strategic partnerships by conducting a series of annual subject matter expert technical exchanges and consultations requested by the Panama Canal Authority on the operation, administration, management, preservation, maintenance, and modernization of the Canal (supports SOUTHCOM LOE 6, Critical Access and Relations).

### **18-16. Support for United States Agencies Overseas**

The Corps is also called upon to provide support for U.S. agencies overseas. For example, the Corps: supports the U.S. Agency for International Development following natural and man-made disasters; builds border facilities for the Republic of Georgia Border Guard and U.S. Customs and Border Protection; provides hydrologic modeling training for Ethiopia and Kenya; and performs government due diligence for major infrastructure projects funded by the Millennium Challenge Corporation.

## **Section V**

### **Support to Unified CCDRs**

#### **18-17. Benefits to Warfighting Capabilities**

The Civil Works Program provides the USACE with a unique capability in DOD. The USACE's extensive professional staff of engineers, scientists, economists, etc.; provide the critical teamwork necessary to plan engineer infrastructure improvements and institution building at the national level. The training and

## CIVIL FUNCTIONS OF THE DEPARTMENT OF THE ARMY

experience gained from the Civil Works program is leveraged by the USACE's Field Force Engineering (FFE) capabilities to provide support to unified CCDRs and their ASCC. The infrastructure these engineers build provides the facilities and enablers for operations in the future. USACE uses its regional alignment and global presence, unique authorities, agreements, and technical and engineering capabilities to deliver integrated solutions to support National Security Strategy and advance America's interests at home and abroad. USACE is working with partners around the globe to develop innovative solutions aimed at strengthening partner nation capacity to address resource security and disaster risk management challenges, which are critical to achieving state and regional stability, sustainability, and economic development. It is actively engaged with the CCMD, ASCC, and interagency partners to maintain partnerships with key allies, build partner capacity, and enhance security around the globe. USACE leverages its expeditionary relationships with joint, interagency, intergovernmental, and multinational partners, and a diverse mix of technical and engineering expertise to support CCMD, ASCC, and interagency activities across the globe. USACE supports the CCMDs' strategic objectives by delivering collaborative solutions through a "toolkit" of engineering and technical capabilities. USACE Major Subordinate Commands have been assigned to support to each of the GCCs with USACE LNO's embedded in each of the GCC's as well as select ASCC's and within SOCOM.

### **18-18. Overview of Support to Unified CCDRs**

Expertise in water resource development, flood risk management, waterway operations, dredging, coastal engineering, environmental stewardship, and disaster response supplement the skills maintained through the Army's MILCON and installation support programs. These expert capabilities are routinely called upon by the warfighting CCDRs and other DOD agencies. When the Army goes to war, USACE personnel use the experience they have gained in the Civil Works and military programs to provide timely analysis and solutions to the warfighters. The USACE's knowledge of beach dynamics, including the Sea State Prediction Models developed at ERDC's Coastal & Hydraulics Laboratory, helps determine sites for shore landings. When combined with its terrain mobility models, the USACE can provide commanders the most effective plan for logistics-over-the-shore sites in combination with the inland road network to optimize reception, staging, and onward movement in the area of operations. Corps expertise in soil mechanics determines the best routes for armored vehicles. Often roads are built using technologies developed in the Civil Works Program. Corps experience gained from work on winter navigation helps the Army to cross frozen rivers. Commanders at all levels make use of geospatial products and satellite-based navigation systems developed at the Geospatial Research Laboratory, Alexandria, Virginia.

## **Section VI Summary and References**

### **18-19. Summary**

The Army, through its civil functions, provides valuable services in maintaining and enhancing the economic and environmental health of the Nation. Civil functions also continue to prove invaluable in furthering national security objectives, both directly and indirectly. The financial and personnel resources associated with these functions are principally authorized and funded under the WRDAs and annual Energy and Water Development Appropriations Acts, respectively. Consequently, civil functions activities, as well as the significant training of the USACE personnel they provide, are at virtually no cost to the DOD's military budget. USACE is a globally-recognized leader in military and civil engineering and science. Its Civil Works mission provides a key foundational component of the Nation's public infrastructure that facilitates economic growth, quality of life, environmental health and national security for the American people. The Corps' highly skilled workforce provides significant value to the Nation—the economy, security and quality of life. But the Corps does not do anything alone. Many partners in other services—interagency, local/regional/state leaders, and contractors—help achieve the Civil Works mission.

### **18-20. References**

- a. Civil Works Strategic Plan, 2014-2018.
- b. HQDA General Orders No. 3, Assignment of Functions and Responsibilities within Headquarters, Department of the Army, 9 July 2002.

## HOW THE ARMY RUNS

- c. Public Law 84-99, Amendment of Flood Control Act of 18 August 1941 (Emergency Flood Control).
- d. Public Law 91-611, Flood Control Act of 1970.
- e. Public Law 93-288, Disaster Relief Act of 1974 (also known as the Stafford Act).
- f. Public Law 99-433, DOD Reorganization Act of 1986 (also known as the Goldwater-Nichols Act).
- g. Public Law 99-662, WRDA of 1986.
- h. Public Law 105-245, Energy and Water Development Appropriations Act, 1999.
- i. Public Law 105-277, Omnibus Consolidated and Emergency Supplemental Appropriations Act, 1999.
- j. Public Law 106-541, WRDA, 2000.
- k. Public Law 110-114, WRDA, 2007.
- l. Public Law 113-121, Water Resources Reform and Development Act (WRRDA), 2014.
- m. Public Law 114-322, Water Infrastructure Improvements for the Nation Act, 2016.
- n. Public Law 15-123, Supplemental Appropriations for Disaster Relief, 2019.

## **Chapter 19**

### **Commander's Communication & Public Affairs**

#### **Section I Introduction**

##### **19-1. Chapter Content**

This chapter provides insights into the commander's responsibilities to communicate with outside audiences and of the roles, functions, and mission of Army Public Affairs (PA). Section I describes how the Army PA community supports commanders through mission, principles, responsibilities, activities, and tasks. Section II describes Army PA organizations, to include headquarters, units, sections, and detachments. Section III provides a summary, key terms, and applicable references.

##### **19-2. PA Mission**

- a. The mission of Army PA is to fulfill the Army's obligation to keep the American people and the Army informed, and help to establish the conditions that lead to confidence in the Army and its readiness to conduct unified land operations.
- b. Army PA activities derive from Title 10, U.S. Code, Section 7014 (10 U.S.C 7014), which requires the Secretary of the Army (SECARMY) to designate a single office within the Office of the Secretary of the Army to conduct the PA function.
- c. Army PA comprises public information, command information, and community engagement activities directed toward both internal and external audiences with an interest in the Department of Defense (DOD).

##### **19-3. Commander's PA Responsibilities**

- a. Army PA doctrine and policy is consistent and compatible with joint PA doctrine and policy, and DOD and DA policies. FM 3-61 is the doctrinal manual for Army PA operations and describes the fundamental principles and concepts that provide information to internal and external national and international key actors and publics—Soldiers, family members, retirees, political leaders, allies and adversaries, as well as PA responsibilities, roles, missions, capabilities and organizations in the operational and home station environment. It also outlines Commander's Communication Synchronization (CCS). Formerly known as strategic communications (STRATCOM), CCS is the process of synchronizing communications and information across all echelons to ensure unity of effort and reduce or eliminate information fratricide. As the primary coordinator of public information within the Army, PA plays a key role in – and often leads – the CCS process to maximize alignment of all communication efforts held by other information-related capabilities (IRC).
- b. PA is a command responsibility. At each level of command, public affairs officers (PAOs) report directly to the commander. The commander may communicate through the PAO as the official spokesperson, but the success or failure of the PA program hinges on the commander's personal support and direct involvement. No PA spokesperson can fully capture the commander's personal perspective or take responsibility for communicating the leader's message.
- c. The PAO serves on the commander's personal staff and supervises PA staff sections or attached PA units. The PAO develops strategies, and leads and supervises the conduct of public information, command information and community engagement. The PAO's principal role is to provide advice and counsel to the commander and the staff on how operations and actions will impact the information environment (IE) and affect identified key audiences.
- d. Commanders are authorized to designate spokespersons to release information pertaining to their command. Because PA is an inherently governmental function, official spokespersons will be military or DA/DOD civilian employees.

## HOW THE ARMY RUNS

e. Commanders and PA professionals should educate and encourage all their military personnel, civilian employees, and contractors to tell the Army story by providing them with timely information that is appropriate for public release. By projecting confidence, commitment and factual information during interviews or in other interactions with families and friends, Army personnel can help promote public understanding of military operations and activities.

### 19-4. PA Activities

a. PA activities synchronize actions and communication across three functional areas: public information, command information, and community engagement. PA staffs develop communication policies, plans and programs in support of command objectives and operations. The current IE, characterized by near-instantaneous and continuous information release empowered by social media and web-based technology, blurs the lines that once separated these three functional areas.

(1) Public Information. Public information is the communication between the Army and local, national, and international publics through the use of coordinated programs, plans, themes, and messages – consistent with standards of security, accuracy, policy and propriety, and following the DOD Principles of Information (see Fig 19-1). Information technology provides a wide range of internet-based information opportunities – to include official command web sites and social media – for public information strategies. However, public information remains largely a matter of ensuring media representatives have access to information they need to report on military policy and operations. Media activities provide information to a wide range of audiences within the U.S. and internationally. Commanders and their PA staffs plan for media briefings and interviews, issue statements, respond to queries, arrange for access to operational units, and provide to the media appropriate equipment, transportation, and communications support. Media plans include specific provisions for each phase of operations.

**It is DOD policy to make available timely and accurate information so that the public, the Congress, and the news media may assess and understand the facts about national security and defense strategy. Requests for information from organizations and private citizens shall be answered quickly. In carrying out that DOD policy, the following principles of information shall apply—**

- **Information shall be made fully and readily available, consistent with statutory requirements, unless its release is precluded by national security constraints or valid statutory mandates or exceptions. The "Freedom of Information Act" will be supported in both letter and spirit.**
- **A free flow of general and military information shall be made available, without censorship or propaganda, to the men and women of the Armed Forces and their dependents.**
- **Information will not be classified or otherwise withheld to protect the Government from criticism or embarrassment.**
- **Information shall be withheld when disclosure would adversely affect national security, threaten the safety or privacy of U.S. Government personnel or their families, violate the privacy of the citizens of the U.S., or be contrary to law.**
- **The DOD's obligation to provide the public with information on DOD major programs may require detailed Public Affairs (PA) planning and coordination in the DOD and with the other Government Agencies. Such activity is to expedite the flow of information to the public; propaganda has no place in DOD PA programs.**

Source: DODD 5122.5, Sep. 27, 2000

Figure 19-1. Department of Defense Principles of Information



(2) **Command Information.** Command information is that communication to internal military, civilian and contract employees and their family members, intended to help members of the command understand organizational goals, operations, and significant developments. PA professionals develop strategies to use and synchronize information through installation and organizational publications, social media platforms, internet-based multimedia products and town-hall-style meetings. PA professionals assess and leverage online digital capabilities such as social media and email, and traditional capabilities such as radio, to quickly and accurately communicate emergencies, operational changes, and hazards to their audiences. During a military operation, commanders should consider all dissemination capabilities available to communicate releasable details and the role of the military in the operation.

(3) **Community Engagement.** Community engagement is the process of working collaboratively with, and through, groups of people affiliated by geographic proximity or special interest to enhance the understanding and support the Army's/command's communication objectives. Objectives can include increasing public awareness and support to the Army, minimizing disruption to the mission, and support for recruiting/retention of the All-Volunteer Force. PA professionals assess and develop strategies for key leader engagements, relationship-building with officials, community influencers, organizations, businesses and individuals with interest in the Army.

### **19-5. PA Tasks**

Within the framework of the three PA functional areas, Army PA core tasks are fundamental to the commander's communication program and objectives—

a. **Provide Advice and Counsel to the Commander.** The PAO is the commander's senior advisor on communication strategy synchronization and PA activities. The PAO maintains direct and timely access to the commander and establishes effective staff relationships in order to maintain situational awareness and access during planning.

b. **Conduct PA and Visual Information Planning.** Continuous, collaborative planning is a core task for developing a synchronized, cohesive, and comprehensive PA plan that meets the objectives of the commander's communication strategy.

c. **Conduct PA Training.** PA professionals train and guide non-PA communicators -- including allies and international partners -- to understand the role of the media and the opportunity and responsibilities associated with media interactions.

d. **Conduct Media Facilitation.** Media facilitation is the process of planning, preparing, executing, and assessing a media engagement. Since engagements with journalists can be unplanned, the PA professional will anticipate and prepare the command with specific guidance about command media policies, and appropriate tips and techniques for successful media interactions.

e. **Conduct Public Communication.** Public communication is the communication between the Army and local, national, and international audiences through the use of coordinated programs, plans, themes, and messages. It involves the receipt and exchange of ideas and opinions that contribute to shaping public understanding of, and discourse with the Army. Public communication includes the release of official information through news releases, public service announcements, media engagements, internet-based multimedia, and social networks. Public Communication supports the commander's responsibility to keep the American people and the Army informed.

f. **Counter Misinformation and Disinformation.** PA professionals enable commanders to preempt, identify, and counter adversary attempts at malign narratives through the distribution of legitimate, timely, and truthful information regarding Army operations, equipment, and personnel across multiple platforms within OPSEC constraints.

g. **Conduct Communications Assessments.** Communications assessments are conducted throughout all phases of an operation and measure whether the communication objectives are being or were achieved as planned. These assessments inform the commander's decision on whether or not to change course.

# HOW THE ARMY RUNS

## Section II Army Public Affairs Organizations

### 19-6. The Office of the Chief of Public Affairs (OCPA)

a. By Army General Order 2019-01, the SECARMY has assigned the Chief of Public Affairs (CPA) the responsibility for keeping the American people and the Army informed about the Army and for providing public affairs support to principal officials. The Office of the CPA (OCPA) is responsible for the PA function throughout the Army and exercises coordinating authority over all PA offices.

b. As principle advisor to the SECARMY and Chief of Staff of the Army (CSA) on Army public communication policies and strategies, the CPA assesses, plans, conducts, and evaluates PA policies, and programs for the Regular Army (RA), Army National Guard (ARNG), and U.S. Army Reserve (USAR).

### 19-7. Army Regional PA Offices

Three regional community engagement offices, organized under the OCPA, are manned with military and civilian PA professionals to provide DA-level coordination with community and business leaders, media, sports teams, military and veteran service organizations, and other agencies and centers of influence. Specific expertise for book projects, TV / movie / documentary projects are described here.

a. OCPA Northeast, New York, New York provides DA-level PA support to northeast region states, while representing Army leadership in the region by establishing, building, and maintaining liaisons with national news and entertainment media, civic leaders, centers of influence, and veterans' and military service organizations. This office also manages the Army Book Program and coordinates with civilian book authors for published works.

b. OCPA Midwest, Chicago, Illinois provides DA-level PA support to Midwest region states; builds and maintains liaisons with civic leaders, centers of influence, veterans' and military service organizations as well as national entertainment and media organizations throughout the region.

c. OCPA West, Los Angeles, California provides DA-level PA support to the entire Army on entertainment media projects. Additionally, supports western region states, by establishing, building, and maintaining liaisons with national news and entertainment media, civic leaders, centers of influence, and veterans' and military service organizations.

### 19-8. Defense Public Affairs-Associated Agencies

a. Defense Media Activity (DMA) is the DOD agency that provides news and information to U.S. forces and families worldwide. The agency presents news, information, and entertainment on a variety of media platforms, including radio, television, internet, print media, and emerging media technologies.

b. The Defense Information School is the joint-service training and education center for all U.S. DOD PA and visual information professionals.

c. Stars and Stripes Newspaper operates as a mission-essential overseas activity of the DOD and designated Unified Combatant Commands (CCMD). The Stars and Stripes newspapers operate with the editorial policies and practices of U.S. commercial newspapers. The Stars and Stripes does not represent the official position of the U.S. Government, including the DOD or the unified CCMD. Every effort should be made to provide Stars and Stripes releasable information about the military and its operations, and they should be afforded the same rights and access as given to commercial media.

### 19-9. Organic PA Sections

PA sections are embedded in the headquarters of Army brigades, divisions, and echelons above division. These sections provide PA support to the command and serve as the commander's principal advisor on PA issues. Ranging from a single senior noncommissioned officer to a colonel with a small staff, these sections conduct PA planning and limited PA operations. PAOs are generally trained and educated in public-affairs specific knowledge and skills at the Defense Information School. Personnel and materiel constraints currently require these organic PA sections be augmented by standard requirements code (SRC) 45 (Public Affairs) units for most operations.

### **19-10. Army Command, Army Service Component Command, and Direct Reporting Unit PA Sections**

An Army Command (ACOM) PAO or Army Service Component Command (ASCC) PAO is a colonel serving on the commanding general's personal staff, responsible to the commander and to units attached, assigned or aligned to the Army, training for, mobilized, or deployed in support of combined or joint operations. The ASCC PA section coordinates closely with the PA sections of other government agencies, coalition commands, and other forces, when appropriate, to synchronize and conduct PA operations. CCMD PA may direct the planning, priorities, and PA activities across the ASCC's operational area. The PA section is organized, staffed, trained, and equipped to deploy rapidly in support of theater Army-level operations and to direct PA activities in support of the commander's communication strategy. When deployed, the Army Headquarters PA staff will be augmented by a SRC 45 Theatre Public Affairs Support Element (TPASE), or multiple Mobile Public Affairs Detachments (MPAD), and will assume all the missions and capabilities of that organization.

### **19-11. Corps and Division PA Sections**

The Corps PAO is a colonel and serves on the personal staff of the Corps commander. The Division PAO is a lieutenant colonel and serves on the personal staff of the division commander. The sections are organized, staffed, trained, and equipped to rapidly deploy in support of task force operations. The Corps and Division PA sections provide PA support to the Corps and Division commander respectively and to all assigned or attached units in support of national, multinational, unified, or joint operations. Corps and Division PAOs exercise planning and supervisory authority over all PA units attached, assigned or under the operational control of the respective headquarters. The PAOs coordinate closely with the organic PA sections of lower and adjacent commands, and other forces to carry out PA operations in support of the commander's PA operations. When deployed, both PA staffs should be augmented by an MPAD or a Public Affairs Detachment (PAD).

### **19-12. Brigade Combat Team and Multi-Functional / Functional Brigade PA Sections**

The Brigade Combat Team (BCT) PAO is a major and serves on the personal staff of the brigade commander. The staff section is organized, staffed, trained, and equipped to deploy rapidly in support of brigade task force operations. The BCT PA section coordinates closely with higher echelons and other forces to carry out PA operations. A multifunctional or functional brigade PA section is comprised of trained PA Soldiers who serve on the special staff of the brigade commander. The multifunctional brigade PA is comprised of a PA sergeant first class (SFC) and a PA sergeant (SGT). The functional brigade PAO is a captain or PA SFC with one PA SGT. The PA staff sections support and receive support from higher echelon PA staffs. When augmented by a PAD team, the PAD commander may serve as the brigade PAO when no organic PA officer is assigned or authorized.

### **19-13. Special Operations Forces PA Sections**

A Special Operations Forces (SOF) PA section is normally comprised of a PA-trained officer and NCO who serve on the special staff of the commander. Due to the nature of special operations, SOF PA personnel have a unique responsibility to ensure that policies regarding the release of information and imagery are followed in accordance with local command policy. SOF PA staff often report or coordinate directly with the Theater Special Operations Command (TSOC), Special Operations Command (SOC), or Joint Special Operations Command (JSOC) PAOs for planning, guidance, and release authority.

### **19-14. Unit PA Representatives**

Unit Public Affairs Representatives (UPAR) are assigned through additional duty appointments by commanders at echelons below brigade to represent their units for PA functions. The brigade or higher PAO will provide UPARs at lower echelons with training on PA policies, planning, and media engagements. While UPARs can create command and public information products, the PAO maintains public release authority, which cannot be delegated.

### **19-15. Garrison PA Offices**

The garrison public affairs office is primarily composed of Department of Army civilians (CP-22) who serve on the staff of the garrison commander. Normally on Army installations, the garrison public affairs staff support the senior mission commander, garrison commander, and tenant commanders on the

## HOW THE ARMY RUNS

installation to plan and conduct public affairs activities in close coordination with partner and higher echelon commands to ensure the Army speaks with one voice. In the case of Joint Basing, garrison public affairs support may vary based on tenant unit make-up and the military service of the senior command.

### **19-16. Reserve Component PA**

The vast majority of PA assets are in the ARNG and USAR—more than 65 percent of the total PA force and 85 percent of the deployable Table of Organization and Equipment (TOE) unit structures. These USAR and ARNG units and personnel must be seamlessly integrated with the active component and focused on supporting the overall Army goals and objectives. The four types of TOE PA organizations, predominately positioned in the USAR and ARNG, are discussed in the following paragraphs.

### **19-17. PA SRC 45 Units**

- a. The Army is the only U.S. military service to have deployable PA units. There are four types of SRC 45 units: TPASE, MPAD, PAD, and Broadcast Operations Detachment (BOD). These units are designed to augment theater, corps, division, brigade, Special Forces Groups (Airborne), and other organic PA staff to support unified land operations. PA SRC 45 units are fully capable of operating in operational environments but require administrative and life support functions, such as field feeding and unit-level maintenance, from the supported command.
- b. SRC 45 units must be requested through U.S. Army Forces Command (FORSCOM).

### **19-18. Theatre Public Affairs Support Element (TPASE)**

The TPASE is the most capable SRC 45 unit in the inventory. The TPASE is commanded by a lieutenant colonel and is modularly organized, staffed, trained, and equipped to rapidly deploy in support of military operations at the Division to Joint Forces Land Component Command (JFLCC) and Theater Army levels. The TPASE is capable of directing and leading subordinate PA activities and units across the Area of Responsibility (AOR) / Joint Operations Area (JOA). The TPASE is capable of performing all core PA tasks and has transportation and audio-visual equipment sufficient to produce radio, television, print, and digital products for internal or external audiences, as well as resources to credential, brief, escort, and support visiting media. When deployed in support of Army, or joint service operations, a BOD and one to three MPADs will augment the TPASE. The TPASE most often collocates with and operates in support of the highest level of U.S. command within the theater or AOR.

### **19-19. Mobile Public Affairs Detachment (MPAD)**

The MPAD is commanded by a major, can be task organized into two or three teams, and is assigned to the theater, corps, division, or Joint Task Force (JTF) Headquarters (HQ) under the operational and tactical control of the senior PA officer or TPASE commander. It is staffed, trained, and equipped to rapidly deploy in support of brigade, division, or corps-size task force operations. MPADs are assigned at a ratio of one per three brigade-size elements.

### **19-20. Public Affairs Detachment (PAD)**

A PAD is commanded by a captain and comes with its own transportation and sufficient still and video equipment to produce print, radio, television, and digital products for internal and external audiences. The PAD typically supports division or brigade-size task force operations. A PAD provides direct support to units in support of Army, combined, joint or coalition operations. Although it is primarily attached or assigned to a division, or a brigade, a PAD may support Special Forces Groups, civil affairs, and brigade equivalents. A PAD is modularly organized, staffed, trained, and equipped to deploy rapidly in support of operations. PADs may be divided into two teams to provide brigade-level support and augment the organic PA element or provide area support within the assigned command's AOR.

### **19-21. Broadcast Operations Detachment (BOD)**

The BOD is commanded by a major and consists of a command element, two broadcast teams, and a maintenance team. The only unit of its kind in DOD and the Army, a BOD operates 24-hours per day producing internal or external information products and sustaining broadcast stations and facilities. The BOD is designed to operate a mobile radio and television broadcast facility in support of Armed Forces

Radio and Television Service operations, or to merge with other independent facilities to form a theater of operations network. A BOD performs as the broadcast support arm for a TPASE, and produces broadcast products for distribution to internal and external worldwide audiences through the DMA. The BOD is assigned to a theater army headquarters, joint task force, or CCMD when a TPASE is assigned.

**19-22. Combat Camera (COMCAM)**

Army COMCAM provides highly-trained and skilled visual information Soldiers deploy to austere operational environment to collect and produce photo, video, graphic and multimedia in support of operational planning, public affairs, information operations, mission assessment, forensic, legal, intelligence and other crises, contingencies, and exercises around the globe. COMCAM maintains airborne-qualified Soldiers and conduct other advanced tactical training, enabling them to operate and capture imagery with airborne and SOF in areas inaccessible to media or other visual information personnel.

**Section III**

**Summary, Key Terms, and References**

**19-23. Summary**

a. Since the nation's founding, the Army has communicated information to the American people through the free and independent media, as an element of the public information program. Implicit in a democratic republic is the right of citizens to know about the activities of their elected government. The government, in return, has an obligation to inform its citizens about its activities. These rights also apply to the activities of the military, established by the Constitution, to provide for the common defense and general welfare of the U.S. One of the most significant conduits through which information is passed to the people is the free press guaranteed by the Constitution.

b. Today's information environment has made possible virtually instantaneous transmission of breaking news to world-wide audiences. The American public is, as it always has been, interested in what happens to its sons and daughters in uniform, especially when they are executing operational missions. The increasing number, variety, and complexity of real-world operations in which the U.S. Army has been involved has attracted considerable public and media interest and will continue to do so in the future. Commanders could conceivably win the battle and lose the information war by excluding, or attempting to exclude, media from operations or by overlooking the value of effective PA involvement throughout operational planning and execution.

**19-24. Key Terms**

a. Community Engagement. Those public affairs activities that support the relationship between military and civilian communities, domestically and in military operations.

b. Command Information. Communication by a military organization directed to the internal audience that creates an awareness of the organization's goals, informs them of significant developments affecting them and the organization, increases their effectiveness as ambassadors of the organization, and keeps them informed about what is going on in the organization. Formerly, called Command Information.

c. Public Affairs. Those internal information, public information, and community engagement activities directed toward both the external and internal audiences with interest in the DOD.

d. Public Information. Within public affairs, that information of a military nature, the dissemination of which is consistent with security and approved for release.

**19-25. References**

- a. Army Regulation (AR) 25-55, The DA FOIA Program.
- b. AR 340-21, The Army Privacy Program.
- c. AR 360-1, The Army Public Affairs Program.
- d. DOD Directive (DODD) 5105.74, Defense Media Activity.
- e. DODD 5122.05, Assistant Secretary of Defense for Public Affairs (ASD(PA)).
- f. DODD 5122.11, Stars and Stripes Newspapers and Business Operations.
- g. DODD 5230-09, Clearance of DOD Information for Public Release.
- h. DODD 5400.07, DOD Freedom of Information Act Program.

## HOW THE ARMY RUNS

- i. DODD 5400.11, DOD Privacy Program.
- j. DODD 5410.18, Public Affairs Community Relations Policy.
- k. DOD Instruction (DODI) 5410.19, PA Community Relations Policy Implementation.
- l. DODI 5040.02, Visual Information.
- m. DODI 5120.4, DOD Newspapers, Magazines and Civilian Enterprise Publications.
- n. DODI 5230.29, Security and Policy Review of DOD Information for Public Release.
- o. DODI 5400.13, Public Affairs Operations.
- p. DODI 5400.14, Procedures for Joint PA Operations.
- q. DODI 5405.3, Development of Proposed PA Guidance.
- r. DODI 5410.15, DOD PA Assistance to Non-Government, Non-Entertainment-Oriented Print and Electronic Media.
- s. DODI 5410.16, DOD Assistance to Non-Government, Entertainment-Oriented Motion Picture, Television, and Video Productions.
- t. FM 3-13, Inform and Influence Activities.
- u. FM 3-61, Public Affairs Operations.
- v. JP 3-61, Public Affairs.

## Chapter 20

### Defense Support of Civil Authorities

#### Section I Introduction

##### 20-1. Chapter Content

This chapter discusses the interaction and cooperation between federal, state and local agencies in responding to official requests for support to provide relief in the event of man-made or natural disasters utilizing federal and state military resources.

##### 20-2. Defense Support of Civil Authorities (DSCA) Overview

a. The U.S. military primarily organizes, trains, equips, plans, and conducts combat and stability operations. However, when requested by civil authority or directed by the President of the United States (POTUS), it also has enormous capability to rapidly respond and provide support to a wide variety of domestic emergencies and disasters. The Department of Defense (DOD) conducts these operations under civilian control and in accordance with the fundamental tenet of its professional ethos - subordination to civilian authority. Federal military forces normally respond in support of another federal agency, most often after a gubernatorial request to supplement the efforts and resources of state and local governments. Based on the U.S. form of government and consistent with its historic experience, the military will not lead the federal response except for the most severe domestic emergency or disaster.

b. DOD Directive (DODD) 3025.18 defines DSCA as support provided by U.S. federal military forces; DOD civilians; DOD contract personnel; DOD component assets; and National Guard forces (when the Secretary of Defense (SECDEF), in coordination with the Governors of the affected states, elects and requests to use those forces in Title 32, U.S.C. status) in response to requests for assistance from civil authorities for domestic emergencies, law enforcement and other domestic activities, or from qualifying entities for special events.

##### 20-3. Constitutional and Policy Basis for DSCA

a. Use of the military to support civil authorities stems from U.S. core national values as expressed in the Constitution which anticipates the use of federal military forces within U.S. borders. Article I, Section 8 states, "Congress shall have power... to provide for calling forth the Militia to execute laws of the Union, suppress Insurrections, and repel Invasions." Article II, Section 3 states POTUS, "...shall take care that the Laws be faithfully executed." The 10th Amendment provides the basis that federal government assistance, including DOD, is provided in support of State and local authorities. It reads in part, "The powers not delegated to the U.S. by the Constitution, nor prohibited by it, are reserved to the States respectively."

b. The 2015 National Security Strategy (NSS) identifies national interests such as the security of the United States and its citizens as well as strategic risks such as a catastrophic attack on the US homeland or critical infrastructure. The 2017 NSS reinforced the need to protect the American people specifically identifying a catastrophic weapon of mass destruction attack and the threat to critical infrastructure posed by cyberattacks.

c. In February 2013, DOD published its most recent Strategy for Homeland Defense (HD) and DSCA. All of these strategies recognize that America's military may respond to a variety of national needs, other than waging war, and DSCA contributes significantly to satisfying America's national security requirements.

## HOW THE ARMY RUNS

### 20-4. Historic Context for Domestic Military Support

a. Since America's inception, the Army has supported civil authorities in times of need. Floods, riots, hurricanes, earthquakes, and wildfires are all examples of situations that have caused states to deploy the National Guard and occasionally request the assistance of federal armed forces. Achieving national goals with regard to terrorism, weapons of mass destruction (WMD), and illegal drug trafficking have also led to supplementing civilian efforts with military forces.

b. When America's Founding Fathers met to draft the U.S. Constitution in Philadelphia in 1787, Shay's Rebellion was a recent memory and insurrection a concern. To protect the viability of government, they created mechanisms to suppress rebellions or insurrections and enforce the law. The 1794 Whiskey Rebellion led to the fundamental precept, codified in current law that the military is in support of civil authority. A taxpayer revolt and increasing violence led to a Presidential response and deployment of federalized militia. Throughout this threat to federal governance, President Washington's guidance was that the military was to support local magistrates, not pre-empt them, and this principle remains the foundation of DSCA law, policy and processes.

c. Significant with regard to current law and policy is the April 1995 domestic terrorist attack on the Alfred P. Murrah Building in Oklahoma City. In the wake of that attack, President Clinton issued Presidential Decision Directives (PDD) 39 and 62 that clarified the roles and missions of various federal agencies with regard to countering and combating terrorism. These documents defined terms such as: Crisis Response Management (CrM), Consequence Management (CM), and Lead Federal Agency (LFA) that have since been given new meaning by more recent documents, particularly Presidential Policy Directive 8 (PPD-8), National Preparedness.

d. Current disaster response organizations, systems and processes evolved from the civil defense mission of the U.S. Army Continental Army Command (CONARC), which was inactivated in 1973. President Carter's 1979 Executive Order 12148 established the Federal Emergency Management Agency (FEMA) and transferred many of the missions formerly performed by CONARC to FEMA. The 1988 Stafford Disaster Relief and Emergency Assistance Act and Executive Order 12656 that delegated most of the President's Stafford Act authority to the FEMA Director were instrumental in establishing current interagency responsibilities. The military also has a history of ensuring the continuity of government in the event of a national emergency and EO 12656 identified agency responsibility and refined those processes as well.

e. In the wake of the September 2001 terrorist attacks, Hurricane Katrina in 2005, and Hurricane Sandy in 2012, the U.S. remains in another period of evolving change with regard to how the military supports civil authority. DOD's Executive and Action Agent responsibilities moved from the Army to the Office of the Secretary of Defense (OSD) and the Joint Staff (JS) respectively. HSPD-5 Homeland Security, and the subsequent PPD-8, directed alignment of federal, state and local coordinating structures, capabilities and processes into a unified, all-discipline, all-hazards approach to domestic incident management. HSPD-5 integrated CrM and CM, recognizing that all agencies responding to a disaster or emergency do so while retaining their own authorities and responsibilities under law and policy.

### 20-5. DOD Role in Homeland Security Today

a. The 2002 National Strategy for Homeland Security (NSHS) defined Homeland Security (HS) as "a concerted national effort to prevent terrorist attacks within the U.S., reduce America's vulnerability to terrorism, and minimize damage and recover from attacks that do occur." In the wake of Hurricane Katrina, many observers expected the next NSHS to expand the definition of HS to include natural and other manmade disasters. However, recognizing the unprecedented threat to national security posed by Chemical, Biological, Radiological, Nuclear and High-Yield Explosive (CBRNE) and Weapons of Mass Destruction (WMD), the 2007 NSHS definition was unchanged, remaining focused on terrorism. In the nearly two decades since 11 September 2001, this clear and present threat to the homeland has resulted in dramatic change to DOD's HS culture and capabilities, particularly the civil support (CS) or DSCA mission. As DOD continues to contribute through its military missions overseas and HS efforts, the pace of change has slowed, although the mission set continues to evolve.

b. The 2013 DOD Strategy for HD and DSCA identifies two broad mission areas: 1) Defend U.S. territory from direct attack by state and non-state actors; 2) Provide assistance to domestic civil authorities in the event of natural or manmade disasters, potentially in response to a very significant or catastrophic event. The HD mission area has two objectives: 1) Counter air and maritime threats at a safe distance; 2) Prevent terrorist attacks on the homeland through support to law enforcement. The



## Defense Support of Civil Authorities

DSCA mission area also has two objectives: 1) Maintain defense preparedness for domestic CBRN; 2) Develop plans and procedures to ensure DSCA during complex catastrophes.

c. A primary means by which DOD can assure its ability to conduct critical missions is through its evolving Mission Assurance (MA) approach which includes activities to ensure DOD support of the POTUS and SECDEF during a national security emergency. MA has traditionally been described as providing a foundation for both HD and DSCA by supporting national continuity of government (COG) and continuity of operations (COOP) programs designed to ensure Enduring Constitutional Government (ECG). At the federal level, COG is a coordinated effort within each branch of government to ensure capability to continue minimum essential functions in a crisis; COOP are internal efforts within various governmental departments, agencies and organizations to ensure capability to continue operations in support COG and ECG.

d. The role of DOD in Cyberspace, as related to Homeland Defense and Defense Support to Civil Authorities, continues to evolve since the September 2010 Memorandum of Agreement between DHS and DOD discussed the groundwork for mutual support.

### 20-6. DSCA Principles

- a. Assure DOD's ability to conduct critical missions.
- b. Promote Federal-State unity of effort.
- c. Conduct integrated planning with Federal and State authorities.
- d. The National Response Framework will remain the primary instrument for applying Federal capabilities during disaster response.
- e. DOD almost always provides DSCA when requested by civil authorities and approved by the SECDEF. DOD can also provide support when directed by POTUS or SECDEF, or when authorized under separate established authorities.
- f. DOD remains in support of civil authority and generally in support of a primary federal agency.
- g. DOD provides DSCA in accordance with applicable laws, Presidential Directives, Executive Orders and DOD policy with absolute, public accountability of officials involved in the oversight of DSCA processes and while maintaining the Nation's constitutional principles and civil liberties.
- h. As a general rule, civil resources are used first, and DSCA is generally provided only when requirements exceed the capabilities of civil authority as determined by FEMA or another federal agency with primary responsibility. DSCA emphasizes DOD's unique skills and structures, and should be limited in scope and duration. DOD advocates that they are the resource of last resort and usually the most expensive option.
- i. DOD usually provides DSCA through designated federal agencies using established agreements and plans, guided by civilian law and the principle that the federal government assists state agencies, except in terrorism and other incidents where the federal government has primary jurisdiction.
- j. DOD Components do not procure or maintain supplies, materiel or equipment exclusively for providing DSCA unless set forth in law or directed by the SECDEF.
- k. Military forces remain under military command and control (C2), and the authority of the DOD Executive Agent at all times.
- l. DOD components do not perform any function of civil government unless absolutely necessary, and then only on a temporary basis.
- m. While there are exceptions, DSCA is provided on a cost reimbursable basis, primarily through the Stafford Act for Presidentially declared disasters or the Economy Act for other situations. Only the SECDEF and POTUS are authorized to grant a reimbursement waiver.

### 20-7. DSCA Mission Sets

The DSCA environment is so complex and dynamic that it is difficult to clearly and consistently create simple categories of missions. The categories used by Joint Publication JP 3-28 Defense Support to Civil Authorities used here are different than Army Doctrine Reference Publication ADP 3-28, but are complementary and may be in effect simultaneously. Subsequent sections explain the categories and describe many, but not all, of the various mission sets DOD could be called on to support.

a. Supporting an all-hazards response. Disasters and declared emergencies will likely be Presidentially declared. In fact, most instances of local commanders invoking immediate response authority are in this category. Disasters and emergencies can be natural or manmade. Examples include: natural disasters (flood, blizzard, earthquake, etc.); wildfire suppression; and CBRN consequence management.

## HOW THE ARMY RUNS

b. Supporting civilian law enforcement agencies. This support falls into two broad categories: direct and indirect support. Direct support involves enforcing the law and engaging in physical contact with offenders. The circumstances under which direct support can be lawfully provided by military forces are exceptionally rare (e.g. actions taken under the Insurrection Act) or are performed by National Guard forces operating in state active duty or Title 32, U.S.C. status (since the Posse Comitatus Act does not apply under these conditions.)

c. Other domestic activities and special events. Special events encompass any recurring or unique event identified by the Department of Homeland Security (DHS) Special Events Working Group that warrants defense support. Examples include the Olympics, Super Bowls, and the World Series. National Special Security Events (NSSE) are a sub-category of such magnitude or importance that the Secretary of HS designates them an NSSE. The U.S. Secret Service assumes responsibility for the security planning and execution. Recent examples include Presidential Inaugurations, Papal Visits, Democratic and Republican National Conventions, and State Funerals. Periodic planned support is a wide ranging category of support to civil authorities that routinely takes place to enhance civil-military relations and meet the needs of local communities, states and even other federal agencies.

### Section II Domestic Emergency Management Environment

#### 20-8. National Incident Management

a. Tiered Response. One of the most important DSCA concepts is that the U.S. has traditionally used a “bottom-up” as opposed to a “top-down” approach to emergency management with three tiers of support—local, state and federal. Primary responsibility for responding to domestic disasters and emergencies rests with the lowest level of government able to effectively deal with the incident. If a situation exceeds local capability, local authorities are generally expected to seek assistance from neighboring jurisdictions under a mutual aid agreement before requesting state assistance. Similarly, if a state’s capability proves insufficient, state authorities ask for assistance, to include non-federalized National Guard from other states under existing agreements and compacts before requesting federal assistance. In the event of a very large or catastrophic event, federal aid may be provided while mutual aid agreements and compacts are still being coordinated. Defense resources are provided when circumstances warrant; military support can be provided at state (National Guard forces under state control) and federal level. Although not a designated tier of support or a level of elected authority, regional response both within a state and among states is increasingly important.

b. Key National Response Documents. The National Incident Management System (NIMS) and National Response Framework (NRF) provide a single, comprehensive, nation-wide approach to incident management. The NIMS provides an action template for incident management. The NRF provides the policy structure and mechanisms for national-level policy for incident management and can be considered a framework for integrating federal support into state and local government efforts.

(1) Updated in October, 2017, NIMS establishes a core set of concepts, principles, terminology and organizational processes to enable effective, efficient and collaborative incident management for federal, state, local and tribal governments, nongovernmental organizations and the private-sector. Responding agencies retain all their jurisdictional authorities and responsibilities, and they maintain operational control of their functions. Thus, another critical DSCA concept is that domestic emergency management operations are much more about unity of effort than about unity of command.

(2) The NRF is a guide to how the Nation responds to all types of disasters and emergencies. It is built on scalable, flexible, and adaptable concepts identified in the NIMS to align key roles and responsibilities across the Nation. This Framework describes specific authorities and best practices for managing incidents that range from the serious but purely local to large-scale terrorist attacks or catastrophic natural disasters. The NRF describes the principles, roles and responsibilities, and coordinating structures for delivering the core capabilities required to respond to an incident and further describes how response efforts integrate with those of the other mission areas.

(a) The NRF applies to all incidents requiring a coordinated federal response in concert with state, local, tribal, private-sector, and nongovernmental entities. The NRF is applicable to all federal departments and agencies that participate in a coordinated federal response. The NRF also applies to

the non-governmental responders such as the American Red Cross and National Voluntary Organizations Active in Disaster (NVOAD).

(b) The NRF is always in effect although the selective implementation of various elements allows flexibility to meet the unique requirements of any situation. It enables effective interaction among federal, state, local, tribal, private-sector, and other nongovernmental entities.

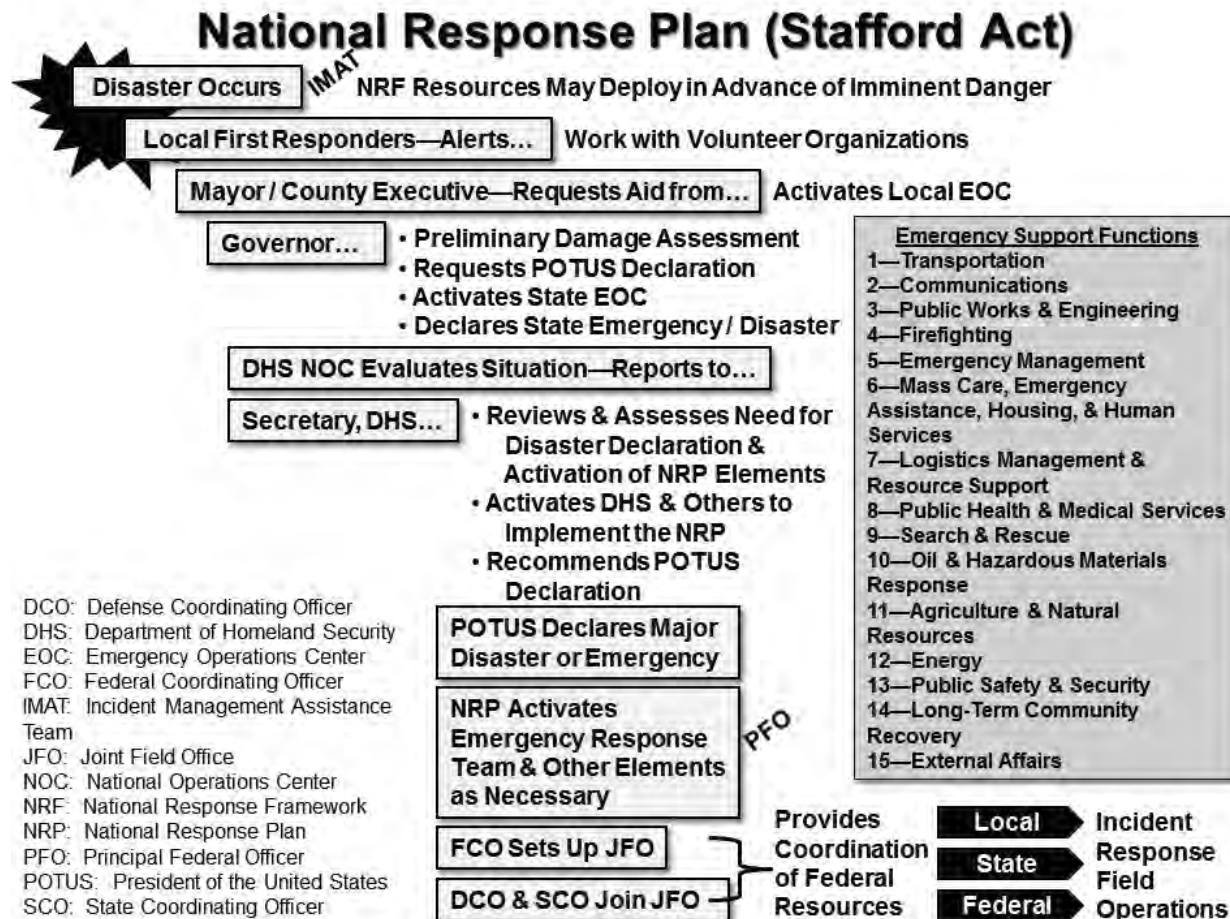

**Figure 20-1. National Response Plan (Stafford Act)**

(c) There are two broad categories of federal assistance for disasters and emergencies. The Robert T. Stafford Disaster Assistance and Emergency Relief Act provides the authority for coordinating federal responses to most disasters. Figure 20-1 provides a schematic of initial federal involvement under the Stafford Act. Figure 20-2 provides a diagrammatic overview of federal-to-federal support in non-Stafford Act situations.

### 20-9. Local Response

a. In the immediate aftermath of a disaster, local responders will arrive first on the scene. First responders normally include law enforcement, fire, emergency medical services (EMS), and HAZMAT teams. At the incident site, local authorities organize the various responders under the Incident Command System (ICS), a major component of the NIMS. Military forces conducting DSCA will interact with and be a part of an ICS structure.

b. Incident Command System. NIMS establishes ICS as the standardized organizational structure for the management of all domestic incidents, yet ICS provides more than just structure. ICS characteristics include: common terminology; modular organization; management by objective; reliance on an incident action plan; manageable span of control; and integrated communications. Within the ICS, there are five

# HOW THE ARMY RUNS

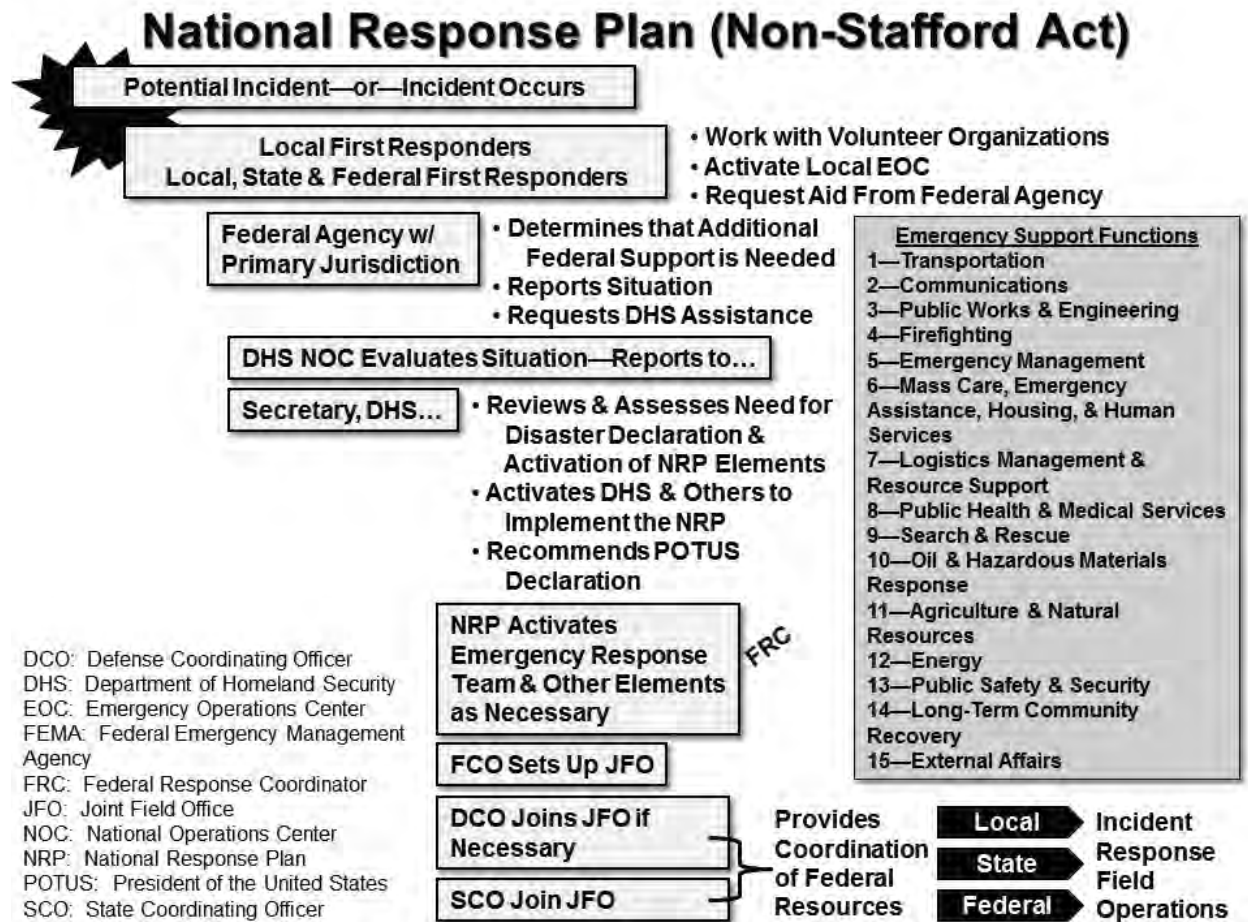

**Figure 20-2. National Response Plan (Non-Stafford Act)**

major functional areas; command, operations, logistics, planning, and finance/administration. Traditionally, information and intelligence functions are located in the planning section; however, if the situation warrants, NIMS ICS can separate intelligence out and add a sixth functional area. An ICS hallmark is the flexibility to accommodate all circumstances including floods, hazardous material accidents, aircraft crashes, and earthquakes—it is an all-hazard system. Flexible enough to manage catastrophic incidents involving thousands of response personnel, several levels of command are possible:

(1) A single command structure provides one commander a reasonable span of control. The incident commander is normally the senior responder of the organization with the responsibility for the event, (e.g., fire chief or police chief). The single incident commander establishes an incident command post to direct operations.

(2) Unified Command (UC). ICS has the flexibility for one or more agencies to coordinate and combine independent efforts should the situation dictate. ICS can transition from a single Incident Commander (IC) to a UC structure to enable agencies with different legal, geographic and functional responsibilities to coordinate, plan and interact effectively. In a UC structure, the individuals designated by their jurisdictional authorities jointly determine objectives, plans, and priorities and work together to execute them. UC as used by NIMS ICS is where the aforementioned unity of effort is manifested as all responding agencies and organizations work to support the IC without giving up individual agency authorities, responsibilities or accountability. An incident large enough to require DOD support will almost certainly be multi-jurisdictional UC.

(3) Area Command is established either to oversee the management of multiple incidents being handled by separate ICS organizations or to oversee the management of a very large incident that involves multiple ICS organizations. Area Command is activated only if necessary, depending on the

## Defense Support of Civil Authorities

complexity of the incident and span-of-control considerations. Area Command does not have operational responsibilities. Functions include: setting priorities; allocating resources according to established priorities; ensuring effective communications; ensuring that incident management objectives are met and do not conflict with each other or with policy.

c. To supplement their capabilities, local governments establish mutual aid agreements with surrounding communities. They are usually activated before local authorities request state assistance.

### 20-10. State Support

a. State Governors are empowered to execute the laws of their states. They are the Commanders in Chiefs of the state National Guard when serving in State Active Duty (SAD) or Title 32 status. Similar authorities are given to the Governors of U.S. territories and possessions. Once a disaster occurs, the Governor decides whether to honor a local government Request for Assistance (RFA) and, if appropriate, declares a state of emergency, activates the state response plan and calls up the National Guard under state orders. The Governor informs the FEMA regional director of these actions and when state resources are insufficient, requests federal assistance.

b. State Office of Emergency Services (OES). All states have an agency that coordinates and conducts emergency preparedness planning, training and exercises, and serves as the coordinating agency for the Governor in an emergency. The titles of these offices vary from state to state (e.g., Emergency Management Agency, Department of Public Safety, State Emergency Management Office, and Office of Emergency Preparedness). The OES is generally organized as a standalone office under the Governor, aligned under The Adjutant General (TAG) or the state police. The senior official in charge of OES varies by state. Some states have a separate Director of Emergency Services and Director of HS. Some states combine the positions and some states dual-hat their TAG as the Director of Emergency Services.

c. State National Guard forces are particularly well-suited to provide military support to local and state agencies. The National Guard in state status is the primary military responder during natural or man-made disasters and emergencies. It is familiar with local conditions and geography, and acting as a state militia, is not constrained by limitations on federal troops, principally the Posse Comitatus Act.

(1) The National Guard operates under one of three statuses: State status (state funding and state control); Title 32 status (federal funding and state control); or Title 10 status (federal funding and federal control). State CS missions are authorized by executive order of the Governor who reimburses the federal government for utilization of federal equipment and facilities. Employment of National Guard assets by the Governor is in accordance with state laws and constitutions.

(2) The State National Guard Joint Force Headquarters (JFHQ) organizes, trains, plans, and coordinates the mobilization of National Guard units and elements for state and federal domestic missions. Deployment and employment of the State National Guard is directed through the JFHQ.

d. In times of emergency, states often call on other states for help through standing agreements or emergency assistance compacts.

(1) The largest agreement is the Emergency Management Assistance Compact (EMAC). The EMAC expedites the employment of interstate emergency response assets and may involve all types of support to include National Guard forces. Assets provided by another state are under operational control of the Governor of the requesting state while assistance is being provided. Units especially suited to provide support for 'predictable' disasters, such as annual wildfires or hurricanes, are pre-arranged during annual EMAC conferences, greatly reducing response times.

(2) Requests for EMAC assistance are legally binding, contractual arrangements requiring the states requesting assistance to reimburse out-of-state costs for out-of-state personnel.

## Section III

### Federal Role in the National Response Process

#### 20-11. Primary Federal Departments and Agencies

a. Secretary of Homeland Security (SECDOHS), DHS, and FEMA. Pursuant to HSPD-5, the Secretary of HS is the principal federal official for domestic incident management within the U.S. to prepare for, respond to, and recover from terrorist attacks, major disasters and other emergencies. Acting through FEMA, the Secretary has responsibility to effectively manage federal response and recovery efforts.

## HOW THE ARMY RUNS

FEMA also initiates proactive mitigation activities, trains first responders, and manages the National Flood Insurance Program. FEMA Headquarters is in Washington, DC. There are ten regional offices, three logistics centers, two training centers, and other special purpose sites.

b. Attorney General of the U.S., Department of Justice (DOJ) and Federal Bureau of Investigation (FBI). Pursuant to HSPD-5, the Attorney General has responsibility for criminal investigations of terrorist acts or threats inside the U.S., or directed at U.S. citizens or institutions abroad, where such acts are within the federal criminal jurisdiction of the U.S. The Attorney General is also responsible for related intelligence collection within the U.S. subject to the National Security Act of 1947, other applicable laws and Executive Order 12333. Generally acting through the FBI, the Attorney General, in cooperation with other federal departments and agencies, coordinates the law enforcement activities to detect, prevent, preempt, and disrupt terrorist attacks against the U.S.

c. DOD. Understanding that DOD has significant resources that might be available to support federal domestic incident management efforts, HSPD-5 states, "The SECDEF shall provide military support to civil authorities for domestic incidents as directed by POTUS or when consistent with military readiness and appropriate under the circumstances and the law. The SECDEF shall retain command of military forces providing civil support."

d. Other Primary Departments and Agencies. Many of the federal agencies DOD could support, or with whom a habitual relationship exists during a DSCA event, are codified in the NRP's Emergency Support Function (ESF) framework (Table 20-1).

### **20-12. Federal Structure for National Response Force Response and Recovery**

a. The Regional Response Coordination Center (RRCC), located in each of the ten FEMA regions, is a standing facility operated by DHS/FEMA that coordinates regional response efforts, establishes federal priorities, and, when disaster strikes, coordinates federal support until a Joint Field Office (JFO) is established. The RRCC establishes communications with affected State Emergency Operations Centers (EOCs) and the DHS National Operations Center (NOC). FEMA and interagency representatives staff the RRCC as needed.

b. A Joint Field Office (JFO) is a temporary federal facility established in a disaster area to provide a central point for federal, state and local executives to coordinate their actions. Although the JFO uses an ICS structure and adapts to the magnitude of the situation, it does not manage on-scene operations. Instead, it focuses on providing support to on-scene efforts and conducting broader support operations that may extend beyond the incident site. When incidents impact multiple states or localities, multiple JFOs may be established. Using NIMS ICS principles of UC, JFO activities are directed by a JFO Coordination Group which may include the following officials:

(1) A Principal Federal Official (PFO) is personally designated by the Secretary of HS as a representative locally to oversee, coordinate and execute the Secretary's incident management responsibilities. The NRF states the PFO does not replace the incident command structure and does not have directive authority over the Federal Coordinating Officer (FCO) or the Senior Federal Law Enforcement Officer (SFLEO). The Secretary will designate a PFO only for complex, high-visibility catastrophic disasters, terrorist events or complex emergencies with significant national impact.

(2) FCO manages and coordinates the overall federal response and recovery activities for Stafford Act disasters and emergencies. The FCO is head of the JFO and works in partnership with the State Coordinating Officer (SCO) to determine and satisfy state and local support requirements. The FCO coordinates and tasks federal departments and agencies as required.

(3) Federal Resource Coordinator (FRC). In non-Stafford Act situations when a federal department or agency acting under its own authority requests DHS assistance to obtain support from other federal departments and agencies, DHS designates a FRC instead of an FCO. In these situations, the FRC coordinates support through interagency agreements and memorandums of understanding.

(4) Senior Federal Law Enforcement Officer (SFLEO) is the senior law enforcement official from the agency with primary jurisdictional responsibility. The SFLEO directs intelligence and investigative law enforcement operations and supports the law enforcement component of the UC on scene. In the event of a terrorist incident, this official will normally be the FBI Special Agent in Charge (SAC).

(5) Officials representing other federal departments or agencies with primary statutory responsibility for certain aspects of incident management are Senior Federal Officials (SFO). SFOs employ existing authorities, expertise and capabilities in coordination with the PFO, FCO, SFLEO and other members of the JFO Coordination Group.

## Defense Support of Civil Authorities

(6) SCO manages the state's incident management activities and is counterpart to the FCO. Another important official is the Governor's Authorized Representative (GAR). The JFO Coordination Group may also include tribal/local area representatives with primary statutory authority for incident management.

(7) The GAR provides executive oversight and direction of the disaster or emergency response and recovery on behalf of the Governor, executes all necessary documents on behalf of the state, and responds to the desires of the Governor.

(8) The Defense Coordinating Officer (DCO), typically an Army O6, represents DOD as the single point of contact, except for ESF #3, Public Works & Engineering, in the JFO. In this capacity, the DCO reporting chain remains through U.S. Northern Command (USNORTHCOM) but the DCO responds to the FCO. The DCO is responsible for validating all requests for DOD support from the FCO or his representative.

c. The NRF organizes emergency response into 15 Emergency Support Functions (ESF) according to the capabilities and resources most likely to be requested by state officials. ESFs are the primary means through which the federal government provides assistance during a disaster or emergency. DOD is more active in response as opposed to recovery.

(1) During an emergency, some or all of the ESF may be activated based on the nature and scope of the event and the level of federal resources required.

(2) DOD is the Primary Coordinating Agency for ESF #3 (Public Works and Engineering), with the U.S. Army Corps of Engineers (USACE) as the DOD lead. DOD is considered a support agency to all ESFs.

(3) DOD, DSCA, Automated Support System (DDASS) is utilized to manage, collaborate, coordinate, and prioritize FEMA Mission Assignments (MA) assigned to the DOD in real time. It provides the means for a Defense Coordinating Unit (DCU), one assigned to each FEMA region, to validate MAs and allow all Orders, Request for Forces (RFF) and FEMA MA forms to be associated with specific missions and provide multiple command situational awareness to view and respond to mission critical actions.

d. FEMA's four Federal Interagency Operational Plans (FIOPs): Protection, Response, Recovery, and Mitigation, greatly updated and expanded in 2016, provide a detailed description of roles and responsibilities, specifies the critical tasks, and identifies Federal resourcing requirements for delivering national preparedness core capabilities for each of the four mission areas. Incident-specific annexes, such as the Nuclear/Radiological Incident Annex to the Response and Recovery Federal Interagency Operational Plans, explores likely disaster scenarios to a high fidelity to assist planners and exercise designers.

### 20-13. Promoting Federal-State Unity of Effort

a. Unity of effort between the federal government and states must be one of DOD's guiding principles in the homeland, since unifying DOD's efforts with those of its external partners improves collaboration and shortens response times for meeting life-saving needs during emergencies. The Council of Governors—established by Executive Order in 2010—is an essential forum for enhanced, senior-level dialogue among federal and state civilian and military officials for this purpose.

b. As DOD seeks a closer and more highly coordinated relationship between federal and state military disaster response elements, it prioritizes these capabilities and activities to achieve unity of effort in the period covered by this strategy.

c. Trained and certified dual status commanders. DOD regards dual status commanders as the usual and customary Command and Control (C2) arrangement in cases where federal military and state National Guard forces are employed simultaneously in support of civil authorities within the U.S.

(1) POTUS may authorize a National Guard officer of a state or a commissioned officer of the Regular Army or the Regular Air Force to serve as a dual status commander, with the consent of the applicable state or territorial Governor. The dual status commander has authority over both state military forces (e.g., National Guard forces in a SAD or Title 32 status) and federal military forces. Only the commander holds dual status, not the commander's staff(s). Forces in the command retain their federal and state chains of command. The dual status commander must, therefore, exercise his authority in a mutually exclusive manner, respecting the often different laws and policies, as well as Commanders in Chief, applicable for both types of forces under his command. When a commander is in dual status (e.g., Title 10 and Title 32), the Governor recommends and the POTUS approves this individual being a dual status commander). The purpose of this status is so the commander can command, control, and coordinate all resources that are either federal or state. This authority allows the commander to coordinate and de-

## HOW THE ARMY RUNS

conflict federal and state operational assignments while respecting the state and federal chains of command.

(2) Historic examples of the employment of dual status commanders include national special security events such as the Democratic and Republican national conventions as well as responses to disasters like Hurricanes Sandy and Maria, and wildfires in the Western U.S.

### 20-14. Emergency Support Function—3 (Public Works and Engineering)

a. USACE's long history of providing CS for flood control, water quality, and hazard mitigation under Public Law 84-99 make it the logical organization to serve as primary agency for ESF-3, Public Works and Engineering. The geographically dispersed location of USACE offices facilitates timely response to disasters in almost any area. The USACE is divided by watershed drainage basins into regional divisions that are subdivided by smaller drainage basins into districts. Personnel are also assigned to various field offices throughout each district. During disasters, USACE personnel quickly mobilize to assist in response and recovery.

b. Each USACE division and district has an emergency operations manager and each office develops plans based on hazards unique to its area, coordinates with appropriate agencies, and identifies response teams to support the assigned missions in the NRF. Types of assistance provided by USACE under ESF #3 include: technical advice and evaluations; engineering services; construction management and inspection; emergency contracting; emergency repair of wastewater and solid waste facilities; real estate support. Some ESF-3 activities include: emergency debris clearance; restoration of critical public services and facilities, including supply of adequate amounts of ice and potable water; temporary restoration of water supply systems; technical assistance; structural evaluation of buildings; and damage assessment. By law, USACE assistance is limited to the preservation of life and protection of residential and commercial developments, to include public and private facilities that provide public services. Exclusive assistance to individual homeowners and businesses, including agricultural businesses, is not authorized. However, during periods of extreme drought, assistance may be provided to farmers and ranchers under some circumstances.

**Table 20-1. Federal Response Plan Emergency Support Functions**

|  | Responsibility  | ESF Coordinator                                     |
|--|---|---|
| ESF 1: Transportation  | Provide civilian & military transportation support  | Department of Transportation                        |
| ESF 2: Communications  | Provide telecommunications support  | DHS, National Communications System                 |
| ESF 3: Public Works and Engineering                              | Restore essential public services & facilities  | DOD, U.S. Army Corps of Engineers                   |
| ESF 4: Fire Fighting   | Detect and suppress wild land, rural & urban fires.   | Department of Agriculture, U.S. Forest Service      |
| ESF 5: Information Planning                                      | Support overall federal activities for domestic Incident Management   | DHS, FEMA   |
| ESF 6: Mass Care, Emergency Assistance, Housing & Human Services | Manage and coordinate food, shelter and first aid for victims; provide bulk distribution of relief supplies; operate a system to assist family reunification. | DHS, FEMA   |
| ESF 7: Logistics Management & Resource Support                   | Provide equipment, materials, supplies and personnel to federal entities during response  | General Services Administration (GSA) and DHS, FEMA |
| ESF 8: Public Health & Medical Services                          | Provide assistance for public health and medical care needs   | Department of Health and Human Services (HHS)       |
| ESF 9: Search and Rescue   | Locate, extricate and provide initial medical treatment to victims trapped in collapsed structures.   | DHS, FEMA   |
| ESF 10: Oil & Hazardous Materials Response                       | Support federal response to actual or potential releases of oil and hazardous materials   | Environmental Protection Agency (EPA)               |



## Defense Support of Civil Authorities

|   | Responsibility  | ESF Coordinator           |
|---|---|---------------------------|
| ESF 11: Agriculture & Natural Resources | Provides nutrition assistance, assurance of food safety and food security, control, and eradication of devastating animal disease or plant pest infestation | Department of Agriculture |
| ESF 12: Energy                          | Restore power systems and fuel supplies.  | Department of Energy      |
| ESF 13: Public Safety & Security        | Provide non-investigative/non-criminal law enforcement, safety and security capabilities  | DOJ                       |
| ESF 14: Long Term Community Recovery    | Provides a framework for federal support to enable community recovery from the long-term consequences of Incidents of National Significance                 | DHS, FEMA                 |
| ESF 15: External Affairs                | Provide public affairs, community relations, Congressional affairs, state & local coordination  | DHS, FEMA                 |

c. Each FEMA regional office is responsible for maintaining an Incident Management Assistance Team (IMAT) and developing appropriate procedures for its notification and deployment. Composed of staff from FEMA and other agencies, it provides administrative, logistical, and operational support to the regional response activities in the field. Likely the first federal response element to arrive in a disaster area, the IMAT can form the core of the Joint Field Office (JFO) once it is established. It also provides support for the dissemination of information to the media, Congress, and the public.

d. There are numerous other federal special teams available to support incident management and domestic response and recovery to include:

- (1) Hurricane Liaison Team (HLT).
- (2) Mobile Emergency Response Support (MERS).
- (3) DHS Situational Awareness Team (DSAT).
- (4) Damage assessment teams.
- (5) Federal Incident Response Support Teams (FIRSTs).
- (6) Nuclear Incident Response Team (NIRT).
- (7) Disaster Medical Assistance Teams (DMATs).
- (8) HHS Secretary's Emergency Response Team.
- (9) DOL/OSHA's Specialized Response Teams.
- (10) Veterinarian Medical Assistance Teams (VMATs).
- (11) Disaster Mortuary Operational Response Teams (DMORTs).
- (12) National Medical Response Teams (NMRTs).
- (13) Scientific and Technical Advisory and Response Teams (STARTs).
- (14) Donation Coordination Teams.
- (15) Urban Search and Rescue (US&R) task forces.
- (16) Federal Type 1 and Type 2 Incident Management Teams.
- (17) Domestic Emergency Support Team.
- (18) Domestic Animal and Wildlife Emergency Response Teams and Mitigation Assessment Teams.

### 20-15. DSCA Structure

Combatant Commands (CCMD) serve as the DOD principal planning agents and supported organizations for geographic areas designated in the Unified Command Plan (UCP). They validate requests for military assistance in their Areas of Responsibility (AOR) and provide DSCA. There are two CCMDs with responsibility for parts of the U.S. homeland.

a. USNORTHCOM is responsible for planning, organizing, and executing all aspects of HD and performing DSCA missions within the continental U.S., Alaska and territorial waters, including Puerto Rico and the U.S. Virgin Islands. USNORTHCOM has few permanently assigned forces, but will have authority over forces necessary to execute missions directed by POTUS or SECDEF.

## HOW THE ARMY RUNS

b. USINDOPACOM is responsible for the Indo-Asia-Pacific region and is responsible for all aspects of HD and DSCA on US territory in that region.

c. U.S. Army Forces North (USARNORTH), Fifth U.S. Army, located at Fort Sam Houston, Texas provides USNORTHCOM with a dedicated Army Service Component Command (ASCC) for HD and DSCA.

(1) There are ten Defense Coordinating Officers (DCO) permanently assigned to USARNORTH. When not deployed, DCOs are assigned to USARNORTH with duty in one of the ten FEMA Regions.

(2) Defense Coordinating Element (DCE). The DCE is manned by military and civilian personnel and functions as the DCO's staff. The DCE optimally contains a small Active Duty / DA Civilian team, and representatives from the Army Reserve, Air Force Reserve, Marine Forces Reserve and the Coast Guard Reserve.

(3) Each state, territory, and FEMA region has assigned Reserve officers, typically O-6s, from the Air Force, Army, Navy, and Marines who are trained in disaster preparedness and military support matters. There are over 425 Emergency Preparedness Liaison Officers (EPLO); Regional Emergency Preparedness Liaison Officers (REPLO), or State EPLOs (SEPLO) assigned nationwide. They have a comprehensive knowledge of their service facilities and capabilities within their assigned area. SEPLOs assist in determining what DOD resources exist within the state, territory, or region and assist in coordinating the Title 10 response. SEPLOs typically report to their respective State EOC or National Guard EOC during a response and represent the DCO.

### Section IV Defense Support Process

#### 20-16. Planning Considerations

Paragraph 20-5 described DOD's Philosophical DSCA Principles and these principles become the basis for planning and executing DSCA missions. Some additional considerations follow:

a. National Guard forces serving on SAD status have primary responsibility for providing military assistance to state and local authorities in emergencies. DSCA planning and execution must foster a close and continuous coordination with the National Guard to ensure unity of effort.

b. Army Reserve forces have extensive capability often located close to a disaster. IAW 10 U.S.C. 12304a, when a governor requests federal assistance in responding to a major disaster or emergency, the SECDEF may, without the consent of the member affected, order any unit of the Army Reserve, Navy Reserve, Marine Corps Reserve, and Air Force Reserve to active duty for a continuous period of not more than 120 days to respond to the Governor's request. A Dual Status (Title10/32) Commander is typically appointed to direct the force's efforts in these instances.

c. Military support will generally be of short duration (generally not exceeding 30 days) to assist civil agencies with establishing essential safety and security.

d. The termination of DSCA and disengagement of DOD resources is a sensitive topic that requires planning consideration from the beginning.

e. Rules of the Use of Force (RUF) serve essentially the same purpose for domestic operations that Rules of Engagement (ROE) serve overseas.

f. Military intelligence assets are prohibited from engaging in intelligence collection activities against U.S. persons (with very limited exceptions clearly specified in law and Executive Order 12333). While there are legal provisions allowing for the use of defense intelligence collection resources in support of domestic incident management, DSCA planners need to be particularly sensitive to statutory limitations on the use of such resources.

g. Defense Planning and Coordination (DPC) is a proposed concept to make use of existing DOD DSCA planning and liaison assets as an effective mechanism for supporting state and federal disaster planning and coordination.

#### 20-17. DSCA Request for Assistance Process

DOD provides its disaster and emergency support of FEMA in response to approved FEMA Mission Assignments (MAs). Most FEMA MAs are generated at the FEMA regional offices or joint field offices based upon requests from State and local officials. Some FEMA MAs are generated at the national level and normally are employed when FEMA is attempting to pre-position capabilities in advance of State and

## Defense Support of Civil Authorities

local needs. As much as possible, Pre-Scripted Mission Assignments (PSMAs) are used to develop FEMA MAs. PSMAs are typically groups of units and capabilities that function best when teamed together. PSMAs may be scaled to meet any given need.

a. FEMA MAs from an FCO (FEMA Regions or Joint Field Office (JFO)).

- (1) The FCO presents a FEMA MA to the DCO.
- (2) The DCO validates the MA using criteria in DoDD 3025.18, including:
  - (a) Legality (compliance with laws).
  - (b) Lethality (potential use of lethal force by or against DOD forces).
  - (c) Risk (safety of DOD forces).
  - (d) Cost (including the source of funding and the effect on the DOD budget).
  - (e) Appropriateness (whether providing the requested support is in the interest of DOD).
  - (f) Readiness (impact on DOD's ability to perform its other primary missions).

(3) The CCDR (USNORTHCOM or USINDOPACOM) may approve MAs within the CCDR's existing authorities (e.g., standing SECDEF -approved EXORD).

(4) If the CCDR does not have the authority to approve the MA, the CCDR forwards the MA to Joint Staff /Homeland Defense Division, DSCA Branch (J33). Joint Staff/J33 forwards the request to office of the Assistant Secretary of Defense for Homeland Defense and Global Security (ASD(HD&GS)) and the DOD Executive Secretariat for staffing (OSD-level) and SECDEF decision. The ASD(HD&GS) has been delegated the authority to approve requests for certain forms of assistance in accordance with DoDD 5111.13. The Joint Staff/J33 prepares an EXORD for SECDEF approval, if appropriate. If approved, DOD provides support. For life-saving and time -sensitive MAs, the approval may be made verbally with confirmatory documents to follow.

b. FEMA MAs From the FEMA Administrator (National Level).

There are occasions where the FEMA Administrator may request that federal partners provide capabilities without a FEMA region request.

(1) The FEMA Administrator may present a FEMA MA to the DOD liaison element at the National Response Coordination Center (NRCC).

(2) The DOD liaison element at the NRCC conducts the necessary coordination to ensure that the DCOs in the affected FEMA regions understand the purpose of the Administrator's MA. DOD may deploy the requested capability to a DOD installation and be prepared to employ when the affected FEMA region requests the capability.

(3) The DCO in the affected region processes employment of the FEMA MA.

(4) If the FEMA region JFO in which the requested capability will be employed is not activated, the DOD LNO element at the NRCC will forward the MA to the geographical CCDR (CDRUSNORTHCOM or CDR USINDOPACOM). The CCDR may approve MAs within the CCDR's existing authorities (normally pursuant to a standing SECDEF approved EXORD).

(5) If a CCDR does not have the authority to approve the MA, the CCDR forwards the MA to Joint Staff/J33 for staffing and SECDEF decision. SECDEF has delegated the authority to approve requests for certain forms of assistance, in accordance with DoDD 5111.13.

### 20-18. Immediate Response Authority (IRA)

Unique circumstances allow commanders to respond immediately, without requesting approval, to imminently serious conditions that are beyond the capability of local authorities. Local commanders can respond on their own authority to requests for assistance to save lives, to prevent human suffering, and to mitigate great property damage. Once initiated, the commander must inform the DOD Executive Agent through command channels as soon as possible but no less than three hours; this notification is not a request for approval. Associated costs should be recorded for potential reimbursement later. Immediate response is normally of short duration, DOD policy suggests no longer than 72 hours after which formal approval should be obtained if continued support is required.

### 20-19. Emergency Authority

This authority is provided in DODD 3025.18. In extraordinary emergency circumstances where prior authorization by POTUS is not possible and duly constituted local authorities are unable to control a situation, federal military commanders have the authority to engage temporarily in activities that are necessary to quell large-scale, unexpected civil disturbances. Such activities need to be necessary to prevent significant loss of life or wanton destruction of property and should be necessary to restore

## HOW THE ARMY RUNS

governmental function or public order. The other circumstance appropriate leading to the implementation of emergency authority is when duly constituted federal, state or local authorities are unable or decline to adequately protect federal property or federal governmental functions.

### **20-20. Media Considerations**

a. During DSCA operations, the media provides invaluable services that can benefit both responding organizations and the public. When considering what information can and should be released to the media, leadership should consider: the need to get accurate and timely information to the public; sensitivity of the information; the possibility of causing panic; building confidence and hope within the affected communities; and correction of false information caused by rumors and distorted reporting. Leadership should strive to ensure the media get as complete and accurate a story as possible, while ensuring that their activities do not adversely affect public safety or compromise the response activities.

b. A Joint Information Center (JIC) is usually established to interface with the media. While DOD representatives are usually represented, it is generally in the nation's interest that, whenever possible, there is a local or state spokesperson engaging the media as opposed to a federal, including active duty military, spokesperson.

c. For major incidents, DOD will publish public affairs guidelines applicable to all participating DOD organizations. The guidance will outline any constraints and the policies for media interaction and contain relevant command messages. Two common command messages are often addressed; civilian authorities are in charge, and military forces are supporting the nation in time of need.

## **Section V**

### **DSCA Mission Category—Disasters and Declared Emergencies**

#### **20-21. Department of Defense National Response Force Response Process**

a. When a disaster occurs and local and state resources are inadequate, POTUS invokes the Stafford Act with a Presidential disaster declaration, thereby releasing Disaster Relief Fund (DRF) monies. While DOD will often take risk with regard to reimbursement and execute some pre-declaration actions, DOD involvement formally begins after the declaration. The JDOMS execute order (EXORD) designating the supported CCDR will also designate supporting DOD agencies and direct the CCDR to appoint a DCO.

b. The DCO activates the DCE and deploys to the JFO to coordinate DOD support for the disaster. Designated federal forces respond to taskings for support validated by the DCO. The DCO has OPCON of all DOD personnel (less ESF #3) deployed in support of the disaster unless a JTF is established. The DCO will receive requests for assistance from the FCO as already described.

c. Tiered Mission Command Options. Based on the type and magnitude of an emergency or disaster, USNORTHCOM will establish C2 relationships based on a flexible, tiered construct.

(1) Small Scale Events can be handled by a DCO, his DCE and EPLOs.

(2) Medium Scale Events require deployment of a C2 headquarters such as JTF-CS or one of USARNORTH's two Operational Command Posts. While there could be exceptions, a medium scale Joint Task Force (JTF) is likely to be commanded by a two star flag officer. The NRF directs that if a JTF is established, its C2 element will be collocated with the PFO at the JFO to ensure coordination and unity of effort.

(3) Large scale events, usually employing multiple JTFs, require an overarching JTF or functional component command. While there could be exceptions, these headquarters will most likely be commanded by a three star flag officer. Any level headquarters can be augmented with special expertise such as a Joint Planning Augmentation Cell (JPAC).

d. Dual Status Command Option. See paragraph 20-13.

e. The supported CCDR will designate a Base Support Installation (BSI), at least one for each disaster. A BSI is a military installation designated to provide joint administrative and logistical support to DOD forces. Selection is based on geographic proximity to an operation, functional capability, and coordination with service regional planning agents.

#### **20-22 DOD Incident Response**

a. The DSCA Standing Execute Orders (EXORDs) empower the CCDR to more rapidly respond in support of a primary federal agency. There are Standing EXORDs for natural or manmade disasters

## Defense Support of Civil Authorities

short of terrorist attack and a separate EXORD for a CBRN incident. The DSCA Standing EXORD specifies four distinct categories of CCDR authorizations from assigned forces (Category 1) to those forces required for large-scale response (Category 4).

b. Pre-Scripted Mission Assignments (PSMA) assist with ensuring support is delivered as rapidly as possible. PSMA are “fill-in-the-blank” templates for the most likely capabilities to be requested of DOD.

c. Request For Forces (RFF). As an exception to the usual RFA process, USNORTHCOM authorizes DCOs to more quickly respond to anticipated requirements by using the RFF process. They do, however, anticipate reimbursement by including a cost estimate.

d. Joint Publication 3-28 Defense Support of Civil Authorities provides commanders and staffs overarching doctrine for conducting DSCA operations. It specifies three phases that align with FEMA’s CONOPS and deviate from the notional phasing construct. The three phases are:

- (1) Phase 1—Pre-Incident.
  - (a) Phase 1a – Normal Operations.
  - (b) Phase 1b – Elevated Threat.
  - (c) Phase 1c – Credible Threat.
- (2) Phase 2—Response.
  - (a) Phase 2a – Initial Response.
  - (b) Phase 2b – Deployment of Resources and Personnel.
  - (c) Phase 2c – Sustained Response.
- (3) Phase 3—Recovery and Transition.

### **20-23. Unique Chemical, Biological, Radiological, Nuclear (CBRN) Response Considerations**

a. CBRN is defined as a chemical, biological, radiological, or nuclear incident including industrial accidents, acts of nature, war or terrorism. A Weapon of Mass Destruction (WMD) is a Chemical, biological, radiological, or nuclear weapon capable of a high order of destruction or causing mass casualties, and excluding the means of transporting or propelling the weapon where such means is a separable and divisible part from the weapon.

b. CBRN Planning Considerations. Unique considerations for CBRN planning include that incidents may not be initially recognized as CBRN until there are multiple CBRN-specific casualties. For example, an explosive Radiological Dispersal Device (RDD) may be first identified as an IED until someone checks for radiation. Radiation-specific casualties from even a highly radioactive RDD may take significant time to appear. Once identified as a CBRN event, an incident location will probably be treated as a crime scene. Responders will be at a higher risk of becoming casualties and the effects may contaminate critical facilities and infrastructure in the area. Planners must anticipate mass casualty decontamination and CBRN-specific mortuary affairs support. In addition to expecting that the response demands will exceed state and local capabilities, planners must remain ready for multiple attacks. FEMA’s new Incident Annexes, such as the Nuclear/Radiological Incident Annex to the Response and Recovery Federal Interagency Operational Plans (FIOP), are of high value to CBRN DSCA Planners and exercise designers.

c. State National Guard CBRN Structure / CBRN Response Enterprise (see Figure 20-3). In October 1998, to enhance the national capability to deal with CBRN CM, Congress authorized and funded the first ten National Guard Rapid Assessment and Initial Detection (RAID) Teams, renamed Civil Support Teams

## CBRN Response Enterprise

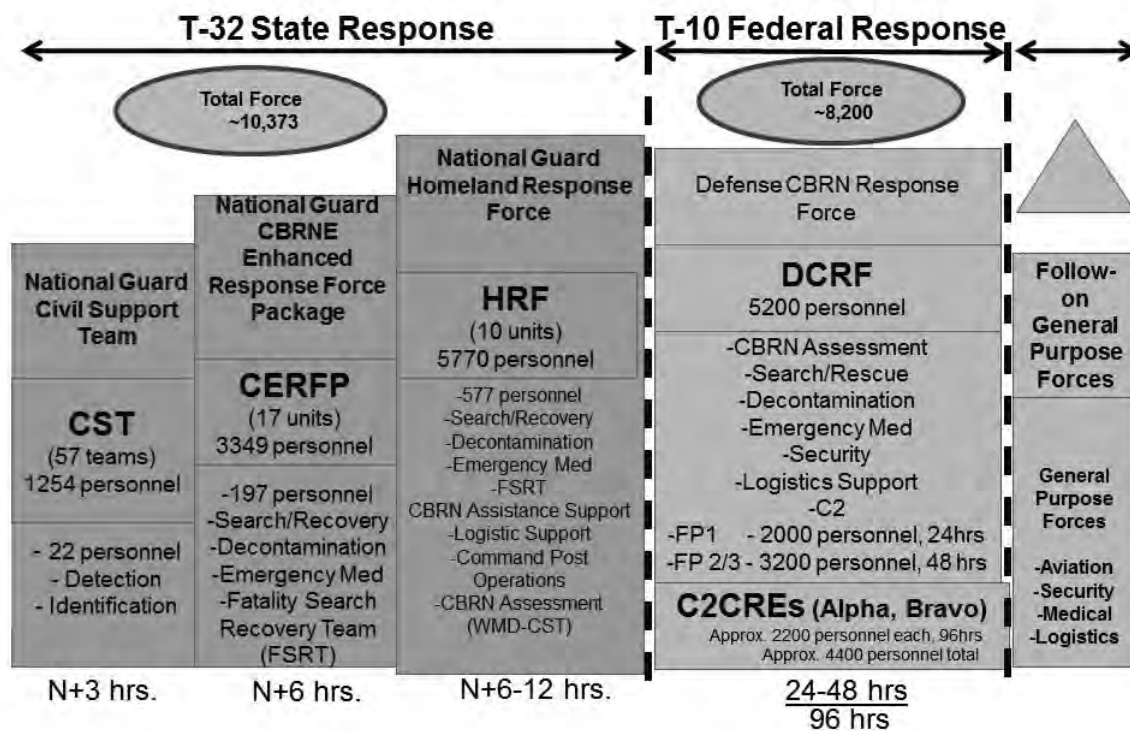

Figure 20-3. CBRN Response Enterprise

(CSTs). Larger, more capable organizations covering multiple states soon emerged, although these remain under State National Guard control.

(1) CSTs. The 57 CSTs nation-wide are comprised of 22 full-time Title-32 National Guard Soldiers, highly trained in a cross-discipline of functional areas. Their mission is to deploy; assess a situation; detect and identify CBRN materials, advise local, state, and federal response elements and facilitate sound public safety decisions. CSTs are unique, in that they are one of a few DOD units authorized by Congress to conduct CBRN response within CONUS. CSTs are a national resource and can move across state lines and provide support to another state, but are still maintained under state control. CSTs can deploy within three hours (plus travel distance) and are commonly pre-deployed in support of key events.

(2) The CBRNE Enhanced Response Force Package (CERFP) is designed to rapidly deploy in less than six hours. The 17 National Guard CERFP teams provide a regional response capability to augment the CSTs. They can locate and extract victims from a CBRN incident site, perform mass casualty decontamination, medical triage, and stabilization. They also include a Fatality Search Recovery Team (FSRT). CERFPs are task organized from existing units.

(3) HRF. As it became clear that the DOD's federal response was too slow to respond to a catastrophic CBRN incident, the idea of creating a regional response from National Guard assets was proposed. The ten HRFs (one in each FEMA region) are assigned 577 personnel and consist of Chemical, Biological, Radiological, and Nuclear (CBRN) assessment, search/extraction, decontamination, emergency medical, security, logistics support, and C2. HRFs deploy in 6-12 hours plus travel time.

d. DOD's Federal CBRN Structure / CBRN Response Enterprise.

(1) Defense CBRN Response Force (DCRF) is a joint, multi-component (primarily COMPO I) organization that provides DOD's federal CBRN response of 5,200 Soldiers to augment ten National Guard regional Homeland Response Forces (HRF). Capabilities include search and recovery,

## Defense Support of Civil Authorities

decontamination and logistic support. DCRF Force Package I, consisting of the first 2000 Soldiers, deploys in 24 hours, with the remaining forces arriving in 48 hours.

(2) Command and Control CBRN Response Element (C2CRE) is a Reserve Component organization that provides a federal military CBRNE response of about 2000 troops to augment ten National Guard regional Homeland Response Forces (HRF) in place of the RCCMRF. There are currently two C2CREs; C2CRE-A is primarily COMPO III and C2CRE-B is primarily COMPO II. C2CREs arrive within 96 hours of a CBRN event.

e. Non-DOD Federal CBRN Response: It is beyond the scope of this chapter to detail an exhaustive list of federal CBRN response assets but the reader should know that significant federal capabilities exist and have an appreciation for the roles and missions of organizations DOD might encounter or support.

(1) Department of Energy (DOE) Nuclear Emergency Support Teams (NEST) provide specialized response to the technical aspects of an unresolved incident involving nuclear or radiological devices. Capabilities include search and identification of nuclear materials, diagnostics and assessment of suspected nuclear devices, technical operations in support of render safe procedures and packaging for transport to final disposal.

(2) Environmental Protection Agency Environmental Response Teams (EPAERT) and Radiological Emergency Response Team (RERT) deal with the human health and environmental impact of terrorist attacks. The EPA's research laboratories offer field monitoring and technical support to quality-assurance programs for air, water, wastewater and solid waste. Some of these laboratories are capable of deploying mobile units to a contaminated site.

(3) The FBI Hazardous-Materials Response Unit (HMRU) has specialized sampling, detection and identification capabilities of NBC agents. Evidence Response Teams (ERTs) provide crime-scene documentation and evidence collection in support of criminal investigations.

(4) U.S.C.G National Strike Force is trained and equipped to assist in responding to major oil or hazardous material spills, particularly in a maritime environment.

(5) Department of Health and Human Services (HHS) coordinates the National Medical Response Teams for WMD that deal with the medical consequences of incidents involving CBRN. In addition, HHS' Centers for Disease Control and Prevention has special responsibilities in the event of terrorism involving infectious agents.

f. DOD has other organizations that assist with the response to a CBRN event.

(1) Defense Threat Reduction Agency (DTRA) exists to safeguard the U.S. and its allies from WMD (CBRN) by providing capabilities to predict, model, reduce, eliminate and counter the threat and mitigate CBRN effects.

(2) USMC Chemical-Biological Incident Response Force (CBIRF) responds to CBRN incidents to assist local, state or federal agencies and designated CDRs with CM operations. CBIRF capabilities include agent detection and identification, casualty search and rescue, personnel decontamination and emergency medical care to stabilize contaminated victims.

(3) U.S. Army 20th Chemical Biological Radiological Nuclear Explosives (CBRNE) Command (CMD) integrates, coordinates, deploys and provides trained and ready forces. It is also prepared to C2 CBRNE operations. The 20th CBRNE CMD provides training and readiness oversight of Army CBRNE assets (active and reserve) to include the 22d Chemical Battalion, 52d Ordnance Group and the US Army Reserve Consequence Management Unit (CMU).

(4) All the services have Explosive Ordnance Disposal (EOD) units. The Army has chemical brigades, battalions, and companies which mostly reside in the reserve component. The Edgewood Chemical Biological Center is the principal research and development center for chemical and biological defense technology.

(5) U.S. Army Medical Command (MEDCOM) also provides a variety of CBRN support. The U.S. Army Medical Research Institute of Chemical Defense (USAMRICD) and U.S. Army Medical Research Institute of Infectious Diseases (USAMRIID) not only conduct research, but provide teams to advise and assist with the medical aspects of incidents. MEDCOM also provides operational Special Medical Augmentation Response Teams (SMART) to provide emergency medical response and a variety of other related services in support of a terrorist attack. These teams can also respond to a non-CBRN natural disaster.

# HOW THE ARMY RUNS

## Section VI

### Defense Support of Civil Authorities Mission Category—Restore Public Health and Services and Civil Order

#### 20-24. Support to Law Enforcement

a. When armed and so used, military forces, will adhere to the Standing Rules for the Use of Force (SRUF), unless the SECDEF has approved mission-specific RUF.

(1) The Posse Comitatus Act of 1878 (PCA), subsequent amendments and policy decisions prohibits the use of federal military forces (to include reserve component forces) to perform internal police functions. PCA, thus, restricts the type of support DOD can provide to domestic law enforcement organizations.

(2) There are a wide variety of exceptions to the PCA, but the law essentially gives POTUS all the authority needed to employ DOD forces inside the U.S.; although there may appropriately be political consequence that would inhibit such employment. The PCA law itself makes provision for POTUS's Article II Constitutional authority. The Act does not pertain to the National Guard when in state status, nor does it apply to the U.S. Coast Guard. There are also a variety of statutory exceptions such as the Protection of Nuclear Materials Act (18 U.S.C. 831), Chemical-Biological Terrorism (10 U.S.C. 382), and Secret Service Assistance (10 U.S.C. 3056). The most renowned statutory exception is The Insurrection Act (10 U.S.C. 251-255), which applies primarily to responses to civil disturbances.

b. POTUS is authorized by the Constitution and 10 U.S.C. 251-255 to suppress insurrections, rebellions, and domestic violence by issuing a Cease and Desist Order (CDO). After issuing a CDO, POTUS issues an executive order that directs the Attorney General and the SECDEF to take appropriate steps to disperse insurgents and restore law and order. The Attorney General is then responsible to coordinate the federal response to domestic civil disturbances. The restrictions of the PCA no longer apply to federal troops executing the orders of POTUS to quell the disturbance in accordance with RUF approved by the DOD General Counsel and the Attorney General.

#### 20-25. Other Types of Public Health and Services DSCA

a. In the event of a work stoppage or disaster leading to disruption of mail service, DOD may be required to provide support to the U.S. Postal Service (USPS) to safeguard process and deliver the mail to areas in which service has been impaired.

b. DOD would provide the U.S. Department of Agriculture (USDA) assistance for emergencies requiring the containment and eradication of plant or animal diseases.

c. DOD medical support would generally be provided to Department of Health and Human Services (DHHS) using the mechanisms of NRP ESF#8 (Health and Medical Services). An important aspect of the ESF#8 process is the National Disaster Medical System (NDMS), a public, private sector partnership involving DHS, DHHS, DOD, and Department of Veteran Affairs. Assisting in the enforcement of quarantines is specifically allowed by DOD under Posse Comitatus.

d. The Environmental Protection Agency (EPA) and DHS-U.S. Coast Guard have responsibilities for oil and hazardous substance spills.

e. The National Interagency Fire Center (NIFC), a joint Department of Agriculture and Department of Interior organization is responsible for coordinating the federal response to wild fires. DOD provides resources for the containment, control and extinguishing of wild fires on lands owned by the federal government.

f. Mass immigration emergencies could result in DOD providing other federal agencies with support such as installations and services associated with housing migrants while the Immigration and Naturalization Service resolves the administrative requirements for migrants to enter the U.S.

## Section VII

### DSCA Mission Category—Special Events and Planned Periodic Support

#### 20-26. DSCA Mission Category—Special Events

a. Pursuant to HSPD-7, the Secretary of HS, after consultation with the HS Council (HSC), is responsible for designating events as an NSSE. These special events of national significance can be political, economic, or international sporting events. When an event is designated an NSSE, the Secret



## Defense Support of Civil Authorities

Service assumes its mandated role as lead for security planning and DOD supports the USSS. Examples of military assets that may be deployed include EOD, technical escort unit teams, and CBRN assets. If an incident occurs at an NSSE, the FBI leads the law enforcement and criminal investigation efforts, and FEMA leads response and recovery efforts. Most events are not designated NSSEs, but may still receive DOD support.

b. JDOMS plans, coordinates, and monitors execution of approved DOD support to other special events as categorized by the DHS Special Events Working Group. Events of a lesser significance are designated Special Events for HS (SEHS) levels 1 to 4, SEHS Level 4 being the lowest priority. DOD focuses on support related to public safety and security, including but not limited to, physical security, aviation, logistics, communications, joint operations and command centers, and explosive ordnance disposal support. DOD support for events may be reimbursable or non-reimbursable depending on the type of support provided and the nature of the event.

c. DOD is authorized under 10 U.S.C. 2564 to provide support to international sporting competitions (SISC) if the Attorney General certifies that support is essential to the safety and security of the event. Congress has established a revolving fund to cover SISC operational expenditures.

d. DOD supports other special events as demonstrated by the many State Designated Special Events that National Guard forces support while on state status under a governor's control.

### **20-27. DSCA Mission Category—Periodic Planned Support**

a. This category enhancing civil-military relations includes DOD laboratory support; specialized and mobile training programs; participation in local, state and federal emergency management exercises; support provided to the Secret Service under 18 U.S.C. 3056; and provision of military bands or honorary fly-over at civic events. It includes Military community affairs programs and community relations programs administered by the Assistant Secretary of Defense for Public Affairs.

b. Installation commanders are authorized under the Installation Mutual Aid Agreements, 42 U.S.C. 1856a-c to enter into limited mutual aid agreements with local communities, usually for fire, emergency medical or hazardous material response. It should be noted that while such memorandums may improve understanding about what resources DOD may be able to provide, they do not constitute preapproved support. Requests must be approved or be provided under some established authority such as Immediate Response authority.

c. Military Assistance to Safety and Traffic (MAST), governed by DODD 4500.09E, authorizes medical helicopter units to provide emergency assistance if local resources are not available or are not sufficient to respond to emergencies. Under this directive, there is no reimbursement, units may not relocate to provide service, and they must operate within their allocated training hour program.

## **Section VIII**

### **Summary and References**

#### **20-28. Summary**

a. The U.S. has a time-tested tradition of civilian control over the military and of limiting military activity within its borders. Balancing that valued tradition with the need for military support in response to disaster and acts or threats of terrorism within the U.S. requires approval by the most senior civilian officials within the U.S. government.

b. The military has available a unique blend of skilled personnel and equipment capable of rapid and effective responses in support of appropriate civil authority. By policy, requests for military resources are only approved when the capacity or resources of other federal, state, and local agencies is exceeded and the crisis remains unresolved.

c. The military continues to provide reliable and responsive DSCA. Moreover, the Army's extensive experience in supporting civil authorities during peacetime disasters, national security emergencies, and special events enhances HS and has kept the U.S. Army in the forefront of domestic disaster response. The military's force projection capability, designed to respond quickly and decisively to global requirements, also allows its rapid response to domestic incidents that occur within the U.S., its territories, and possessions. The judicious use of military forces in support of civil requirements complements the military's war fighting and force projection capabilities, while ensuring the American people get maximum return from their military investment.

## HOW THE ARMY RUNS

### 20-29. References

- a. Publications:
- (1) 10 U.S.C. Chapter 13 (Sect 251-255), Insurrection.
  - (2) 10 U.S.C. Chapter 15 (Sect 271-284), Military Support for Civilian Law Enforcement Agencies.
    - (a) 10 U.S.C. 282, Emergency situations involving weapons of mass destruction.
    - (b) 10 U.S.C. 284, Support for counterdrug activities and activities to counter transnational organized crime.
  - (3) 10 U.S.C. 382, Chemical-Biological Terrorism.
  - (4) 10 U.S.C. 2564, Provision of support for certain sporting events.
  - (5) 10 U.S.C. 12304a, Army Reserve, Navy Reserve, Marine Corps Reserve, Air Force Reserve: order to active duty to provide assistance in response to a major disaster or emergency.
  - (6) 18 U.S.C. 1385, Use of Army and Air Force as Posse Comitatus (with revisions).
  - (7) 18 U.S.C. 3056, Powers, authorities, and duties of United States Secret Service.
  - (8) 31 U.S.C. 1535, Economy Act.
  - (9) 32 U.S.C. 109, Maintenance of other troops.
  - (10) 32 U.S.C. 112, Drug interdiction and counter-drug activities.
  - (11) 32 U.S.C. 315, Detail of regular members of Army and Air Force to duty with National Guard, note: Delegation of Authority to permit an Active Component dual-status commander.
  - (12) 32 U.S.C. 317, Command during joint exercises with Federal troops, note: dual-status commander usual and customary arrangement for DSCA.
  - (13) 32 U.S.C. 508, Assistance for certain youth and charitable organizations.
  - (14) 32 U.S.C., Chapter 9, Homeland Defense Activities.
  - (15) 42 U.S.C. 1856a-c, Reciprocal Fire Protection Agreements.
  - (16) 42 U.S.C. Chapter 68, Disaster Relief (Public Law 93-288, as amended, The Robert T. Stafford Disaster Relief and Emergency Assistance Act).
  - (17) Public Law 104-201, Defense Against Weapons of Mass Destruction Act of 1996 (Nunn-Lugar-Domenici).
  - (18) Public Law 106-65, NDAA for FY 2000, Section 1023, Assistance to Civil Authorities to Respond to Act or Threat of Terrorism.
  - (19) Public Law 104-321, Emergency Management Assistance Compact, 19 October 1996.
  - (20) Public Law 107-56, The USA Patriot Act, 26 October 2001.
  - (21) Public Law 107-296, as amended, The Homeland Security Act of 2002, 25 November 2002.
  - (22) Presidential Decision Directive 39 (PDD-39), U.S. Policy on Counterterrorism, 21 June 1995.
  - (23) Presidential Decision Directive 62 (PDD-62), Protection Against Unconventional Threats to the Homeland and Americans Overseas, 22 May 1998. (Full Text classified)
  - (24) Presidential Policy Directive 8 (PPD-8), National Preparedness, 30 Mar 2011.
  - (25) Presidential Policy Directive 21 (PPD-21), Critical Infrastructure Security and Resilience, 12 February 2013.
  - (26) Homeland Security Presidential Directive/HSPD-5, Management of Domestic Incidents, 28 February 2003.
  - (27) Homeland Security Presidential Directive/HSPD-7, Critical Infrastructure Identification, Prioritization and Protection, 17 December 2003.
  - (28) Homeland Security Presidential Directive/HSPD-8, National Preparedness, 17 December 2003.
  - (29) National Security Strategy, December 2017.
  - (30) National Response Framework, Third Edition, June 2016.
  - (31) National Incident Management System (NIMS), Third Edition, October 2017.
  - (32) Protection Federal Interagency Operational Plan, First Edition, August 2016.
  - (33) Mitigation Federal Interagency Operational Plan, Second Edition, August 2016.
  - (34) Response Federal Interagency Operational Plan, Second Edition, August 2016.
  - (35) Recovery Federal Interagency Operational Plan, Second Edition, August 2016.
  - (36) FEMA Publication 1, The Federal Emergency Management Agency, April 2016.
  - (37) Strategy for Homeland Defense and Defense Support of Civil Authorities, February 2013.
  - (38) DODD 3020.26, Department of Defense Continuity Policy, 14 February 2018.
  - (39) DODD 3020.40, Mission Assurance (MA), w/Chg 1, 11 September 2018.

## Defense Support of Civil Authorities

- (40) DODD 3025.13, Employment of DOD Capabilities in Support of the U.S. Secret Service (USSS), Department of Homeland Security (DHS), w/Chg 1, 4 May 2017.
- (41) DODD 3025.18, DSCA, w/Chg 2, 19 March 2018.
- (42) DODD 3150.08, DOD Response to Nuclear and Radiological Incidents, 31 August 2018.
- (43) DODD 3160.01, Homeland Defense Activities Conducted by the National Guard, w/Chg 2, 6 June 2017.
- (44) DODD 4500.09E, Transportation and Traffic Management, w/Chg 2, 31 August 2018.
- (45) DODD 5105.62, Defense Treat Reduction Agency (DTRA), w/Chg 1, 6 December 2017.
- (46) DODD 5105.77, National Guard Bureau, w/Chg 1, 10 October 2017.
- (47) DODD 5105.83, National Guard Joint Force Headquarters – State (NG JFHQs-State), w/Chg 1, 30 September 2014.
- (48) DODD 5111.13, Assistant Secretary of Defense for Homeland Defense and Global Security (ASD(HD&GSA)), 23 March 2018.
- (49) DODD 5210.55, Department of Defense Presidential Support Program, 15 December 1998.
- (50) DODI 1235.12, Accessing the Reserve Components, w/Chg. 1, 28 February 2017.
- (51) DODI 3003.01, DOD Support to Civil Search and Rescue (SAR), w/Chg 1, 12 May 2017.
- (52) DODI 3020.45, Mission Assurance (MA) Construct, 14 August 2018.
- (53) DODI 3020.47, DOD Participation in the National Exercise Program (NEP), 29 January 2019.
- (54) DODI 3025.16, Defense Emergency Preparedness Liaison Officer (EPLO) Programs, w/Chg 1, 8 May 2017.
- (55) DODI 3025.17, Civil-Military Assistance for Certain Youth and Charitable Organizations, 16 December 2002.
- (56) DODI 3025.19, Procedures for Sharing Information with and Providing Support to the U.S. Secret Service, (USSS), Department of Homeland Security, w/Chg 1, 13 March 2017.
- (57) DODI 3025.20, Defense Support of Special Events, w/Chg 1, 24 May 2017.
- (58) DODI 3025.21, Defense Support of Civil Law Enforcement Agencies, w/Chg 1, 8 February 2019.
- (59) DODI 3025.22, The Use of the National Guard for Defense Support of Civil Authorities, w/Chg 1, 15 May 2017.
- (60) DODI 3025.23, Domestic Defense Liaison with Civil Authorities, 25 May 2016.
- (61) DOD Manual 3025.01, Volumes 1-3, Defense Support to Civil Authorities, 12 April 2017.
- (62) CJCSI 3125.01D, Defense Support to CBRN Incidents in the Homeland, 7 May 2015.
- (63) CJCSI 3710.01B, DOD Counterdrug Support, 26 Jan 2007.
- (64) JP 3-07.2, Antiterrorism, 14 March 2014.
- (65) JP 3-26, Counterterrorism, 24 October 2014.
- (66) JP 3-27, Homeland Defense, 10 April 2018.
- (67) JP 3-28, Defense Support to Civil Authorities, 29 October 2018.
- (68) JP 3-41, CBRN Response, 9 September 2016.
- (69) ADP 3-28, Defense Support to Civil Authorities, 11 February 2019.
- (70) ATP 2-91.7, Intelligence Support to Defense Support of Civil Authorities, 29 June 2015.
- (71) ATP 11.41 Multi-service Tactics, Techniques and Procedures for Chemical, Biological, Radiological, and Nuclear Consequence Management Operations, 30 July 2015.
- (72) ATP 3-11.46, Weapons of Mass Destruction—Civil Support Team Operations, 20 May 2014.
- (73) ATP 3-11.47, Chemical, Biological, Radiological, and Nuclear, and High-Yield Explosives Enhanced Response Force Package (CERFP)/Homeland Response Force (HRF) Operations, 26 April 2013.
- (74) ATP 3-28.1 Multi-service Tactics, Techniques and Procedures for the Employment of Nonlethal Weapons, 31 February 2015.
- (75) ATP 3-28.1 Multi-service Tactics, Techniques and Procedures for Defense Support of Civil Authorities (DSCA), 25 September 2015.
- (76) ATP 3-37.11, Chemical, Biological, Radiological, and Nuclear, and Explosives Command, 28 August 2018.
- (77) CNGBI 1001.01, National Guard Joint Force Headquarters-State, 29 June 2016.
- (78) CNGBI 1302.01, Guidance for Members Performing Duty Under the Authority of 32 U.S.C. 502(f), 23 April 2013.
- (79) CNGBI 3000.01, Joint Enabling Team, 30 April 2015.
- (80) CNGBI 3000.02, Adaptive Battle Staff, 08 June 2018.

## HOW THE ARMY RUNS

- (81) CNGBI 3000.04, National Guard Bureau Domestic Operations, 24 January 2018.
  - (82) CNGBI 3100.01A, National Guard Counterdrug Support, 23 June 2015.
  - (83) CNGBI 3501.00, Weapons of Mass Destruction Civil Support Team Management, 08 July 2014.
  - (84) CNGBI 3501.01, National Guard Homeland Response Force/Chemical, Biological, Radiological, and Nuclear Enhanced Response Force Package Management, 7 June 2016.
  - (85) CNGBI 3100.01A, National Guard Counterdrug Support, 22 June 2015.
  - (86) CNGBI 3302.01, Continuity of Operations (COOP) Program Policy, 31 October 2014.
  - (87) CNGBI 5200.01, National Guard Bureau All-Hazards Support Plan, 03 February 2017.
  - (88) CNGBI 5500.01, National Guard Interaction with State Defense Forces, 15 June 2017.
  - (89) CNGBI 7100.00, Training of JFHQ State Personnel, JOC, State Emergency Operations Center for Domestic Operations, 10 June 2014.
  - (90) CNGBM 3501.01, National Guard Homeland Response Force and Chemical, Biological, Radiological, and Nuclear Enhanced Response Force Package Procedures, 25 August 2016.
  - (91) National Guard Regulation 500-5/Air National Guard Instruction 10-208, Domestic Law Enforcement Support and Mission Assurance Operations, 18 August 2010.
- b. Usefull Links:
- (1) <https://www.fema.gov/mission-areas>
  - (2) <https://www.fema.gov/federal-interagency-operational-plans>
  - (3) <https://www.dhs.gov/presidential-policy-directive-8-national-preparedness>
  - (4) <https://www.dhs.gov/sites/default/files/publications/20101013-dod-dhs-cyber-moa.pdf>
  - (5) [https://www.apd.army.mil/epubs/DR\\_pubs/DR\\_a/pdf/web/](https://www.apd.army.mil/epubs/DR_pubs/DR_a/pdf/web/)

## **Chapter 21**

### **Foreign Military Sales**

#### **Section I Introduction**

##### **21-1. Chapter Content**

a. Foreign Military Sales (FMS) is the government-to-government method for transferring U.S. defense equipment, services, and training to a foreign government. According to the Defense Security Cooperation Agency (DSCA), the goal of the U.S. FMS program is responsible arms transfer to further national security and foreign policy objectives by strengthening bilateral defense relations, supporting coalition building, and enhancing interoperability between U.S. forces and militaries of friends and allies. These sales also contribute to American prosperity by improving the U.S. balance of trade position, sustaining highly skilled jobs in the defense industrial base, and extending production lines and lowering unit costs for key weapon systems.

b. This chapter provides an overview of the FMS process, its role in national defense, the authorities for conducting FMS, responsible agencies, FMS procedures, financial management, and workforce development.

##### **21-2. FMS Overview**

a. Under FMS, the U.S. Department of Defense (DOD) procures defense articles and services for a country using the same acquisition and training process used to procure and train for U.S. military needs. This acquisition process is governed by the Federal Acquisition Regulation (FAR) and the Defense Federal Acquisition Regulation Supplement (DFARS). The foreign purchaser benefits from the DOD technical and operational expertise, procurement infrastructure, and purchasing practices. The country also benefits from the lower unit costs that result when the DOD is able to combine FMS purchases with purchases for U.S. forces to achieve greater economies of scale. In addition, the DOD ensures purchases take into consideration all of the necessary training, support, and sustainment to give an ally the lasting operational capability it seeks; this process is known as the “Total Package Approach”. A major FMS program increases an ally’s interoperability with U.S. military forces, creating potential opportunities for joint training, joint exercises, cooperation in humanitarian assistance / disaster relief, and peacekeeping operations (DSCA Foreign Customer Guide).

b. The FMS program is operated on a “no-profit” and “no-loss” basis to the U.S. Government (USG). An authorized representative from a foreign government must submit a Letter of Request (LOR) to the USG for the desired defense articles and services. By policy and law, the USG does not conduct FMS for profit or may not incur any debt on FMS sales cases. FMS requires a government-to-government agreement, known as a Letter of Offer and Acceptance (LOA), which is also referred to as an “FMS case”. The LOA requires that the foreign partner country pay the full cost associated with the FMS sale, which includes the cost of the defense equipment/services and any costs incurred by the USG while providing the defense equipment/services (DSCA process and benefits guide). The full cost includes the addition of a surcharge, applied to each FMS case to cover the cost of manpower and infrastructure that supports the FMS program.

c. The USG writes the LOA, which the foreign government must formally accept. The LOA specifies the items and services to be provided and an estimated cost and timeframe for doing so. The USG may supply items from its own stocks, or it may enter into a contract with a defense contractor to obtain the items on the foreign partner’s behalf. The USG writes any necessary contracts with U.S. defense contractors using standard USG competitive contracting procedures, to include robust oversight and auditing. The USG then provides the equipment or service to the foreign country as agreed in the government-to-government LOA.

## HOW THE ARMY RUNS

d. To build and re-build the administrative infrastructure necessary to support individual FMS cases, the USG maintains a standing infrastructure at the DOD level and within each of the Military Departments (MILDEP) which conduct FMS. That standing infrastructure consists of skilled employees, information technology systems, offices, and etcetera. It is funded by an administrative surcharge applied to every FMS case. The DSCA, with DOD Comptroller oversight, manages the FMS administrative surcharge fund. The Deputy Assistant Secretary of the Army for Defense Exports and Cooperation (DASA (DE&C)) allocates the Army share of funding annually across the Army Security Assistance Enterprise.

### Section II

#### FMS Linkage to DOD Through Security Cooperation (SC) and Security Assistance (SA)

##### 21-3. SC and SA Definitions

a. SC includes all activities undertaken by the DOD to encourage and enable international partners to work with the United States to achieve strategic objectives. It includes all DOD interactions with foreign defense and security establishments, including all DOD-administered SA programs, which build defense and security relationships; promote specific U.S. security interests, including all international armaments cooperation activities and SA activities; develop allied and friendly military capabilities for self-defense and multinational operations; and provide U.S. forces with peacetime and contingency access to host nations (ESAMM, Chapter 1).

b. SA is a group of programs authorized under Title 22 of US law, by which the United States provides defense articles, military education and training, and other defense-related services by grant, loan, credit, cash sales, or lease in furtherance of national policies and objectives. The U.S. Department of State (DOS) supervises and directs the USG's SA programs in consultation and coordination with the DOD, the Department of Justice, and other interagency partners. DOD administers seven major SA programs: FMS, Foreign Military Construction Services, Foreign Military Financing (FMF) Program, Leases, Military Assistance Program, International Military Education and Training (IMET), and DOD Drawdowns.

##### 21-4. Role of SC and SA Programs in National Defense

a. SC and SA programs are the means by which the United States provides defense articles, military training, and other defense services to the Nation's partner nations in support of U.S. National Security objectives, including Building Partner Capacity (BPC). They are distinguished by the statutes under which they are authorized and funded. However, when implemented by DOD, SA is a subset of SC.

b. DODD 5132.03 defines SC planning as a requirement-driven, risk and resource-informed process that will be undertaken through a holistic approach that identifies and addresses capability requirements across a comprehensive spectrum of materiel and non-materiel inputs. DOD will prioritize, plan, conduct, and align resources for SC as an integral element of the DOD mission and a tool of national security and foreign policy. DOD SC, which includes DOD-administered SA programs and international armaments cooperation, will be undertaken to achieve specific ends in support of defense and national security strategy, rather than serving as an end unto itself.

c. SC program authorizations and appropriations are provided to the Secretary of Defense (SECDEF) primarily under the annual National Defense Authorization Act (NDAA) and DOD Appropriations Act. By statute or Executive Order, SC program authorizations and appropriations are sometimes required to be exercised in coordination with the Secretary of State. These programs vary greatly in terms of the agency or DOD activity responsible and the manner in which they are planned for and funded.

d. DOD policy states that SC is an important tool of national security and foreign policy, as well as is an integral element of the DOD mission. SC activities shall be planned, programmed, budgeted, and executed with the same high degree of attention and efficiency as other integral DOD activities. SC requirements shall be combined with other DOD requirements and implemented through standard DOD systems, facilities, and procedures (ESAMM, Chapter 2).

##### 21-5. FMS Process

The FMS program uses non-appropriated funding administered by DSCA through eligible foreign governments that purchase defense articles, services, and training from the USG. The purchasing government pays all costs associated with a sale. The USG manages FMS through the government

## HOW THE ARMY RUNS

agency with the appropriate expertise to manage the process, generally according to the type of equipment or service requested. A signed LOA establishes what is commonly referred to as a "FMS case" providing the responsible agency or MILDEP with the legal authority, technical, and financial details to manage the sale. For new procurements, the established FMS Case provides the responsible agency or MILDEP with legal authority to establish contracts with U.S. industry to provide the required article or service.

### Section III FMS Authorities and Responsible Agencies

#### 21-6. Statutory Authorities

a. Congress authorizes and appropriates funds for the USG-financed portions of SA. SA authorizations and appropriations are provided primarily under three public laws: The Foreign Assistance Act (FAA) of 1961, as amended; the Arms Export Control Act (AECA) of 1976, as amended; and the annual appropriations acts for Foreign Operations, Export Financing, and Related Programs. Congress has a keen interest in the sale and transfer of defense articles and services to foreign countries and international organizations. Executive Branch agencies such as the National Security Staff, the Office of Management and Budget, the Department of the Treasury, and others have responsibilities related to SA. However, aside from the President, the principal legislated responsibilities fall to the DOS and the DOD (ESAMM, Chapter 3).

b. Section 515(a) of the FAA of 1961, as amended, authorizes the President to assign U.S. military personnel overseas to manage SA programs administered by the DOD. The Security Cooperation Organization (SCO) encompasses all DOD elements, regardless of actual title, located in a foreign country to carry out SC and SA management functions under the FAA and the AECA of 1976, as amended. The SCO develops and maintains professional working relationships that advance U.S. strategic objectives and manages DOD SC programs under the guidance of the Combatant Commands (CCMD).

c. Section 656 of the FAA of 1961, as amended (22 U.S.C. 2416) and Section 652 of the Consolidated Appropriations Act, 2008 (Division J - Foreign Operations and Related Programs Appropriations Act, 2008) (P.L. 110-161) require that the SECDEF and the Secretary of State shall jointly prepare and submit an annual report to Congress. The report is submitted to the appropriate congressional committees on all military training provided to foreign military personnel by the DOD and the DOS during the previous fiscal year, and all such training proposed for the current fiscal year.

#### 21-7. DOD Authorities and Responsible Agencies

a. The SECDEF establishes military requirements and implements programs to transfer defense articles and services to eligible foreign countries and international organizations (see figure 21-1). The Under Secretary of Defense for Policy (USD(P)) is the SECDEF's principal SA representative. The USD (P) is assisted by the Assistant Secretary of Defense (International Security Affairs) (ASD (ISA)). The ASD (ISA) exercises authority, direction, and control over the DSCA, which is the DOD's principal organization for management of SA and provides overall SA guidance to each MILDEP (AR 12-1). Within DOD, the principal responsible agencies for SC are DSCA, the CCMDs, the Joint Staff and the MILDEPs.

b. DSCA leads the broader U.S. SC enterprise in its efforts to train, educate, advise, and equip foreign partners. DSCA administers SC programs that support U.S. policy interests and objectives identified by the White House, DOD, and DOS. These objectives include developing specific partner capabilities, building alliances and partnerships, and facilitating U.S. access. DSCA integrates SC activities in support of a whole-of-government approach; provides execution guidance to DOD entities that implement SC programs; exercises financial and program management for the FMS system and many other SC programs; and educates and provides for the long-term development of the SC workforces.

#### 21-8. Army Security Assistance Enterprise (ASAE)

a. Over fifty organizations across twelve Army Commands currently contribute to SA activities. These organizations span across Assistant Secretary of the Army (Acquisition, Logistics, and Technology (ASA(ALT))) DASA (DE&C), the Army Materiel Command (AMC), U.S. Army Training and Doctrine Command (TRADOC), the U.S. Army Corps of Engineers (USACE), Army Futures Command, the

# HOW THE ARMY RUNS

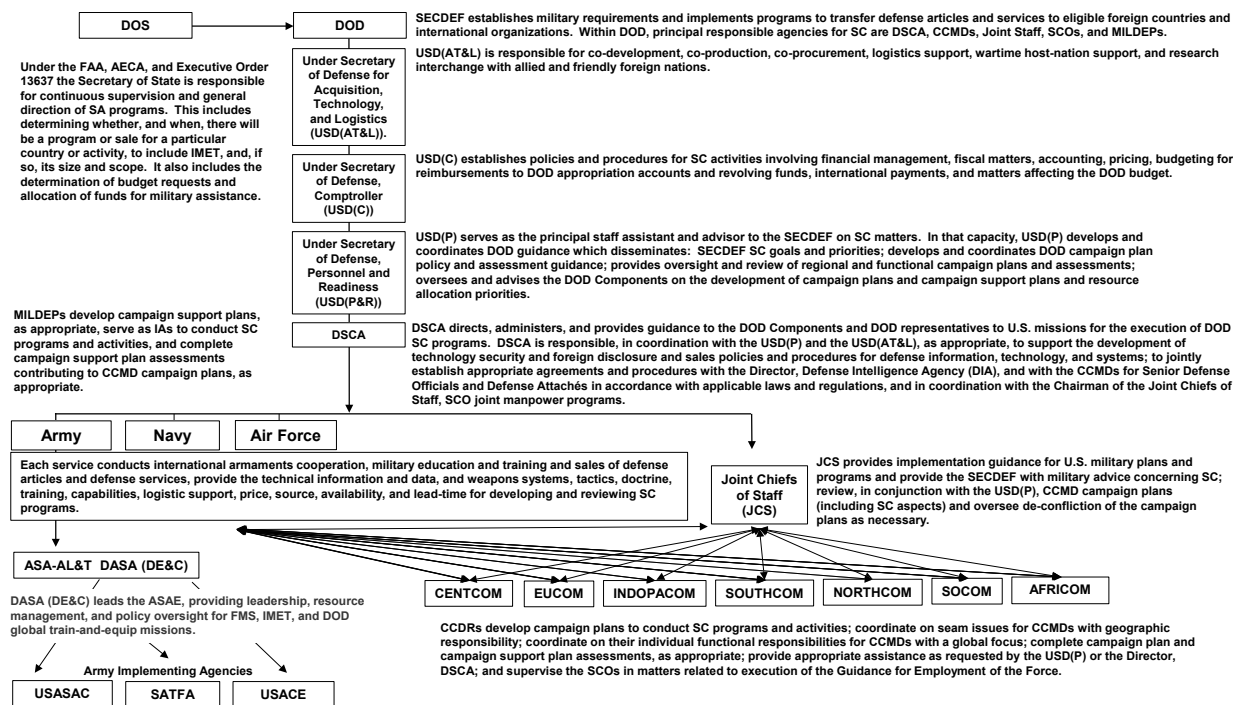

**Figure 21-1. Responsible Agencies**

Program Executive Offices (PEOs), and OTSG/MEDCOM communities. Collectively referred to as the Army Security Assistance Enterprise (ASAE), these fifty organizations collaboratively participate in the planning, development, and execution of SA programs.

b. As delegated from the Secretary of the Army (SECARMY) through ASA(ALT) DASA (DE&C) leads the ASAE, providing leadership, resource management, and policy oversight for FMS, International Military Education & Training (IMET), and DOD global train-and-equip missions. It serves as the ASAE interface to the DOS, DSCA, and DTSA for matters related to Army SA activities, and it is the Army focal point for developing, staffing, and publishing Army SA policy / guidance. DASA (DE&C) is responsible to the ASA(ALT) for oversight of and advocacy for the Army-wide SC programs that include FMS, international training, excess defense article transfers, foreign disclosure, technology transfer and direct commercial sales activities, including munitions case processing. The SC Integration and Exports Directorate within DASA (DE&C) establishes Army FMS and export policy, issues implementation guidance, advocates for diversions from stock, manages the excess defense articles (EDA) process, and processes all congressional notifications and waivers. A waiver is normally referred to as a Yockey Waiver and it is an item that has not completed USG testing that is not yet in full production, but may be sold to partners. There is a risk that if problems arise in testing, the USG may decide not to acquire this system. In this eventuality, the procurement cost of the item will likely increase and there could be future interoperability problems with U.S. forces.

c. The ASAE has three major Implementing Agencies (IAs), which are authorized to receive and respond to LORs. They include the U.S. Army Security Assistance Command (USASAC), a subordinate command of AMC, for approved SA programs, equipment, services, and OCONUS training; the Security Assistance Training Field Activity (SATFA), a subordinate command of TRADOC, for approved continental United States (CONUS) SA training; and the USACE for approved SA programs for construction, construction design services, civil works/water resource management, engineering research and development, geospatial services, and other engineering services.



# HOW THE ARMY RUNS

## Section IV Army Foreign Military Sales Process

### 21-9. FMS Request and Approval Process

The IAs (USASAC, USACE, and TRADOC) work with the Life Cycle Management Commands (LCMC), Security Assistance Management Directorates (SAMd) in Tank and Automotive Command (TACOM); the Army Aviation and Missile Command (AMCOM) and Communications-Electronics Command (CECOM); and applicable Program Executive Offices (PEO) and Program Manager (PM) offices to develop FMS products needed throughout the FMS process. Listed below are the basic steps that each IA works as part of the FMS process:

a. The Pre-LOR process (see figure 21-2) allows FMS customers to obtain general and technical information prior to submitting a formal LOR (see figure 21-3 for the LOR process). The goal of the Pre-LOR process is to assist the international customer in making an informed decision regarding the possible submission of an LOR and to assist the customer in developing an actionable LOR. During the Pre-LOR process the ASAE helps customers more clearly define requirements and match needs to ASAE materiel, training, and services. The initial releasability of materiel, technology, and information to any particular country or international organization is first considered during the Pre-LOR process. Pre-LOR coordination requires the SCO to reach out to the MILDEPS early to coordinate.

b. The Pre-LOR process adds to synchronization early. Most LORs focus on referencing a simple overall capability requirement that can lead to a very vague request. The Pre-LOR can lay out in detail a proposed procurement. LORs, can be received via many channels, are processed by DSCA and turned into a draft LOA, which provides far more detail, including cost. LOAs, once fully approved with the U.S. government and accepted by the foreign government, ultimately constitute an agreement between the partner and the USG.

c. The DSCA provides the draft LOA to the DOS, which reviews the case under the statutory, regulatory, and policy frameworks identified above. While processing times can vary depending on the circumstances of individual proposed sales, the DOS FMS review process is an efficient one. DOS reviews and adjudicates FMS sales offers on a daily basis, typically providing its assent in all but a small minority of cases.

d. If the LOA is above monetary thresholds established in the AECA, Congress must be notified before the sale can be approved. Once Congress or the DOD has approved the sale, DSCA may offer the LOA to the partner country. Its signature on the LOA is contractually binding. DOD then implements the case.

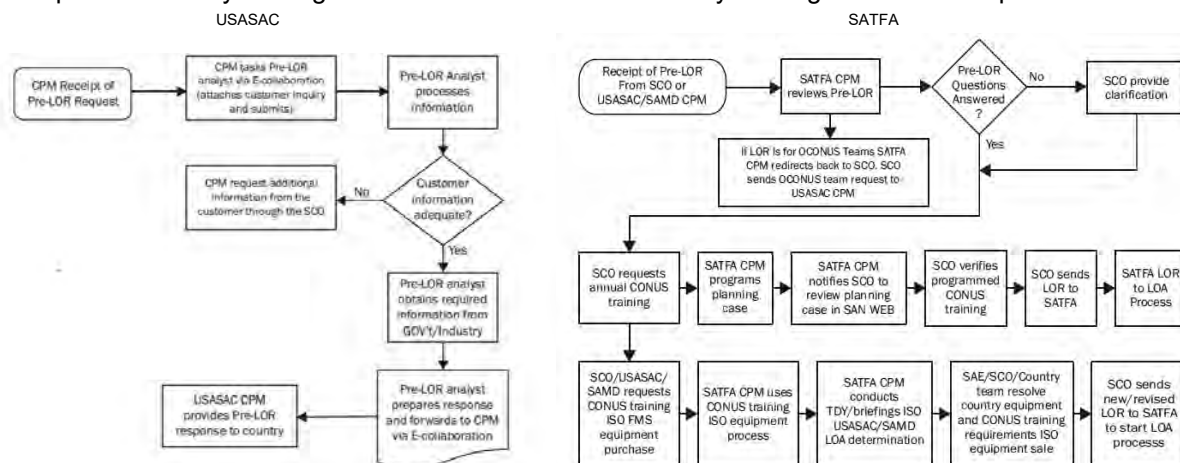

Figure 21-2. Pre-LOR Process

### 21-10. FMS Delivery of Capability

a. Application of the Total Package Approach (TPA) ensures that a customer has the opportunity to plan for and obtain all support items and services such as technical assistance, ammunition, and training necessary to operate, maintain, employ, and sustain a major end item or system. Development of an



## HOW THE ARMY RUNS

b. TRADOC/SATFA brokers Army CONUS-based training within established Army training requirements to include resourcing for Geographic Combatant Command (GCC)/Country training programs (see figure 21-4). This includes Professional Military Education (PME) and technical training authorized and approved for funding under SA (Title 22) and select SC (Title 10) programs. The SATFA CPM is the SCO's initial point of entry regarding all training requirements requests.

c. The requesting country and the SCO are responsible for identifying and forecasting long-term training requirements. SATFA submits and justifies these requirements during the structure manning decision review (SMDR) via the Army Program for Individual Training. For near-term training or year of execution training, SATFA plans, schedules, coordinates, confirms and requests additional seats through the Army Training Requirements and Resources System and the Training Resource Arbitration Panel (TRAP) process. TRAPs support increases and decreases in training requirements during the year of execution.

d. The CONUS Institutional SA Training process typically begins with a representative from DOD, COCOM or SCO providing their training requirements to SATFA, who is responsible for brokering the country's requirements against available seats. SATFA manages various Security Assistance and related programs (for example, FMS and International Military Education and Training (IMET)) somewhat differently because of the type of funding involved.

e. SATFA, in coordination with the training institutions, creates the Training Military Articles and Services Listings (T-MASL), which includes prerequisites, tuition pricing and disclosure approval by country for available courses. SATFA ensures all training institutions are reimbursed for all services rendered. A forfeiture fee is charged for cancelling or rescheduling training in accordance with the annual U.S. Army Forfeiture Charge Policy message.

f. The IMET program is a DOS program, jointly managed by the DSCA and DOS, that funds military education and training courses for international military and related civilian personnel of foreign countries. It is a key component of SC, promoting regional stability and defense capabilities through professional military and technical courses and specialized instruction. IMET courses are provided primarily at military schoolhouses in the United States, exposing the IMS to the U.S. culture, military students, practices, standards, and professionalism (ESAMM, Chapter 10).

g. SCOs process an IMS for training to include vetting, validation of medical coverage, a pre-departure briefing and issuance of an Invitational Travel Order (ITO). Once the IMS arrives in CONUS International Military Student Offices (IMSO) are located at most training sites to oversee life support and academic progress until the IMS departs for home country.

TRADOC/SATFA brokers Army CONUS-based training within established Army training requirements to include resourcing for Geographic Combatant Command (GCC)/Country training programs. This includes Professional Military Education (PME) and technical training authorized and approved for funding under SA (Title 22) and select Security Cooperation (Title 10) programs.

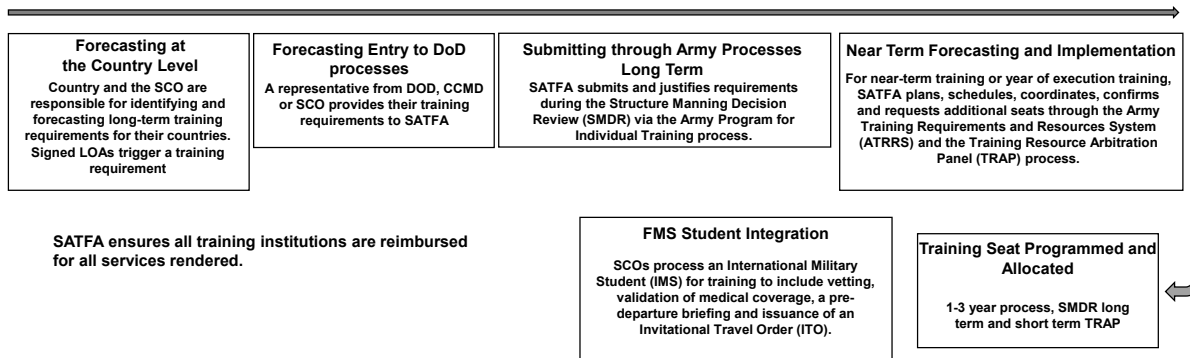

**Figure 21-4. FMS Delivery of Training Capability**

h. Outside the continental United States, training managed by Security Assistance Training Management Organization provides technical assistance and training services, which cover PCS teams: Extended Training Service Specialists (ETSS), Technical Assistance Field Teams (TAFTs), Field training services, including contractor field services, Mobile Training Teams (MTTs) and country Surveys. When an LOA for a system that is new to a customer is prepared, the ASAE considers including appropriate training teams for a TPA. Training teams provide in-country technical assistance to the armed forces of a

## HOW THE ARMY RUNS

foreign, government on specific equipment, technology, procedures, weapons, and supporting systems. They provide services that CONUS training programs or commercial training contracts cannot satisfy.

### 21-12. FMS Financial Management

a. Army Activities manage the FMS program at no cost to the USG with certain exceptions identified in the AECA. FMS funding encompasses the resources for SA programs, appropriation (DSCA managed appropriation) fund type 8242. FMS financial management includes the management of multiple types of FMS funding, to include FMS Administrative Funds, FMS Case Funds, and FMF administrative funds. DASA (DE&C) is responsible for oversight of all FMS and FMF funds, the management of FMS and FMF administrative funding, and the submission of the Security Assistance Program and Budget Review (SAPBR).

b. FMS Administrative funds are a result of a surcharge assessed on each FMS case (see figure 21-5). The funds, collected and placed in the FMS Trust Fund provide funding for those efforts considered standard level of service. FMF Administration funds support manpower and travel associated with FMF type purchases. FMF funding is managed by the DASA (DE&C) office. FMS administration funding is obtained through a SAPBR (POM and Budget process) conducted on an annual basis. FMS administration funds are administered from the DASA (DE&C) office.

c. FMS Case funds are those funds identified on a line in a case and are specifically identified for a designated item, level of support, training or assistance and is allocated by the IA (see figure 21-6).

### 21-13. FMS Workforce Development

a. The 2017 NDAA had two fundamental goals pertaining to SC. The first was to streamline and simplify a number of DOD authorities, the second was to challenge the DOD to professionalize the SC (SC and SA) workforce, address the full range of a partner nation's requirements, prioritized according to strategy, and to robustly implement the full array of assessment, monitoring and evaluation functions. The Army expects to play a proactive role in the certification of its SC personnel and seeks to establish a functional management cell to carry out its responsibilities.

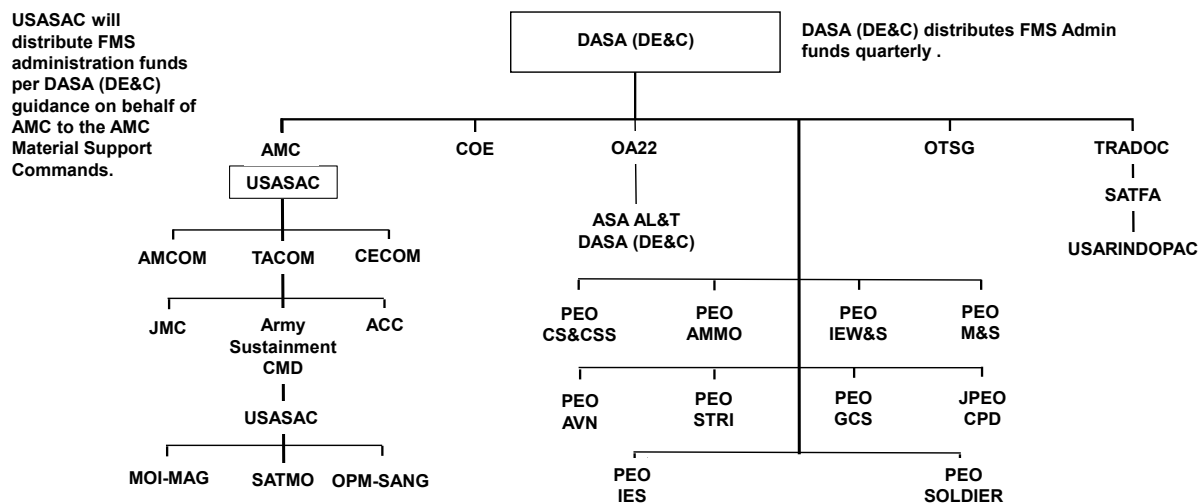

#### FMS Administration Funds (8242) in General Fund Enterprise Business System

FMS funding encompasses the resources for SA programs, appropriation 8242. FMS/FMF administration funds are obtained through a yearly SA Program and Budget Review (SAPBR) process, which combines the POM and Budget Call reviews. DASA (DE&C) is responsible for the Army's overall SAPBR submission to the DSCA, but each FMS organization requiring FMS/FMF administration funds must submit their requirements through their headquarters to DASA (DE&C) and the Assistant Secretary of the Army (Financial Management and Comptroller).

Figure 21-5. FMS Admin Fund Flow

## HOW THE ARMY RUNS

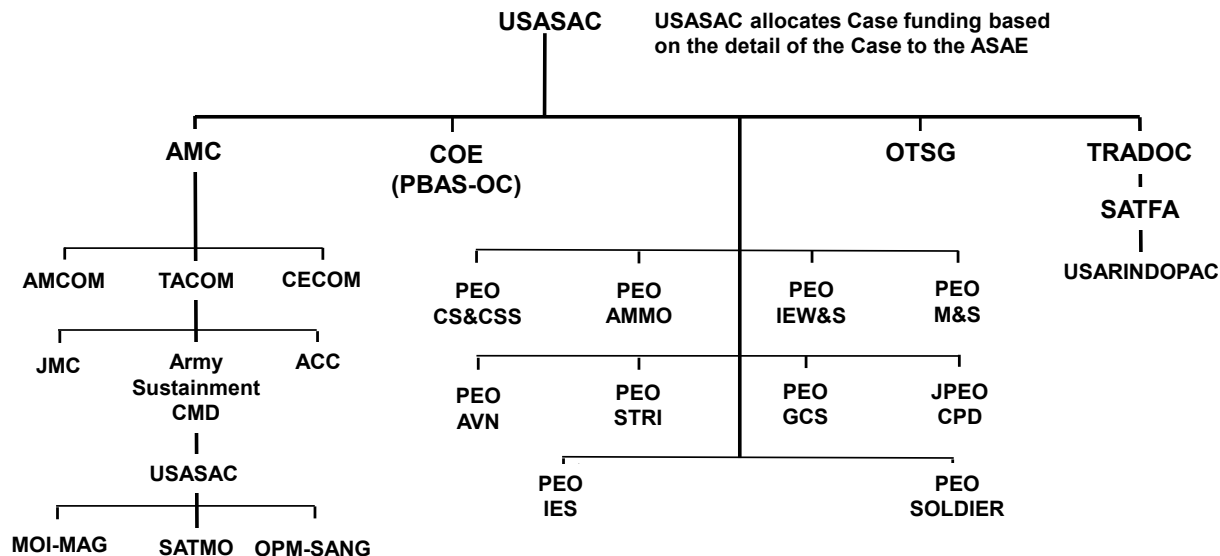

**Figure 21-6. FMS Case Funds Flow**

b. The 2017 NDAA reforms of the SC community represent a twofold message from Congress. The first message is that the Congress recognized the complex nature of the SC enterprise. Congress simplified authorities and mandated that a single official serve as the decision-making authority for allocating security cooperation resources. The second is the DOD must increase performance and accountability in SC planning and implementation, evaluate its effectiveness, professionalize the SC workforce, and clearly indicate to Congress the type and magnitude of resources applied to individual country plans.

c. NDAA 2017 established the Security Cooperation workforce development program. The purpose of the Program is to improve the quality and professionalism of the security cooperation workforce to ensure that the workforce has the capacity, in both personnel and skills, to properly perform its mission, provide appropriate support to the assessment, planning, monitoring, execution, evaluation, and administration of security cooperation programs and activities and to ensure that the Department receives the best value for the expenditure of public resources on such programs and activities. The program is also intended to ensure that personnel with the appropriate level of expertise and experience are assigned in sufficient numbers to fulfill requirements for the security cooperation programs and activities of the DOD and the execution of security assistance programs and activities.

d. The Defense Institute of Security Cooperation Studies (DISCS) has the mission to educate the Security Cooperation Workforce, enabling the development and execution of innovative Security Cooperation solutions that support mutual U.S. and partner interests. DISCS offers a range of resident, mobile, and online courses, and learning tools for personnel performing security cooperation functions in the DOD and other USG agencies, as well as the U.S. defense industry, and partner countries and organizations. DISCS offers resident courses at the DISCS main campus at Wright-Patterson AFB, Ohio with selected course offerings also available in the National Capital Region. Core SC subjects such as the FMS process and BPC are included in the DISCS curriculum, as well as Technology Transfer (International Program Security Requirements), the Missile Technology Control Regime, and other related subjects. DISCS is accredited by the Council on Occupational Education, and offers courses with recommended college credit through the American Council on Education (ESAMM Chapter 2).

e. The Army SC Workforce is defined as both uniformed and civilian employees working in SC organizations overseas in the geographic combatant commands and functional combatant commands, who are responsible for planning, monitoring, or conducting SC/SA activities. The SC workforce also includes those performing SC activities in connection with the acquisition and development of technology

## HOW THE ARMY RUNS

release, policies and Field Activities which perform SC/SA missions, assessments, monitoring, or evaluations of SC/SA programs and activities.

### Section V Summary, Key Terms, and References

#### 21-14. Summary

a. The Army Mission and purpose is to deploy, fight, and win the Nation's wars by providing ready, prompt, and sustained land dominance by Army forces across the full spectrum of conflict as part of the Joint Force. The Army will train and fight as a member of the Joint and Multinational Team. Army doctrine, tactics, and equipment must be complementary to and interoperable with its sister services, allies, and partners.

b. FMS is a key enabler to build defense relationships that promote specific U.S. security interests, develop allied and partner nation military and security capabilities for self-defense and multinational operations, and provide U.S. forces with peacetime and contingency access to allied and partner nations.

c. SC/SA is becoming increasingly more important in U.S. national strategy to further national security and foreign policy objectives by strengthening bilateral defense relations, supporting coalition building, and enhancing interoperability between U.S. forces and militaries of friends and allies. FMS integration through SC/SA is a key tool Combatant Commanders use to shape their areas of responsibility in ways that deter and prevent conflict and enable the U.S. and its allies and partners to prevail if conflict becomes necessary.

#### 21-15. Key Terms

**Implementing Agency (IA):** The military department or defense agency responsible for the execution of military assistance programs. With respect to FMS, the military department or defense agency assigned responsibility by the Defense Security Cooperation Agency to prepare an LOA and to implement an FMS case. The implementing agency is responsible for the overall management of the actions that will result in delivery of the materials or services set forth in the LOA that was accepted by a foreign country or international organization.

**Security Cooperation (SC):** SC comprises all activities undertaken by the DOD to encourage and enable international partners to work with the United States to achieve strategic objectives. It includes all DOD interactions with foreign defense and security establishments, including all DOD-administered Security Assistance (SA) programs, that build defense and security relationships; promote specific U.S. security interests, including all international armaments cooperation activities and SA activities; develop allied and friendly military capabilities for self-defense and multinational operations; and provide U.S. forces with peacetime and contingency access to host nations.

**Security Assistance (SA):** SA is a group of programs, authorized under Title 22 authorities, by which the United States provides defense articles, military education and training, and other defense-related services by grant, loan, credit, cash sales, or lease, in furtherance of national policies and objectives. All SA programs are subject to the continuous supervision and general direction of the Secretary of State to best serve U.S. foreign policy interests; however, programs are variously administered by DOD or DOS. Those SA programs that are administered by DOD are a subset of SC.

**Security Cooperation Community:** The security cooperation community is defined as a subset of U.S. government executive branch entities within the security cooperation enterprise directly responsible for managing or executing security cooperation programs or the policies that affect those programs. The security cooperation enterprise is the overall network of entities engaged in any element of security cooperation programs, either as providers or as beneficiaries. This includes USG agencies, the U.S. Congress, foreign partners, and industry. See DOD, *Vision 2020: Update 2, Featuring FMS Improvement Initiatives*, Washington, D.C.: Defense Security Cooperation Agency, October 2016, p. 9.

#### 21-16. References

a. Army General Order (AGO) 2019-01 Assignment of functions and responsibilities within Headquarters, Department of the Army.

## HOW THE ARMY RUNS

- b. AR-12-1 Security Assistance, Training, and Export Policy.
- c. DA PAM 12-1 Security Assistance Procedures and Operations.
- d. Security Assistance Management Manual (SAMM) DSCA 5105.38-M.
- e. E-SAMM Electronic Security Assistance Management Manual.
- f. NDAA 2017.
- g. Federal Acquisition Regulation (FAR).
- h. Defense Federal Acquisition Regulation Supplement (DFARS).
- i. Foreign Assistance Act (FAA) of 1961, as amended.
- j. Arms Export Control Act (AECA) of 1976, as amended.
- k. Foreign Operations, Export Financing and Related Programs.
- l. Title 22 FOREIGN RELATIONS AND INTERCOURSE.
- m. Arms Export Control Act (AECA) of 1976, as amended.
- n. Article 3 of Geneva conventions of 12 August 1949.
- o. Controlled Substances Import and Export Act (21 U.S.C. 951 et seq).
- p. Department of State, Foreign Operations and Related Programs Appropriations Act 2009, Division H of the Omnibus Appropriations Act, 2009, P.L. 111-8.
- q. Economy Act (31 U.S.C. 1535).
- r. Foreign Assistance Act (FAA) of 1961, as amended.
- s. NATO Enlargement Facilitation Act of 1996 (Section 609 of Public Law No. 104-208).
- t. Security Assistance Act of 2000, Section 706 of Public Law 106-280.
- u. DOD Directive 2010.06, Materiel Interoperability with Allies and Coalition Partners.
- v. DOD Directive 2140.2, Recoupment of Nonrecurring Costs (NCs) on Sales of U.S. Items.
- w. DOD Directive 4270.5, Military Construction.
- x. DOD Directive 5100.03, Support of the Headquarters of Combatant and Subordinate Unified Commands.
- y. DOD Directive 5100.46, Foreign Disaster Relief.
- z. DOD Directive 5105.36, Defense Contract Audit Agency (DCAA).
- aa. DOD Directive 5105.64, Defense Contract Management Agency (DCMA).
- bb. DOD Directive 5105.65, Defense Security Cooperation Agency (DSCA).
- cc. DOD Directive 5118.05, Defense Finance and Accounting Service (DFAS).
- dd. DOD Directive 5132.03, DOD Policy and Responsibilities Relating to Security Cooperation.
- ee. DOD Directive 5134.01, Under Secretary of Defense for Acquisition, Technology, and Logistics (USD(AT&L)).
- ff. DOD Directive 5230.11, Disclosure of Classified Military Information to Foreign Governments and International Organizations.
- gg. DOD Directive 5530.3, International Agreements.
- hh. Executive Order 13637, Administration of Reformed Export Controls.
- ii. Executive Order 12163, Administration of Foreign Assistance and Related Functions.
- jj. <https://asc.army.mil/web/foreign-military-sales-the-process-and-benefits/>, Online Green Book "The Management of Security Cooperation: DISCS hand book."

## HOW THE ARMY RUNS

**This page is intentionally left blank**



# EMERGING INITIATIVE: GLOBAL FORCE INFORMATION MANAGEMENT

## Chapter 22

### Emerging Initiative: Global Force Information Management

#### Section I Introduction

##### 22-1. Chapter Content

a. This chapter introduces the Army's global information management system, processes, and organizations for establishing a 21st Century enterprise for:

- (1) Near real-time integration of force management, readiness, and resourcing data.
- (2) An integrated and interoperable automated capability for the Deploy-to-Redeploy/Retrograde (D2RR) end-to-end business process.
- (3) Enablement of Dynamic Force Employment (DFE).

b. Authoritative and actionable information is essential for warfighting and business decisions impacting execution of Army's Title 10 U.S. Code (U.S.C.) functions and realizing the Army Strategy's objectives of building readiness for high intensity conflict; modernizing doctrine, equipment, and formations; and reforming the Army to maximize time, funding, and manpower.

c. The Global Force Information Management (GFIM) Objective Environment (OE) will provide the Army the ability to use resources for the improvement of operating and institutional force investment decisions. It also will provide the ability to reuse force structure data without significant manual reconciliations and enable accurate views of the Army's lifecycle model through common lenses, such as a Modernization common operating picture.

d. Implementing Global Force Management (GFM) Data Initiative (DI), a Department of Defense (DOD) mandated data standard for enterprise force structure, provides the Army the ability to provide strategic command and control (C2) through the integration of assignment, allocation, and apportionment processes. It also facilitates an enterprise capability to exchange data (in the classified and unclassified domains) across Army systems to support DFE. Finally, it will directly enable Army Senior Leaders, as they approve the release of information, to support the Joint Strategic Planning System.

#### Section II Deploy-to-Redeploy/Retrograde

##### 22-2. Deploy-to-Redeploy/Retrograde (D2RR) Overview

Deploy-to-Redeploy/Retrograde (D2RR) is one of the Total Army's end-to-end (E2E) business process as specified in Army Regulation (AR ) 5-1 (Management of Army Business Operations) that aligns with DOD Business Enterprise Architecture (BEA) and Army Business Systems Architecture requirements supporting the Army Business Strategy (ABS). It is the tool by which the ABS establishes strategic direction for the business operation of the Army in support of The Army Plan. D2RR encompasses all of the business functions necessary to plan, notify, deploy, sustain, recall and reset tactical units to and from theaters of engagement (see Figure 22-1).



Figure 22-1. Deploy-to-Redeploy/Retrograde End-to-End Business Process

## HOW THE ARMY RUNS

### 22-3. D2RR Operational Activities and Definitions

D2RR consists of eleven Level 1 operational activities, each of which represents a sub-process to the overarching D2RR E2E business process. These definitions continue to evolve based on decision-making at the appropriate governance forums:

a. D2RR.01 – Perform Army Strategic Planning: Development of the strategy that directs how the Army will fulfill its Title 10 responsibilities and additional statutory requirements in support of the National Military Strategy (NMS).

b. D2RR.02 – Determine Force Requirements: This process step represents the theatre and operational deliberate planning and crisis action planning performed to capture all the various types of force requirements associated with current operations (Annual/Rotational), emerging threats (Emergent requirements), training exercises, demand for individual augmentations, and Army Service Requirements.

c. D2RR.03 – Design the Force: Design the Forces consists of defining military capabilities, designing force structures to provide these capabilities, and translating organizational concepts based on doctrine, technologies, materiel, manpower requirements, and limited resources into a trained and ready Army.

d. D2RR.04 – Align Forces: This process includes the GFM Assignment, Apportionment, and Allocation processes associated with providing Combatant Commanders (CCDRs) with the most capable forces for execution based on stated requirements, balanced against risks (operational, future challenges, force management, and institutional) and global priorities (CJCSM 3130.06, Encl B, para 4). This process also includes the allocation of forces to meet internal Service specific demands. Near-term known requirements are approved and ordered annually through the Global Force Management Board (GFMB) process and published in the Global Force Management Allocation Plan, or, for Combatant Command (CCMD) assigned forces demands, through the Joint Capabilities Requirements Manager.

e. D2RR.05 – Prepare Forces and Infrastructure/Platform: The synchronization of resources and training to bring a unit or individuals to the state of readiness needed to perform the assigned mission. Sustainable Readiness is the Army's force generation process adapted to build a force to meet contingency and known demand requirements, and is globally responsive and regionally engaged.

f. D2RR.06 – Conduct Mobilization: Mobilization is the process of assembling and organizing national resources to support national objectives in time of war or other emergencies. Mobilization includes assembling and organizing personnel and materiel for regular military forces, activating the Reserve Component (RC) (including federalizing the National Guard), extending terms of service, surging and mobilizing the industrial base and training bases, and bringing the Armed Forces of the United States to a state of readiness for war or other national emergency. Source: JP 4-05 Joint Mobilization Planning, page I-1.

g. D2RR.07 – Deploy Forces: The movement of forces into and out of an operational area. This task focuses on the movement of forces and resources from a point of origin to a specific operational area and planning for subsequent joint reception, staging, onward movement, and integration to transition from deployment to employment. Reception includes functions to receive personnel and equipment. Staging assembles arriving personnel, equipment and materiel into capabilities. Onward movement is the process of moving units to the tactical assembly area or other theater destinations. Integration is the synchronized transfer of capabilities into an operational commander's force prior to mission execution or back to the component/Service. Source: DOD Dictionary, JP 3-35 and ATP 3-35.

h. D2RR.08 – Employ Forces: The strategic, operational, or tactical use of forces in support of global force demands (partially JP-5-0).

i. D2RR.09 – Support Deployed Forces: This task includes providing, maintaining, transporting, or assisting/coordinating those levels of force, personnel, materiel, and consumables necessary to support the national and/or multinational military strategy. In military operations other than war, this task pertains to support of US forces and agencies and to advisory and training assistance to a host-nation. Sources: JP 0-2, 3-0, 3-07.1, 4-0, 4-01.1, 4-01.2, 4-01.3, 4-01.7, 4-02.1, 5-0, CJCSI 3100.01.

j. D2RR.10 – Redeploy Forces: The transfer or rotation of forces and materiel to support another commander's operational requirements, or to return personnel, equipment, and materiel to the home and/or demobilization stations for reintegration and/or out-processing. It includes planning for reception, staging, onward movement, and integration to transition from employment to redeployment. Reception includes functions to receive personnel and equipment. Staging assembles arriving personnel, equipment and materiel into capabilities. Onward movement is the process of moving units to the

## **EMERGING INITIATIVE: GLOBAL FORCE INFORMATION MANAGEMENT**

tactical assembly area or other theater destinations. Integration is the synchronized transfer of capabilities into an operational commander's force prior to mission execution or back to the component/Service. Sources: DOD Dictionary, JP 3-35 and ATP 3-35.

k. D2RR.11 – Demobilize and Regenerate Forces: Demobilization is the process to transition from a conflict or wartime military establishment and defense-based civilian economy to a peacetime configuration to maintain national security and economic vitality. Demobilization involves more than releasing personnel from active duty, inactivating units, and reorganizing the RC. Although these activities drive the process, capability or capacity in the other resource areas must be reduced and reorganized at the same time. Recovery activities must also be planned along with demobilization. These include activities for restoring force readiness. Source: JP 4-05. Note: Under the Multi-Domain Operations (MDO) concept [TRADOC Pamphlet 525-3-1, "The U.S. Army in Multi-Domain Operations 2028"], demobilization and regeneration may occur once Army forces, as an element of the Joint Force, achieve strategic objectives (win) and force a return to competition on favorable terms.

### **22-4. D2RR Governance**

D2RR is governed through the Army Business Council (ABC) and its subordinate forums. The ABC advises the Under Secretary of the Army in his role of Chief Management Officer of the Army on Army business operations and implementation of an integrated management system as specified in Section 904, fiscal year (FY) 2008, National Defense Authorization Act (NDAA) and Section 908, FY 2009 NDAA. Additionally, D2RR is unique in that the Headquarters, Department of the Army (HQDA) Deputy Chief of Staff (DCS), G-3/5/7, the US Army Forces Command (FORSCOM), and the Office of Business Transformation are designated co-process champions as outlined in AR 5–1. To facilitate this co-responsibility across three Army organizations, the D2RR E2E Business Process Tri-Chair Oversight Panel was established with the signing of the Memorandum of Agreement (MOA) between the HQDA Assistant DCS, G-3/5/7, Deputy G-3/5/7, FORSCOM, and Deputy Director of Business Transformation. The MOA for D2RR established the method for implementing and adhering to the eight specified responsibilities as described in AR 5–1. Further, the agreement facilitates the full oversight of the D2RR E2E business process, sub-processes and defense business systems that support D2RR capabilities. The Tri-Chair Oversight Panel established direction for governance, funding, and resource allocation for those D2RR processes and systems to ensure effective and efficient delivery of trained and ready units and Army capabilities in support of CCDR and internal Army requirements.

## **Section III**

### **Global Force Information Management (GFIM) Objective Environment (OE)**

#### **22-5. Overview**

The GFIM OE is an emerging capability solution that will fundamentally change the way the Total Army manages its Title 10 U.S.C. functions to generate, sustain, and deploy forces in support of CCDR requirements. HQDA G-3/5/7 is leading efforts to develop the GFIM OE. The GFIM OE will enhance readiness and improve the Army's ability to make risk-informed DOD GFM decisions through improved visibility and accountability of Army forces around the globe. To do this, GFIM OE will automate and integrate force structure, force management, readiness, mobilization, manning, equipping, resourcing, real property, and logistical data from multiple, disparate sources to provide a near real-time common operating picture that displays the current status of Army resources and capabilities in a dynamic and transparent manner.

#### **22-6. Background**

a. The Army currently supports the DOD GFM, Joint C2, and Army D2RR processes using a portfolio of 12 information technology systems (and related subsystems) developed over the past 30 years in response to the dynamic and complex operational environment. These 12 systems comprise the Army's current GFIM portfolio and are relied upon to conduct force management for the Total Army, monitor and assess readiness, and respond to the dynamic force and capability requirements of CCDRs. The systems that comprise the GFIM portfolio include:

- (1) Army Force Generation Synchronization Toolset (AST).
- (2) Army Organization Server (AOS).

## HOW THE ARMY RUNS

- (3) Computerized Movement Planning and Status System (COMPASS).
- (4) Defense Readiness Reporting System – Army (DRRS-A).
- (5) Enterprise Management Decision Support (EMDS).
- (6) Equipment Common Operating Picture (ECOP).
- (7) Force Management System (FMS).
- (8) Force Management System Website (FMSWeb).
- (9) Mobilization Common Operating Picture (MOBCOP).
- (10) Reserve Component Automation System (RCAS).
- (11) Structure and Manpower Allocation System (SAMAS).
- (12) Worldwide Individual Augmentation System (WIAS).

b. Each of the 12 systems within the GFIM portfolio are important for supporting mission critical capabilities across the Army and must be sustained to support DOD GFM and enable the Army's input to Joint C2 planning and execution capabilities. However, many of these systems were developed without fully documented requirements, lack adequate acquisition oversight, and/or are sustained annually as unfunded requirements. This approach is not reliable or cost effective. Additionally, these systems lack the interoperability needed to enable an automated and enterprise approach to machine-to-machine data exchange. These antiquated system also present risks, and in some cases vulnerabilities, with respect to cyber and security compliance. Significant manual input and manipulation of data is often required to compile information, which impacts the timeliness and accuracy of information to support senior leader risk-informed decisions. Ultimately, the Army lacks a common operating picture of the Army at rest and the Army in motion because of these current "stove-piped" systems within the GFIM portfolio, which impedes the Army's ability to rapidly respond to CCDR requests for forces resulting from urgent needs.

c. Each system within the current GFIM portfolio relies on force structure data by using it or producing it. Half of the systems use Army force structure data to enable force management processes, while the other half use Army force structure to report or assess readiness. Collectively, these 12 systems enable the Army to support DOD GFM, Joint C2, and Army D2RR processes. An enterprise approach to management of the Total Army that integrates force structure, force management, readiness reporting, mobilization management, and operational requirements validation together within a common enterprise data environment is needed to fully enable the Dynamic Force Employment concept as prescribed in the 2018 National Defense Strategy.

d. The HQDA DCS, G-3/5/7 established a GFIM Capability Management Office (CMO) within HQDA G-37/Force Management Directorate on 8 July 2014 as the designated capability manager or office of primary responsibility for policy, governance, portfolio oversight, architecture development, resourcing of automation systems, and information in support of DOD GFM. The GFIM CMO has the authority to lead the Army's:

(1) Participation and alignment with Joint Staff and Office of the Secretary of Defense initiatives that are designated to standardize force structure representation, making it visible, accessible, and understandable across the DOD.

(2) GFM Business Case and governance structures development, and related planning for Doctrine, Organization, Training, Materiel, Leadership and Education, Personnel, Facilities, and Policy.

(3) Requirement to formalize, integrate, and normalize a portfolio of GFM Army capabilities and system solutions.

(4) Completion of GFM Planning, Programming, Budget and Execution, investment review and other related activities, documentation and submissions

(5) Delivery of auditable and transparent GFM outcomes

e. The GFIM OE aligns with one of the three Secretary of the Army's priorities to "Reform the Department for Greater Performance and Affordability" while directly supporting the Chief of Staff of the Army's emphasis on Readiness and Lethality. The GFIM OE will seamlessly interface with the Army's Enterprise Resource Planning (ERP) systems providing authoritative force structure and force management data to assure compliance with GFM DI standards and to promote auditability. Additionally, the GFIM OE will be postured to provide the Army Leader Dashboard (i.e., Vantage) with timely, accurate, and integrated data while also directly contributing to the enablement of MDO with visibility of readiness at the lowest employable entity. The GFIM OE will provide a common operating picture for the Total Army and provide fully integrated information from across D2RR to enable risk informed decisions by senior leaders to meet the dynamic challenges of the current and future operating environment.

## **EMERGING INITIATIVE: GLOBAL FORCE INFORMATION MANAGEMENT**

### **22-7. GFIM OE Validated Requirements**

Validated high-level requirements for the Army's GFIM OE capability are derived from three key documents. The Army's adoption of Joint GFM capability gaps from the Joint Initial Capabilities Document (ICD) for GFM combined with high-level outcomes from the Dynamic Force Structure (DFS) problem statement and required capabilities from HQDA G-3/5/7 adoption memo collectively encompass validated requirements for GFIM OE. These requirements are needed for the integration of key Army information technology (IT) systems and processes that collectively support DOD GFM, Joint C2, and Army D2RR processes.

a. Joint ICD for GFM (May 2010). This document outlines 12 prioritized Joint GFM capability gaps the Army adopted as the foundation for GFIM OE capability needs. These capability gaps include:

- (1) Lack of process, technology, and data interoperability between GFM and related processes
- (2) CCDRs do not have an effective means to predict the availability of forces for plans
- (3) Joint and Service GFM data (e.g., readiness, force structure, force alignment, and data context) are neither globally visible nor accessible
- (4) There are insufficient means to update and maintain the current tool suites
- (5) GFM is not fully incorporated into DOD policy, doctrine and procedures
- (6) A common understanding of the capabilities and limitations of contingency sourcing process does not exist across all GFM stakeholders
- (7) GFM risk assessments neither fully analyze nor communicate the risks of sourcing decisions
- (8) The capacity of the GFM enterprise is limited by deficiencies in manning and supporting tools
- (9) Allocation is not aligned with the budgeting process
- (10) Force providers do not have sufficient lead-time to train ad-hoc/ILO forces for near-term force requirements
- (11) GFM feedback to the force development/force generation decision process is late and incomplete
- (12) The DOD lacks institutionalized training in GFM processes and procedures

b. Army Dynamic Force Structure Problem Statement (Feb 2015). This document outlines the high-level goals, objectives, and business outcomes for the GFIM OE. See Figure 22-2 for details.

c. HQDA G-3/5/7 Joint GFM Adoption Memo (July 2015). This document outlines the six required capabilities for the GFIM OE. See Figure 22-3 on next page for details.

### **22-8. GFIM OE Acquisition Approach**

The GFIM OE will be developed as a defense business system and provide a sustainable enterprise IT solution leveraging commercial off-the-shelf technology and best business practices. While acquisition planning for the GFIM OE is under way and still subject to change, below are known key characteristics:

a. Acquisition Category (ACAT) III Non-Covered potential (<\$49.9M over Future Years Defense Program).

b. Rapidly plan, acquire, and deliver system functionality through two increments and multiple builds/releases. Leverage a hybrid "12-3-1" approach for modernizing or consolidating functions from legacy IT systems (see Figure 22-4).

(1) GFIM OE Increment 1 will consolidate and/or modernize the 12 IT systems in GFIM portfolio down to 3 modernized IT systems (AOS, AST, and EMDS).

(2) GFIM OE Increment 2, with acquisition oversight, will develop and deliver the enduring solution by combining the 3 modernized systems (AOS, AST, and EMDS) into a single, integrated GFIM OE.

c. Each increment will be a manageable subset of functionality that provides operational utility in support of the introduction of improved business processes linked to the Army's D2RR end-to-end business process.

d. Each increment will be structured to be a logical progression of functional capabilities, which are building blocks leading to an integrated end-to-end capability to replace or interface with the current IT systems that collectively support DOD GFM, Joint C2, and Army D2RR processes.

e. Budget will be guided by DOD Planning, Programming, Budgeting, and Execution (PPBE) process with annual funding certification by the Army's Chief Management Officer.

f. Legacy systems will be sustained by unfunded requirement submissions until functionality is modernized or consolidated within the GFIM OE.

## HOW THE ARMY RUNS

| SMP / DoD Goal or Objective  | High-Level Outcomes (HLOs)   | Business Outcomes (BOs)  |
|--|--|--|
| <b>Optimize DoD Personnel Readiness Posture</b><br><br><i>Force Structure Visibility</i>   | <ul style="list-style-type: none"> <li>• Enable task organized units to be structured using GFM DI</li> </ul>  | <ul style="list-style-type: none"> <li>• Accurate cost accounting for deployed units</li> <li>• Accurate portrayal of Command and Control and supporting relationships</li> </ul>  |
| <b>Strengthen DoD Financial Management</b><br><br><i>Implement Interoperability Standards</i>  | <ul style="list-style-type: none"> <li>• Establish standard organizational relationship types</li> <li>• Enable capturing of all organizational relationship types using GFM DI compliant system(s)</li> </ul> | <ul style="list-style-type: none"> <li>• Common understanding across the Army of all support and Command and Control relationships</li> <li>• Accurate representation of the Army as it operates to fulfill its mission</li> </ul> |
| <b>Strengthen DoD Financial Management</b><br><br><i>Lower cost of strategic mission command, financial management, and logistics operations</i> | <ul style="list-style-type: none"> <li>• Eliminate manual reconciliation and integration of force structure data from multiple systems</li> </ul>  | <ul style="list-style-type: none"> <li>• Reduced spending on manual work associated with organizational / force structure data consumption and maintenance</li> </ul>  |
| <b>Strengthen DoD Financial Management</b>   | <ul style="list-style-type: none"> <li>• Subsume legacy systems functionality</li> </ul>   | <ul style="list-style-type: none"> <li>• Reduced spending on legacy systems</li> </ul>   |

Figure 22-2. Army Dynamic Force Structure Problem Statement Goals, Objectives, and Outcomes

| # | Requirement  | Description  |
|---|--|--|
| 1 | Shape and Align the Total Army   | The ability to manage current Army force and to provide feedback to the force development decision processes. GFM shapes the force by providing feedback to help determine the future size and type of forces in the Army inventory. Moreover, influence the content in the Guidance for Employment of the Force (GEF) and the Total Army Analysis (TAA) through an analysis of requirements levied against the current force. An analysis of the risks associated with sourcing the Combatant Commander's (CCDR) operational needs is derived from the annual persistent shortfall analysis, also critical to providing feedback content.   |
| 2 | Provide a Common Framework for Force Structure and Command Relationships | The GFM DI is a Joint Staff and Office of the Secretary of Defense (OSD) initiative for a Joint data standard designed to standardize force structure representation, making it visible, accessible, and understandable across the DOD. The results of this effort will provide a capability to link authorized force structure, resources, and capabilities data to support risk analysis and informed decision-making. This concept of a dynamic representation of chain of command links enabled through electronic manipulation and distribution of force structure data across multiple Army IT capabilities is characterized by the Army as the Dynamic Force Structure (DFS) solution utilizing GFM DI. Capability must include the receipt of Force Management Identifier (FMID) data which defines Command and Control (C2) relations from authoritative resources and correlates this information with the Derivative Unit Identification Code (DUIC) and C2 relationships created in other systems for the consumption by Army and Joint systems. |
| 3 | Provide Visibility of the Army's Force Generation Process                | The ability to provide a common understanding and context associated with the availability and operational availability of the force through the Army's Force Generation process. The Army's Force Generation process is part of the GFM process, leveraging modular unit designs and operational cycles, to provide operationally ready units in predictable patterns while retaining the capability to surge combat power for major combat operations.   |
| 4 | Assess the Readiness of the Army   | The assessment of the Readiness of individual units is characterized in the Unit Status Report (USR) readiness reporting process (i.e., Army Regulation 220-1), and the strategic assessment of Army Readiness (i.e., Army Regulation 525-30) to meet the Army Campaign Plan (ACP), The Army Plan (TAP), and the National Defense Strategy. This includes considering a myriad of factors influencing the availability and readiness of the force. This common understanding of force availability and readiness is an enabler for both supported and supporting commands to collaboratively develop and execute relevant plans.   |
| 5 | Globally Align Army Forces   | The ability of the Army to recommend feasible alignment of forces for operational tasks to the Joint Staff for approval by the Secretary of Defense (SECDEF). The analysis process leading to the recommended sourcing solutions contains a quantification of the available capacity of the Army and an articulation of the risks. It is in the execution of SECDEF decisions to support a CCDR's operational task, preparing the individual(s) or forces for deployment (i.e., train, organize, and equip). A key element of this capability is the ability of the Army to adapt the force structure in creative ways (in-Lieu-of forces) to meet the capability needs of the warfighter, deploy the selected force(s) or individual(s), and sustain deployed forces.   |
| 6 | Assess Impact and Risk on the Army                                       | Effective GFM enables sufficient and accurate knowledge of the risks and trade-offs of demand fulfillment and proposed changes to the force. These risks include meeting strategic and operational objectives while balancing the Army's capacity to provide sufficient forces to meet the CCDR's current operational requirements against potential future operational needs.   |

Figure 22-3. Army Global Force Information Management Required Capabilities



# HOW THE ARMY RUNS

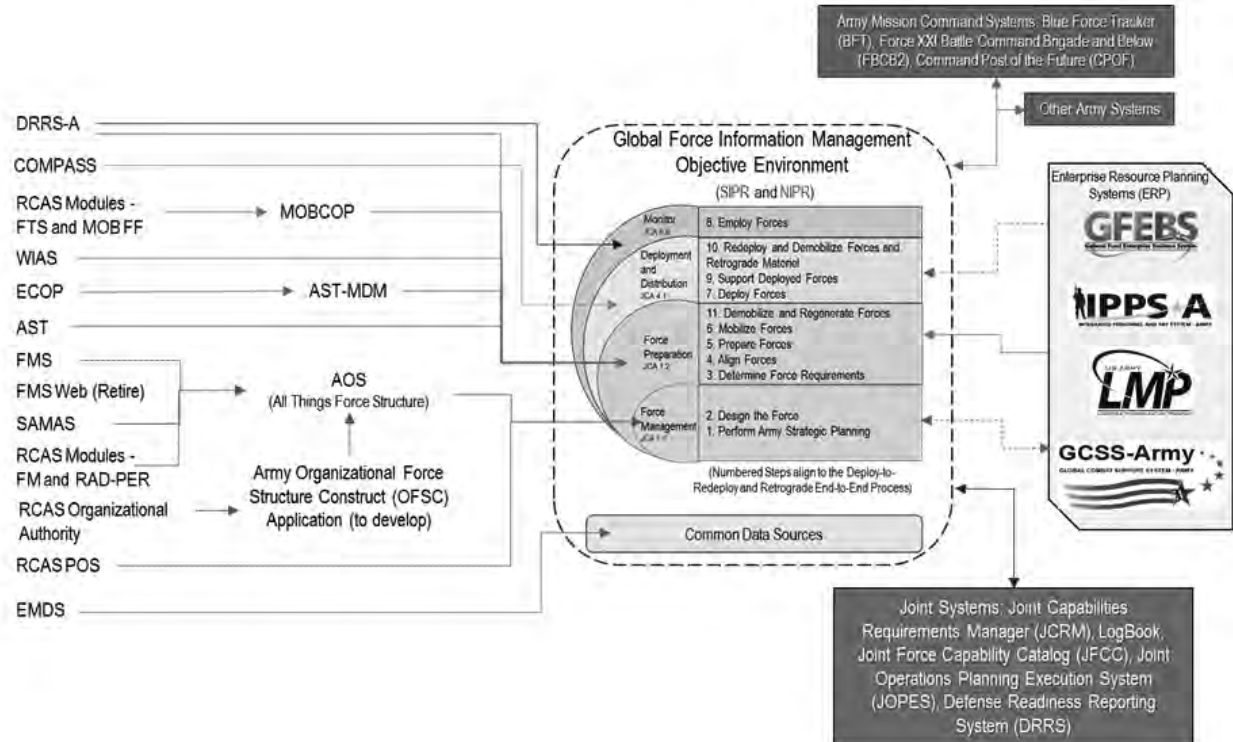

**Figure 22-5. How the Global Force Information Management Objective Environment Supports Deploy-to-Redeploy/Retrograde**

## Section IV Global Force Management Data Initiative

### 22-10. Overview

The DOD-directed GFM DI provides a common data standard for the digital representation of force structure across the DOD. GFM DI provides Enterprise Force Structure (EFS) data in a standardized hierarchical framework to enable an enterprise approach to GFM and to support DFE. Two key things to understand about the GFM DI standard are: 1) All authorizations are documented down to the individual level – the individual Soldier billet and the individual piece of equipment; 2) Through the use of Organizational Force Structure Construct (OFSC) the Army’s force structure can be modified to reflect changing relationships over time. The GFM DI schema enables the linkage of personnel, equipment, readiness, real property, as well as command and support relations from the individual Soldier billet to Army and Joint Commands. GFM DI provides a common data standard across PPBE, as well as reporting processes and systems to integrate data in a timely, accurate, and auditable manner to support risk informed decisions and enable an enterprise approach to D2RR, GFM, and DFE (see Figure 22-6).



## EMERGING INITIATIVE: GLOBAL FORCE INFORMATION MANAGEMENT

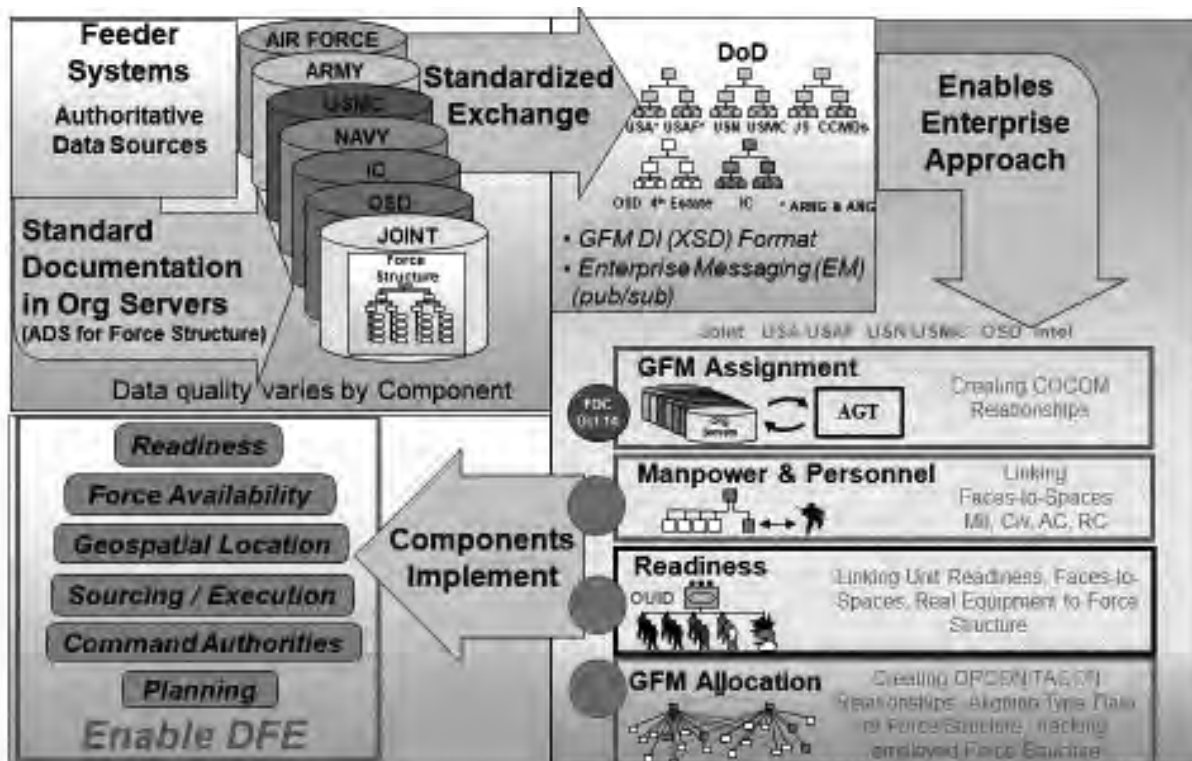

**Figure 22-6. GFM DI Provides Common Data Standard Across PPBES and Reporting Systems to Support Enterprise Approach to D2RR and DFE**

### 22-11. Background

GFM DI requirements validated by the Joint Requirements Oversight Council (JROC) are split between two capability increments (see Figure 22-7).

a. GFM DI Increment 1 (Organization Servers). The first increment directed OSD, Joint Staff, DOD Intelligence Agencies, and each Service to establish a GFM DI compliant authoritative data source for force structure. The Army fielded the Army Organization Server (AOS) in 2014, which provided classified and unclassified databases for GFM DI formatted force structure for Modified Table of Organization and Equipment (MTOE), Table of Distribution and Allowance (TDA), and Augmentation TDA Documents. The AOS exchanges force structure data across the DOD enterprise. Along with the AOS Data Interface (AOS-DI), developed to support the Integrated Personnel and Pay System Army (IPPS-A), the GFM DI formatted force structure data will replace the TAADS data standard for authoritative force structure for consumption by Army ERP systems.

b. GFM DI Increment 2 (Next Steps Implementation). The second increment requires the implementation of requirements identified in four Capability Development Documents (CDD) that are approved by the JROC. The four Joint CDDs address GFM Assignment, Manpower and Personnel, Readiness, and GFM Allocation. The DOD directed Services achieve full operational capability for the GFM DI Next Steps NLT fourth quarter, Fiscal Year 2020 (4QFY20). The Army Requirements Oversight Council approved adoption and issued a directed requirement for implementation of GFM DI standards. The directed requirement included the synchronization of funding for sustainment of the current GFIM portfolio and the development of the GFIM OE.

c. Functional Leads and owners of systems that consume force structure shall incorporate GFM DI compliance as part of ongoing modernization and materiel development plans and programs. GFM DI Data standard will be incorporated into the Army's common operating environment and Army Data Strategy Implementation Plan as the authoritative data standard for force structure and organization identity data.

# HOW THE ARMY RUNS

Services directed to implement GFM-DI in two increments through a series of JROCMs and CDDs.

## GFM DI Increment 1

### Organization Servers

Services directed to establish an authoritative data source for providing force structure

Army Organization Server (AOS) was deployed in 2011

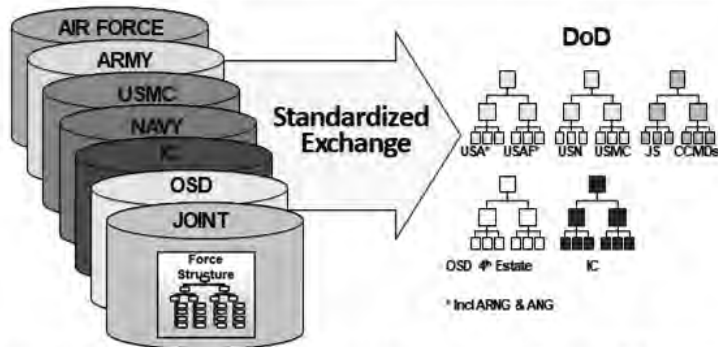

## GFM DI Increment 2:

### Next Steps Implementation

Services directed to meet FOC for the 4 CDDs (Assignment, Allocation, Readiness, and Manpower and Personnel) by 4<sup>th</sup> Qtr FY20. AROC adopted and issued a directive for implementation

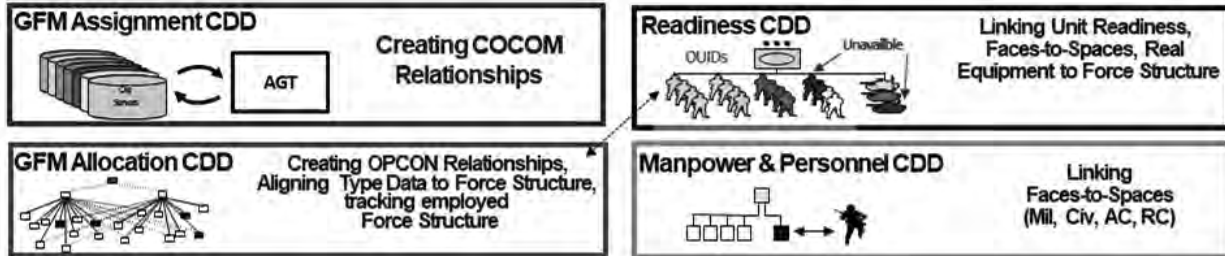
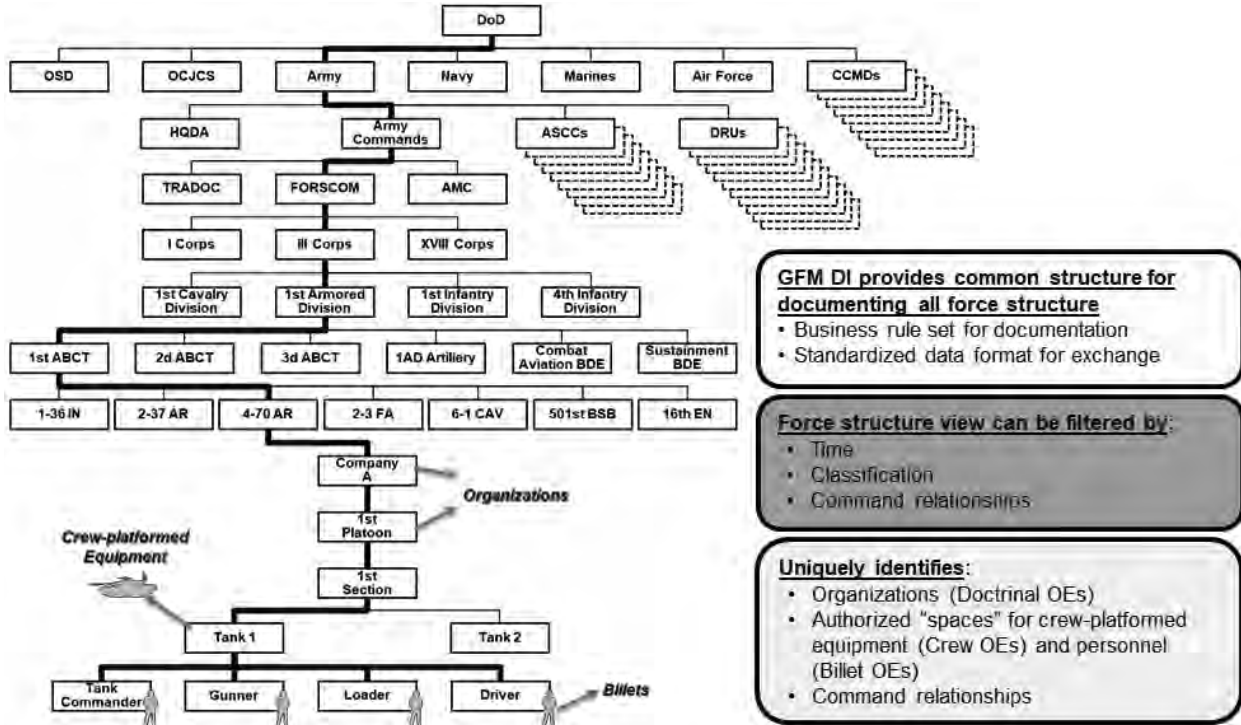

Figure 22-7. Department of Defense Global Force Management Data Initiative Overview

## 22-12. Organizational and Force Structure Construct (OFSC)

a. The OFSC, outlined in DODM 8260.03 Volume 2, provides a hierarchical framework, with business rules, to provide and enable the exchange of standardized enterprise force structure across the DOD and Army enterprise. The OFSC provides the relationships and logic to digitally build high resolution organizations from the highest command level to the individual Soldier billet using an organization tree format. The organizational tree is composed of a series of organizational elements that are connected by specific associations and command relationships (see Figure 22-8). The result provides structure, leadership, reporting chain of command, and command relationships, that reflects task organization and missioning of a unit across D2RR.

# EMERGING INITIATIVE: GLOBAL FORCE INFORMATION MANAGEMENT



**Figure 22-8. Organizational and Force Structure Construct Overview**

b. An organizational element (OE) is the aggregation point (node) that links force structure to personnel, equipment, platform, designated leader, chain of command and operational command. OEs represent billet, crew, squad, platoon, company, etc.; installations, and augmentation organizations. OEs provide the basis to build and establish command relationships with other organizations and are used to reflect operational force and generating force organizations. OEs are assigned specific identification numbers (organizational unique identifiers (OUID)) or GFM Identifiers (GFMID) as unique primary keys for linking, integrating and exchanging data.

c. The link between one OE and another is called an association. Associations define the structure or composition of a unit, the specific leader for a specific unit (is-led-by), and the chain of command or reporting chain for a unit from the individual soldier billet to the highest level of the organization (see Figure 22-9).

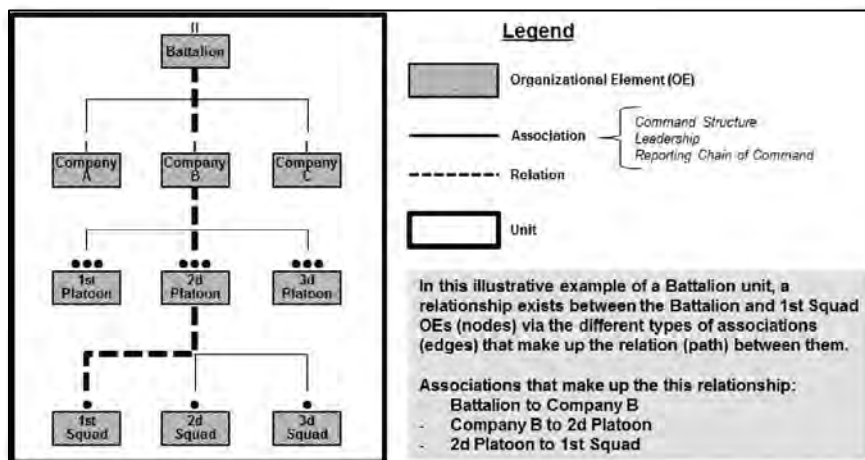

**Figure 22-9. Organizational and Force Structure Construct Terminology and Components**

## HOW THE ARMY RUNS

d. The lowest hierarchical entity or OE is the BILLET. A billet is an OE for a single soldier authorization (space). Billets are associated or linked to form crews and squads that are aggregated to form larger units. A billet is always associated with a manpower authorization and includes the required qualifications for the billet (rank, military occupational specialty, military education level, etc.). A temporary billet (TEMPLET) is used to account for Soldiers that are not assigned to a billet in the programmed force structure. TEMPLETs are primarily used for trainees, transients, holdees, and students (TTHS); cadets; and directed overmanning. In the past, personnel systems allowed for slotting multiple individuals against a position. A key GFM DI business rule is that only one Soldier can occupy one billet at a given time (i.e., One Face to One Space). The Army's new enterprise Human Resource System, the Integrated Personnel and Pay System – Army (IPPS-A), is GFM DI compliant and currently being fielded to the Total Army. IPPS-A will link a Soldier's DOD Identification (DODID) number to the GF MID of the billet or TEMPLET to which he or she is assigned to meet the requirements outlined in the four Joint CDDs to achieve GFM DI compliance (see Figure 22-10).

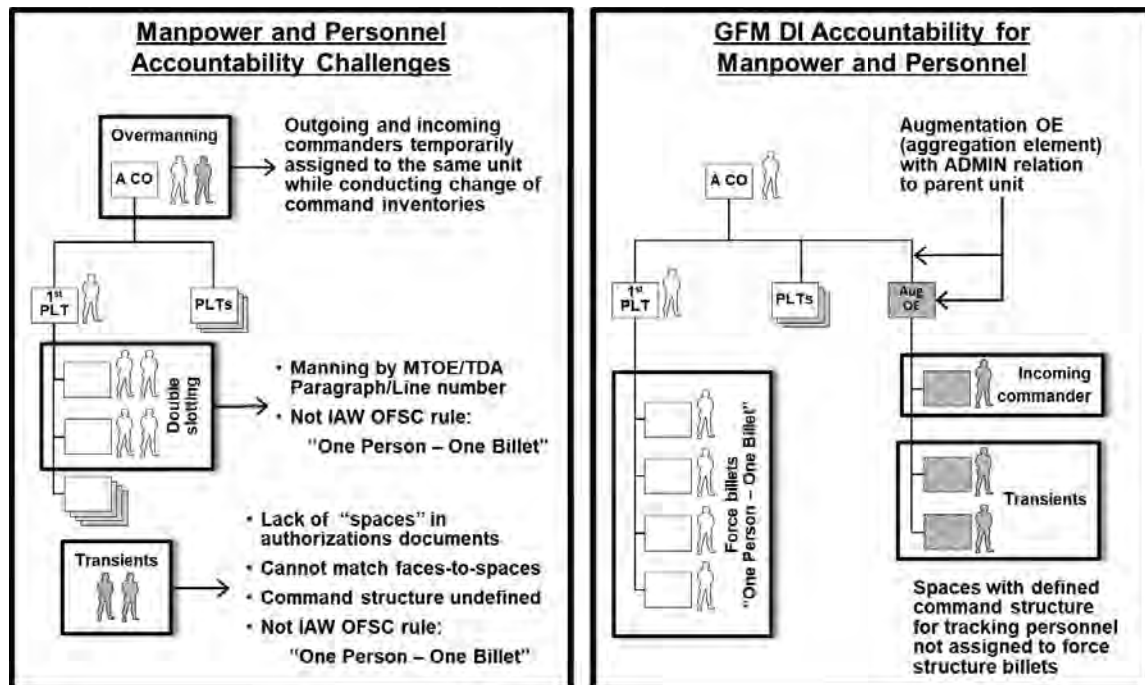

**Figure 22-10. Organizational and Force Structure Construct Billet, TEMPLET, and Personnel Accountability**

e. Crews and/or billet OEs are grouped to form squads, sections, and platoons that serve as the building blocks for larger organizations, and provide the basis to link force structure, personnel, equipment, and readiness data (see Figure 22-11). Application of the OFSC facilitates simultaneous and different views of the Total Force by mathematically relating all of the DOD down to the billet level.

# EMERGING INITIATIVE: GLOBAL FORCE INFORMATION MANAGEMENT

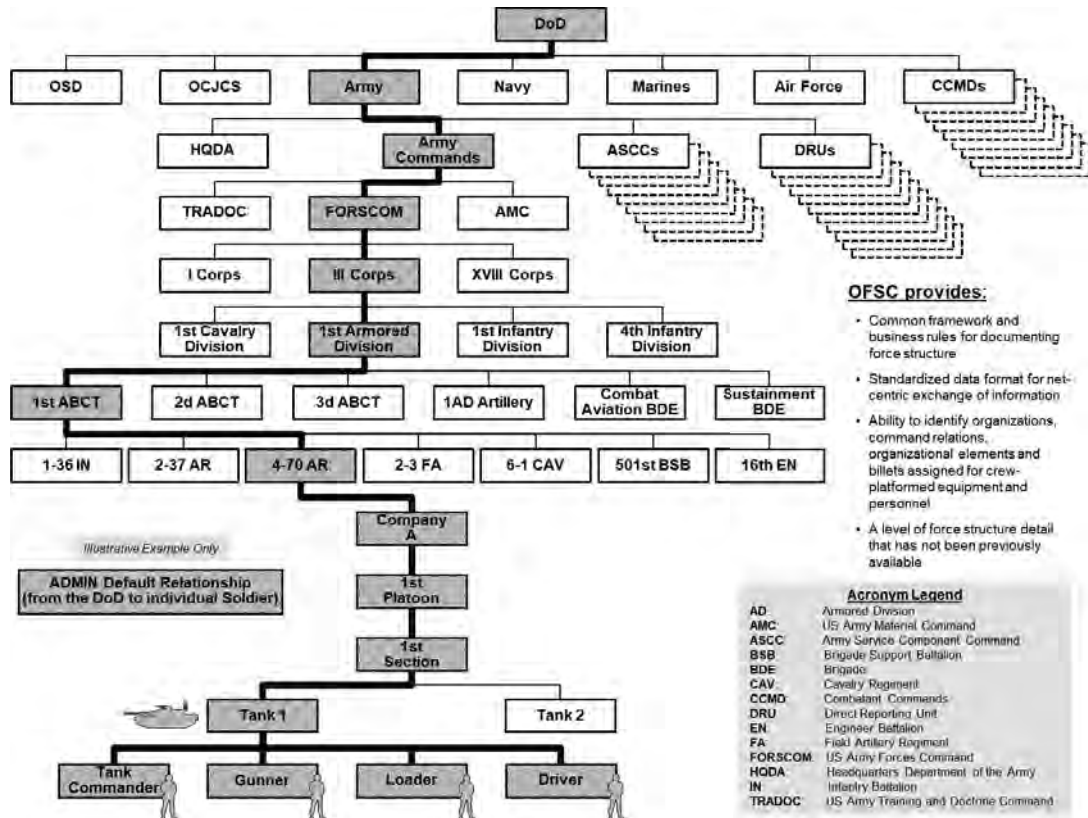

**Figure 22-11. Organizational and Force Structure Construct Organizational Tree From DOD Down to Billet Level**

f. C2 relationships determine how force structure is organized and employed. In addition to the above mentioned associations, OFSC specifies the command relationships of each unit for both Service Retained (Army at Rest) and operationally committed (Army in Motion). OFSC relations are grouped based on their application for Army at rest/ force generation (i.e., Title 10 functions within the administrative command structure), force employment (i.e., C2 in operational command structure), and other unique situations that could apply to either category. OFSC relations are addressed in DODM 8260.03 Volume 2 and the GFM DI Intellipedia site, but for the purpose of this document several key relations are highlighted (see Figure 22-12):

(1) ADMIN is the foundational relation for OFSC serving as the primary mechanism for establishing the Army's command structures and executing all Title 10 and 32 U.S.C. authorities, responsibilities, and activities. The ADMIN relation is enduring regardless of COCOM assignment or operational commitment. For Regular Army and Army Reserve units, ADMIN flows from the billet to the SECARMY/HQDA. For Army National Guard (ARNG), admin is established from the billet through the State Adjutant General to the Governor of the state where the soldier and his/her unit are assigned and stationed. ADMIN should not be confused with Administrative Control (ADCON).

(2) C2 Default (C2DEF) is an OFSC relation that links capability packages for the purpose of readiness reporting and operational employment. The C2DEF relation has several uses across DOD but its primary role for the Army is related to ARNG units that are assigned/stationed across multiple states. As previously stated, ADMIN relation is established for ARNG units from the unit OE to the Governor of the state where the unit is assigned and stationed. C2DEF is used to establish a relation between subordinate elements of a parent/MTOE unit that is "split" across two or more states. C2DEF is not a command relation.

(3) Direction and Control (DIRCON) is a versatile relation that reflects habitual relationship and operational organization of units. For example, DIRCON is used to link a support battalion to a specific Brigade. The DIRCON tree is a modification of the ADMIN hierarchy to show how the command operates.

## HOW THE ARMY RUNS

Because OPCON and TACON are exclusively reserved for operational employment of units under the C2 of a COCOM/Joint command, DIRCON reflects the task organization of one Army unit to another that Army doctrine refers to as OPCON.

(4) Installation Commander (INSCMD) establishes the Title 10 U.S.C. command authorities and responsibilities exercised by the designated Senior Commander (generally Army Senior Commander, but may be from another Service for Joint Bases) of an installation over the tenant units (members of the Installation Force OE) on the installation. The Installation Force OE, which is led by the Senior Commander, is used as an aggregation point (node) through which the SC exercises the INSCMD authorities.

(5) Installation Support (INSSUP) is a special category of support that conveys the support responsibilities to the base tenants as exercised through the garrison. INSSUP establishes the supporting and supported relation between installation support units and agencies (garrison) and the tenant units on the installation (particularly with regard to mobilization).

(6) Combatant Command (COCOM) is the relation for forces assigned to a CCMD. The COCOM relation is exclusive, which means a unit, or individual, can only be assigned to one CCMD at a time. Both COCOM assigned and Service Retained operational forces are allocated to joint force commanders through the GFM process.

(7) Operational Control (OPCON) is the primary relation for force employment in support of a joint force commander. OPCON establishes the relation for employment of an OE by the commander of the joint force (e.g., task force, task group, etc.) for a specific period of time. To ensure unity of command, there can only be one OPCON relation between two OEs at a time. The OPCON relation does not change the COCOM, ADMIN, DIRCON, or other foundational relations.

(8) Tactical Control (TACON) occurs at the tactical level and is limited to the direction and control of movements and actions within the operational area. Like OPCON, a subordinate unit can only be TACON to one unit, for a specific period of time, to ensure unity of command.

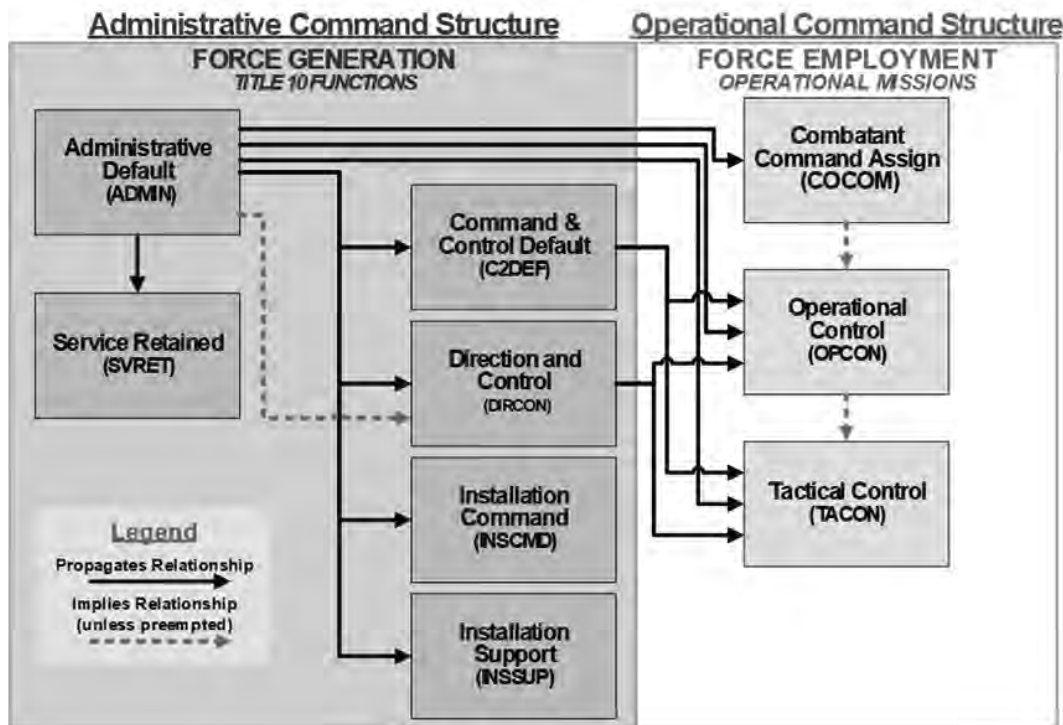

**Figure 22-12. Primary Organizational and Force Structure Construct Relations for Army at Rest and Army in Motion**

g. OFSC provides the construct for organizing and managing force structure data. OFSC relations reflect the command, control, and support relationship of units that provide accountability and visibility of

# EMERGING INITIATIVE: GLOBAL FORCE INFORMATION MANAGEMENT

the Total Army, at rest and in motion. This directly supports DFE, to include the Joint Staff's ORION suite of decision support tools, to enable time sensitive decisions to support CCDRs in the execution of the National Defense Strategy.

## 22-13. Enterprise Force Structure

a. The enterprise force structure data standard established by GFM DI links Total Army force structure to readiness and addresses the DOD readiness requirements to link crew-served equipment to the crew in the AOS (see Figure 22-13).

b. Within the AOS, specific OE OUIDs are created for crews with the purpose of operating a piece of equipment or weapon system. Three aspects of crew OE employment are described: the placement of the platform authorization that caused the crew OE to be established; the persistence of the association between the crew and the actual asset that the crew operates; and the placement of the crew within the command structure. This structure is implemented for crewed platforms that are key, crewed pieces of equipment that enable an SRC capability as determined by the Services.

c. A crew OE is required for equipment or platforms that either: 1) transport the crew, and/or 2) provide a critical enabling capability that warrants documentation as determined by the Service (e.g., a towed weapon or radar system).

d. Crew properties are defined from two perspectives: crew membership and asset affiliation. Crew membership refers to the subordinate OEs that ultimately include the billet OEs that operate the asset or piece of equipment. Asset affiliation refers to the physical platform the crew operates. For clarity and simplicity, the processes of configuring these two crew properties are referred to as crew assignment and crew alignment. Routine relationships are documented in the forces structure with a fixed set of billet OEs placed under the crew OE. This is a common characteristic for many ground crews, such as those in Army armor units.

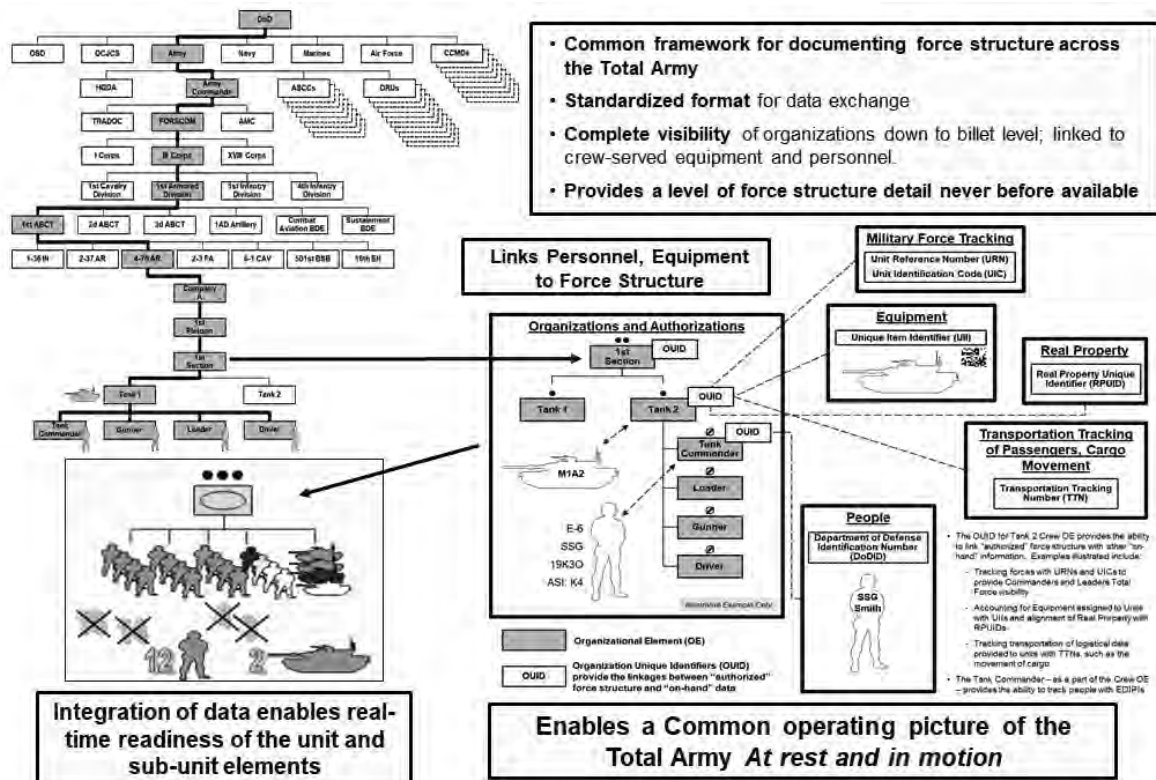
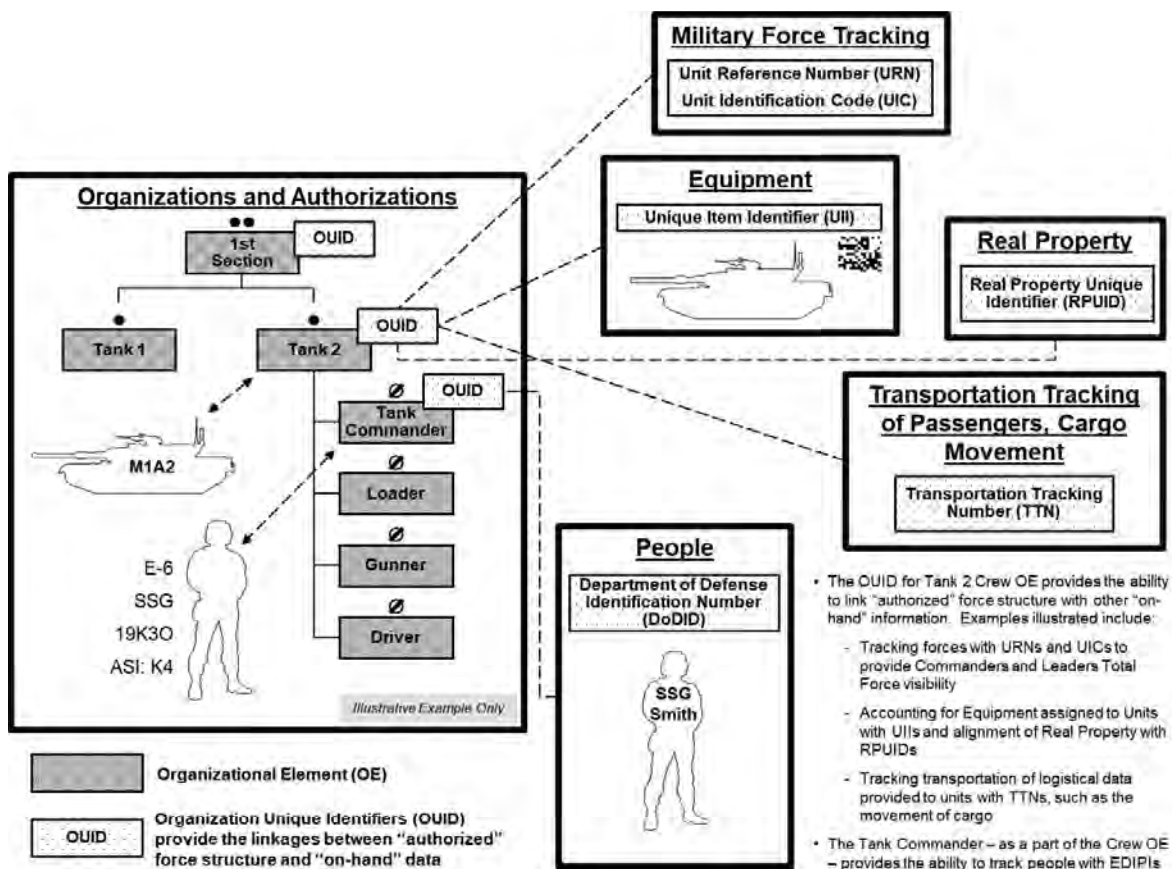

Figure 22-13. The Enterprise Force Structure Data Standard Enables Common Operating Picture of the Total Army

## HOW THE ARMY RUNS

### 22-14. Linking Enterprise Force Structure with Readiness

- a. The DOD GFM DI Joint CDD for Readiness requires that Component readiness systems consume and integrate OUIDs of crewed-platform authorizations to serialized (actual) platforms. The OUIDs are the crew and equipment OEs.
- b. Equipment data linked to OUIDs will be integrated in Service logistics systems for direct feed using Enterprise Messaging (EM) to DRRS-Strategic.
- c. EM topics will be established and subscribed to by DRRS-Strategic.
- d. Crewed-platform authorizations to serialized platforms will be integrated by DRRS-Strategic.
- e. The GFM DI requirement to link personnel, equipment, and readiness to force structure using Organization Unique Identifiers (OUID) GFMIDs, at the Lowest Employable Entity (LEE), directly supports and enables DFE (see Figure 22-14).



**Figure 22-14. Linking Personnel and Equipment to Force Structure**

- f. To accomplish this, the crewed platform is linked to the Crew that "fights" or operates the crewed platform. GFM DI uses unique equipment organizational elements (EOEs) to identify unique crewed platforms. GFM DI will create a linkage between the EOE OUID for a crewed platform with on hand materiel data identified by the specific platform Item Unique Identification (IUID) code to seamlessly exchange this information. Since all data must be standardized and GFM DI compliant and serial numbers and equipment numbers are not standardized, the DOD standardized IUID Unique Item Identifier (UII) code will be used to "map" equipment in the GCSS-Army Property Book to force structure in the AOS. Specifically, the UII of the crewed platform will be linked to the EOE GFMID that corresponds to the Crew OE that operate/fight the equipment/system (see Figure 22-15). This information is made available to DRRS-Strategic and the Readiness Enterprise.



**EMERGING INITIATIVE:  
GLOBAL FORCE INFORMATION MANAGEMENT**



**Figure 22-15. Linking the Crewed Equipment (Tank IUID) to the EOE (GF MID) that is Associated with the Crew**

g. The GFM DI Manpower and Personnel and Readiness CDDs require DoDIDs for military and civilian personnel be linked to the billet to which he or she is assigned. This is accomplished with the AOS providing Billet GF MIDs to IPPS-A where the DoDID is linked and made available to DRRS-Strategic and the Readiness Enterprise.

h. This common framework allows GCSS-Army and IPPS-A to integrate with AOS authorization data to provide a level of force structure and readiness detail never before available. The linkage of force structure, personnel, equipment, and OFSC relations provides the basis for a dynamic common operating picture of the Total Army, at Rest and in Motion. This provides GFIM-OE and DRRS-Strategic with the capability, readiness, availability and employability information at the unit and sub-unit (lowest employable entity) to support DFE (see Figure 22-16).

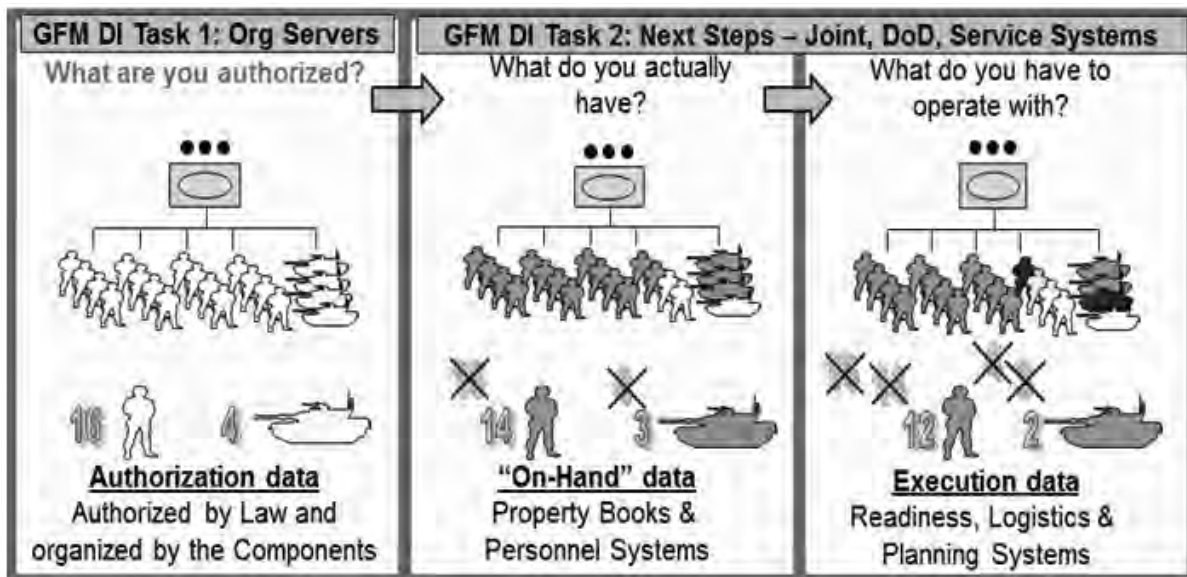
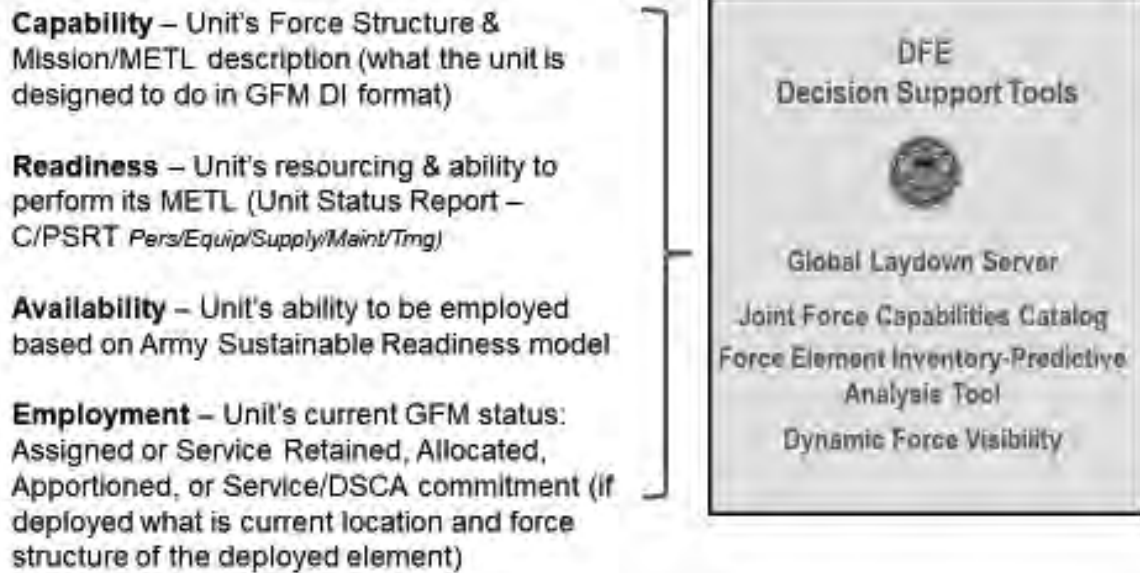

**Figure 22-16. GFM DI Enterprise Force Structure Enables Dynamic Readiness at the Lowest Employable Entity**

**22-15. Dynamic Force Employment (DFE)**

a. The 2018 National Defense Strategy introduced DFE for the employment of forces to engage partners, reinforce allies, deter conflict, and in the event of conflict, rapidly respond and defeat aggression to the Nation's national security interests. DFE enables the proactive and scalable employment of joint forces in a timely, risk-informed manner. Implementation of DFE requires accurate and real-time information on the capability, readiness, availability, and employability (CRAE) of forces to respond and support COCOM requests for forces (see Figure 22-17). For this reason, the Deputy Secretary of Defense identified GFM DI as a "critical enabler" to support DFE.

## HOW THE ARMY RUNS

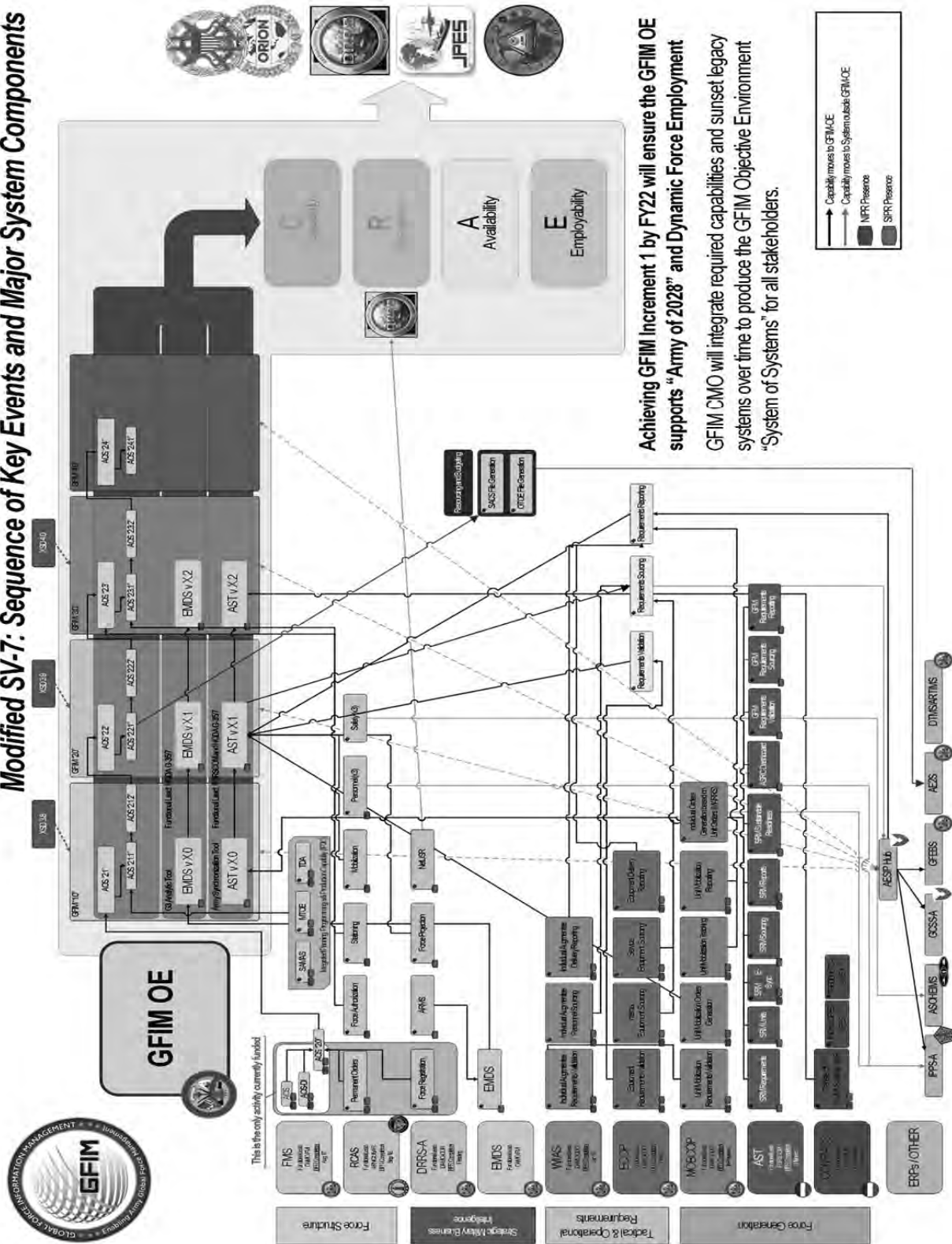

**Figure 22-17. Required Information and Data to Support DEF Decisions**

b. The Joint Staff has developed ORION, which is a suite of decision support tools to enable senior leaders to make time sensitive decisions to execute DFE. ORION relies on the system-to-system enterprise exchange of CRAE data at the lowest employable entity to support the "scalable employment" of forces. GFM DI integrates force structure, personnel, equipment, and readiness. OFSC relations, along with additional input from AST (within the GFIM OE), provide a complete picture of unit availability and employability to support sourcing a force requirement. GFIM OE, exchanging EFS with integrated data using the GFM DI schema, provides timely and accurate CRAE data for enable time sensitive decisions to support DFE (see Figure 22-18).

# EMERGING INITIATIVE: GLOBAL FORCE INFORMATION MANAGEMENT

## Modified SV-7: Sequence of Key Events and Major System Components



Achieving GFIM Increment 1 by FY22 will ensure the GFIM OE supports "Army of 2028" and Dynamic Force Employment. GFIM CMO will integrate required capabilities and sunset legacy systems over time to produce the GFIM Objective Environment "System of Systems" for all stakeholders.

Figure 22-18. The Planned Integration of Capabilities in the Army GFIM OE (as of 2 December 2019)

# HOW THE ARMY RUNS

## Section V

### Summary, Key Terms, and References

#### 22-16. Summary

a. In modern and complex organizations, there are cause and effect relationships involving almost every process and system. An appreciation of these interrelationships and knowledge of the individual systems that contribute to force management and readiness will in turn lead to a better understanding of how the Army runs. The success of future senior Army leaders and managers depends on their understanding of the interrelations of the systems and subsystems as well as knowing the key players responsible for managing change. Senior leaders who possess an understanding of how these force management and readiness processes work will be more effective and efficient in decision-making and mission execution. Experience shows that successful senior leaders understand how the Army develops and sustains its part of the nation's military capability and use this knowledge to make informed decisions on how to use or change the processes to improve that capability.

b. The GFIM OE will be a GFM DI-compliant, integrated, and interoperable digital environment that enables, thru automation, the D2RR end-to-end business processes in support of DFE.

c. GFM DI is a DOD-mandated data standard to enable an enterprise approach to support GFM. The enterprise force structure data standard established by GFM DI enables the Army to integrate readiness and force management data to provide an enterprise approach to manage the force; aggregate authoritative data to provide near-real time common operating picture to increase agility and reduce risk; and track near real time the readiness and availability of forces to support DFE.

#### 21-17. Key Terms

a. Army Organization Server (AOS). Mandated by CDD1. Operational since 2009. GFM-DI Force Structure data is documented for the Army (and each Service) in a single authoritative data source called the Organization Server.

b. AOS Data Interface. An interface initially developed to support IPPS-A has been fully integrated into the AOS. This capability allows the Army to collaboratively build various OFSCs over time.

c. Association. A link of an OFSC organization tree. The OFSC includes three classes of associations: composition, leadership, and reporting. Composition associations invoke the OFSC relations. Reporting associations document the chain of command and may be derived using the composition and leadership associations.

d. Augmentation OE. An OE created to unite and account for a grouping of OEs that are to be embedded in another unit. They are an exception to OFSC Rule 1 that every internal OE must have a designated leadership billet identified.

e. Authoritative Data Source (ADS). A recognized or official data source with a designated mission statement, source, or product to publish reliable and accurate data for subsequent use by customers. An authoritative data source may be the functional combination of multiple separate data sources.

f. Billet Organizational Element. An OE created for the purpose of employing a person (i.e., manpower). A billet OE may represent a military end-strength authorization for the purpose of employing a military service member or a workload equivalent created for the purpose of employing a civilian, either a Government employee or a non-government employee.

g. Command Authority. The authority that a military commander lawfully exercises over subordinates including authority to assign missions and accountability for their successful completion. Command authority is exercised in the administrative and operational branches of the chain of command. It should not be confused with COCOM. The definition for command authority is derived from a description of Command in Joint Publication 1, Doctrine for the Armed Forces of the United States.

h. Command Structure. 1) The organizational hierarchy through which command or leadership is exercised; 2) A set of composition associations that define a unit.

i. Construct. A concept, model, or schematic idea. In the context of the OFSC, it does not refer to a particular organization tree.

j. Crew OE. An OE created for the purpose of employing a piece of materiel, commonly called a platform. It is a MILITARY-ORGANIZATION-TYPE, composed of one or more subordinate manpower positions, that possesses a 1:1 correspondence with an EQUIPMENT-TYPE, commonly called a platform. A platform requires an associated CREW to operate and either: 1) transports the CREW, and/or 2)

## **EMERGING INITIATIVE: GLOBAL FORCE INFORMATION MANAGEMENT**

provides a critical enabling capability that warrants documentation as an EQUIPMENT-TYPE, as determined by the Service (e.g., a towed weapon or radar system).

k. Deploy-to-Redeploy/Retrograde (D2RR). The DOD's end-to-end business process architecture encompasses all business functions necessary to plan, notify, deploy, sustain, recall and reset tactical units to and from theaters of engagement. Enables Business, Operational, and Warfighting Systems, Processes, and Requirements integration across all Title 10 functions and domains.

l. Dynamic Force Employment (DFE). A DOD GFM construct that categorizes forces into bins to increase the SECDEFs visibility of the force. Enables unit lifecycle management as CRAE unit bins.

m. Dynamic Force Structure (DFS). Common, hierarchical, GFM DI compliant, representation of the Army's force structure At Rest and In Motion that enables warfighting and business systems to consume and utilize a common view of the Army's force structure and C2 hierarchies. DFS is the Army's implementation of DOD OFSC to provide enterprise force structure to the Army and DOD.

n. Enterprise. The DOD, including all of its organizational components.

o. Enterprise Force Structure. The digitized hierarchical representation of DOD organizations, documented in accordance with the standardized precepts of the OFSC, generated and shared from org servers for DOD-wide integration and use.

p. Explicit Relation. A relation whose properties exist in an org tree due to the presence of an invoking association.

q. Force Structure. The composition of DOD organizations that comprise and support U.S. defense forces as specified in the current NDAA and defines the organizational hierarchy through which leadership authority is exercised.

r. Force Management Identifier (FMID). The set of identifiers and indexes used to identify data within the GFM XSD. FMIDs convey no information about the entity they identify, are a fixed size, and are exchanged as a single attribute.

s. Global Force Information Management Capability Management Office (GFIM CMO). The DCS, G-3/5/7-directed organization authorized to align with JS and OSD initiatives, develop the GFIM OE business case and governance, integrate systems, manage GFIM Portfolio investments, and deliver GFIM OE. HQDA G-37/DAMO-FME is the GFIM CMO.

t. Global Force Information Management Objective Environment (GFIM OE). The integration and modernization of the Army's Force Management, Readiness, Mobilization and other systems. The GFIM Objective System will be GFM DI compliant and interface with other Enterprise Resource Planning systems to execute Title 10/32 responsibilities.

u. Global Force Management. The Joint process to Assign, Allocate, and Apportion forces to CCDRs in support of the national defense strategy and joint force availability requirements (JP 1-02).

v. Global Force Management Data Initiative (GFM DI). The effort within the DOD to formulate a strategy for organizing data to better support the GFM process. GFM DI was established by the Strategic Planning Guidance FY 2006-2011. GFM DI is the mandated data standard for all DOD Force Structure data. A hierarchical way to document force structure to allow integration across Service-lines. Top to bottom granularity (individual billet or platform level) of all Service organizations. GFM DI enables relationships between people, billets, units, and equipment (DODI 8260.03).

w. Global Force Management Unique Identifier (GFMID). An alias for the GFMID used to distinguish it from the Force Module Identifier used by the Joint Operational Planning and Execution System.

x. Global Force Management XML Schema Definition. An extensible markup language (XML) document that defines a schema supported by the Web services of the GFM OS.

y. Implied Relation. A relation whose properties exist in an org tree as an inherent aspect of another relation without being invoked. See OFSC Business Rule 10 in Annex A of the base order.

z. Installation Force Organizational Element. A type of OE created for the purposes of reflecting support responsibilities to the tenants of a particular garrison. Previously termed "Garrison Force OE" on page 21 of the OFSC Manual (DODM 8260.03, Vol 2), the 2 May 2017 GFM DI GOSC implemented a name change to make it more widely applicable. Installation Force OEs are created for the purpose of operating an installation and managing the assets assigned to accomplish the installation mission. Some type of real property is always associated with a garrison force. Real property includes land, land rights, and improvements to land including all types of facilities such as buildings and structures. Although not authorizations, installations and facilities require operation; thus these can be analogously considered as "crews" for fixed sites.

aa. Link. A connector between nodes in a tree graph.

## HOW THE ARMY RUNS

- bb. Node. The aggregation points of a tree graph that are connected by links in accordance with the tree property.
- cc. Organization (Org) Server. A Web-enabled service that provides access to organizational data that abide by the representational precepts of the OFSC and is available, at a minimum, in a format defined by the GFM community of interest. The term “server” is used in its original meaning a software application program that accepts connections based upon a request and/or response paradigm. In this usage, it does not mean a physical computer system.
- dd. Organization (Org) Tree. In OFSCs, a tree structure composed of connected nodes (organizations) and links (command relationships), used to represent the military command structure, of which the primary function is to define aggregation (or decomposition) of units.
- ee. Organization Unique Identifier (OUID). The means of uniquely distinguishing one DOD organizational element from another, allowing DOD systems to identify an organization individually across the DOD enterprise.
- ff. Organizational and Force Structure Construct (OFSC). The standardized precepts for the digitization of hierarchical enterprise force structure data for DOD-wide integration and use.
- gg. Organizational Element (OE). Any of five types of aggregation points (nodes) within a graph (unit) that has a designated leader documented by an OFSC association (link).
- hh. Path. In a tree graph, a sequence of nodes whereby each node has a link to the next.
- ii. Platform. In the OFSC, a vehicle that transports people on land, sea, or in the air.
- jj. Propagation. The transfer by a default relation (ADMIN or C2DEF) of the properties of a different explicit relation. The ADMIN, COCOM, and support relations cannot be propagated.
- kk. Reassign. The transfer of previously assigned forces to a different joint force either permanently or for a lengthy duration, enacted in the OFSC by the COCOM and ADMIN relations.
- ll. Relation. In an OFSC organization tree, a predefined transitive property that exists between a sequence of associations between two OEs where one OE is a descendant of the other.
- mm. Suspension. The termination of a propagating operational relation by an association specific to that purpose. See OFSC Business Rule 12 (for the COCOM relation) and Rule 13 (for the OPCON and TACON relations) in Annex A of the base order.
- nn. Temporary Billet Organizational Element (TEMPLET). A type of OE, short for temporary billet, created for the purposes to account for soldiers that are temporarily not assigned to a specific billet in accordance with department of defense instruction 1120.11. Temporary status includes TTHS and cadets assigned to the United States Military Academy (USMA). A TEMPLET OE is a billet-like OE for tracking the soldier and account for Army End-Strength that is not assigned to an authorized billet. TEMPLETs do not reflect authorized force structure, but are intended as a placeholder for manpower management purposes. TEMPLETs allow force managers and personnel management professionals to get after actual faces as well as true TTHS numbers.
- oo. Tree Property. The characteristics of tree graph theory that mandate that every node must have a link to it and that a node can only have one parent, maintained by the OFSC in accordance with Business Rules 1, 4, and 5 in Annex A of the base order.
- pp. Tree Traversal. The action of moving from node to node along the links of a graph (or from OE to OE along the associations).
- qq. Unique Identification (UID). A system of establishing globally ubiquitous unique identifiers within DOD.
- rr. Unique Identifier. A character string, number, or sequence of bits assigned to a discrete entity or its associated attribute that serves to uniquely distinguish it from other entities. Each unique identifier occurs only once within its defined scope of use.
- ss. Unit. A unit is an instance of an OFSC organization tree composed of a set of OEs and a corresponding set of associations that are based upon time, command relationships, or security classification level.
- tt. Unity of Command. Unity of command means all forces operate under a single commander with the requisite authority to direct all forces employed in pursuit of a common purpose. Unity of command requires that two commanders may not exercise the same command relationship over the same force at any one time. See OFSC Business Rules 4 and 5 in Annex A of the base order.

## **EMERGING INITIATIVE: GLOBAL FORCE INFORMATION MANAGEMENT**

### **21-18. References**

- a. Department Of Defense Manual 8260.03, Volume 1, Subject: Global Force Management Data Initiative (GFM DI) Implementation: Unique Identification (UID) for GFM, 20 November 2009.
- b. Department Of Defense Manual 8260.03, Volume 2, Subject: Global Force Management Data Initiative (GFM DI) Implementation: The Organizational and Force Structure Construct (OFSC), 14 June 2011.
- c. Army General Order 2017-01, Subject: Assignment of Functions and Responsibilities within Headquarters, Department of the Army (HQDA), 5 January 2017.
- d. Department Of Defense Instruction 8260.03, Subject: The Global Force Management Data Initiative (GFM DI), 19 February 2014.
- e. Department Of Defense Instruction 8320.03, Subject: Unique Identification (UID) Standards for Supporting DOD Net-Centric Operations, 4 November 2015.
- f. Vice Chairman of the Joint Chiefs of Staff Memorandum, Cm-0130-16, Subject: Global Force Management Data Initiative Next Steps and Global Command and Control, 29 July 2016.
- g. Global Force Management Data Initiative Intellipedia Website, [https://Intellipedia.Intelink.Gov/Wiki/Global\\_Force\\_Management\\_Data\\_Initiative](https://Intellipedia.Intelink.Gov/Wiki/Global_Force_Management_Data_Initiative).
- h. Army Regulation 10-87, Subject: Army Commands, Army Service Component Commands, and Direct Reporting Units, 4 September 2007.
- i. Army Regulation 5-1, Subject: Management of Army Business Operations, 12 November 2015.
- j. HQDA EXORD 229-14, Subject: Common Operating Environment (COE) Implementation in Support of the Operational Force, 10 September 2014.
- k. Department Of Defense Instruction 1120.11, Subject: Programming and Accounting for Active Component (AC) Military Manpower, 17 March 2015.
- l. Army Data Strategy, Office of the Army Chief Information Officer/G-6, February 2016.
- m. Joint Requirements Oversight Council Memorandum 025-08, Subject: Global Force Management Data Initiative, Increment 1, Capability Development Document, 28 January 2008.
- n. Capability Development Document for Global Force Management Data Initiative, Increment I, 20 August 2007.
- o. Joint Requirements Oversight Council Memorandum 107-12, Subject: Global Force Management Data Initiative Next Steps: Assignment Capability Development Document, 20 July 2012.
- p. Capability Development Document for the Global Force Management Data Initiative Next Steps: Assignment, 20 July 2012.
- q. Joint Requirements Oversight Council Memorandum 190-12, Subject: Global Force Management Data Initiative Next Steps: Manpower and Personnel Capability Development Document, 10 December 2012.
- r. Capability Development Document for Global Force Management Data Initiative Increment 2 Next Steps: Manpower and Personnel, 27 September 2012.
- s. Joint Requirements Oversight Council Memorandum 101-13, Subject: Global Force Management Data Initiative Increment 2 Next Steps: Enterprise Force Structure Data to Support Readiness Capability Development Document, 8 May 2013.
- t. Capability Development Document for The Global Force Management Data Initiative Increment 2 Next Steps: Enterprise Force Structure Data To Support Readiness, 8 May 2013.
- u. Joint Requirements Oversight Council Memorandum 111-14, Subject: Capability Development Document for Global Force Management Data Initiative Increment 2 Next Steps: Enterprise Force Structure Data to Support Allocation, 15 October 2014.
- v. Capability Development Document for The Global Force Management Data Initiative Increment 2 Next Steps: Enterprise Force Structure Data to support Allocation, 15 October 2014.
- w. Under Secretary Of The Army Memorandum, Subject: Development of the Global Force Information Management (GFIM) Objective Capability as a Defense Business System, 13 February 2017.
- x. TRADOC Pamphel 525-3-1, " The U.S. Army in Multi-Domain Operations 2028, 6 December 2018.
- y. Army Organization Server (AOS) [NIPRNET]: <https://aos.fms.army.mil/AOS/>.
- z. Enterprise Management Decision Support (EMDS) [SIPRNET]: <https://emds.army.smil.mil/>.
- aa. Army Force Generation Synchronization Toolset (AST) [NIPRNET]: <https://ast.forscom.army.mil/>.

## HOW THE ARMY RUNS

**This page is intentionally left blank**



## Terms

**Adaptive Planning and Execution.** A DOD enterprise of joint policies, processes, procedures, and reporting structures, supported by communications and information technology, that is used by the joint planning and execution community to monitor, plan, and execute mobilization, deployment, employment, sustainment, redeployment, and demobilization activities associated with joint operations. Also called APEX.

**Allocation.** Distribution of limited forces and resources for employment among competing requirements.

**Anticipation.** The ability to foresee events and requirements and initiate necessary actions that most appropriately satisfy a response without waiting for operations orders or fragmentary orders.

**AOS Data Interface.** An interface initially developed to support IPPS-A has been fully integrated into the AOS. This capability allows the Army to collaboratively build various OFSCs over time.

**Apportionment.** The quantities of force capabilities and resources provided for planning purposes only, but not necessarily an identification of the actual force that may be allocated for use when a plan transitions to execution.

**Army Installation.** An Army installation constitutes the following: 1) An installation is defined as an aggregation of contiguous or near contiguous, real property holdings commanded by a centrally selected commander. Installations represent management organizations. An installation may be made of one or more sites. 2) A site is a physically defined location which can be supported by a legal boundary survey which closes a polygon. It can be owned, leased, or otherwise possessed or used. A site may exist in one of three forms: land only, facility or facilities only, or land and all the facilities on it. A site is the sum of all real property at a specific location.

**Army Organization Server (AOS).** Mandated by CDD1. Operational since 2009. GFM-DI Force Structure data is documented for the Army (and each Service) in a single authoritative data source called the Organization Server.

**Asset Leverage.** The combination of government assets with private sector knowledge, expertise, equity and or financing in a venture (partnership) which results in long term benefit to the government.

**Assigned.** Units or personnel assigned relatively permanently to a command or mission, where that organization controls and administers the units or personnel for the primary function, or greater portion of the functions, of the unit or personnel.

**Association.** A link of an OFSC organization tree. The OFSC includes three classes of associations: composition, leadership, and reporting. Composition associations invoke the OFSC relations. Reporting associations document the chain of command and may be derived using the composition and leadership associations.

**Augmentation OE.** An OE created to unite and account for a grouping of OEs that are to be embedded in another unit. They are an exception to OFSC Rule 1 that every internal OE must have a designated leadership billet identified.

**Authoritative Data Source (ADS).** A recognized or official data source with a designated mission statement, source, or product to publish reliable and accurate data for subsequent use by customers. An authoritative data source may be the functional combination of multiple separate data sources.

**Billet Organizational Element.** An OE created for the purpose of employing a person (i.e., manpower). A billet OE may represent a military end-strength authorization for the purpose of employing a military service member or a workload equivalent created for the purpose of employing a civilian, either a Government employee or a non-government employee.

## HOW THE ARMY RUNS

**Budget Activity 1.** Operating Forces.

**Budget Activity 2.** Mobilization.

**Budget Activity 3.** Training and Recruiting.

**Budget Activity 4.** Administration and Service-Wide Activities.

**Budget Authority.** The authority to incur a legal obligation to pay a sum of money from the U.S. Treasury. BA is not “money.” The U.S. Treasury actually disburses cash only after an agency (e.g., DFAS) issues a U.S. Treasury check withdrawing money from the Treasury and thus disburses the money to pay a previously incurred obligation.

**Capability Developer.** A person who is involved in analyzing, determining, prioritizing, and documenting requirements for doctrine, organization, training, materiel, leadership and education, personnel, facilities, and policy (DOTMLPF-P) implications within the context of the force development process. Also responsible for representing the end user during the full development and lifecycle process and ensures all enabling capabilities are known, affordable, budgeted, and aligned for synchronous fielding and support. The CAPDEV is the command or agency that formulates warfighting requirements for DOTMLPF-P. The acronym CAPDEV may be used generically to represent the user and user maintainer community role in the materiel acquisition process (counterpart to generic use of MATDEV).

**Capability Development.** The analysis, determination, prioritization, and documentation of requirements for doctrine, organization, training, materiel, leadership and education, personnel, facilities, and policy implications within the context of the force development process.

**Capital Planning and Investment Control.** The management process for ongoing identification, selection, control, and evaluation of investments in information resources. The process links budget formulation and execution, and is focused on agency missions and achieving specific program outcomes.

**Combatant Command.** A unified or specified command with a broad continuing mission under a single commander established and so designated by the President, through the SECDEF and with the advice and assistance of the CJCS of the Joint Chiefs of Staff.

**Combatant Commander.** A commander of one of the unified or specified combatant commands established by the President. Also called CCDR.

**Command Authority.** The authority that a military commander lawfully exercises over subordinates including authority to assign missions and accountability for their successful completion. Command authority is exercised in the administrative and operational branches of the chain of command. It should not be confused with COCOM. The definition for command authority is derived from a description of Command in Joint Publication 1, Doctrine for the Armed Forces of the United States.

**Command Information.** Communication by a military organization directed to the internal audience that creates an awareness of the organization’s goals, informs them of significant developments affecting them and the organization, increases their effectiveness as ambassadors of the organization, and keeps them informed about what is going on in the organization. Formerly, called Command Information.

**Command Structure.** 1) The organizational hierarchy through which command or leadership is exercised; 2) A set of composition associations that define a unit.

**Commercial Cloud Services.** CSOs are cloud services offered by a commercial Cloud Service Provider (CSP). Examples: Infrastructure-as-a-Service (IaaS), Platform-as-a-Service (PaaS), Software-as-a-Service (SaaS), storage, compute processing, security, access.

**Communications.** JP 6.0 describes a joint communications system as one that is comprised of the networks and services that enable joint and multinational capabilities. The objective of the joint communications system is to assist the JFC in C2 of military operations. Effective C2 is vital for proper integration and employment of capabilities. The HQDA's end-to-end communications system supporting the JFC is called the DODIN-A. The DODIN conceptually unifies DOD's information systems and networks into a real-time information system of systems that provides increased information capabilities to the joint force. Communications systems are more than electronic boxes, wires, and radio signals, and the DODIN is more than a collection of information networks. The interdependence of the parts, as well as the processes, policy, and data on those systems, permeate daily life, and preparation for and execution of operations. An effective communications system helps commanders maintain the unity of effort to apply their forces' capabilities at critical times and places to achieve objectives.

**Community Engagement.** Those public affairs activities that support the relationship between military and civilian communities, domestically and in military operations.

**Comptroller.** The Comptroller is a key member of the commander's staff with primary responsibility to execute the command's funding. They provide analysis, recommendations and accounting of appropriated funds allocated to the unit to accomplish its mission. The Comptroller is often referred to as the Director of Resource Management or its staff moniker – S/G/J8. (At the Army/HQDA level the DA G8 has the responsibility of working Programming functions, e.g. the POM and not the execution of the budget).

**Construct.** A concept, model, or schematic idea. In the context of the OFSC, it does not refer to a particular organization tree.

**Congressional Appropriation.** A law passed by the Congress and signed by POTUS that provides BA for the specific purpose(s) stated in the law. In the case of the annual DOD appropriations act (e.g., Public Law 111-118, Department of Defense Appropriations Act, 2015) BA is provided for a number of appropriations (e.g., OMA; Military Personnel, Army (MPA); RDT&E,A; MCA) for a specified period of time for the Army to incur legal obligations as it executes the programs authorized by Congress and other laws that guide Army operations.

**Congressional Authorization.** A law passed by the Congress and signed by POTUS that establishes or continues a federal program or agency, and sets forth guidelines to which it must adhere. Generally for every FY, the Congress passes a National Defense Authorization Act (NDAA) (e.g., Public Law 111-383, Ike Skelton National Defense Authorization Act for Fiscal Year 2015), which directs by law what can be purchased, what manpower resource levels each service can have, and how many weapon and other materiel systems can be bought. It also provides additions and changes to Title 10 USC that, among other laws, guide the management of the Army and the other activities of the DOD. An authorization act does not provide the BA to draw funds from the U.S. Treasury to pay an obligation.

**Container Management.** The process of establishing and maintaining visibility and accountability of all cargo containers moving within the Defense Transportation System.

**Continuity.** The uninterrupted provision of sustainment across all levels of war.

**Cost-Benefit Analysis.** A structured methodology for forecasting and comparing the anticipated costs and benefits of alternative courses of action in order to identify the optimum solution for achieving a stated goal or objective. The goal is to produce a strong value proposition—a clear statement that the benefits more than justify the costs, risks, and bill payers.

**Crew OE.** An OE created for the purpose of employing a piece of materiel, commonly called a platform. It is a MILITARY-ORGANIZATION-TYPE, composed of one or more subordinate manpower positions, that possesses a 1:1 correspondence with an EQUIPMENT-TYPE, commonly called a platform. A platform requires an associated CREW to operate and either: 1) transports the CREW, and/or 2)

## HOW THE ARMY RUNS

provides a critical enabling capability that warrants documentation as an EQUIPMENT-TYPE, as determined by the Service (e.g., a towed weapon or radar system).

**Cyberspace Operations.** CO includes offensive cyberspace operations, defensive cyberspace operations, and DODIN operations.

**Department of the Army.** The executive part of the Department of the Army at the seat of government and all field headquarters, forces, Reserve Component, installations, activities, and functions under the control or supervision of the Secretary of the Army. Also called DA.

**Deployment Order.** A planning directive from the Secretary of Defense, issued by the Chairman of the Joint Chiefs of Staff, that authorizes the transfer of forces between CCMDs, Services and DOD agencies and specifies the authorities the gaining CCDR will exercise over the specific forces to be transferred. Also called DEPORD.

**Deploy-to-Redeploy/Retrograde (D2RR).** The DOD's end-to-end business process architecture encompasses all business functions necessary to plan, notify, deploy, sustain, recall and reset tactical units to and from theaters of engagement. Enables Business, Operational, and Warfighting Systems, Processes, and Requirements integration across all Title 10 functions and domains.

**Directive Authority for Logistics.** The combatant commander's authority to issue directives to subordinate joint force commanders of service component commands for as many common support capabilities required to accomplish the assigned mission.

**Disbursement.** Payment of an obligation of the U.S. Government.

**Document Integrator.** Ensures that requirements and authorization documents meet approved Army force programs and link requirements, planned or programmed force structure actions, and the documentation processes.

**DODIN-A.** DODIN-A is the portion of the DODIN operated by the Army. DODIN-A is the set of information solutions, and associated processes that collect, process, store, disseminate, and manage information on demand to warfighters, policy makers, and support personnel, whether interconnected or stand-alone, including owned and leased communications and computing systems and services, software (including applications), data, security services, other associated services, and national security systems.

**Dynamic Force Employment (DFE).** A DOD GFM construct that categorizes forces into bins to increase the SECDEFs visibility of the force. Enables unit lifecycle management as CRAE unit bins.

**Dynamic Force Structure (DFS).** Common, hierarchical, GFM DI compliant, representation of the Army's force structure At Rest and In Motion that enables warfighting and business systems to consume and utilize a common view of the Army's force structure and C2 hierarchies. DFS is the Army's implementation of DOD OFSC to provide enterprise force structure to the Army and DOD.

**Economy.** Providing sustainment resources in an efficient manner that enables the commander to employ all assets to the greatest effect possible.

**Electromagnetic spectrum operations.** Coordinated military actions to exploit, attack, protect, and manage the electromagnetic spectrum.

**End Strength.** The total number of personnel authorized by the Congress to be in the Army on the last day of the Fiscal Year (FY) (30 September). This is normally provided in the NDAA.

**Enterprise.** The DOD, including all of its organizational components.

**Enterprise Computing Environment.** The ECE is one of the six Computing Environments (CEs) in the Army Common Operating Environment (COE). The COE includes technologies and standards for

enabling capability development, delivery and interoperability across the six CEs. When and where appropriate, the CEs will connect to the ECE via the DODIN.

**Enterprise Force Structure.** The digitized hierarchical representation of DOD organizations, documented in accordance with the standardized precepts of the OFSC, generated and shared from org servers for DOD-wide integration and use.

**Explicit Relation.** A relation whose properties exist in an org tree due to the presence of an invoking association.

**Fiscal Year.** The FY is the government's accounting period. For the federal government, it begins on 1 October and ends on 30 September. The FY is designated by the calendar year in which it ends. For example, FY 2015 begins on 1 October 2014 and ends on 30 September 2015.

**Force Development.** The process of determining Army doctrinal, leader development, training, organizational, Soldier development, and materiel requirements and translating them into programs and structure, within allocated resources, to accomplish Army missions and functions.

**Force Integration.** The synchronized, resource-constrained execution of an approved force development program to achieve systematic management of change, including: the introduction, incorporation, and sustainment of doctrine, organizations, and equipment in the Army; coordination and integration of operational and managerial systems collectively designed to improve the effectiveness and capability of the Army; and knowledge and consideration of the potential implications of decisions and actions taken within the execution process.

**Force Integrator.** A manager of resourcing, documentation, fielding, and sustainment to assure doctrinal, operational, and technical integration of functionally dissimilar organizations. Responsible for the horizontal integration of large units such as brigades, regiments, groups, divisions and corps.

**Force Management.** The capstone process to establish and field mission-ready Army organizations. The process involves organization, integration, decision-making, and execution of the spectrum of activities encompassing requirements definition, force development, force integration, force structuring, combat developments, materiel developments, training developments, resourcing, and all elements of the Army Organizational Life Cycle Model (AOLCM).

**Force Management Identifier (FMID).** The set of identifiers and indexes used to identify data within the GFM XSD. FMIDs convey no information about the entity they identify, are a fixed size, and are exchanged as a single attribute.

**Force Modernization.** The process of improving the Army's force effectiveness and operational capabilities through force development and integration.

**Force Structure.** The manpower and materiel composition, by number and type of organizations, of the current, planned, or programmed Total Army tasked to perform missions in peace and war.

**Force Structure (DOD Definition).** The composition of DOD organizations that comprise and support U.S. defense forces as specified in the current NDAA and defines the organizational hierarchy through which leadership authority is exercised.

**Force Structure Allowance.** The sum of authorized spaces contained in all Modification Tables of Organization and Equipment units and Table of Distribution and Allowances type organizations.

**Future Years Defense Program.** Program and financial plan for the DOD as approved by the Secretary of Defense. The FYDP arrays cost data, manpower, and force structure over a 5-year period (force structure for an additional 3 years), portraying this data by major force program for DOD internal review

## HOW THE ARMY RUNS

for the program and budget review submission. It is also provided to the Congress annually in conjunction with the President's budget.

**Global Force Information Management Objective Environment (GFIM OE).** The integration and modernization of the Army's Force Management, Readiness, Mobilization and other systems. The GFIM Objective System will be GFM DI compliant and interface with other Enterprise Resource Planning systems to execute Title 10/32 responsibilities.

**Global Force Management.** The Joint process to Assign, Allocate, and Apportion forces to CCDRs in support of the national defense strategy and joint force availability requirements.

**Global Force Management Data Initiative (GFM DI).** The effort within the DOD to formulate a strategy for organizing data to better support the GFM process. GFM DI was established by the Strategic Planning Guidance FY 2006-2011. GFM DI is the mandated data standard for all DOD Force Structure data. A hierarchical way to document force structure to allow integration across Service-lines. Top to bottom granularity (individual billet or platform level) of all Service organizations. GFM DI enables relationships between people, billets, units, and equipment.

**Global Force Management Unique Identifier (GF MID).** An alias for the GF MID used to distinguish it from the Force Module Identifier used by the Joint Operational Planning and Execution System.

**Global Force Management XML Schema Definition.** An extensible markup language (XML) document that defines a schema supported by the Web services of the GFM OS.

**Implementing Agency (IA):** The military department or defense agency responsible for the execution of military assistance programs. With respect to FMS, the military department or defense agency assigned responsibility by the Defense Security Cooperation Agency to prepare an LOA and to implement an FMS case. The implementing agency is responsible for the overall management of the actions that will result in delivery of the materials or services set forth in the LOA that was accepted by a foreign country or international organization.

**Implied Relation.** A relation whose properties exist in an org tree as an inherent aspect of another relation without being invoked. See OFSC Business Rule 10 in Annex A of the base order.

**Improvisation.** The ability to adapt sustainment operations to unexpected situations or circumstances affecting a mission.

**Individuals Account.** This account, often referred to as the Trainee, Transient, Holdee, and Student (TTHS) account, is comprised of those personnel unavailable to fill spaces in units. The six sub-accounts are trainees, officer accession students, transients, holdees (short explanation needed), students, and U.S. Military Academy (USMA) cadets.

**Information Management.** The planning, budgeting, manipulating, and controlling of information throughout its life cycle.

**Information Resource Management.** The process of managing information resources to accomplish agency missions. The term encompasses both information itself and the related resources, such as personnel, equipment, funds, and information technology.

**Information Technology.** Any equipment or interconnected system or subsystem that is used in the automatic acquisition, storage, manipulation, management, movement, control, display, switching, interchange, transmission, or reception of data or information by an executive agency (EA). For purposes of the preceding sentence, equipment is used by an EA if the equipment is used by the EA directly or is used by a contractor under a contract with the EA which: one, requires the use of such equipment; or two, requires the use, to a significant extent, of such equipment in the performance of a service or the furnishing of a product. The term "information technology" includes computers, ancillary equipment,

software, firmware, and similar procedures, services (including support services), and related resources. The term "information technology" does not include any equipment that is acquired by a federal contractor incidental to a federal contract. The term "information technology" does not include national security systems as defined in the CCA of 1996 (40 U.S.C. 1452).

**Installation Force Organizational Element.** A type of OE created for the purposes of reflecting support responsibilities to the tenants of a particular garrison. Previously termed "Garrison Force OE" on page 21 of the OFSC Manual (DODM 8260.03, Vol 2), the 2 May 2017 GFM DI GOSC implemented a name change to make it more widely applicable. Installation Force OEs are created for the purpose of operating an installation and managing the assets assigned to accomplish the installation mission. Some type of real property is always associated with a garrison force. Real property includes land, land rights, and improvements to land including all types of facilities such as buildings and structures. Although not authorizations, installations and facilities require operation; thus these can be analogously considered as "crews" for fixed sites.

**Instruments of National Power.** All of the means available to the government in its pursuit of national objectives. They are expressed as diplomatic, economic, informational, and military.

**Integration.** Combining all of the sustainment elements within operations assuring unity of command and effort.

**Intermodal Operations.** The process of using multiple modes (e.g., air, sea, highway, rail) and conveyances (e.g., truck, barge, containers, pallets) to move troops, supplies and equipment through expeditionary entry points and the network of specialized transportation nodes to sustain land forces.

**Internal Information.** Communication by a military organization directed to the internal audience that creates an awareness of the organization's goals, informs them of significant developments affecting them and the organization, increases their effectiveness as ambassadors of the organization, and keeps them informed about what is going on in the organization. Formerly, called Command Information.

**Internal Use Software.** Software that includes applications and operating system programs, procedures, rules, and any associated key supporting documentation pertaining to the operation of a computer system or program, and are developed to meet the Army's internal or operational needs. IUS is an integral part of overall system(s) having interrelationships between software, hardware, personnel, procedures, controls, and data.

**Joint.** Connotes activities, operations, organizations, etc., in which elements of two or more Military Departments participate.

**Joint Operation Planning.** Planning activities associated with joint military operations by combatant commanders and their subordinate joint force commanders in response to contingencies and crises.

**Joint Operation Planning and Execution System.** An Adaptive Planning and Execution system technology. Also called JOPES.

**Joint Operation Planning Process.** An orderly, analytical process that consists of a logical set of steps to analyze a mission, select the best course of action, and produce a joint operation plan or order. Also called JOPP.

**Joint Operations.** Military actions conducted by joint forces and those Service forces employed in specified command relationships with each other, which of themselves, do not establish joint forces.

**Joint Planning.** Planning activities associated with military operations by CCDRs and their subordinate commanders.

## HOW THE ARMY RUNS

**Joint Staff.** 1) The staff of a commander of a unified or specified command, subordinate unified command, joint task force, or subordinate functional component (when a functional component command will employ forces from more than one Military Department), that includes members from the several Services comprising the force. 2) The Joint staff under the Chairman of the Joint Chiefs of Staff that assists the Chairman and the other members of the Joint Chiefs of Staff in carrying out their responsibilities. Also called JS.

**Joint Strategic Capabilities Plan.** A plan that provides guidance to the combatant commanders and the Joint Chiefs of Staff to accomplish tasks and missions based on current military capabilities. Also called JSCP.

**Joint Strategic Planning System.** One of the primary means by which the Chairman of the Joint Chiefs of Staff, in consultation with the other members of the Joint Chiefs of Staff and the combatant commanders, carries out the statutory responsibilities to assist the President and Secretary of Defense in providing strategic direction to the Armed Forces. Also called JSPS.

**Joint Task Force.** A joint force that is constituted and so designated by the Secretary of Defense, a combatant commander, a subunified commander, or an existing joint task force commander. Also called JTF.

**LandWarNet.** LandWarNet is the portion of the DODIN operated by the Army. LandWarNet is the set of information solutions, and associated processes that collect, process, store, disseminate, and manage information on demand to warfighters, policy makers, and support personnel, whether interconnected or stand-alone, including owned and leased communications and computing systems and services, software (including applications), data, security services, other associated services, and national security systems.

**Link.** A connector between nodes in a tree graph.

**Logistics.** Planning and executing the movement and support of forces. It includes those aspects of military operations that deal with: design and development, acquisition, storage, movement, distribution, maintenance, evacuation, and disposition of materiel; acquisition or construction, maintenance, operation, and disposition of facilities; and acquisition or furnishing of services.

**Materiel Developer.** The Research, Development, and Acquisition command, agency, or office assigned responsibility for the system under development or being acquired. The term may be used generically to refer to the Research, Development, and Acquisition community in the materiel acquisition process (counterpart to the generic use of CAPDEV).

**Materiel Development.** The research and development, production, and fielding of a new materiel system.

**Military Department.** One of the departments within the Department of Defense created by the National Security Act of 1947, which are the Department of the Army, the Department of the Navy, and the Department of the Air Force. Also called MILDEP

**Mode Operations.** The execution of movements using various conveyances (truck, lighterage, railcar, aircraft) to transport cargo.

**Movement Control.** The dual process of committing allocated transportation assets and regulating movements according to command priorities to synchronize distribution flow over lines of communications to sustain land forces.

**National Military Strategy.** A document approved by the CJCS for distributing and applying military power to attain national security strategy and national defense strategy objectives. Also called NMS.



**National Security Council.** A governmental body specifically designed to assist the President in integrating all spheres of national security policy. Also called NSC.

**National Security Strategy.** A document approved by the President of the United States for developing, applying, and coordinating the instruments of national power to achieve objectives that contribute to national security. Also called NSS.

**Node.** The aggregation points of a tree graph that are connected by links in accordance with the tree property.

**Obligation.** Any act that legally binds the USG to make a payment. From the central concept of “obligating the USG to make a payment” springs forth the foundation of our fiscal law and the legal parameters under which the Army must operate as a part of the USG. The obligation may be for a service rendered by a contractor, the acquisition of materiel items (e.g., a tank), the construction or repair of a facility, or salary for a Soldier or civilian.

**Operating Strength.** Those Soldiers available to fill spaces in MTOE units and TDA organizations, sometimes referred to as the distributable inventory.

**Organization Integrator.** Manages TOE and/or MTOE units, by branch, to provide an operational view of change management. OIs are branch assigned personnel who are the focal point for force accounting, documentation, resourcing, and readiness of assigned units; exercise resource controls for documentation; coordinate and recommend approval or disapproval of all branch specific actions and documentation. The OI is the subject matter expert for branch issues and advises DCS, G-3/5/7 and G-3/7 FM on the disposition of branch actions at HQDA. The OI is the focal point for proponent and field access to the larger HQDA force management processes.

**Organization (Org) Tree.** In OFSCs, a tree structure composed of connected nodes (organizations) and links (command relationships), used to represent the military command structure, of which the primary function is to define aggregation (or decomposition) of units.

**Organization Unique Identifier (OUID).** The means of uniquely distinguishing one DOD organizational element from another, allowing DOD systems to identify an organization individually across the DOD enterprise.

**Organizational and Force Structure Construct (OFSC).** The standardized precepts for the digitization of hierarchical enterprise force structure data for DOD-wide integration and use.

**Organizational Element (OE).** Any of five types of aggregation points (nodes) within a graph (unit) that has a designated leader documented by an OFSC association (link).

**Outlays.** Outlays are the amount of money the Government actually disburses in a given FY.

**Overall Category Level 1.** The unit possesses the required resources and is trained to accomplish or provide the core functions and fundamental capabilities for which it was designed or to undertake the mission it is currently assigned. The status of resources and training in the unit does not limit flexibility in methods to accomplish core functions or assigned missions nor increase vulnerability of unit personnel and equipment. The unit does not require any compensation for deficiencies.

**Overall Category Level 2.** The unit possesses the required resources and is trained to accomplish or provide most of the core functions and fundamental capabilities for which it was designed or to undertake most of the mission it is currently assigned. The status of resources and training in the unit may cause isolated decreases in the flexibility of choices to accomplish core functions or currently assigned missions. However, this status will not increase the vulnerability of the unit under most envisioned operational scenarios. The unit will require little, if any, compensation for deficiencies.

## HOW THE ARMY RUNS

**Overall Category Level 3.** The unit possesses the required resources and is trained to accomplish or provide many, but not all, of the core functions and fundamental capabilities for which it was designed or to undertake many, but not all, portions of the mission it is currently assigned. The status of resource and training in the unit will result in significant decreases in flexibility to accomplish the core functions or the assigned missions and will increase vulnerability of the unit under many, but not all, envisioned operational scenarios. The unit will require significant compensation for deficiencies.

**Overall Category Level 4.** The unit requires additional resources or training to accomplish or provide the core functions and fundamental capabilities for which it was designed or to undertake the mission currently assigned. However, the unit may be directed to undertake portions of the assigned mission with resources on hand (available).

**Overall Category Level 5.** The unit is undergoing a HQDA-directed resource action and/or is part of a HQDA-directed program and is not prepared to accomplish or provide the core functions or fundamental capabilities for which it was designed. Units report C-5 in accordance with the policy and procedures established in paragraph 4–8 of AR 220-1. Level 5 is not applicable to A-Level reporting. C-5 units are restricted to the following: units undergoing activation, inactivation, conversion, or other HQDA directed resource action; units that have their levels for authorized personnel and/or equipment established so that, even when filled to the authorized level, the established level does not allow the unit to achieve level 3 or higher; and units that are not manned or equipped but are required in the wartime structure.

**Path.** In a tree graph, a sequence of nodes whereby each node has a link to the next.

**Personnel Services.** Sustainment functions that man and fund the force, maintain Soldier and Family readiness, promote the moral and ethical values of the nation, and enable the fighting qualities of the Army.

**Platform.** In the OFSC, a vehicle that transports people on land, sea, or in the air.

**Port Opening.** The ability to establish, initially operate and facilitate throughput for ports of debarkation to support unified land operations.

**Program Objective Memorandum.** The final product of the programming process within the DOD, the DOD Component's POM displays the resource allocation decisions of the Military Departments in response to and in accordance with planning and programming guidance (DODD 7045.14).

**Propagation.** The transfer by a default relation (ADMIN or C2DEF) of the properties of a different explicit relation. The ADMIN, COCOM, and support relations cannot be propagated.

**Public Affairs.** Those internal information, public information, and community engagement activities directed toward both the external and internal publics with interest in the DOD.

**Public Affairs Guidance.** Constraints and restraints established by proper authority regarding public information, command information, and community relations activities. It may also address the method(s), timing, location, and other details governing the release of information to the public.

**Public Information.** Within public affairs, that information of a military nature, the dissemination of which is consistent with security and approved for release.

**Readiness Assessment Level 1.** Issues and/or shortfalls have negligible impact on readiness and ability to accomplish assigned mission(s) in support of the NMS as directed in the Global Employment of the Force and Joint Strategic Capabilities Plan.

**Readiness Assessment Level 2.** Issues and/or shortfalls have limited impact on readiness and ability to accomplish assigned mission(s) in support of the NMS as directed in the GEF and JSCP.

**Readiness Assessment Level 3.** Issues and/or shortfalls have significant impact on readiness and ability to accomplish mission(s) in support of the NMS as directed in the GEF and JSCP.

**Readiness Assessment Level 4.** Issues and/or shortfalls preclude accomplishment of assigned mission(s) in support of the NMS as directed in the GEF and JSCP.

**Reassign.** The transfer of previously assigned forces to a different joint force either permanently or for a lengthy duration, enacted in the OFSC by the COCOM and ADMIN relations.

**Relation.** In an OFSC organization tree, a predefined transitive property that exists between a sequence of associations between two OEs where one OE is a descendant of the other.

**Resource Management.** RM is the direction, guidance, and control of financial and other resources. It involves the application of programming, budgeting, accounting, reporting, analysis, and evaluation.

**Responsiveness.** The ability to react to changing requirements and respond to meet the needs to maintain support.

**Security Assistance (SA).** SA is a group of programs, authorized under Title 22 authorities, by which the United States provides defense articles, military education and training, and other defense-related services by grant, loan, credit, cash sales, or lease, in furtherance of national policies and objectives. All SA programs are subject to the continuous supervision and general direction of the Secretary of State to best serve U.S. foreign policy interests; however, programs are variously administered by DOD or DOS. Those SA programs that are administered by DOD are a subset of SC.

**Security Cooperation (SC).** SC comprises all activities undertaken by the DOD to encourage and enable international partners to work with the United States to achieve strategic objectives. It includes all DOD interactions with foreign defense and security establishments, including all DOD-administered Security Assistance (SA) programs, that build defense and security relationships; promote specific U.S. security interests, including all international armaments cooperation activities and SA activities; develop allied and friendly military capabilities for self-defense and multinational operations; and provide U.S. forces with peacetime and contingency access to host nations.

**Security Cooperation Community.** The security cooperation community is defined as a subset of U.S. government executive branch entities within the security cooperation enterprise directly responsible for managing or executing security cooperation programs or the policies that affect those programs. The security cooperation enterprise is the overall network of entities engaged in any element of security cooperation programs, either as providers or as beneficiaries. This includes USG agencies, the U.S. Congress, foreign partners, and industry.

**Simplicity.** Relates to processes and procedures to minimize the complexity of sustainment.

**Spectrum Management.** The management of how electromagnetic spectrum resources are used. The goal of Army spectrum management is to support telecommunications, weapons systems, and electronic warfare requirements. This goal will be accomplished through the acquisition of spectrum resources, the efficient use of those resources, and the attainment of Electromagnetic Compatibility.

**Staff Synchronization Officer.** The Army G-8 SSO is charged with the synchronization of the JCIDS, force structure, DAS, PPBE and equipment allocation processes in support of recommending an affordable equipment modernization investment strategy that best balances approved equipment modernization requirements and available fiscal resources to develop, procure, field and sustain material capabilities needed to meet ACP directed equipping objectives. In doing so, the SSO is a member of the force development team consisting of: The G-3/5/7 Requirements Staff Officer (RSO); the G-3/5/7 Organizational Integrator (OI); the NGB and OCAR System Integrator (SI); the Department of the Army System Coordinator (DASC); and, the ASC (LMI) Material Integrator (MI). As a member of this force development team, the SSO is not an acquisition system/program advocate, but rather, facilitates

## HOW THE ARMY RUNS

informed HQDA decision making that balances approved equipment modernization requirements and available fiscal resources in order to equip the force to meet Army Title 10 mission requirements.

**Stationing.** Stationing is the process of combining force structure and installation structure at a specific location to satisfy a specific mission requirement. As such, it includes all forms of realignment or relocation and includes those actions that determine the authorized population (military and civilian) at a particular installation. Each stationing action is composed of a force component and an installation component. The force component consists of the personnel (military and civilian) and equipment of an organization. The installation component deals with all the facilities required to support the unit. Both components must be considered as part of the stationing process. The desired end of this process is a force that is based in a manner that ensures effective and efficient mission accomplishment. The ways used to accomplish stationing include transfer, consolidation, or relocation of a function, manpower, or personnel; activation or inactivation; or reduction or increase of civilian personnel. The means to execute these actions are encompassed in the procedures used to manage directed actions (for example, those actions mandated by Congress, BRAC, and discretionary actions resulting from ACOM, ASCC and/or DRU requests, HQDA direction, or directed actions requiring additional actions not originally specified).

**Strategic Direction.** The strategy and intent of the President, SECDEF, and CJCS in pursuit of national interests.

**Strategy.** A prudent idea or set of ideas for employing the instruments of national power in a synchronized and integrated fashion to achieve theater, national, and/or multinational objectives.

**Suspension.** The termination of a propagating operational relation by an association specific to that purpose. See OFSC Business Rule 12 (for the COCOM relation) and Rule 13 (for the OPCON and TACON relations) in Annex A of the base order.

**Sustainment.** The provision of logistics, personnel services, and health service support necessary to maintain operations until successful mission completion.

**Sustainment Preparation of the Operational Environment.** The analysis to determine infrastructure, physical environment, and resources in the operational environment that will optimize or adversely impact friendly forces means for supporting and sustaining the commander's operations plan.

**Sustainment Warfighting Function.** The related tasks and systems that provide support and services to ensure freedom of action, extended operational reach, and prolong endurance.

**Synchronization Staff Officer (SSO).** Is charged with the synchronization of the JCIDS requirements process, DAS, PPBE, and equipment allocation processes. The SSO recommends an affordable equipment modernization investment strategy that best balances approved equipment modernization requirements and available fiscal resources to meet ACP directed equipping objectives. Facilitates informed HQDA decision making to equip the force to meet Army Title 10 mission requirements.

**System Integrator.** The coordinator for determining requirements, assuring operational and organizational documentation, coordinating, planning, and programming fielding, and recommending resourcing priorities for designated functional areas or specific materiel systems.

**Temporary Billet Organizational Element (TEMPLET).** A type of OE, short for temporary billet, created for the purposes to account for soldiers that are temporarily not assigned to a specific billet in accordance with department of defense instruction 1120.11. Temporary status includes TTHS and cadets assigned to the United States Military Academy (USMA). A TEMPLET OE is a billet-like OE for tracking the soldier and account for Army End-Strength that is not assigned to an authorized billet. TEMPLETs do not reflect authorized force structure, but are intended as a placeholder for manpower management purposes. TEMPLETs allow force managers and personnel management professionals to get after actual faces as well as true TTHS numbers.

**Theater Closing.** The process of redeploying Army forces and equipment from a theater, the drawdown and removal or disposition of Army non-unit equipment and materiel, and the transition of materiel and facilities back to host nation or civil authorities.

**Theater Distribution.** The flow of equipment, personnel, and materiel within theater to meet the combatant commander's mission.

**Theater Opening.** The ability to establish and operate ports of debarkation (e.g., air, sea, and rail), establish a distribution system and sustainment bases, and to facilitate port throughput for the reception, staging, onward movement and integration of forces within a theater of operations.

**Total Strength.** The total of all personnel serving on active duty in the Army, including Soldiers in units and organizations and those in the individuals account.

**Training Developer.** The Army agency that determines requirements for a system's training subsystem and formulates, develops, and documents associated training concepts, strategies, plans, and required training support. IAW AR 71-9, is a subset of and included within capability developer; serves as the user's representative during development and acquisition of a system's training subsystem.

**Training Development.** The process of developing, integrating, prioritizing, resourcing and providing quality control/quality assurance of the Army's training and education concepts, strategies, and products to support the Army's training and education of Active Army and Reserve component Soldiers, Civilians and units across the institutional, self-development and operational training domains.

**Tree Property.** The characteristics of tree graph theory that mandate that every node must have a link to it and that a node can only have one parent, maintained by the OFSC in accordance with Business Rules 1, 4, and 5 in Annex A of the base order.

**Tree Traversal.** The action of moving from node to node along the links of a graph (or from OE to OE along the associations).

**Unified Command.** A command with a broad continuing mission under a single commander and composed of significant assigned components of two or more Military Departments that is established and so designated by the President, through the Secretary of Defense with the advice and assistance of the Chairman of the Joint Chiefs of Staff. Also called unified combatant command or unified CCMD.

**Unified Command Plan.** The document, approved by the President, that sets forth basic guidance to all unified combatant commanders; establishes their missions, responsibilities, and force structure; delineates the general geographical area of responsibility for geographic combatant commanders; and specifies functional responsibilities for functional combatant commanders.

**Unique Identification (UID).** A system of establishing globally ubiquitous unique identifiers within DOD.

**Unique Identifier.** A character string, number, or sequence of bits assigned to a discrete entity or its associated attribute that serves to uniquely distinguish it from other entities. Each unique identifier occurs only once within its defined scope of use.

**Unit.** A unit is an instance of an OFSC organization tree composed of a set of OEs and a corresponding set of associations that are based upon time, command relationships, or security classification level.

**Unity of Command.** Unity of command means all forces operate under a single commander with the requisite authority to direct all forces employed in pursuit of a common purpose. Unity of command requires that two commanders may not exercise the same command relationship over the same force at any one time. See OFSC Business Rules 4 and 5 in Annex A of the base order.

## HOW THE ARMY RUNS

**This page is intentionally left blank**

## Glossary

|               |   |
|---------------|---|
| <b>A2/AD</b>  | Anti-Access/Area Denial   |
| <b>A2R</b>    | Acquire to Retire   |
| <b>A2SF</b>   | Active Army Strength Forecaster                                 |
| <b>AA</b>     | Active Army   |
| <b>AAC</b>    | Army Acquisition Corps  |
| <b>AACMO</b>  | Army Acquisition Corps Management Office                        |
| <b>AAE</b>    | Army Acquisition Executive                                      |
| <b>AAFES</b>  | Army and Air Force Exchange Service                             |
| <b>AAMMP</b>  | Active Army Military Manpower Program                           |
| <b>AAO</b>    | Army Acquisition Objective                                      |
| <b>AAR</b>    | After Action Review   |
| <b>AARTS</b>  | Army / American Council of Education Registry Transcript System |
| <b>AASA</b>   | Administrative Assistant to the Secretary of the Army           |
| <b>ABC</b>    | Activity Based Costing  |
| <b>ABC-C</b>  | Army Benefits Center-Civilian                                   |
| <b>ABC</b>    | Army Business Council   |
| <b>ABCT</b>   | Armored Brigade Combat Team                                     |
| <b>ABO</b>    | Army Budget Office  |
| <b>ABS</b>    | Army Business Strategy  |
| <b>AC</b>     | Advanced Course   |
| <b>AC</b>     | Active Component  |
| <b>ACAP</b>   | Army Career and Alumni Program                                  |
| <b>ACAT</b>   | Acquisition Category  |
| <b>ACB</b>    | AROC Capabilities Board   |
| <b>ACC</b>    | Army Capstone Concept   |
| <b>ACC</b>    | Army Competitive Category                                       |
| <b>ACC</b>    | Army Community Covenant   |
| <b>ACC</b>    | Army Contracting Command  |
| <b>ACC</b>    | Army Corrections Command  |
| <b>ACD</b>    | Accelerated Capabilities Division                               |
| <b>ACE-IT</b> | Army Corps of Engineers Information Technology                  |
| <b>ACES</b>   | Army Continuing Education System                                |
| <b>ACF</b>    | Army Concept Framework  |
| <b>A-CIDS</b> | Army- Capabilities Integration and Development                  |
| <b>ACOE</b>   | Army Community of Excellence                                    |
| <b>ACOM</b>   | Army Command  |

## HOW THE ARMY RUNS

|                |  |
|----------------|--|
| <b>ACP</b>     | Army Campaign Plan (The Army Plan (TAP), Part 5)               |
| <b>ACP</b>     | Army Cost Position   |
| <b>ACP17</b>   | Army Campaign Plan for Fiscal Year 2017                        |
| <b>ACR</b>     | Advanced Concepts and Requirements                             |
| <b>ACR</b>     | Armored Cavalry Regiment                                       |
| <b>ACRB</b>    | Army Cost Review Board   |
| <b>AC / RC</b> | Active / Reserve Component                                     |
| <b>ACS</b>     | Army Community Service   |
| <b>ACSIM</b>   | Assistant Chief of Staff for Installation Management           |
| <b>ACT</b>     | Army Career Tracker  |
| <b>ACTEDS</b>  | Army Civilian Training, Education, and Development System      |
| <b>ACWA</b>    | Assembled Chemical Weapons Alternatives                        |
| <b>AD</b>      | Active Duty  |
| <b>AD</b>      | Armored Division   |
| <b>ADA</b>     | Air Defense Artillery  |
| <b>ADA</b>     | Anti-Deficiency Act  |
| <b>ADB</b>     | Army Data Board  |
| <b>ADCON</b>   | Administrative Control   |
| <b>ADCS</b>    | Assistant Deputy Chief of Staff                                |
| <b>ADDIE</b>   | Analyze, Design, Development, Implementation and Evaluation    |
| <b>ADL</b>     | Active Duty List   |
| <b>ADM</b>     | Acquisition Decision Memorandum                                |
| <b>ADMP</b>    | Army Data Management Program                                   |
| <b>ADOS</b>    | Active Duty Operational Support                                |
| <b>ADP</b>     | Army Doctrine Publication                                      |
| <b>ADR</b>     | Alternative Dispute Resolution                                 |
| <b>ADRP</b>    | Army Doctrine Reference Publication                            |
| <b>ADS</b>     | Authoritative Data System- Listed as Authoritative Data System |
| <b>ADSO</b>    | Active Duty Service Obligation                                 |
| <b>ADT</b>     | Academic Degree Training                                       |
| <b>ADT</b>     | Active Duty for Training                                       |
| <b>ADTLP</b>   | Army Doctrine and Training Literature Program                  |
| <b>ADVON</b>   | Advanced Echelon   |
| <b>AE</b>      | Active Enlisted  |
| <b>AE2S</b>    | Army Equipping Enterprise System                               |
| <b>AEA</b>     | Army Enterprise Architecture                                   |
| <b>AECA</b>    | Arms Export Control Act  |
| <b>AEDC</b>    | Army Enterprise Data Centers                                   |
| <b>AEF</b>     | American Expeditionary Force                                   |



|                 |   |
|-----------------|---|
| <b>AEMS</b>     | Army Equipment Modernization Strategy                   |
| <b>AENC</b>     | Army Enterprise Network Council                         |
| <b>AEP</b>      | Army Experimentation Plan                               |
| <b>AEPI</b>     | Army Environmental Policy Institute                     |
| <b>AER</b>      | Academic Evaluation Report                              |
| <b>AESIP</b>    | Army Enterprise System Integration Program              |
| <b>AESM</b>     | Army Enterprise Service Management                      |
| <b>AESMF</b>    | Army Enterprise Service Management Framework            |
| <b>AEWRS</b>    | Army Energy and Water Reporting System                  |
| <b>AF</b>       | Appropriated Funds                                      |
| <b>AFAMC</b>    | Air Force Air Mobility Command                          |
| <b>AFARS</b>    | Army Federal Acquisition Regulation Supplement          |
| <b>AFC</b>      | Army Functional Concepts                                |
| <b>AFC</b>      | Army Futures Command                                    |
| <b>AFCS</b>     | Active Federal Commissioned Service                     |
| <b>AFHC</b>     | Army Family Housing (Construction)                      |
| <b>AFHO</b>     | Army Family Housing (Operations)                        |
| <b>AFHSC</b>    | Armed Forces Health Surveillance Center                 |
| <b>AFM</b>      | Army Flow Model   |
| <b>AFMM</b>     | Army Force Management Model                             |
| <b>AFMS</b>     | Army Force Management School                            |
| <b>AFPD</b>     | Available Force Pool Date                               |
| <b>AFR</b>      | Agency Financial Report                                 |
| <b>AFS</b>      | Active Federal Service                                  |
| <b>AFS</b>      | Army Facility Strategy                                  |
| <b>AFSB</b>     | Army Field Support Brigade                              |
| <b>AFSC</b>     | Army Facilities Standardization Committee               |
| <b>AG</b>       | Activity Groups   |
| <b>AG</b>       | Adjutant General  |
| <b>AG-1 CP</b>  | Assistant G-1 for Civilian Personnel                    |
| <b>AGO</b>      | Army General Order                                      |
| <b>AGR</b>      | Active Guard Reserve                                    |
| <b>AGTS</b>     | Advanced Gunnery Training System                        |
| <b>AHLTA</b>    | Armed Forces Health Longitudinal Technology Application |
| <b>AHS</b>      | U.S. Army Headquarters Services                         |
| <b>AHS</b>      | Army Health System                                      |
| <b>A&amp;ID</b> | Analysis and Integration Directorate                    |
| <b>AI</b>       | Artificial Intelligence                                 |
| <b>AIA</b>      | Army Information Architecture                           |

## HOW THE ARMY RUNS

|                     |  |
|---------------------|--|
| <b>AIC</b>          | Automation Innovation Center                                 |
| <b>AIM</b>          | Acquisition Information Management                           |
| <b>AIP</b>          | Assignment Incentive Pay                                     |
| <b>AIS</b>          | Automated Information Systems                                |
| <b>AIT</b>          | Advanced Individual Training                                 |
| <b>AIT</b>          | Automatic Identification Technologies                        |
| <b>AJ</b>           | Administrative Judge   |
| <b>AJA</b>          | Annual Joint Assessment                                      |
| <b>AJPME</b>        | Advanced Joint Professional Military Education               |
| <b>AKEA</b>         | Army Knowledge Enterprise Architecture                       |
| <b>AKO</b>          | Army Knowledge Online  |
| <b>ALC</b>          | Advanced Leaders Course                                      |
| <b>ALCMC</b>        | Army Learning Content Management Capability                  |
| <b>ALC-TE</b>       | Army Learning Concept for Training and Education             |
| <b>ALDS</b>         | Army Leader Development Strategy                             |
| <b>ALM</b>          | Army Learning Model  |
| <b>ALMS</b>         | Army Learning Management System                              |
| <b>ALO</b>          | Authorized Level of Organization                             |
| <b>ALT</b>          | Acquisition, Logistics & Technology                          |
| <b>ALU</b>          | Army Logistic University                                     |
| <b>AM2020CP</b>     | Army Medicine 2020 Campaign Plan                             |
| <b>AMA</b>          | Analysis of Materiel / Non-Materiel Approaches               |
| <b>AMAG</b>         | Army Management Action Group                                 |
| <b>AMC</b>          | Army Materiel Command  |
| <b>AMC</b>          | Air Mobility Command   |
| <b>AMCB</b>         | Army Marine Corps Board                                      |
| <b>AMCMOPES</b>     | AMC Mobilization and Operation Planning and Execution System |
| <b>AMCOM</b>        | Aviation and Missile Command                                 |
| <b>AMCP</b>         | Army Medicine Campaign Plan                                  |
| <b>AMCS</b>         | Army Mission Command System                                  |
| <b>AMDR</b>         | Army Mobilization and Deployment Reference                   |
| <b>AME</b>          | Army Modernization Enterprise                                |
| <b>AME</b>          | Assigned Mission Equipping                                   |
| <b>AMEDD</b>        | Army Medical Department                                      |
| <b>AMEDDC&amp;S</b> | Army Medical Department Center and School                    |
| <b>AMET</b>         | Agency Mission-Essential Task                                |
| <b>AMETL</b>        | Assigned Mission Essential Task List                         |
| <b>AMF</b>          | Army Mobilization Forum                                      |
| <b>AMHA</b>         | Army Management Headquarters Activities                      |

|                  |   |
|------------------|---|
| <b>AMHA</b>      | Army Management Headquarters Account                          |
| <b>AMLC</b>      | Army Medical Logistics Command                                |
| <b>AMLE</b>      | Army Medical Logistics Enterprise                             |
| <b>AMM</b>       | Assigned Mission Manning                                      |
| <b>AMMDB</b>     | Army MARC Maintenance Data Base                               |
| <b>AMP</b>       | Army Mobilization Plan  |
| <b>AMP</b>       | Army Modernization Plan                                       |
| <b>AMRDEC</b>    | Aviation & Missile Research, Development, and Engineer Center |
| <b>AMRB</b>      | Army Mission Essential Task List (METL) Review Board          |
| <b>AMRG</b>      | Army Marketing and Research Group                             |
| <b>AMRWG/COC</b> | Army Munition Requirements Working Group /Counsel of Colonels |
| <b>AMS</b>       | Army Management Structure                                     |
| <b>AMS</b>       | Army Mobilization System                                      |
| <b>AMSCO</b>     | Army Management Structure Code                                |
| <b>AMSH</b>      | Army Medicine System for Health                               |
| <b>AMSP</b>      | Advanced Military Studies Program                             |
| <b>AMT</b>       | Army Modernization Training                                   |
| <b>ANAD</b>      | Anniston Army Depot   |
| <b>AMT</b>       | Assigned Mission Training                                     |
| <b>ANC</b>       | Arlington National Cemetery                                   |
| <b>ANC</b>       | Army Nurse Corps  |
| <b>ANIP</b>      | Army Network Implementation Plan                              |
| <b>ANNPRO</b>    | Annual Program  |
| <b>ANP</b>       | Army Network Plan   |
| <b>ANPF</b>      | Army Network Plan Framework                                   |
| <b>ANS</b>       | Activity, Nutrition, and Sleep                                |
| <b>AO</b>        | Action Officer  |
| <b>AO</b>        | Active Officer  |
| <b>AO</b>        | Area of Operation   |
| <b>AO / AE</b>   | Active Officer / Active Enlisted                              |
| <b>AoA</b>       | Analysis of Alternatives                                      |
| <b>AOC</b>       | Area of Concentration   |
| <b>AOC</b>       | Army Operating Concept  |
| <b>AoCC</b>      | Analysis of Change Cell                                       |
| <b>AODC</b>      | Action Officer Development Course                             |
| <b>AOI</b>       | Area of Interest  |
| <b>AOLCM</b>     | Army Organizational Life Cycle Model                          |
| <b>AOR</b>       | Area of Responsibility  |
| <b>AOS</b>       | Army Organization Server                                      |

## HOW THE ARMY RUNS

|                 |   |
|-----------------|---|
| <b>APA</b>      | Aircraft Procurement, Army                                      |
| <b>APAC</b>     | U.S. Army Public Affairs Center                                 |
| <b>APB</b>      | Acquisition Program Baseline                                    |
| <b>APD</b>      | Army Publishing Directorate                                     |
| <b>APE</b>      | Army Program Elements   |
| <b>APEX</b>     | Adaptive Planning and Execution                                 |
| <b>APF</b>      | Appropriated Fund   |
| <b>APFT</b>     | Army Physical Fitness Test                                      |
| <b>APG</b>      | Aberdeen Proving Ground   |
| <b>APG</b>      | Army Planning Guidance (The Army Plan (TAP) Part 3)             |
| <b>APGM</b>     | Army Program Guidance Memorandum (The Army Plan (TAP) Part 4)   |
| <b>APLDF</b>    | Army Profession Leader Development Forum                        |
| <b>APMS</b>     | Army Portfolio Management Solution                              |
| <b>APOD</b>     | Aerial Port of Debarkation                                      |
| <b>APP</b>      | Army Protection Program   |
| <b>APPN</b>     | Appropriation   |
| <b>APR</b>      | Annual Performance Report                                       |
| <b>APRB</b>     | Army Requirements Oversight Council (AROC) Process Review Board |
| <b>APS</b>      | Army Posture Statement  |
| <b>APS</b>      | Army Pre-Positioned Stocks                                      |
| <b>APUC</b>     | Average Procurement Unit Cost                                   |
| <b>AR</b>       | Army Regulation   |
| <b>AR2B</b>     | Army Requirements and Resourcing Board                          |
| <b>ARA</b>      | Acquisition Reporting and Assessments                           |
| <b>ARADS</b>    | Army Recruiting and Accession Data System                       |
| <b>ARB</b>      | Army Resources Board  |
| <b>ARB</b>      | AROC Review Board   |
| <b>ARBA</b>     | Army Review Boards Agency                                       |
| <b>ARCCR</b>    | Annual Report of Combatant Command Requirements                 |
| <b>ARCIC</b>    | Army Capabilities Integration Center                            |
| <b>ARCOM</b>    | Army Reserve Command  |
| <b>ARCYBER</b>  | U.S. Army Cyber Command   |
| <b>ARDEC</b>    | U.S. Army Armament Research, Development and Engineering Center |
| <b>AREF</b>     | Army Reserve Expeditionary Force                                |
| <b>AREP</b>     | Army Reserve Expeditionary Package                              |
| <b>ARFORGEN</b> | Army Force Generation   |
| <b>ARFPC</b>    | Army Reserve Forces Policy Committee                            |
| <b>ARIMD</b>    | Army Reserve Installation Management Directorate                |
| <b>ARISS</b>    | Army Recruiting Information Support System                      |

## GLOSSARY

|                        |  |
|------------------------|--|
| <b>ARL</b>             | Army Research Laboratory   |
| <b>ARMS</b>            | Armament Retooling and Manufacturing Support                                       |
| <b>ARMS</b>            | Army Readiness Management System   |
| <b>ARNG</b>            | Army National Guard  |
| <b>ARNGUS</b>          | U.S Army National Guard  |
| <b>ARNORTH</b>         | Army Forces North  |
| <b>AROC</b>            | Army Requirements Oversight Council  |
| <b>ARPA</b>            | Advanced Research Projects Agency  |
| <b>ARPRINT</b>         | Army Program for Individual Training   |
| <b>ARSEC</b>           | Army Secretariat   |
| <b>ARSTAF</b>          | Army Staff   |
| <b>ARSTRAT</b>         | Army Strategic Command   |
| <b>ARSTRUC</b>         | Army Structure   |
| <b>ARTCP</b>           | Army Reserve Transformation Campaign Plan  |
| <b>ARTEP</b>           | Army Training and Evaluation Program   |
| <b>AS</b>              | Acquisition Strategy   |
| <b>A&amp;S</b>         | Acquisition & Sustainment  |
| <b>ASA</b>             | Army Support Activities  |
| <b>ASA</b>             | Assistant Secretary of the Army  |
| <b>ASA(ALT)</b>        | Assistant Secretary of the Army for Acquisition, Logistics, and Technology         |
| <b>ASA(CW)</b>         | Assistant Secretary of the Army for Civil Works                                    |
| <b>ASA(FM&amp;C)</b>   | Assistant Secretary of the Army for Financial Management and Comptroller           |
| <b>ASA(IE&amp;E)</b>   | Assistant Secretary of the Army for Installations, Energy and Environment          |
| <b>ASA(M&amp;RA)</b>   | Assistant Secretary of the Army for Manpower and Reserve Affairs                   |
| <b>ASAE</b>            | Army Security Assistance Enterprise  |
| <b>ASARC</b>           | Army Systems Acquisition Review Council  |
| <b>ASAT</b>            | Automated Systems Approach to Training   |
| <b>ASATBC</b>          | ASAT Basic Course  |
| <b>ASB</b>             | Army Science Board   |
| <b>ASB</b>             | Aviation Support Battalion   |
| <b>ASC</b>             | Acquisition Support Center   |
| <b>ASC</b>             | Army Sustainment Command   |
| <b>ASCC</b>            | Army Service Component Command   |
| <b>ASCF</b>            | Army Senior Civilian Fellowships   |
| <b>ASD(HA)</b>         | Assistant Secretary of Defense (Health Affairs)                                    |
| <b>ASD(HD&amp;ASA)</b> | Assistant Secretary of Defense for Homeland Defense and America's Security Affairs |
| <b>ASD(HD&amp;GS)</b>  | Assistant Secretary of Defense for Homeland Defense and Global Security            |
| <b>ASD(ISA)</b>        | Assistant Secretary of Defense International Security Affairs                      |
| <b>ASD(M&amp;RA)</b>   | Assistant Secretary of defense for Manpower and Reserve Affairs                    |

## HOW THE ARMY RUNS

|                   |  |
|-------------------|--|
| <b>ASD(PA)</b>    | Assistant Secretary of Defense (Public Affairs)                                |
| <b>ASD(RA)</b>    | Assistant Secretary of Defense (Reserve Affairs)                               |
| <b>ASD(SOLIC)</b> | Assistant Secretary of Defense (Special Operations and Low Intensity Conflict) |
| <b>ASEP</b>       | Army Strategic Education Program   |
| <b>ASI</b>        | Additional Skill Identifier  |
| <b>ASIOE/P</b>    | Associated Support Items of Equipment and Personnel                            |
| <b>ASIP</b>       | Army Stationing and Installation Plan  |
| <b>ASK</b>        | Assignment Satisfaction Key  |
| <b>ASL</b>        | Army Senior Leaders  |
| <b>ASL</b>        | Authorized Stockage List   |
| <b>ASLDP</b>      | Army Strategic Leader Development Program                                      |
| <b>ASLSP</b>      | Advanced Strategic Leadership Studies Program                                  |
| <b>ASORTS</b>     | Army Status of Resources and Training System                                   |
| <b>ASOS</b>       | Army Support to Other Services   |
| <b>ASP</b>        | Army Strategic Plan (The Army Plan (TAP) Part 2)                               |
| <b>ASRA</b>       | Army Strategic Readiness Assessment  |
| <b>ASRC</b>       | Army Synchronization and Resourcing Conference                                 |
| <b>ASRP</b>       | Army Synchronization & Resourcing Process                                      |
| <b>AST</b>        | Army Force Generation Synchronization Toolset                                  |
| <b>AST</b>        | Army Test and Evaluation Command System Team                                   |
| <b>ASTAG</b>      | Army Science and Technology Advisory Group                                     |
| <b>ASTMP</b>      | Army Science and Technology Master Plan  |
| <b>ASTWG</b>      | Army Science and Technology Working Group                                      |
| <b>ASVAB</b>      | Armed Services Vocational Aptitude Battery                                     |
| <b>ASV</b>        | Armored Security Vehicle   |
| <b>AT</b>         | Annual Training  |
| <b>AT&amp;L</b>   | Acquisition, Technology, and Logistics   |
| <b>AT&amp;LDG</b> | Army Training and Leader Development Guidance                                  |
| <b>ATA</b>        | Army Tasking Authority   |
| <b>ATA</b>        | Additional Training Assembly   |
| <b>ATC</b>        | Army Training Center   |
| <b>ATD</b>        | Advanced Technology Demonstration  |
| <b>ATDC</b>       | Army Training Development Capability   |
| <b>ATEC</b>       | U.S. Army Test and Evaluation Command  |
| <b>ATED</b>       | Army Training and Education  |
| <b>ATFP</b>       | Army Total Force Policy  |
| <b>ATIA</b>       | Army Training Information Architecture   |
| <b>ATIS</b>       | Army Training Information System   |

## GLOSSARY

|                 |   |
|-----------------|---|
| <b>ATLDC</b>    | Army Training and Leader Development Conference       |
| <b>ATLDP</b>    | Army Training and Leader Development Panel            |
| <b>ATMC</b>     | Army Training Management Capability                   |
| <b>ATMS</b>     | Army Training Management System                       |
| <b>ATN</b>      | Army Training Network                                 |
| <b>ATO</b>      | Army Technology Objectives                            |
| <b>ATO(D)</b>   | Advance Technology Objectives (Demonstration)         |
| <b>ATO(M)</b>   | Army Technology Objectives (Manufacturing)            |
| <b>ATO(R)</b>   | Advance Technology Objectives (Research)              |
| <b>ATR</b>      | Above Threshold Reprogramming                         |
| <b>ATRRS</b>    | Army Training Requirements and Resources System       |
| <b>ATRM</b>     | Aviation Training Resource Model                      |
| <b>ATS</b>      | Army Training Strategy                                |
| <b>ATSC</b>     | Army Training Support Center                          |
| <b>ATTP</b>     | Army Tactics, Techniques, and Procedures              |
| <b>AUGTDA</b>   | Augmentation Table of Distribution and Allowances     |
| <b>AUJTL</b>    | Army Universal Joint Task List                        |
| <b>AUS / RA</b> | Army of the U.S. / Regular Army                       |
| <b>AUSA</b>     | Association of the U.S. Army                          |
| <b>AUTH</b>     | Authorization   |
| <b>AUTL</b>     | Army Universal Task List                              |
| <b>AUTS</b>     | Automatic Update Transaction System                   |
| <b>AV</b>       | Army Vision (The Army Plan (TAP) Part 1)              |
| <b>AW</b>       | Asymmetric Warfare                                    |
| <b>AWC</b>      | Army War College                                      |
| <b>AWCF</b>     | Army Working Capital Fund                             |
| <b>AWE</b>      | Advanced Warfighting Experiment                       |
| <b>AWFC</b>     | Army Warfighting Challenges                           |
| <b>AWG</b>      | Asymmetric Warfare Group                              |
| <b>AWG</b>      | AROC Working Groups                                   |
| <b>AWRDS</b>    | Army War Reserve Deployment System                    |
| <b>AWT/CMA</b>  | Army Wide Transportation /Centrally Managed Allotment |
| <b>BA</b>       | Budget Activity                                       |
| <b>BA</b>       | Budget Authority                                      |
| <b>BAG</b>      | Budget Activity Group                                 |
| <b>BAH</b>      | Basic Allowance for Housing                           |
| <b>BASOPS</b>   | Base Operations                                       |
| <b>BBS</b>      | Brigade/Battalion Battle Simulation                   |
| <b>BC</b>       | Basic Course  |

## HOW THE ARMY RUNS

|               |  |
|---------------|--|
| <b>BCA</b>    | Budget Control Act                               |
| <b>BCP</b>    | Budget Change Proposal                           |
| <b>BCT</b>    | Basic Combat Training                            |
| <b>BCT</b>    | Brigade Combat Team                              |
| <b>BCTP</b>   | Battle Command Training Program                  |
| <b>BEA</b>    | Business Enterprise Architecture                 |
| <b>BES</b>    | Budget Estimate Submission                       |
| <b>BH</b>     | Behavioral Health                                |
| <b>BIDE</b>   | Basic Identity Data Elements                     |
| <b>BIDS</b>   | Biological Integrated Detection System           |
| <b>BI-PMO</b> | Border Infrastructure Program Management Office  |
| <b>BLC</b>    | Basic Leader Course                              |
| <b>BLCSE</b>  | Battle Lab Collaborative Simulation Environment  |
| <b>BLIN</b>   | Budget Line Item Number                          |
| <b>BMA</b>    | Business Mission Area                            |
| <b>BMC</b>    | Brigade Modernization Command                    |
| <b>BMDR</b>   | Ballistic Missile Defense Review                 |
| <b>BMIS-T</b> | Battlefield Medical Information System-Tactical  |
| <b>BOD</b>    | Board of Directors                               |
| <b>BOD</b>    | Broadcast Operations Detachment                  |
| <b>BOG</b>    | Boots on Ground                                  |
| <b>BOIP</b>   | Basis of Issue Plan                              |
| <b>BOIPFD</b> | Basis of Issue Plan Feeder Data                  |
| <b>BOLC</b>   | Basic Officer Leaders Course                     |
| <b>BOS</b>    | Base Operations Support                          |
| <b>BOS</b>    | Business Operating System                        |
| <b>BOXi</b>   | Business Objects Xi                              |
| <b>BPC</b>    | Building Partner Capacity                        |
| <b>BPLAN</b>  | Base Plan  |
| <b>BR</b>     | Budget Review                                    |
| <b>BRAC</b>   | Base Realignment and Closure                     |
| <b>BRM</b>    | Base Operations Support (BOS) Requirements Model |
| <b>BRP</b>    | Budget, Requirements & Programs                  |
| <b>BSA</b>    | Budget Sub-Activity                              |
| <b>BSB</b>    | Brigade Support Battalion                        |
| <b>BSI</b>    | Base Support Installation                        |
| <b>BT</b>     | Basic Training                                   |
| <b>BTM</b>    | Battalion Level Training Model                   |
| <b>BTOE</b>   | Base Table of Organization and Equipment         |



|               |   |
|---------------|---|
| <b>BTR</b>    | Below Threshold Reprogramming   |
| <b>BUR</b>    | Bottom Up Review  |
| <b>BY</b>     | Budget Year   |
| <b>C2</b>     | Command and Control   |
| <b>C2CRE</b>  | Command and Control CBRN Response Element   |
| <b>C2DEF</b>  | Command and Control Default   |
| <b>C3I</b>    | Command, Control, Communications, and Intelligence  |
| <b>C3T</b>    | Command, Control, and Communications-Tactical   |
| <b>C4</b>     | Command, Control, Communications, and Computers   |
| <b>C4IM</b>   | Command, Control, Communications, Computers and Information Management                      |
| <b>C4ISR</b>  | Command, Control, Communications, Computers, Intelligence, Surveillance, and Reconnaissance |
| <b>CA</b>     | Coordinating Authority  |
| <b>CAA</b>    | U.S. Center for Army Analysis   |
| <b>CAC</b>    | Combined Arms Center  |
| <b>CAC</b>    | Common Access Card  |
| <b>CAC</b>    | Cost Accounting Codes   |
| <b>CAE</b>    | Component Acquisition Executive   |
| <b>CAER</b>   | Command Accountability and Execution Reviews  |
| <b>CAIG</b>   | Cost Analysis Improvement Group   |
| <b>CAIV</b>   | Cost as an Independent Variable   |
| <b>CALL</b>   | Center for Army Lessons Learned   |
| <b>CAM</b>    | Combined Arms Maneuver  |
| <b>CAMS</b>   | Capabilities and Army Requirements Oversight Council (AROC) Management System               |
| <b>CAP</b>    | Crisis Action Planning  |
| <b>CAP</b>    | Critical Acquisition Position   |
| <b>CAPDEV</b> | Capability Developer  |
| <b>CAPE</b>   | Cost Assessment and Program Evaluation  |
| <b>CAR</b>    | Chief, Army Reserve   |
| <b>CARD</b>   | Cost Analysis Requirements Description  |
| <b>CARDS</b>  | Catalog of Approved Requirements Documents  |
| <b>CASCOM</b> | Combined Arms Support Command   |
| <b>CATS</b>   | Combined Arms Training Strategy   |
| <b>C-BA</b>   | Capabilities-Based Assessment   |
| <b>CB</b>     | Contingency Basing  |
| <b>CBA</b>    | Cost Benefit Analysis   |
| <b>CBARB</b>  | Cost Benefit Analysis Review Board  |
| <b>CBD</b>    | Chemical-Biological Defense   |
| <b>CBDRT</b>  | Chemical-Biological Defense Readiness Training  |

## HOW THE ARMY RUNS

|                      |   |
|----------------------|---|
| <b>CBIRF</b>         | Chemical Biological Incident Response Force (USMC)  |
| <b>CBM</b>           | Condition Based Maintenance   |
| <b>CBP</b>           | Customs and Border Protection   |
| <b>CBRN</b>          | Chemical, Biological, Radiological, and Nuclear   |
| <b>CBRNE</b>         | Chemical, Biological, Radiological, Nuclear, and High-Yield Explosives  |
| <b>CBS</b>           | Corps Battle Simulation   |
| <b>CBV</b>           | Capability-Based Volunteer  |
| <b>CBTDEV</b>        | Combat Developer  |
| <b>CBWTU</b>         | Community-Based Warrior Transition Unit   |
| <b>CCA</b>           | Clinger-Cohen Act   |
| <b>CCC</b>           | Captains Career Course  |
| <b>CCAD</b>          | Corpus Christi Army Depot   |
| <b>CCDC</b>          | Combat Capabilities Development Command   |
| <b>CCDR</b>          | Combatant Commander   |
| <b>CCDOR</b>         | Combatant Commander's Daily Operational Requirements  |
| <b>CCJO</b>          | Capstone Concept for Joint Operations   |
| <b>CCMD</b>          | Combatant Command (Organization)  |
| <b>CCMRF</b>         | Chemical, Biological, Radiological, Nuclear, and High-Yield Explosives (CBRNE)<br>Consequence Management Response Force |
| <b>CCP</b>           | Concept Capability Plan   |
| <b>CCP</b>           | Combatant Command Campaign Plan   |
| <b>CCS</b>           | Commander's Communication Synchronization   |
| <b>CCTT</b>          | Close Combat Tactical Trainer   |
| <b>CD&amp;E</b>      | Concept Development and Experimentation   |
| <b>CDA</b>           | Capability Demand Analysis  |
| <b>CDD</b>           | Capability Development Document   |
| <b>CDID</b>          | Capability Development Integration Directorate  |
| <b>CDLD</b>          | Concept Development and Learning Directorate  |
| <b>CDO</b>           | Cease and Desist Order  |
| <b>CDO</b>           | Chief Data Officer  |
| <b>CDO</b>           | Civil Disturbance Operations  |
| <b>CDPL</b>          | Command Designated Positional List  |
| <b>CDR</b>           | Critical Design Review  |
| <b>CDRT</b>          | Capabilities Development for Rapid Transition   |
| <b>CDRUSSTRATCOM</b> | Commander, USSTRATCOM   |
| <b>CDTM</b>          | Capability Development Tracking and Management  |
| <b>CE</b>            | Continuous Evaluation   |
| <b>CECOM</b>         | Communications-Electronics Command (Life Cycle Management Command (LCMC))   |
| <b>CEF</b>           | Contingency Expeditionary Force   |

|                |  |
|----------------|--|
| <b>CEMA</b>    | Cyberspace Electromagnetic Activities  |
| <b>CENTCOM</b> | U.S. Central Command   |
| <b>CEO</b>     | Chief Executive Officer  |
| <b>CEP</b>     | Concept Experimentation Program  |
| <b>CER</b>     | Cost Estimating Relationship   |
| <b>CERFP</b>   | Chemical, Biological, Radiological, Nuclear, and High-Yield Explosives (CBRNE) Enhanced Response Force Package |
| <b>CES</b>     | Civilian Education System  |
| <b>CESL</b>    | Continuing Education for Senior Leaders  |
| <b>CEW</b>     | Civilian Expeditionary Workforce   |
| <b>CF</b>      | Conventional Force   |
| <b>CFLCC</b>   | Coalition Forces Land Component Command  |
| <b>CFMO</b>    | Construction and Facility Management Officer   |
| <b>CFO</b>     | Chief Financial Officer  |
| <b>CFR</b>     | Code of Federal Regulations  |
| <b>CFSC</b>    | Community and Family Support Center  |
| <b>CFT</b>     | Cross-Functional Team  |
| <b>CG</b>      | Commanding General   |
| <b>CG CAP</b>  | Coast Guard Capabilities Plan  |
| <b>CGA</b>     | Capabilities Gap Assessment  |
| <b>CGSOC</b>   | Command and General Staff Officer Course   |
| <b>CHES</b>    | Computers, Hardware, Enterprise Software and Solutions   |
| <b>CHR</b>     | Civilian Human Resource  |
| <b>CHRA</b>    | U.S. Army Civilian Human Resources Agency  |
| <b>CHRM-IT</b> | Civilian Human Resources Management Information Technology   |
| <b>CHRTAS</b>  | Civilian Human Resource Training Application System  |
| <b>CIA</b>     | Central Intelligence Agency  |
| <b>CIC</b>     | Critical Intelligence Category   |
| <b>C-IED</b>   | Counter-Improvised Explosive Device  |
| <b>CIMT</b>    | Center for Initial Military Training   |
| <b>CIO</b>     | Chief Information Officer  |
| <b>CIPMS</b>   | Civilian Intelligence Personnel Management System  |
| <b>CIPPS</b>   | Civilian Integration into the Personnel Proponent System   |
| <b>CIS</b>     | Comptroller Information System   |
| <b>CJA</b>     | Comprehensive Joint Assessment   |
| <b>CJCS</b>    | Chairman of the Joint Chiefs of Staff  |
| <b>CJCSG</b>   | Chairman of the Joint Chiefs of Staff Guide  |
| <b>CJCSI</b>   | Chairman of the Joint Chiefs of Staff Instruction  |
| <b>CJCSM</b>   | Chairman of the Joint Chiefs of Staff Manual   |

## HOW THE ARMY RUNS

|                |  |
|----------------|--|
| <b>CJTG</b>    | Chairman's Joint Training Guidance               |
| <b>C&amp;L</b> | Capabilities and Limitations                     |
| <b>CLO</b>     | Consolidated Legal Office                        |
| <b>CLS</b>     | Common Levels of Support                         |
| <b>CLSSA</b>   | Cooperative Logistics Supply Support Arrangement |
| <b>C-MNS</b>   | Combat-Mission Need Statement                    |
| <b>CM</b>      | Current Month                                    |
| <b>CM</b>      | Command Manager                                  |
| <b>CM</b>      | Consequence Management                           |
| <b>CM</b>      | Cost Management                                  |
| <b>CMA</b>     | Chemical Materials Activity                      |
| <b>CMEP</b>    | Civil-Military Emergency Planning                |
| <b>CMETL</b>   | Core Mission Essential Task List                 |
| <b>CMF</b>     | Career Management Field                          |
| <b>CM (FS)</b> | Command Manager (Force Structure)                |
| <b>CMH</b>     | U.S. Army Center of Military History             |
| <b>CMICS</b>   | Civilian Manpower Integrated Costing System      |
| <b>CMO</b>     | Capability Management Office                     |
| <b>CMO</b>     | Chief Management Officer                         |
| <b>CMP</b>     | Change Management Plan                           |
| <b>CMU</b>     | Consequence Management Unit                      |
| <b>CNA</b>     | Capability Needs Analysis                        |
| <b>CNGB</b>    | Chief, National Guard Bureau                     |
| <b>CNs</b>     | Congressional Notifications                      |
| <b>COA</b>     | Course of Action                                 |
| <b>COCOM</b>   | Combatant Command (Command Authority)            |
| <b>CoC</b>     | Council of Colonels                              |
| <b>CoE</b>     | Center of Excellence                             |
| <b>COE</b>     | Chief of Engineers                               |
| <b>COE</b>     | Common Operating Environment                     |
| <b>COE</b>     | Contemporary Operational Environment             |
| <b>COFT</b>    | Conduct of Fire Trainer                          |
| <b>COG</b>     | Continuity of Government                         |
| <b>COIC</b>    | Critical Operational Issues and Criteria         |
| <b>COIN</b>    | Counterinsurgency                                |
| <b>COIST</b>   | Company Intelligence Support Team                |
| <b>COL</b>     | Colonel  |
| <b>COLS</b>    | Common Output Level Standards                    |
| <b>COMCAM</b>  | Combat Camera                                    |

## GLOSSARY

|                 |   |
|-----------------|---|
| <b>COMPASS</b>  | Computerized Movement Planning and Status System      |
| <b>COMPO</b>    | Component   |
| <b>CONARC</b>   | Continental Army Command                              |
| <b>CONOPS</b>   | Concept of Operations                                 |
| <b>CONPLAN</b>  | Concept Plan  |
| <b>CONPLAN</b>  | Contingency Plan                                      |
| <b>CONUS</b>    | Continental U.S.                                      |
| <b>CONUSA</b>   | Continental U.S. Army                                 |
| <b>COOP</b>     | Continuity of Operations Program                      |
| <b>COR</b>      | Contracting Officer Representative                    |
| <b>CORTRAIN</b> | Corps and Division Training Coordination Program      |
| <b>COTR</b>     | Cost of Training Readiness                            |
| <b>COTS</b>     | Commercial Off The Shelf                              |
| <b>CP</b>       | Change Proposals                                      |
| <b>CPA</b>      | Chairman's Program Assessment                         |
| <b>CPA</b>      | Chief of Public Affairs                               |
| <b>CPAC</b>     | Civilian Personnel Advisory Center                    |
| <b>CPD</b>      | Capability Production Document                        |
| <b>CPD</b>      | Competitive Professional Development                  |
| <b>CPG</b>      | Contingency Planning Guidance                         |
| <b>CPI</b>      | Critical Program Information                          |
| <b>CPIM</b>     | Capital Planning and Investment Management            |
| <b>CPLAN</b>    | Command Plan  |
| <b>CPMD</b>     | Command Provost Marshal Directorate                   |
| <b>CPOL</b>     | Civilian Personnel Online                             |
| <b>CPP</b>      | Cost & Performance Portal                             |
| <b>CPPP</b>     | Caregiving Personnel Pay Program                      |
| <b>CPR</b>      | Chairman's Program Recommendation                     |
| <b>CPR</b>      | Capability Portfolio Review                           |
| <b>CPX</b>      | Command Post Exercise                                 |
| <b>CRA</b>      | Chairman's Risk Assessment                            |
| <b>CRA</b>      | Continuing Resolution Authority                       |
| <b>CRAE</b>     | Capability, Readiness, Availability and Employability |
| <b>CRB</b>      | Cost Review Board                                     |
| <b>CRC</b>      | Continental U.S. (CONUS) Replacement Center           |
| <b>CREL</b>     | Cultural Regional Expertise and Language              |
| <b>CREST</b>    | Contingency Real Estate Support Teams                 |
| <b>CRM</b>      | Composite Risk Management                             |
| <b>CrM</b>      | Crisis Response Management                            |

## HOW THE ARMY RUNS

|                  |   |
|------------------|---|
| <b>CROWS</b>     | Common Remotely Operated Weapons System           |
| <b>CRS</b>       | Chairman's Readiness System                       |
| <b>CRXXI</b>     | Classroom Twenty One                              |
| <b>C / S / A</b> | Combatant Commands, Services, and Agencies        |
| <b>CS</b>        | Civil Support                                     |
| <b>CS</b>        | Combat Support                                    |
| <b>CSA</b>       | Chief of Staff, U.S. Army                         |
| <b>CSA</b>       | Combat Support Agency                             |
| <b>CSB</b>       | Configuration Steering Board                      |
| <b>CSB</b>       | Continental U.S. (CONUS) Support Base             |
| <b>CSB</b>       | Contracting Support Brigade                       |
| <b>CSDJF</b>     | Chairman's Strategic Direction to the Joint Force |
| <b>CSF</b>       | Common Service Functions                          |
| <b>CSL</b>       | Centralized Selection List                        |
| <b>CSLMO</b>     | Civilian Senior Leader Management Office          |
| <b>CSM</b>       | Command Sergeant Major                            |
| <b>CSM</b>       | Capability Set Management                         |
| <b>CSO</b>       | Cloud Service Offering                            |
| <b>CSP</b>       | Cloud Service Provider                            |
| <b>CSRA</b>      | Civil Service Reform Act                          |
| <b>CSRC</b>      | Cyber Survivability Risk Categories               |
| <b>CSS</b>       | Combat Service Support                            |
| <b>CSSB</b>      | Combat Sustainment Support Battalion              |
| <b>CST</b>       | Civil Support Team                                |
| <b>CSTC</b>      | Combat Support Training Center                    |
| <b>CSTX</b>      | Combat Support Training Exercise                  |
| <b>CTA</b>       | Common Table of Allowances                        |
| <b>CTC</b>       | Combat Training Center                            |
| <b>CTC</b>       | Combine Training Center                           |
| <b>CTE</b>       | Critical Technology Element                       |
| <b>CTE</b>       | Culminating Training Event                        |
| <b>CTPF</b>      | Counterterrorism Partnership Program Fund         |
| <b>CTS</b>       | Contingency Tracking System                       |
| <b>CTT</b>       | Collective Training Task                          |
| <b>CTU</b>       | Consolidated TOE Update                           |
| <b>CTYPE</b>     | Civilian Type                                     |
| <b>CUSR</b>      | Commander's Unit Status Report                    |
| <b>CWMD</b>      | Counter Weapons of Mass Destruction (WMD)         |
| <b>CWT</b>       | Civilian Workforce Transformation                 |

|                       |   |
|-----------------------|---|
| <b>CXO</b>            | Chief Integration Officer- Command Executive Officer                                    |
| <b>CY</b>             | Calendar Year   |
| <b>CY</b>             | Current Year  |
| <b>CYBERCOM</b>       | U.S. Cyber Command  |
| <b>CYPPP</b>          | Child and Youth Personnel Pay Program   |
| <b>D2RR</b>           | Deploy-To-Redploy/Retrograde  |
| <b>DA</b>             | Department of the Army  |
| <b>DA PAM</b>         | Department of the Army Pamphlet   |
| <b>DAB</b>            | Defense Acquisition Board   |
| <b>DAB</b>            | Director of the Army Budget   |
| <b>DAC</b>            | Department of the Army Civilian   |
| <b>DACIL</b>          | Department of the Army Critical Items List  |
| <b>DACOM</b>          | Director, Acquisition Career Management   |
| <b>DAE</b>            | Defense Acquisition Executive   |
| <b>DAES</b>           | Defense Acquisition Executive Summary   |
| <b>DAGO</b>           | Department of the Army General Order  |
| <b>DAGR</b>           | Defense Advanced Global Positioning System (GPS) Receiver                               |
| <b>DALSO</b>          | Department of the Army Logistics Support Officer  |
| <b>DAMPS</b>          | Department of the Army Mobilization Processing System                                   |
| <b>DANTES</b>         | Defense Activity for Non-Traditional Education Support                                  |
| <b>DAO</b>            | Defense Accounting Office   |
| <b>DAPE-PRP</b>       | Deputy Chief of Staff, Personnel  |
| <b>DARNG</b>          | Director, Army National Guard   |
| <b>DARPA</b>          | Defense Advanced Research Projects Agency   |
| <b>DARPL</b>          | Dynamic Army Resourcing Priority List   |
| <b>DAS</b>            | Defense Acquisition System  |
| <b>DAS</b>            | Director of the Army Staff  |
| <b>DASA</b>           | Deputy Assistant Secretary of the Army  |
| <b>DASA(CE)</b>       | Deputy Assistant Secretary of the Army for Cost and Economics                           |
| <b>DASA(DE&amp;C)</b> | Deputy Assistant Secretary of the Army for Defense Exports and Cooperation              |
| <b>DASA(DL)</b>       | Deputy Assistant Secretary of the Army for Diversity and Leadership                     |
| <b>DASA(E&amp;S)</b>  | Deputy Assistant Secretary of the Army for Energy and Sustainability                    |
| <b>DASA(ESOH)</b>     | Deputy Assistant Secretary of the Army for Environment, Safety, and Occupational Health |
| <b>DASA(FIM)</b>      | Deputy Assistant Secretary of the Army for Financial Information Management             |
| <b>DASA(FO)</b>       | Deputy Assistant Secretary of the Army for Financial Operations                         |
| <b>DASA(IHP)</b>      | Deputy Assistant Secretary of the Army for Installations, Housing, and Partnerships     |
| <b>DASA(R&amp;T)</b>  | Deputy Assistant Secretary of the Army for Research and Technology                      |
| <b>DASA(SI)</b>       | Deputy Assistant Secretary of the Army for Strategic Integration                        |
| <b>DASC</b>           | Department of the Army System Coordinator   |

## HOW THE ARMY RUNS

|                   |   |
|-------------------|---|
| <b>DASD(CPP)</b>  | Deputy Assistant Secretary of Defense for Civilian Personnel Policy   |
| <b>DASD(IP)</b>   | Deputy Assistant Secretary of Defense for Industrial Policy   |
| <b>DASD(MIBP)</b> | Deputy Assistant Secretary of Defense for Manufacturing and Industrial Base Policy  |
| <b>DASM</b>       | Deputy for Acquisition & Systems Management   |
| <b>DAS POR</b>    | Defense Acquisition System Program of Record  |
| <b>DATE</b>       | Decisive Action Training Environment  |
| <b>DAU</b>        | Defense Acquisition University  |
| <b>DAWIA</b>      | Defense Acquisition Workforce Improvement Act   |
| <b>DB</b>         | Design Build  |
| <b>DBB</b>        | Design Bid Build  |
| <b>DBS</b>        | Defense Business System   |
| <b>DBSMC</b>      | Defense Business System (DBS) Management Council  |
| <b>DC</b>         | Dental Corps  |
| <b>DCAA</b>       | Defense Contract Audit Agency   |
| <b>DCE</b>        | Defense Coordinating Element  |
| <b>DCG-CEO</b>    | Deputy Commanding General for Civil and Emergency Operations  |
| <b>DCG / Cofs</b> | Deputy Commanding General / Chief of Staff  |
| <b>DCI</b>        | Director, Central Intelligence  |
| <b>DCIPS</b>      | Defense Casualty Information Processing System  |
| <b>DCIPS</b>      | Defense Civilian Intelligence Personnel System  |
| <b>DCLM</b>       | Department of Command, Leadership, and Management   |
| <b>DCMA</b>       | Defense Contract Management Agency  |
| <b>DCMO</b>       | Deputy Chief Management Officer   |
| <b>DCO</b>        | Defense Coordinating Officer  |
| <b>DCO</b>        | Defensive Cyberspace Operations   |
| <b>DCPAS</b>      | Defense Civilian Personnel Advisory Services  |
| <b>DCPDS</b>      | Defense Civilian Personnel Data System  |
| <b>DCR</b>        | Doctrine, Organization, Training, Materiel, Leadership and Education, Personnel, Facilities, and Policy (DOTMLPF-P) Change Recommendation |
| <b>DCRF</b>       | Defense CBRN Response Force   |
| <b>DCS</b>        | Deputy Chief of Staff   |
| <b>DCSOPS</b>     | Deputy Chief of Staff, Operations and Plans   |
| <b>DCU</b>        | Defense Coordinating Unit   |
| <b>DD</b>         | Department of Defense (Form)  |
| <b>DDASS</b>      | Department of Defense Support to Civil Authorities Automated Support System   |
| <b>DDFP</b>       | Deputy Director, Force Protection   |
| <b>DDN</b>        | Defense Data Network  |
| <b>DDOT</b>       | Deputy Director of Training   |
| <b>DDR</b>        | Deputy Director Requirement   |
| <b>DDRCD</b>      | Deputy Director for Requirements for Capabilities Development   |



## GLOSSARY

|                  |   |
|------------------|---|
| <b>DDS</b>       | Director of Dental Services                       |
| <b>DDS</b>       | Dynamic Distribution System                       |
| <b>DDTC</b>      | Deployed Digital Training Campus                  |
| <b>DEA</b>       | Drug Enforcement Administration                   |
| <b>DEF</b>       | Deployment Expeditionary Force                    |
| <b>DEHS</b>      | Defense Enterprise Hiring Solution                |
| <b>DEIC</b>      | Defense Environmental International Cooperation   |
| <b>DELDP</b>     | Defense Executive Leadership Development Program  |
| <b>DENCOM</b>    | Dental Command                                    |
| <b>DENTAC</b>    | Dental Activity                                   |
| <b>DEOMI</b>     | Defense Equal Opportunity Management Institute    |
| <b>DEPORD</b>    | Deployment Order                                  |
| <b>DEPSECDEF</b> | Deputy Secretary of Defense                       |
| <b>DERA</b>      | Defense Environmental Restoration Account         |
| <b>DEROS</b>     | Date Eligible to Return from Overseas             |
| <b>DES</b>       | Directorate of Emergency Services                 |
| <b>DESMF</b>     | Defense Enterprise Service Management Framework   |
| <b>DEST</b>      | Domestic Emergency Support Team (FBI)             |
| <b>DET</b>       | Displaced Equipment Training                      |
| <b>DFARS</b>     | Defense Federal Acquisition Regulation Supplement |
| <b>DFAS</b>      | Defense Finance and Accounting Service            |
| <b>DFAS-IN</b>   | Defense Finance and Accounting Service-Indiana    |
| <b>DFBA</b>      | Defense Forensics and Biometrics Agency           |
| <b>DFE</b>       | Dynamic Force Employment                          |
| <b>DFM</b>       | Director of Force Management                      |
| <b>DFMWR</b>     | Director of Family, Morale, Welfare & Recreation  |
| <b>DFS</b>       | Dynamic Force Structure                           |
| <b>DG</b>        | Defense Guidance                                  |
| <b>DHA</b>       | Defense Health Agency                             |
| <b>DHHS</b>      | Department of Health and Human Services           |
| <b>DHP</b>       | Defense Health Program                            |
| <b>DHR</b>       | Director of Human Resources                       |
| <b>DHS</b>       | Director of Health Services                       |
| <b>DHS</b>       | Department of Homeland Security                   |
| <b>DI</b>        | Data Initiative                                   |
| <b>DI</b>        | Document Integrator                               |
| <b>DIA</b>       | Defense Intelligence Agency                       |
| <b>DIB</b>       | Defense Industrial Base                           |

## HOW THE ARMY RUNS

|                   |  |
|-------------------|--|
| <b>DICR</b>       | Doctrine, Organization, Training, Materiel, Leadership and Education, Personnel, Facilities, and Policy (DOTMLPF-P); Integrated Change Recommendation- Capabilities Recommendation |
| <b>DIEMS</b>      | Date Initially Entered Military Service  |
| <b>DIFS</b>       | Defense Integrated Financial System  |
| <b>DIMAS</b>      | Drilling IMAs  |
| <b>DINFOS</b>     | Defense Information School   |
| <b>DIRLAUTH</b>   | Direct Liason Authorized   |
| <b>DISA</b>       | Defense Information Systems Agency   |
| <b>DISCS</b>      | Defense Institute of Security Cooperation Studies  |
| <b>DISES</b>      | Defense Intelligence Senior Executive Service  |
| <b>DISL</b>       | Defense Intelligence Senior Level  |
| <b>DISR</b>       | DOD Information Technology Standards Registry  |
| <b>DIU</b>        | Defense Innovation Unit  |
| <b>DJ3</b>        | Director, J3   |
| <b>dL</b>         | Distributed Learning   |
| <b>dLC</b>        | Distance Learning Classrooms   |
| <b>dLS</b>        | Distance Learning System   |
| <b>DL</b>         | Distance Learning  |
| <b>DLA</b>        | Defense Logistics Agency   |
| <b>DLEA</b>       | Drug Law Enforcement Agency  |
| <b>DLIFLC</b>     | Defense Language Institute Foreign Language Center   |
| <b>DLMP</b>       | Doctrine and Literature Master Plan  |
| <b>DLS</b>        | Distributed Learning System  |
| <b>DMA</b>        | Defense Media Activity   |
| <b>DMAG</b>       | Deputy's Management Action Group   |
| <b>DMAT</b>       | Disaster Medical Assistance Team   |
| <b>DMC</b>        | Distribution Management Center   |
| <b>DMETL</b>      | Directed Mission Essential Task List   |
| <b>DML / DMSL</b> | Distribution Management Level / Sub-Level  |
| <b>DMLSS</b>      | Defense Medical Logistics Standard Support   |
| <b>DMO</b>        | Directed Military Overstrength   |
| <b>DMORT</b>      | Disaster Mortuary Operational Response Team  |
| <b>DMPM</b>       | Director of Manpower and Personnel Management  |
| <b>DMSS</b>       | Defense Medical Surveillance System  |
| <b>DMSSC</b>      | Defense Medical Systems Support Center   |
| <b>DOC</b>        | Department of Commerce   |
| <b>DOC DEV</b>    | Document Developer   |
| <b>DOD</b>        | Department of Defense  |
| <b>DOD (B)</b>    | Department of Defense Budget   |

## GLOSSARY

|                   |  |
|-------------------|--|
| <b>DODD</b>       | Department of Defense Directive  |
| <b>DoD-EC</b>     | Department of Defense-Expeditionary Civilians  |
| <b>DODI</b>       | Department of Defense Instruction  |
| <b>DODID</b>      | Department of Defense Identification Number  |
| <b>DODIN-A</b>    | Department of Defense Information Network  |
| <b>DOD IRD</b>    | Department of Defense Investigations and Resolutions Division  |
| <b>DODM</b>       | Department of Defense Manual   |
| <b>DOE</b>        | Department of Energy   |
| <b>DOI</b>        | Department of Interior   |
| <b>DOJ</b>        | Department of Justice  |
| <b>DOL</b>        | Directorates of Logistics  |
| <b>DOM</b>        | Directorate of Materiel  |
| <b>DOPMA</b>      | Defense Officer Personnel Management Act   |
| <b>DOR</b>        | Director of Resources (Force Development Directorate)  |
| <b>DOS</b>        | Department of State  |
| <b>DOT</b>        | Department of Transportation   |
| <b>DOT</b>        | Director of Training   |
| <b>DOT&amp;E</b>  | Director, Operational Test and Evaluation  |
| <b>DOTmLPPF-P</b> | Doctrine, Organization, Training, Leadership and Education, Personnel, Facilities, and Policy (Non-Materiel) |
| <b>DOTMLPPF-P</b> | Doctrine, Organization, Training, Materiel, Leadership and Education, Personnel, Facilities, and Policy      |
| <b>DPAE</b>       | Director of Program Analysis and Evaluation  |
| <b>DPAS</b>       | Defense Priorities and Allocations System  |
| <b>DPD</b>        | Defense Programming Database   |
| <b>DPG</b>        | Defense Planning Guidance  |
| <b>DPP</b>        | Dedicated Procurement Program  |
| <b>DPS</b>        | Defense Planning Scenarios   |
| <b>DPTMS</b>      | Directorate of Plans, Training, Mobilization and Security  |
| <b>DPW</b>        | Directorate of Public Works  |
| <b>DRB</b>        | Defense Resources Board  |
| <b>DRF</b>        | Disaster Relief Fund   |
| <b>DRMO</b>       | Defense Reutilization and Marketing Office   |
| <b>DRRS</b>       | Defense Readiness Reporting System   |
| <b>DRRS-A</b>     | Defense Readiness Reporting System-Army  |
| <b>DRRS-S</b>     | Defense Readiness Reporting System-Strategic   |
| <b>DRs</b>        | Directed Requirements  |
| <b>DRU</b>        | Direct Reporting Unit  |
| <b>DS</b>         | Direct Support   |
| <b>DSAMS</b>      | Defense Security Assistance Management System  |

## HOW THE ARMY RUNS

|                       |   |
|-----------------------|---|
| <b>DSAT</b>           | Department of Homeland Security (DHS) Situational Awareness Team      |
| <b>DSC</b>            | Dual Status Commanders  |
| <b>DSCA</b>           | Defense Security Cooperation Agency                                   |
| <b>DSCA</b>           | Defense Support of Civil Authorities                                  |
| <b>DSG</b>            | Defense Strategic Guidance  |
| <b>DSLDP</b>          | Defense Senior Leader Development Program                             |
| <b>DSMC</b>           | Defense Systems Management College                                    |
| <b>DSR</b>            | Defense Strategy Review (previously Quadrennial Defense Review (QDR)) |
| <b>DST</b>            | Decision Support Tool   |
| <b>DT</b>             | Developmental Test  |
| <b>DT&amp;E</b>       | Developmental Test and Evaluation                                     |
| <b>DTF</b>            | Digital Training Facility   |
| <b>DTG</b>            | Date Time Group   |
| <b>DTM</b>            | Directive –Type Memorandum  |
| <b>DTMS</b>           | Digital Training Management System                                    |
| <b>DTOE</b>           | Draft Table of Organization and Equipment                             |
| <b>DTOS</b>           | Deployable Tactical operations System                                 |
| <b>DTR</b>            | Defense Transportation Regulation                                     |
| <b>DTRA</b>           | Defense Threat Reduction Agency                                       |
| <b>DTS</b>            | Defense Transportation System   |
| <b>DTT</b>            | Doctrine and Tactics Training   |
| <b>DUIC</b>           | Derivative UIC's  |
| <b>DUSD(AS&amp;C)</b> | Deputy Under Secretary of Defense (Advanced Systems and Concepts)     |
| <b>DUSD(R&amp;T)</b>  | Deputy Undersecretary of Defense (Research and Technology)            |
| <b>DVA</b>            | Department of Veterans Affairs  |
| <b>DVIDS</b>          | Defense Video and Imagery Distribution System                         |
| <b>E2E</b>            | End to End  |
| <b>EA</b>             | Economic Analysis   |
| <b>EA</b>             | Executive Agent   |
| <b>EAB</b>            | Echelons Above Brigade  |
| <b>EAC</b>            | Echelons Above Corps  |
| <b>EAS</b>            | European Activity Set   |
| <b>EB</b>             | Executive Board   |
| <b>EBIS</b>           | Employee Benefits Information System                                  |
| <b>E&amp;C</b>        | Existence & Completeness  |
| <b>ECAS</b>           | Environmental Compliance Assessment System                            |
| <b>ECE</b>            | Enterprise Computing Environment                                      |
| <b>ECG</b>            | Enduring Constitutional Government                                    |
| <b>ECOP</b>           | Equipment Common Operating Picture                                    |

|                |   |
|----------------|---|
| <b>ECP</b>     | Engineering Change Proposal                                       |
| <b>ECQ</b>     | Executive Core Qualifications                                     |
| <b>EDA</b>     | Excess Defense Articles   |
| <b>EDAS</b>    | Enlisted Distribution and Assignment System                       |
| <b>EDATE</b>   | Effective Date  |
| <b>EDLP</b>    | Executive Leader Development Program                              |
| <b>EDM</b>     | Engineering Development Model                                     |
| <b>EDRE</b>    | Emergency Deployment Readiness Exercises                          |
| <b>EDTA</b>    | Early Deployer Time Phased Force Deployment Data (TPFDD) Analysis |
| <b>EDTM</b>    | Enlisted Distribution Target Model                                |
| <b>E-E</b>     | Emergency Essential   |
| <b>EEE</b>     | Emergency and Extraordinary Expenses                              |
| <b>EEOO</b>    | Equal Employment Opportunity Office                               |
| <b>EEO</b>     | Equal Employment Opportunity                                      |
| <b>EEOC</b>    | Equal Employment Opportunity Commission                           |
| <b>EEOC AJ</b> | Equal Employment Opportunity Commission Administrative Judge      |
| <b>EEOCCR</b>  | Equal Employment Opportunity Compliance and Complaints Review     |
| <b>EE PEG</b>  | Equipping (Program Evaluation Group (PEG))                        |
| <b>EES</b>     | Enlisted Evaluation System  |
| <b>efd</b>     | Enterprise Funds Distribution                                     |
| <b>EFMP</b>    | Exceptional Family Member Program                                 |
| <b>EFS</b>     | Enterprise Force Structure  |
| <b>EG</b>      | Enlisted Grade  |
| <b>EIEMA</b>   | Enterprise Information Environment Mission Area                   |
| <b>EIS</b>     | Enterprise Information System                                     |
| <b>EIS</b>     | Enterprise Infrastructure Services                                |
| <b>EL</b>      | Environmental Liability   |
| <b>ELC</b>     | Executive Leaders Course  |
| <b>EM</b>      | Enterprise Messaging  |
| <b>EMAC</b>    | Emergency Management Assistance Compact                           |
| <b>EMD</b>     | Engineering and Manufacturing Development                         |
| <b>EMDS</b>    | Enterprise Management Decision Support System                     |
| <b>EMG</b>     | Emergency Management Group  |
| <b>eMILPO</b>  | Electronic Military Personnel Office                              |
| <b>EMP</b>     | Emergency Management Program                                      |
| <b>EMS</b>     | Electromagnetic Spectrum  |
| <b>EMS</b>     | Emergency Medical Services  |
| <b>EMSO</b>    | Electromagnetic Spectrum Operations                               |
| <b>EO</b>      | Equal Opportunity   |

## HOW THE ARMY RUNS

|                |   |
|----------------|---|
| <b>EO</b>      | Executive Order   |
| <b>EOA</b>     | Equal Opportunity Advisor                                   |
| <b>EOC</b>     | Emergency Operation Center                                  |
| <b>EOD</b>     | Explosive Ordinance Disposal                                |
| <b>EOE</b>     | Equipment Organizational Element                            |
| <b>EOL</b>     | Equal Opportunity Leader                                    |
| <b>eOPF</b>    | Electronic Official Personnel Record- Folder                |
| <b>EOPM</b>    | Equal Opportunity Program Manager                           |
| <b>EOR</b>     | Element of Resource   |
| <b>EO WH</b>   | Executive Office White House                                |
| <b>EPA</b>     | Environmental Protection Agency                             |
| <b>EPA/ERT</b> | Environmental Protection Agency Environmental Response Team |
| <b>EPgMP</b>   | Enterprise Program Management Plan                          |
| <b>EPLO</b>    | Emergency Preparedness Liaison Officer                      |
| <b>EPMD</b>    | Enlisted Personnel Management Directorate                   |
| <b>EPMS</b>    | Enlisted Personnel Management System                        |
| <b>EPP</b>     | Extended Planning Period                                    |
| <b>EPW</b>     | Enemy Prisoners of War                                      |
| <b>EQ4</b>     | Equip the Force (AE2S)                                      |
| <b>ERB</b>     | Executive Resources Board                                   |
| <b>ERC</b>     | Equipment Readiness Code                                    |
| <b>ERDC</b>    | U.S. Army Engineer Research and Development Center          |
| <b>ERF</b>     | European Rotational Force                                   |
| <b>ERGO</b>    | Environmental Review Guide for Operations                   |
| <b>ERP</b>     | Enterprise Resource Planning                                |
| <b>ERT</b>     | Evidence Response Team (FBI)                                |
| <b>ES</b>      | Embedded Simulation   |
| <b>ES</b>      | End Strength  |
| <b>ES</b>      | Enlisted Specialty  |
| <b>ESC</b>     | Expeditionary Sustainment Command                           |
| <b>ESD</b>     | Equipment Sourcing Document                                 |
| <b>ESF</b>     | Emergency Support Function                                  |
| <b>ESGR</b>    | Employer Support of the Guard and Reserve                   |
| <b>ESLRG</b>   | Expanded Senior Leader Review Group                         |
| <b>ESP</b>     | Executive and Senior Professional                           |
| <b>ETC</b>     | Exportable Training Capability                              |
| <b>ETS</b>     | Expiration of Term of Service                               |
| <b>ETSS</b>    | Extended Training Service Specialists                       |
| <b>ETM</b>     | Enterprise Talent Management                                |

|                    |   |
|--------------------|---|
| <b>EUCOM</b>       | U.S. European Command                           |
| <b>EUSA</b>        | Eighth U.S. Army                                |
| <b>EW</b>          | Electronic Warfare                              |
| <b>EXCOM</b>       | Executive Committee                             |
| <b>EXORD</b>       | Execute Order                                   |
| <b>F2028&amp;B</b> | Force 2028 & Beyond                             |
| <b>FA</b>          | Functional Area                                 |
| <b>FA</b>          | Foundational Activity                           |
| <b>FA-TRAC</b>     | Foreign Army Training Assistance Command        |
| <b>FAA</b>         | Final Agency Action                             |
| <b>FAA</b>         | Foreign Assistance Act                          |
| <b>FAA</b>         | Functional Area Analysis                        |
| <b>FAD</b>         | Final Agency Decision                           |
| <b>FAD</b>         | Fund Authorization Document                     |
| <b>FADM</b>        | Force Allocation Decision Model                 |
| <b>FAR</b>         | Federal Acquisition Regulation                  |
| <b>FASCLASS</b>    | Fully Automated System for Classification       |
| <b>FBI</b>         | Federal Bureau of Investigation                 |
| <b>FC</b>          | Finance and Comptroller                         |
| <b>FC</b>          | Foundation Course                               |
| <b>FCB</b>         | Functional Capabilities Board                   |
| <b>FCC</b>         | Futures and Concepts Center                     |
| <b>FCCE</b>        | Flood Control and Coastal Emergencies           |
| <b>FCG</b>         | Facility Category Group                         |
| <b>FCO</b>         | Federal Coordinating Officer                    |
| <b>FCP</b>         | Functional Campaign Plan                        |
| <b>FD</b>          | Force Development                               |
| <b>FDA</b>         | Food and Drug Administration                    |
| <b>FDD</b>         | Force Design Division                           |
| <b>FDIIS</b>       | Force Development Investment Information System |
| <b>FDO</b>         | Flexible Deterrent Option                       |
| <b>FDT&amp;E</b>   | Force Development Tests and Experimentation     |
| <b>FDU</b>         | Force Design Update                             |
| <b>FEA</b>         | Front End Analysis                              |
| <b>FECA</b>        | Federal Employees Compensation Act              |
| <b>FEMA</b>        | Federal Emergency Management Agency             |
| <b>FFDB</b>        | Future Forces Database                          |
| <b>FFC</b>         | Fact Finding Conference                         |
| <b>FFE</b>         | Field Force Engineering                         |

## HOW THE ARMY RUNS

|                 |  |
|-----------------|--|
| <b>FFME</b>     | Future force Modernization Enterprise                      |
| <b>FFMIA</b>    | Federal Financial Management Improvement Act               |
| <b>FFR</b>      | Force Feasibility Review                                   |
| <b>FG</b>       | Fiscal Guidance  |
| <b>FHP</b>      | Force Health Protection                                    |
| <b>FI</b>       | Force Integrator   |
| <b>FIFA</b>     | Force Integration Functional Area                          |
| <b>FIG</b>      | Facilities Investment Guidance                             |
| <b>FIOPS</b>    | Federal Interagency Operational Plans                      |
| <b>FIRST</b>    | Federal Incident Response Support Team                     |
| <b>FIS</b>      | Facility Investment Strategy                               |
| <b>FISMA</b>    | Federal Information Security Act                           |
| <b>FLRA</b>     | Federal Labor Relations Authority                          |
| <b>FM</b>       | Field Manual   |
| <b>FM</b>       | Force Management   |
| <b>FM&amp;C</b> | Financial Management and Comptroller                       |
| <b>FMC</b>      | Financial Management Center                                |
| <b>FMCS</b>     | Federal Mediation and Conciliation Service                 |
| <b>FMF</b>      | Foreign Military Financing                                 |
| <b>FMFIA</b>    | Federal Manager's Financial Integrity Act                  |
| <b>FMID</b>     | Force Management Identifier                                |
| <b>FMR</b>      | Financial Management Regulation                            |
| <b>FMR</b>      | Force Management Review                                    |
| <b>FMR</b>      | Full Materiel Release                                      |
| <b>FMS</b>      | Force Management System                                    |
| <b>FMS</b>      | Foreign Military Sales                                     |
| <b>FMSWeb</b>   | Force Management System (FMS) Web                          |
| <b>FMT</b>      | Foreign Military Training                                  |
| <b>FMWR</b>     | Family and Morale, Welfare, and Recreation                 |
| <b>FMWRC</b>    | Family and Morale, Welfare, and Recreation Command         |
| <b>FNA</b>      | Functional Needs Analysis                                  |
| <b>FO</b>       | Financial Operations                                       |
| <b>FOA</b>      | Field Operating Agency                                     |
| <b>FOA</b>      | Forward Operational Assessment                             |
| <b>FOC</b>      | Force Operating Capabilities                               |
| <b>FOC</b>      | Full Operational Capability                                |
| <b>FOIA</b>     | Freedom of Information Act                                 |
| <b>FoJC</b>     | Family of Joint Concepts                                   |
| <b>FORMDEPS</b> | Forces Command Mobilization and Deployment Planning System |



## GLOSSARY

|                   |  |
|-------------------|--|
| <b>FORSCOM</b>    | U.S. Army Forces Command                               |
| <b>FoS</b>        | Family of Systems                                      |
| <b>FOT&amp;E</b>  | Follow-on Operational Test and Evaluation              |
| <b>FOUO</b>       | For Official Use Only                                  |
| <b>FP</b>         | Force Protection                                       |
| <b>FPMS</b>       | Flood Plain Management Services Program                |
| <b>FPPM</b>       | Functional Proponent for Preventive Medicine           |
| <b>FR</b>         | Functional Review                                      |
| <b>FRAGO</b>      | Fragmentary Orders                                     |
| <b>FRC</b>        | Federal Resource Coordinator                           |
| <b>FRCS</b>       | Facility Related Control System                        |
| <b>FRD</b>        | Facility Readiness Drivers                             |
| <b>FRP</b>        | Force Review Point                                     |
| <b>FRP</b>        | Full Rate Production                                   |
| <b>FS</b>         | Force Structure  |
| <b>FSA</b>        | Force Structure Allowance                              |
| <b>FSA</b>        | Functional Solution Analysis                           |
| <b>FSBP</b>       | First Sergeant's Barracks Program                      |
| <b>FSIP</b>       | Federal Service Impasses Panel                         |
| <b>FSM</b>        | Facility Sustainment Model                             |
| <b>FSRT</b>       | Fatality Search and Recovery Team                      |
| <b>FTNGD</b>      | Full Time National Guard Duty                          |
| <b>FTN</b>        | Force Tracking Number                                  |
| <b>FTS</b>        | Full Time Support                                      |
| <b>FTS TDA</b>    | Full Time Support Table of Distribution and Allowances |
| <b>FTX</b>        | Field Training Exercises                               |
| <b>FUDS</b>       | Formerly Used Defense Site                             |
| <b>FUE</b>        | First Unit Equipped                                    |
| <b>FUSRAP</b>     | Formerly Utilized Sites Remedial Action Program        |
| <b>FWS</b>        | Federal Wage System                                    |
| <b>FY</b>         | Fiscal Year  |
| <b>FYDP</b>       | Fiscal Year Defense Plan                               |
| <b>FYDP</b>       | Future Years Defense Program                           |
| <b>FYTP</b>       | Five-Year Test Program                                 |
| <b>G-3 / 7 FM</b> | G-37 Force Management                                  |
| <b>GAO</b>        | Government Accountability Office                       |
| <b>GAR</b>        | Governor's Authorized Representative                   |
| <b>GC</b>         | General Counsel  |
| <b>GC</b>         | Garrison Commander                                     |

## HOW THE ARMY RUNS

|               |   |
|---------------|---|
| <b>GCC</b>    | Geographic Combatant Commander                  |
| <b>GCP</b>    | Global Campaign Plan                            |
| <b>GCCS</b>   | Global Command and Control System               |
| <b>GCMCA</b>  | General Court Martial Convening Authority       |
| <b>GCS</b>    | Ground Combat Systems                           |
| <b>GCSS</b>   | Global Combat Support System                    |
| <b>GCSS-A</b> | Global Combat Support System Army               |
| <b>GCV</b>    | Ground Combat Vehicle                           |
| <b>GDF</b>    | Guidance for Development of the Force           |
| <b>GDP</b>    | Gross Domestic Product                          |
| <b>GDP</b>    | Global Defense Posture                          |
| <b>GDPRS</b>  | Global Defense Posture Realignment Strategy     |
| <b>GEF</b>    | Guidance for Employment of the Force            |
| <b>GF</b>     | Generating Force                                |
| <b>GFEBs</b>  | General Fund Enterprise Business System         |
| <b>GFIM</b>   | Global Force Information Management             |
| <b>GFm</b>    | Global Force Management                         |
| <b>GFMAP</b>  | Global Force Management Allocation Plan         |
| <b>GFMB</b>   | Global Force Management Board                   |
| <b>GFm-DI</b> | Global Force Management Database Initiative     |
| <b>GFmID</b>  | Global Force Management Identifier              |
| <b>GFmIG</b>  | Global Force Management Implementation Guidance |
| <b>GFT</b>    | Games for Training                              |
| <b>GIE</b>    | Global Information Environment                  |
| <b>GIG</b>    | Global Information Grid                         |
| <b>GIHS</b>   | Globally Integrated Health Services             |
| <b>GINA</b>   | Genetic Information Nondiscrimination Act       |
| <b>GIS</b>    | Geospatial Information System                   |
| <b>GIWW</b>   | Gulf Intracoastal Waterway                      |
| <b>GMRA</b>   | Government Management Reform Act                |
| <b>GO</b>     | General Officer                                 |
| <b>GO</b>     | General Order                                   |
| <b>GOCO</b>   | Government-Owned, Contractor-Operated           |
| <b>GOI</b>    | Government of Iraq                              |
| <b>GOMR</b>   | General Officer Mobilization Review             |
| <b>GOSC</b>   | General Officer Steering Committee              |
| <b>GPF</b>    | General Purpose Forces                          |
| <b>GPP</b>    | Graduate Placement Program                      |
| <b>GPRA</b>   | Government Performance and Results Act          |

## GLOSSARY

|                  |  |
|------------------|--|
| <b>GRB</b>       | Government & Retirements Benefits  |
| <b>GRD</b>       | Grade  |
| <b>GRF</b>       | Global Response Force  |
| <b>GS</b>        | General Schedule   |
| <b>GSA</b>       | General Services Administration  |
| <b>GSORTS</b>    | Global Status of Resources and Training System                                   |
| <b>HA</b>        | Humanitarian Assistance  |
| <b>HAAP</b>      | Homebase / Advanced Assignment Program   |
| <b>HAC</b>       | House Appropriations Committee   |
| <b>HAC-D</b>     | House Appropriations Committee-Defense   |
| <b>HASC</b>      | House Armed Services Committee   |
| <b>HCM</b>       | Human Capital Management   |
| <b>HD</b>        | Homeland Defense   |
| <b>HEAT</b>      | High-Mobility Multipurpose Wheeled Vehicle (HMMWV) Egress Assistance Trainer     |
| <b>HHA</b>       | Health Hazard Assessment   |
| <b>HHC / HHD</b> | Headquarters and Headquarters Company / Headquarters and Headquarters Detachment |
| <b>HHS</b>       | Health and Human Services  |
| <b>HIV</b>       | Human Immunodeficiency Virus   |
| <b>HLT</b>       | Hurricane Liaison Team   |
| <b>HMRU</b>      | Hazardous Material Response Unit (FBI)   |
| <b>HN</b>        | Host Nation  |
| <b>HNS</b>       | Host Nation Support  |
| <b>HP&amp;RR</b> | Health Promotion & Risk Reduction  |
| <b>HQ</b>        | Headquarters   |
| <b>HQDA</b>      | Headquarters, Department of the Army   |
| <b>HQE</b>       | Highly Qualified Expert  |
| <b>HQIIS</b>     | Headquarters Installation Information System                                     |
| <b>HQIMCOM</b>   | Headquarters, Installation Management Command                                    |
| <b>HHS</b>       | Department of Health and Human Services  |
| <b>HLT</b>       | Hurricane Liaison Team   |
| <b>HR</b>        | Human Resources  |
| <b>HRC</b>       | Human Resources Command  |
| <b>HRCoE</b>     | Health Readiness Center of Excellence  |
| <b>HRC-STL</b>   | Human Resources Command-St Louis   |
| <b>HRD</b>       | Human Resources Development  |
| <b>HRF</b>       | Homeland Response Force  |
| <b>HRM</b>       | Human Resource Management  |
| <b>HRSC</b>      | Human Resources Sustainment Center   |

## HOW THE ARMY RUNS

|                 |  |
|-----------------|--|
| <b>HRT</b>      | Hostage Rescue Team (FBI)                        |
| <b>HS</b>       | Homeland Security                                |
| <b>HSC</b>      | Homeland Security Council                        |
| <b>HSDRRS</b>   | Hurricane and Storm Damage Risk Reduction System |
| <b>HSI</b>      | Human Systems Integration                        |
| <b>HSPD</b>     | Homeland Security Presidential Directive         |
| <b>HSS</b>      | Health Service Support                           |
| <b>HTAR</b>     | How The Army Runs                                |
| <b>IA</b>       | Individual Account                               |
| <b>IA</b>       | Individual Augmentation                          |
| <b>IA</b>       | Information Assurance                            |
| <b>IAA</b>      | Interagency Agreement                            |
| <b>IADT</b>     | Initial Active Duty for Training                 |
| <b>IAEMP</b>    | Interagency Emergency Management Program         |
| <b>IAPM</b>     | Information Assurance Program Manager            |
| <b>IAs</b>      | Implementing Agencies                            |
| <b>IAW</b>      | In Accordance With                               |
| <b>IC</b>       | Incident Commander                               |
| <b>IC</b>       | Intermediate Course                              |
| <b>ICA</b>      | Industrial Capability Assessment                 |
| <b>ICAF</b>     | Industrial College of the Armed Forces           |
| <b>ICD</b>      | Initial Capabilities Document                    |
| <b>ICDT</b>     | Integrated Capabilities Development Team         |
| <b>ICE</b>      | Independent Cost Estimate                        |
| <b>ICO</b>      | Installation Contractor Office                   |
| <b>ICP</b>      | Integrated Contingency Plan                      |
| <b>ICP</b>      | Inventory Control Point                          |
| <b>ICPA</b>     | Injury Compensation Program Administrator        |
| <b>ICS</b>      | Incident Command System                          |
| <b>ICS</b>      | Injury Compensation Specialist                   |
| <b>ICS</b>      | Institutional Capability Sets                    |
| <b>ICT</b>      | Integrated Concept Team                          |
| <b>ICW</b>      | In Coordination With                             |
| <b>ICW</b>      | In Compliance With                               |
| <b>IDP</b>      | Individual Development Plan                      |
| <b>IDT</b>      | Inactive Duty Training                           |
| <b>IE</b>       | Information Environment                          |
| <b>IE</b>       | Integration Evaluation                           |
| <b>IE&amp;E</b> | Installations, Energy, and Environment           |

|                  |  |
|------------------|--|
| <b>IEMP</b>      | Integrated Emergency Management Plan           |
| <b>IES</b>       | Information Exchange Specifications            |
| <b>IET</b>       | Initial Entry Training                         |
| <b>IEW</b>       | Intelligence and Electronic Warfare            |
| <b>IEWS</b>      | Intelligence, Electronic Warfare and Sensors   |
| <b>IG</b>        | Inspector General                              |
| <b>IGI&amp;S</b> | Installation Geospatial Information & Services |
| <b>IGO</b>       | Intergovernmental Organization                 |
| <b>IGSA</b>      | Intergovernmental Support Agreement            |
| <b>II PEG</b>    | Installations (Program Evaluation Group (PEG)) |
| <b>IIQ</b>       | Initial Issue Quantity                         |
| <b>ILE</b>       | Intermediate Level Education                   |
| <b>ILO</b>       | In Lieu Of                                     |
| <b>ILS</b>       | Integrated Logistics Support                   |
| <b>ILSM</b>      | Integrated Logistic Support Manager            |
| <b>IM</b>        | Information Management                         |
| <b>IMA</b>       | Individual Mobilization Augmentee              |
| <b>IMA</b>       | Installation Management Agency                 |
| <b>IMAT</b>      | Incident Management Assistance Team            |
| <b>IMBOD</b>     | Installation Management Board of Directors     |
| <b>IMC</b>       | Installation Management Community              |
| <b>IMCOM</b>     | U.S. Army Installation Management Command      |
| <b>IMD</b>       | Integrated Missile Defense                     |
| <b>IMET</b>      | International Military Education and Training  |
| <b>IMI</b>       | Interactive Multimedia Instruction             |
| <b>IMO</b>       | Information Management Office                  |
| <b>IMS</b>       | Integrated Management System                   |
| <b>IMS</b>       | International Military Student                 |
| <b>IMSO</b>      | International Military Student Offices         |
| <b>IMT</b>       | Initial Military Training                      |
| <b>INDOPACOM</b> | U.S. Indo-Pacific Command                      |
| <b>INFOSEC</b>   | Information Security                           |
| <b>ING</b>       | Inactive National Guard                        |
| <b>INSCMD</b>    | Installation Commander                         |
| <b>INSCOM</b>    | U.S. Army Intelligence and Security Command    |
| <b>INSSUP</b>    | Installation Support                           |
| <b>IOC</b>       | Initial Operational Capability                 |
| <b>IOT</b>       | Initial Operational Test                       |
| <b>IOT&amp;E</b> | Initial Operational Testing and Evaluation     |

## HOW THE ARMY RUNS

|                 |  |
|-----------------|--|
| <b>IP</b>       | Individual Permit                              |
| <b>IP</b>       | Installation Preparedness                      |
| <b>IP</b>       | Issue Paper                                    |
| <b>IPA</b>      | Integrated Program Assessment                  |
| <b>IPL</b>      | Integrated Priority List                       |
| <b>IPM</b>      | Industrial Preparedness Measure                |
| <b>IPMO</b>     | Intelligence Personnel Management Office       |
| <b>IPP</b>      | Industrial Preparedness Planning               |
| <b>IPPL</b>     | Industrial Preparedness Planning List          |
| <b>IPPS-A</b>   | Integrated Personnel & Pay System              |
| <b>IPR</b>      | In-Process Review                              |
| <b>IPR-C</b>    | In-Process Review-Concept Development          |
| <b>IPR-F</b>    | In-Process Review-Plan Approval                |
| <b>IPRG</b>     | Intelligence Program Review Group              |
| <b>IPS</b>      | Integrated Product Support                     |
| <b>IPT</b>      | Integrated Process Team                        |
| <b>IPT</b>      | Integrated Product Team                        |
| <b>IPT</b>      | Integrated Planning Team                       |
| <b>IRA</b>      | Immediate Response Authority                   |
| <b>IRACO</b>    | Internal Review and Audit Compliance Office    |
| <b>IR&amp;D</b> | Independent Research and Development           |
| <b>IRBOD</b>    | Installation Readiness Board of Directors      |
| <b>IRC</b>      | Information-Related Capabilities               |
| <b>IRD</b>      | Investigation and Resolutions Division         |
| <b>IRMD</b>     | Information Resource Management Division       |
| <b>IRR</b>      | Individual Ready Reserve                       |
| <b>IS</b>       | Information System                             |
| <b>ISEW</b>     | Intelligence, Security, and Electronic Warfare |
| <b>ISO</b>      | Installation Safety Office                     |
| <b>ISP</b>      | Information Support Plan                       |
| <b>ISR</b>      | Installation Status Report                     |
| <b>ISR</b>      | Intelligence, Surveillance, and Reconnaissance |
| <b>ISR-MC</b>   | Installation Status Report- Mission Capacity   |
| <b>ISR-S</b>    | Installation Status Report- Services           |
| <b>ISS</b>      | Installation Service Standards                 |
| <b>ISS</b>      | Interagency and International Services         |
| <b>IT</b>       | Information Technology                         |
| <b>ITA</b>      | U.S. Army Information Technology Agency        |
| <b>ITAB</b>     | Information Technology Acquisition Board       |

|                  |  |
|------------------|--|
| <b>ITAPDB</b>    | Integrated Total Army Personnel Data Base                              |
| <b>ITAM</b>      | Integrated Training Area Management                                    |
| <b>ITE</b>       | Integrated Training Environment  |
| <b>ITM GOSC</b>  | Input to Training Management General Officers Steering Committee- GOSC |
| <b>ITMRA</b>     | Information Technology Management Reform Act of 1996                   |
| <b>ITO</b>       | Invitational Travel Order  |
| <b>ITOC</b>      | Information technology Oversight Council                               |
| <b>ITP</b>       | Individual Training Plan   |
| <b>ITR</b>       | Individual Training Record   |
| <b>ITRM</b>      | Individual Training Resource Module                                    |
| <b>ITSM</b>      | IT Service Management  |
| <b>ITTP</b>      | Institutional Training Technology Program                              |
| <b>ITU</b>       | International Telecommunications Union                                 |
| <b>ITV</b>       | In-Transit Visibility  |
| <b>IUID</b>      | Item Unique Identification   |
| <b>IUS</b>       | Internal Use Software  |
| <b>IW</b>        | Irregular Warfare  |
| <b>IWR</b>       | Institute for Water Resources  |
| <b>JAGC</b>      | Judge Advocate General's Corps   |
| <b>JAWS</b>      | Joint Advanced Warfighting School                                      |
| <b>JBIG</b>      | Joint Basing Implementation Guidance                                   |
| <b>JC</b>        | Joint Concept  |
| <b>JCA</b>       | Joint Capability Area  |
| <b>JCB</b>       | Joint Capabilities Board   |
| <b>JCCA</b>      | Joint Combat Capability Assessment                                     |
| <b>JCCAG</b>     | Joint Combat Capability Assessment Group                               |
| <b>JCCA-PA</b>   | Joint Combat Capability Assessment-Plan Assessment                     |
| <b>JCD</b>       | Joint Capabilities Division  |
| <b>JCD&amp;E</b> | Joint Concept Development and Experimentation                          |
| <b>JCIDS</b>     | Joint Capabilities Integration and Development System                  |
| <b>JCLL</b>      | Joint Center for Lessons Learned                                       |
| <b>JCRM</b>      | Joint Capabilities Requirements Manager                                |
| <b>JCS</b>       | Joint Chiefs of Staff  |
| <b>JCTD</b>      | Joint Capabilities Technology Demonstration                            |
| <b>JCWS</b>      | Joint and Combined Warfighting School                                  |
| <b>JDOMS</b>     | Joint Director of Military Support                                     |
| <b>JEON</b>      | Joint Emergent Operational Need  |
| <b>JFC</b>       | Joint Force Commander  |
| <b>JFCC IMD</b>  | Joint Functional Component Command for Integrated Missile Defense      |

## HOW THE ARMY RUNS

|                   |   |
|-------------------|---|
| <b>JFCC ISR</b>   | Joint Functional Component Command for Intelligence, Surveillance, and Reconnaissance (ISR) |
| <b>JFHQ</b>       | Joint Forces Headquarters   |
| <b>JFHQ-NCR</b>   | Joint Force Headquarters-National Capital Region  |
| <b>JFHQ-State</b> | Joint Forces Headquarters-State   |
| <b>JFLCC</b>      | Joint Forces Land Component Command   |
| <b>JFM</b>        | Joint Force Manager   |
| <b>JFO</b>        | Joint Field Office (FBI)  |
| <b>JFP</b>        | Joint Force Provider  |
| <b>JFRR</b>       | Joint Force Readiness Review  |
| <b>JFSC</b>       | Joint Forces Staff College  |
| <b>JIA</b>        | Joint Individual Augmentee  |
| <b>JIC</b>        | Joint Information Center  |
| <b>JICM</b>       | Joint Integrated Contingency Model  |
| <b>JIE</b>        | Joint Information Environment   |
| <b>JIEDDO</b>     | Joint Improvised Explosive Devices Defeat Organization                                      |
| <b>JIIM</b>       | Joint, Interagency, Intergovernmental, and Multinational                                    |
| <b>JLE</b>        | Joint Logistics Environment   |
| <b>JLE</b>        | Joint Logistics Estimate  |
| <b>JLLP</b>       | Joint Lessons Learned Program   |
| <b>JLTV</b>       | Joint Light Tactical Vehicle  |
| <b>JMC</b>        | Joint Modernization Command   |
| <b>JMC</b>        | Joint Munitions Command   |
| <b>JMD</b>        | Joint Manning Document  |
| <b>JMET</b>       | Joint Mission Essential Task  |
| <b>JMETL</b>      | Joint Mission Essential Task List   |
| <b>JM&amp;L</b>   | Joint Munitions and Lethality (Life Cycle Management Command (LCMC))                        |
| <b>JMIP</b>       | Joint Military Intelligence Program   |
| <b>JMNA</b>       | Joint Military Net Assessment   |
| <b>JMRC</b>       | Joint Multinational Readiness Center  |
| <b>JOA</b>        | Joint Operations Area   |
| <b>JOC</b>        | Joint Operations Center   |
| <b>JOC</b>        | Joint Operating Concepts  |
| <b>JOE</b>        | Joint Operating Environment   |
| <b>JOIN</b>       | Joint Optical Information System- Network   |
| <b>JOPEC</b>      | Joint Operational Contract Support Planning and Execution Course                            |
| <b>JOPES</b>      | Joint Operations Planning and Execution System  |
| <b>JOPP</b>       | Joint Operation Planning Process  |
| <b>JP</b>         | Joint Publication   |



## GLOSSARY

|                  |  |
|------------------|--|
| <b>JPAC</b>      | Joint Planning Augmentation Cell                                 |
| <b>JPE</b>       | Joint Personnel Estimate   |
| <b>JPEC</b>      | Joint Planning and Execution Community                           |
| <b>JPME</b>      | Joint Professional Military Education                            |
| <b>JPMRC</b>     | Joint Pacific Multinational Readiness Capability                 |
| <b>JPP</b>       | Joint Planning Process   |
| <b>JPR</b>       | Joint Performance Requirements                                   |
| <b>JRAC</b>      | Joint Rapid Acquisition Cell                                     |
| <b>JROC</b>      | Joint Requirements Oversight Council                             |
| <b>JROCM</b>     | Joint Requirements Oversight Council Memorandum                  |
| <b>JROTC</b>     | Junior Reserve Officer Training Corps                            |
| <b>JRP</b>       | Joint Reconciliation Program                                     |
| <b>JRTC</b>      | Joint Readiness Training Center                                  |
| <b>JS</b>        | Joint Staff  |
| <b>JSA</b>       | Joint Strategic Assessment                                       |
| <b>JSCP</b>      | Joint Strategic Campaign Plan                                    |
| <b>JSCP</b>      | Joint Strategic Capabilities Plan                                |
| <b>JSD</b>       | Joint Staffing Designator  |
| <b>JSIE</b>      | Joint Strategic Intelligence Estimate                            |
| <b>JSO</b>       | Joint Specialty Officer  |
| <b>JSOC</b>      | Joint Special Operations Command                                 |
| <b>JSOTF</b>     | Joint Special Operations Task Force                              |
| <b>JSPS</b>      | Joint Strategic Planning System                                  |
| <b>JSR</b>       | Joint Strategy Review  |
| <b>JST</b>       | Joint Service Transcript   |
| <b>JSWG</b>      | Joint Strategy Working Group                                     |
| <b>JTA</b>       | Joint Table of Authorizations                                    |
| <b>JTA / JTD</b> | Joint Table of Authorizations / Joint Table of Distribution      |
| <b>JTAPIC</b>    | Joint Trauma Analysis and Prevention of Injury in Combat Program |
| <b>JTF</b>       | Joint Task Force   |
| <b>JTF-CS</b>    | Joint Task Force-Civil Support                                   |
| <b>JTF-N</b>     | Joint Task Force-North   |
| <b>JTF-PO</b>    | Joint Task Force-Port Opening                                    |
| <b>JTRS</b>      | Joint Tactical Radio System                                      |
| <b>JULLS</b>     | Joint Universal Lessons Learned                                  |
| <b>JUON</b>      | Joint Urgent Operational Need                                    |
| <b>JWA</b>       | Joint Warfighting Assessments                                    |
| <b>JWE</b>       | Joint Warfighting Experiment                                     |
| <b>JWPS</b>      | Joint Worldwide Planners Seminar                                 |

## HOW THE ARMY RUNS

|                  |   |
|------------------|---|
| <b>JWSTAP</b>    | Joint Weapon Safety Technical Advisory Panel  |
| <b>KD</b>        | Key Developmental                             |
| <b>KDRO</b>      | Known Demand Readiness Objectives             |
| <b>KEES</b>      | Korean Enduring Equipment Set                 |
| <b>KFL</b>       | Key Facilities List                           |
| <b>KM / DS</b>   | Knowledge Management / Decision Support       |
| <b>KO</b>        | Contracting Officer                           |
| <b>KPP</b>       | Key Performance Parameter                     |
| <b>KSA</b>       | Key System Attribute                          |
| <b>LAD</b>       | Latest Arrival Date                           |
| <b>LAN</b>       | Local Area Network                            |
| <b>LAP</b>       | Logistic Assistance Program                   |
| <b>LC</b>        | Lead Component                                |
| <b>LCMC</b>      | Life Cycle Management Command                 |
| <b>LCSP</b>      | Life Cycle Sustainment Plan                   |
| <b>LEA</b>       | Law Enforcement Agency                        |
| <b>LEAD</b>      | Letterkenny Army Depot                        |
| <b>LEE</b>       | Low Employable Entity                         |
| <b>LFA</b>       | Lead Federal Agency                           |
| <b>LFT</b>       | Live First Testing                            |
| <b>LFT&amp;E</b> | Live Fire Test and Evaluation                 |
| <b>LHWCA</b>     | Longshore and Harbor Workers Compensation Act |
| <b>LIA</b>       | Logistics Innovation Agency                   |
| <b>LIC</b>       | Language Identification Code                  |
| <b>LIN</b>       | Line Item Number                              |
| <b>LIO</b>       | Limited Intervention Operations               |
| <b>LIRA</b>      | Long-Range Investment Requirements Analysis   |
| <b>LIW</b>       | Logistics Information Warehouse               |
| <b>LMER</b>      | Labor and Management Employee Relations       |
| <b>LMI</b>       | Lead Materiel Integrator                      |
| <b>LMI</b>       | Logistics Management Information              |
| <b>LMI</b>       | Lower Mekong Initiative                       |
| <b>LMP</b>       | Logistics Management Program                  |
| <b>LOA</b>       | Letter of Offer and Acceptance                |
| <b>LOB</b>       | Line of Business                              |
| <b>LOC</b>       | Lines of Communication                        |
| <b>LOD</b>       | Line of Duty                                  |
| <b>LOE</b>       | Line of Effort                                |
| <b>LOGCAP</b>    | Logistics Civil Augmentation Program          |

## GLOSSARY

|                 |   |
|-----------------|---|
| <b>LOGSA</b>    | Logistics Support Activity                        |
| <b>LOGSACS</b>  | Logistics Structure and Composition System        |
| <b>LOI</b>      | Letter of Instruction                             |
| <b>LOO</b>      | Line of Operation                                 |
| <b>LOR</b>      | Letter of Request                                 |
| <b>LRC</b>      | Logistics Readiness Centers                       |
| <b>LRIP</b>     | Low Rate Initial Production                       |
| <b>LSCO</b>     | Large-Scale Combat Operations                     |
| <b>LTC</b>      | Lieutenant Colonel                                |
| <b>LVC</b>      | Live, Virtual, Constructive                       |
| <b>LVCG</b>     | Live, Virtual, Constructive, and Gaming           |
| <b>LWN</b>      | LandWarNet  |
| <b>M&amp;S</b>  | Modeling and Simulation                           |
| <b>M2PR</b>     | Monthly Military Personnel Review                 |
| <b>MA</b>       | Mission Assignments                               |
| <b>MA</b>       | Mission Assurance                                 |
| <b>MA</b>       | Mortuary Affairs                                  |
| <b>MACA</b>     | Military Assistance to Civil Authorities          |
| <b>MACDIS</b>   | Military Assistance for Civil Disturbance         |
| <b>MACOM</b>    | Major Army Command                                |
| <b>MAIS</b>     | Major Automated Information System                |
| <b>MAISRC</b>   | Major Automated Information System Review Council |
| <b>MANPRINT</b> | Manpower and Personnel Integration                |
| <b>MAP</b>      | MTOE Assigned Personnel                           |
| <b>MARC</b>     | Manpower Requirements Criteria                    |
| <b>MAST</b>     | Military Assistance to Safety and Traffic         |
| <b>MATDEV</b>   | Materiel Developer                                |
| <b>MBI</b>      | Major Budget Issue                                |
| <b>MC</b>       | Medical Corps                                     |
| <b>MC</b>       | Mission Command                                   |
| <b>MC4</b>      | Medical Communications for Combat Casualty Care   |
| <b>MCA</b>      | Military Construction, Army                       |
| <b>MCAR</b>     | Military Construction, Army Reserve               |
| <b>MCASP</b>    | Mission Command Art and Sciences Program          |
| <b>MCC</b>      | Millennium Challenge Corporation                  |
| <b>MCD</b>      | Materiel Capabilities Document                    |
| <b>MCNG</b>     | Military Construction, Army National Guard        |
| <b>MCO</b>      | Major Combat Operations                           |
| <b>MCS</b>      | Managed Care Support                              |

## HOW THE ARMY RUNS

|                |   |
|----------------|---|
| <b>MCTC</b>    | Maneuver CTC  |
| <b>MCTP</b>    | Mission Command Training Program  |
| <b>MCTSP</b>   | Mission Command Training Support Program  |
| <b>MCU</b>     | Multiple Component Unit   |
| <b>MDA</b>     | Missile Defense Agency  |
| <b>MDA</b>     | Milestone Decision Authority  |
| <b>MDAP</b>    | Major Defense Acquisition Program   |
| <b>MDC</b>     | Manager Development Course  |
| <b>MDD</b>     | Materiel Development Decision   |
| <b>MDEP</b>    | Management Decision Evaluation Package  |
| <b>MdLC</b>    | Mobile Distance Learning Classroom  |
| <b>MDO</b>     | Multi- Domain Operations  |
| <b>MDR</b>     | Milestone Decision Review   |
| <b>MDW</b>     | Military District of Washington   |
| <b>ME</b>      | Materiel Enterprise   |
| <b>MEDCEN</b>  | Medical Center  |
| <b>MEDCoE</b>  | Medical Center of Excellence  |
| <b>MEDCOM</b>  | Medical Command   |
| <b>MEDDAC</b>  | Medical Department Activity   |
| <b>MEDLOG</b>  | Medical Logistics   |
| <b>MEF</b>     | Mission Essential Functions   |
| <b>MEO</b>     | Military Equal Opportunity  |
| <b>MEPCOM</b>  | Military Entrance Processing Command  |
| <b>MEPS</b>    | Military Entrance Processing Station  |
| <b>MER</b>     | Manpower Estimate Report  |
| <b>MER</b>     | Mission Essential Requirements  |
| <b>MERS</b>    | Mobile Emergency Response Support   |
| <b>MET</b>     | Mission Essential Task  |
| <b>METL</b>    | Mission Essential Task List   |
| <b>METT-TC</b> | Mission, Enemy, Terrain and Weather, Troops and Support Available, Time Available, and Civilians Considerations |
| <b>MFA</b>     | Materiel Fielding Agreement   |
| <b>MFE</b>     | Maneuver, Fires, and Effects  |
| <b>MFGI</b>    | Mobilization Force Generation Installation  |
| <b>MFORCE</b>  | Master Force  |
| <b>MFP</b>     | Materiel Fielding Plan  |
| <b>MFTB</b>    | Multifunctional Training Brigade  |
| <b>MHRM</b>    | Military Human Resource Management  |
| <b>MHS</b>     | Military Health System  |

## GLOSSARY

|                      |  |
|----------------------|--|
| <b>MIC</b>           | Managers Internal Control                          |
| <b>MICC</b>          | Mission and Installation Contracting Command       |
| <b>MID</b>           | Management Initiative Decisions                    |
| <b>MILCON</b>        | Military Construction                              |
| <b>MILDEP</b>        | Military Department                                |
| <b>MILDEP</b>        | Military Deputy                                    |
| <b>MILPER</b>        | Military Personnel                                 |
| <b>MILSPEC / STD</b> | Military Specifications and Standards              |
| <b>MILTECH</b>       | Military Technician                                |
| <b>MILVAX</b>        | Military Vaccine                                   |
| <b>MIP</b>           | Military Intelligence Program                      |
| <b>MIPS</b>          | Modified Integrated Program Summary                |
| <b>MLC</b>           | Master Leader Course                               |
| <b>MLMC</b>          | Medical Logistics Management Center                |
| <b>MM PEG</b>        | Manning (Program Evaluation Group (PEG))           |
| <b>MMDF</b>          | Maintenance Master Data File                       |
| <b>MMEWR</b>         | Minimum Mission Essential Wartime Requirement      |
| <b>MMG</b>           | Master Mobilization Guide                          |
| <b>MOA</b>           | Memorandum of Agreement                            |
| <b>MOB</b>           | Mobilization                                       |
| <b>MOB ARPRINT</b>   | Mobilization Army Program for Individual Training  |
| <b>MOBCOP</b>        | Mobilization Common Operating Picture              |
| <b>MOBMAN</b>        | Mobilization Manpower Planning System              |
| <b>MOBTDA</b>        | Mobilization Table of Distribution and Allowances  |
| <b>MOC</b>           | Media Operations Center                            |
| <b>MOCS</b>          | Military Occupational Classification and Structure |
| <b>MOD</b>           | Modernization                                      |
| <b>MOE</b>           | Measures of Effectiveness                          |
| <b>MOI</b>           | Memorandum of Instruction                          |
| <b>MOPP</b>          | Mission Oriented Protective Posture                |
| <b>MOS</b>           | Military Occupational Specialty                    |
| <b>MOS-T</b>         | Military Occupational Specialty Training           |
| <b>MOSLS</b>         | Military Occupational Specialty Level System       |
| <b>MOSQ</b>          | Military Occupational Specialty Qualification      |
| <b>MOU</b>           | Memorandum of Understanding                        |
| <b>MPA</b>           | Military Personnel, Army                           |
| <b>MPA</b>           | Military Personnel Appropriations                  |
| <b>MPAD</b>          | Mobile Public Affairs Detachment                   |
| <b>MPE</b>           | Mission Partner Environment                        |

## HOW THE ARMY RUNS

|                |  |
|----------------|--|
| <b>MPS</b>     | Mobilization Planning System                                   |
| <b>MPT</b>     | Manpower, Personnel, and Training                              |
| <b>MRAP</b>    | Mine Resistant Ambush Protected                                |
| <b>MRD</b>     | Material Requirements Document                                 |
| <b>MRE</b>     | Mission Rehearsal Exercises                                    |
| <b>MRL</b>     | Materiel Requirements List                                     |
| <b>MRMC</b>    | Medical Research and Material Command                          |
| <b>MRO</b>     | Maintenance, Repair, and Overhaul                              |
| <b>MRP</b>     | Material Requirements Planning                                 |
| <b>MRX</b>     | Mission Readiness Exercises                                    |
| <b>MS</b>      | Milestone  |
| <b>MSA</b>     | Materiel Solution Analysis                                     |
| <b>MSC</b>     | Military Sealift Command                                       |
| <b>MSC</b>     | Medical Service Corps  |
| <b>MSC</b>     | Major Subordinate Command                                      |
| <b>MSCLEA</b>  | Military Support to Civil Law Enforcement Agencies             |
| <b>MSF</b>     | Mobilization Support Force                                     |
| <b>MSFD</b>    | Multi-Service Force Development                                |
| <b>MSLS</b>    | Multi-Service Launch System                                    |
| <b>MSO</b>     | Military Service Obligation                                    |
| <b>MSP</b>     | Mission Support Plan   |
| <b>MSPB</b>    | Merit Systems Protection Board                                 |
| <b>MSU</b>     | Mobilization Support Unit                                      |
| <b>MTA</b>     | Middle -Tier Acquisition                                       |
| <b>MTBF</b>    | Mean Time Between Failure                                      |
| <b>MTF</b>     | Military Treatment Facility                                    |
| <b>MTOE</b>    | Modified Table of Organization and Equipment                   |
| <b>MTP</b>     | Master Training Plan   |
| <b>MTP</b>     | Mission Training Plan  |
| <b>MTT</b>     | Mobile Training Team   |
| <b>MUA</b>     | Military Utility Assessment                                    |
| <b>MUTA</b>    | Multiple Unit Training Assembly                                |
| <b>MUTA-4</b>  | Multiple Unit Training Assemblies-Four Consecutive Assemblies) |
| <b>MWR</b>     | Morale, Welfare, and Recreation                                |
| <b>MWR BOD</b> | Morale, Welfare, and Recreation Board of Directors             |
| <b>MYR</b>     | Mid-Year Review  |
| <b>NAF</b>     | Non-Appropriated Funds   |
| <b>NAFI</b>    | Non-Appropriated Funds Instrumentality                         |
| <b>NAP</b>     | Not Authorized Prepositioning                                  |

## GLOSSARY

|               |   |
|---------------|---|
| <b>NASA</b>   | National Aeronautics and Space Administration           |
| <b>NATO</b>   | North Atlantic Treaty Organization                      |
| <b>NAVSUP</b> | Naval Supply Systems Command                            |
| <b>NC</b>     | Nurse Corps   |
| <b>NCA</b>    | National Command Authority                              |
| <b>NCE</b>    | Non-Combat Essential                                    |
| <b>N-CFT</b>  | Network Cross Functional Team                           |
| <b>NCMP</b>   | Navy Capabilities and Mobilization Plan                 |
| <b>NCO</b>    | Noncommissioned Officer                                 |
| <b>NCOA</b>   | Noncommissioned Officer Academy                         |
| <b>NCOER</b>  | Noncommissioned Officer Evaluation Report               |
| <b>NCOES</b>  | Noncommissioned Officer Education System                |
| <b>NCOPDS</b> | Noncommissioned Officer Professional Development System |
| <b>NCR</b>    | National Capital Region                                 |
| <b>NCS</b>    | Network Capability Sets                                 |
| <b>NCs</b>    | Non-Recurring Costs                                     |
| <b>NDAA</b>   | National Defense Authorization Act                      |
| <b>NDI</b>    | Non-Developmental Item                                  |
| <b>NDMS</b>   | National Disaster Medical System                        |
| <b>NDS</b>    | National Defense Strategy                               |
| <b>NDS</b>    | National Defense Stockpile                              |
| <b>NEC</b>    | Network Enterprise Center                               |
| <b>NEO</b>    | Non-Combatant Evacuation Operations                     |
| <b>NEP</b>    | National Exercise Program                               |
| <b>NEPA</b>   | National Environmental Policy Act of 1969               |
| <b>NEST</b>   | Nuclear Emergency Support Team                          |
| <b>NET</b>    | New Equipment Training                                  |
| <b>NETCOM</b> | Network Enterprise Technology Command                   |
| <b>NETP</b>   | New Equipment Training Plan                             |
| <b>NETT</b>   | New Equipment Training Team                             |
| <b>NetUSR</b> | Net-Centric Unit Status Report                          |
| <b>NFIP</b>   | National Flood Insurance Program                        |
| <b>NFIP</b>   | National Foreign Intelligence Program                   |
| <b>NGB</b>    | National Guard Bureau                                   |
| <b>NGO</b>    | Nongovernmental Organization                            |
| <b>NGPA</b>   | National Guard Pay Appropriation                        |
| <b>NGPA</b>   | National Guard Personnel, Army                          |
| <b>NGREA</b>  | National Guard and Reserve Equipment Appropriation      |
| <b>NGRER</b>  | National Guard and Reserve Equipment Report             |

## HOW THE ARMY RUNS

|                 |   |
|-----------------|---|
| <b>NGS</b>      | Non-Government Standards                                |
| <b>NIE</b>      | Network Integration Evaluation                          |
| <b>NIFC</b>     | National Interagency Fire Center                        |
| <b>NIMS</b>     | National Incident Management System                     |
| <b>NIPRNET</b>  | Non-Classified Internet Protocol Router Network         |
| <b>NIR</b>      | Network Integration Rehearsal                           |
| <b>NIRT</b>     | Nuclear Incident Response Team                          |
| <b>NIST</b>     | National Institute of Standards and Technology          |
| <b>NMA-GOSC</b> | Network Mission Area General Officer Steering Committee |
| <b>NMRTS</b>    | National Medical Response Teams                         |
| <b>NMS</b>      | National Military Strategy                              |
| <b>NMUSA</b>    | National Museum of the U.S. Army                        |
| <b>NNSA</b>     | National Nuclear Security Administration                |
| <b>NOAA</b>     | National Oceanic and Atmospheric Administration         |
| <b>NOC</b>      | National Operations Center                              |
| <b>NOF</b>      | Notional Force  |
| <b>NOFC</b>     | Notification of Future Change                           |
| <b>NOK</b>      | Next of Kin   |
| <b>NORTHCOM</b> | Northern Command  |
| <b>NP</b>       | Neuropsychiatric  |
| <b>NPG</b>      | National Preparedness Goal                              |
| <b>NPR</b>      | Nuclear Posture Review                                  |
| <b>NPS</b>      | Non-Prior Service                                       |
| <b>NRC</b>      | Nuclear Regulatory Commission                           |
| <b>NRCC</b>     | National Response Coordination Center                   |
| <b>NR-KPP</b>   | Net-Ready Key Performance Parameter                     |
| <b>NRF</b>      | National Response Framework                             |
| <b>NRF</b>      | NATO Response Force                                     |
| <b>NRP</b>      | National Response Plan                                  |
| <b>NSA</b>      | National Security Agency                                |
| <b>NSC</b>      | National Security Council                               |
| <b>NSCS</b>     | National Security Council System                        |
| <b>NSDD</b>     | National Security Decision Directive                    |
| <b>NS-E</b>     | Non-Standard Equipment                                  |
| <b>NSHS</b>     | National Strategy for Homeland Security                 |
| <b>NSN</b>      | National Stock Number                                   |
| <b>NSPM</b>     | National Security Presidential Memorandums              |
| <b>NSPS</b>     | National Security Personnel System                      |
| <b>NSS</b>      | National Security Strategy                              |



|                         |  |
|-------------------------|--|
| <b>NSS</b>              | National Security System   |
| <b>NSSE</b>             | National Special Security Event  |
| <b>NSTD</b>             | Non-Standard Training Aids, Devices, Simulations and Simulators                      |
| <b>NTC</b>              | National Training Center   |
| <b>NTV</b>              | Non-Tactical Vehicle   |
| <b>NULO</b>             | Negative Unliquidated Obligations  |
| <b>NVOAD</b>            | National Voluntary Organizations Active in Disaster                                  |
| <b>O / H</b>            | On-Hand  |
| <b>O / M</b>            | Operator and Maintainer  |
| <b>O&amp;M</b>          | Operations and Maintenance   |
| <b>O&amp;M(R&amp;M)</b> | Operations and Maintenance (Restoration and Modernization)                           |
| <b>O&amp;O</b>          | Operational and Organizational   |
| <b>O&amp;R</b>          | Oversight and Review   |
| <b>O&amp;S</b>          | Operations and Support   |
| <b>OA</b>               | Officer Aggregate  |
| <b>OA</b>               | Obligational Authority   |
| <b>OA</b>               | Operating Agency   |
| <b>OA</b>               | Operational Architecture   |
| <b>OA</b>               | Operational Availability   |
| <b>OAA</b>              | Office of the Administrative Assistant   |
| <b>OACSIM</b>           | Office of the Assistant Chief of Staff for Installation Management                   |
| <b>OASA(FM&amp;C)</b>   | Office of the Assistant Secretary of the Army for Financial Management & Comptroller |
| <b>OASD</b>             | Office of the Assistant Secretary of Defense   |
| <b>OBT</b>              | Office of Business Transformation  |
| <b>OCAR</b>             | Office of the Chief, Army Reserve  |
| <b>OCE</b>              | Office of the Chief of Engineers   |
| <b>OCLL</b>             | Office, Chief of Legislative Liaison   |
| <b>OCO</b>              | Offensive Cyberspace Operations  |
| <b>OCO</b>              | Overseas Contingency Operations  |
| <b>OCONUS</b>           | Outside of the Continental U.S.  |
| <b>OCPA</b>             | Office of the Chief of Public Affairs  |
| <b>OCS</b>              | Officer Candidate School   |
| <b>OCS</b>              | Operational Capability Sets  |
| <b>OCS</b>              | Operational Contract Support   |
| <b>ODCS</b>             | Office of Deputy Chief of Staff  |
| <b>ODP</b>              | Officer Distribution Plan  |
| <b>ODS</b>              | Officer Development System   |
| <b>ODS</b>              | Officer Distribution System  |
| <b>ODT</b>              | Overseas Deployment Training   |

## HOW THE ARMY RUNS

|                 |   |
|-----------------|---|
| <b>OE</b>       | Objective Environment                           |
| <b>OE</b>       | Operational Energy                              |
| <b>OE</b>       | Operational Environment                         |
| <b>OE</b>       | Organizational Element                          |
| <b>OEF</b>      | Operation Enduring Freedom                      |
| <b>OER</b>      | Officer Evaluation Report                       |
| <b>OES</b>      | Officer Education System                        |
| <b>OES</b>      | Office of Emergency Services                    |
| <b>OF</b>       | Operating Force                                 |
| <b>OFM</b>      | Officer Forecasting Model                       |
| <b>OFO</b>      | Office of Federal Operations                    |
| <b>OFSC</b>     | Organizational Force Structure Construct        |
| <b>OGA</b>      | Other Government Agency                         |
| <b>OGLA</b>     | Officer Grade Limitation Act                    |
| <b>OI</b>       | Organizational Integrator                       |
| <b>OIF</b>      | Operation Iraqi Freedom                         |
| <b>OIPT</b>     | Overarching Integrated Product Team             |
| <b>OJT</b>      | On-the-Job Training                             |
| <b>OMA</b>      | Operations and Maintenance, Army                |
| <b>OMAR</b>     | Operations and Maintenance, Army Reserve        |
| <b>OMB</b>      | Office of Management and Budget                 |
| <b>OMNG</b>     | Operations and Maintenance, Army National Guard |
| <b>OMS / MP</b> | Operational Mode Summary / Mission Profiles     |
| <b>OneSAF</b>   | One Semi-Automated Forces                       |
| <b>ONN</b>      | Operational Network Node                        |
| <b>ONS</b>      | Operational Needs Statement                     |
| <b>OO PEG</b>   | Organizing (Program Evaluation Group (PEG))     |
| <b>OOC</b>      | Out-of-Cycle                                    |
| <b>OPA</b>      | Officer Personnel Act                           |
| <b>OPA</b>      | Other Procurement, Army                         |
| <b>OPCON</b>    | Operational Control                             |
| <b>OPFOR</b>    | Opposing Forces                                 |
| <b>OPLAN</b>    | Operations Plan                                 |
| <b>OPLOC</b>    | Operating Location                              |
| <b>OPM</b>      | Office of Personnel Management                  |
| <b>OPMD</b>     | Officer Personnel Management Directorate        |
| <b>OPMEP</b>    | Officer Professional Military Education Policy  |
| <b>OPMG</b>     | Office of the Provost Marshall General          |
| <b>OPMS</b>     | Officer Personnel Management System             |

## GLOSSARY

|                 |   |
|-----------------|---|
| <b>OPMS-AR</b>  | Officer Personnel Management System-Army Reserve  |
| <b>OPORD</b>    | Operation Order   |
| <b>OpSD</b>     | Operating Strength Deviation  |
| <b>OPSEC</b>    | Operational Security  |
| <b>OPS GRP</b>  | Operations Group  |
| <b>OPSTR</b>    | Operating Strength  |
| <b>OPTEMPO</b>  | Operating Tempo   |
| <b>ORDAB</b>    | Organizational Requirements Document Approval Briefing                                    |
| <b>ORG DB</b>   | Organization (Component of Total Army Personnel Database (TAPDB)) Organizational Database |
| <b>ORB</b>      | Officer Record Brief  |
| <b>OS</b>       | Operating Strength  |
| <b>OSA</b>      | Office of the Secretary of the Army   |
| <b>OSC</b>      | Office of Special Counsel   |
| <b>OSD</b>      | Office of the Secretary of Defense  |
| <b>OSUT</b>     | One Station Unit Training   |
| <b>OT</b>       | Operational Test  |
| <b>OT&amp;E</b> | Operational Test and Evaluation   |
| <b>OTA</b>      | Operational Test Agency   |
| <b>OTA</b>      | Other Transaction Authority   |
| <b>OTA TP</b>   | Operational Test Agency Test Plan   |
| <b>OTIG</b>     | Office of the Inspector General   |
| <b>OTJAG</b>    | Office of the Judge Advocate General  |
| <b>OTOE</b>     | Objective Table of Organization and Equipment   |
| <b>OTRA</b>     | Other than Regular Army   |
| <b>OTSG</b>     | Office of the Surgeon General   |
| <b>OID</b>      | Organization Unique Identifier  |
| <b>OUSD(C)</b>  | Office of the Under Secretary of Defense (Comptroller)                                    |
| <b>OV</b>       | Operational View  |
| <b>P3I</b>      | Preplanned Product Improvement  |
| <b>P&amp;D</b>  | Production and Deployment   |
| <b>P&amp;R</b>  | Personnel and Readiness   |
| <b>PA</b>       | Public Affairs  |
| <b>PA&amp;E</b> | Program Analysis and Evaluation   |
| <b>PAA</b>      | Procurement Ammunition Army   |
| <b>PAD</b>      | Public Affairs Detachment   |
| <b>PAED</b>     | Program Analysis and Evaluation Directorate   |
| <b>PAG</b>      | Public Affairs Guidance   |
| <b>PAIO</b>     | Plans, Analysis & Integration Office  |

## HOW THE ARMY RUNS

|                  |   |
|------------------|---|
| <b>PAL</b>       | Privatization of Army Lodging                                     |
| <b>PAO</b>       | Public Affairs Officer  |
| <b>PARD</b>      | Priorities Analysis and Requirements Directorate                  |
| <b>PAUC</b>      | Program Acquisition Unit Cost                                     |
| <b>PB</b>        | President's Budget  |
| <b>PBA</b>       | Performance-Based Agreements                                      |
| <b>PBA</b>       | Production Base Analysis  |
| <b>PBAC</b>      | Program Budget Advisory Committee                                 |
| <b>PBAS</b>      | Program Budget Accounting System                                  |
| <b>PBAT</b>      | Program Budget Assessment Team                                    |
| <b>PBD</b>       | Program Budget Decision   |
| <b>PBG</b>       | Program and Budget Guidance                                       |
| <b>PBL</b>       | Performance Based Logistics                                       |
| <b>PBR</b>       | Program Budget Review   |
| <b>PBUSE</b>     | Property Book Unit Supply Enhanced                                |
| <b>PC-ASORTS</b> | Personal Computer-Army Status of Resources and Training System    |
| <b>PCA</b>       | Posse Comitatus Act of 1878                                       |
| <b>PCC</b>       | Policy Coordination Committee                                     |
| <b>PCC</b>       | Pre-Command Course  |
| <b>PCH</b>       | Press Camp Headquarters   |
| <b>PCP</b>       | Program Change Proposals  |
| <b>PCS</b>       | Permanent Change of Station                                       |
| <b>PCTEF</b>     | Percent Effective   |
| <b>PD</b>        | Position Description  |
| <b>PD</b>        | Program Directive   |
| <b>PDASA</b>     | Principal Deputy Assistant Secretary of the Army                  |
| <b>PDD</b>       | Presidential Decision Directive                                   |
| <b>PDIP</b>      | Program Development Increment Package                             |
| <b>PDM</b>       | Program Decision Memorandum                                       |
| <b>PDR</b>       | Preliminary Design Review   |
| <b>PDR</b>       | Programming Data Requirements                                     |
| <b>PE</b>        | Program Element   |
| <b>PE/AS</b>     | PEG Executives / Appropriations Sponsors                          |
| <b>PEC</b>       | Protection Executive Committee                                    |
| <b>PED</b>       | Processing, Exploitation, and Dissemination                       |
| <b>PEG</b>       | Program Evaluation Group  |
| <b>PEO</b>       | Program Executive Officer   |
| <b>PEO EIS</b>   | Program Executive Office Enterprise Information Systems           |
| <b>PEO STRI</b>  | Program Executive Office Simulation, Training and Instrumentation |

## GLOSSARY

|                  |   |
|------------------|---|
| <b>PEPDUS</b>    | Human Resources Command (HRC) Enlisted Personnel Data Update System                             |
| <b>PERDB</b>     | Personnel (Component of Total Army Personnel Database (TAPDB))                                  |
| <b>PERMISS</b>   | Personnel Management Information and Support System   |
| <b>PERMS</b>     | Personnel Electronic Records Management System  |
| <b>PERNET</b>    | Personnel Network   |
| <b>PERSACS</b>   | Personnel Structure and Composition System  |
| <b>PERSO</b>     | Personnel System Staff Officer  |
| <b>PFA</b>       | Personnel Functional Assessment   |
| <b>PfM</b>       | Portfolio Management  |
| <b>PFO</b>       | Principal Federal Official  |
| <b>PfP</b>       | Partnership for Peace   |
| <b>PFY</b>       | Prior Fiscal Year   |
| <b>PH</b>        | Public Health   |
| <b>PHC</b>       | Public Health Command   |
| <b>PHCR</b>      | Public Health Command Region  |
| <b>PI</b>        | Product Improvements  |
| <b>PIANC-USA</b> | United States National Section of the World Association for Waterborne Transport Infrastructure |
| <b>PIM</b>       | Pre-Trained Individual Manpower   |
| <b>PIMS</b>      | Partnership for Peace (PfP) Information Management System                                       |
| <b>PKO</b>       | Peacekeeping Operations   |
| <b>PL</b>        | Public Law  |
| <b>PLANORD</b>   | Planning Order  |
| <b>PLL</b>       | Prescribed Load List  |
| <b>PM</b>        | Program, Project, or Product Manager  |
| <b>PMAD</b>      | Personnel Management Authorizations Document  |
| <b>PME</b>       | Professional Military Education   |
| <b>PME</b>       | Professional Military Exchange  |
| <b>PMF</b>       | Presidential Management Fellows   |
| <b>PMG</b>       | Provost Marshall General  |
| <b>PMJ</b>       | Professional Military Judgment  |
| <b>PMO</b>       | Program Management Office   |
| <b>PMS</b>       | Personnel Management System   |
| <b>POC</b>       | Point of Contact  |
| <b>POD</b>       | Point of Delivery   |
| <b>POD</b>       | Point of Debarkation  |
| <b>POE</b>       | Point of Embarkation  |
| <b>POE</b>       | Program Office Estimate   |
| <b>POI</b>       | Program of Instruction  |

## HOW THE ARMY RUNS

|                   |   |
|-------------------|---|
| <b>POL</b>        | Petroleum, Oils, Lubricants   |
| <b>POM</b>        | Program Objective Memorandum  |
| <b>POP</b>        | Proponency Office for Preventive Medicine   |
| <b>POR</b>        | Preparation for Overseas Replacement  |
| <b>POR</b>        | Program of Record   |
| <b>POSC-Edit</b>  | Personnel Occupational Specialty Code Edit  |
| <b>POSH</b>       | Prevention of Sexual Harassment   |
| <b>POTUS</b>      | President of the U.S.   |
| <b>PPAG</b>       | Proposed Public Affairs Guidance  |
| <b>PPB</b>        | Planning, Programming and Budget  |
| <b>PPBC</b>       | Planning Program Budget Committee   |
| <b>PPBE</b>       | Planning, Programming, Budgeting, and Execution                                     |
| <b>PPBES</b>      | Planning, Programming, Budgeting, and Executing System                              |
| <b>PPBS</b>       | Planning, Programming, and Budgeting System   |
| <b>PPD</b>        | Presidential Policy Directive   |
| <b>PPP</b>        | Power Projection Platforms  |
| <b>PPP</b>        | Public-Private Partnering   |
| <b>PPV</b>        | Public Private Ventures   |
| <b>PQT</b>        | Production Qualification Test   |
| <b>PR</b>         | Program Review  |
| <b>PRC</b>        | Presidential Reserve Call-Up  |
| <b>PREPO</b>      | Pre-Positioned  |
| <b>PRESBUD</b>    | President's Budget  |
| <b>PRG</b>        | Program Review Group  |
| <b>PROC</b>       | Procurement   |
| <b>PROC\$</b>     | Procurement Dollars   |
| <b>PROBE</b>      | Program Optimization and Budget Evaluation  |
| <b>PROFIS</b>     | Professional Filler Information System  |
| <b>PSA</b>        | Principal Staff Assistant   |
| <b>PSAC</b>       | PPBE Strategic Automation Committee   |
| <b>PSMA</b>       | Pre-Scripted Mission Assignment   |
| <b>PSMIPT</b>     | Product Support Management Integrated Process Team                                  |
| <b>PSP</b>        | Power Support Platforms   |
| <b>P, S, R, T</b> | Personnel, Equipment & Supplies, Equipment readiness/Serviceability, Unit Training  |
| <b>PSS</b>        | Product Support Strategy  |
| <b>PTA</b>        | Purpose-Time-Account  |
| <b>PURE</b>       | Prepositioning Of Materiel Configured in Unit Sets (POMCUS) Unit Residual Equipment |
| <b>PX</b>         | Post Exchange   |
| <b>PY</b>         | Prior Year  |

## GLOSSARY

|                |   |
|----------------|---|
| <b>PY</b>      | Program Year  |
| <b>QA</b>      | Quality Assurance   |
| <b>QAO</b>     | Quality Assurance Office  |
| <b>QDR</b>     | Quadrennial Defense Review (renamed Defense Strategic Review (DSR)) |
| <b>QFR</b>     | Question for the Record   |
| <b>QRF</b>     | Quick Reaction Force  |
| <b>QMP</b>     | Qualitative Management Program                                      |
| <b>QRM</b>     | Quadrennial Roles and Missions Review                               |
| <b>QRRC</b>    | Quarterly Readiness Report to Congress                              |
| <b>QTY</b>     | Quantity  |
| <b>R2C</b>     | Ready and Resilient Campaign  |
| <b>R&amp;D</b> | Research and Development  |
| <b>RA</b>      | Readiness Assessment  |
| <b>RA</b>      | Regular Army  |
| <b>RAA</b>     | Rapid Acquisition Authority   |
| <b>RAD</b>     | Requirements and Assessment Division                                |
| <b>RAD</b>     | Research Area Directorates  |
| <b>RAF</b>     | Regionally Aligned Forces   |
| <b>RAID</b>    | Rapid Assessment and Initial Detection                              |
| <b>RAM</b>     | Reliability, Availability, and Maintainability                      |
| <b>RAP</b>     | Revised Approved Program  |
| <b>RAP-C</b>   | Requisition Allocation Plan-Continental U.S. (CONUS)                |
| <b>RAR</b>     | Rapid Acquisition Review  |
| <b>RAR</b>     | Rapid Action Revision   |
| <b>RC</b>      | Reserve Component   |
| <b>RC</b>      | Required Capabilities   |
| <b>RCAS</b>    | Reserve Component Automation System                                 |
| <b>RCCC</b>    | Reserve Component Coordination Council                              |
| <b>RCI</b>     | Residential Communities Initiative                                  |
| <b>RCP</b>     | Regional Campaign Plans   |
| <b>RCP</b>     | Retention Control Point   |
| <b>RCSOF</b>   | Reserve Component Special Operations Forces                         |
| <b>RCTID</b>   | Reserve Component Training Integration Directorate                  |
| <b>RD</b>      | Readiness Division  |
| <b>RD</b>      | Region Director   |
| <b>RDA</b>     | Readiness Deficiency Assessment                                     |
| <b>RDA</b>     | Research, Development, and Acquisition                              |
| <b>RDAP</b>    | Research, Development, and Acquisition Plan                         |
| <b>RDC</b>     | Rapid Deployment Capability   |

## HOW THE ARMY RUNS

|                  |  |
|------------------|--|
| <b>RDC</b>       | Regional Dental Commands   |
| <b>RDD</b>       | Radiological Disperse Device                                     |
| <b>RDD</b>       | Resource Decision Documents                                      |
| <b>RDECOM</b>    | Research, Development, and Engineering Command                   |
| <b>RDL</b>       | Reimer Digital Library   |
| <b>RDS</b>       | Requirements Documentation System                                |
| <b>RDT&amp;E</b> | Research, Development, Test, and Evaluation                      |
| <b>RECBASS</b>   | Reception Battalion Automated Support System                     |
| <b>REF</b>       | Rapid Equipping Force  |
| <b>REIMC</b>     | Reimbursable Command   |
| <b>REIMS</b>     | Reimbursable Source  |
| <b>REP-63</b>    | Reserve Enlistment Program of 1963                               |
| <b>REPLO</b>     | Regional Emergency Preparedness Liaison Officer                  |
| <b>REQDB</b>     | Requisition (Component of Total Army Personnel Database (TAPDB)) |
| <b>REQUEST</b>   | Recruit Quota Enlistment System                                  |
| <b>RERT</b>      | Radiological Emergency Response Team                             |
| <b>RETAIN</b>    | Reenlistment/Reclassification System                             |
| <b>RFA</b>       | Request for Assistance   |
| <b>RFC</b>       | Request for Capabilities   |
| <b>RFF</b>       | Request for Forces   |
| <b>RFG</b>       | Resource Formulation Guide                                       |
| <b>RFFID</b>     | Request for Forces (RFF) Identification Number                   |
| <b>RFP</b>       | Request for Proposal   |
| <b>RFPB</b>      | Reserve Forces Policy Board                                      |
| <b>RFTA</b>      | Reserve Force Training Areas                                     |
| <b>RHC</b>       | Regional Health Command  |
| <b>RHC-A</b>     | Regional Health Command-Atlantic                                 |
| <b>RHC-C</b>     | Regional Health Command-Central                                  |
| <b>RHC-E</b>     | Regional Health Command-Europe                                   |
| <b>RHC-P</b>     | Regional Health Command-Pacific                                  |
| <b>RI</b>        | Resource Integrator  |
| <b>RIA</b>       | Rock Island Arsenal  |
| <b>RID</b>       | Requirements Integration Directorate                             |
| <b>RIF</b>       | Reduction in Force   |
| <b>RISMS</b>     | Requirements Integration Synchronization Meetings                |
| <b>RISO</b>      | Requirements Integration Staff Officer                           |
| <b>RMC</b>       | Regional Medical Command   |
| <b>RMD</b>       | Resource Management Decision                                     |
| <b>RMD</b>       | Requirements Management Division                                 |



## GLOSSARY

|                |   |
|----------------|---|
| <b>RMF</b>     | Risk Management Framework                           |
| <b>RMG</b>     | Readiness Management Group                          |
| <b>RMO</b>     | Resource Management Office                          |
| <b>RO</b>      | Readiness Objectives                                |
| <b>ROA</b>     | Rules of Allocation                                 |
| <b>ROC</b>     | Rehearsal of Concept                                |
| <b>ROE</b>     | Rules of Engagement                                 |
| <b>ROI</b>     | Report of Investigation                             |
| <b>ROMO</b>    | Range of Military Operations                        |
| <b>ROPMA</b>   | Reserve Officer Personnel Management Act            |
| <b>ROTC</b>    | Reserve Officers' Training Corps                    |
| <b>RPA</b>     | U.S. Army Resources and Programs Agency             |
| <b>RPA</b>     | Reserve Personnel Appropriation                     |
| <b>RPA</b>     | Reserve Personnel, Army                             |
| <b>RPG</b>     | Rocket-Propelled Grenade                            |
| <b>RPLANS</b>  | Real Property Planning and Analysis System          |
| <b>RPUID</b>   | Real Property Unique Identifier                     |
| <b>RRAD</b>    | Red River Army Depot                                |
| <b>RRCC</b>    | Regional Response Coordination Center               |
| <b>RSC</b>     | Regional Support Command                            |
| <b>RSO</b>     | Religious Support Office                            |
| <b>RSO</b>     | Requirements Staff Officer                          |
| <b>RSO</b>     | Retirement Services Officer                         |
| <b>RSOI</b>    | Reception, Staging, Onward Movement and Integration |
| <b>RTLTP</b>   | Range and Training Land Program                     |
| <b>RTS-M</b>   | Regional Training Site-Maintenance                  |
| <b>RUDIST</b>  | REQUEST Unit Distribution Program                   |
| <b>RUF</b>     | Rules for the Use of Force                          |
| <b>S&amp;T</b> | Science and Technology                              |
| <b>SA</b>      | Secretary of the Army                               |
| <b>SA</b>      | Security Assistance                                 |
| <b>SA</b>      | Supportability Analysis                             |
| <b>SA</b>      | Systems Architecture                                |
| <b>SAAG</b>    | Auditor General of the Army                         |
| <b>SAC</b>     | Senate Appropriations Committee                     |
| <b>SAC</b>     | Special Agent in Charge (FBI)                       |
| <b>SAC</b>     | Strategic Air Command                               |
| <b>SAC-D</b>   | Senate Appropriations Committee- Defense            |
| <b>SACDB</b>   | Structure and Composition Database                  |

## HOW THE ARMY RUNS

|               |  |
|---------------|--|
| <b>SACEUR</b> | Supreme Allied Commander, Europe                       |
| <b>SACS</b>   | Structure and Composition System                       |
| <b>SAD</b>    | State Active Duty                                      |
| <b>SAE</b>    | Service Acquisition Executive                          |
| <b>SAG</b>    | Sub- Activity Groups                                   |
| <b>SAMAS</b>  | Structure and Manpower Allocation System               |
| <b>SAMD</b>   | Security Assistance Management Directorates            |
| <b>SAMM</b>   | Security Assistance Management Manual                  |
| <b>SAMS</b>   | School of Advanced Military Studies                    |
| <b>SANG</b>   | Saudi Arabian National Guard Modernization Program     |
| <b>SAP</b>    | Special Access Program                                 |
| <b>SAPBR</b>  | Security Assistance Program and Budget Review          |
| <b>SAPP</b>   | Security, Accuracy, Propriety, and Policy              |
| <b>SAPR</b>   | Sexual Assault Prevention Response                     |
| <b>SAR</b>    | Search and Rescue                                      |
| <b>SAR</b>    | Selected Acquisition Report                            |
| <b>SAS</b>    | Statistical Analysis Software                          |
| <b>SASC</b>   | Senate Armed Services Committee                        |
| <b>SAT</b>    | Systems Approach to Training                           |
| <b>SATCOM</b> | Satellite Communications                               |
| <b>SATD</b>   | Security Assistance Training Directorate               |
| <b>SATFA</b>  | Security Assistance Training Field Activity            |
| <b>SATP</b>   | Security Assistance Training Program                   |
| <b>SB</b>     | Supply Bulletin  |
| <b>SB</b>     | Sustainment Brigade                                    |
| <b>SBC</b>    | Service Based Costing                                  |
| <b>SBCT</b>   | Stryker Brigade Combat Team                            |
| <b>SBIR</b>   | Small Business Innovation Research                     |
| <b>SBP</b>    | Survivor Benefit Plan                                  |
| <b>SC</b>     | Security Cooperation                                   |
| <b>SC</b>     | Senior Commander                                       |
| <b>SCI</b>    | Sensitive Compartmented Information                    |
| <b>SCI</b>    | Service Culture Initiative                             |
| <b>SCO</b>    | Security Cooperation Organization                      |
| <b>SCO</b>    | State Coordinating Officer                             |
| <b>SCO</b>    | Strategic Capabilities Office                          |
| <b>SCoE</b>   | Sustainment Centers of Excellence                      |
| <b>SCRA</b>   | Service Members Civil Relief Act                       |
| <b>SCRAG</b>  | Senior Civilian Representative of the Attorney General |

## GLOSSARY

|                |  |
|----------------|--|
| <b>SDAP</b>    | Special Duty Assignment Pay                      |
| <b>SDC</b>     | Supervisor Development Course                    |
| <b>SDCS</b>    | Standard Data Collection System                  |
| <b>SDC-EX</b>  | Supervisor Development Course – Executive        |
| <b>SDDC</b>    | Surface Deployment and Distribution Command      |
| <b>SDOB</b>    | Secretary of Defense Orders Book                 |
| <b>SDT</b>     | Second Destination Transportation                |
| <b>SE</b>      | Systems Engineering                              |
| <b>SECARMY</b> | Secretary of the Army                            |
| <b>SECDEF</b>  | Secretary of Defense                             |
| <b>SEC DHS</b> | Secretary of Homeland Security                   |
| <b>SEHS</b>    | Special Events for Homeland Security             |
| <b>SEP</b>     | Systems Engineering Plan                         |
| <b>SEPLO</b>   | State Emergency Preparedness Liaison Officer     |
| <b>SERB</b>    | Selective Early Retirement Board                 |
| <b>SES</b>     | Senior Executive Service                         |
| <b>SETM</b>    | Senior Enterprise Talent Management              |
| <b>SFC</b>     | Sergeant First Class                             |
| <b>SfH</b>     | System for Health                                |
| <b>SFLEO</b>   | Senior Federal Law Enforcement Officer           |
| <b>SFL-TAP</b> | Soldier for Life – Transition Assistance Program |
| <b>SFO</b>     | Senior Federal Official                          |
| <b>SFRBOD</b>  | Soldier and Family Readiness Board of Directors  |
| <b>SG</b>      | Standards of Grade                               |
| <b>SGO</b>     | Standard Garrison Organization                   |
| <b>SGM</b>     | Sergeant Major                                   |
| <b>SGS</b>     | Strategic Guidance Statement                     |
| <b>SGT</b>     | Sergeant   |
| <b>SHARP</b>   | Sexual Harassment / Assault Response Prevention  |
| <b>SHCP</b>    | Strategic Human Capital Planning                 |
| <b>SHRM</b>    | Strategic Human Resource Management              |
| <b>SI</b>      | Skill Identifier                                 |
| <b>SI</b>      | System integrator                                |
| <b>SICE</b>    | Services & Infrastructure Core Enterprise        |
| <b>SIG</b>     | Senior Integration Group                         |
| <b>SIG</b>     | Strategic Initiatives Group                      |
| <b>SIGINT</b>  | Signals Intelligence                             |
| <b>SIMLM</b>   | Single Integrated Medical Logistics Manager      |
| <b>SIPRNet</b> | Secure Internet Protocol Router Network          |

## HOW THE ARMY RUNS

|                 |  |
|-----------------|--|
| <b>SIPT</b>     | Supportability Integrated Product Team   |
| <b>SISC</b>     | Support for International Sporting Competitions  |
| <b>SKA</b>      | Skills, Knowledge, and Attributes  |
| <b>SL</b>       | Senior Level   |
| <b>SLAMIS</b>   | Standard Study Number (SSN)-Line Item Number (LIN) Automated Management and Integrating System |
| <b>SLC</b>      | Senior Leaders Course  |
| <b>SLDA</b>     | Senior Leaders, Department of the Army   |
| <b>SLEP</b>     | Service Life Extension Program   |
| <b>SLRF</b>     | Senior Leader Readiness Forum  |
| <b>SLRG</b>     | Senior Leader Review Group   |
| <b>SLS</b>      | Senior Leader Seminar  |
| <b>SM</b>       | Soldier's Manual   |
| <b>SM</b>       | Spectrum Management  |
| <b>SMART</b>    | Special Medical Augmentation Response Team   |
| <b>SMC</b>      | Sergeants Major Course   |
| <b>SMCT</b>     | Soldier's Manual of Common Tasks   |
| <b>SMDC</b>     | Space and Missile Defense Command  |
| <b>SMDR</b>     | Structure and Manning Decision Review  |
| <b>SME</b>      | Subject Matter Expert  |
| <b>SMSP</b>     | Strategic Materials Security Program   |
| <b>SM / TG</b>  | Soldier's Manuals / Trainers Guides  |
| <b>SMU</b>      | Special Mission Unit   |
| <b>SNaP</b>     | Select and Native Programming  |
| <b>SOC</b>      | Special Operations Command   |
| <b>SOCOM</b>    | Special Operations Command   |
| <b>SOF</b>      | Special Operations Forces  |
| <b>SOFA</b>     | Status of Forces Agreement   |
| <b>SOP</b>      | Standard Operating Procedure   |
| <b>SORTS</b>    | Status of Resources Training System  |
| <b>SoS</b>      | System of Systems  |
| <b>SOUTHCOM</b> | U.S. Southern Command  |
| <b>SP</b>       | Army Medical Specialist Corps  |
| <b>SPAR</b>     | Strategic Portfolio Analysis and Review  |
| <b>SPOD</b>     | Seaport of Debarkation   |
| <b>SPP</b>      | State Partnership Program  |
| <b>SPR</b>      | Strategic Portfolio Reviews  |
| <b>SQI</b>      | Special Qualification Identifier   |
| <b>SR</b>       | Sustainable Readiness  |

## GLOSSARY

|                 |   |
|-----------------|---|
| <b>SR2R</b>     | Service Request to Resolution                       |
| <b>SRAG</b>     | Strategic Readiness Assessment Group                |
| <b>SRB</b>      | Selective Retention Board                           |
| <b>SRC</b>      | Standard Requirements Code                          |
| <b>SRCA</b>     | Service Retained Combatant Command Aligned          |
| <b>SRG</b>      | Senior Review Group                                 |
| <b>SRM</b>      | Sustainable Readiness Model                         |
| <b>SRM</b>      | Sustainment, Restoration and Modernization          |
| <b>SRO</b>      | System Readiness Objective                          |
| <b>SROC</b>     | Senior Readiness Oversight Council                  |
| <b>SRP</b>      | Soldier Readiness Process                           |
| <b>SRP</b>      | Sustainable Range Program                           |
| <b>SRP</b>      | Sustainable Readiness Process                       |
| <b>SRT</b>      | Strategic Readiness Tenet                           |
| <b>SRTRA</b>    | Short-Range Training Requirements Analysis          |
| <b>SRU</b>      | Strategic Readiness Update                          |
| <b>SRUF</b>     | Standing Rules for the Use of Force                 |
| <b>SS PEG</b>   | Sustaining (Program Evaluation Group (PEG))         |
| <b>SS</b>       | Supportability Strategy                             |
| <b>SSA</b>      | Source Selection Authority                          |
| <b>SSA</b>      | Staff Support Agency                                |
| <b>SSA</b>      | Support for Strategic Analysis                      |
| <b>SSA</b>      | System Safety Assessment                            |
| <b>SSC</b>      | Senior Service College                              |
| <b>SSC</b>      | Standard Service Costing                            |
| <b>SSD</b>      | Structured Self-Development                         |
| <b>SSG</b>      | Staff Sergeant                                      |
| <b>SSN</b>      | Standard Study Number                               |
| <b>SSO</b>      | Staff Synchronization Officer                       |
| <b>ST</b>       | Sustainment Training                                |
| <b>STANFINS</b> | Standard Financial System                           |
| <b>STAR</b>     | System Threat Assessment Report                     |
| <b>START</b>    | Scientific and Technical Advisory and Response Team |
| <b>STE</b>      | Synthetic Training Environment                      |
| <b>STO</b>      | Split Training Option                               |
| <b>STP</b>      | Short Term Project                                  |
| <b>STP</b>      | Soldier Training Publication                        |
| <b>STRAMS-E</b> | Student / Trainee Management System-Enlisted        |
| <b>STRAP</b>    | System Training Plan                                |

## HOW THE ARMY RUNS

|                  |   |
|------------------|---|
| <b>STRATCOM</b>  | U. S. Strategic Command   |
| <b>STRI</b>      | Simulation, Training and Instrumentation                            |
| <b>STSP</b>      | Soldier Training Support Program                                    |
| <b>STTR</b>      | Small Business Technology Transfer Pilot Program                    |
| <b>STX</b>       | Situational Training Exercises                                      |
| <b>SUT</b>       | System Under Testing  |
| <b>SVP</b>       | Special Visibility Program  |
| <b>SVTC</b>      | Secure Video Teleconference   |
| <b>SWANCC</b>    | Solid Waste Agency of Northern Cook County                          |
| <b>T&amp;E</b>   | Test and Evaluation   |
| <b>T&amp;EO</b>  | Training and Evaluation Outline                                     |
| <b>TAA</b>       | Total Army Analysis   |
| <b>TAC</b>       | Transportation Account Code   |
| <b>TACITS</b>    | Total Army Centralized Individual Training Solicitation             |
| <b>TACOM</b>     | U.S. Army Tank-Automotive and Armaments Command                     |
| <b>TACON</b>     | Tactical Control  |
| <b>TADSS</b>     | Training Aids, Devices, Simulators, and Simulations                 |
| <b>TAEDP</b>     | Total Army Equipment Distribution Program                           |
| <b>TAFT</b>      | Technical Assistance Field Teams                                    |
| <b>TAG</b>       | The Adjutant General  |
| <b>TAMIS</b>     | Total Ammunition Management Information System                      |
| <b>TAP</b>       | The Army Plan   |
| <b>TAPDB</b>     | Total Army Personnel Database                                       |
| <b>TAPDB-AE</b>  | Total Army Personnel Database-Active Enlisted                       |
| <b>TAPDB-AO</b>  | Total Army Personnel Database-Active Officer                        |
| <b>TAPDB-MOB</b> | Total Army Personnel Database-Mobilization                          |
| <b>TAPES</b>     | Total Army Performance Evaluation System                            |
| <b>TASS</b>      | The Army School System  |
| <b>TATS</b>      | The Army Training System  |
| <b>TAV</b>       | Total Asset Visibility  |
| <b>TBE</b>       | Training Base Expansion   |
| <b>TC</b>        | Training Command  |
| <b>TCA</b>       | Traditional COCOM Activities  |
| <b>TCM</b>       | U.S. Army Training and Doctrine Command (TRADOC) Capability Manager |
| <b>TC STD</b>    | Type Classification Standard  |
| <b>TD</b>        | Technology Demonstration  |
| <b>TD</b>        | Training Development  |
| <b>TDA</b>       | Table of Distribution and Allowances                                |
| <b>TDDC</b>      | Training and Doctrine Development Configuration                     |

## GLOSSARY

|                  |  |
|------------------|--|
| <b>TDDT</b>      | Training and Doctrine Development Tool                       |
| <b>TDS</b>       | Technology Development Strategy                              |
| <b>TDY</b>       | Temporary Duty   |
| <b>TE</b>        | Training Environment   |
| <b>TE&amp;PD</b> | Training Education and Professional Development              |
| <b>TEC</b>       | Theater Engineer Command                                     |
| <b>TECD</b>      | Technology-Enabled Capability Demonstration                  |
| <b>TEDP</b>      | Training and Education Development Process                   |
| <b>TEMP</b>      | Test and Evaluation Master Plan                              |
| <b>TEMPLET</b>   | Temporary Billet   |
| <b>TESC</b>      | Training Enterprise Scheduling Capability                    |
| <b>TEU</b>       | Technical Escort Unit  |
| <b>TF</b>        | Task Force   |
| <b>TFE</b>       | Tactical Field Exchange                                      |
| <b>TFER</b>      | Task Force for Emergency Readiness                           |
| <b>TFM</b>       | Training Feedback Module                                     |
| <b>TFT</b>       | Technical Field Test   |
| <b>TG</b>        | Training Guide   |
| <b>TGM</b>       | Technical Guidance Memorandum                                |
| <b>TGOSC</b>     | Training General Officer Steering Committee                  |
| <b>THP</b>       | TRICARE Health Plan  |
| <b>TIARA</b>     | Tactical Intelligence and Related Activities                 |
| <b>TID</b>       | Training Integration Directorate                             |
| <b>TIG</b>       | The Inspector General  |
| <b>TIG</b>       | Time in Grade  |
| <b>TII</b>       | Training Information Infrastructure                          |
| <b>TIM</b>       | Transformation of Installation Management                    |
| <b>TIS</b>       | Time in Service  |
| <b>TISO</b>      | Threat Integration Staff Officer                             |
| <b>TJAG</b>      | The Judge Advocate General                                   |
| <b>TJAGLCS</b>   | U.S. Army The Judge Advocate General Legal Center and School |
| <b>TJC</b>       | The Joint Commission   |
| <b>TLAMM</b>     | Theater Lead Agent for Medical Materiel                      |
| <b>TMA</b>       | Training Mission Area  |
| <b>TMA</b>       | TRICARE Management Activity                                  |
| <b>T-MASL</b>    | Training Military Articles and Service Listings              |
| <b>TMCA</b>      | Theater Movement Control Agency                              |
| <b>TMCA</b>      | Transportation Movement Control Agency                       |
| <b>TMD</b>       | Theater Missile Defense                                      |

## HOW THE ARMY RUNS

|                 |  |
|-----------------|--|
| <b>TMIP</b>     | Theater Medical Information Program  |
| <b>TMOPEs</b>   | U.S. Training and Doctrine Command (TRADOC) Mobilization and Operation Planning and Execution System |
| <b>TMRR</b>     | Technology Maturation & Risk Reduction   |
| <b>TNGDEV</b>   | Training Developer   |
| <b>TO</b>       | Theater Opening  |
| <b>TOA</b>      | Total Obligation Authority   |
| <b>TOE</b>      | Table of Organization and Equipment  |
| <b>TOMA</b>     | Training Operations Management Activity  |
| <b>TOPMIS</b>   | Total Officer Personnel Management Information System  |
| <b>TP</b>       | Training Publication   |
| <b>TPA</b>      | Total Package Approach   |
| <b>TPASE</b>    | Theater Public Affairs Support Element   |
| <b>TPE</b>      | Theater Provided Equipment   |
| <b>TPF</b>      | Total Package Fielding   |
| <b>TPFDD</b>    | Time-Phased Force Deployment Data  |
| <b>TPFDL</b>    | Time-Phased Force Deployment List  |
| <b>TPG</b>      | Transformation Planning Guidance   |
| <b>TPSN</b>     | Troop Program Sequence Number  |
| <b>TPU</b>      | Troop Program Unit   |
| <b>TRA</b>      | Technology Readiness Assessment  |
| <b>TRAC</b>     | Training and Doctrine Command Analysis Center  |
| <b>TRAC2ES</b>  | Transportation Command (TRANSCOM) Regulating and Command and Control Evacuation System               |
| <b>TRADOC</b>   | U.S. Army Training and Doctrine Command  |
| <b>TRANSCOM</b> | U.S. Transportation Command  |
| <b>TRAP</b>     | Training Resources Arbitration Panel   |
| <b>TRAS</b>     | Training Requirements Analysis System  |
| <b>TRL</b>      | Technology Readiness Level   |
| <b>TRM</b>      | Training Resource Model  |
| <b>TRMC</b>     | Test Resource Management Center  |
| <b>TRMIS</b>    | Training Resource Model Information System   |
| <b>TRP</b>      | Test Resource Plan   |
| <b>TSARC</b>    | Test Schedule and Review Committee   |
| <b>TSB</b>      | Training Support Brigade   |
| <b>TSC</b>      | Theater Security Cooperation   |
| <b>TSC</b>      | Theater Sustainment Command  |
| <b>TSC</b>      | Training Support Center  |
| <b>TSC</b>      | Theater Support Command  |
| <b>TSG</b>      | The Surgeon General  |



## GLOSSARY

|               |   |
|---------------|---|
| <b>TSM</b>    | Talent and Succession Management                                |
| <b>TSOC</b>   | Theater Special Operations Command                              |
| <b>TSP</b>    | Training Support Package  |
| <b>TSS</b>    | Training Support System   |
| <b>TSWG</b>   | Training Support Work Group                                     |
| <b>TT PEG</b> | Training (Program Evaluation Group (PEG))                       |
| <b>TTHS</b>   | Trainees, Transients, Holdees, and Students                     |
| <b>TTN</b>    | Transportation Tracking Number                                  |
| <b>TTP</b>    | Tactics, Techniques, and Procedures                             |
| <b>TTRRS</b>  | TRADOC The Army School System (TASS) Readiness Reporting System |
| <b>TVA</b>    | Tennessee Valley Authority                                      |
| <b>TWOS</b>   | Total Warrant Officer System                                    |
| <b>TWVRMO</b> | Tactical Wheeled Vehicle Requirements Management Office         |
| <b>TYAD</b>   | Tobyhanna Army Depot  |
| <b>UAD</b>    | Updated Authorizations Document                                 |
| <b>UAP</b>    | Unified Action Partners   |
| <b>UAS</b>    | Unit Activation Schedule  |
| <b>UAV</b>    | Unmanned Aerial Vehicle   |
| <b>UC</b>     | Unified Command   |
| <b>UCMJ</b>   | Uniform Code of Military Justice                                |
| <b>UCP</b>    | Unified Command Plan  |
| <b>UFR</b>    | Unfunded Requirement  |
| <b>UHTS</b>   | Un sourced and/or Hard to Source                                |
| <b>UIC</b>    | Unit Identification Code  |
| <b>UICIO</b>  | Unit Identification Code Information Officer                    |
| <b>UII</b>    | Unique Item Identifier  |
| <b>UJTL</b>   | Universal Joint Task List                                       |
| <b>ULO</b>    | Unified Land Operations   |
| <b>ULP</b>    | Unfair Labor Practice   |
| <b>UMD</b>    | Unmatched Disbursements   |
| <b>UMFP</b>   | Unit Materiel Fielding Points                                   |
| <b>UMMCA</b>  | Unspecified Minor Military Construction Army                    |
| <b>UNAAF</b>  | Unified Action Armed Forces                                     |
| <b>UO</b>     | Urban Operations  |
| <b>UON</b>    | Urgent Operational Need   |
| <b>UP</b>     | Utilities Privatization   |
| <b>UPAR</b>   | Unit Public Affairs Representatives                             |
| <b>URC</b>    | Unit Readiness Cycle  |
| <b>URN</b>    | Unit Reference Number   |

## HOW THE ARMY RUNS

|                       |  |
|-----------------------|--|
| <b>URS</b>            | Unit Reference Sheet   |
| <b>U.S.</b>           | United States  |
| <b>USA</b>            | Under Secretary of the Army  |
| <b>USAAA</b>          | U.S. Army Audit Agency   |
| <b>USAAC</b>          | U.S. Army Accessions Command   |
| <b>USAASC</b>         | U.S. Army Acquisition Support Center                                     |
| <b>USACC</b>          | U.S. Army Cadet Command  |
| <b>USACCSA</b>        | U.S. Army Command and Control Support Agency                             |
| <b>USACE</b>          | U.S. Army Corps of Engineers   |
| <b>USACIDC</b>        | U.S. Army Criminal Investigation Command                                 |
| <b>USAEC</b>          | U.S. Army Environmental Command  |
| <b>USAEUR</b>         | U.S. Army, Europe  |
| <b>USAFINCOM</b>      | U.S. Army Finance Command  |
| <b>USAFMCOM</b>       | U.S. Army Financial Management Command                                   |
| <b>USAFMSA</b>        | U.S. Army Force Management Support Agency                                |
| <b>USAFR</b>          | U.S. Air Force Reserve   |
| <b>USAFRICOM</b>      | U.S. Africa Command  |
| <b>USAID</b>          | U.S. Agency for International Development                                |
| <b>USAIGA</b>         | U.S. Army Inspector General Agency                                       |
| <b>USAJFKSWCS</b>     | U.S. Army John F. Kennedy Special Warfare Center and School              |
| <b>USALSA</b>         | U.S. Army Legal Services Agency  |
| <b>USAMAA</b>         | U.S. Army Manpower Analysis Agency                                       |
| <b>USAMEB</b>         | U.S. Army Marketing and Engagement Brigade                               |
| <b>USAMMDA</b>        | U.S. Medical Material Development Activity                               |
| <b>USAMRICD</b>       | U.S. Army Medical Research Institute of Chemical Defense                 |
| <b>USAMRIID</b>       | U.S. Army Medical Research Institute of Infectious Diseases              |
| <b>USAMRDC</b>        | U.S. Army Medical Research and Development Command                       |
| <b>USAMRMC</b>        | U.S. Army Medical Research and Materiel Command                          |
| <b>USANCA</b>         | U.S. Army Nuclear and Combating Weapons of Mass Destruction (WMD) Agency |
| <b>USAPA</b>          | U.S. Army Publishing Agency  |
| <b>USAPHC</b>         | U.S. Army Public Health Command  |
| <b>USAR</b>           | U.S. Army Reserve  |
| <b>USARAF / SETAF</b> | U.S. Army Africa / Southern European Task Force                          |
| <b>USARC</b>          | U.S. Army Reserve Command  |
| <b>USARCENT</b>       | U.S. Army, Central   |
| <b>USAREC</b>         | U.S. Army Recruiting Command   |
| <b>USAREUR</b>        | U.S. Army, Europe  |
| <b>USARF</b>          | U.S. Army Reserve Forces   |
| <b>USARNORTH</b>      | U. S. Army, North  |

## GLOSSARY

|                          |  |
|--------------------------|--|
| <b>USARPAC</b>           | U.S. Army, Pacific   |
| <b>USARSO</b>            | U.S. Army, South   |
| <b>USASAC</b>            | U.S. Army Security Assistance Command                                |
| <b>USASATMO</b>          | U.S. Army Security Assistance Training Management Organization       |
| <b>USASMDC / ARSTRAT</b> | U.S. Army Space and Missile Defense Command / Army Strategic Command |
| <b>USASOC</b>            | U.S. Army Special Operations Command                                 |
| <b>USASSI</b>            | U.S. Army Soldier Support Institute                                  |
| <b>USATC</b>             | U.S. Army Training Center  |
| <b>USAWC</b>             | U.S. Army War College  |
| <b>USC</b>               | U.S. Code  |
| <b>USCENTCOM</b>         | U.S. Central Command   |
| <b>USCG</b>              | U.S. Coast Guard   |
| <b>USCGR</b>             | U.S. Coast Guard Reserve   |
| <b>USCYBERCOM</b>        | U.S. Cyber Command   |
| <b>USD</b>               | Under Secretary of Defense   |
| <b>USDA</b>              | U.S. Department of Agriculture                                       |
| <b>USD(A&amp;S)</b>      | U.S. Defense for Acquisition and Sustainment                         |
| <b>USD(AT&amp;L)</b>     | Under Secretary of Defense (Acquisition, Technology, and Logistics)  |
| <b>USD(C)</b>            | Under Secretary of Defense (Comptroller)                             |
| <b>USD(C)/CFO</b>        | Under Secretary of Defense (Comptroller)/ Chief Financial Officer    |
| <b>USD(I)</b>            | Under Secretary of Defense for Intelligence                          |
| <b>USD(P)</b>            | Under Secretary of Defense (Policy)                                  |
| <b>USD(P&amp;R)</b>      | Under Secretary of Defense (Personnel and Readiness)                 |
| <b>USELENORAD</b>        | United States Element, North American Aerospace Defense Command      |
| <b>USERRA</b>            | Uniform Services Employment and Reemployment Rights Act              |
| <b>USF</b>               | Unit Set Fielding  |
| <b>USFOR-A</b>           | U.S. Forces-Afghanistan  |
| <b>USFOR-I</b>           | U.S. Forces-Iraq   |
| <b>USFORSCOM</b>         | U.S. Army Forces Command   |
| <b>USG</b>               | U.S. Government  |
| <b>USMA</b>              | U.S. Military Academy  |
| <b>USMCR</b>             | U.S. Marine Corp Reserve   |
| <b>USMEDCOM</b>          | Medical Command  |
| <b>USNORTHCOM</b>        | U.S. Northern Command  |
| <b>USNAR</b>             | U.S. Naval Reserve   |
| <b>USPACOM</b>           | U.S. Pacific Command   |
| <b>USPFO</b>             | U.S. Property & Fiscal Office  |
| <b>USPFO</b>             | U.S. Property and Fiscal Officer                                     |
| <b>USPS</b>              | U.S. Postal Service  |

## HOW THE ARMY RUNS

|                   |   |
|-------------------|---|
| <b>US&amp;R</b>   | Urban Search and Rescue                               |
| <b>USR</b>        | Unit Status Report                                    |
| <b>USSGL</b>      | U.S. Standard General Ledger                          |
| <b>USSOCOM</b>    | U.S. Special Operations Command                       |
| <b>USSOUTHCOM</b> | U.S. Southern Command                                 |
| <b>USSS</b>       | U.S. Secret Service                                   |
| <b>USSTRATCOM</b> | U.S. Strategic Command                                |
| <b>USTRANSCOM</b> | U.S. Transportation Command                           |
| <b>UTA</b>        | Unit Training Assembly                                |
| <b>UTP</b>        | Unit Training Plan                                    |
| <b>UTR</b>        | Unit Training Record                                  |
| <b>UUNS</b>       | Urgent Universal Need Statement                       |
| <b>VC</b>         | Veterinary Corps                                      |
| <b>VCCT</b>       | Virtual Combat Convoy Trainer                         |
| <b>VCJCS</b>      | Vice Chairman of the Joint Chiefs of Staff            |
| <b>VCSA</b>       | Vice Chief of Staff, U.S. Army                        |
| <b>VEOA</b>       | Veterans Employment Opportunity Act                   |
| <b>VERRP</b>      | Voluntary Early Release and Retirement Program        |
| <b>VI / TSC</b>   | Visual Information / Training Support Centers         |
| <b>VISMOD</b>     | Visually Modified                                     |
| <b>VMAT</b>       | Veterinarian Medical Assistance Team                  |
| <b>VOLT</b>       | Validated On-Line Life-Cycle Threat Report            |
| <b>VTC</b>        | Video Teleconference                                  |
| <b>VTF</b>        | Virtual Training Facility                             |
| <b>VTIP</b>       | Voluntary Transfer Incentive Program                  |
| <b>VTT</b>        | Video Tele-Training                                   |
| <b>WAS</b>        | Wide Area Security                                    |
| <b>WFF</b>        | Warfighting Function                                  |
| <b>WG</b>         | Working Group   |
| <b>WHINSEC</b>    | Western Hemisphere Institute for Security Cooperation |
| <b>WHS</b>        | Washington Headquarters Service                       |
| <b>WIAS</b>       | Worldwide Individual Augmentation System              |
| <b>WIF</b>        | Wales Initiative Funds                                |
| <b>WIN-T</b>      | Warfighter Information Network-Tactical               |
| <b>WIP</b>        | Work In Process                                       |
| <b>WIPT</b>       | Working-Level Integrated Product Team                 |
| <b>WIT</b>        | Weapons Intelligence Team                             |
| <b>WLC</b>        | Warrior Leader Course                                 |
| <b>WMA</b>        | Warfighting Mission Area                              |

## GLOSSARY

|                  |  |
|------------------|--|
| <b>WMD</b>       | Weapons of Mass Destruction                            |
| <b>WMD-E</b>     | Weapons of Mass Destruction-Elimination                |
| <b>WMP</b>       | Air Force War and Mobilization Plan                    |
| <b>WO</b>        | Warrant Officer  |
| <b>WOAC</b>      | Warrant Officer Advanced Course                        |
| <b>WOBC</b>      | Warrant Officer Basic Course                           |
| <b>WOCC</b>      | Warrant Officer Career Center                          |
| <b>WOCS</b>      | Warrant Officer Candidate School                       |
| <b>WOES</b>      | Warrant Officer Education System                       |
| <b>WOILE</b>     | Warrant Officer Intermediate Level Education           |
| <b>WOLDAP</b>    | Warrant Officer Leader Development Action Plan         |
| <b>WOMA</b>      | Warrant Officer Management Act                         |
| <b>WOS</b>       | Warrant Officer Service                                |
| <b>WOSC</b>      | Warrant Officer Staff Course                           |
| <b>WOSSC</b>     | Warrant Officer Senior Staff Course                    |
| <b>WOSSE</b>     | Warrant Officer Senior Service Education               |
| <b>WOTTC</b>     | Warrant Officer Technical and Tactical Training Course |
| <b>WPB</b>       | War Production Board                                   |
| <b>WRDA</b>      | Water Resources Development Act                        |
| <b>WRMR</b>      | War Reserve Materiel Requirement                       |
| <b>WRMS</b>      | War Reserve Materiel Stock                             |
| <b>WTC</b>       | Warrior Transition Command                             |
| <b>WTCV</b>      | Weapons and Tracked Combat Vehicles                    |
| <b>WVA</b>       | Watervliet Arsenal                                     |
| <b>WWW</b>       | World-Wide Web   |
| <b>XCTC</b>      | Exportable Combat Training Capability                  |
| <b>Y / Q / N</b> | Yes / Qualified Yes / No                               |
| <b>ZLIN</b>      | Developmental Line Item Number                         |

## HOW THE ARMY RUNS

**This page is intentionally left blank**

# ARMY FORCE MANAGEMENT MODEL

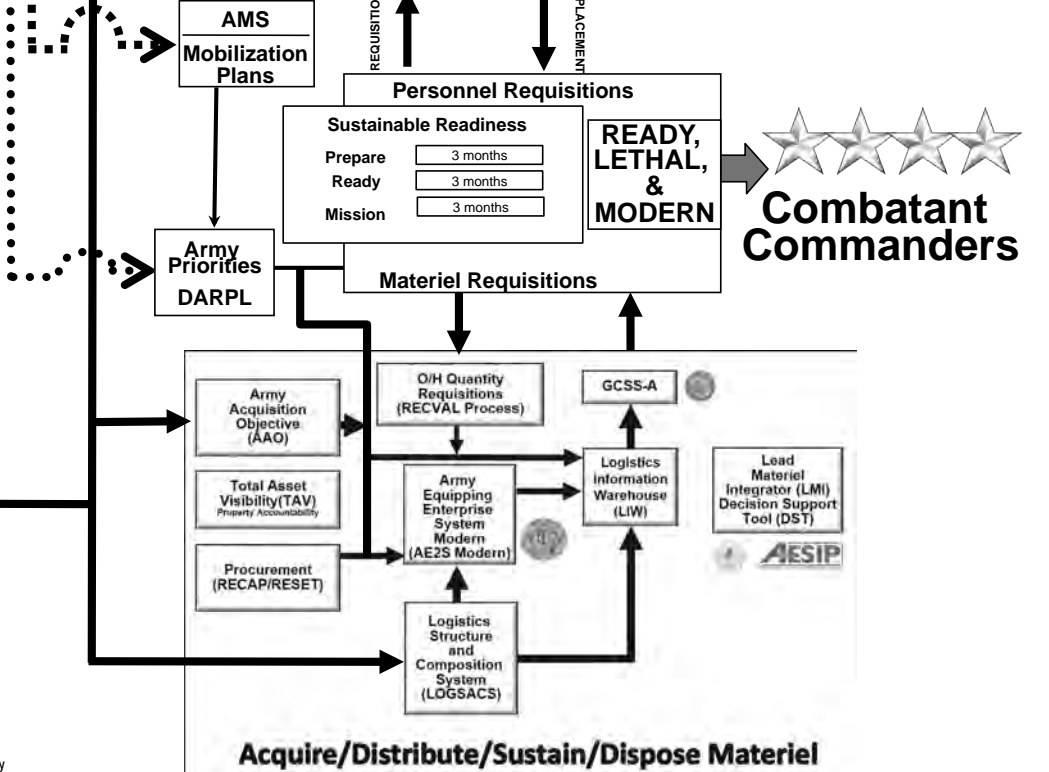
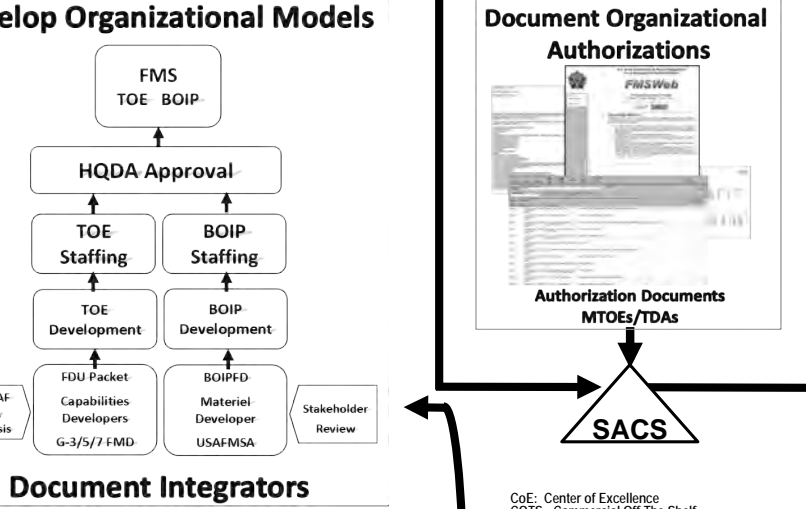
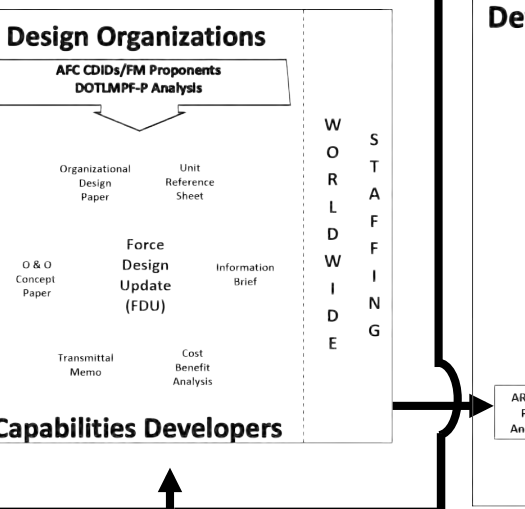
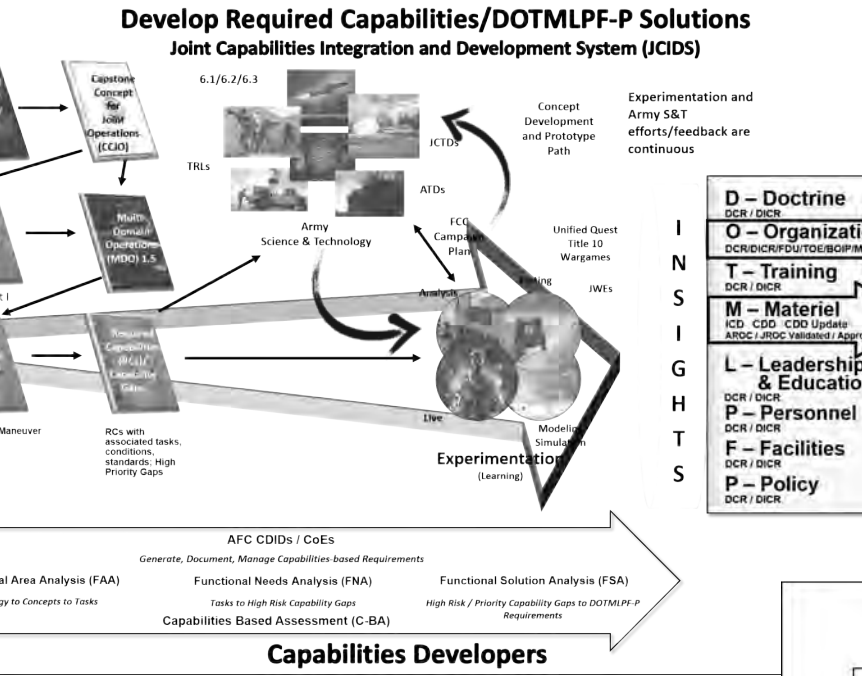
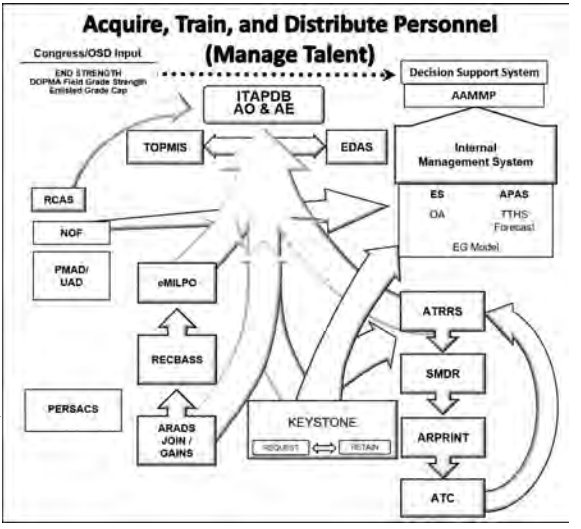
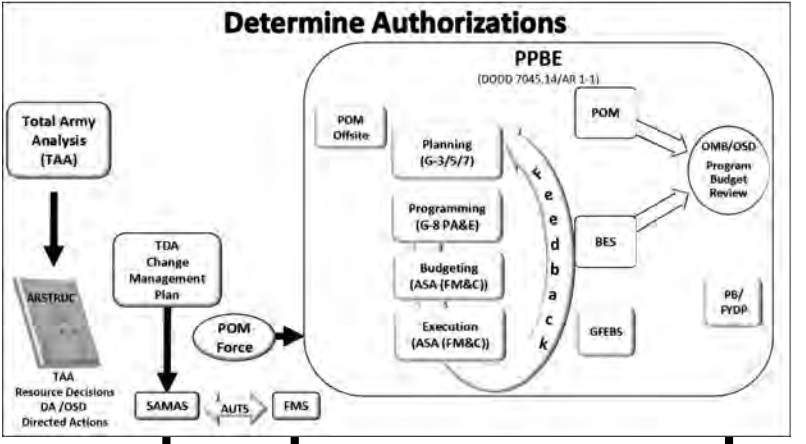
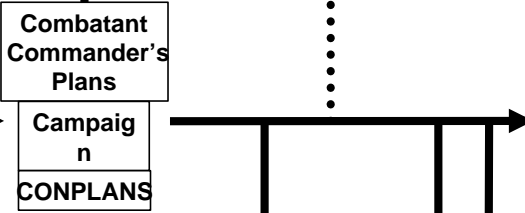
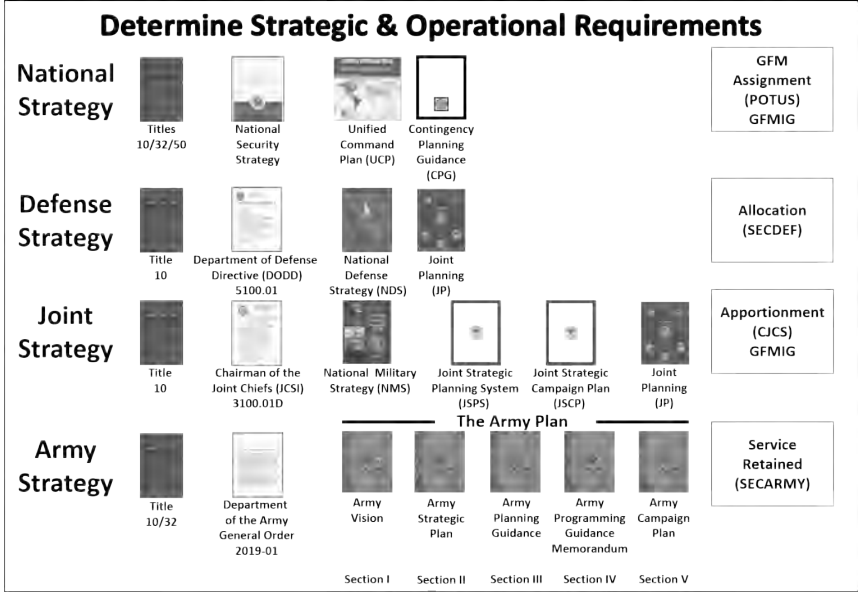

- CoE: Center of Excellence  
COTS: Commercial Off The Shelf  
CPA: Chairman's Program Assessment  
CPG: Contingency Planning Guidance  
CPR: Chairman's Program Recommendation  
CTA: Common Table of Allowances  
CRA: Chairman's Risk Assessment  
DAGO: Department of the Army General Order  
DARPL: Dynamic Army Resourcing Priority List  
DAS: Defense Acquisition System  
DCR: Doctrine, Organization, Training, Materiel, Leadership & Education, Personnel, Facilities, and Policy Change Recommendation  
DICR: Doctrine, Organization, Training, Materiel, Leadership & Education, Personnel, Facilities, and Policy Integrated Change Recommendation  
DI: Document Integrator  
DOC DEV: Document Developer  
DODD: Department of Defense Directive  
DODI: Department of Defense Instruction  
DOPMA: Defense Officer Personnel Management Act  
DOTMLPF-P: Doctrine, Organization, Training, Materiel, Leadership & Education, Personnel, Facilities, and Policy Change Recommendation  
DPG: Defense Planning Guidance  
DSI: Decision Support Tool  
EDAS: Enlisted Distribution and Assignment System  
ELM: Enlisted Distribution Target Model  
EG: Enlisted Grade  
EMILPO: Electronic Military Personnel Office  
ES: Enlisted Specialty  
FAA: Functional Area Analysis  
FDU: Force Design Update  
FIFA: Force Integration Functional Areas  
FMS: Force Management System  
FMSWEB: Force Management System Web  
FNA: Functional Needs Analysis  
FDC: Full Operational Capability  
FRP: Full Rate Production  
FSA: Functional Solution Analysis  
FUE: First Unit Equipped  
GFEBS: General Fund Enterprise Business System  
GFM: Global Force Management  
GFMAB: GFM Allocation Plan  
GFMIG: GFM Implementation Guidance  
HODA: Headquarters, Department of the Army  
HSL: Human Systems Integration  
IA: Individual Account  
ICD: Initial Capabilities Document  
ILS: Integrated Logistics Support  
IOC: Initial Operational Capability  
IOTE: Initial Operational Test and Evaluation  
ITAPDB: Integrated Total Army Personnel Data Base  
ITP: Individual Training Plan  
JCIDS: Joint Capabilities Integration and Development System
- JCID: Joint Capabilities Technology Demonstration  
JOE: Joint Operating Environment  
JOIR: Joint Optical Information System  
JP: Joint Planning  
JROC: Joint Requirements Oversight Council  
JSCIP: Joint Strategic Capabilities Plan  
JSPS: Joint Strategic Planning System  
JSR: Joint Strategy Review  
JWE: Joint Warfighting Experiment  
KEYSTONE: Capstone Recruit & Retention System  
LTF&E: Live Fire Test and Evaluation  
MAT DEV: Materiel Developer  
MDD: Materiel Development Decision  
MILCON: Military Construction  
MOD: Modernization/Modernize  
MS: Milestone  
MSA: Materiel Solution Analysis  
MTOE: Modified Table of Organization and Equipment  
FDC: National Defense Strategy  
NMS: National Military Strategy  
NOF: Notional Force  
NSS: National Security Strategy  
OA: Officer Aggregate  
OH: On Hand  
OMA: Operations and Maintenance Appropriations  
OMAS: Operations and Maintenance Appropriation Dollars  
OMD: Office of Budget and Management  
OPLAN: Operation Plan  
ORDAR: Organizational Requirements Document Approval Briefing  
OSD: Office of the Secretary of Defense  
PA&E: Program Analysis and Evaluation  
PBG: Program and Budget Guidance  
PERSACS: Personnel Structure and Composition System  
PMAD: Personnel Management Authorization Document  
POI: Program of Instruction  
POM: Program Objective Memorandum  
POTUS: President of the United States  
PM: Program Manager  
PPBE: Planning, Programming, Budgeting and Execution Process
- PDR: Preliminary Design Review  
RCAS: Reserve Component Automation System  
RDA: Research, Development, and Acquisition  
RDTE: Research Development Test and Evaluation  
RECBASS: Reception Battalion Automated Support System  
RECVAL: Requisition Validation System  
RMD: Resource Management Decision  
S & T: Science & Technology  
SACS: Structure and Composition System  
SAMAS: Structure and Manpower Allocation System  
SOD: Secretary of Defense Orders Book  
SMDR: Structure and Manning Decision Review  
SRCA: Service-Retained, Combatant Command-Aligned  
SSO: Synchronization Staff Officer  
SRM: Sustainable Readiness Model  
SRP: Soldier readiness Process  
T & E: Test & Evaluation  
TAA: Total Army Analysis  
TADS: Training aids, devices, simulations, and simulators  
TAPDB: Total Army Personnel Database  
TAPDB-AE: Total Army Personnel Data Base-Active Enlisted  
TAPDB-AO: Total Army Personnel Data Base-Active Officer  
TAV: Total Asset Visibility  
TD: Technology Demonstration  
TD: Training Development  
TDA: Table of Distribution and Allowances  
TNG DEV: Training Developer  
TOE: Table of Organization and Equipment  
TOPMIS: Total Officer Personnel Management Information System  
TPG: Transformation Planning Guidance  
TRADOC: US Army Training and Doctrine Command  
TRL: Technology Readiness Level  
TTHS: Trainers, Transients, Holders, Students  
UAD: Updated Authorization Document  
UCP: Unified Command Plan  
URS: Unit Reference Sheet  
USAFMSA: United States Army Force Management Support Agency  
USAR: United States Army Reserve  
U.S.C.: United States Code

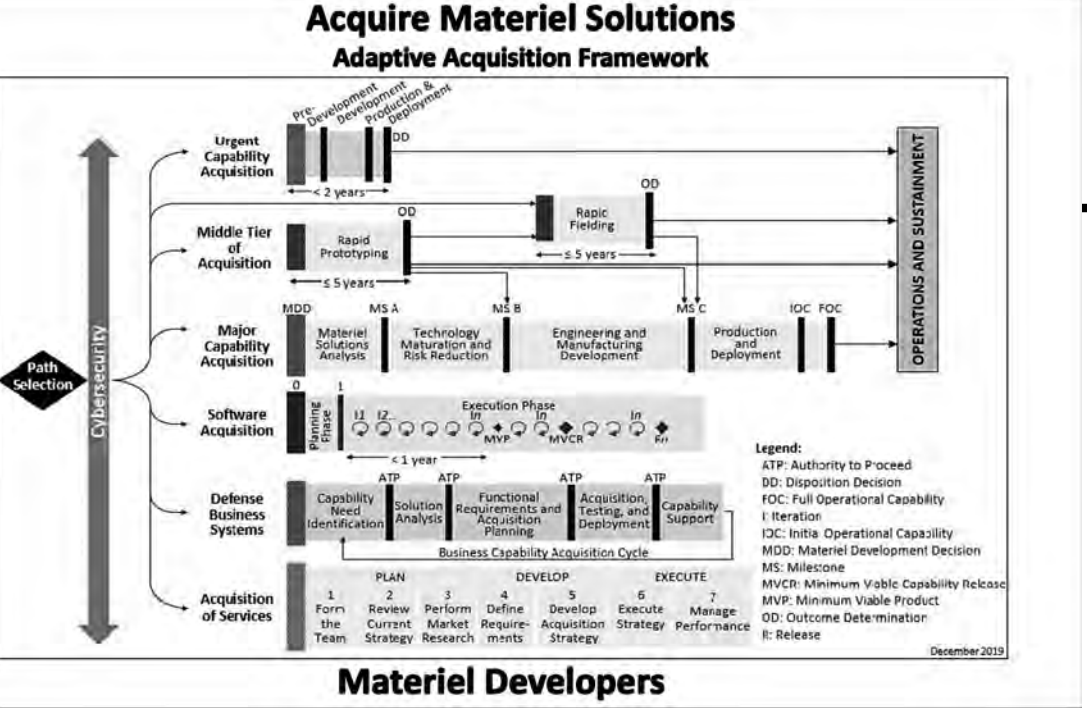

Army Modernization Enterprise

As of: 27 February 2020

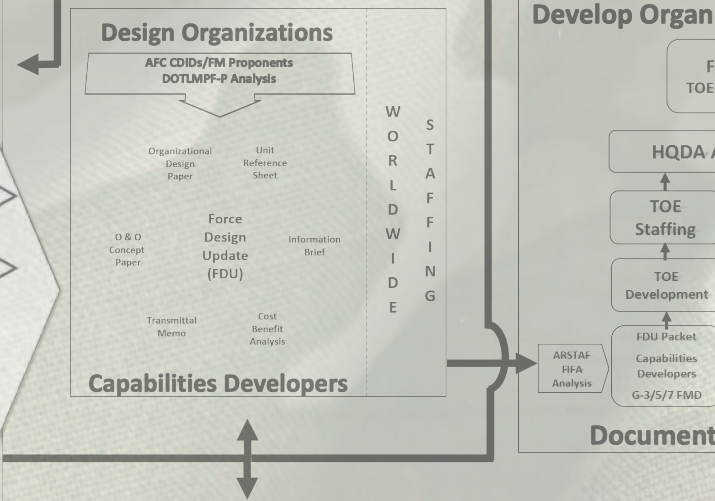
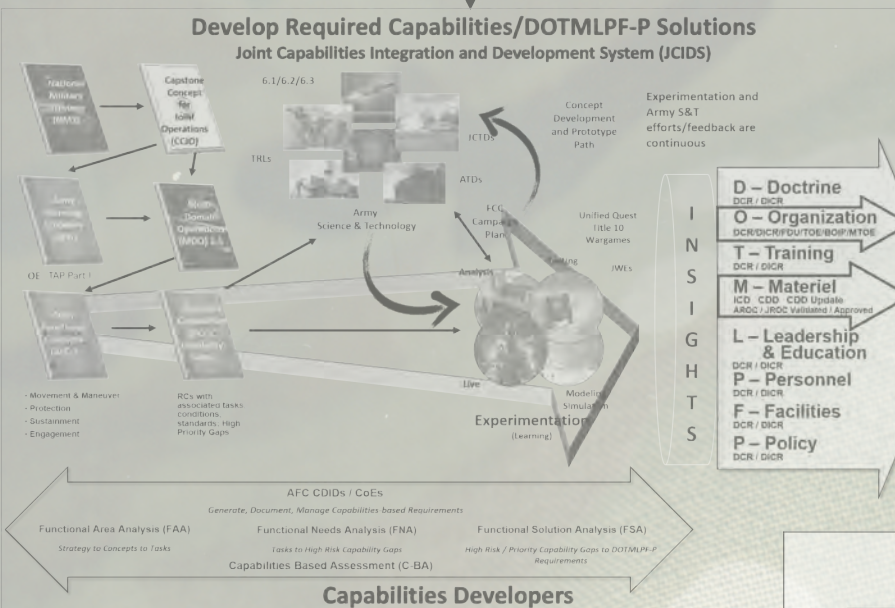
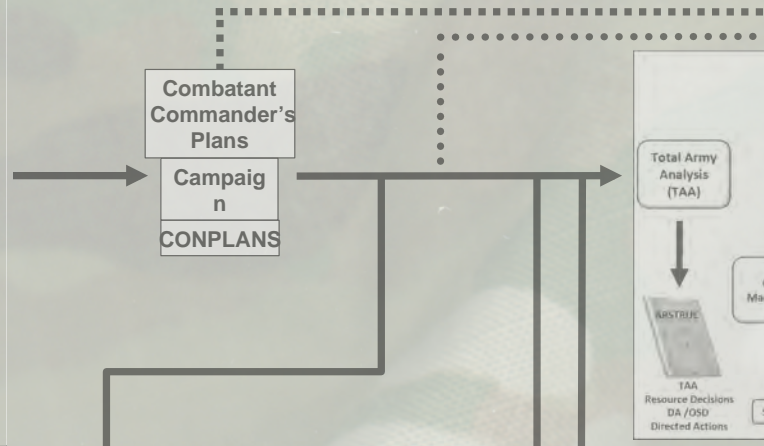
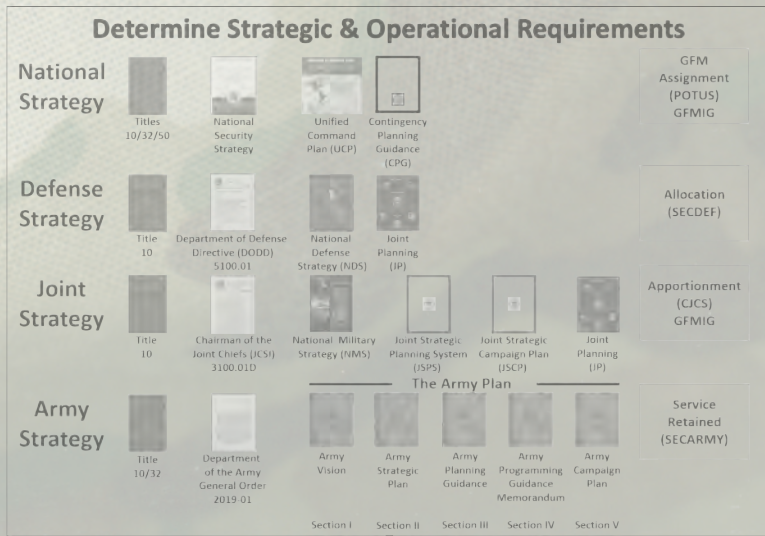

- AAAMP: Active Army Military Manpower Program
- AAC: Army Acquisition Objective
- ACSIM: Assistant Chief of Staff Installation Management
- ACP: Army Campaign Plan
- ADM: Acquisition Decision Memorandum
- AEP: Army Experimentation Plan
- AE2S: Army Equipping Enterprise System
- AMS: Army Mobilization System
- AOA: Analysis of Alternatives
- AO/AE: Active Officer / Active Enlisted
- APAS: Army Personnel Assignment System
- APG: Army Planning Guidance
- APGM: Army Program Guidance Memorandum
- ARADS: Army Recruiting and Accession Data System
- ARCIC: Army Capabilities Integration Center
- ARNG: Army National Guard
- AROC: Army Requirements Oversight Council
- ARPRINT: Army Program for Individual Training
- ARSTAF: Army Staff
- AS: Acquisition Strategy
- ASA (F&MC): Assistant Secretary of the Army for Financial Management and Comptroller
- ASP: Army Strategic Plan
- ASTMP: Army Science & Technology Master Plan
- ATC: Army Training Center
- ATD: Advanced Technology Demonstration
- ATRRS: Army Training Requirements and Resources System
- AUTS: Automated Update Transaction System
- AV: Army Vision
- AWE: Advanced Warfighter Experiment
- BES: Budget Estimate Submission
- BOIP: Basis of Issue Plan
- BOIPFD: BOIP Feeder Data
- CAD: Course Administrative Data
- CAP DEV: Capability Developer
- C-BA: Cost Benefit Analysis
- CBA: Capability Based Assessment
- CDD: Capability Development Document
- CDID: Capability Development Integration Directorate
- CDR: Critical Design Review
- CONPLAN: Concept Plan
- CJA: Comprehensive Joint Assessment
- CJCSI: Chairman of the Joint Chiefs Instruction

**Army Modernization Enterprise**

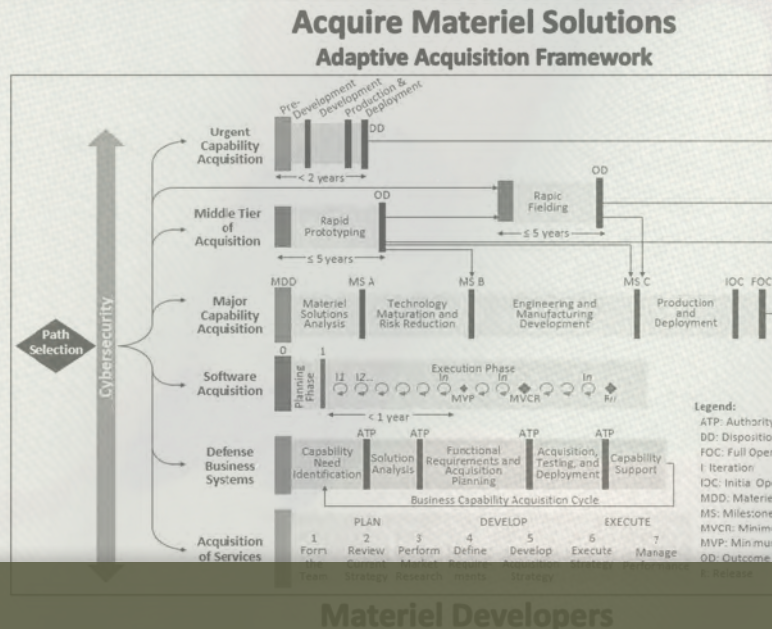

As of: 27 February 2020



# 2019-2020 How the Army Runs

## A Senior Leader Reference Handbook