

MICROCOPY RESOLUTION TEST CHART
NATIONAL BUREAU OF STANDARDS-1963-A

2

NAVAL POSTGRADUATE SCHOOL

Monterey, California

AD-A143 163



DTIC
ELECTE
JUL 18 1984
S B

THESIS

DTIC FILE COPY

AN EVALUATION OF THE
AIR-TO-AIR ENGAGEMENT MODELS
IN THE NAVAL WARFARE GAMING SYSTEM

by

Nicholas I. Ardan III

March 1984

Thesis Advisor:

A. F. Andrus

Approved for public release; distribution unlimited

84 07 13 033

Unclassified

SECURITY CLASSIFICATION OF THIS PAGE (When Data Entered)

REPORT DOCUMENTATION PAGE		READ INSTRUCTIONS BEFORE COMPLETING FORM
1. REPORT NUMBER	2. GOVT ACCESSION NO.	3. RECIPIENT'S CATALOG NUMBER
4. TITLE (and Subtitle) An Evaluation of the Air-to-Air Engagement Models in the Naval Warfare Gaming System		5. TYPE OF REPORT & PERIOD COVERED Master's Thesis March 1984
7. AUTHOR(s) Nicholas I. Ardan III		6. PERFORMING ORG. REPORT NUMBER
9. PERFORMING ORGANIZATION NAME AND ADDRESS Naval Postgraduate School Monterey, California 93943		8. CONTRACT OR GRANT NUMBER(s)
11. CONTROLLING OFFICE NAME AND ADDRESS Naval Postgraduate School Monterey, California 93943		10. PROGRAM ELEMENT, PROJECT, TASK AREA & WORK UNIT NUMBERS
14. MONITORING AGENCY NAME & ADDRESS (if different from Controlling Office)		12. REPORT DATE March 1984
		13. NUMBER OF PAGES 209
		15. SECURITY CLASS. (of this report) Unclassified
		15a. DECLASSIFICATION/DOWNGRADING SCHEDULE
16. DISTRIBUTION STATEMENT (of this Report) Approved for public release; distribution unlimited		
17. DISTRIBUTION STATEMENT (of the abstract entered in Block 20, if different from Report)		
18. SUPPLEMENTARY NOTES		
19. KEY WORDS (Continue on reverse side if necessary and identify by block number)		
Anti-Air-Warfare NWGS Aircraft versus War Game Models AAW Cruise Missile Combat Modeling Fleet Air Defense Air-to-Air Engagement Aircraft Versus Aircraft		
20. ABSTRACT (Continue on reverse side if necessary and identify by block number)		
This thesis is an examination of the Air-to-Air engagement models in the Naval Warfare Gaming System installed at the Center for War Gaming, Naval War College, Newport, Rhode Island. Descriptive narrative and flow charts derived directly from the computer code are included. Qualitative evaluation of the models and their documentation is provided from both an operational and an analytical point of view. Problem areas and discrepancies are identified and specific recommendations for model improvement are discussed. <p style="text-align: right;">(continued)</p>		

DD FORM 1473
1 JAN 73

EDITION OF 1 NOV 65 IS OBSOLETE
S/N 0102-LF-014-6601

1

Unclassified
SECURITY CLASSIFICATION OF THIS PAGE (When Data Entered)

Unclassified

SECURITY CLASSIFICATION OF THIS PAGE (When Data Entered)

Item 20. (continued)

The intent is to provide a course of action for the Center for War Gaming to use in modifying the existing Air-to-Air engagement routines in order to produce reasonable and more realistic outputs for war gaming. General recommendations concerning future development for additional modeling levels of detail are also discussed.

Accession For	
NTIS GEAR1	<input checked="" type="checkbox"/>
DTIC TAB	<input type="checkbox"/>
Unannounced	<input type="checkbox"/>
Justification	
By _____	
Distribution/ _____	
Availability Codes	
Dist	Avail and/or Special
A-1	



Approved for public release; distribution unlimited.

An Evaluation of the
Air-to-Air Engagement Models
in the Naval Warfare Gaming System

by

Nicholas I. Ardan III
Lieutenant Commander, United States Navy
E.S., St. Lawrence University, 1971

Submitted in partial fulfillment of the
requirements for the degree of

MASTER OF SCIENCE IN OPERATIONS RESEARCH

from the

NAVAL POSTGRADUATE SCHOOL
March 1984

Author:

Nicholas I. Ardan III

Approved by:

Alvin F. Anderson

Thesis Advisor

John R. Porter

Second Reader

John W. Washburn

Chairman, Department of Operations Research

Kenneth T. Marshall

Dean of Information and Policy Sciences

ABSTRACT

This thesis is an examination of the Air-to-Air engagement models in the Naval Warfare Gaming System installed at the Center for War Gaming, Naval War College, Newport, Rhode Island. Descriptive narrative and flow charts derived directly from the computer code are included. Qualitative evaluation of the models and their documentation is provided from both an operational and an analytical point of view. Problem areas and discrepancies are identified and specific recommendations for model improvement are discussed. The intent is to provide a course of action for the Center for War Gaming to use in modifying the existing Air-to-Air engagement routines in order to produce reasonable and more realistic outputs for war gaming. General recommendations concerning future development for additional modeling levels of detail are also discussed.

TABLE OF CONTENTS

I. INTRODUCTION 10

A. PREFACE 10

B. NAVAL WARFARE GAMING SYSTEM 11

 1. NWGS Description 11

 2. NWGS Games and Objectives 12

 3. NWGS Design Features 13

 4. NWGS Operational Data Structure 15

 5. NWGS Modeling Structure 16

C. PURPOSE AND SCOPE OF THESIS 17

D. STUDY PROCEDURES 20

E. THESIS CONTENT 21

F. NWGS ANTI-AIR-WARFARE OVERVIEW 24

II. CURRENT PROGRAM OPERATION 27

A. OVERVIEW 27

 1. Chapter Structure 27

 2. Preparatory Comments 28

B. TARGETING PHASE 30

 1. Overview 30

 2. Aircraft Targeting 33

 3. Missile Targeting 43

C. SHOOT PHASE 45

 1. Overview 45

 2. Aircraft Target Shoot Phase 47

 3. Missile Target Shoot phase 60

D. ENGAGEMENT RESULT PHASE 63

 1. Overview 63

 2. Aircraft Target Engagement Results 65

 3. Missile Target Engagement Results 75

	E. FREE LAUNCHERS PHASE	77
III.	EVALUATION	73
	A. OVERVIEW	78
	1. Evaluation of Data Based Models	73
	2. Evaluation Approach	79
	B. NWGS TARGETING PHASE EVALUATION	81
	1. Weapons Free Check	85
	2. Range Determination	85
	3. Mission Weighting and Targeting Limits	86
	4. Altitude Differential and Weapon Parameters	86
	5. Jamming Evaluation	88
	6. Multi-Targeting	89
	7. Summary	90
	C. NWGS SHOOT PHASE EVALUATION	90
	1. Baseline Probability of Conversion ('PCONV')	93
	2. PCONV Modification Factors	95
	3. Firing Doctrine	101
	4. Weapon Expenditure	102
	5. Weapon Time of Flight	103
	6. Summary	104
	D. NWGS ENGAGEMENT RESULT PHASE EVALUATION	105
	1. Baseline 'PKSS'	108
	2. 'PKSS' Modification Factors	109
	3. Damage Assessment	114
	4. Summary	115
	E. DOCUMENTATION EVALUATION	116
IV.	RECOMMENDATIONS AND CONCLUSIONS	120
	A. MODEL EVALUATION CONCLUSIONS	120
	1. Approach to Air-to-Air Engagement Modeling	121

2.	Data Base Values and Parameter	
	Definitions	122
3.	Program Documentation	124
B.	SPECIFIC RECOMMENDATIONS	124
1.	Targeting Phase	125
2.	Shoot Phase	126
3.	Engagement Result	128
4.	Documentation	129
C.	GENERAL RECOMMENDATIONS	129
1.	Level One	130
2.	Level Two	131
3.	Level Three	131
D.	STUDY CONCLUSIONS	132
APPENDIX A:	PROCEDURE AND SUBROUTINE FLOW CHARTS . . .	134
APPENDIX B:	BASIC MODEL GENERALIZED FLOW CHARTS . . .	194
LIST OF REFERENCES	203
INITIAL DISTRIBUTION LIST	209

LIST OF TABLES

I.	Aircraft Targeting Phase Limits and Weighting Factors	37
II.	Environmental Factor Index Determination	52
III.	Rounds Fired Determination	56
IV.	Time of Flight Calculation	59

LIST OF FIGURES

1.1 NWGS Application Software Overview 18

1.2 NWGS Engagements Family Overview 22

1.3 NWGS Anti Air Warfare Design 25

2.1 Aircraft and Missile Targeting Phase
Subroutines 32

2.2 Aircraft Shoot Phase Subroutines 48

2.3 Missile Shoot Phase Subroutines 61

2.4 Aircraft Engagement Result Phase Subroutines . . 66

2.5 Missile Engagement Result Phase Subroutines . . 76

3.1 Weapon Look-Up/Look-Down Determination 87

I. INTRODUCTION

A. PREFACE

"War games, . . . , are extremely useful tools for studying war games but are less appropriate, perhaps even misleading, for investigating some questions. Our understanding of war games and what we can learn from them lag behind their growing popularity."

This quote, taken from an article written by Frederick D. Thompson and printed in the October 1983 U.S. Naval Institute PROCEEDINGS, exemplifies the need for ongoing study and validation of all war gaming systems. The same article points out that war game learning depends upon the game's resemblance to the real world. And even when the resemblance is great, success in a war game does not equate to success in the real world.

Given the many artificialities inherent in a war game, the next most obvious hurdle to overcome is determining the reliability of the underlying assumptions and battle simulation models. War game objectives are critical to the determination of the required level of model realism. And to derive reliable conclusions about tactics and strategies demands reliable, sensitive models. Even good war game models will not provide all of the answers, but if the underlying models are of unknown or poor quality, then the game play may only provide misleading results.

Even when war games are used for decision maker training, it is important that the decision maker observes reasonable outcomes as a result of his decisions. Otherwise, the war gaming system and the entire war gaming program loses credibility with the individuals most needed for its support.

Computerized war gaming will never be a satisfactory replacement for underway maneuvers and exercises but can certainly prove to be a valuable adjunct to them. Regardless of the purpose of a particular war game, the results obtained can only be as good as the assumptions and models that make up the game. For this reason, the verification, validation and modification of existing war games must be an ongoing effort.

B. NAVAL WARFARE GAMING SYSTEM

1. NWGS Description

The Naval Warfare Gaming System (NWGS) is an interactive data based computerized war gaming system, designed by the Computer Sciences Corporation of Moorestown, New Jersey, under U.S. Navy contract. It was developed for the Center for War Gaming at the Naval War College in Newport, Rhode Island. Its purpose is to provide realistic interactive computerized war gaming for the Naval War College students, Commander in Chiefs and Fleet staffs. NWGS applications may include rehearsal of fleet operations or exercises, evaluation of both strategic and tactical war plans, analysis of existing and proposed tactics and improved education and training for U.S. Navy and Military decision makers.

The central computer facility for NWGS is a Honeywell Multics Level 68 Multiprocessing Computer System. The interactive display systems consist of Sanders Associates, Incorporated, high resolution, color graphics displays. At the Center for War Gaming, there are 22 interactive console stations in the Coordinator Area and one station in each of the 22 Command Centers for the game players, for a total of 44 stations. Individual console stations in the Coordinator area are linked to the Command

Centers by computer, teletype and voice communications. Currently, there are remote console stations located at CINCPACFLT Headquarters in Pearl Harbor, Hawaii, and for CINCLANTFLT use in Dam Neck, Virginia. An additional remote unit is to be installed at the Naval Postgraduate School in Monterey, California in FY85. Additionally the two Fleet Training Groups located in Dam Neck, Virginia and San Diego, California are scheduled to have a stand alone NWGS capability by FY87.

The Naval Warfare Gaming System software consists of some 990 subroutines/procedures written in the high level programming language, Programming Language One (PL/I). Approximately 156,000 lines of executable PL/I code make up these procedures. There are about 50,000 lines of code in 170 procedures that define the warfare area models alone.

2. NWGS Games and Objectives

The NWGS is designed to support two major categories of games: Command-level Games and Student-level games. Both types of games may be played at different levels of interaction, from unit versus unit on up to global multi-task force conflict.

The Command-level games, also known as fleet games, are operational war games and are the type most frequently played. They are generally sponsored by theater commander, school commands, Department of Defense Agencies or academic departments of the Naval War College. Their objectives include: gaining tactical decision making experience, evaluating operational concepts and plans, rehearsing at sea operations and supporting the Naval War College Curriculum. Problems of Command, Control and decision making for Naval forces in theater level operations are the key interests of these games. The Command-level games are the most extensive in scope and duration. Lasting from one day to several

weeks, only one of these games can be played at a time. A Command game may be one-, two-, or multi-sided and may focus on a specific warfare area or encompass multiple warfare areas. Since these games generally entail large amounts of data and complex organizational structure, a control group of umpires and console operators is required to monitor the players progress and assist them in game play.

The Student-level Games are of two types: full-scale games played at the Naval Task Force level and one-on-one engagements played at the individual unit level. The Student games are less extensive in scope than the Command games and are played in support of the Naval War College curriculum. Their primary goal is to enhance the professionalism of future operational commanders. The Student full-scale games provide players the opportunity to act as a task group or task force commander and staff. A single moderator provides the control group function and ensures that the teaching objectives are achieved. Ten Student full-scale games may be played at one time with each lasting from 4 to 8 hours of game play. The Student one-on-one games may be played using players versus players or players versus the computer. These one-on-one games allow the players to act as commanding officers of forces or units making decisions in the Naval tactical environment. One-on-one games last approximately one to four hours of real time. Ten player versus player or twenty computer opposed games may be played simultaneously.

3. NWGS Design Features

The Naval Warfare Gaming System takes advantage of three general modeling and war game concepts in order to provide the flexibility required by a war gaming system that will yield realistic representations of both unit versus unit and global level conflict. These features are: use of

families of models, use of data based modeling and doctrinal control of forces.

A family of models is a set of models in which each model is a representation of an identical phenomenon, but uses a different level of detail or complexity in its simulation of the phenomenon. Only one model level from a particular family can be used in a given situation. Use of this concept supports the requirement for different levels of detail and realism. NWGS provides for three levels of modeling detail throughout its software structure. Some of the modeled areas currently have only two levels available. The level of detail for game play is determined by the type of game and by the game sponsor's goals and objectives for the game. Level one is the least detailed and levels two and three are each more complex or detailed in structure. The game preparator selects the level of modeling detail to be used in game play during the game preparation phase.

Data based modeling is the use of table look-up in an operational model to access the appropriate parameter values for the specific simulation situation. The war game data tables are generally compiled from a master data base which contains all of the possible game entities and the descriptive parameter values necessary to fully define each particular entity or factor in the model. Use of this modeling concept and the model's resultant inherent generality provide NWGS with tremendous flexibility, longevity of software and reduced computation times. All models are highly dependent on their data base parameter values. The flexibility provided by this method allows for unlimited scenario possibilities, as well as the capability to use experimental or futuristic weapon systems and platforms in war game evaluations. The NWGS uses the Master Entity Data Base (MEDB) to maintain the incredible number of parameters for every platform, weapon system and projectile that can be

used by the gaming system. For example, the MEDB includes: fuel usage rates for each ship and aircraft type, single shot probabilities of kill for every possible weapon-target-launcher combination and even factors of weapon system degradation in a Jamming environment.

In NWGS, the doctrinal control of forces is a series of individual action orders or instructions to game entities issued by the player, which are linked together to evoke a series of actions by the particular unit or units. This feature alleviates some of the work load of monitoring and controlling directly all elements under the player's command. By selecting the appropriate doctrine a player can create pre-planned missions and be freed from having to enter numerous tactical commands. An example might be an air defense doctrine that would cause Combat Air Patrol aircraft to maintain individual stations and to intercept and engage any unknown targets approaching within 300 miles at speeds greater than 500 knots. This sort of doctrinal control leaves the player free to monitor forces and make larger scale decisions.

4. NWGS Operational Data Structure

The NWGS operational data structure refers to the general underlying filing system which allows NWGS to perform the many required phases of war gaming. These phases range from pre-game preparation to post-game analysis. The NWGS operational data structure consists of one permanent and four temporary files. These files are:

- The Master Data Base File containing all NWGS software, the Master Entity Data Base and the world map data.
- The Game Design File containing the game specific Pregame scenario, objectives and initial conditions supplied by the game sponsor.

- The Game Play File containing the game specific software, game specific entities, environment, game plans, geographic start points and initial conditions. It is created during game preparation from information in the previous two files.
- The Game Data File containing game specific information detailing the current game status for all game entities and events, such as platform positions, detections and level of battle damage.
- The Game History File containing all reported data and event information needed to replay the game for post game analysis.

5. NWGS Modeling Structure

NWGS models are grouped into modules of closely related areas of Naval operations and warfare simulation. Within each module, the families of models for specific events provide two or three levels of realism or detail. There are eight general categories of modules that form the NWGS modeling structure. [Ref. 3] These categories are:

- The General Warfare Areas modules, which simulate the activities of forces engaged in Submarine Warfare, Mine Warfare, Amphibious Warfare, Surface Warfare and Anti-Submarine Warfare.
- The Kinematics module which simulates force and unit movement according to individual platform parameters.
- The Intelligence and Communications modules which determine player access to game information through simulations of Communications networks, satellite, HF/DF, and intelligence information flow.

- The Detection modules which simulate the activity of all sensors, both active and passive and generate detections and lost contacts.
- The Logistics module which simulates the availability, consumption and replenishment of fuel, ammunition and supplies.
- The Air Operations modules which simulates the specifics of Naval Air operations on and around an Aircraft Carrier or land base.
- The Engagement modules which simulate the Anti-Air-Warfare interactions: Air-to-Surface, Surface-to-Air and Air-to-Air targeting and engagements.
- The Battle Damage Assessment Modules which evaluate the results of engagements with respect to the involved platforms.

The models within these categories of NWGS modules can be further classified according to the timing mechanism used to access them. They are periodic if they are accessed routinely at regular time intervals or they are aperiodic if they are accessed only by event scheduling. The Kinematics, Detection, Intelligence and Communications modules and parts of the Logistics module are included in the periodic category. All of the other modules are accessed aperiodically by the event schedule method. Figure 1.1 shows the hierarchy of the NWGS application software and the relationship of the various categories of models with their associated modules.

C. PURPOSE AND SCOPE OF THESIS

The purpose of this thesis is to conduct a detailed examination of the NWGS models used to simulate the

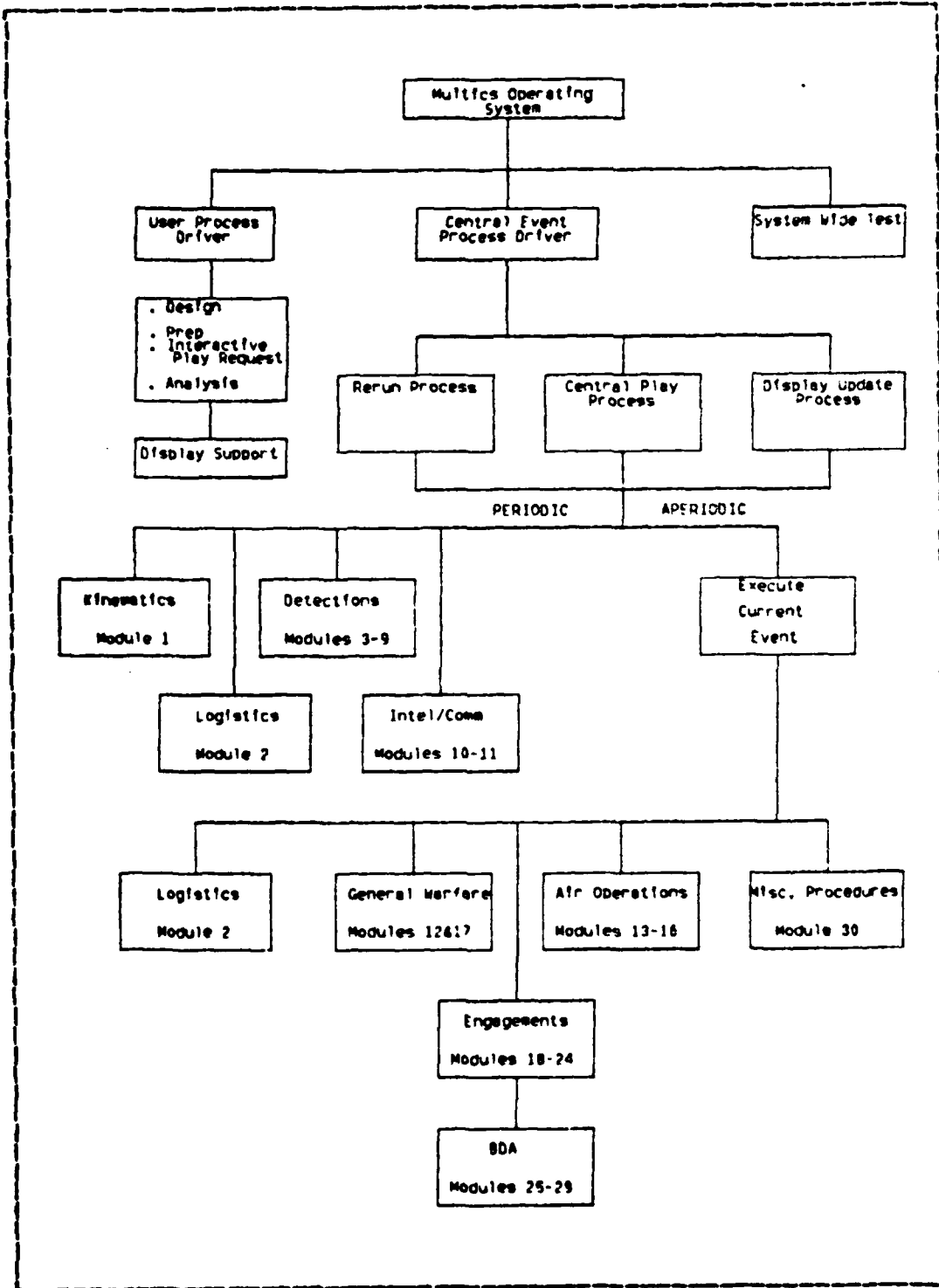

Figure 1.1 NWGS Application Software Overview.

air-to-air engagements area of Naval Warfare. This study will provide the Center for War Gaming with complete and clear model descriptions, model evaluations from an analytical and operational point of view and recommendations for changes and improvements to the existing models.

The primary objective is to ensure that NWGS provides a realistic representation of the air-to-air engagement aspect of Naval Warfare. The credibility of NWGS and its usefulness as a tool for training and evaluation is very important to the Naval War College. This objective is accomplished by applying knowledge of combat modeling techniques, fleet operational experience and logical analysis to a thorough examination of the actual PL/I code used by NWGS. The area of interest includes several procedures that make up the Air-to-Air engagement Modules and the Aircraft Battle Damage Assessment procedure in Module 26.

The secondary objective of this study is to evaluate and corroborate the NWGS documentation related to the air-to-air engagement models and to provide useful model descriptions for both NWGS users and computer programmers. It should be noted that much of the NWGS documentation in existence at the time this thesis was written is usually general in nature and when specific details are provided, they are often contradictory or confusing. It is the hope of this study to alleviate this problem with respect to the air-to-air engagement modules.

The need for this work is evident. The Naval Warfare Gaming System has been in place at the Center for War Gaming since early 1983 and has been utilized extensively at all levels of simulated conflict. However, there has been some dissatisfaction expressed concerning the quality of modeling and the model documentation, particularly in the areas of engagements, logistics and general warfare areas.

The Center for War Gaming is staffed with Navy personnel and contract civilian analysts and programmers who assist in operating and maintaining NWGS. The Navy staff at the Center for War Gaming is deeply involved in the daily operation of the Center. Gaming services are provided continually for NWC students, fleet staffs, and many others. Routine testing is performed and often uncovers discrepancies. However, the time and trained Navy personnel necessary to conduct the type of thorough model evaluations needed to validate NWGS are not available. The civilian system designers assigned to the Center for War Gaming are extremely proficient programmers and computer system analysts, but many are limited in their knowledge of Naval Warfare and Operations. Therefore, an analysis of the models based on combat modeling experience as well as an operational Navy background will be of great benefit to the Center for War Gaming and contribute significantly to the Navy's ongoing evaluation and validation of the Naval Warfare Gaming System as a whole.

D. STUDY PROCEDURES

The study procedure for this thesis consists of three phases. They are the models description phase, the models and documentation evaluation phase and the recommendations phase. During the description phase, a close examination and analysis of the routines and procedures that make up the Air-to-Air engagement models of NWGS is performed. The actual FI/I code as of August 1983 is used in this examination, to derive written and flowchart procedural descriptions. The evaluation phase includes analysis of the model logical flows, factor and parameter determination and the degree of operationally realistic approach used in the models. The system documentation is also studied thoroughly

to evaluate its accuracy, consistency and overall usefulness. The final phase of study includes the consideration of possible solutions to discrepancies, inaccuracies and unrealistic mission decomposition in the models, discovered during the evaluation phase. These considerations are intended to yield reasonable recommendations for NWGS model and documentation improvement.

For this study, in cases where more than one level of detail model is available, as in the Aircraft versus Aircraft engagement routine, only the highest level is analyzed. The specific engagement procedures studied by this thesis are:

- M19_AC_AC_TGTING (Aircraft vs Aircraft Targeting),
- M19_AC_MSL_TGTING (Air vs Missile Targeting),
- M20_AC_AC_2_ee (Aircraft vs Aircraft Engagement),
- M20_AC_MSL_ee (Aircraft vs Missile Engagement).

Several external and included subroutines called by the main engagement routines above are also evaluated. Figure 1.2 shows an overview of the Engagement modules and the relationship of the main air-to-air procedures and their phases of execution. NWGS documentation used in this study and provided by Computer Sciences Corporation and the Center for War Gaming includes: the Program Performance Specifications (PPS) [Ref. 1], the Program Description Document (PDD) [Ref. 2], the Student's Training Course [Ref. 3] and [Ref. 4], the Command and Staff Users Manual [Ref. 5], the Program Design Manual [Ref. 6] and some documentation within the procedure's PL/I code.

E. THESIS CONTENT

Chapter Two of this thesis is the description of the program's operation, specifically the modeling used, with

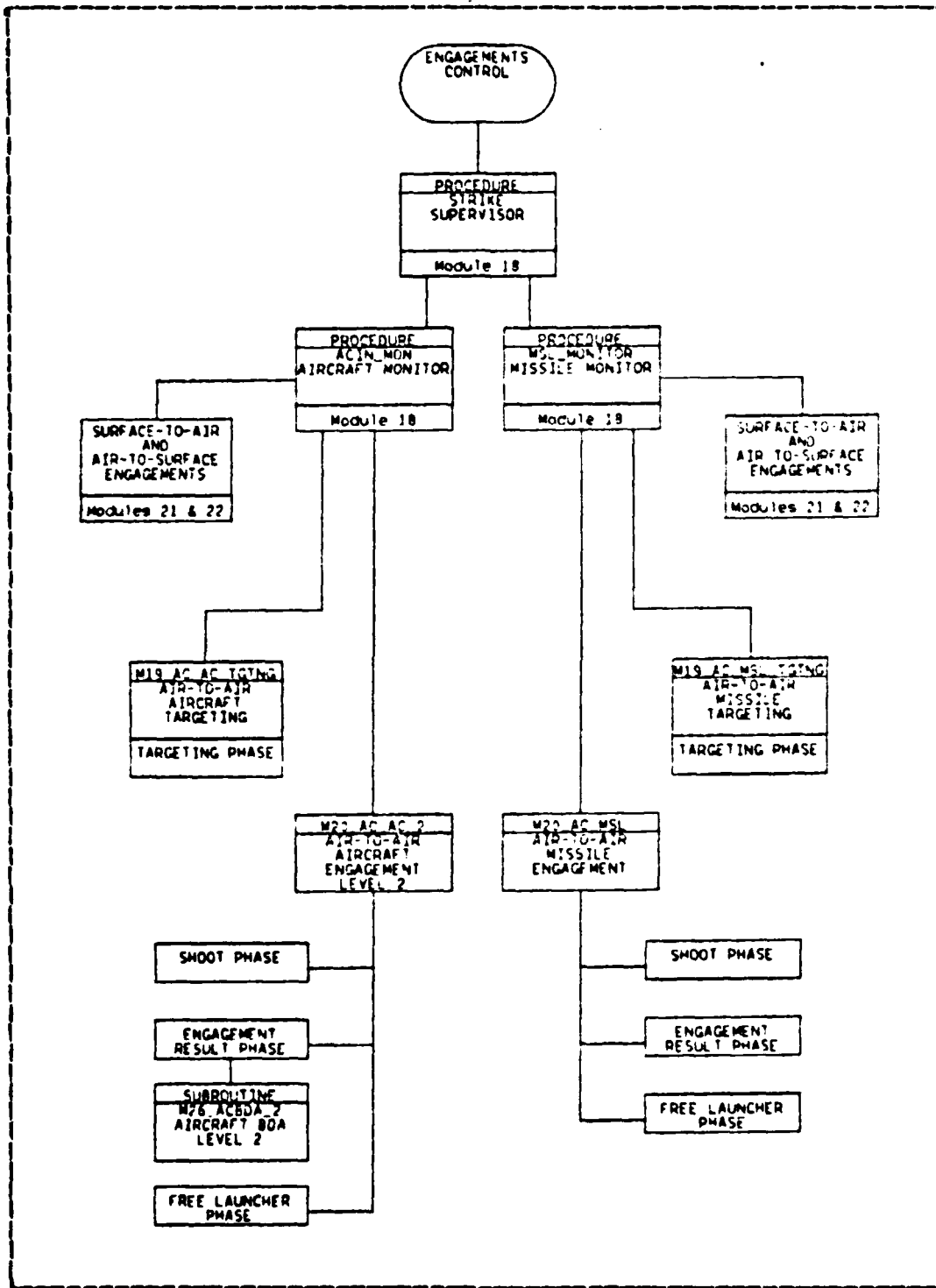

Figure 1.2 BWGS Engagements Family Overview.

little critical commentary. This is presented in the order of the naturally occurring sequence of events. First the Targeting Phase for aircraft and missile target types is described and then the three phases of actual engagement are described individually. These phases are treated as separate entry points by the engagement routines. The phases are the Shoot Phase, the Engagement Result Phase which includes damage assessment and the Free Launchers Phase.

Chapter Three is the evaluation of the model documentation and the existing model's methodology from an analytical and an operational point of view. Specific areas of discussion are: target assignment, target detection, weapon selection, probability of kill, firing doctrine and many more. The evaluation emphasizes the modeling approach used with respect to the level of realism required by the players and discusses both strengths and weaknesses of the models. Programming errors are pointed out, but programming techniques are not discussed.

Chapter Four is for recommendations and conclusions, the natural result of the solution consideration phase. This chapter provides recommendations, corrections, improvements on modeling, considerations for more realism, as well as suggestions concerning documentation. No new computer code or algorithms will be provided, only itemized recommendations for improvement are included.

Appendix A contains complete logical flowcharts of the air-to-air engagement procedures using actual variable names and includes complete program detail. This appendix will be of great value to a programmer in installing program modifications or evaluating discrepancies. Appendix B contains the very general model flowcharts for the same procedures. It uses plain language and emphasizes the general modeling aspects of the routines. In this appendix, most of the administrative programming is bypassed. In Appendix B, the

modeling is more transparent than in Appendix A, with descriptions and decision logic operationally oriented. Therefore, Appendix B would be of more interest to an operationally oriented individual. In Chapter Two and Appendix B, the emphasis is placed on the modeling of the Air-to-Air targeting and engagements and not in the programming methodology.

F. NWGS ANTI-AIR-WARFARE OVERVIEW

Prior to starting the descriptive phase of this study, a brief discussion of the NWGS generalized game scenario, with respect to the Air-to-Air engagement arena, will prove to be instructive.

The NWGS Anti-Air-Warfare models are designed around the concept of Naval Task Force Defense. That is, the protection of a Naval Task Force against aircraft or missile attack. The zones of potential battle are divided very clearly into the Outer Air Battle arena where defending aircraft can target and engage incoming strike aircraft and missiles, and the Inner Defense Zone where surface ships can target and engage incoming strike platforms. The dividing line between these two potential battle areas in NWGS is called the "Crossover range" and is controlled by the game preparator. Figure 1.3 shows the overview of NWGS Anti-Air-Warfare.

Figure 1.2 illustrates the relationship of the Air-to-Air engagement procedures with the overall NWGS Anti-Air-Warfare modules. The NWGS Strike_Supervisor procedure utilizes the ACIN_Monitor and the MSL_Monitor procedures to control access to the Air-to-Air engagement routines, the Surface-to-Air engagement routines and the Air-to-Surface routines. These three procedures make up the engagements control module. Data updates for all defending

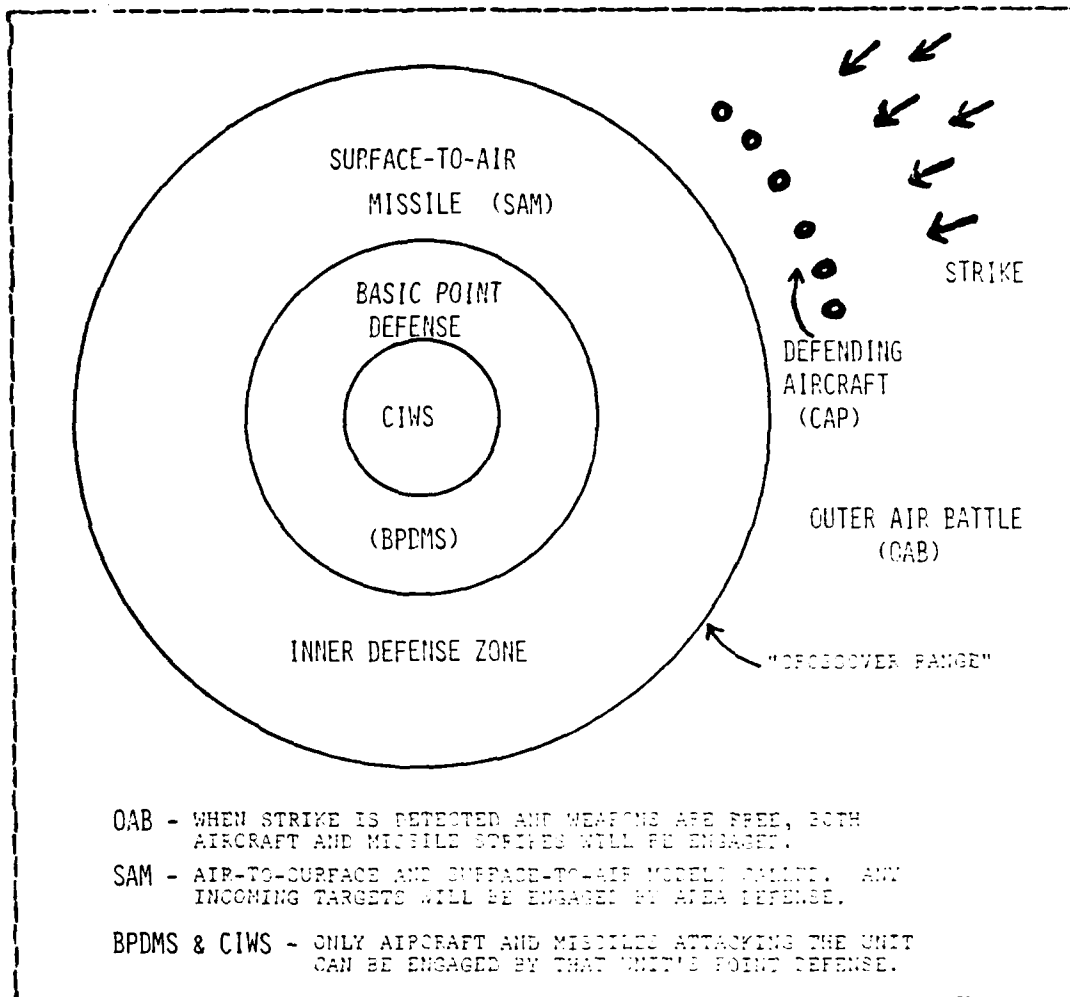

Figure 1.3 NWGS Anti Air Warfare Design.

and attacking platforms, and event scheduling for each phase of the engagement are controlled by one of the monitor procedures depending on the makeup of the attacking group. An inbound strike group of aircraft or cruise missiles outside of the predefined Crossover Range will cause the engagements control module to invoke calls to Module 19 and 20 for Air-to-Air targeting and engagement. The procedures making up these modules are the subjects of this study and

are described in Chapter II. Calls to these modules will be scheduled repeatedly until the targets or defending aircraft have all been destroyed or the targets reach Crossover Range, whichever occurs first. If the targets have reached Crossover range, then at that time, the engagement control module shifts its calls from Modules 19 and 20 to Module 21, the Surface-to-Air engagement module, to simulate the Inner Defense Zone interactions. The procedures and models making up the Surface-to-Air engagement routines have been evaluated prior to this study by D.T. Stokowski [Ref. 7]. The evaluation performed by Stokowski compliments and provides continuity to this study of the WWSG Air-to-Air engagement routines.

II. CURRENT PROGRAM OPERATION

A. OVERVIEW

1. Chapter Structure

The NWGS Air-to-Air engagement models, as a total package, simulate the air battle interactions between defending aircraft and incoming air strikes. The simulations are concerned with the methodology and logic of launcher-target pairing, weapon selection, firing doctrine, warhead success or failure and battle damage assessment. An incoming air strike is composed exclusively of either aircraft or cruise missiles. The NWGS provides separate sets of procedures to model these two variations of strike composition. This chapter provides a thorough description of the air-to-air models for both strike group types.

Just as the actual sequencing of events occur in an air battle, the model descriptions in this chapter are divided into four engagement phases. They are the Targeting Phase, the Shoot Phase, the Engagement Result Phase and the Free Launchers Phase. The main NWGS procedures which define these phases are:

- M19_AC_AC_TGTING (Aircraft vs Aircraft Targeting),
- M20_AC_AC_2 (Aircraft vs Aircraft Engagement),
- M19_AC_MSL_TGTING (Aircraft vs Missile Targeting),
- M20_AC_MSL (Aircraft vs Missile Engagement).

Several additional subroutines are called by these procedures during each of the engagement phases. They are identified and described under their appropriate phase heading. Each engagement phase description includes a separate subsection for aircraft and missile strike descriptions.

Throughout the model descriptions in this chapter, references to the particular engagement phase name and the strike composition are used in lieu of the NWGS procedure names. This is done to improve the clarity and flow in the often complex descriptions. A discussion here of the relationship between the engagement phases and the NWGS procedures will promote this effort.

The Targeting Phase is performed by the procedure M19_AC_AC_TGTING or M19_AC_MSL_TGTING depending on the air strike composition. The remaining three phases Shoot, Engagement Result and Free Launchers are accomplished by the procedure M20_AC_AC_2 or M20_AC_MSL depending again on the strike group composition. These two procedures are each divided into three different entry points. Each entry point performs one of the three remaining engagement phases.

For further clarification, all references to subroutines in this chapter will appear in upper case text. References to actual program variable names will appear within single quotation marks (' '). However, as often as feasible, program variables are referred to by general description rather than by actual names.

2. Preparatory Comments

This section of the chapter overview provides the reader with a few clarifying concepts for the detailed procedure descriptions. First, it is helpful to have an understanding of the relationship between the air-to-air engagements routines with respect to the ongoing war game. Second, the role of sensor detections in the air battle modeling is important to realize. Finally, very general descriptions of each of the engagement phases are given to clarify their relationships.

While the war game is in progress, access to the air-to-air engagement routines is preceded by movement of

the air strike and the defending aircraft. This is performed by the NWGS kinematics routines. At the same time all activated sensors are evaluated through the periodic execution of the NWGS detection routines. The air-to-air models are activated by the engagement control module once a two-sided engagement has been defined and the opposing sides have been identified by the NWGS detection routines. The engagement routines may be initiated by player command or automatically as a result of doctrinal control of forces. In either case, the engagement processing is the same. In the Anti-Air-Warfare arena, the air battle simulations are followed by the Surface-to-Air and the Air-to-Surface battle simulations. In other arenas, they may be followed only by the Air-to-Surface battle simulations or battle damage assessment.

The NWGS detection routines are periodically executed for all active sensors participating in the war game. A player must have detection information available before the engagement procedures can be initiated. However, detection information is not used directly by any of the air-to-air engagement models. The NWGS philosophy states that in an actual Naval Combat situation, sufficient sensor data is always available to execute the necessary engagements [Ref. 6]. For this reason, the NWGS assumes that it is unnecessary to connect the detection simulation to the air-to-air engagement simulation.

The following is an introductory description of the NWGS air-to-air engagement phases of execution. It provides the overall understanding of the goals of each phase for the detailed model discussion. Recall the four engagement phases are:

- The Targeting Phase,
- The Shoot Phase,
- The Engagement Result Phase,
- The Free Launchers Phase.

The Targeting Phase determines launcher and target platform eligibility for engagement, based on the range capabilities of the launcher's weapon complement. All launcher, weapon and target platform combinations that may engage are identified for entry into the Shoot Phase. The Shoot Phase evaluates all of these potential engagement combinations to determine which will actually engage. This determination is made through the evaluation of the probability of launcher conversion for each combination. The Shoot Phase then executes the actual weapons expenditure. The Engagement Result Phase is scheduled for activation at the expected time of weapon-target impact. This phase then evaluates the effectiveness of each fired weapon through the probability of kill evaluation. This evaluation uses either a deterministic or a stochastic method to determine each engagement outcome. The Free Launchers Phase releases the launchers and updates information so that the launchers are available for reassignment.

E. TARGETING PHASE

1. Overview

The Targeting Phase is performed by the procedure M19_AC_AC_TGTING or M19_AC_MSL_TGTING, depending on the air strike composition. M19_AC_AC_TGTING is the aircraft targeting procedure and M19_AC_MSL_TGTING is the cruise missile targeting procedure. Each procedure, with its associated subroutines, models the logical processes of pairing potential weapon launching aircraft with target platforms. The aircraft targeting procedure considers the defending aircraft and the attacking strike group aircraft as potential launchers. The missile targeting procedure is one-sided in this respect.

Each call to one of these procedures considers a single strike group of aircraft or cruise missiles. An aircraft strike may include several tracks, each with its own subtask or mission assignment. A cruise missile strike, whether surface-, subsurface- or air-launched, is always considered as a single homogeneous track. It is important to note that a single track of aircraft or missiles may consist of one or several platforms. Defending aircraft are composed of Combat Air Patrol (CAP) and Deck Launched Interceptors (DLI). All available CAP and DLI associated with the particular strike are considered in the targeting process.

Both procedures access several system common procedures and subroutines that assist in this phase of processing. Subroutines available to the targeting procedures are the TARGETING and WEAPON_FREE_CHECK subroutines used only by the aircraft targeting procedure, and the M30_PROXIMITY, LIST_PLAT, OAB_PAIRS, ASSIGN_MULTII and ORDER_PAIRS subroutines, which are used by both. The important aspects of these are described when applicable. Figure 2.1 shows the Targeting Phase procedure and subroutine hierarchy.

Throughout the Targeting Phase description, most program variables are referred to in general descriptive terms. However, a few of the actual variable names are used repeatedly and are considered to be more effective than their general descriptions. Two of these variables, 'q_strike_entity' and 'air_air_pair', represent large data structures. The 'q_strike_entity' variable is referred to as a table. It contains all of the necessary information to define the potential air battle. The 'air_air_pair' data structure is also a table. As the name implies, it contains the launcher and target pairs created by the Targeting Phase. The 'strike_ix' variable is the index to a specific

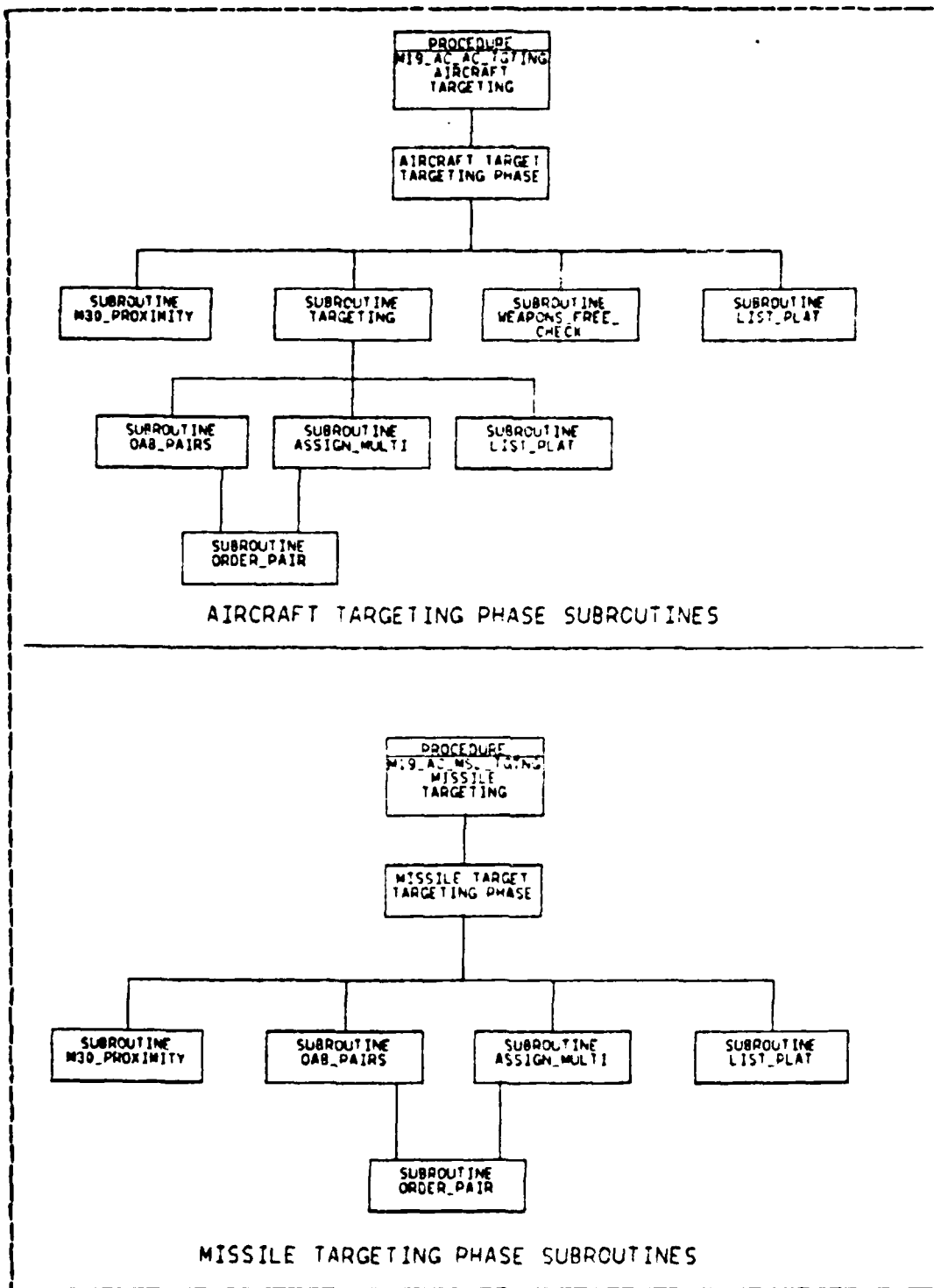

Figure 2.1 aircraft and Missile Targeting Phase Subroutines.

'q_strike_entity' table. The 'wpn_limit', 'no_limit' and 'max' variables are all one dimensional limits used in optimizing the targeting process.

The Targeting Phase is initiated when the engagement control module calls one of the targeting procedures. Regardless of which procedure is being called, the control module passes the single index parameter 'strike_ix'. This index provides access to the 'q_strike_entity' table, which totally defines the potential air battle. The result of the Targeting Phase is the globally defined data structure 'air_air_pair'. This table contains the selected launcher-weapon and target platform combinations with the associated data needed by subsequent engagement phases to continue processing.

2. Aircraft Targeting

The aircraft targeting procedure M19_AC_AC_TGTING performs the Targeting Phase when the strike group is composed of aircraft. It considers all of the tracks which make up the strike group when processing for appropriate engagement pairings. All available CAP and DLI aircraft are considered as well. Appendix A (p.135) and Appendix B (p.195) show the procedure and model flows for the aircraft targeting procedure.

a. Initialization

Upon initial activation, the aircraft targeting procedure uses the 'strike_ix' parameter to access information relative to the strike group and the potential air battle. Among the variables which are then initialized are the following engagement parameters:

- the total number of CAP tracks,

- the total number of CAP aircraft included in the CAP tracks,
- the number of tracks included in the strike group, given as mission subtasks,
- and the total number of aircraft in the strike group.

Also obtained, are the indices to game data base tables which identify the individual CAP and strike group aircraft tracks. The 'wpn_limit' variable is set at this time according to the size of the potential air battle. This and other targeting limits are discussed in detail in subsection (d).

The remainder of the Targeting Phase is divided into two halves. The first half evaluates the CAP aircraft as potential launchers and the strike aircraft as targets. The second half performs the same task with the roles of launcher and target reversed. This allows the air-to-air capable strike aircraft the opportunity to target the CAP aircraft. The methodology of the two halves is identical. Therefore the remainder of the Targeting Phase is described using the general terms launcher and target in place of CAP and strike aircraft. The processing point at which the roles are reversed is identified at the appropriate time during this description.

Each of the following subsections represents a sequential subphase of the processing for the aircraft Targeting Phase.

b. Weapons Free Check

This section of the Targeting Phase determines which of the launcher aircraft are qualified for further processing. For each potential launcher track, the subroutine WEAPONS_FREE_CHECK is called to evaluate each track's

clearance-to-fire status. Appendix A (p.140) shows the procedure flow for this subroutine.

WEAPONS_FREE_CHECK evaluates the first aircraft of each launcher track. If the first aircraft has been assigned a weapons-free status, then all other members of that track are assumed to have the same status. The weapons-free status is assigned during game play by the appropriate authority and stored in each aircraft's data base table. This subroutine also keeps a running count of the total number of qualified launcher aircraft. Only launcher tracks with weapons-free status are processed further. These qualified launcher tracks are indexed in a separate table for further processing.

c. Range Determination

Following the determination of qualified launchers, the main control loop of the aircraft targeting procedure executes the complete targeting process for one target track at a time. From this point on in the processing, a single track of potential targets and all weapons-free launchers are being considered for targeting.

The subroutine M30_PROXIMITY is now called to perform the launcher to target track range determination. This subroutine uses a great-circle ranging routine to calculate the ranges between the target track and every eligible launcher track. It then orders the launcher tracks according to increasing range from the subject target track. The result of this subroutine is a table of launcher-target track pairings by increasing range. The tabled ranges represent the distance along the surface of the globe and do not account for track altitude.

When the range determination is complete for a particular target track, the subroutine LIST_PLAT is called. This subroutine identifies and tables the individual target

aircraft within the subject target track. It also determines the total number of aircraft in the target track.

d. Mission Weighting and Targeting Limits

Prior to performing the actual targeting for each particular target track, three limiting parameters must be evaluated and set. The parameter names are 'MAX', 'wpa_limit' and 'at_limit'.

The 'MAX' parameter is the maximum number of launcher aircraft that may be assigned to the particular target track. The determination of this parameter includes the target track's mission weighting factor, the total number of launchers available and the ratio of aircraft in the target track to the total number of targets in the air battle. The mission weighting factor represents the importance of the target track mission assignment. Table I shows the various mission weighting factors. Equation 2.1 shows the model used for determining 'MAX', the launcher assignment limit.

$$\text{MAX} = (R * \text{TL} * (\text{ST} / \text{TT})) + .5, \quad (2.1)$$

where R = the track mission weighting factor,

TL = the number of eligible launcher aircraft,

ST = the number of aircraft in the target track,

TT = the total number of aircraft in the strike.

The 'wpa_limit' parameter is defined as the maximum number of times that a single target aircraft may be targeted at a given time. This parameter value is assigned based on the size of the potential air battle. If the number of CAP aircraft and the number of strike aircraft are both greater than two, then the 'wpa_limit' is set to two

(2). Otherwise, the 'wgn_limit' is set to one (1) for the smaller air battle. This targeting limit applies only during the one-to-one targeting phase which is discussed in subsection (e-1). The one-to-one targeting phase allows launchers to be assigned only one target aircraft.

The 'mt_limit' parameter is defined as the maximum number of times that a single target aircraft may be targeted at a given time including the consideration of multi-targeting launchers. This targeting limit applies only during the multi-targeting phase which is discussed in subsection (e-2). Table I summarizes the assignment of 'wgn_limit' and 'mt_limit'.

TABLE I
Aircraft Targeting Phase Limits and Weighting Factors

MISSION	WEIGHTING FACTOR	LARGE AIR BATTLE >2 PER SIDE		SMALL AIR BATTLE <=2 PER SIDE
STRIKE	1.5	2	*	1
		3	**	2
ECSORT	1.2	2	*	1
		2	**	2
OTHER	0.8	2	*	1
		1	**	1
CAP as TARGETS	1.2	2	*	1
		3	**	2

* wgn_limit

** mt_limit

e. Individual Track Targeting

The aircraft targeting procedure now calls the subroutine TARGETING to perform the decision analysis needed to complete the targeting process for the subject target track. This subroutine searches for appropriate combinations of launcher aircraft, weapon type and target aircraft. The subroutine executes in two segments. The first segment performs one-to-one pairing of launchers to targets, assigning at most one target to a launcher. The second segment creates additional targeting assignments using previously paired launchers that have multiple targeting capability. When appropriate matches are found, either the CAB_PAIRS subroutine or the ASSIGN_MULTI subroutine is used to store the necessary information. Which subroutine is used depends on the segment that is being executed. The necessary pairing information is stored in the 'air_air_pair' table for access during the remaining engagement phases. Appendix A (p.141) and Appendix B (p.196) show the procedure and basic model flow for the subroutine TARGETING.

(1) One-to-One Targeting Segment. The one-to-one targeting segment of the subroutine TARGETING considers all available qualified launcher aircraft and the single target track of interest. Initially encountered in this segment of processing is a pair of nested procedural loops. The outer loop increments through each launcher track. The inner loop steps through the individual launcher aircraft within each track. Either loop may be exited if the "MAX" number of launcher assignments for this target track is reached.

For each launcher aircraft that is evaluated, two initial status checks are performed. The first check confirms that the potential launcher is not already

destroyed. The second one insures that the launcher aircraft is not already assigned. If either of these checks fail, evaluation of that launcher is bypassed.

If both of the above checks are successful, then processing of that particular launcher continues. At this point the single qualified launcher aircraft and the multiple target track are being evaluated. The one-to-one targeting segment now evaluates one weapon of the launcher aircraft's weapon complement at a time until the appropriate weapon is found. Each air-to-air type weapon onboard the potential launcher is evaluated for suitability in the specific situation. The weapons are evaluated in order of their range capability. Longer range weapons are evaluated first. This is the order of their indexing in the NWGS data base. The weapon parameters used to evaluate the weapon's suitability are its minimum and maximum range capability and its maximum lock in and lock down capability in terms of altitude differential. The limiting parameter values are accessed from the NWGS data base listed under weapon properties. The actual range and altitude difference values used in the evaluation are determined using the launcher and target tracks. When a qualified weapon is identified, processing continues to the next nested level. If a satisfactory weapon is not found then processing of that launcher aircraft is bypassed and another launcher will be evaluated.

The next level of processing is nested within the above weapon evaluation structure. It considers the launcher and the selected weapon while evaluating individual target aircraft as potential targets. Two individual search processes may be conducted to find an appropriate pairing. The first search evaluates alternate target aircraft in the track. This method is used until a qualified pairing is found or half of the aircraft within the

track have been targeted. If no pairing is found using this search method or half of the aircraft are targeted, then the second search method is executed. The second method evaluates every target aircraft in the track until a pairing is found. The target evaluation within these searches consists of two target status checks. The first check confirms that the target aircraft has not already been destroyed. The second check determines if the target aircraft has already been targeted to its limit 'wpa_limit'. If these two checks are satisfactory, then the subroutine OAB_PAIRS is called to store the launcher-weapon and target 'air_air_pair' information. If a qualified target can not be found for this launcher and weapon, then another weapon on this launcher is evaluated.

After the launcher aircraft has been assigned to a target, the subroutine TARGETING will continue to increment through the launcher's remaining weapon complement. However, the subroutine logic will only allow another pairing for that launcher under certain special circumstances. The weapon being evaluated must be an aerial gun or a short range non-missile weapon, such as a rocket. This is the only exception to the single pairing per launcher rule for the one-to-one targeting segment. Even in this case, a single weapon may only be assigned to one target.

At the completion of a launcher aircraft processing, whether a targeting assignment is found or not, the subroutine TARGETING increments to the next aircraft in the launcher track and repeats the evaluation sequencing. At the completion of each launcher track processing, the next more distant launcher track is processed, until all available launcher tracks have been evaluated. The only limiting factors in effect during the one-to-one targeting segment are the 'max' parameter for this target track and the 'wpa_limit' parameter, both discussed earlier.

(2) Multi-Targeting Segment. When all of the qualified pairings have been identified in the one-to-one targeting segment, the multi-targeting segment for that track begins. This segment considers all of the aircraft in the current target track whether already targeted or not. The only launcher aircraft that are considered are those which have already been assigned to targets in this air battle. An initial check determines if any pairs exist in the 'air_air_pair' table. If no pairs exist, then multi-targeting proceeds no further and control is returned to the main aircraft targeting procedure to process the next target track.

If pairs do exist in the 'air_air_pair' table for this air battle, then the multi-targeting segment begins processing with a pair of nested loops. The outer loop evaluates each aircraft in the subject target track. For each target aircraft, two status checks are performed. The first check confirms that the target aircraft has not already been destroyed. The second check determines if the target aircraft has already been targeted 'mt_limit' times. If either of these checks fail, then that particular target is bypassed. If both checks are satisfactory, then processing continues to the inner nested loop. This loop increments through every launcher-target pair currently listed in the 'air_air_pair' table for the subject air battle. A search is conducted for a launcher aircraft and selected weapon with multi-targeting capability to pair with the particular target aircraft. A launcher will not be assigned again to the same target aircraft. If a qualified match is found for this target aircraft and more than one round of the selected weapon is available, then the subroutine ASSIGN_MULTI is called to add the additional pairing to the 'air_air_pair' table. When a pairing for this target aircraft has been found, the inner loop is exited and the

counter loop increments to the next aircraft in the target track. If no match is found for any one target aircraft processed after evaluating all eligible launchers, then the multi-targeting segment is terminated and control is returned to the main aircraft targeting procedure M19_AC_AC_TGTING for processing of the next target track.

(3) Subroutines. The subroutines OAB_PAIRS, ASSIGN_MULTI and ORDER_PAIR are accessed by the subroutine TARGETING during the individual track targeting process. The subroutine OAB_PAIRS, called during the one-to-one targeting segment, records the data for each 'air_air_pair' that is required for further engagement processing. It is primarily administrative in nature. This subroutine actually creates the 'air_air_pair' table which will be used by the remaining engagement routines to execute the later phases of the air battle. The subroutine ASSIGN_MULTI performs the same task as OAB_PAIRS except that it is called during the multi-targeting segment. Each of these routines keeps a running total count of the number of launchers assigned to the particular target track being processed. This count is used in the subroutine TARGETING, for comparison to the 'MAX' limit. Since a target may ultimately be targeted more than once, the subroutine ORDER_PAIRS is used to sort the 'air_air_pair' table to keep pairs with the same target together in the table. This is done to simplify processing during the Engagement Result Phase. This subroutine is called by both OAB_PAIRS and ASSIGN_MULTI. Appendix A (p.146-149) shows the flow for these subroutines.

f. Other Target Tracks

The subroutine TARGETING returns control to the aircraft targeting procedure M19_AC_AC_TGTING. The main control loop of this procedure increments to the next target track and repeats the processing already described,

beginning with the range determination. When all of the defined target tracks have been processed, one half of the aircraft targeting procedure has been completed. When the first half is completed, then the launcher and target roles are reversed and sequencing begins again at the weapons fire check. When both halves are completed, aircraft targeting for this targeting interval is complete. The only noticeable difference between the two halves of the procedure is the use of different variables to identify the appropriate 'air_air_pair' tables.

g. Prepare for Shoot Phase

At this point, the existence of the 'air_air_pair' table represents potential air-to-air engagements. The aircraft targeting procedure returns control to the engagement control module and the pending engagements are immediately made available to the air-to-air engagement procedure. Calls for targeting between other strike groups and their associated defending aircraft will continue. When the next targeting interval for the currently targeted strike comes up, the strike group will be processed again. This process will continue until either side is destroyed or the strike group reaches the crossover range.

3. Missile Targeting

The missile targeting procedure M19_AC_MSL_TGTING performs the Targeting Phase for air strikes composed of cruise missiles. The cruise missile strike, whether surface-, subsurface- or air-launched, is always considered a single homogeneous track. All available CAP and DLI aircraft are considered as potential launchers when processing for appropriate engagement pairing. Appendix A (p.176) and Appendix B (p.204) show the procedure and basic model flows for the missile Targeting Phase. Appendix A

(p.146) also shows the flow for the subroutines CAB_PAIRS, ASSIGN_MULTI and ORDER_PAIR accessed during the missile Targeting Phase.

The modeling methodology used for the missile Targeting Phase is very similar to that used for the aircraft Targeting Phase. For this reason, the following description discusses only the effective differences between the missile and aircraft Targeting Phases.

The only notable modeling differences between the aircraft Targeting Phase and the missile Targeting Phase are in the determination of the targeting limits. Since the missile strike consists of one homogeneous track of cruise missile targets, there is no need for a limiting parameter like 'MAX' to restrict the number of launcher assignments. The one-to-one targeting limit 'wgn_limit' is set exactly as in the aircraft Targeting Phase. However, the multi-targeting limit 'mt_limit' is set to the constant value of two (2) for cruise missile targets. This means that a single cruise missile may never be targeted by more than two defending aircraft at one time.

The missile Targeting Phase is, in general, more streamlined than the aircraft Targeting Phase. An obvious reason for this is that the cruise missiles are not provided an opportunity to engage the defending aircraft. Therefore, there is no role reversal coding necessary. Also, the missile targeting procedure internally performs its own weapons free checks and individual track targeting without accessing subroutines. When performing the weapons free checks, the aircraft targeting procedure checks only the first aircraft in each launcher track. The missile targeting procedure checks each potential launcher aircraft directly for a weapons-free rules-of-engagement status. Other subroutines including M30_PROXIMITY, LIST_PLAT, CAB_PAIRS, ASSIGN_MULTI and ORDER_PAIRS are used by the

missile Targeting Phase and perform the same tasks as in the aircraft Targeting Phase.

C. SHOOT PHASE

1. Overview

The air-to-air engagement Shoot Phase commences at the first entry point of the procedure M20_AC_AC_2 or M20_AC_MSL, depending on the the air strike composition. The procedure M20_AC_AC_2 is the NWGS level two air-to-air aircraft engagement procedure. The procedure M20_AC_MSL is the NWGS air-to-air cruise missile engagement procedure. The Shoot Phase models the prelaunch factors which contribute to the success or failure of the launch aircraft in achieving a firing position. These factors are used by the Shoot Phase to determine which launchers will actually engage targets. The call to this phase will evaluate every pending engagement pairing created by the Targeting Phase for the current air strike. The Shoot Phase terminates with the execution of the actual weapon expenditure.

At the completion of the Targeting Phase, the pending engagements are listed in a single 'air_air_pair' table. The Shoot Phase evaluates each targeted pair based on its potential for success. This evaluation considers the availability of Ground Control Intercept vectoring, Airborne Early Warning, environmental weather effects, fire control and weapon launcher reliability and electronic warfare effects.

The factors above are used to calculate the probability of conversion 'PCONV'. The 'PCONV' represents the likelihood that the launcher aircraft will reach a satisfactory weapon launch position and then accomplish the launch.

For each engagement pair, the calculated 'PCONV' and the weapon probability of kill 'PKSS' are used to determine

the actual weapon expenditure. The Shoot Phase routine provides both deterministic and stochastic methods for the weapon expenditure determination.

The Shoot Phase processes will delete some of the engagement pairings created by the Targeting Phase. For the 'air_air_pairs' that survive the evaluation, the Shoot Phase executes the logistics of ordnance expenditure for the launcher aircraft. Each weapon time of flight is calculated in order to approximate an impact time. The average expected weapon-target impact time is used to schedule access to entry point two of the appropriate engagement procedure. Entry point two will then perform the Engagement Result Phase.

The Shoot Phases of the aircraft engagement and the missile engagement procedures access several system common subroutines. Many of these subroutines are purely utility function or administrative in nature and are not described here. The subroutines which are considered relevant to the Shoot Phase modeling and are discussed in this section are:

WEATHER_FACTCS,
TIME_OF_FLIGHT,
VECTOR_CHECK,
M30_DAY_NIGHT,
M02_LEVEL_1_USAGE,
DELETE_PAIR,
LINK_PAIR,
LOOP_AGAIN,
EW
and OP_CM.

The Shoot Phase is initiated when the engagement control module calls the first entry point of an engagement procedure. Regardless of which procedure is called, the control module passes to it the single index parameter 'pstrike_ix'. This index provides access to the

'q_strike_entity' table for the subject air battle. The table contains the cross reference index to the associated 'air_air_pair' table of pending engagements. The final outputs of the Shoot Phase are individual 'air_air_pair' tables which define the engagements that are in progress. For the aircraft Shoot Phase, each table contains engaged pairs using the same weapon type. For the missile Shoot Phase, one 'air_air_pair' table contains all of the engagements in progress. Each 'air_air_pair' table has an expected impact time which is determined from the average times of flight for all of the weapons launched within that table.

2. Aircraft Target Shoot Phase

The Shoot Phase of the aircraft engagement procedure M20_AC_AC_2 evaluates all 'air_air_pairs' of pending aircraft engagements created by the aircraft Targeting Phase. These include the pairs created when the strike aircraft are evaluated as launchers. Figure 2.2 shows the procedure and subroutine hierarchy for the aircraft Shoot Phase. Appendix A (p.150) and Appendix B (p.199) show the procedure and model flow for aircraft Shoot Phase. Flow charted subroutines are listed separately in the applicable subsection below.

a. Initialization and Checks

Upon initial entry, the aircraft engagement procedure uses the calling parameter 'pstrike_ix' to access the appropriate 'q_strike_entity' table. This table provides access to all of the information required for Shoot Phase execution. The associated 'air_air_pair' table contains most of that needed data. The Shoot Phase is controlled by a single loop structure which increments through each engaged pair listed in the 'air_air_pair'

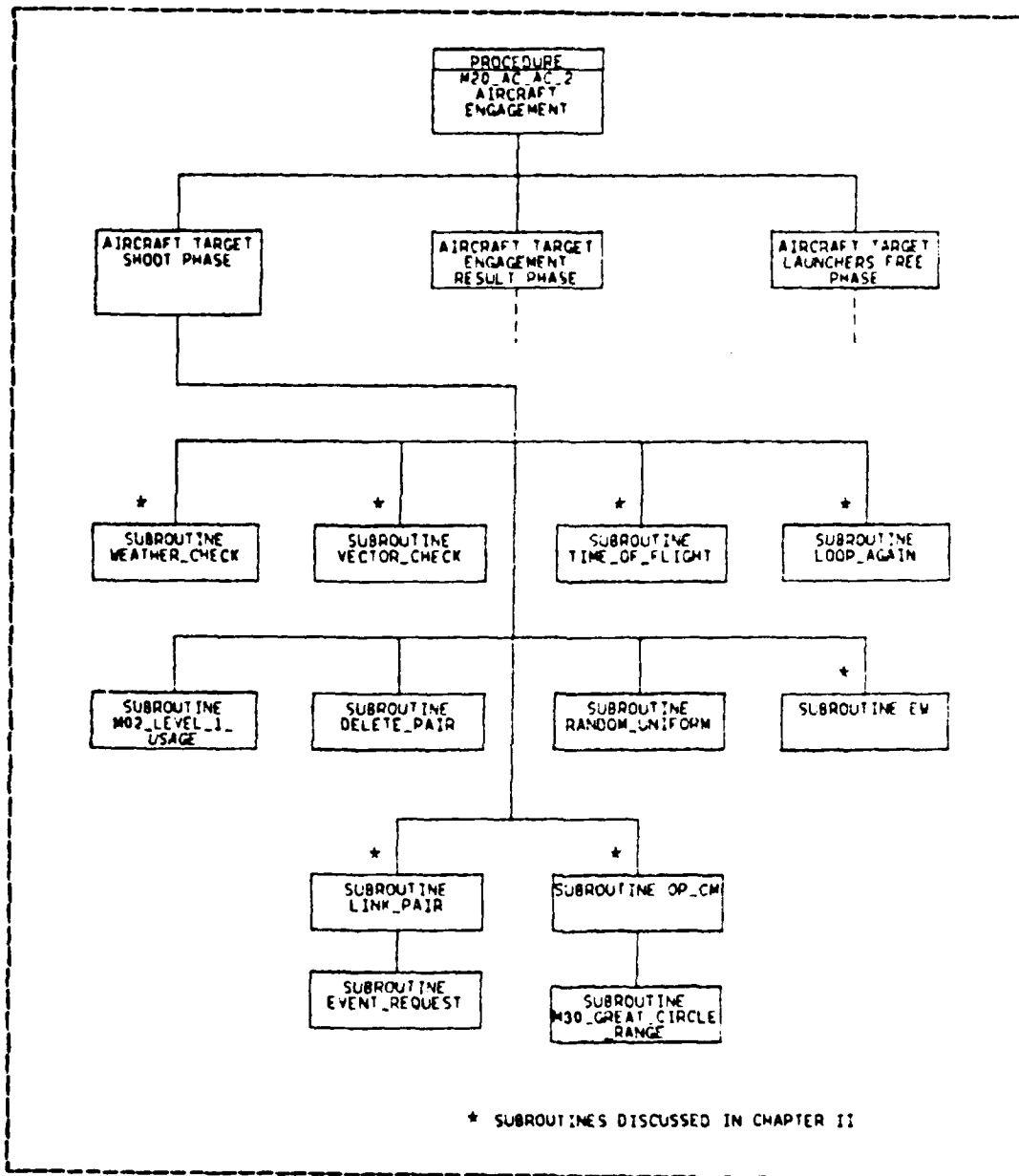

Figure 2.2 Aircraft Shoot Phase Subroutines.

table. This loop structure allows complete Shoot Phase processing for each pair that is using the same weapon type. 'Air_air_pairs' using different weapon types are bypassed.

When the end of the table is reached, additional passes through the table are performed. This is done for each different weapon type used. For each pair that is processed, several working variables are initialized. These include precise aircraft identifications, track indices, flight schedule event indices, target and launcher track altitudes, target track speed, and indices to data base tables for platform and weapon system properties. Each of the following chapter subsections represents a significant sequential section of the aircraft Shoot Phase processing.

b. Baseline Probability Determinations

The Shoot Phase processing next assigns to each 'air_air_pair' two baseline probability values. They are the Probability of Conversion 'PCONV' and the Single Salvo Probability of Kill 'PKSS'. The baseline 'PCONV' appears to be defined as the probability that the proposed launcher aircraft is able to detect the target and maneuver to a satisfactory firing position for the selected weapon. The baseline 'PKSS' must be defined as the conditional probability that a single salvo of the weapon fired will kill the target, given that the launch parameters, the weapon guidance and the fusing are satisfactory.

The NWGS data base provides for a different set of probabilities for each launcher aircraft and weapon combination. For aircraft targets, each probability set may contain up to six different probability values for PCONV and PKSS. The different values are based on the target's speed and size classification. There are two speed categories and three size categories for aircraft targets.

This section of the Shoot Phase initially searches for the data base probability set associated with the particular 'air_air_pair' launcher-weapon combination. If the search is successful, the index to the appropriate

tables is saved for later reference. If the search is not successful, the 'air_air_pair' will later be assigned default values for its baseline probabilities.

Next, the target aircraft of the air_air_pair is classified according to its speed and size category. There are two speed categories. Speed category one is for less than 600 knots. Faster aircraft are assigned to speed category two. There are three aircraft size categories. Aircraft sizes are based on the number of engines on the aircraft and are represented in the NWGS data base under target platform properties. Aircraft target size categories are determined from these data base values. Size category one indicates a single engine aircraft. Category two indicates a twin engine aircraft and size category three represents any larger multi-engine aircraft.

When the target aircraft has been classified according to speed and size, the assignment of baseline probability values may be made. If the appropriate probability table was found in the initial search, the values are provided from the table for aircraft targets of the appropriate speed and size categories. When the appropriate tables are not found, default values are assigned. The default values currently used for a generalized air-to-air missile weapon are PCONV equal to 0.8 and PKSS equal to 0.8. The values for a gun weapon are PCONV equal to 0.4 and PKSS equal to 0.4. These default values are the same for all target aircraft speed and size categories. They are initialized in the variable declaration section of the M20_AC_AC_2 procedure's PL/I code.

c. Weather Factor Determination

The Shoot Phase processing now continues by calling the subroutine WEATHER_FACTOR to evaluate the engagement weather environment. This subroutine returns two

environmental factor values, 'env_fac_cv' and 'env_fac_pk', to the aircraft engagement procedure. Both values are numbers between 0.0 and 1.0, and are used as multiplicative factors for the final 'PCONV' and 'PKSS' calculations. The 'env_fac_cv' parameter applies to 'PCONV' and the 'env_fac_pk' applies to 'PKSS'. The environmental area weather evaluation includes cloud density, precipitation density, day-or-night and the launcher and target location relative to these factors. WEATHER_FACTOR accesses the subroutine M30_DAY_NIGHT. Appendix A (p.160) shows the subroutine flow for WEATHER_FACTOR.

The war game environmental weather quality is established in the NWGS data base during program scenario initialization. Cloud and precipitation densities are categorically classified as none, low, medium or high. The NWGS data base contains property tables for each weapon system and weapon used by the gaming system. Within these tables are environmental factors for effectiveness which are indexed in terms of cloud density and precipitation density levels.

The subroutine WEATHER_FACTOR first calls M30_DAY_NIGHT to determine if the current game time is day or night. When it is night time, the precipitation density level is set to a value of medium or high for effect. At day times, the actual precipitation level is used. The location of the target with respect to clouds is then determined. The subroutine WEATHER_FACTOR then determines the appropriate category indices for table look up of the appropriate environmental factors. The 'env_fac_cv' is accessed from the weapon system property table. The 'env_fac_pk' is accessed from the weapon property table. Table II summarizes the determination and assignment of the weather factor indices by this subroutine. The subroutine WEATHER_FACTOR uses the indices to look up the appropriate factors for each

pair evaluated and returns them to the aircraft engagement procedure.

TABLE II
Environmental Factor Index Determination

CONDITION	WEAPON TYPE	INDEX for ENV_FAC_CV (q_weapon_system)	INDEX for ENV_FAC_PK (q_weapon)
Launcher and/or Target Inside Clouds	GUN	MAX (0,1,2,3) (cloud,precip)	NO EFFECT
	AAM	MAX (0,1,2,3) (cloud,precip)	PRECIP + 3 (4,5,6)
Launcher and Target Outside Clouds **	GUN	NO EFFECT	NO EFFECT
Launcher and Target Below Clouds and Precip NOT=0	AAM	PRECIP (0,1,2,3)	PRECIP + 3 (4,5,6)
Launcher and/or Target above cloud tops and below tops	AAM	?	3

** OR No Precip OR No Clouds

AAM = Air-to-Air Missile

d. Vector Assistance Factor Evaluation

This portion of the Shoot Phase determines if there is vectoring assistance available for each launcher aircraft. Vector assistance may come from either Ground Control Intercept (GCI) or Airborne Early Warning (AEW). The subroutine VECTOR_CHECK is called to perform the evaluation. It returns an effectiveness factor that is used as another multiplicative factor for modifying 'PCONV'. Appendix A (p.162) shows the subroutine flow for VECTOR_CHECK.

The evaluation of vectoring assistance is performed only if the launcher aircraft is associated with CAP tracks or defending aircraft. If the launcher aircraft is part of the strike group, this portion of the shoot phase is bypassed and the vector assistance multiplicative factor is set to 1.0. Both of these capabilities, GCI and AEW, are assumed to enhance the PCONV.

The actual factor values used by the Shoot Phase are initialized in the variable declaration section of the aircraft engagement procedure M20_AC_AC_2. When there is GCI available, the vector assistance factor is set to 1.1. When AEW is available, the vectoring assistance factor is set to 1.2. If the launcher aircraft is operating autonomously, a factor of 1.0 is used.

e. Final PCONV Calculation

This portion of the Shoot Phase calculates the final 'PCONV'. The 'pconv' is used to evaluate the firing doctrine and determine the actual weapons expenditure for each 'air_air_pair' engagement. The baseline PCONV value from the initial data base table look-up is modified by several factors. These factors are weapon system fire control reliability, weapon system launcher reliability, environmental factor for conversion and the vectoring assistance factor. The first two factors are weapon system properties accessed directly from the data base. The last two factors are determined as described previously in the weather factor and vector assistance factor determination descriptions. The final 'PCONV' appears to be defined as the probability that the launcher is able to detect, track, intercept and successfully launch the selected weapon at a target of the specific speed and size category.

Equation 2.2 gives the formula used to modify the baseline PCONV.

$$PCONV = PCVB * FCR * LP * EF * CF \quad (2.2)$$

where PCVB = the particular baseline PCONV,
FCR = the weapon system fire control reliability,
LP = the weapon system launcher reliability,
EF = the environmental weather factor for PCONV,
CF = the vectoring assistance factor.

f. Firing Doctrine and Weapons Expenditures

The Shoot Phase next determines the firing doctrine and weapon expenditure used by the launcher aircraft for the subject engagement. The result of this portion of the Shoot Phase is the actual number of missiles fired or rounds of bullets expended by the launcher aircraft. The final PCONV value previously calculated and the baseline PKSS are the parameters used to make the firing doctrine decision.

If the selected weapon is an aerial gun, then Equation 2.3 gives the formula which determines the number of rounds actually expended.

$$\text{Rounds_Fired} = PCONV * \text{MIN} (RA, MR) \quad (2.3)$$

where RA = the rounds available to fire,
MR = the maximum rounds that can be fired
based on the gun's rate of fire and the
duration of the strike.

If the selected weapon is an air-to-air missile, then the number of missiles actually fired may be either

deterministically or stochastically evaluated based on firing doctrine and PCONV. The firing doctrine is first determined as a function of the baseline 'PKSS' and the number of the selected missile type available. There are two firing doctrines. Firing doctrine one will consider firing one missile and is used when the baseline 'PKSS' is greater than 0.7 or when there are less than four rounds of the selected weapon available. Firing doctrine two will consider firing two missiles and is used only when the PKSS is less than or equal to 0.7 and more than 4 rounds are available. The actual weapon expenditure is evaluated using the firing doctrine and the 'PCONV'.

When the deterministic method is used, the number of missile rounds fired is determined primarily by the 'PCONV'. If the 'PCONV' is less than 0.5, no missiles will be fired. If the 'PCONV' is between 0.5 and 0.7, one missile is launched and if the 'PCONV' is greater than or equal to 0.7, the firing doctrine discussed in the previous paragraph is used.

If the stochastic method is used, a randomization process is performed. For each round of the firing doctrine, a Uniform (0,1) random number is drawn and compared to the 'PCONV'. If the random number is less than the 'PCONV', then a missile is launched. Otherwise, that round is not launched. If firing doctrine two is used, then this comparison is repeated with another random number. The maximum number that may be launched is equal to the firing doctrine. Table II summarizes the actual rounds expended determination.

When the number of rounds expended is determined to be more than zero, then the level one logistics procedure M02_LEVEL_1_USAGE is called to update the launcher weapon load. This is accomplished simply by decrementing the weapons available by the number fired. The pairs in which

the launcher fires zero rounds are deleted from the 'air_air_pair' table by the subroutine DELETE_PAIR. These launchers are then released for retargeting. When all of the 'air_air_pairs' for the current table have been processed, the resulting 'air_air_pair' tables will hold the parameters needed for the Engagement Result Phase.

TABLE III
Rounds Fired Determination

AIR-TO-AIR MISSILES		GUNS
Deterministic		Deterministic only
<4 Rounds Avail.	>=4 Rounds Avail.	RA = Rounds Avail. MR = Rate-of-Fire * Strike-period
PCONV>=0.5 Rnds_f=1	PCONV>=0.7 PKSS<=0.7 Rnds_f=2	Rnds_f = PCONV * MIN(RA,MR)
	PCONV>=0.5 AND PCONV<=0.7 Rnds_f=1	
PCONV<=0.5 Rnds_f=0		
Stochastic		
PKSS>0.7 Rnds_f= 1 if RN<=PCONV 0 if RN>PCONV	PKSS>0.7 Rnds_f= 2 if 2 RN<=PCONV 1 if 1RN<=PCONV 0 if 0RN<=PCONV	

g. Weapon Time of Flight

Following each weapon expenditure determination, the subroutine TIME_OF_FLIGHT is called to determine the approximate weapon time of flight. These times are later used to obtain an average impact time. The impact time will be used to schedule the call to the Engagement Result Phase of the aircraft engagement procedure. Appendix A (p.163) shows the subroutine flow for TIME_OF_FLIGHT.

The subroutine TIME_OF_FLIGHT uses the range between the launcher and target tracks, the target track speed, the average weapon speed and a target aspect in determining the approximate weapon time of flight.

The range and target track speed are accessed from the 'air_air_pair' table for the particular pair. The weapon property tables of the NWGS data base provide the average speed of each air-to-air missile type and the muzzle velocity for gun system. The data base also provides weapon aspect effectiveness factors. They are numbers between 0.0 and 1.0 representing the particular weapon's effectiveness with respect to target aspect. Target aspect is defined as the angle between the target's flight path vector and the line of bearing from the target to the launcher aircraft. The data base has provisions for four different factors for each weapon type. The factors represent four general categories of target aspect. They are:

- Head-On,
- Tail-On,
- Forward-Quarter
- Rear-Quarter.

The subroutine TIME_OF_FLIGHT first searches through the specified weapon's aspect effectiveness factors for the maximum value. It then uses the associated target aspect category to calculate the approximate weapon time of

flight. For the Tail-On case, if the weapon speed is more than 1.2 times the target speed, then time of flight (TOF) is calculated as the range divided by the difference between target and weapon speeds. For other aspect categories or for the Tail-On aspect case with a slower weapon, TOF is initialized as the range divided by the sum of the target and weapon speeds. Then if the chosen aspect is Rear-Quarter or Forward-Quarter, a delta factor is added to the initialized TOF. The delta factor calculation is shown in Equation 2.4. The current time of flight model output is summarized in Table IV.

$$\text{Delta} = (2 * VT * R) / (VM**2 - VT**2) \quad (2.4)$$

where VM = the average weapon speed,

VT = the target speed,

R = the launcher-to-target range.

When the approximate TOF has been calculated, it is compared with the weapon property table value for this weapon's maximum time of flight. If the calculated TOF is greater, then the actual TOF used is set to the maximum value. The resultant weapon TOF for each 'air_air_pair' is added to a running total of TOFs for this type of weapon.

h. Electronic Warfare Effects

The final evaluation made during the aircraft engagement Shoot Phase is performed only when the launcher aircraft being processed is part of the attacking strike group. The subroutines EW and OP_CM are called to determine if any aircraft associated with the target are using electronic warfare (EW) measures. In this case, the target

TABLE IV
Time of Flight Calculation

LAUNCH ASPECT USED	TIME OF FLIGHT FORMULA	NOTES
HEAD-ON	$TOF = RNG/VM+VT$	RNG = Launcher Track - Target Track Range VM = Average weapon Speed VT = Target Track Speed $Delta = \frac{2 \cdot VT \cdot RNG}{VM+2 \cdot VT+2}$
TAIL-ON VM>1.2*VT	$TOF = RNG/VM-VT$	
TAIL-ON VM<=1.2*VT	$TOF = RNG/VM+VT$	
FORWARD Quarter	$TOF = RNG/VM+VT + Delta$ $= RNG/VM-VT$	
REAR QUARTER	$TOF = RNG/VM+VT + Delta$ $= RNG/VM-VT$	

aircraft must be CAP or defending aircraft. An array of status flags is set that will be used later in the engagement result phase. The status array defines the characteristics of the electronic warfare measures. The subroutine EW checks all of the aircraft associated with the CAP that is targeted for active EW support. The subroutine CP_CM uses 150 miles as the maximum EW effectiveness range. If the range between the EW support aircraft and the launcher aircraft is less than 150 miles, the appropriate flags are set to indicate jammer support for the CAP aircraft. appropriate flags in the launcher's subtask data table. Appendix A (p.164) shows the flow for the subroutines EW and CP_CM.

1. Prepare for Engagement Result Phase

Much of the modeling in the Shoot Phase should be considered as preparation for the Engagement Result Phase. Specifically, the baseline PK3S, EW evaluation and

the weapon TOF calculations are all used in the third phase of the air battle execution. These preparatory evaluation results are currently stored in the 'air_air_pair' data structure.

The subroutine LINK_PAIR is responsible for creating the separate 'air_air_pair' tables for pairs firing the same type of weapon. This subroutine averages all of the times of flight to obtain an approximation for the weapon-target impact time. That impact time is used to schedule the return call to entry point two of the aircraft engagement procedure. Appendix A (p.166) shows the flow of the subroutine LINK_PAIR.

The subroutine LOOP_AGAIN is used to recycle the original 'air_air_pair' table in order to process the next set of pairs using a different weapon type. This occurs after LINK_PAIR has isolated the prior set of pairs for separate Engagement Result evaluation. Launchers that have fired launch-and-leave weapons are scheduled for immediate calls to entry point three of the aircraft engagement procedure. Launch-and-leave weapons do not require guidance from the launcher after launch. Therefore, the launchers may be freed for further targeting assignment. Otherwise, the launchers will not be freed until after weapon impact and completion of the engagement result phase. Appendix A (p.167) shows the flow for the subroutine LOOP_AGAIN.

3. Missile Target Shoot phase

The Shoot Phase of the cruise missile engagement procedure M20_AC_MSL evaluates all of the 'air_air_pairs' created by the missile targeting routine for the subject cruise missile strike. The missile target Shoot Phase is more streamlined than the aircraft target Shoot Phase. Again, this is primarily due to the single homogeneous track of the cruise missile strike. The basic modeling of the

missile target Shoot Phase is very similar to that of the aircraft target Shoot Phase. Appendix A (p.181) and Appendix B (p.205) show the procedure and model flow for the missile target Shoot Phase. Figure 2.3 shows the missile

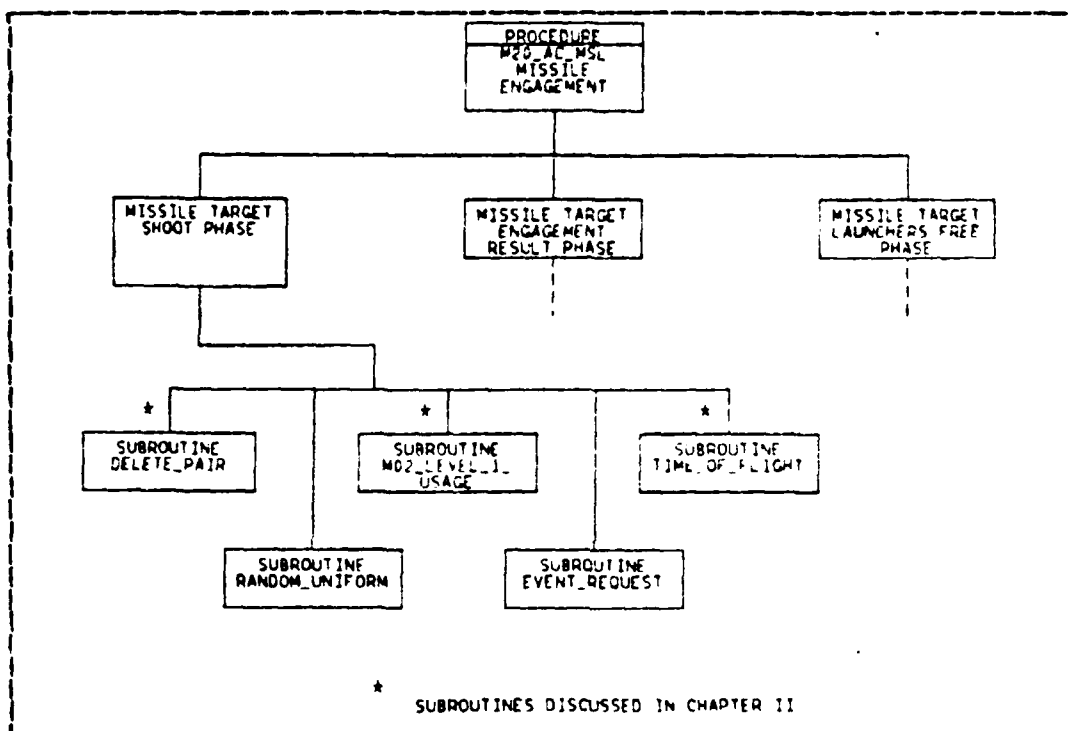

Figure 2.3 Missile Shoot Phase Subroutines.

target Shoot Phase subroutine hierarchy.

The most notable difference in the modeling is in the classification of targets for determining baseline probabilities. Also, no vectoring assistance evaluation is performed during the missile target Shoot Phase. The environmental effectiveness factor is evaluated in exactly the same manner except that it is accomplished totally within the missile targeting procedure. The final calculation of PCONV, firing doctrine, weapons expenditure and weapon time

of flight are precisely the same. Since the cruise missiles will never be evaluated as launchers themselves, the evaluation of the CAP EW support is not performed. Because of the degree of modeling similarity, the following process description discusses only the differences of the missile target Shoot Phase.

a. Baseline Probabilities Determination

As in the aircraft target Shoot Phase, this portion of the missile target Shoot Phase assigns to each 'air_air_pair' two baseline probabilities, 'PCONV' and 'PKSS'. The NWGS data base provides sets of probabilities for each launcher aircraft and weapon type combination. When the targets are cruise missiles, they are assumed to be roughly equal in size. Therefore, the differentiating categorical factors used in this model are target speed and altitude. There are three speed categories for cruise missile targets: less than 500 knots, 500 - 1200 knots and greater than 1200 knots. There are four altitude categories for cruise missile targets: 0 - 5000 feet, 5000 - 20,000 feet, 20,000 - 50,000 feet, and above 50,000 feet. The data base provides for different 'PCONV' and 'PKSS' values for each combination of target speed and altitude categories. This results in twelve different baseline probability values, for each launcher aircraft and weapon combination, a cruise missile target.

As in the aircraft target procedure, default values for PCONV and PKSS are provided for the cases when a probability set for the selected weapon can not be found. These values are initialized in the variable declaration section of the procedure M20_AC_MSL. The default parameter names are 'msl_default_pconv', 'msl_default_pk', 'gun_default_pconv' and 'gun_default_pk'. Their values are currently set at 0.8, 0.8, 0.4, and 0.4 respectively.

b. Final PCCNV Calculation

The final 'PCONV' calculation used by the missile target Shoot Phase differs from the aircraft Shoot Phase only in the omission of the vector assistance evaluation. The formula used for the final 'PCONV' calculation is shown in Equation 2.5

$$\text{PCONV} = \text{PCVB} * \text{FCR} * \text{LR} * \text{EF} \quad (2.5)$$

where PCVB = baseline PCCNV,

FCR = Fire Control reliability,

LR = Launcher Rail reliability,

EF = Environmental Weather factor.

c. Prepare for Engagement Result Phase

The final output for each execution of the missile-target Shoot Phase is always a single 'air-air-pair' table. This table contains every engagement that is currently in progress for that particular air battle. Different weapons are not separated out, as in the aircraft target Shoot Phase. They are all included in the same table. The primary result of this modeling difference is that a single impact time is calculated for the entire missile strike.

D. ENGAGEMENT RESULT PHASE

1. Overview

The Air-to-Air Engagement Result Phase commences at the second entry point of the procedure M20_AC_AC_2 or M20_AC_MSI, depending on the strike composition. The

procedure M20_AC_AC_2 is the aircraft strike engagement procedure and the procedure M20_AC_MSL is the cruise missile strike engagement procedure. The Engagement Result Phase models the postlaunch factors that contribute to a launched weapon's degree of success in killing its assigned target. These factors are used by this phase to determine the outcome of weapon firings that were executed during the Shoot Phase. Both weapon performance and battle damage assessment are included in this determination.

Calls to the Engagement Result Phase are scheduled during the Shoot Phase based on the expected weapon-target impact time. The engagement pairs to be evaluated are provided in the 'air_air_pair' table scheduled for that specified impact time. Factors included in the weapon performance evaluation are weapon guidance reliability, weapon reliability, electronic counter measures, environmental weather effects and target aspect effects. The final probability of kill for each engagement is calculated by modifying the baseline PKSS according to the above factors. The modified 'PKSS' is in turn used to evaluate the probability of target destruction. The Engagement Result Phase terminates with the completion of battle damage assessment.

The Engagement Result Phases for both aircraft strikes and cruise missile strikes access several system common subroutines to assist in processing. Many are purely utility functions or administrative in nature and are not described here. The relevant model related subroutines accessed by the aircraft Engagement Result Phase are M30_EW, M26_ACEDA_2, and UPDATE. The only model related subroutine used by the Engagement Result Phase for cruise missile targets is M30_EW. The important aspects of these are described were applicable.

The final result of the Engagement Result Phase is the actual outcome of one set of simulated air battle

interactions. For each engagement pair, the target platform is determined to be destroyed, damaged or totally undamaged. Cruise missiles and single engine aircraft targets are simply destroyed or not destroyed. Larger aircraft may be damaged and consequently accumulate damage over multiple engagements.

2. Aircraft Target Engagement Results

The Engagement Result Phase of the aircraft engagement procedure M20_AC_AC_2 evaluates the outcome of all 'air_air_pair' engagements with their impact time equal to the current game time. Figure 2.4 shows the aircraft Engagement Result Phase subroutine hierarchy. Appendix A (p.156) and Appendix B (p.201) show the procedure and model flow for the aircraft target Engagement Result Phase. Flow charted subroutines are listed separately below where applicable.

a. Initialization and Checks

Entry point two of the aircraft target engagement procedure is activated when the actual game time reaches the average weapon impact time calculated during the Shoot Phase. The particular 'air_air_pair' table to be evaluated is identified by the parameter structure created at the completion of the Shoot Phase.

The Engagement Result Phase uses a single control structure to complete the weapon performance evaluation for every 'air_air_pair' before the battle damage assessment is executed. This control loop performs the complete factor evaluation and final 'PKSS' calculation for each pair. The following three subsections contain descriptions of the processing within this control structure.

For each pair that is evaluated, two status checks must be performed before processing can continue.

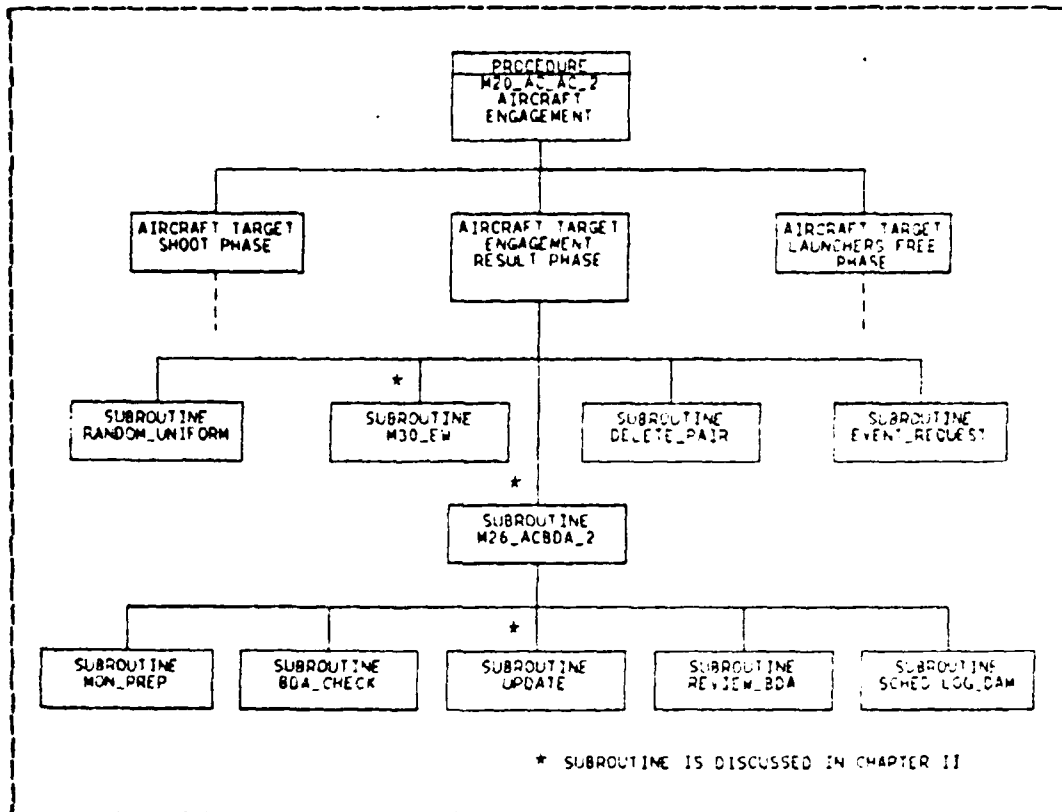

Figure 2.4 Aircraft Engagement Result Phase Subroutines.

The first check determines if there has been an untargeting command issued for the subject target. The current engagement has already been executed and therefore can not be stopped. However, if the particular target aircraft is currently targeted by another launcher which has not fired yet, then that engagement will be stopped. The evaluation of the current weapon continues. The second status check confirms that the target aircraft has not already been destroyed. If the target aircraft still exists, evaluation continues. Otherwise, that pair is deleted from the table without being processed and the next pair is processed.

If the subject engaged pair passes the above checks, then several indices are accessed from the 'air_air_pair' table which identify the target, launcher and weapon data structures needed for further evaluation. Also initialized is the environmental factor for 'PKSS' evaluated during the Shoot Phase and the attacking strike group's global electronic warfare status, which is discussed in subsection (C).

F. Launch Aspect and Effectiveness Factor

This section of the Engagement Result Phase determines the target aspect effectiveness factor for the engaged weapon. The effectiveness factor is used as a multiplicative factor for the final PKSS calculation.

The weapon property tables of the NWGS data base can provide weapon aspect effectiveness values for each weapon type. These factors represent the particular weapon's effectiveness with respect to target aspect at launch. They are the same values used in the subroutine TIME_OF_FLIGHT discussed during the aircraft target Shoot Phase. The four factors provided represent the general categories of target aspect:

- Head-On,
- Tail-On,
- Forward-Quarter
- Rear-Quarter.

The Engagement Result Phase provides two methods for determining the aspect effectiveness factor to be used for each 'air_air_pair'. The deterministic or the stochastic method will be used depending on the game preparator's selection. When the deterministic method is used the aspect effectiveness value used is simply the largest. The most advantageous value of the four factors given for the particular weapon will be used. When the stochastic

method is used a random comparison value is created by summing all four of the weapon aspect factors and multiplying the total by a Uniform (0,1) random number. The resultant random value is then compared first to the head-on factor and then compared progressively to the accumulated factors until the random value is less than or equal to the accumulated sum of the data base factors. When the comparison is satisfied, the aspect effectiveness factor used is the last one added to the cumulative sum.

c. Electronic Warfare Factors Determination

This portion of the Engagement Result Phase uses the subroutine M30_EW to evaluate the effects of operating Electronic Countermeasures (ECM) and Electronic Counter Countermeasures (ECCM). For this phase, the effects of greatest interest are those which impact on the engaged weapon 'PKSS'. The subroutine M30_EW is provided with the input parameters weapon type and 'tgt_cm'. It returns two effectiveness factors which are used in the final 'PKSS' calculation. The two factors are 'ecm_eff' and 'eccm_eff'. The 'ecm_eff' parameter is associated with the target aircraft and the 'eccm_eff' parameter is associated with the engaged weapon. The effectiveness values are numbers between 0.0 and 1.0 and are used as multiplicative factors. Appendix A (p.168) shows the flow for the subroutine M30_EW.

Prior to calling the subroutine M30_EW, the input parameter 'tgt_cm' must be initialized. This variable is an array of indicator bits which defines the characteristics of the ECM associated with the target aircraft. The characteristics included are noise jamming, chaff, infra-red decoys and electronic decoys. If the target is a member of the strike group, then the 'tgt_cm' array is set using the strike group global ECM status which was initialized at the start of this phase. If the target is a CAP aircraft, then

the 'tgt_cm' array is set according to the evaluation made by the subroutines EW and OP_CM at the end of the Shoot Phase. It should be noted that the target in either case need not be operating active ECM itself. When the target is a CAP aircraft, ECM support may be provided by any associated aircraft. However, when the target is a strike group aircraft, support must be within the same target track.

The subroutine M30_EW, when called, first determines if the target aircraft has ECM support. If it does, then the subroutine further evaluates the ECM characteristics with respect to the operating frequency bands and chaff or decoy usage. The weapon property tables of the NWGS data base contain parameters that indicate each weapon's susceptibility to different types of ECM. These weapon property tables also contain a single 'ecm_eff' value and a single 'eccm_eff' value for each weapon type in the NWGS system. These parameters are accessed to determine the ECM and ECCM effectiveness. If the target is jamming, using chaff or using decoys and the weapon is susceptible to any of these, then the weapon's 'ecm_eff' factor is set to the data base value. Otherwise, the 'ecm_eff' factor is set to zero (0). The same sort of evaluation is performed for the weapon's ECCM capabilities. If the engaged weapon has ECCM capabilities against the operating ECM, then the 'eccm_eff' factor is set to the data base value. Otherwise, the 'eccm_eff' factor is set to zero (0). The values assigned to 'ecm_eff' and 'eccm_eff' are returned to the Engagement Result Phase of the aircraft engagement procedure for 'PKSS' evaluation.

d. Probability of Kill Calculation

This section of the Engagement Result Phase modifies the baseline 'PKSS' determined during the Shoot Phase. The calculation is performed for each 'air_air_pair' being evaluated. Equation 2.6 shows the model formula.

$$PKSS = (PKSS * WRF * GRF * ASP * ENV) * (1 - (1 - eccm) * ecm) \quad (2.4)$$

where PKSS = the final probability of kill,

PKSS = the baseline probability of kill,

WRF = the weapon reliability factor,

GRF = the guidance reliability factor,

ASP = the target aspect effectiveness factor,

ENV = the environmental factor for PKSS,

eccm = the weapon ECCM effectiveness,

ecm = the target ECM effectiveness.

One additional evaluation is performed for weapons that require postlaunch guidance from the launching aircraft. If the launching aircraft has been destroyed prior to the weapon impact time, then the PKSS is further degraded by a factor of 0.5. Otherwise, the final 'PKSS' remains unchanged.

Finally, for each engagement pair processed, the final 'PKSS' is stored with the appropriate 'air_air_pair' for access by the battle damage assessment subroutine.

e. Target Damage Assessment

The final process of the aircraft target Engagement Result Phase is the target damage assessment. When the weapon performance evaluation for each pair has been completed, the aircraft engagement procedure calls the level two battle damage assessment subroutine M26_ACEDA_2 to perform the final target damage evaluations. This subroutine uses the final calculated 'PKSS' for each engaged pair to determine if the target aircraft is destroyed or not destroyed. If the target is not destroyed, then the

subroutine M26_ACBDA_2 calls the subroutine UPDATE to evaluate the level of damage. Appendix A (p.169) and Appendix B (p.202) show the subroutine and model flow for M26_ACBDA_2.

The subroutine M26_ACBDA_2 execution is controlled by a pair of nested loops. The outer loop allows processing to continue while there are still engaged pairs in the 'air_air_pair' table. The inner loop processes pairs while the same target aircraft is involved. During the Targeting Phase, pairs with the same target were kept together in the 'air_air_pair' table. For each pair, a status check is performed to insure that the target aircraft has not already been destroyed. If the target still exists, then the aircraft battle damage subroutine begins the process that converts the 'PKSS' for each engagement pair to the cumulative probability of target destruction 'PROC_DES'. First, the standard salvo size for the subject weapon is obtained from the data base weapon property table. Salvo size is defined as the number of shots that make up a single salvo. The PKSS is based on a single salvo firing. Second, a cumulative damage weighting factor is initialized based on the type of weapon fired. For all air-to-air missiles, the 'cum_dam' is set to three (3). For all guns, the 'cum_dam' is set to one (1). This variable is used to assist in evaluation of accumulated damage when the target is determined not to be destroyed.

For each 'air_air_pair' with the same target, equation 2.7 is used iteratively to determine the cumulative probability of no damage to the target.

$$PND = END * (1-PKSS) ** (NS/SS) \quad (2.7)$$

where, PND = the prob. of no damage by this engagement,

PKSS = the probability of kill for this pair,
NS = the number of shots fired for this pair,
SS = the number of shots per salvo.

When all of the 'air_air_pairs' having the same target have been processed, the cumulative probability of no damage (PND) is examined. If the cumulative PND is equal to 1.0, then further processing of that target is bypassed, since no damage will occur. In this case, the subroutine's outer loop increments to the next target aircraft for evaluation.

If some positive probability of target damage (1-PND), the final calculation to determine the probability of target destruction 'PROB_DES' is performed as shown in Equation 2.8

$$\text{PROB_DES} = (1 - \text{PND}) * (.8 + .4 * \text{RN}) \quad (2.8)$$

where PND = the cum. probability of no target damage,

RN = a number between 0.0 and 1.0, which is random Uniform if the method is stochastic or a default value if the method is deterministic.

If the value for 'RN' alone is less than the final PROB_DES, then the target aircraft is determined to be destroyed. Otherwise, the target is not destroyed and must be evaluated further for damage. When the aircraft target has two or more engines and the 'PROB_DES' to 'RN' ratio is greater than 0.5, then the subroutine UPDATE is called to evaluate the target damage. If the 'PROB_DES' to 'RN' ratio is less than 0.5, or the target aircraft has only one

engine, the target is determined to be undamaged. Appendix A (p.173) shows the subroutine flow for UPDATE.

The subroutine UPDATE is called when the target aircraft is not destroyed but the PROB_DES is considered large enough to warrant damage to its sensors or weapons. First, the damage ratio (DR) is set equal to the 'PROB_DES'/'RN' ratio. At this point, the target's cumulative damage status is updated according to the variable parameter 'cum_dam' initialized earlier. Air-to-air missiles were assigned a factor of 3 and guns a factor of 1. The appropriate value is added to the target's cumulative damage status. This status is a running total of the damage incurred on the target aircraft during the current flight, including other engagements. At this point, if the cumulative damage status is greater than five (5), the subroutine UPDATE determines the target to be destroyed. In this case, control is returned to the aircraft battle damage assessment subroutine and evaluation of the next target begins.

When the target's cumulative damage is less than six (6), the subroutine UPDATE continues to evaluate the damage to sensors and weapons. The number of sensors and weapons damaged is determined according to Equation 2.9 and 2.10 .

$$n_{\text{sen_dam}} = PD * TNS + 0.5 \quad (\text{truncated}) \quad (2.9)$$

$$n_{\text{wep_dam}} = PD * TNW + 0.5 \quad (\text{truncated}) \quad (2.10)$$

where $n_{\text{sen_dam}}$ = the number of sensors damaged,
 $n_{\text{wep_dam}}$ = the number of weapons damaged,

PD = FROB_DES/RN ratio,
TNS = the target aircraft sensor capacity,
TNW = the target aircraft weapon capacity.

The subroutine UPDATE uses separate loops to step through the target's sensor systems and weapon systems. Within each loop, the subroutine codes the operative systems as damaged until 'nsen_dam' and 'nwep_dam' are reached. If all of either system type are damaged, the respective loop is exited. If all sensor systems and all weapon systems are damaged, then the subroutine UPDATE again determines that the target is destroyed.

At the completion of the target damage evaluation, control is returned to the battle damage assessment subroutine M26_ACBDA_2. Several administrative subroutines are then called to perform the necessary record keeping tasks. These subroutines are not relevant to the Engagement Result Phase modeling and are not discussed further. Now, if there are more aircraft targets to be evaluated for this impact time, the subroutine's outer control loop initiates another target evaluation sequence. Otherwise, control is returned to the aircraft target engagement procedure M20_AC_AC_2 and the Engagement Result Phase is complete.

f. Prepare for Free Launchers Phase

When all Engagement Results have been evaluated for a particular impact time, the Engagement Result Phase final action is to fill the parameter structure which is used by NWGS to schedule and call entry point three of the aircraft engagement procedure M20_AC_AC_2. Entry point three is the Free Launchers Phase of engagement execution. This event is scheduled for 15 seconds after the engagement result time.

3. Missile Target Engagement Results

The Engagement Result Phase of the cruise missile engagement procedure M20_AC_MSL uses virtually the identical methodology and modeling as the aircraft engagement procedure M20_AC_AC_2. Except for the one-sidedness of the air battle with cruise missiles, a few different variable names and a simplified battle damage assessment, the two procedures for this phase are indistinguishable. Initial checks, launch aspect effectiveness, electronic warfare effectiveness and probability of kill determination are modeled in exactly the same manner as the aircraft target routine. The only notable modeling difference which needs discussion is in the damage assessment area. Figure 2.5 shows the missile target Engagement Result Phase subroutine hierarchy. Appendix A (p.188) and Appendix B (p.206) show the procedure and model flow for the missile target Engagement Result Phase.

The target damage assessment portion of the Engagement Result Phase for missile targets is accomplished totally within the missile engagement procedure. However, the missile target evaluation routine contains a simplified version of the M26_ACSDA_2 subroutine. The methodology is the same, but the evaluation is carried out only to the point where the target is determined to be either destroyed or not destroyed. The variable for probability of kill 'PK_PROD' is calculated as shown in equation 2.11 and it uses an identical formula for PND (Equation 2.7) as in the aircraft target routine. The 'PK_PROD' is evaluated for each 'air_air_pair' even when the same target platform is involved. Therefore, any cumulative probability of kill for a given target is not considered for cruise missile targets, as it is for aircraft targets.

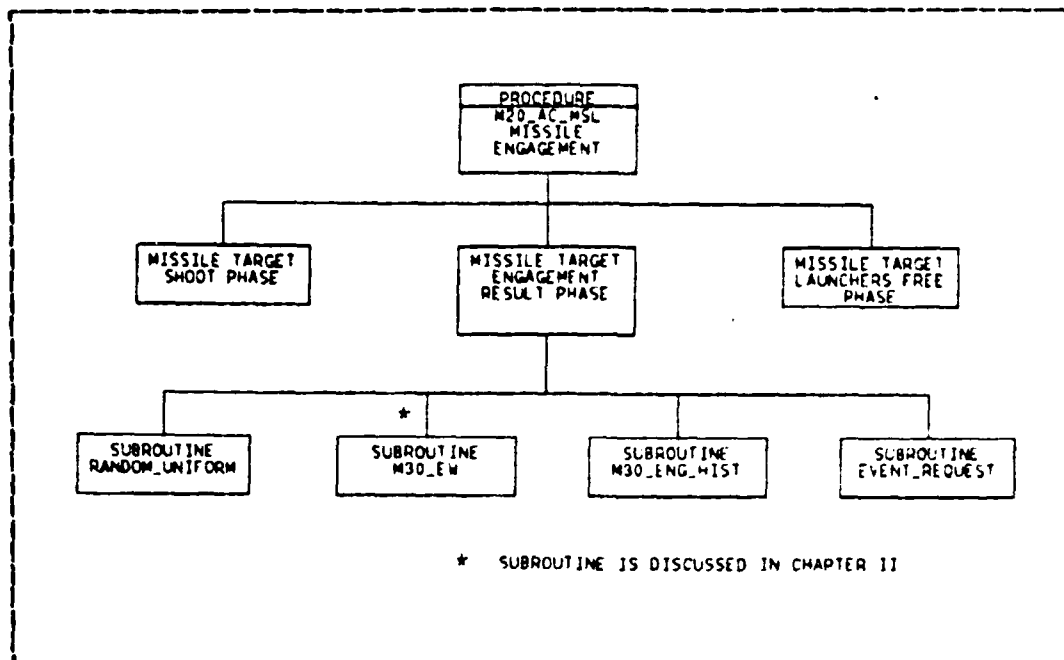

Figure 2.5 Missile Engagement Result Phase Subroutines.

$$PK_PROD = 1 - PND \quad (2.11)$$

where PND = cumulative probability of no damage to this target.

When the value for 'PK_PROD' is calculated, it is compared to a reference probability. The reference probability is set by the game preparator when the deterministic evaluation method is used. When the stochastic method is used, the reference probability is a Uniform (0,1) random number redrawn for each comparison. The reference value assigned by the game preparator is different from the 'RN' reference value used in the aircraft target procedure. Both values are accessed from the 'q_model_ctl' table. However, the missile engagement reference probability is found under

'reference_prob.engagements', and the aircraft target engagement 'RN' value is found under '.bda'. In any case, for cruise missile targets, if the 'PK_PROD' value is greater than or equal to the reference probability, then the cruise missile is determined to be destroyed. Otherwise, the cruise missile target completely escapes damage and the next target 'air_air_pair' begins processing.

E. FREE LAUNCHERS PHASE

For both the M20_AC_AC_2 and the M20_AC_MSL procedures, the execution of this phase is identical. For some engagements, when the weapon involved is a launch-and-leave type weapon, which requires no guidance information after launch, this phase is scheduled immediately at the end of the Shoot Phase. In all other cases, it is scheduled following the Engagement Result Phase. It is a very simple phase, yet it is essential because it allows the launcher aircraft to be freed for further targeting assignment. This is accomplished simply, by setting the launcher assignment bit in the appropriate launcher platform data table to zero (0) for each launcher indicated by the scheduling parameter structure. Once this has been accomplished, control is returned to the Aircraft or Missile monitor routines in the engagement control modules and these aircraft are available for targeting and other air battles if necessary. The 'air_air_pair' created by a launch-and-leave weapon engagement is still evaluated at the appropriate impact time even though the launcher aircraft may have been freed. Appendix A (p.159) and Appendix B (p.203) show the Free Launchers Phase flow for the aircraft target routines. Appendix A (p.193) and Appendix B (p.207) show the corresponding flow for the cruise missile target routines.

III. EVALUATION

A. OVERVIEW

This chapter provides qualitative commentary concerning the suitability and reasonability of the NWGS air-to-air engagement models described in Chapter II. From an operational point of view, it discusses the strong and weak points of the models with respect to the level of realism. From an analytic point of view, parameter definition, parameter aggregation and modeling technique are the main points of emphasis. This discussion furnishes an understanding of what the models actually provide for the user and also clarifies that which is not provided. Computer programming errors that effect the model outputs are also identified in this chapter. An added purpose for this discussion is to lay the groundwork for recommendations made in Chapter IV.

1. Evaluation of Data Based Models

Data based modeling in general has both advantages and disadvantages. The main advantage is that it permits development of very generalized and unclassified models. Thus, a single model may be used to describe several scenarios. Given such a model with sufficient parameters and a data base with the appropriate parameter values, almost any process may be simulated. The major disadvantage of data based modeling may result directly from this capability. The model builder can easily acquire a tendency to define convenient arbitrary parameters for his model. These parameters, as defined and combined within the model, may completely satisfy the model requirements. However, when the model user attempts to fill the data base with the

required values, the parameter definitions may become difficult to represent.

The availability of appropriate data for the parameter structure of a data based model is a critical issue. The model builder must always be concerned with the existence of representative data for the parameters defined, whether or not it is the model builder's responsibility to provide those values. Appropriate data can be obtained from actual performance or test evaluations, Fleet operational evaluations, intelligence publications or from other commonly accepted models and simulations. In any case, the information required must be either directly available or obtainable through derivation.

The system contractor for NWGS, Computer Sciences Corporation, was required to provide only the data base structure and parameter definitions with their models. The data base values, some of which are classified, are to be provided by the U.S. Navy. The problem of arbitrary parameter definitions and the subsequent difficulty of parameter representation in the data base have become significant problems for the Center for War Gaming in the installation of NWGS.

Throughout this evaluation, an emphasis is placed on the availability of data for the defined parameters. The actual parameter values to be provided by the classified data base are not included in this study. However, the NWGS air-to-air models are so dependent on their data base values, that an effort is made throughout the evaluation to provide clear parameter definitions for use by the NWGS Data Base Manager.

2. Evaluation Approach

The organization of this evaluation is based on the three major engagement phases of the NWGS air-to-air

engagement routines. They are the Targeting Phase, the Shoot Phase and the Engagement Result Phase. It should be understood however, that the underlying structure of the evaluation is founded in the reality of air-to-air engagements. The implication is that certain minimum sequential components of air-to-air engagements must be considered by any model that intends to describe that warfare environment. There are five major components that must be accounted for, regardless of the model's level of detail. They are:

- Detection evaluation,
- Targeting/Weapon Assignment evaluation,
- Conversion to Firing Position,
- Shoot Determination,
- Engagement Outcome.

Operators and analysts alike would agree that these provide a minimum structure for modeling the air-to-air arena. Any particular model should also be able to distinguish between the long range type of engagement and the short range and/or dog fight type of air-to-air engagement.

Each of the five components above includes several subcomponents which should be considered by the model in some appropriate way during the major component analysis. The level of detail required in the model is generally dictated by the detail implied by the model inputs. More importantly, the level of detail should be determined by the detail of the outputs that the model user requires to make decisions. This required level of detail in turn dictates the degree of subcomponent aggregation that is allowable. These subcomponents are identified and discussed further within the applicable evaluation sections.

The NWGS approach to air-to-air engagement modeling is quite different than the sequential component structure discussed above. No detection evaluation is performed once

the strike group has been detected by the defending force. The Targeting Phase performs an optimized assignment of launcher, weapon and target combinations while assuming that all targets are detected by all eligible launcher aircraft. These assignments are made when a target is within a weapon maximum effective range. The Shoot Phase then performs several different evaluations for each targeting assignment to determine which engagements are actually executed. This phase must account for all factors involved in the engagement scenario that contribute to the launcher's ability to launch a specific weapon. There is no time delay between the Targeting Phase and the Shoot Phase. This means that the evaluation of the Conversion to Firing Position is conducted after the fact. The original targeting assignments are made at the desired weapon firing position. When the weapon launches have been executed, the Engagement Result Phase determines the outcome by evaluating the factors which contribute to the weapon performance and subsequent target damage.

The discussions contained in this chapter relate the five major components of generalized air-to-air engagements to the three modeling phases of the NWGS air-to-air engagement routines. The procedure descriptions in Chapter II demonstrate the significant commonality of the aircraft target and cruise missile target routines. Therefore, the following discussions do not generally separate the evaluation of different target types. However, the important modeling aspects related specifically to different target types are pointed out in the appropriate sections.

E. NWGS TARGETING PHASE EVALUATION

Since the Targeting Phase is the first phase of the NWGS air-to-air engagement routines, it must satisfy the minimum

modeling requirement of the initial components of the generalized air-to-air engagement. The components that should be considered during this phase are the Detection evaluation and the Weapons Assignment evaluation.

In an aggregate model where only the numbers of launchers and targets are used, factors that effect individual target detection ranges can be consumed into a single factor. For models using more detail, where individual platform versus platform engagements are represented, it is important to account for the subcomponents of the Detection and Targeting evaluations individually.

Important subcomponents that should be considered during the Detection evaluation component are:

- Jamming (both self screening and stand-off),
- Target Density for Radar Resolution,
- Radar Target Size,
- Weather Factors.

If a target has jamming support, this will have a great impact on the actual target detection range. A launcher may be unable to detect a jammer screened target until well inside its maximum effective weapon range. The air strike density will also have significant impact on long range radar resolution of individual targets. For example, in a realistic long range scenario, a weapon may initially be assigned to a single radar track which may actually be composed of multiple platforms. These individual platforms will not be resolvable until a shorter range. The target size and weather also directly influence the radar's ability to detect the target. In the short range cases, the most important factor becomes First Radar or Visual Detection and Jamming becomes much less critical.

Subcomponents that contribute to the Targeting evaluation in both the short and the long range cases are:

- Rules of Engagement Status,
- Potential Launcher Weapon Compliment,
- Launcher Target Range.

The important point to be made here is that targeting of individual target platforms cannot and should not be performed until the individual targets are detectable. When multiple targets are detected as a single radar track, only the single radar track should be targeted.

The NWGS Targeting Phase, for both aircraft and cruise missile targets, does not follow the sequential component approach of the generalized air-to-air engagement model. Detection information including jamming analysis, target density, target size and weather are not evaluated at all during this phase. The significant effects of intercept geometry on the weapon maximum range capability are also not considered during this phase.

The Targeting Phase is initiated when the strike group as a whole is detected, but targeting assignments are not made until the launcher-to-target range is within a launcher weapon's maximum effective range. When the Targeting Phase is initiated it begins immediately performing the targeting process. First, it evaluates the rules-of-engagement status for all potential launchers. Then the NWGS Targeting Phase performs an idealized weapon assignment process which creates specific launcher-weapon and target combinations. These targeting assignments are based solely on the launcher-to-target range and altitude differential with respect to the specific weapon capabilities.

Idealized targeting refers to the NWGS effort to optimize the platform-to-platform weapon assignments. Throughout the targeting process, the general assumption is that all target platforms are identified and resolvable, even with respect to their missions. Targeting limits

calculated during this phase control the number of launchers assigned to a single mission track and prevent over targeting of individual target platforms. The process is purely deterministic and the result is a perfect and all knowing launcher allocation for the given range separation.

The NWGS Targeting Phase is not a one-time operation. It is executed repeatedly as the ranges between launchers and targets close. There is only one special provision during the Targeting Phase to distinguish the short range air battle from the long range engagement. When a launcher has multiple aerial guns on board, more than one target may be assigned to that launcher aircraft. That extra provision affects primarily large bomber aircraft with multiple gun systems for defense. Otherwise, close range targeting assignments are performed in the same manner as the long range assignments.

It appears that the NWGS approach to the modeling of the air-to-air engagement arena is based on the following conceptual sequence. The Targeting Phase will first create the idealized, all knowing launcher-target allocation. Then the Shoot Phase, in an effort to account for all of the aspects of realism, will perform the appropriate evaluations. These evaluations then totally determine the decision to actually execute each engagement. This approach is contrary to a realistic or expected sequencing of events. In the final analysis, if the model output should happen to be reasonable, it will be extremely difficult to explain in realistic terms, how the model produced those results.

The following subsections provide discussion of specific areas of interest in the existing Targeting Phase modeling. Although the NWGS approach is not considered desirable, most of the suggested solutions below are discussed in terms of improving the existing model.

1. Weapons Free Check

The rules-of-engagement evaluation for both aircraft and cruise missile targets is performed, as it should be, early in the Targeting Phase. Neither model allows a launcher to be assigned a target without a weapons-free status. Since the actual targeting assignments are created at the proposed weapon launch point, the weapons-free status check must be performed at that time. Models that simulate the conversion process from a long range detection to the weapon firing position, may evaluate the weapons-free status at the completion of the conversion, long after the initial weapon selection is made. A weapon-tight status should not preclude the execution of a conversion if the conversion is desired. In reality, the appropriate time for a rules-of-engagement check is prior to the shoot decision. It is important that during game play, the player is forced to be aware of the weapons-free status.

2. Range Determination

The subroutine M30-PROXIMITY is called by the Targeting Phase to determine the ranges that are used for later evaluations. This subroutine calculates the great-circle range between tracks. The great-circle ranging method yields the distance along the surface of the earth. It does not take the track altitudes into account. Altitude differential will have a significant effect on the range determination. In the air-to-air targeting environment, ranges are short enough so that the slant-range method will provide much better information. The slant-range, or the line of sight range, method should be used during this phase to calculate the range between launchers and targets. during the Targeting Phase evaluation.

3. Mission Weighting and Targeting Limits

The Targeting Phase uses mission weighting factors and target proportion ratios to determine the targeting limit "max". The "max" value controls the number of launchers assigned to a particular track of targets. The targeting limits "max", "wpn_limit" and "mt_limit" all assist in targeting optimization. The use of mission weighting factors implies launcher knowledge of each target mission. Such emphasis on the target mission importance is a reasonable approach when the air-to-air engagements reach the visual detection or short range arena. In that environment, the launcher can pick its target through visual identification. However, in the classic long range scenario, it is doubtful that such mission knowledge would be available during target assignment. For this reason, the mission weighting factors should only be used by the Targeting Phase when the launcher-to-target range is less than some reasonable visual range, say eight miles. If any target weighting is to be performed at long range, it should really be based on radar return size or passive sensor information. The use of the targeting limits "wpn_limit", "mt_limit" and "max" without the mission weighting factor are very effective controls for performing the optimized target allocation.

4. Altitude Differential and Weapon Parameters

The Targeting Phase uses the altitude differential between launcher and target tracks to evaluate the selected weapon's lock-up and lock-down limitations. The actual weapon lock-up and lock-down limitations for most air-to-air weapons are expressed in terms of degrees. There is no meaningful way to define these limits in terms of altitude differential as this model does. These angular limitations of interest here are given relative to the horizon. A

simple calculation using the slant range and altitude differential between launcher and target can be made to determine the appropriate value. Figure 3.1 illustrates the problem. If the angular limitation of interest were radar or weapon gimbal limitations, then calculations would have to evaluate the angle relative to the aircraft center line. The information required to perform that calculation can not

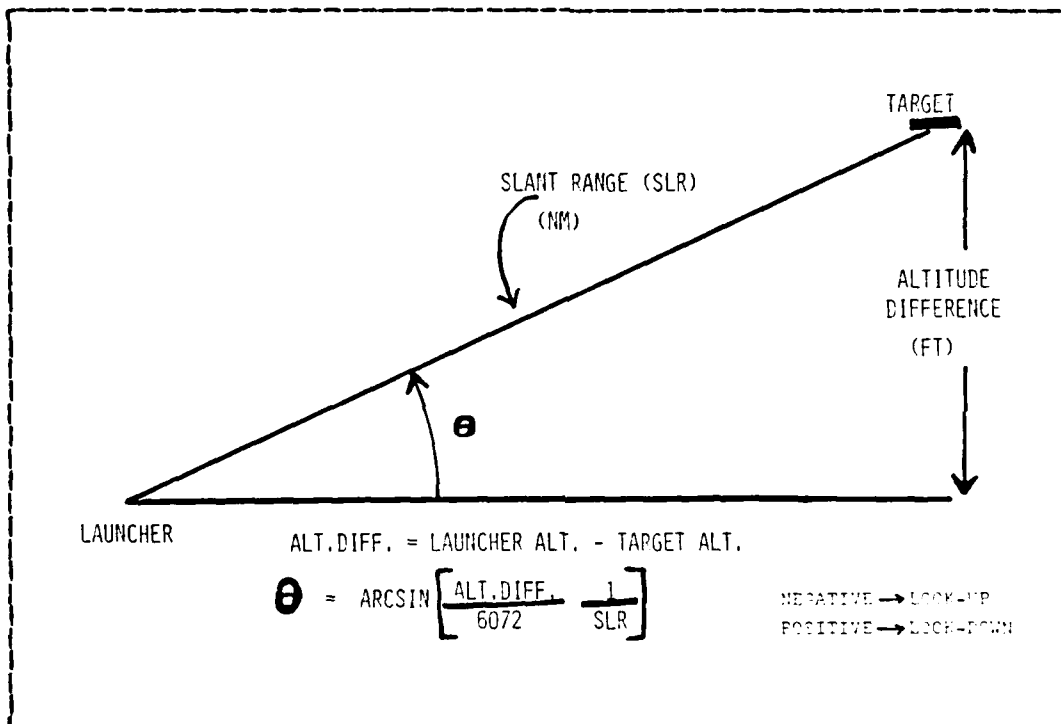

Figure 3.1 Weapon Look-Up/Look-Down Determination.

be provided by NWGS. If this method is used, the appropriate changes must also be made to the data base weapon property limits for lock-up and lock-down.

The current Targeting Phase method for evaluating the weapon's lock-up and lock-down limits, besides using altitude differential, also has a logical error in the PL/T

coding. The error exists in both the aircraft and missile target procedures and is repeated wherever this evaluation is performed. The altitude differential will always be a negative value when the target is higher than the launcher. If the data base look-up limit value is positive, the look-up limit will always be satisfied. If the data base value is negative, then the look-up limit will only be satisfied when there is actually an excessive look-up.

There is also some question as to the necessity of this evaluation considering the level of detail provided by this model. The check is certainly appropriate for the longer range engagements. However, for the close range engagements where the dynamic launcher positioning is not actually modeled, the Targeting Phase should assume that these limitations are accounted for through the launcher positioning. Therefore, the appropriate model should use degrees of launcher look-up or look-down for long range targeting and then stop using the limitations when the range closes to less than five miles.

5. Jamming Evaluation

Several factors have been mentioned which are subcomponents of the Detection component of the generalized air-to-air engagement. The most significant of these is probably the jamming effect on detection ranges and the resultant effect on first weapon launch opportunities. This model would appear much more realistic if the consideration of jammer effects on detection ranges were added. The Subroutine M30_EW currently performs an evaluation of weapon susceptibility to ECM during the Engagement Result Phase. Such an evaluation should be performed during the Targeting Phase in terms of the fire control radar susceptibility. Once the susceptibility evaluation is completed, the following simple method could be used to apply limited

jamming effects to the model. A target supported by jamming within its own track could be treated as a self screened target and a target supported by a jammer in another track could be treated as a target screened by a stand-off jammer. Any number and variety of degradation factors could be used. It is important that the effects on the specific radar detection range are represented and then the subsequent effect on weapon launch range. This will insure that in the short range case, jamming will not be as effective as in the longer range engagements. Arriving at appropriate detection range limits will require additional analysis, but this addition alone could significantly improve the Targeting Phase realism.

6. Multi-Targeting

The Targeting Phase represents the multi-targeting capability of certain weapons very well. It requires the multi-targeting weapon type to be selected and already assigned to one target before the capability can be used. The model is also not permitted to target the same target as the launcher's first weapon.

There is an additional factor which should be considered in determining the application the multi-targeting capability. For today's multi-targeting weapons, the operating mode of the weapon's fire control system is very significant. The fire control system must also be operating in a multi-targeting mode. Environments, such as those with heavy jamming may prescribe the use of singly targeted weapons even when the weapon type has a multi-targeting capability. With the inclusion of the jamming evaluation suggested above in subsection (5), it would be relatively easy to influence the execution of the multi-targeting phase in such cases.

7. Summary

The NWGS Targeting Phase performs the idealized targeting assignments in a very effective and well controlled manner. With the exception of the coding error in the altitude differential check, the routine performs as expected. However, as suggested throughout the discussions above, the NWGS approach to modeling the Targeting Phase is not realistic in its sequencing nor is it likely to produce reasonable results for further evaluation. It appears that the model is designed so that the Shoot Phase evaluation must account for all of the various effects of realism. It seems that some of these effects must be incorporated in the Targeting Phase in order to create some realism.

C. NWGS SHOOT PHASE EVALUATION

Based on the generalized component structure of air-to-air engagements, the NWGS Shoot Phase should encompass both the Conversion and Shoot component evaluations. The Conversion component represents the maneuvering of the launcher aircraft from the initial target detection position to the ultimate weapon launch position. The Shoot component represents the final evaluation of the attained launch position, the decision to execute the weapon launch and the subsequent launch success or failure. The final launch position evaluation is performed in terms of the envelope of the selected weapon.

In a highly aggregated model, the number and types of weapons fired may be the only desired output. In that case, the many factors contributing to the Conversion and Shoot component evaluation may be generalized into a few overall effectiveness factors. However, when the required level of detail is such that individual intercepts and specified launcher-target pairings are created, the contributing factors must be more precisely considered.

There are several important contributing factors that influence the Conversion to Firing Position component for individual engagements. For long range engagements, the following factors should be considered.

- Starting Intercept Geometry (defined by launcher and target),
- Target Speed and Altitude,
- Intercept Control Radar Reliability,
- Weather,
- Vectoring Assistance,
- Range for Conversion,
- Selected Weapon,
- Launcher Aircraft Performance Capabilities.

For the close range visual arena the significant factors that should be considered are reduced to:

- First Detection,
- Weather,
- Relative Launcher and Target Maneuverability,
- Launcher Selected Weapon.

The Shoot Component evaluation should consider the factors that contribute to the actual firing decision and then the actual execution of the launch itself. These factors include:

- Firing Doctrine,
- Weapon Firing Parameter Requirements,
- ECM/ECCM,
- Launcher Reliability.

The Shoot Phase of the NWGS air-to-air engagement models proves to be the most significant of the four engagement phases with respect to the realism and believability of the overall engagement model output. The current model

operation for this phase must account for all of the contributing factors involved in air-to-air engagement from initial target detection through trigger squeeze. The Shoot Phase is provided with the table of idealized targeting assignments created by the Targeting Phase. Each of these launcher-target pairs have already closed to firing range and are waiting only for the decision to execute. This phase must consider the realistic aspects of the conversion that would have had to take place in order for the launcher to arrive at the current launcher position. Then, if the model determines that the conversion had a high probability of being successful, the decision to shoot is made. Otherwise, a successful conversion is considered to be unlikely and the particular engagement is cancelled.

The basis used by NWGS during the Shoot Phase to determine the likelihood of a successful conversion is the evaluation of the Probability of Conversion 'PCONV'. This evaluation combines some of the factors of both the Conversion component and the Shoot component of the generalized air-to-air engagement. The factors that are included in the NWGS Shoot Phase model are weather, vector assistance, target speed, altitude and size, firing doctrine, weapon system reliability, launcher reliability and the specific launcher aircraft and weapon combination. It also appears that the NWGS model design for this phase may try to account for some of the initial target detection limitations. The NWGS approach to modeling these factors is discussed in detail later. Two critical subcomponents missing from the above list are the intercept geometry at the start of the conversion and the range available to accomplish the conversion. The impact of these omissions are also discussed later.

The Shoot Phase, like the Targeting Phase, is not a one-time execution. It is repeatedly activated as long as

the Targeting Phase is creating launcher-target pairings. Therefore, Shoot Phase evaluations are performed over the entire possible launcher-target range spectrum used by the Targeting Phase. No special provisions are contained in the Shoot Phase modeling to account for the short range air battle. In this arena, First Detection and Launcher-Target Relative Maneuverability should become the critical factors in the conversion evaluation.

The NWGS Shoot Phase uses the classic conditional probability product sequence approach to determine the final 'PCONV' for each engagement pair provided by the Targeting Phase. Then, a straight forward reference 'PCONV' or a simple Monte Carlo random draw is used for comparison to determine if the weapon launch is actually performed. The following subsections provide detailed discussion of specific areas of interest involved in the Shoot Phase modeling. These comments assume that the Targeting Phase provides the idealized launcher-target pairing as discussed earlier and that none of the implied changes have been incorporated in the Targeting Phase.

1. Baseline Probability of Conversion ('PCONV')

The NWGS data base provides the capability to maintain a table of baseline 'PCONV' values for each launcher aircraft type and specific weapon combination. Each table may contain several different values referenced by the specific target classification parameters. Aircraft targets are classified into two speed categories and three size categories resulting in six possible 'PCONV' values. Cruise missile targets are classified into three speed categories and four altitude categories resulting in twelve possible 'PCONV' values.

This classification approach provides tremendous flexibility to the model and should allow the user to

observe the effects of various target types on the engagement outcome. A major difficulty arises when one attempts to determine the representative values for these data base parameters.

The baseline 'PCONV' parameter is not clearly defined for the Data Base Manager. It is absolutely necessary that an adequate definition be used as the analytical basis for this measure of effectiveness. Otherwise, there is no hope of obtaining reasonable engagement outcomes. The current data base values are completely arbitrary and are only meant to be temporary until the appropriate values are provided.

Each baseline 'PCONV' value appears to represent the expected probability that the launcher aircraft detects a target of the specified type and maneuvers to a satisfactory launch position for the selected weapon. The expectation should be taken over all possible range separations for the subject conversion. The analytical basis for the detection portion of this probability could be the cumulative probability of detection for the specific target type from the radar system maximum range to the selected weapon maximum effective range. With these definitions, the ability to determine reasonable approximations for the 'PCONV' parameter values seems more feasible. Significant analysis and the application of a detailed micro level research simulation will undoubtedly be required. If such an analysis were accomplished, the baseline 'PCONV' values should account for the following factors:

- Launch Aircraft Performance,
- Selected Weapon Launch Point,
- Target Size, Speed and Altitude (cruise missile only),
- Average Range for Conversion,

- Accumulated Probability of Detection at Launch Point.

Such baseline 'PCONV' values would apply equally to long and short range engagements.

This discussion is aimed at providing means for obtaining reasonable results from the existing air-air engagement model. The suitability of using this type of aggregate factor modeling in conjunction with individual platform engagement modeling is discussed later in the Shoot Phase summary.

2. PCONV Modification Factors

The methodology of calculating total probabilities by multiplying sequences of conditional probabilities is a classical and commonly accepted modeling technique. Assuming that the baseline 'PCONV' parameter values are reasonable, the application of additional effectiveness parameters to calculate total probability should also be reasonable. It is important to keep in mind that this 'PCONV' evaluation is performed at the proposed launch point which, in reality, is after the actual conversion would have taken place. The NWGS Shoot Phase evaluates the following factors:

- Launcher Weapon System Reliability,
- Launcher Rail Reliability,
- Vector Assistance Availability,
- Weather Factor for Conversion.

Additional factors that contribute to the total conversion success probability that could also be evaluated are:

- ECM/ECCM,
- Initial Intercept Geometry (target aspect),

AD-A143 163

AN EVALUATION OF THE AIR-TO-AIR ENGAGEMENT MODELS IN
THE NAVAL WARFARE GAMING SYSTEM(U) NAVAL POSTGRADUATE
SCHOOL MONTEREY CA N I ARDAN MAR 84

23

UNCLASSIFIED

F/G 15/7

NL

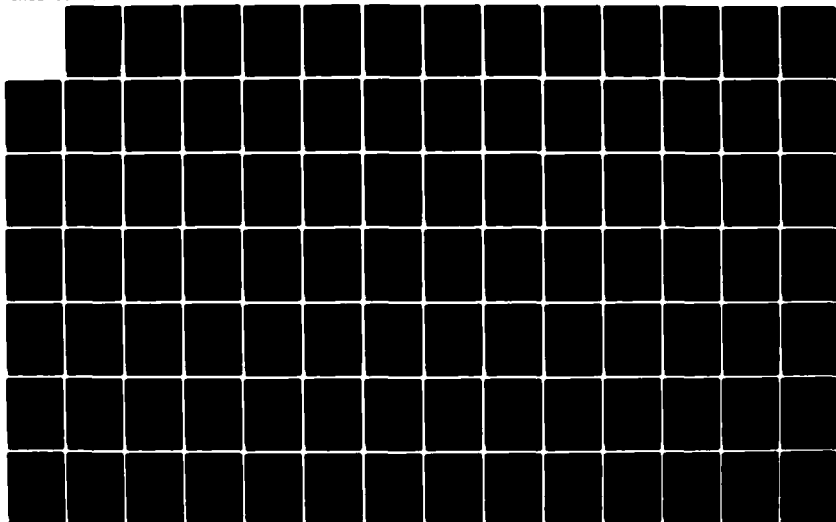

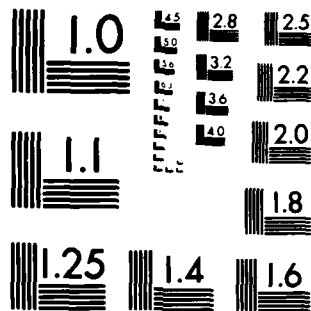

MICROCOPY RESOLUTION TEST CHART
NATIONAL BUREAU OF STANDARDS-1963-A

- Relative Launcher-target maneuverability (short-range engagements).

Most of the NWGS Shoot Phase factors are accessed as data base parameter values. Therefore, the following discussions focus on the availability of the required data. The appropriateness of specific factors and the model's approach to their evaluation are also discussed where applicable.

a. Reliability Factors

The Shoot Phase 'PCONV' evaluation uses two reliability factors both of which are associated with the specific weapon system in use. The aircraft and cruise missile Shoot Phase models both use these factors. They are:

- Weapon System Fire Control Reliability,
- Weapon System Launcher Reliability.

The fire control parameter represents the probability that the onboard weapon system support requirements for the selected weapon will be met. The launcher reliability represents the probability that the weapon will successfully launch, given the weapon launch command. Both of these parameters are accessed from the specific weapon system property table. Therefore, the values are related to the selected weapon and not to the launcher aircraft. This means that the same weapon type launched from different launcher aircraft types will have the same reliability values. In reality the fire control reliability would be significantly effected by the launcher aircraft type as well. It appears that this launch aircraft related factor may be accounted for later during the Engagement Result Phase.

Nothing is gained by having two separate reliability parameters except some flexibility in the data base. One overall reliability parameter at this point in the model would suffice. In fact, the values could be included in the baseline 'PCONV' tables without affecting the model. Of all the parameters used during the Shoot Phase, these are the only hardware related values. For that reason, the availability of data to describe these parameters should not be a problem.

b. Vector Assistance

The vector assistance evaluation is performed only during the aircraft target Shoot Phase when the launcher aircraft is designated as a defending aircraft or CAP. For these launchers, there are two possible vector assistance factors that may be used to modify the 'PCONV' value. Ground Control Intercept (GCI) assistance alone enhances the 'PCONV' by a factor of 1.1. Airborne Early Warning (AEW) assistance alone or with GCI enhances the 'PCONV' by a factor of 1.2. Otherwise, there is no vector assistance factor applied. These are the only Shoot Phase parameters not provided by the data base. They are set within the computer program code.

The NWGS documentation gives no justification for not providing the same vector assistance evaluation for an attacking aircraft strike group. It is certainly feasible that in some scenarios, a strike group might have vectoring assistance support. There is also no reason why the missile target Shoot Phase should not include vectoring assistance for the defending aircraft.

The actual values used appear to be rather arbitrary but seem reasonable. It is generally accepted that AEW assistance is more capable than GCI assistance and there is no question that either of them should be enhancements to

'PCONV'. The degree of enhancement is the question and again, a detailed analysis may provide more representative values. There is also a possibility that the degree of enhancement is largely determined by the launcher aircraft and its own radar control capability.

c. Weather Factor

The Shoot Phase weather factor evaluation is performed for both aircraft and missile strike groups. The subroutine WEATHER_FACTOR evaluates the current game weather conditions and determines the factors that most affect the Conversion to Firing Position and the weapon performance. Based on these determinations, the subroutine returns an effectiveness factor for each. The subroutine use of precipitation and cloud density is very effective and properly analyzes the factors that have the greatest effect on 'PCONV' and weapon performance. The weather effects for 'PCONV' are related to the specific weapon system. The weapon system, in this case, is independent of the launch aircraft. Again, the sensitivity question arises when trying to determine the actual effectiveness values for given weather conditions. Data for such an analysis will most likely have to be simulated. The current temporary values are strictly subjective.

d. ECM/ECCM Effects

Electronic Counter Measures (ECM) and Electronic-Counter Counter Measures (ECCM) come into play during two components of the generalized air-to-air engagement. The Detection component and the Engagement Outcome component are affected in different ways by ECM/ECCM and both should be accounted for in some way. In the Detection component, ECM affects primarily the radar detection ranges and thereby may limit some weapon launch ranges. In the

Engagement Outcome component ECM and ECCM capabilities affect primarily the weapon performance. Separate evaluation are required to fully account for ECM and ECCM effects.

Jamming effects and implications for the Detection component were discussed in the NWGS Targeting Phase evaluation where it logically should be approached. However, assuming that no changes are made to the Targeting Phase model, ECM and ECCM effects can and must be accounted for during the Shoot Phase in order to realistically influence the decision to shoot. In the Targeting Phase, application of jamming effects could simply limit the weapon targeting range. In the Shoot Phase, for the longer range engagements, ECM and ECCM effectiveness parameters may be used to degrade the 'PCONV' parameter. The short range engagement 'PCONV' should be unaffected by jamming.

The ECM and ECCM effectiveness parameters currently available in the NWGS data base apply to specific weapon performance. Therefore, a different parameter must be provided to represent the effectiveness of specific radar/fire control systems with respect to 'PCONV' under jamming conditions. Reasonable representations of ECM/ECCM effects on 'PCONV' will be much more difficult to derive than their effects on radar detection range. It will most certainly require a detailed simulation analysis designed for the specific purpose of determining ECM/ECCM effectiveness values for the 'PCONV' evaluation.

e. Intercept and Engagement Geometry

The geometry of an air-to-air engagement comes into play during two components of the generalized air-to-air engagement. The Conversion component and the Engagement Outcome component are both affected in different ways by the situation geometry and both should be accounted for at this NWGS level of detail. In the Conversion

component, the initial intercept geometry defined by target aspect angle, altitude differential, range to launch position and relative speeds all significantly affect the launcher's ability to successfully complete the conversion. In the Engagement Outcome component, the target aspect at weapon intercept time effects the weapon performance. These two areas should be accounted for separately. Neither the Targeting Phase nor the Shoot Phase evaluate initial intercept geometry. The apparent assumption made is that the baseline 'PCONV' values, which account for the launcher type and the target descriptive parameters, will adequately represent all possible cases of initial geometry. Again, the NWGS models are using techniques typically used for aggregate macro level models, yet attempting to provide micro level detail.

Since the first NWGS target evaluations occur within weapon launch range, any application of initial intercept geometry would require tremendous model revision. An alternative approach is to perform a target aspect evaluation during the Shoot Phase in order to influence the decision to shoot. All of the necessary parameter values for such an evaluation are currently available in the data base game track tables. For the longer range engagements, the most realistic approach is to adjust the weapon maximum effective range based on the target aspect evaluation. Then an explicit shoot/no shoot decision can be made based on that range and the weapon's target aspect cut off limits. It would be sufficient for this model to use the four general target aspect categories rather than exact measurements. This improvement would require the addition of these weapon specific parameters to the data base. The data for derivation of these values would be fairly accessible. Another alternative for this model, is to use the target aspect effectiveness factor for the specific weapon as a

modification factor for the 'PCONV'. Such parameters are provided for in the data base under weapon properties. However, the availability of data to derive reasonable representation for these values is uncertain. The latter alternative would also aggravate the already serious arbitrary parameterization problem.

f. Maneuverability Effects

In the short range visual arena it would be extremely difficult to model the maneuvering dynamics of close in air-to-air combat. For this reason, the PCONV determination for short range engagements should be based on a comparison of the relative launcher-target maneuverabilities and the impact of First Detection.

3. Firing Doctrine

The NWGS Shoot Phase determines the firing doctrine for air-to-air missiles (AAM) based on the particular weapon's baseline single shot probability of kill ('PKSS') and the number of that missile type on board the launcher. The baseline 'PKSS' values are provided by the data base for specified launcher-weapon and target combination. The 'PKSS' represents the probability that the AAM launched from the specific launcher type will destroy a target of the specified type, assuming that it guides and fuses properly. The 'PKSS' values are discussed in greater detail in the Engagement Result Phase evaluation.

There are two firing doctrines, shoot-look-shoot (1) and shoot-shoot-look (2). The shoot-look-shoot doctrine is always used for AAMs unless the missile 'PKSS' is less than 0.7 and there are at least four of that missile type on board the launcher aircraft. This determination is very straight forward. Its accuracy depends primarily on the baseline 'PKSS' values. In reality, CAP aircraft will very

rarely use any fire doctrine other than shoot-look-shoot. This firing doctrine determination is used only as a parameter for the actual weapon expenditure determination for AAM.

4. Weapon Expenditure

The Shoot Phase uses the firing doctrine and the final 'PCONV' value to determine the actual number of rounds fired for AAMs. When aerial guns are used only the final 'PCONV' value is considered in determining the number of rounds fired. The evaluation method may be stochastic or deterministic for AAMs. This is the only portion of the Shoot Phase that offers a stochastic determination. Otherwise the entire Shoot Phase is a deterministic process.

The methodology of the stochastic AAM evaluation uses the classic Monte Carlo approach for each round of the firing doctrine. The deterministic method for AAMs simply compares the 'PCONV' to reference probabilities and deletes all engagements with final 'PCONV' values less than 0.5. This is a very important consideration for the Data Base Manager when deriving the numerous baseline 'PCONV' values and modification factors. Assuming that the final 'PCONV' values are reasonable representations of reality, this final Shoot Phase decision should yield reasonable results. It should be clear now, how dependant the entire air battle outcome is on the Shoot Phase evaluation of 'PCONV'.

The rounds fired determination for aerial guns is always deterministic. The 'PCONV' value is used as a multiplicative factor. The maximum number of rounds that the launcher can fire during the engagement is modified by the 'PCONV' value. The result is that the launcher fires some percentage of its bullet load.

An alternate approach to the aerial gun evaluation will simplify this portion of the Shoot Phase model and in

turn, make the rounds fired determination for guns more realistic. Most aerial gun systems fire a standard number of rounds for each trigger squeeze, resulting in a predictable maximum number of gun firings. If the standard number of rounds fired is considered as a single salvo or burst and the maximum number of gun firings is considered as the number of weapons available, then the same firing doctrine determination and weapon expenditure routines could be used for aerial guns. Baseline 'PCONV' and 'PKSS' values for guns must then be based on a single burst rather than a single round. Again, reasonable results depend entirely on the 'FCCNV' evaluation.

5. Weapon Time of Flight

The actual Shoot Phase is complete following the weapon expenditure determination. However, in order to prepare for the Engagement Result Phase, the time delay until weapon impact must be determined. The last portion of the Shoot Phase modeling purports to calculate an approximate time of flight (TOF) for each weapon. The actual impact time used to schedule the Engagement Result Phase for these engagements will be an average of several weapon TOFs. Clearly, these calculations ought to be purely deterministic.

The NWGS subroutine TIME_OF_FLIGHT supposedly evaluates the target aspect used for weapon launch and uses this target aspect category, the weapon average speed and the target speed for the TOF calculation. It would be most realistic to use the actual target aspect category at launch if it were evaluated during the Shoot Phase. Instead, the model uses either a deterministic method or a stochastic method to determine the launch target aspect. The deterministic method simply chooses the most effective target aspect for that weapon. The stochastic method randomly selects the

target aspect to be used. There is no basis for use of the stochastic approach. It will only detract from any realism in the model.

By this time in the Shoot Phase model, if a weapon has been launched, it should have been launched with a desirable target aspect. And since the TOF and the ultimate impact time calculation are approximations, it seems much more reasonable to always use the most effective target aspect for the calculation.

Table IV in Chapter II indicates that there are errors in the model's TOF calculations. The currently used 'delta' factor is the difference between the Head-on and Tail-on TOFs. The model's calculation of Forward-Quarter and Rear-Quarter TOF adds the 'delta' factor to the Head-On TOF. Clearly, this is not appropriate. A reasonable approximation of the Forward-Quarter and Rear-Quarter TOF is to add a fractional part of the current 'delta' factor to the Head-On TOF. Fractional values of 0.3 and 0.7 respectively will provide much more reasonable results. For the Tail-on case, when the missile average speed is less than 1.2 times the target speed, the model yields a TOF equal to the Head-On case. A more reasonable result is obtained if the 'PKSS' for that pair is set to zero in the 'air_air_pair' table. This will account for the fact that the weapon has been fired and will never reach the target. The same adjustment to 'PKSS' should be made for a weapon whose calculated TOF is more than ten percent greater than the data base maximum TOF for that weapon.

6. Summary

The NWGS Shoot Phase approach to the evaluation of the Conversion and Shoot components of the generalized air-to-air engagement is extremely difficult to relate to reality. For this reason, the adequacy of the model's

output is also difficult to evaluate. Several suggestions for Shoot Phase improvements with regard to realism have been discussed. However, the primary determining factor for suitability of this phase of the NWGS air-to-air modeling lies in the ability to provide reasonable representations of the numerous parameters used by the Shoot Phase models.

As suggested throughout the Shoot Phase discussion, the entire 'PCONV' evaluation is an example of how arbitrary parameter definitions can create difficult problems in data based models. The use of this type of aggregate effectiveness factor is more appropriate to a macro level model where the forces are aggregated and expected value modeling can be used. The purpose for modeling individual platform engagements in these routines becomes somewhat obscured by using such techniques. If modeling the individual platform is critical to the required level of detail, then much more of the realistic detail is needed in this model. For the greatest percentage of the NWGS use, platform versus platform detail is not required.

The Shoot Phase and its 'PCONV' evaluation prove to be the driving forces in producing reasonable or unreasonable results from the entire air-to-air engagement routine. This tremendous dependence on the collective data base effectiveness values indicates the need for devoted effort to arrive at values to satisfy the parameter definitions specified by this study. Otherwise, the air-to-air engagement models will never produce realistic or even reasonable results.

D. NWGS ENGAGEMENT RESULT PHASE EVALUATION

The NWGS Engagement Result Phase correlates very well to the generalized air-to-air engagement component of Engagement Outcome. This component of an individual

air-to-air engagement represents the evaluation of the specific weapon's performance from launch to target intercept and includes target damage assessment. The weapon performance evaluation is expressed in terms of weapon probability to kill.

In a highly aggregated macro level model where the outputs of interest are the number of survivors on each side following the air battle, probabilities of kill are blended into relative effectiveness values. This allows the model to produce expected value results. A more detailed level of model which executes individual platform-to-platform engagements will evaluate the weapon probability of kill for each weapon firing to decide the engagement result.

In the actual air-to-air engagement arena, there is also a potential for damaged aircraft which may then be considered partially out of action. Generally, only very detailed models will attempt to model this aspect of battle damage assessment.

There are several important contributing factors that influence a weapon's probability of kill for an individual engagement. These factors are:

- Weapon Guidance System Reliability,
- Weapon Fusing/Detonation Reliability,
- Fire Control Support Reliability,
- Weapon Target Aspect/Target Maneuver
- Weather Effects
- Target ECM Effects
- Weapon ECCM Capability
- Target Size, Speed, Altitude

All of these factors will sufficiently distinguish the difference between aircraft and cruise missile target types. In the short range visual arena, target aircraft maneuverability becomes a very significant contributor to the final

probability of kill when the target knows it has been fired at.

The Engagement Result Phase of the NWGS air-to-air engagement models considers almost all of the above factors in its weapon performance evaluation. The model's evaluation is based on the launcher-weapon baseline single shot probability of kill ('PKSS') against a specified target type. This baseline 'PKSS' value is modified by effectiveness values representing some of the factors listed above. All factors except the weapon target aspect/target maneuverability factor are used in a reasonable manner. It is not clear whether the fire control support reliability is included in the evaluation.

The Engagement Result Phase is repeatedly activated for each scheduled average weapon impact time during the subject air battle. These evaluations are performed for engagements over the entire possible launcher-target range spectrum. No special provisions are contained in the model to account for the short range air battle evaluations where the contributing factors may differ.

The NWGS Engagement Result Phase uses the classic conditional probability product sequence approach to determine the final 'PKSS' for each engagement in progress. This weapon performance evaluation is performed in exactly the same way for aircraft and cruise missile targets. The determination of the actual probability of target destruction is slightly different between the aircraft and cruise missile target models. These differences are discussed in more detail later. Both models offer a deterministic and a Monte Carlo approach to the target destruction determination. Cruise missile targets and single engine aircraft targets can only be destroyed or undamaged. Larger aircraft may accumulate damage if they are not destroyed by the weapon.

The following chapter subsections provide discussion of specific areas of interest involved in the Engagement Result Phase modeling. These comments assume that the inputs to this Phase provided by the Shoot Phase are reasonable and that no adjustments need to be made here for Shoot Phase problems.

1. Baseline 'PKSS'

The baseline 'PKSS' values which are provided by the NWGS data base are the most critical parameters contributing to this modeling phase. The data base has the capability to provide unique 'PKSS' values for every launcher and weapon combination against each of several different target types. For aircraft targets, two speed and three size categories are available. For cruise missile targets, three speed and four altitude categories are available.

This classification approach provides tremendous flexibility to the model and should allow the user the opportunity to observe the effects of various target types on the engagement outcome. Currently, the 'PKSS' values in the data base appear rather arbitrary and the capability for weapon uniqueness is not utilized. All of the air-to-air missiles have the same set of values as do the gun systems. As discussed earlier, it is the NAVY's responsibility to provide the values for the data base. However, before this can be done, it is imperative that the exact definition of the baseline 'PKSS' parameter used in the model is known.

In this model, the baseline 'PKSS' must be defined as a conditional probability of kill. Specifically defined, it is the probability that a single salvo of the particular weapon, with the fire control support of the specified launcher, will kill a target of the specified type, given that it has guided, fused and detonated successfully. Without the launcher's fire control factor included, there

is no reason to associate the weapon with the particular launcher. However, this method provides a way to account for fire control support from the launcher without evaluating an additional factor. It is quite important to keep in mind the above definition when deriving values for the data base. Otherwise, the model will produce totally unrealistic results.

Availability of data for the required derivation of baseline 'PKSS' values is a much more promising proposition than is the 'PCONV' case. Weapon performance data for allied weapons is available through analyses of weapon firing reports as well as Test and Evaluation reports. However, adequate data for analysis of the 18 target variations for each launcher-weapon combination, are certainly not available. The appropriate analysis will most likely require engineering and phenomenological weapon firing simulation.

2. 'PKSS' Modification Factors

The NWGS Engagement Result Phase modeling currently incorporates seven modification factors for the final evaluation of each weapon 'PKSS'. Each factor is represented as a conditional probability or effectiveness and used as a multiplier to influence the total 'PKSS' calculation. These values will therefore, have either a degrading effect on the weapon baseline 'PKSS' or no effect at all. The factors considered by both the Aircraft and Cruise Missile Engagement Result Phases during 'PKSS' evaluation are:

- Weapon Guidance Reliability,
- Weapon Reliability,
- Environmental Effects,
- Target Aspect Effects,
- ECM/ECCM Effects,
- Guidance Required until Impact.

An important factor in the short range engagement evaluation, particularly for aircraft targets when they know that they have been fired at, is their ability to maneuver defensively.

As in the Shoot Phase 'PCONV' factor determination, the actual effectiveness values for the above factors are accessed as data base parameter values. Therefore, the availability of the required data, the factor suitability and the model's approach to their application are the focal points of the following discussions.

a. Reliability Factors

The Engagement Result Phase accesses the two weapon specific reliability values from the weapon property tables of the NWGS data base. Weapon guidance reliability refers to the weapon's inner guidance mechanism. The weapon reliability then must represent the weapon's internal arming, fusing and detonation mechanisms. These factors have no relation to the launcher aircraft or its fire control system. The combination of these two factors with baseline 'PKSS' value yields a weapon probability of kill that better represents the Fleet operational concept of probability of kill. Since the same two values are always paired together, it seems reasonable to combine the values for each weapon into an overall weapon reliability. For more simplicity, the values could be included in the baseline 'PKSS' tables without adversely affecting the model.

b. Environmental Factor

The subroutine WEATHER_CHECK is called during the Shoot Phase to evaluate the current game environmental effects on both 'PCONV' and weapon performance. The environmental effects on weapon performance are provided by the weapon property tables of the NWGS data base and are applied

to the 'PKSS' calculation during the Engagement Result Phase. The model evaluates the relative cloud and precipitation densities and selects the effectiveness factor for probability of kill that reflects the appropriate degradation to weapon performance. The model's evaluation is performed in a reasonable manner. However, determining the appropriate effectiveness values for each air-to-air weapon given particular cloud or rain density situations, is a significant task. An analysis of the various weather effects on each weapon type must be performed in terms of 'PKSS' degradation if reasonable representations are to be expected over all.

c. Target Aspect Effects

The NWGS Engagement Result Phase application of launch target aspect effectiveness is operationally improper. Like the Shoot Phase time-of-flight application of target aspect, either the aspect with maximum weapon effectiveness is selected or a random aspect is used. The use of maximum effectiveness for all cases denies the player observation of any variation in results due to engagement geometry. The random aspect method has the potential to totally obscure any realism that does exist. Therefore, this evaluation must be improved or it should be eliminated all together.

In the Shoot Phase discussion of intercept and engagement geometry, it was pointed out that during the Engagement Outcome component of the air-to-air engagement, the weapon target aspect greatly affects the actual weapon performance. This is true for weapon target aspect at both launch time and at weapon intercept time. For long range engagement, the target aspect at weapon launch time should be evaluated by the Shoot Phase model prior to the shoot decision. If this check is performed, then the appropriate

aspect effectiveness factor may be used in the 'PKSS' modification. The close range engagements and the air combat maneuvering environment are too dynamic to model adequately at this level of detail. Therefore, it is suggested that for the short range weapon performance evaluation, the target relative maneuverability be used in place of the weapon aspect effectiveness.

The weapon target aspect at weapon intercept time is determined primarily by the target aircraft after the weapon has been launched. Defensive maneuvering on the part of the target will most often adversely affect target aspect for the weapon. Performance of a defensive maneuver is determined by the target's maneuverability and whether or not he knows that he has been fired at. It can be assumed for modeling purposes that for the long range engagements, targets will not perform defensive maneuvers. However, for the short range case, perhaps defensive maneuvering capabilities and target knowledge of attack should be incorporated. An added benefit of employing relative maneuverability factors is ability to more realistically represent the air combat maneuvering or Dog fight arena of air-to-air engagements.

The availability of data for determining reasonable weapon aspect effectiveness and relative maneuverability factors is more promising than for most other parameters. Weapon firing simulations and numerous aircraft performance comparison studies are available to generate the appropriate data for such an analysis.

d. ECM/ECCM Effects

The NWGS Engagement Result Phase performs the ECM and ECCM effectiveness factor determination and their probabilistic application in a very satisfactory manner. The subroutine M30_EW is used to evaluate the weapon

specific susceptibility to target ECM support and the weapon's ECCM capabilities against that ECM. ECM frequency, chaff and decoys are evaluated. If the ECM and ECCM are determined to be effective, each weapon type has a pair of effectiveness values representing ECM effectiveness and ECCM capability which are accessed from the data base and used to modify the 'PKSS'.

The model's ECM/ECCM evaluation does not distinguish between self-screen and stand-off screen targets. The difference between the two types of jammer support are important, but are most critical in the Detection and Targeting components.

The determination of representative ECM and ECCM effectiveness values is a critical task that has not been solved. There are numerous factors that contribute to the impact any given jamming scenario has on detection, targeting and weapon performance. Therefore, without elaborate simulation analysis, commonly used and accepted past analytical results may be the best source for this data.

e. Guidance to Impact Check

The final 'PKSS' factor evaluated by the Engagement Result Phase is a check to insure that the launcher aircraft has not been destroyed. This check is performed only for weapons that require guidance, such as a semi-active radar guided missile. When such a weapon's launcher aircraft is destroyed before weapon impact, the final 'PKSS' value is degraded by a factor of 0.5. In reality, when this type of weapon loses its guidance information, it becomes a ballistic missile and may even be internally instructed to detonate. In either case, the degradation factor should probably be weapon specific and based on its flight profile and average range. A long range missile with a maneuvering profile should be degraded much

more than 0.5. A short range straight flying missile against a large target might perform well. On the average for simplicity, a 0.5 degradation might yield acceptable results.

3. Damage Assessment

The damage assessment portion of the Engagement Result Phase modeling for both aircraft and cruise missile targets is by far the most appropriate and well done part of the entire air-to-air engagement models package. The final model output depends greatly on the prior evaluation of 'PKSS' for each engagement pair. Assuming that the executed engagement and subsequent 'PKSS' evaluations are reasonable, the damage assessment routine will produce very reasonable results.

The cruise missile Engagement Result Phase internally performs a very straight forward kill/no kill evaluation for each engaged pair. It does not accumulate 'PKSS' for engagement pairs with the same target.

The aircraft Engagement Result Phase calls the aircraft battle damage assessment subroutine M26_ACBDA to perform a much more sophisticated evaluation. Engagement pairs with the same targets are compounded. Their individual 'PKSS' values are probabilistically combined for a cumulative probability of target destruction. The model scales the cumulative probability of destruction by a random uniform (-.2,.2) factor based on the uniform (0,1), random number drawn for comparison to the probability of destruction. The basis for this adjustment is not clear. However, it is an appealing method for scaling down the effect of randomness in this Monte Carlo evaluation.

Small single engine aircraft may only be killed or not killed. Larger aircraft may also be destroyed by the initial Monte Carlo evaluation. However, depending on

further comparison of the probability of destruction and the reference probability, the larger aircraft may be left undamaged or it may enter a more detailed damage evaluation. The detailed evaluation will downgrade specific weapons and sensors on the aircraft. The detail is more than appropriate for the overall detail of the engagement models, but it is performed efficiently enough that it can not be faulted.

4. Summary

The NWGS Engagement Result Phase, for both target types, provides a very reasonable approach and suitable modeling for this phase of air-to-air engagements. This is the most realistic and representative portion of the NWGS air-to-air engagement modeling. One area that must be improved is the application of target aspect effectiveness in the 'PKSS' evaluation. The short range engagement arena also needs to be more clearly defined and evaluated using more appropriate attributes. The battle damage assessment modeling is superb. However, it may not be appreciated if reasonable results can not be obtained up to the point where the battle damage assessment takes affect.

The concern for reasonable results at any point in the NWGS air-to-air engagement modeling is a major problem throughout the air battle models. The problem is related primarily to deriving representative effectiveness values for parameters in the NWGS data base. The Engagement Result Phase is relatively free of this difficulty. The required analyses and data sources are available for baseline 'PKSS', weapon target aspect effectiveness, relative aircraft maneuverability and weapon reliabilities. The environmental effects and ECM/ECCM effects are the weakest measures of effectiveness and are not as clearly defined. Finally, the output from this phase of modeling can only be as good as the input from the Shoot Phase.

E. DOCUMENTATION EVALUATION

Through the Naval War College Center for War Gaming, the Computer Sciences Corporation provided five NWGS support documents as reference material for this study. Portions of these documents related to the study's area of interest were referred to throughout the air-to-air engagement model examination. The documents include:

- The Command Staff Users Manual,
- The Student Training Course Guide and Video Tape,
- The Program Performance Specification,
- The Program Description Document,
- The Program Design Manual.

In addition, some program description documentation is contained in comment blocks within the PL/I procedures themselves. The following discussions contain brief description and qualitative evaluation of these documents with respect to their usefulness.

The Command and Staff Users Manual, (CSUM) [Ref. 5], is a very general overview and description of the Naval Warfare Gaming System hardware and approach concepts. It contains a very cursory discussion of player and umpire system interface. The CSUM provides very good general information concerning the NWGS system and its use for an individual who is totally unfamiliar with it. It is adequate for player introduction to NWGS. Operator manuals are available for the detailed description of operator and umpire interaction with NWGS through specific equipment. These manuals are not included in this report.

The Student Training Course (STC) consists of the Guide [Ref. 3] and the Video Tape [Ref. 4] in which the NWGS senior designer uses the course guide to explain the system to personnel at the Center for War Gaming. The Guide itself

is difficult to effectively use without the accompanying Video Tape. The course is a generalized description of NWGS functional operation with emphasis on both models and the reasons for a particular design approach. The STC discusses the air-to-air engagement modeling only superficially. Most of the questions raised in this study's evaluation are not addressed. The Course Guide and Video Tape in conjunction provide a complete introduction to NWGS design and general model capabilities for the interested person. However, the Course was originally conducted over a one week time frame. The STC provided much insight to understanding the War Gaming System design, but did not provide adequate detail for model evaluation.

The Program Performance Specification (PPS) [Ref. 1] is the most general of the program description documents. It contains brief descriptions of the general functions provided in the various model areas and very simplified function diagrams for each of the modeling environments. Input parameters and required output quantities are given in this document. During system development and design approval, The PPS would have been important to evaluate the planned system functional design and basic operation. The usefulness of this document now that system development is well past the design stages is doubtful. The detail required to evaluate the actual modeling techniques and the application of evaluated parameters is not contained in this document.

The two documents most relevant to the NWGS model and algorithm descriptions are the Program Description Document (PDD) [Ref. 2], and the Program Design Manual (PDM) [Ref. 6].

The PDD contains the basic processing logic for each procedure and describes the procedure's associated data base parameters, the procedure's usage and the system interfaces.

It gives each model's general task description and a detailed algorithmic description for every system procedure. This document is a computer program configuration item and has the potential to be the ultimate authority defining the NWGS routines.

The actual PL/I program code was created following approval of the PDD. It appears, at least in the area of air-to-air engagement models, that the PDD has not been updated for design changes that have been incorporated. There are a number of major differences between the PDD procedure algorithms and the actual PL/I coding. Incompleteness and differences also exist in the PDD in the area of subroutines utilization and data base parameters accessed. This document should be the ultimate model documentation authority. It is currently inaccurate enough in specific areas to be very misleading and confusing. The NWGS Model Manger's goal should be a totally updated PDD for system documentation.

The Program Design Manual (PDM) is the most recent document, dated April 1983. It is very limited in scope, but contains the latest description of specific aspects of the NWGS models. Many parameter definitions given in the PDM remain unclear and confusing. However, this document provided the most accurate modeling information available for the NWGS. A more complete and precise PDM along with an updated PDD would provide the necessary complete documentation of NWGS models and design concepts.

The descriptive documentation within the PL/I computer code is accurate and very informative in almost all cases where it is provided. Occasionally, as in the aircraft and cruise missile engagement procedures, program description is duplicated making it inappropriate for the specific procedure. The descriptive documentation provided in the data base structure declarations is particularly helpful for

analyzing the routines. This type of documentation is very helpful to programmers and model evaluators. An effort should be made to complete the procedure's internal documentation blocks.

IV. RECOMMENDATIONS AND CONCLUSIONS

This chapter provides the overall recommendations and conclusions derived from this study of the NWGS air-to-air engagement procedures. It is divided into four sections including Model Evaluation Conclusions, Specific Recommendations, General Recommendations and Study Conclusions. As in the Chapter III evaluation, recommendations and conclusions discussed in this chapter do not distinguish between the aircraft and cruise missile target procedures except when the differences are relevant. In general, all comments concerning these procedures are valid for both target types.

A. MODEL EVALUATION CONCLUSIONS

This study confirms that the NWGS level two air-to-air engagement routines, as they currently execute, will not produce reasonable results for war games. This does not imply that the entire air-to-air engagement module needs to be reconstructed. Certain aspects of the models, particularly the Engagement Result Phase and its aircraft battle damage assessment routine, are superbly done. The logical processes of the Targeting Phase are also extremely effective at accomplishing the idealized target allocation that they are designed to do. With the exception of a few minor coding errors, all probability applications, equations and logic evaluations contained throughout the four phases of engagement execution are used correctly.

Several problem areas of varying degrees of severity have been identified during the evaluation portion of this study. Although the specific data base values were not

evaluated by this study, it has become apparent that a major reason that these routines are unusable today is due to the improper assignment of many of the data base parameter values. Other problems areas relate primarily to the NWGS unrealistic approach to air-to-air engagements. Specific areas for application of suggested improvements are given in the next section of this chapter. This section is dedicated to the more general findings of the study.

Throughout the evaluation, there are three general topics that repeatedly demand attention. They are the NWGS approach to air-to-air engagements, parameter definition/data base values and program documentation. The following chapter subsections provide conclusive comments concerning these aspects of the NWGS level two air-to-air routines.

1. Approach to Air-to-Air Engagement Modeling

The overall NWGS approach to modeling the air-to-air engagement arena does not represent an appropriately realistic sequencing of events. It is understood that modeling techniques often require an approach which is not completely realistic. However, at some point in such a model, suitable evaluations must be applied to reflect reasonable consideration of the realistic factors. This requirement for suitable evaluations is not accomplished adequately by these NWGS models.

In the NWGS models, at a given separation range, the Targeting Phase creates the optimized all knowing target allocations. Then the Shoot Phase is responsible for applying all of the realism of the scenario and thereby eliminating the unlikely allocations. Both the Targeting Phase allocation and the Shoot Phase evaluations occur at the selected weapon's launch point. After the Shoot Phase executes the selected engagements, the Engagement Result Phase evaluates each weapon's performance and the subsequent

target damage. Although this approach is not totally realistic, it initially appears to have some merit. However, its weakness is demonstrated through the Shoot Phase evaluations. These evaluations fail to address the most critical factors for determining if and when a weapon launch opportunity will occur. Factors such as detection status, jamming, target density and engagement geometry are all critical and are neglected by the NWGS Shoot Phase.

It is also important that the air-to-air engagement models are supposedly designed to simulate all types of air battles. These types may include the Outer Air Battle portion of the Anti-Air-Warfare problem, the Strike Escort versus defending aircraft problem or the visual identification to air combat maneuvering scenario. To model all of these with a single simulation that considers platform-to-platform engagements, a distinction must be made between long range engagements and the short range arena. These models do not make such a distinction.

As outlined in Chapter III, any model of the air-to-air engagement arena should use the five components of the generalized air battle as its underlying structure. The components include Detection, Weapon Assignment, Conversion, Shoot and Engagement Outcome. These components and their internal subcomponents are particularly important when the model level of detail implies platform-to-platform engagement evaluation.

2. Data Base Values and Parameter Definitions

The NWGS concepts and general applications of data based modeling are extremely effective. They should provide the flexibility required in a system which services such an extreme variety of objectives. However, the advantages of data base modeling have been misused in certain areas of the NWGS air-to-air engagement models. The Shoot Phase modeling

appears to be particularly hampered with arbitrary and unclear parameter definitions.

The type of data desired for data base modeling is definitive data. It should represent clearly defined parameters and describe specific items, such as weapon systems, platforms and environments. Definitive data refers to "hard" data or measurable values such as weight, wing span, radar operating frequency, effective ranges or cloud heights. The major advantage of a properly used data based model is the scenario and input parameter flexibility achieved without altering the model itself. Models that utilize definitive data in their data bases can be clearly evaluated as reasonable or unreasonable, solely by evaluating the application of the parameters. When many of the parameters are defined as arbitrary effectiveness values and compounded representations of probabilities, the data base flexibility is being misused.

The appropriate application of effectiveness values and probabilities in themselves is perfectly acceptable. However, the parameters that they represent must be clearly defined. The NWGS Shoot Phase modeling is a significant weakness of the entire air-to-air engagement routine because of its excessive application of arbitrarily defined parameters. The 'PCONV' parameter in particular, is an extremely difficult parameter to represent.

A serious consideration which surfaced during the evaluation of the Shoot Phase modeling is the question of the required level of model detail. The Shoot Phase uses some parameters that appear to be the type of aggregate effectiveness factors which would be used in a less detailed macro level model. The detail implied by the Engagement Result Phase modeling leads one to believe that the overall model results are very precise. Knowing that the Shoot Phase modeling is very imprecise makes it difficult to know

what is represented by the engagement results. The current actual level of detail provided by the level two models might be more effectively achieved through an aggregated model.

Most of the current data base parameter values remain from the initial unclassified installation of NWGS. For this reason, all of the data base values involved with air-to-air engagement models should be evaluated and verified using the specific parameter definitions provided in Chapter III of this study.

3. Program Documentation

The basic ingredients for a thorough documentation package for the NWGS models are already in existence. The Program Description Document and the program imbedded comment blocks provided by the Computer Sciences Corporation have the potential to provide all of the necessary model documentation. Much of the existing documentation however, has been shown to be out of date. The specific model documentation for the level two air-to-air engagement models is currently inadequate. The narrative descriptions, the parameter definitions and the variable usages do not match the current procedures. The documentation within the PL/I code is generally accurate but is incomplete and occasionally unclear. Improvements are required in these areas before the documentation will be useful to any investigator.

B. SPECIFIC RECOMMENDATIONS

Recommendations provided in this section are aimed at improving the realism and reasonability of the existing NWGS level two air-to-air engagement modeling. All suggestions are made with the idea of minimal model reconstruction in mind. Since thorough evaluation, discussion and suggestions

concerning the model problem areas are provided in Chapter III, completely detailed recommendations are not given here. However, references to Chapter III subsections are included. Specific recommendations are provided under their applicable engagement execution phase.

1. Targeting Phase

a. Provide a subroutine similar to M30_PROXIMITY which uses Slant-Range calculations for launcher-target range determination instead of great-circle ranging. (III B-2)

b. Add coding that will exclude the target mission weighting factor from the 'MAX' calculation when the targeting range is greater than visual range. Continue use of weighting factors when targeting range is within visual range. Let the visual range cutoff be eight miles. (III B-3)

c. Add coding that will account for high target density. In long range cases, when several target platforms are contained within a single track, treat them as unresolvable. Limit the number of platforms within such a track that are eligible for targeting. (III B)

d. Reconstruct the calculations of launcher-to-target look-up and look-down to reflect degrees of elevation from the horizon. The data base weapon specific look-up and look-down limitations must be corrected to the appropriate degree limits. This check is to be used only in the long range cases and bypassed for the short range engagements. Insure that the logical evaluation of these limits is performed correctly. (III B-4)

e. Make use of the unused variable 'det_rng', defined as detection range, contained in the 'air_air_pair' structure. (III B-5)

f. Provide a subroutine similar to M30_ew that will evaluate the launcher aircraft radar system susceptibility to ECM. Evaluate self-screening and stand-off jammers and provide the reduced maximum effective radar detection ranges as weapon limitations for the Shoot Phase evaluation. (III B-5)

g. Bypass the Multi-targeting segment of the Targeting Phase when the target of interest is a self screening jammer or supported by a jammer within the same track. (III B-6)

2. Shoot Phase

a. Perform a thorough analysis to determine representative values for the baseline probability of conversion 'PCONV' tables. The following definition applies. Baseline 'PCONV' is the probability that the particular launcher aircraft type detects a single non-maneuvering target of the specified type in a clear environment and maneuvers to a satisfactory launch position for the selected weapon. This value assumes that the fire control and weapons system are functioning adequately. It is important to realize that the current model in the deterministic mode will cancel any engagement pairing with a final modified 'PCONV' less than 0.5. (III C-1)

b. Evaluate and combine the weapon system fire control reliability and launcher reliability parameters for each launcher aircraft and weapon system combination. The single values should represent the

overall reliability of the launcher aircraft and weapon system with respect to performance of the conversion to launch position and a successful weapon launch. (III C-2a)

c. Determine the appropriate effectiveness values for the 'PCCNV' modification factors vector assistance and weather effects. For vector assistance, evaluate the concept of variable effectiveness factors for different launcher aircraft types being supported.

d. Add coding to perform the actual launch target aspect evaluation for long range engagements. Application of the four general target aspect categories is sufficient. Adjust the weapon maximum effective range based on the target aspect category and the appropriate target aspect category cutoff limits to influence the shoot decision. (III C-2b)

e. Provide an additional 'PCCNV' modification factor to be used only for short range engagements. The factor should represent the relative launcher-target maneuverability which influences the launcher's ability to gain a launch position. If possible, also consider the influences of first detection, simultaneous detection and no detection on the part of the target. (III C-2e,f)

f. Redefine the application of the 'rounds_fired' determination for aerial guns to function exactly as for air-to-air missiles. Define a single gun firing as a burst of a standard number of rounds and define the gun system rounds available as the number of standard burst available. (III C-4)

g. Reconstruct the subroutine TIME_OF_FLIGHT to utilize the actual launch target aspect category. Correct the TOF approximations using fractional 'delta' factors. Also, if it is determined that the weapon will not reach the target, set the PKSS for that engagement to zero. (III C-5)

3. Engagement Results

a. Analyze and provide the appropriate baseline 'PKSS' values for both aircraft and cruise missile probability of kill tables. The values should reflect the relative capabilities of the various weapons. The analysis must consider the following definition. Each baseline 'PKSS' is the conditional probability that a single salvo of the fired weapon, with the fire control support of the specific launcher aircraft type, will kill the specified target type given that the weapon has guided, fused and detonated successfully. (III D-1)

b. Analyze and combine the weapon guidance reliability and weapon reliability into a single weapon specific reliability factor which represents the overall reliability of the weapon's internal mechanisms. It is also recommended that these values be incorporated into the baseline 'PKSS' tables to account for the conditional portion of the baseline 'PKSS'. (III D-2a)

c. Analyze and provide the appropriate weapon specific target aspect effectiveness values that will account for effects on weapon performance due to launch target aspect. (III D-2c)

d. Reconstruct the launch target aspect evaluation segment of the Engagement Result Phase to utilize the actual target aspect category in modifying 'PKSS' for long range engagements. (III D-2c)

e. For the short range engagements, bypass the application of target aspect effectiveness and determine the targets capability to perform a defensive maneuver by examining the target platform's relative maneuverability. (III D-2c)

f. Analyze and provide appropriate weapon specific ECM and ECCM effectiveness values. These values should represent the ECM effect on weapon performance and the weapon's ECCM capability to counter the ECCM.

4. Documentation

a. Update the procedure narratives and the variable usage and definitions contained in the Program Description Document (PDD). (III E)

b. Complete and verify the documentation comment blocks contained within the procedures PL/I code. Reduce the discussions of design concepts within these procedures.

C. GENERAL RECOMMENDATIONS

The general recommendations proposed in this section are intended for NWGS long range improvement plans. They are applicable to all NWGS engagement models, but are discussed here in terms of the air-to-air engagements arena. The recommendations focus on the system design concept of model families which simulate identical environments, but utilize varying levels of detail. Three levels of air-to-air

engagement modeling should ultimately be provided by NWGS to adequately account for its varying application objectives.

1. Level One

The NWGS level one air-to-air engagement models should provide the systems lowest level of detail and be utilized for large scale global and theater level war games. This modeling should be accomplished through the careful application of a highly aggregated macro level model which produces classic expected value results. Such a model will provide simplified air strike versus defending aircraft force encounter evaluation in a single computer program iteration. Any number of associated factors may be evaluated and applied to this type of model. The appropriate inputs for this level one model are the numbers and types of platforms on opposing sides. The required outputs for this level of detail are the number of strike platforms surviving the air battle and the surviving defending aircraft. The strike platform output will then be the input for the surface-to-air engagement model. This recommended level one model design is perfectly suited for the large scale global level of conflict frequently used for the CWG war games.

The current NWGS level one air-to-air engagement model, although not thoroughly evaluated by this study, appears to be extremely similar to the level two model. The identical targeting procedure is used for individual target platform allocation and the remaining phases of execution are simplified only by the omission of ECM/ECCM and vector assistance factors. The target battle damage is determined simply as kill or no kill for all target types. This is not a suitable level one model for large scale war gaming.

2. Level Two

The NWGS level two air-to-air engagement modeling has been very thoroughly criticized in this study. In a three level of detail system, the middle level inevitably becomes a compromise between a totally basic and a totally detailed model. This causes difficulty for the model builder from the outset. Much of this study's criticism focuses on improvements in the model realism. It should be noted that the assumed degree of required realism is rather subjective. The proper application of the recommendations made by this study will make the NWGS level two model suitable for the intermediate level of detail. A further recommendation discussed in subsection A-2 of this chapter suggests some aggregation of the level two models. This type of model reconstruction would definitely impact the program execution time without any loss of detail.

3. Level Three

The potential use of NWGS as a research, analytical and tactics evaluation tool dictates that level three engagement models must ultimately be provided for NWGS. The NWGS level three kinematics modeling currently provides satisfactory track movement for very detailed engagement evaluation. The NWGS data base currently maintains the track parameters necessary for any geometric or trigonometric evaluation that may be required of a level three model. The implication of platform-to-platform engagement evaluations dictates the use of the most complete detail possible.

A NWGS level three air-to-air engagement model should utilize all available NWGS models to simulate actual sensors, detections and kinematics. This model must consider actual intercept geometry, launcher and target performance, and the geometric implications of jammer

positioning on detections as well as weapon performance. Most phenomenon at this level should be evaluated using engineering and phenomenological models. The difficulties of modeling the close in air combat maneuvering arena will still exist and will most likely require special handling. The current data base structure provides for most of the parameters required for level three modeling.

The level three model, as described here, will be appropriate for war gaming only when this level of detail is absolutely required. War games whose purpose it is to evaluate current and proposed tactics at the unit versus unit level definitely require this level of detail.

D. STUDY CONCLUSIONS

Since the Naval Warfare Gaming System installation at the Naval War College, in early 1983, the Center for War Gaming has exercised NWGS over its entire capability spectrum. It was soon discovered that many of the engagement routines were not producing the expected results. Further investigation indicated that the existing documentation was inadequate to troubleshoot the problems. Since that time, a dedicated effort to evaluate and validate the NWGS models has been ongoing.

This study of the NWGS air-to-air engagement models confirms that these models will not produce reasonable engagement results. This finding alone is not particularly important. However, through the thorough examination of the actual PI/I computer code, complete and accurate procedure and model descriptions for the existing air-to-air engagement routines are provided. In addition, the close examination and evaluation of the level two models resulted in several specific and general recommendations for model improvements while identifying major problem areas in the

data base. Management of the NWGS Data Base will continue to be an extremely significant task and will certainly continue to require a tremendous amount of dedicated analytical effort.

Although fairly substantial changes and additions are recommended for the models, their implementation will provide adequate realism for any intermediate level war gaming analysis. This study's general recommendations for level one and level three models are considered very critical to the long range mission of NWGS. An aggregate model is the only way that adequate air-to-air engagement modeling can be provided for the large scale global war games frequently played today. And if NWGS is ever intended for use in tactics development and evaluation or for tactical operational training, the proposed level three model is absolutely necessary.

The intention of this study is to help further the cause and acceptance of computerized war gaming. By contributing to the ongoing NWGS model evaluation and validation efforts, that goal is accomplished. Implementation of the this study's specific recommendations will allow use of the level two air-to-air engagement models for intermediate levels of game play. Applications of NWGS for many of its game objectives can now be enhanced through improved realism and reasonableness in game output with respect to the air-to-air arena. This work will assist others in recommendation implementation and in further analysis of these routines.

APPENDIX A
PROCEDURE AND SUBROUTINE FLOW CHARTS

This appendix contains the completely detailed flow charts for the relevant procedures and subroutines making up the NWGS Air-to-Air Engagement Module.

M19_AC_AC_TGTING.....	135
TARGETING PHASE SUBROUTINES.....	140
M20_AC_AC_2.....	150
SHOOT PHASE.....	150
ENGAGEMENT RESULT PHASE.....	155
FREE LAUNCHERS PHASE.....	159
ENGAGEMENT SUBROUTINES.....	160-163
M26_ACEDA_2.....	169
BDA SUBROUTINE UPDATE.....	173
M19_AC_MSL_TGTING.....	176
M19_AC_MSL	
SHOOT PHASE.....	181
ENGAGEMENT RESULT PHASE.....	188
FREE LAUNCHERS PHASE.....	193

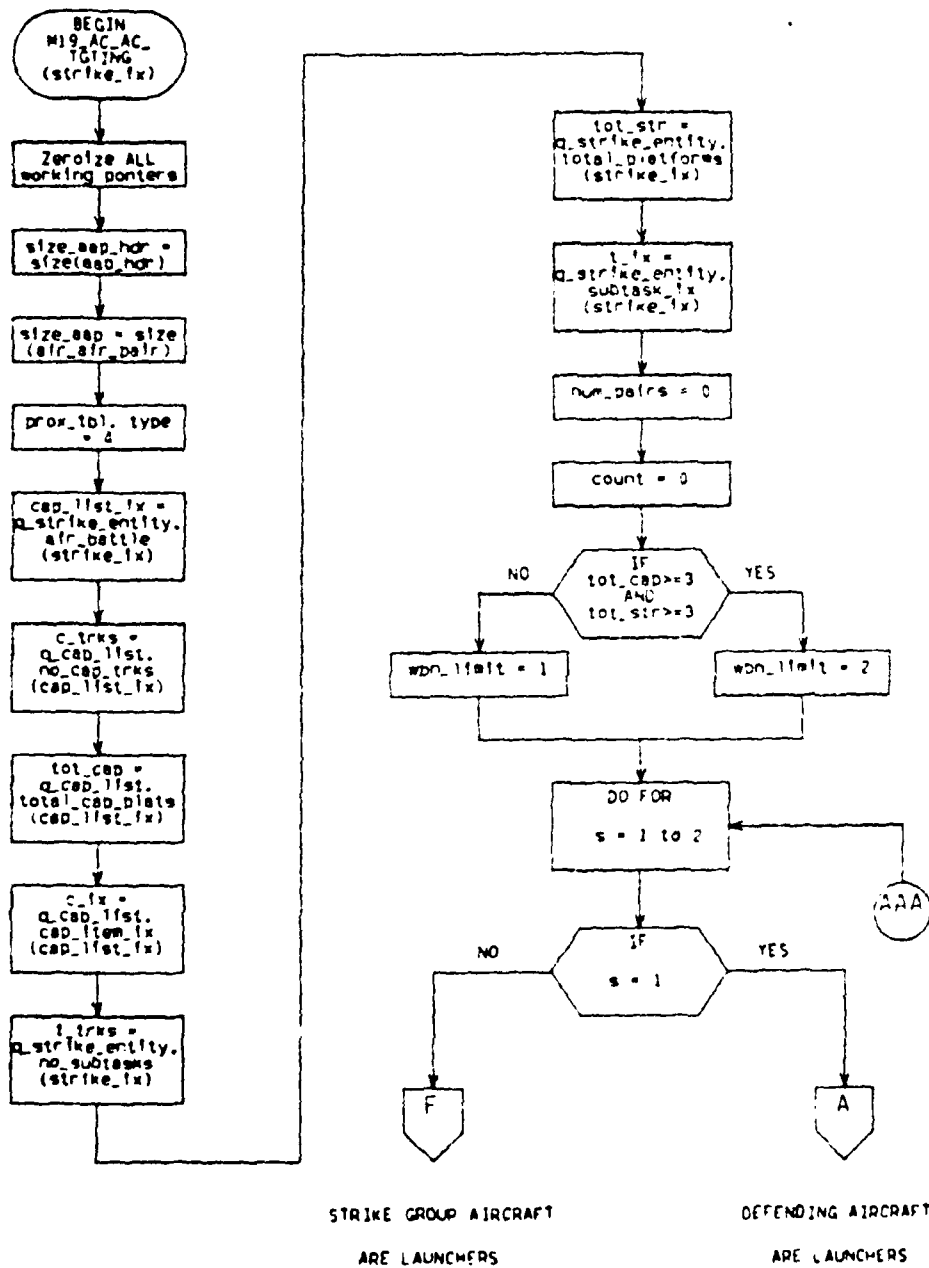

M19_AC_AC_TGTING (a) Parameter Initialization

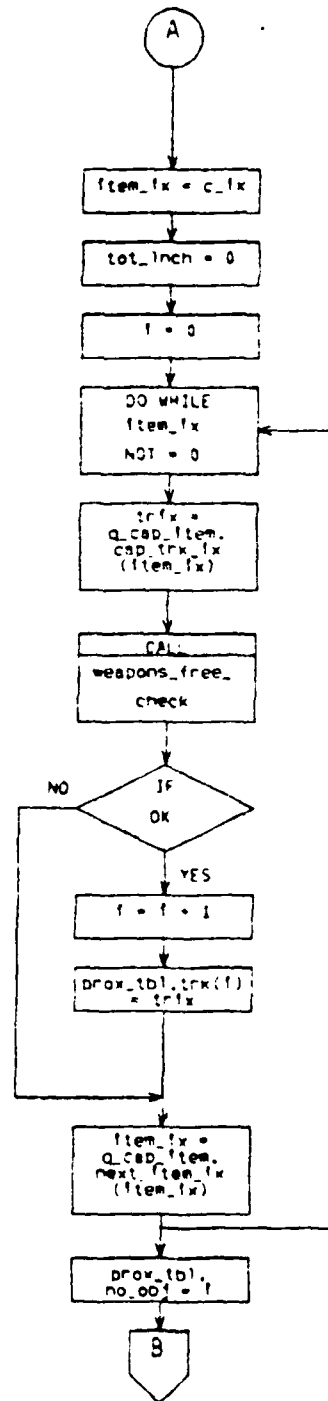
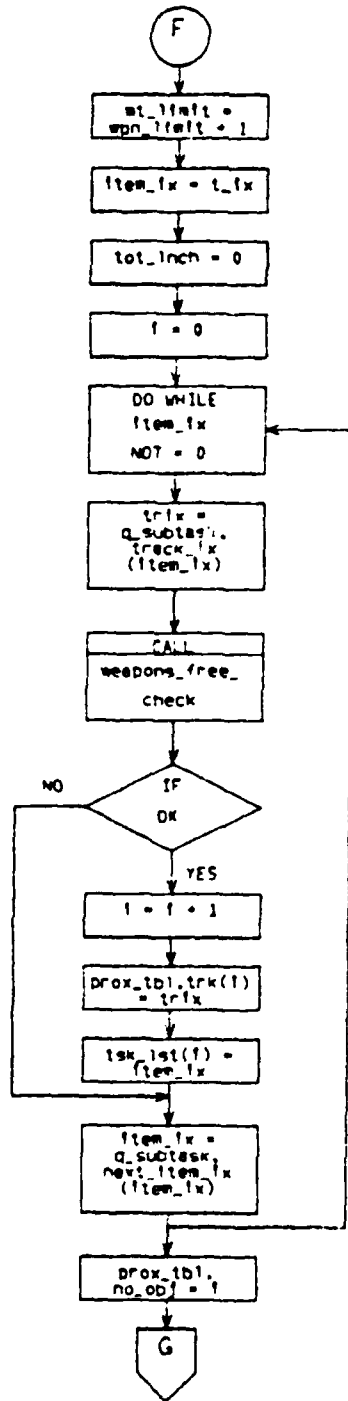

M19 AC AC TGTING (b) Initialization and Checks

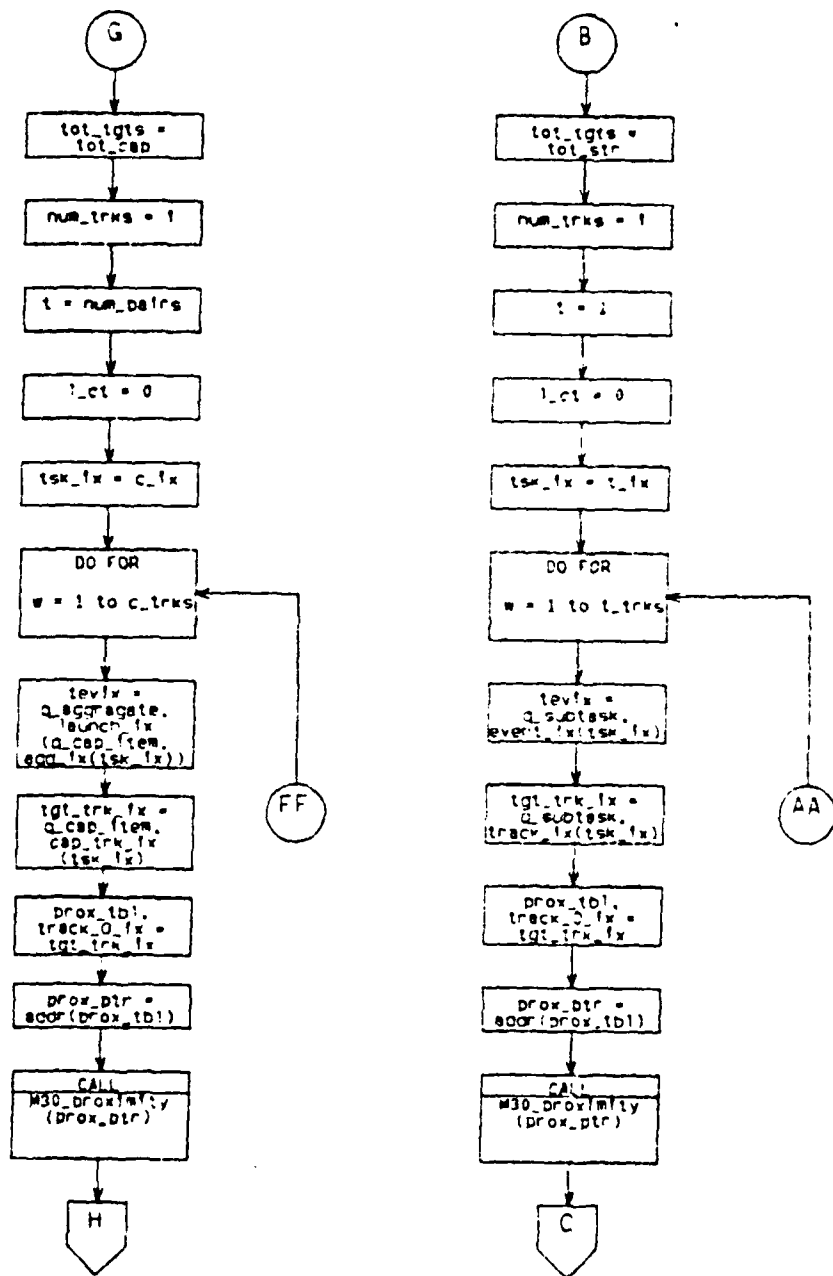

M19_AC_AC_TGTING (c) Preparation for Proximity Checks

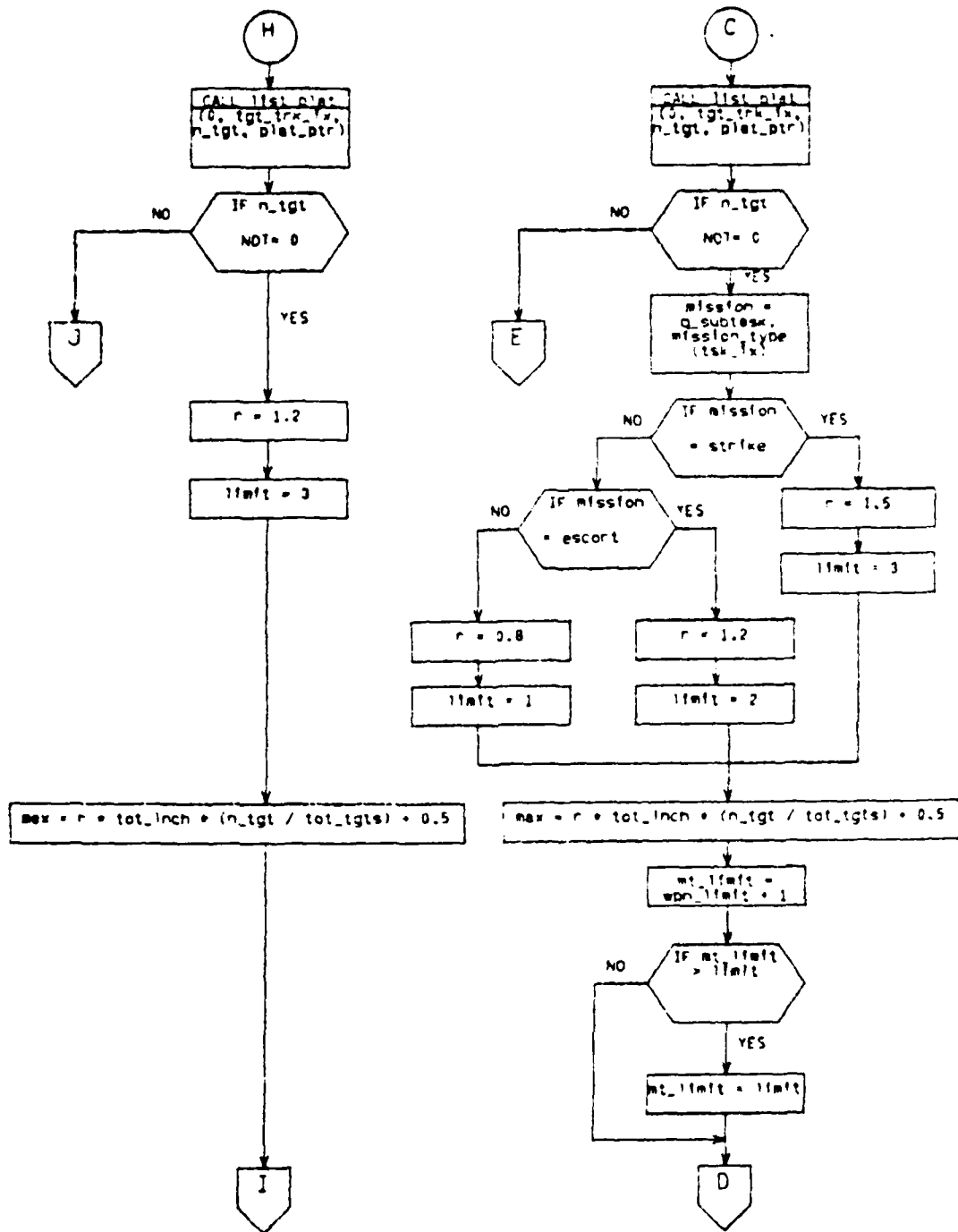

Mi9 AC AC TGTING (d) Mission weighting and Targeting limits

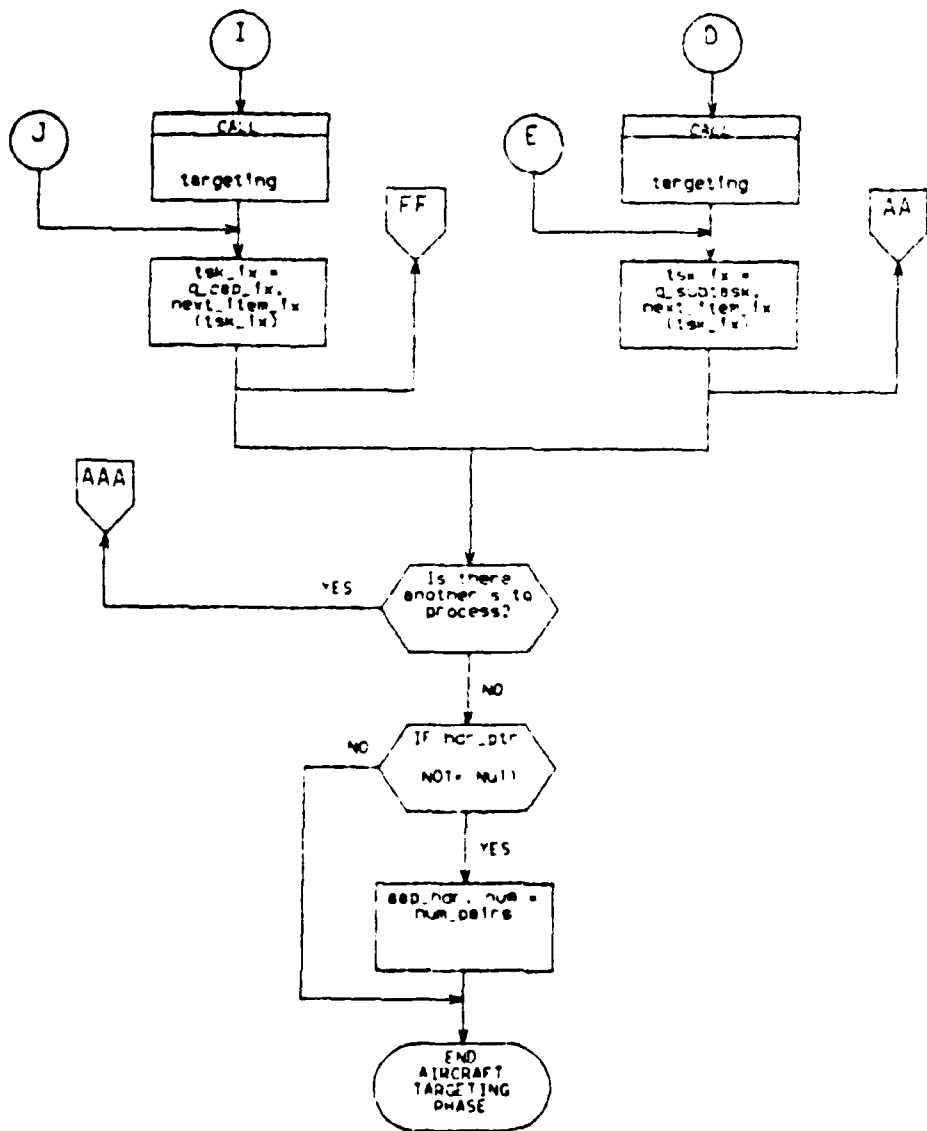

M19_AC_AC_TGTING (e)

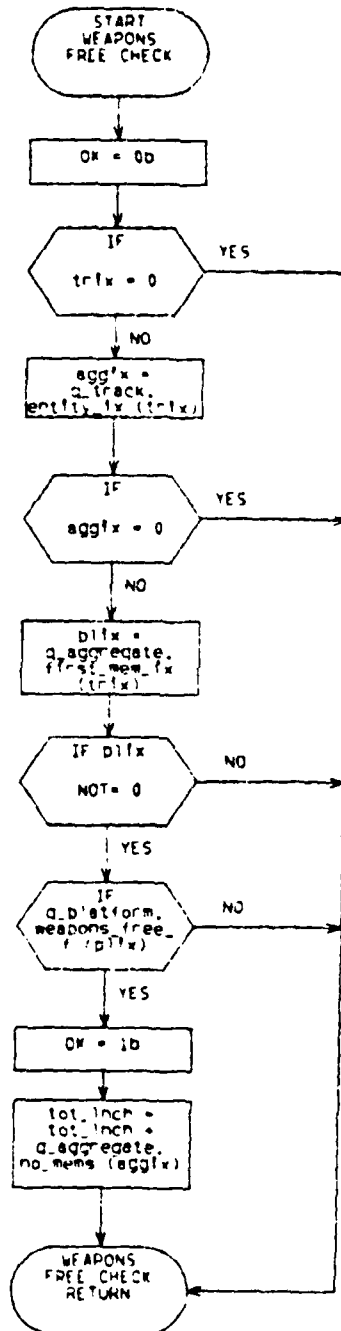

Subroutine WEAPON_FREE_CHECK

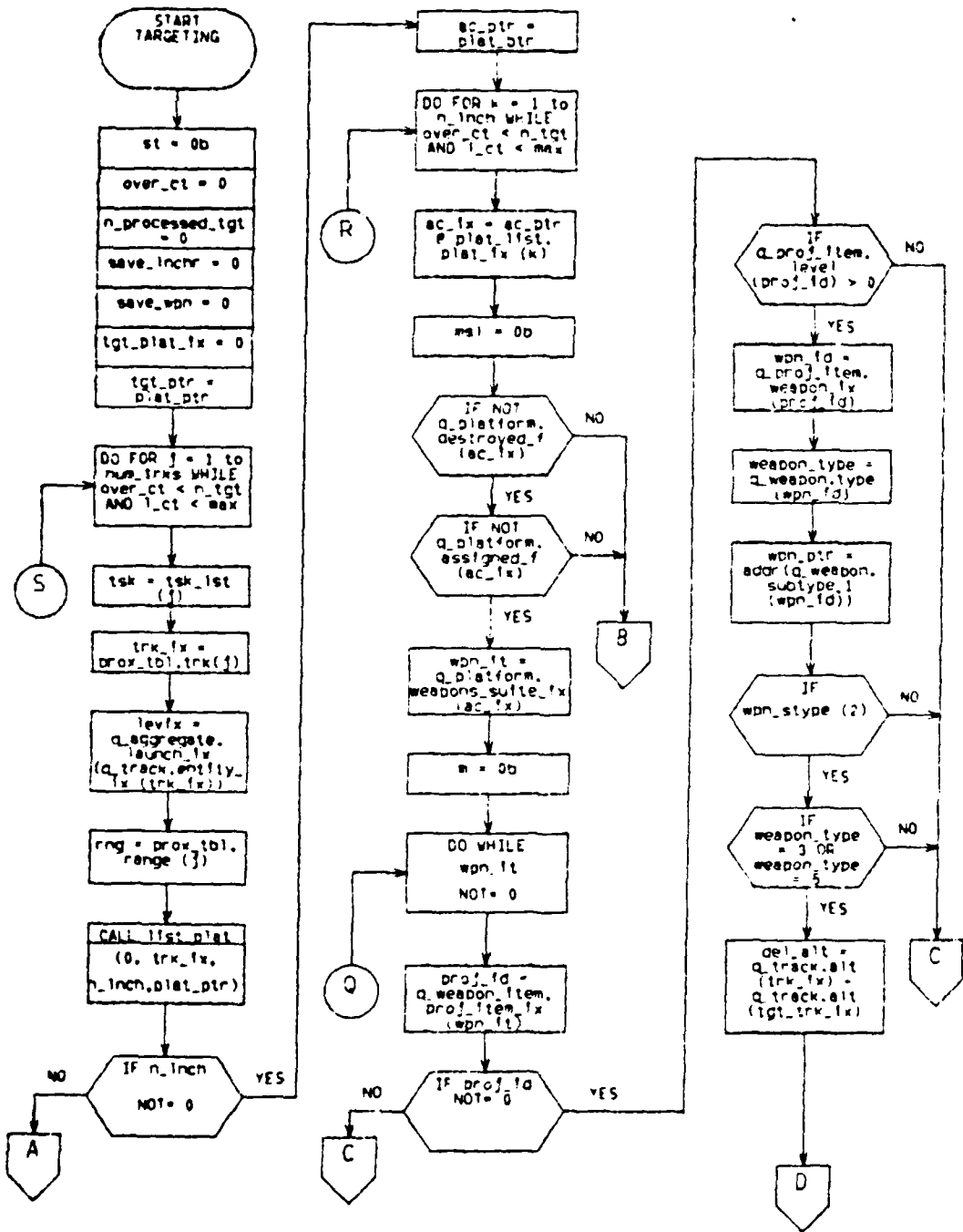

Subroutine TARGETING (a)

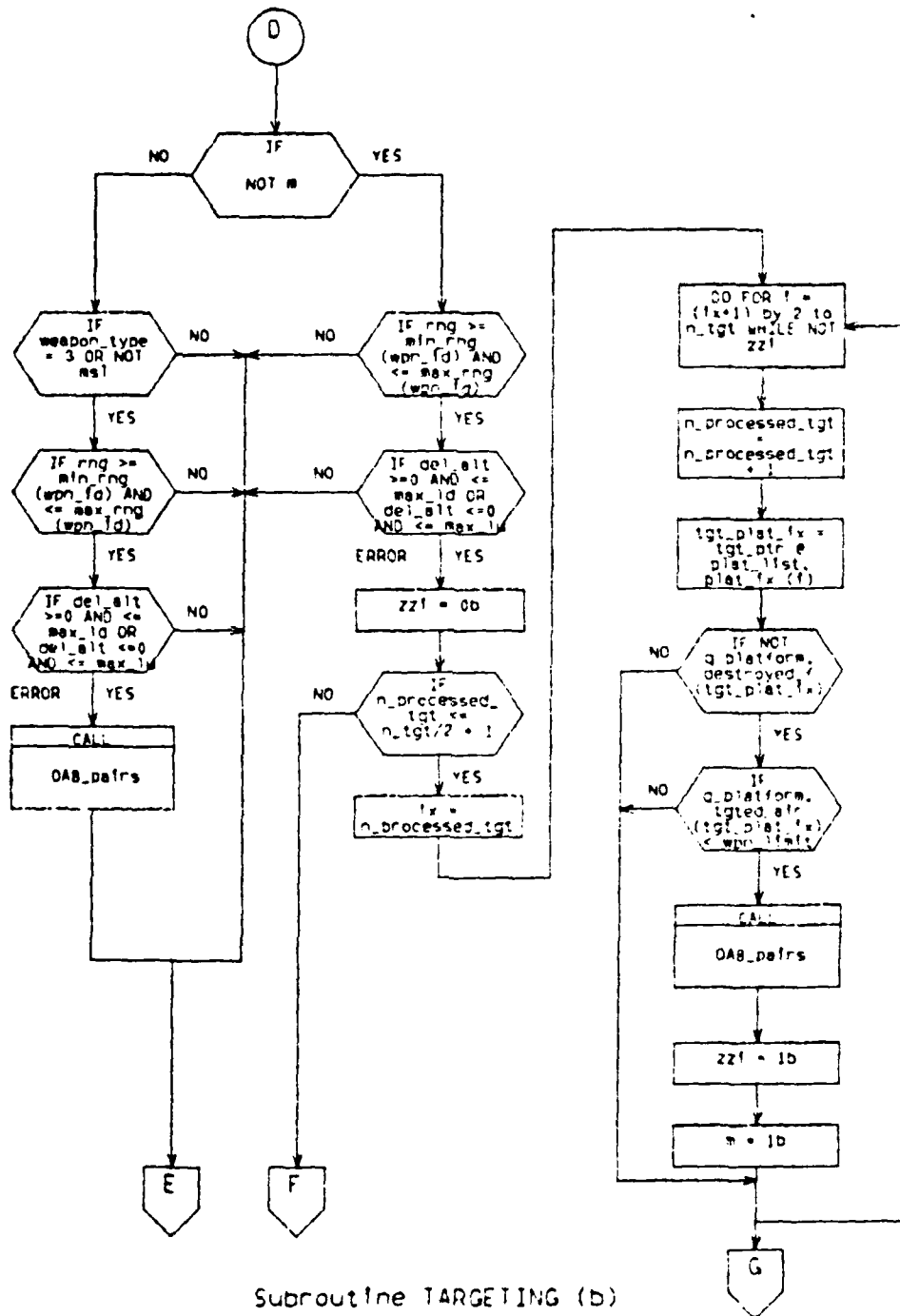

Subroutine TARGETING (D)
One-to-One Targeting

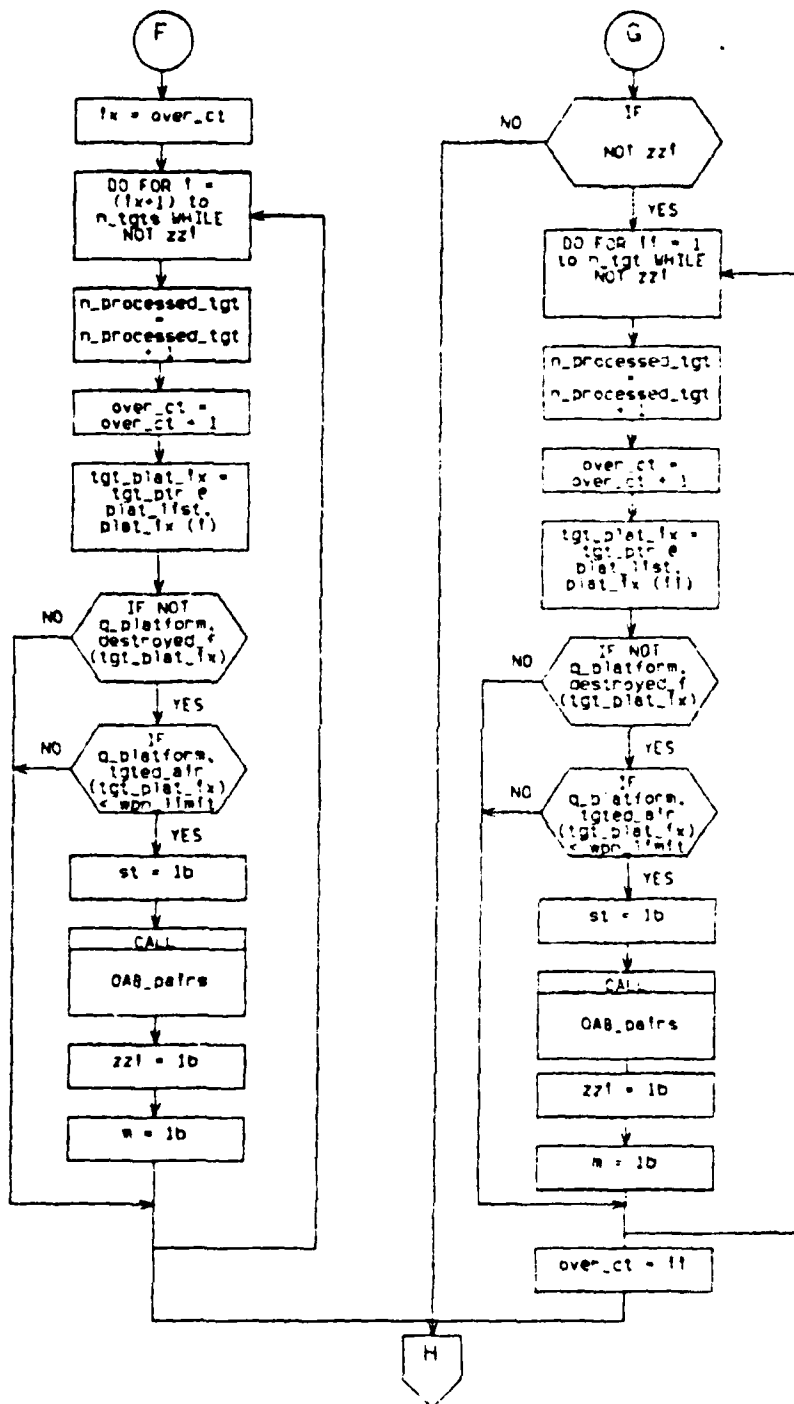

Subroutine TARGETING (c)

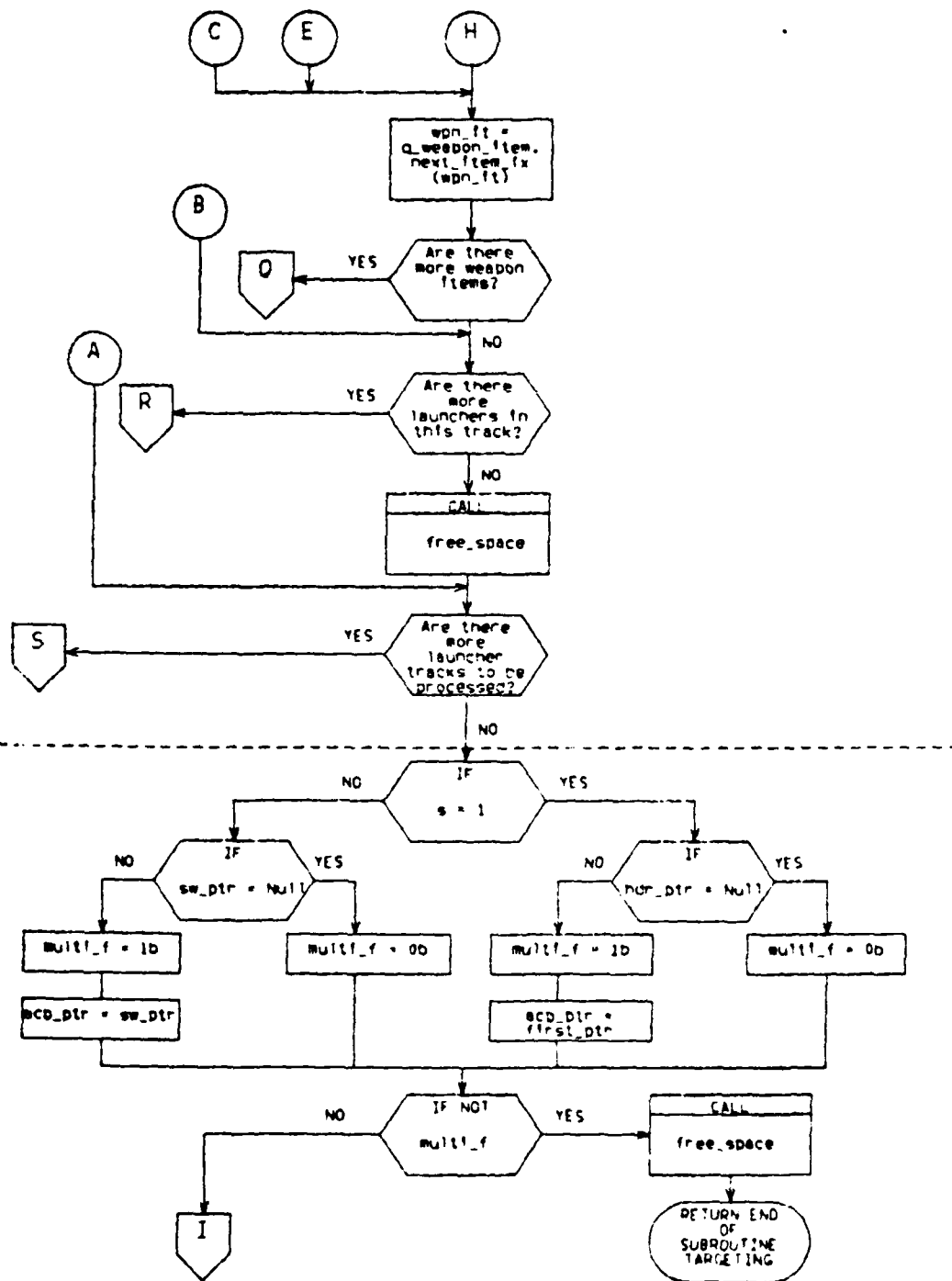

Subroutine TARGETING (d) Multi-Targeting

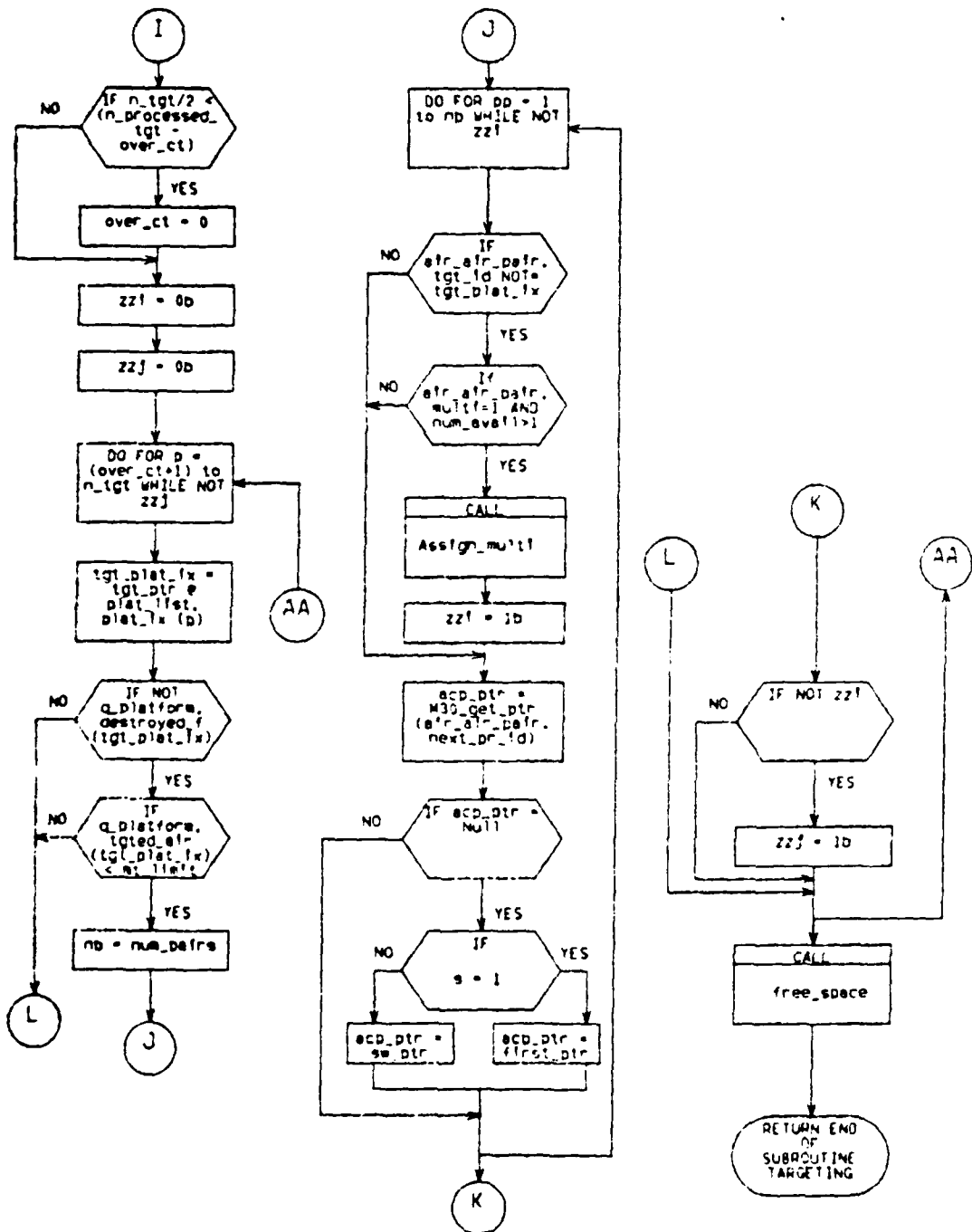

Subroutine TARGETING (e) Multi-Targeting

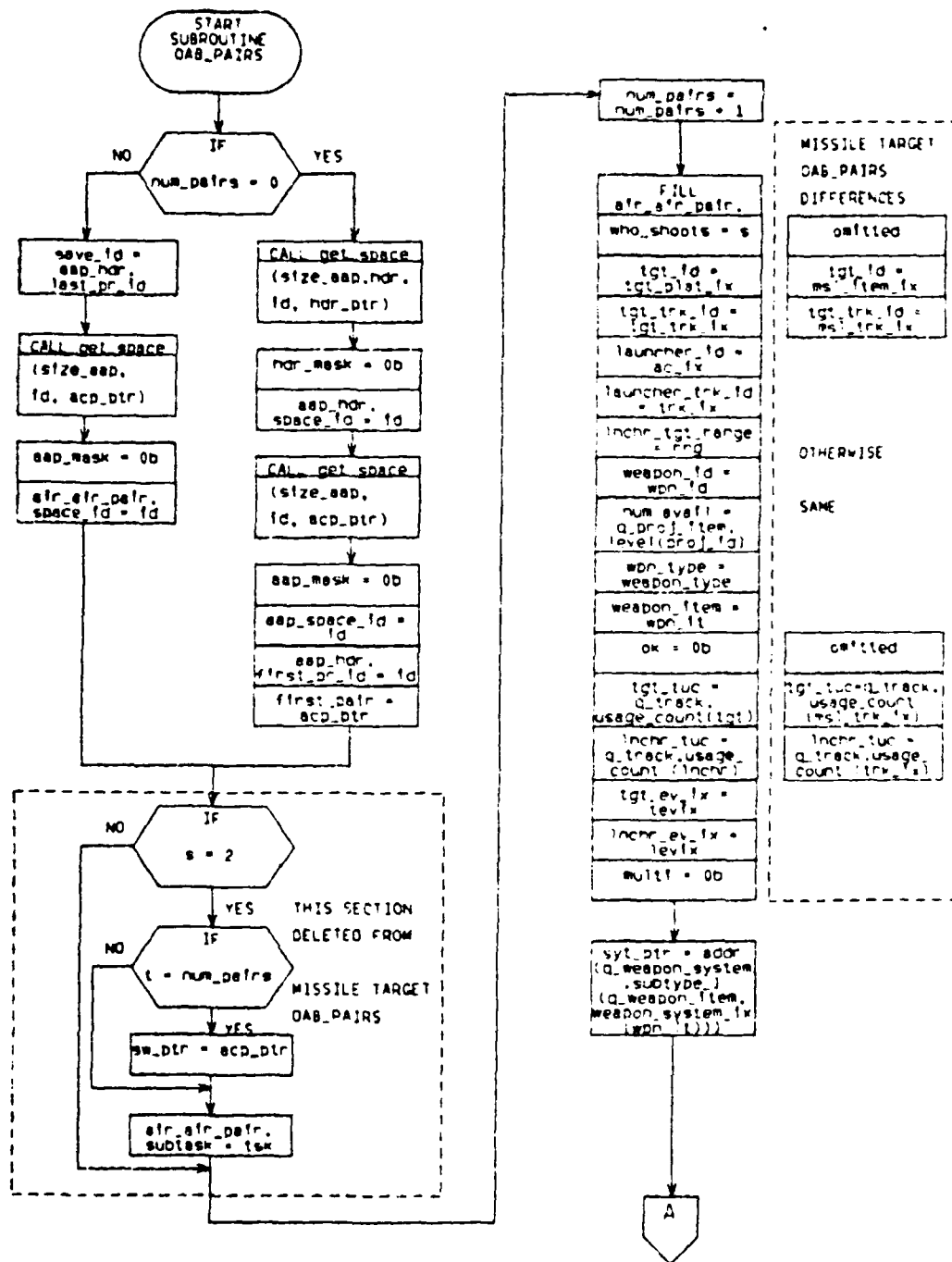

Subroutine OAB_PAIRS (a) Aircraft and Missile Targets

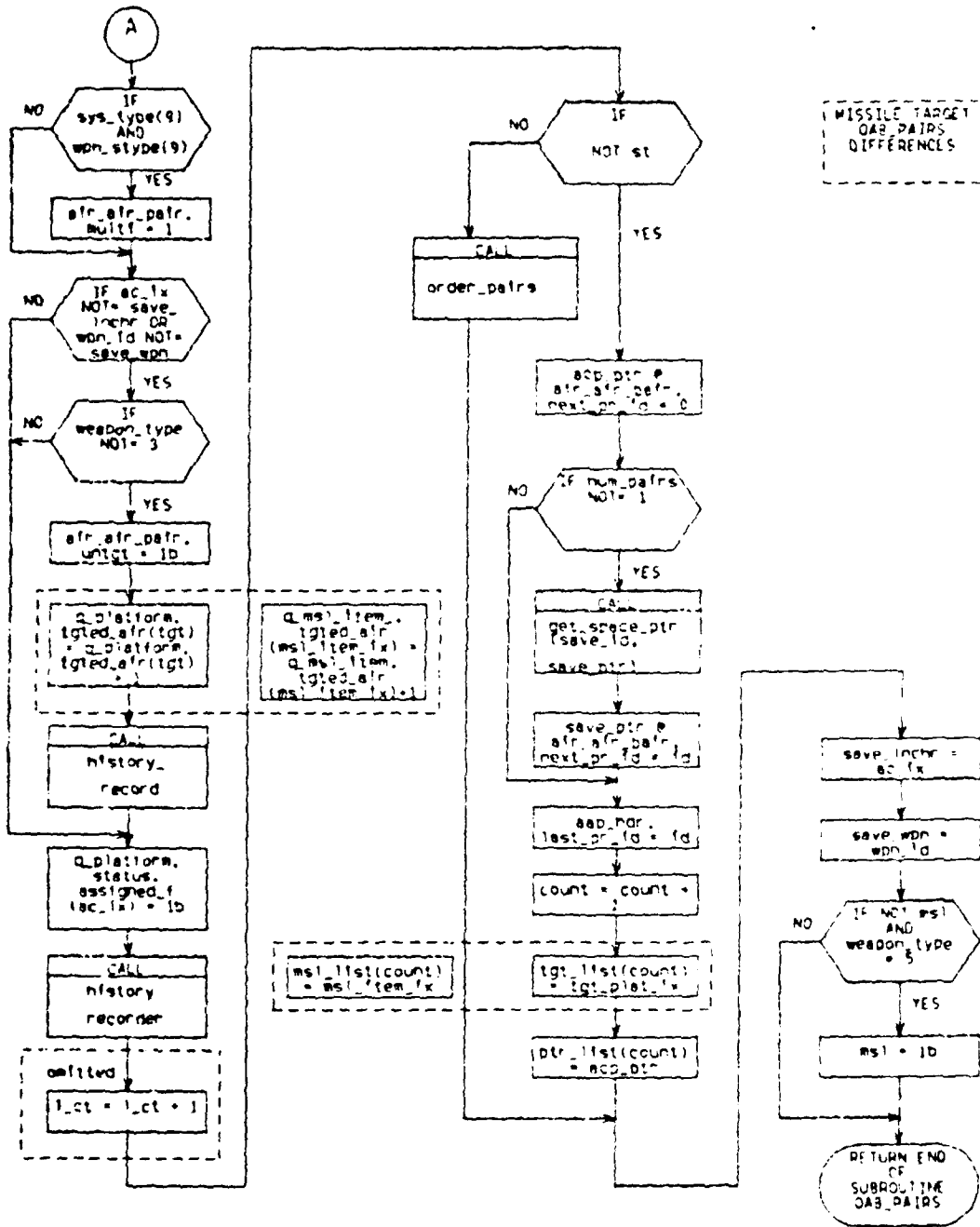

Subroutine OAB_PAIRS (b) Aircraft and Missile Targets

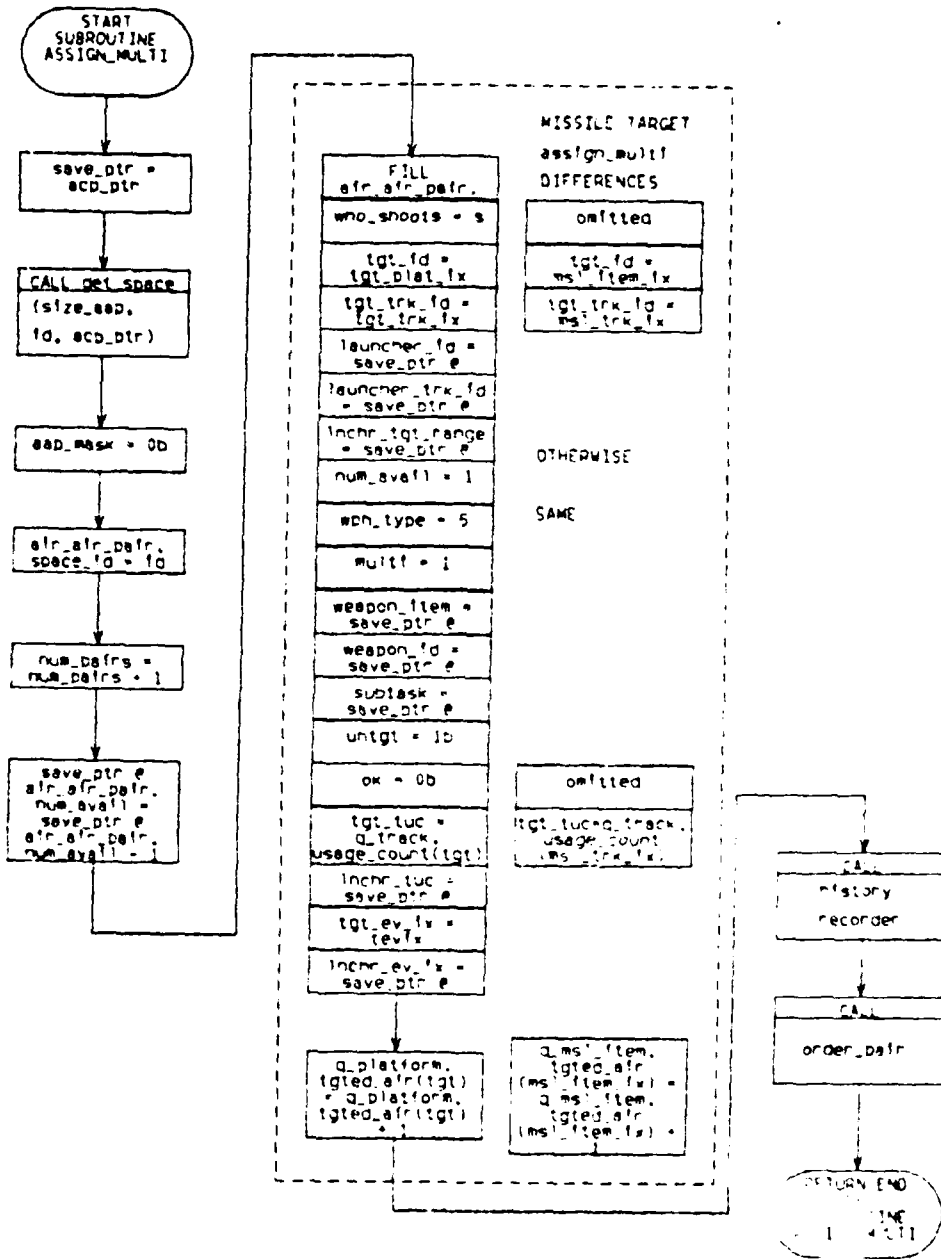

Subroutine ASSIGN_MULTI Aircraft and Missile Targets

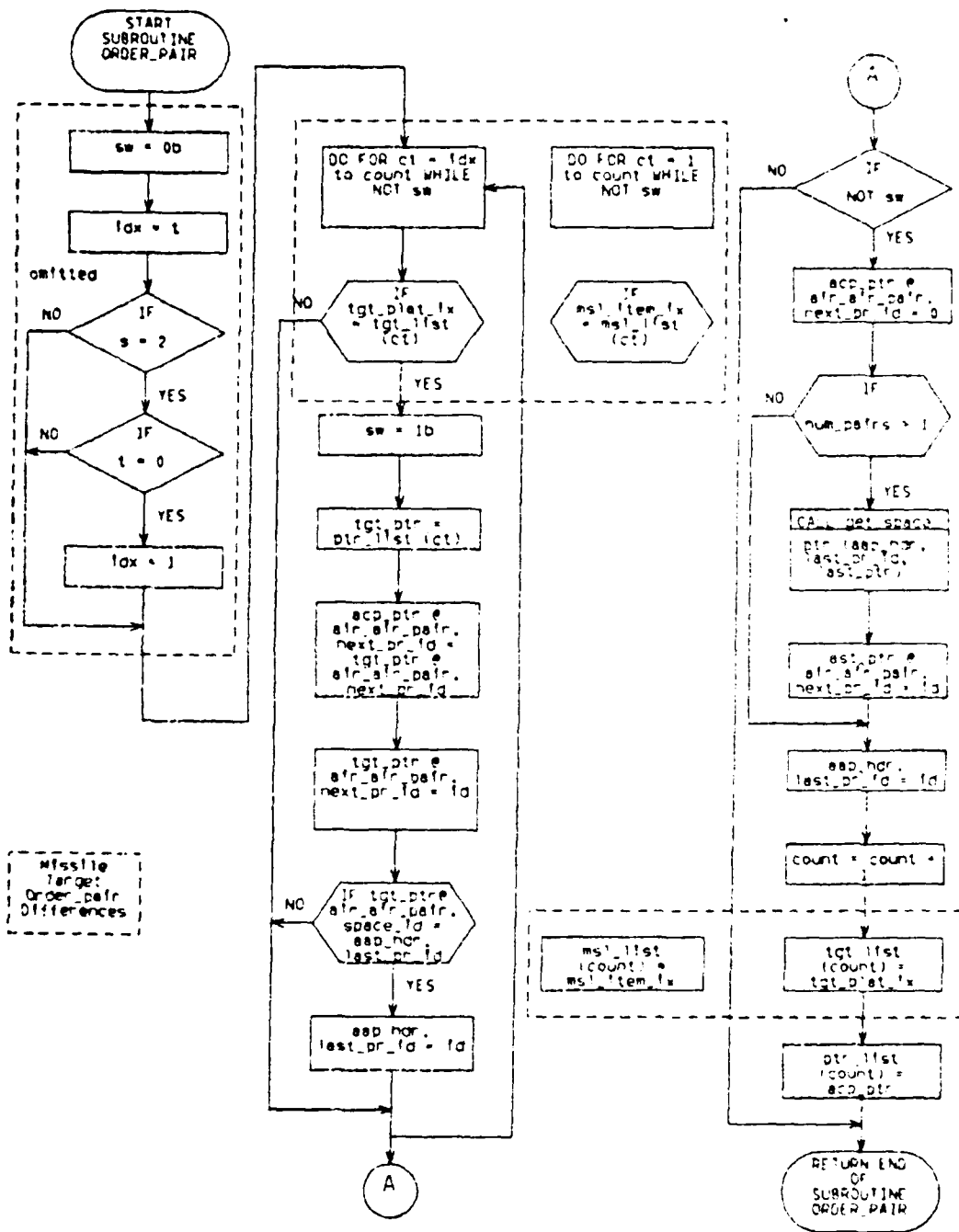

Subroutine ORDER_PAIR Aircraft and Missile Targets

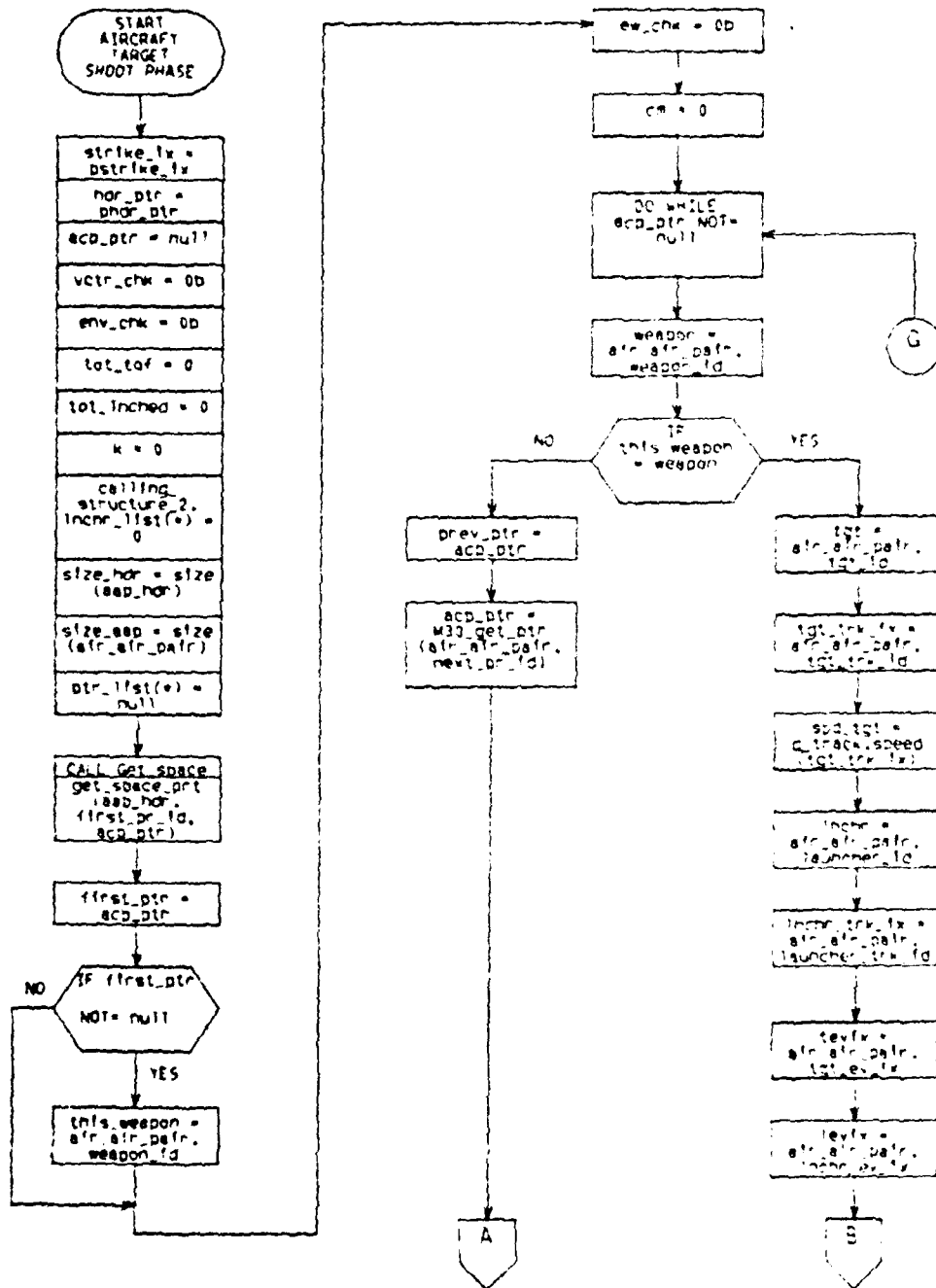

M20_AC_AC_2(a) AIRCRAFT TARGET SHOOT PHASE

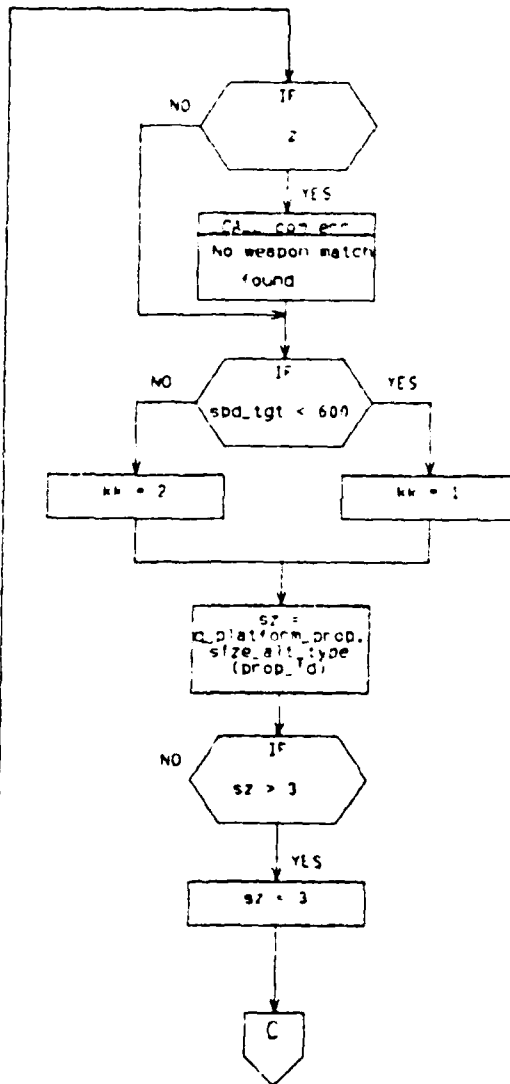
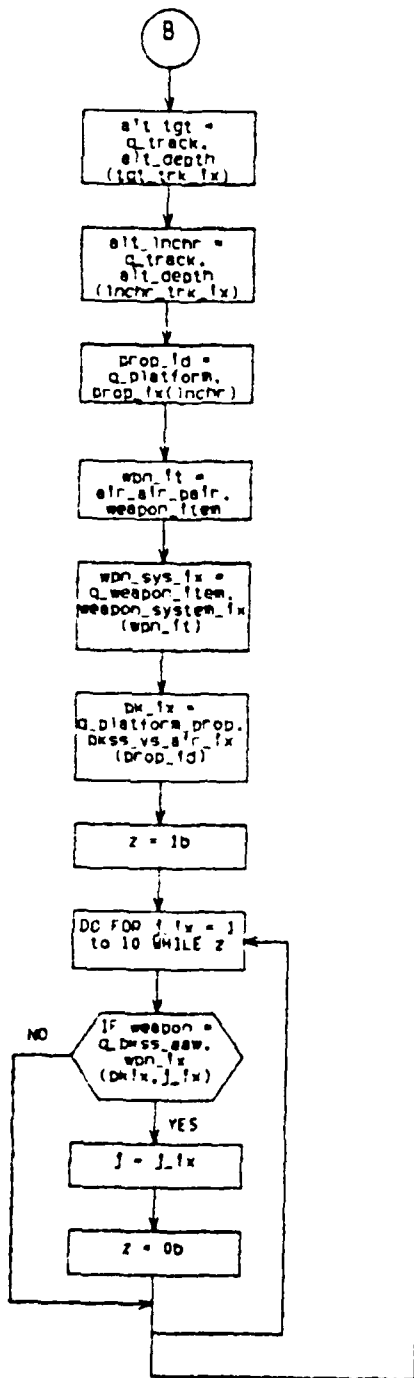

M20_AC_AC_2 (b) AIRCRAFT TARGET SHOOT PHASE

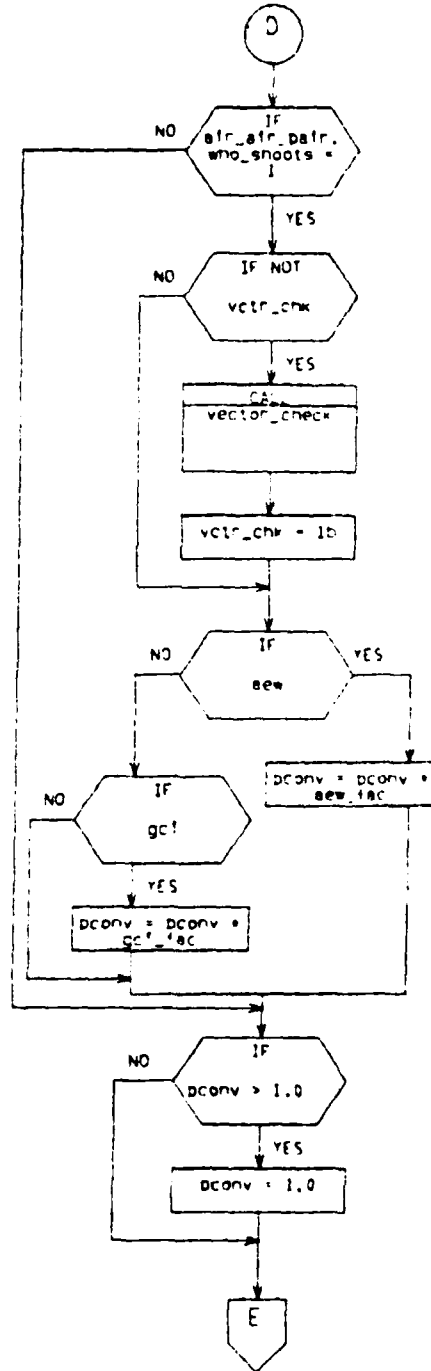
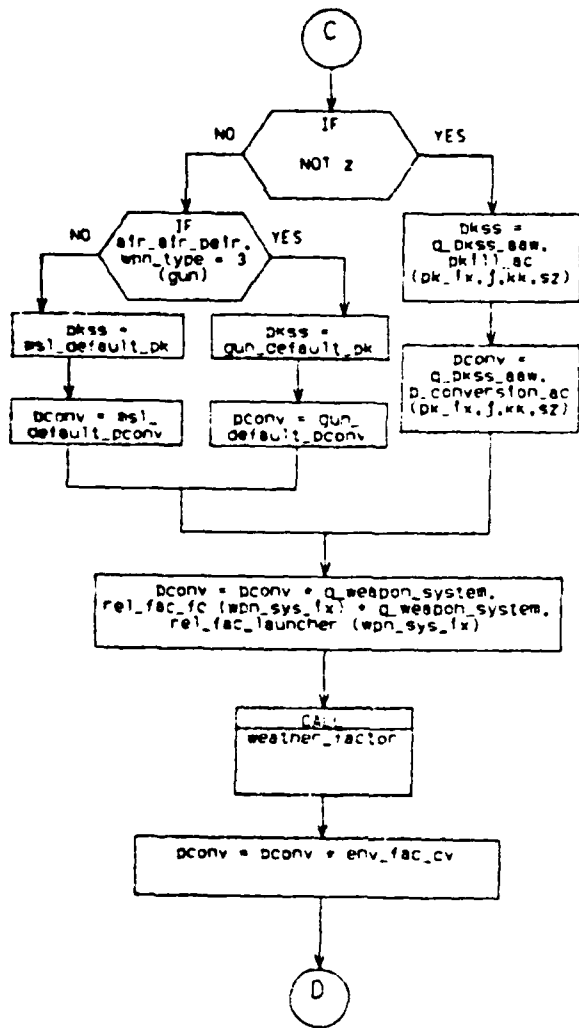

M20_AC_AC_2 (c) AIRCRAFT TARGET SHOOT PHASE

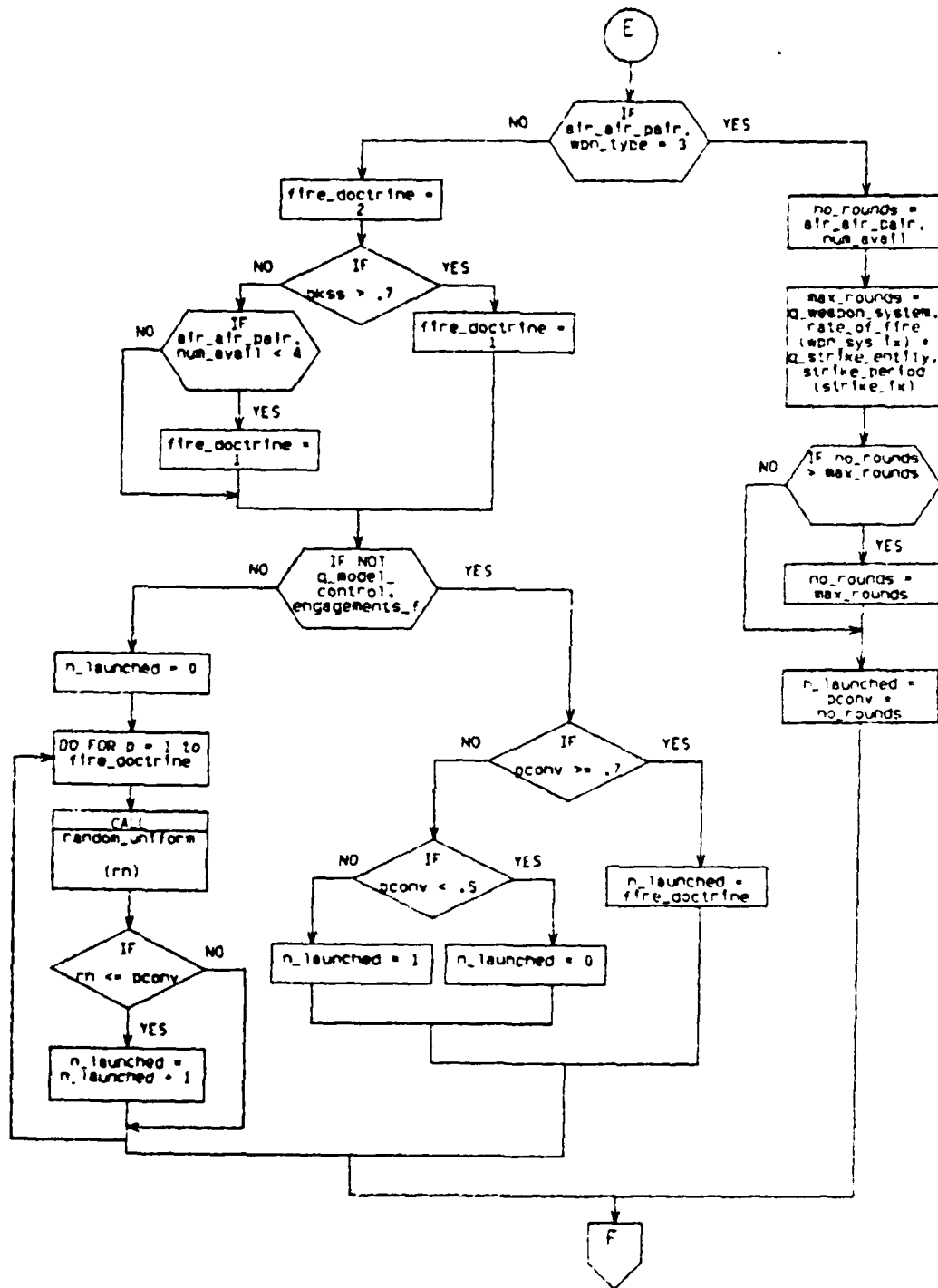

M20_AC_AC_2 (d) AIRCRAFT TARGET SHOOT PHASE

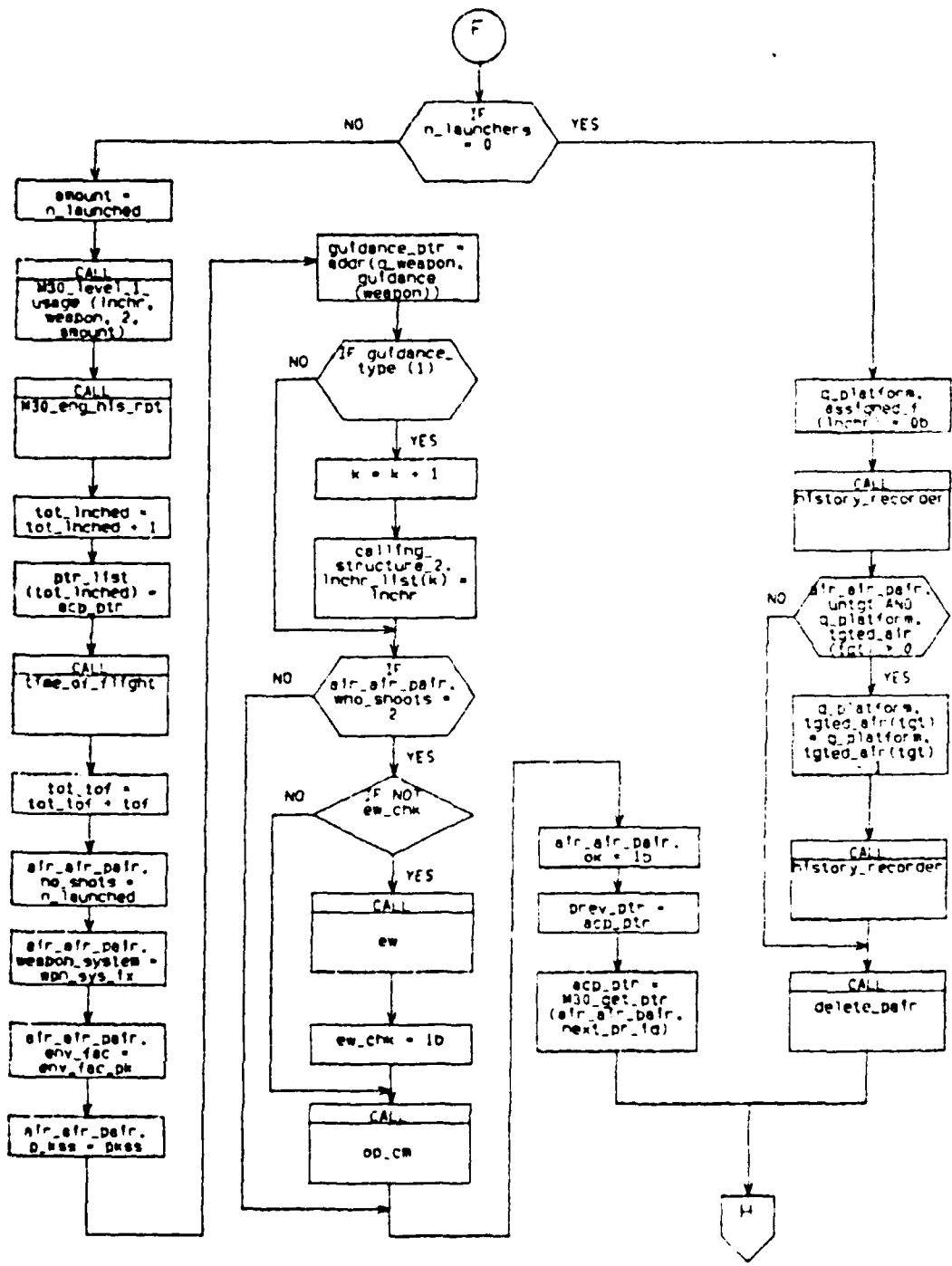

M20_AC_AC_2 (e) AIRCRAFT TARGET SHOOT PHASE

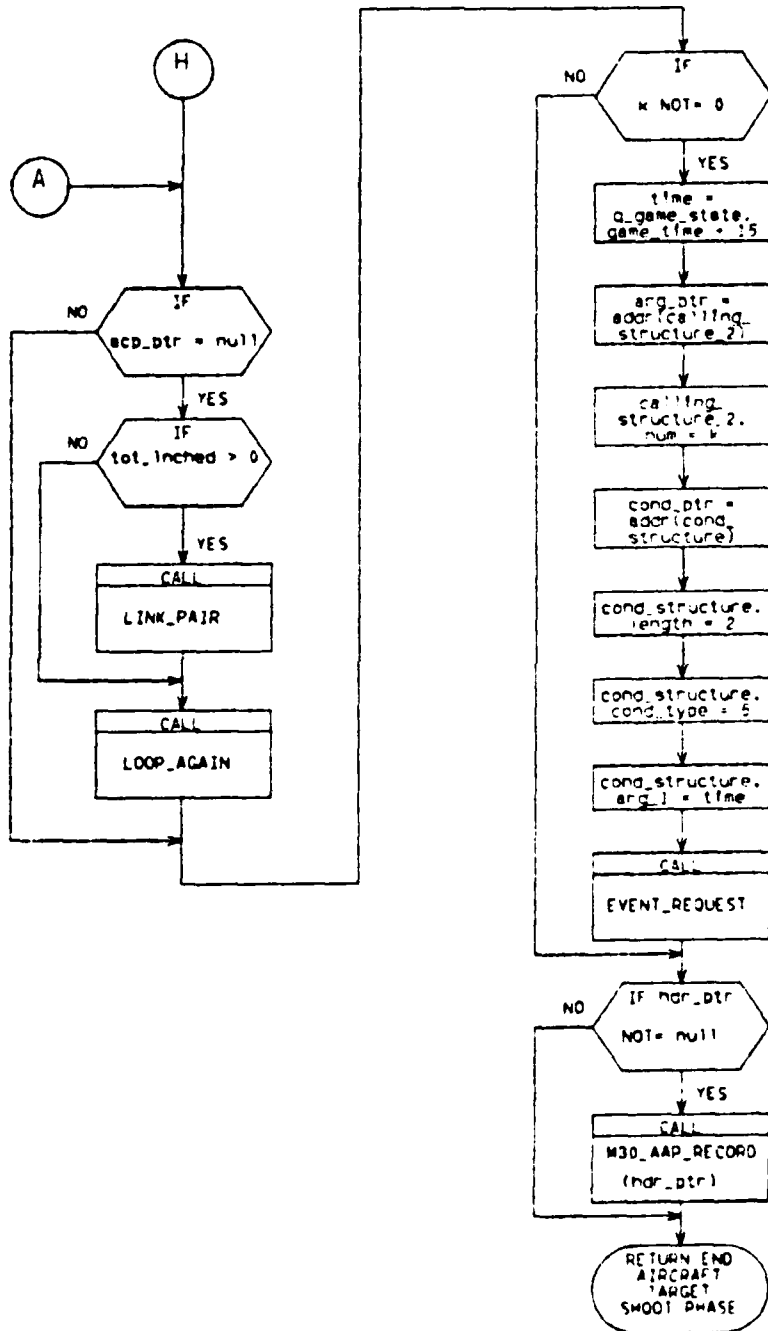

M20_AC_AC_2 (f) AIRCRAFT TARGET SHOOT PHASE

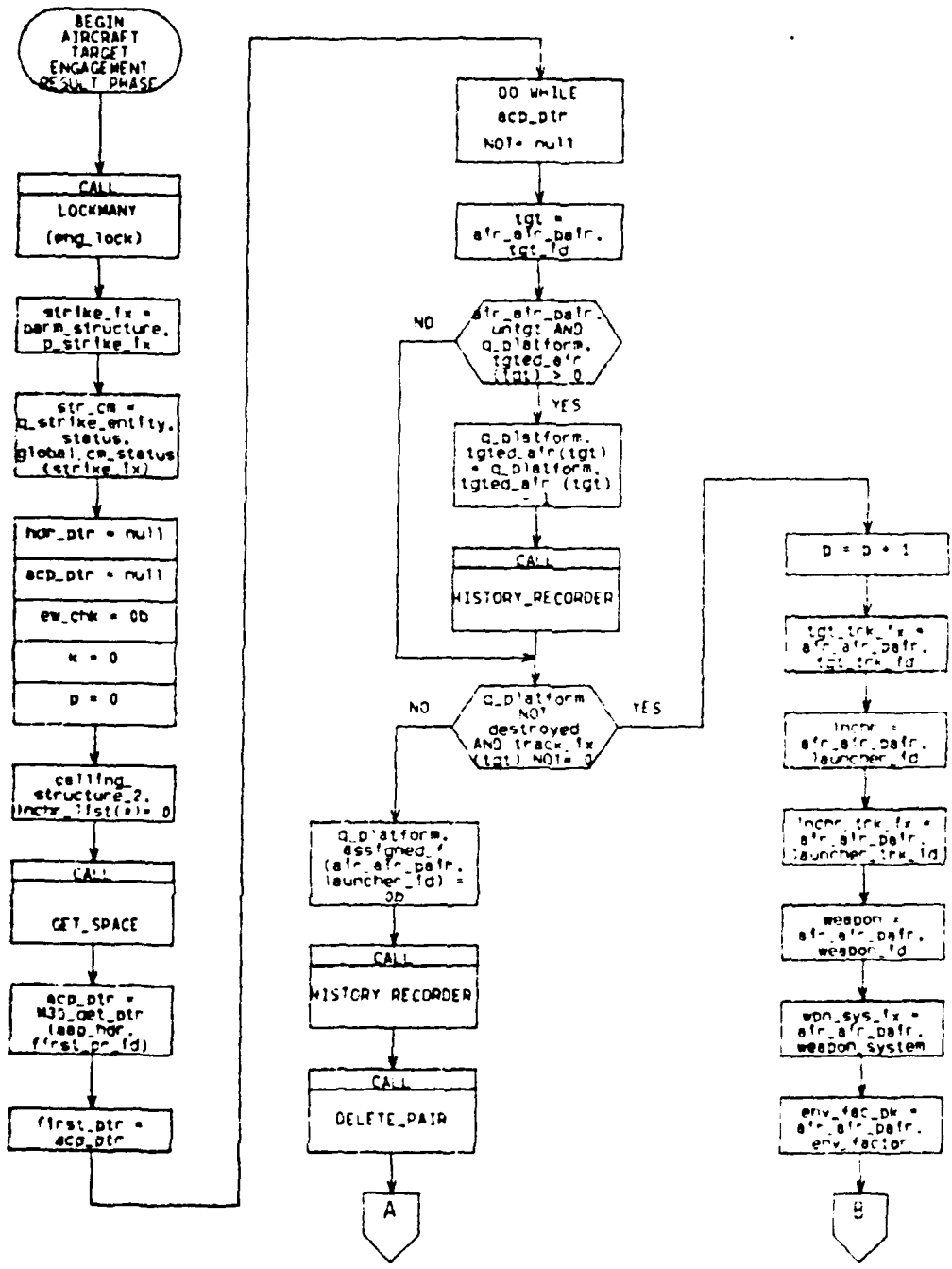

M20_AC_AC_2 (g) AIRCRAFT TARGET ENGAGEMENT RESULT PHASE

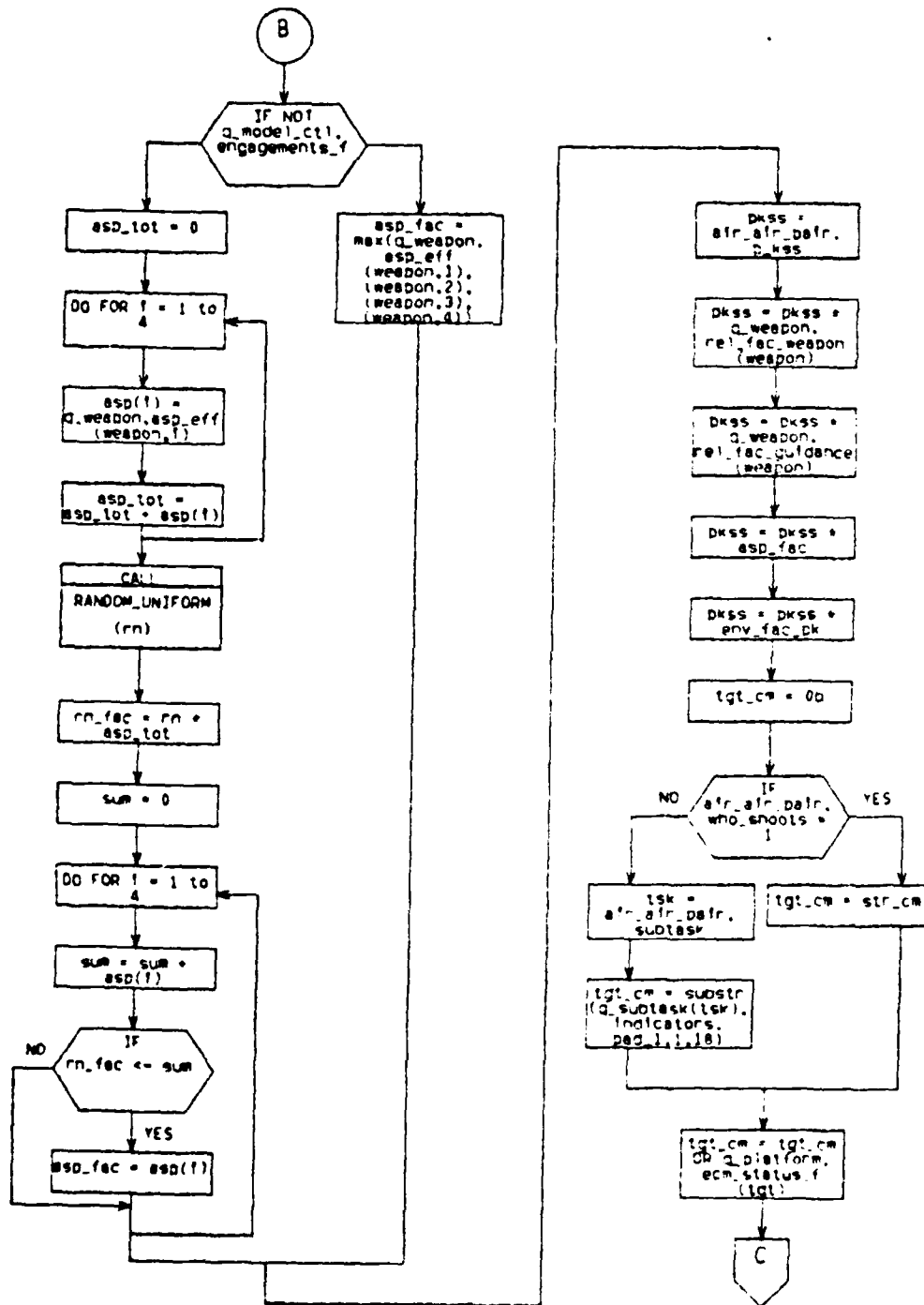

M20_AC_AC_2 (h) AIRCRAFT TARGET ENGAGEMENT RESULT PHASE

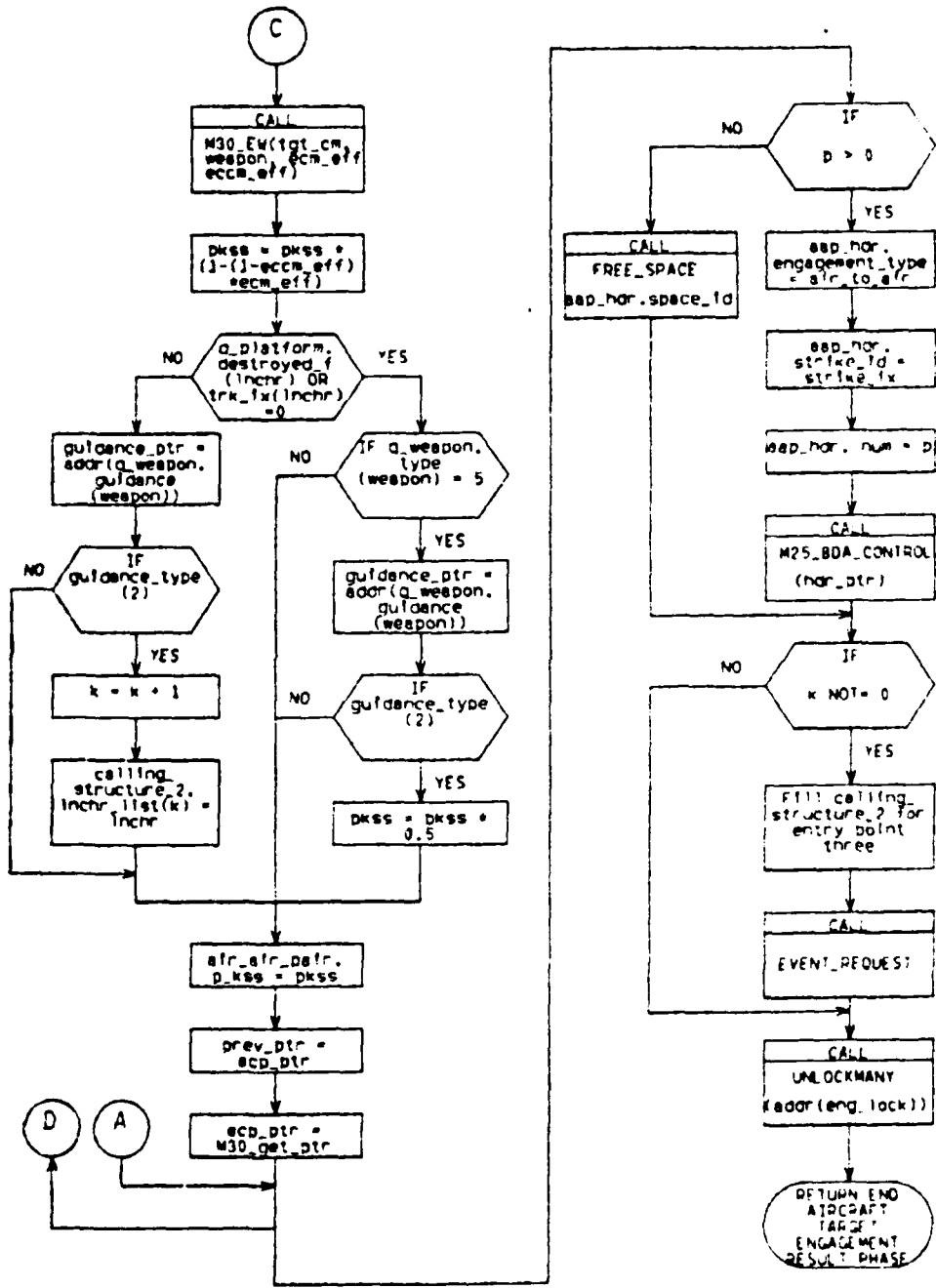

M20 AC AC 2 (1) AIRCRAFT TARGET ENGAGEMENT RESULT PHASE

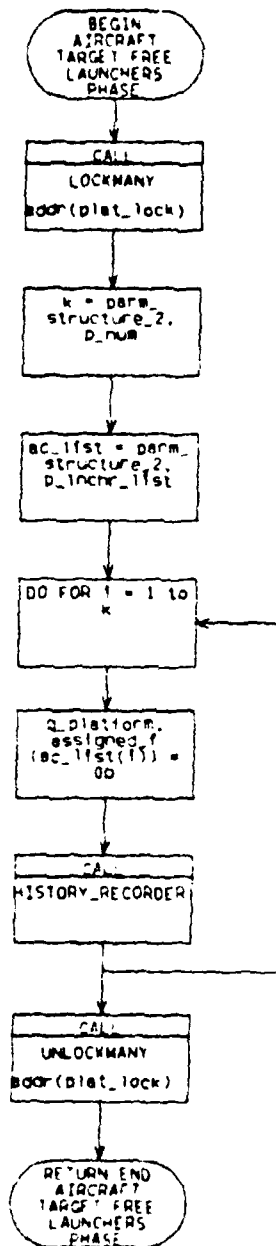

M20_AC_AC_2 (j) AIRCRAFT TARGET FREE LAUNCHERS PHASE

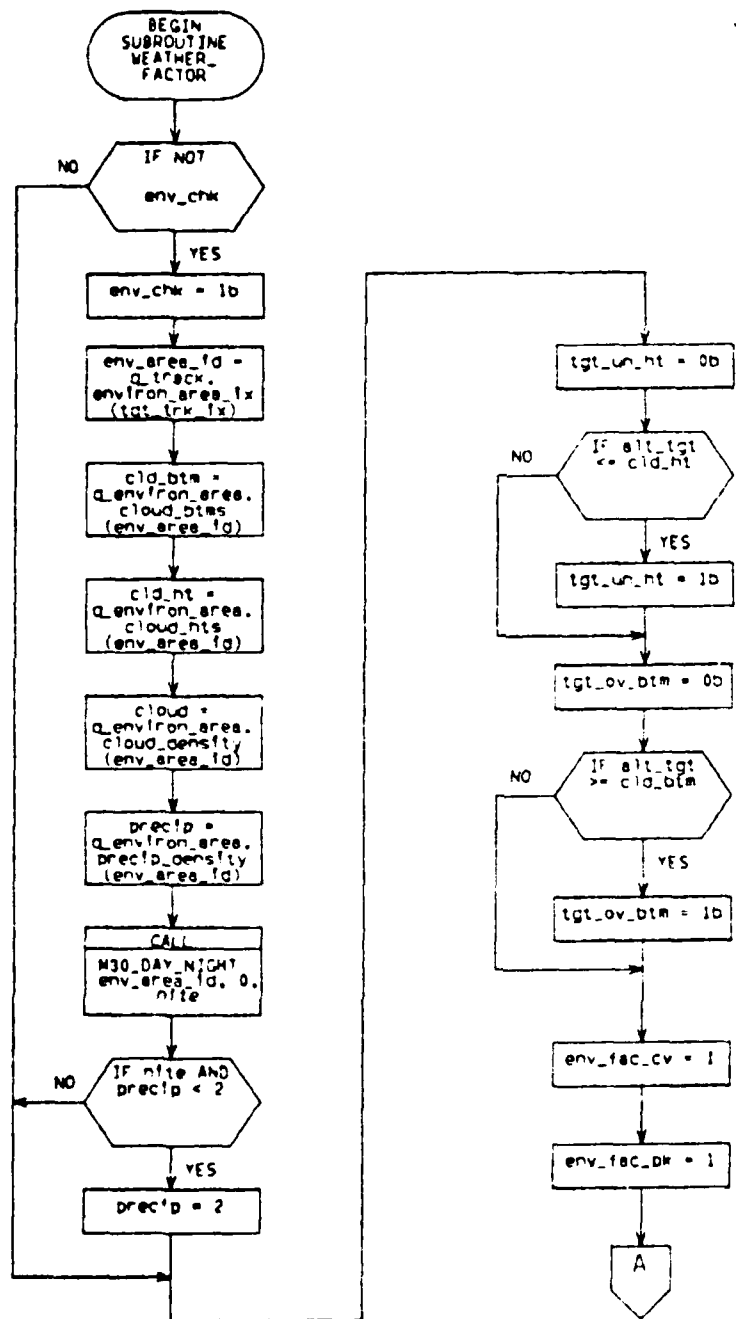

Subroutine WEATHER_FACTOR (a)

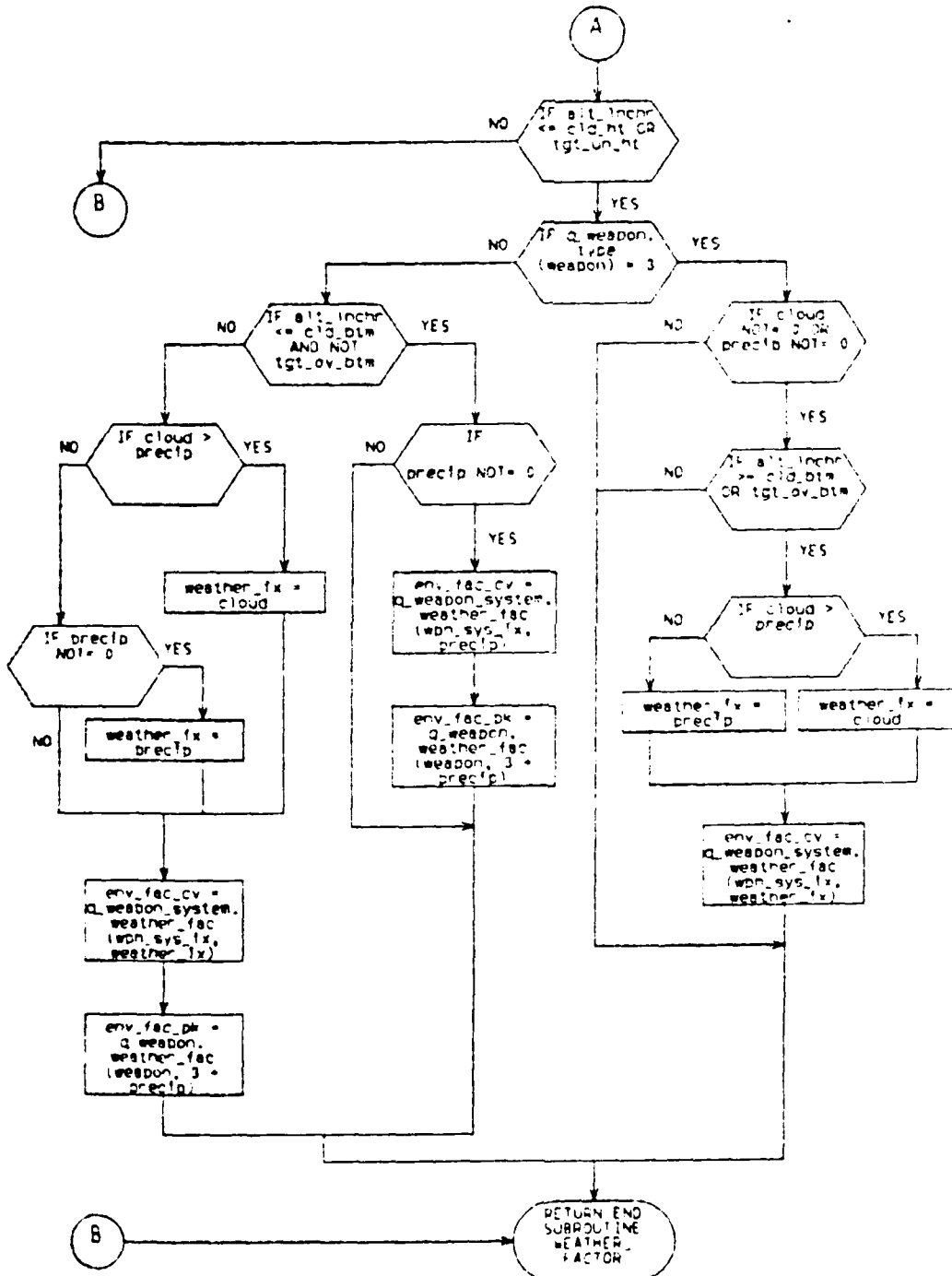

Subroutine WEATHER_FACTOR (b)

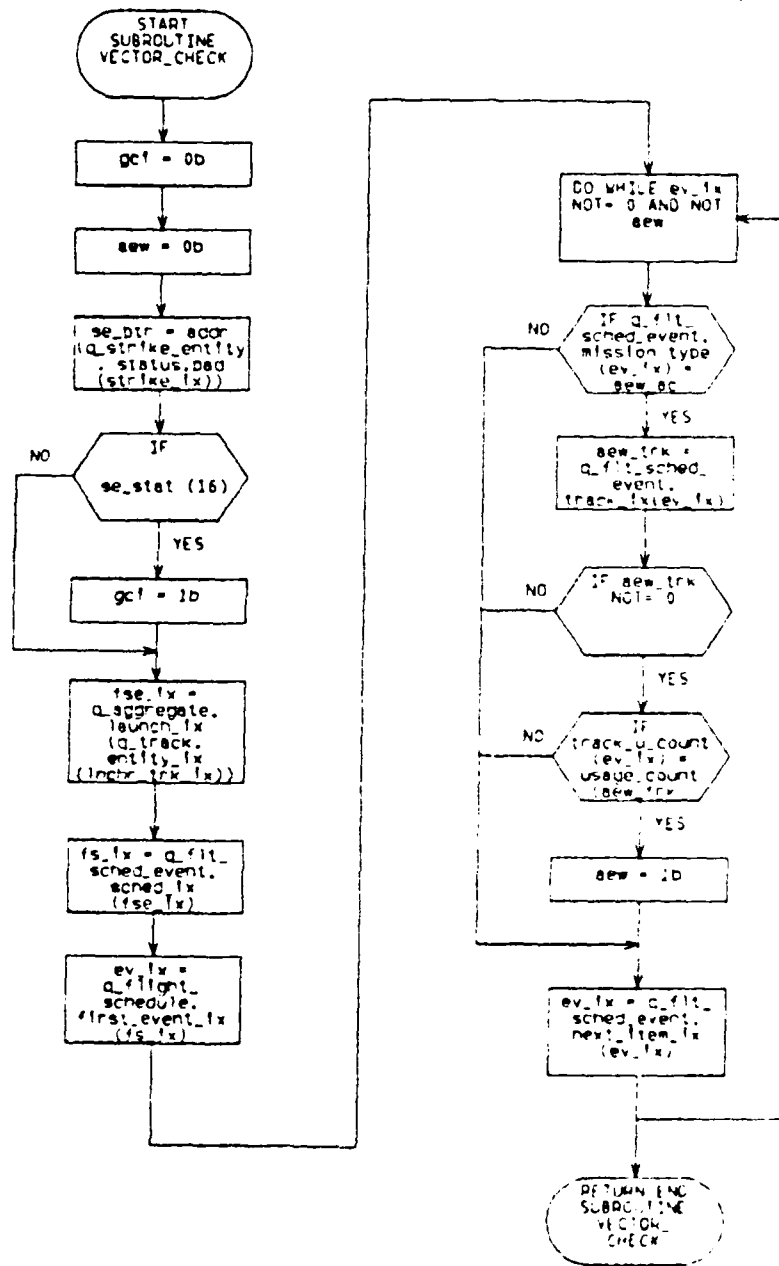

Subroutine VECTOR_CHECK

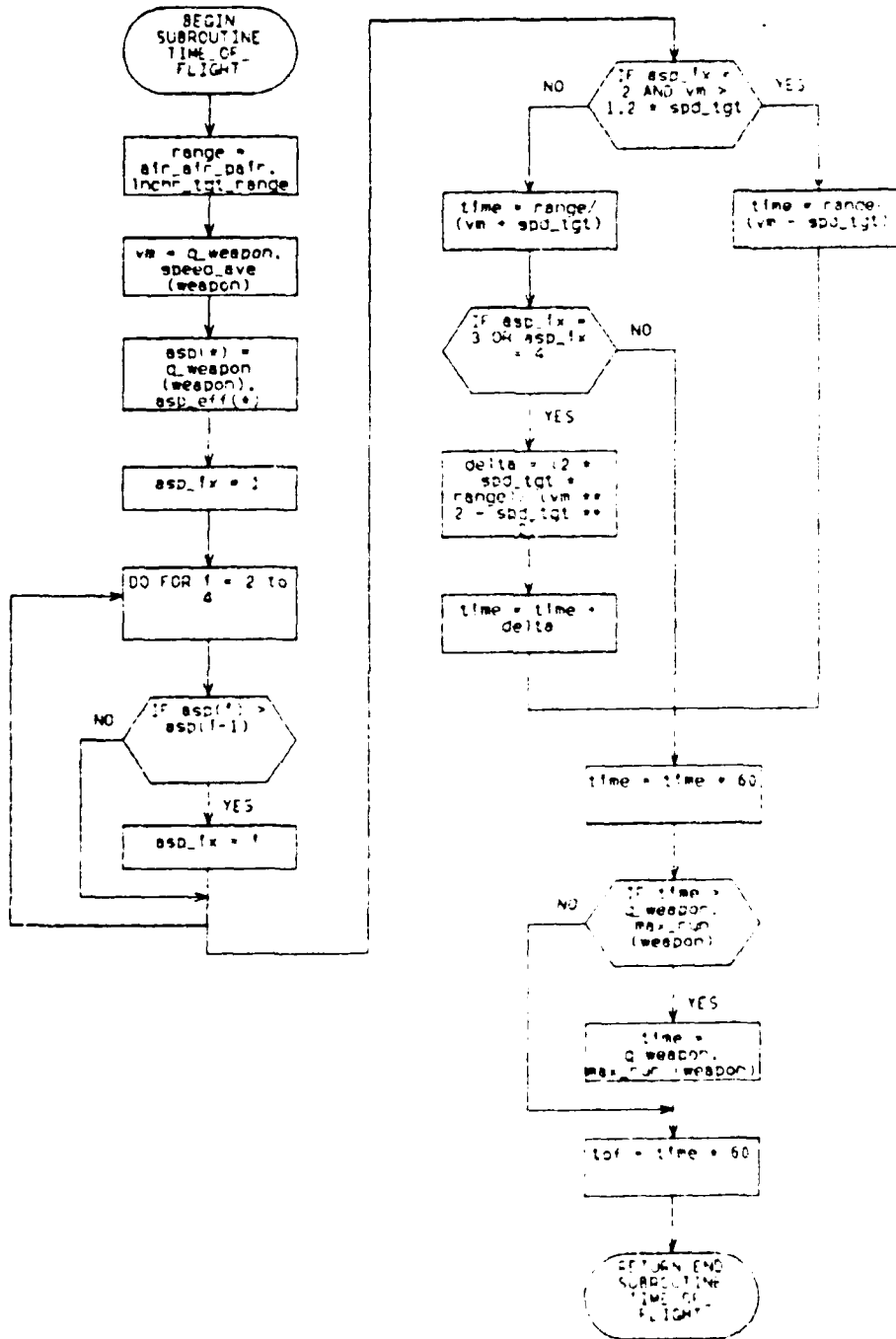

Subroutine TIME_OF_FLIGHT

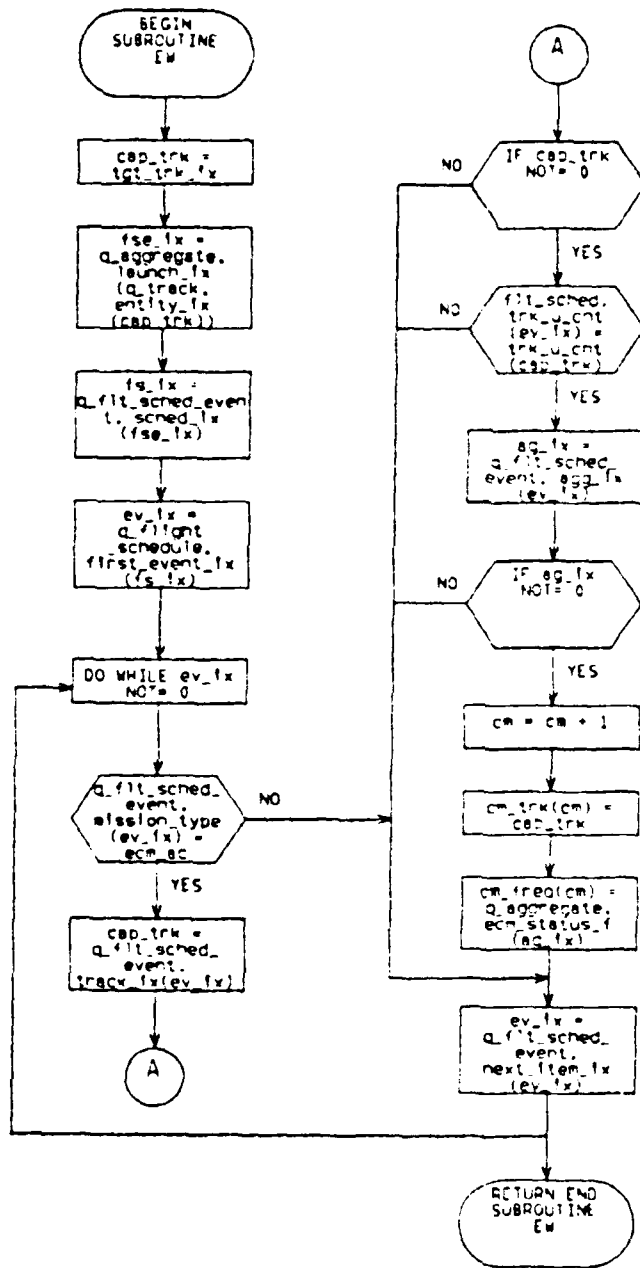

Subroutine EW

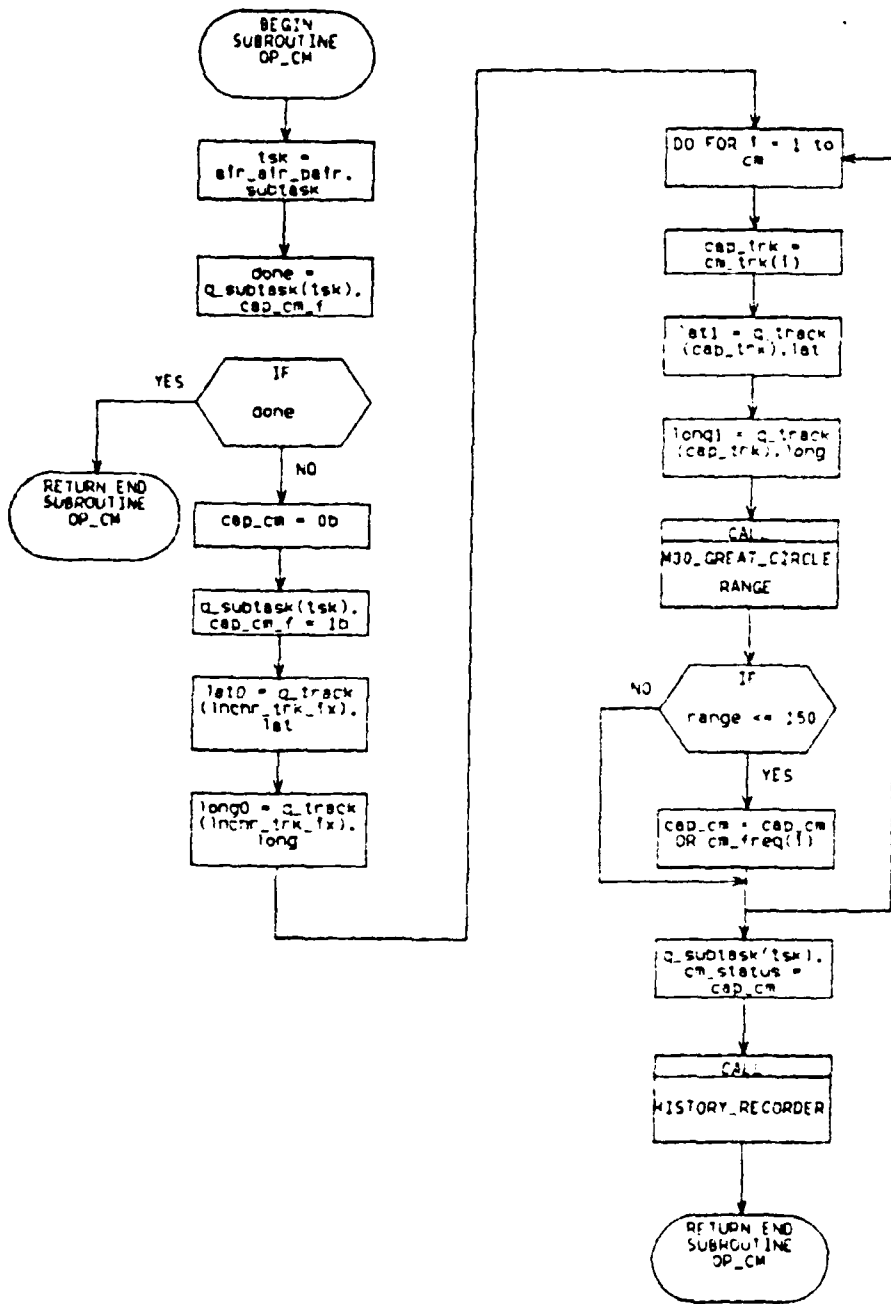

Subroutine OP_CM

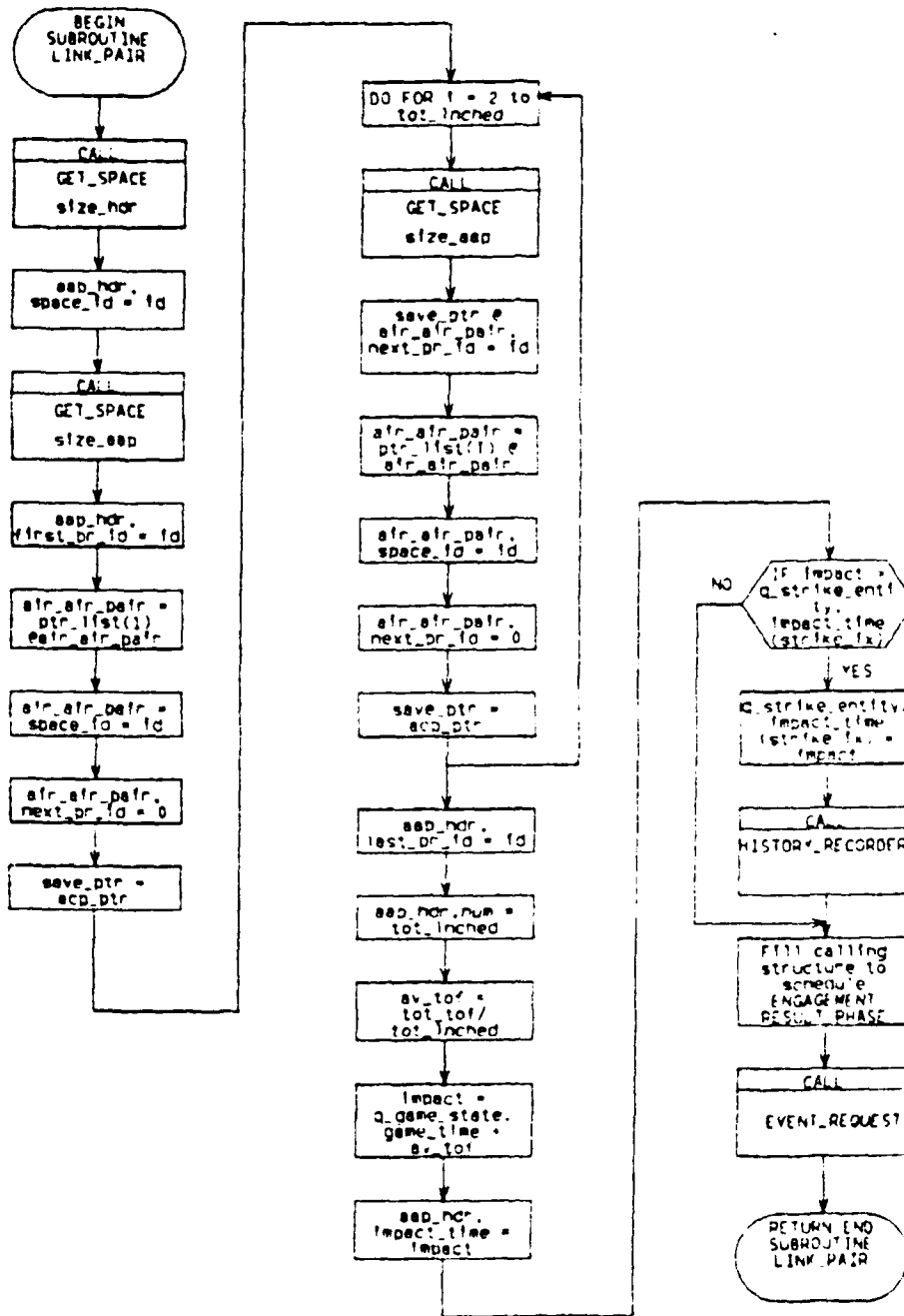

Subroutine LINK_PAIR

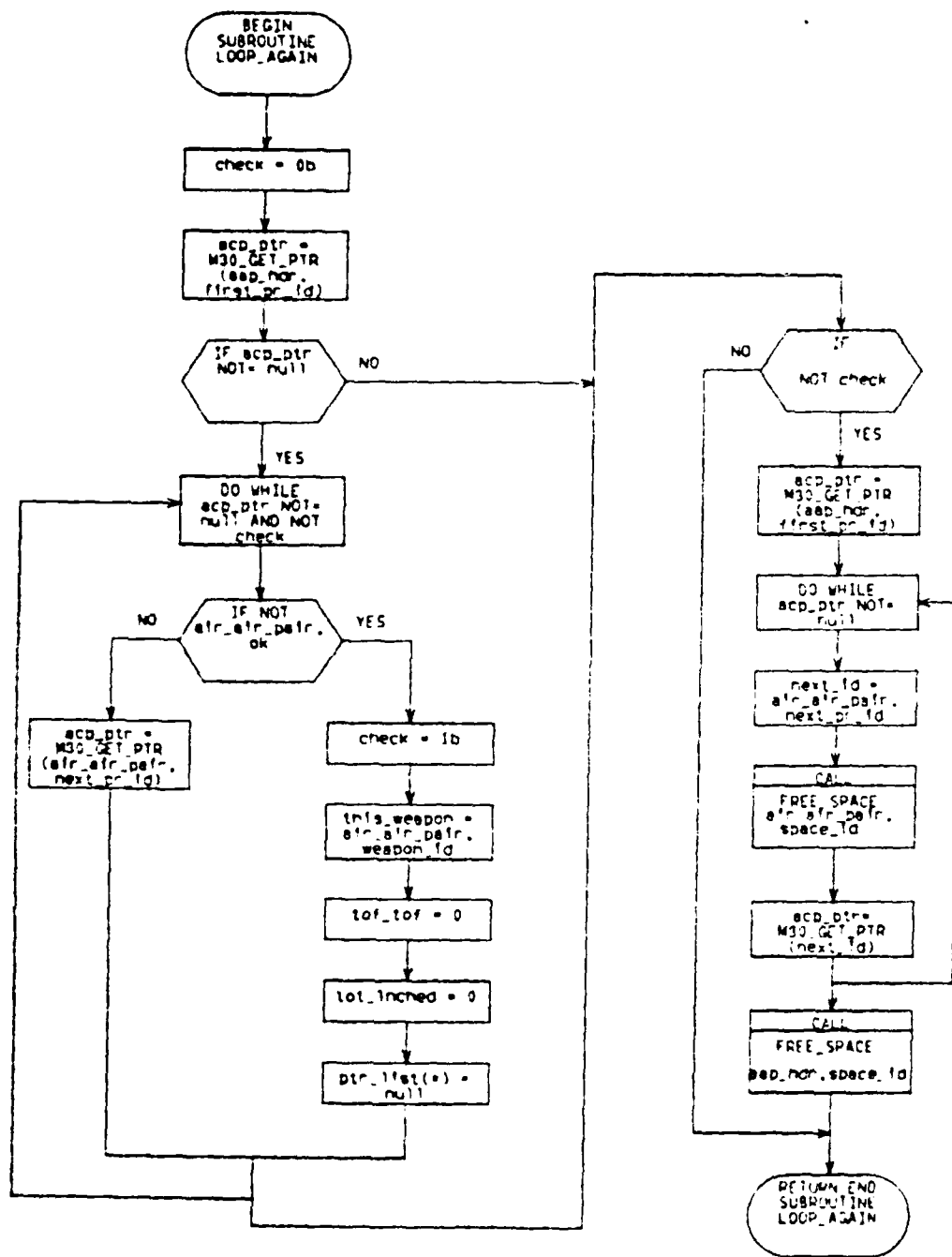

Subroutine LOOP_AGAIN

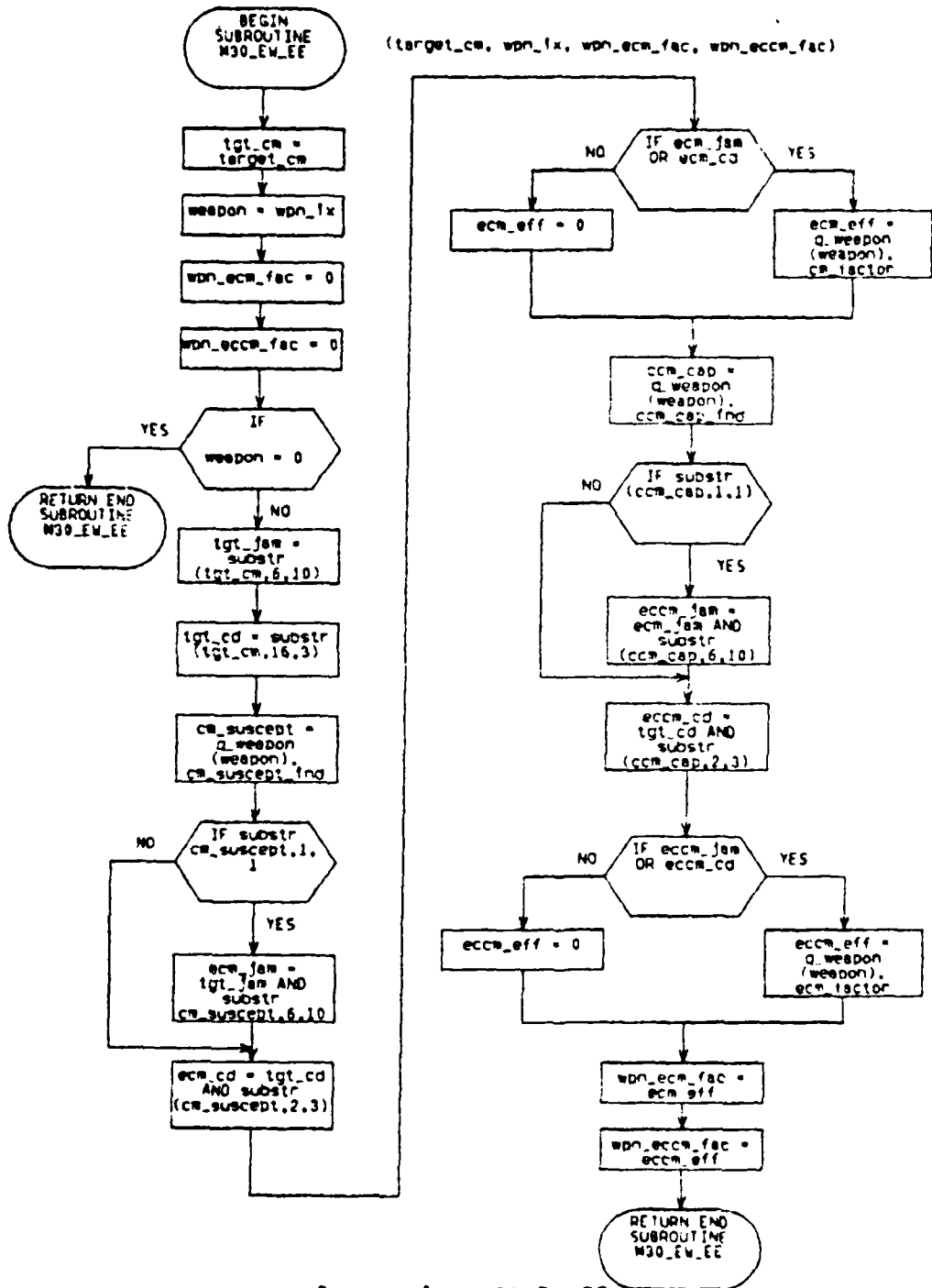

Subroutine M30_EW_EE

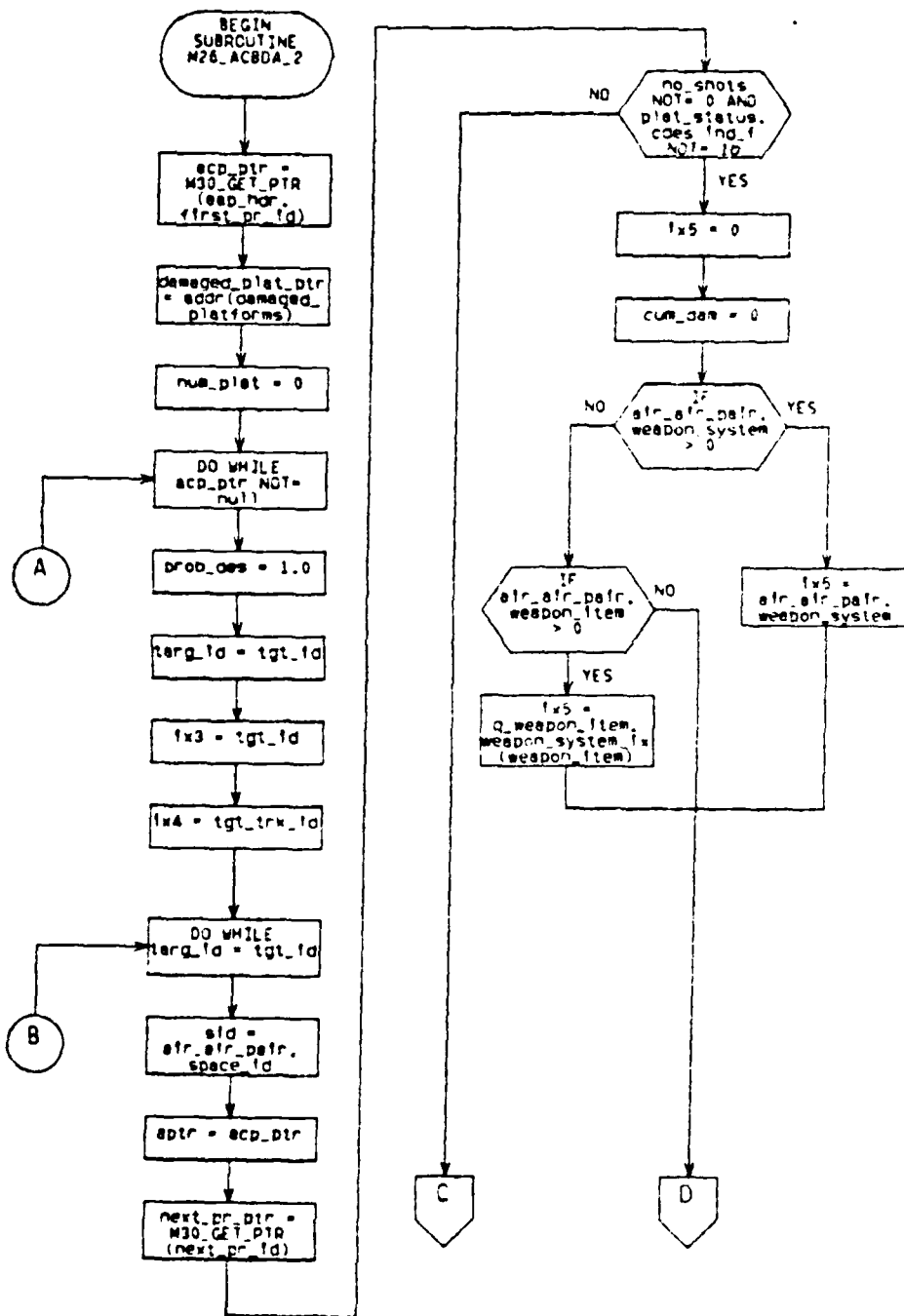

Subroutine M26_ACBDA_2 (a) Called By M25_BDA_CTL

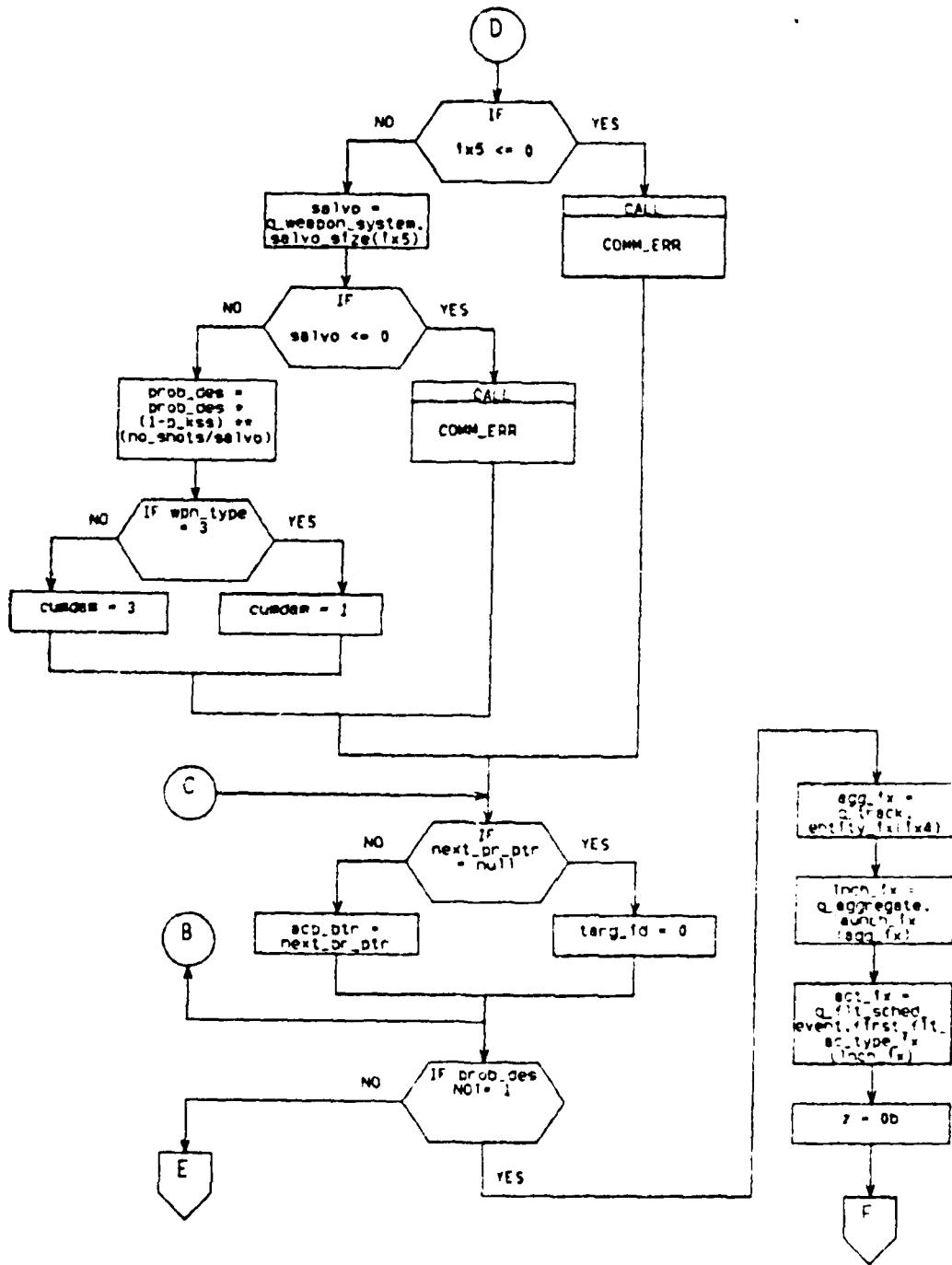

Subroutine M26_ACBDA_2 (b)

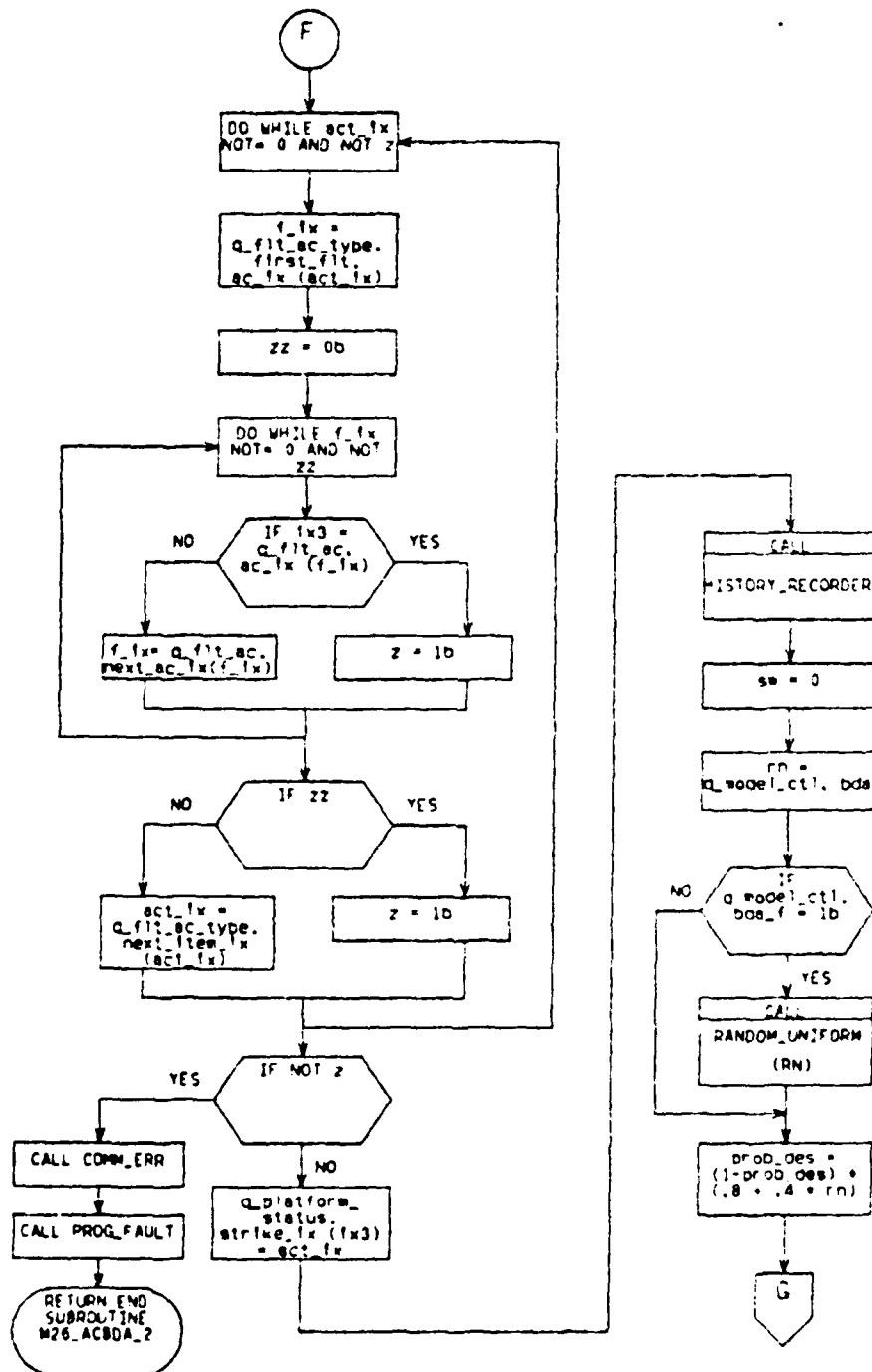

Subroutine M26_AC8DA_2 (c)

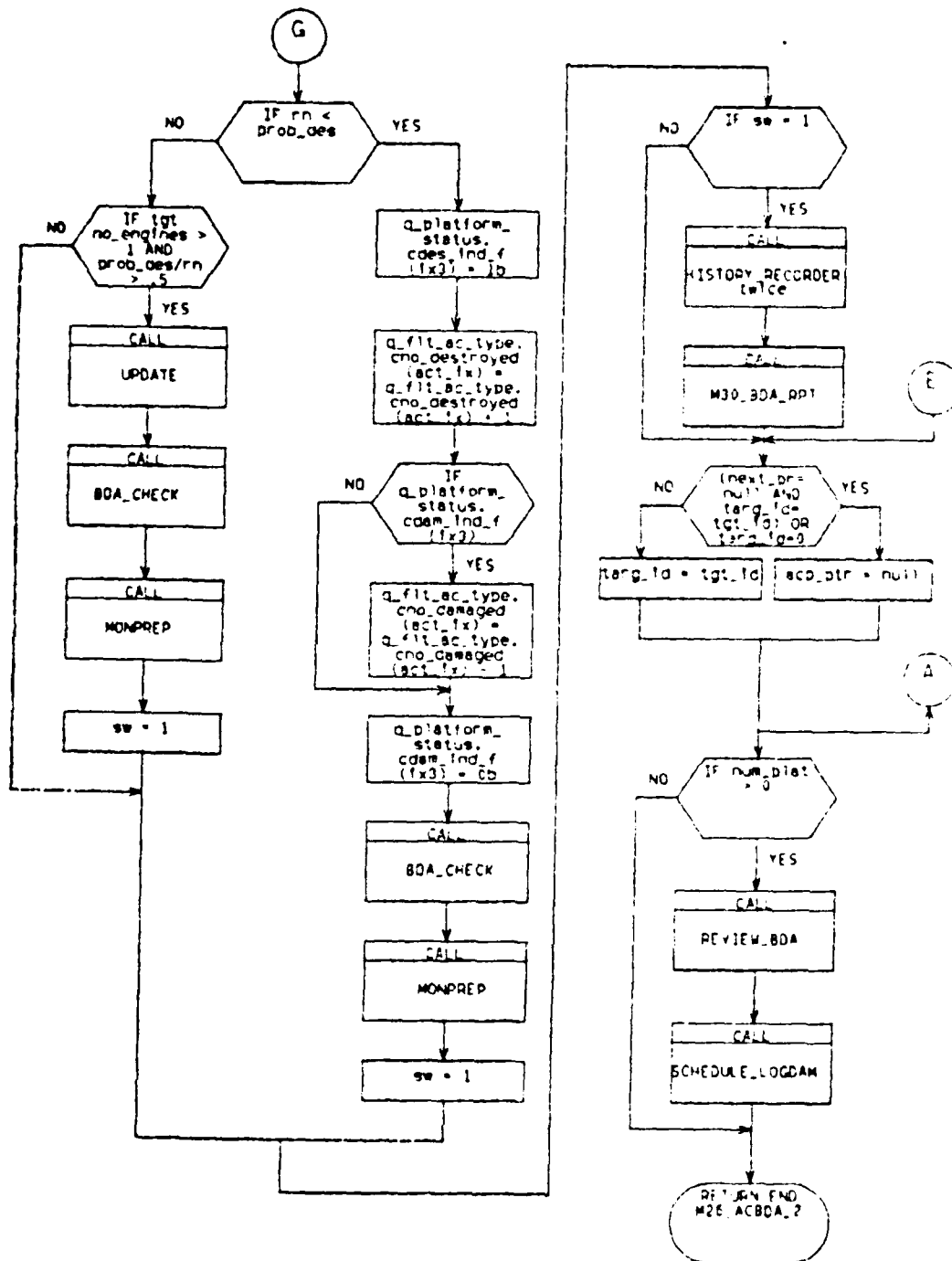

Subroutine M26_AC8DA_2 (d)

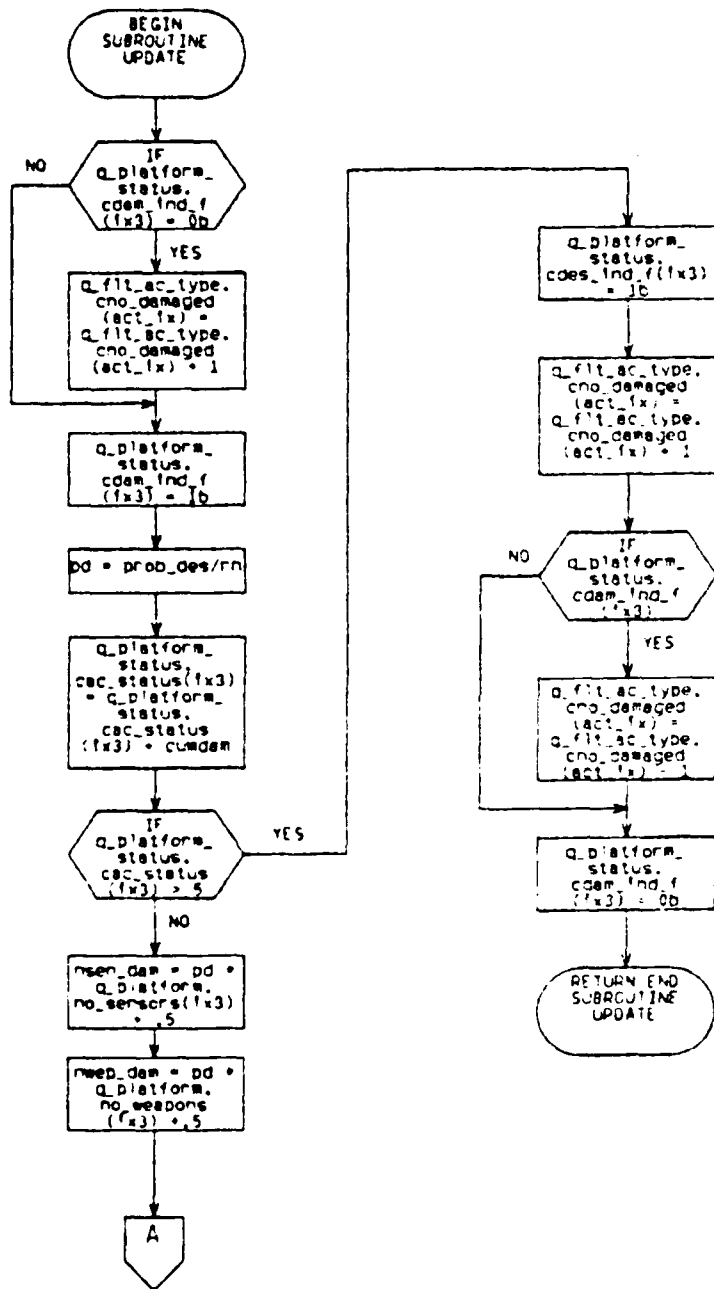

Subroutine UPDATE (a)

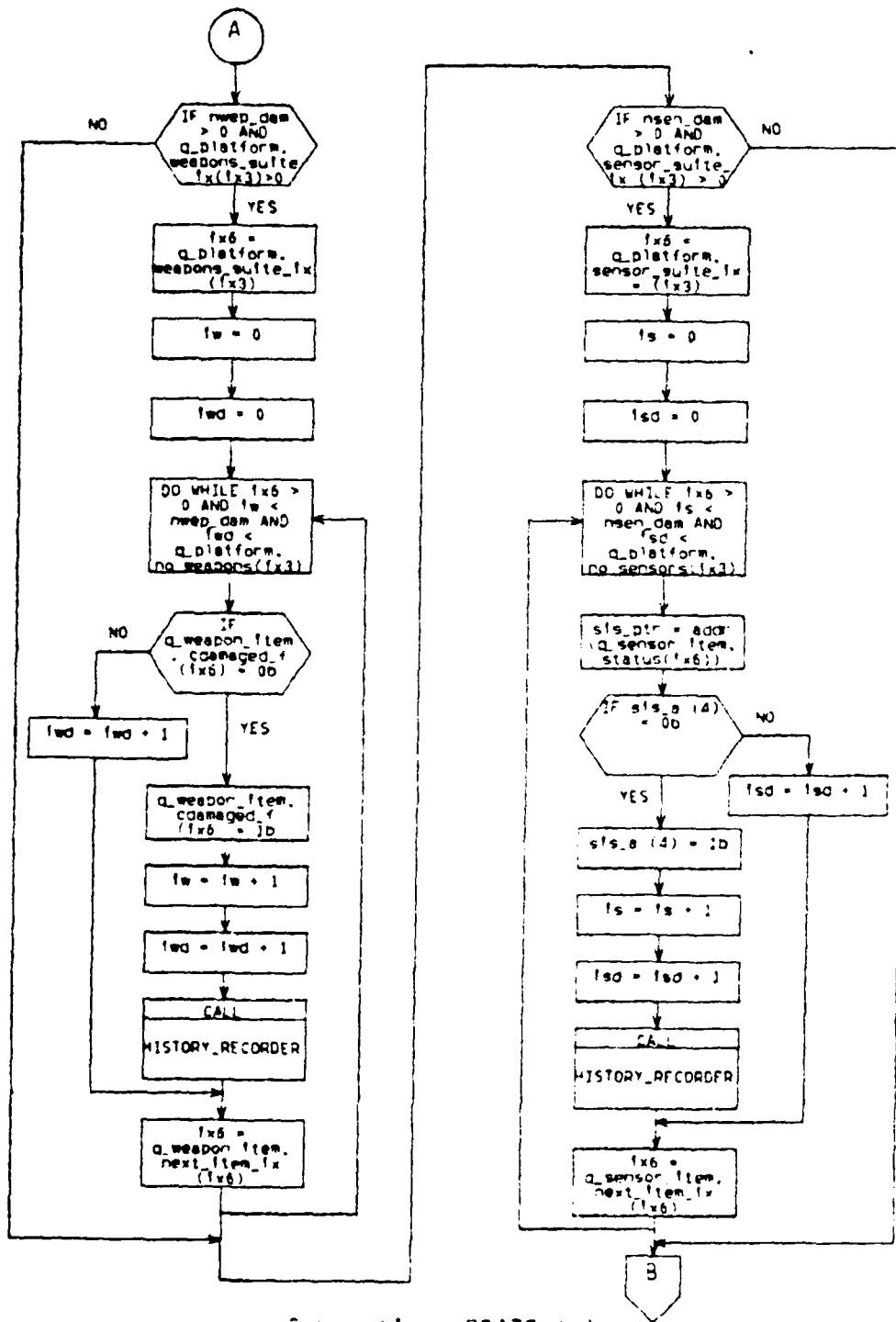

Subroutine UPDATE (b)

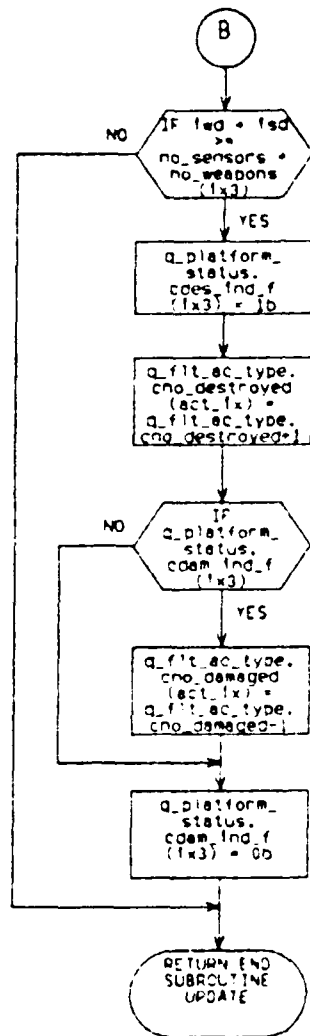

Subroutine UPDATE (c)

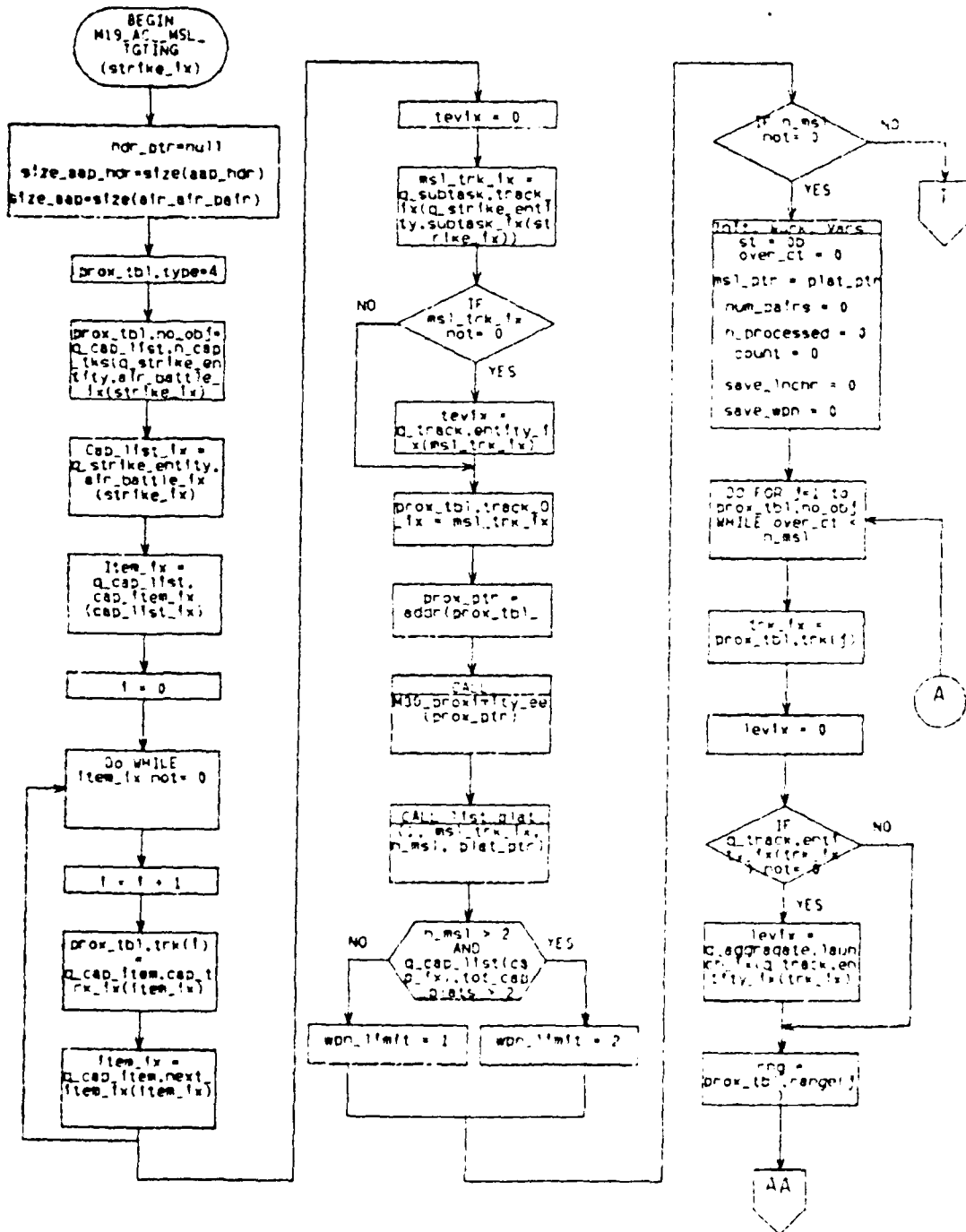

M19_AC_MSL_TGTING (a)

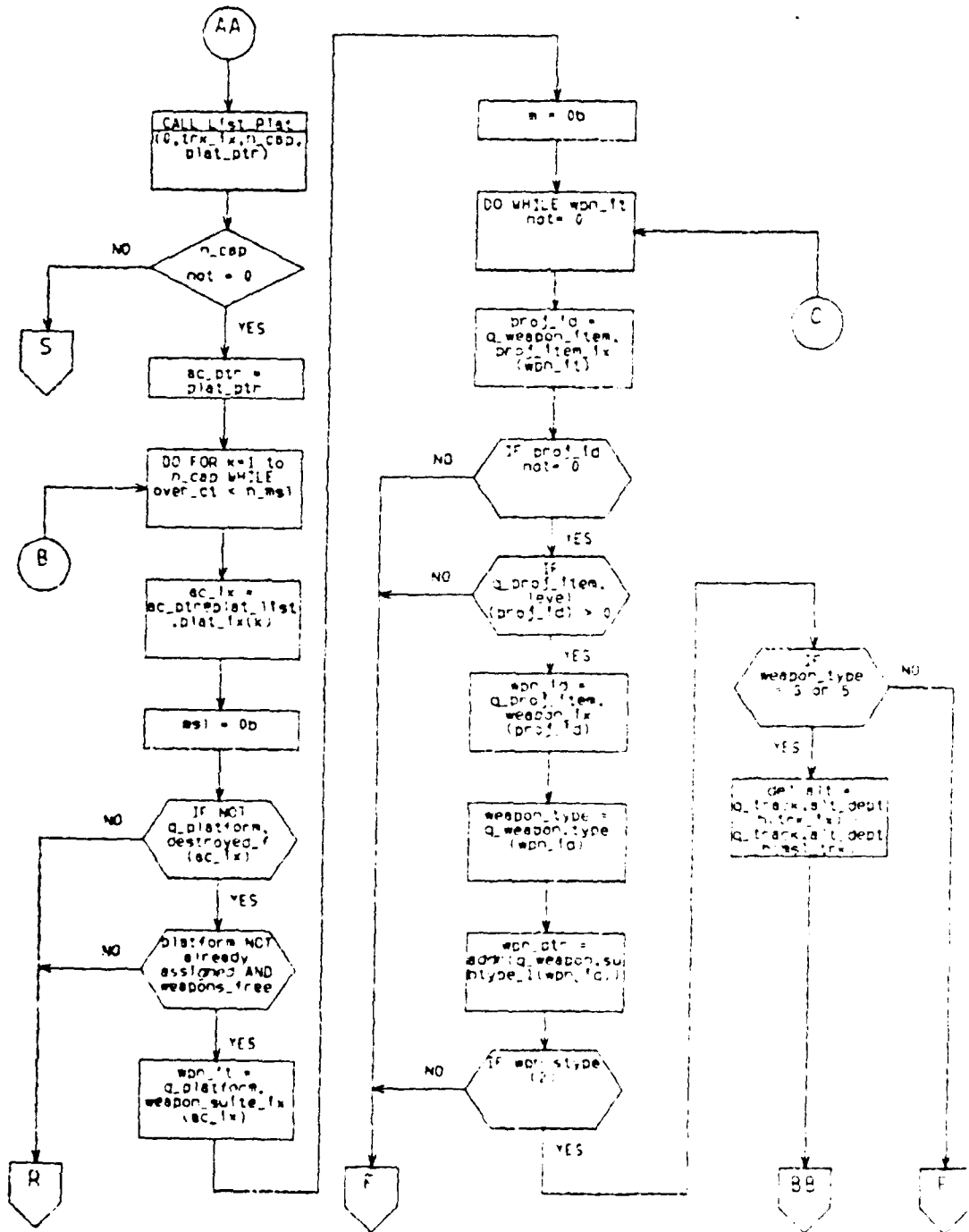

M19_AC_MSL_TGTING (b)

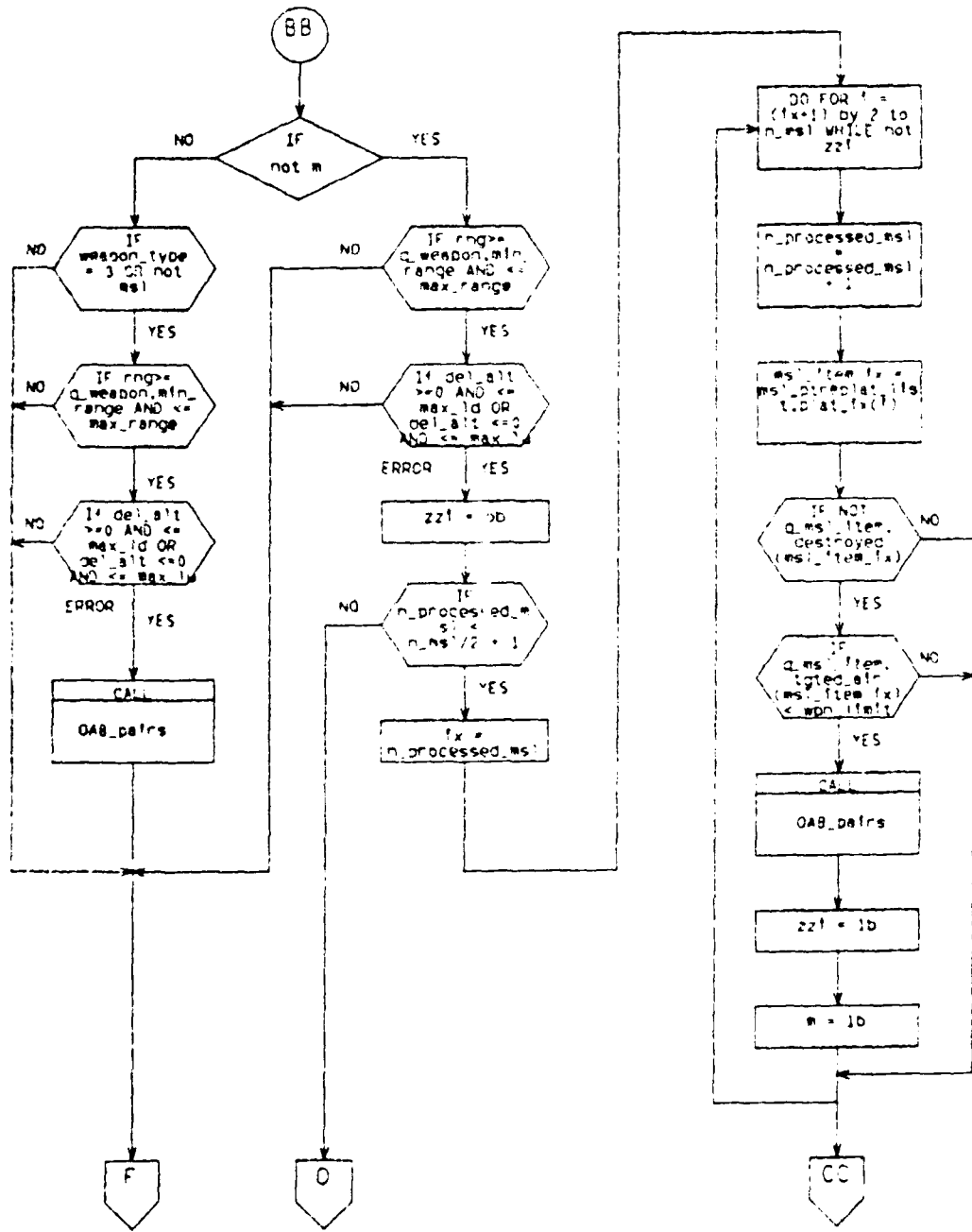

M19_AC_MSL_LIGHTING (c) One-To-One Targeting

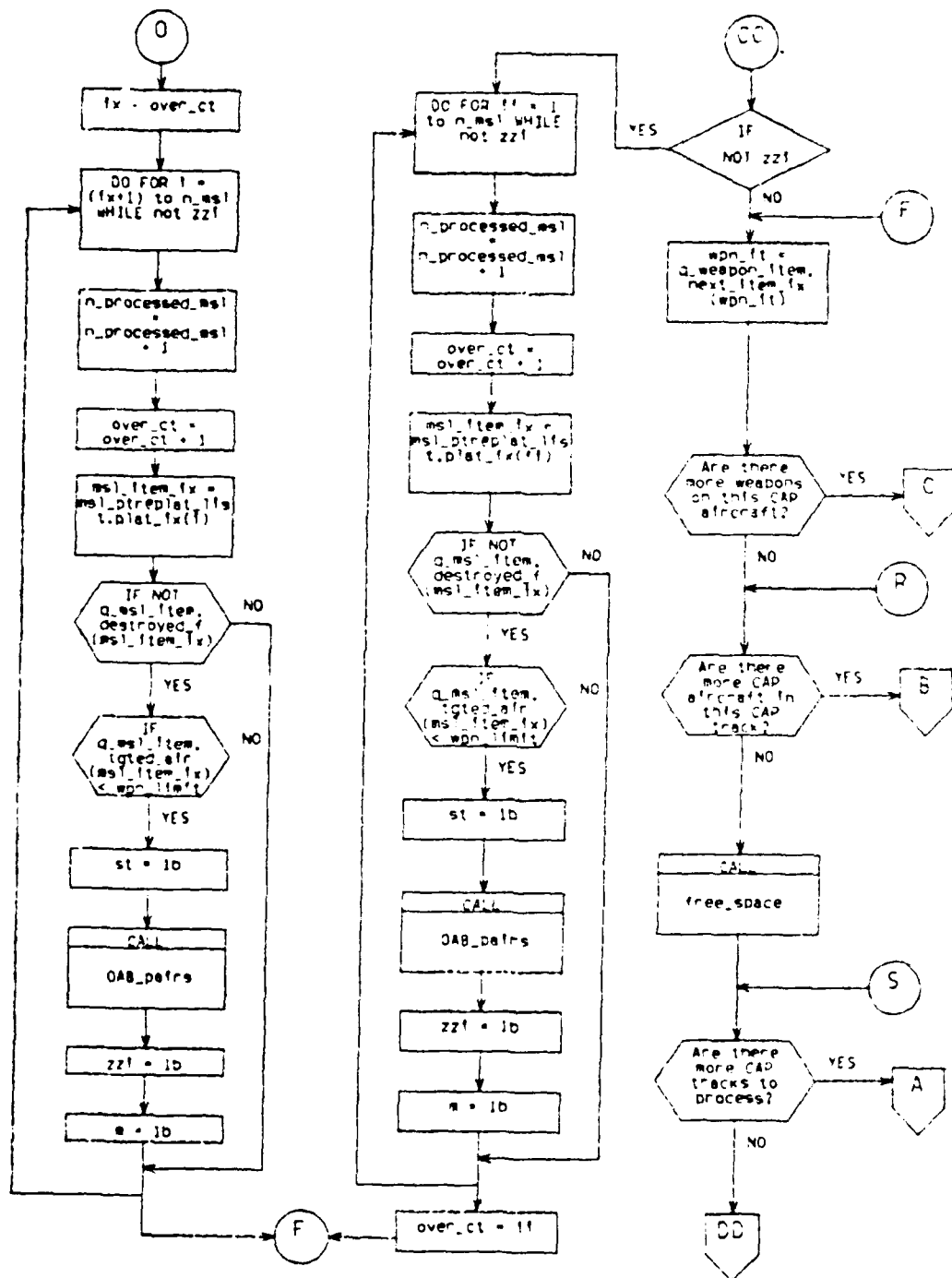

M19_AC_MSL_TGTING (d) One-To-One Targeting

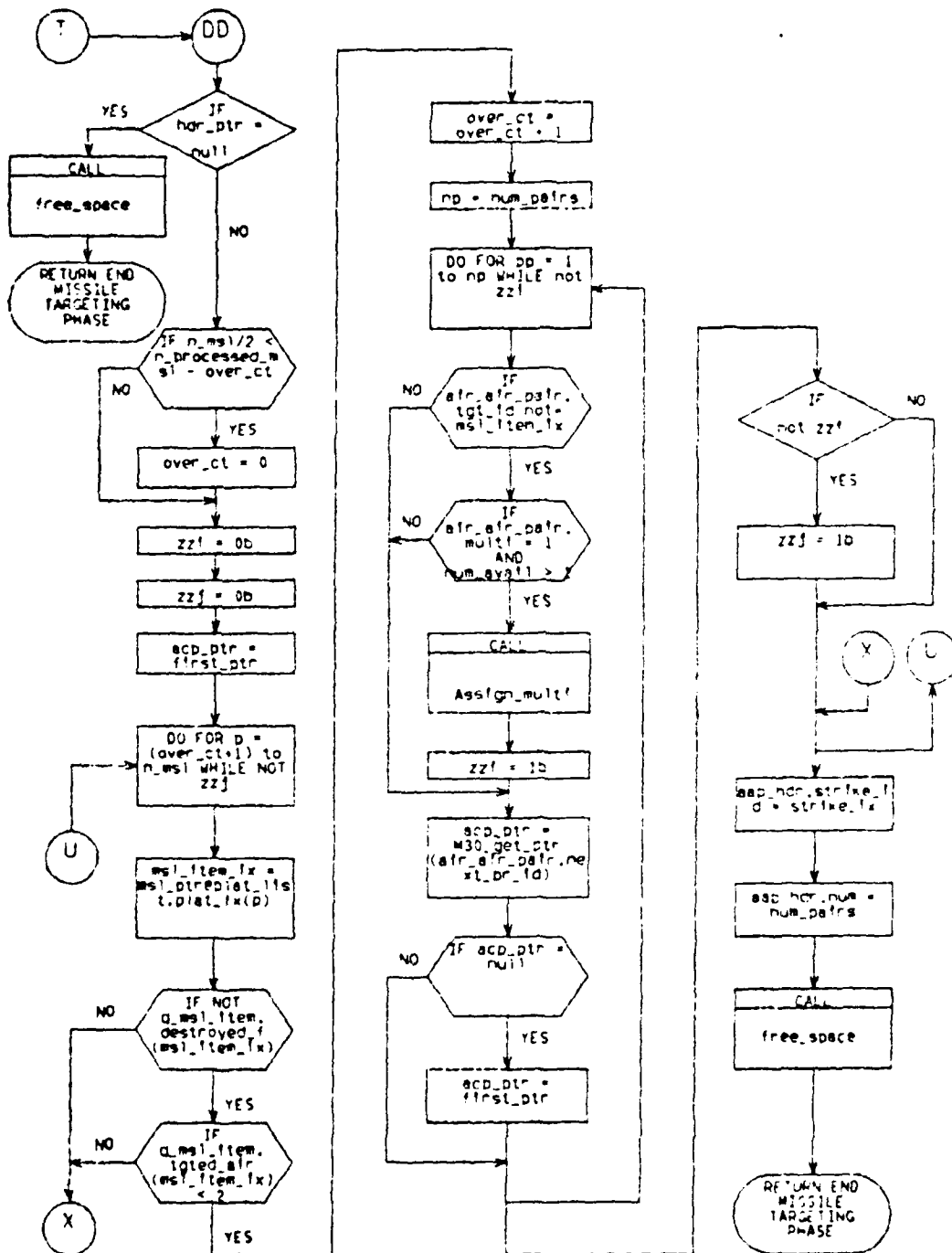

M19_AC_MSL_TGTING (e) Multi-Targeting

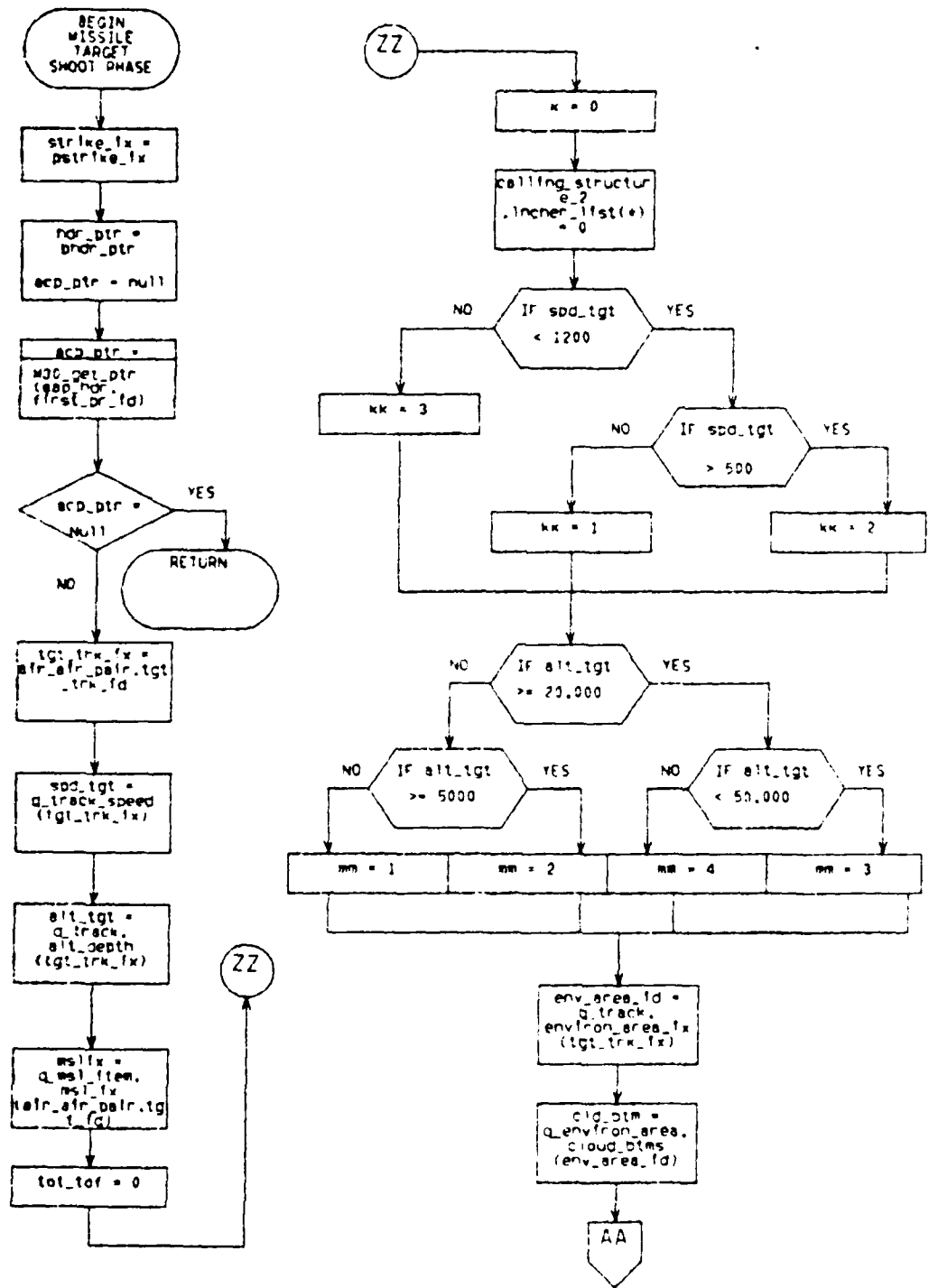

M20_AC_MSL (a) MISSILE TARGET SHOOT PHASE

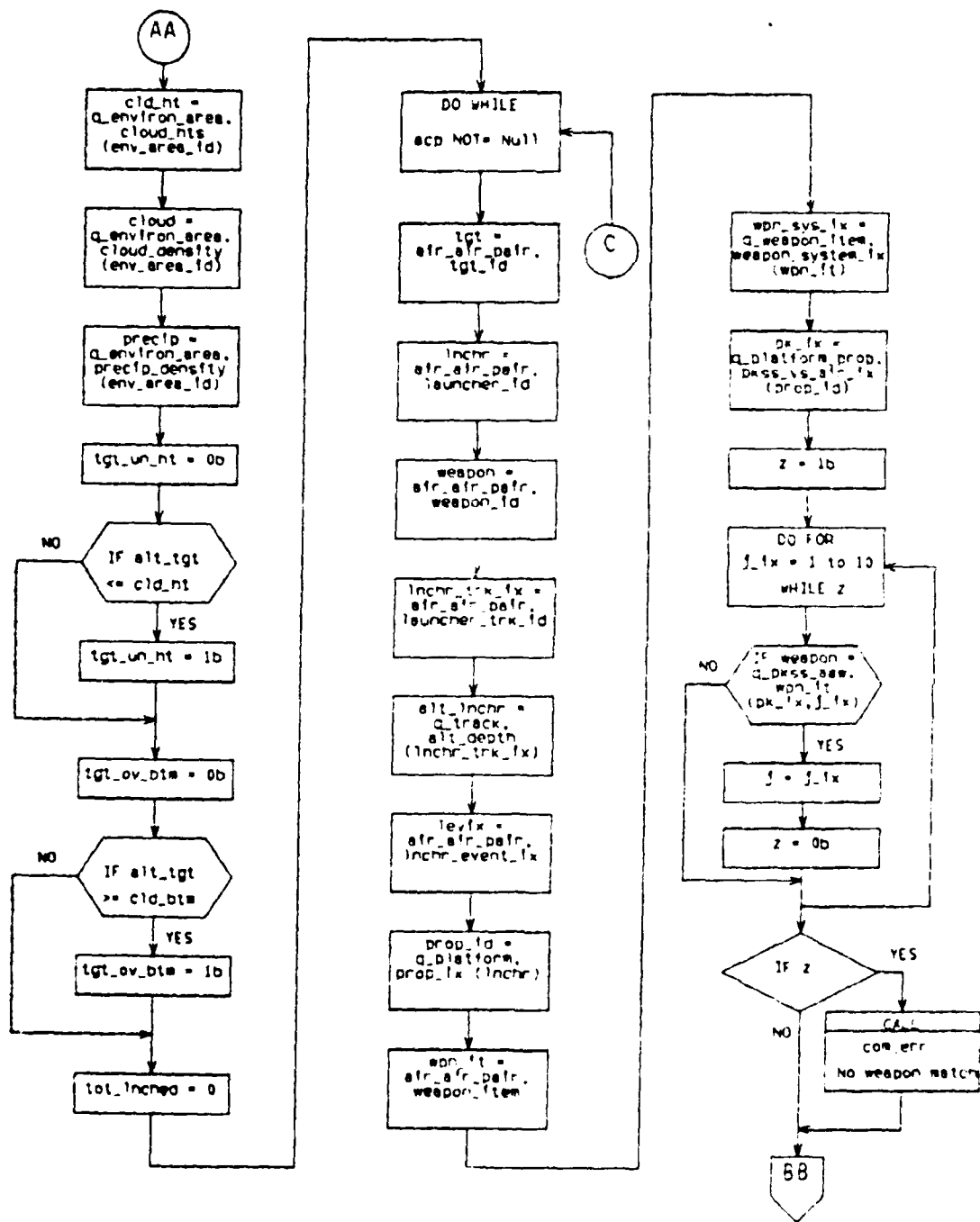

M20 AC MSL (b)

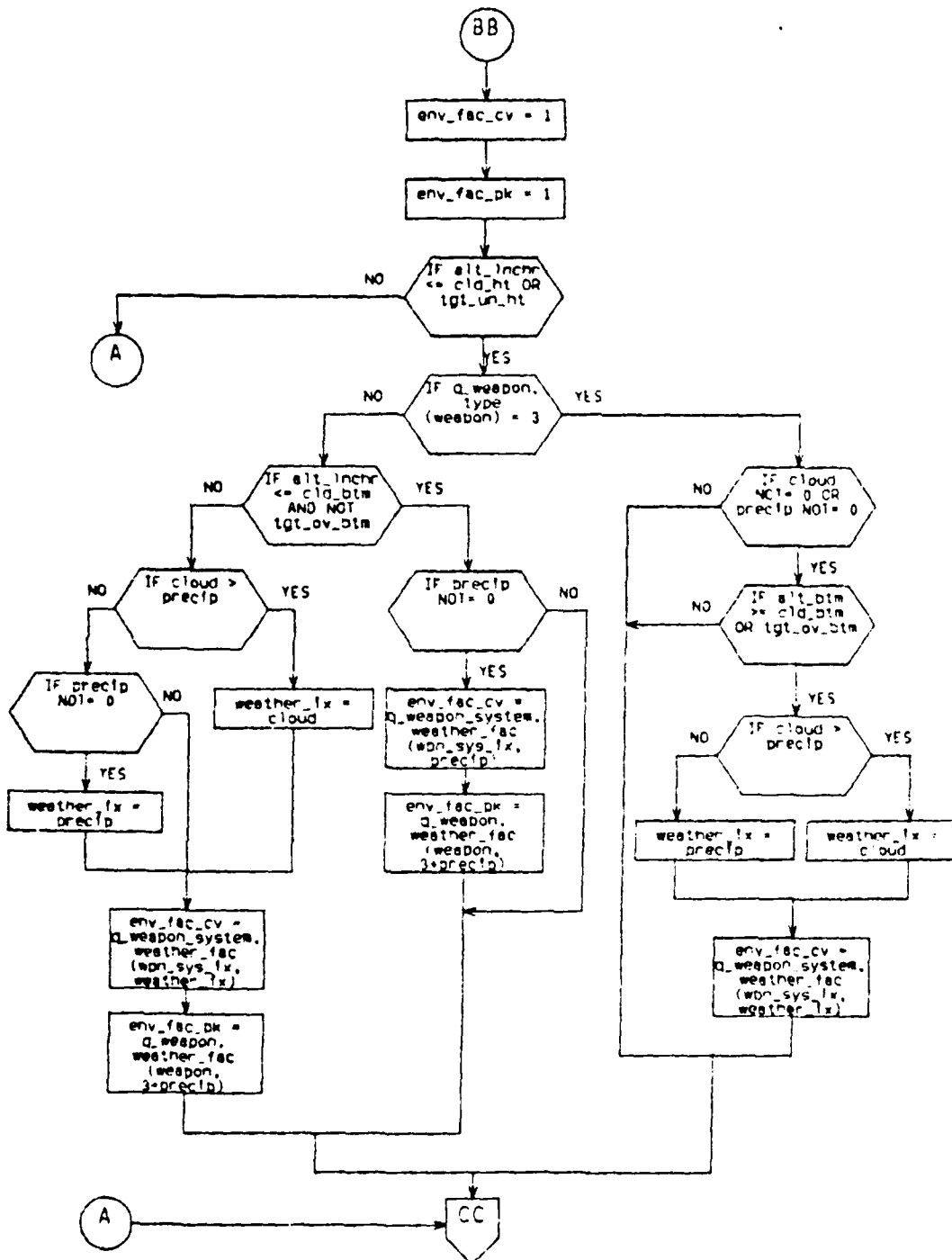

M20_AC_MSL (c) Weather Factor Determination

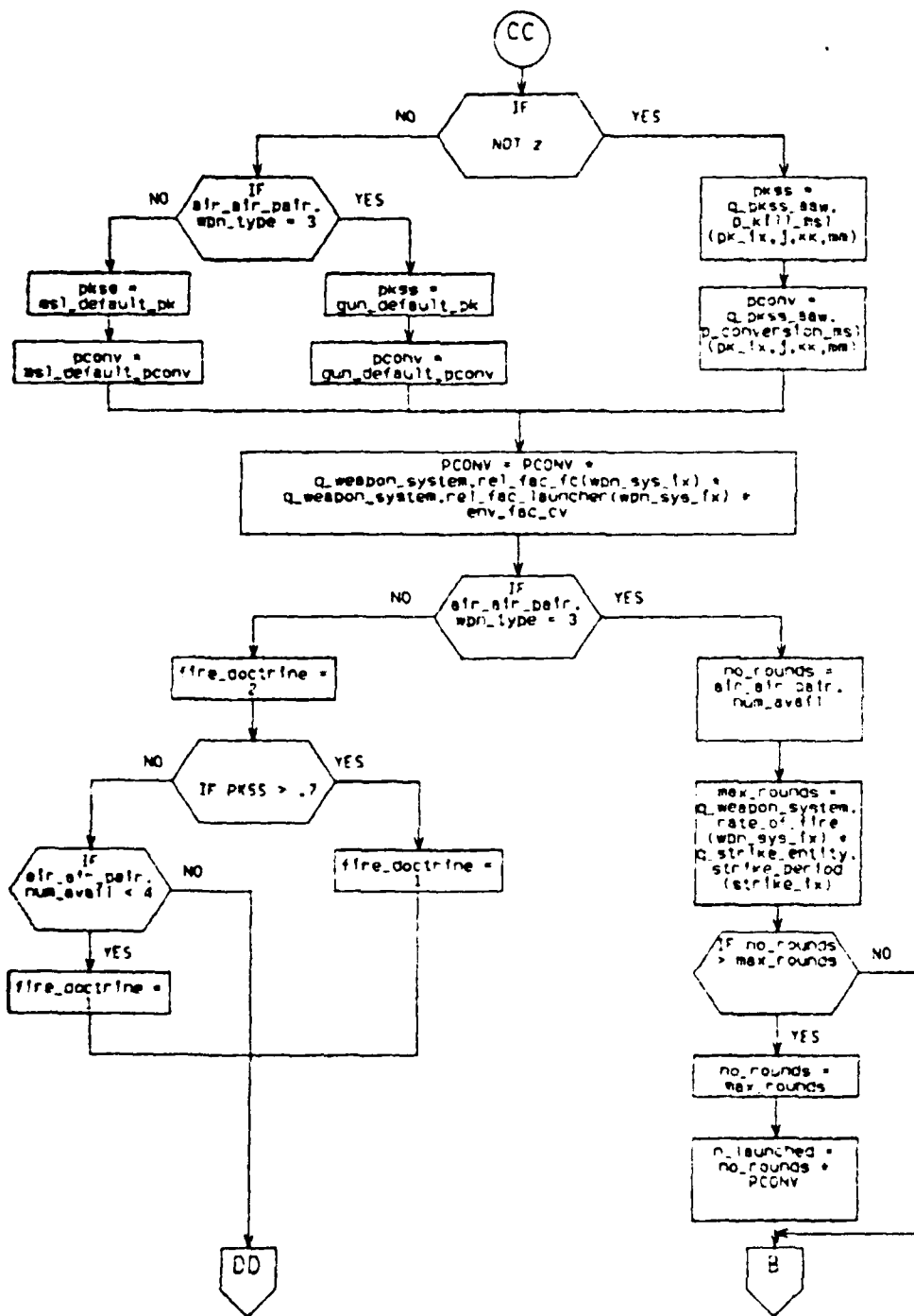

M20_AC_MSL (d)

Fire Doctrine Determination

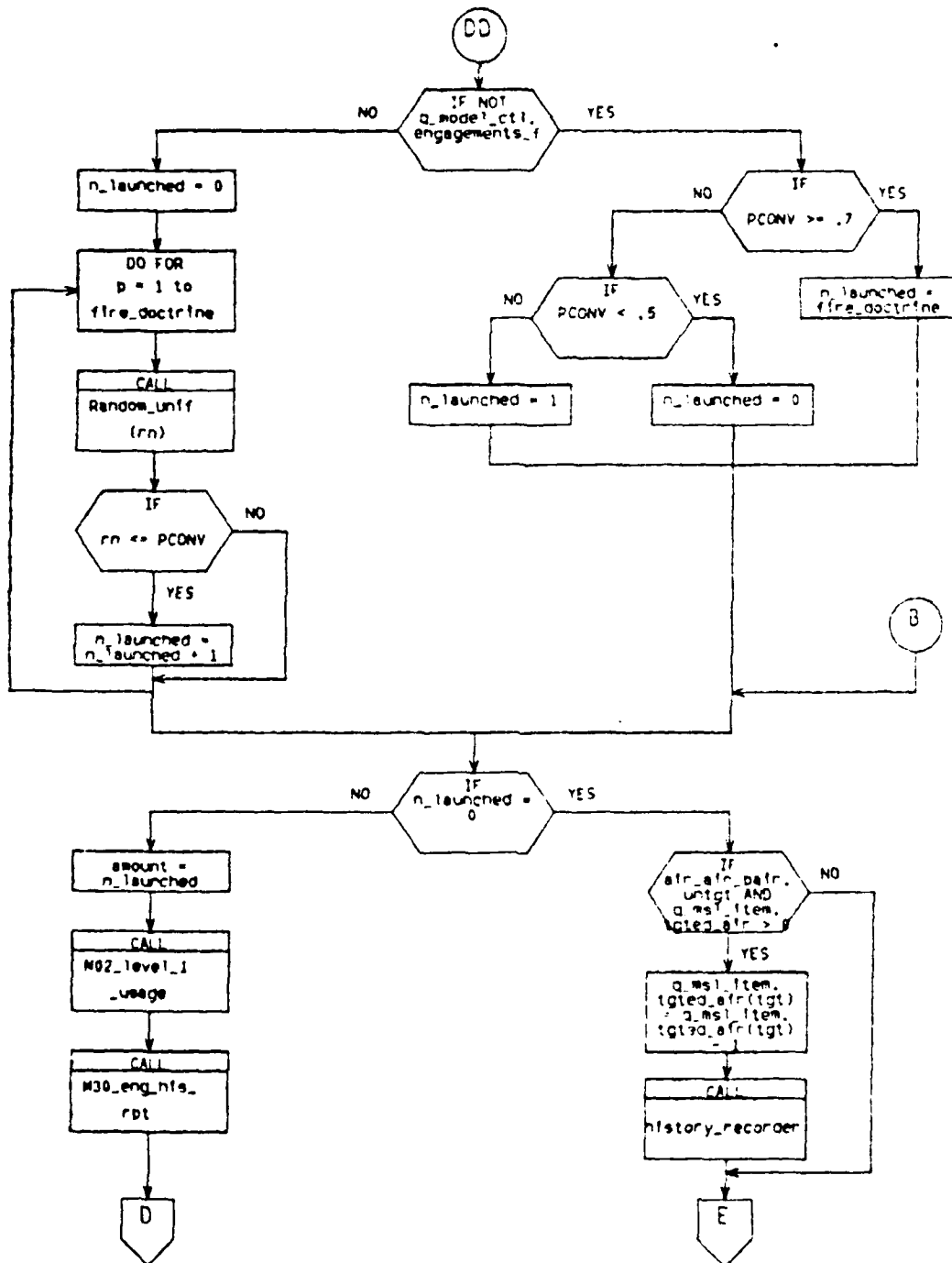

M20_AC_MSL (e)

Weapon Expenditure Determination

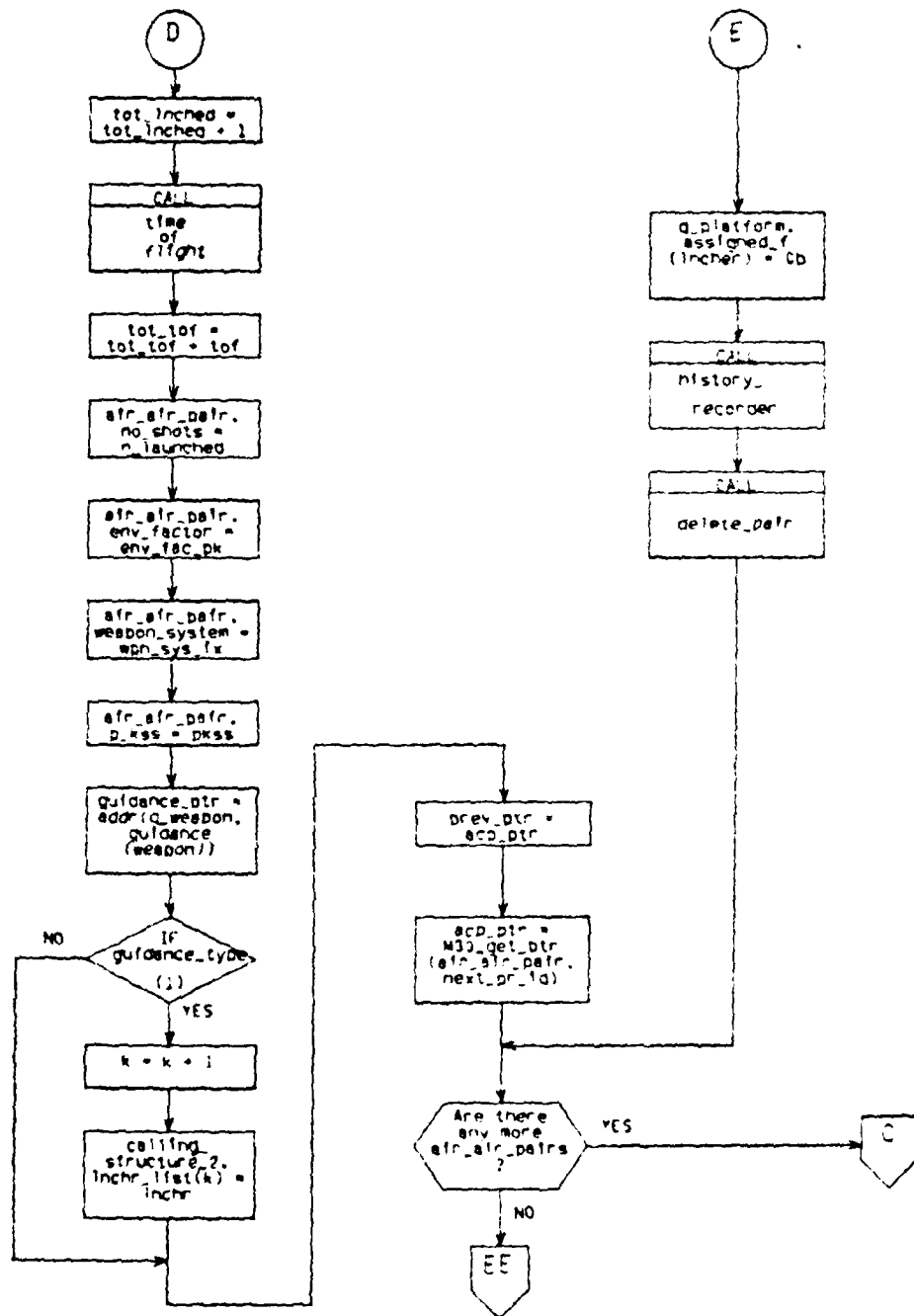

M20 AC MSL (f) Launch and Leave Evaluation

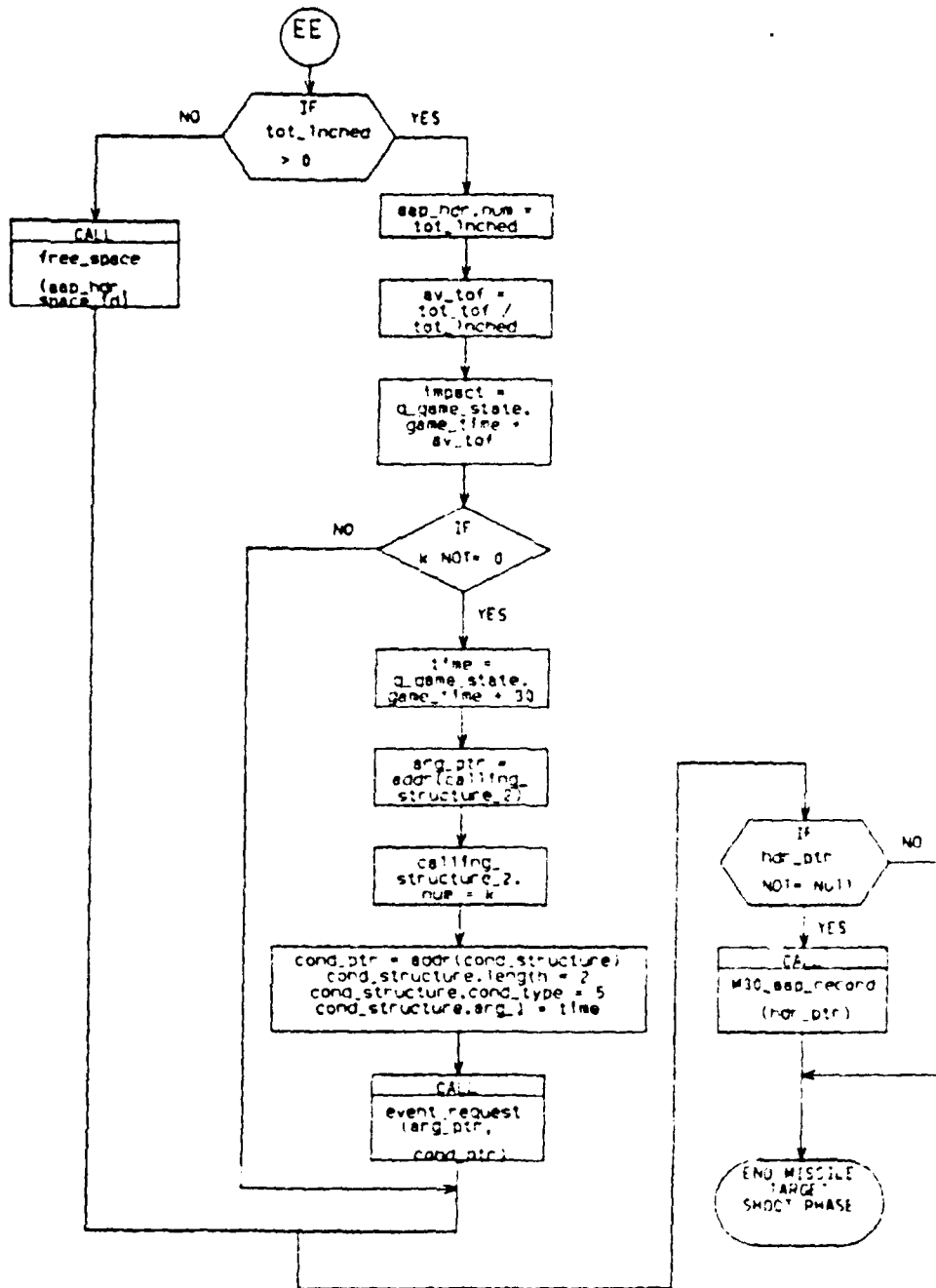

M20_AC_MSL (g) Preparation for Entry Point Two

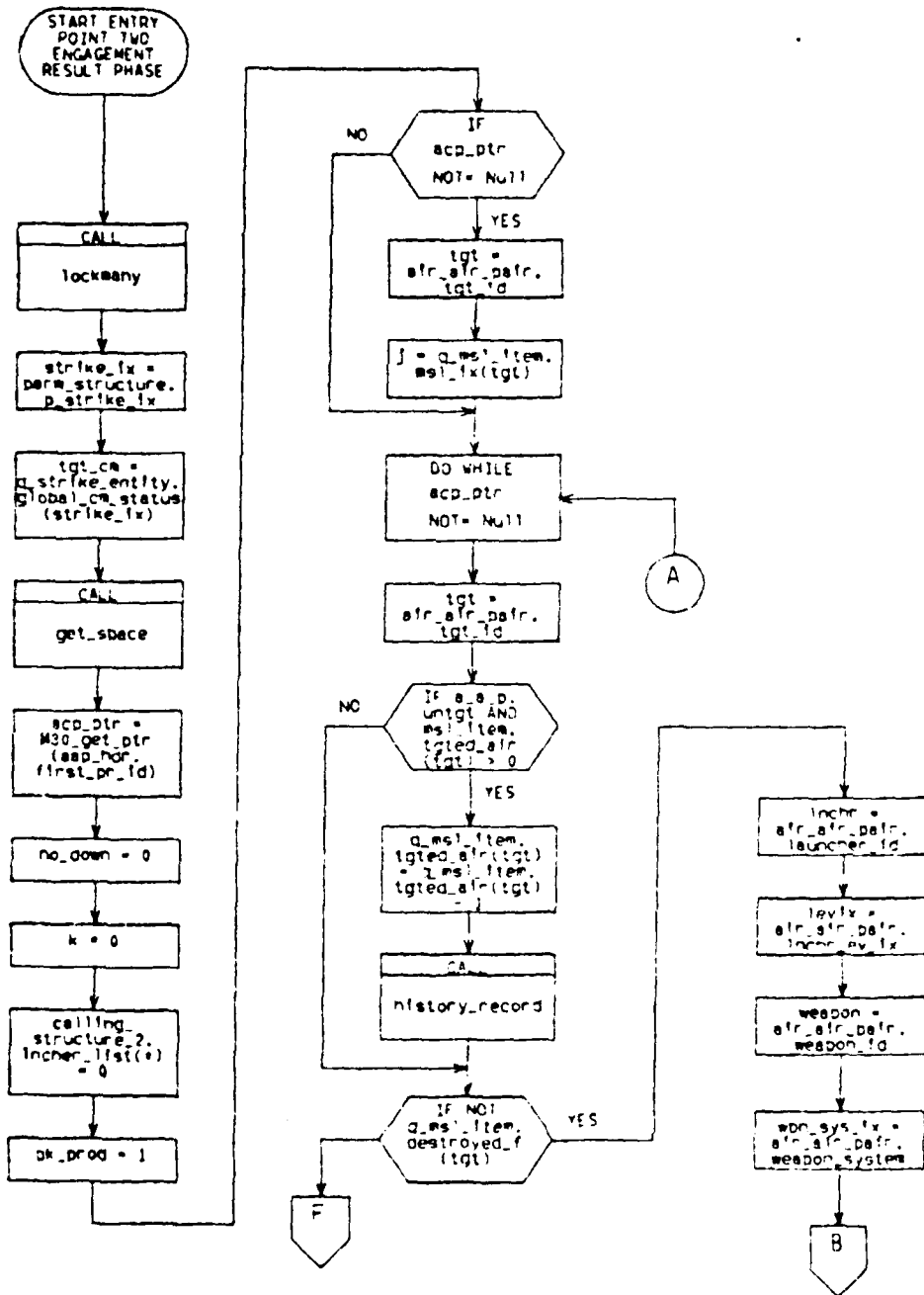

M20_AC_MSL (h) MISSILE TARGET ENGAGEMENT RESULT PHASE

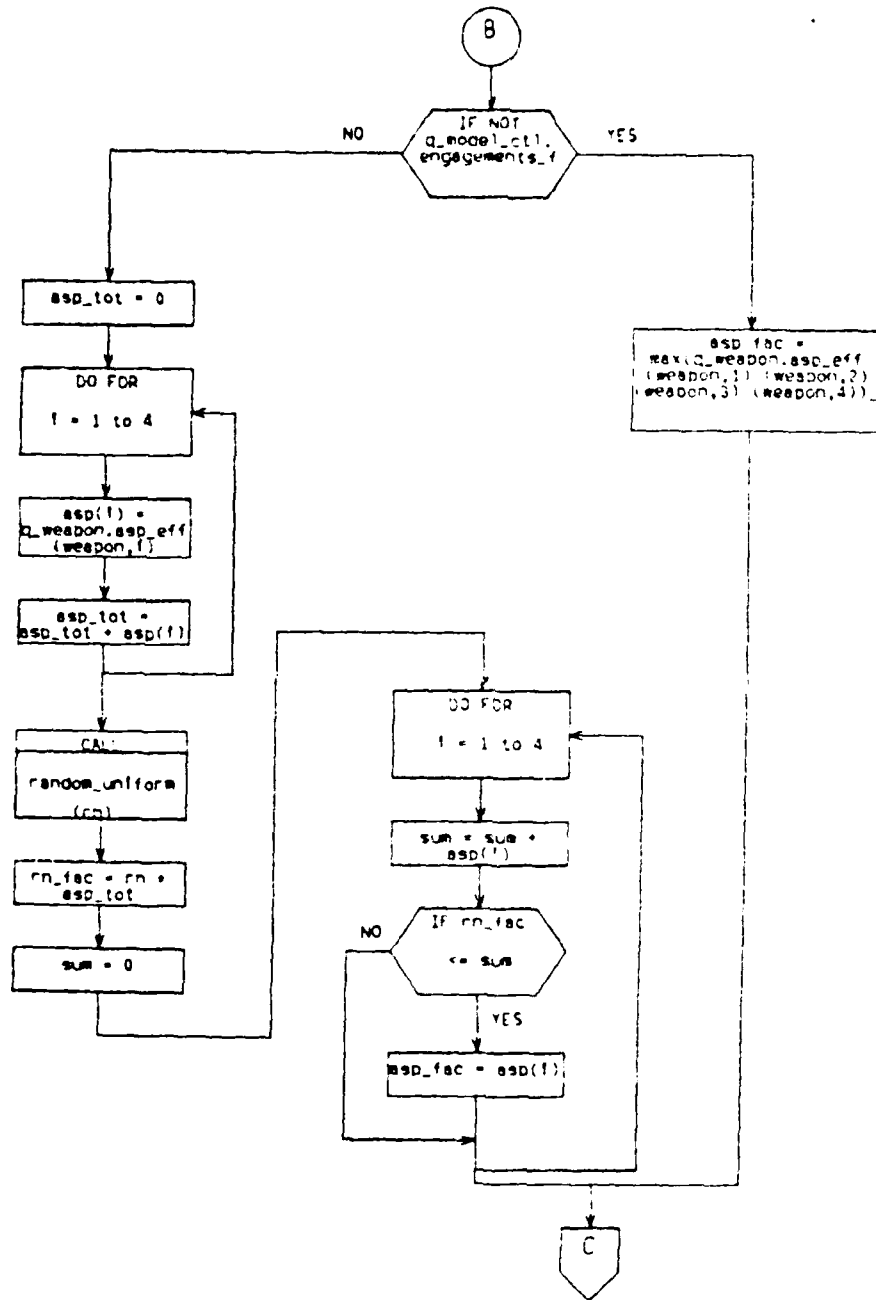

M20_AC_MSL (f) Aspect Factor Determination

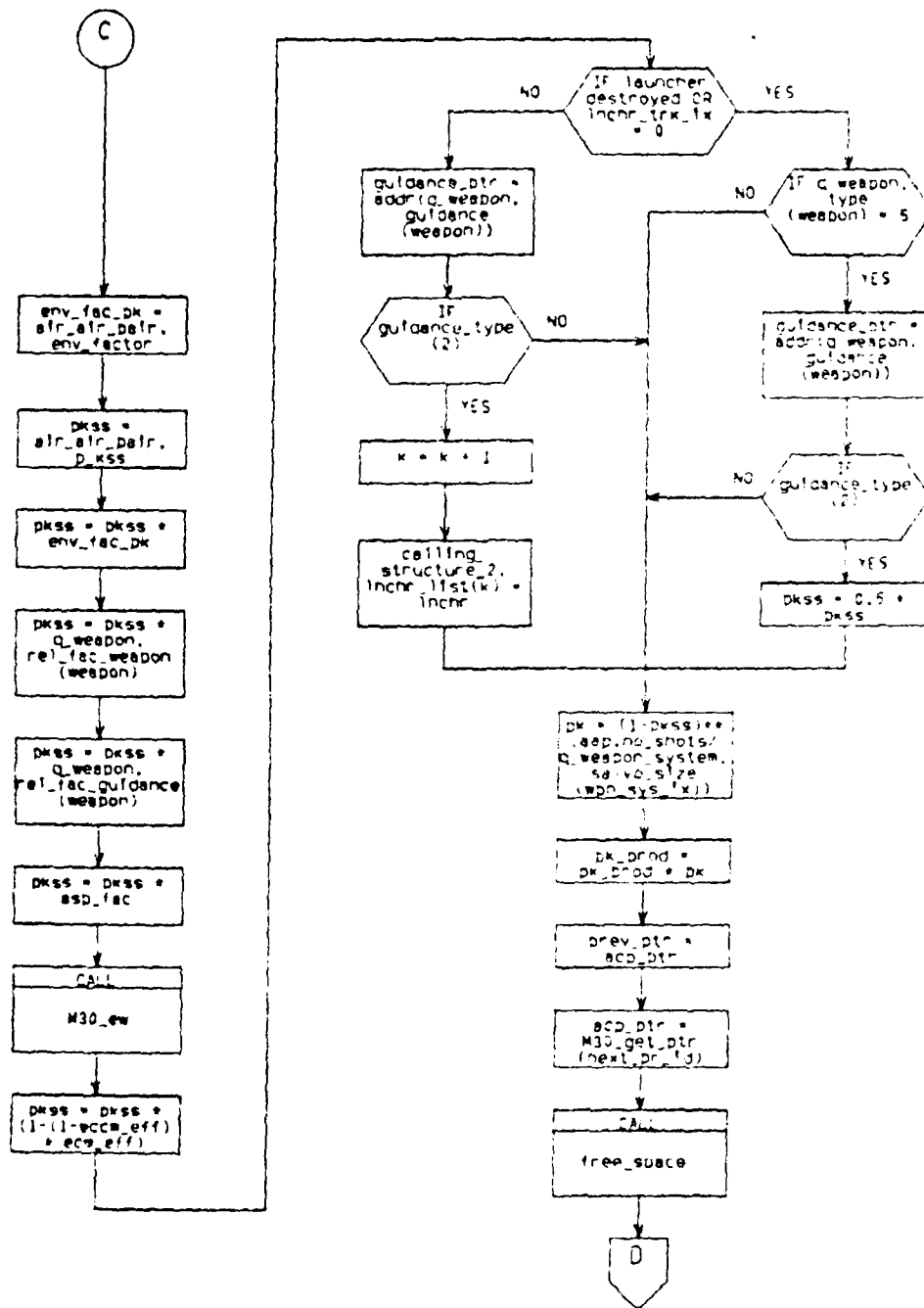

M20 AC MSL (j) Probability of Kill Determination

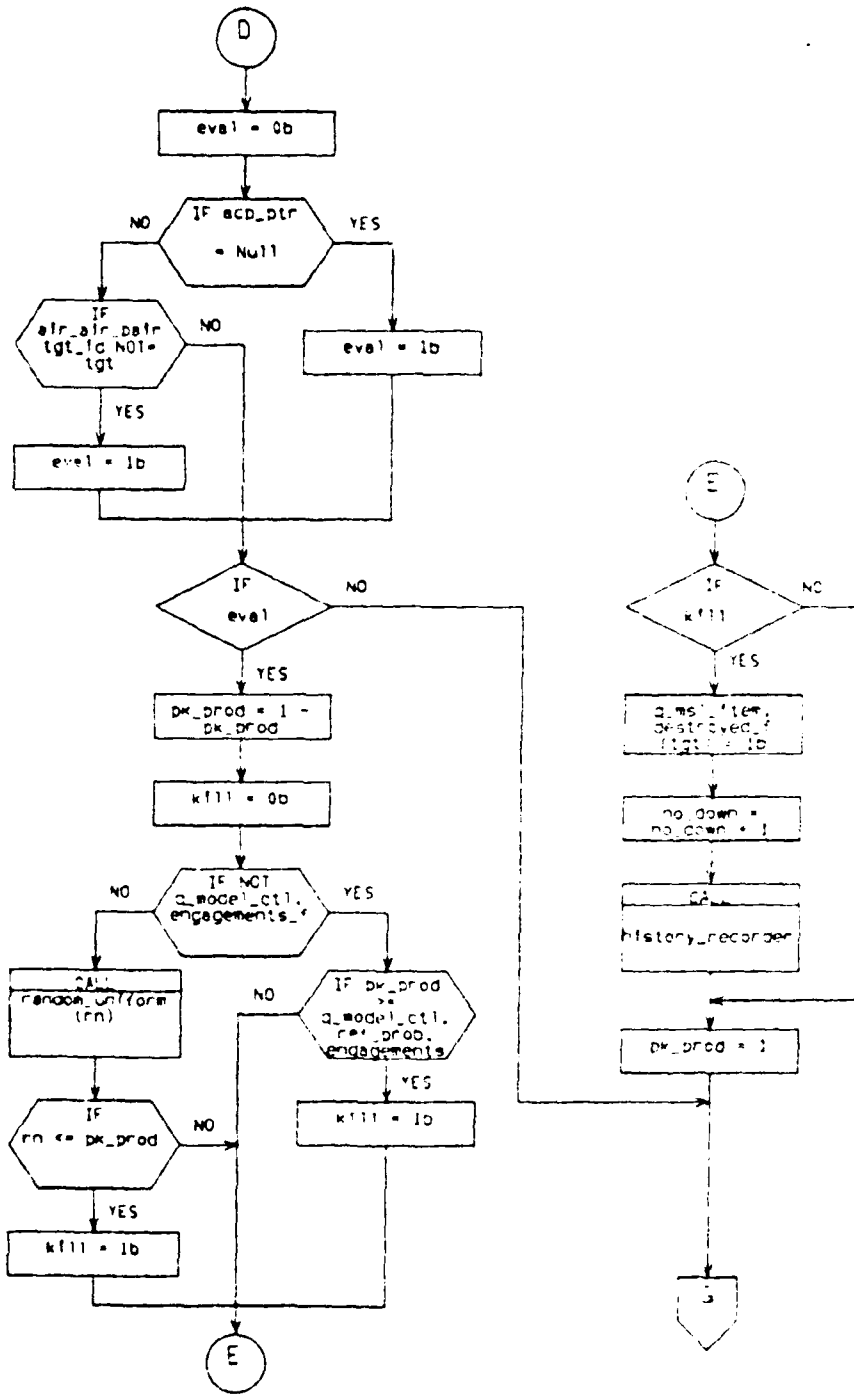

M20_AC_MSL (k) Target kill - No kill Detection

AD-A143 163

AN EVALUATION OF THE AIR-TO-AIR ENGAGEMENT MODELS IN
THE NAVAL WARFARE GAMING SYSTEM(U) NAVAL POSTGRADUATE
SCHOOL MONTEREY CA N I ARDAN MAR 84

3/3

UNCLASSIFIED

F/G 15/7

NL



END
DATE
FILMED
8 84
DTIC

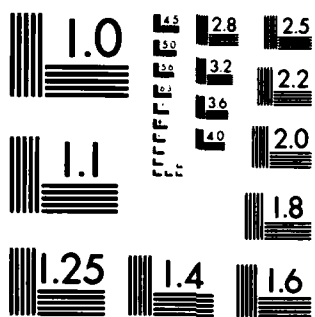

MICROCOPY RESOLUTION TEST CHART
NATIONAL BUREAU OF STANDARDS-1963-A

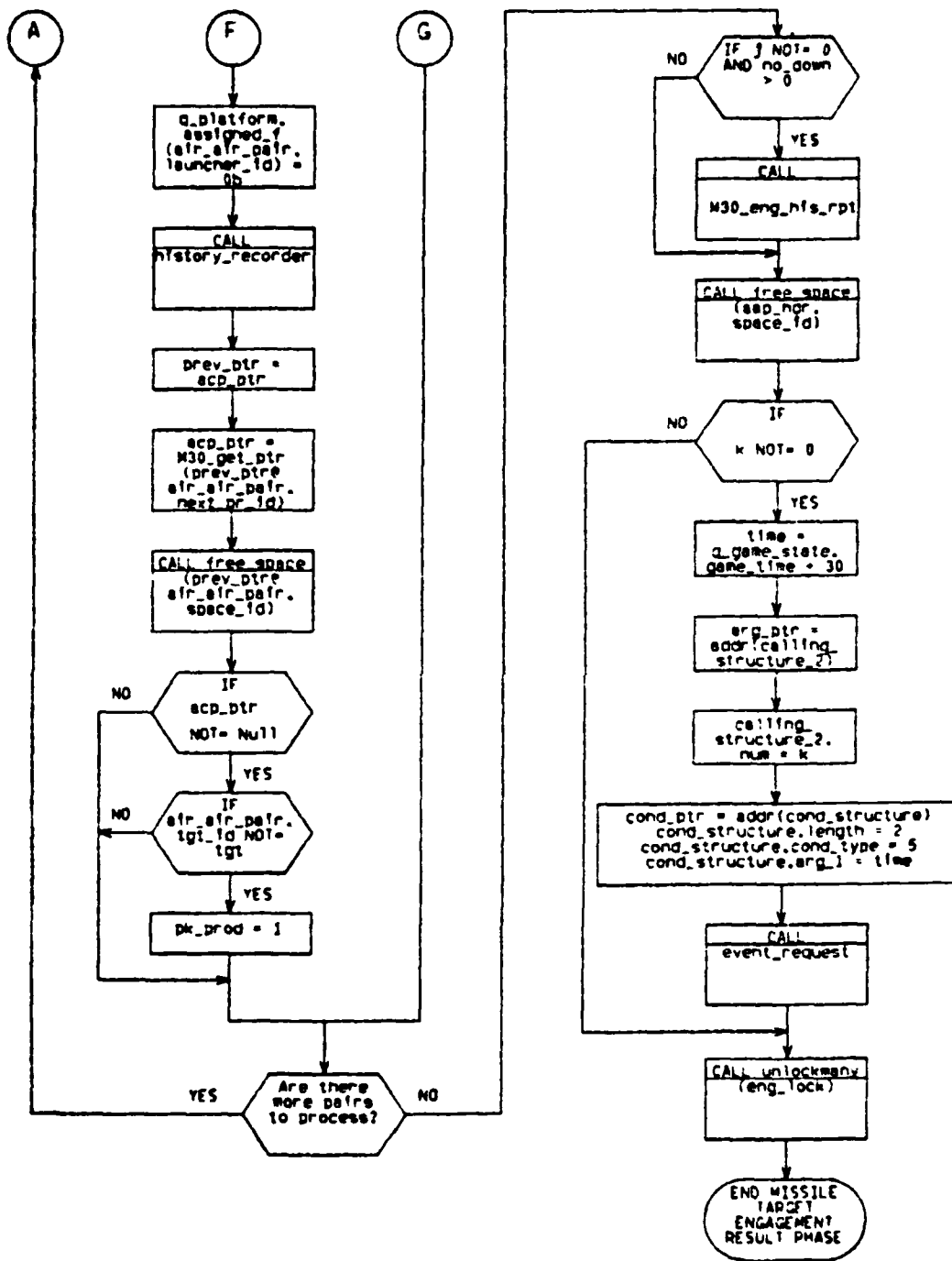

M20_AC_MSL (1) Preparation for Entry Point Three

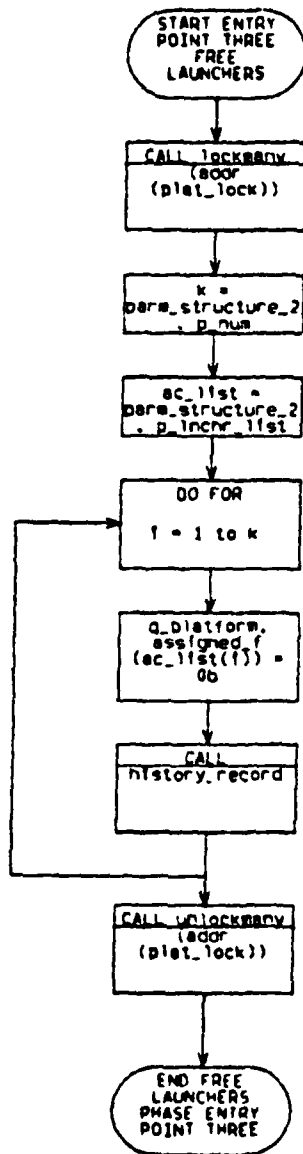

M20_AC_MSL (m) Free Launchers Phase

APPENDIX B
BASIC MODEL GENERALIZED FLOW CHARTS

This appendix contains flow charts describing the general model flow of the the NWGS Air-to-Air engagement models. Models for subroutines that are easily followed in Appendix A flow charts are not included.

AIRCRAFT TARGETS

TARGETING PHASE.....	195
Subroutine TARGETING.....	196
SHOOT PHASE.....	199
ENGAGEMENT RESULT PHASE.....	201
Subroutine M26_ACBDA_2.....	202
FREE LAUNCHERS.....	203

CRUISE MISSILE TARGETS

TARGETING PHASE.....	204
SHOOT PHASE.....	205
ENGAGEMENT RESULT PHASE.....	206
FREE LAUNCHERS PHASE.....	207

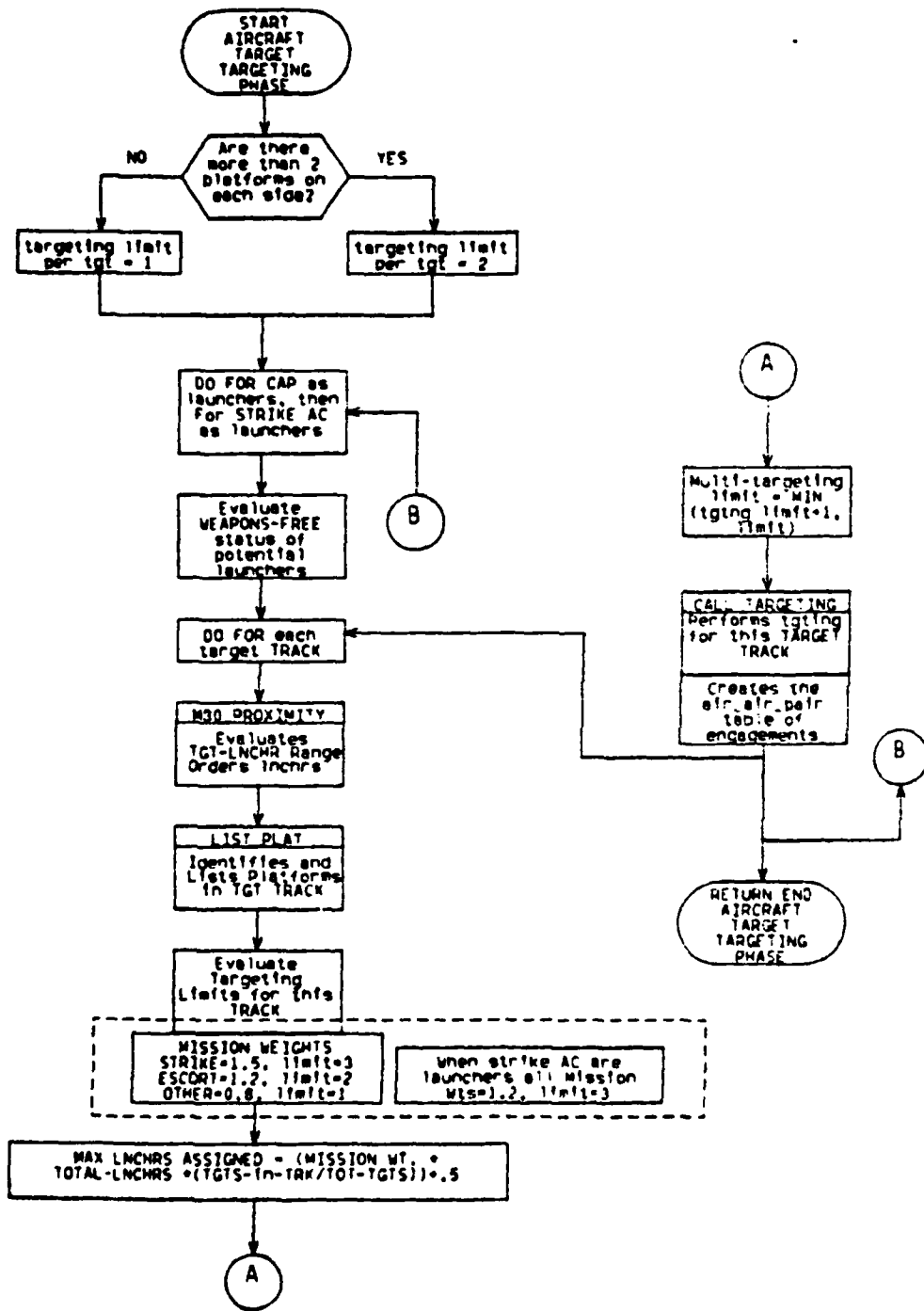

AIRCRAFT TARGET TARGETING PHASE ROUTINE

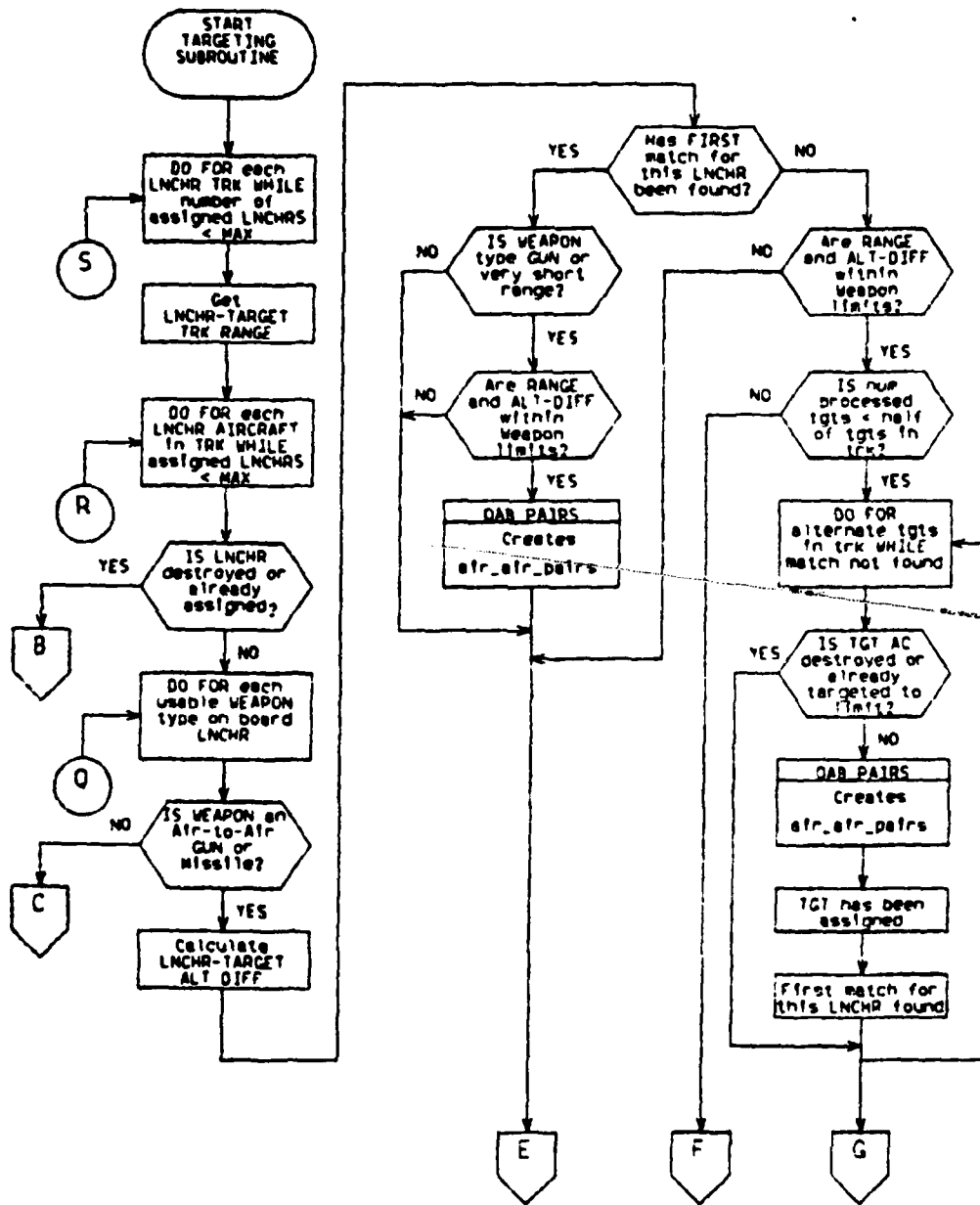

Subroutine TARGETING (a)

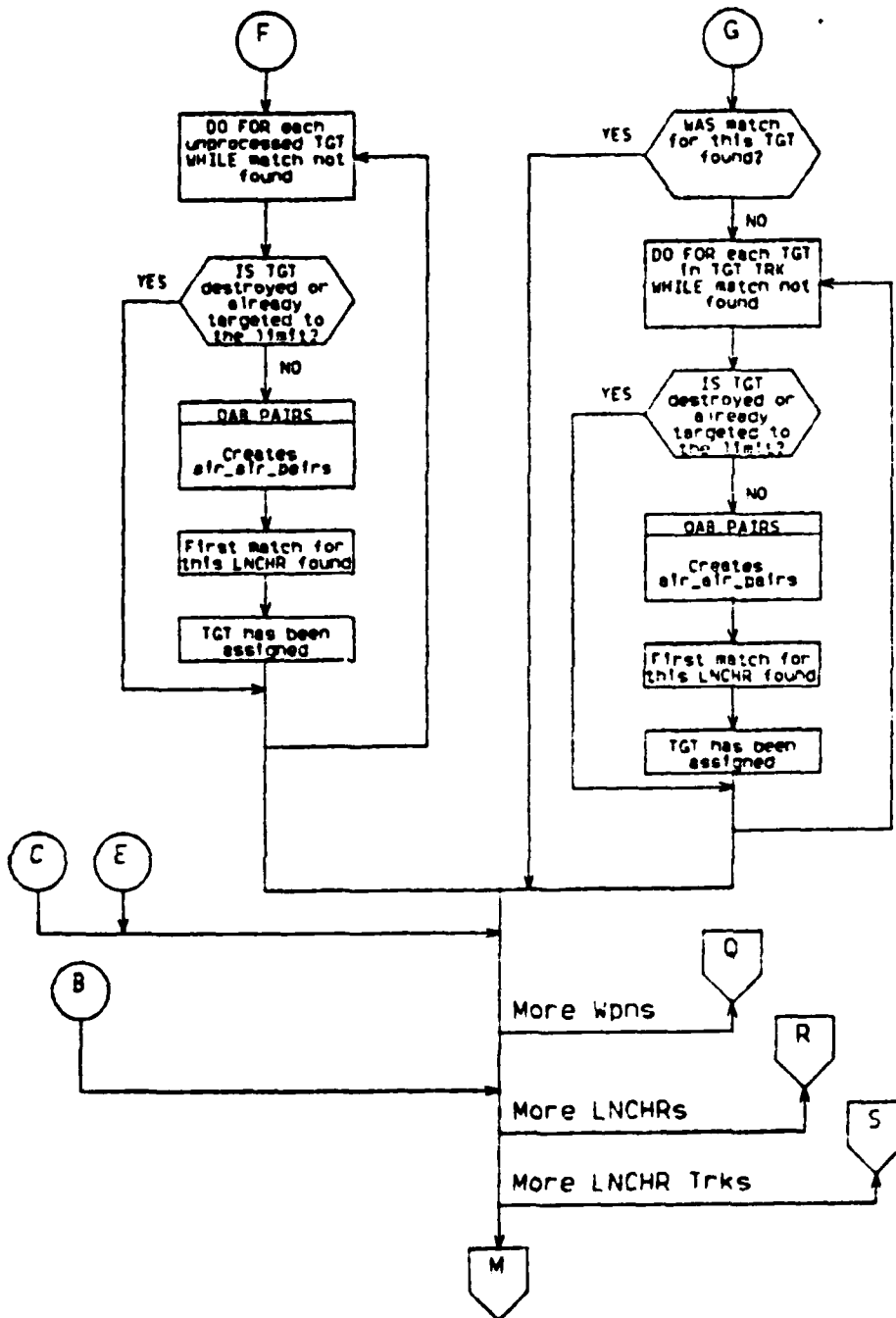

Subroutine TARGETING (b)

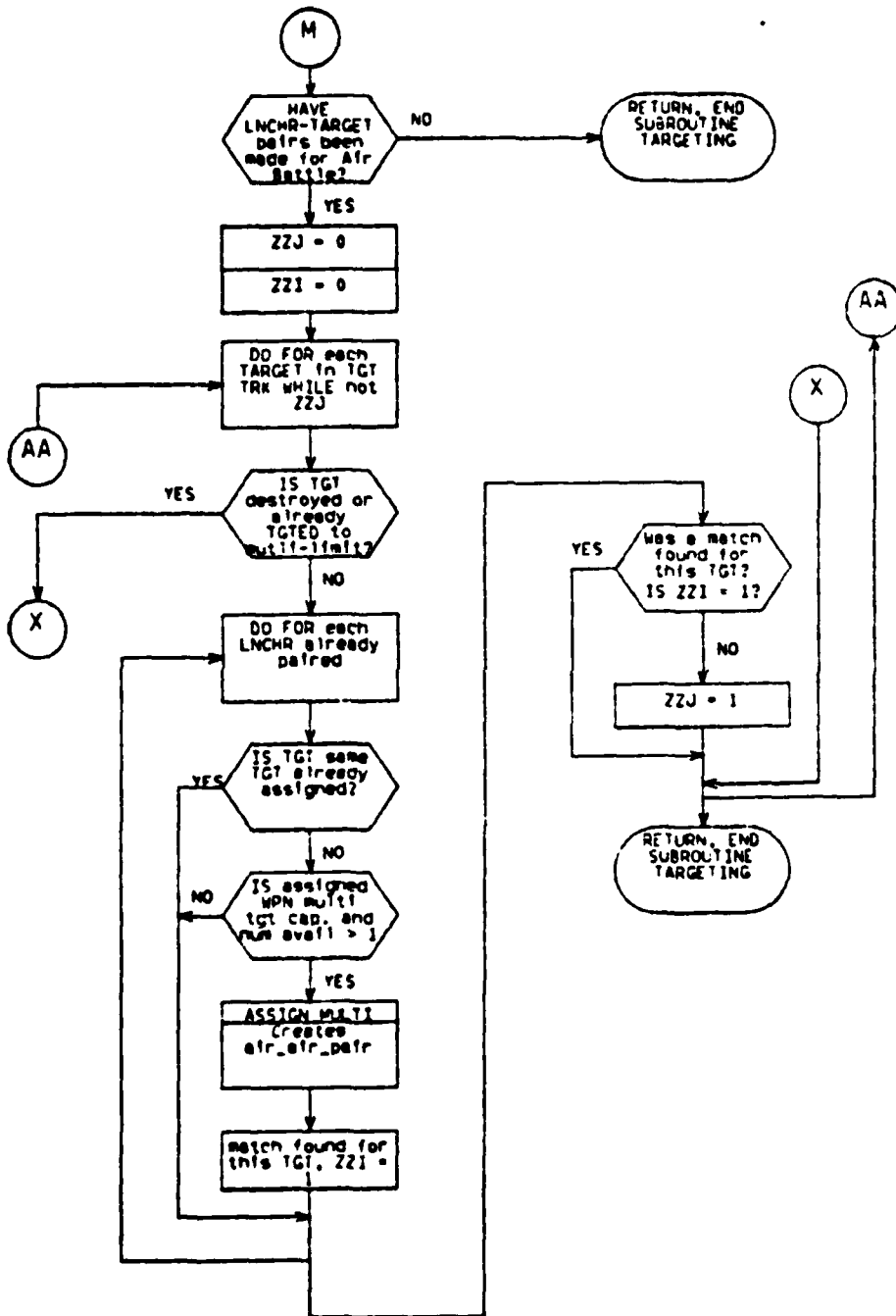

Subroutine TARGETING (c) Multi-Targeting

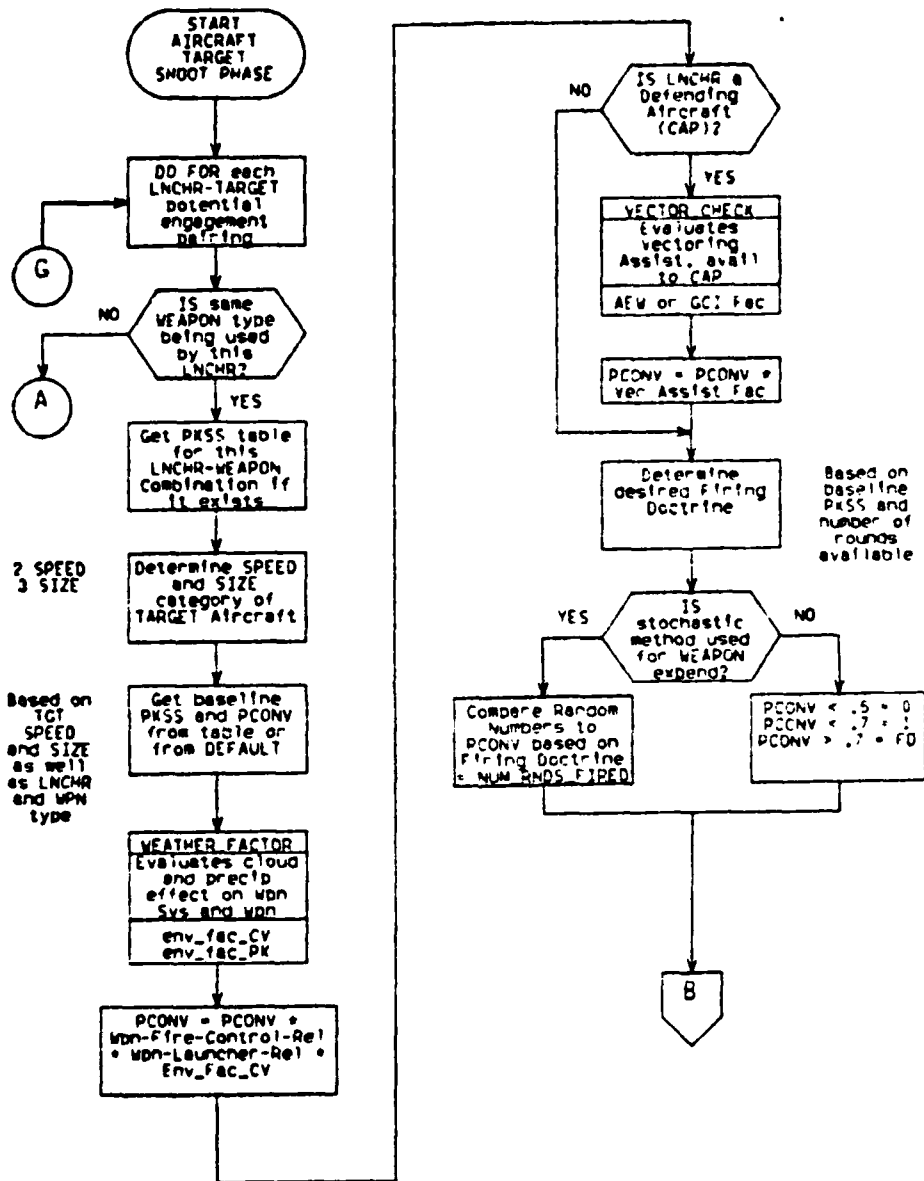

AIRCRAFT TARGET SHOOT PHASE (a)

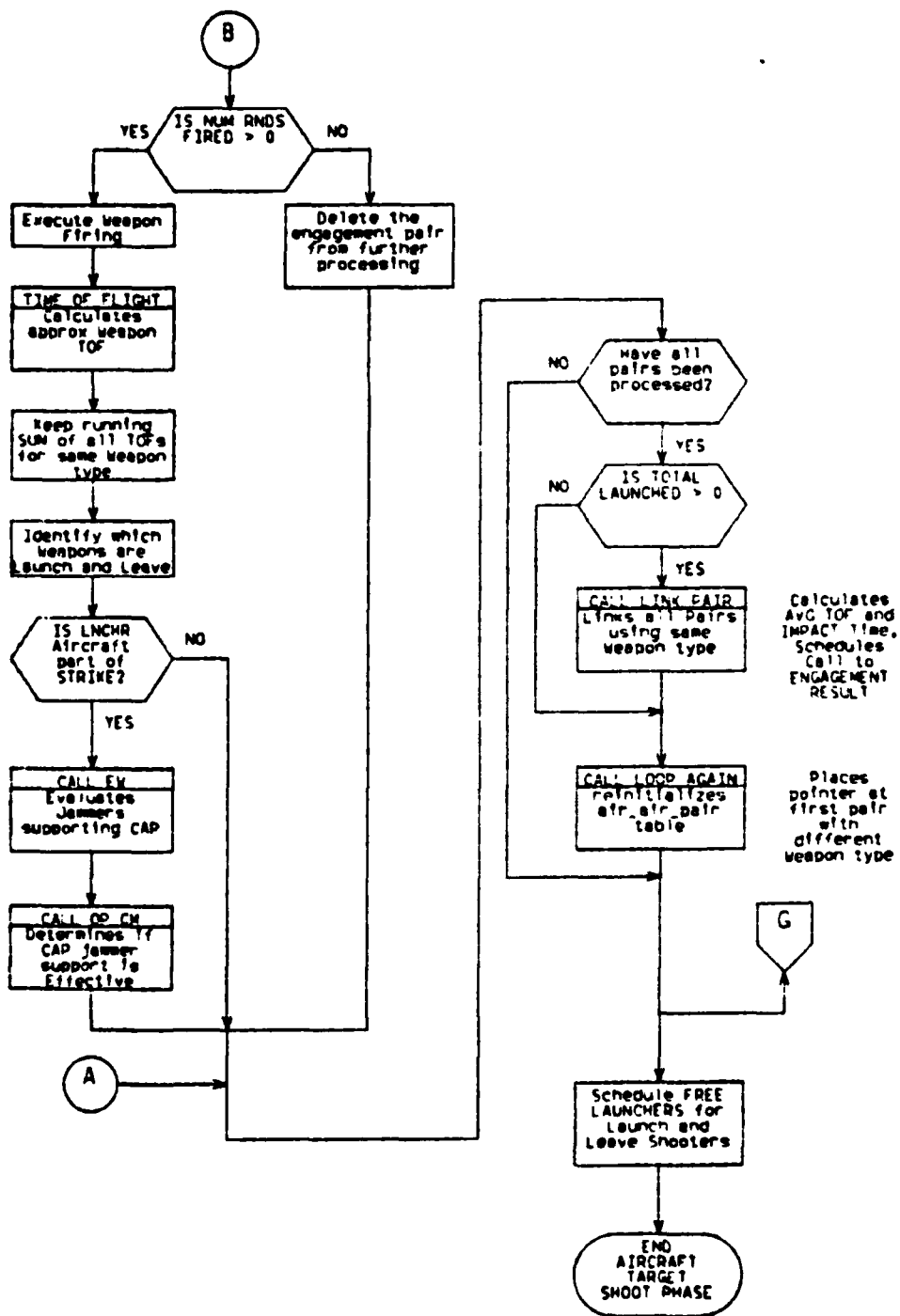

AIRCRAFT TARGET SHOOT PHASE (b)

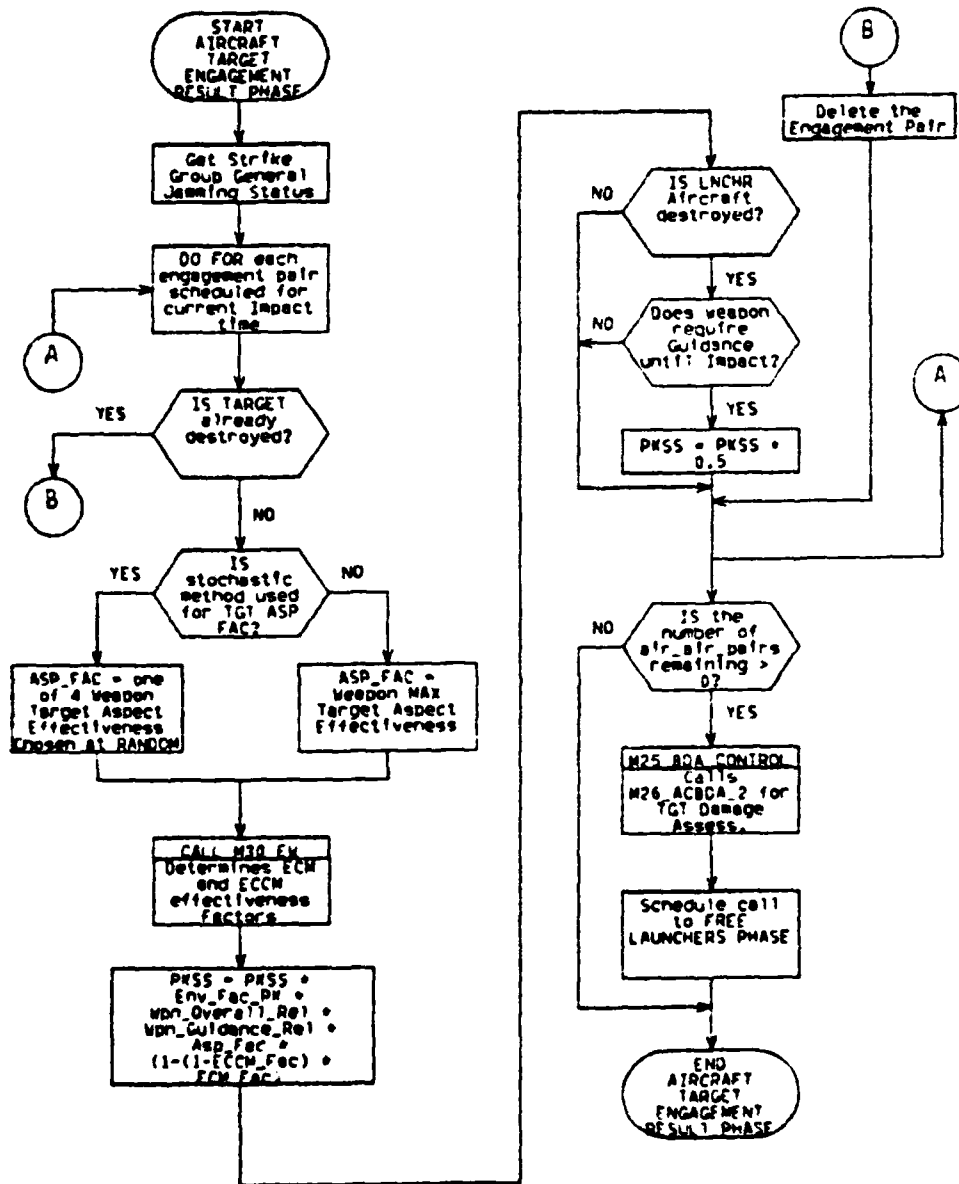

AIRCRAFT TARGET ENGAGEMENT RESULT PHASE

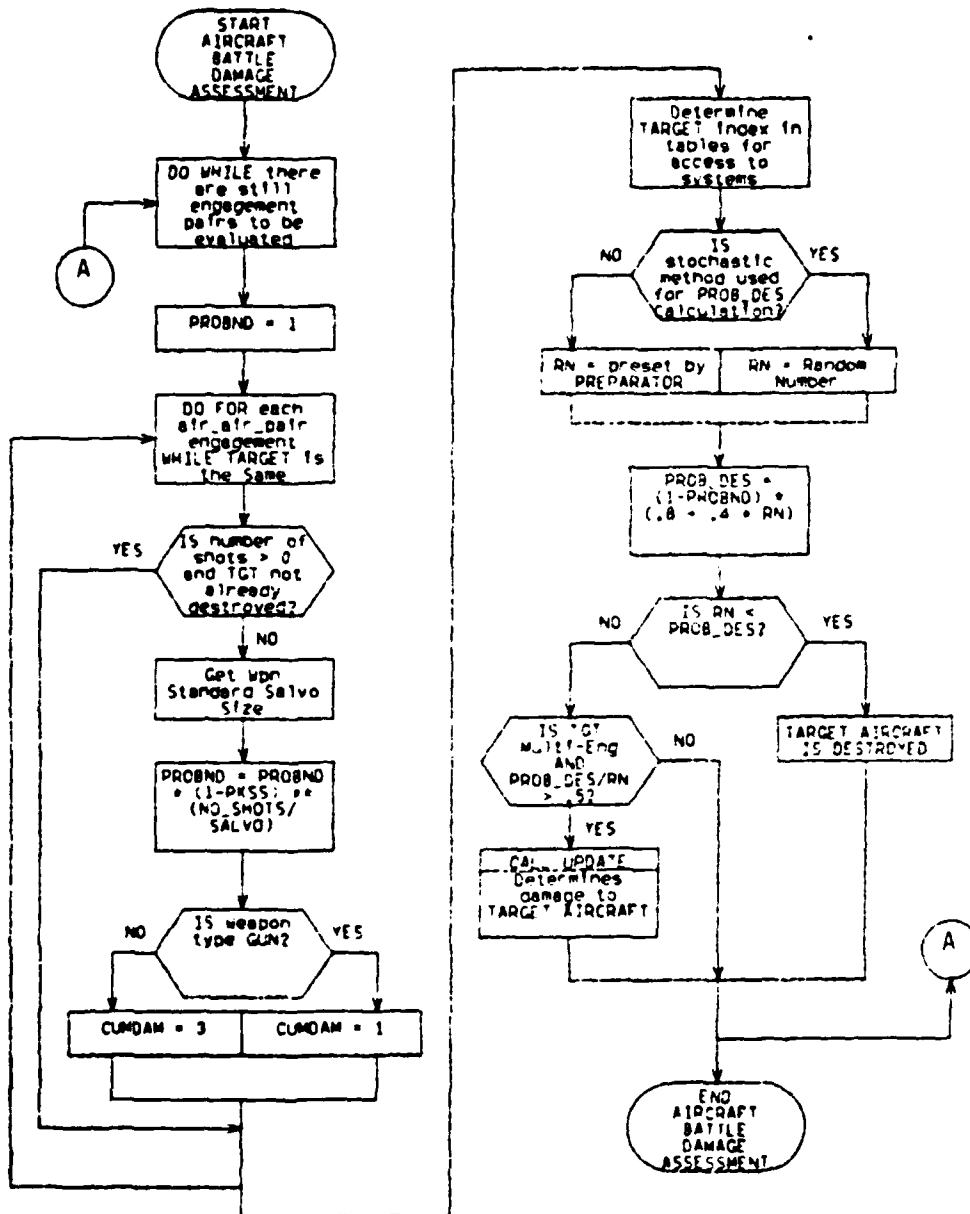

The Subroutine UPDATE determines the cumulative damage to the TARGET Aircraft. SENSORS and WEAPONS are put out of Action.

The target may be DESTROYED by CUM_DAM

AIRCRAFT BATTLE DAMAGE ASSESSMENT ROUTINE M26_ACBDA_2

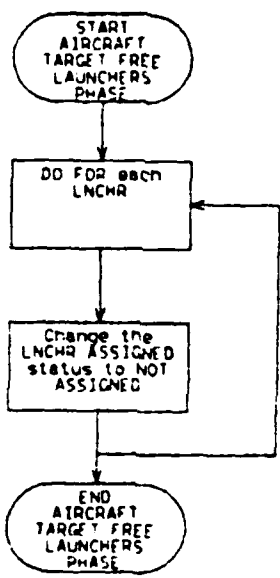

AIRCRAFT TARGET FREE LAUNCHERS PHASE

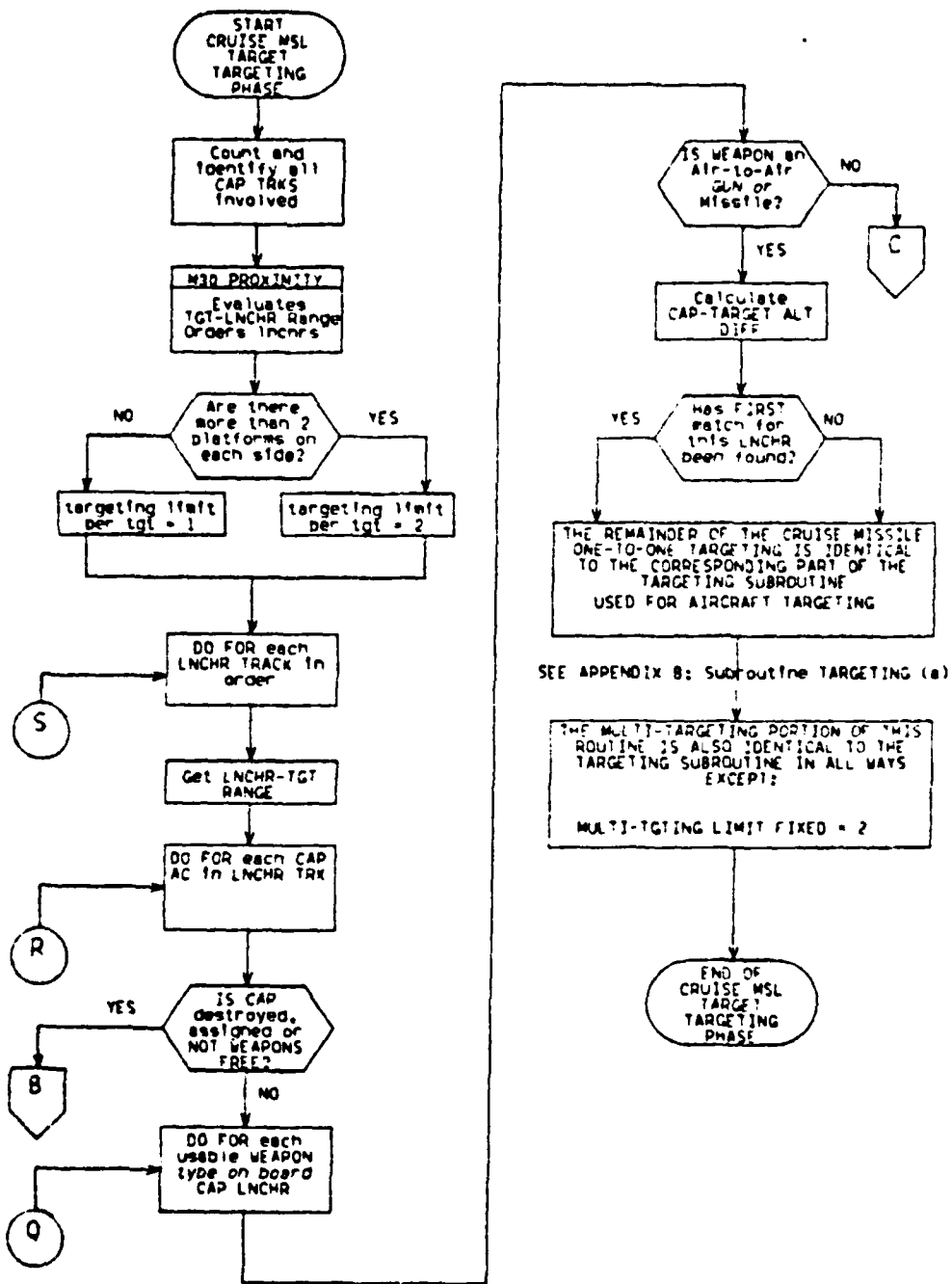

CRUISE MISSILE TARGETING ROUTINE

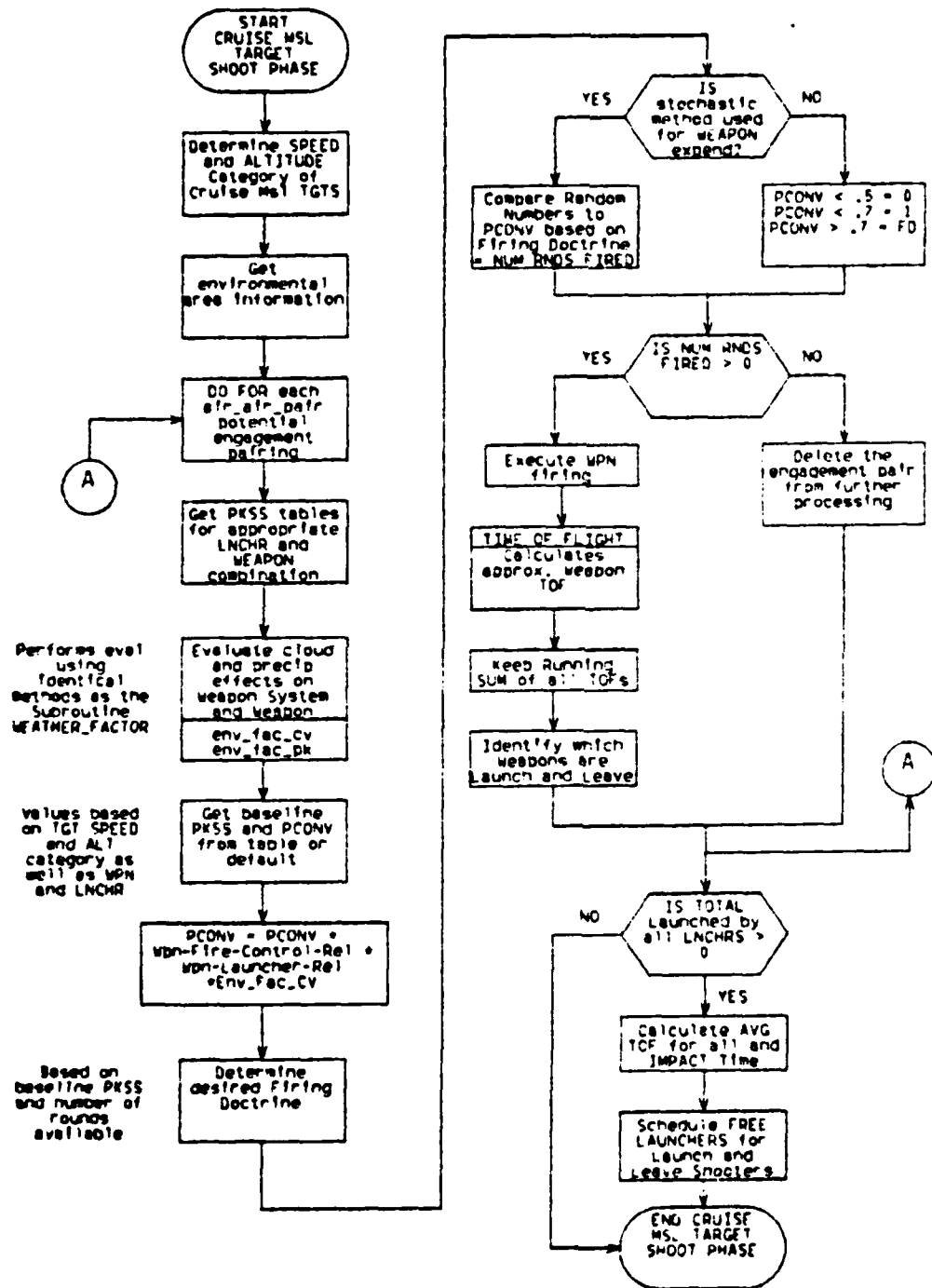

CRUISE MISSILE TARGET SHOOT PHASE

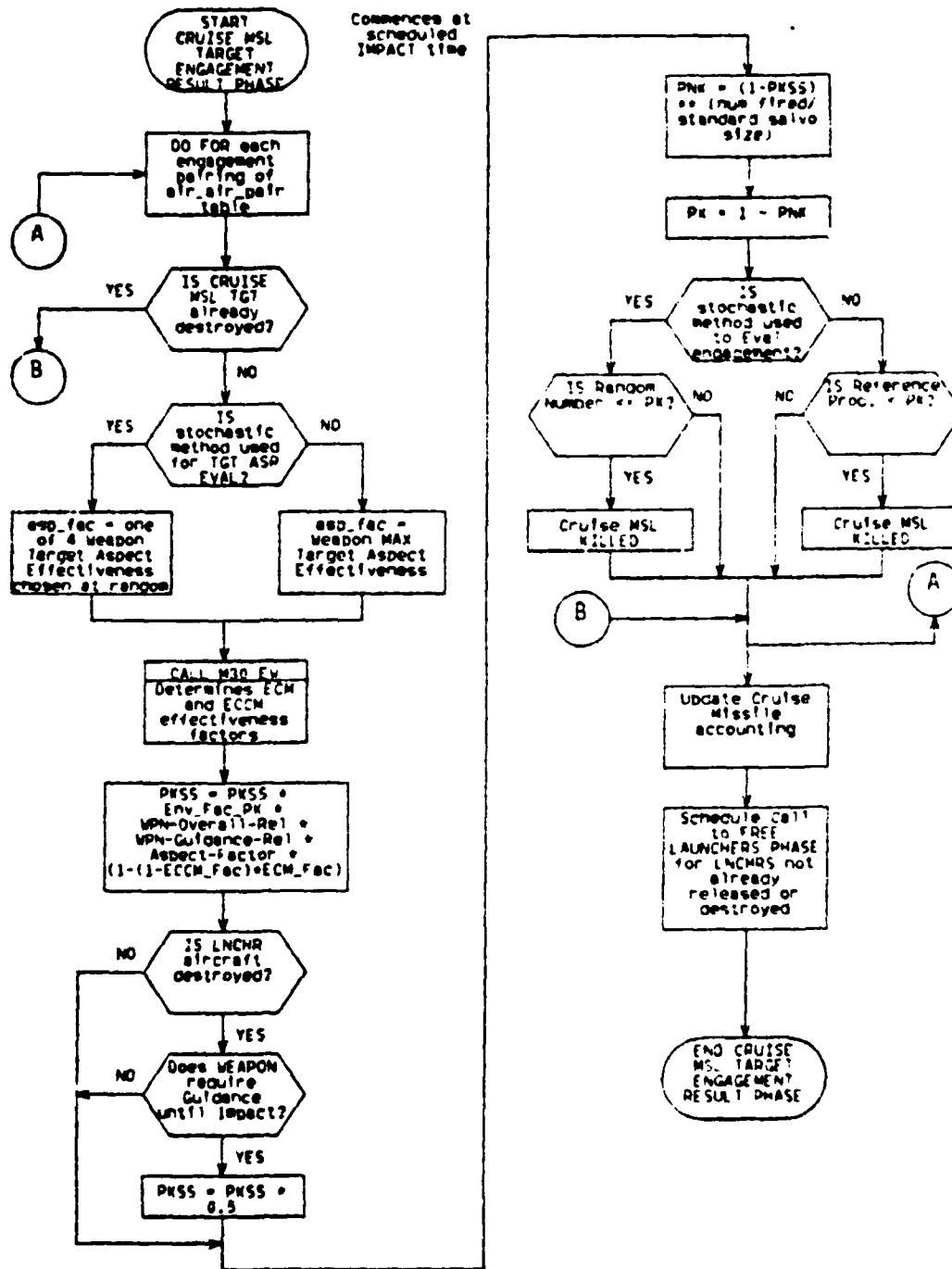

CRUISE MISSILE TARGET ENGAGEMENT RESULT PHASE

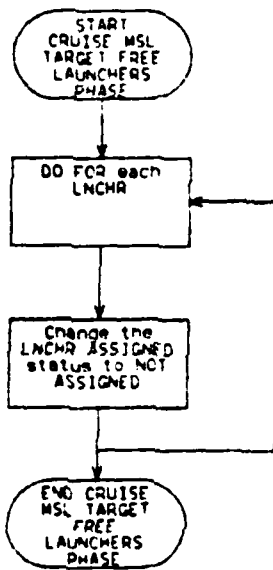

CRUISE MISSILE TARGET FREE LAUNCHERS PHASE

LIST OF REFERENCES

1. Computer Sciences Corporation, Naval Warfare Gaming System (NWGS) Program Performance Specification (PPS), Center for War Gaming, U.S. Naval War College, Newport RI, January 1981.
2. Computer Sciences Corporation, Naval Warfare Gaming Systems (NWGS) Program Description Document Data Base (MCDDB), Computer Program Configuration Item, Center for War Gaming, U.S. Naval War College, Newport RI, November 1980.
3. Computer Sciences Corporation, Naval Warfare Gaming System (NWGS) Student's Training Course Guide for Application Software, Center for War Gaming, U.S. Naval War College, Newport RI October 1982.
4. Naval Warfare Gaming System (NWGS) Student's Training Course, video tape of, Center for War Gaming, Naval War College, Newport RI, October 1982.
5. Computer Sciences Corporation, Command and Staff Users Manual for Naval Warfare Gaming System, (NWGS), Center for War Gaming, U.S. Naval War College, Newport RI, June 1981.
6. Computer Sciences Corporation, Naval Warfare Gaming System (NWGS) Program Design Manual (PDM), Center for War Gaming, U.S. Naval War College, Newport RI, April 1983.
7. Stekowski, Dennis T., Analysis of The Naval Warfare Gaming System Surface-To-Air Missile Routine, Master's Thesis, Naval Postgraduate School, Monterey California, September 1983.

INITIAL DISTRIBUTION LIST

		No. Copies
1.	Defense Technical Information Center Cameron Station Alexandria, Virginia 22314	2
2.	Superintendent Attn: Library, Code 0142 Naval Postgraduate School Monterey, California 93943	2
3.	Professor A.F. Andrus, Code 55As Naval Postgraduate School Monterey, California 93943	1
4.	Cdr. G.R. Porter, USN, Code 55Pt Naval Postgraduate School Monterey, California 93943	1
5.	Capt. W.P. Hughes, USN (Ret), Code 55H1 Naval Postgraduate School Monterey, California 93943	1
6.	Capt. E.J. Naughton, USN, Code 332 Center for War Gaming Naval War College Newport, Rhode Island 02841	2
7.	Icdr. M.I. Ardan, USN 10670 Esmeraldas Drive San Diego, California 92124	1
8.	Capt. T.H. Hoivik, USN, Code 55Ha Naval Postgraduate School Monterey, California 93943	1
9.	Professor M.G. Scvereign, Code 55Zo Naval Postgraduate School Monterey, California 93943	1
10.	Director, OP-953 Tactical Readiness Division Navy Department Washington, D.C. 20370	1

