

MICROCOPY RESOLUTION TEST CHART  
NATIONAL BUREAU OF STANDARDS-1963-A

AD-A135823

12

TECHNICAL REPORT NAVTRAEQUIPCEN 80-C-0063-2

**PILOT BEHAVIOR MODELS  
FOR LSO TRAINING SYSTEMS**

J. Thei Hooks and William S. McMurry  
MATHETICS, INC.  
10721 Treana Street  
San Diego, Ca. 92131

October 1983

Final Report 30 June 1980-30 October 1981

**DOD DISTRIBUTION STATEMENT**

Approved for public release;  
distribution unlimited.

**S** DTIC  
ELECTE **D**  
DEC 14 1983  
**D**

DTIC FILE COPY

83 12 13 295

NAVTRAEQUIPCEN 80-C-0063-2

GOVERNMENT RIGHTS IN DATA STATEMENT

Reproduction of this publication in whole or in part is permitted for any purpose of the United States Government.

Unclassified

SECURITY CLASSIFICATION OF THIS PAGE (When Data Entered)

REPORT DOCUMENTATION PAGE		READ INSTRUCTIONS BEFORE COMPLETING FORM
1. REPORT NUMBER NAVTRAEQUIPCEN 80-C-0063-2	2. GOVT ACCESSION NO. AD-A135 825	3. RECIPIENT'S CATALOG NUMBER
4. TITLE (and Subtitle) PILOT BEHAVIOR MODELS FOR LSO TRAINING SYSTEMS	5. TYPE OF REPORT & PERIOD COVERED Final Report 30 June 1980 - 30 Oct. 1981	
		6. PERFORMING ORG. REPORT NUMBER
7. AUTHOR(s) J. The1 Hooks, William S. McMurry	8. CONTRACT OR GRANT NUMBER(s) N61339-80-C-0063	
9. PERFORMING ORGANIZATION NAME AND ADDRESS Mathetics, Inc. 10721 Treena Street, Suite 217 San Diego, Ca. 92131	10. PROGRAM ELEMENT, PROJECT, TASK AREA & WORK UNIT NUMBERS 7754-4P3 PE 62757N	
11. CONTROLLING OFFICE NAME AND ADDRESS Naval Training Equipment Center Code N-711 Orlando, Florida 32813	12. REPORT DATE October 1983	13. NUMBER OF PAGES
14. MONITORING AGENCY NAME & ADDRESS (if different from Controlling Office)	15. SECURITY CLASS. (of this report) Unclassified	
15a. DECLASSIFICATION/DOWNGRADING SCHEDULE		
16. DISTRIBUTION STATEMENT (of this Report) Approved for public release; distribution unlimited.		
17. DISTRIBUTION STATEMENT (of the abstract entered in Block 20, if different from Report)		
18. SUPPLEMENTARY NOTES		
19. KEY WORDS (Continue on reverse side if necessary and identify by block number) Landing Signal Officer (LSO)                      Carrier Operations Carrier Landing Safety                              LSO Training Automated Training System                        Carrier Landing Accidents Pilot Errors in Carrier Landings		
20. ABSTRACT (Continue on reverse side if necessary and identify by block number) This report promulgates results of a project to develop pilot/aircraft behavior models for an automated LSO training system. Data supporting the identification of critical LSO task conditions were collected through literature search, accident report review and survey of the LSO community. Results of data collection and their implications to model development are presented. Pilot/aircraft models, a listing of key LSO learning concepts and a functional design for the models are included. An extensive bibliography is also included.		

FOREWORD

This report is one of a series of reports dealing with the development of data for use in the design of an automated LSO training system. This report describes the pilot, aircraft and environment model from a functional standpoint. The report is intended for two audiences. The body of the report addresses how the study was conducted and is intended for researchers who want to verify the methodology of the study. The appendices contain the data. The software model and the design of the system are provided in Appendix E and F, respectively. Thus, the system builder need not read the entire report to find the information of interest for implementing an automated LSO training system. It is intended that this division of the report into a "scientific" section and a "data" section will facilitate its use by the research and the engineering communities, and aid in the transfer of technology from the laboratory to an operational LSO training system.

*R. Breaux*  
 R. BREAU, Ph.D.  
 Scientific Officer

<b>Accession For</b>	
NTIS GRA&I	<input checked="" type="checkbox"/>
DTIC TAB	<input type="checkbox"/>
Unannounced	<input type="checkbox"/>
Justification	
By _____	
Distribution/	
Availability Codes	
Dist	Avail and/or Special
A/1	



PREFACE

The authors are indebted to many individuals within the Landing Signal Officer (LSO) community who contributed their valuable time and ideas to this research effort.

LCDR Jerry Singleton, who at the time was the LSO Training Model Manager and OinC of the LSO Phase I School, was extremely valuable as a subject matter expert and as a coordinator of access to other LSOs. His staff assistants, Major Ted Lyons and LCDR Earle Rudolph also provided valuable assistance to this study.

The type commander LSOs who were also instrumental in assuring comprehensive LSO community participation in various aspects of the study included: LCDR Bob Day and LCDR Frank Roberts of COMNAVAIRLANT; LCDR Jerry Arbiter and LCDR J. R. Davis of COMNAVAIRPAC; and LCDR Fred Jung of CNATRA.

Dr. Michael Borowsky and Mrs. Jo Knott provided assistance at the Naval Safety Center in the coordination of carrier landing accident data requirements. Dr. Mike McCauley of Canyon Research Group provided excellent technical interchange between this study and his parallel effort concerned with instructor model functions for LSO training systems.

NAVTRAEQUIPCEN 80-C-0063-2

TABLE OF CONTENTS

<u>Section</u>		<u>Page</u>
I	INTRODUCTION . . . . .	5
II	APPROACH . . . . .	8
III	DOCUMENTATION REVIEW . . . . .	14
IV	LSO SURVEY . . . . .	21
V	COST SAVINGS ESTIMATION . . . . .	33
VI	SUMMARY OF LSO TRAINING IMPLICATIONS . . . . .	51
VII	PILOT/AIRCRAFT MODELS DEVELOPMENT. . . . .	60
VIII	CONCLUSIONS AND RECOMMENDATIONS . . . . .	63
	REFERENCES . . . . .	64
	BIBLIOGRAPHY . . . . .	66
APPENDIX A	STUDY OBJECTIVES . . . . .	69
APPENDIX B	SURVEY QUESTIONNAIRE AND DATA . . . . .	71
APPENDIX C	COST SAVINGS ESTIMATION MATERIALS AND DATA . . . . .	85
APPENDIX D	KEY CONCEPTS . . . . .	117
APPENDIX E	PILOT/AIRCRAFT BEHAVIOR MODELS . . . . .	129
APPENDIX F	FUNCTIONAL DESIGN FOR MODELS . . . . .	173
APPENDIX G	ANALYSIS OF CARRIER LANDING ACCIDENTS . . . . .	208
APPENDIX H	LSO TRAINING MODEL MANAGER AND NAVAL SAFETY CENTER INTERFACE . . . . .	225
ACRONYMS . . . . .		231

LIST OF ILLUSTRATIONS

<u>Figure</u>		<u>Page</u>
1	LSO TRAINING SYSTEM CONCEPT . . . . .	10
2	APPROACH . . . . .	12
E-1	MODELS INTERACTION . . . . .	130
E-2	RANGE SEGMENTATION . . . . .	131
E-3	"SNAPSHOT" SEGMENTATIONS FOR APPROACH . . . . .	133
E-4	PILOT RESPONSE LOGIC FOR DISCRETE LSO ACTIONS . . . . .	138
E-5	RESPONSE LOGIC FOR MOVLAS SIGNALS . . . . .	143
F-1	LSO TRAINING SYSTEM CONCEPT . . . . .	175
F-2	MODELS INTERACTION . . . . .	178
F-3	LSO TRAINING SYSTEM SUBSYSTEMS . . . . .	182
F-4	SIMULATION SUBSYSTEM MODULE HIERARCHY . . . . .	184



NAVTRAEQUIPCEN 80-C-0063-2

LIST OF TABLES

<u>Table</u>		<u>Page</u>
1	RATINGS OF NIGHT SITUATION VARIABLES . . . . .	22
2	VOICE CALL RATINGS . . . . .	24
3	SITUATION VARIABLES . . . . .	27
4	CRITICAL APPROACH PROFILES . . . . .	30
5	ACCIDENTS IN WHICH LSO CITED AS CAUSE FACTORS . . . . .	37
6	DATA COLLECTED . . . . .	40
7	LSO TRAINING REQUIREMENTS IDENTIFIED . . . . .	41
8	DATA ANALYSIS RESULTS . . . . .	44
9	COMPARISON OF REPRESENTATIVE AND ACTUAL SAMPLES . . . . .	46
10	TRAINING REQUIREMENTS AND RELATED ACCIDENTS . . . . .	47
11	CRITICAL SKILL AREAS . . . . .	53
12	STRUCTURE OF SITUATION VARIABLES . . . . .	57
E-1	OVERVIEW OF MODELS AND ELEMENTS . . . . .	129
E-2	RESPONSES BY DEVIATION . . . . .	139
E-3	RESPONSES BY DISCRETE LSO ACTIONS . . . . .	140
E-4	SIMPLE PROFILES . . . . .	144
E-5	COMPLEX PROFILES . . . . .	146
E-6	SINK AND DRIFT RATE DISTRIBUTIONS . . . . .	150
E-7	AIRCRAFT CHARACTERISTICS . . . . .	155
E-8	AIRCRAFT STATUS . . . . .	159
E-9	ENVIRONMENTAL VARIABLES . . . . .	162
E-10	OPERATIONS VARIABLES . . . . .	164
E-11	LSO STATION VARIABLES . . . . .	166
E-12	SOURCES OF IMPLEMENTATION INFORMATION . . . . .	172
G-1	DATA COMPARISONS: CARRIER LANDING ACCIDENTS . . . . .	209
G-2	PERCENTAGES FOR LSO RELATED ACCIDENTS . . . . .	213
G-3	ACCIDENT TREND ANALYSIS WORKSHEET EXAMPLE . . . . .	216
G-4	TRENDS IN CARRIER LANDING ACCIDENTS . . . . .	217
G-5	TRENDS IN RAMP STRIKE ACCIDENTS . . . . .	219
G-6	TRENDS IN HARD LANDING ACCIDENTS . . . . .	221
G-7	TRENDS IN OFF-CENTER LANDING ACCIDENTS . . . . .	222
G-8	TRENDS IN IN-FLIGHT ENGAGEMENT ACCIDENTS . . . . .	223

SECTION I

INTRODUCTION

This report describes the activities and results of a study to develop pilot and aircraft behavior models for Landing Signal Officer (LSO) training systems. This study is one in a series of research efforts sponsored by the Naval Training Equipment Center (NAVTRAEQUIPCEN) to apply advances in computer technology toward the improvement of LSO training.

BACKGROUND

A major problem faced by the Navy's LSO community is a shortage of skilled LSOs. There are two primary causes of this problem. One factor has been the drastic reduction in carrier landing operations since the Vietnam conflict ended. On-the-job-training (OJT) aboard ship has historically been the primary medium for the LSO training process. Reductions in the availability of this medium have caused a lengthening of the already long learning process for an LSO trainee. A promising trainee frequently reaches a fully productive skill level for only the last several months of his first sea duty tour (a three year period). The reduction in carrier operations also has the effect of reducing exposure of LSOs and trainees to the wide variety of job conditions for which they must be prepared to handle. There are many LSOs and supervisory personnel who speculate that the qualified LSOs of today may be less skilled than those of the Vietnam era. The other factor has been a significant decrease in the Navy pilot retention rate. Since pilot qualification is a prerequisite to entering LSO training, the pilot retention rate also reflects the availability of LSO personnel for experienced LSO billets, such as those in Training and Fleet Readiness Squadrons and Air Wings. This impacts LSO training in that there is a shortage of senior LSOs to provide guidance and instruction to LSO trainees, thus reducing the quality and efficiency of the training program.

Applications of simulation technology in other training programs have proved very successful in the improvement of instructional quality and efficiency. Recent NAVTRAEQUIPCEN research studies of LSO training have

pointed out the promising potential of an automated LSO training system.<sup>1,2,3,4</sup> It has the potential to increase LSO trainee exposure to various waving situations, to decrease dependency on instructor interaction and to promote task performance standardization. In developing such a system, there appears to be minimal technical risk involved with the simulation aspects. In fact, a recently procured system, the LSO Reverse Display, which is located at two Navy bases, is proving to be an excellent simulation for support of LSO training.<sup>5</sup> Its major limitation is its dependency on instructor availability for the conduct of LSO training. This limitation has had a significant negative impact on recent utilization of the device. Therefore, some level of automated instructional support is needed to maximize the benefits of an LSO training system.

The study which is the subject of this report addresses the modelling of pilot and aircraft behavior as a part of automated LSO instructional support.

## OVERVIEW

The purpose of this effort was to develop a functional design for models of pilot and aircraft behavior which can help LSO trainees acquire perceptual and decision-making skills for carrier landing operations. A primary objective in this study was to insure that the models would be particularly suited to the representation of critical waving situations.

---

<sup>1</sup> Hooks, J.T., Butler, E.A., Gullen, R.A. and Petersen, R.J., Design Study for an Auto-Adaptive Landing Signal Officer (LSO) Training System, Technical Report, NAVTRAEQUIPCEN 77-C-0109-1, Naval Training Equipment Center, 1978.

<sup>2</sup> Breaux, R., (Ed.), LSO Training R&D Seminar Proceedings, Technical Report IH-320, Naval Training Equipment Center, 1980.

<sup>3</sup> McCauley, Michael E. and Borden, Gail J., Computer-Based Landing Signal Officer Carrier Aircraft Recovery Model, Technical Report, NAVTRAEQUIPCEN 77-C-0110, Naval Training Equipment Center, 1980.

<sup>4</sup> Hooks, J.T., Butler, E.A., Reiss, M.J. and Peterson, R.J., Landing Signal Officer (LSO) Laboratory System Software, Technical Report, NAVTRAEQUIPCEN 78-C-0151-1, Naval Training Equipment Center, 1980.

<sup>5</sup> Hooks, J. Thel, McCauley, Michael E., Training Characteristics of the LSO Reverse Display, Technical Report, NAVTRAEQUIPCEN 79-C-0101-2, Naval Training Equipment Center, 1980.

Thus, the analytical activities were focused on critical aspects of LSO performance and carrier landing situations. The analytical efforts were intended to result in the identification of key LSO learning concepts and training situation variables on which to base model development. Another objective in the study was to identify the potential cost savings which could result from improved LSO training. The functional design effort was intended to provide guidance for detailed software design of the models and their incorporation in an automated LSO training system. In pursuing these objectives, the results of this effort were also expected to be compatible with automated instructor model functions being addressed in another LSO study effort sponsored by NAVTRAEQUIPCEN.<sup>6</sup> Appendix A presents a summary of the technical objectives of this study, progress made toward their achievement and the degree to which they were met.

Early study activities included the review of many documents related to LSO performance, carrier landing situations, carrier landing accidents and LSO training system concepts. This review provided initial data and guidance for subsequent activities which included a survey of LSOs, initial identification of situation variables and key LSO learning concepts, and initial formulation of pilot/aircraft model functions. The latter stages of the study involved the estimation of potential cost savings, comprehensive analysis of carrier landing accidents, the iterative refinement of key concepts and pilot/aircraft models and the development of a functional design for the models.

The results of analytical activities provide very comprehensive coverage of the critical aspects of successful LSO performance. The key concepts presented in Appendix D extensively describe the interrelationships among situation cues, decision factors and LSO actions. The pilot/aircraft model descriptions presented in Appendix E are a comprehensive compilation of the variables with which an LSO must contend in carrier landing operations. The cost savings estimation effort described in Section V provides insight to the return on investment for procuring LSO training systems. The documentation review and bibliography provide historical perspective for the emergence of automated LSO training system concepts. The accident analysis presented in Appendix G shows how accident data can be useful in LSO training program design and quality control. Appendix H suggests improvements for interaction between the LSO Training Model Manager (TMM) and the National Safety Center.

Subsequent portions of this report present descriptions of study activities, discussions of analytical results and conclusions and recommendations emerging from the study. The primary outputs from the study are presented in Appendix E (Pilot/Aircraft Behavior Models) and Appendix F (Functional Design for Models).

---

<sup>6</sup>McCauley, M.E., and Cotton, J.C. Automated Instructor Models for LSO Training Systems, Technical Report, NAVTRAEQUIPCEN 80-C-0073-1, Naval Training Equipment Center, 1982.

## SECTION II

## APPROACH

In the past few years there has been an on-going LSO training research program at the NAVTRAEQUIPCEN. The early efforts<sup>7,8</sup> focused on LSO training program shortcomings and training requirements, LSO "waving" behavior, and the potential functions and benefits of an automated LSO training system. More recent efforts involved continued analysis of LSO "waving" behavior, identification of LSO performance measures, laboratory investigations of training system feasibility and field evaluation of an LSO training device.<sup>9,10,11</sup> These activities have been focused on the applicability and cost-effectiveness of advanced technologies for improving the LSO training program.

The most recent efforts, including the one reported herein, involved the design of modelling functions to operate within an automated LSO training system. One set of functions is intended to represent pilot and aircraft behavior for simulated, interactive waving situations for the LSO trainee. The other set of functions is intended to provide instructor support in the conduct of training.<sup>12</sup> This support is to encompass syllabus decisions, trainee performance assessment and other instructor aids needed for effective utilization of an automated LSO training system.

---

<sup>7</sup> Hooks, J.T., Butler, E.A., Gullen, R.A. and Petersen, R.J., Design Study for an Auto-Adaptive Landing Signal Officer (LSO) Training System, Technical Report, NAVTRAEQUIPCEN 77-C-0109-1, Naval Training Equipment Center, 1978.

<sup>8</sup> McCauley, Michael E. and Borden, Gail J., Computer-Based Landing Signal Officer Carrier Aircraft Recovery Model, Technical Report, NAVTRAEQUIPCEN 77-C-0110, Naval Training Equipment Center, 1980, (in press).

<sup>9</sup> Brictson, C.A., Breidenbach, S.T., Narsete, E.M., Pettigrew, K.M., Objective Measures of Landing Signal Officer (LSO) Performance During Night Carrier Recovery, Technical Report, NAVTRAEQUIPCEN 78-C-0123-1, Naval Training Equipment Center, 1980.

<sup>10</sup> Hooks, J.T., Butler, E.A., Reiss, M.J. and Peterson, R.J., Landing Signal Officer (LSO) Laboratory System Software, Technical Report, NAVTRAEQUIPCEN 78-C-0151-1, Naval Training Equipment Center, 1980.

<sup>11</sup> Hooks, J. Thel, McCauley, Michael E., Training Characteristics of the LSO Reverse Display, Technical Report, NAVTRAEQUIPCEN 79-C-0101-2, Naval Training Equipment Center, 1980.

<sup>12</sup> McCauley, M.E., and Cotton, J.C. Automated Instructor Models for LSO Training Systems, Technical Report, NAVTRAEQUIPCEN 80-C-0073-1, Naval Training Equipment Center, 1982.

The subject of this report is the development of pilot/aircraft models and the design of system functions for their incorporation in an automated LSO training system. This section of the report describes the approach which was proposed and followed in the execution of the study.

## LSO INSTRUCTIONAL CONTROL CONCEPTS

Automated instructional control in an LSO training system encompasses the process of managing the learning experience of an LSO trainee. There are several elements involved in accomplishing the instructional control process. Figure 1 is a simplified representation of an automated LSO training system which shows the conceptual relationships of these elements. The instructor model can be viewed as the system executive: collecting and evaluating data, making instructional decisions or providing recommendations to the human instructor, providing instructional feedback to the trainee, directing training exercise generation, informing the instructor of trainee performance results and storing trainee performance data. Thus, a simple instructor console, perhaps only a CRT, is all that is required in an automated training system.

Automated instructional control should support both instructor-present and instructor-absent modes of training. Instructor-present training is necessary due to the significant level of subjectivity involved in several aspects of LSO task performance. Some time in the future most of this subjectivity may become quantifiable. However, for the near future, human instructor judgment must remain a part of the LSO training process and automated instructor support can enhance the efficiency of the instructor-present mode of training. On the other hand, instructor-absent training is also an important aspect of LSO training system effectiveness. Inadequate availability of instructor LSOs, as was mentioned earlier, can minimize the potential benefits of an LSO training system. Valuable capabilities associated with an instructor-absent mode of training include provisions for auto-adaptive instruction in selected syllabus segments which are amenable to objective performance assessment, and self-paced trainee practice sessions for review, remediation and additional experience.

The need for exercise generation and control to support instructor-absent training is fairly obvious. As Figure 1 implies, this is the mechanism utilized by the instructor model function to implement instructional decisions relevant to the trainee skill level. For instructor-present training it supports training session efficiency by minimizing instructor task loading. The exercise generation and control function interacts with the simulation portion of the training system to provide the trainee with the required conditions for skill acquisition and practice.

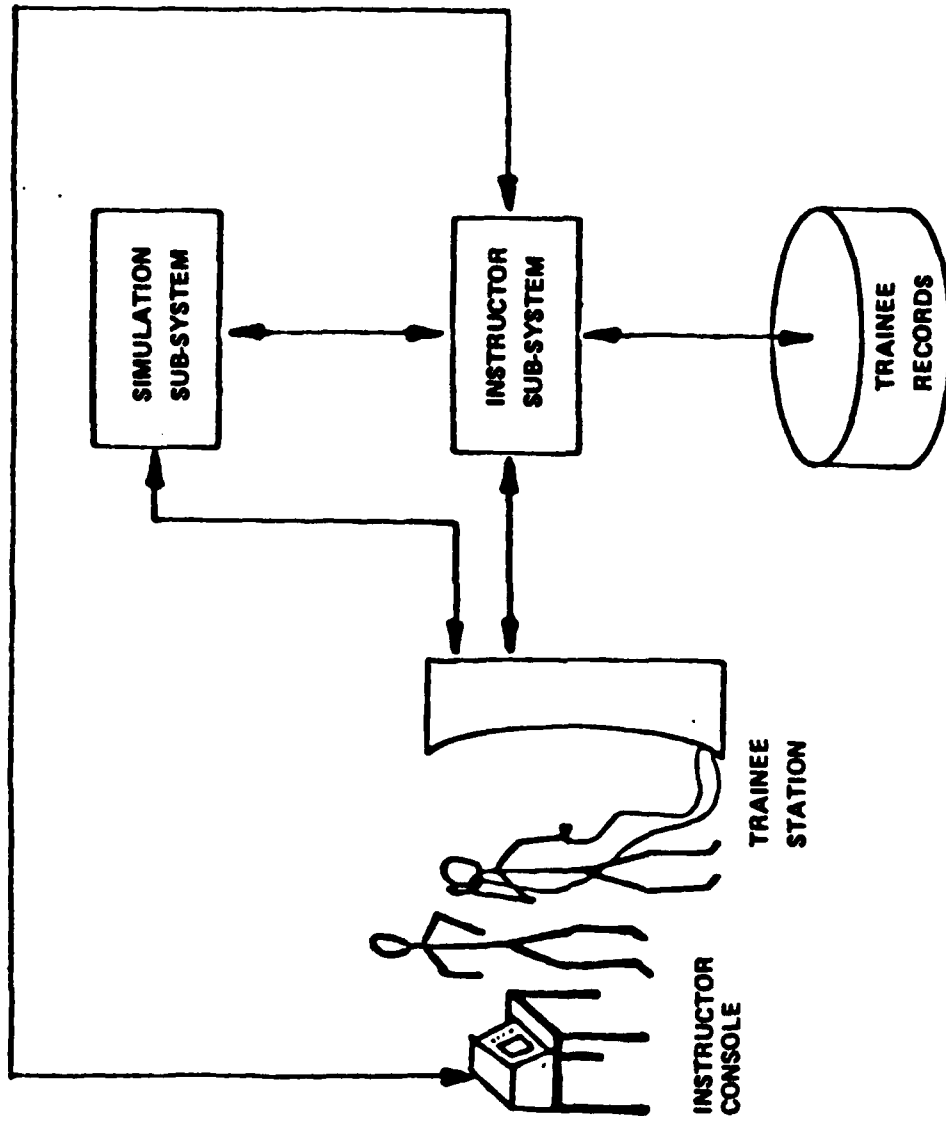

Figure 1. LSO Training System Concept

## APPROACH

Mathetics proposed and executed a systematic data gathering and analysis approach leading to the development of pilot/aircraft behavior models and their functional design. The approach involved parallel performance of training analysis and model function design efforts, as well as interaction with the Canyon Research Group instructor model functional design project. The approach is depicted in Figure 2. The initial project activity was a planning effort which resulted in the formulation and documentation of a work plan. This plan was formulated in liaison with Canyon Research Group to clarify the interaction requirements between the two related studies. The work plan established personnel and task scheduling, data sources, anticipated analyses, liaison with the LSO community and expected results of study activities.

The initial training analysis effort involved the review of documentation relevant to LSO task performance. Data sources included technical reports, safety journals and descriptions of recent carrier landing accidents. These activities resulted in the identification of critical LSO skill areas and associated job conditions.

The initial functional design effort involved the review of technical reports concerning LSO training system concepts. This effort led to the formulation of a top-level automated LSO training system structure and the initial definition of pilot/aircraft behavior model functions within the structure. This effort included liaison with the instructor model study personnel.

The second training analysis effort included the collection and analysis of additional LSO task performance data gathered through survey of the LSO community. The focus in this effort was upon critical waving situations and variables which had been identified in the earlier analysis phase. The results of this effort provided initial inputs to the pilot/aircraft behavior modelling effort and established an initial basis for the identification of key LSO learning concepts.

The next step involved the identification of pilot/aircraft behavior model requirements. The waving conditions and situations mentioned above were segmented into related groups of instructional variables. Groupings were established as the basis for development of separate models and model elements for the pilot and the aircraft. Other variables were also organized into groupings to account for environmental and operational conditions needed for LSO training exercises. This was an iterative effort over time during the study as variables were added and groupings were revised.

Based on the model requirements mentioned above, functions were identified for their interaction within the exercise generation and control process for the system. The descriptions of the functions, their



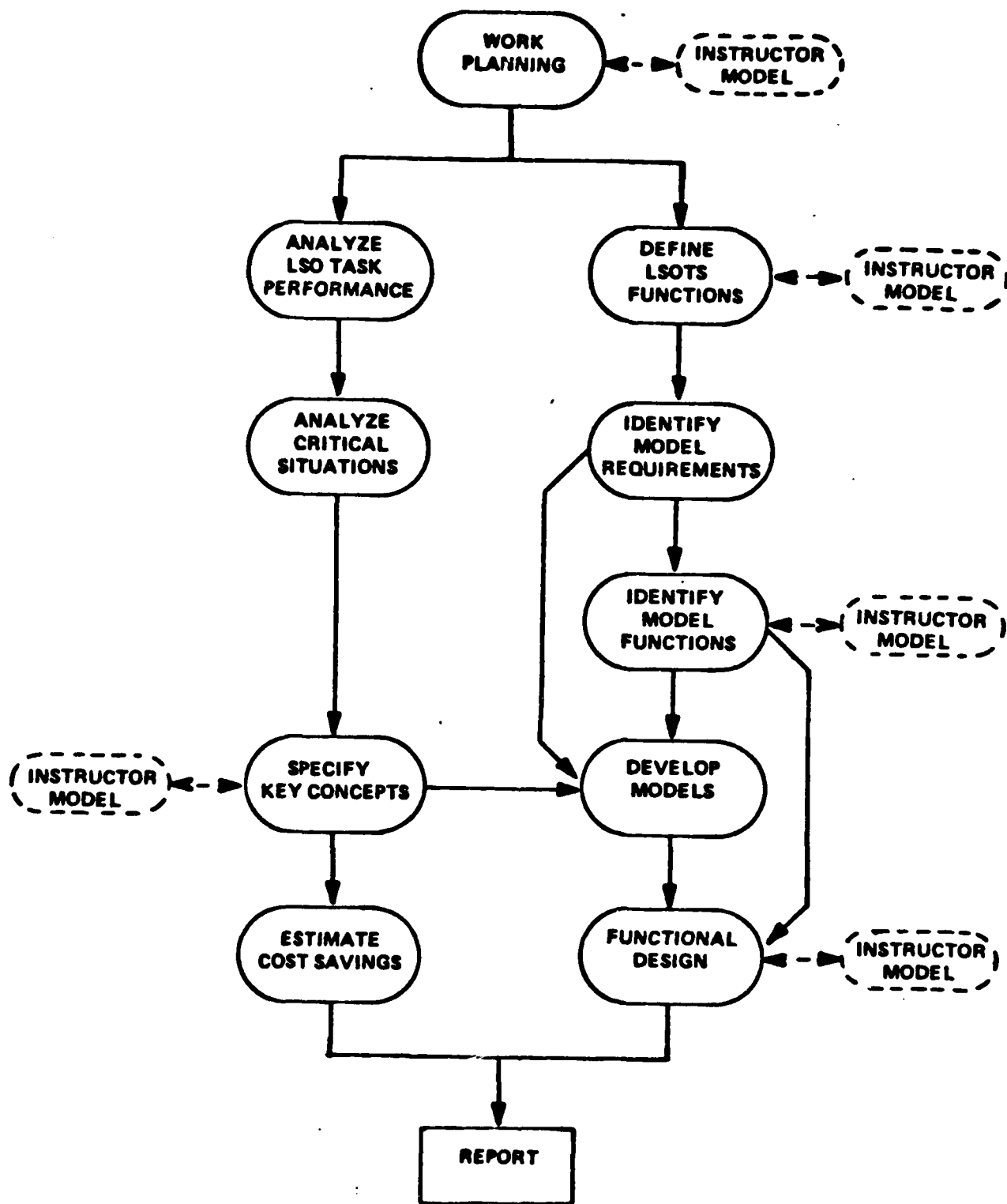

Figure 2. Approach

interrelationships and other considerations which resulted from this effort formed an initial iteration of the functional design for the pilot/aircraft behavior model functions.

The next training analysis activity involved the formulation of key LSO learning concepts from the task performance and situation data gathered and analyzed earlier. This was an iterative effort which included periodic liaison and review of results with the LSO Training Model Manager and other LSOs. The key concepts are primarily intended to provide the foundation of LSO training emphasis upon critical decision aspects of the waving task. They are specified in terms of decision influences and relationships, and "rule-of-thumb" guidance for critical situations. As such they are important influences on syllabus design and control. Therefore, there was interaction with Canyon Research Group concerning LSO training requirements and the syllabus decisions aspect of the instructor model study.

At this stage of the study most of the information was available for the development of the pilot/aircraft behavior models. This effort involved the specification of model elements and sub-elements, their attributes and values, and their functional interrelationships to form exercise scenarios responsive to LSO training requirements. The primary emphasis in this effort was upon models of pilot and aircraft behavior. However, the environmental and operational elements of exercise scenarios were also addressed. Liaison with Canyon Research Group and the LSO Training Model Manager was a part of this activity.

The final step in the training analysis portion of the study was the estimation of the potential cost savings which could accrue from automated LSO training system utilization. This analysis focused on the potential benefits of the system relative to LSO performance in carrier landing accident situations. Judgments of skill and training program deficiencies in accident situations were obtained from experienced LSOs and analyzed in conjunction with anticipated training capabilities and accident costs to estimate potential cost savings.

The final step was the translation of the pilot/aircraft behavior models into a design of software functions for implementation of the models into the system. The functional design evolved from a top-down hierarchical approach. There was significant interaction with the Canyon Research Group effort to ensure comprehensive definition of interfaces with all aspects of the system, including the instructor model functions.

Subsequent sections of this report provide additional detail concerning specific activities within this approach and their results. Section III reviews documentation. Section IV reviews the survey data. Section V reviews the costing and accident data collected from the Naval Safety Center. The remaining sections address the integration and correlation of data to formulate pilot/aircraft modelling concepts and functions.

### SECTION III DOCUMENTATION REVIEW

Early in this project, a review of documentation relevant to LSO training, LSO training system concepts, and carrier landing operations was conducted. The purposes of this activity were two fold. Literature relevant to LSO training system concepts was reviewed to insure that pilot/aircraft modelling function designs would be compatible extensions of instructional concepts derived in earlier studies. The other purpose of the review was to provide initial guidance in the identification of particularly critical aspects of the LSO waving task. The remainder of this section will describe the review in two segments: LSO training system concepts, and critical LSO skills and conditions. Within each segment, relevant information reviewed and its implications for pilot/aircraft modelling function design will be discussed.

#### LSO TRAINING SYSTEM CONCEPTS

The original basis for an LSO training system was promoted by a Navy fleet-generated operational requirement (O.R.) proposal for an LSO training device called Carrier Aircraft Recovery Simulator (CARS).<sup>13</sup> It was suggested that this device provide extensive, high fidelity simulation of the carrier recovery environment from the LSO platform perspective. Some of the features proposed included: recovery visual scene, LSO/pilot interaction, multiple aircraft simulation, full LSO workstation instrumentation, sound effects, aircraft malfunctions, and environmental effects (including deck motion). The prevailing rationale supporting the need for CARS was that LSO trainees were not receiving adequate waving experience due to a significant reduction in carrier operating tempo following the Vietnam conflict.

NAVTRAEQUIPCEN subsequently sponsored research into the definition and feasibility of developing an LSO training system. Extensions beyond the basic CARS design which evolved from an initial design study were automated LSO performance evaluation (using automated speech recognition) and automated adaptive syllabus control.<sup>14</sup> The results of the initial design study which are relevant to the development of pilot/aircraft behavior models included:

- LSO job tasks and conditions descriptions
- definition of LSO training system functional concepts
- potential roles of an LSO training system
- syllabus content and sequence guidance
- technology assessment

<sup>13</sup> U.S. Navy, Carrier Aircraft Recovery Simulator (CARS) proposal letter, VAQ-129 NAS Whidbey Island, Washington, May 26, 1976.

<sup>14</sup> Hooks, J.T., Butler, E.A., Gullen, R.A. and Petersen, R.J., Design Study for an Auto-Adaptive Landing Signal Officer (LSO) Training System, Technical Report, NAVTRAEQUIPCEN 77-C-0109-1, Naval Training Equipment Center, 1978.

A concurrent NAVTRAEQUIPCEN program was underway to develop a model of LSO behavior to support automated performance evaluation.<sup>15</sup> This resulted in the increased awareness of the perceptual and decision-making complexities of waving aircraft. Additionally, it provided an initial quantification of aircraft approach dynamics associated with the use of LSO voice calls.

During the same time frame, an effort was underway by the Vought Corporation, under Naval Air Systems Command sponsorship, to develop an LSO training station for the A-7E Night Carrier Landing Trainer (NCLT).<sup>16</sup> This device, called the LSO Reverse Display (LSORD), incorporated some of the features suggested for CARS, but simulated only the A-7 aircraft and was dependent upon interface with the NCLT for LSO/pilot interaction. Following the operational deployment of this device to NAS Lemoore and NAS Cecil Field, NAVTRAEQUIPCEN initiated a training effectiveness evaluation. The results of this evaluation were favorable but indicated a need for operating independence from the NCLT and for enhancement of device capabilities.<sup>17</sup> In general, the study suggested that capabilities resembling those of CARS and those suggested from the first NAVTRAEQUIPCEN study would provide a higher payoff in LSO training effectiveness.

As the LSORD was being evaluated, two other NAVTRAEQUIPCEN-sponsored programs were underway. One involved the laboratory development and demonstration of an automated LSO training system.<sup>18</sup> This system exercised automated speech, performance measurement, and training feedback for limited LSO waving skills. This system also employed pre-defined waving scenarios tied to specific learning goals. There were positive indications for the feasibility of the automated concepts which were investigated. However, training effectiveness was not validated. The other NAVTRAEQUIP-

---

<sup>15</sup> McCauley, Michael E. and Borden, Gail J., Computer-Based Landing Signal Officer Carrier Aircraft Recovery Model, Technical Report NAVTRAEQUIPCEN 77-C-0110, Naval Training Equipment Center, 1980 (in press).

<sup>16</sup> Lacy, J.W. and Meshier, C.W., Development of a Landing Signal Officer Trainer, Proceedings, First Interservice/Industry Training Equipment Conference, Technical Report, NAVTRAEQUIPCEN IH-316, Naval Training Equipment Center, 1979, 79-90.

<sup>17</sup> Hooks, J. Thel and McCauley, Michael E., Training Characteristics of the LSO Reverse Display, Technical Report, NAVTRAEQUIPCEN 79-C-0101-2, Naval Training Equipment Center, 1980.

<sup>18</sup> Hooks, J. Thel, Butler, E.A., Riess, M.J. and Petersen, R.J., Landing Signal Officer (LSO) Laboratory System Software, Technical Report, NAVTRAEQUIPCEN 78-C-0151-1, Naval Training Equipment Center, 1980.

CEN-sponsored program involved an analysis of historical carrier landing data to identify candidate measures of LSO performance.<sup>19</sup> The results of this effort showed the potential of carrier landing results as indicators of LSO performance quality.

NAVTRAEQUIPCEN also sponsored several other research efforts which were not directly related to LSO training but are relevant to automated LSO training system design. One was the development of a Precision Approach Radar Controller training system, which employs automated speech recognition, syllabus control, and performance evaluation.<sup>20</sup> Another was the development of an Air Intercept Controller training system, with similar capabilities, but with more complex training situations.<sup>21</sup> Two other studies involved research into adaptive syllabus control and automated instructor concepts.<sup>22,23</sup> These are primarily relevant to development of an automated instructor model for the LSO training system.

A seminar was sponsored by NAVTRAEQUIPCEN in January 1980 on the topic of LSO Training R&D. The papers presented at that seminar provide an overview of NAVTRAEQUIPCEN research efforts in support of LSO training system design.<sup>24</sup>

---

<sup>19</sup> Bricton, C.A., Breidenbach, S.T., Narsete, E.M., Pettigrew, K.W., Objective Measures of Landing Signal Officer (LSO) Performance During Night Carrier Recovery, Technical Report, NAVTRAEQUIPCEN 78-C-0123-1, Naval Training Equipment Center, 1980.

<sup>20</sup> McCauley, Michael E., and Semple, Clarence A., Precision Approach Radar Training System (PARTS) Training Effectiveness Evaluation, Technical Report, NAVTRAEQUIPCEN 79-C-0042-1, Naval Training Equipment Center, 1980.

<sup>21</sup> Halley, Robin, King, M.R. and Regelson, E.C., Functional Requirement for Air Intercept Controller Prototype Training System, Technical Report, NAVTRAEQUIPCEN 78-C-0182-4, Naval Training Equipment Center, 1980.

<sup>22</sup> Chatfield, Douglas C. and Gidcumb, Charles F., Optimization Techniques For Automated Adaptive Training Systems, Technical Report, NAVTRAEQUIPCEN 77-M-0575, Naval Training Equipment Center, 1977.

<sup>23</sup> Chatfield, Douglas C., Marshall, P.H., and Gidcumb, C.F., Instructor Model Characteristics for Automated Speech Technology (IMCAST), Technical Report, NAVTRAEQUIPCEN 79-C-0085-1, Naval Training Equipment Center, 1979.

<sup>24</sup> Breaux, R., (Ed.), LSO Training R&D Seminar Proceedings, Technical Report IH-320, Naval Training Equipment Center, 1980.

The reports referenced above influenced early activities associated with definition of interactions of the pilot/aircraft modelling functions within the automated LSO training system. They continued to serve as primary references as this project progressed to completion. They should also be considered valuable references in the future development and implementation of an LSO training system.

#### CRITICAL SKILLS AND CONDITIONS

Some of the reports mentioned earlier were also good sources of critical skills and waving conditions information. Other technical reports and recent Approach magazine articles (past eight years) were also valuable sources. Summaries of recent carrier landing accidents were reviewed to provide more specific operational indications of critical LSO skills and job performance conditions.

Several technical reports provided comprehensive descriptions of LSO waving tasks and conditions.<sup>25,26,27</sup> These references, in many cases, were explicit in highlighting the more critical aspects of waving. The waveoff decision was the LSO task receiving the most attention. Night, pitching deck, Manually Operated Visual Landing Aid System (MOVLAS), wind and no horizon were among the conditions most frequently noted. An old article from Approach provided a comprehensive examination of basic pilot carrier landing techniques, typical errors and error trends and effective pilot/LSO interaction.<sup>28</sup> Most environmental factors were also discussed. One very experienced LSO provided excellent insight to some of the psychological implications of waving and the interrelationships between LSO and pilot in the LSO job.<sup>29</sup>

---

<sup>25</sup> Borden, G.J., The Landing Signal Officer: A Problem Analysis, Vols. I, II. Technical Report 785-1, Goleta, Calif.: Human Factors Research, Inc., May 1969.

<sup>26</sup> Hooks, J.T., Butler, E.A., Gullen, R.A. and Petersen, R.J., Design Study for an Auto-Adaptive Landing Signal Officer (LSO) Training System. Technical Report, NAVTRAEQUIPCEN 77-C-0109-T, Naval Training Equipment Center, 1978.

<sup>27</sup> McCauley, Michael E. and Borden, Gail J., Computer-Based Landing Signal Officer Carrier Aircraft Recovery Model, Technical Report NAVTRAEQUIPCEN 77-C-0110, Naval Training Equipment Center, 1980 (in press).

<sup>28</sup> Netherland, R.M., The Total Approach, Approach, Naval Safety Center, 1965.

<sup>29</sup> Rubel, Robert C., Confessions of a CAG LSO, Approach, Naval Safety Center, 1980.

Excellent discussion of the waveoff was found in one article<sup>30</sup> and an LSO reference manual.<sup>31</sup> The reference manual also covered a broad spectrum of operational (lens, wires missing, MOVLAS, etc.) and environmental factors (wind-over-deck, deck motion) critical to successful waving performance. Another paper which was reviewed, addressed environmental factors in carrier landing accidents.<sup>32</sup> Pitching deck and no horizon were identified as the most significant factors. The F-4 aircraft was identified as most susceptible to accidents under pitching deck conditions.

MOVLAS was the topic of three articles reviewed.<sup>33,34,35</sup> These provided excellent insight into the effective use of MOVLAS and the need for increased MOVLAS training emphasis. Pilot factors were the subject of four other articles. One emphasized that even the "best" pilot can have a bad approach.<sup>36</sup> Another pointed to the relatively high accident potential of the inexperienced pilot.<sup>37</sup> Two articles provided examples of degraded approach performance by pilot. In one case the pilot was distracted by unexpected mission changes and negatively influenced by a "Can Do" attitude.<sup>38</sup> In the other case the pilot had to fly a night approach with degraded vision due to lightning.<sup>39</sup> One article described a situation in which a timely LSO call to an aircraft on CCA (1-1/2 miles) prevented the

---

<sup>30</sup> Webb, G.J., The In-Close Waveoff, Approach, Naval Safety Center, 1976.

<sup>31</sup> Erickson, D.P., Landing Signal Officer Guide and Training Plan, circa 1978.

<sup>32</sup> Bricton, C.A., The Influence of Environmental Factors in Aircraft Carrier Landing Accidents, Conference Proceedings No. 82 on Adaptation and Acclimatisation in Aerospace Medicine, AGARD, September 1970.

<sup>33</sup> Whalen, Dan, Rig the MOVLAS, Starboard Side, Approach, 1976.

<sup>34</sup> Mears, Mike, MOVLAS Techniques for Pilots and LSOs, Approach, Naval Safety Center, 1976.

<sup>35</sup> Naval Safety Center, Ask Any Centurion, Approach, 1979.

<sup>36</sup> Naval Safety Center, It Happens to the Best, Approach, 1977.

<sup>37</sup> Borowsky, Michael S., Barrett, Gloria B., Beck, Art, Gaynor, John, Aviation Safety vs. Pilot Experience, Approach, Naval Safety Center, 1980.

<sup>38</sup> Hoggart, F.A., Night Tanker, Approach, Naval Safety Center, 1980.

<sup>39</sup> Franken, D.J., Oh What a Night!, Approach, Naval Safety Center, 1981.

pilot from flying into the water.<sup>40</sup> A final article addressed the difficulties associated with a low visibility landing and LSO problems in perceiving late lineup deviations.<sup>41</sup>

The accident review portion of this activity utilized Naval Safety Center computer printout summaries of 63 accidents which occurred between January 1974 and January 1980. The purpose of this review was to identify factors, variables and trends within accident situations which appear particularly critical to successful LSO performance. The results of this review are discussed in subsequent paragraphs.

Pilot and other factors were cited as causes in the majority of accidents reviewed. There were twenty cases in which material failures of aircraft or ship systems were cited and no blame was attributed to the LSO. However, performance of the LSO was cited as a cause factor in more than one-third of the accidents reviewed. In the majority of these cases, he was cited for failure to give a timely waveoff. The large number of ramp strike and hard landing outcomes are also indicative of waveoff performance criticality. These outcomes plus the occurrence of inflight and off-center engagements are indicative that general LSO performance within the "in close" portion of an approach is particularly critical. There were several instances of late waveoffs leading to inflight engagements. The off-center engagements in most cases were indicative of poor LSO attention to lineup deviations. Better use of "Power" and "Attitude" calls could have minimized the occurrence of ramp strike/hard landing outcomes. There also appeared to be a tendency for many LSOs to wait until the "in close" area to resolve approach deviations. Another observation from the review was an apparent deficiency in the teamwork displayed by LSOs on the platform. There appeared to be a need for more active involvement by the back-up LSO, especially in situations with difficult environmental conditions or with multiple approach deviations "in close."

F-4 and A-7 were the aircraft most frequently involved in accidents during this period. This was not surprising due to the fact that these two types had more carrier landings during the period. What was interesting from an LSO training standpoint is that the majority of F-4 accidents were the result of hard landings. The excellent power response of the F-4 seems to have turned many potential ramp strikes into hard landings. For the A-7, the majority of accidents involved ramp strikes, which may be attributable to its relatively poor power response. These and other aircraft accident outcome trends and performance characteristics are indicative of their criticality to successful LSO performance.

---

<sup>40</sup> Heyworth, Gordon, Touch-and-Go With the Grim Reaper, Approach, Naval Safety Center, 1980.

<sup>41</sup> Logan, Robert J., Paddles Contact - You're Looking Good, Keep It Coming, Approach, Naval Safety Center, 1980.



Another important result of this review was the identification of other conditions which appear frequently in accident situations. As mentioned earlier, the pilot is the most frequently cited accident cause factor. From the accident review, there appears to be some predictability of pilot influence in accident situations. The primary factor identified was that of low pilot experience, a factor which was also noted in an article discussed earlier. The track record of pilot landing skill, including pilot responsiveness to the LSO, was also identifiable in the review as a frequent factor in accidents. The pilot approach trend that was most apparent in leading to accidents was one in which the aircraft had a high deviation "in-close" leading to excessive rate of descent "at the ramp". Of the environmental factors, night conditions and deck motion were most frequently noted in the accidents reviewed. Although the day/night factor is always explicitly identified in accident summaries, other environmental factors may have existed and not been noted. Also, environmental conditions are seldom cited as accident cause factors.

Later in the project, a more comprehensive analysis of carrier landing accidents was conducted. The accidents analyzed occurred in the fifteen year period between 1965 and 1980. Results are presented in Appendix G.

The primary benefit in this review of documents and accident reports was to establish an initial picture of critical LSO skill areas and waving conditions as guidance for further data gathering and analysis in the study. Additionally, the sources used in this review also proved beneficial in the identification of key LSO learning concepts.

SECTION IV

LSO SURVEY

A training survey was distributed to the LSO community to identify critical aspects of "waving" which are most important for successful trainee progression to a Wing LSO designation. Thirty-four responses were received. For sample size perspective, there are approximately ninety LSO billets requiring at least a Wing Qualification. Most respondents were from this population. However, a few were recently "retired" LSOs. A copy of the survey including a summary of data is provided as Appendix B. Results of the survey are described and discussed below.

RESPONDENTS

The respondents were asked to list their LSO qualification level, years since starting LSO training, day and night carrier landings, the number of cruises completed and their primary aircraft as pilot. Additionally, they were to mention the aircraft which they were qualified to wave.

All but 2 of the 34 respondents had achieved at least a Wing Qualification. Eighteen were Staff Qualification level. The average number of years experience was over seven. Only four had less than five years of experience. The average number of day landings was 261, night 102. The average number of cruises completed was 2.9. All current Navy inventory aircraft were listed as aircraft which the respondents were qualified to wave. All but a few respondents were from the A-6, A-7, F-4 and F-14 pilot communities. The experience, expertise and cross-section of the respondents are considered to be excellent with respect to the credibility of information obtained. Comments regarding the F/A-18 were obtained via telephone conversations with Naval Air Test Center LSOs.

SITUATION VARIABLE RATINGS

The respondents were asked to rate 25 night situation variables as to the emphasis required in training LSOs. Some of the 25 were combinations of two or more individual variables. The mean ratings and standard deviations are listed in Table 1. All variables received a mean rating of 3.00 (moderate priority) or above. Sixteen of the 25 were rated above 3.50. This outcome was probably biased in the selection of variables to be rated by the LSOs, since the purpose of the questioning was to have LSOs discriminate among variables generally accepted as having some criticality to waving performance. However, the primary result appears to be that of confirming the criticality of all variables rated.

Seven variables were rated above the 4.00 level (high priority). Among the four highest rated variables, "pitching deck" was included three times, and "MOVLAS" and "no horizon" were each included twice. Pitching deck and no horizon are variables having major impact on the perceptual aspects of waving. Use of the MOVLAS significantly increases the LSO's

TABLE 1. RATINGS OF NIGHT SITUATION VARIABLES

<u>Variables</u>	<u>Mean</u>	<u>Standard Deviation</u>
Pitching Deck, No Horizon	4.32	.77
MOVLAS, Pitching Deck	4.29	.80
MOVLAS, Steady Deck	4.20	.41
Pitching Deck, MOVLAS, No Horizon	4.20	1.20
Pilot Unresponsive or Slow to Respond to LSO	4.12	.91
Very Unpredictable Pilot	4.06	1.04
"Trick or Treat" Pass, No Tanker, No Divert	4.03	.94
LSO Talkdown	3.97	.67
Pitching Deck, Clear Horizon	3.94	.78
Aircraft Flight Control Emergency	3.91	.91
No Horizon, No Plane Guard	3.89	.86
Extremely Poor Start Off CCA	3.88	.73
Aircraft Breaking Out of WX Inside 3/4 mile	3.88	1.07
Barricade Recovery	3.74	1.33
Single Engine Approach	3.67	.92
Very Inexperienced Pilot	3.59	.92
No. 3 and 4 Wires Missing	3.41	.82
Very Unproficient Pilot	3.41	.99
Extremely High or Low WOD	3.38	.85
No Wing Lights	3.35	.73
Higher than Normal Approach Speed Configuration	3.26	.89
NORDO	3.24	.85
Loss of LSO Radio After Ball Call	3.15	.82
No External AOA Indexers	3.06	.69
Recovery Crosswind	3.06	.95

Scale: 1 = No training emphasis required  
 2 = Low priority  
 3 = Moderate priority  
 4 = High priority  
 5 = Extremely high priority

workload, especially when compounded by the presence of deck motion. The situation of "Pitching Deck, MOVLAS, No Horizon" is generally considered among the most difficult waving situations encountered by the LSO. However, its occurrence is relatively infrequent, probably the reason why it did not receive the highest rating. "Pitching Deck, No Horizon" is a frequent occurrence during a deployment. Two other variables which rated highly were related to pilot characteristics. "Poor pilot responsiveness" complicates the LSO decision process regarding voice call selection and regarding whether to accept an approach or call for a waveoff in close. The "unpredictable pilot" causes similar waving difficulties. The final variable above a 4.00 rating causes a high pressure waving situation. "Trick or Treat" without a tanker or a divert field places an extreme burden on the LSO to get the aircraft aboard. Failure to do so may lead to a barricade recovery or controlled ejection. Of the highest rated variables, most had relatively low standard deviations. Highest variability was noted in ratings for "Pitching Deck, MOVLAS, No Horizon." This was probably influenced by its infrequency of occurrence, as mentioned earlier.

The responses on situation variables were also grouped into logical categories to provide additional analytical perspective. The categories and their respective mean ratings and standard deviations are delineated below:

Environmental Conditions	3.87	1.00
Operational/Ship Conditions	3.84	1.00
Pilot Characteristics	3.81	.95
Aircraft Malfunctions	3.41	.88

"Pitching Deck", "No Horizon" and "Aircraft breaking out of weather inside 3/4 mile" had relatively high ratings which apparently had a strong influence on the Environmental Conditions category. Strongest influences in the Operational/Ship Conditions category included "MOVLAS", "Trick or Treat Pass", "LSO Talkdown" and "Barricade Recovery." The Pilot Characteristics category was most strongly influenced by high ratings for "Unresponsive Pilot", "Unpredictable Pilot", "Poor start off CCA" and "Inexperienced Pilot." Only two variables in the Aircraft Malfunctions category had ratings above 3.50 ("Flight Control Emergency" and "Single Engine Approach"), thus a relatively low rating for this category.

#### VOICE CALL RATINGS

The respondents were asked to rate 56 standard and non-standard LSO voice calls as to "their criticality to successful LSO waving performance under night carrier landing conditions." The mean ratings and standard deviations for the calls are listed in Table 2. LSOs were also asked to indicate whether a specific call should never be used (a rating of 0 on the scale provided).

TABLE 2. VOICE CALL RATINGS (Night Assumed)

<u>Voice Call</u>	<u>Mean</u>	<u>Standard Deviation</u>
Waveoff	4.74	.57
Power	4.65	.49
Right for Lineup	4.26	.71
Paddles Contact	3.88	1.14
Attitude	3.74	.83
You're Low	3.62	1.04
Waveoff, Foul Deck	3.61	1.39
Roger Ball	3.58	1.50
Left for Lineup	3.43	1.50
A Little Power	3.30	1.10
Don't Go Low	3.03	1.00
Don't Settle	3.03	.90
A Little Attitude	3.03	1.00
You're High	3.00	.95
You're a Little Low	2.91	.93
You're Slow	2.91	1.19
You're Settling (N)	2.88	1.30
Don't Climb	2.85	1.05
You're Low and Slow (N)	2.85	1.97
A Little Power, Right for Lineup (N)	2.82	1.09
You're Going Low	2.79	.98
Fly the Ball (N)	2.74	1.42
Uncouple	2.70	1.40
Hold What You've Got	2.68	1.15
Go Manual	2.65	1.12
You're a Little High	2.62	.89
A Little Power, Left for Lineup (N)	2.61	1.56
Bolter	2.59	.96
Deck is Moving (N)	2.59	1.60
Deck is Moving, Don't Chase the Ball (N)	2.56	1.67
Start it Back to the Right (N)	2.53	1.26
Start it Back to the Left (N)	2.53	1.31
Don't Go High	2.50	1.02
Start it Down (N)	2.47	1.11
You're Fast	2.44	.89
You're High, Ease it Down (N)	2.42	1.12

TABLE 2. VOICE CALL RATINGS (Continued)

<u>Voice Call</u>	<u>Mean</u>	<u>Standard Deviation</u>
You're Lined Up Right	2.38	1.28
Don't Go Through It (N)	2.38	1.16
You're Lined Up Left	2.35	1.25
A Little Right for Lineup (N)	2.33	1.31
You're Going High	2.26	.90
Cut	2.26	1.69
Hold Your Attitude	2.18	1.19
Catch It (N)	2.09	1.40
A Little Left for Lineup (N)	1.97	1.40
You're Drifting Left	1.94	1.18
You're Drifting Right	1.91	1.14
Stop it in the Middle (N)	1.88	1.25
Check Your Lineup	1.85	1.09
Ease it Down (N)	1.83	1.11
Fly it Down (N)	1.58	1.32
Work it Up (N)	1.56	1.35
Check Your Lineup, Don't Go Low (N)	1.53	1.35
Hold It Up (N)	1.50	1.54
A Little Power, Don't Climb (N)	1.24	1.35
Keep Your Nose Up	0.76	.99

Scale: 0 = Do not feel it should ever be used  
 1 = Definitely not critical  
 2 = Possibly critical  
 3 = Fairly critical  
 4 = Definitely critical  
 5 = Extremely critical

Note: (N) = Non-standard call

As expected, "Waveoff" and "Power" were among the highest rated calls. These two calls and "Right for Lineup" had mean ratings above the "definitely critical" level (4.00). They also had the lowest standard deviations of all calls rated.

There were 14 calls rated at the "fairly critical" level (3.00) or higher. Eight of those were "imperative" calls as defined by LSO NATOPS. Seven calls were related to impending or existing low glideslope deviations. Only one call was related to a high deviation and only two were related to lineup deviations. Variability among responses for these 14 calls was relatively low. The only exceptions were "Roger Ball" and "Left for Lineup".

Standard LSO NATOPS voice calls generally rated higher than non-standard calls. Only three non-standard calls ("You're settling", "You're low and slow" and "A little power, right for lineup") had moderately high ratings between 2.8 and 2.9. There were a few standard calls that were rated below the "possibly critical" level (2.00): "Check your lineup", "You're drifting right/left" and "Keep your nose up." There were 19 instances in which respondents indicated that the lowest rated call, "Keep your nose up", should never be used.

Several respondents added additional voice calls to the listing. There were several call variations regarding deck motion which were rated relatively high. There were also a few suggestions for call variations including "ease" or "easy." "DLC" was suggested by three respondents. Two additional calls were considered unique: "Power, please!" and "You're going to die if you keep this up!" They are indicative of occasional waving frustration and exhibit LSO creativity in catching the pilot's attention in critical situations.

#### DIFFICULT WAVING SITUATIONS

Two questions in the survey asked for descriptions of extremely difficult waving situations. Question 3 asked for descriptions "...of the most difficult waving situations you have experienced." Question 6 asked for "...the most difficult night waving situations you can imagine." In response to the first question, 82 actual situations were described. Approximately 60 situations were described in response to the second question. Of the 82 actual situations described, 54 occurred at night. Night conditions were specified in the question for the imagined situations. How often specific situation variables were mentioned within the actual and imagined situations is listed in Table 3.

TABLE 3. SITUATION VARIABLES (Day and Night Situations)

<u>Variable</u>	<u>Frequency</u>
No Horizon	55
Night	54
Pitching Deck	47
Inexperienced Pilot	30
"Blue Water" OPS (no divert)	27
Reduced Visibility	26
Unresponsive Pilot	21
MOVLAS	20
Non-Optimum WOD	19
Boarding Pressure on LSO	19
Unproficient Pilot	18
Low Pilot Skill Level	18
Rain	18
LSO Talkdown	17
Aircraft Lighting Problem	12
Low Fuel State	11
Aircraft Engine Problem	10
Barricade Recovery	8
NORDO	6
Poor CCA Control	6
Pilot Vertigo	6
Aircraft Flight Control Problem	5
Aircraft Visibility Problem	4
ACLS Problem	4
Arresting Wires Missing	3
No Lens	3
ZIPLIP/EMCON	3
Ship Turn	2
PRIFLY/CATCC Coordination Problem	2
No LSO Radio	2
Landing Gear Problem	1



NAVTRAEQUIPCEN 80-C-0063-2

"No Horizon", "Night" and "Pitching Deck" were mentioned much more often than other variables. Overall, variables within the Environmental Conditions category were mentioned most frequently, as indicated below:

Environmental Conditions	-	165
Operational/Ship Conditions	-	130
Pilot Factors	-	93
Aircraft Malfunctions	-	42

Additional environmental conditions frequently noted included: reduced visibility, non-optimum WOD and rain. Operational and ship conditions most frequently noted included: "blue water" OPS, MOVLAS, boarding pressure and LSO talkdown. The most significant pilot factors included: inexperience, poor responsiveness, low proficiency and low skill level. Aircraft malfunctions were infrequently noted. Aircraft types which were most frequently noted were the A-7 (22 times) and F-4 (21 times). The A-6 and F-14 were each mentioned 9 times.

In a breakout of the 28 day situations, variables related to the pilot were mentioned much more frequently than others, as indicated below:

Pilot Factors	-	38
Operational/Ship Conditions	-	23
Environmental Conditions	-	16
Aircraft Malfunctions	-	6

Pilot inexperience (14 times), low skill (10 times) and low proficiency (eight times) were most frequently noted factors. Boarding pressure on the LSO (eight times) was the most frequently noted operational condition. No other conditions or factors were mentioned more than six times. The F-4 was the most frequently mentioned aircraft (7 times).

The actual and imagined situations were also reviewed to identify frequently mentioned combinations of variables. "Pitching Deck" and "No Horizon" were most frequently noted. Frequently noted combinations are listed below (all assume the night environment):

Pitching Deck, No Horizon	-	33
MOVLAS, No Horizon	-	19
Pitching Deck, No Horizon, MOVLAS	-	18
Pitching Deck, MOVLAS	-	18
Aircraft Malfunction, No Horizon	-	14
Pitching Deck, "blue water" Ops	-	12

In general, the results from analyzing difficult waving situations appear to correlate to the ratings of night situation variables discussed earlier.

**CRITICAL APPROACH PROFILES**

Respondents were asked to describe typical approach profiles which can lead to unsuccessful results (i.e. ramp strike, hard landing, off-center engagement, bolter and in-flight engagement). The approach profile trends which emerged are described below in conjunction with their landing outcomes. Table 4 presents a summary of the profiles in LSO shorthand (shorthand explanations are provided in LSO NATOPS).<sup>42</sup>

**RAMP STRIKE/HARD LANDING.** There were several profile trends leading to potential ramp strike/hard landing outcomes. Four general trends were prominent. The first trend involves an over-reaction to an existing or impending high deviation in close. Profiles exhibiting this trend include:

- "low start to high in the middle or in close, come down at the ramp"
- "high start to in close, come down at the ramp"
- "over-control a climb in close, come down at the ramp"

The second trend involves an underpowered approach in which the aircraft settles at the ramp as the result of a deceleration or passing through the burble. The third trend involves a settle at the ramp due to an under-powered condition caused by a late lineup correction. The final trend involves a premature power reduction and/or nose down adjustment, while correcting for a low deviation in close.

**OFF-CENTER ENGAGEMENT.** Three general profile trends leading to off-center engagement outcomes emerged. The first trend involves a lineup deviation (right or left) early in the approach followed by a gradual drift to an opposite off-lineup deviation at the ramp. The second trend involves an over-reaction to an off-lineup deviation in close leading to an unacceptable lineup drift at the ramp. The third profile trend is a drift right or left in close or at the ramp, probably under the influence of a recovery cross-wind and/or a breakdown in the pilot's lineup scan.

**BOLTER.** Most bolters result from an over-reaction to a low deviation or a settle in close, or to an LSO call for power or attitude. Another bolter trend results from an over-powered condition caused by late lineup corrections.

**IN-FLIGHT ENGAGEMENT.** In-flight engagement typically occurs when the pilot increases nose attitude excessively in response to an excessive sink rate in close or at the ramp, or in response to an LSO call for power or attitude. It can also occur in response to a waveoff.

<sup>42</sup> U.S. Navy, Office of the Chief of Naval Operations. The Naval Air Training and Operating Procedures Standardization (NATOPS) Program Manual. Landing Signal Officer (LSO), Department of the Navy, 1975.

TABLE 4. CRITICAL APPROACH PROFILES

Ramp Strike/Hard Landing:

LOX HIM-IC CDAR  
HX-IC CDAR  
OC CIC/HIC CDAR  
NEPAW SAR  
SAR on LLU  
EG/DN correcting for LOIC

Off-Center Engagement:

LURX/IM R-LAW  
LULX/IM L-RAW  
OCLULIC L-RAR  
OCLURIC R-LAR  
DRRIC/AR  
DRLIC/AR

Bolter:

OCLOIC/SIC   
OCCO   
TMP on LLUIC 

In-flight Engagement:

CDIC-AR PNU OCO  
CDIC-AR PNU on WO  
OCCDAR PNU

**AIRCRAFT CHARACTERISTICS/LIMITATIONS**

The LSOs were also asked to describe aircraft characteristics, performance limitations and malfunctions of concern to the LSO when waving an approach. The information gathered is summarized below.

- A-6:** Excellent power and waveoff response, but easily over controlled.  
Tendency to settle on late lineup corrections.  
Tendency for hook-skip bolters on nose down landings.  
KA6 (tanker) is a little underpowered.  
Pilot visibility deficiencies result in frequent lineup control difficulties.  
Single engine is only a problem under conditions of high gross weight, high winds, high temperature.  
With a single generator failure all external lights are out except AOA indicator.
- EA-6B:** Excellent power and waveoff response.  
Long fuselage and sensitive nose, therefore high in-flight engagement potential.  
Tendency for hook-skip bolters on nose down landings.  
Frequently described as similar to basic A-6.  
Tendency for decel due to sensitive nose.
- A-7:** Slow engine response when back on power.  
HIM frequently leads to SIC-AR; LOX-IM frequently leads to bolter.  
LOB pass requires nose finesse to avoid bolter or ramp strike/hard landing.  
AOA system and external AOA indicator lights fail frequently.
- E-2:** Excellent power response.  
Lineup control difficult; also very critical due to long wingspan.  
Long fuselage, therefore high in-flight engagement potential.  
Glideslope control very sensitive to nose movement.  
Fuselage alignment lights (when visible) indicate need for right rudder.  
Tendency for hook skip bolter on nose down landing.  
On single engine approach, lineup control is difficult; also decel must be avoided.  
Lineup is extremely critical (+ 2-1/2 feet) on barricade recovery.  
On no-flap approach, very cocked up and hook-to-ramp clearance is reduced.
- F-4:** Excellent power and waveoff response; also easy to overcontrol glideslope (up and down).  
Faster approach speed than others; high WOD requirements due to arresting gear engaging limits.

NAVTRAEQUIPCEN 80-C-0063-2

Fuel critical; frequently few looks before tanking or divert.  
Must beware of HIC; can lead to hard landing due to ease of  
glideslope correction with power reduction.  
Loss of Boundary Layer Control (BLC) means very high approach speed.  
Single engine approach done at half flaps and speed is significantly increased; power response significantly degraded.

- F-14: Slow engine response after back on power.  
Tends to SIC when "gliding" through burble.  
Long fuselage, therefore in-flight engagement potential.  
Hook-skip bolter potential on nose down landings and for late  
lineup corrections at ramp.  
Lineup critical due to long wingspan.  
Without DLC engaged, aircraft is back on power.
- F/A-18: Excellent power and waveoff response.  
Flat attitude when on AOA.  
If back on power and cocked up, SIC-AR is probable.  
Easy to overrotate on waveoff; in-flight engagement potential.  
Nose adjustments must be coordinated with power changes to get  
glideslope correction results.
- S-3: Slow engine response when back on power.  
Tendency to "glide" during approach.  
DLC is good for correcting high deviation and avoiding an  
undesired power reduction.  
Without DLC system, nose pitch is sensitive to power changes.  
Difficulties with burble under high WOD conditions.

SUMMARY

The results of this survey provided excellent insight to LSO perceptions of what is difficult and critical within the job of the LSO. The survey also proved to be an excellent source of "lessons learned" inputs to the identification of key LSO learning concepts. However, the perceptions by LSOs of what is critical versus the conditions which have actually led to accidents may or may not agree. The next section addresses accident data.

SECTION V

COST SAVINGS ESTIMATION

INTRODUCTION AND SUMMARY

One of the study objectives for this contract was to identify the potential cost savings which could accrue from implementation of an automated LSO training system into the LSO training program. Through analysis of recent carrier landing accidents it was estimated that savings of more than \$21 million are probable over a ten-year period. The analysis effort leading to this estimate is introduced below and described later in detail.

The general characteristics and capabilities of an automated LSO training system have emerged from earlier NAVTRAEQUIPCEN studies. An important aspect of the instructional concept for the system is emphasis on critical waving situations. This is analogous to the use of flight simulation in pilot training for emphasis on emergency procedures and situations. Critical waving situations can be defined as instances where deficiencies in waving skills can lead to unsafe landing results, or failure to achieve required boarding efficiencies. The most obvious concern is directed toward preventing aircraft damage and personnel injuries and losses in the carrier landing process.

Carrier landing mishaps are occurrences which are quantifiable in terms of dollars lost due to aircraft damage (or loss). Sometimes personnel losses are also stated in terms of dollars. In this study, personnel losses were not addressed. Thus the analysis focused on aircraft damages and losses as the basis for estimating potential cost savings. However, other potential benefits were looked at from a qualitative standpoint and are addressed later in this report.

At this point some clarification about the role of the LSO in carrier landing accidents may be appropriate to some readers. Historically, the LSO and pilot have been the most frequently noted causal factors in carrier landing accidents. Over the past 15 years, the LSO has been cited as a causal factor in about 20 percent of all carrier landing accidents. Over the same period the pilot has been cited about 62 percent of the time. It should be noted here that in a single accident both the pilot and the LSO can be cited as causal factors. The determination of causal factors is initially established by an accident investigation board whose findings are reviewed by several command levels and the Naval Safety Center prior to the final establishment of official cause factors.

Pilot performance during landing has obvious implications to a carrier landing accident. An accident can result from poor flying performance, thus the basis for the pilot being cited a causal factor in an accident. The implications of LSO performance are not quite so obvious. His job is to assist the pilot during the landing process with voice calls and light

signals as supplemental cueing. This task is most important at night when the pilot must perform his task with reduced visual cues, or anytime there are unusual operating conditions, such as pitching deck, which may increase the difficulty of the pilot's tasking. However, the most critical role played by the LSO during landing is that of judging whether the aircraft can continue the approach to a safe landing. This is where the LSO is usually "on the hook" as a potential accident causal factor. No matter how poor the pilot's performance, if the LSO allows an unsatisfactory approach to continue to an accident, he too will usually be cited as a causal factor. Typically this case would be stated in an accident report as "the LSO failed to give a timely waveoff."

One of the primary goals of LSO training is to equip the LSO with the perceptual and decision skills needed to prevent carrier landing accidents. Research has identified that there is room for improvement in the LSO training program.<sup>43,44</sup> It has also identified that simulation of the carrier landing environment and effective utilization of this medium has significant potential to make a positive impact on the LSO training program.<sup>44,45</sup>

The study described in this part of the report attempts to quantify the value of such an improvement in LSO training by analyzing LSO performance in carrier landing accidents and relating LSO performance deficiencies to anticipated LSO training system capabilities.

One could make a theoretical case for the possibility that perfect LSO performance could prevent all accidents in which the LSO was cited as a causal factor. However, it will never be realistic to assume perfect LSO performance. Since there are other human factors in the landing process (pilot, shipboard personnel), as well as operational and environmental factors, total accident prevention is also an unrealistic expectation. Therefore expert judgments were used to conservatively assess the extent to which these factors could be mitigated through improved LSO training.

---

<sup>43</sup> Borden, G.J., The Landing Signal Officer: A Problem Analysis, Vols. I, II. Technical Report 785-1, Goleta, Calif.: Human Factors Research, Inc., May 1969.

<sup>44</sup> Hooks, J.T., Butler, E.A., Gullen, R.A. and Petersen, R.J., Design Study for an Auto-Adaptive Landing Signal Officer (LSO) Training System, Technical Report, NAVTRAEQUIPCEN 77-C-0109-1, Naval Training Equipment Center, 1978.

<sup>45</sup> Hooks, J. Theil, McCauley, Michael E., Training Characteristics of the LSO Reverse Display, Technical Report, NAVTRAEQUIPCEN 79-C-0101-2, Naval Training Equipment Center, 1980.

Experienced LSOs were used in this study to judge two aspects of carrier landing accidents which occurred over the past ten years. A sample of 24 accidents was used in the study. The first judgment was whether the LSO could have prevented the accident. The second judgment was whether improved LSO training could have had a positive influence on the quality of his performance. The judgments were obtained in group LSO sessions and were in probability terms. For example, after reviewing the description of an accident, the group of LSOs may have judged that there was a 60 percent probability that the LSO could have prevented the accident, and that there was a 50 percent probability that improved LSO training could have positively influenced his performance. Subsequent to obtaining LSO judgments, the primary author who is a senior training systems analyst with experience in LSO training system research, judged the likelihood that an LSO training system could provide improved training for each accident situation.

This series of three probability terms was then multiplied with costing values associated with each accident to estimate potential cost savings. This cost savings estimation process can be expressed:

$$\$save = PP \times PT \times PS \times \$loss$$

where:

Pp	=	probability of LSO preventing accident
PT	=	probability training would have helped LSO
PS	=	probability that LSO training system can be developed with required capability

The results indicate that an LSO training system has significant potential for saving dollars by helping LSOs reduce carrier landing accidents. Subsequent sections of this part of the report describe the design of the study, data collection and analysis, and interpretation of the results. Appendix C of the report presents the materials used in the study and raw data collected.

## STUDY DESIGN

The study plan originated from the notion that if LSO training is improved, there should be some improvement in carrier landing safety. Improvements in carrier landing safety are typically reflected in reductions of the carrier landing accident rate. However, the cost of carrier landing accidents was considered a more sensitive indicator of this improvement since they can vary by aircraft type and in the level of damage incurred. For example, the official cost assigned to loss of an F-14A is much higher than that for an A-7E. Additionally, the damage may be classified as aircraft destroyed or substantial damage. An early step in this study was to obtain official costing figures for the two levels of damage by aircraft type. The figures obtained were average costs for FY80 as established by the Naval Air Systems Command.



There were other influences upon the design of this study. Of major importance was selection of an approach for estimating the potential impact of improved training on LSO job performance. A general estimate of improved LSO performance from experienced LSOs was considered an acceptable and expeditious approach. This could then have been used with accident costs to estimate cost savings accruing from improved LSO training. However, it was felt that the experienced LSO estimates would be more valid if they were based on specific accident occurrences. The next consideration was how to look at past accident occurrences and project the estimated cost savings to future carrier landing operations. To do this with a reasonable confidence level, the estimates should cover a representative historical period of sufficient duration to account for influences on carrier landing safety, such as operations tempo. The recent decade was considered promising in that it included variations in operations tempo (combat and peacetime operations), transition of new aircraft into the fleet (F-14, S-3), and a wide variation in carrier landing accident rate (high early in period and low late in period).

A major component required for the study was a set of carrier landing accident descriptions. Computer printout summaries of 158 carrier landing accidents were available and covered the period from July 1970 through December 1979. The next step was to determine a meaningful and reasonable sample of accidents to be used. The first criteria that was used was to select only those accidents in which the LSO was officially cited as a causal factor. There were 51 which met this criteria. They are listed in Table 5. Next, the sample was reduced on the basis of other factors. Accidents involving older aircraft (such as RA-5C, F-8, A-3, E-1 and fleet A-4) were eliminated to insure LSO experience with the aircraft used in the study. Of the remaining accidents, several more were eliminated due to the paucity of descriptive information available in the computer summary. This left a sample of 24 accidents to be used in the study. They are noted by asterisk in Table 5. The aircraft represented in the sample include A-7, F-4, F-14, A-6 and TA-4.

Selection of a method for obtaining LSO judgments was another important aspect of study design. The survey questionnaire method was one which was considered and rejected for several reasons. First, there was too much uncertainty regarding whether responses would be timely enough within the contract period. Secondly, there was concern for whether there would be an adequate response rate since the survey approach would require a few hours of each respondent's time. The final reason was one of practicality relative to time required for initial data reduction. Many individual responses would require the handling of a large amount of data, demanding more time and resources than were available for the study. Thus, the determination was made to collect the judgments in one or more group LSO accident review sessions. Liaison with the COMNAVAIRPAC and COMNAVAIRLANT LSOs indicated the feasibility of scheduling two group sessions of highly experienced LSOs, one on each coast.

NAVTRAEQUIPCEN 80-C-0063-2

TABLE 5. ACCIDENTS IN WHICH LSO CITED AS CAUSE FACTOR

	A/C	D/N	Date	Dem	\$ Loss x 1000
1	F-BJ	N	AUG 70	C	134
2	F-BM	N	AUG 70	C	134
* 3	A-7A	D	NOV 70	A	1,518
4	A-4F	N	FEB 71	C	119
5	F-BJ	N	FEB 71	A	892
6	F-4B	D	FEB 71	C	300
7	RA-5C	N	APR 71	C	538
8	EKA3B	N	JUN 71	C	401
* 9	A-7E	N	JUL 71	A	2,874
10	E-1B	N	JUL 71	C	65
* 11	A-7E	N	NOV 71	A	2,874
12	F-4J	D	DEC 71	C	477
* 13	F-4B	N	Jan 72	C	300
14	A-7E	N	FEB 72	A	2,874
15	RA-5C	D	MAR 72	C	538
* 16	F-4J	DSK	APR 72	C	477
17	EKA3B	N	JUN 72	C	401
* 18	F-4B	N	AUG 72	C	300
19	A-4E	D	SEP 72	A	776
* 20	A-6A	N	OCT 72	A	3,712
21	TA-4J	D	OCT 72	C	122
* 22	A-7E	N	5 NOV 72	A	2,874
* 23	A-7E	N	23 NOV 72	A	2,874
* 24	A-7E	N	27 NOV 72	A	2,874
25	RF-8G	D	DEC 72	C	500
* 26	F-4J	N	DEC 72	C	477

	A/C	D/N	Date	Dem	\$ Loss x 1000
27	F-BJ	N	JUN 73	C	134
28	F-BJ	N	AUG 73	C	134
29	RA-5C	D	SEP 73	C	538
* 30	F-4J	D	JAN 75	C	477
31	RA-5C	N	APR 75	C	538
32	F-8J	N	JUL 75	A	892
* 33	A-7A	N	NOV 75	C	143
* 34	TA-4J	D	JAN 76	C	122
* 35	A-7E	N	APR 76	A	2,874
* 36	A-7A	N	NOV 76	A	1,518
* 37	A-7A	N	NOV 76	C	143
* 38	F-14A	N	MAR 77	A	13,997
* 39	F-4J	N	MAY 77	A	2,510
40	EKA3B	N	SEP 77	C	273
* 41	F-14A	N	OCT 77	A	13,997
* 42	KA-6D	N	DEC 77	A	2,076
43	A-7E	N	JAN 78	A	2,874
* 44	TA-4J	D	MAY 78	C	122
* 45	F-4J	N	JUN 78	C	477
46	F-4J	N	JUN 78	C	477
* 47	F-4J	N	AUG 78	C	477
48	EKA3B	N	OCT 78	C	273
49	A-7E	N	OCT 78	A	2,874
50	RA-5C	D	DEC 78	C	538
51	F-4J	N	MAR 79	C	477

\$75,649

\* Sample Used

## NAVTRAEQUIPCEN 80-C-0063-2

The details of the data gathering session were then planned and evaluated. For each accident, relevant descriptive information was extracted from the computer summary and prepared in the form of overhead projector viewgraphs. The information for each accident included: 1) aircraft type, 2) day or night conditions, 3) carrier, 4) narrative, verbatim from computer summary, and 5) pilot experience information, when available. Instructions to respondents provided some background on the purpose of the study, the sample of accidents to be reviewed, session procedures and guidelines for LSO judgments. Formats for data gathering included rating scales, a checklist of training topics to use when identifying important training requirements for each accident and an experience questionnaire for each LSO participant. Appendix C includes copies of the viewgraph materials designed for data gathering during the sessions. Review of Appendix C will provide amplification of the descriptions provided above. Materials and procedures were then used in a trial session with an experienced LSO to evaluate adequacy of the data gathering method and materials, and to determine time requirements for the session. This resulted in a few minor refinements to the process and materials.

In conducting the data gathering session, a general procedure was followed. The session was conducted by the senior study analyst. The session was initiated by the presentation of background information, session procedures and guidelines for LSO judgments. The first two accidents presented were treated as examples, to allow the participants to warm up to the data gathering task. As each accident was presented, the participants were given a few minutes to read it, then the session leader clarified or highlighted relevant items in the narrative. LSOs who had first hand information or experience with the accident were then given an opportunity to present amplifying commentary. Following this, the group was asked to judge the "possibility that the LSO (controlling or backup) could have prevented the mishap." Following an initial response, some discussion usually occurred as the group was asked to judge the "possibility that improved training and/or additional experience could have helped the LSO(s) to better handle the situation." Again, there was usually group interaction prior to establishing a consensus judgment. The final step for each accident reviewed was for the group to identify "aspects of this mishap situation which would be particularly important in preparing an LSO for this or a similar situation." There were no cases during data gathering in which a consensus was not attained for Pprevent or Ptrain. Most of the time, the judgments which were obtained were for a 20 percent range on the scale (i.e., 40-60 percent, 80-100 percent). In several cases, a specific probability value was agreed upon (i.e., 80 percent, 100 percent). Responses during the session were recorded on paper and on tape. Tape recording of the session was done because it had been anticipated that there would be discussions and commentary relevant to other aspects of the study, such as the identification of additional key concepts and critical waving situations and variables.

## DATA COLLECTED

The first data gathering session was held at NAS Miramar, California, with participation by seven experienced LSOs, including the COMNAVAIRPAC LSO. The second session was held at NAS Cecil Field, Florida. Of the 13 experienced LSOs involved in this session, one was the COMNAVAIRLANT LSO and another was the LSO Training Model Manager. This sample of 20 from the LSO community had impressive credentials. Eight of the LSOs had attained a Staff LSO qualification level. The remaining LSOs all had either a Wing or Training qualification, or both. There was also a good mix of fleet aircraft communities represented (Eight from A-7, four from F-14, three from A-6, two from F-4).

The data collected are presented in Table 6. The accident sample of 24 was from the period of July 1970 through December 1979. Most accidents (19) occurred at night. There were two levels of damage specified: aircraft destroyed (A) and substantial damage (C). The total loss for the accidents was \$57,356,000 based on official Navy figures for FY80. Most of the accidents (18) involved A-7 and F-4 aircraft.

The LSO judgments presented in the table are based on a weighted average of the judgments obtained at the two data collection sessions. Table 7 provides an accounting of the frequency with which an LSO training requirement topic was noted during the data collection sessions. Raw data from the sessions are presented in Appendix C.

## DATA ANALYSIS AND RESULTS

Given the data collected, the major analytical thrust was to relate anticipated LSO training system capabilities to specific improvements in LSO training. The approach taken was to establish a probability ( $P_S$ ) that an LSO training system could be developed to provide effective LSO training for each accident situation.

To produce this judgment there were two major considerations. The first was the complexity of the learning required for a particular accident situation. The estimated impact of this factor was that for higher complexity there would be higher risk involved in the attainment of an effective and appropriate improvement in LSO training with an automated LSO training system. Thus high complexity would reduce  $P_S$ . The second consideration was one of technological risk relative to the attainment of required training system capability. The estimated impact of this factor was that for higher technological risk,  $P_S$  would be reduced.

The training requirements specified by LSOs for each accident situation were analyzed to estimate the complexity of the training process required to support learning. If the training requirements suggested simple relationships between cues and appropriate LSO actions, the learning complexity factor was considered minimal. An example of this would be a case in which the pilot flew an extremely erratic approach giving the LSO no

## NAVTRAEQUIPCEN 80-C-0063-2

TABLE 6. DATA COLLECTED (in order presented)

Accident Information					LSO Judgments	
ACFT	DATE	D/N	DAMAGE	\$ LOSS	P <sub>PREV</sub>	P <sub>TRAIN</sub>
A-7A	NOV 76	N	C	143,000	.43	.895
A-7A	NOV 70	D	A	1,518,000	.935	.77
F-4J	JUN 78	N	C	477,000	.44	.44
KA-6D	DEC 77	N	A	2,076,000	.675	.835
F-14A	MAR 77	N	A	13,997,000	.76	.83
A-7E	NOV 71	N	A	2,874,000	.9	.935
A-7A	NOV 75	N	C	143,000	.57	.7
F-4J	JAN 75	D	C	477,000	.965	.965
F-4J	DEC 72	N	C	477,000	.835	.9
A-7E	JUL 71	N	A	2,874,000	.64	.64
A-7E	NOV 72	N	C	143,000	.9	.965
F-4J	MAY 77	N	A	2,510,000	.835	.965
A-7E	NOV 72	N	A	2,874,000	1.0	.935
A-7A	NOV 76	N	A	1,518,000	1.0	1.0
F-4B	AUG 72	N	C	300,000	.935	.935
F-4J	APR 72	DUSK	C	477,000	.935	1.0
F-14A	OCT 77	N	A	13,997,000	.64	.965
F-4J	AUG 78	N	C	477,000	.205	.57
TA-4J	JAN 76	D	C	122,000	1.0	.965
A-6A	OCT 72	N	A	3,712,000	.825	.76
F-4B	JAN 72	N	C	300,000	.5	.63
TA-4J	MAY 78	D	C	122,000	1.0	.965
A-7E	NOV 72	N	A	2,874,000	1.0	1.0
A-7E	APR 76	N	A	2,874,000	.805	.935

TABLE 7. LSO TRAINING REQUIREMENTS IDENTIFIED

<u>Requirement</u>	<u>No. of Accidents</u>
Waveoff decision	20
Use of timely and correct LSO calls/signals	16
LSO platform team interaction/coordination	16
Recognizing approach deviations	14
LSO knowledge (procedures, rules/limits, aircraft, etc.)	14
Poor pilot responsiveness to LSO	12
Low pilot experience level	11
Boarding pressure	7
Aircraft malfunctions	7
"Classic" approach trends	6
Recovery coordination (CATTC/PRIFLY/LSO)	6
Non-optimum WOD	5
Deck motion	4
Platform location	3
Knowledge of low pilot skill level	3
MOVLAS	2
Barricade recovery	2
Deck status (clear/foul)	2
Weather/rain/poor visibility	2

confidence that it could lead to a safe landing. The appropriate LSO action based on these rather obvious cues would be a waveoff. However, at the other end of the learning complexity spectrum would be a case where the relationships between cues and LSO actions are not so obvious. An example of this would be a case in which there were non-optimum operating conditions (deck motion, weather, wires missing, etc.) and subtle indications of less than acceptable pilot performance (sluggish response to LSO calls, tendency to fly slightly low or high, slightly unsettled lineup control, etc.). For this situation, the LSO must be taught to integrate many factors and complex relationships into the waving decision process.

The technological risk aspect of this judgment was influenced by the training requirements and the status of technology to provide simulation and instructional support. The training requirements suggested specific simulation and instructional support capability requirements. These capability requirements were then analyzed by looking at existing evidence of feasibility and projections of near-term training systems technology.

Evidence of technological feasibility exists in utilization of the LSO Reverse Display (LSORD), an LSO training station attached to the A-7E Night Carrier Landing Trainer (NCLT). This device is being used for limited support of LSO training at NAS Cecil Field under the cognizance of the LSO Training Model Manager. It has proven capabilities for some simulation aspects of the waving environment. It also has proven capabilities for some instructional support. The results of an evaluation of the LSORD were reported by Hooks and McCauley (1980).<sup>46</sup> Their report provides elaboration on the capabilities and limitations of the LSORD and its effectiveness for supporting LSO training. In cases where the LSORD has demonstrated the capability to effectively support training for an accident situation, a low risk factor was assigned. In cases where there were only projections of technological feasibility based on research or other training applications, a higher risk factor was assigned.

An important assumption was included in the determination of P<sub>S</sub>. It was assumed that the LSO training system provided training support to all LSO trainees. One of the major limitations of the LSO Reverse Display technology is that it is not available to all LSO trainees because it is only located at two sites, NAS Cecil Field and NAS Lemoore. There is additional limitation in its accessibility since it is linked to the A-7E NCLT which is used extensively for pilot training and which has utilization priority. For an LSO training system to be effective, it must be located at a sufficient number of sites to provide priority access for all participants in the LSO training program.

<sup>46</sup> Hooks, J. Thel, McCauley, Michael E., Training Characteristics of the LSO Reverse Display, Technical Report, NAVTRAEQUIPCEN 79-C-0101-2, Naval Training Equipment Center, 1980.

In summary, the analytical process described above can be conceptually represented by:

$$P_S = f(P_I, P_C)$$

where:  $P_S$  = probability that LSO training system can be developed with required capability

$P_I$  = probability of instructional effectiveness

$P_C$  = probability that technology can provide required capability

and,

$$P_C = f(P_L, P_A)$$

where:  $P_L$  = probability that LSO Reverse Display has demonstrated required technology

$P_A$  = probability that advancing technology can provide required capability

The determination of  $P_S$  was made by the senior training analyst for this project. His qualifications for this task included extensive experience as a Navy LSO and over three and a half years of continuous involvement in LSO training research. This effort also included frequent interface with the LSO Training Model Manager and other experienced LSOs regarding training requirements and updated feedback concerning the effectiveness of the LSORD.

Soon after this analytical effort was started it was noted that the subjective nature of the task might cause some questions regarding credibility. It was therefore decided to provide two separate  $P_S$  estimates for each accident situation. The first estimate represents the conservative fiscal judgment of the training analyst. This estimate is based primarily on technological evidence as demonstrated by the LSORD, and thus can be characterized as relatively low cost, low technical risk. The second estimate represents the best technical judgment of the training analyst. This estimate includes some optimism for the near-term state of training system technology.

The results of this analytical effort were then combined with the data described earlier to provide a range of estimated cost savings. Table 8 shows the estimates of  $P_S$  and the resultant range of estimated cost savings, combined with accident information and LSO judgments. Based on the original loss figure (\$57,356,000), the estimated cost savings range from over \$21 million to over \$32 million (38 percent to 56 percent savings).



NAVTRAEQUIPCEN 80-C-0063-2

TABLE 8. DATA ANALYSIS RESULTS

Accident Information				LSO Judgments		P <sub>3</sub>		Estimated Cost Savings (\$K)	
Aircraft	Date	D/N	Damage	Loss(\$K)	P <sub>PREV</sub>	P <sub>TRAIN</sub>	Low	High	
A-7A	Nov 76	N	C	143	.430	.895	.4	.8	22 - 44
A-7A	Nov 70	D	A	1,518	.935	.770	.4	.8	437 - 874
F-4J	Jun 78	N	C	477	.440	.440	.3	.6	28 - 55
KA-60	Dec 77	N	A	2,076	.675	.835	.5	.8	585 - 936
F-14A	Mar 77	N	A	13,997	.760	.830	.5	.8	4,415 - 7,063
A-7E	Nov 71	N	A	2,874	.900	.935	.3	.7	726 - 1,693
A-7A	Nov 75	N	C	143	.570	.700	.4	.8	23 - 46
F-4J	Jan 75	D	C	477	.965	.965	.8	.9	355 - 400
F-4J	Dec 72	N	C	477	.835	.900	.4	.8	143 - 287
A-7E	Jul 71	N	A	2,874	.640	.640	.5	.8	589 - 942
A-7E	Nov 72	N	C	143	.900	.965	.4	.8	50 - 99
F-4J	May 77	N	A	2,510	.835	.965	.8	.9	1,618 - 1,820
A-7E	Nov 72	N	A	2,874	1.000	.935	.5	.9	1,344 - 2,418
A-7A	Nov 76	N	A	1,518	1.000	1.000	.4	.9	607 - 1,366
F-4B	Aug 72	N	C	300	.935	.935	.7	.9	184 - 236
F-4J	Apr 72	DUSK	C	477	.935	1.000	.7	.9	312 - 401
F-14A	Oct 77	N	A	13,997	.640	.965	.6	.8	5,187 - 6,916
F-4J	Aug 78	N	C	477	.205	.570	.7	.9	39 - 50
TA-4J	Jan 76	D	C	122	1.000	.965	.7	.9	82 - 106
A-6A	Oct 72	N	A	3,712	.825	.760	.6	.8	1,396 - 1,852
F-4B	Jan 72	N	C	300	.500	.630	.5	.8	47 - 76
TA-4J	May 78	D	C	122	1.000	.965	.5	.9	59 - 106
A-7E	Nov 72	N	A	2,874	1.000	1.000	.8	.9	2,299 - 2,587
A-7E	Apr 76	N	A	2,874	.805	.935	.5	.8	1,082 - 1,731

\$21,629 - 32,114

As insight to the operational value of the estimated cost savings, they can be converted into numbers of replacement aircraft. The conservative estimate of over \$21 million equates to:

7.5 A-7Es or,	1.2 E-2Cs or,
1.5 F-14As or,	1.5 EA-6Bs or,
2.6 A-6Es or,	2 S-3As or,
8 F-4Ss or,	2 P-3Cs.

An after-the-fact analysis of the sample was performed to determine whether it was representative of current and near-term future aircraft types. Of the 51 accidents in which the LSO was cited, those with older aircraft (in terms of current fleet deployment) were eliminated leaving a set of 36 accidents. This set is thus representative of current aircraft. It can also be considered representative of operational aircraft for the next decade, with two exceptions. The F/A-18 is not represented since it is not yet operational. The A-3 derivatives may be phased out of the fleet during the coming decade due to their age. From this set, a representative sample by aircraft type and other factors of 24 accidents was calculated and compared to the sample actually used. Table 9 shows that the sample which was used does not deviate significantly from a calculated representative sample.

Additional analysis was performed to look at the potential cost savings associated with groups of accidents for which the LSOs identified similar training requirements. This was done to gain insight to training and system capability priorities. Table 8, which was presented earlier showed an accounting of how often various training requirements were identified by the LSOs. Those which were most frequently identified were reviewed to gain some insight into their value. For all the accidents in which one of these frequently noted training requirement was identified, the dollars lost and estimated cost savings were summarized. Except possibly for waveoff decision, the cost savings cannot be related directly to the training requirements due to interactions in the waving process. The results of this analysis are summarized in Table 10.

During this project, some qualitative insight was gained into other potential benefits of an LSO training system. It proved difficult to attach dollar values to these benefits but they were considered worthy of mention due to their potential influence on procurement decisions. Improved LSO job performance may also result in improved carrier landing boarding rates, thus enhancing carrier operating efficiency. The system has the potential to produce more qualified LSOs, thus reducing an existing LSO workload problem and allowing higher selectivity for critical LSO jobs (such as Training and Air Wing LSO billets). The system should lead to improved standardization of job performance. The system, as envisioned, could play an important role in refresher training for the Naval Air Reserve and for LSOs returning to the fleet from duty in a non-LSO capacity. Improved LSO job performance for the waving task may lead to improvements of LSO performance in the training of pilots.

NAVTRAEQUIPCEN 80-C-0063-2

TABLE 9. COMPARISON OF REPRESENTATIVE AND ACTUAL SAMPLES

		<u>Of the 36 Accidents</u>	<u>Representative Sample of 24</u>	<u>Actual Sample Used</u>
Aircraft type:	A-3	4	3	0
	TA-4J	3	2	2
	A-6	2	1	2
	A-7	13	9	10
	F-4	12	8	8
	F-14	2	1	2
Day/night:	Day	7	5	4
	Night	28	19	19
	Dusk	1	0	1
Level of damage:	A	16	11	12
	C	20	13	12

TABLE 10. TRAINING REQUIREMENTS AND RELATED ACCIDENTS

<u>Training Requirements</u>	<u>Number of Accidents</u>	<u>Loss(\$K)</u>	<u>Estimated Cost Savings for Related Accidents (\$K)</u>
Waveoff decision	20	53,749	19,921 - 30,144
Use of timely and correct calls/signals	16	47,402	17,998 - 27,024
LSO platform team inter- action/coordination	16	39,853	14,843 - 21,809
Recognizing approach deviations	14	48,054	18,466 - 27,219
LSO knowledge (procedures, rules/limits, aircraft, etc.	14	43,812	15,587 - 22,296
Poor pilot responsiveness to LSO	12	41,028	14,476 - 22,023
Low pilot experience level	11	37,942	14,686 - 21,432

## INTERPRETATION OF RESULTS

The major thrust of this analysis effort was to estimate potential cost savings associated with an LSO training system and to project the estimates to the future. All things being equal, it would be possible to project that, for a similar sample, the projection (in constant FY80 dollars) for a future 9-1/2 year period would be equal to the cost savings estimated in this study. However, all things may not remain equal in the future. There will probably be variations in the tempo of carrier operations, new fleet aircraft will be introduced, there may be improvements in carrier landing aids and general pilot skill levels may differ. Additionally, the cost savings derived in this study are only for a sample of carrier landings and do not cover other cost areas related to the LSO job and the LSO training program. The primary purpose of this discussion is to address projected cost savings for an LSO training system based on interpretations of the cost savings analysis results. It will also address the anticipated impact of various factors on this projection.

The first consideration in this interpretation was to reassess the credibility of the cost savings estimates derived through analysis. There are several indications that the estimates are very conservative. Only a small sample (24) of 158 accidents was used. This sample included only those accidents in which the LSO was cited as a causal factor. There is a high probability that improved LSO performance could have prevented some of the other accidents or otherwise reduced the resultant dollar losses. The estimation process employed three different probability factors with a multiplier effect which essentially biased the results in a conservative direction. The cost of personnel losses was left out of the estimation process. Uncertainty in the estimation of potential LSO training system effectiveness ( $P_5$ ) was minimized by relying heavily on the demonstrated capabilities of the LSO Reverse Display as a foundation for technical judgment. Finally, there was a high confidence in the judgments obtained from LSOs due to their high levels of experience and qualifications. In summary, it was concluded that the cost savings estimates were very credible, and probably very conservative.

Given credible cost savings estimates for the period July 1970 through December 1979, the next step was to project these estimates to future carrier operations. A case can be made that estimated cost savings would be equaled or exceeded in a time period of similar duration in the near future. The period on which the estimate was based appears to be very representative of carrier operations over the next two decades. Variations in operations tempo included some combat operations and some low and high levels of peacetime operations. Transitions of new aircraft into the fleet occurred in this period (F-14, S-3). For the majority of the period the carrier landing accident rate was relatively low. The Automatic Carrier Landing System (ACLS) reached maturity in this period. Additionally, the sample of accidents used included aircraft technology which is very representative of that anticipated in the near future. Thus it is reasonable to

expect cost savings of about \$20 million or more for a near term, ten-year period.

However, analyses leading to projections of future conditions always have some degree of risk. Therefore, consideration must be given to the impact of possible future influences on the projection discussed above. From a procurement decision perspective, these potential influences must be considered, even though they are unquantifiable and uncertain.

Although the costs of aircraft, and therefore individual accidents, are likely to increase in the future, there are several factors which could reduce the overall cost savings projection. Some are associated with potential advancements in technology. Factors which could influence the projection downward include:

- . improvements in carrier landing aids
- . improvements in aircraft landing characteristics
- . absence of intense carrier landing operations
- . improvements in carrier landing training for pilots
- . higher retention rates for experienced pilots and LSOs

Factors which could influence the projection upward include:

- . higher unit costs for aircraft (very likely considering the F/A-18; over \$30 million each)
- . more intense levels of carrier operations
- . emergence of new fleet aircraft with high accident potential (like the F-8 and RA-5C; however, not likely)
- . necessity for increased carrier operations under undesirable conditions (deck motion, weather, no divert field, etc.)

Additionally, survey results (Section IV) were reviewed in conjunction with the results of this accident analysis. The most noteworthy correlation was between LSO opinions of waveoff criticality (Table 2) and the accident cost implications of waveoff performance (Table 10). With regard to situational variables, the most obvious correlation between LSO opinion (Table 3) and carrier landing accidents (Table 9) is that of the night environment. LSO opinion regarding pilot factors (Tables 1 and 3) also appears to be supported in the accident analysis (Tables 7 and 10). Other situation variables which received very high criticality ratings from LSOs (Tables 1 and 3), such as Pitching Deck, MOVLAS, No Horizon, No Divert and Reduced Visibility, did not show up directly as major factors with regard to the cost implications of carrier landing accidents (Tables 7 and 10). There is no question that these factors and others increase the difficulty of LSO task performance. The fact that they do not appear to be major factors in carrier landing accidents may be attributed to their infrequency of occurrence. It may also be attributed to the fact that the most experienced LSOs usually wave the recoveries when difficult and complex conditions exist.

Reviewing these factors and considering that there may be others, leads this analyst to conclude that significant savings are highly probable. Even using an extremely conservative projection that an LSO training system will only bring about a 10 percent improvement in overall LSO performance, the estimated cost savings should be noteworthy. For a sample similar to that used in this study, the cost savings would be nearly \$6 million.

There will obviously be costs associated with the procurement and life-cycle ownership of an LSO training system. The return on investment must be one of the major considerations in system acquisition. This study provides quantitative data as insight to the potential return on investment for an LSO training system.

In the next section, the implications of data and analyses presented in this and earlier sections will be discussed in the context of the LSO training program.

## SECTION VI

## SUMMARY OF LSO TRAINING IMPLICATIONS

The purpose of this section is to summarize the training implications of information gathered and analyzed in the activities described in preceding sections of this report. From these activities evolved a "data base" of job performance and critical situation information. From that "data base" two separate, but related, sets of information were extracted and structured to support LSO training system design: key concepts and training situation variables. The key concepts are descriptions of what must be learned by the trainee for successful performance in potentially critical situations. The training situation variables are the conditions to which the trainee must be exposed in the learning process. Thus this section provides a structured informational foundation for the pilot and aircraft behavior models described later in the report.

In subsequent portions of this section, discussions of key concepts and situation variables are preceded by a discussion of data correlation and the critical LSO skill areas identified in this study.

## CORRELATION OF DATA

Before discussing specific results of analyzing LSO performance information, it is necessary to provide some insight to how data was correlated in the analysis. This will also provide insight into the basis for LSO training requirements priorities. In general, the expert opinions of LSOs (Section IV) and other authors (Section III) were considered in conjunction with accident analysis results (Section V and Appendix G). The author then used his personal judgment (based on his LSO and his training analysis experience) to integrate the information in determining key concepts and critical situation variables. The integration process first involved judging the level of criticality of training requirements implied by the evidence obtained in the various information gathering activities (literature review, survey and accident review). For this judgment, candidate training requirements were loosely grouped into categories. Job performance skills were categorized by:

- waveoff
- aircraft control strategies
- recovery management

Situation variables were categorized by:

- pilot
- aircraft
- environment
- operational



The next step involved a review of the criticality levels implied by the evidence from each activity for each category to identify data correlations.

As expected, waveoff performance was highly correlated across all activities. In other words, expert LSO opinions gave it the highest criticality ratings and this was strongly supported by accident analysis results. One aspect of the waveoff category which surfaced as highly critical in the accident review was the performance of the backup LSO. This criticality was not evident from the survey of LSOs, but later received concurrence when the accident analysis results were discussed with LSOs. Within the aircraft control strategy category there was concurrence among all data sources of a high level of criticality for the use of imperative voice calls (i.e., "power," "right for lineup," etc.) during the "in close" segment of an approach. Within this category there was also strong concurrence on the criticality of an LSO's ability to "predict" pilot actions or trends based on observation of preceding trends in an approach. MOVLAS performance was considered highly critical in the survey of LSOs. However, this criticality was not supported by evidence from the accident review, probably because the most experienced LSOs are usually on the job when MOVLAS is in use. The recovery management category surfaced as only a moderately critical aspect of the LSO job, although there were a few accident cases in which LSOs recovered aircraft without adhering to operational rules and policy. The primary training requirements implication for this aspect of LSO job performance is for the very advanced stages of training, such as preparation for platform team leader and Air Wing LSO responsibilities.

Among categories of situation variables, those related to the pilot appeared to be the most critical; and there was strong concurrence between LSO opinions and accident analysis results. This was especially evident for pilot responsiveness and approach trend factors. Pilot background (in terms of experience and specific known tendencies) rated only a moderate level of criticality. This was concurred upon by all data sources. There was also concurrence among data sources that aircraft factors had only a moderate level of criticality. Although certain types of aircraft were prevalent among the accidents analyzed, pilot factors in controlling the aircraft appeared more important to the context of LSO training requirements. In the category of environmental variables there was concurrence that night and pitching deck were highly critical. Absence of horizon and non-optimum wind conditions were agreed upon as moderately critical. There was concurrence among data sources that complex situations caused by operational pressures (such as aircraft emergencies, poor coordination among recovery personnel and complex combinations of undesirable recovery conditions) have a moderate to high level of criticality. Even under relatively uncomplicated circumstances there is a lot of operational pressure on the LSO for recovery efficiency and safety. However, cases of extremely high levels of operational pressure are infrequent. Accidents occurring under these circumstances are even less frequent (which is probably attributable to high LSO experience levels being employed in such situations). There

are, however, obvious implications that operational pressure situations are important training requirements for very advanced stages of the LSO training program.

CRITICAL SKILL AREAS

This discussion of critical LSO skill areas is presented to summarize the findings of study activities described earlier. It also provides background to the utility of key concepts and situation variables in LSO training. The critical LSO skill areas which are discussed below are also outlined in Table 11.

TABLE 11. CRITICAL SKILL AREAS

WAVEOFF

Decision Point/Window  
Decision Factors  
LSO Team Interaction

AIRCRAFT CONTROL STRATEGIES

Expectancy  
Approach Trends  
Pilot Tendencies  
Aircraft Performance  
Complex Situations.

RECOVERY MANAGEMENT STRATEGIES

Recovery Rules/Constraints  
Recovery Efficiency/Safety

From the evidence obtained in study activities, the waveoff decision overwhelmingly appears to be the most critical aspect of the LSO job. The most vivid indicator of this fact is the frequency in which the waveoff factor appeared in carrier landing accidents. There are two aspects of the waveoff which were found to be critical. One was the timeliness of issuing the waveoff. There were many cases in which the waveoff was issued too late to prevent a ramp strike or in which a late waveoff led to an inflight engagement. The other aspect was absence of a waveoff when one was needed. There were carrier landing accidents and reported near-misses in which no waveoff was issued by the LSO. A few of these resulted in ramp strikes. However, they most frequently resulted in a hard landing or an off-center engagement. It was also noted that poor waveoff decision performance by the LSO was not necessarily associated with complex recovery situations. In most cases the accidents and near-misses occurred under relatively normal circumstances. This highlights the criticality of determining the proper

waveoff decision point, based on aircraft dynamics and trends, and pilot tendencies. There were cases in which the situations were complicated by the presence of poor environmental conditions (deck motion, non-optimum wind, poor visibility, etc.) or other factors (aircraft malfunctions, operational pressures, etc.). These cases highlight the criticality of integrating multiple and complex factors into the waveoff decision process. Another noteworthy observation from the review of accidents and from discussions with LSOs was the disturbing frequency of situations in which the backup LSO did not provide adequate support to the controlling LSO. Many of the accidents could have been prevented by issuance of a waveoff by the backup LSO. This highlights the criticality of LSO team interaction during recovery situations.

There was also evidence that overall aircraft control strategies are very critical to successful LSO performance. In many situations, effective LSO interaction prior to the waveoff decision point in an approach could have minimized the necessity for a waveoff. There were many cases in which the LSO allowed an aircraft to reach the waveoff decision point with excessive deviations. This is indicative of the criticality which should be placed on perceptual and decision strategy skills in the early to middle segments of an approach. From accident reports and LSO survey responses, it was evident that there is a useful level of predictability in dynamic approach trends, pilot tendencies and aircraft performance. Skilled LSO performance requires a cognitive component of expectancy in the assessment of approach dynamics. The LSO must recognize dynamic approach trends and pilot tendencies, be aware of aircraft performance capabilities, and then select actions (voice calls or light signals) which provide effective aircraft control assistance to the pilot. Both the timeliness and correctness of LSO assistance are critical to successful correction or effective "dampening" of approach deviations.

As carrier landing situations increase in complexity, aircraft control strategy decisions can become increasingly complex and difficult. The strategies of the LSO may require modification in response to the additional recovery factors. For example, LSO actions may have to be initiated earlier than usual, more voice calls may be needed, imperative voice calls may be necessary in cases where informative calls are typically appropriate. Some conditions which can lead to these types of adjustments in LSO performance include the existence of adverse environmental conditions, aircraft malfunctions, pilot disorientation or lack of proficiency, MOVLAS utilization, communications failure, etc. The decision processing for a skilled LSO must include cognitive schemes to guide aircraft control strategy adjustments in response to many variances in approach situations.

The LSO also plays a critical role in the management of the overall recovery process. Failures of LSOs in fulfilling their recovery management duties have been noted or implied in carrier landing accident reports. The LSO must monitor recovery conditions to insure adherence to operating policies and rules associated with factors such as weather conditions and pilot proficiency. He must insure that shipboard and aircraft operating

limitations are not exceeded due to such factors as adverse wind conditions and deck motion. He must be alert for indications of improper approach geometry caused by mistrim of the ship or malfunction of the Fresnel lens. He must determine the need for utilization of the MOVLAS, and changes in targeted touchdown point. He is responsible for managing the interaction among the members of the LSO platform team to preclude excessive task loading on the controlling LSO in adverse recovery conditions. He must keep Primary Flight Control (PRI-FLY) and Carrier Air Traffic Control Center (CATCC) informed of unusual operating conditions and actively participate in the coordination of appropriate actions and establishment of operating priorities. He must insure that safety is not jeopardized due to the existence of operational pressure for increased boarding rate. If he judges that operating conditions exceed pilot capabilities, he is obligated to recommend the cancellation of recovery operations.

In summary, the LSO performance skills which must receive highest priority are: waveoff decision, expectancy of pilot behaviors based on observed trends, and the ability to integrate multiple recovery factors into the decision processes involved with waving.

#### KEY CONCEPTS

Many of the global aspects and discrete components of the LSO job have been researched, analyzed and reported in previous studies (referenced in Section III). However, within the LSO training program, there has been minimal attention and documentation of the concepts and cognitive relationships inherent in the decision process of the LSO. These were recognized by researchers and the current LSO Training Model Manager as important ingredients for helping the LSO trainee develop cognitive structures for effective decision-making in the almost infinite number of critical situations which can arise in the carrier landing environment. For LSO training system design these "key concepts" are necessary influences in the design of the syllabus and decision logic for the training process, the specification of training situation variables, and the design of performance evaluation schemes. The key concepts which were identified in this study are delineated in Appendix D.

The key concepts evolved iteratively through efforts of the project training analyst and the LSO community. The first set of key concepts were generated by the training analyst based on review of job performance and critical situation information obtained in the documentation review and initial LSO survey responses. This set was then submitted to the LSO Training Model Manager for review and feedback. Other iterations involved incorporation of additional information from later LSO survey responses, analysis of carrier landing accidents and the LSO review of accidents during the cost savings estimation effort. The Commander Naval Air Forces Atlantic Fleet (COMNAVAIRLANT) and Commander Naval Air Forces Pacific Fleet (COMNAVAIRPAC) LSOs were also included in the review and feedback process. There was also interaction with the Canyon Research Group analyst for the instructor model study throughout this effort.

A part of this effort was the structuring of key concepts into related groupings. The initial taxonomy utilized in this effort involved categorization of the key concepts by situation factors, such as pilot, aircraft, environment, ship, etc. However, some that were not identifiable with situation factors were grouped separately.

The key concept statements vary greatly in level of specificity. Some are very general descriptions of LSO decision considerations in the carrier landing process. Others are very specific rules to guide LSO performance of duties. Most of the key concept statements express or imply the relationships between situation factors and LSO actions or decisions. One critical relationship which shows up frequently in the key concept listing is the relative positioning of the waveoff decision point based on such factors as pilot characteristics, aircraft type and environmental conditions. Several are precautionary statements of situation relationships ("If. . .be alert for. . ."). Many of the key concepts provide guidance on what to do when certain conditions exist or certain events occur ("If/when. . .the LSO should. . ."). There are also several concepts which express basic "do's" and "don'ts" of LSO performance ("The LSO should always. . ." or "The LSO should never. . .").

The set of key concepts resulting from this study is quite extensive. However, it cannot be considered exhaustive, nor can the statements themselves be considered firm. This is due to the nearly infinite number of carrier landing situations which can occur and to the variety of individual waving styles and techniques which exist within the LSO community. This set of key concepts should continue growing and evolving into more specific cognitive performance guidance as a part of LSO training system development, as well as ongoing LSO training program management and quality control. During an LSO training system development effort, critical attention should be devoted to the evolution and validation of key concepts, both by LSO subject matter experts and training specialists. Additional analyses of carrier landing accidents and surveys for additional lessons learned from "close calls" are recommended activities during system development. Ongoing training program management and quality control should include continual and, preferably, formal LSO Training Model Manager interaction with the Naval Safety Center (as suggested in Appendix H), the type commander LSOs and Air Wing LSOs. The goals of such interaction would be to identify needed changes in training program content and emphasis and to ensure effective utilization of training program resources, particularly the LSO training system(s).

#### SITUATION VARIABLES

The study activities described earlier in the report were instrumental in identifying situation variables requiring attention in LSO training. These variables were the basis for pilot and aircraft behavior models which could present meaningful exercise conditions in an LSO training systems context.

Several logical segmentations surfaced among the situation variables. Initial groupings included: pilot, aircraft and environment. The pilot related variables were representative of aircraft control and response (to LSO) characteristics. Aircraft related variables were representative of variances in performance among different types of aircraft and among different aircraft malfunctions. Environmental variables included phenomena such as night/day, wind, carrier deck motion and visibility. However, additional segmentations were found to be required to account for ship and operational conditions.

As variables were identified they were iteratively labeled and grouped to develop a structure which was considered comprehensive and logical. The final set of labels and groupings was also designed for ease of association with specific LSO training situations and for flexibility of manipulation for generating exercises. The structure is summarized in Table 12 and discussed below. Additional detail is provided later in discussions and descriptions of models.

TABLE 12. STRUCTURE OF SITUATION VARIABLES

PILOT:

Pilot Characteristics  
Approach Profile (aircraft control)  
Response to LSO

AIRCRAFT:

Performance Characteristics  
Malfunctions

ENVIRONMENT:

Day/Night  
Deck Motion  
Visibility  
Wind  
Horizon

SHIP:

Specific Carrier  
Recovery Aids/Equipment  
LSO Job Aids  
Ship Trim

OPERATIONAL:

Type Recovery  
Recovery Pressure Factors

From earlier analytical activities it was noted that the decision processes and actions of a skilled LSO are influenced by several pilot factors. Some factors are related to the known ("a priori") characteristics of the pilot. These include his experience and proficiency levels, his track record of carrier landing performance and specific flying tendencies. Others are related to real time events or trends which are observable by the LSO during an approach. These include the dynamic profile flown by the pilot during approach and the responses of the pilot to LSO voice calls and signals.

The performance of the skilled LSO is also influenced by aircraft factors. Each type of aircraft has different performance characteristics. Some of these characteristics include approach speed, glideslope/lineup/AOA control stability, power response for waveoffs, attitude sensitivity, etc. Visual characteristics, such as exterior lighting, also differ by aircraft type. There are many aircraft malfunctions which affect performance characteristics. Some also affect aircraft visual characteristics.

Environmental factors also have some impact on carrier landing situations. The night environment, carrier deck motion due to sea state, restricted visibility and absence of a visible horizon negatively affect LSO perception of cues during an approach. Non-optimum wind conditions have an effect on aircraft dynamics during approach. The skilled LSO has learned to adjust his performance in response to the existence of variations in these conditions.

Skilled LSO performance must also be responsive to variations in conditions related to the ship. There are configuration and LSO platform position differences among different carriers. Malfunctions of recovery aids and equipment such as the Fresnel lens and the arresting wires have an effect on the conduct of carrier landing operations. Malfunctions of LSO workstation controls and displays can affect the LSO's job. The geometry of the carrier landing process is affected by the lack of proper ship trim.

The pace, complexity and difficulty of the LSO job in carrier landing operations can be influenced by several operational factors. The type of recovery may involve various numbers of aircraft approaching at very close interval. There may be pressure to expedite the recovery process due to impending weather problems, low fuel state aircraft, lack of a divert field, lack of an airborne tanker, etc. The skilled LSO must be able to keep these factors in proper perspective and avoid jeopardizing the safety aspects of the carrier landing process.

In summary, the situation variables which must receive the highest priority are: undesirable pilot responses and approach trends, variations in aircraft performance characteristics (particularly engine response and attitude sensitivity), night environment and deck motion.

**SUMMARY**

The preceding discussions of critical skill areas, key concepts and situation variables summarize the requirements for LSO training system pilot/aircraft behavior models based on the review and analysis activities described in earlier sections. The discussions also provide insight to training priorities and to the training requirements which will be supported by automated instructor model functions in an LSO training system.

The next section addresses the development of pilot/aircraft behavior models and a functional design for their incorporation into an automated LSO training system.



## SECTION VII

### PILOT/AIRCRAFT MODELS DEVELOPMENT

The purpose of this section is to discuss pilot and aircraft behavior models for LSO training systems. This section includes a description of model development and functional design activities and a discussion of results. The actual results of these activities are presented in Appendix E (Pilot/Aircraft Behavior Models) and Appendix F (Functional Design for Models).

#### MODEL DEVELOPMENT AND FUNCTIONAL DESIGN

The model development and functional design activities had their beginnings during study planning efforts. Based on a preliminary review of technical reports, tentative pilot aircraft and environmental models and elements were identified for pilot, aircraft and environmental factors. Additionally a tentative structure of LSO training system functions was defined.

During subsequent training analysis activities, there was periodic input of results to an iterative model formulation effort. There was periodic review and feedback by the LSO Training Model Manager during model formulation, as well as interaction with instructor model development personnel.

Concurrent with model formulation was the identification and definition of functions to support model interactions within an automated LSO training system context. This involved liaison with instructor model development personnel for compatibility of overall system functional design concepts and structures.

Following completion of training analysis activities, model development activity intensified to complete the structuring of models and elements and to specify attributes, values and interrelationships among modeling variables. The functional design activity was completed with the final specification of model support function interactions and system interfaces.

Subsequent paragraphs briefly describe the models and their roles in an automated LSO training system context. Detailed results are presented in Appendix E and Appendix F.

#### SYSTEM CONTEXT FOR MODEL IMPLEMENTATION

The concept of an automated LSO training system is to provide instructional support for a variety of LSO training requirements, from basic through advanced skill levels. The concept includes several required functional characteristics. It includes visual simulation and control of

carrier landing situations from the LSO workstation perspective. It enables LSO task interaction with a simulated pilot during the landing process. The concept also includes automated support for instructor functions. Within this support are curriculum control, exercise selection, trainee evaluation and recording of trainee progress. The concept includes support for both instructor-present and instructor-absent modes of operation.

The primary goal of concept application is to promote the acquisition of judgmental skills needed by the LSO in the carrier landing operations environment. The training scope is intended to encompass perceptual and decision skills oriented to the development of cognitive processing of the interrelationships among cues, decision factors and appropriate LSO actions. To accomplish this, the concept calls for simulation and control of many situation variables related to the pilot, aircraft and other critical factors associated with successful LSO performance.

There are three technological areas which were recognized as particularly important to the automated LSO training system concept. Automated speech recognition (and understanding) is a key functional element in the representation of the results of LSO interaction with the simulated pilot. The most critical aspect of speech recognition for pilot model implementation is time. For effective training transfer, the time from voice call to pilot response must closely replicate actual behavior for the critical pilot tendencies being simulated. Visual simulation and control technology is critical to effective presentation of the LSO's primary cues during the simulated carrier landing process. The technology of automated "intelligence" is important to the efficiency and training effectiveness of syllabus control, and for minimizing instructor workload and dependency on instructor availability.

The pilot and aircraft behavior models provide the functional requirements basis for simulation and control of carrier landing situations for LSO training. The most important aspect of modelling pilot behavior is the representation of pilot characteristics which are most critical to successful LSO performance. Variations in characteristics of pilot response to LSO actions is one critical modelling area. The other is associated with variations in the simulated approach profiles presented to the LSO. The most critical aspects of aircraft modelling are associated with the representation of differences in aircraft performance characteristics and the effects of aircraft system malfunctions. The modelling effort also addressed other training situation factors, but not as comprehensively as pilot and aircraft factors.

The functional design provides software design and development guidance for implementation of the models into an LSO training system. It presents the overall automated LSO training system functional structure and delineates the system functions needed to support model operations and interfaces within the overall system. Particular attention is devoted to the relationships with automated instructor model functions. Attention is also devoted to software detailed design and program control considerations

such as modularity, design flexibility, design language selection and data management within the system.

Implementation of the enclosed models and functional design will require extensive human factors, training analysis, and subject matter expertise during development and testing. This will be necessary in order to ensure that training effectiveness potential is not reduced due to lack of user acceptance. Extensive involvement of this type of expertise will also be necessary to provide proper training goal orientation to any design and development trade-off decision situations which may arise. Follow-up use of the data and analysis concepts presented in earlier portions of this report (Sections III, IV and V) and in Appendix G should be very useful during detailed design and development.

SECTION VIII

CONCLUSIONS AND RECOMMENDATIONS

1. An LSO training system which can present interactive waving situations, with instructional emphasis on critical situations, would be a cost-effective improvement for the LSO training program. (See pages 6, 48-50)
2. LSO trainee experience with a variety of simulated waving situations can have a positive impact on the development of effective cognitive processing skills. (See pages 55, 56)
3. Representation of pilot behavior and aircraft characteristics through modelling functions are the most important simulation aspects of an LSO training system. (See pages 52, 58)
4. Automated speech recognition processing time is critical to the effective representation of pilot response to LSO actions. (See pages 54, 61)
5. An extensive follow-up effort is needed for comprehensive detailed design of a training requirements data base and for specific correlation of the requirements to the situation variables identified in this study. (See pages 62, 170, 171)
6. It is recommended that consideration be given to the implementation of pilot modelling functions in the LSO Reverse Display for timely assessment of the automated pilot concept. This should also enhance the effectiveness of the device. (See pages 15, 167, 168, 170, 171)
7. To insure user acceptance and training effectiveness, the LSO training system development process will require extensive and continuous involvement by subject matter expert, training analysis and human factors personnel. (See pages 61, 170, 171)
8. To increase the effectiveness of an LSO training system within the overall LSO training program, a total training program analysis and design effort should be undertaken. (See pages 55, 56)
9. The Naval Safety Center is an excellent source of data for the LSO Training Model Manager to use in monitoring training program effectiveness and for identifying training program emphasis needs. (See pages 19-21, 33-35, 208, 225)
10. The waveoff decision is by far the most critical skill component of the LSO's job. (See pages 17-19, 26, 45, 52, 53, 54)

## REFERENCES

- Borden, G.J., The Landing Signal Officer: A Problem Analysis, Vols. I,II. Technical Report 785-1, Goleta, CA: Human Factors Research, Inc., May 1969.
- Borowsky, M.S., Barrett, G.B., Beck, A., and Gaynor, J., Aviation Safety vs. Pilot Experience, Approach, Naval Safety Center, 1980.
- Breaux, R., (Ed.), LSO Training R&D Seminar Proceedings, Technical Report IH-370, NAVTRAEQUIPCEN, 1980.
- Bricton, C.A., The Influence of Environmental Factors in Aircraft Carrier Landing Accidents, Conference Proceedings No. 82 on Adaptation and Acclimatization in Aerospace Medicine, AGARD, September 1970.
- Bricton, C.A., Breidenbach, S.T., Narsete, E.M., Pettigrew, K.M., Objective Measures of Landing Signal Officer (LSO) Performance During Night Carrier Recovery, Technical Report, NAVTRAEQUIPCEN 78-C-0123-1, Naval Training Equipment Center, 1980.
- Chatfield, D.C., Marshall, P.H., and Gidcumb, C.F., Instructor Model Characteristics for Automated Speech Technology (IMCAST), Technical Report, NAVTRAEQUIPCEN 79-C-0085-1, Naval Training Equipment Center, 1979.
- Chatfield, D.C. and Gidcumb, C.F., Optimization Techniques for Automated Adaptive Training Systems, Technical Report, NAVTRAEQUIPCEN 77-M-0575, Naval Training Equipment Center, 1977.
- Erickson, D.P., Landing Signal Officer Guide and Training Plan, circa 1978.
- Franken, D.J., Oh What A Night!, Approach, Naval Safety Center, 1981.
- Halley, R., King, M.R., and Regelson, E.C., Functional Requirements for Air Intercept Controller Prototype Training System, Technical Report, NAVTRAEQUIPCEN 78-C-0182-4, Naval Training Equipment Center, 1979.
- Heyworth, G., Touch-and-Go With the Grim Reaper, Approach, Naval Safety Center, 1980.
- Hoggart, F. A., Night Tanker, Approach, Naval Safety Center, 1980.
- Hooks, J.T., Butler, E.A., Gullen, R.A., and Petersen, R.J., Design Study for an Auto-Adaptive Landing Signal Officer (LSO) Training System, Technical Report, NAVTRAEQUIPCEN 77-C-0109-1, Naval Training Equipment Center, 1978.
- Hooks, J.T., Butler, E.A., Reiss, M.J., and Petersen, R.J., Landing Signal Officer (LSO) Laboratory System Software, Technical Report, NAVTRAEQUIPCEN 78-C-0151-1, Naval Training Equipment Center, 1980.
- Hooks, J.T., McCauley, M.E., Training Characteristics of the LSO Reverse Display, Technical Report, NAVTRAEQUIPCEN 79-C-0101-2, Naval Training Equipment Center, 1980.

NAVTRAEQUIPCEN 80-C-0063-2

- Lacy, J.W., and Meshier, C.W., Development of a Landing Signal Officer Trainer, Proceedings, First Interservice/Industry Training Equipment Conference, Technical Report, NAVTRAEQUIPCEN IH-316, Naval Training Equipment Center, 1979, 79-90.
- Logan, R.J., Paddles Contact - You're Looking Good, Keep It Coming, Approach, Naval Safety Center, 1980.
- McCauley, M.E., and Borden, G.J., Computer-Based Landing Signal Officer Carrier Aircraft Recovery Model, Technical Report, NAVTRAEQUIPCEN 77-C-0110-1, Naval Training Equipment Center, 1983.
- McCauley, M.E., and Semple, C.A., Precision Approach Radar Training System (PARTS) Training Effectiveness Evaluation, Technical Report, NAVTRAEQUIPCEN 79-C-0042-1, Naval Training Equipment Center, 1980.
- McCauley, M.E., and Cotton, J.C., Automated Instructor Models for LSO Training Systems, Technical Report, NAVTRAEQUIPCEN 80-C-0073-2, Naval Training Equipment Center, 1982.
- Mears, M., NOVLAS Techniques for Pilots and LSOs, Approach, Naval Safety Center, 1976.
- Naval Safety Center, It Happens To The Best, Approach, 1977.
- Naval Safety Center, Ask Any Centurion, Approach, 1979.
- Netherland, R.M., The Total Approach, Approach, Naval Safety Center, 1965.
- Rubel, R.C., Confessions of a CAG LSO, Approach, Naval Safety Center, 1980.
- U.S. Navy, Carrier Aircraft Recovery Simulator (CARS) proposal letter, VAQ-129 NAS Whidbey Island, Washington, May 26, 1976.
- U.S. Navy, Office of the Chief of Naval Operations, The Naval Air Training and Operating Procedures Standardization (NATOPS) Program Manual, Landing Signal Officer (LSO NATOPS), Department of the Navy, 1975.
- Webb, G.J., The In-Close Waveoff, Approach, Naval Safety Center, 1976.
- Whalen, D., Rig the MOVLAS, Starboard Side, Approach, Naval Safety Center, 1976.

## BIBLIOGRAPHY

- Borden, G.J., The Landing Signal Officer: Display Requirements for ACLS Recoveries, Goleta, CA: Human Factors Research, Inc., 1972.
- Borden, G.J., The Landing Signal Officer: Work Station Design. Technical Report 1707, Human Factors Research, Inc., 1970.
- Bricton, C.A., Pitrella, F.D., and Wulfeck, J.W., Analysis of Aircraft Carrier Landing Accidents (1965-1969), Technical Report for Office of Naval Research, Dunlap and Associates, Inc., Santa Monica, CA, November 1969.
- Bricton, C.A., Evaluation of the Special Senses for Flying Duties: Perceptual Abilities of Landing Signal Officers (LSOs), La Jolla, CA: Dunlap and Associates, Inc., 1974.
- Bricton, C.A., Breidenbach, S.T., and Stoffer, G.R., Operational Performance Measures for Carrier Landing; Development and Application, Proceedings of the Human Factors Society, 24th Annual Meeting, Human Factors Society, Santa Monica, CA, 1980.
- Durand, T.S., and Wasicko, R.J., Factors Influencing Glide Path Control in Carrier Landing, Journal of Aircraft, 4, Systems Technology, Inc., 1967, 146-158.
- Flatley, J.H., The LSO - Forever an Asset, Approach, Naval Safety Center, 1974.
- Mitchell, C.S., The LSO Head-Up Display, Approach, Naval Safety Center, 1975.
- Naval Safety Center, various articles, Approach, 1972 - 1980.
- Nave, R.L., A Pilot/LSO Simulation Conducted to Investigate Aircraft Waveoff Performance and to Determine the Ability of the Landing Signal Officer to Judge Aircraft Approaches, Naval Air Development Center, Warminster, PA, 1974.
- Keigle, M.E., and Smith, R.H., Preliminary Study of Optimal Waveoff Control: A Parametric Approach, Naval Air Development Center, NADC-72079-VT, 1973.
- Saunders, G.J., LSO - The Forgotten Man, Approach, Naval Safety Center, 1977.
- Smith, R.H., LSO-Pilot Interviews on Carrier Approach, Naval Air Development Center, VT-TM-1681, 1973.
- Smith, R.H., The Landing Signal Officer: A Preliminary Dynamic Model for Analyses of System Dynamics, Naval Air Development Center, NADC-72078-VT, Warminster, PA, 1973.
- Stueck, P.G., LSO Pilot Interaction Simulator, Naval Postgraduate School, Monterey, CA, June 1973.

NAVTRAEQUIPCEN 80-C-0063-2

- U.S. Navy, Office of the Chief of Naval Operations. The Naval Air Training and Operating Procedures Standardization (NATOPS) Program Manual, CV, Department of the Navy, 1975.
- U.S. Navy, Landing Signal Officer School Relocation request letter, OinC LSO School, NAS Pensacola, FL, 2 April 1980.
- Van Hemel, P.E., Van Hemel, S.B., King, W., Judson, and Breaux, R., Training Implications of Airborne Applications of Automated Speech Recognition Technology, Technical Report, NAVTRAEQUIPCEN 80-D-0009-0155-1, Naval Training Equipment Center, 1980.
- Vought Corporation, Proposal for Development of an A-7E NCLT Landing Signal Officer (LSO) Training Station, May 1977 (with revision R1 of July 1977 and R2 of September 1977).
- Webb, G.J., LSOs - An Endangered Species, Approach, Naval Safety Center, 1975.



APPENDIX A

STUDY OBJECTIVES

1. Identify Critical Aspects of LSO Waving Tasks - This objective was fundamental to the determination of modelling requirements which could have a positive impact on LSO training. The study resulted in the comprehensive compilation of key LSO learning concepts and critical situation variables. Achievement of this objective was considered very successful.
2. Identify Potential Cost Savings of Improved LSO Training - This objective was important to the verification that LSO training research activities and results can have a positive impact on LSO training. The objective was also important in providing procurement decision-makers with quantitative indications of potential return on investment. Achievement of this objective was considered very successful.
3. Develop Pilot/Aircraft Behavior Models For Presentation of Situations to Help LSO Trainee Acquire Key Waving Concepts and Critical Skills - Excellent progress was made in the compilation of pilot, aircraft and other situation variables needed for effective LSO training. Additional model detail will be required prior to detailed software design of model functions.
4. Develop Functional Design For Incorporation and Use of The Models In An Automated LSO Training System - The functional design resulting from this study should provide excellent top level guidance for detailed design of software for the models and for interactions within the LSO training system.

NAVTRAEQUIPCEN 80-C-0063-2

APPENDIX B

SURVEY QUESTIONNAIRE AND DATA  
LSO TRAINING SURVEY

NTEC, in conjunction with the LSO Training Model Manager, is in the process of identifying critical aspects of "waving" which are most important to successful trainee progression to a Wing LSO designation. Mathetics, Inc., under contract to NTEC, is surveying the LSO community for information to support this effort. Since the results of this survey will eventually be used in the LSO training program, it is very important that there be broad LSO participation in this survey and that the questions be answered diligently and with careful consideration. Many of the questions require only that you check blocks to rate certain aspects of waving. However, other questions require narrative descriptions of your waving experiences.

Personal identification data is desired in order to allow possible future follow-up. However, if an anonymous submission is preferred, please provide the information requested to describe your background.

For questions or suggestions about the survey or help with questionnaire completion, contact LCDR Jerry Singleton of the LSO School at NAS Cecil Field (AUTOVON 860-6267) or Mr. Thel Hooks of Mathetics, Inc., in San Diego (commercial 714-578-5931). If returning this questionnaire by mail, please send it to the following address:

Mathetics, Inc.  
P.O. Box 26655  
San Diego, Ca. 92126

\_\_\_\_\_ Date

Name \_\_\_\_\_ Unit \_\_\_\_\_ Phone \_\_\_\_\_

LSO Qual Level 18 = Staff  
14 = Wing Years since starting LSO training 7.09

Carrier landings 261.3 day, 88.5 night Cruises Completed 2.9

Primary aircraft type as pilot A-7=12, F-4=8, F-14=6, A-6=5

Aircraft which you are qualified to wave: All covered except F/A-18

NAVTRAEQUIPCEN 80-C-0063-2

1. Below are listed many of the variables that can affect a night waving situation for a Wing Qual LSO. Your inputs are needed to help establish priorities for their emphasis in the training process leading up to Wing LSO designation. In considering your ratings of these variables several factors should influence your opinion:

- How much the variable can affect recovery safety
- How much the variable can affect boarding rate, especially when there is a real need to expedite recovery
- Difficulty experienced by a trainee in learning how to wave approaches with the variable present

Please rate each situation variable using the following scale:

- 1 = No training emphasis required
- 2 = Low priority
- 3 = Moderate priority
- 4 = High priority
- 5 = Extremely high priority

SITUATION VARIABLES	1	2	3	4	5	
Pilot unresponsive or very slow to respond to LSO				x		4.12
Very unproficient pilot			x			3.41
Very inexperienced pilot				x		3.59
Very unpredictable pilot				x		4.06
LSO talkdown				x		3.97
NORDO			x			3.24
Pitching deck, clear horizon				x		3.94
MOVLAS, steady deck				x		4.20
No horizon, no plane guard destroyer				x		3.89
Aircraft breaking out of WX inside 3/4 mile				x		3.88
Barricade recovery				x		3.74
Extremely high or low WOD			x			3.38
Recovery crosswind			x			3.06
Aircraft without external AOA indexers			x			3.06
Aircraft without wing tip lights			x			3.35
Pitching deck, MOVLAS, no horizon				x		4.20
Single engine approach (twin engine aircraft)				x		3.67
"Trick or treat" pass, no tanker, no divert				x		4.03

1. (Continued)

SITUATION VARIABLES

	1	2	3	4	5	
Pitching deck, no horizon				x		4.32
No. 3 and 4 wires missing			x			3.41
Loss of LSO radio after ball call			x			3.15
MOVLAS, pitching deck				x		4.29
Aircraft flight control emergency				x		3.91
Higher than normal approach speed configuration			x			3.26
Extremely poor start off CCA				x		3.88
Other: _____						
Other: _____						
Other: _____						

Comments, as desired:



NAVTRAEQUIPCEN 80-C-0063-2

2. Please rate the following LSO voice calls for their criticality to successful LSO "waving" performance under night carrier landing conditions, at the Wing LSO designation level. The results of your ratings will help establish priorities for voice call emphasis in LSO training. A scale of 0-5 is provided, where:

- 0 = Do not feel it should ever be used
- 1 = Definitely not critical
- 2 = Possibly critical
- 3 = Fairly critical
- 4 = Definitely critical
- 5 = Extremely critical

VOICE CALLS

	0	1	2	3	4	5	
A little power				x			3.30
Power						x	4.65
Go manual				x			2.65
A little attitude				x			3.03
Attitude					x		3.74
Right for lineup						x	4.26
Left for lineup				x			3.43
Bolter				x			2.59
Waveoff						x	4.74
Waveoff, foul deck					x		3.61
Cut			x				2.26
Uncouple				x			2.70
Check your lineup			x				1.85
Don't settle				x			3.03
Don't go low				x			3.03
Don't climb				x			2.85
Don't go high				x			2.50
Keep your nose up		x					0.76
Hold your attitude			x				2.18
Hold what you've got				x			2.68
You're a little high				x			2.62
You're high				x			3.00
You're a little low				x			2.91
You're low					x		3.62
You're going high			x				2.26
You're going low				x			2.79
You're lined up left			x				2.35
You're lined up right			x				2.38

2. Continued

VOICE CALLS

	0	1	2	3	4	5	
You're fast			x				2.44
You're slow				x			2.91
You're drifting left			x				1.94
You're drifting right			x				1.91
Roger Ball					x		3.58
Paddles Contact					x		3.88
A little left for lineup			x				1.97
A little right for lineup			x				2.33
Hold it up			x				1.50
Fly the ball				x			2.74
Fly it down			x				1.58
Catch it			x				2.09
The deck is moving				x			2.59
Stop it in the middle			x				1.88
Don't go through it			x				2.38
You're settling				x			2.88
Ease it down			x				1.83
Start it down			x				2.47
Start it back to the left				x			2.53
Start it back to the right				x			2.53
Work it up			x				1.56
A little power, right for lineup				x			2.82
A little power, left for lineup				x			2.61
You're high, ease it down			x				2.42
Check your lineup, don't go low			x				1.53
A little power, don't climb		x					1.24
The deck is moving, don't chase the ball				x			2.56
You're low and slow				x			2.85
Other: _____							
Other: _____							
Other: _____							
Other: _____							
Comments, as desired:							

3. Please describe three of the most difficult (or "hairiest") waving situations you have experienced. These may have occurred when you were a controlling or observing LSO, or when you were in the aircraft. Maximum detail surrounding each situation is desired. To help in your description, a check-off list for many of the possible situation variables is included. Please provide a chronological narrative of the approach including a description of the profile flown by the aircraft. Also provide commentary regarding what the LSO's actions were, and how, in retrospect, the LSO could have done a better job of waving the approach in terms of calls used and the timing of calls. There is no intent here to "hammer" the LSO, only to learn from previous experiences. The intent is to identify, and detail, critical situations for which an LSO must be prepared. Therefore priority should be on describing situations from which LSO performance lessons can be learned. Situations resulting in accidents which were (or may have been) preventable by LSO actions are of particular interest. This, however, does not necessarily imply that the LSO caused the accident; just that by doing something different, he may have prevented or reduced the probability of accident occurrence.

(On the following pages, four representative responses are included.)

Aircraft type F-14A, Day \_\_\_\_\_ or Night   
 Approach results: ramp strike \_\_\_\_\_, hard landing \_\_\_\_\_, inflight engage-  
 ment \_\_\_\_\_, off-center engagement \_\_\_\_\_, waveoff \_\_\_\_\_, bolter \_\_\_\_\_.  
 successful arrestment on ~~barricade~~   
 Pilot experience: high \_\_\_\_\_, average , low \_\_\_\_\_.  
 Pilot proficiency: recent , unproficient \_\_\_\_\_.  
 Pilot skill level: average , above \_\_\_\_\_, below \_\_\_\_\_.  
 Pitching deck 4-6, MOVLAS \_\_\_\_\_, LSO Talkdown \_\_\_\_\_, Barricade \_\_\_\_\_.  
 WOD: ~~high~~ 50% very low \_\_\_\_\_, crosswind \_\_\_\_\_.  
 Extremely reduced ceiling/visibility \_\_\_\_\_, no horizon   
 Aircraft malfunction/emergency NONE  
 Extreme pressure on LSO to get aircraft aboard NO.

## Narrative:

NIGHT CQ PASS, F-4 EXPERIENCED AVIATOR  
 ON INITIAL F-14 CARROLL, PILOT REDUCED POWER  
 TO  IDLE WHILE BETWEEN IN-CLOSE TO AIR, WHEN  
 HE SAW BALL RAPIDLY RISING. DECK HAD JUST GONE  
 ↓, COMBINED WITH AIC BEING OVERPOWERED. BALL  
 HAD ALREADY GONE OFF THE TOP. CONTROLLING  
 LSO HIT WAVE-OFF LINES, AND AIC CAUGHT A  
 2 WIRE. ABOVE AVERAGE MOVE AS TIME DIDN'T  
 ALLOW FOR VERON POWER CALLS, AND PADDLES WANTED  
 AIC AT 100% RIGHT NOW. PILOT HELD PROPER  
 ATTITUDE WHICH ELIMINATED CHANCE FOR IN-FLIGHT.  
 GOOD TRAINING LESSON LEARNED, ESPECIALLY FOR  
 FWD ENGINE AIC.



Aircraft type A7, Day        or Night   /  .  
 Approach results: ramp strike       , hard landing       , inflight engage-  
 ment       , off-center engagement       , waveoff       , bolter       ,  
 successful arrestment or barricade   /  .  
 Pilot experience: high   /  , average       , low       .  
 Pilot proficiency: recent   /  , unproficient       .  
 Pilot skill level: average       , above   /  , below       .  
 Pitching deck       , MOVLAS       , LSO Talkdown       , Barricade       .  
 WOD: very high       , very low       , crosswind       .  
 Extremely reduced ceiling/visibility       , no horizon   /  .  
 Aircraft malfunction/emergency       .  
 Extreme pressure on LSO to get aircraft aboard       .

## Narrative:

STANDARD NO HORIZON NIGHT, HIGHLY SKILLED  
 PILOT ATTEMPTED MODE I APPROACH - LOCK-UP,  
 PUSHOVER AND APPROACH NORMAL UNTIL  
 IN CLOSE - LSO OBSERVED ACLS UNCOUPLE  
 LIGHT ILLUMINATE AND CALLED PILOT -  
 A/C BEGAN TO SETTLE RAPIDLY AND  
 CLEARED RAMP BY 3-4 FEET. PILOT  
 HAD CYCLED FREE ON VHF INADVERTENTLY  
 AND HAD NOT SEEN ACLS UNCOUPLE.  
 PILOT'S LSO LULLED INTO COMPLACENCY  
 BY VERY SMOOTH MODE I PRIOR  
 TO DROP LOCK.

Aircraft type F-4, Day  or Night   
 Approach results: ramp strike , hard landing , inflight engagement , off-center engagement 35' RT waveoff , bolter , successful arrestment or barricade   
 Pilot experience: high , average , low   
 Pilot proficiency: recent , unproficient   
 Pilot skill level: average , above , below   
 Pitching deck , MOVLAS , LSO Talkdown , Barricade   
 WOD: very high , very low , crosswind   
 Extremely reduced ceiling/visibility , no horizon   
 Aircraft malfunction/emergency   
 Extreme pressure on LSO to get aircraft aboard

Narrative: VERY MARGINAL WEATHER. I WAS BACK-UP LSO AND WE WERE PICKING AIRPLANES UP AT ABOUT 1/2 MILE. CEILING WAS BELOW 200 FT. WE LANDED FIVE AIRPLANES BY PICKING THEM UP AND TALKING THEM DOWN. THE INCIDENT F-4 WAS FLOWN BY A NUGGET PILOT WITH BELOW AVERAGE ABILITY. WE PICKED HIM UP A LITTLE HIGH AND LINED UP LEFT AND HE WAS TOLD TO COME RIGHT. APPROACHING THE CENTERLINE HE WAS TOLD TO START IT BACK TO THE LEFT, WHEN THE PILOT DID NOT RESPOND, A STRONG "LEFT FOR LINEUP" CALL WAS ISSUED AND THEN "LEFT RUDDER LEFT RUDDER". THE AIRPLANE WAS INSIDE THE WAVE-OFF POINT AND CROSSED THE RAMP LOW, FLAT, LINED UP RIGHT AND DRIFTING RIGHT. THE PILOT CORRECTED BACK TO THE LEFT AT THE LAST INSTANT, AND PICKED UP THE 4 WIRE THIRTY-FIVE (35) FEET RIGHT. THE AIRPLANE SWERVED AND SKIDDED BUT FORTUNATELY THE WIRE AND THE TAILHOOK HELD. HAD THEY NOT, THE RESULTS WOULD HAVE BEEN CATASTROPHIC.

LESSONS LEARNED: A TIMELY WAVE-OFF WAS OBVIOUSLY THE RIGHT COURSE OF ACTION, BUT WE WERE WILLED INTO BELIEVING THAT WE COULD TALK ANYBODY ABOARD. THE PILOT DID NOT RESPOND TO CALLS AND HAD A HORRENDOUS DRIFT RIGHT CROSSING THE RAMP. YOU CAN'T TRUST ANYBODY AND A WAVEOFF IS SOMETHING WE DON'T USE ENOUGH. ALSO, THE WEATHER WAS BELOW MINIMUMS. LSO'S NEED TO ENSURE THAT THE DECISION-MAKERS ARE AWARE OF DETERIORATING MARGINAL CONDITIONS.

Aircraft type F-4B, Day \_\_\_\_\_ or Night   
 Approach results: ramp strike \_\_\_\_\_, hard landing \_\_\_\_\_, inflight engage-  
 ment \_\_\_\_\_, off-center engagement \_\_\_\_\_, waveoff \_\_\_\_\_, bolter \_\_\_\_\_.  
 successful arrestment or barricade   
 Pilot experience: high \_\_\_\_\_, average , low \_\_\_\_\_.  
 Pilot proficiency: recent , unproficient \_\_\_\_\_  
 Pilot skill level: average , above \_\_\_\_\_, below \_\_\_\_\_  
 Pitching deck \_\_\_\_\_, MOVLAS \_\_\_\_\_, LSO Talkdown \_\_\_\_\_, Barricade \_\_\_\_\_  
 WOD: very high \_\_\_\_\_, very low \_\_\_\_\_, crosswind \_\_\_\_\_  
 Extremely reduced ceiling/visibility \_\_\_\_\_, no horizon   
 Aircraft malfunction/emergency \_\_\_\_\_  
 Extreme pressure on LSO to get aircraft aboard

## Narrative:

Black night, no bingo, no tanker assets (yet), Yankee Station  
 One F-4 already on a bolter, next 2 F-4's trapped OK  
 4<sup>th</sup> F-4 was low all the way, LSO knew who pilot was,  
 trusted his responses (follow LSO) and waved tailhook vice A/c  
 F-4 crossed ramp in LOS attitude, possibly 2' or less hook to  
 ramp. - Could easily have been a ramp strike (hook clap or worse)  
 A/c was low all the way, sometimes slow.

Made C S-BC (LOAW) NEPSLOIC HBWN LOAR T-1

Comments: LSO assumed pilot would "hack-it", trusted pilot and personal  
 ability - Dumb move, brought about by pressures to not bolter any  
 more A/c.

4. Please use LSO shorthand symbology, with additional narrative as required, to describe five or more typical approach profiles which can lead to unsuccessful approaches. Also note the different types of results (ramp strike, hard landing, bolter, inflight, etc.) which can result from each profile. For example: HFX CDAW, ramp strike or hard landing; OC (LOSLO)IC ↷, bolter; SIC-AR PNU on WO, inflight engagement.

Ramp Strike/Hard Landing:

LOX HIM-IC CDAR  
HX-IC CDAR  
OC CIC/HIC CDAR  
NEPAW SAR  
SAR on LLU  
EG/DN correcting for LOIC

Off-Center Engagement:

LURX/IM R-LAW  
LULX/IM L-RAW  
OCLULIC L-RAR  
OCLURIC R-LAR  
DRRIC/AR  
DRLIC/AR

Bolter:

OCLOIC/SIC ↷  
OCCO ↷  
TMP on LLUIC ↷

In-flight Engagement:

CDIC-AR PNU OCO  
CDIC-AR PNU on WO  
OCCDAR PNU

NAVTRAEQUIPCEN 80-C-0063-2

5. For each aircraft listed below, please describe specific characteristics or performance limitations which can affect the LSO when waving a night approach. Also mention malfunctions or emergencies of particular concern to the LSO.

A6: Excellent power  
Settles on late lineup  
Hook-skip bolters on ND  
KA6 underpowered  
single engine-only problem high G.W., high temp., high winds  
Lineup difficulties

EA6: Excellent power  
Long fuselage and sensitive nose - in-flight potential  
Hook-skip bolters on ND  
Decel tendency due to sensitive nose

A7: slow engine (fan) response  
HIM SIC-AR and LOX-IM to Bolter are common  
AOA and lights fail frequently

E2: Excellent power  
Lineup difficult and critical  
Hook-skip bolters on ND  
No-flap approach-cocked up, reduced H/R clearance  
Glideslope sensitive to nose

F4: Excellent power, easy to over-control  
High WOD requirements due to high approach speed  
Fuel critical  
Single engine -- poor response, high speed ( $\frac{1}{2}$  flaps)  
HIC CDAR common

F14: Slow engine (fan) response  
Long fuselage -- in-flight potential  
Hook-skip bolters on ND and late lineup  
Lineup critical

F/A18: Excellent power  
Flat attitude on AOA  
Nose and power adjustments must be coordinated  
Easy to overrotate on WO

S3: Slow engine (fan) response  
Tendency to "glide"  
DLC good for high deviation  
Difficulties with burble

6. In the space below, describe two or more of the most difficult night waving situations you can imagine. Note the primary reasons for difficulty and your estimate of the probability such a situation would ever occur.

Frequently mentioned situations:

pitching deck, no horizon, MOVLAS  
pitching deck, no horizon, MOVLAS, "Blue Water"

Frequently mentioned variables:

pitching deck  
no horizon  
MOVLAS  
"Blue Water"  
rain/low visibility  
low fuel state

Primary reason for difficulty:

- LSO waving overload (perception, pressure, complexity)

7. Additional comments, including any criticisms of this questionnaire and suggestions for improvement:

APPENDIX C

COST SAVINGS ESTIMATION MATERIALS AND DATA

RESEARCH FOR LSO TRAINING:  
CARRIER LANDING ACCIDENT SEMINAR



THEL HOOKS ("RETIRED" LSO) - MATHETICS, INC.

RESEARCH FOR LSO TRAINING:

NTEC/HUMAN FACTORS LAB

LSO TRAINING MODEL MANAGER

POTENTIAL PAYOFFS FROM IMPROVED TRAINING:

MORE WING QUAL LSOs

REDUCED LSO WORKLOAD - JOB/TEACHING

BETTER PREP FOR CRITICAL SITUATIONS

POTENTIAL IMPROVEMENT AREAS:

GUIDANCE/MATERIALS FOR LSO TRAINING

- INFORMATION ABOUT TASKS/RESPONSIBILITIES
- EMPHASIS ON MORE CRITICAL ASPECTS OF WAVING

SIMULATED WAVING ENVIRONMENT

- EARLY EYE-MOUTH COORDINATION
- PICKLE TIME
- CONTROLLED EXPOSURE TO CRITICAL SKILLS/SITUATIONS

INPUTS DESIRED FROM LSO COMMUNITY

- CRITICAL SKILLS/WAVING CONDITIONS FOR TRAINING
- TRAINING EMPHASIS PRIORITIES



**TODAY'S SEMINAR -- REVIEW AND DISCUSS MISHAPS:**

**MISHAP PREVENTION**

**LSO SKILL IMPROVEMENT THROUGH TRAINING**

**MISHAP SAMPLE:**

**158 JULY '70 - DEC '79**

**LSO CITED IN 51**

**22 TO BE REVIEWED**

**CONDUCT OF SESSION:**

**REVIEW MISHAP SUMMARY**

**HIGHLIGHT KEY ELEMENTS**

**JUDGE POSSIBILITY THAT LSO COULD HAVE PREVENTED  
THE MISHAP**

**JUDGE POSSIBILITY THAT LSO COULD HAVE BEEN TRAINED  
TO BETTER HANDLE SITUATION**

**IDENTIFY IMPORTANT TRAINING IMPLICATIONS**

**SESSION CONSTRAINTS - INFO AVAILABLE, TIME**

**OPEN DISCUSSION FOLLOWING REVIEW OF ALL MISHAPS**

MISHAP PREVENTION

"POSSIBILITY THAT LSO (CONTROLLING OR BACKUP) COULD HAVE PREVENTED MISHAP"

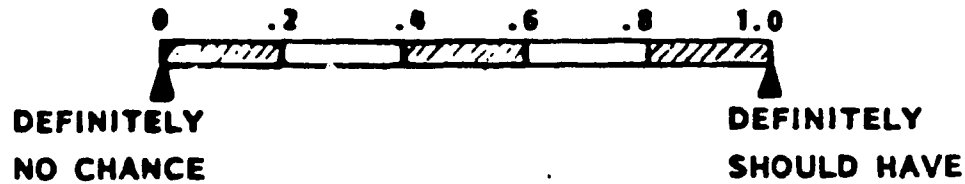

HIGH RATING FOR HIGH LEVEL OF RESPONSIBILITY:

- LANDING AIRCRAFT ON FOUL DECK
- OBVIOUSLY AFU APPROACH WITHOUT WAVEOFF
- LINEUP SCAN BREAKDOWN BY LSO(s)
- ETC.

MODERATE RATING FOR AVAILABILITY OF CLUES SUGGESTING THAT WAVEOFF OR OTHER ACTION MIGHT BE PRUDENT:

- POOR CONDITIONS, UNSTABLE APPROACH
- BAD START/OTHER INDICATIONS OF PILOT BEHIND AIRCRAFT
- "CLASSIC" APPROACH TRENDS
- ETC.

LOW RATING FOR CIRCUMSTANCES WELL OUTSIDE LSO CONTROL

- ACCEPTABLE APPROACH, PILOT DN /EG /DR WELL INSIDE WAVEOFF WINDOW
- ETC.

## LSO TRAINING

**"POSSIBILITY THAT IMPROVED TRAINING AND/OR ADDITIONAL EXPERIENCE COULD HAVE HELPED THE LSO(S) TO BETTER HANDLE SITUATION"**

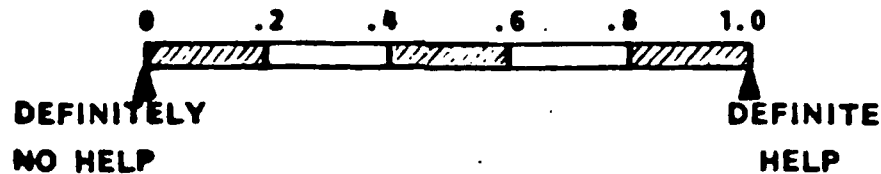

**HIGH RATING IF ANY OF THE FOLLOWING WOULD HAVE HAD STRONG POSITIVE INFLUENCE ON LSO(S) PERFORMANCE IN MISHAP SITUATION:**

- MORE OVERALL WAVING EXPERIENCE (PICKLE TIME)
- PRIOR EXPERIENCE WITH THIS OR SIMILAR SITUATIONS
- MORE EXTENSIVE TRAINING EMPHASIS ON DECISION FACTORS/  
WAVING CONDITIONS ASSOCIATED WITH THIS MISHAP SITUATION

**MODERATE RATING IF THE ITEMS ABOVE WOULD HAVE HAD SOME POSITIVE INFLUENCE ON LSO(S) PERFORMANCE .**

**LOW RATING IF THE ITEMS ABOVE WOULD HAVE HAD LITTLE OR NO POSITIVE INFLUENCE ON LSO(S) PERFORMANCE**

IMPORTANT TRAINING IMPLICATIONS

ASPECTS OF THIS MISHAP SITUATION WHICH WOULD BE PARTICULARLY IMPORTANT IN PREPARING AN LSO FOR THIS OR A SIMILAR SITUATION:

- WAVEOFF DECISION
- RECOGNIZING APPROACH DEVIATIONS
- USE OF TIMELY AND CORRECT LSO CALLS/SIGNALS
- USE OF AND/OR DECISION TO USE MOVLAS
- LSO SCAN
- LSO KNOWLEDGE (PROCEDURES, OPERATING RULES/LIMITS, AIRCRAFT CHARACTERISTICS/LIMITATIONS, ETC.)
- LSO PLATFORM "TEAM" INTERACTION/COORDINATION
- BARRICADE RECOVERY
- "CLASSIC" APPROACH TREND
- RECOVERY COORDINATION (CATCC/PRI FLY/LSO)
- DECK MOTION
- NIGHT ENVIRONMENT
- NON-OPTIMUM WOD
- NO HORIZON
- LOW PILOT EXPERIENCE LEVEL
- POOR PILOT RESPONSIVENESS TO LSO
- ABNORMAL AIRCRAFT CONFIGURATION
- BOARDING PRESSURE
- DECK STATUS (CLEAR/FOUL)
- AIRCRAFT MALFUNCTIONS
- OTHER: \_\_\_\_\_

A-7A NIGHT MIDWAY NU/ '76 "C" DAMAGE \$143,000 1 FATAL

PLG COLLAPSE NIGHT SOLS LAN. SOLS UTILIZED DUE DECK MOTION. PLY CALLED BALL 3/4 MILE WITH GOOD START.  
SETTLE IN MIDDLE INDICATED ON SOLS. PWR ADDED. CLY @ IN-CLOSE POSIT. NOSE DOWN ABEAM LSO. LAN IN PLY  
ATTITUDE. ON T/O, LOAD BANG, SETTLE ON PORT WING TIP. ENGAGE #2 COP, PML @ WHEEL, BRAKE, TENSION STRUT @  
ACT CYL LOFT OVER SIDE. ENG SECURED, PLY EGRESS NORM. INVES REVL LSO ON 7TH SOLS RECOVERY OF DAYI HIS 3RD  
NIGHT RECOVERY. THIS ACPT MADE HARD LAN PREVIOUS FLT BUT THOROUGH INSP REVL NO DISCREPS. DIR PWC TENSION  
STRUT ATTACH PT LUS REVL FAILIME DUE GROSS OVERLOAD. 1 MINOR STRESS CORROSION CRACK NOTED. NO EVIDENCE TO  
INDIC FAILURE DUE STRESS CORROSION CRACKING. DURING ACDT APPR, DECK MOVING MODERATELY, DECK DOWN AS RAMP  
CROASD @ MOVING UP @ T/O. CONTINUED USE OF SOLS UNDER ADVERSE DECK CONDITS, DAY @ NIGHT, QUESTIONABLE.  
CAUSE(S) OTHER PERS- CONTROLLING- LSO (FATIGUE). PLY- EXCESS SINK RATE. PROB O/P- SUPV- CV COMMAND LEVEL @  
CVS COMMAND LEVEL. PROB O/P- PREVIOUS PLY(S)- 2 HARDER THAN NORM LANDINGS.

PILOT EXPERIENCE: TOTAL Hours - 4665  
 M/N AT LANDINGS - 296/76

C = Cecil Mtg  
 M = Miramar Mtg

"POSSIBILITY THAT LSO (CONTROLLING OR BACKUP) COULD HAVE PREVENTED EMERG"

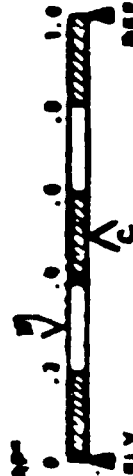

DEFINITELY  
 NO CHANCE

"POSSIBILITY THAT IMPROVED TRAINING AND/OR ADDITIONAL EXPERIENCE COULD HAVE HELPED THE LSO(S) TO BETTER HANDLE SITUATION"



DEFINITELY  
 NO HELP

WAVEOFF DECISION

- RECOGNIZING DEVIATIONS
- TIMELY/CORRECT CALLS
- LSO SCAN
- KNOWLEDGE (PROCEDURES, RULES, LIMITS, AIRCRAFT, ETC.)
- PLATFORM TEAM INTERACTION
- COORDINATION W/CATCC, PRIFLY
- MOVLAS
- AIRCRAFT MALFUNCTION
- AIRCRAFT CONFIGURATION

DECK MOTION

- NIGHT ENVIRONMENT
- NON-OPTIMUM WOB
- NO HORIZON
- LOW PILOT EXPERIENCE
- POOR PILOT RESPONSE
- BOARDING PRESSURE
- CLEAR/POUL DECK
- BARRICADE
- CLASSIC TREND

A-7A DAY TICONDEROGA NOV 78 "A" DAMAGE \$1,518,000

RAMP STRIKE/EJT. REPL PLY W/ DAY CANNALS HAD COMPLETED 8 OF REV'D TO ARMESIS PREVIOUS DAY. 1ST ARMIST THIS PLY -PAIR-LOW ALL THE WAY-A LITTLE CLB IN CLOSE-NUSE DOWN TO LAN-3 WING. BALL CALLED 4ND APPR, ADVISED BY L30 PITCHING DECK, ACFT SLIGHT UNDER PWR IN GNDVZ 6 PWR ADDED. APPR IN CLOSE POSIT PORT DRIFT. L30 CALLED RIGHT FOR LINE-UP. LINE-UP CORRECTION MADE. NUSE LOWERED ESTAB EXCESS RATE UP DESCENT. DECK MOVEMENT UP. L30 FELT ACFT PAST W/O POINT. GAVE 2 PWR CALLS. ACFT IMPACTED RAMP WITH WING. SHEARED 3M6 6 MOOK ASBY. CONTINUED UP DECK 6 BECAME ARMED. PLY EJT APPROX 8 MILE AHEAD CY/HELD RESCUE. ACFT LOST 8 SEA. PLY TREND HAD GREATER THAN NORM TENDENCY TO DRUP NUSE IN CLOSE UN 6 OF 12 APPRS PRIOR TO AC01 6 SHEARDOWN IN SCAM IN 1ST TRAINING. L30 ALLOWED APPR TO CONTINUE UNDER UNSAT DECK COMUITS. PNI- PLY- IMPROPER LAN TECHNIQUE. COMRIE- PLY- IMPROPER SCAM. OTHER PERS- CONTROLLING- CONT L30- DIVERIED ATTENTION WITH ACFT IN CLUSE. D/P - CONTROLLING- SUPV L30- FAILED TO INFORM CURT L30 OF PLY TREND 3 DECK MOTION.

POSSIBILITY THAT L30 (CONTROLLING OR BACKUP) COULD HAVE PREVENTED MISMAP

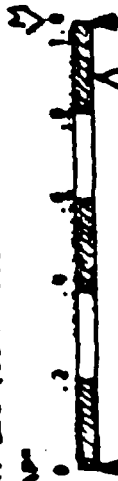

DEFINITELY  
NO CHANCE  
SHOULD HAVE

POSSIBILITY THAT IMPROVED TRAINING AND/OR ADDITIONAL EXPERIENCE COULD HAVE HELPED THE L30(S) TO BETTER HANDLE SITUATION



DEFINITELY  
NO HELP  
DEFINITE  
HELP

- WAVEOFF DECISION
  - RECOGNIZING DEVIATIONS
  - TIMELY/CORRECT CALLS
  - L30 SCAM
  - KNOWLEDGE (PROCEDURES, RULES, LIMITS, AIRCRAFT, ETC.)
  - PLATFORM TEAM INTERACTION
  - COORDINATION W/CATCC, PRIFLY
  - MOV/LAS
  - AIRCRAFT MALFUNCTION
  - AIRCRAFT CONFIGURATION
- DECK MOTION
  - NIGHT ENVIRONMENT
  - NON-OPTIMUM BOB
  - NO HORIZON
  - LOW PILOT EXPERIENCE
  - POOR PILOT RESPONSE
  - BOARDING PRESSURE
  - CLEAR/FOUL DECK
  - BARRICADE
  - CLASSIC TREND

F-4J NIGHT AMERICA JUN '78 "C" DAMAGE \$477,000

PILOT FELT SOMETHING POP AFTER SHUTTLE RELEASED FOL CAT STROKE. PATTERN FLOWN WITH GEAR & FLAPS DOWN WITH NO PROBLEMS WITH ACFT. ACFT MADE APPROX 8 LANDING. ACFT TOUCHED DOWN LEFT OF C/L WITH LEFT BRK. THE MLG APPARENTLY STRUCK THE 03 CAT SHUTTLE COVER DURING LOG ROLLOUT. THE AFT ATTACH POINT OF MLG DRAG BRACE ACTUATOR FAILED. BUCKLING CROSS MEMBER & RUPTURING FWD CFT FLOOR. BOTH MLG TIRES FAILED. ENVIRON COND- BARE WTE. NO WOOD. 40 HORIZON. H-WIND 13 KTS FROM STBD. TIME WIND JMED FOL MISHAP WAS 360-SECT. BRP WGS AT TIME OF MISHAP 132 DEG. LSO HAD REPORTED LESS THAN OPTIMUM WIND TO PRI-FLY. CONTRIB 1.90-FAILURE TO ADVISE FLT OF H-WIND CONDITIONS & FAILING TO WAVE ACFT OFF WHEN IT WAS APPARENT THAT ACFT WAS NOT LINED UP . PILOT-LANDING TECHNIQUE. SHUTTLE COVER (FAC FACTOR) H-WIND (ENVIRON FACTOR).

(40)

... Pilot experience: TOTAL HOURS - 1777  
D/N F4 LANDINGS - 264/123

POSSIBILITY THAT LSO (CONTROLLING OR BACKUP) COULD HAVE PREVENTED MISHAP



DEFINITELY NO CHANCE

POSSIBILITY THAT IMPROVED TRAINING AND/OR ADDITIONAL EXPERIENCE COULD HAVE HELPED THE LOG(S) TO BETTER HANDLE SITUATION.



DEFINITELY NO HELP

- \_\_\_ WAVEOFF DECISION
- \_\_\_ RECOGNIZING DEVIATIONS
- \_\_\_ TIMELY/CORRECT CALLS
- \_\_\_ LSO SCAN
- KNOWLEDGE (PROCEDURES, RULES, LIMITS, AIRCRAFT, ETC.)
- PLATFORM TEAM INTERACTION
- COORDINATION W/CATCC, PRIFLY
- \_\_\_ MOVLAS
- AIRCRAFT MALFUNCTION
- \_\_\_ AIRCRAFT CONFIGURATION
- \_\_\_ DECK MOTION
- \_\_\_ NIGHT ENVIRONMENT
- NON-OPTIMUM WOOD
- \_\_\_ NO HORIZON
- \_\_\_ LOW PILOT EXPERIENCE
- \_\_\_ POOR PILOT RESPONSE
- BOARDING PRESSURE
- \_\_\_ CLEAR/POUL DECK
- \_\_\_ BARRICADE
- \_\_\_ CLASSIC TREND
- PLATFORM LOCATION

KA-60 NIGHT MIDWAY DEC '77 "A" DAMAGE \$2,076,000

WIFE BAMP STRIKE/CREW EJT, HEAVY RAIN DURING IN AREA WHILE DWD FOR RECOVERY. NO USE OF ACLS NEEDED DURING  
 SCA DUE LACK EXPERIENCE. 0 1/1/0N1 RAIN HEAVIER, 3PM-42 BROKE LOCK/CCA TERMINATED. PRECISION DESCENT  
 CONTINUED. CALL FOR RAIN REMOVAL (PROPER CP). AT 2/3RDS-1 MI. APPR CALLED MINS. CALL BALL, NO RESPONSE, AT  
 8 MI. BACKUP LSO CALLED LITTLE LOW, HOLD IT UP. D/M CALLED BALL (LOW). CAB LSO (NOT WAVING) FELT APCY ON  
 SLOPE (CONT LSO IN-TRAINING). RAIN INTENSIFIED. CAB LSO DDBR DECEL. DROP NOSE, SWITCHED REFERAR ATT. W/ AIR  
 INCREASED SINE. CONT LSO CALLED LITTLE PWR. PLY LOST PWD VIS & FELT STUNNED/FROZEN, DID NOT HEAR PWR CALLS  
 • MORE PWR CALLS, W/O LIGHTS ON. NO W/O CALL. PLY WENT TO MNT. LOOKED FOR BALL. NOTING VERY LOW, NOSE PULL  
 UP. BAMP IMPACTED. TIMED EXPLO/PLAMES, ACFT INTACT SLID UP DECK. BOTH CREW EJT/MELO RESCUE. ACFT JUST Y  
 SEA. I PARKED P/J B BAW. INVES REVD LSO FAILED TO INITIATE AN EARLY W/O DUE LATE BALL ACQUISITION. SLOW.  
 SLIGHTLY LOW & WE COMBIT. PLY FAILED TO INITIATE W/O WHEN BALL LOST. CAUSES! OTHER PERS- CONTROLLING- LSO  
 (IN TRAINING) & SA LSO (BACK-UP)- TAILED INITIATE TIMELY W/O. PLY- POOR W/DVELOPE COMT, PWR PWR  
 MANAGEMENT. FAILURE TO INITIATE W/O.

PILOT EXPERIENCE: TOTAL HOURS - 972  
 D/M AC LANDINGS - 89/61

POSSIBILITY THAT LSO (CONTROLLING OR BACKUP) COULD HAVE PREVENTED MIDWAY

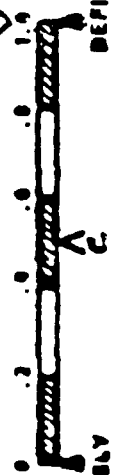

DEFINITELY  
 NO CHANCE

DEFINITELY  
 SHOULD HAVE

POSSIBILITY THAT IMPROVED TRAINING AND/OR ADDITIONAL EXPERIENCE COULD HAVE HELPED THE LSO(S) TO BETTER HANDLE SITUATION

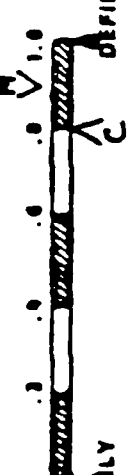

DEFINITELY  
 NO HELP

DEFINITE  
 HELP

- WAVEOFF DECISION
- RECOGNIZING DEVIATIONS
- TIMELY/CORRECT CALLS
- LSO SCAN
- KNOWLEDGE (PROCEDURES, RULES, LIMITS, AIRCRAFT, ETC.)
- PLATFORM TEAM INTERACTION
- COORDINATION W/CATCC, PRIFLY
- MOV/LAS
- AIRCRAFT MALFUNCTION
- AIRCRAFT CONFIGURATION
- Recovery Strategy/Decision to accept aircraft given conditions and pass
- DECK MOTION
- NIGHT ENVIRONMENT
- NON-OPTIMUM W/O
- NO HORIZON
- LOW PILOT EXPERIENCE
- POOR PILOT RESPONSE
- BOARDING PRESSURE
- CLEAR/FOUL DECK
- BARRICADE
- CLASSIC TREND
- Poor Visibility/Rain



F-14A NIGHT AMERICA MAR '77 "A" DAMAGE \$13,997,000

MITE RAMP STRIKE. CREW EJECTED SAFELY. ACFT ENTERED WATER OFF PORT SIDE ANGLE DECK. ON FIRST APPROCH, PLY OVERCONTROLLED ATTITUDE & FLEW THRU THE GLIDESLOPE. LSO MANEVED ACFT OFF TOR BELMS TOO HIGH. PLY OVERRODE AMP'S & EXECUTED WAVE OFF. SECOND PASS BEGAN WITH GOOD START AT 3/4 MILE. IN THE MIDDLE ACFT DRIFTED TO RT OF C/A AT ABOUT 7 SEC FROM RAMP. INCREASED RATE OF DESCENT & BEGAN TO GO LOW. LSO GAVE "A LITTLE ATTITUDE" CALL. PLY RESPONDED WITH A BARELY PERCEPTIBLE INCR & RATE OF DESCENT CONTD. CONTROLLING [REDACTED] IN STRONG "ATTITUDE" CALL WHICH PLY DID NOT HEAR. WFC HEARD POWER CALLS RIGHT UP TO RAMP. HEATBALL DISAPPEARED OFF BOTTOM OF LEWS. ONE SECOND FROM RAMP BOTH THE CONTROLLING LSO & SENIOR LSO CALLED FOR POWER & SENIOR LSO INITIATED THE WAVEOFF LITES. ACFT IMPACTED RA HALF WAY UP THE ROUND DOWN. PLY RELIED ON HUD FOR ATTITUDE REF & FLEW ALL PASSES USING APC3. PLY WAS BELOW AVG IN CARBINALS BUT SOON HAD NOT RECVR TREND ANALYSIS FROM HTS. CSOC FAILED ON INTERCEPTION OF FINAL DRG, PRODUCING A DATA FREEZE ON PLY'S HUD/VDI & STBY/READY LITE ON THE WFO'S INS STATUS INDICATOR. PLY FLEW APPROACHES USING STBY GYRO. CONTRIB: NAT FAILURE CSOC/VTCT. LANDING TECHNIQUE (BOTH)-FAILURE TO PROVIDE A TIMELY WAVEOFF.

PILOT EXPERIENCE: TOTAL HOURS - 517 1ST F-14 Ramp Strike (512)

POSSIBILITY THAT LSO (CONTROLLING OR BACKUP) COULD HAVE PREVENTED MISHAP



DEFINITELY  
NO CHANCE

POSSIBILITY THAT IMPROVED TRAINING AND/OR ADDITIONAL EXPERIENCE COULD HAVE HELPED THE LSO(S) TO BETTER HANDLE SITUATION



DEFINITELY  
NO HELP

- WAVEOFF DECISION
- RECOGNIZING DEVIATIONS
- TIMELY/CORRECT CALLS
- LSO SCAN
- KNOWLEDGE (PROCEDURES, RULES, LIMITS, AIRCRAFT, ETC.)
- PLATFORM TEAM INTERACTION
- COORDINATION W/CATCC, PRIELY MOV/LAS
- AIRCRAFT MALFUNCTION
- AIRCRAFT CONFIGURATION
- WAVEOFF DECISION
- NIGHT ENVIRONMENT
- NON-OPTIMUM WOB
- NO HORIZON
- LOW PILOT EXPERIENCE
- POOR PILOT RESPONSE
- BOARDING PRESSURE
- CLEAR/POUL DECK
- BARRICADE
- CLASSIC TREND

A-7E NIGHT CORAL SEA NOV '71 "A" DAMAGE \$2,874,000 1 FATAL

NIGHT BAMP STRIKE/EJTS. AFTER BALTER, PLY CALLED BALL W 3/4 MILE. SLIGHTLY BELOW SLOPE ON CEILING. AS IN-CLINE POSIT REACHED. SLIGHT SETTL. LSO CALLED LITTLE PWR, RESPUNDE MAND. NO CMB IN ALTITUDE NOTED. RAPID SETTLE STRIKING RAMP/ROUND-DOWN. M/L6 STRUCK 10 INCHES BELOW DECK LEVEL. PDNT WING LOW 2-3 DEG. NOOK STRUCK 3 FT BELOW DECK LEVEL. P/W/6 STRUT SHARED. NOOK SEP. SKID UP ANGLE WITH P/L1 ATTEMPTING COMT ACFT. NO PWR CMB NOTED. EJTS JUST PRIOR UPF LND ANGLE. ACFT LUST 0 SEA. PLY RECOVERED BY D06 DECK RESCUE/FATAL ONE DRAINING (ENTANGLEMENT SHRIED LINES). PLY HISTORY OF ACCEPTING APPR COMDITS UNTIL LSO CALLED CORRECTIONS. BLACK NIGHT. NO HORIZON. PLY ACCEPTED LOW BALL. ALLOWED ACFT TO SETTLE-IN-CLOSE 6 DID NOT ADD ENOUGH PWR. LSO FAILURE TO GIVE PWR OR W/D CALLS ONCE RAPID CLOSURE BETWEEN ALF1 6 RAMP STARTED P/RO COMRID FACTOR. CAUSE: P/L1- POOR GLIDESLOPE CONT, SETTLED-IN-CLOSE. POOR PWR MANAGEMENT. P/RO OTHER PERIS. CONTROLLING-LSO.

(41)

"POSSIBILITY THAT LSO (CONTROLLING OR DASHUP) COULD HAVE PREVENTED MISAP"



DEFINITELY  
NO CHANCE

"POSSIBILITY THAT IMPROVED TRAINING AND/OR ADDITIONAL EXPERIENCE COULD HAVE HELPED THE LSO(S) TO BETTER HANDLE SITUATION"

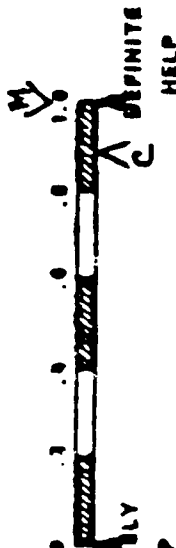

DEFINITELY  
NO HELP

WAVESOFF DECISION

RECOGNIZING DEVIATIONS

TIMELY/CORRECT CALLS

LSO SCAN

KNOWLEDGE (PROCEDURES, RULES, LIMITS, AIRCRAFT, ETC.)

PLATFORM TEAM INTERACTION

COORDINATION W/CATCC, PRIFLY

MOV/LAS

AIRCRAFT MALFUNCTION

AIRCRAFT CONFIGURATION

DECK MOTION

NIGHT ENVIRONMENT

NON-OPTIMUM W/D

NO HORIZON

LOW PILOT EXPERIENCE

POOR PILOT RESPONSE

BOARDING PRESSURE

CLEAR/FOUL DECK

BARRICADE

CLASSIC TREND

Low Pilot Skill (Known)



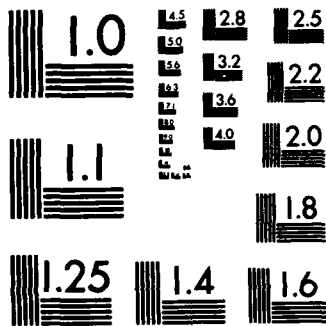

MICROCOPY RESOLUTION TEST CHART  
NATIONAL BUREAU OF STANDARDS-1963-A

A-7A NIGHT MIDWAY NOV 75 "C" DAMAGE \$143,000 1 MAJOR INJURY

NIGHT RAMP STRIKE. UNDER-PWR APPR TO W/O DECISION. PWR REDUCED, 4 PWR CALLS, PWR ADDED, NOSE UP ROTATION. RAMP IMPACTED WITH NOSE, LOWER PORTION OF ACFT. BULTER. JOINED BY OTHER ACFT. OIL PRESS DECREASING TO 13 PSI, PWR SET TO 800, EPP DEPLOYED, BARRICADE RIGGED. ON DOWNING O OIL PRESS, 1ST PASS W/O FOLDED DECK, 2ND PASS HIGH, FAST, NOSE OVER O RAMP. T/O SHORT OI COP, IMPACT BARRICADE. SALS COLLAPSE. ENG SECURED. PLY EXPRESS HOP. 2 DECK CREW INJ- 1B, 16 FROM DEBRIS, PARKED PASS OTT E DAM IDEMISI. INVES REVED NOSE WAS NOT FULLY DOWN (RAMP STRIKE DAM) PRECLUDING ENGAGING COP ON BARRICADE PASS. O OIL PRESS DUE RUPTURE ACCY DRIVE CLEAR CASE FROM BLOW OF BASH POT (RAMP STRIKE). LSO/TREND EVAL PLY SHOWS BELOW AVG PWR CONT, NO DANGEROUS TENDENCIES. CATCC VECTORED PLY TO AHEAD SUBO TO RAMP STRIKE WHEN OIL PRESS WENT TO 0. COMFUS. ON BETWEEN LSO. AIR OPS & CATCC HAD ACFT ON EARLY FINAL DURING BARRICADE RIGGING RESULTING IN FOLDED DECK W/O. LSO THEN GAVE VISUAL FOR PATTERN TO BARRICADE ARREST. CAUSES: PLY- POOR PWR MANAGEMENT, SLOW RESPONSE TO LSO. -PROB OTHER PERS- CONTROLLING- LSO- FAILED TO CALL FOR W/O. PROB O/P- CONTROLLING/SUPV- CAT LSO- AIR OPS. AIR OFFICER- LACK OF COORD & DEVIATION FROM SOP.

PILOT EXPERIENCE: TOTAL HOURS - 442  
W/M AT LANDINGS - 27/19

(Two sets of judgments obtained, one for Ramp Strike, one for Barricade; for cost analysis, Ramp Strike used)

"POSSIBILITY THAT LSO (CONTROLLING OR BACKUP) COULD HAVE PREVENTED HIGHWAY M(800)

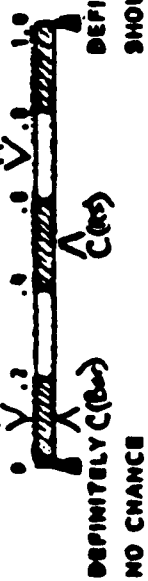

"POSSIBILITY THAT IMPROVED TRAINING AND/OR ADDITIONAL EXPERIENCE COULD HAVE HELPED THE LSO(S) TO BETTER HANDLE SITUATION"

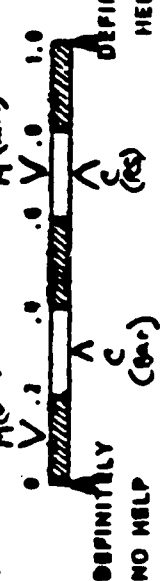

- (23)  WAVEOFF DECISION
- (80r)  RECOGNIZING DEVIATIONS
- (85)  TIMELY/CORRECT CALLS
- (80r)  KNOWLEDGE (PROCEDURES, RULES, LIMITS, AIRCRAFT, ETC.)
- (85)  PLATFORM TEAM INTERACTION
- (80r)  COORDINATION W/CATCC, PRIFLY
- (80r)  AIRCRAFT MALFUNCTION
- (85)  AIRCRAFT CONFIGURATION
- DECK MOTION
- NIGHT ENVIRONMENT
- NON-OPTIMUM WOB
- NO HORIZON
- (85)  LOW PILOT EXPERIENCE
- (85)  POOR PILOT RESPONSE
- (80r)  BOARDING PRESSURE
- CLEAR/POUL DECK
- (80r)  BARRICADE
- CLASSIC TREND

F-4J DAY SARATOGA JAN '75 "C" DAMAGE \$477,000

ACFT GIVEN LATE WAVE OFF BECAUSE CDP WAS STILL RETRACTING. PLT SELECTED MIL PAR & ROTATED. WOOD ENGAGED 01 CDP. WOOD GEAR BROKE OFF AT TRANSITION FITTING. DECK PITCHING 3-4 FT. CONTRIB LSO (CONTROLLING & SUPER LSO) LATE WAVEOFF PLT-OVERROTATED ON WAVEOFF ATTEMPT.

(32)

PILOT EXPERIENCE: TOTAL HOURS - 1533  
W/ F4LAWMS - 69/25

"POSSIBILITY THAT LSO (CONTROLLING OR BACKUP) COULD HAVE PREVENTED Mishap"



DEFINITELY NO CHANCE

DEFINITELY SHOULD HAVE

"POSSIBILITY THAT IMPROVED TRAINING AND/OR ADDITIONAL EXPERIENCE COULD HAVE HELPED THE LSO(S) TO BETTER HANDLE SITUATION"



DEFINITELY NO HELP

DEFINITE HELP

C

- WAVEOFF DECISION
- RECOGNIZING DEVIATIONS
- TIMELY/CORRECT CALLS
- LSO SCAN
- KNOWLEDGE (PROCEDURES, RULES, LIMITS, AIRCRAFT, ETC.)
- PLATFORM TEAM INTERACTION
- COORDINATION W/CATCC, PRIFLY
- MOV/LAS
- AIRCRAFT MALFUNCTION
- AIRCRAFT CONFIGURATION
- DECK MOTION
- NIGHT ENVIRONMENT
- NON-OPTIMUM WOOD
- NO HORIZON
- LOW PILOT EXPERIENCE
- POOR PILOT RESPONSE
- BOARDING PRESSURE
- CLEAR/POUL DECK
- BARRICADE
- CLASSIC TREND

F-4J NIGHT CONSTELLATION DEC '72 "C" DAMAGE \$477,000 1 MAJOR INJURY

100030Z DEC 72. DURING WIFE APPROACH, ACFT ENAGED 03 COP 29 FT LEFT OF C/L IN RT TO LEFT DRIFT. ON ENROUTE, LEFT WLB DEPARTED FLT DECK & ALST WALKED OVER DECK EDGE. RIO INITIATED COP EJECTION, RIO SEAT LEFT THE A/C AT APPROX 75 DEG OF BANK. FLT WAS EJECTED WITH ACFT AT APPROX 110 DEG OF BANK. RIO'S CANUTE BLOSSOMED INSTANTANEOUSLY & FLT'S SEAT WAS OVER SLIPPING ACROSS THE WATER. BOTH WERE RESCUED BY HELO. FLT RECEIVED HEAD & NECK INJURY. INVT'S REPORT THAT FLT WAS QUALIFIED IN SOME VIEWS. HE HAD TROUBLE IN WIFE DUALS & RECEIVED ADDITIONAL TONS IN P.M.P. MUCH OF THE LSO'S EQUIP WAS IMPERATIVE. THE LSO MOVED OFF THE PLATFORM ON THE DECK & COULD NOT RECEIVE LINE UP IMPU FROM THE PLAT. THE SHOW LSO WAS ON THE PLATFORM BUT WAS NOT IMPROVED BY FLT MAKING APPROX 30 DEG NOT CONTROL THE APPROCH. CONTRIB: FLT LANDING (EJECTING-INTERRUPTED DEAR. LSO FAILED TO DETECT A DANGEROUS SITUATION & TAKE APPROPRIATE CORRECTIVE ACTION) SUPER-CMD LEVEL (PAILED TO TAKE MORE POSITIVE ACTION BASED UPON FLT'S DEMONSTRATED DIFFICULTIES WITH LINE UP). (7)

"POSSIBILITY THAT LSO (CONTROLLING OR BACKUP) COULD HAVE PREVENTED MIDMAP"



DEFINITELY  
NO CHANCE

"POSSIBILITY THAT IMPROVED TRAINING AND/OR ADDITIONAL EXPERIENCE COULD HAVE HELPED THE LSO(S) TO BETTER HANDLE SITUATION"



DEFINITELY  
NO HELP

- WAVEOFF DECISION
- RECOGNIZING DEVIATIONS
- TIMELY/CORRECT CALLS
- LSO SCAN
- KNOWLEDGE (PROCEDURES, RULES, LIMITS, AIRCRAFT, ETC.)
- PLATFORM TEAM INTERACTION
- COORDINATION W/CATCC, PRIFLY
- MOVLAS
- AIRCRAFT MALFUNCTION
- AIRCRAFT CONFIGURATION
- Platform Location
- DECK MOTION
- NIGHT ENVIRONMENT
- NON-OPTIMUM WOB
- NO HORIZON
- LOW PILOT EXPERIENCE
- POOR PILOT RESPONSE
- BOARDING PRESSURE
- CLEAR/POUL DECK
- BARRICADE
- CLASSIC TREND
- Low Pilot Skill (200000)

A-7E NIGHT INDEPENDENCE JULY '71 "A" DAMAGE \$2,874,000

BIENE RAMP STRIKE/CRASH. PLY ON NAV/INATICS PLY AND INITIALLY TACAN DME. ON COMPLETION NAV PORTION OF PLY, COMM DIFFICULTIES WITH CY MARSHALL CONTROLLER. PLY THEN JOINED ONTO ANOTHER SOP ACFT, BOTH PROCEEDED TO MARSHALL UNDER INFO PASSED BY ABBIE CIC. AS CY APPR. PLY RECD GOOD TACAN LOCK-ON. BOTH DME & ALTIMETER, PLY DETACHED & PROCEEDED TO MARSHALL. AT MARSHALL, TACAN LOCK, AGAIN, RETURN IN SOP ACFT. ABBIE CIC WITH CY. DETACH & BEGIN APPR. TOLD TO CALL WALK & 8 MILE WERE SLIGHTLY OFF COURSE & DESCENDING INTO SLOPE. LSO CALLED LOW. PWR CORRECTION MADE. CLR TO SLOPE. OVERCORRECTION BY REDUCING PWR & LOWERING HDGT. & RAPID PWR CALLS BY LSO WITH NO REACTION. ACFT STRUCK WAMP. SLID DOWN ANGLE IN PWR. PLY LEFT JUST PRIOR LEAVING ANGLE W/NO RESCUE. ACFT LOST PWR. PLY HAD ONLY 100 MRS & LEEP PREVIOUS 72 MRS. CY CLR BROWNY PLY INTO PATIERN FIRST WITH BROWN TACAN ONE PROBLEMS WHICH IS NOT IAW CY SOP. LSO FAILED TO W/D PLY DURING POOR APPR. CAUSES- OTHER PWR- CONTROLLING- CLR PERS. LSO, PLY- PATIERN. IMPROPER SCAM IS PUTTING DECK, EXCESS STIM RATE. (17A)

"POSSIBILITY THAT LSO (CONTROLLING OR BACKUP) COULD HAVE PREVENTED MISAP"

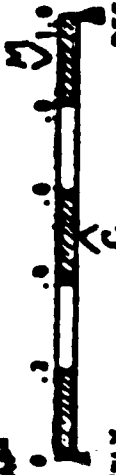

DEFINITELY  
NO CHANCE

DEFINITELY  
SHOULD HAVE

"POSSIBILITY THAT IMPROVED TRAINING AND/OR ADDITIONAL EXPERIENCE COULD HAVE HELPED THE LSO(S) TO BETTER HANDLE SITUATION"



DEFINITELY  
NO HELP

DEFINITE  
HELP

- |   |   |
|---|---|
| <input checked="" type="checkbox"/> WAVEOFF DECISION                                      | <input type="checkbox"/> DECK MOTION              |
| <input checked="" type="checkbox"/> RECOGNIZING DEVIATIONS                                | <input type="checkbox"/> NIGHT ENVIRONMENT        |
| <input type="checkbox"/> TIMELY/CORRECT CALLS   | <input type="checkbox"/> NON-OPTIMUM WOB          |
| <input type="checkbox"/> LSO SCAN   | <input type="checkbox"/> NO HORIZON               |
| <input checked="" type="checkbox"/> KNOWLEDGE (PROCEDURES, RULES, LIMITS, AIRCRAFT, ETC.) | <input type="checkbox"/> LOW PILOT EXPERIENCE     |
| <input type="checkbox"/> PLATFORM TEAM INTERACTION  | <input type="checkbox"/> POOR PILOT RESPONSE      |
| <input type="checkbox"/> COORDINATION W/CATCC, PRIFLY                                     | <input type="checkbox"/> BOARDING PRESSURE        |
| <input checked="" type="checkbox"/> MOVLS   | <input type="checkbox"/> CLEAR/POUL DECK          |
| <input checked="" type="checkbox"/> AIRCRAFT MALFUNCTION                                  | <input checked="" type="checkbox"/> BARRICADE     |
| <input type="checkbox"/> AIRCRAFT CONFIGURATION   | <input checked="" type="checkbox"/> CLASSIC TREND |



A-7E NIGHT CONSTELLATION NOV '72 "C" DAMAGE \$143,000

000700Z NOV 72. OFF-CEX NIGHT CV LAN/ALPT SURVEYED PORT SIDE OF COV. AFTER FOUL DECK W/D. 2ND ACL MADE 11  
APPR. BALL CALL @ 3/4 MILE. PITCHING DECK. 1ST ADVISED PLY OF H-UP/L VARIATIONS. 1/8 TO 22 FT 3 INCHES PORT OF  
CENTLINE. 03 COV ENGAGED. ROLL W/ WIND INTO CAT WALK FWD OF LENS. CONTINUE ROLL OVER PORT SIDE CV  
SURVEYED BY COV, ENG SECURED. PLY CROSS VIA LINE WITH HOOD HANDED DOWN FROM PLY DECK. MOVED TO FORWARD  
MAINDECK. SWAMP LINE & MOVED TO CATWALK. CV RETURNED TO PORT. ACFT RECOVERED BY CRANE. INVEL REVEL 12 FT  
DECK PITCH. REL WIND 000/34 KTS. PLAY TAPE REULD SLIGHT PORT TURN 7 SECONDS FROM 1/8 TO CORRECT 3RD LINE  
UP WITH PORT DRIFT INTO CEN LINE 3 SECONDS PRIOR 1/8- NO CORRECTIVE ACTION BY LSO. CHANNICLED ATTENTION  
ON SLICE SLOPE DEVIATIONS/PITCHING DECK. LINE-UP MONITOR LSO TURNED LINE-UP DURING CRITICAL FINAL 272  
SECONDS OF APPR. CAUSED DIVER PERS- CONTROLLING LSO & LINE-UP MONITOR LSO. PLY- NOT LINE UP  
IN TACTICAL SCAN.

(64)

"POSSIBILITY THAT LSO (CONTROLLING OR BACKUP) COULD HAVE PREVENTED MISHAP"



DEFINITELY NO CHANCE SHOULD HAVE

"POSSIBILITY THAT IMPROVED TRAINING AND/OR ADDITIONAL EXPERIENCE COULD HAVE HELPED THE LSO(S) TO BETTER HANDLE SITUATION"



DEFINITELY NO HELP

- |   |   |
|---|---|
| <ul style="list-style-type: none"> <li><input checked="" type="checkbox"/> WAVEOFF DECISION</li> <li><input checked="" type="checkbox"/> RECOGNIZING DEVIATIONS</li> <li><input type="checkbox"/> TIMELY/CORRECT CALLS</li> <li><input type="checkbox"/> LSO SCAN</li> <li><input type="checkbox"/> KNOWLEDGE (PROCEDURES, RULES, LIMITS, AIRCRAFT, ETC.)</li> <li><input checked="" type="checkbox"/> PLATFORM TEAM INTERACTION</li> <li><input type="checkbox"/> COORDINATION W/CATCC, PRIFLY</li> <li><input type="checkbox"/> MOVLAB</li> <li><input type="checkbox"/> AIRCRAFT MALFUNCTION</li> <li><input type="checkbox"/> AIRCRAFT CONFIGURATION</li> </ul> | <ul style="list-style-type: none"> <li><input checked="" type="checkbox"/> DECK MOTION</li> <li><input type="checkbox"/> NIGHT ENVIRONMENT</li> <li><input checked="" type="checkbox"/> NON-OPTIMUM W/D</li> <li><input type="checkbox"/> NO HORIZON</li> <li><input type="checkbox"/> LOW PILOT EXPERIENCE</li> <li><input type="checkbox"/> POOR PILOT RESPONSE</li> <li><input type="checkbox"/> BOARDING PRESSURE</li> <li><input type="checkbox"/> CLEAR/FOUL DECK</li> <li><input type="checkbox"/> BARRICADE</li> <li><input type="checkbox"/> CLASSIC TREND</li> <li><input checked="" type="checkbox"/> Platform Location</li> </ul> |
|---|---|

F-4J NIGHT INDEPENDENCE MAY '77 "A" DAMAGE \$2,510,000 2 FATAL

NITE RAMP STRIKE. FOLLOWING RAMP STRIKE, ACFT BOLTERED, PORT WLG & WING TIP DAMAGED. AFTER TAXISING WAS COMPLETED, REVISION WAS MADE TO TAKE ACFT INTO BARRICADE. ACFT EXPERIENCED FAILURE. APPROXIMATELY IN REAR QUARTER WING FLAP CONFIG. UPON BARRICADE ENGAGEMENT, ACFT CONTINUED UP ANGLE DECK SHEDDING BARRICADE, AIRCREW EJECTED AS ACFT LEFT THE ANGLE DECK. BOTH CREWMEMBERS MISSING. CAUSE OF RAMP STRIKE-PLY-FATIGUE & IMPROPER LOG TECHNIQUE. CAUSE OF UNSUCCESSFUL BARRICADE ENGAGEMENT: PLY/RIO-LACK OF COMM WITH CV (FAILURE TO NOTIFY SHIP OF INCR A/S FOR APPROX. OR BY. ACFT CONTROLLABILITY, ETC); LSO'S-FAILED TO CHECK SPN-04 TO DETERMINE FINAL APPROX SPEED; SUPV PERS (CV & AIR WING) MADE EVAL OF ALL DATA AVAILABLE WHICH SHOULD HAVE LED TO A DETERMINATION THAT A CONTROLLED EJT WAS THE ONLY VIABLE OPTION LACK OF ORG & ANTICIPATION WHICH KEPT WELL KNOWN PROCEDURES FROM BEING EXECUTED & PERMITTED A MAJOR BREAKDOWN IN BOTH SUPERVISION & CONTROL. CAUSE OF BARRICADE FAILURE RESULTED FROM EXCESS ENGAGEMENT SPEED (25 KTS).

(37)6

PHOT OBSERVANCE: TOTAL HOURS - 1430  
D/N F4 LANDINGS - 54/21 (only judged barricade pass)

POSSIBILITY THAT LOG (CONTROLLING OR BACKUP) COULD HAVE PREVENTED INSHAP



POSSIBILITY THAT IMPROVED TRAINING AND/OR ADDITIONAL EXPERIENCE COULD HAVE HELPED THE LOG(S) TO BETTER HANDLE SITUATION



- |   |   |
|---|---|
| WAVEOFF DECISION  | DECK MOTION   |
| <input checked="" type="checkbox"/> RECOGNIZING DEVIATIONS                                | <input type="checkbox"/> NIGHT ENVIRONMENT              |
| <input type="checkbox"/> TIMELY/CORRECT CALLS   | <input type="checkbox"/> NON-OPTIMUM WOOD               |
| <input type="checkbox"/> LSO SCAN   | <input type="checkbox"/> NO HORIZON                     |
| <input checked="" type="checkbox"/> KNOWLEDGE (PROCEDURES, RULES, LIMITS, AIRCRAFT, ETC.) | <input type="checkbox"/> LOW PILOT EXPERIENCE           |
| <input checked="" type="checkbox"/> PLATFORM TEAM INTERACTION                             | <input checked="" type="checkbox"/> POOR PILOT RESPONSE |
| <input checked="" type="checkbox"/> COORDINATION W/CATCC, PRIFLY                          | <input checked="" type="checkbox"/> BOARDING PRESSURE   |
| NOVLAS  | <input type="checkbox"/> CLEAR/FOUL DECK                |
| <input checked="" type="checkbox"/> AIRCRAFT MALFUNCTION                                  | <input checked="" type="checkbox"/> BARRICADE           |
| <input checked="" type="checkbox"/> AIRCRAFT CONFIGURATION                                | <input type="checkbox"/> CLASSIC TREND                  |

A-7E NIGHT ENTERPRISE NOV '72 "A" DAMAGE \$2,874,000

231500Z NOV 72. NIGHT RAMP STRIKE/LSO. AT 9 MILES. MODE 11 APPR ATTEMPTED WHEN DOWNWARD TO MODE III. PLY  
 ... PLY GRABES SLOPE TO 3/4 MILE WHEN CONTROLLER CALLED SLOW SLOPE. WALL CALLED. CONNECTION TO SLOPE. LSO  
 CALLED FOR SEVERAL TIMES. CONNECTIONS ROUN WITH 100 MACH FOR ADD/REDUCED PREMATURELY ANTICIPATING SLOPE  
 INTERCEPTION. IN-CLOSE. LSO CALLED FOR 6 AS ACFT RAPIDLY SETTLED. INITIATED W/O LIGHTS. FULL PWR. ROTATED  
 MODE. RAMP IMPACTED BY TAILHOOK 6 API BELLY PAN (PUS 37A 593). WALTER. COMIS VERY STIFF. CLB TO VFR ON TOP  
 • SLOW PLY TEST SUBDUCE TO DIVERSE. WINGMAN HEPT MUCH BAR UNDERSIDE ACFT APT. LOW OIL LIGHT. FLUCTUATING  
 DIE PRESSURE. INS VIBS. PIECES COME OUT TAILPIPE. EGT 0 FLITE/HELD RESUCE. ACFT LOST 0 SEA. INVED DEVELD NO  
 HORIZON. BLACK NIGHT. 12C FT OVERCAST. PLY RUSHED IN EARLY STAGES OF APPR. CONTROLLING LSO (TRAINING) DID  
 NOT RECOGNIZE IMPENDING RAMP STRIKE & INITIATE W/O ALING & PWR CALLS GIVEN DURING APPR. SUPV LSO FAILED TO  
 INITIATE W/O ACTION. CAUSE: OTHER PERS- CONTROLLING- LSO (CONTROLLING & SUPV). PLY- ATTEMPTED SLOW POOR  
 APPR. POOR PWR MANAGEMENT. OVERROTATE ON W/O.

"POSSIBILITY THAT LSO (CONTROLLING OR BACKUP) COULD HAVE PREVENTED MIDRAMP"



DEFINITELY  
NO CHANGE

DEFINITELY  
SHOULD HAVE

"POSSIBILITY THAT IMPROVED TRAINING AND/OR ADDITIONAL EXPERIENCE COULD HAVE HELPED THE LSO(S) TO BETTER HANDLE SITUATION"



DEFINITELY  
NO HELP

DEFINITE  
HELP

- WAVEOFF DECISION
  - RECOGNIZING DEVIATIONS
  - TIMELY/CORRECT CALLS
  - LSO SCAN
  - KNOWLEDGE (PROCEDURES, RULES, LIMITS, AIRCRAFT, ETC.)
  - PLATFORM TEAM INTERACTION
  - COORDINATION W/CATCC, PRIFLY
  - MOVLAS
  - AIRCRAFT MALFUNCTION
  - AIRCRAFT CONFIGURATION
- DECK MOTION
  - NIGHT ENVIRONMENT
  - NON-OPTIMUM W/O
  - NO HORIZON
  - LOW PILOT EXPERIENCE
  - POOR PILOT RESPONSE
  - BOARDING PRESSURE
  - CLEAR/FOUL DECK
  - BARRICADE
  - CLASSIC TREND

(6)

A-7A NIGHT RANGER NOV '76 "A" DAMAGE \$1,518,000 (USNR)

NIGHT RAMP STRIKE/EJT, WOBDO APPR ON WING OF 300 ACFT, CCA, DROPPED OFF ON BALL @ 3/4 MILE. LITTLE LOW @ START/PORT LINE-UP. CONTINUE LOW, OVERSHOOT LINE-UP TO STD. PWR INCREASE HEARD AS LSO (GUARD TREE) PWSH  
"SET ER BACK UP". STD TO PORT, CLB TO SLOPE. DURING FINAL LINE-UP TO STD. LSO CALLED "OK, DON'T GO THRU, FLY IT DOWN". IMMED. LARGE PWR REDUCTION, RAPID SETTLE, NOSE LOWERED, RAMP IMPACTED, PMLG COLLAPSE. SLID UP DECK AFORE. PORT WING DOWN. EJT PRIOR DEPART FLY DECK. CHUTE SEEN TO BLOSSOM, INTO WATER, MELD SWIMMER  
UNABLE LOCATE PLY OR REACH RISERS. BOTH PLY/ACFT LOST @ SEA. INVES REVL'D BLACK, NO MORIZ NIGHT, DECK PITCH  
"CORRECT". UNP HAD FAIL PRIOR LAUNCH I MIT REPL. ONLY ABLE READ GUARD AFTER CAT LAUNCH. ENTER LAN PATTERN.  
PLY FUCH JET/COMBAT EXPERIENCE. HOWEVER, SCANTY THIS ACFT I CV LAN, 300 MRS). LSO USED NON-STD MATOPS  
PARADELOGY FOR READY GLIDE PATH NOR INITIATED TIMELY W/O. CAUSES! OTHER PERS- CONTROLLING- LSO, PLY-  
GLIDELOPE CONT. PWR MANAGEMENT.

(25)

PLYOT EXPERIENCE: TOTAL ABUES - 2997  
 Q/N 17 LANINGS - 16/8

"POSSIBILITY THAT LSO (CONTROLLING OR BACKUP) COULD HAVE PREVENTED MISHAP"



DEFINITELY NO CHANCE SHOULD HAVE

"POSSIBILITY THAT IMPROVED TRAINING AND/OR ADDITIONAL EXPERIENCE COULD HAVE HELPED THE LSO(S) TO BETTER HANDLE SITUATION"



DEFINITELY NO HELP DEFINITE HELP

- WAVEOFF DECISION
- RECOGNIZING DEVIATIONS
- TIMELY/CORRECT CALLS
- LSO SCAN
- KNOWLEDGE (PROCEDURES, RULES, LIMITS, AIRCRAFT, ETC.)
- PLATFORM TEAM INTERACTION
- COORDINATION W/CATCC, PRIFLY
- MOVLAS
- AIRCRAFT MALFUNCTION
- AIRCRAFT CONFIGURATION
- Non Standard Calls
- DECK MOTION
- NIGHT ENVIRONMENT
- NON-OPTIMUM W/O
- NO HORIZON
- LOW PILOT EXPERIENCE
- POOR PILOT RESPONSE
- BOARDING PRESSURE
- CLEAR/FOUL DECK
- BARRICADE
- CLASSIC TREND
- LSO Talkdown

F-48 NIGHT KENNEDY AUG '72 "C" DAMAGE \$300,000

TAILHOOK NOT BAMP DURING WTE CV LANDING, ACFT WAS VECTORED BY CCA TO FINAL AT 8 MILES. AT 3 MILES ACFT  
 ATTEMPTED TO SWIVEL. PLY SIPPED PRESSURE. SCHEDULED ALL A REPORTED AS 1000 C/L. WEIMR 2-3 MILES. SHIP'S  
 DEEP LINES WERE TURNED ON. PLY MADE LINE UP CONNECTION. AT 3/4 MILE. CONTROLLER REPORTED ACFT ON C/L &  
 SLIGHTLY BELOW C/S. PLY REPORTED "WALL" AS ACFT BEGAN TO SETTLE. PWR WAS ADDED & WALL WAS CENTERED. PWR  
 WAS DECREASED & ACFT BEGAN TO SWIVEL. PLY REQUESTED RED BALL TO AIR W/PTXED OUT TO VERIFY THE RED BALL.  
 RED THEN LANDED AT 2/3 DECREASING W/LOD 129. ETS. RED CALLED "DELETING" TWICE TO PLY & TRAINEE LSO GAVE 1ST  
 POWER CALL 3 SEC FROM BAMP FOR BY 2 MORE POWER CALLS. THE 3RD POWER CALL WAS FOR BY W/D LINES 12 SEC PRIOR  
 TO 1/20. PLY HAD 100% PWR AT ON JUST AFTER HOOK IMPACTED BAMP. ACFT ENGAGED IN WIRE. PLY HAD ONLY BEEN  
 ADVISED CV 60 WPS FOR AN EXTENDED FLI FROM CUNYSSI HAD FLOWN ONLY 2 DAY FLTS WITH DIFF SIGS PRIOR TO MISHAP  
 1 3 WPS SINCE LAST CCA FLOWN. CONTINUED SUPERVISOR CO-INTEGRATED APPRAISAL OF FACTORS PRIOR TO SCHED FLT FOR  
 THIS FLTY AIR WING-IMAGED PLY-TO-LSO IDENT PROCEDURES; LSO-ALLOWED PLY TO CONTINUE APPROCH BEYOND  
 ACCEPTABLE RECOVERY PARAMETERS & FAILURE TO IDENTIFY PLY WHEN APPROCH BEGAN PLY-LANDING TECHNIQUE. (5)

"POSSIBILITY THAT LSO (CON/ROLLING OR BACKUP) COULD HAVE PREVENTED MISHAP"



DEFINITELY  
NO CHANCE

"POSSIBILITY THAT IMPROVED TRAINING AND/OR ADDITIONAL EXPERIENCE COULD HAVE HELPED THE LSO(S) TO BETTER HANDLE SITUATION"



DEFINITELY  
NO HELP

WAVEOFF DECISION  
 RECOGNIZING DEVIATIONS  
 TIMELY/CORRECT CALLS

LSO SCAN  
 KNOWLEDGE (PROCEDURES, RULES, LIMITS, AIRCRAFT, ETC.)  
 PLATFORM TEAM INTERACTION  
 COORDINATION W/CATCC, PRIFLY  
 MOVLAB  
 AIRCRAFT MALFUNCTION  
 AIRCRAFT CONFIGURATION

DECK MOTION  
 NIGHT ENVIRONMENT  
 NON-OPTIMUM WOOD  
 NO HORIZON  
 LOW PILOT EXPERIENCE  
 POOR PILOT RESPONSE  
 BOARDING PRESSURE  
 CLEAR/FOUL DECK  
 BARRICADE  
 CLASSIC TREND  
 Low Pilot Proficiency

F-14A NIGHT NIMITZ OCT'77 "A" DAMAGE \$13,997,000

WTE BWP STRIKE-CREW EJECTED AS ACFT CONTINUED UP DECK. ACFT STRUCK PARKED HELO. ACFT DEPARTED MARSHAL FOR CASE 3 RECOVERY. NO PRECISION RADAR AVAIL. PLY FLEW ASR APPROX. PLY OVER-CONTROLLED A LOW SLOW IN THE HIBBLE; A LITTLE HIGH, NOSE DOWN IN CLOSE, VERY COCKED UP COMING DOWN AT THE RAMP. RIO INITIATED CRO EJT AS ACFT CONTINUED UP DECK. RIO LANDED ON PLY DECK. PILOT PICKED UP FROM WATER BY HELO. THE ACFT HAD BEEN CLEARED FOR A TACAN APPROCH. WX WAS CLEAR. STEADY DECK WITH NO MOON OR VISIBLE HORIZON. FINAL CONTROLLER FAILED TO GET A LOCK-ON WITH SP4 42. PLY WAS ANTICIPATING A CCA WHEN IN CLOSE. THE SP4-41 (ILSI) WAS DOWN. ACFT'S ABILITY TO DISPLAY ILS WAS ALSO IMPERATIVE. THE SP4-43 (APPROCH RADAR) WAS NOT OPERATING PROPERLY. THE PLY BECAME CONFUSED, WAS BEHIND ACFT THRU-OUT APPROCH, CONTRIB: PLY-LANDING TECHNIQUE-INEFFECTIVE POWER REDUCTION IN-CLOSE; LSO-FAILED TO WAVEOFF ACFT IN A TIMELY MANNER. (5)

*Pilot experience: TOTAL HOURS - 476  
 2/IN FLY LANDINGS - 31/6*

"POSSIBILITY THAT LSO (CONTROLLING OR BACKUP) COULD HAVE PREVENTED MISHAP"



DEFINITELY NO CHANCE SHOULD HAVE

"POSSIBILITY THAT IMPROVED TRAINING AND/OR ADDITIONAL EXPERIENCE COULD HAVE HELPED THE LSO(S) TO BETTER HANDLE SITUATION"



DEFINITE NO HELP

- WAVEOFF DECISION
  - RECOGNIZING DEVIATIONS
  - TIMELY/CORRECT CALLS
  - LSO SCAN
  - KNOWLEDGE (PROCEDURES, RULES, LIMITS, AIRCRAFT, ETC.)
  - PLATFORM TEAM INTERACTION
  - COORDINATION W/CATCC, PRIFLY
  - MOVLAS
  - AIRCRAFT MALFUNCTION
  - AIRCRAFT CONFIGURATION
- DECK MOTION
  - NIGHT ENVIRONMENT
  - NON-OPTIMUM WOD
  - NO HORIZON
  - LOW PILOT EXPERIENCE
  - POOR PILOT RESPONSE
  - BOARDING PRESSURE
  - CLEAR/FOUL DECK
  - BARRICADE
  - CLASSIC TREND
  - Shipboard Failure

F-4J DUSK KITTY HAWK APRIL '72 "C" DAMAGE \$477,000

WAS ON LOW AT DUSK. FLT WAS ON 2ND COMBAT FLT OF THE DAY, WE WAS POOR & ALSO ON HIGH OF INST FLT. ACFT  
 BELIEVED TO BE 1000 FT. 2. APPROX. ACFT WAS AT 20 MILES WHEN FLI WAS ADVISED THAT APPROX WAS 2000-  
 3000 FT. ACFT BEGAN APPROACH 1000 FT LEFT OF C/L AT 20 MILES. ACFT BROKE OUT OF DESCENT AT 800 FT.  
 ACFT SETTLED LOW & TO THE RT AT 3/4 MILE. CORRECTED BACK & CLIMB VERY HIGH IN CLOUDS. NO WAVEOFF WAS GIVEN.  
 FLI LINGERED WITH CROSSING THE HAMP & STARTED A RAPID RATE OF DESCENT WHILE BRIFING RT TO LEFT. ACFT L/O  
 ON BY 100 FT. PAST TIME WAS 1000 FT FROM HAMP. DAN INCURRED TO PORT INSD & OUTSD FLAPS, BING  
 SPASMS WERE OVERSTRESSED. INSD NEWLY FLT'S WAS TERRIBLE PERFORMANCE WAS A/B TO BELIEVE AND EXCEPT TABLE TOPS.  
 FLI DID NOT CANCEL IN THE HAMP. FLI CANCELLED IN SOON ON HIS 2ND ATTEMPT. HIS OVERALL CY PERFORMANCE WAS  
 POOR ACCORDING TO LSO'S ANALYSIS REPI. WE AT TIME OF RECOVERY WAS POOR. RAIN WAS VERY HEAVY. CONTRIBUTED OVP  
 -CCA PLAS (POOR LINE UP) LSO (PALE TO W/O ACFT) FLT (LACK TECHNIQUE). WX-ENVIRON. (FD)

"POSSIBILITY THAT LSO (CONTROLLING OR BACKUP) COULD HAVE PREVENTED MISAP"



DEFINITELY  
NO CHANGE

"POSSIBILITY THAT IMPROVED TRAINING AND/OR ADDITIONAL EXPERIENCE COULD HAVE HELPED THE LSO(S) TO BETTER HANDLE SITUATION"



DEFINITELY  
NO HELP

- WAVEOFF DECISION
- RECOGNIZING DEVIATIONS
- TIMELY/CORRECT CALLS
- LSO SCAN
- KNOWLEDGE (PROCEDURES, RULES, LIMITS, AIRCRAFT, ETC.)
- PLATFORM TEAM INTERACTION
- COORDINATION W/CATCC, PRIFLY
- MOV/LAS
- AIRCRAFT MALFUNCTION
- AIRCRAFT CONFIGURATION
- DECK MOTION
- NIGHT ENVIRONMENT
- NON-OPTIMUM WOB
- NO HORIZON
- LOW PILOT EXPERIENCE
- POOR PILOT RESPONSE
- BOARDING PRESSURE
- CLEAR/POUL DECK
- BARRICADE
- CLASSIC TREND
- Low Pilot Skill (Known)
- WX/Rain

F-4J NIGHT SARATOGA AUG '78 "C" DAMAGE \$477,000

NITE CV LAN. MOVLSA RECOVERY LSO COMMENTS: ON. LITTLE HIGH AT RAMP. THREE WIRE. DECK CONDITIONS: 20-22  
 ETS ARIAL WIND. DECK AT LEVEL PITCH. ONE HALF DEG STDD LIST. DECK LIGHTING NORMAL. PORT W/ATE-HEAVY TIRE  
 BLOWN ON TOUCHDOWN. PORT WING-SPAR DAM DISCOVERED ON TURN-AROUND INSP. CAUSE FACTORS: 1-CONTROLLING LSO'S  
 FAILURE TO RECOGNIZE A POTENTIALLY HAZARDOUS SITUATION, DIRECTED THE PILOT TO FLY A STEEPER THAN OPTIMUM  
 SLIDE-SLOPE. RESULTING IN HARD LANDING. 121-FACILITIES-ELECTRICAL POWER FAIL TEMPORARILY FORCED USE OF  
 MOVLS UNDER LIGHT WIND CONDITIONS. (42)

PILOT EXPERIENCE: TOTAL HOURS - 3061.  
 D/N F4 LANDINGS - 145/62

"POSSIBILITY THAT LSO (CONTROLLING OR BACKUP) COULD HAVE PREVENTED MISHAP"



"POSSIBILITY THAT IMPROVED TRAINING AND/OR ADDITIONAL EXPERIENCE COULD HAVE HELPED THE LSO(S) TO BETTER HANDLE SITUATION"

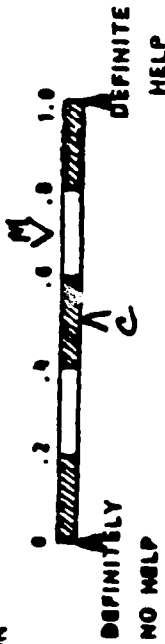

- |   |   |
|---|---|
| <input type="checkbox"/> WAVEOFF DECISION   | <input type="checkbox"/> DECK MOTION                |
| <input type="checkbox"/> RECOGNIZING DEVIATIONS   | <input type="checkbox"/> NIGHT ENVIRONMENT          |
| <input type="checkbox"/> TIMELY/CORRECT CALLS   | <input checked="" type="checkbox"/> NON-OPTIMUM WOD |
| <input type="checkbox"/> LSO SCAN   | <input type="checkbox"/> NO HORIZON                 |
| <input checked="" type="checkbox"/> KNOWLEDGE (PROCEDURES, RULES, LIMITS, AIRCRAFT, ETC.) | <input type="checkbox"/> LOW PILOT EXPERIENCE       |
| <input type="checkbox"/> PLATFORM TEAM INTERACTION  | <input type="checkbox"/> POOR PILOT RESPONSE        |
| <input type="checkbox"/> COORDINATION W/CATCC, PRIFLY                                     | <input type="checkbox"/> BOARDING PRESSURE          |
| <input checked="" type="checkbox"/> MOVLS   | <input type="checkbox"/> CLEAR/FOUL DECK            |
| <input type="checkbox"/> AIRCRAFT MALFUNCTION   | <input type="checkbox"/> BARRICADE                  |
| <input type="checkbox"/> AIRCRAFT CONFIGURATION   | <input type="checkbox"/> CLASSIC TREND              |



TA-4J DAY LEXINGTON JAN '76 "C" DAMAGE \$122,000

STUDENT GIVEN IN-CLOSE FOUL DECK W/O ACFT LEVELED OFF OVER RAMP, BUT WITH ROTATION ON W/O HOOK ENGAGED MRS WIRE IMPLY. NOSE GEAR COLLAPSED ON T/O. CAUSE FACTOR, OTHER PERS CONTROLLING-LSO UNDER TRNG FAILED TO GIVE TIMELY W/O SIGNAL TO STUDENT. SENIOR LSO FAILED TO EVALUATE EXISTING SITUATION & TAKE TIMELY CONTROL OF

ACFT. EXPERIENCE: TOTAL HOURS - 264  
 CV-22S IN 44 - 2/0

"POSSIBILITY THAT LSO (CONTROLLING OR BACKUP) COULD HAVE PREVENTED MISHAP"



DEFINITELY NO CHANCE  
 DEFINITELY SHOULD HAVE

"POSSIBILITY THAT IMPROVED TRAINING AND/OR ADDITIONAL EXPERIENCE COULD HAVE HELPED THE LSO(S) TO BETTER HANDLE SITUATION"



DEFINITELY NO HELP  
 DEFINITE HELP

- WAVEOFF DECISION
- RECOGNIZING DEVIATIONS
- TIMELY/CORRECT CALLS
- LSO SCAN
- KNOWLEDGE (PROCEDURES, RULES, LIMITS, AIRCRAFT, ETC.)
- PLATFORM TEAM INTERACTION
- COORDINATION W/CATCC, PRIFLY
- MOVLAS
- AIRCRAFT MALFUNCTION
- AIRCRAFT CONFIGURATION
- DECK MOTION
- NIGHT ENVIRONMENT
- NON-OPTIMUM W/O
- NO HORIZON
- LOW PILOT EXPERIENCE
- POOR PILOT RESPONSE
- BOARDING PRESSURE
- CLEAR/FOUL DECK
- BARRICADE
- CLASSIC TREND

5 FATAL  
12 MAJOR INJURY

A-6A NIGHT MIDWAY OCT '72 "A" DAMAGE \$3,712,000

201800Z OCT 72. LOSS STOOD WHEEL/AIRL NIGHT LV LAN. CRASH INTO PACK. ACFT MADE APPROX 1114 2 MINS MX-82 BOMBS  
 STRUCK HIGH STAS 3 6.0 WITH T/O @ 35072 LBS GROSS WT. WIND DOWN AIRL & ELS. T/O. OLD DEG REL. SOME DECK  
 PITCH. SMALL LING AHEAD. JUST PRIOR T/O, SINK RATE INCREASED, DECK RISING. T/O STOOD WHEEL FIRST. WHEEL  
 SEP. IMMED. STRUT ENGAGED @ COP. ACFT VISEMABLE COP. SKIDDED PUNT WING P/D UP AIRL INTO PACK. B/W EJI  
 PRIOR IMPACTING 1ST ACFT. UNSUCCESSFUL SAM. ENGS SECURED. FLT EGRESS IMMEDIATE SIDE CPY. 1ST ACFT  
 IMPACTED 1740 ONY LOST OVERW. AT 1745 390. 319. 343. 390 C DAN. 340 214 D DAN. 340 060 E DAN. INVES DEVLG  
 BLACK HITTING HORIZ. BALL @ 1/2 HIGH IN CLUDG WHEN PWR REDUCED AS FLT INSTANT L30 CALLED HIGH WHEN IN FACT  
 O/D CALLED YOU'RE HIGH. B/W 3RD PISTON @ ARLE FRAGS REVLG FAILURE USE DENING @ 3RD OVERSRESSI NEAR  
 TREATMENT SATISFACTORY NO FATIGUE. PHYSICAL DAN OR CORROSION CONTRIBUT TO FAILURE. CAUSE HANG ORD NOT REPT.  
 WIND AT TIME OF LAN WITHIN LIMITS NOT VERY NEAR THE HAZ. ADEQUATE ADVANCED WARNING BY L30 THAT WING COMPLY  
 UNACCEPTABLE. A TIMELY DECISION BY AIR OFFICER UR L30 TO W/O ACFT IN ADAPT NUM. FAVORABLE WIND COMDITS  
 COULD HAVE PREVENTED ACFT. CAUSES: UTMER PERS- SUPV- FLT CONTROLLING- AIR OFFICER. O/P- CONTROLLING- L30.  
 P/L- IMPROVE PWR MANAGEMENT. EXCESS SINK RATE.

Damage to other Aircraft NOT INCLUDED IN STUDY.

"POSSIBILITY THAT L30 (CONTROLLING OR BACKUP) COULD HAVE PREVENTED MISHAP"



DEFINITELY NO CHANCE  
 DEFINITELY SHOULD HAVE

"POSSIBILITY THAT IMPROVED TRAINING AND/OR ADDITIONAL EXPERIENCE COULD HAVE HELPED THE L30(S) TO BETTER HANDLE SITUATION"



DEFINITELY NO HELP  
 DEFINITE HELP

- WAVEOFF DECISION
- RECOGNIZING DEVIATIONS
- TIMELY/CORRECT CALLS
- LSO SCAN
- KNOWLEDGE (PROCEDURES, RULES, LIMITS, AIRCRAFT, ETC..)
- PLATFORM TEAM INTERACTION
- COORDINATION W/CATCC, PRIFLY
- MOVLAS
- AIRCRAFT MALFUNCTION (ORD)
- AIRCRAFT CONFIGURATION
- DECK MOTION
- NIGHT ENVIRONMENT
- NON-OPTIMUM WOD
- NO HORIZON
- LOW PILOT EXPERIENCE
- POOR PILOT RESPONSE
- BOARDING PRESSURE
- CLEAR/FOUL DECK
- BARRICADE
- CLASSIC TREND

F-4B NIGHT CORAL SEA JAN '72 "C" DAMAGE \$300,000

HAND WIFE CV LANDING, ACFT WENT SLIGHTLY HIGH AT DMR. AT 3/4 MILE PLY TRANSITIONED TO VISUAL APPROACH. LSO CALLED AT TOP LINE UP. ACFT WAS SLIGHTLY LOW & TURN MADE ACFT SKIPPED. PLY CORRECTED WITH 100 MACH PWR. BALL WENT HIGH & PLY DROPPED WING & SET UP HIGH DIVE RATE RESULTING IN SUBSTANTIAL DAM TO THE PORT WING. LSO WAS BEING 3.5 DEG CLIMB-SLOPE VICE 0 DEG DUE TO LOW WOB. PASS HAD STARTED SLIGHTLY ERRATIC BECAUSE OF VARIOUS PROBING AND GIVEN BY CDR. CVA ALSO HAD A FORWARDING APPEAL. CONTINUED ISLANDING RESUMING. LSO FAILED TO RECOGNIZE THAT APPROCH HAD EXCEEDED ACCEPTABLE PARAMETERS & FAILED TO INITIATE A WAVE-OFF. (A)

"POSSIBILITY THAT LSO (CONTROLLING OR BACKUP) COULD HAVE PREVENTED MISHAP"

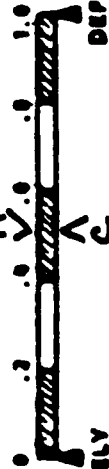

DEFINITELY  
NO CHANCE

DEFINITELY  
SHOULD HAVE

"POSSIBILITY THAT IMPROVED TRAINING AND/OR ADDITIONAL EXPERIENCE COULD HAVE HELPED THE LSO(S) TO BETTER HANDLE SITUATION"



DEFINITELY  
NO HELP

DEFINITE  
HELP

WAVEOFF DECISION

RECOGNIZING DEVIATIONS

TIMELY/CORRECT CALLS

LSO SCAN

KNOWLEDGE (PROCEDURES, RULES, LIMITS, AIRCRAFT, ETC.)

PLATFORM TEAM INTERACTION

COORDINATION W/CATCC, PRIFLY

MOV/LAS

AIRCRAFT MALFUNCTION

AIRCRAFT CONFIGURATION

DECK MOTION

NIGHT ENVIRONMENT

NON-OPTIMUM WOB

NO HORIZON

LOW PILOT EXPERIENCE

POOR PILOT RESPONSE

BOARDING PRESSURE

CLEAR/FOUL DECK

BARRICADE

CLASSIC TREND

"Carrier Fish tailing"

TA-4J DAY LEXINGTON MAY '78 "C" DAMAGE \$122,000

IMPLY ENGAGEMENT RESULTED WHEN STUDENT OVERROTATED A/C DURING CLOSE IN W/O. PLAY VIDEO TAPE CLEARLY SHOWED A SAFE APPR LINED UP LEFT ALL THE WAY. LSO TOLD STUDENT "CK YOUR LINE-UP" AS A/C APPROACHED CLOSE-IN POSIT A LITTLE LOW. DECELERATING SLIGHTLY & LINED UP 8-10' LT. LSO GAVE A PAR CALL THEN RIGHT FOR LINE-UP. PLY RESPONDED SLOWLY FOR ERRORS IN BOTH LINE-UP & GLIDE SLOPE. LSO'S DECISION TO CONTINUE WORKING STUDENT THIS LATE IN APPR IS QUESTIONABLE. INEVES ALSO REVL'D THAT STUDENT SHIFTED HIS SCAN FROM THE PRESMET CEN'S TO THE PLY DECK AT THE CRITICAL PHASE OF HIS APPR-EXECUTING A W/O-HIS IMPROPER W/O TECHNIQUE CAUSED IMPLY APPERT & SUBO FAILURE OF MLDG. CAUSAL FACTORS: PLY-STUDENT'S POOR CV LAN TECHNIQUE-NOT LINED UP-IMPROPER SCAN AND OVERROTATED. PROB CONTRIB. LSO-FAILED TO SIGNAL TIMELY W/O.

ESTIMATED TOTAL HOURS - 255  
 LV 6825 2V 4V - 0

"POSSIBILITY THAT LSO (CONTROLLING OR BACKUP) COULD HAVE PREVENTED MISHAP"



DEFINITELY NO CHANCE  
 DEFINITELY SHOULD HAVE

"POSSIBILITY THAT IMPROVED TRAINING AND/OR ADDITIONAL EXPERIENCE COULD HAVE HELPED THE LSO(S) TO BETTER HANDLE SITUATION"



DEFINITELY NO HELP  
 DEFINITE HELP

- WAVEOFF DECISION
- RECOGNIZING DEVIATIONS
- TIMELY/CORRECT CALLS
- LSO SCAN
- KNOWLEDGE (PROCEDURES, RULES, LIMITS, AIRCRAFT, ETC.)
- PLATFORM TEAM INTERACTION
- COORDINATION W/CATCC, PRIFLY
- MOVLAS
- AIRCRAFT MALFUNCTION
- AIRCRAFT CONFIGURATION
- DECK MOTION
- NIGHT ENVIRONMENT
- NON-OPTIMUM WOD
- NO HORIZON
- LOW PILOT EXPERIENCE
- POOR PILOT RESPONSE
- BOARDING PRESSURE
- CLEAR/FOUL DECK
- BARRICADE
- CLASSIC TREND

A-7E NIGHT LEXINGTON NOV '72 "A" DAMAGE \$2,874,000

200900Z NOV 72. NIGHT RAMP STRIKE/EJI. CARWAL PLY CALLED BALL 3/4 MILE. SKITTLED BELLOW SLOPE. LSO MADE 2  
 APPROX ADVISING LOW, 312 SECONDS ELAPSED DURING WHICH TIME A LOW FLAT APPR CONFINED WITH NO LSR ENDSMS.  
 THREE SECONDS PRIOR TO RAMP, ALPT ALTITUDE REDUCED 6/ON PWR REDUCED CAUSING FUMINEN SETTLE. LSO CALLED FOR  
 PWR. W/O PWR. FULL PWR APPLIED. NOSE ROTATED ABOVE LAN ADA. IMPACT WITH RAMP. CONTINUE UP ANGLE DECK.  
 PLY EJI/HELLO RESCUE. ACFT W/SCAPE ANIME. REMAINED IN FLT 32 MINUTES PRIOR IMPACT WATER/LOST 0 SEA, INVES  
 REULD FLT HISTORY ABOVE-AVERAGE FCLPI PREVIOUS 0 DAY CV LANS LOW OR UNDERPOWERED 0 RAMP ON 4 OF 0 APPRS.  
 WATER W/ TO REQUIRED DAY LANS TO 0 PRIOR TO NIGHT DUALS NOT WARRANTED WUE LOW/UNDERPOWERED TENDENCY. LSO  
 ADVISED APPR TO CONTINUE BELLOW OPTIMUM SLOPE TO A POINT INSIDE SAFE W/O POSIT. CAUSES: OTHER PERS- SUPV-  
 SOP TRAINING (LSO)- UNWARRANTED WAIVER OF DAY LAN REQUIREMENTS. O/P- CONTROLLING- LSO- FAILURE TO INITIATE  
 W/SC PLY- POOR PWR MANAGEMENT. IMPROPER SCAN. (63)

"POSSIBILITY THAT LSO (CONTROLLING OR BACKUP) COULD HAVE PREVENTED MISHAP"



DEFINITELY NO CHANCE  
 DEFINITELY SHOULD HAVE

"POSSIBILITY THAT IMPROVED TRAINING AND/OR ADDITIONAL EXPERIENCE COULD HAVE HELPED THE LSO(S) TO BETTER HANDLE SITUATION"

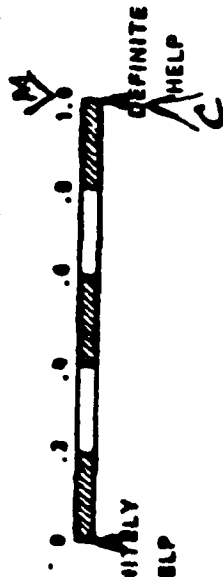

DEFINITELY NO HELP  
 DEFINITE HELP

WAVEOFF DECISION

RECOGNIZING DEVIATIONS

TIMELY/CORRECT CALLS

LSO SCAN

KNOWLEDGE (PROCEDURES, RULES, LIMITS, AIRCRAFT, ETC.)

PLATFORM TEAM INTERACTION

COORDINATION W/CATCC, PRIFLY

MOVLAS

AIRCRAFT MALFUNCTION

AIRCRAFT CONFIGURATION

DECK MOTION

NIGHT ENVIRONMENT

NON-OPTIMUM WOD

NO HORIZON

LOW PILOT EXPERIENCE (in type)

POOR PILOT RESPONSE

BOARDING PRESSURE

CLEAR/FOUL DECK

BARRICADE

CLASSIC TREND

LSO Complacency for high level of prior experience

TA-4J DAY LEXINGTON MAY '78 "C" DAMAGE \$122,000

IMPLY ENGAGEMENT RESULTED WHEN STUDENT OVERRATED A/C DURING CLOSE IN W/O. FLAT VIDEO TAPE CLEARLY SHOWED A SAFE APPR LINED UP LEFT ALL THE WAY. LSO TOLD STUDENT "OK YOUR LINE-UP" AS A/C APPROACHED "CLOSE-IN POSTY" A LITTLE LOW. DECELERATING SLIGHTLY & LINED UP 8-10° LT. LSO GAVE A PWR CALL THEN RIGHT FOR LINE-UP. PLY RESPONDED SLOWLY FOR ERRORS IN BOTH LINE-UP & CLINE SLOPE. LSO'S DECISION TO CONTINUE WORKING STUDENT THIS LATE IN APPR IS QUESTIONABLE. INVES ALSO REYLD THAT STUDENT SHIFTED HIS SCAN FROM THE FRESHET CENSTO THE PLY DECK AT THE CRITICAL PHASE OF HIS APPR-EXECUTING A W/O-HIS IMPROPER W/O TECHNIQUE CAUSED IMPLY APPERT & SUBO FAILURE OF WLOG. CAUSAL FACTORS: PLY-STUDENT'S POOR CV LAN TECHNIQUE-NOT LINED UP-IMPROPER SCAN AND OVERRATED. PROB CONTRIB. LSO-FAILED TO SIGNAL TIMELY W/O.

REFERENCE: TOTAL WLOGS - 255  
LV 6625 MAY - 0

"POSSIBILITY THAT LSO (CONTROLLING OR BACKUP) COULD HAVE PREVENTED MISHAP"



DEFINITELY  
NO CHANGE

DEFINITELY  
SHOULD HAVE

"POSSIBILITY THAT IMPROVED TRAINING AND/OR ADDITIONAL EXPERIENCE COULD HAVE HELPED THE LSO(S) TO BETTER HANDLE SITUATION"



DEFINITELY  
NO HELP

DEFINITE  
HELP

- WAVEOFF DECISION
- RECOGNIZING DEVIATIONS
- TIMELY/CORRECT CALLS
- LSO SCAN
- KNOWLEDGE (PROCEDURES, RULES, LIMITS, AIRCRAFT, ETC.)
- PLATFORM TEAM INTERACTION
- COORDINATION W/CATCC, PRIFLY
- MOVLAS
- AIRCRAFT MALFUNCTION
- AIRCRAFT CONFIGURATION
- DECK MOTION
- NIGHT ENVIRONMENT
- NON-OPTIMUM WOB
- NO HORIZON
- LOW PILOT EXPERIENCE
- POOR PILOT RESPONSE
- BOARDING PRESSURE
- CLEAR/FOUL DECK
- BARRICADE
- CLASSIC TREND

A-7E NIGHT ENTERPRISE APRIL '76 "A" DAMAGE \$2,874,000 2 FATAL

NIGHT RAMP STRIKE. CO PLY GIVEN CCA HANDOFF TO INITIAL PASS. SEVERAL SLOPE/PWR/LINEUP CALLS BY LSO. AFTER IN-CLOSE PASSED, STBO PWR LINEUP CALL. LSO OBSR DECEL & SETTLE. CALLED FOR PWR, NO RESPONSE. CONTINUE ROSE HIGH. SLIGHT STBO WING DOWN DESCENT, M/G IMPACTED PAMP SHEARING SWLG. ACFT CONTINUED FWD ALONG AXIAL AFIRE . PLY EJT AREA #2 JBO. ACFT OFF AXIAL, LOST @ SEA. PLY OBSR STRUGGLING WITH SHROUD LINES IN WATER AHEAD STBO SIDE. DELAY SAR HELD OVER PLY DUE TO WINGS IN WATER & MATRIX LIGHT FROM LSO. WHEN SIGHTED SWIFTLY SHUTTER UNABLE FREE SHROUDS. W/ALREADY RESCUE. PLY DROWNED. 1 A INJURY PLY DECK CREWMAN. INVES PLYD PLY TOTAL FLY TIME 21.9 HRS PREVIOUS 90 DAYS. 13.4 HRS PREVIOUS 30 DAYS. PLY COMPLETED 2 T 6 6 PLUS 6 DAY TRAPS OF DAY CO REPTS. WAS HI @1 COP RATE DURING DAY CO. PLY RECF FOR PROVISIONAL DAY QUAL TO PERMIT NIGHT QUAL WITH 6 TRAPS ALTHO DA PASS TRND UNDER POWERED DURING APPR & @ RAMP. CAUSES! OTHER PEPs- SUPV- SOO COMMAND- ALLOWED PROVISIONAL DAY QUAL. O/P- CONTROLLING- LSO- FAILED TO GIVE W/O. PLY- POOR GLIDESLOPE CONTROL.

EXPERIENCE: TOTAL HOURS - 570  
 (VLOS) 17 60

"POSSIBILITY THAT LSO (CONTROLLING OR BACKUP) COULD HAVE PREVENTED MISHAP"



"POSSIBILITY THAT IMPROVED TRAINING AND/OR ADDITIONAL EXPERIENCE COULD HAVE HELPED THE LSO(S) TO BETTER HANDLE SITUATION"

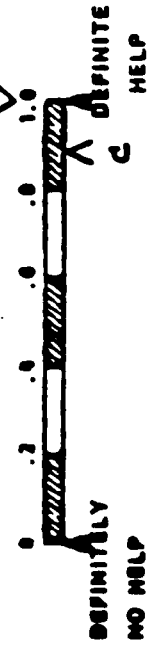

- WAVEOFF DECISION
- RECOGNIZING DEVIATIONS
- TIMELY/CORRECT CALLS
- LSO SCAN
- KNOWLEDGE (PROCEDURES, RULES, LIMITS, AIRCRAFT, ETC.)
- PLATFORM TEAM INTERACTION
- COORDINATION W/CATCC, PRIFLY
- MOVLAS
- AIRCRAFT MALFUNCTION
- AIRCRAFT CONFIGURATION
- "Bubble" (E-boat)
- DECK MOTION
- NIGHT ENVIRONMENT
- NON-OPTIMUM WOB
- NO HORIZON
- LOW PILOT EXPERIENCE
- POOR PILOT RESPONSE
- BOARDING PRESSURE
- CLEAR/FOUL DECK
- BARRICADE
- CLASSIC TREND
- Waiver judgment

## APPENDIX D

## KEY CONCEPTS

This appendix presents an extensive listing of key concepts to be acquired by an LSO trainee. They describe many of the interrelationships among situation cues, decision factors and LSO actions. This listing cannot be considered exhaustive but should provide direction in the continuing definition of LSO training requirements. Categories into which the key concepts have been grouped include:

- Basic
- Pilot
- Profile
- Aircraft
- Malfunction
- Environment
- Operational Situation

## BASIC

As a general voice call strategy, informative calls are used early in an approach and imperative calls are used late in the approach.

A calm and confident sounding "Roger Ball" (or "Paddles Contact") is critical to pilot confidence in LSO. An excitable or unconfident sounding call may have a negative effect on subsequent pilot responsiveness.

LSO can become perceptually "deceived" by a smooth approach with a minor deviation (such as little high). This can negatively affect critical perceptions in close and can also hurt LSO credibility during debrief. This deception can also be brought on by a series of smooth approaches with some deviation. Over a period of time, pilots will try to fly the type of approach that they think the LSO wants to see for an OK grade.

LSO scan breakdown (GS, LU, AOA cues) can lead to drastic deviation in one dimension. A common LSO (and pilot) mistake is excess attention to GS at the expense of LU. Thus the B/U LSO must also be actively involved in the pass and alert to breakdown of controlling LSO scan.

Always use waveoff call and pickle simultaneously when waveoff is required.

LSO (or B/U, or other team member) must always check roll angle, hook-to-ramp, hook-to-eye and wind before each pass.



NAVTRAEQUIPCEN 80-C-0063-2

Inside the normal waveoff point, use waveoff any time deck goes foul and any time 100% power is needed for aircraft to clear ramp (however, the latter may be controversial).

At least one LSO must always be monitoring the radio during a recovery.

LSO has dual waving responsibilities (responsible for safe and expeditious recovery). The safety aspect must never be compromised.

LSO must be alert for a settle on lineup correction. A "power" call prior to the lineup call should be considered when aircraft is approaching in close.

Do not accept an aircraft without an approach light or with a flashing approach light. If possible, ask pilot to check gear or hook (as appropriate) well prior to ball call.

Do not secure from the LSO platform with the lens still on.

Do not let the lens be turned on until assured you have the capability to communicate and to use the pickle.

Try to wave such that the pilot makes his own corrections. When his performance or recovery conditions start deteriorating, you must increase your involvement in the pass.

The waveoff call must be given firmly but calmly. An over-excited call may lead to excessive pitch response from the pilot and an inflight engagement.

Insure pilots are informed when MOVLAS is in use.

MOVLAS must be moved enough to enable pilot discrimination of ball movement.

More LSO calls than usual should be made when MOVLAS is in use with pitching deck conditions.

The LSO must avoid the tendency for a "high eye" when using MOVLAS.

When working MOVLAS, do not delay the waveoff decision. Remember that you are busier than usual.

The B/U LSO should never assume that the controlling LSO will keep aircraft off the ramp or that the controlling LSO has a handle on a lineup deviation. Be prepared (as B/U LSO) to give waveoff.

As controlling LSO, do not become too dependent on aircraft control inputs from B/U LSO.

A fatigued or medically grounded LSO should not be waving or backing up.

**PILOT:**

If LSO notes slow pilot responsiveness approaching in close, use waveoff earlier for critical deviations.

LSO should consider very inexperienced pilot as especially unpredictable, however, LSO should not "lower his guard" for highly skilled or experienced pilots. They will occasionally make critical, unpredictable errors requiring waveoffs.

LSO should never assume that a pilot can salvage an approach without LSO help.

LSO should never assume that pilot will make proper correction for a given deviation.

For a disoriented pilot (i.e. vertigo) or one suffering from fatigue, LSO may have to "climb into cockpit" (i.e. LSO talkdown) to effect a safe recovery (however, do not stay there if you do not have to).

LSO should never assume that the pilot will make correct response to LSO call in close. Be prepared to follow up the call with waveoff.

The quality level of a pilot's past performance (FCLP or CV ops) is no guarantee of the same on any given approach.

Any malfunction which causes a change in the normal pilot habit patterns can degrade the visual portion of the approach (i.e. no TACAN, no needles, no gyro).

Low proficiency in pilots tends to be evidenced by poor starts and overcontrolling everything all the way.

The pilot who experiences more than 2 passes (possibly excluding foul deck waveoffs) to get aboard has a higher probability of making radical corrections in-close to in-the-wires.

For CQ-type "endurexes", the last pass has a good probability of exhibiting some type of "get-aboard-it-is".

Early wires over a period of time by the same pilot is indicative of "deck-spotting".

During CQ, pilot scan is usually slow, therefore, be extremely cautious of multiple deviations in-the-middle to in-close.

LSO should consider moving waveoff point out slightly for a pilot known to be unproficient.

Waveoff point should be moved out for a disoriented or unresponsive pilot.

After about 2 or 3 power calls without sufficient pilot response, the waveoff should be used.

If one attitude call does not get sufficient pilot response, switch to a power call (or waveoff, if needed).

PROFILE:

More ramp strikes occur when pilot is correcting for a high deviation in close than for a low deviation.

For significant multiple deviations in close, a waveoff should be used by the LSO. As a rule of thumb, if 2 major deviations (from among GS, LU, AOA or power) are AFU approaching the waveoff point, use waveoff. This is especially critical with CQ pilot.

For unsettled dynamics (speed, power, wing position, flight vector, pitch) in close, LSO should consider giving a waveoff.

High at the ramp with less than optimum rate of descent can lead to a dangerous long bolter. Do not hesitate to use waveoff.

High at the ramp with excessive rate of descent can easily result in a hard landing.

LSO should never accept a low trend on an approach.

Be prepared for sink rate increases during late lineup corrections.

LSO should not accept a high trend on an approach.

Poor trends leading to the start and at the start are good indicators that the pass is going to be a problem due to pilot disorientation or poor pilot scan.

A poor start frequently leads to overcontrol tendencies in the remainder of the pass.

Be alert for the "moth effect" (drift left in close or at the ramp) due to pilot fixation on the meatball at the expense of lineup control.

NAVTRAEQUIPCEN 80-C-0063-2

During day recoveries, beware of pilot tendency to try to salvage an extremely poor start (i.e. OSX, NESA HFX, HFX, etc.). If not stable approaching in close position, use waveoff.

A major glideslope deviation at the start to in the middle is difficult for the pilot to salvage. Extra LSO assistance may be needed to help pilot get aboard.

**AIRCRAFT:**

If calls are necessary for aircraft with slow engine response (A-7, S-3, F-14), they must be given well prior to glideslope interception when correction is being made for a high deviation.

For aircraft with excellent engine response (A-6, EA-6, F-4), be alert for pilot overcontrol of power. This also includes excessive power reductions following too much power.

For aircraft which have difficult APCS disengagement, waveoff point should be moved out slightly.

Lineup control for "slow movers" (i.e., S-3, E-2) is more critical in shifting wind conditions than for "fast movers."

APCS should not be used in high wind conditions (greater than 35 knots).

Large wingspan aircraft (i.e., E-2, S-3, F-14, etc.) must be on lineup and have little or no drift by the in close position.

For A-7 and F-14, HFIM-IC trend is potentially disastrous due to DEC CD potential.

For A-7, do not allow HCDIC trend. Excess sink rate is difficult to stop with power due to poor engine response.

For A-6, beware of settle on lineup correction when aircraft is LOSLOIC.

For F-4, do not allow significant nose movement and/or power reduction, especially for HIC deviation. An extremely high sink rate can result.

For F-14, in a HNDIC situation with APCS, excessive sink rate will result. Attitude correction will not be adequate, therefore use power call(s).

EA-6B, E-2 and F-14 have long fuselages, therefore potential for inflight engagement.

NAVTRAEQUIPCEN 80-C-0063-2

For A-7, a LOB pass requires critical nose finesse to avoid bolter or ramp strike.

For F-4 and A-7, due to normally high approach speed, must pay close attention to closure under light WOD conditions.

For EA-6B, glideslope control is very sensitive to nose movement. This sensitivity can also lead to a decel.

For S-3, aircraft glideslope control through the "burble" is difficult under high WOD conditions.

For S-3 and F-14, beware of a drop nose in conjunction with DLC activation in close. Excessive sink rate will result.

Lineup corrections are difficult with F-4S due to reduced lateral control effectiveness.

For S-3, use of DLC is good for high deviations and avoiding large power reductions except when approaching "at the ramp" area.

F-4 and EA-3B are very fuel critical due to max trap fuel limitations.

**MALFUNCTION:**

With less than optimum lighting configuration, LSO range discrimination is degraded, thus causing difficulty in determining a safe waveoff point (for both technique and foul deck waveoffs).

For a NORDO aircraft, move waveoff window out.

For a NORDO aircraft, always use voice calls and emergency UHF override anyway, in addition to light signals.

Remain alert for malfunction during ACLS Mode I approach. Smooth trends early in approach are no assurance of successful termination.

For single engine approach, do not accept a poor start.

For an aircraft with only a single light visible, consider having the NFO use his flashlight as an extra reference. Also consider having CATCC or B/U LSO provide range calls.

Whenever time permits, obtain briefing on aircraft malfunction. Try to avoid relying on memory.

Be aware of possible configuration and/or speed differences for an aircraft with a malfunction.

For a malfunction situation with abnormal configuration, always ask the pilot what his approach speed will be (in IAS).

For A-6, flaps can creep up with hydraulic failure.

For abnormal configuration approaches always check to see if a roll angle change is needed.

For S-3, no flap approach waveoff point must be moved out significantly.

For F-14, pilot has to work very hard for a successful single engine approach.

For S-3 and E-2, single engine approach lineup control is difficult due to asymmetric thrust.

For E-2 on single engine approach, decel must be avoided.

On single engine approach, F-4 is underpowered and needs afterburner on waveoff and bolter.

For a single engine landing, the C-1 is faster and should not flare for landing.

For F-4, with loss of BLC or half-flap configuration, approach speed is very high. Therefore WOD requirements are critical.

For E-2, lineup is extremely critical ( $\pm 2\text{-}1/2$  feet) for a barricade recovery.

For S-3, without DLC, nose pitch is very sensitive to power changes.

For F-14, without DLC engaged, aircraft is farther back on power than normal, thus resulting in reduced engine responsiveness.

#### ENVIRONMENT:

With pitching deck conditions, be very hesitant to accept a high deviation in close.

For reduced visibility situation with a late breakout (inside 3/4 mile), LSO must track aircraft positioning and trends with whatever means are available (SPN-42, LSO HUD, listen to CCA calls, etc.) so that there are no surprises and the LSO is prepared to give timely aid to the pilot (or make a timely waveoff decision).

NAVTRAEQUIPCEN 80-C-0063-2

With a high WOD situation (35 knots or more) aircraft dynamics can rapidly deteriorate to a settle in close with only slight power or aircraft attitude changes. Also APCS should not be used in this situation.

With a low WOD situation (less than 25 knots), the high closure rate does not allow much margin for salvaging a come down or settle in-close, therefore, move waveoff window out.

Starboard crosswind causes increased sink rates at the ramp.

Crosswind conditions can cause rapid drift rates in close and at the ramp.

During crosswind conditions be prepared for increased sink rates with late lineup corrections.

When there is no horizon and deck is moving, have plane guard destroyer or helo positioned aft of the ship near final bearing to aid glideslope reference.

When deck is moving, move waveoff window out.

LSO talkdown may be required when pilot visibility is reduced by sun/moon glare, smoke in the groove, rain, canopy fog, etc. If pilot can not see by 1/4 - 1/2 mile, he should waveoff or be waved off.

LSO (or B/U) must continually check closure speed to insure adherence to max engaging speeds, especially under low WOD conditions.

With no visible horizon use dynamic hook-to-ramp indicator to help predict deck pitch cycle; however, remember that there is some lag in the indication.

When deck is moving, LSO must make more voice calls than usual.

With no horizon reference available, use other means (HUD, SPN-42) to insure proper eyeball calibration.

LSO should inform pilot of abnormal WOD conditions.

For WOD greater than 35 knots, a 4.0 degree basic angle should be used. When basic angle is changed, CATCC must be informed.

As a rule of thumb, if 50% or more of the passes are indicative that pilots are "chasing the ball", MOVLAS should be rigged. If stabilization appears good, stick with lens.

When aircraft is lined up left in close, it is easy for the controlling LSO to lose track of deck motion cycle.

NAVTRAEQUIPCEN 80-C-0063-2

Under reduced visibility conditions, the pilot has more difficulty seeing visual landing aids than LSO does seeing aircraft. Be prepared to provide extra assistance.

When deck is moving, be alert for "dutch-roll" which affects lineup as well as glideslope.

When the wind is 30-35 knots and aircraft are landing short, consideration should be given to targeting the number 4 wire.

OPERATIONAL SITUATION:

Do not let low fuel state situation or any other boarding pressure cause you to lessen the safety margin for an approach.

Never press the waveoff decision point, no matter what boarding pressure exists.

For a situation requiring increased need for a trap, give extra aid to pilot earlier than usual in an approach. Work to get aircraft in a "workable" position in close (i.e. more informative calls early).

Do not use calls that can be misinterpreted by the pilot as "go for it" until the ramp is made, no matter what the pressure to get the aircraft aboard.

In high workload situations involving MOVLAS, consider dividing the controlling LSO workload (one with MOVLAS, one with radio).

When supervisory personnel demonstrate confusion or incompetence, LSO must know the rules (i.e. max. engaging speeds, ramp "tap" to divert or barricade, crosswind limits, etc.) and be prepared to assert himself ("hang it out") to insure correct action is taken.

When CCA "loses the bubble" on aircraft control, LSO must be prepared to safely salvage the situation.

Under ZIPLIP/EMCON conditions, safety is still paramount, therefore, do not hesitate to use voice calls as needed.

Do not allow use of platform calls like "wire coming back" and "good chance". They could influence the controlling LSO to press the waveoff point in a foul deck situation.

When directed to wave under obviously unsatisfactory recovery conditions (i.e. insufficient WOD, excessive crosswind, etc.), the pickle can be a very effective tool for aborting the recovery process.



NAVTRAEQUIPCEN 80-C-0063-2

When late wire(s) is missing and roll angle has been changed, do not forget that hook-to-ramp clearance has been reduced.

For barricade engagement, give "cut" call prior to engagement, but only after ramp is made.

For barricade recovery, remember that pilot's view of meatball will be lost temporarily in-close.

For barricade recovery, waveoff point must be moved out significantly.

For barricade recovery, remember that hook-to-ramp clearance is reduced and that basic angle is 4.0 degrees.

For barricade recovery, remember that hook-to-ramp and hook touchdown point are different for each aircraft type.

Use dynamic hook-to-ramp and/or CLASS indicator to help detect out-of-trim condition for ship and its effect on hook-to-ramp clearance and touchdown point.

Avoid allowing a R-L drift particularly when ship has port list.

Avoid allowing a L-R drift particularly when ship has a starboard list.

With a ramp out-of-trim condition, touchdown angle is changed. Try to minimize excess sink rate landings for ramp down condition.

With a starboard side MOVLAS, expect some breakdown in pilot scan.

If the pilot is flying poorly and if CCA is well out of limits, use "Paddles Contact" or directional calls inside 2 miles to help avoid an extremely poor start.

Move the waveoff point out when there are men on deck or aircraft in landing area.

Roll angle changes to move targeted touchdown point should be considered for missing wires and for excessive out-of-trim condition.

CATCC voice calls may indicate that the SPN-42 glideslope is improperly calibrated. Inform them if such is the case.

If closure speed readout is not available on the platform, consider asking for speed calls from Air Boss or CATCC.

For a barricade recovery, check the ship's trim and make appropriate adjustments to targeted touchdown.

NAVTRAEQUIPCEN 80-C-0063-2

For normal recovery ops, on-glideslope hook-to-ramp clearance should never be less than 10 feet.

For a barricade recovery, on-glideslope hook-to-ramp clearance should never be less than 8 feet.

If during a recovery, there are a lot of relatively smooth bolters or early wires, it may be a indication that the ship is out of trim.

Recommend a change in targeted touchdown point when an out-of-trim condition causes a change in touchdown point by about half the distance between wires. Also, when the 4 wire, or 4 and 3 wires are missing.

## APPENDIX E

## PILOT/AIRCRAFT BEHAVIOR MODELS

This appendix describes the pilot and aircraft behavior models resulting from this study. Modelling information for other carrier landing situation factors is also included. The models are intended to provide guidance in the implementation of simulation and control functions for representation of carrier landing situations for LSO training. Table E-1 provides an outline of the models and their elements. The interaction of these models within an LSO training system context are depicted in Figure E-1. The remainder of this appendix provides discussion, tables and figures which describe each of the three modelling areas.

TABLE E-1. OVERVIEW OF MODELS AND ELEMENTS

## PILOT MODEL:

Pilot Response (to LSO)

Approach Profiles

Simple Profiles

Complex Profiles

Critical Outcome Profiles

Background Characteristics

Experience

Proficiency

Skill

Tendencies

Condition

## AIRCRAFT MODEL:

Aircraft Type

Aircraft Status

Malfunctions

Configuration

Approach Mode

Fuel State

## OTHER SITUATION FACTORS:

Environment

Ship

Operations

LSO Station

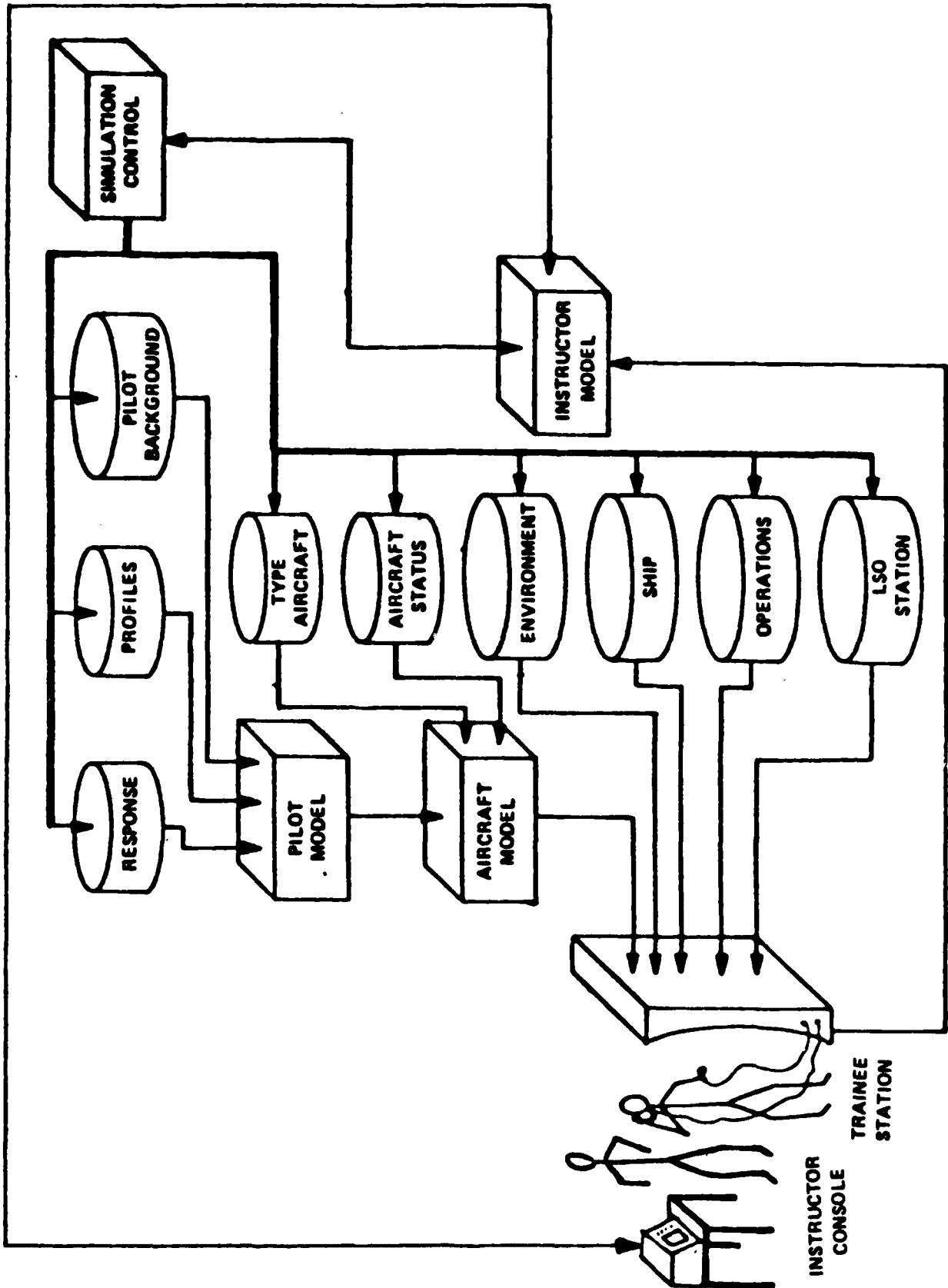

Figure E-1. Models Interaction

APPROACH SEGMENTATION AND SYMBOLOGY

A major consideration in the modelling of pilot behavior is the segmentation of approach dynamics for representing the results of simulated pilot actions. LSO oriented terms are used as much as possible to represent the segmentations which are discussed in subsequent paragraphs.

Parameters of initial interest are those which provide "snapshot" depictions of an approach: range, glideslope position, lineup position and AOA. Range is commonly segmented by LSOs into four components: start (X), in the middle (IM), in close (IC), and at the ramp (AR). To denote that a deviation has existed throughout the approach, the term "all the way" (AW) is used. For the purposes of modelling, additional range segmentations are needed. They are depicted below:

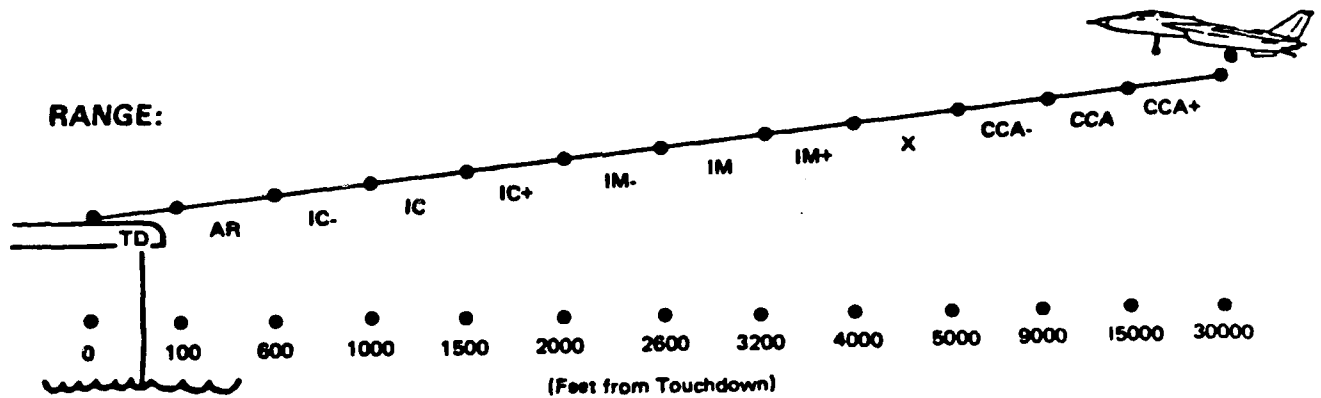

Figure E-2. Range Segmentation.

The common LSO segmentations for glideslope and lineup position, and AOA appear adequate for approach description purposes. These parameters are depicted in Figure E-2. Note that parentheses modify a basic descriptor to mean "slightly" and that underlining of a basic descriptor indicates a larger deviation. For example: H = very high; H = high; (H) = slightly high. If additional segmentation is ever required, a "+" and "-" scheme can be used. For example, the glideslope position segment H (very high) can be further broken into three increments (H+, H, H-) using such a scheme.

There are also dynamic parameters which must be represented. Among the dynamic parameters, sink rate and drift rate are of prime importance to the LSO. Sink rate is the rate of descent of the aircraft during approach. There is a nominal sink rate for maintaining the existing angular glide-slope position. Variations from the nominal rate cause the aircraft to go higher (not enough rate of descent, or NERD) or lower (too much rate of descent, or TMRD). Drift rate is associated with changes in lineup position. Drift is represented by the prefix DR and followed by the direction of drift (R for right, or L for left). Sink rate and drift rate segmentations are delineated below:

Sink Rate:	<u>NERD</u>	Drift Rate:	<u>DRR</u>
	NERD		DRR
	(NERD)		(DRR)
	OK		OK
	(TMRD)		(DRL)
	TMRD		DRL
	<u>TMRD</u>		<u>DRL</u>

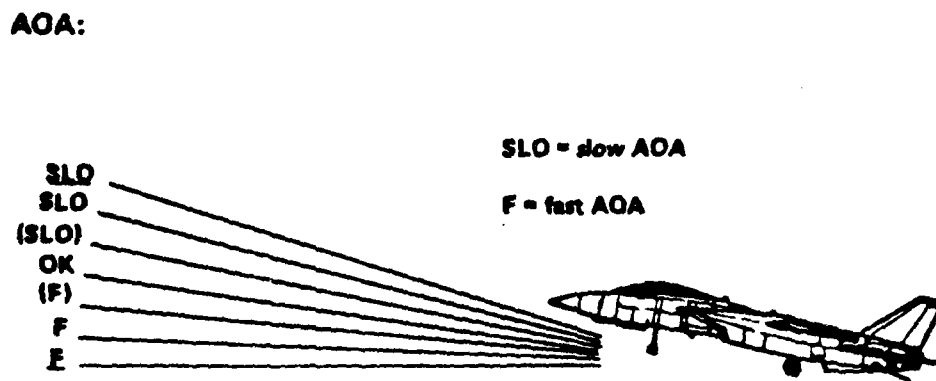
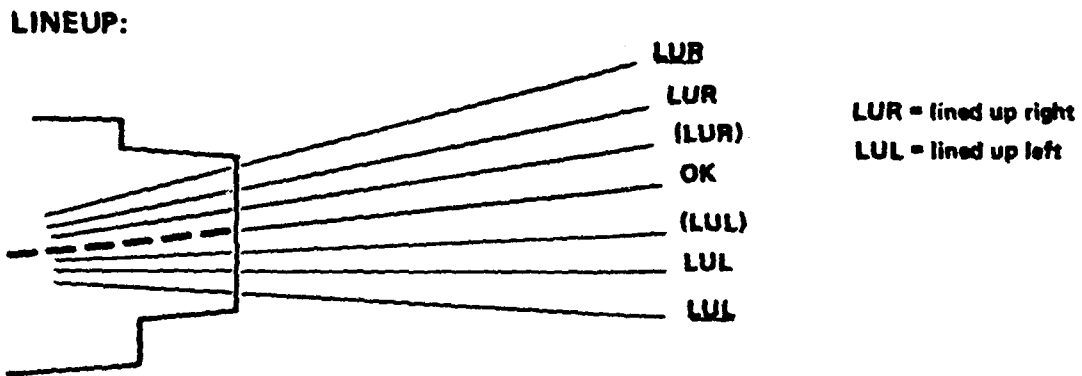
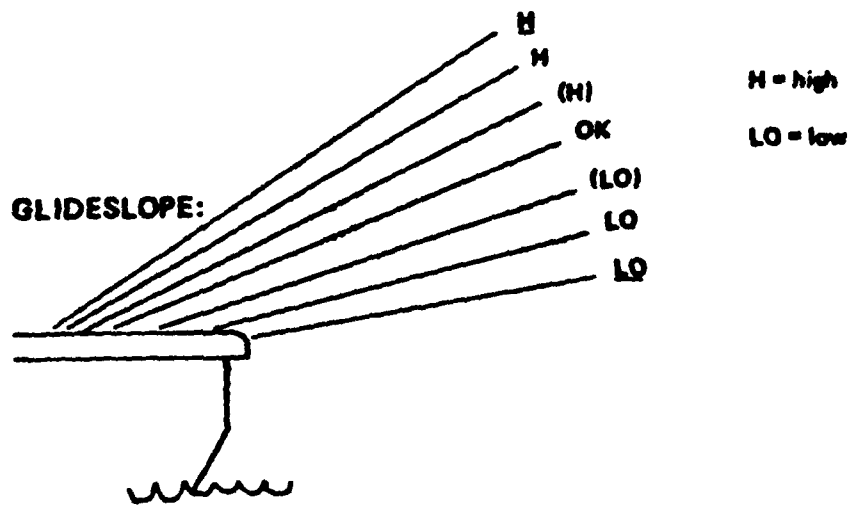

Figure E-3. "Snapshot" Segmentations For Approach

Pitch and power changes are also parameters of concern in an approach. Pitch denotes abrupt changes in nose position and is represented by the terms "drop nose" (DN) and "pulled nose up" (PNU) for discrete changes, and "rough nose" (RUFN) for frequent changes in nose position. Power denotes changes in thrust based on the throttle movements of the pilot. "Too much power" (TMP) usually leads to a decrease in sink rate or AOA (acceleration). "Not enough power" (NEP) usually leads to an increase in sink rate or AOA (deceleration). Frequent, excessive power changes during approach is represented by "rough power" (RUFP). An abrupt reduction in power is represented by "ease gun" (EG). Full throttle ("military power"), as for a waveoff, is represented by MP. A final parameter of interest is wing position. Abrupt changes in wing position (roll) are represented by the terms "left wing down" (LWD) and "right wing down" (RWD). Pitch, power and roll segmentations are delineated below:

Pitch:	RUFN	Power:	RUFP	Roll:	RWD
	DN		MP		(RWD)
	<u>DN</u>		TMP		OK
	(DN)		<u>TMP</u>		(LWD)
	OK		(TMP)		LWD
	(PNU)		OK		
	PNU		(NEP)		
	<u>PNU</u>		NEP		
			<u>NEP</u>		
			EG		

Other examples of LSØ "shorthand" symbols which will be used in describing approach profiles include:

CD = come down (CDAR = come down at ramp)  
 S = settle (SIC = settle in close)  
 . = on (S . X = settle on start)  
 OC = overcontrolled (OCHIC = overcontrolled high in close)  
 C = climb (CIC = climb in close)  
 ⤴ = "over the top"; bolter  
 OK = okay (optimum segment for dimension or dynamic parameter)  
 GS = glideslope  
 LU = lineup  
 TL = to land (DNTL = drop nose to land)  
 AFU = all fouled up  
 DEC = decelerate; slow down  
 ACC = accelerate  
 LLU = late lineup  
 CU = cocked up  
 B = flat glideslope

Reference will be made to approach segmentation and symbology in the model descriptions to follow. The codes specified for these segmentations should also be considered for use in man-machine interfaces (display and input).



## PILOT MODEL

There are three elements of the pilot model. One involves the response of the pilot to LSO calls and signals. Another involves approach profiles of aircraft control prior to, or independent of, LSO intervention. The third element is associated with background characteristics and tendencies of individual pilots.

**PILOT RESPONSE.** From an LSO training standpoint, the operationally effective LSO must learn how to handle several pilot response characteristics. Each can be very critical to the success of an approach, from both a safety and an expeditious recovery perspective. Undesireable pilot response characteristics include:

- o no response to LSO call/signal
- o over/under-control response
- o "wrong way" response
- o slow response

These characteristics when known (as pilot tendencies) or recognized (in real-time) influence the decisions of the LSO regarding calls/signals to be used during an approach. They also have some influence on recovery strategy decisions. However, the focus for this portion of pilot behavior modelling is primarily on teaching aircraft control strategies (waving approaches) to the LSO trainee. The pilot response element of a pilot behavior model must be able to realistically simulate real-time LSO/pilot interaction for the characteristics above. Additionally, the characteristics must be selectable based on syllabus control decisions from the instructor model.

There are several factors which can influence the realistic representation of various pilot response characteristics. One of these factors is whether the pilot evaluates the relative "correctness" of the LSO call or signal prior to selecting a response. One case involves the pilot who trusts the LSO and responds to the call or signal regardless of its validity. The other case involves a "smart" pilot who evaluates the deviation implied by the call and initiates a response influenced more by the deviation than by the call. Thus enters another factor in pilot response: the relationship of the LSO call to the existence (or non-existence) of a deviation. There are several alternatives which may affect response selection for the "smart" pilot:

- o no deviation exists
- o deviation agrees with LSO call
- o deviation opposite to that implied by call  
(high vs low, left vs right)
- o deviation may be unrelated to call (lineup call  
when glideslope deviation exists)

In the absence of a deviation or for an unrelated call, the "smart" pilot is not likely to respond. For a call opposite to the direction of deviation and for a correct call the "smart" pilot is likely to initiate a response.

Another factor is the quality of pilot response. There are two aspects involved: correctness and timeliness. Correctness may vary among several alternatives:

- o good response
- o over response
- o under response
- o response in wrong direction

A good response either corrects the existing deviation (if valid call) or responds correctly to the call. For over response the pilot goes in the proper direction suggested by the call or the deviation but goes too far (i.e. call "You're Low" and aircraft goes from low deviation to high deviation). For an under response the pilot goes in the proper direction but doesn't give a complete response to the call or deviation (i.e., call "You're Low" and aircraft goes from very low to slightly low). For a wrong way response, the pilot response is in the wrong direction in relationship to the call or deviation (i.e., call "You're Low" and aircraft goes lower). The timeliness aspect is associated with how quickly the pilot initiates the response (fast or slow).

Another consideration in the modelling of pilot responses is that pilot characteristics may vary among the three dimensions of an approach: glideslope, lineup and AOA. The pilot may be very responsive to glideslope deviations and related calls, but unresponsive in the lineup dimension.

Pilot response modelling is also influenced by whether the LSO is utilizing the MOVLAS during recovery. If the MOVLAS is not being used, the LSO interventions in an approach are voice calls and discrete light signals (cut and waveoff lights). If the MOVLAS is being used, the LSO is presenting continuous glideslope information as a substitute for the Fresnel lens. The LSO may also use voice calls and discrete light signals when MOVLAS is in use.

Two sets of pilot response modelling logic were devised for these factors. The first is based on discrete LSO actions (voice calls/light signals). The other is for MOVLAS utilization. The logic for pilot response to discrete LSO actions is depicted in Figure E-3. For the logic, four factors are pre-defined by syllabus decision functions and known by simulation control:

- pilot response - yes, no
- pilot response to deviation - yes ("smart" pilot),  
no ("trusting" response to call)
- quality of response desired - good, wrong way, under, over
- speed of response - fast, slow

If these characteristics differ by approach dimension, call/signal or range, this fact is also pre-defined. There are also two tables associated with logic output. One specifies the responses to deviations for the

"smart" pilot. The other provides various responses to specific calls/signals for the "trusting" pilot. Within the two tables are provisions for responses of varying quality levels.

Figure E-3 depicts the logic flow after initial screening for differences in pre-defined factors based on dimension, call/signal and range. The logic starts with a question of whether the pilot is to respond. If a responsive pilot is selected then the question is whether he responds to the deviation ("smart" pilot) or the call ("trusting" pilot). Subsequent flow for "smart" pilot responses leads to the question of whether the voice call is in the same approach dimension (GS/LU/AOA) as the deviation. If not there is no response, since the call is unrelated to the deviation. If the call is related to the deviation, even if in the wrong direction, then the question of response quality arises. Subsequent questions in the flow lead to the determination of whether the response is to be "good", "wrong way", "over" or "under". This determination in conjunction with the type of existing deviation is input to the selection of a response from Table E-2. The final step in the "smart" pilot logic is the determination of response speed (fast or slow).

The portion of logic for the "trusting" pilot, as noted earlier in the flow, leads to the determination of response quality as in the case of the "smart" pilot. This determination is used in conjunction with the voice call or signal to select the appropriate response from Table E-3. The flow is completed with the selection of response speed (fast or slow). The parenthetical numbers in the blanks of Table E-3 are intended to show relative differences among the responses.

Some of the responses delineated in Table E-2 (i.e. go lower, go to high deviation, etc.) will eventually need more specificity. However, the level of specificity will probably have to be determined during developmental testing. A similar statement applies to the responses in Table E-3.

The logic for pilot response to MOVLAS signals is similar to that presented earlier for the "trusting" pilot. An exception is that MOVLAS signals are only related to glideslope positioning during approach. Additionally, a MOVLAS controlled approach is likely to also include voice calls and discrete light signals. Therefore, their response logic is also applicable when MOVLAS is in use. When MOVLAS indications are in disagreement with discrete signals, the pilot is likely to be more responsive to discrete signals. Therefore, in such a case the response logic for discrete signals and "trusting" pilot should take priority over MOVLAS response logic.

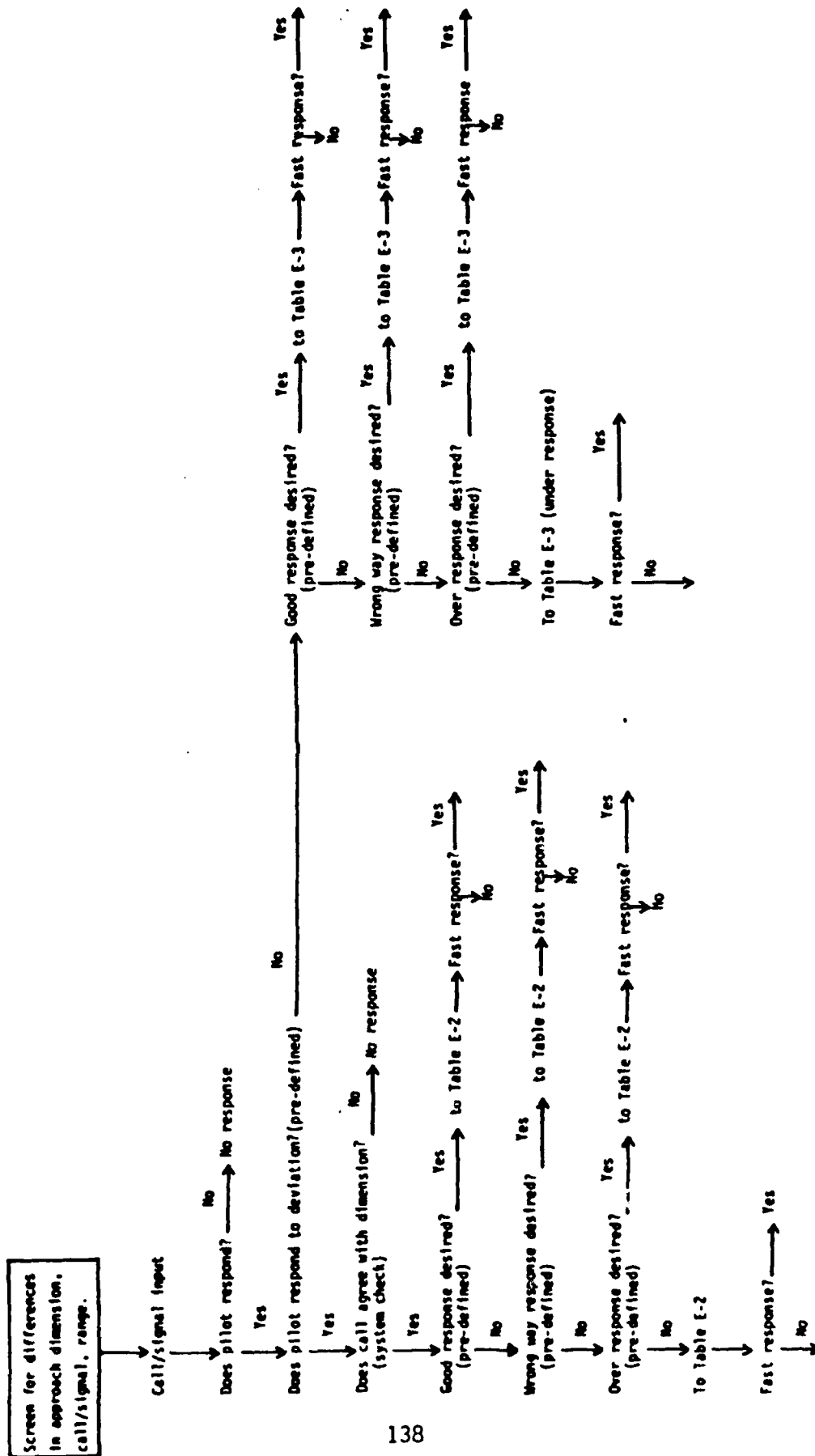

Figure E-4. Pilot Response Logic for Discrete LS0 Actions

TABLE E-2. RESPONSES BY DEVIATION  
("Smart" Pilot)

<u>Deviation</u>	<u>Response</u> (G = good, W = wrong way, O = over, U = under)
Low	G = correct the deviation W = go lower O = go to high deviation U = correct only half the deviation
High	G = correct the deviation W = go higher O = go to low deviation U = correct only half the deviation
Left	G = correct the deviation W = go further left O = go to right deviation U = correct only half the deviation
Right	G = correct the deviation W = go further right O = go to left deviation U = correct only half the deviation
Fast	G = correct the deviation W = accelerate O = go to slow deviation U = correct only half the deviation
Slow	G = correct the deviation W = decelerate O = go to fast deviation U = correct only half the deviation

Note: Maintain other approach parameters in accordance with profile.

NAVTRAEQUIPCEN 80-C-0063-2

TABLE E-3. RESPONSES BY DISCRETE LSO ACTIONS  
("Trusting" Pilot)

<u>Call/Signal</u>	<u>Response</u> (G = good, W = wrong way, O = over, U = under)
You're (a little)High	G = go down (2) GS increments W = go up (2) GS increments O = go down (4) GS increments U = go down (1) GS increment
You're (a little) Low	G = go up (2) GS increments W = go down (2) GS increments O = go up (4) GS increments U = go up (1) GS increments
You're Lined Up Left; Right for Lineup	G = go right (2) LU increments W = go left (2) LU increments O = go right (4) LU increments U = go right (1) LU increment
You're Lined Up right; Left for Lineup	G = go left (2) LU increments W = go right (2) LU increments O = go left (4) LU increments U = go left (1) LU increment
You're Going High; Don't Go High; Don't Climb	G = increase sink rate (2) increments W = decrease sink rate (2) increments O = increase sink rate (4) increments U = increase sink rate (1) increment
You're Going Low; Don't Go Low; Don't Settle	G = decrease sink rate (2) increments W = increase sink rate (2) increments O = decrease sink rate (4) increments U = decrease sink rate (1) increment
You're Fast	G = decelerate (2) AOA increments W = accelerate (2) AOA increments O = decelerate (4) AOA increments U = decelerate (1) AOA increment
You're Slow	G = accelerate (2) AOA increments W = decelerate (2) AOA increments O = accelerate (4) AOA increments U = accelerate (1) AOA increment

NAVTRAEQUIPCEN 80-C-0063-2

TABLE E-3. RESPONSES BY DISCRETE LSO ACTIONS (Continued)  
("Trusting" Pilot)

(A little) Power;  
cut lights

G = add power, decrease sink rate (2) increments  
W = decrease power, increase sink rate (2) increments  
O = add power, decrease sink rate (4) increments  
U = add power, decrease sink rate (1) increment

(A little) Attitude

G = add power, increase pitch (2) increments,  
decrease sink rate (2) increments  
W = decrease power, decrease pitch (2) increments,  
increase sink rate (2) increments  
O = add power, increase pitch (4) increments,  
decrease sink rate (4) increments  
U = add power, increase pitch (1) increment,  
decrease sink rate (1) increment

Waveoff;  
waveoff lights

G = add full power, increase pitch (2) increments,  
decrease sink rate (2) increments  
W = decrease power, decrease pitch (2) increments,  
increase sink rate (2) increments  
O = add full power, increase pitch (4) increments,  
decrease sink rate (2) increments  
U = add full power, increase pitch (1) increment,  
decrease sink rate (1) increment

Note: Maintain other approach parameters in accordance with profile.

The logic devised for pilot response to MOVLAS signals is depicted in Figure E-4. This flow essentially leads to the quality and speed of glide-slope responses. These responses are related to MOVLAS control positioning by the LSO. Since pilot responses to MOVLAS signals involve human tracking, it will probably increase response realism if some random variability of response characteristics is designed for implementation of the MOVLAS response. However, the majority of time the response characteristics should be those specified for the exercise.

**APPROACH PROFILES.** Approach profiles represent pilot behaviors in the control of aircraft during approach in the absence of LSO intervention. In an LSO training system they are useful in helping the trainee learn to perceive deviations and relate them to appropriate calls. The profiles are also useful in helping the trainee build cognitive processing schemes for anticipating future deviations based on observed trends. The most important use of the profiles is to help the trainee learn how to handle critical approaches, those which frequently lead to undesirable landing results. The descriptive symbology presented earlier and other LSO "shorthand" terms will be used frequently for describing profiles in subsequent discussions and tables. For the pilot model, three categories of approach profiles have been identified and are outlined and discussed below:

**SIMPLE PROFILES:**

- Glideslope Deviations
- Lineup Deviations
- AOA Deviations
- Multi-dimensional Deviations

**COMPLEX PROFILES:**

- Pilot Tendencies
- Other Trends

**CRITICAL OUTCOME PROFILES:**

- Hard Landing/Ramp Strike
- Off-center Engagement
- Bolter
- Inflight Engagement

The simple profiles include relatively simple approach deviation situations. They are primarily useful for teaching the trainee to recognize deviations and relate those deviations to the use of voice calls and light signals. The simple profiles are delineated in Table E-4. The listing of multi-dimensional profiles in the table is extensive but does not include all possible combinations of deviations. For all the simple profiles, additional variability is available using the segmentation modifiers described earlier. For example, additional variations of the profile HIC can include HIC and (H)IC.



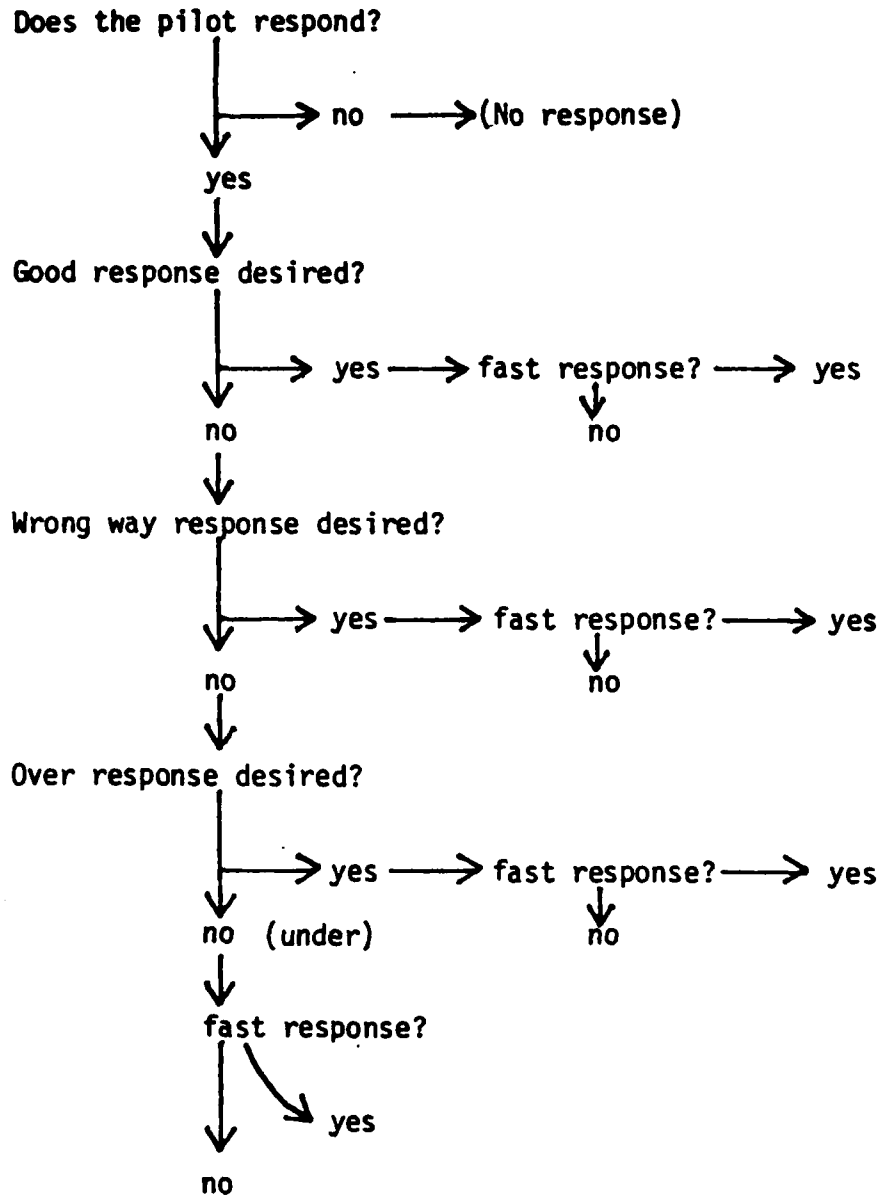

Note:

- GOOD = Change position by amount indicated by MOVLAS positioning
- WRONG = Change position by amount indicated but in wrong direction
- OVER = Change position by twice the amount indicated
- UNDER = Change position by half the amount indicated

Figure E-5. Response Logic For MOVLAS Signals

TABLE E-4. SIMPLE PROFILES

## Glideslope Deviations:

HX	HIC	HAW
LOX	LOIC	LOAW
HIM	HAR	
LOIM	LOAR	

## Lineup Deviations:

LULX	LULIC	LULAW
LURX	LURIC	LURAW
LULIM	LULAR	
LURIM	LURAR	

## AOA Deviations:

FX	FIC	FAW
SLOX	SLOIC	SLOAW
FIM	FAR	
SLOIM	SLOAR	

## Multi-dimensional Deviations:

HFX	LOSLOIM	LOSLOIC	HFAR
LOSLOX	LOLULIM	LOLULIC	LOSLOAR
HLULX	HLURIM	LOLURIC	LOLULAR
LOLURX	HFIM	HLULIC	LOLURAR
SLOLULX	LOLURIM	HFIC	HLURAR
FLURX	SLOLULIM	HLURIC	HLULAR

Complex profiles are intended to acquaint the trainee with common approach trends and pilot tendencies, and help him learn to anticipate future deviations based on observed trends. The first set of complex profiles to be addressed are those associated with pilot tendencies. A tactic which may be useful in an LSO training system context is to relate the pilot tendency profiles to pilot "labels". Some pilot "label" examples and related profiles include:

- o "Deck Spotter" - a tendency to drop nose and/or ease power in close or at the ramp; usual result is excessive sink rate and early wire with less than optimum hook-to-ramp clearance. (HIC) DN/EG IC-AR
- o "Moth" - tendency to drift left in close or at the ramp ("fly to the light of the lens") DRL IC-AR
- o "Ramp Shy" - tendency to deviate high at the ramp; usual result is bolter. OCOKIC TMPAR



- o "Death Wish" or "No Fear of Death" - tendency similar to that of "Deck Spotter"; pilot drops nose and/or eases power in close even though he is below glideslope. LOIC DN/EG
- o "4 Degree Glideslope" - tendency to start high and work off deviation very gradually to a low or slightly low deviation with excess sink rate at the ramp. HX-IM (HIC) CDAR
- o "Low Flat All the Way" - tendency to start low and correct for the deviation too slowly; usual result is bolter or LOAR. LOIM LOIC (LOAR)
- o "Tunnel Vision" - tendency to work on one deviation while neglecting control of another approach dimension. For example, pilot works on a lineup deviation, neglects glideslope cues and goes low. LULX-IM TMRDIC LOAR

These and other pilot tendency profiles are delineated in Table E-5. Other complex trends are also listed. These listings cannot be considered exhaustive but should be useful as a departure point for future expansion.

Critical outcome profiles are those which historically have been associated with undesirable landing results. Within this category the profiles are grouped by landing outcome. The profiles and their groupings are delineated and discussed below:

Ramp Strike/Hard Landing:  
 LOX HIM-IC CDAR  
 HX-IC CDAR  
 OC CIC/HIC CDAR  
 NEPAW SAR  
 SAR on LLU  
 EG/DN correcting for LOIC

Off-Center Engagement:  
 LURX/IM R-LAW  
 LULX/IM L-RAW  
 OCLULIC L-RAR  
 OCLURIC R-LAR  
 DRRIC/AR  
 DRLIC/AR

Bolter:  
 OCLOIC/SIC   
 TMP on LLUIC 

Inflight Engagement:  
 OCCDAR PNU  
 LOBIC PNUAR

TABLE E-5. COMPLEX PROFILES

## Pilot Tendencies:

Deck Spotter	(HIC) DN/EG IC-AR (CIC) DN/EG TL HAR DN/EGTL
Moth	DRLIC-AR
Ramp Shy	OC OK IC TMPAR ↗
Death Wish	LOIC DN/EG
4 Degree Glideslope	HX-IM (HIC)CDAR
Low Flat All the Way	LOIM LOIC (LOAR)
Tunnel Vision	LOX-IM DR LIC LULAR LULX-IM TMRDIC LOAR
Cowboy	HX LOIM HIC LOAR LOX HIM LOIC HAR
Wanderer	LULX LURIM LULIC DRRAR
Low Nibbler	LOX (LOIM) LOIC (LOAR)
Nugget	OC (HIM) CDIC OC (LOIM) HIC OC (SLOIM) HFIC
Accelerator	(FX) FIM FIC-AR
Nosey	RUFN RUGS AW
Black Hole	S-X LOIM
Slow Nibbler	SLOX (SLOIM) SLOIC (SLOAR)
Tail Dragger	(HIC) NEP PNU CUAR
Swooper	HLULIM DN/DRRIC-AR
High Dipper	HIC DNIC PNUAR
Nervous	RUFP RUGS AW
Old Pro	(HAW) (DN/EGAR)
Shaky Starter	HX AFUAW LOX AFUAW

## Other Complex Trends:

OCHF X LOIM HIC	DECIM LOSLOLULIC
OCLOSLOX HIM CDIC	TMPIM HFIC DRLAR
LURIM SIC•LLU	OCFIM SIC LOBAR
OCLULIM L-RIC	

Ramp strike/hard landing profiles are the most critical in terms of landing results. These profiles also have a higher likelihood of occurrence in actual fleet operations than those in the other groupings. The terminal portions of the profiles in this grouping are similar, involving a significant deviation below optimum glideslope (a "comedown"). However, there are significant variances in the profile leading to the "comedown". The most common trend is a deviation above glideslope within the "in close" portion of the approach. The "comedown" results when the pilot makes an excessive pitch and/or power correction for this deviation or when the pilot fails, or is slow, to make a re-correction to reduce sink rate to within acceptable parameters. There are also typical deviations which occur early in approaches (prior to the in close area). The most common is a low glideslope deviation in the middle portion of an approach.

Off-center engagement profiles are also relatively critical, although less so than those discussed earlier. Off-center landings, if drastic, can result in an aircraft drifting off the port side of the carrier (with or without engagement of an arresting cable) or drifting into aircraft parked outside the landing area. They can also cause time consuming inspections of the arresting gear machinery and, in the worst case, actual damage to the machinery. Fortunately, drastic off-center landings are infrequent occurrences.

Bolter profiles are of significance to LSO waving performance primarily from an "expeditious recovery" perspective. This perspective becomes critical when there is a strong operational requirement for getting an aircraft aboard (such as in a low fuel state, no tanker, no divert situation). An extremely long bolter can be a dangerous situation in which there may be insufficient landing area remaining for aircraft rotation and lift-off. The most typical bolter profile involves excessive pilot control response to a low glideslope deviation in the terminal portion of an approach.

Inflight engagement profiles lead to results which are generally outside the direct influence of the LSO. However, they are included here because they can lead to landing accidents, and because they are related to the LSO responsibility for evaluating pilot performance and conducting pilot landing training (including pilot debriefing aboard ship). The most drastic result of an inflight engagement on landing is damage to an aircraft as the nose falls through from a cocked-up condition (typically collapse of the nose landing gear). Inflight engagement typically occurs when the pilot increases nose attitude excessively in response to an excess sink rate at the ramp. It can also occur in response to an LSO call (such as "power" or "attitude") or in response to a waveoff when the pilot uses poor waveoff technique.

Effective implementation of the Simple, Complex and Critical Outcome profiles described above requires some variability in occurrence of deviations within multiple presentations of the same profile. As an example, the profile LOX CIM/HIM CDIC-AR involves:

- o low deviation at the start (LOX)
- o high deviation in the middle (CIM or HIM)
- o comedown in close or at the ramp (CDIC-AR)

Typically, the middle portion of an approach encompasses a range segment between 2,000' and 4,000' from touchdown. Onset of the high deviation should vary within this range segment in different scenarios. The same can be said for the other deviations called for in this profile. These variances enhance approach realism and provide multiple examples of similar task stimuli to enhance concept acquisition for the LSO trainee's instructional situation.

A "brute force" approach to defining profiles would involve the specification of a large number of variations for this profile. However a more efficient approach would be to specify the profile in one general statement and to incorporate mechanisms for randomly varying the deviations within specified limitations.

As an example, consider the profile LOIM HIC. This suggests that the aircraft should be below optimum glideslope by a significant amount within the "in the middle" range zone, and later be above optimum glideslope by a significant amount within the "in close" range zone. For the LSO training system we would want the actual range of occurrence for the deviations and the amount of the deviations to vary. With the approach segmentation scheme described earlier, several variations of range and deviation are available:

<u>Range</u>	<u>Below Glideslope</u>	<u>Above Glideslope</u>
IM = IM+	(LO) = (LO)+	(H) = (H)-
IM	(LO)	(H)
IM-	(LO)-	(H)+
	LO = LO+	H = H-
IC = IC-	LO	H
IC	LO-	H+
IC	<u>LO+</u> = <u>LO+</u>	<u>H</u> = <u>H-</u>
	<u>LO</u>	<u>H</u>
	<u>LO-</u>	<u>H+</u>

Limitations in glideslope variation can be imposed if desired, such as those indicated below:

LO = LO+ or LO- or LO or LO+

H = H- or H+ or H or H-

Given these constraints, some of the variations of the profile LOIM HIC which can be used include:

- . LO IM, H IC
- . LO+ IM, H- IC+
- . LO IM+, H+ IC
- . LO- IM, H IC+
- . LO+ IM-, H- IC
- . LO IM, H- IC-
- . LO+ IM+, H IC-

The operations of the profile modelling element can use the segmentation scheme in conjunction with pre-determined distribution factors to provide desired profile variances. The distributions can be symmetrical or skewed. For example, using the LO term, the distribution of variances could be programmed as:

<u>symmetrical</u>	<u>skewed</u>
(LO)- = .05	(LO)- = .05
LO+ = .1	LO+ = .05
LO = .7	LO = .6
LO- = .1	LO- = .2
<u>LO+</u> = .05	<u>LO+</u> = .1

Skewing the distribution may be based on such factors as real-world profile trends or requirements for training emphasis.

Implementation of this profile also requires specification of the rate of change in glideslope position (sink rate). The example profile, LOIM HIC, specifies that the aircraft goes from on glideslope to below glideslope but the sink rate is not specified. There are two ways sink rate can be handled in the model. One way is to specify it in the profile description. The other is to pre-define a distribution of sink rate variances for each type of deviation. In most of the profile descriptions the rate will not be specified. It may also be desirable to vary the distributions of rates as a function of range. Table E-6 delineates sink and drift rate distributions as a function of deviation and range. If it is later determined that the rates require additional segmentation, a "+" and "-" scheme can be utilized as discussed earlier.

NAVTRAEQUIPCEN 80-C-0063-2

TABLE E-6. SINK AND DRIFT RATE DISTRIBUTIONS

<u>Deviation</u>	<u>Rates</u>	Distribution By Range			
		<u>X</u>	<u>IM</u>	<u>IC</u>	<u>AR</u>
LO	(TMRD)	.2	.2	.1	.1
	TMRD	.6	.6	.6	.6
	<u>TMRD</u>	.2	.2	.3	.3
H	(NERD)	.2	.2	.1	.1
	NERD	.6	.6	.6	.6
	<u>NERD</u>	.2	.2	.3	.3
LUL/R-L	(DRL)	.2	.2	.1	.1
	DRL	.6	.6	.6	.6
	<u>DRL</u>	.2	.2	.3	.3
LUR/L-R	(DRR)	.2	.2	.1	.1
	DRR	.6	.6	.6	.6
	<u>DRR</u>	.2	.2	.3	.3
S/CD	(TMRD)	-	-	-	-
	TMRD	.6	.6	.4	.4
	<u>TMRD</u>	.4	.4	.6	.6
C/↘	(NERD)	-	-	-	-
	NERD	.6	.6	.4	.4
	<u>NERD</u>	.4	.4	.6	.6
OCH, OCC	(TMRD)	.1	.1	-	-
	TMRD	.6	.6	.5	.5
	<u>TMRD</u>	.3	.3	.5	.5
OCLO, OCCD, OCS	(NERD)	.1	.1	-	-
	NERD	.6	.6	.5	.5
	<u>NERD</u>	.3	.3	.5	.5



**BACKGROUND CHARACTERISTICS.** The background characteristics of a pilot which are addressed include experience and proficiency levels, skill level (past performance), tendencies and condition. These factors can influence the waving performance of an LSO. The trainee must learn the effects of these pilot factors on his waving judgments. He must also learn not to "lower his guard" just because he is waving a highly skilled and experienced pilot. Even the best pilots can make critical errors in an approach.

As conceived for an LSO training system, these characteristics are intended to be presented to the trainee prior to an approach or a recovery situation. In many training situations they may also be correlated to the pilot response characteristics and approach profiles presented to the trainee, depending on training session objectives. The variables associated with pilot background characteristics and the relative values for each variable are listed and discussed below:

<u>Variable</u>	<u>Values</u>
Experience	High Low
Proficiency	High Low
Skill Level	High Average Low
Tendencies	None Various(related to Complex Profiles)
Condition	Normal Fatigued Disoriented

Experience and proficiency levels have been identified as factors in carrier landing accidents. Pilots with low experience or proficiency levels are more likely to be involved in carrier landing accidents than more experienced pilots. A high level of pilot experience and proficiency is typically reflected in smoothness of aircraft control, infrequent approach deviations, good corrections for deviations and responsiveness to the LSO. Conversely, low experience and proficiency are typically reflected in roughness and insubility of aircraft control, more frequent and extensive approach deviations, and sluggish or over-reactive response to deviations and to the LSO.

Over time, a pilot builds a track record of performance which establishes him within a skill level category. Being in the high skill level category means that, typically, his behavior during approach is similar to that described above for high experience and proficiency levels. Low skill level characteristics are similar to those described for low experience and proficiency levels. Additionally, undesirable pilot tendencies are frequently associated with low skill levels. These tendencies vary greatly among pilots.

The condition of the pilot is another important factor in LSO performance. A fatigued or disoriented pilot will need more assistance from the LSO during approach. Pilot fatigue is typically reflected in sluggish reactions to approach deviations and LSO assistance. Pilot disorientation is reflected in generally unpredictable reactions to deviations and LSO assistance. It may also include lack of response to the LSO and reactions or attempted corrections in the wrong direction.

#### AIRCRAFT MODEL

The aircraft model establishes and controls scenario variances associated with the approaching aircraft. Different types of aircraft have different characteristics. Characteristics also vary as a function of malfunctions, configuration and approach mode. Aircraft fuel state is also a factor in an approach. The aircraft model is discussed below in two separate segments: aircraft type (characteristics) and aircraft status (malfunctions, configuration, approach mode and fuel state).

**AIRCRAFT TYPE.** There are three types of characteristics of an aircraft which are of interest to the LSO: visual, audio and flight performance characteristics. Each type of aircraft has its own unique set of characteristics. Thus, an LSO training system needs a separate model for each type of aircraft. The types of aircraft which should be considered for an LSO training system include:

A-3 series (EA-3B, KA-3B)	F-4 series (RF-4B, F-4J, F-4N, F-4S)
A-4 series (TA-4J, A-4M)	
A-6 series (EA-6A, KA-6D, A-6E)	F-14A
A-7 series (A-7B, TA-7C, A-7E)	F/A-18
C-1A	RF-8G
C-2A	T-2C
E-2 series (E-2B, E-2C)	S-3A
EA-6B	VTX

With the exception of F/A-18 and VTX (which are in the future), all aircraft listed above are currently operational. However, the RF-8G, A-7B, F-4N and F-4J may not be appropriate for an LSO training system since they are likely to be phased out of operations over the next few years. The aircraft which are considered by this author to be most important for an LSO training system are:

A-6E	E-2C	F-4S	F/A-18
A-7E	EA-6B	F-14A	S-3A

These aircraft are, or will be, the most prominent in Carrier Air Wings during the 1980s and 1990s. This mix also appears to provide an adequate cross-section of aircraft characteristics needed to support LSO training requirements. VTX is one aircraft that may need to be added to this list depending on perceived future needs for LSO training within the Naval Air Training Command.

Several visual characteristics are important to LSO training. For day recovery situations, shape, size, perspective and engine exhaust smoke are important cues. At night, exterior lighting is important. Since a night approach terminates in the white carrier deck lighting, shape, size and perspective are also relevant. For some aircraft the sound of the engine during approach is a useful cue to the LSO.

Flight performance characteristic differences among types of aircraft are reflected in the responsiveness of aircraft control within the basic dimensions of approach dynamics (lineup, glideslope, AOA). Lineup positioning is controlled by rate of drift relative to the landing area centerline. Drift is influenced by aircraft heading, roll and yaw, and by the relative effects of wind and ship movement. Glideslope positioning is controlled by sink rate relative to the angular projection of glideslope from the ideal touchdown point. This dimension is influenced by aircraft pitch and power, and by the relative effects of wind and ship movement. AOA is the pitch angle of the aircraft relative to the flight path (relative wind) and is controlled by coordination of pitch and power.

From an LSO training perspective, several aircraft flight characteristics are of particular interest:

- o waveoff capability
- o acceleration/deceleration (AOA) sensitivity to pitch changes
- o acceleration/deceleration (AOA) sensitivity to power setting changes

NAVTRAEQUIPCEN 80-C-0063-2

- o sink rate sensitivity to power setting changes
- o sink rate sensitivity to pitch changes
- o sink rate sensitivity to aircraft roll (for lineup corrections)
- o drift rate sensitivity to lineup control inputs (roll, yaw, heading changes)
- o optimum approach speed range

Aircraft capability to arrest sink rate with full power and optimum AOA when given a waveoff is the most critical aircraft characteristic to be learned by an LSO. The LSO must coordinate this characteristic with range from touchdown, glideslope position and other factors (wind, deck position, pilot skill, etc.) as a part of the waveoff decision process.

To provide amplification, a few examples are presented. The F-4 and A-6 are aircraft with excellent responsiveness (sensitivity) to power increases for arresting excess sink rate (as in a waveoff situation). The F-4 aircraft also has high sink rate sensitivity to power reduction (due to BLC system). Aircraft which have low sink rate sensitivity to power increases are the A-7, F-14 and S-3 (due to slower engine windup time), particularly when at very low power settings (as when correcting for a high glideslope deviation).

Table E-7 delineates many of the performance characteristics for different aircraft types which are of interest to LSO training. This table also includes some of the malfunctions of interest to the LSO.

TABLE E-7. AIRCRAFT CHARACTERISTICS

- A-3:** Good power response.  
 Frequently drops nose on lineup correction to left.  
 Occasional yaw due to asymmetric throttle control.  
 Lineup a little difficult to control due to size and long wing span.  
 Tendency to go nose up on power increase, nose down on power decrease.  
 Will bounce on nose down landing.  
 EA-3B is faster than KA-3B and is more sensitive to nose movement.  
 KA-3B tends to decel more than EA-3B.  
 Single engine - power response adequate.
- A-4:** Excellent lineup control.  
 Good power response.  
 Tendency for hook-skip bolter on nose down landing and on rough wings (swinging hook).  
 Good speed stability.  
 Utility hydraulic failure - no flap, no speedbrakes.  
 Tendency for nose pitch up on waveoff.  
 When cocked-up, hard for pilot to see landing area.
- A-6:** Excellent power and waveoff response, but easily over-controlled.  
 Tendency to settle on late lineup corrections.  
 Tendency for hook-skip bolter on nose down landing.  
 Lineup control difficulties due to pilot visibility problems.  
 Frequently shows rough wings, but not always associated with lineup deviation.  
 Gliding approach and back on power if speedbrakes retracted.  
 KA-6D is a little underpowered.  
 EA-6A has no speedbrakes, thus more back on power than A-6E.  
 Single engine only a problem with high gross weight, high winds, high ambient temperature. Speedbrakes in.  
 With single generator failure, AOA is only external light visible.  
 With hydraulic failure, flaps can creep up.
- A-7:** Slow engine response when back on power.  
 Nose movement is common during approach.  
 AOA system and AOA indicator lights fail frequently.  
 Loss of control augmentation results in heavy controls.  
 Loss of yaw augmentations results in yaw instability.  
 No flap approach - much faster and well back on power.  
 Poor rain removal system.

TABLE E-7. AIRCRAFT CHARACTERISTICS (Continued)

- C-1:** Nearly instantaneous power response.  
On the "cut" signal takes "high dip" to land.  
Single engine - faster, no flare on touchdown; no problem.
- C-2:** Like E-2, except that when very light there is tendency to float during approach.
- E-2:** Excellent power and waveoff response.  
Lineup control difficult.  
Glideslope control very sensitive to nose movement.  
Tendency for hook-skip bolter on nose down landing.  
Fuselage alignment light (when visible) and "popping sound" indicates need for right rudder.  
Excessive power reduction can "flatten" prop enough to cause a rapid settle.  
Single engine - lineup control very difficult due to asymmetric thrust.  
No flap approach - very cocked up.
- EA-6B:** Excellent power and waveoff response.  
Sensitive nose.  
Tendency for hook-skip bolter on nose down landing.  
Tendency to decel.  
Very similar to A-6E.
- F-4:** Excellent power and waveoff response, but easily over-controlled.  
Stable AOA and nose.  
Very fast approach speed.  
Lineup control is more difficult in F-4S model.  
Single engine - half flaps, higher approach speed, power response significantly degraded; burner needed for waveoff.  
BLC failure - increased approach speed.  
Utility hydraulic failure - half flaps.  
Glideslope control primarily with power, very little nose movement.

TABLE E-7. AIRCRAFT CHARACTERISTICS (Continued)

- F-14:** Slow engine response when back on power.  
 Glideslope control - coordinated power and nose.  
 Tendency to glide leading to decel, come down.  
 Tendency for hook-skip bolter on nose down landing and  
 on late lineup corrections (swinging hook).  
 Without DLC engaged, back on power.  
 Single engine - speedbrakes retracted, no problem except  
 that pilot must work very hard.  
 No flaps - higher speed, no problem.
- F/A-18:** Excellent power and waveoff response.  
 Attitude very flat when on-speed.  
 Glideslope control - coordinated power and nose.
- T-2:** Excellent power and waveoff response.  
 Glideslope control - coordinated power and nose.  
 Can get nose pitch up with large power addition.  
 Tendency to hook-skip bolter on nose down landing and  
 late lineup (swinging hook).  
 Single engine - good power response.
- S-3:** Slow engine response when back on power.  
 Tendency to glide.  
 -Burple causes glideslope control difficulties.  
 Lineup control difficult, especially with shifting  
 wind conditions.  
 Nose pitch is sensitive to power changes, especially  
 with DLC failure.  
 No flap - very fast and well back on power.  
 Single engine - half flaps, lineup control difficulties  
 due to asymmetric thrust.  
 Blue external light to indicate DLC activation.

**AIRCRAFT STATUS.** Aircraft status factors for LSO training situations include malfunctions, configuration, approach mode and fuel state. These areas are discussed below and outlined in Table E-8.

Aircraft malfunctions can affect several aspects of an aircraft on approach. A lighting malfunction or a configuration variance (like half flaps) can change the visual cueing provided to the LSO. Malfunctions with aircraft subsystems can frequently alter dynamic flight characteristics. Engine failures (in twin engine aircraft), flap malfunctions and flight control problems are examples. Malfunctions associated with pilot instrumentation (such as the AOA indicator and other flight instruments) can decrease pilot control effectiveness during an approach. An aircraft radio failure degrades communications between the pilot and LSO. Some of the likely malfunctions to be simulated are described below.

a. **NORDO (No Radio)** - There are three variations of aircraft radio malfunction: pilot can receive but not transmit, pilot can transmit but not receive, and pilot can neither transmit nor receive. Approach situations in which the pilot cannot receive radio transmissions are the most critical. This degradation in pilot/LSO interaction increases task difficulty for both the pilot and the LSO.

b. **Lighting** - There are several variances in external aircraft lighting which impact upon the LSO waving task. A loss of one or more external lights increases LSO perceptual difficulty in assessing aircraft approach dynamics at night. Lights or sets of lights which may malfunction include: approach (AOA), wingtip, and fuselage lights. Approach light variations include the following:

- o total failure (no lights visible)
- o failure of a single light (red, amber or green)
- o single light (red, amber or green) showing regardless of actual AOA
- o incorrect light indication relative to actual AOA
- o day brightness setting (extremely bright!)

Wingtip light malfunctions include failure of a single light or concurrent failure of both lights. Fuselage lighting varies significantly among different aircraft types. Fuselage lighting malfunctions do not have a major impact upon the LSO.

c. **Engine** - The engine malfunction of primary interest is a single engine failure for a twin engine aircraft (all types, except A-4 and A-7). This malfunction changes flight characteristics, power response and, in many cases, flap configuration.

d. **Landing Subsystems** - APCS malfunctions include: sluggish APCS response, overresponsive APCS, and APCS holding incorrect AOA. The DLC malfunction of note is for the system to be inoperative. This affects the



TABLE E-8. AIRCRAFT STATUS

Malfunctions:	NORDO External Lighting Single Engine APCS AFCS DLC ACLS AOA Pilot Instruments Hydraulic Systems Flaps Launch Bar Speedbrakes Wingsweep (F-14) Multiple Malfunctions
Configuration:	Normal Landing Gear Up Flaps (up or partial) Hook Up Speedbrakes (wrong position) DLC (Not Selected, F-14) Wingsweep Aft (F-14) External Stores Asymmetric External Load
Approach Mode:	Manual APCS ACLS I
Fuel State:	Bingo ("Trick or Treat") Low (Two Passes) Moderate Max Trap (Maximum fuel allowable for landing) Excess

flight characteristics of the F-14 by reducing normal approach power setting, thus aggravating its engine responsiveness problem slightly. For the S-3, an inoperative DLC reduces glideslope control effectiveness and causes nose control difficulties on power changes. ACLS malfunctions of interest to LSO training involve incorrect/erratic glideslope or lineup commands (leading to deviations during ACLS Mode I approaches) and loss of ACLS Mode I commands during approach due to system failures.

e. **Flight Controls** - Flight control malfunctions primarily affect the pilot. In doing so, they increase the LSO workload by typically requiring increased LSO assistance. Some of the malfunctions include: hydraulic system problems affecting flight control effectiveness, flap/spoiler failure, and stabilization augmentation failure.

f. **Configuration** - There are several types of malfunctions involving aircraft configuration variations. These variations encompass such items as flaps, ailerons, spoilers, wing sweep (F-14), launch bar, nose gear, and speed brakes.

g. **Pilot Instruments** - Malfunctions with several types of pilot instruments can affect his tasking, thus impacting upon the LSO waving task during approach. Instruments of significance include carrier approach navigational aids (TACAN, needles), attitude indicator, altimeter, AOA indicator, vertical speed indicator and HUU.

Abnormal aircraft configurations can be caused by pilot forgetfulness or can be required for certain malfunction situations. Variations in external stores (bombs, missiles, fuel tanks) configuration may be dictated by mission requirements. Representation of abnormal configurations is required to teach the trainee to recognize them and to help him learn their effects on LSO waving decisions.

The mode of the approach is another aircraft factor which affects LSO performance. For an APCS approach, the LSO uses slightly different voice calls and strategies than for a manual throttle approach. An ACLS Mode I approach is computer controlled and the LSO must closely monitor the approach, alert for control deviations and system malfunctions.

Aircraft fuel state is another factor. The fuel state factor is related to configuration, divert field distance, divert field weather and the amount of fuel required per approach. The fuel state segmentations delineated in Table E-8 are relative; actual fuel state for each is a function of aircraft type and the factors mentioned above. For example, the Bingo fuel for an F-4 may be 3000 pounds with a close divert field which has clear weather conditions. If the divert field is much farther away or has adverse weather conditions, the Bingo fuel state may be much higher. The real impact of fuel state on LSO performance is how many approaches are available before the aircraft must be diverted or refueled by the tanker.

## OTHER SITUATION FACTORS

This portion of the appendix presents information about other situation factors which are required for LSO training scenarios in addition to pilot and aircraft factors. Groups of situation factors which are addressed below include:

- Environment
- Operations
- LSO Station
- Ship

Tables are also included in this subsection to delineate situation variables and their values.

**ENVIRONMENT.** There are a variety of environmental conditions with which the LSO must contend during carrier landing operations. Environmental variables and their values are delineated in Table E-9. Some, like deck motion, affect the LSO directly by complicating his perceptual and decision processing. Others, like wind variations, primarily affect the pilot/aircraft component of the approach, and have significant influence upon the resultant approach profile which must be waved by the LSO. The three most difficult environmental conditions faced by the LSO are: night, deck motion, and absence of a defined horizon. Part of the task difficulty can be attributed to the fact that these conditions also increase pilot task difficulty, frequently causing more erratic approaches. One of the most significant effects on the LSO is the degradation of visual cues for waving. The other is the requirement to integrate additional factors into his decision processing.

One of the most significant aspects of deck motion is that ramp motion affects the safe clearance margin for the terminal portion of an approach. Pitch and heave can also affect stabilization of the FLOLS, giving erroneous "meatball" (glideslope) indications to the pilot. This can lead to incorrect pilot control relative to an "earth-stabilized" glideslope. The motion degrades LSO perception of optimum glideslope and adds ramp position, and the prediction of it, to the decision process. Roll and yaw motion cause lineup control difficulties for the pilot. Several variations of deck motion, including pitch, roll, yaw, heave and their combinations will be required for LSO training.

Absence of a defined horizon degrades the perceptual performance of the LSO by taking away his earth stabilization reference for glideslope. This is particularly critical under pitching deck conditions. Frequently a plane guard destroyer which follows the aircraft carrier can be a substitute horizon reference. Restrictions in pilot and LSO visibility again complicate the performance of each. The decrease in visibility may be caused by low ceiling, fog or rain. Usually, in these conditions, the LSO can see the aircraft before the pilot sees the ship. A visibility condition which precludes the LSO from seeing the aircraft until inside one half mile, reduces the time that the LSO has to monitor and evaluate approach

## NAVTRAEQUIPCEN 80-C-0063-2

TABLE E-9. ENVIRONMENTAL VARIABLES

<u>Variable</u>	<u>Values</u>
AMBIENT LIGHT	Day Dusk Night
HORIZON	Clear Dim None
DECK MOTION	Steady Mild Pitch Mild Roll Mild Yaw Moderate Pitch Moderate Roll Moderate Yaw Moderate Pitch/Roll/Yaw Heavy Pitch Heavy Pitch/Roll/Yaw
WIND DIRECTION	Optimum Axial Starboard Port Shifting
WIND VELOCITY	Optimum High Very High Low Very Low
VISIBILITY	Unlimited (7 nm+) Fair (4-5 nm) Poor (2 nm) Very Poor ( $\frac{1}{2}$ nm)
CEILING	None Low Very Low
BURBLE	None Slight Significant

trends and provide assistance. Wind direction and intensity affect approach geometry. Optimum wind is a resultant wind vector down the angle deck (direction) of between about 20 and 30 knots (intensity), depending on aircraft type. Deviations in direction influence lineup control by the pilot. Deviations in intensity affect LSO waving strategies. For low wind conditions, aircraft approach speed may exceed arresting gear or aircraft structural limitations.

OPERATIONS. There are several operational situations and factors which affect LSO performance. They are delineated in Table E-10. Several of these place added pressure on the LSO during the course of waving. Knowledge that an aircraft is low on fuel and there is no airborne tanker or divert field places a high demand on the LSO to help get the approaching aircraft aboard safely. A barricade recovery is another pressure situation. EMCON conditions require the LSO to wave approaches without voice communications. Timely attention to the status (clear/foul) of the deck for landing aircraft is a basic, but very critical, aspect of the waving task. An out-of-trim condition by the ship can negatively affect the geometry and ramp clearance margins during recovery, increasing the vigilance of the LSO for approach deviations. Waving an approach while the ship is turning is a demanding task for the LSO.

Another important area is the coordination among members of the recovery team on the ship. On the platform the controlling LSO interacts with a backup LSO, a phone talker and a hook spotter. He must also interact with PRIFLY and CATCC personnel. Any breakdown in coordination or communication among these team members can place added pressure and decision-making complexity on the controlling LSO.

LSO STATION. This grouping addresses the status of LSO work station equipment. Variations in LSO station configuration are discussed later under ship factors.

Several LSO station indicators are frequently integrated into the LSO scan prior to each approach: WOD, FLOLS (Roll Angle, Basic Angle and Hook-to-Eye settings), ACLS Mode, Hook-to Ramp and CLASS indicators. Some provide information relative to aircraft approach dynamics: SPN-42, SPN-44, HUD and PLAT. The MOVLAS repeater provides MOVLAS control movement feedback and the Waveoff light repeater enables the LSO to confirm the status of waveoff light activation. The status of LSO controls (radio, pickle, MOVLAS) is also relevant for LSO training situations. Indicator and control variables for the LSO station are delineated in Table E-11.

SHIP. There are many variations among the different aircraft carriers. Size, shape, LSO platform position and resultant geometrical relationships differ among carriers thus affecting the perspective of the LSO. Some carriers have an LSO platform which is flush with the flight deck, others have a recessed platform. The configuration of the LSO work station differs among carriers. Additionally, a program for modifications to the LSO work station is underway. Some of the LSO platform equipment involved in this

TABLE E-10. OPERATIONS VARIABLES

<u>Variables</u>	<u>Values</u>
AIRBORNE TANKER	Yes No
DIVERT FIELD	Close Far None
DIVERT FIELD WEATHER	VFR IFR At Minimums
NO. OF AIRCRAFT	One Few Some Many
LANDING INTERVAL	Normal (Day 45-50 sec., Night 60-80 sec.) Long Close Very Close
COMM RESTRICTIONS	None Ziplip Emcon
BARRICADE	No Yes
MOVLAS	No Yes
DECK STATUS	Closed Clear Foul No Indication
WIRES MISSING	None Early Late Target

TABLE E-10. OPERATIONS VARIABLES (Continued)

<u>Variables</u>	<u>Values</u>
CCA MODE	ACLS I ACLS IA ACLS II ACLS III Single Channel SPN-42 ASR TACAN None (Case I, II)
SHIP TRIM	Level Stbd List Port List Ramp up Ramp down Combinations
SHIP TURN	No Yes
AMBIENT NOISE	Normal Quiet High
LENS STATUS	Normal INOP Stability Malfunction Other Malfunction
PLANE GUARD HELO/ DESTROYER	Yes No
TYPE OPS	Fleet Cyclic Fleet CQ/REF FRS CQ CNATRA CQ

NAVTRAEQUIPCEN 80-C-0063-2

TABLE E-11. LSO STATION VAIRABLES

LSO RADIO	Normal INOP Wrong Frequency
ROLL ANGLE	Correct Incorrect
BASIC ANGLE	Correct Incorrect
HOOK/EYE SETTING	Correct Incorrect
PLAT	Normal INOP
SPN-42	Normal INOP
SPN-44	Normal INOP
ACLS MODE INDICATION	Normal INOP
WOD	Normal INOP
CLASS	Normal INOP
HUD	Normal INOP Partial Failure
PICKLE	Normal INOP
MOVLAS REPEATER	Normal INOP Inaccurate
WAVEOFF LIGHT REPEATER	Normal INOP
MOVLAS CONTROL	Normal INOP
HOOK-TO-RAMP	Normal INOP



program include: LSO HUD, CLASS, Indicator Console and PLAT. For each carrier (or carrier class, in some cases) there are differences in FLOLS geometrical considerations for targeted touchdown position. Arresting gear engaging speed limitations and other factors which enter into recovery decisions by the LSO also differ among carriers. Therefore LSO training situations may require the representation of different aircraft carriers.

#### MODEL IMPLEMENTATION GUIDELINES AND CRITERIA

This portion of the appendix addresses the implementation of the model requirements presented earlier. Initially the goals and implementation criteria are discussed. Following that is a discussion of some guidelines for model implementation. Within the discussions there are frequent references to the possible implementation of the pilot model in the LSO Reverse Display. Such an option has the potential of increasing its effectiveness through the application of a limited aspect of the automated LSO training system concept.

**IMPLEMENTATION GOALS.** The ultimate goal of training system performance is that it provide a high transfer of training for LSO waving skills. In support of this, the primary goal in model implementation is that the operation of models be responsive to LSO training needs. Based on analyses conducted during this study, the most important LSO training needs are reduction in the time required to complete LSO training and increased trainee exercise of critical decision skills.

Reduction in training time is likely if the LSO training system can provide additional waving experience to the trainee and effective feedback on waving performance. It would be desirable that the waving experience provided to the trainee encompass all situations likely to be encountered on the job. However, this goal may be achievable with a limited set of waving situations which provide a strong foundation of basic decision skills and cognitive schema for expansion of these skills on the job. Instruction which allows a trainee to walk aboard ship and immediately take on unsupervised waving duties is not a realistic goal for an LSO training system.

The basic perceptual skills are rapidly acquired on the job. However, trainee interaction with the pilot is an initial stumbling block during on-the-job training. Thus, effective simulation to support this interactive training-task must receive very high-priority as a part of the goal to reduce on-the-job training time.

The waveoff decision skill must receive highest priority if the system is to provide effective trainee preparation for on-the-job training. Use of the training system must provide a foundation of cognitive skills from which to learn how to handle increasingly complex and stressful waveoff decision situations. On-the-job there are relatively few opportunities for

the trainee to actively exercise waveoff decision skills. An LSO training system can provide opportunities to interactively explore the influences on the waveoff decision without jeopardizing carrier landing safety.

It is apparent to the authors that LSOs have difficulty in verbalizing and quantifying the tasks they perform while waving approaches. This has reduced the efficiency of the performance feedback process between LSO teacher and trainee. An LSO training system can increase the efficiency of task performance feedback through performance measurement, task replay and other instructionally oriented capabilities. These capabilities are therefore likely to provide the trainee with better insight to the waving tasks through objective performance assessment and to better equip him to be an active learner on the job. In view of these considerations, the learning process should be accelerated.

Another consideration in achieving the goal of responsiveness to training needs is flexibility of model implementation. The pilot behaviors and aircraft performance being simulated must be implemented such that model parameters can be easily modified based on initial testing, as well as on feedback from operational use. The aircraft simulation must also be implemented to allow for future inclusion of different types of aircraft. The communications between instructor model and pilot/aircraft models must be implemented such that the interface can be refined and/or revised based on changing training requirements.

The LSO Reverse Display already has some of the capabilities desired for an automated LSO training system. Implementation of the pilot model requirements described in this appendix would reduce the need for pilot personnel in LSO Reverse Display utilization for LSO training. It may also enable trainee practice sessions without the presence of an instructor LSO. However, the training effectiveness of this latter notion has not been confirmed.

The above discussions have addressed system and model implementation considerations relative to LSO training system performance goals. The next discussion addresses implementation criteria for pilot/aircraft models in support of these goals.

**IMPLEMENTATION CRITERIA.** The primary criterion for model implementation is face validity of the pilot behavior, aircraft performance characteristics and other conditions simulated, relative to the training goals of the system. The criteria for face validity are addressed below from two perspectives. The first perspective is that of minimum simulation requirements for an LSO training system. The other is the performance quality of pilot and aircraft simulations.

As mentioned earlier, it would be desirable to simulate all waving conditions and situations which the trainee may encounter on the job. However, in view of potential funding constraints, technological limitations and limited training time available, this may be unachievable. Thus,

a realistic goal for the training system would be to provide the trainee with waving experience and performance feedback for situations which exercise the most critical decision skills required for the job. To achieve this goal, the waving situations used in training must include the conditions and decision factors which have been identified as most critical to successful waving performance.

During this study it was evident from many information sources that the waveoff decision is the most important aspect of successful waving performance. It was also apparent that the most important situation factor affecting the waveoff and other decisions is the behavior of the pilot during approach. Thus, a primary criterion of implementation is to provide meaningful simulation for LSO and pilot interaction during approach. For the simulation to be meaningful, it must very closely replicate the time criticalities of pilot behavior found in on-the-job waving decisions, which will be discussed in more detail later. Pilot behavior must be represented from two aspects; approach profile control, and response to LSO calls/signals. Pilot behavior must also be represented in conjunction with at least three types of aircraft in order for the trainee to experience a variety of example decision situations. The aircraft types should have dissimilar performance characteristics. The F-14 is suggested as one type since it represents: large aircraft, relatively slow approach speed, variety of approach modes (APC, DLC, manual throttles), and relatively difficult lineup control. The A-7 is suggested as another as it is representative of: small aircraft, relatively fast approach speed, relatively easy lineup control. Since both have sluggish power response following power reductions, either the A-6 or E-2 is suggested as the third type, which would be representative of excellent power response. Besides providing a representative cross-section of aircraft performance characteristics, these aircraft also allow the presentation of typical multi-aircraft carrier recovery scenarios.

Four environmental conditions are considered to be minimum requirements for implementation within the simulation: night, deck motion, wind variations, and horizon definition variations. Night is the most difficult environment for both the pilot and LSO, and is the condition under which most accidents occur. Deck motion and wind variations are critical factors in carrier landing accidents. Providing these conditions and variations in horizon definition will enable the trainee to exercise his waving skills under a wide variety of example situations. For an LSO Reverse Display application, these conditions are already incorporated.

The final minimum requirement for an LSO training system is the provision for using the MOVLAS. Although MOVLAS does not appear very frequently as an accident factor, it is a critical LSO skill for which there are few opportunities for practice in the operational environment. The LSO Reverse Display already includes provisions for MOVLAS.

The quality of pilot behavior and aircraft performance simulations will be extremely important to training system effectiveness. The pilot

behavior simulation must very closely replicate actual control of approach parameters, particularly during the final half mile of the approach. This is also true in the case of the aircraft model. The dynamics of the pilot and aircraft working together provide the primary decision cues for LSO actions. The approach profile control component of the pilot model controls the dynamic cues which precede and are independent of LSO intervention. The response component of the pilot model controls the dynamic cues which result from LSO intervention in the approach. The primary dynamic cues under the control of these model components are rate of descent, lineup drift, AOA. Representation of rate of descent and AOA, must be based on realistic control of engine power and pitch. During implementation, the realism of control for these approaches must be thoroughly tested and evaluated by expert LSOs to assure face validity of the simulation of pilot and aircraft.

A consideration for partial pilot model implementation in the LSO Reverse Display would be use of existing Mode I ACLS software to control the approaches. Additional software could be added to tell the ACLS software where to fly the aircraft (i.e., go very high in the middle, go a little low in close, etc.). This is called a partial implementation since the ACLS does not control AOA.

**OTHER IMPLEMENTATION CONSIDERATIONS.** The guidelines presented below suggest some of the near-term considerations and activities for implementation of the models. They are applicable both to an LSO Reverse Display retrofit and a new procurement.

Near term implementation activities must include involvement by system analysts, software programmers, training analysts and LSO subject matter experts. This mix of expertise is required to complete the detailed design of the models and to ease transition from functional requirements to software and hardware reality without jeopardizing the training requirements orientation of system development. Subject matter and systems analysis expertise must be applied to the detailed derivation of specific model parameters and values, and to the development of appropriate algorithms based on requirements described earlier in this appendix. Training analysis, subject matter and systems analysis expertise must be applied to the detailed design of the interactions between the simulation (pilot and aircraft models) and instructional control (instructor model) aspects of the training system. Training analysis and subject matter expert personnel must be involved in the testing of model validity and overall system operation to insure that system capabilities adhere to the training requirements on which it is based.

In the derivation of specific model parameters and values, the LSO Reverse Display is suggested as a potentially useful tool. Approaches flown from the NCLT could be recorded and parameters analyzed to establish values for the variations needed in training scenarios.

A major concern for the automated LSO training system concept is the performance of speech recognition technology. Its feasibility in providing realistic representation of pilot responses must be evaluated as early as possible during implementation of the models. Additionally, there should be early design attention to alternative control schemes such as trainee interaction strictly through the waveoff and cut light controls and provisions for "joystick" type responses activated by an instructor. These considerations would be particularly relevant if the pilot model was to be implemented with the LSO Reverse Display.

A final consideration is the availability of information and data which are relevant to model implementation. Besides this report, there are several others listed in the bibliography which are valuable references for various aspects of model implementation. Additionally, the Naval Safety Center is a source of data specific to carrier landing accidents. Useful reports and other sources of data are listed in Table E-12. The table also includes coded categories for the types of information available in each. Refer to the References and Bibliography for additional identifying details for the reports listed.

TABLE E-12. SOURCES OF IMPLEMENTATION INFORMATION

<u>Source</u>	<u>Type of Information</u>
Borden, 1969	A, B
Breaux, 1980	A, D, E, G
Bricton, et al., 1980 (2 reports)	A, B, C
Chatfield, et al, 1979	D, G
Erickson, 1978	A, B
Hooks, et al., 1978	A, B, D
Hooks, et al., 1980	C, D, F
Hooks and McCauley, 1980	D, E, F
LSO School (course Materials)	A, B
McCauley and Borden, 1980	A, B, C, D
McCauley and Semple, 1980	G
McCauley and Cotton, 1981	D, G
Nave, 1974	C, F
Naval Safety Center (Accident Reports)	E, G
Netherland, 1965	A, B, C
Reigle and Smith, 1973	F
Smith, 1973 (2 reports)	C, F
U.S. Navy, 1975	A
U.S. Navy, 1976	A, B, D
Van Hemel, et al., 1980	G
Vought Corp. 1977	E

## Type Information Codes:

- A = LSO Job and Training
- B = Carrier Landing Situations/Factors
- C = Pilot Behavior
- D = LSO Training System
- E = LSO Reverse Display
- F = Carrier Recovery Simulation
- G = Automated Speech Recognition

## APPENDIX F

## FUNCTIONAL DESIGN

## 1.0 INTRODUCTION

This appendix is the final of two primary products produced in the course of this project (the preceding appendix being the other). The project involved a series of analytical studies to identify critical aspects of the LSO waving task upon which to base the functional characteristics of pilot and aircraft models within LSO training systems. Appendix E addresses the functional characteristics of pilot and aircraft behavior models which are needed to support interactive LSO training. Appendix F addresses the overall functional design context for an LSO Training System within which the pilot and aircraft behavior models are intended to operate. System developers must refer to both appendices (E and F) during detailed design and implementation. Developers must also refer to similar products developed in a companion project devoted to automated instructor model functions for LSO Training Systems.F1

## 1.1 PURPOSE

This appendix describes the plan for the definition, design, development, and implementation of the software for the Simulation Subsystem portion of the Landing Signal Officer Training System (LSOTS) during detailed design. It should be used in conjunction with Appendix E, which provides detailed descriptions of the pilot/aircraft modelling requirements for the Simulation Subsystem. This functional design provides a description of the main characteristics of the software, placed in context with the purpose, design, and operational concept of the overall training system. The section on Program Design addresses the functional and operational considerations of the software and describes simulation subsystem modules. Training and system constraints are also discussed.

## 1.2 DESIGN

The LSO training program requires a medium which can provide interactive trainee task performance situations within the context of instructional guidance. This is currently being accomplished in the job environment of field and carrier landing operations under the guidance of supervisory LSOs. However, this dependency upon the OJT environment has become unacceptable due to frequent extended periods of reduced levels of operations and shortages of skilled LSOs. To supplement the OJT environment, an automated LSO training concept has been conceived and researched by the Navy. Some aspects of the concept have been exercised in the laboratory and in the field, and are discussed earlier in the report in Section III.

---

F1 McCauley, Michael E. and Cotton, John C., Automated Instructor Models for LSO Training Systems. Technical Report NAVTRAEQUIPCEN 80-C-0073-2. Naval Training Equipment Center, Orlando, Florida, 1982.

The design concept of an automated LSO training system is based on several required functional characteristics. It must provide visual simulation of the carrier landing environment from the LSO workstation perspective. It must provide the means for LSO task interactions with the pilot during the landing process. It must be independent of other training devices. It must provide automated support for instructional guidance, syllabus control, trainee evaluation in the learning process, and recording of trainee progress in the training program.

This design concept can be simplistically represented by five major system elements:

- o Trainee Station
- o Instructor Console
- o Instructor Subsystem
- o Simulation Subsystem
- o Trainee Performance Records

These elements and their interrelationships are simplistically depicted in Figure F-1.

The pilot/aircraft behavior model requirements will be implemented within the Simulation Subsystem. Requirements for the pilot model are described in Appendix E and include approach profile control and dynamic response to LSO voice calls/signals during approach. The purpose of approach profile control is to depict various deviations and trends in glideslope, lineup, and AOA for LSO perceptual and decision skill acquisition. The purpose of dynamic response to the LSO is to present variations in pilot responsiveness which must be learned by the LSO trainee. Requirements from the aircraft model include variations in aircraft type, aircraft malfunctions, and other approach characteristics (mode, configuration, and fuel state).

There are three technological areas which are important to the automated LSO training system, and consequently to the pilot/aircraft behavior models functions. The effectiveness of pilot/aircraft model output is somewhat dependent upon the quality of visual simulation to portray the required dynamic cues. Another is automated speech recognition (and understanding). This technology will be important to effective representation of pilot responses to LSO voice calls and to automated performance measurement. The third technological area is the automated "intelligence" associated with syllabus control. This affects the quality of decisions made (human or automated instructor) regarding pilot and aircraft behavior selections for training situations. The technological aspects of system design and their functional implications are addressed later in more detail.



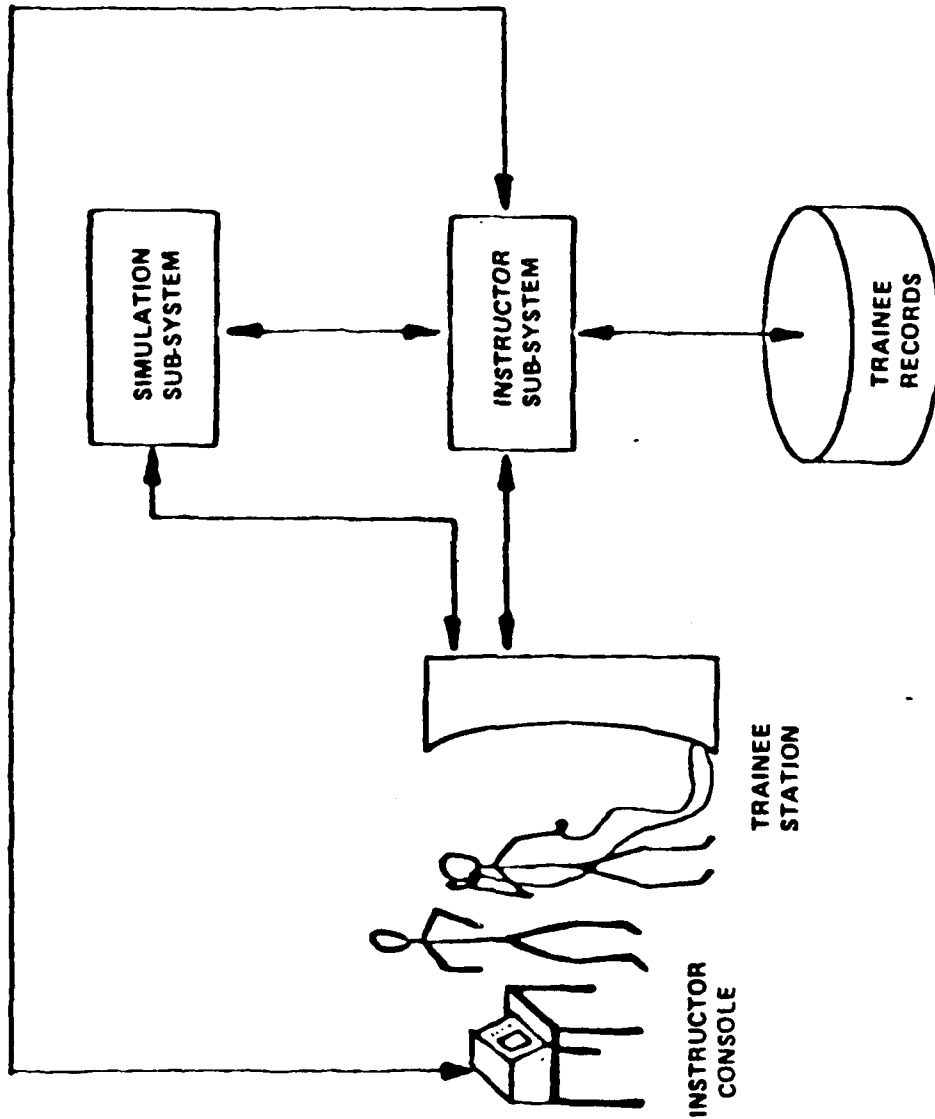

Figure F-1. LSO Training System Concept

### 1.3 OPERATIONAL CONCEPT

An LSO training system will be one instructional component within the overall LSO training program. Other methods and media employed within this integrated training program will include academics, field carrier landing practice (FCLP) operations and actual carrier landing operations.

The operational concept of an automated LSO training system is to provide instructional support for a variety of LSO training requirements, from basic through advanced skills. Basic skill areas include perception of aircraft approach dynamic cues, correlation of cues to appropriate LSO actions, and LSO workstation habit patterns. Intermediate skill areas include the formulation of aircraft control ("waving") strategies for a variety of aircraft types and pilot characteristics. Advanced skill areas include the extension of basic and intermediate skills into complex recovery situations. These situations include: aircraft malfunctions, difficult environmental conditions (deck motion, low visibility, non-optimum wind, etc.) and difficult operational conditions (low fuel state aircraft, arresting wires missing, mistrim of ship, malfunctions of workstation aids, etc.). In addition to aircraft control skills, the trainee must learn to make decisions associated with safety and efficiency of the overall recovery process. Throughout the training program the trainee will be learning increasingly complex concepts and relationships. The automated LSO training system concept also encompasses refresher training for LSOs following extended absences from LSO duties.

The training in an automated LSO training system will involve the presentation of interactive, simulated carrier landing situations to the LSO trainee. The trainee will observe an approaching aircraft and initiate voice calls or light signals based on aircraft dynamics in conjunction with other conditions existing in the simulated carrier landing situation, such as deck motion, wind, aircraft malfunctions, etc. Pilot reactions to trainee voice calls and signals will also be included in the simulated carrier landing situations. Situations will also be presented which demand that the trainee make decisions regarding management of the recovery process (such as rigging the MOVLAS and changing the target wire). Instruction regarding what is to be learned in training sessions will also be provided in the form of task descriptions, explanations and demonstrations. In conjunction with the interactive recovery situations, the trainee will also be provided with feedback regarding the quality of his performance.

Progression by the trainee through the training program will be based upon a combination of human instructor decisions and automated syllabus recommendations generated by the instructor subsystem. The system will also have provisions for trainee selection of practice exercises. A goal of the system is to minimize the loading on the human instructor and to reduce the need for human instructor presence during training. As experience is gained in the use of the system, it is anticipated that the

automated instructor decision logic will be refined to enable a significant amount of effective "instructor-absent" training.

The pilot/aircraft behavior models play an important functional role within the system. They guide the representation of pilot and aircraft behavior in the simulated carrier landing environment. The variations of behavior presented are based on deliberate guidance from instructional objectives. This guidance comes from an instructor (human or automated) component of the system. Pilot behavior will be represented in variations of the approach profiles being observed by the LSO. It will also be represented in variations of how the pilot responds to calls and signals from the LSO. Aircraft behavior and appearance will vary by type of aircraft and aircraft system malfunctions. An overview of models interaction presented earlier in Appendix E is repeated here in Figure F-2.

#### 1.4 SOFTWARE

The LSO Training System and its applications software are being designed based on the following goals and assumptions:

- o Top Down, Structured Design. The LSO Training System should be designed using a top-down, structured approach. This method involves defining the system in terms of functions provided at the highest possible logical level. The function interfaces are described while implementation details are assumed to be defined and available at the next lower level in a functional form. The process is repeated recursively at successively lower levels until all functional and procedural details have been identified. This occurs at the lowest level. In this way the exact details are left to be identified and solved only when the highest levels have been completed. This process has been proven to significantly improve design characteristics and reduce development time in both large and small software projects.
- o Modular Design. All LSO Training System software should be designed around the concept of modularity. This involves partitioning the identified functions into separate software entities called modules. These modules are either internal procedures or external procedures. The use of external procedures in LSO Training System software is being emphasized as this results in a system that is easier to design, implement, debug, and maintain.
- o System Connectivity. The concept of strongly versus weakly connected systems has long been a software design controversy. A strongly connected system is one that relies heavily on the use of shared memory variables to pass control information and data between modules. A weakly connected system uses parameters and variables that are "passed" between the modules needed to reference them. The LSO Training System should be designed as a weakly connected message driven system.

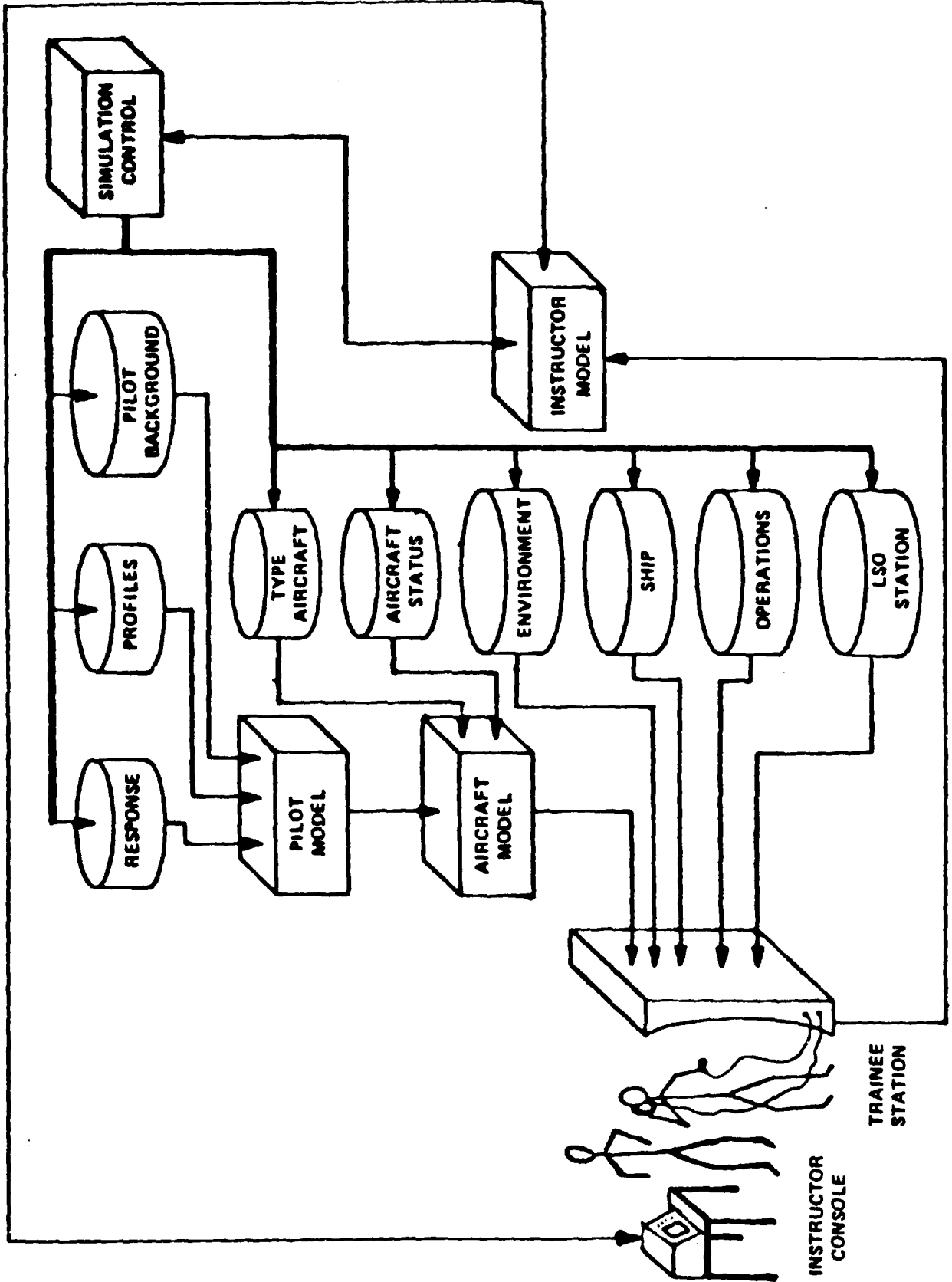

Figure F-2. Models Interaction

- o Data Driven. The LSO Training System software should be designed as a data driven system where all the input parameters, data and constants, and the majority of the control and decision logic are defined externally to the program in system resident disk files. This means that the execution and nature of the program depends solely on the data it uses. This approach allows one set of programs to serve many purposes, each of which is defined by a new set of parameters and data contained in user selectable disk files.
- o System Flexibility. Software design must also be flexible enough to be responsive to future system refinements and change requirements. Visual simulation changes may eventually be needed for such items as new fleet aircraft, major modifications of existing aircraft, additional aircraft carriers and modifications to the LSO platform. The training tasks may change with the addition and deletion of acceptable LSO voice calls. As more is learned about correct LSO behavior, the performance measures and evaluation criteria may have to be modified. Discovery of new instructional techniques may require modifications to the graphic effects and display formats used for instruction and feedback.
- o Training Goal Orientation. The LSO training system has not been conceived as merely a vehicle for practice of waving tasks. It has been conceived as a system in which training sessions and specific exercises are to be based upon definitive LSO performance and training goals. Within the training system, the performance goals and the logic for presentation of related instructional situations must be under the control of the instructor subsystem. This does not preclude trainee and human instructor intervention in the training process. It does insure that system users are made aware of training goals in order to minimize inappropriate uses of the system. If the resident performance goals, course of instruction, syllabus logic or other aspects of the system are found to be deficient, change requirements should be verified and the system modified.

Using the above goals and assumptions will allow portions of the system to be concurrently developed by separate groups and still maintain a complete and integrated design of the system as a whole. The remainder of this document addresses the LSO Training System in general and the Simulation areas in particular. Other areas are discussed as needed.

## 2.0 PROGRAM DESIGN

The LSO Training System applications software is being designed to provide the programs, modules, and functions needed to fulfill the training requirements and operational system requirements within the system constraints. The software must be capable of the following:

- o interacting with instructors and trainees and curriculum design personnel;
- o controlling the access to and manipulation of large and complex data bases associated with general and specific training applications and situations (syllabus, visual simulation, training records);
- o simulating the action of sophisticated hardware systems (aircraft);
- o simulating the human decision making process (LSO, pilot);
- o monitoring and directing the activity of a system whose parts may be partially external to itself;
- o provide off-line support for the above functions.

The LSO Training System hardware is assumed to consist of one or more central processor units (CPUs), random access memory, disk storage, a display subsystem, a speech subsystem, and various general purpose interfaces. The system hardware is not known at this time, but it is assumed that when the selection is made the hardware will provide the basic subsystems and capabilities assumed in the design.

## 2.1 PROGRAM CONTROL

The LSO Training System is a computer based training system. The functional organization of the system is described below. Overall system functional areas consist of the following:

- o **Syllabus Control.** The Syllabus Control function embodies all the capabilities associated with an Instructor Model: Syllabus Decisions, Performance Monitoring, Performance Evaluation, Student Records and the man-machine interface.
- o **Exercise Control.** The Exercise Control function consists of Scenario Control, Scenario Generation, Task Monitoring, and processing associated with speech understanding inputs generated by the trainee.

- o Exercise Presentation. The Exercise Presentation function includes all non-instructor modeling and simulation routines, and the display of exercise or task related data and cues.
- o Data Management. The Data Management function controls access to and maintenance of all information used in the LSO Training System. This includes student records, simulation data, display data, syllabus data, speech data, and task related data.

It must be remembered that these functional groupings in no way depict their logical interrelationships. Figure F-3 shows the functional areas partitioned into subsystems. Here the relationships of the functions to their logical and physical interaction are more apparent.

The Instructor Subsystem contains the functions responsible for syllabus selection, syllabus control, performance monitoring, performance evaluation, system summary, and the access and control of student records, speech data, and some task related data. The design of this subsystem must also include the man-machine interface for the LSO Training System as a whole. The Instructor Subsystem interacts with all the remaining subsystems.

The Simulation Subsystem implements the functions of scenario generation, scenario monitoring, scenario control, all non-instructor related modeling and simulation, acting on speech understanding (SUS) inputs from the Speech Subsystem, and the use of simulation and task related data. The Simulation Subsystem also processes inputs from the Instructor Subsystem and the Data Management Subsystem while applying inputs to the Display Subsystem and to the Instructor Subsystem.

The Display Subsystem is a totally self-contained system that receives display requests and produces graphic images and text for presentation to the trainee. The Display Subsystem receives inputs from the Instructor and Simulation Subsystems. Based on inputs from the Simulation Subsystem, the Display Subsystem provides the trainee with visual representation of the approaching aircraft, carrier deck outline, horizon, sea/sky conditions and LSO workstation displays. This subsystem is also responsible for providing sound simulation as appropriate to scenario requirements. Examples include flight deck sounds and the engine of the approaching aircraft. This subsystem is completely passive and generates no outputs to any of the other subsystems.

The Voice Subsystem will use trainee oriented speech data and student utterances as inputs and produce data indicative of the recognized spoken phrase. It will also generate synthesized speech as appropriate to scenario requirements. Examples include the pilot, Air Boss and CATCC personnel. This subsystem will interact with both the Instructor and Simulation subsystems.

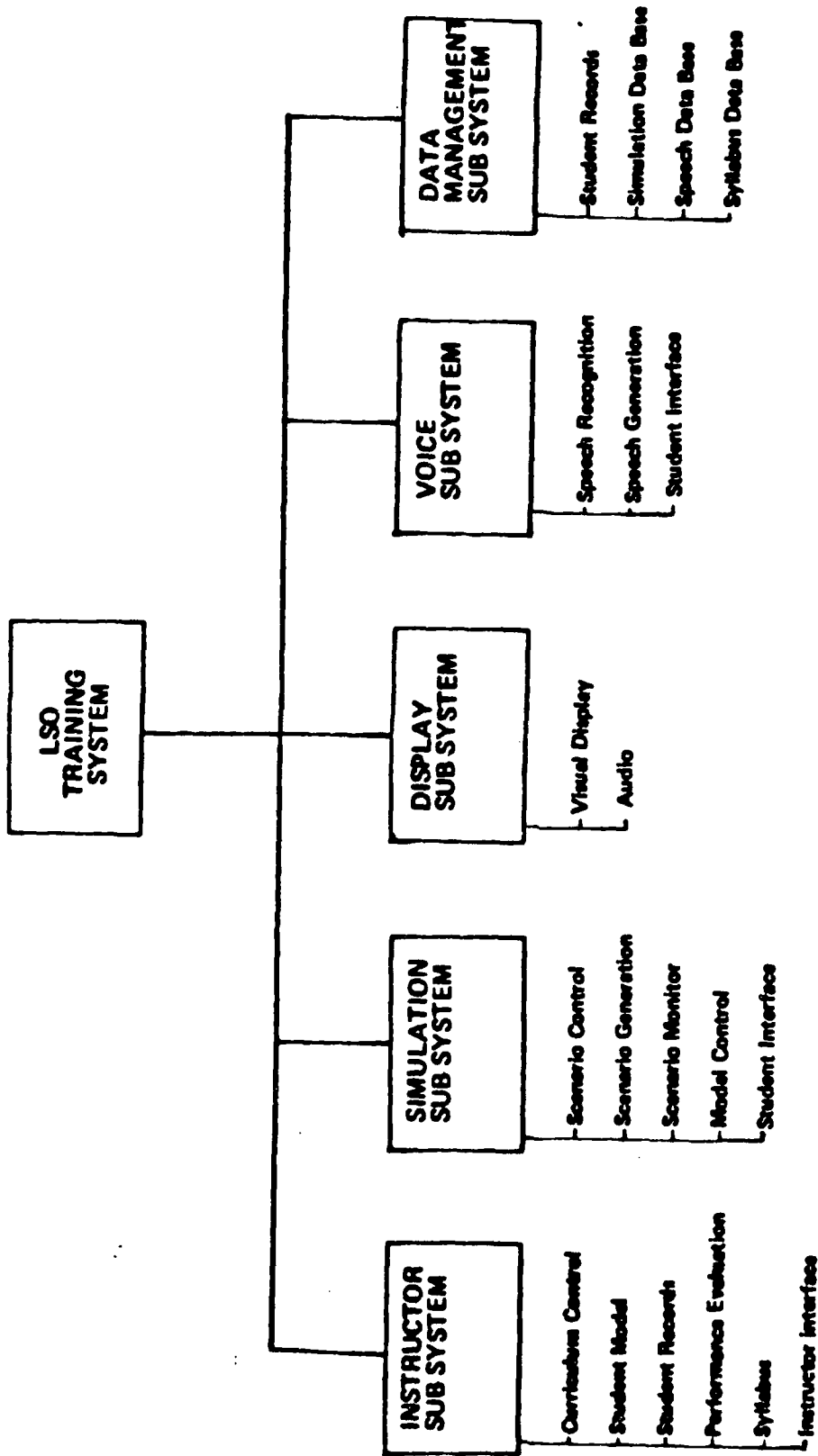

Figure F-3. LSO TRAINING SYSTEM SUB SYSTEMS



The Data Management Subsystem is included in the subsystem diagram even though it is primarily an off-line program. This subsystem is totally responsible for maintaining the integrity of all data used by the LSO Training System. It interacts with all of the remaining subsystems except the Display Subsystem in the off-line mode. To ease design and development time, portions of the Data Management Subsystem will be used during run-time by other subsystems to access system related data.

### 2.1.1 SIMULATION SUBSYSTEM MODULE DESCRIPTIONS

The functional areas of the Simulation Subsystem are shown in Figure F-4 and discussed below. The term "scenario" is used frequently in the discussion below. This term refers to the training situation being presented to the trainee. The scenario consists of the presentation of one or more carrier landing approaches and related recovery conditions for instructional explanation, demonstration or as an interactive training exercise. The elements of a scenario are the approaching aircraft, the carrier and LSO workstation conditions, environmental effects (such as wind, deck motion, weather and horizon), sounds and voices. A scenario may be only a single approach or it may encompass a series of approaches. The conditions existing in a series of approaches may be relatively stable (i.e., same type aircraft, same deck and environmental conditions, etc.) or they may change from approach to approach representative of a carrier operations recovery cycle (i.e., different aircraft types, increasing deck motion, deteriorating weather, etc.).

**SIMULATION EXECUTIVE.** The Simulation Executive module is the heart of the Simulation Subsystem. It controls the execution of the Scenario Generator and Scenario Monitor subfunctions.

**Function.** The Simulation Executive is responsible for routing all incoming and outgoing message traffic -- the individual modules and subfunctions are responsible for assuring that messages are properly formatted. The Simulation Executive module also processes errors detected within the Simulation Subsystem and manages exception handling. Disk file accesses are also managed by the Simulation Executive as are requests for user (Instructor or Trainee) input from the Instructor Subsystem. The Simulation Executive is also responsible for data management requests of any nature (via system disk files) by use of selected routines from the Data Management Subsystem.

**Inputs.** Inputs to the Simulation Executive consist of the following:

- a. Requests for Simulation data from the Training System Executive.
- b. Requests for scenario generations based on information in the Instructor Subsystem. These data consist primarily of syllabus information.

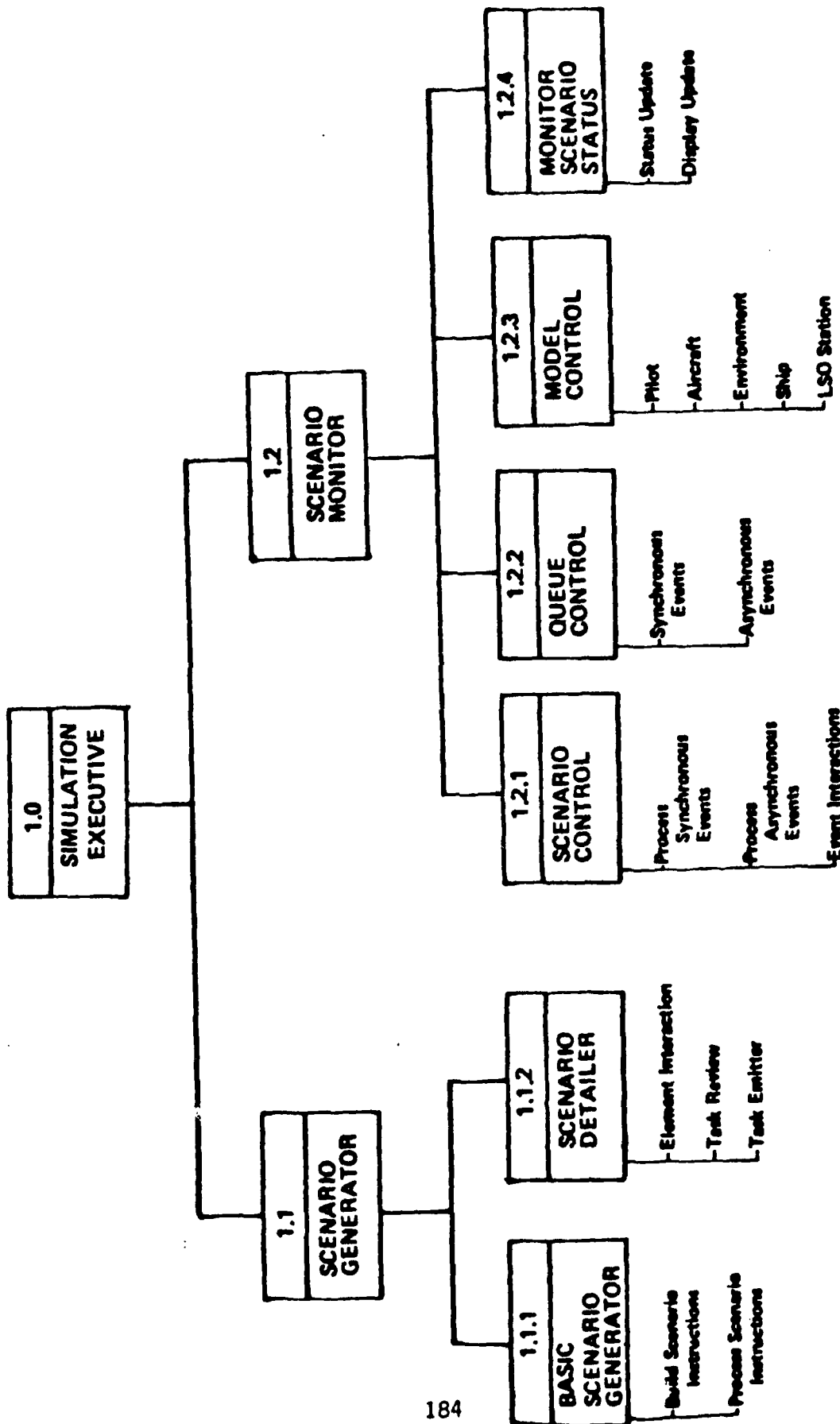

Figure F-4. SIMULATION SUB SYSTEM MODULE HIERARCHY

- c. Requests for Instructor overrides of data and/or events in the scenario file.
- d. Formatted messages for overall system control and synchronization.
- e. Requests for data and/or services from subordinate modules in the Simulation Subsystem. These requests fall into two categories. The first is for services within the Simulation Subsystem that the Simulation Executive can either provide directly or can obtain from another subordinate module. The second type of request is for services and/or data that reside outside the Simulation Subsystem. These requests are passed directly on to the Training System Executive for final processing.

Outputs. The following represent outputs from the Simulation Executive:

- a. Data requested by the Training System Executive. These data consist mainly of aircraft status and state vectors, feedback from the Pilot/Aircraft models, and information to the Display Subsystem. These data are also used by the Performance Monitoring function of the Instructor Subsystem.
- b. Data and/or services to modules within the Simulation Subsystem. These correspond to "e." above.

**SCENARIO GENERATOR.** The Scenario Generator module functions under the Simulation Executive to oversee the generation of scenarios.

Function. The Scenario Generator module provides the complete high-level interface between the Instructor element and the actual production of scenarios via the Basic Scenario Generator and Scenario Detailer modules. The Scenario Generator module is a control and sequence module that does not directly generate any data.

Inputs. Inputs to the Scenario Generator consist of requests from the Instructor Subsystem Executive via the Training System Executive to generate or execute a scenario specific to a task, key concept, or critical situation as described in the Syllabus data base resident in the Instructor Subsystem.

Outputs. Outputs from the Scenario Generator consists of control and sequence data.

**BASIC SCENARIO GENERATOR.** The Basic Scenario Generator module functions under the Scenario Generator to build the basic scenario instructions and then process them.

Function. Building scenario instructions consists of processing any existing scenario build command files on disk and/or instructor inputs from the console. These scenario instructions are then processed so that various model elements are selected from the model element disk files and element modifiers are included. This results in an intermediate scenario file that is passed to the next module in the build sequence.

Inputs. Inputs to the Basic Scenario Generator consist of specific scenario data requests from the Instructor Subsystem Syllabus data base. These function as instructions on how the Basic Scenario Generator is to combine the simple elements from the Simulation Data Base - the various model elements and scenario templates to produce a scenario. For example, the instructions may request (or imply) the number of approaches, type(s) of aircraft, types of profiles, pilot response characteristics, ship and environmental conditions, etc., to be included in the scenario.

Outputs. Output from the Basic Scenario Generator is an intermediate scenario file.

**SCENARIO DETAILER.** The Scenario Detailer module functions to complete the scenario generation process by using the intermediate file as input to produce an executable scenario file for use by the LSO Training System Simulation Subsystem Executive.

Function. The Scenario Detailer uses the intermediate scenario file as input for processing by its three subfunctions. First, the intermediate file is scanned for conflicts and inconsistencies resulting from model element interactions. These interactions can result from build instruction errors (of logic, incorrect actions of modifiers and situational variables, and intrinsic element interactions). An example would be a request for an external aircraft light malfunction in a day carrier landing situation. These interactions are either resolved or a diagnostic message is issued giving the cause of the problem and whether or not it is possible to continue the build.

Second, the user is given the opportunity to review the generated scenario prior to saving it. At this time the user may alter those portions of the scenario that are deemed inappropriate. However, it is highly recommended that user modifications be used sparingly and judiciously as the training value of the scenario may be adversely affected.

Last, a scenario data file is generated for use by the Scenario Monitor. While the above paragraphs describe an off-line session, the same sequence of events occurs during a dynamic generation session with the exception that there is no provision for reviewing the finished product.

Inputs. Inputs to the Scenario Detailer consist of the intermediate scenario file, instructor/user requests or overrides, and specific information from the model files to resolve model interactions.

Outputs. The primary outputs from this function consist of a reviewable scenario file and/or a saved executable scenario.

**SCENARIO MONITOR.** The Scenario Monitor module executes under the control of the Simulation Executive module and controls all aspects of scenario execution and simulation control.

Function. The Scenario Monitor module controls scenario execution via the Scenario Control, Queue Control, Model Control, and Monitor Scenario Status subfunctions. The Scenario Monitor handles disk file accesses of scenario, task, and simulation related data. It also controls the Simulation Timer Event Queue. This is a queue of timers that are associated with the occurrence or non-occurrence of selected and pre-defined events. Like the Scenario Generator module, the Scenario Monitor module is primarily a control module only and generates no data.

Inputs. Inputs to the Scenario Monitor consist of requests from the Training System Executive to execute a scenario as well as inputs from the subordinate modules from within the Simulation Subsystem. These internal inputs include the scenario file, data from the scratch pad disk file, data from the Simulation Subsystem Data base, and additional information from any pre-existing record/playback files.

Outputs. The outputs from this function consists primarily of commands to the Model Control submodule, the Queue Control submodule, and the Monitor Scenario Status submodule.

**SCENARIO CONTROL.** The Scenario Control module is a submodule of the Scenario Monitor module. Its function is to control the basic actions selected in the scenario data file subject to modifications triggered by Instructor and/or Trainee inputs, and event interactions.

Function. It accomplishes this by processing a series of events and their interactions. Events may be of two types, synchronous and asynchronous, each of which is maintained in a separate data structure. Synchronous events are those events which are predictable in advance and dependent on some variable such as time, distance, altitude, etc. An example would be the requirement for a low, slow approach profile deviation at a range representative of "in the middle" (4000 feet from touchdown). Another would be the requirement to initiate an aircraft engine failure at a pre-defined range. Asynchronous events are those that occur primarily because of some external action such as Instructor or Trainee input. The most frequent examples of this type event will be the actions of the LSO trainee (voice calls, light signals). Element interactions may be either synchronous or asynchronous depending on what single or multiple event caused them.

Inputs. Inputs consist of the Synchronous and Asynchronous Event Queues, event interaction modifiers from the model element files of the Simulation Subsystem Data base, and Instructor and Trainee inputs (e.g. voice calls).

Outputs. Outputs are mainly concerned with display commands to the Display Subsystem and commands to the Model Control module.

**QUEUE CONTROL.** The Queue Control module builds and maintains the synchronous and asynchronous event queues.

Function. These queues are simply two lists of actions to be taken based on exercise time, distance, or some other task or scenario related variable. These actions may be based on a single variable or combinations of variables. At periodic intervals or when an asynchronous event has occurred, the Queue Control module reevaluates the information contained in the two queues and may restructure them if needed. Event interactions may also cause queue reevaluation.

Inputs. Inputs to the Queue Control module consist of time and or positional event data from the scenario file and Instructor/Trainee inputs.

Outputs. The output of the Queue Control module consists of updated Synchronous and Asynchronous Event Queues.

**MODEL CONTROL.** The Model Control module controls the execution of the various model elements used during the scenario.

Function. Model Control functions to control the simulation of the actions and conditions of the aircraft, the pilot, the environment, etc. The elements to be used are maintained on an execution list based on scenario data. At periodic intervals during scenario execution, the Model Controller invokes the various model elements. When invoked, the elements operate on the simulation data structures resulting in updated positions, pilot, aircraft, or environmental actions. For example, Model Control will "fly" the aircraft in accordance with the profile specified in scenario instructions. It will also activate the appropriate pilot response for a LSO trainee voice call input. These updated simulation data are used by the Monitor Scenario Status module.

Inputs. Inputs to the Model Control module consist of scenario instructions and related data, the Synchronous and Asynchronous Event Queues, and feedback on trainee actions from the Instructor Subsystem.

Outputs. Outputs from the Model Control module consist of commands invoking the various model elements used in the Simulation Subsystem.

**MONITOR SCENARIO STATUS.** The Monitor Scenario Status module executes under the control of the Scenario Monitor module. It is responsible for maintaining and providing updates of aircraft status and other situation variables.

**Function.** Monitor Scenario Status provides information on aircraft status (position, velocity, attitude, etc.) and other situation variables (wind, deck motion, etc.) to the Instructor Subsystem, and display updates (in terms of display related coordinates) to the Display Subsystem. Display and status updates are provided on a periodic basis. Updates of aircraft position must be at the rate of at least fifteen per second. Status updates may be requested at any time to facilitate asynchronous event processing either by other modules in the Simulation Subsystem or by the Training System Executive for use by other parts of the system.

**Inputs.** Inputs to the Monitor Scenario Status module consist of elapsed time data, event related data, and scenario execution data.

**Outputs.** The primary outputs of this module are aircraft status information. It also outputs information on other situation variables.

### 2.1.2 SYSTEM SOFTWARE

The LSO Training System software is divided into system software and applications software. The system software selected for the LSO Trainer will be influenced by the final hardware selection but it is assumed that it will be supplied either by the hardware manufacturer or a reputable software house.

The design of the LSO Training System assumes that the system software will provide the capabilities discussed below.

**EXECUTIVE.** The Executive shall be capable of handling all low level device interactions as well as interpretation of console (CRT) user inputs. The Executive shall be capable of controlling multi-task programs.

**LANGUAGE PROCESSORS.** The system software shall provide at least one High Level Language (HLL) to be used for software development. While the exact language to be used will be greatly influenced by the final hardware selection, some of the advantages and disadvantages of several of today's currently popular HLLs are discussed below.

This discussion will center on only a handful of the dozens of HLLs available and in use today. These HLLs fall into two broad groups - unstructured and structured. However, all do share some common characteristics which make them desirable for use in the LSOTS software development effort. They all make use of symbolic variable naming constructs. They vary in the allowable length of variable names and legal characters. Most all of them have at least one implementation that supports separate compilation of program units (eg. procedures, subroutines, functions, etc.).

All HLLs have floating point, integer, and logical data types. They all feature powerful numerical processing capabilities. Most support some system of statements to implement various control and sequencing capabilities and to perform logical tests of equality. Finally, most are available for a variety of hardware suites. The HLL selected for the LSOTS development must be standardized, supported on a wide selection of hardware, readily available, and widely known and used.

The discussion of structured languages available today begins with PL/I and its subset compilers. PL/I is an extremely powerful and versatile language developed several years ago by IBM. PL/I supports all the advantages listed above and some peculiar capabilities associated with defining the precision of numbers and implementation of bit fields. The latter capability is especially useful when memory is a limiting resource and execution time is not. PL/I also has a character data type which can be especially useful. The main disadvantage to using a member of the PL/I family is that its compilers tend to be somewhat memory inefficient in the code generated and that almost all implementations are for either large IBM mainframes or small microprocessor based systems. For these reasons PL/I is not considered to be a serious contender.

PASCAL and its variants are extremely attractive as HLLs for software implementation because of the expanded nature of their statements for controlling program execution. This allows algorithms to be implemented in a very human oriented manner. Another important feature that PASCAL possesses is its rich variety of data types as well as the RECORD feature. This allows the designer/programmer to easily and quickly define new data types and data structures as the need arises and to specify clearly readable (and efficient) algorithms for their access.

PASCAL is not without its disadvantages. First and foremost, most implementations of PASCAL are interpreted. This is due mainly to the origins of PASCAL and why it even came about. Since LSOTS is a real time system, a high overhead interpreted software system simply cannot be tolerated. PASCAL also suffers from a lack of standardization. While many implementations share the spirit of the original language specification, vendors tend to add extensions that make the language somewhat less than portable. While this happens with nearly all languages developed by vendors, its effects are especially detrimental when there is no standard language specification upon which a majority of implementors can base their designs. Also related to this is the fact that PASCAL is still not a widely accepted language outside of the university community and while many hardware manufacturers offer or claim to offer a PASCAL, many still do not. These reasons all tend to reduce the desirability of using PASCAL for LSOTS software development.

ALGOL is a language that is a predecessor of PASCAL. Both languages share many common characteristics which may at first seem to make ALGOL the obvious choice, but ALGOL also suffers from many of the same shortcomings



as does PASCAL with two important additions. One, the language specification for ALGOL does not include any provision for input/output. While the reasons for this may at one time have been clear, the result is ludicrous. The main function of over half of all programs written and over 90 percent of each program's execution time is spent either doing or waiting for input/output. Lack of an input/output specification is more than likely the primary reason that there are so very few ALGOL compilers available today and that those that are used are so very different. Thus, ALGOL can be eliminated.

Mention is made now of ADA since it fits in the category of structured languages and is viewed by many to be the ultimate solution to the software development problem. ADA incorporates most of the "good" features of the more popular HLLs available on the market today. It is also DoD's choice for software in embedded applications. ADA is not a serious choice because there are currently no commercially available compilers on the market. Furthermore, ADA is what could be termed too powerful for the LSOTS application since there are few of what are called exceptions in the LSOTS software architecture. Perhaps in the future ADA will become the primary HLL for use in military applications.

The next candidate, HLL, is not actually a structured language, yet it has so many advantages that it is included in the discussion. That HLL is called "C". It was developed with a specific hardware architecture in mind. It therefore takes advantage of that architecture in its capabilities and structures. "C" further has the advantage of having all the power and flexibility of assembly language without the headaches. While many people still have not heard of "C", those who have tend to become part of a group of dedicated users. However, "C" suffers from the same two faults as do the previously mentioned languages - lack of standardization and limited implementation on a wide selection of hardware.

The final HLL in the discussion is also the only non-structured language considered. That HLL is FORTRAN. FORTRAN is probably the oldest and most widely accepted HLL currently in existence. It is also the closest thing to a truly standard and portable HLL available - mostly due to its long existence. Virtually every hardware manufacturer supports at least one standard version of FORTRAN. All usually have various extensions, but over the years even the extensions have tended to become standardized. FORTRAN has the advantages of wide availability, support, and use. It is standardized and eminently portable.

FORTRAN does have two serious drawbacks. One is that its control statements have been criticized as awkward and lending themselves to unstructured programs full of "GOTOS." The other is that FORTRAN has almost no data structure capabilities other than arrays and matrices. The former drawback is annoying while the latter is frustrating and serious. Both of these have helped give FORTRAN a bad reputation for applications requiring manipulation of large data structures of varying data types.

These problems have been somewhat solved by the latest ANSI specification for FORTRAN 77. This specification extends the allowable control statements and adds new data types. If one of the various commercially available FORTRAN structured preprocessors is combined with a FORTRAN 77 implementation, the result should satisfy all the HLL requirements listed earlier as well as provide a software development environment that is both productive and as close to portable and hardware independent as is practicable.

Based on the above discussion, the HLL used for LSOTS software development should be a FORTRAN compiler (ANSI 77 or later if possible) used in conjunction with a commercially available structured FORTRAN preprocessor.

**UTILITY PROCESSORS.** The system software shall also provide an assortment of utility programs including editors, assemblers (macro type preferred), standard device drivers, debugger(s), linking loader, object file librarian, and file manager. Also included shall be object libraries for peripheral use and system specific operations.

**FILE SYSTEM.** The operating system shall provide a means of storing information in the form of disk files. This file system shall be designed to support sequential, random, and indexed sequential file structures using either contiguous or linked disk allocation schemes. Files should be accessible for creation, deletion, updating, or extending from either a user console or under program control.

**SIMULATION EXECUTIVE.** All simulation and modelling related activities will be monitored and coordinated by the Simulation Executive. This program is one of a series of executives that resides and functions in each subsystem of the LSOTS. The primary functions of the Simulation Executive are:

- o provide run-time support for the remaining modules and submodules in the Simulation subsystem
- o provide for handling message traffic between the other subsystems and between modules within the subsystem
- o provide dynamic scheduling of the modules in the Simulation subsystem as run-time needs and message traffic require
- o provide an interface to the DATA MANAGEMENT subsystem
- o provide an internal mechanism to monitor the status of program execution and supply the other subsystems with this information

The remaining sections of this document generically describe the submodules in the Simulation Executive and the functions they perform.

**INITIALIZATION.** The Initialization module is invoked whenever the system is initially started or when the system performs a Master Reset after an error condition has been detected or when requested by the Instructor. The Initialization module is composed of the five submodules described below.

**Sb\$Prep.** The function of the Sb\$Prep submodule is to allocate and initialize the root buffers of the Simulation Executive. Root buffers are those buffers which the EXEC needs for temporary work space before any other buffer functions can be performed. These buffers are not part of those maintained by the BUFFER MANAGEMENT module and are transparent to the rest of the Simulation Executive. Sb\$Prep also initializes and maintains the variables associated with root buffer management (i.e. pointers, use counts, locks, etc.).

**Sf\$Prep.** The function of the Sf\$Prep submodule is to open and read in the System Parameter file into one of the root buffers for use by the remaining submodules of the Initialization module. Sf\$Prep is also responsible for creating any temporary work files needed.

**Sv\$Init.** The Sv\$Init submodule performs all functions associated with initialization of system variables. These initial values are contained in a System Parameter file which Sv\$Init reads in and uses.

**Sd\$Init.** The Sd\$Init submodule is responsible for initializing all system data areas and tables. The initial values for some of these tables are contained in the System Parameter file which was opened by Sv\$Init. The remainder of the system tables are initialized to default values.

**Tc\$Init.** The Tc\$Init submodule performs all the functions that allow the remaining submodules that are tasks in the Simulation Executive to perform their local initialization. Tc\$Init does this by first creating these tasks and then "waking them up" so that they may perform their initialization. Once complete, each task will then suspend itself until required by the EXEC. The Tc\$Init submodule accomplishes this by creating those tasks named in the System Task Table that was initialized by Sd\$Init. Tc\$Init will kill the Initialization task once initialization is completed.

**TIMER MANAGEMENT.** The Timer Management module is responsible for managing all timer and timing related operations for all timers used in the Simulation subsystem. There are currently 3 timers defined. They are a local timer that keeps elapsed wall clock time, a master timer that tracks scenario elapsed time, and a freeze/event timer that is used to track time spent in freezes and to determine when an event should be triggered.

**T\$Init.** This submodule initializes all timer variables and data areas including the DELAYED EVENT QUEUE. It also establishes linkage with the hardware clock and sets the initial clock rate and therefore the value of a "tick".

T\$Start. The T\$Start submodule is called by a user module to start timer #n from its current value. No check is made of what the current value is.

T\$Stop. This submodule stops timer #n and preserves its current value.

T\$Reset. T\$Reset clears timer #n to zero and starts it.

T\$Set. The T\$Set submodule is called to set timer #n to a specified value without starting the timer.

T\$Clear. This submodule is called to clear timer #n to zero without starting the timer.

T\$Add. T\$Add adds an event #m to the delay queue associated with timer #n.

T\$Remove. The T\$Remove submodule is called to remove event #m from the delay queue associated with timer #n.

**MODULE SCHEDULER.** The Module Scheduler module is responsible for scheduling the execution of all run-time (or user) modules in the Simulation subsystem. This module implements the submodules described below.

S\$Init. The S\$Init submodule is responsible for initializing all local variables, data areas, and tables. This also includes the ACTIVE MODULE TABLE. This table is a list of all modules that are currently active and need to be executed. At initialization, all modules are active so they may perform any initialization local to them. Once completed, the ACTIVE MODULE TABLE entries are adjusted so that only those modules required for the current training state are used.

S\$Create. This submodule is responsible for creating tasks for those modules in the ACTIVE MODULE TABLE that are defined as tasks. A task that has been created does not necessarily execute immediately. S\$Create only ensures that the required tasks are created.

S\$Queue. The function of this module is to build and maintain the ACTIVE MODULE QUEUE. This is a list of those modules and tasks that are candidates for delayed execution at some future point in time. The requisites for delayed execution may be time, positional, or occurrence or non-occurrence of a specific event.

S\$Wakeup. The S\$Wakeup submodule's purpose is to activate or wake up those tasks (or modules) that are ready to be executed as listed in the ACTIVE MODULE TABLE and ACTIVE MODULE QUEUE. S\$Wakeup also activates a task/module on the receipt of an incoming message either from outside the Simulation subsystem or from another module or submodule within it.



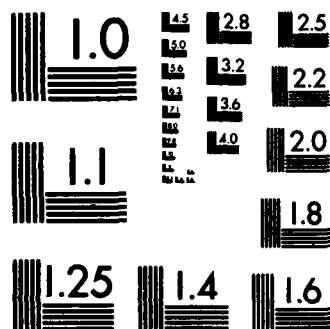

MICROCOPY RESOLUTION TEST CHART  
NATIONAL BUREAU OF STANDARDS-1963-A

**SSSuspend.** This submodule's purpose is to suspend the execution of an active task or module and place it as an entry in the SUSPEND TABLE. Tasks or modules that have been suspended may only be awakened when the cause of their suspension has been removed. Suspension may be based on time, position, the occurrence or non-occurrence of an event, or by specific request.

**SSKill.** The SSKill submodule is called to kill the execution of a currently running module or task. A suspended or non-existent task or suspended module cannot be killed.

**SSDequeue.** This submodule's responsibility is to remove a task or module from the ACTIVE MODULE QUEUE either by request or the occurrence of a specific event. Once removed, a task or module must be either active, suspended, or killed.

**ERROR PROCESSOR.** The Error Processor module is responsible for monitoring the internal status of the Simulation subsystem and report any errors, warnings, or informative messages to the rest of the system. The Error Processor accomplishes this by monitoring a specific area in memory known as the SYSTEM STATUS TABLE. Most modules and submodules in the subsystem will define variables in this table to report status and error conditions. The Error Processor as an asynchronous task, will constantly examine this table, interpret its contents, and report the results. Additionally, any module or submodule in the system may send a message to the Error Processor reporting its status. Upon detecting an exception condition, the Error Processor will take one or more of the following actions:

- o send a message to the affected subsystem, cause the condition to be displayed on the Instructor console, and allow program execution to continue. This is used to display informative messages only.
- o suspend system execution, cause the condition to be displayed on the Instructor console, and ask if execution should be allowed to continue. This is most commonly used for warning conditions that may affect the program's operation in mild but unpredictable ways.
- o send a message to all other subsystems, cause the message to be displayed on the Instructor's console, and terminate the execution of the Simulation subsystem. This will occur only when severe error conditions are detected that would adversely affect program execution and reduce training effectiveness of the system as a whole.

The submodules that comprise the Error Processor are described below.

**ESInit.** The ESInit submodule is responsible for all local variable and data area and table initialization. The MONITOR CONTROL TABLE is one of

these. This is a table of all status variables in the SYSTEM STATUS TABLE, the name of the task module, or submodule responsible for updating it, and the action to be taken by the Error Processor when one of the three error conditions is detected.

ESMonitor. This submodule's purpose is to periodically examine the SYSTEM STATUS TABLE to see if any variables have been changed to an error condition. When an error is detected, ESMonitor consults the appropriate entry in the MONITOR CONTROL TABLE, takes the actions previously described, and transfers control to one of the three submodules described below.

ESMessage. The ESMessage submodule is responsible for causing an informative message to be routed through the system. Normally this is only to the Instructor console to provide him with additional information regarding the status of the system.

ESWarn. This submodule is responsible for causing a warning message to be routed through the system to any tasks, modules, or submodules that may require it to ensure their continued execution. The warning message is also displayed on the Instructor console. If the condition is serious enough, the Instructor may be given the option to stop execution of the system based on his observations of its performance, the nature of the warning, and his appraisal of the training value of continuing.

ESFatal. The ESFatal submodule's purpose is to cause a fatal message to be sent to the remaining subsystems, send a message to the Instructor console, and terminate program execution in the Simulation subsystem.

## 2.2 DATA STORAGE AND SERVICE ROUTINES

Within the LSO Training System, the use of common data storage areas should be kept to a minimum. This will result in a strongly connected system since most control and status information must be communicated among the modules that need it by parameter passing.

There may be instances where a common data area is the most efficient solution to the problem of access speed and sharing. For this reason, some common data will be allowed but the following represent the criteria for placing data in the common area:

a. The amount of data required by the modules is larger than will practically fit in an Inter-Module Message (IMM), or the number of passed parameters is large. The key point to consider here is the trade-off between modularity, storage utilization, and intrinsic overhead. For data requirements of up to about 100 words, the IMM is the preferred method. When message lengths increase much beyond this, storage, overhead, and time costs may make the IMM impractical.



b. The frequency of data access is high enough to risk overflowing the receiving module's message queue. What constitutes high frequency should be determined as the design progresses to the detailed stage.

c. The timing requirements of a module are critical enough so that IMM usage would seriously degrade system performance. This is also somewhat of a subjective decision, but certain items are excellent indicators of performance. These include graphics displays, keyboard responses, and speech recognition delays.

The high level modules used for data storage and service are discussed below.

**BUFFER MANAGEMENT.** This submodule is responsible for managing all system and user requests for buffers. This is accomplished by calls to the submodules described below.

**BSInit.** This submodule initializes all buffer variables and builds the buffer available and in-use queues. It also sets up all allocation, releasing, and management variables.

**BSAlloc.** This submodule is used by the BUFFER MANAGEMENT module to allocate additional blocks of memory to the buffer pool after initialization and during run-time if the user modules request more buffers than are currently available. If no memory can be allocated, BSAlloc returns an error code, otherwise it allocates the memory to a buffer, links the buffer into the available queue, and updates the variables associated with the available queue.

**BSRelease.** BSRelease is used to delete unused buffers from the available queue and return the memory they used to the host operating system for other uses. Buffers will be released only when a selectable percentage of them are unused for some period of time which will also be selectable. This feature will allow the system to be fine tuned to maximize memory use while minimizing run-time overhead.

**BSGet.** This submodule is called by user modules to request a buffer for use from the free pool. If a buffer is free, it is removed from the free queue, added to the in-use queue, and the associated queue maintenance variables are updated. BSGet returns a pointer to the buffer, a buffer identifier, and its length. If no buffers are free, BSGet will call BSAlloc in an attempt to allocate more memory for buffers. If the call to BSAlloc fails, then BSGet will return an error code to its caller.

**BSPut.** This submodule is called to return a buffer to the free queue. The CALLING module need only supply the buffer identifier that was returned by BSGet. BSPut does not return any error codes.

**BSSet.** BSSet is used by user modules to initialize a buffer to some value supplied by the user. The caller must supply the buffer identifier and the

desired value. B\$Set initializes the entire buffer to the value and does not check to see if the initialization value "fits". B\$Set does not return any error codes.

**MESSAGE PROCESSOR.** The Message Processor module is responsible for all external message traffic (between other subsystems) and all internal message traffic between modules in the Simulation subsystem. This module is implemented as a separate asynchronous task composed of the following submodules.

**M\$Init.** The M\$Init submodule is responsible for initializing the message areas, allocating buffer space, and synchronizing intersystem message links. When finished, all LSOTS subsystems should be in communication with each other. M\$Init will return an error code if buffer allocation fails or synchronization does not occur after ten retries. If either of these conditions occurs, a fatal system error will occur.

**M\$Send.** This submodule is called by a user module to place a message in the queue to be sent to another subsystem. The caller is responsible for all message data validation and supplying the buffer for the message. M\$Send will return an error code only if the send queue overflows. There will be no acknowledgement of the message being sent and none of its receipt unless provided for by the two submodules communicating.

**M\$Receive.** M\$Receive is a separate task within the Message Processor called by user submodules to receive a message from another subsystem. M\$Receive will return a pointer to the buffer containing the message if one is waiting or a code signifying that no messages have been received for the caller. M\$Receive is subject to the same limitations and restrictions listed for M\$Send.

**M\$Put.** This submodule is a task and is called by a user submodule to send a message to another submodule in the same subsystem. M\$Put works in exactly the same way as does M\$Send and is subject to the same limitations and restrictions.

**M\$Get.** The M\$Get submodule is a task and is called by a user submodule to receive a message from another submodule in the same subsystem. M\$Get works in exactly the same way as does M\$Receive and is subject to the same limitations and restrictions.

**FILE PROCESSOR.** The File Processor module is responsible for controlling access to all system files by all user modules in the Simulation subsystem. While the host operating system will provide the actual primitive functions, the File Processor will provide a high level interface between user requests and the host operating system. This protocol is deemed necessary to ensure reasonable and prudent access to files and to preserve the data used and collected by the system that resides in these files. The various submodules that embody the File Processor are described below.

**F\$Init.** The F\$Init submodule initializes all data areas and variables local to the File Processor. It opens the system's ACCESS CONTROL file and builds the file ACCESS CONTROL TABLE.

**Create.** This submodule creates a file name by the caller and enters its name and access parameters into the file ACCESS CONTROL TABLE. Unless deleted, the created file's access parameters will become a permanent part of the system ACCESS CONTROL file. Create will return a code signifying success or failure.

**Delete.** This submodule deletes a file name by the caller and removes its name and access parameters from the file ACCESS CONTROL TABLE. Delete will return a code signifying success or failure.

**Open.** The Open submodule opens an existing file for the indicated operation if the caller has the correct access rights. Open assigns a file descriptor and marks the file as in use in the FILE ACTIVE TABLE. Only one user may open a file for write or update, while any number of users may read from an open file. Open returns an indication of success or an error code if the file does not exist or the caller does not have access privileges.

**Close.** This submodule closes an existing file only if all other users have closed it. If a file is in use by more than one user, the call to Close only "closes" the caller's access to the file. This protocol is required to prevent the owner or original requestor from causing serious problems if they attempt to close the file before other modules are finished with it. If successful, Close releases the file descriptor and removes the file from the FILE ACTIVE TABLE. It returns an indication if the file is not open or the caller does not have access privileges.

**Ac1.** The Ac1 submodule is responsible for setting the calling module's file access privileges as indicated. Access rights are defined as:

- O - owner, may do anything to the file;
- R - read access is allowed;
- W - write (update) access is allowed.

An asterisk (\*) in any field signifies a "don't care" condition. Only the owner of a file may call Ac1 at any time to change any or all of the access parameters.

**Getc.** Getc is called by a user submodule to read a single character from the specified file. This is normally used for console I/O. Getc will return file not open and end of file conditions.

**Putc.** Putc writes a single character to the specified file. Putc is normally used for console I/O. Putc returns file not open and end of medium conditions.

**Position.** The Position submodule is called by a user module to position the file pointer associated with the specified file to the record or byte indicated. Position can only be used with direct access files and returns file not open, end of file, and not a direct access file condition.

**Read.** This submodule will read the next or the n-th record from the specified file. The next record will be read from a sequential, random access, or stream file. The n-th record can be read only from a random access file. Read returns file not open, access not allowed, end of file, and not a direct access file conditions.

**Write.** The Write submodule writes to a file and returns the same conditions as Read does except that end of medium replaces end of file.

**Rdblck.** The Rdblck submodule is responsible for performing block I/O on the specified file. Data are read from the file in large chunks equal to the smallest physical addressable quantity of the file's medium. Rdblck reads the n-th block from the specified file. The caller must update the block pointer and supply buffer space. Rdblck returns the same conditions as does Read except for not a random access file.

**Wrblk.** Wrblk writes to the specified file in the same way as Rdblck reads from the file. Wrblk returns the same conditions as Rdblck except that end of medium replaces end of file.

**Rdline.** The Rdline submodule reads the next line of data from the specified file. A line of data is defined as a sequence of ASCII bytes terminated by a <NUL>, <LF>, <FF>, or <CR>. Lines may be any length up to 255 characters. Rdline returns the length of the line and conditions indicating line too long or end of file.

**Wrline.** This submodule writes a line of data to the specified file as described for Rdline. The same conditions are returned except that end of medium replaces end of file.

**Rdbyte.** The Rdbyte submodule reads COUNT bytes from the specified file. If COUNT bytes are not available, COUNT will be set to the number of bytes actually read. Rdbyte returns end of file and file not open conditions.

**Wrbyte.** This submodule writes COUNT bytes to the specified file as described for Rdbyte except that end of medium replaces end of file.

**DATA MANAGEMENT.** This module provides all the functions needed to control, maintain, and update the training and simulator data bases. The training data base consists of syllabus data, student record information and speech related data. The simulator data base consists of all simulation data related to models. The Data Management module is primarily an off-line support program. All subsystems will use parts of this module during runtime to minimize development and overhead time and to preserve the in-

egrity of the data bases. All file access is implemented by calls to the Simulation Executive's File Processor. The submodules described below are only the very high level ones used.

**D\$Init.** This submodule is responsible for initializing all local variables and data areas prior to any data base accesses.

**D\$Define.** The D\$Define submodule is called to define a new subtree of an existing database schema. D\$Define may be used to define subtrees, records, fields, and subfields. This also includes defining such items as field size, key fields, formats, and range values. Since this operation is very time consuming, its use during run-time should be minimized.

**D\$Display.** This submodule is used to display portions of the specified schema including subtrees. It may be used with any legal clause modifiers such as WHERE, AS, WHEN, and UNTIL and these clauses may be modified by conditions (i.e. WHERE pilot\_landings > 100).

**D\$Create.** The D\$Create submodule is called to create and initialize the root node or parent of a database schema. This includes the setting of any access parameters.

**D\$Open.** This submodule is called to open an existing schema file for access as described for Open.

**D\$Close.** The D\$Close submodule is called to close an open schema file as described for Close.

**D\$Delete.** D\$Delete is used to delete any portion of a schema (subtree, record, field, subfield) or the entire schema. The use of D\$Delete is subject to the restrictions imposed by access parameters.

**D\$Enter.** This submodule is used to enter new records (fields, subfields) into an existing schema.

**D\$update.** D\$update is used to update records (fields, subfields) in an existing schema.

### 2.3 INSTRUCTIONAL SUPPORT

Most of the information required to explain concepts being demonstrated resides within the Instructor Subsystem. Outputs from the simulation Subsystem to support the explanations include aircraft state information such as range, position, and rate of position change. Some other approach information will not be "known" by the Instructor Subsystem. In other words, some approach conditions may not be explicitly called out by the Instructor Subsystem because of an exercise requirement for random variability of certain conditions. Groups of conditions for which Simulation Subsystem output may be required include:

- o pilot characteristics
- o aircraft type, malfunction
- o environmental conditions
- o operations conditions
- o ship conditions
- o LSO workstation conditions

However, the Instructor Subsystem does not require any output from the Simulation Subsystem to explain the intent of the exercise being generated.

There is one area of instructional support which is worthy of discussion in the context of pilot/aircraft behavior model functions. There will be a requirement for (human) instructor intervention in the generation of exercise scenarios. His judgment of trainee progress or performance may lead him to select specific variations in exercise scenarios other than those called for by syllabus control. Thus there should be instructional support capabilities to enable this instructor control flexibility. The impact of such a capability is that the Instructor Subsystem should incorporate appropriate control features and the simulation model functions should be designed to respond to this control flexibility.

### 3.0 CONSTRAINTS

The purpose of this section is to describe the various constraints which may limit the capabilities of an automated LSO Training System. Constraints are discussed under two major headings: training and system. Training constraints are categorized by capabilities and utilization. System constraints deal with the constraints associated with the actual implementation of the software on the hardware to provide the system.

#### 3.1 TRAINING

There are several potential constraints on the training effectiveness of an automated LSO training system. These constraints can be separated into two groupings, those related to system capabilities and those related to utilization of the system.

One of the potential constraints related to system capability is the performance quality of advanced technologies incorporated in the system. The visual simulation is one of these technologies. How well it can depict LSO task cues and other simulated conditions can have a significant impact on training effectiveness. However, at this time, it is not expected to be a technological problem area. Another potential constraint is the performance of automated speech recognition. Poor speech recognition and/or excessive processing time for speech recognition results could have a negative impact on the effectiveness of trainee task interaction in training exercises. The advancement of the status of this technology is expected to be adequate to minimize concern in this area. However, as of this moment there has not been a successful demonstration of automated

speech recognition technology in a real-time application with similarly critical timing requirements. The effectiveness of automated "intelligence" within the instructional control component of the system is another potential constraint. One of the goals of the system is to enhance LSO training effectiveness without imposing excessive burdens on the LSO instructor. This technology should provide assistance for "instructor-present" training sessions to enhance session efficiency and human instructor effectiveness. It should also enable some amount of "instructor-absent" training. There is little doubt that the technology can prove beneficial to LSO training effectiveness. However, there is some uncertainty for how much of an improvement in training effectiveness will result.

Even given adequate technology, there is still some uncertainty for how effectively some of the system's functions will perform. Syllabus control, trainee evaluation and scenario presentation are important individual functions which can affect training effectiveness. Equally important are the functional interactions among these and other system functions, as well as the human interfaces provided for system operations. The system must also be designed for efficient modification in response to system performance deficiencies and changes in LSO training requirements. Functional deficiencies in any of these areas can significantly constrain the training effectiveness of the system.

The most capable training system can fall far short of desired training effectiveness through ineffective utilization. There are several potential constraints on utilization effectiveness. Quality control of the training plan and syllabus associated with the system is one area of concern. The training must be continually monitored, and revised as necessary to reflect current LSO training requirements. Prospective LSOs must be given priority access to the system and its training program. This may require multiple training locations for the system and/or funding for travel. Command support will be required to minimize interferences to LSO training resulting from other duties and other training. Adequate numbers of instructors must be available for the timely conduct of training. Adequate preparation of LSO instructors must be provided. If instructor and trainee attitudes toward the system are not considered in the system design, user acceptance will suffer. Insufficient attention to these factors mentioned above can inhibit effective system utilization, and consequently its training effectiveness.

In summary, LSO training system effectiveness can be affected by many factors. Awareness of these human and system factors and their potentially negative impact must exist throughout system design, development, and implementation phases. This will require their attention in system capability design and tradeoff decisions, significant involvement of user personnel in design and development, thorough testing of system functional and training effectiveness, and clear communication of system design objectives among the various personnel disciplines involved in development.

### 3.2 SYSTEM

This section establishes suggestions and guidelines for the various software efforts involved in the detailed design, implementation, testing, and integration phases of an LSO Training System project.

The primary objective of any complex software development effort is that the programs be developed in an orderly and efficient manner. A secondary benefit is that software developed be flexible and easily maintained. All too often the initial system analysis and requirements definition phases are poorly done or not done at all. This results in system designs that are not oriented to solving the problems at hand. This is one of the most obvious system constraints, yet it is very often overlooked or poorly understood. The following paragraphs serve to clarify procedures to follow to minimize potential development problems.

**DOCUMENTATION.** Much has been written about, and many efforts have historically been made to provide, adequate documentation for software projects. The LSO Training System should emphasize documentation in the different areas indicated below.

**Functional Design.** The Functional Design is intended to be an important part of the LSO Training System evolution. It is a high level, functionally oriented specification of the design of the entire system. It is organized in terms of the functions that the system must perform in order to fulfill the requirements imposed by the training objectives. It specifies the functions, their inputs, outputs, and the method of implementation. It is intended to serve as a guide to future design and implementation for those persons building the system. It is intended to represent the system design as of the date of publication of the document, and to fix it in that state; any changes to the overall design after publication should be the result of necessity and not mere changes in policy.

**System Interface Document.** The sole function of this document will be to clearly and accurately record the interfaces between all software modules and subsystems in the LSO Training System. It should include interfaces between computers as well as modules within a computer. The format of the System Interface Document should be flexible as well as complete.

**Program Design Practices.** The Program Design practices used in developing software for the LSO trainer should be centered around the use of what is commonly called "pseudo code." Pseudo code is simply the designer's (and programmer's) specification of the data structures, procedures, and algorithms used within a module to fulfill its defined function. Pseudo code has several distinct advantages over traditional methods such as flow charts and string charts. First, it allows the programmer to specify his solution to the problem at hand in a way that is close to natural thought processes. This can dramatically speed the design process alone. Second, the resulting pseudo code can be understood by non-programmers. This is very important for the design review process when it can be very valuable



to have the options and constructive criticisms of outsiders who may not be intimately familiar with all details of the design but who may have had similar design experiences. Third, and perhaps most important, the resulting design can be readily comprehended by other project programmers in the event of personnel changes. This can be of critical importance since many projects tend to have problems due to personnel changes. While pseudo code can be produced manually using a text editor, it is strongly urged that a commercially available pseudo code processor be purchased for use.

Program Source Listings. The lowest and most detailed level of software documentation will be the program listings themselves. They will serve as the final reference for any changes or modifications to the software. As a minimum, each program module listing should contain a header with the following information:

- o The module name if it does not already appear as part of the program.
- o The name of the principle author and the date the module was first created.
- o The name of each modifying author and the date of each major modification in chronological order as well as the nature of the change.
- o The module calling sequence even if evident in the code.
- o A broad definition of the module's function. This includes inputs and outputs not obvious in the code, files referenced, external references, or any other information which is likely to be needed by another programmer to maintain or modify the program. If this module is the main module of a task then this section should contain a detailed explanation of how the entire task or program functions. This should include the circumstances under which it runs, how it communicates with other tasks or modules, as well as significant resources that it uses. It should be the program author's responsibility to see that this section contains all pertinent information.

GENERAL PROGRAMMING STANDARDS. The purpose of the standards and conventions described in this section is to ensure the writing of "proper" programs and thereby contribute to the ease of testing and integration of the software. Almost everyone in the software field has an intuitive feeling of what constitutes a proper program. The following standards and conventions are presented as firm guidelines and not as unbreakable rules.

Modularity. Programs will be constructed of independent modules following the single function module concept. To the greatest extent possible, these

modules will be designed so that they can be replaced or modified without affecting other modules.

Source Files. Each program module should exist as a separate file. This should also apply to "include" files if available on the system. Files should include documentation specifying all modules that incorporate them.

Comments. All comments should convey the larger functional role of a statement or instruction or a group of statements or instructions. A comment should not be the translation of the particular line of code into English. Any particularly obscure or complex section of code should be preceded by a paragraph of comments explaining the intention of that code. In any case there should be sufficient comments in a module to enable a following programmer to finish, test and debug, or modify the module.

Self Modifying Code. Under no circumstances should self modifying code be permitted. Although there may be occasions where execution time and/or memory constraints or device requirements may make self modifying code seem attractive, it is certain that its use will make testing, debugging, and maintenance difficult if not impossible (even by the author).

Shared Temporary Storage. Modules should not share temporary storage among themselves. Sharing temporary storage requires the assurance that modules will not conflict with each other. This needlessly complicates system design, testing and debugging, and maintenance.

Local Data Items. Local data items should be defined in a separate section of the module preceding any executable code.

Entry Points. Each module should have only a single entry point. This entry point should be the first executable instruction or statement in the module.

Program Flow. Modules should be coded in such a way that they "flow" down the page, even at the cost of extra branches or jumps. This organization enhances the readability of the listings. This guideline is intended primarily for non-structured assembly language programs.

Exit Points. All exits from a module (or submodule) should occur through a single normal, or one alternate error, exit point. These exit points should be the last executable statements or instructions in a module.

Module Length. Each module should be long enough to perform a single function. This should normally not require over 75 to 100 executable statements or one to two pages.

Variable Names. All variables should be explicitly typed and defined. At no time should any default data typing features be used. Variable names should be chosen to reflect or indicate contents and/or use of the variable as much as possible within the limitations of the programming language

being used. Where severe limitations exist for variable name lengths, variable use should be defined when the variable is defined.

Reentrant Code. If available as part of the vendor software, all routines should be written to be reentrant. This implies not using declarations which result in the allocation of "common", "own", or "equivalence" storage.

Debugging Measures. To the greatest extent possible, programs should be written to prevent, or automatically detect, errors (bugs). They should include measures to do the following:

- o Check the validity of arguments passed to a module.
- o Make range and other reasonableness checks on all data input from outside the program.
- o Check the range of control variables used in "CASE" statements or its analogue.
- o Make array subscript range checks if not a compiler feature.

In some cases these checks may require extra code, and in some cases they may be accomplished by the use of compiler options. If the checks require additional code, this code should be clearly marked as such so that it can easily be removed after testing has determined that the program functions correctly.

## APPENDIX G

## ANALYSIS OF CARRIER LANDING ACCIDENTS

A review of carrier landing accident data for the years 1965-1980 was conducted in order to identify factors, variables, and trends within accident situations which appear to be particularly critical to successful LSO performance. The results of this review along with subsequent discussions follow. The first part of this appendix addresses overall trends among recovery variables within carrier landing accidents. The final portion addresses trends of pilot behavior in approaches leading to carrier landing accidents.

## ACCIDENT DATA COMPARISONS (1965-1980)

In order to determine whether or not the LSO's role as an accident causal factor has become more visible with the passage of time, comparisons between three groupings of carrier landing accident data were made. The first set of data resulted from an analysis performed by Dunlap and Associates, Inc. covering accidents in the period 1965-1969. The analysis provided an in-depth review of 191 carrier landing accidents during that period and grouped several accidents into different categories. Of primary interest to this current study were causal factors of these accidents, environmental factors and types of landing accidents. The second group of accidents was a NAVSAFECEN computer printout of carrier landing accidents from July 1970 through December 1973. December 1973 was chosen as a stopping point because that time frame is generally accepted as the end of combat-type of operations and it was of interest to determine what, if any, trends developed after this operational tempo changed. The final group of landing accidents covered the period from January 1974 to May 1980, and was also in the form of a NAVSAFECEN computer printout.

**OVERALL ACCIDENT TRENDS.** Upon analyzing these three groups of accidents, several commonalities surfaced. These were:

- a. The pilot is most often listed as a causal factor.
- b. More accidents happen at night than day, even though the number of day landings is significantly higher than night.
- c. Undershoots (ramp strikes) and hard landings account for the greatest number of carrier landing accidents.
- d. When "other personnel" is listed as a causal factor, the LSO is mentioned more frequently than any other type in this category.

---

<sup>61</sup> Britson, C.A., Pitrella, F.D. and Wulfeck, J.W. Analysis of Aircraft Carrier Landing Accidents (1965-1969), Technical Report for Office of Naval Research, Dunlap and Associates, Inc., Santa Monica, Ca. November 1969.

- e. "Combat area" was the most frequent environmental causal factor in the Dunlap study, however it was not addressed in the printouts. Considering this exclusion, "pitching deck" was listed most often as an environmental contributing causal factor.

Since these commonalities readily surfaced, comparisons between the groups were made in these categories. The results are given in Table G-1.

TABLE G-1. DATA COMPARISONS: CARRIER LANDING ACCIDENTS  
(% of Total Carrier Landing Accidents)

	July 1965 - June 1969 (N=191)	July 1970 - Dec. 1973 (N=96)	Jan. 1974 - May 1980 (N=67)
<b>CAUSAL FACTORS:</b>			
Pilot	86.0	71.9	64.2
LSO	18.8	27.0	31.3
<b>ENVIRONMENT:</b>			
Night	55.0	54.2	59.7
Pitching Deck	12.0	13.5	13.4
<b>TYPE ACCIDENT:</b>			
Undershoot (Ramp Strike)	28.8	28.1	25.4
Hard Landing	63.4	30.2	25.4

The most dramatic difference appears to be the drop-off in accidents of the "hard landing" nature. After analyzing the many parameters which affect landing performance that have changed during the interval studied, the study group feels that this large shift is due to an equally dramatic drop in landing approach speeds for fleet aircraft (due to phase out of RA-5C and F-8). When considering the change in percentage of hard landings from an LSO training standpoint, one would expect this statistic to also reflect better results in LSO performance. However this is not the case, as is discussed later.

Night, pitching deck and ramp strikes remain about the same in regard to percentage of total accidents. However, there are distinct differences in the trends of pilots and LSOs as causal factors.

Upon observation, the following conclusion is reached: During the periods studied, the rate of mention of the pilot as an accident causal factor was significantly reduced, while the rate of mention of the LSO as a causal factor increased. This comparison is even more significant when the following is considered. In the Dunlap analysis, the LSO was mentioned as

a causal factor if at fault in either the "platform" (i.e. waving) environment or "counseling" environment. That is, an LSO could be held accountable for an accident if he had "failed to counsel" a pilot on a dangerous trend in previous landings, and the same pilot later became involved in an accident. On the other hand, in the analysis of the NAVSAFECEN printouts in this project, only the "platform" environment was considered when citing the LSO as a causal factor for the periods 1970-1973, and 1974-1980. The trends established in the above conclusion led the study group to believe there were grounds to further analyze accident data to determine what, if any, LSO training implications exist therein.

**OVERALL TRAINING IMPLICATIONS.** Since accident narratives were not included in the Dunlap analysis, it could not be employed for the in-depth analysis required to identify any training implications which could be derived. The remaining accident data (1970-1980) were examined in order to identify possible training requirements. It was decided that of the carrier landing accidents studied, only those in which the LSO played some role would be considered. This eliminated most, but not all, "material failure" or "facility failure" type accidents. Using this criteria, the 1970-1973 time frame included 67 accidents; the 1974-1980 period included 41. The same categories were used for evaluation as in the previous overall analysis. However, upon closer observation, it became apparent that some sub-categories could be formed in order to surface pertinent results. These sub-categories were:

a. Undershoots. It was found that ramp strikes could be placed in one of two "classic" types of approaches. The first was a "come-down" approach in which the aircraft hit the ramp in a downward motion from on or above glideslope. The second was a low approach in which the aircraft had been below glideslope for some time prior to impact.

b. Environment. Since "black night" or "no horizon" was of interest from an LSO standpoint, its frequency of mention was observed.

c. Hard Landings. Hard landings are the result of one of two occurrences: excessive sink rate or an in-flight engagement with a wire. Hence these two sub-categories are used in this area.

d. LSO Cause. The leading LSO cause in the "platform" environment was "failure to give a timely waveoff". Within this area, it was determined that three "classic" approaches could be identified during which such "failures" occurred. They were a "come down at the ramp," "low all the way" and line-up deviations. Additionally, it was possible to determine when other LSOs, either back-up or supervisory, were listed as causal factors. It was also considered apropos to examine the number of times an aircraft that had already been waved off incurred accident damage during the same approach. With these sub-categories defined, the analysis was then conducted. The following results were derived for the periods indicated.

Accidents, 1970-1973.

**Causal factors.** Of the 67 accidents studied, only two left the pilot completely blameless. The leading types of accidents in which the pilot was a causal factor were hard landings and ramp strikes.

**Type Accidents.** Twenty-six of the accidents were undershoots. Of these, 17 were of the "come down" category. This high rate of descent was due either to a "drop nose," "settle on a line up correction" or a significant power reduction. The remaining nine ramp strikes were of the "low all the way" variety and approached the ramp from below glideslope. Twenty-eight accidents were hard landings. Twelve of these were in-flight engagements, and the remaining 16 were due to high rates of descent.

**Environment.** Forty-two of the accidents occurred at night. "Pitching deck" was mentioned in 13 of the cases, and "no horizon" or "black night" in 11. "Combat area" factors were not cited in any of the narratives, even though the time frame covers periods of combat operations.

**LSO Inputs.** LSOs were listed as causal factors in 26 of the accidents. In 16 of the cases, the expression "failure to give a timely waveoff" was employed. Seven of these involved coming down "in-close" or "at-the-ramp." Seven were also "low all-the-way" in nature. The remaining two were other types of judgment errors.

Because of the narrative content, it was possible to extract other data considered pertinent to this study. In an effort to establish the role the LSO/pilot interface plays in this area, a record was made of the number of accidents in which radio transmissions from the LSO to the pilot were mentioned specifically in the narratives of this group. Such transmissions were recorded only if mentioned specifically. That is, no implied or expected transmission (e.g. "Roger Ball") was recorded with the exception of an aircraft being waved off, in which case it was assumed a radio transmission accompanied the waveoff. In this group, UHF transmissions were mentioned in 74.6 percent of the accidents. Eighteen of the accidents occurred after the aircraft had already been given a waveoff.

Considering only the waving environment, other LSOs were considered causal factors in four of the total 67 accidents. The number of accidents during MOVLAS use was also found to be four.

**Other Considerations.** One element that surfaced just by virtue of frequency of mention, and therefore considered noteworthy, was the fact that in 26 of the reports, the pilot had already attempted to land at least once prior to the accident.

Accidents, 1974-1980.

**Causal Factors.** Thirty-six listed the pilot as a causal factor. Hard landings and undershoots were the prominent types of accidents in which the pilot was listed as a causal factor.

**Type accidents.** Fifteen of these accidents were undershoots. Seven were of the "come down" type, five were "low all the way" and three could not be determined from the narrative content. Hard landings were mentioned in 17 of the total group of accidents in this time frame. Five were due to in-flight engagements, and 12 involved a high rate-of-descent.

**Environment.** Thirty-one occurred at night. Nine mentioned pitching deck. "No horizon" was mentioned in three of the reports.

**LSO Inputs.** The controlling LSO was cited as a causal factor in 21 of these accidents. "Failure to give a timely waveoff" was listed in 12 cases. Of these, four involved a "come down at the ramp", three were line-up related, two were "low all the way", two were late waveoffs and one was a judgment error. Other LSOs present were listed in six of the 41 mishaps. LSO radio calls were specifically mentioned in 10 of 21 reports, and 14 of the mishap aircraft had already been given a waveoff. Three involved MOVLAS controlled approaches.

**Other Considerations.** Nine of the pilots involved were making other than first attempts at landing.

**Conclusions.** Table G-2 displays accident data in tabular format. Note that the percentages presented are based on accidents in which the LSO played a role. From observation of Table G-2, the following conclusions were drawn:

a. In LSO related accidents, from 1970-1980, the rate of mention of the pilot as a causal factor decreased, while the rate of mention of the LSO as a causal factor increased. The LSO was a causal factor in over one-half of these accidents from 1974-1980.

b. Approximately seven in ten of all landing accidents were either ramp strikes or hard landings.

c. The night accident rate increased.

d. The high rate of mention for LSO/pilot radio transmissions confirms the important role of that interface during the landing environment.

e. Other LSOs present on the platform were increasingly recognized as a causal factor.

f. MOVLAS recoveries were rare in the accident scenarios.

g. The classically dangerous approaches involving a "come down at the ramp", or "low all the way" play major roles in ramp strikes and accidents in which LSOs were cited for failure to give timely waveoffs.



NAVTRAEQUIPCEN 80-C-0063-2

TABLE G-2. PERCENTAGES FOR LSO RELATED ACCIDENTS

	July 1970 - Dec. 1973 (N=67)	Jan. 1974 - May 1980 (N=41)
PILOT AS CAUSAL FACTOR	97.0%	87.8%
NIGHT	65.7	75.6
PITCHING DECK	19.4	22.0
NO HORIZON	16.4	7.3
UNDERSHOOTS (Ramp Strikes)	38.8	36.6
% Undershoots: "Come downs"	65.4	46.7
% Undershoots: "Low all the way"	34.6	33.3
HARD LANDINGS	41.8	41.5
% Hard Landings: In-Flights	42.8	29.4
% Hard Landings: High Sink Rate	57.2	70.6
LSO AS CAUSAL FACTOR	38.8	51.2
LSO CITED FOR "FAILED TO GIVE TIMELY WAVEOFF"	23.9	29.3
% "Failed to Give": "Come Downs"	43.8	33.3
% "Failed to Give": "Low all the way"	43.8	25.0
% "Failed to Give": Line up Deviations	.0	16.7
ALREADY WAVED OFF	26.9	34.1
OTHER LSO AS CAUSAL FACTOR	6.0	14.6
LSO/PILOT UHF TRANSMISSION	74.6	51.2
MOVLAS	6.0	7.3
OTHER THAN FIRST PASS	38.8	22.0

A trend established in the analysis of overall accidents from 1965-1980 continued for the LSO related accidents from 1970-1980. The pilot causal factor decreased, while the LSO causal factor increased with the cessation of combat activity. This would seem to indicate that LSO training became less effective during the latter period. The high rate of "failure to give a timely waveoff" mention, combined with the high incidence of ramp strikes and hard landings are indicative that general LSO performance within the "in-close" portion of the approach is particularly critical. Within both the ramp strike and "failed to give waveoff" categories, the "come down" has the most potential for danger. However, it is disturbing to note the high incidence of the "low all the way" types of approach. Such low deviations are unacceptable, and such approaches should be aborted by the LSO. Acceptance of such approaches is possibly indicative of operational landing pressures. In summary, high rate of descent is the most visible parameter in ramp strikes, hard landings and LSO "failure to give timely waveoff" situations. Better use of "power" and "attitude" calls could have minimized the occurrence of the ramp strike/hard landing outcomes.

The criticality of the waveoff is also reflected in the high rate of accidents involving aircraft that had already been waved off (i.e. aircraft waved off too late). The rise in this category may be indicative of a decrease in LSO ability to judge the waveoff window.

Environmentally, the incidence of accidents at night and with pitching deck showed slight increases. This is considered noteworthy from an LSO standpoint because such situations create the need for closer LSO/pilot interface, and more refined LSO skills. The reduction in carrier operations and the resultant decrease in waving opportunities is a likely influence on these trends. Note that although the day/night factor is always explicitly identified in accident summaries, other environmental factors may have existed and not been noted.

Another observation from this review was an apparent deficiency in teamwork displayed by LSOs on the platform. From an analysis of these accidents, there appeared to be a need for more active involvement by the backup LSO, especially in situations with difficult environmental and operational conditions, or with multiple approach deviations in-close.

The low incidence of MOVLAS in accidents is probably based on two factors. First, MOVLAS usage is usually low. Second, when it is in use the controlling LSO is usually very experienced.

Finally, the frequency of accidents for aircraft on other than their first attempts at landing indicates the need for increased LSO attention on subsequent passes.

In summary, this comparative analysis provided empirical evidence of the critical aspects of LSO waving performance. It was also concluded that the trends of pilot behavior during carrier landing accidents required a

closer look. The next section of this appendix presents an analysis of pilot approach profile trends.

#### ANALYSIS OF APPROACH PROFILE TRENDS (1970-1980).

Earlier analyses addressed in this appendix addressed causal factors and additional variables associated with carrier landing accidents. Pilot approach trends, such as "high in close, coming down at the ramp" and "low all the way," were described and their implications to LSO training were discussed. This subsection of the appendix describes a more comprehensive analysis of pilot approach trends. The results of this analysis indicate the frequency of various aspects of pilot behavior in carrier landing accidents. Thus they provide an empirical basis for the use of pilot behavior modelling functions in an LSO Training System to prepare the LSO for undesirable pilot characteristics during approaches.

This analysis was based on the traditional LSO responsibility for analyzing the FCLP and carrier landing trends of his assigned pilots. The analysis was also influenced by the author's familiarity with a NAVTRAEQUIPCEN-sponsored research project to develop an Automated Performance Measurement and Appraisal System (APARTS) for pilot carrier landing training. NAVSAFECEN computer printouts for carrier landing accidents occurring between January 1970 and May 1980 were used in this analysis. LSO shorthand descriptions of the approach profiles were generated from the accident narratives and recorded on a trend analysis worksheet similar to that used by LSOs. An example is depicted in Table G-3. From the accident data available, 102 accident approaches were selected for analysis. The only ones which were left out were those attributed strictly to material or facilities failures.

**OVERALL DEVIATION TRENDS.** Using the descriptive data for accident approaches, an accountability was made of pilot approach deviations (i.e. high, too much rate of descent, lined up left). This accountability also related the deviations to the range segment in which they occurred (i.e. in close, at the ramp). The results of this accounting are presented in Table G-4. The table presents the percentages of deviations (by range) based on the total number of descriptive comments generated from the accident narratives. The table also lists the seven most frequent deviations.

From this table, two things are initially evident. First, the large majority of deviations identified in the narratives occur in the "in close" and "at the ramp" range segments. Secondly, the most frequent type of deviation identified in the narratives is "too much rate of descent" (coming down), with most of these deviations occurring "at the ramp."

---

<sup>62</sup> Britson, C.A., Breidenbach, S.T. and Stoffer, G.R., Operational Performance Measures for Carrier Landing: Development and Application, Proceedings of the Human Factors Society, 24th Annual Meeting, Human Factors Society, Santa Monica, Ca., 1980.

TABLE G-3. ACCIDENT TREND ANALYSIS WORKSHEET EXAMPLE

DATE	ACST	% CV	CV RESULT	Underline & Speed Errors				Control Errors		Lineup & Wings	MISC.	CAUSE
				X	IM	IC	AR	Minor	Altitude			
2/14/71	FMA	N	RAMP STRIKE			CD	LO		NRATIC	LUBIM	over gear	✓
2/15/71	FMA	N	RAMP STRIKE		LO SLO	(N)	CD	GCIC	NDIC CJAR		off	✓
2/16/71	FMA	N	MAED LANDING	LO		C	H CD		NBAR		by next round	
4/10/71	E2B	D	OFF CENTER (GO)				(N)			L-EAR	CA	✓
5/16/71	T4J	D	IN-FLIGHT GUNNER			(LO)(DCL)			PHJOM	LUBIM	CO	✓
6/12/71	A7A	N	MAED LANDING		S	H	CD		NBAR		accus ps	✓
7/10/71	A7E	N	RAMP STRIKE	H	H	H CD	CD	EGIC	DNIC			✓
7/10/71	S3A	N	OFF CENTER							LL DELTD	CO F-400	✓
7/10/71	F9J	N	RAMP STRIKE	(N)	(1)	(C)	3	EGIC			WJ	✓
11/10/71	R5C	D	MAED LANDING			(N)	CD		NDIC		(FD)	✓
11/17/71	R5B	N	RAMP STRIKE		(LO)	DEC CD		MEAC	DNIC PAJAR		WJ	✓

TABLE G-4. TRENDS IN CARRIER LANDING ACCIDENTS (N=102 1970-1980  
(ENTRIES INDICATE PERCENTAGE OF TOTAL DESCRIPTIVE COMMENTS)

	GS		SR		ADA/SPEED		LU		DR/WINGS		POWER		PITCH	
	LO	HI	TM	NE	SLO/DEC	F/ACC	L	R	L	R	TM	NE	ND	PNU
X	4.7	4.4	0.3	--	0.3	--	1.3	1.8	--	--	--	--	--	12.7
IM	3.6	3.1	1.8	0.5	0.8	--	1.8	1.3	--	--	0.3	0.3	--	13.4
IC	2.3	5.7	4.7	1.8	2.3	1.3	0.8	1.0	0.8	0.5	0.5	6.7	4.7	33.3
AR	03.	3.9	13.2	--	0.5	0.3	0.5	0.3	3.1	0.8	--	1.6	4.7	31.5
TD/MD	--	--	--	--	--	--	1.8	0.5	2.3	0.5	--	0.3	0.3	9.0
	10.9	17.1	19.9	2.3	3.9	1.6	6.2	4.9	6.2	1.8	0.8	8.8	9.6	6.2

MOST FREQUENT DEVIATIONS:

TMRDAR (too much rate of descent at ramp)	13.2%
NEPIC (not enough power in close)	6.7
HIC (high in close)	5.7
TMRDIC (too much rate of descent in close)	4.7
MDIC (nose down in close)	4.7
MDAR (nose down at ramp)	4.7
LOX (low start)	4.7

Neither of these observations are surprising since the terminal portion of the approach is known to be the most critical and the majority of accidents are ramp strikes or hard landings caused by excessive sink rate.

Upon closer observation it is important to LSO decision training to note that a relatively high percentage of accidents are preceded by a high glideslope deviation (17%). Other general deviations which are noteworthy are low glideslope (10.9%), "nose down" or "drop nose" (9.6%) and "not enough power" or "ease gun" (8.8%).

Of the specific deviations correlated to range (in the lower portion of the table), "too much rate of descent at the ramp" is by far the most frequent (13.2%). The next most frequently identified deviations are "not enough power in close" (6.7%) and "high in close" (5.7%). These two deviations are related to each other in that a power reduction is the primary method for correcting a high deviation. An excessive power reduction in close also leads to excessive sink rate at the ramp, thus indicating the interrelationships among the three most frequent deviations. Among the next most frequent deviations are "nose down in close" and "nose down at the ramp". These are also precursors of excessive sink rate in close and at the ramp. Other deviations of relatively high frequency are indicative of the importance of a good approach start and subsequent glideslope control toward accident prevention. These include "low start", "too much rate of descent in close," "high start," "high at the ramp" and "low in the middle."

Another deviation with a relatively high frequency of occurrence is excessive pitch up ("pull nose up") approaching touchdown. This was mostly evident as an undesirable pilot response to the waveoff. The lineup deviations with the highest frequency include "lined up left" and "drifting left." More specifically, "drift left at the ramp" has a relatively high frequency of occurrence.

**DEVIATION TRENDS BY ACCIDENT CATEGORY.** The discussion above addressed overall deviation trends in carrier landing accident approaches. The analysis also focused on deviation trends within four accident categories: ramp strike, hard landing, in-flight engagement and off-center landing.

Ramp strikes are typically the most tragic of all carrier landing accidents. Analysis of ramp strikes has uncovered some deviation trends which can be of use to LSO training. Table G-5 presents the results of ramp strike trend analysis. As the table indicates, most of the deviations occur in close and at the ramp. The table also indicates that the primary type deviation is excessive sink rate at the ramp (16.9%), which is also not surprising. From a closer look at the data, it appears that the primary precursor of excessive sink rate is "not enough power in close" (13.1%). Other promising indicators of a potential ramp strike include "low start" (7.5%), excessive sink rate in close (6.9%), "nose down in close" (6.9%) and "low in the middle" (6.3%). All the deviations discussed thus far account for over 50 percent of the descriptive comments derived from ramp strike accident narratives.

TABLE G-5. TRENDS IN RAMP STRIKE ACCIDENTS (N=40)

	GS		SR		AOA/SPEED		LU		DR/WINGS		POWER		PITCH	
	LO	HI	TM	NE	SLO/DEC	F/ACC	L	R	L	R	TM	NE	ND	PNU
X	7.5	3.1	0.6	--	0.6	--	0.6	1.3	--	--	--	--	--	13.8
IM	6.3	2.5	2.5	0.6	0.6	--	--	1.9	--	--	--	0.6	--	15.0
IC	1.9	4.4	6.9	1.9	3.1	0.6	0.6	--	1.9	--	--	13.1	6.9	41.9
AR	0.6	--	16.9	--	0.6	--	--	--	1.3	--	--	1.9	2.5	27.5
TD/NO	--	--	--	--	--	--	--	0.6	--	--	--	--	--	1.3
	16.3	10.0	26.9	2.5	5.0	0.6	1.3	3.8	3.1	--	--	15.6	9.4	5.6

MOST FREQUENT DEVIATIONS:

- TMRDAR (too much rate of descent at ramp) . . . . . 16.9%
- NEPIC (not enough power in close) . . . . . 13.1
- LOX (low start) . . . . . 7.5
- NDIC (nose down in close) . . . . . 6.9
- TMRDIC (too much rate of descent in close) . . . . . 6.9
- LOIM (low in middle) . . . . . 6.3

The hard landing accident trend analysis results are presented in Table G-6. As in the case of ramp strike accidents, most of the deviations occur in close and at the ramp. However, for hard landings, more occur at the ramp than in close, the opposite of the frequency distribution for ramp strikes. For hard landings, like ramp strikes, excessive sink rate at the ramp is the most prevalent deviation. Unlike the ramp strike, the primary precursors to excessive sink rate in hard landing accidents are "nose down at the ramp" (8.9%), "high in close" (8.9%) and "high at the ramp" (8.9%). Power deviations do not appear as significant in hard landing accidents as they are for ramp strikes. One other deviation, "high start" (6.5%), may also be useful in conjunction with the others as indicative of a potential hard landing accident.

In looking at accidents resulting from off-center landings, it became very evident that the primary problem is lineup deviation to the left. The results of off-center landing accident trend analysis are presented in Table G-7. Deviations for this type of accident occur most frequently at the ramp and on touchdown. By far the most prevalent deviation is a "drift left on touchdown" (17.8%). Next in frequency are "drift left at the ramp" (8.9%) and "land left" (8.9%). What is disturbing about the deviations mentioned so far is that they occur near or past the point where the LSO can initiate a safe waveoff. The data derived from the accident narratives did not indicate the presence of very many cues which could help the LSO prevent these off-center landing accidents. The implication to LSO training appears to be that an LSO must be critically alert for the least indication of lineup control instability approaching the waveoff decision point in order to preclude this type of accident. This problem also points to the importance of the backup LSO, especially when the controlling LSO is faced with other simultaneous approach deviations.

The final category of carrier landing accidents which were analyzed were in-flight engagements. Results of this analysis are presented in Table G-8. Most of the deviations in this type of accident occurred in close and at the ramp. However, the most prevalent deviation was "pull nose up on waveoff or approaching touchdown" (18.4%). The most frequent precursors to this deviation were "too much rate of descent at the ramp" (14.3%), "too much rate of descent in close" (6.1%) and "not enough power in close" (6.1%). As mentioned earlier, most of the in-flight engagement accidents occurred during waveoff. The sink rate and power deviations were probably the cues which led to initiation of waveoffs. The implications to LSO training is that the LSO must learn to factor the possibility of pilot waveoff technique into his waveoff decision.



TABLE G-6. TRENDS IN HARD LANDING ACCIDENTS (N=33)

	GS		SR		AOA/SPEED		LU		DR/WINGS		POWER		PITCH	
	LO	HI	TM	NE	SLO/DEC	F/ACC	L	R	L	R	TM	ME	ND	PNU
X	4.1	6.5	--	--	--	--	1.6	1.6	--	--	--	--	--	13.8
IM	1.6	4.1	1.6	0.8	0.8	--	4.1	0.8	--	--	0.8	--	--	14.6
IC	2.4	8.9	3.3	3.3	0.8	1.6	0.8	0.8	--	0.8	1.6	1.6	4.1	30.1
AR	--	8.9	11.4	--	--	0.8	--	--	3.3	0.8	--	1.6	8.9	37.4
TD/WO	--	--	--	--	--	--	--	--	0.8	--	--	0.8	0.8	4.1
	8.1	28.5	16.3	4.1	1.6	2.4	6.5	3.3	4.1	1.6	2.4	4.1	13.8	3.3

MOST FREQUENT DEVIATIONS:

- THRDAR (too much rate of descent at ramp) . . . . . 11.4%
- NDAR (nose down at ramp) . . . . . 8.9
- HIC (high in close) . . . . . 8.9
- HAR (high at ramp) . . . . . 8.9
- HX (high start) . . . . . 6.5

TABLE G-7. TRENDS IN OFF-CENTER LANDING ACCIDENTS (N=15)

	GS		SR		AOA/SPEED		LU		DR/WINGS		POWER		PITCH	
	LO	HI	TM	NE	SLO/DEC	F/ACC	L	R	L	R	TM	NE	ND	PNU
X	2.2	4.4	--	--	--	--	2.2	2.2	--	2.2	--	--	--	13.3
IM	2.2	2.2	--	--	2.2	--	2.2	2.2	--	--	--	--	--	11.1
IC	2.2	2.2	--	--	2.2	--	--	4.4	--	4.4	--	--	--	15.5
AR	--	4.4	2.2	--	--	--	2.2	2.2	8.9	4.4	--	--	2.2	26.7
TD/NO	--	--	--	--	--	--	8.9	2.2	17.8	4.4	--	--	--	33.3
	6.7	13.3	2.2	--	4.4	--	15.5	13.3	26.7	15.5	--	--	2.2	--

MOST FREQUENT DEVIATIONS:

DRL-TD (drift left on touchdown) . . . . . 17.8%  
 DRLAR (drift left at ramp) . . . . . 8.9  
 LL (land left) . . . . . 8.9

TABLE G-8. TRENDS IN IN-FLIGHT ENGAGEMENT ACCIDENTS (N=14)

	GS		SR		AOA/SPEED		LU		DR/WINGS		POWER		PITCH		
	LO	HI	TM	NE	SLO/DEC	F/ACC	L	R	L	R	TM	NE	ND	PNU	
X	--	4.1	--	--	--	--	2.0	2.0	--	--	--	--	--	--	8.2
IM	2.0	4.1	2.0	--	--	--	2.0	--	--	--	--	--	--	--	10.2
IC	4.1	4.1	6.1	--	4.1	2.0	2.0	--	--	--	--	6.1	4.1	--	32.7
AR	--	2.0	14.3	--	2.0	--	2.0	--	2.0	--	--	2.0	2.0	4.1	30.6
TD/WO	--	--	--	--	--	--	--	--	--	--	--	--	--	18.4	18.4
	6.1	14.3	22.4	--	6.1	2.0	8.2	2.0	2.0	--	--	8.2	6.1	22.4	

MOST FREQUENT DEVIATIONS:

- PNU-WO/TD (pull nose up on waveoff or touchdown) . . . . . 18.4%
- TMRDAR (too much rate of descent at ramp) . . . . . 14.3
- TMRDIC (too much rate of descent in close) . . . . . 6.1
- NEPIC (not enough power in close) . . . . . 6.1

**SUMMARY.** In terms of deviation trends within carrier landing accidents, excessive sink rate "at the ramp" must be of prime concern to the LSO and to LSO training. Deviations which most frequently precede the excessive sink rate problem include "not enough power in close" (frequently a precursor to a ramp strike), "high nose down at the ramp" (frequently a precursor to a hard landing), "high in close" and "nose down in close." These are prime cues to the LSO that he should strongly consider a waveoff if an accident is to be prevented. Unfortunately these cues occur very late in the approach, near the waveoff decision point. Poor starts (high and low) and poor glideslope control early in an approach are also cues to the LSO to be alert for glideslope control and other problems approaching the waveoff decision point.

Most of the lineup problems with which an LSO must contend in potential accident situations are associated with "lined up left" and "drifting left," particularly approaching the ramp. They often occur with little warning and with little, if any, spare time for initiating a waveoff. The frequency of the "pull nose up" problem, which usually occurs on a waveoff, must be an influencing factor for the LSO in his waveoff decision process.

## APPENDIX H

## LSO TRAINING MODEL MANAGER AND NAVAL SAFETY CENTER INTERFACE

The current relationship between the TMM and the Safety Center was studied in order to determine whether there was a need for improving the flow of communications between them. Such a need does in fact exist. The background for this requirement, along with accompanying recommendations follow.

## CURRENT NAVSAFECEN DATA

The primary source of information that the NAVSAFECEN uses for analysis purposes is the Mishap Investigation Report (MIR) generated for each accident. The procedures for compiling this report are described below, along with a summary of the NAVSAFECEN analysis of such data.

**MISHAP REPORTING PROCEDURES.** Current procedures require that the custodian (e.g. squadron) of an aircraft involved in an accident submit a preliminary report that briefly describes the circumstances surrounding the mishap. An Aircraft Mishap Board (AMB) is then convened which performs an exhaustive analysis of the events that occurred before, during and after the accident, as well as addressing the need for material analysis of equipment involved. The AMB then issues a final Mishap Investigation Report (MIR) which details the analysis performed, lists empirical data (aircrew names, date, weather conditions, etc.) and determines the causal factors of the accident. The MIR is then forwarded up the chain of command from the custodian unit to the cognizant type-commander (CNAL, CNAP, etc). Each level of the chain of command has the opportunity to endorse the board's findings and any accompanying recommendations. The type-commander then adds an endorsement and forwards the report to NAVSAFECEN, where the Commander, NAVSAFECEN makes a final decision regarding the accident's causal factors and employment of associated recommendations. The MIR is routed to NAVSAFECEN data processing where, using 400 different coding possibilities, the information contained within is entered into the center's computer storage banks. The hard copy of the MIR is kept for 18 months, after which it is transferred to microfiche. The coding for data entry consists mostly of empirical data. Such data needs to be called out by code in order to be listed on any computer printout for subsequent trend analysis. A narrative or brief description of each accident is included, however, there is not a standardized format for this narrative's construction or content. If information regarding LSO related accidents is desired for trend analysis, the coding "carrier landing accidents" can be used. To be even more specific, a computer printout of empirical data can be generated according to the code: "Fixed wing, embarked, landing phase of operation." Such a printout supplies the following information automatically:

- a. Data period (time interval) covered
- b. Model aircraft
- c. Damage
- d. Date

## NAVTRAEQUIPCEN 80-C-0063-2

- e. Day/night
- f. CV name/number
- g. Causal factors
- h. Type of mishap
- i. Injuries
- j. Mishap narrative

The narrative may or may not include environmental conditions, LSO actions or other information considered important from an LSO's point of view. Such information must be specifically requested by code from the Safety Center. Physical evidence, when considered pertinent, is retained by the type commander.

**ANALYSIS.** The only routine landing analysis performed at the NAVSAFECEN is a quarterly report which categorizes landing mishaps by period of day (day/night). This is forwarded to the statistics section where it is stored for reference purposes. Any other type of analysis must be specifically requested from NAVSAFECEN data processing using the appropriate code. Several studies of accident information have been performed by members of the NAVSAFECEN staff in order to determine if any trends surface as a result of accident data analysis. Examples of such trend analysis are the correlation between accident rate and pilot's time-in-type, and the number of hard landings associated with a particular type of aircraft.

The capability exists for interested parties with a need-to-know to receive computer printouts of desired accident data by requesting such information from the NAVSAFECEN. This request can be made by letter with the reason for the request (e.g. Navy training course support, study under government contract) stated within.

### PHASE ONE SCHOOL ACCIDENT INFORMATION

At present no accident data is being forwarded as a matter of course to the LSO Training Model Manager (TMM) at the Phase One School. Such data can be forwarded if it is specifically requested. However, the LSO TMM does maintain a close informal liaison with the type-commander LSOs. Should he become aware of an LSO related accident, it is not unusual for the LSO TMM to establish phone contact with the staff LSO and obtain information considered useful.

### RECOMMENDATIONS

The following recommendations are listed in order to provide suggested courses of action that might improve fleet LSO training.

**NAVSAFECEN AND LSO TMM INTERFACE.** In the course of analyzing accident data for this report, the study group found that several training implications can be gleaned from comprehensive accident review. There is no doubt that the LSO TMM and his staff could find a similar use for the same data. Therefore, if it is possible to initiate automatic forwarding of accident

data from the NAVSAFECEN to the LSO TMM, the administrative steps necessary to accomplish such an interface should be undertaken. Such an automatic forwarding process should exist for accidents that meet the following criteria: MAJOR CV LANDING ACCIDENTS FIXED WING. Presently, accident data considered pertinent to fleet units (e.g. because of aircraft model) is forwarded to such units. This includes preliminary and final MIRs. In like manner, accidents that meet the above stated criteria could be sent to the LSO TMM. Involving the LSO TMM in the endorsement process for such accidents should also be considered. His comments as a "training" endorser would be most beneficial to fleet LSOs.

What the LSO TMM Needs to Know. In order for the LSO TMM to perform a meaningful analysis of accident data, the following information should be made available to him for every carrier landing mishap.

- a. Aircraft type
- b. Period of day
- c. Approach results (ramp strike, in-flight engagement, etc.)
- d. Pilot's hours: total, and in-type
- e. Pilot's history of carrier landings (last 7/30/90 days, total CV landings and total in type)
- f. Flight deck pitch and/or roll, if applicable; flight deck trim
- g. Status of landing aids
- h. Barricade arrest if applicable
- i. Speed and relative direction of wind-over-the deck
- j. Ceiling, visibility and whether or not precipitation was present. Horizon definition.
- k. Any facility or aircraft malfunction present
- l. Aircraft/facility damage
- m. Divert/tanker assets available
- n. Type of operations (CNATRA/RAG CQ, refresher CQ, fleet ops, etc.)
- o. A comprehensive narrative of the accident, to include all voice transmissions, aircraft position, speed and attitude during the defined LSO stages of the approach (in-the-middle, in-close, etc.), and all LSO grading comments. Previously established trends of the pilot should also be included.

The ideal situation would be for someone in the accident investigation process to fill in such a checklist with the appropriate data for each mishap. At the time nearly all of this information is available in various parts of the MIR. A brief description of where such data is recorded follows.

Available MIR data. OPNAV Form 8750/1 is a summary form used by Accident Mishap Boards to simplify the report and enable statistical recording of pertinent data. The following items should be extracted from this form and forwarded to the LSO TMM:

- a. Narrative description of the accident
- b. Model aircraft
- c. Period of day

- d. Flying experience (pilot's)
- e. Cause factors
- f. Environmental conditions
- g. Optical glideslope devices available
- h. Arresting equipment utilized
- i. Damage to aircraft

In addition to this information, the following information from the MIR should also be included from the "account" portion of the formal MIR.

a. From "Support Personnel Factors:" The evaluation of the physiological and psychological status of the LSO(s) and his (their) role in the mishap.

b. From "Facilities:" The use and status of the LSO platform displays and other landing aids as an influence, favorable or unfavorable, on the accident.

c. From statements "by the controlling LSO and senior LSO:" A complete account of the accident from the LSO viewpoint (including grade and LSO comments from LSO log); an analysis of the pilot's LSO graded landings for the previous 30 days; and items as required by Section VIII (Aircraft Mishap Statement Considerations) of the LSO NATOPS Manual.

Additionally, if at all possible, time correlated transcriptions of LSO-pilot voice tapes, and copies of PLAT video tapes should be included.

The sensitivity of accident-related data is greatly appreciated and should remain intact. The LSO TMM should not be so much interested in the WHO of the accident, but rather what the LSO did or could have done to affect its outcome. There seems to be no reason to believe that any compromise of sensitive information would occur if only the items listed are included in the forwarded data.

**TMM DATA USAGE.** What follows is a description of how accident data described above could be used to assist the LSO TMM in changing or developing training objectives for the Phase I School curriculum and the overall LSO training program.

**Accident Trend Analysis.** An extensive analysis of carrier landing accident data is provided in Appendix G of this report. It was done in order to determine what trends might surface as regards types of approaches and LSO actions that occur in major landing accidents. The authors group believes that a similar analysis of data for these types of accidents, as they occur, could be most beneficial to the LSO TMM. One measure of LSO training effectiveness is the frequency of accidents in the carrier landing environment. If the accident rate in this regime rises, then one reason could possibly be less effective training in a particular area. Should such a discovery be made, the LSO TMM could act to insure an appropriate training "alert" be promulgated to fleet LSOs and incorporated in the Phase I syllabus. In short, accident data made available to the LSO TMM as it



surfaces could be used as an effective tool for "quality control" of fleet LSO training. In keeping with this, it is recommended that carrier accident landing data be analyzed to determine whether or not the frequency of accidents is decreasing or increasing with respect to the following categories:

- a. Pilot as a causal factor
- b. Controlling LSO as a causal factor
- c. Other LSO(s) as a causal factor
- d. Period of day (day/night)
- e. Deck pitch or roll; mistrim of ship
- f. Little or no horizon
- g. Weather at or near minimums
- h. Aircraft already waved off
- i. Types of approaches that resulted in an accident involving "come-down from a high", "low-all-the-way", and line-up deviations.
- j. Final result of the approach, including ramp strike, hard landing, in-flight engagement, and off-center engagement. This should be coordinated with "i." above in order to determine if there are noteworthy trends leading to these results.
- k. Type of OLS in use (e.g. MOVLAS)
- l. Pilot's history, including total flight time and time in-type, carrier landings (total and in-type) and previously established approach trends.
- m. Wind conditions (high/low WOD, crosswind, etc.)
- n. Emergency in progress (aircraft or facility)
- o. Operational situation (CQ, no tanker/divert, etc.)
- p. Aircraft type

Additionally, the LSO grading comments should be observed in order to determine the "starting point" of the accident. That is, at what point (in-the-middle, in-close) of the approach did the aircraft begin to deviate from acceptable parameters, and what, if anything, the LSO could have done to prevent these deviations from terminating in an accident.

If such an analysis were performed, possible trends in accidents could be identified. For example, the types of approach trends that develop for a new inventory aircraft (e.g. F/A-18) could be identified and then appropriate LSO actions defined to anticipate such trends. A rise in the percentage of accidents listing the LSO as a causal factor would be a most positive indication that further research into LSO training was warranted. As an example of the usefulness of such data, consider a Flight Safety Advisory issued by NAVSAFECEN in 1972. In it accident data were analyzed, and it was determined that there was a recent marked increase in hard landing type accidents. The analysis defined exact reasons for such an increase. These included "in-close corrections," and "late line up corrections" in the F-4 aircraft. The F-4 has a tendency to develop an immediate increased sink rate should the pilot drop the nose in-close to correct for an above glideslope deviation. The result can be a hard landing if timely action is not taken by the LSO (e.g. an "attitude" call, or waveoff). This fact surfaced in the F-4 trend analysis. Such a trend analysis could be performed by the LSO TMM. His discovery of such a fact would lead him to bring it up when discussing the F-4 training environment, thus alerting fleet LSOs to be ready to act should an F-4 "drop nose in close." Such discoveries could be promulgated in a monthly LSO newsletter, Naval message or Approach Magazine.

The possibility of computer resources becoming available to the LSO TMM is another reason for funneling accident data to him. Such an asset could be programmed to identify trends such as those listed above over a period of time in order to assist the LSO TMM in keeping the fleet informed. Type commanders and NAVSAFECEN are quick to act when a dangerous trend in the structure of an aircraft surfaces and is found to cause accidents. There is no reason why the same prevention philosophy cannot be applied to the LSO community in order to prevent future accidents.

ACRONYMS

AMB	Aircraft Mishap Board
AOA	Angle of Attack
ACLS	Automatic Carrier Landing System
APCS	Automatic Power Compensation System
B/U	Backup
CARS	Carrier Aircraft Recovery Simulator
CCA	Carrier Controlled Approach
COMNAVAIRLANT	Commander Naval Air Forces Atlantic Fleet
COMNAVAIRPAC	Commander Naval Air Forces Pacific Fleet
CQ	Carrier Qualification
CV	Aircraft Carrier
DLC	Direct Lift Control
DR	Drift Rate
EMCON	Electronic Emission Control
FCLP	Field Carrier Landing Practice
FLOLS	Fresnel Lens Optical Landing System
GS	Glideslope
HUD	Head Up Display
LSO	Landing Signal Officer
LSORD	LSO Reverse Display
LSO TMM	LSO Training Model Manager
LSOTS	LSO Training System
LU	Lineup
MIR	Mishap Investigation Report
MOVLAS	Manually Operated Visual Landing Aid System
NAS	Naval Air Station
NATOPS	Naval Air Training and Operating Procedures Standardization
NAVTRAEQUIPCEN	Naval Training Equipment Center
NCLT	Night Carrier Landing Trainer
NORDO	No Radio
OJT	On the Job Training
OLS	Optical Landing System
OR	Operational Requirement
PE	Performance Evaluation
PLAT	Pilot Landing Aid Television
PM	Performance Measurement (or Monitor)
SR	Sink Rate
SUS	Speech Understanding System
MOD	Wind Over Deck

NAVTRAEQUIPCEN 80-C-0063-2

Commanding Officer  
Naval Training Equipment Center  
Orlando, FL 32813

Defense Technical Information  
Center  
Cameron Station  
Alexandria, VA 22310

LSO Training Model Manager  
Officer in Charge  
LSO School  
Box 171  
NAS Cecil Field, FL 32215

(ALL OTHERS RECEIVE ONE COPY)

National Aviation Facilities  
Experimental Center  
Library  
Atlantic City, NJ 08405

Naval Air Development Center  
Code 6022  
Warminster, PA 18974

Director  
Defense Research and Engineering  
Washington, DC 20301

OUSDR&E (R&AT) (E&LS)  
CAPT Paul R. Chatelier  
Washington, DC 20301

Chief of Naval Operations  
OP-115  
Research, Development & Studies  
Room 6836  
Washington, DC 20350

Chief of Naval Operations  
OP-987H  
ATTN: Dr. R. G. Smith  
Washington, DC 20350

Chief of Naval Operations  
OP-593B  
Washington, DC 20350

Chief of Naval Operations  
OP-596  
50 Washington, DC 20350

Commander  
Naval Air Systems Command  
AIR 334A  
12 Washington, DC 20361

Commander  
Naval Air Systems Command  
AIR 41311B  
10 Washington, DC 20361

Scientific Technical Information Office  
NASA  
Washington, DC 20546

Federal Aviation Administration  
Technical Library  
Bureau Research and Development  
Washington, DC 20590

Commanding Officer  
Naval Air Station (Code 62)  
ATTN: Station Library, Bldg 407  
Patuxent River, MD 20670

Chief of Naval Research  
Director, Air Programs  
Code 210  
Arlington, VA 22217

Chief of Naval Research  
Code 455  
800 N. Quincy St.  
Arlington, VA 22217

Chief of Naval Research  
Code 458  
800 N. Quincy St.  
Arlington, VA 22217

Commander  
Naval Air Force  
US Atlantic Fleet (Code 312E)  
NAS Norfolk  
Norfolk, VA 23511

Commanding Officer  
FASOTRAGRULANT (50)  
NAS  
Norfolk, VA 23511

Defense Ad. Res. Projects Agency  
Cybernetics Technology Office  
1400 Wilson Blvd.  
Arlington, VA 22209

Chief of Naval Education & Training  
Code 017  
NAS  
Pensacola, FL 32508

Selection & Training Div.  
Dept. of Psychology  
Code 26  
Naval Aerospace Medical Research Lab  
Pensacola, FL 32512

Federal Aviation Administration  
AAC-954C  
Aeronautical Center, Flight Standards Br.  
Oklahoma City, OK 73101

Chief, Methodology & Standards Staff  
Federal Aviation Administration Academy  
Aeronautical Center, AAC - 914  
P. O. Box 25082  
Oklahoma City, OK 73125

Chief of Naval Air Training  
ATTN: Code 333 (LSO)  
NAS Corpus Christi, TX 78419

Chief of Naval Air Training  
ATTN: Code N-301  
NAS Corpus Christi, TX 78419

Commanding Officer  
Human Resources Laboratory  
Operational Training Div.  
Williams AFB, AZ 85224

Commander  
Naval Air Force  
US Pacific Fleet (Code 311 L)  
NAS North Island  
San Diego, CA 92135

Commander  
Naval Air Force  
US Pacific Fleet (Code 342)  
NAS North Island  
San Diego, CA 92135

Commander  
Pacific Missile Test Center  
Point Mugu, CA 93042

National Aeronautical & Space Admin.  
High Speed Research Center Library  
Edwards AFB, CA 93523

Commanding Officer  
Air Force Flight Test Center  
FTOTL  
Technical Library Branch  
Edwards AFB, CA 93523

National Aeronautical & Space Admin.  
Ames Research Ctr Aircraft Inspection Br.  
Mail Stop 211-5  
Moffett Field, CA 95050

**FILM**  
**1-8**