

POWERING PREDICTION FOR VARIOUS HYBRID SHIP CONCEPTS

ADA030530

SPD-765-01

12 B.S.

DAVID W. TAYLOR NAVAL SHIP RESEARCH AND DEVELOPMENT CENTER



Bethesda, Md. 20084

POWERING PREDICTION FOR VARIOUS HYBRID SHIP CONCEPTS

by

Gabor Karafiath

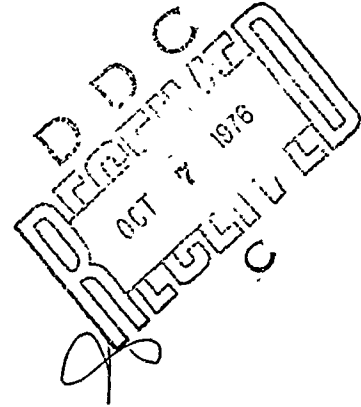

APPROVED FOR PUBLIC RELEASE: DISTRIBUTION UNLIMITED

SHIP PERFORMANCE DEPARTMENT

April 1976

SPD-675-01

MAJOR DTNSRDC ORGANIZATIONAL COMPONENTS

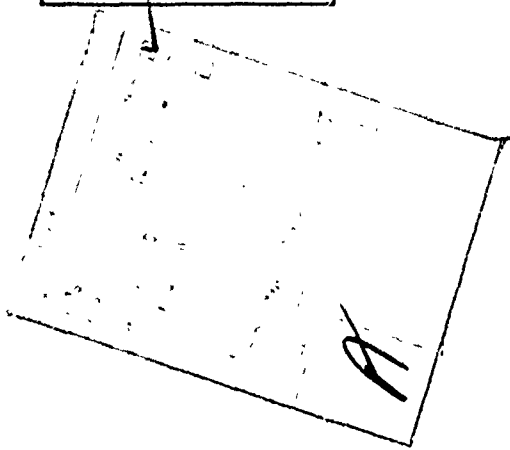
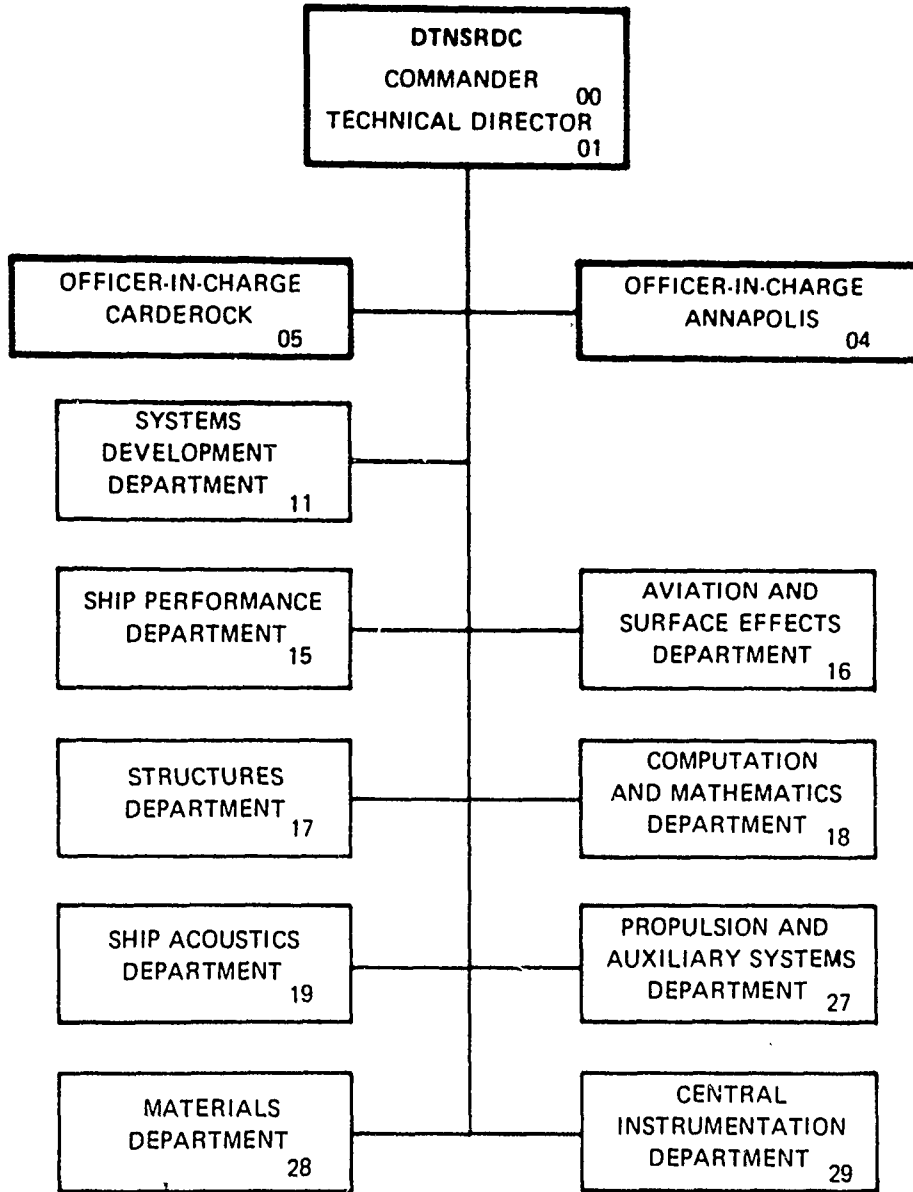

REPORT DOCUMENTATION PAGE		READ INSTRUCTIONS BEFORE COMPLETING FORM
1. REPORT NUMBER 14 SPD-675-01	2. GOVT ACCESSION NO.	3. RECIPIENT'S CATALOG NUMBER
4. TITLE (and Subtitle) 6 Powering Prediction for Various Hybrid Ship Concepts		5. TYPE OF REPORT & PERIOD COVERED
7. AUTHOR(s) 10 Gabor/Karafiath		6. PERFORMING ORG. REPORT NUMBER
9. PERFORMING ORGANIZATION NAME AND ADDRESS David W. Taylor Naval Ship R&D Center Bethesda, Maryland 20084		8. CONTRACT OR GRANT NUMBER(s) 16 ZF61-412 17 ZF61-412-001
11. CONTROLLING OFFICE NAME AND ADDRESS Naval Material Command Washington D.C. 20360		10. PROGRAM ELEMENT, PROJECT, TASK AREA & WORK UNIT NUMBERS ZF61412001 (Task Area) 1-1170-031 (Work Unit)
14. MONITORING AGENCY NAME & ADDRESS (if different from Controlling Office)		12. REPORT DATE 11 April 1976
		13. NUMBER OF PAGES 12 65 p.
		15. SECURITY CLASS (of this report) Unclassified
		15a. DECLASSIFICATION/DOWNGRADING SCHEDULE
16. DISTRIBUTION STATEMENT (of this Report) APPROVED FOR PUBLIC RELEASE: DISTRIBUTION UNLIMITED		
17. DISTRIBUTION STATEMENT (of the abstract entered in Block 20, if different from Report)		
18. SUPPLEMENTARY NOTES		
19. KEY WORDS (Continue on reverse side if necessary and identify by block number) Advanced Ship Concepts, Powering Prediction, Hydrofoils, Air Cushion, Small Waterplane Area		
20. ABSTRACT (Continue on reverse side if necessary and identify by block number) A computer program called TRIBRID is described which can rapidly calculate the smooth water resistances of some advanced hybrid and tribrid ship concepts that are supported by buoyant, dynamic, and aerostatic forces. These forces are produced by one or more hull-strut combinations similar to a demi SWATH in conjunction with large hydrofoils and/or air cushions. For a given displacement and shape, the size of each concept is determined and various drag components along with some interference drag are then calculated for a calm water, fixed zero trim and free to heave operating condition.		

TABLE OF CONTENTS

	Page
ABSTRACT.....	1
INTRODUCTION.....	2
TRIBRID PROGRAM DESCRIPTION.....	4
TRIBRID PROGRAM INPUT.....	7
SUMMARY OF CALCULATED LIFT AND DRAG COMPONENTS.....	17
TRIBRID PROGRAM OUTPUT.....	20
LIMITATIONS OF THE TRIBRID PROGRAM.....	26
CONCLUSIONS AND RECOMMENDATIONS.....	28
ACKNOWLEDGEMENTS.....	29
REFERENCES.....	30
APPENDIX A - FOIL SYSTEM PERFORMANCE.....	31
APPENDIX B - HULL-STRUT-SUPERSTRUCTURE PERFORMANCE.....	43
APPENDIX C - AEROSTATIC LIFT SYSTEM PERFORMANCE.....	54

LIST OF FIGURES

	Page
Figure 1 - Hybrid Ship Concepts.....	3
Figure 2 - Basic Tribrid Definitions.....	9
Figure 3 - Schematic of Ship Configurations.....	11
Figure 4 - Midship Section Schematic Corresponding to Sample Output.....	22
Figure 5 - Computer Output for Sample Case.....	23

ABSTRACT

A computer program called TRIBRID is described which can rapidly calculate the smooth water resistances of some advanced bibrig and tribrid ship concepts that are supported by buoyant, dynamic, and powered aerostatic forces. These forces are produced by one or more hull-strut combinations similar to a demi SWATH in conjunction with large hydrofoils and/or air cushions. For a given displacement and shape, the size of each concept is determined and various drag components along with some interference drag are then calculated for a calm water, fixed zero trim and free to heave operating condition.

INTRODUCTION

The primary intent of this report is to describe the TRIBRID computer program which can quickly calculate the smooth water resistance of some of the advanced hybrid ship concepts investigated by J. Meyer (Reference 1) and D. Jewell and of many possible and foreseeable modifications of these concepts. The terms hybrid and tribrid refer to a ship which is supported by a combination of buoyant, hydrofoil, and powered air cushion generated lift. Bibrid vehicles have two of the above support modes and tribrids have three.

The computer program was initially developed for the Hydrofoil Small Waterplane Area Ship (HYSWAS) and has been expanded to handle the Small Waterplane Area Air Cushion Ship (SWAACS) and many variations of the Small Waterplane Area Twin Hull (SWATH) ship with air cushion and/or hydrofoil support. In addition, the program may be used, with some modification, for predicting some of the calm water drag components of the Hydrofoil Air Cushion Ship (HYACS) and the Large Hybrid Hydrofoil Ship (LAHHS). Figure 1 shows some of these concepts.

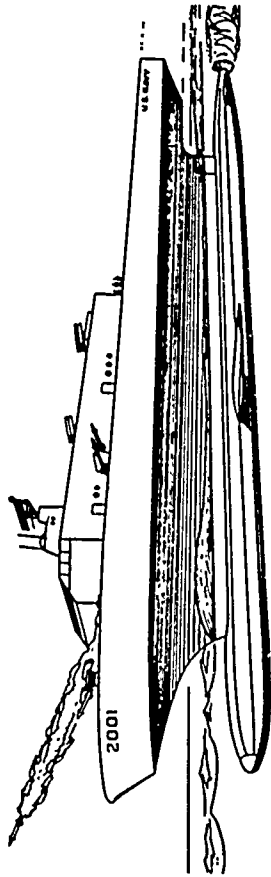

HYDROFOIL SMALL WATERPLANE AREA SHIP
(HYSWAS)

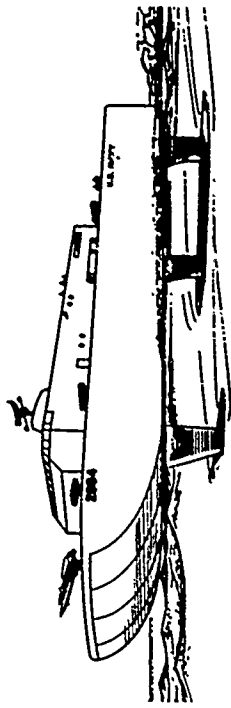

HYDROFOIL AIR CUSHION SHIP
(HYACS)

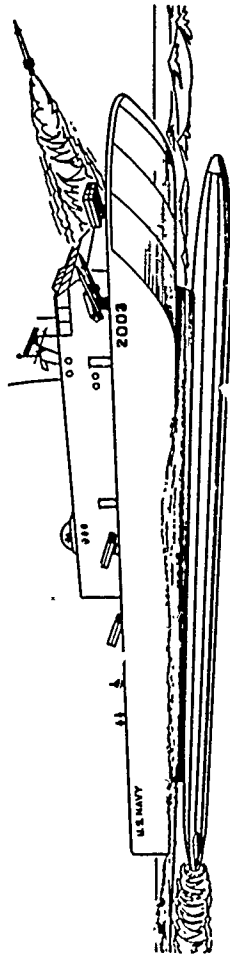

SMALL WATERPLANE AREA AIR CUSHION
SHIP (SWAACS)

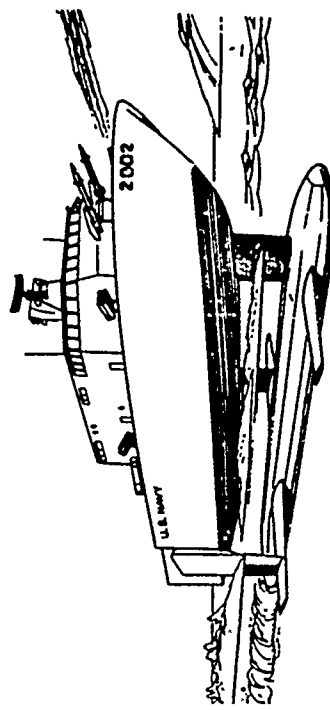

LARGE HYDROFOIL HYBRID SHIP
(LAHHS)

FIG. 1 HYBRID SHIP CONCEPTS

TRIBRID PROGRAM DESCRIPTION

The TRIBRID program was written to quickly estimate the resistance of hybrid and tribrid ship concepts which depend on buoyant, dynamic or air cushion sustentation devices. The buoyant displacement is derived from a slender body of revolution (called a hull in this report) operating under the free surface and also from a low aspect ratio strut situated on top of the body and piercing the free surface. The dynamic lift is due to very large subcavitating foils moving through the water, and the air cushion lift is derived from pressure supplied by powered fans aboard the ship. The hull-strut combination can be used singly, in pairs as in a catamaran or in triplets as in a trimaran. The foils may be cantilevered from the hull or strut like the wings of an airplane or they may span two adjacent hulls or struts depending on the desired arrangement. The air cushions utilize the struts as side seals and they may be placed between adjacent struts. The resistance of a large number of possible hull-strut, foil and cushion arrangements can be evaluated by the TRIBRID program. A few of these arrangements are shown in the TRIBRID program input section of this report.

Existing equations and computer programs which were available at the inception of the project were gathered to predict the drag components associated with the foils, air cushions and hull-strut combinations and were incorporated into the TRIBRID program. In the area of foil wave drag and the wave drag of flared struts no suitable existing program was found.

A subroutine was written to evaluate the wave drag of large foils operating at shallow submergences and an existing computer program was modified to take into account the effect of strut flare on the wavemaking drag of the hull-strut combination. Since it was not the intent of this project to develop new technology, a number of foreseeable interference effects between the foils, hull-strut combination, and air cushions along with some other drag components have not been evaluated. A complete list of anticipated drag components that are not evaluated is found in the section on the limitations of the TRIBRID program.

Since some drag components are not accounted for by the TRIBRID computer program, it is inadvisable to make resistance comparisons between a concept evaluated by the TRIBRID program and an already existing ship whose resistance is known. The TRIBRID program neglects certain resistances and therefore the comparison of the resistance generated by TRIBRID to a known ship resistance must be considered speculative to a certain extent.

Approximate methods are used (See the Appendices for details) for the computation of the various drag components. Hard data are not available to verify the validity of most of these formulations. It is thus conceivable that the ranking of widely different concepts based solely on these powering-performance computations may not be born out in reality. For example, if one compares a concept having mainly dynamic-lift sustension with another that is mainly cushion-supported,

an error in the relative ranking could be caused by the overpredicted cushion drag. Additional error in the ranking can be introduced if non-optimum versions of the concepts are used to represent each component.

It should be emphasized here that the TRIBRID program deals only with resistance and powering. Powering is addressed superficially, and only because it is necessary to calculate the total required power for valid comparisons between cushion and non cushion concepts. An assumed fan efficiency, duct efficiency, propulsive coefficient and the calculated effective power and fan ideal power are used to determine the total required power.

The feasibility of a configuration is not examined with regard to propulsor sizing or propulsor efficiency calculations, nor are any basic Naval Architectural feasibility questions with regard to static stability, motions, maneuvering, structures, machinery arrangement, fuel and payloads investigated.

TRIBRID PROGRAM INPUT

The required input to run the TRIBRID program consists of the following data cards. Numbers in [brackets] are SI unit conversion factors. (i.e., quantity in British Unit x Conversion Factor = quantity expressed in SI units.)

Card 1 12A6 Format

Columns 1-72 Enter concept name or title

Card 2 8F10.6 Format - Constants

Columns 1-10 RHO - density of water slugs/ft³ [515.3788 K_g/m³]

11-20 GRAV - gravitational constant ft/sec² [.3048 m/s²]

21-30 PI - Value of pi 3.14159...

31-40 E - Logarithmic base 2.71828...

41-50 GAMMA - Euler's constant .55721...

51-60 VISC. - Kinematic Viscosity of water ft/sec³ [10.76423 m/s³]

61-70 RHOAIR - Air density $\frac{\text{slugs}}{\text{ft}^3}$ [515.3788 K_g/m³]

Card 3 8F10.6 Format

Columns 1-10 DELTCF - Correlation coefficient (.0005 for example)

11-20 FKS - Equivalent sand grain diameter-used as a measure of foil roughness - inches [2.54 cm]

Card 4 8F10.6 Format

Columns 1-10 DELTA - Total buoyant displacement at rest. Tons Weight
[RHO x GRAV *0.9910 m³]

11-20 CWP - Waterplane coefficient of the strut

21-30 CP - Hull prismatic coefficient

31-40 CI - Strut inertial coefficient (see appendix B for definition)

41-50 EXP - Strut flare exponent enter 1.0, 2.0, or 3.0 only.

51-60 LCBOLH - Ratio of the hull longitudinal center of buoyancy measured from midships, LCB, to the hull length, LH (Positive=LCB fwd of \bar{x})

61-70 LCFOLS - Ratio of the strut longitudinal center of floatation measured from amidships, LCF, to the strut length, LS (Positive=LCF forward of \bar{x})

Card 5 8F10.6 Format (see Figure 2 for a schematic showing of the geometric quantities discussed below)

Columns 1-10 TZODH - Ratio of the strut thickness, TZ, at strut bottom to horizontal hull diameter, DH

11-20 TR - Ratio of the strut thickness, BSH, at the top to the thickness, TZ, at bottom

21-30 HSODV - Ratio of strut height, HS, to the vertical hull diameter, DV

31-40 DVODH - Ratio of hull vertical diameter, DV, to horizontal diameter, DH

41-50 LSOLH - Ratio of strut length, LS, to hull length, LH

51-60 DHOLH - Ratio of horizontal hull diameter, DH, to hull length, LH

Card 6 8I Format - Concept Configuration Card

Column 5 NS - Number of struts

10 NSH - Number of hull strut intersections

15 NH - Number of hulls

20 NCUSS - Number of cushions

25 NF - Number of foil sets. (NF=2 for tandem foils)

30 NFC - Number of foil sections

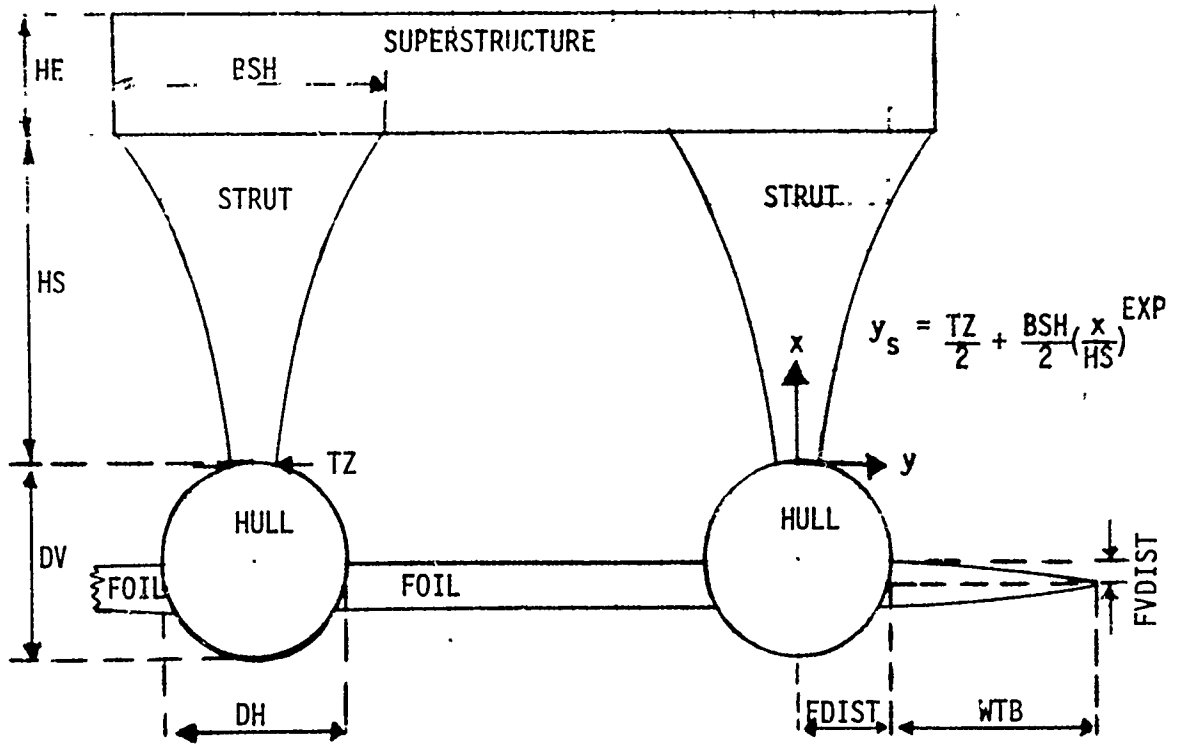

MIDSHIP SECTION

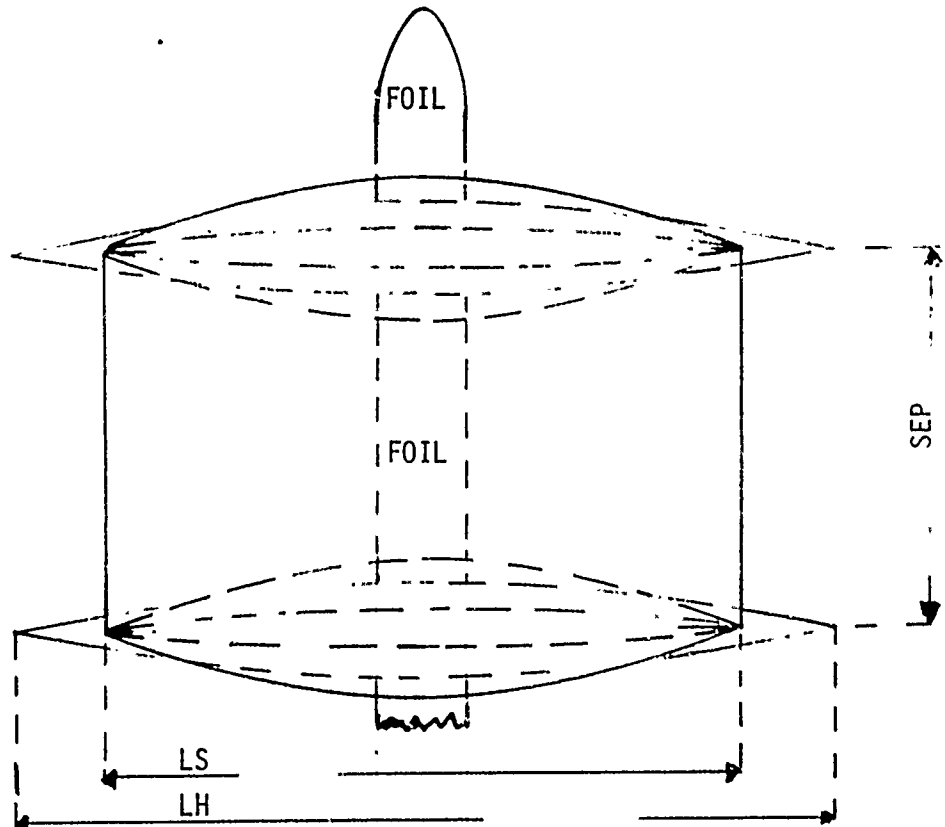

FIG. 2 BASIC TRIBRID DEFINITIONS

A foil set may consist of one, two, or three sections. A one section foil set is a foil spanning two hulls. A two section foil set consists of two outboard wing foils on a single hull, or on two hulls. A three section foil consists of a center spanning foil between two hulls and two outboard wing foils. See Figure 3 for some of the various possible foil, hull, strut and cushion combinations.

Card 7 8F10.6 Format - VKNOT(I)

Enter the eight desired speeds in knots. [.5144444 m/s] They may be the same speed or different speeds.

Card 8 8F10.6 Format - CPSF(I) [47.88026 Pa]

Enter the eight cushion pressures in pounds/ft² corresponding to the above speeds. Enter zeroes if the concept does not use aerostatic lift.

Card 9 8F10.6 Format

Columns	1-10	LCOLS - Enter the ratio of cushion length to strut length	(1.0)
	11-20	SLOLC - Enter the ratio of the combined forward and aft seal length to cushion length	(0.5)
	21-30	CD - Enter aerodynamic drag coefficient for the craft	(0.3)
	31-40	HEOLS - Enter the ratio of the average super-structure height, HE, to strut length	(.06)

Card 10 8F10.6 Format - SODH(I) ft. [.3048 m] - See Figure 2

Enter eight ratios of the centerline separation distance SEP, between adjacent hulls to the horizontal hull diameter, DH. For single

FRONT VIEW							COMMENTS
	NS	NSH	NH	NCUSS	NF	NFC	
	1	1	1	0	0	0	BASIC HULL STRUT COMBINATION
	1	1	1	0	1	2	HYSWAS FOR TANDEM FOILS SET NF=2
	2	2	2	0	0	0	SWATH TYPE BASIC TWIN HULL- STRUT CONFIGURATION
	2	2	2	1	0	0	AIR CUSHION SUPPORTED SET NCUSS=2 FOR TANDEM CUSHIONS ONE BEHIND THE OTHER

FIG. 3 SCHEMATIC OF SHIP CONFIGURATIONS

FRONT VIEW							COMMENTS
	NS	NSH	NH	NCUSS	NF	MFC	
	2	2	2	0	1	1	<p>TWIN HULL-STRUT COMBINATION WITH CENTRAL FOIL SUPPORT</p> <p>SET NF=2 FOR TANDEM CENTRAL FOILS</p>
	2	2	2	0	1	2	<p>TWIN HULL-STRUT COMBINATION WITH WING FOIL SUPPORT</p> <p>SET NF=2 FOR TANDEM WING FOILS</p>
	2	2	2	0	1	3	<p>TWIN HULL-STRUT TYPE WITH CENTRAL AND WING FOILS</p> <p>SET NF=2 FOR TANDEM CENTRAL AND WING FOILS</p>
	2	2	2	1	1	3	<p>TWIN HULL-STRUT TYPE WITH CUSHION AND FOIL SUPPORT</p> <p>FOR TANDEM CUSHION NCUSS=2</p> <p>FOR TANDEM FOILS NF=2</p>

FIG. 3 SCHEMATIC OF SHIP CONFIGURATIONS

FRONT VIEW	NS	NSH	NH	NCUSS	NF	NFC	COMMENTS
	3	1	1	0	0	0	BASIC TRIMARAN CONFIGURATION
	3	1	1	2	0	0	TRIMARAN WITH TWIN SIDE BY SIDE CUSHION "SWAACS" TYPE CONFIGURATION
	3	1	1	0	1	2	TRIMARAN WITH WING FOILS SET NF=2 FOR TANDEM FOILS
	3	1	1	0	1	2	TRIMARAN WITH WING FOILS TOUCHING OUTBOARD STRUTS SET NF=2 FOR TANDEM FOILS SEE CARD 12 FOR FVDIST THE VERTICAL FOIL LOCATION OFFSET FROM THE HULL CENTERLINE

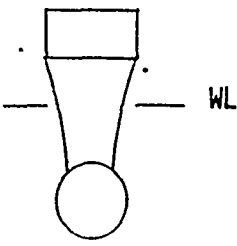
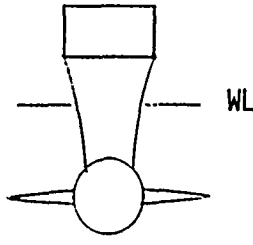
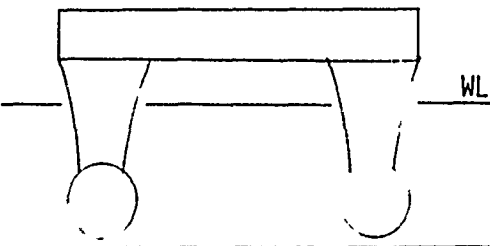
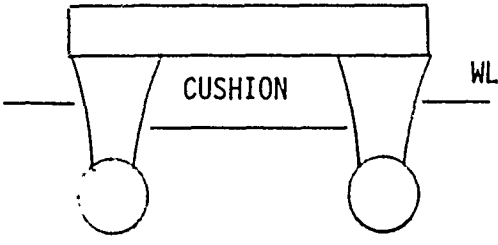
FIG. 3 SCHEMATIC OF SHIP CONFIGURATIONS

FRONT VIEW		COMMENTS												
	<table border="1"> <thead> <tr> <th data-bbox="774 217 820 269">NS</th> <th data-bbox="820 217 865 269">NSH</th> <th data-bbox="865 217 911 269">NH</th> <th data-bbox="911 217 956 269">NCUSS</th> <th data-bbox="956 217 1002 269">NF</th> <th data-bbox="1002 217 1047 269">NFC</th> </tr> </thead> <tbody> <tr> <td data-bbox="774 269 820 563">3</td> <td data-bbox="820 269 865 563">1</td> <td data-bbox="865 269 911 563">1</td> <td data-bbox="911 269 956 563">2</td> <td data-bbox="956 269 1002 563">1</td> <td data-bbox="1002 269 1047 563">2</td> </tr> </tbody> </table>	NS	NSH	NH	NCUSS	NF	NFC	3	1	1	2	1	2	<p data-bbox="1063 279 1274 341">"HYACS" TYPE CONFIGURATION</p> <p data-bbox="1063 372 1380 466">TRIMARAN WITH TWIN SIDE BY SIDE CUSHION AND WING FOILS</p>
NS	NSH	NH	NCUSS	NF	NFC									
3	1	1	2	1	2									

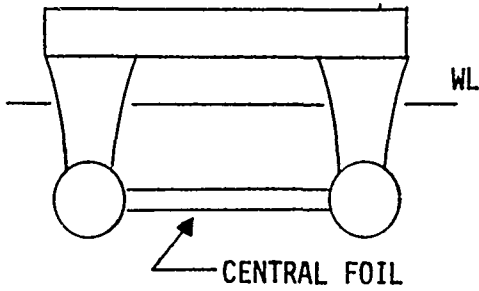
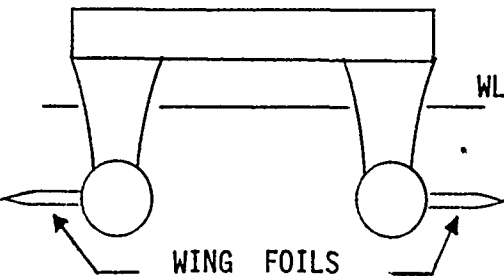
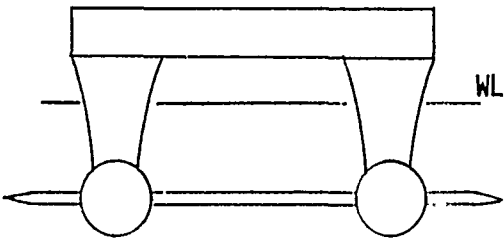
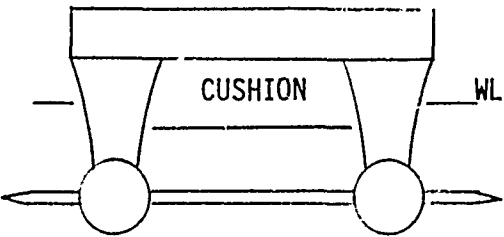
NOTES ON FIG. 3

- 1) CONFIGURATIONS ARE NOT DRAWN TO SCALE
- 2) ALL HULLS, STRUTS, WING FOILS, AND CENTRAL FOILS MUST BE IDENTICAL WHEN MORE THAN ONE IS USED IN A CONFIGURATION
- 3) THERE ARE OTHER CONFIGURATIONS USING A COMBINATION OF HULLS, STRUTS, FOILS AND CUSHIONS THAT CAN BE EVALUATED BY THE TRIBRID PROGRAM

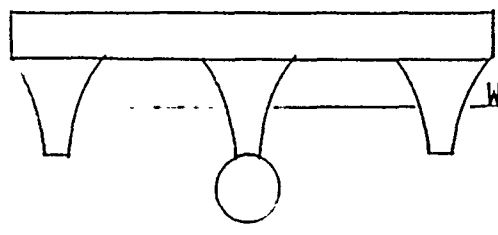
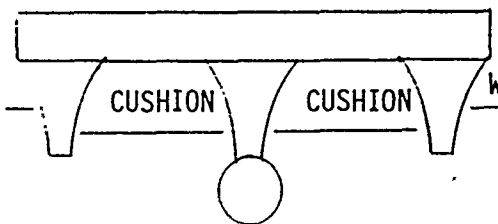
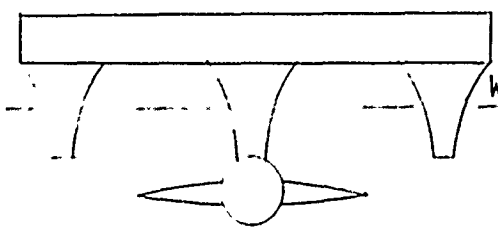
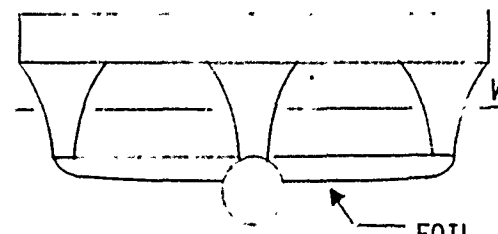
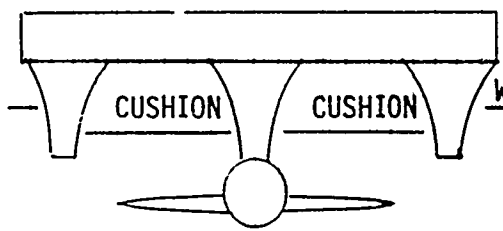
FIG. 3 SCHEMATIC OF SHIP CONFIGURATIONS

hull-strut concepts enter zeroes. For catamaran and trimaran type concepts SODH must be greater than 1.0. For trimaran concepts, SODH is the ratio of the distance between the centerlines of the center hull and the side hull to the horizontal hull diameter.

Card 11 8F10.6 Format - CSTRUT(I) ft. [.3048 m]

Enter eight values of the longitudinal distance in ft. between the centerline of strut and centerline of hull. (+ is fwd of hull centerline)

Card 12 8F10.6 Format

- Columns 1-10 FAC - Foil average chord ft. [.3048 m]
11-20 FATC - Foil average thickness to average chord ratio
21-30 WTB - Foil wing tip to body distance ft. [.3048 m]
if NFC on card 6 is 1 then set WTB equal to zero.
31-40 AZ - Foil lift curve slope. Change in foil lift coefficient per angle of attack in degrees
41-50 FDIST - Transverse distance in ft [.3048 m] between the tip of a central foil section and the body centerline. For a central foil at the bow or stern, FDIST is zero.
51-60 FVDIST - Vertical distance in ft [.3048 m] between the centerplane of a central foil and/or wing foil and the hull axis.

Card 13 Format 810.6 -FLOAD(I)

Enter eight values of foil loading corresponding to the eight speeds on card 7. Units are $\frac{lb}{ft^2}$ [47.88026 Pa] Enter zeroes if the craft has no foils.

Card 14 8F10.6 Format - ETAPC

Enter 8 propulsive coefficients corresponding to each of the speeds on card 7. ETAPC must be greater than 0.

Card 15 8F10.6 Format - ETAF

Enter eight fan efficiencies corresponding to each of the speeds on card 7. ETAF must be greater than 0.0.

Card 16 8F10.6 Format - ETAD

Enter eight duct efficiencies corresponding to each of the speeds on card 7. ETAD must be greater than 0.0.

Card 17 8I5 Format

Columns 1-15 NSTART - Enter 99999 if another concept is being run and insert cards 1-17 for new concept. Enter zero for the last case or if only one case is run.

SUMMARY OF CALCULATED LIFT & DRAG COMPONENTS

The following is a list of the lift and drag components evaluated by the TRIBRID program.

HULL - consists of a slender body of revolution below the free surface.

The calculated lift and drag components are:

- A) Buoyant lift
- B) Friction drag
- C) Eddy drag
- D) Wave making drag
- E) Wave making interference drag between hull(s) and struts(s)

STRUT - The strut connects the upper superstructure or cross-structure of a concept with the hull. It is long and slender and may be wall sided or flared.

- A) Buoyant lift
- B) Friction drag
- C) Eddy and/or tip drag (Tip drag is calculated only for concepts that have no hull under one or more of the struts)
- D) Wave making drag
- E) Wave making interference drag between strut(s) and hull(s)

FOIL - The foil has a subcavitating section shape and is attached to the hull or strut like a wing. The foil can also span two hulls or struts.

- A) Dynamic lift
- B) Buoyant lift
- C) Friction drag (See Appendix A for the calculation of the foil friction coefficient which is expected to be high due to roughness and fouling resulting from long periods of foil submergence)
- D) Induced drag
- E) Wave making drag
- F) Eddy making drag

AIR CUSHION - The air cushion is contained between two adjacent struts and fore and aft seals.

- A) Cushion aerostatic lift
- B) Wave making drag
- C) Seal drag
- D) Momentum drag
- E) Fan ideal power (calculated for purposes of comparing cushion and non cushion craft)

SUPERSTRUCTURE - The aerodynamic pressure drag is calculated.

The equations for calculating the above listed lift and drag components are presented in appendices A, B, and C. These appendices correspond to the modular subroutines in the TRIBRID computer program which evaluate foil system performance, hull-strut performance and cushion system performance. Each of the appendices has its own list of symbols identical to the symbols in the original reference sources.

The subroutine corresponding to each appendix is designed so that it can easily be replaced by a new subroutine describing the performance of a different lift device that might be employed on a future concept. In fact, the present TRIBRID program was developed this way from a January 1975 computer program that had the capability of evaluating concepts only with buoyant and dynamic support and no air cushion support.

TRIBRID PROGRAM OUTPUT

Three pages of output are generated by the TRIBRID program. The first contains quantities which do not vary with speed such as displacement, hull, strut, foil and cushion dimensions, foil lift curve slope and number of hulls, struts, foils and cushions. The various hull, strut, foil, cushion and superstructure drag components for maximum of eight specified input speeds are printed in tabular form on the second page in English Units and on the third page in SI Units. The tables also include the following.

- a) Assumed propulsive coefficient, fan efficiency, and duct efficiency. These efficiencies are needed in order to compare the total power required by craft with air cushion support to craft without air cushion.
- b) Buoyant, dynamic and aerostatic lift expressed as a percentage of the total craft weight. The percentages are calculated in order to place each concept on the sustension triangle proposed by Jewel (Reference 2).
- c) Cushion pressure - specified for each speed.
- d) Strut wetted surface, strut draft on the cushion side, and the total draft - these are all quantities which change with the heave of the craft.
- e) Fan flow rate - depends on cushion pressure as well as on speed.
- f) Foil loading - pressure prescribed by the user.
- g) Foil angle of attack and foil lift coefficient. The program can generate foil angles beyond stall if the foil loading specified is too high for a particular speed. The user should check that the foil angle and foil lift coefficient are below the stall values. If not, the loading should be decreased.
- h) Sum of the drag components calculated
- i) Effective power

- j) Fan ideal power
- k) Total shaft power - the total shaft power is the sum of the effective power divided by the propulsive coefficient plus the fan ideal power divided by the product of the fan and duct efficiencies.

A sample computer output is shown in Figure 5. The sample is for a twin-hull, foil and cushion supported concept, the midship section of which is shown in Figure 4. The sample output is included for illustrative purposes only and not for making any evaluation of the concept.

SCHEMATIC OF A TRIBRID TYPE CONCEPT

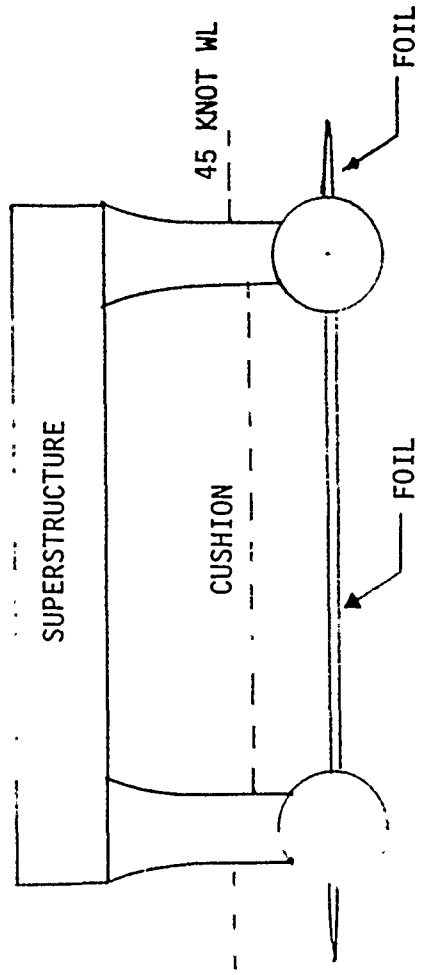

FIG. 4 MIDSHIP SECTION SCHEMATIC CORRESPONDING TO SAMPLE OUTPUT

TWIN HULL TRIPLING WITH FOIL AND CUSHION SUPPORT EXAMPLE CASE

DISPLACEMENT DELTA = 4000.000 TONS 396.223 CURIC METERS
 HULL LENGTH LH = 302.273 FEET = 92.133 METERS
 STRUT LENGTH LS = 211.591 FEET = 64.493 METERS
 HORIZ. HULL DIAM. DS = 15.114 FEET = 4.607 METERS
 VERT. HULL DIAM. DV = 15.114 FEET = 4.607 METERS
 STRUT HEIGHT HS = 22.670 FEET = 6.910 METERS
 STRUT THICKNESS, BOTTOM TB = 9.068 FEET = 2.764 METERS
 STRUT THICKNESS, TOP TH = 13.602 FEET = 4.146 METERS
 HULL-STRUT PARAMETERS
 LCR/LH = -0.000
 WATERPRISMATIC COEFF. CP = .666
 WATERPLANE AREA COEFF. CWP = .666
 WATERPLANE INERTIA COEFF. CI = .033
 LCF/LS = -0.000
 EXP = 2.000

NUMBER OF STRUTS = 2 NUMBER OF S-H INTERSECTIONS = 2 NUMBER OF FOIL SECTIONS = 3

FOIL AVERAGE THICKNESS/CHORD RATIO = .100
 FOIL LIFT CURVE SLOPE (CL/DEG) = .104
 STRUT LENGTH/HULL LENGTH = .700
 HORIZ. HULL DIA. / HULL LENGTH = .050
 VERT. HULL DIA./HORIZ. HULL DIA. = 0.000
 STRUT HEIGHT / VERT HULL DIA. = 1.500
 SEAL LENGTH / CUSHION LENGTH = .050
 CUSHION LENGTH / STRUT LENGTH = 1.000
 SUPERSTRUCTURE HEIGHT / STRUT L. = .060
 AERODYNAMIC DRAG COEFFICIENT = .300
 CORRELATION COEFFICIENT = .000500

HULL WETTED SURFACE = 16527.50 FT. STATION -.5 IS AFT. STATION .5 IS AT THE BOW OF THE STRUT OR HULL AS APPLICABLE
 FOIL EQUIV. ROUGH. = .001600 IN. = .000059 CM.
 FOIL AVERAGE CHORD = 5.00 FEET = 1.53 METERS
 CENTER FOIL-HULL CL. = -0.00 FEET = 0.00 METERS
 FOIL BELOW HULL AXIS = -0.00 FEET = 0.00 METERS
 WING FOIL-HULL CL. = 15.00 FEET = 4.57 METERS

NORMALIZED HULL AND STRUT OFFSETS, STATION -.5 IS AFT. STATION .5 IS AT THE BOW OF THE STRUT OR HULL AS APPLICABLE
 STATIONS -0.50 -0.45 -0.40 -0.35 -0.30 -0.25 -0.20 -0.15 -0.10 -0.05 0.00 .05 .10 .15 .20 .25 .30 .35 .40 .45 .50
 STRUT OFFSETS .000 .190 .351 .502 .636 .750 .841 .912 .961 .990 1.000 .990 .961 .912 .841 .750 .636 .502 .351 .190 .000
 HULL OFFSETS .000 .221 .366 .501 .625 .734 .827 .902 .956 .989 1.000 .989 .956 .902 .827 .734 .625 .501 .366 .221 .000

STRUT THICKNESS OFFSETS AT MIDSHIPS, NORMALIZED ON T/2 AT 2.0 FT. HEIGHTS FROM THE STRUT HULL INTERSECTION.
 HEIGHTS FROM S-H INTERSECTION 0.00 2.00 4.00 6.00 8.00 10.00 12.00 14.00 16.00 18.00 20.00 22.00 24.00
 NORMALIZED THICKNESS OF STRUT 1.00 1.00 1.00 1.02 1.04 1.06 1.10 1.14 1.19 1.25 1.32 1.39 1.47 1.56

FIGURE 5 - Computer Output for Sample Case

	TWIN HULL TRIBRID WITH FOIL AND CUSHION SUPPORT				EXAMPLE CASE				
VFLOCITY	10.00	15.00	20.00	25.00	30.00	35.00	40.00	45.00	KNOTS
ASSUMED PROPULSIVE COEFFICIENT	.500	.500	.500	.500	.500	.500	.500	.500	.500
ASSUMED FAN EFFICIENCY	.500	.500	.500	.500	.500	.500	.500	.500	.500
ASSUMED DUCT EFFICIENCY	.700	.700	.700	.700	.700	.700	.700	.700	.700
RUOYANT PERCENT LIFT	96.55	92.94	89.03	84.82	80.31	75.51	70.42	65.07	
DYNAMIC PERCENT LIFT	.54	1.22	2.17	3.39	4.87	6.64	8.68	10.98	
AEROSTATIC PERCENT LIFT	2.91	5.84	8.80	11.79	14.81	17.84	20.89	23.94	
HULL BUOYANT LIFT	2064.88	2066.81	2066.81	2066.81	2066.81	2066.81	2066.81	2066.81	2066.81 TONS
STRUT BUOYANT LIFT	1787.50	1641.37	1484.90	1316.46	1136.15	944.14	740.774	526.41	526.41 TONS
FOIL BUOYANT LIFT	9.37	9.38	9.38	9.38	9.38	9.38	9.38	9.38	9.38 TONS
CUSHION AEROSTATIC LIFT	116.22	233.58	352.04	471.61	592.20	713.63	835.60	957.63	957.63 TONS
FOIL DYNAMIC LIFT	21.79	48.90	86.94	135.70	194.65	265.74	347.16	439.28	439.28 TONS
TOTAL LIFT	4000.00	4000.00	4000.00	4000.00	4000.00	4000.00	4000.00	4000.00	4000.00 TONS
HULL FRICTION DRAG	8057.06	17210.87	29510.82	44853.13	63161.23	84374.76	108444.18	135327.57	135327.57 LB.
HULL EDDY DRAG	468.56	1054.26	1874.24	2928.50	4217.03	5739.85	7496.95	9486.33	9486.33 LB.
STRUT FRICTION DRAG	9169.16	18137.04	28398.47	38594.42	47189.32	52416.34	52268.12	44540.53	44540.53 LB.
STRUT EDDY AND/OR TIP DRAG	42.46	89.00	149.72	223.23	308.52	405.20	514.30	642.43	642.43 LB.
ROUGHNESS ALLOWANCE	4887.37	10578.50	17993.17	26695.11	36161.48	45768.22	54786.98	62399.26	62399.26 LB.
HULL WAVE DRAG	1.91	119.04	673.24	14180.25	31465.94	39609.51	44212.15	49712.50	49712.50 LB.
STRUT WAVE DRAG	1264.37	1321.35	56274.21	134505.89	125398.31	89243.09	55541.27	30166.41	30166.41 LB.
HULL STRUT INTERFERENCE WAVE DRAG	88.81	-2222.20	-2663.05	76282.73	113556.63	106373.08	85845.82	63547.68	63547.68 LB.
STRUT CROSS-INTERFERENCE WAVE DRAG	-132.00	-1247.06	26788.20	40966.69	26545.16	12266.27	4081.29	725.44	725.44 LB.
HULL CROSS-INTERFERENCE WAVE DRAG	-67	-66.58	-336.56	9549.79	14710.61	10869.99	5202.46	486.44	486.44 LB.
HULL STRUT CROSS-INTERF. WAVE DRAG	-23.71	925.76	4430.08	44319.15	40777.81	22395.68	8447.08	1222.24	1222.24 LB.
CUSHION WAVE DRAG	30.89	282.01	3618.52	5987.44	15458.54	23007.06	28209.56	32106.86	32106.86 LB.
CUSHION SEAL DRAG	1512.94	3194.13	5433.15	8208.03	11502.69	15304.54	19603.26	24390.21	24390.21 LB.
CUSHION MOMENTUM DRAG	66.92	163.78	310.38	520.52	809.84	1195.58	1696.46	2332.49	2332.49 LB.
EXTERNAL AERODYNAMIC DRAG	148.49	367.64	719.13	1238.69	1969.30	2962.33	4277.68	5982.36	5982.36 LB.
FOIL WAVE MAKING DRAG	4.87	190.10	660.77	1204.21	1762.91	2415.26	3202.24	4220.83	4220.83 LB.
FOIL INDUCED DRAG	122.75	270.35	470.37	713.12	986.79	1293.77	1593.90	1858.48	1858.48 LB.
FOIL FRICTION DRAG	1578.05	3552.87	6316.22	9869.09	14211.49	19343.42	25264.87	31975.86	31975.86 LB.
FOIL EDDY DRAG	325.29	731.89	1301.14	2033.03	2927.57	3984.74	5204.56	6587.03	6587.03 LB.
CUSHION PRESSURE	15.00	30.00	45.00	60.00	75.00	90.00	105.00	120.00	120.00 PSF.
HULL CENTERLINE SEPERATION	90.68	90.68	90.68	90.68	90.68	90.68	90.68	90.68	90.68 FEET
STRUT WETTED SURFACE	17950.27	16639.46	15205.57	13603.72	11817.03	9859.40	7628.48	5210.67	5210.67 SO.FT.
STRUT DRAFT ON CUSHION SIDE	21.09	19.43	17.61	15.60	13.38	10.91	8.19	5.22	5.22 FEET
TOTAL DRAFT	36.44	35.01	33.43	31.65	29.66	27.43	24.95	22.21	22.21 FEET
FAN FLOW RATE	1668.23	2721.64	3868.39	5190.02	6728.93	8514.90	10571.86	12920.39	12920.39 CFS.
FOIL LOADING	64.00	144.00	256.00	400.00	576.00	784.00	1024.00	1296.00	1296.00 PSF.
FOIL PLANFORM AREA	760.09	760.09	760.09	760.09	760.09	760.09	760.09	760.09	760.09 SQ.FT.
FOIL ANGLE OF ATTACK NEG.	2.47	2.46	2.46	2.46	2.46	2.48	2.49	2.51	2.51
FOIL LIFT COEFFICIENT (DYNAMIC)	.23	.23	.23	.23	.22	.23	.23	.23	.23
SUM OF DRAG COMPONENTS CONSIDERED	27614.53	66652.75	181922.20	462873.02	553121.17	538968.69	515893.16	507713.11	507713.11 LB.
EFFECTIVE POWER (PE)	847.41	3068.09	11165.39	35510.78	50921.34	57888.18	63325.42	70111.49	70111.49 HP.
FAN IDEAL POWER	45.50	148.45	316.50	566.18	917.58	1393.35	2018.26	2818.99	2818.99 HP.
TOTAL SHAFT POWER	1824.82	6560.32	23235.08	72639.22	104464.34	119757.35	132417.30	146277.24	146277.24 HP.

FIGURE 5 - Computer Output for Sample Case

	TWIN HULL TRIARRID WITH FOIL AND CUSHION SUPPORT				EXAMPLE CASE				
VELOCITY	5.14	7.72	10.29	12.86	15.43	18.01	20.58	23.15	M/S
ASSUMED PROPULSIVE COEFFICIENT	.500	.500	.500	.500	.500	.500	.500	.500	
ASSUMED FAN EFFICIENCY	.500	.500	.500	.500	.500	.500	.500	.500	
ASSUMED DUCT EFFICIENCY	.700	.700	.700	.700	.700	.700	.700	.700	
BUOYANT PERCENT LIFT	96.55	92.94	89.03	84.82	80.31	75.51	70.42	65.07	
DYNAMIC PERCENT LIFT	.54	1.22	2.17	3.39	4.87	6.64	8.68	10.98	
AEROSTATIC PERCENT LIFT	2.91	5.84	8.80	11.79	14.81	17.84	20.89	23.94	
HULL BUOYANT LIFT	20574.54	20593.74	20593.74	20593.74	20593.74	20593.74	20593.74	20593.74	KN.
STRUT BUOYANT LIFT	17813.88	16354.60	14795.54	13117.27	11320.64	9407.43	7380.73	5245.19	KN.
FOIL BUOYANT LIFT	9.37	9.38	9.38	9.38	9.38	9.38	9.38	9.38	KN.
CUSHION AEROSTATIC LIF	1158.06	2327.37	3507.74	4699.14	5900.71	7110.65	8325.91	9541.80	KN.
FOIL DYNAMIC LIFT	217.15	487.22	866.26	1352.12	1939.53	2647.82	3459.12	4376.95	KN.
TOTAL LIFT	39856.07	39856.07	39856.07	39856.07	39856.07	39856.07	39856.07	39856.07	KN.
HULL FRICTION DRAG	36113.50	77142.92	132273.97	201041.62	283102.53	378186.24	486070.65	606567.94	NEWTON
HULL EDDY DRAG	2100.19	4725.42	8400.74	13126.16	18901.67	25727.28	33602.97	42526.76	NEWTON
STRUT FRICTION DRAG	41098.17	81294.19	127288.20	172988.68	211512.89	234941.58	234277.23	199646.48	NEWTON
STRUT EDDY AND/OR TIP DRAG	190.33	398.91	671.09	1000.59	1382.87	1816.19	2305.20	2879.50	NEWTON
ROUGHNESS ALLOWANCE	21906.27	47415.15	80649.32	119653.33	162083.71	205143.25	245567.29	279687.22	NEWTON
HULL WAVE DRAG	8.54	533.58	3017.59	63558.99	141037.29	17538.52	198168.60	222822.35	NEWTON
STRUT WAVE DRAG	5667.18	59709.20	252233.39	602884.98	562062.83	400007.17	248948.21	135212.50	NEWTON
HULL-STRUT INTERFERENCE WAVE DRAG	398.09	-9960.40	-11936.39	341915.96	508983.79	476787.53	384779.87	284838.69	NEWTON
STRUT CROSS-INTERFERENCE WAVE DRAG	-591.65	-5589.59	12007.60	183621.70	114981.24	54580.12	12293.26	3252.34	NEWTON
HULL CROSS-INTERFERENCE WAVE DRAG	-3.01	-298.41	-1508.52	42804.24	65936.18	48721.68	23318.56	2180.32	NEWTON
HULL-STRUT CROSS-INTERF. WAVE DRAG	-106.27	4149.47	19856.59	198648.19	182775.12	100382.38	37861.67	5478.35	NEWTON
CUSHION WAVE DRAG	138.44	1264.01	16214.99	26937.03	69288.56	103122.69	126441.47	143910.83	NEWTON
CUSHION SEAL DRAG	6781.33	14316.78	24352.56	36790.21	51557.60	68598.30	87866.15	109322.30	NEWTON
CUSHION MOMENTUM DRAG	299.97	734.09	1391.19	2333.10	3629.88	5358.87	7603.90	10454.74	NEWTON
EXTERNAL AERODYNAMIC DRAG	665.58	1647.46	3223.31	5552.08	8826.83	13277.83	19173.51	26814.23	NEWTON
FOIL WAVEMAKING DRAG	21.84	852.08	2961.70	5397.52	7901.74	10825.72	14353.13	18918.67	NEWTON
FOIL INDUCED DRAG	550.21	1211.75	2108.30	3196.36	4423.01	5798.95	7144.22	8339.12	NEWTON
FOIL FRICTION DRAG	7077.67	15924.76	28310.68	44235.44	63699.03	86701.46	113242.72	143322.82	NEWTON
FOIL EDDY DRAG	1458.00	3280.50	5832.00	9112.50	13122.00	17860.00	23328.00	29524.50	NEWTON
CUSHION PRESSURE	.72	1.44	2.15	2.87	3.59	4.31	5.03	5.75	KPA
HULL CENTERLINE SEPERATION	27.64	27.64	27.64	27.64	27.64	27.64	27.64	27.64	METERS
STRUT WETTED SURFACE	146.76	154.59	141.26	126.38	109.78	91.32	70.87	48.41	SO. M.
STRUT DRAFT ON CUSHION SIDE	6.43	5.92	5.37	4.76	4.08	3.33	2.50	1.59	METERS
TOTAL DRAFT	11.11	10.67	10.19	9.65	9.04	8.36	7.60	6.77	METERS
FAN FLOW RATE	4.72	7.71	10.95	14.70	19.05	24.11	29.94	36.59	CU. M/S
FOIL LOADING	3.06	6.49	12.26	19.15	27.58	37.54	49.03	62.05	KPA
FOIL PLANFORM AREA	7.06	7.06	7.06	7.06	7.06	7.06	7.06	7.06	SO. M.
FOIL ANGLE OF ATTACK DEG.	2.47	2.46	2.46	2.46	2.46	2.48	2.49	2.51	
FOIL LIFT COEFFICIENT (DYNAMIC)	.23	.23	.23	.23	.22	.23	.23	.23	
SUM OF DRAG COMPONENTS CONSIDERED	123774.38	298752.28	815415.33	2074698.69	2479210.78	2415776.25	2312346.62	2275681.87	NEWTON
EFFECTIVE POWER (PE)	631.92	2287.87	8326.03	26480.38	37972.04	43167.21	47221.76	52282.13	KW.
FAN IDEAL POWER	33.93	110.70	236.02	422.20	684.24	1039.02	1505.02	2102.12	KW.
TOTAL SHAFT POWER	1824.92	6560.12	23235.08	72639.22	104464.34	119757.35	132417.30	148277.24	KW.

FIGURE 5 - Computer Output for Sample Case

LIMITATIONS OF THE TRIBRID PROGRAM

The following lift and drag components are not evaluated by the TRIBRID program:

- 1) Any wavemaking interference drag between
 - a) foil and hull
 - b) foil and strut
 - c) foil and cushion
 - d) cushion and hull
 - e) cushion and strut
- 2) Any boundary layer type interference drag, for example; any change in foil lift or drag due to operating a part of the foil in the hull boundary layer is not accounted for.
- 3) Drag due to any part of the ship above the struts coming in contact with the water. This is especially important in the low speed drag prediction for the HYSWAS concept which relies on the upper hull for static roll stability prior to take-off. The upper hull must be in the water until sufficient speed is attained for the foils to provide roll stability. The resistance of the upper hull is not evaluated; the magnitude of expected HYSWAS hump drag at take-off will depend upon the design of the upper hull and the proportions of buoyancy and dynamic lift selected for a particular design.
- 4) Any drag or lift due to cavitation and/or ventilation of the foils, strut or any other part of the ship. Fully wetted flow is assumed.
- 5) Drag due to a non zero trim, yaw or roll angle. The TRIBRID program assumes that the craft has zero trim, zero yaw and zero heel attitude. No moment or equilibrium calculations are performed.

- 6) Drag due to the sinkage of the hull caused by dynamic forces
- 7) Lift and Drag generated by control surfaces such as rudders or small foils.
- 8) Appendage drag due to shafting, bosses, shaft supports or other appendages
- 9) Rough water drag. Only smooth water performance is considered.
- 10) Spray drag

CONCLUSIONS AND RECOMMENDATIONS

The TRIBRID computer program is a useful tool for quickly calculating the resistances of many advanced ship concepts. The program is limited in that no hard full scale data exist to verify some of the drag component predictions. In addition, certain foreseeable interference drags are neglected because there is no accurate way of calculating them. It is strongly recommended that resistance experiments be performed as a concept in order to predict its resistance with greater confidence.

Additional research and development is needed to improve the powering prediction capability of the TRIBRID program. At present there is no acceptably accurate tool for estimating the drag of the following drag components: hull-foil-cushion wavemaking and viscous interference drag, the drag due to cavitation and/or ventilation of the foils and struts, spray drag of the strut and the wavemaking drag of the unconventional upper hulls.

ACKNOWLEDGMENTS

The author wishes to thank Dr. Michael B. Wilson of DTNSRDC (Code 1532) for the foil wavemaking resistance program and Dr. Arthur M. Reed of DTNSRDC (Code 1524) for the hull strut wavemaking resistance program and Elizabeth Waksmunski for the typing and help in the preparation of this report.

REFERENCES

1. Meyer, J.R. Jr. "Calm-Water Speed-Power of Hybrid Ship Concepts" NSRDC SDD Report 117-05, Jun 1975
2. Jewel, D.A. "Hybrid Fluid Borne Vehicles," The Senior Engineer, Volume 23, No. 9, Nov 1973
3. Wu, Y.T., "A Theory for Hydrofoils of Finite Span," California Institute of Technology Hydromechanics Laboratory, Report No. 26-8, May 1953
4. Grumman Air Craft Engineering Corporation, "Study of Hydrofoil Seacraft," Volume I and II, October 1958
5. Schlichting, Herman, "Boundary Layer Theory," 4th Edition, McGraw-Hill Book Company, Inc., New York
6. Hoerner, S.F., Fluid Dynamic Drag, 1957
7. Lin, When-Chin and Day, William G., Jr., "The Still-Water Resistance and Propulsion Characteristics of Small-Waterplane Area Twin-Hull (SWATH) Ships," AIAA, paper No. 74-325, Feb 1974
8. Ravenscroft, Lincoln T., "A Closed Form Approximation for the Wave Resistance of a Moving Uniform Pressure Distribution Acting Over a Rectangular Platform," NSRDC Ship Performance Department, Report No. 570-01, August 1974

APPENDIX A
FOIL SYSTEM PERFORMANCE

LIST OF SYMBOLS FOR APPENDIX A

AR	aspect ratio of hydrofoil = $(2b)^2/s$
B(k)	modified complete elliptic integral $B(k)=1/2[E(k)-(1-k)^2K(k)]$
C _f	foil friction coefficient based on total wetted surface
D	total foil drag = $D_i + D_4 + D_E + D_F$
D _E	foil eddy making drag
D _F	foil friction drag
D _i	foil induced wave
D ₄	foil wave making drag
E(k)	complete elliptic integral of the second kind of argument (k)
J _n (z)	Bessel function of the first kind of order n
K(k)	complete elliptic integral of the first kind of argument (k)
L	total foil lift = $L_0 + \Delta L_1 + \Delta L_2 + L_B$
L _B	lift due to static buoyant displacement of foil
L ₀	aerodynamic value of foil lift
R	g/U^2
R _{cav}	reynolds number based on average foil chord
S	plan area of the foil
U	free stream velocity

α_a	absolute angle of attack, measured from the free stream to the zero-lift direction
a_e	slope of the lift coefficient curve
b	half span of the foil
c_{avg}	average chord length of elliptic planform foil
$c(y)$	chord length of the foil $c(o) \equiv c_o$
g	gravitational acceleration constant
h	depth of submergence of foil measured from trailing edge to mean free surface
t_{avg}	average thickness of elliptic planform foil
$t(y)$	thickness of foil $t(o) \equiv t_o$
β	Froude number with respect to b
$\Gamma(y)$	distribution of the circulation strength $\Gamma(o) \equiv \Gamma_o$
ξ	elevation of the disturbed free surface
ρ	water density
σ	Froude number with respect to $h = \frac{U^2}{gh}$
λ	depth - 1/2 span ratio $= h/b = \beta/\sigma$
γ	Euler's constant 0.5772...
ΔL_1	lift due to presence of free surface
ΔL_2	lift due to wave effects

APPENDIX A - FOIL SYSTEM PERFORMANCE

The foil prediction method is based upon lifting line theory with linearized free surface assumptions as outlined in Reference 3 which considers a hydrofoil of finite span moving with constant velocity at a fixed distance below the surface. See Figure 1A.

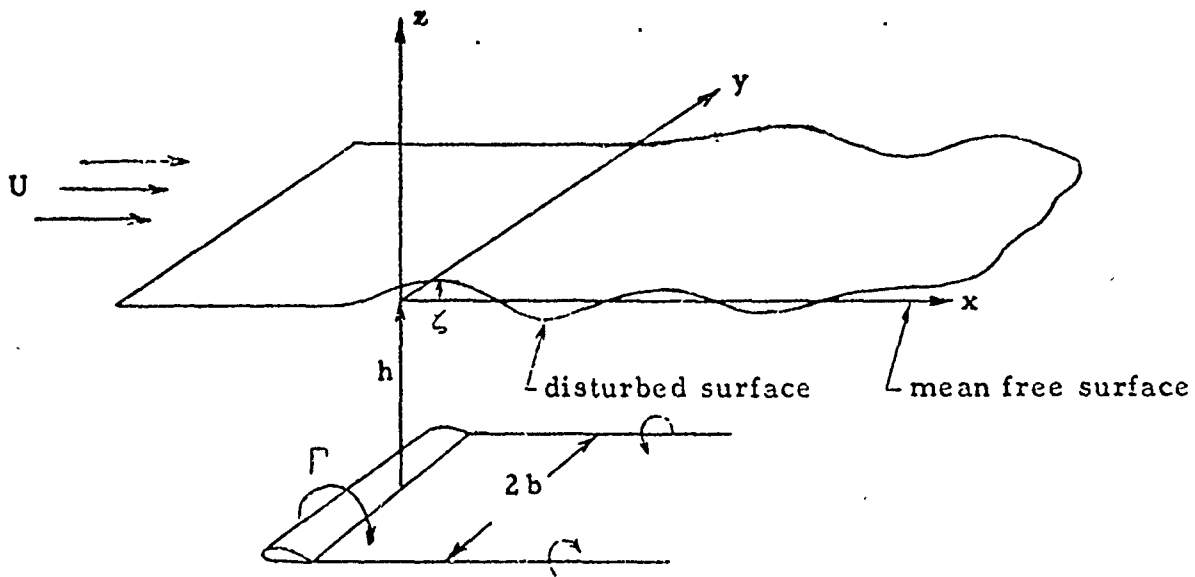

Fig. 1A- Coordinate system for the hydrofoil motion.

The details of the general formulation of the problem, the boundary conditions used and the solution of the Laplace equation are presented in Reference 3 and will not be repeated here.

All the following equations for foil performance are applicable to

a foil with elliptical distribution of the circulation strength Γ as given by equation 1A. The equation numbers in brackets are the equation numbers as they appear in Reference 3.

$$\Gamma(y) = \Gamma_0 \sqrt{1 - \frac{y^2}{b^2}}, \quad |y| \leq b, \quad (1A)$$

$$\Gamma(y) = 0, \quad |y| \geq b.$$

The lift and drag equations are presented in terms of a depth Froude number σ , a span Froude number β and a 1/2 span-depth ratio λ . as shown in equation 2A and 3A

$$\sigma = \frac{1}{hR} = \frac{U^2}{gh} \quad (2A)$$

$$\beta = \frac{1}{bR} = \frac{U^2}{gb}, \quad \frac{\beta}{\sigma} = \frac{h}{b} = \lambda. \quad (3A)$$

The equations for lift are:

$$L = L_0 + \Delta L_1 + \Delta L_2 + L_B \quad (4A)$$

where

$$L_0 = \rho U \Gamma_0 \int_{-b}^b \sqrt{1 - \frac{y^2}{b^2}} dy = \frac{\pi}{2} \rho U \Gamma_0, \quad [70] \quad (5A)$$

$$\Delta L_1 = -\frac{\rho \Gamma_0^2}{3\pi\lambda} \left\{ 1 - 3\lambda^2 \left[\log 2 - \frac{3}{4} + \frac{5}{8} \log \frac{\sqrt{1+\lambda^2}}{\lambda} \right] \right\} + o(\lambda^4 \log \lambda) \text{ as } \lambda \rightarrow 0 \quad [78a] \quad (6A)$$

$$\Delta L_2 = \frac{\rho \Gamma_0^2}{4\sqrt{2}} \Gamma\left(\frac{1}{4}\right) \left[1 - \frac{\Gamma\left(\frac{3}{4}\right)}{\sqrt{\pi}\Gamma\left(\frac{1}{4}\right)} \frac{\lambda}{\sqrt{1+\lambda^2}} \right] \cdot \left[1 + \sqrt{\frac{2}{\pi\sigma}} \left(\gamma + \log \frac{2}{\sigma} \right) \right] (1 + o(\lambda^2, \frac{1}{\sigma})) \quad [80] \quad (7A)$$

L_0 is the aerodynamic value for a foil in an infinite medium. L_1 is independent of gravitational effects and represents the lift due to the mean free surface. L_2 is the lift caused by surface wave effects. L_B represents the static buoyant foil lift and is calculated from the displaced foil volume. The foil is assumed to be elliptic in planform with a constant thickness to chord ratio as shown in Figure 2A

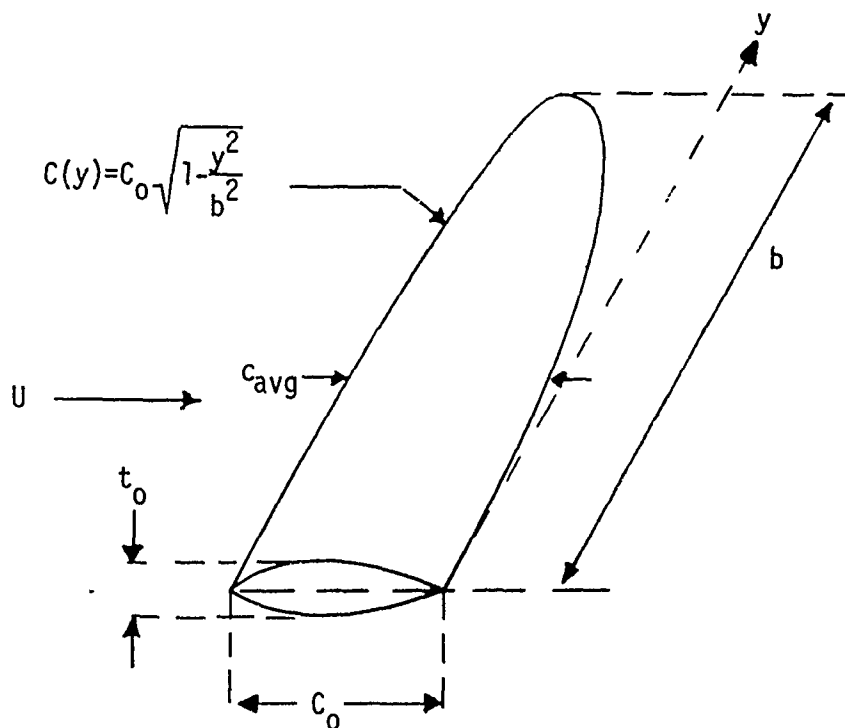

FIG. 2A ELLIPTIC PLANFORM FOIL (only half span is shown)

The drag equations are:

$$D = D_1 + D_2 + D_3 + D_4 + D_E + D_F \quad (11A)$$

$$D_1 = \frac{\pi \rho \Gamma_o^2}{4} \int_0^\infty \frac{J_1^2(\mu b)}{\mu} d\mu = \frac{\pi \rho \Gamma_o^2}{8} ; \quad [60] \quad (12A)$$

$$D_2 + D_3 = \frac{\pi \rho \Gamma_o^2}{4} \int_0^\infty e^{-2h\mu} \frac{J_1^2(\mu b)}{\mu} d\mu \quad [61] \quad (13A)$$

$$= - \frac{\pi \rho \Gamma_o^2}{8} \left\{ 1 - \frac{4}{\pi} \lambda \sqrt{1+\lambda^2} \left[K \left(\frac{1}{\sqrt{1+\lambda^2}} \right) - E \left(\frac{1}{\sqrt{1+\lambda^2}} \right) \right] \right\}$$

$$D_4 = \pi \rho \Gamma_o^2 \int_0^{\pi/2} e^{-\frac{2}{\sigma} \sec^2 \theta} \left[\frac{J_1 \left(\frac{1}{\beta} \sec^2 \theta \sin \theta \right)}{\sec^2 \theta \sin \theta} \right]^2 \sec^5 \theta d\theta \quad (14A) \quad [63]$$

D_1 is the induced drag due to the trailing vortices of the hydrofoil. The combination of $D_2 + D_3$ represents the total contribution of the mean free surface effect which favorably decreases the total drag especially when h is small. As h tends to zero, $D_2 + D_3$ cancels D_1 . D_4 represents the wave drag due to the downstream wave formation which results from the gravity effect. In equation 13A, $K(k)$ and $E(k)$ denote the complete elliptic integral of the first and second kind respectively and are evaluated by the NSRDC Mathematics Laboratory library function CELLI. The integral portion of equation 14A is evaluated using standard numerical techniques.

D_F represents the viscous friction drag and is given by equation 15A.

$$D_F = C_f \frac{\rho U^2}{z} (4 c_{avg} b) \quad \text{where} \quad (15A)$$

c_{avg} is the average chord length and the quantity $(4 c_{avg} b)$ represents the total wetted surface of the foils.

C_f is the foil friction drag coefficient for hydraulically smooth foils. C_f is given by the Schoenherr friction line as given in equation 16A Reference 6

$$\frac{0.242}{\sqrt{C_f}} = \log(R_{cav} C_f) \quad (16A)$$

where R_{cav} is the Reynolds number based on the average foil chord length. For foils which are not hydraulically smooth, the foil friction coefficient is given by equation 17A Reference 6

$$C_f = (1.89 + 1.62 \log \left(\frac{c_{avg}}{K_s} \right)^{-2.5}) \quad (17A)$$

where K_s is the equivalent sand grain diameter and is used as a measure of the foil roughness. The larger value of C_f as predicted from equations 16A and 17A is used.

Values of Ks from References 4 and 5 for different surfaces are presented in the following table.

SURFACE	EQUIVALENT SAND GRAIN DIAMETER Ks INCHES[2.54 cm]
mirror	0 - .00008
polished metal or wood	.00008 - .00016
natural sheet metal	.00016 - .00032
optimum paint sprayed	.00032 - .00048
average paint sprayed	.00048 - .00159
mass production paint sprayed	.00159 - .016
newly launched ships	.012
camouflage paint on airplanes	.003

The value of Ks that is selected depends upon how the hydrofoil is used. Hydrofoils which retract out of the water and are unpainted will have Ks values near those given for natural sheet metal. Daily cleaning could even reduce these values. Hydrofoils which are generally kept submerged will probably have a Ks value in the range given for mass production paint sprayed surfaces. Fouling of the foil surface will increase the Ks values substantially above that of the mass production spray painted surface.

D_E represents the eddy making drag and is given by Equation 18A (See Reference 6.

$$D_E = D_F \left(2 \frac{t_{avg}}{c_{avg}} + 60 \left(\frac{t_{avg}}{c_{avg}} \right)^4 \right) \quad 18A$$

where t_{avg} and c_{avg} are the average thickness and chord of the foil. The above equations for D_1 , D_2 , D_3 , D_4 , L_0 , ΔL_1 , and ΔL_2 are all expressed in terms of Γ_0 , the circulation strength at $y=0$. For the assumed elliptic circulation, Γ_0 is expressed by equations 19A, 20A, and 21A.

$$\Gamma_0 = \frac{\frac{1}{2} U \cdot c_0 \cdot \alpha_a \cdot a_e}{1 + \frac{1}{4} \cdot \frac{c_0}{b} a_e \left[f_2(\lambda, \sigma) + \frac{2}{\pi} \alpha_a f_1(\lambda, \sigma) \right]} \quad [93a] \quad (19A)$$

where

$$f_1(\lambda, \sigma) = \frac{B' \frac{1}{\sqrt{1+4\lambda^2}}}{4\lambda \sqrt{1+4\lambda^2}} + \frac{2B \left(\sqrt{\frac{1}{2}} - \frac{\lambda}{\sqrt{1+4\lambda^2}} \right) \left[\sqrt{1+4\lambda^2+2\lambda} \right]}{\sqrt{2\lambda(1+4\lambda^2)}^{1/4}} + \left[1 + \sqrt{\frac{2}{\pi\sigma}} (\lambda + \log \frac{2}{\sigma}) \right] + O\left(\frac{1}{\sigma}\right). \quad [93b] \quad (20A)$$

and

$$f_2(\lambda, \sigma) = \left[1 - \frac{\lambda}{\sqrt{1+4\lambda^2}} \right] \cdot \left[1 + O\left(\frac{1}{\sigma}, \frac{1}{B}\right) \right] \quad [93c] \quad (21A)$$

The above equations for foil lift and foil drag are used in the FOIL subroutine of the TRIBRID computer program. They are subject to the following limitations:

- a) Fully wetted, non cavitating flow exists over the foil surface.
This limitation is inherent in the linearized lifting line theory.
- b) The foil has elliptical planform. This limitation is the result of assuming an elliptical distribution of the circulation strength. Reference 3 states that for an elliptical distribution of $\Gamma(y)$, the planform is also nearly elliptical and that the sum of the foil drag components D_1 , $D_2 + D_3$, and D_4 is approximately minimum

for a given lift. Reference 4 also recognizes that for a fixed geometrical form the elliptic circulation distribution can not be held constant for different values of h . However, the calculation of the induced downwash velocity at the hydrofoil supports the assumption that the same circulation distribution will hold for a wide range of depths.

- c) Foil aspect ratio, AR, is not to be lower than 4.0. It is assumed that the aspect ratio of the hydrofoil is so large that the whole hydrofoil may be replaced by a lifting line. However, experience with airfoils indicates that the lifting line theory can be expected to be sufficiently accurate for foils of aspect ratio AR as low as 4.0.
- d) The foil prediction method is valid for only a certain range of operating depths. The depth-half span ratio λ should be less than 1.0. Equation 6A is an approximation for ΔL_1 which was derived for $\lambda \rightarrow 0$. For values of λ greater than 1 a different equation for ΔL_1 results, which is not presented here because in the TRIBRID program we are not interested in foil performance at depths greater than the half span of the foil. The requirement for fully wetted foil invalidates the performance prediction at zero depth or very small depths where the foil might be planing. Since no prediction technique for the minimum foil depth at which the foil remains wetted is presented, the establishment of this

minimum is a matter of engineering judgement and experience. Calculations for foil depth to average chord ratios as low as 1/2 yield reasonable results and it is suggested that this value be used for minimum foil depth.

APPENDIX B
HULL-STRUT-SUPERSTRUCTURE PERFORMANCE

SYMBOLS FOR APPENDIX B

$A, \dots A_n$	Chebychev coefficients for hull and strut
AF	frontal area of ship
ARC	arc length along midship section of strut (see Fig 1B)
$B, \dots B_n$	Chebychev coefficients for hull and strut
BSH	maximum thickness at top of strut
CD	aerodynamic drag coefficient
C_F	friction coefficient
CI	strut waterplane inertia coefficient = $I_{yy}/T_{\max}LS^3$
CP	hull prismatic coefficient
CWP	strut waterplane area coefficient
D_{areo}	aerodynamic drag of the struts and superstructure above water
D_H	horizontal hull diameter
D_{HE}	hull eddy making drag
D_{HF}	hull friction drag
D_{HSS}	total drag of the hulls, struts and superstructure
D_{RA}	drag due to roughness allowance
DSF	strut friction drag
DSE	strut eddy making drag
D_{tip}	tip drag for strut with no hull underneath

DV	vertical hull diameter
D_w	wave making drag
EXP	strut flare exponent
HS	strut height (see fig 1B)
HWL	strut depth below static water line (ship is 100% buoyant supported)
HWS	hull wetted surface
I_{yy}	strut waterplane longitudinal inertia about midship
LCBOLH	ratio of hull center of buoyancy measured from midship to hull length
LCFOLS	ratio of strut center of flotation measured from midship to strut length
LH	length of hull
L_{HB}	hull buoyant lift
LS	length of strut
L_{SB}	strut buoyant lift
SWS	strut wetted surface
T_{max}	maximum thickness of strut at the waterline
TZ	midship section strut thickness at strut bottom
U	free stream velocity
XWL	strut immersed depth at speed
g	gravitational constant
x_s	longitudinal strut position forward of midship section
x_h	longitudinal hull position forward of midship section

y_s	strut half breadth at any fore and aft location
y_h	hull half breadth at any fore and aft location measured in the waterplane through the hull axis
ρ_a	density of air
ρ	density of water
Δ_{CF}	Correlation Coefficient

The buoyant lift provided by each hull and each strut is given in Equation 1B and 2B. This buoyant lift is based upon the displacement below an idealized level waterline.

$$L_{HB} = (\pi/4)(DV)(DH)(LH)(CP)\rho g \quad (1B)$$

$$L_{SB} = \rho g \left[(TZ)(XWL) + \left(\frac{BSH - TZ}{EXP + 1} \right) \left(\frac{HWL^{EXP + 1}}{HS^{EXP}} \right) \right] (LS)(CWP) \quad (2B)$$

The equation for L_{SB} is modified for air cushion supported concepts in order to account for the depressed waterline on the cushion side of the strut.

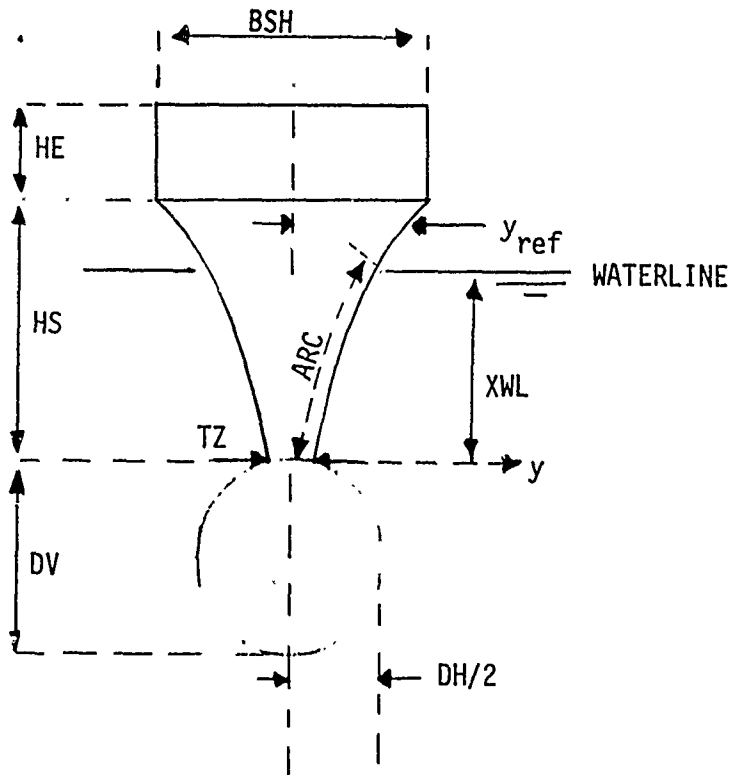

FIG. 1B SINGLE HULL-STRUT-SUPERSTRUCTURE GEOMETRY

The drag of the hull-strut-superstructure combination is given by Equation 3B

$$D_{HSS} = D_{HF} + D_{SF} + D_{HE} + D_{SE} + D_{RA} + D_{AERO} + D_{tip} + \Sigma D_w \quad (3B)$$

The individual component drags are the following. Hull friction drag for each hull is:

$$D_{HF} = C_F \cdot 1/2 \cdot \rho U^2 \cdot HWS \quad (4B)$$

The hull wetted surface HWS is determined by dividing the hull into 20 segments, calculating the average circumference and slant height of each segment and summing the wetted surface of each segment. The resulting wetted surface area is then corrected by subtracting the area masked by the strut.

The shape of the hull is generated by a series of Chebychev coefficients. The equations for obtaining the hull offsets are presented under the discussion of wave drag since it is the wave drag calculation which requires that the hull be represented by Chebychev coefficients.

The strut friction drag is given by

$$D_{SF} = C_F \cdot 1/2 \rho \cdot U^2 \cdot SWS \quad (5B)$$

and the strut wetted surface SWS is given by

$$SWS = 2((XWL)(LS) + 1.33(ARC - XWL)) \quad (6B)$$

For cushion supported concepts, SWS is corrected for the depressed waterline inside the cushion and for struts with wetted bottoms an additional area equal to (CWP)(LS)(TZ) is included. The hull eddy making drag is given by

$$D_{HE} = 0.0001 \rho/2 U^2 HWS \quad (7B)$$

and it is based on the residuary resistance of deeply submerged bodies of revolution with length to diameter ratios of 10.0 or greater.

The strut eddy making drag (Reference 3) is given by

$$D_{SE} = \left(\frac{2T_{avg}}{LS} + 100 \left(\frac{T_{avg}}{LS} \right)^4 \right) SFD \quad (8B)$$

For struts with wetted bottoms an additional tip drag component D_{tip} is added to the eddy making drag.

$$D_{tip} = 0.0315 \frac{TZ^3}{LS} CWP \rho U^2 \quad (9B)$$

The roughness allowance is given by

$$D_{RA} = \Delta_{CF} \rho/2 U^2 (SWS + HWS) \quad (10B)$$

The sum of the wave making drag components, ΣD_w , is calculated by a computer program written by Lin (Reference 7). This program is based on linearized thin ship theory and assumes incompressible, inviscid potential flow.

The theory also requires that the ship either have a small camber which satisfies the no-cross-flow condition between the SWATH type hulls and struts or that the thickness of each strut be small compared to the separation between the struts.

The wavemaking interference drag components are due to the interference of wave trains formed by the different hulls and struts. Figure 2B shows the wavemaking drag components that are calculated for three different basic configurations. It should be noted that the tripple strut-single hull configuration should have an additional wavemaking drag component included to account for the wavemaking interference between the two outboard struts. This component is expected to be small due to the large distance between the struts and to their relatively small displaced volume at speed when they are expected to be mostly out of the water.

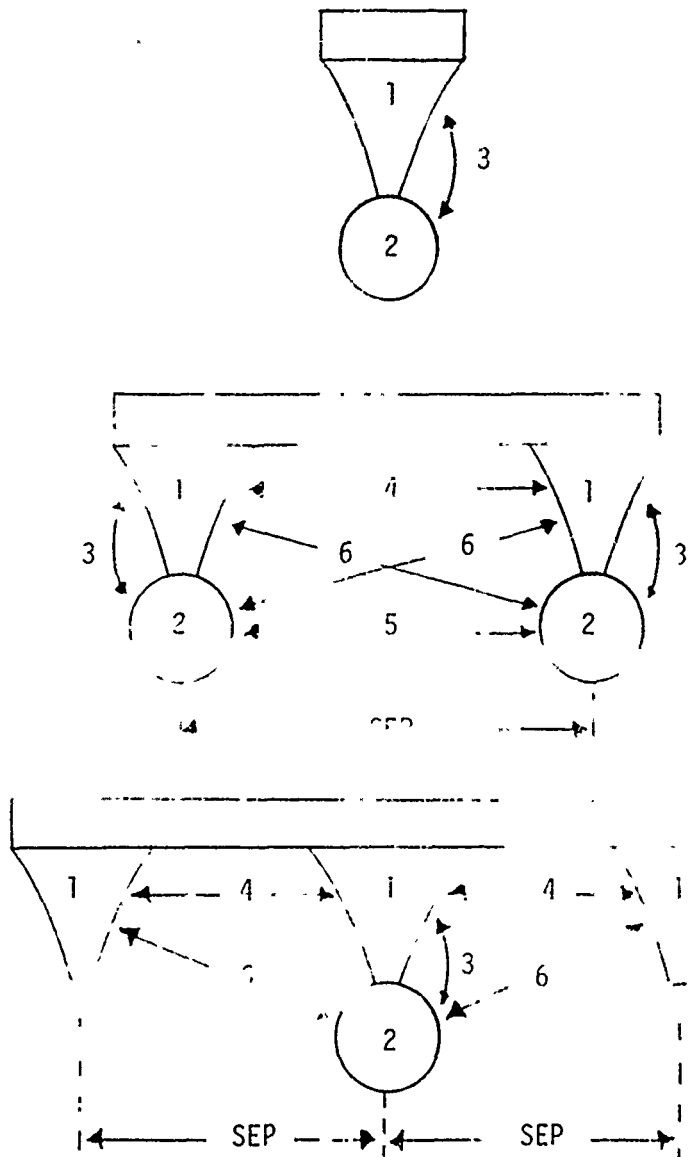

- 1 Wave drag of one strut
- 2 Wave drag of one hull
- 3 Hull-strut interference wave drag
- 4 Strut cross interference wave drag
- 5 Hull cross interference wave drag
- 6 Hull-strut cross interference wave drag

FIG. 2B SCHEMATIC DIAGRAM OF
WAVE DRAG AND WAVE INTERFERENCE DRAG BETWEEN HULLS AND STRUTS

The computer program for calculating the wave drag requires that the hull and strut shape be defined by a series of Chebychev coefficients. With many Chebychev coefficients (up to 15 have been used) almost any desired hull and strut shape can be generated to within 1% accuracy, however, in order to save computer time, only 3 Chebychev coefficients are used in this report.

The hull Chebychev coefficients A and B are:

$$A_1 = 4 \cdot CP/PI \quad (11B)$$

$$A_2 = 1 - A_1 \quad (12B)$$

$$B_1 = 2 \cdot A_1 \cdot LCBOLH \quad (13B)$$

$$B_3 = B_2 = A_3 = 0.0 \quad (14B)$$

and the strut Chebychev coefficients are:

$$A_1 = 4 \cdot CWP/PI \quad (15B)$$

$$A_2 = A_1 - 64 \cdot CI/PI \quad (16B)$$

$$A_3 = 1 - A_1 - A_2 \quad (17B)$$

$$B_1 = 2 \cdot A_1 \cdot LCFOLS \quad (18B)$$

$$B_2 = B_3 = 0 \quad (19B)$$

The equation for calculating the offsets of the strut at any waterline is

$$y_s(x)_s = \pm y_{ref} \sum_{i=1}^N [A_i \cos[(2i-1)\theta] + B_i \sin[2i\theta]] \quad (20B)$$

y_{ref} is the half breadth of the waterline at midships and is constant for struts with no flare.

The offset of the hull at a waterline through the axis of rotation of the hull is

$$y_H(x)_H = \pm \frac{DH}{2} \sum_{i=1}^N A_i \cos[(2i-1)\theta] + B_i \sin[2i\theta] \quad (22B)$$

where $\theta = \sin^{-1}\left(\frac{2x_H}{LH}\right)$ (23B)

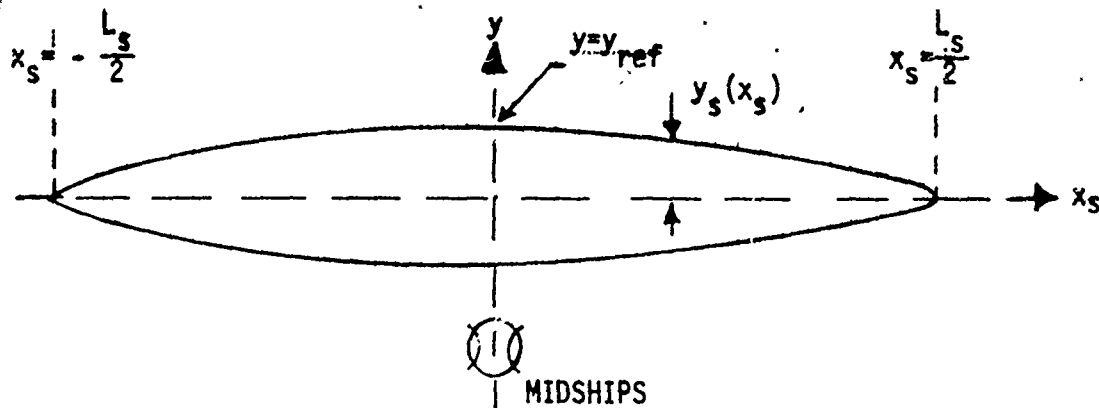

FIG. 3B STRUT OFFSETS (plan view of strut-waterline)

For hull offsets, replace subscript s by h and y_{ref} by $\frac{DH}{2}$ in Figure 3B.

The aerodynamic drag component D_{aero} for the parts of the ship above water is given by

$$D_{aero} = CD \cdot \rho_a \cdot U^2 \cdot AF/2 \quad (24B)$$

Reference 6, p. 11-8 presents values of $CD = .68$ for a passenger liner, 1.22 for a cargo ship and 0.17 for a hypothetical streamlined ship. A CD value between 0.17 and 1.22 is suggested depending on the extent of streamlining.

APPENDIX C
AEROSTATIC LIFT SYSTEM PERFORMANCE

LIST OF SYMBOLS FOR APPENDIX C

A_{cuss}	cushion area
A_{seal}	total wetted area of the seals
C_{FS}	friction coefficient for seal
C_{wp}	waterplane area coefficient of each strut
D_{mom}	momentum drag
D_{seal}	seal drag
FB	Froude number based on cushion
FIP	Fan ideal power
F_{ℓ}	Froude number based on ℓ
F_{ℓ_H}	Froude number corresponding to hump speed
GRAV,g	gravitational constant
LC, l	cushion length
LS	strut length
L_{stat}	aerostatic lift
P_c	cushion pressure
R	wave resistance of pressure patch
SEAL W	width of seal
SEP	separation distance between strut centerlines
T_{CWL}	maximum strut thickness at the elevation corresponding to the waterline on the cushion side of the strut.

U	velocity of pressure patch
WPAR	wave resistance parameter
b	beam of pressure distribution
γ	Eulers constant .577...
λ	length to beam ratio of pressure patch
ρ	water density
ρ_{air}	air density

AEROSTATIC LIFT

The lift provided by the air cushion is given by:

$$L_{\text{STAT}} = P_c \times A_{\text{cuss}} \quad (1C)$$

the cushion area is estimated by equation 2C which is exact for any value of LC provided that CWP = 1, and for any value of CWP provided that LC = LS

$$A_{\text{cuss}} = LWP * SEP - C_{\text{WP}} * LC * T_{\text{CWL}} \quad (2C)$$

The air flow required to maintain cushion pressure is given by equations 3C and 3D. Equation 3C is based on model experimental results and was developed by Mr. Robert A. Wilson of DTNSRDC (Code 1630).

$$FB = U / \sqrt{\text{GRAV} * \text{SEALW}} \quad (3C)$$

$$Q = 1.67 (0.203 FB^2 + .15 FB + .247) \times \text{SEALW}^2 * \sqrt{P_c} \quad (4C)$$

The ideal lift power is $FIP = Q * P_c$

DRAG DUE TO AEROSTATIC LIFT

The wavemaking resistance due to the moving cushion pressure patch is estimated using the closed form approximations derived by Ravenscroft in Reference 8. The wave resistance parameter WPAR is given by equation 5C, 6C or 7C depending on the Froude number F_ℓ .

$$\text{WPAR} = \frac{16\lambda}{\pi F_{\ell H}^4} \cdot \frac{F_\ell^2}{(1+1.6 \lambda^{1/4})^2} \left\{ 3 - \gamma + \epsilon n \frac{(1 + 1.6 \lambda^{1/4})^2 F_{\ell H}^2}{16\lambda} \right\}$$

$$0 \leq F_\ell \leq \frac{1}{2} F_{\ell H} \quad (5C)$$

$$\begin{aligned} \text{WPAR} = e^{-\sqrt{\lambda} F_\ell^{1/4}} \sin^2 \left[\frac{\pi}{2} \left(\frac{F_{\ell H}}{F_\ell} \right)^2 \right] + \frac{\lambda}{\pi} \cdot \frac{1}{(F_\ell + \frac{4}{5} \lambda^{1/4} F_{\ell H})^2} \left\{ 3 - \gamma \right. \\ \left. + \epsilon n \frac{(\frac{4}{5} \lambda^{1/4} F_{\ell H})^2}{4\lambda} \right\} ; \frac{1}{2} F_{\ell H} \leq F \leq \frac{4}{5} \lambda^{1/4} F_{\ell H} \end{aligned} \quad (6C)$$

$$\text{WPAR} = e^{-\sqrt{\lambda} F_\ell^{1/4}} \sin^2 \left[\frac{\pi}{2} \left(\frac{F_{\ell H}}{F_\ell} \right)^2 \right] + \frac{\lambda}{4\pi} \cdot \frac{1}{F_\ell^2} \left\{ 3 - \gamma + \epsilon n \left(\frac{F_{\ell H}^2}{\lambda} \right) \right\} ;$$

$$\frac{4}{5} \lambda^{1/4} F_{\ell H} \leq F_\ell \quad (7C)$$

The primary hump Froude number F_{λ_H} is estimated by Equation 8C

$$F_{\lambda_H} = \sqrt{\frac{1}{\pi} + .01745\lambda^2} \quad (8C)$$

The wave resistance due to the moving pressure patch is given

by
$$R = WPAR \times 4 P_C^2 b / (*GRAV). \quad (9C)$$

The momentum drag associated with the lift system is simply given by

$$D_{mom} = U \cdot \rho_{air} \cdot Q \quad (10C)$$

where Q is given by Equation 4C and the seal drag based on flat plate friction is given by

$$D_{seal} = C_{FS} \cdot \rho \cdot U^2 \cdot A_{seal} \quad (11C)$$

DTNSRDC ISSUES THREE TYPES OF REPORTS

(1) DTNSRDC REPORTS, A FORMAL SERIES PUBLISHING INFORMATION OF PERMANENT TECHNICAL VALUE, DESIGNATED BY A SERIAL REPORT NUMBER

(2) DEPARTMENTAL REPORTS, A SEMIFORMAL SERIES, RECORDING INFORMATION OF A PRELIMINARY OR TEMPORARY NATURE, OR OF LIMITED INTEREST OR SIGNIFICANCE, CARRYING A DEPARTMENTAL ALPHANUMERIC IDENTIFICATION

(3) TECHNICAL MEMORANDA, AN INFORMAL SERIES, USUALLY INTERNAL WORKING PAPERS OR DIRECT REPORTS TO SPONSORS, NUMBERED AS TM SERIES REPORTS; NOT FOR GENERAL DISTRIBUTION.