

EXPLANATION OF DYNAMICAL BIEFELD-BROWN EFFECT FROM THE STANDPOINT OF ZPF FIELD

TAKAAKI MUSHA

3-11-7-601, Namiki, Kanazawa-ku, Yokohama 236-005, Japan.

Email: takaaki.musha@gmail.com and musha@cs.trdi.mod.go.jp

The research group of the HONDA R&D Institute observed a weight reduction by applying alternating electric field to a capacitor. This phenomenon, which is called the “dynamical Biefeld-Brown effect”, cannot be explained within the framework of conventional physics. From the standpoint of ZPF field, the author tries to explain this phenomenon as an interaction between the vacuum electromagnetic zero-point field and the high potential electric field. By theoretical analysis, it is considered that the interaction of zero-point vacuum fluctuations with high potential electric field can induce a greater momentum for the dielectric material, which would produce sufficient artificial gravity to propel space vehicles.

Keywords: Electromagnetic propulsion, zero-point field, electrogravitics, artificial gravity, high-voltage capacitors, Biefeld-Brown effect

1. INTRODUCTION

This is a speculative paper on a phenomenon that might have space applications in the long-term, provided that it can be repeated, controlled, and a full explanation found.

In 1956, T.T. Brown presented a discovery known as the Biefeld-Brown effect (abbreviated B-B effect) that a sufficiently charged capacitor with dielectrics exhibited unidirectional thrust in the direction of the positive plate [1]. In recent years, it was confirmed by the research group of the HONDA R&D Institute that a weight reduction was observed by applying high intensity electric field to the capacitor [2]. D.R. Bueller performed experiments with high voltage single and parallel plate electric capacitors, which indicated a net force acting upon the capacitor mass [3]. In an experiment conducted by Woodward transient mass shift was also observed in the dielectric material by rapidly charging and high energy capacitors [4]. Recently it has been reported that Borbás Miklós detected a force by using a device, which was a simple ping-pong ball with a high voltage discharge element inside [5]. From his experimental result, the device generated a propulsive force which was not due to air movement caused by ion flow (ion-wind) contrary to the conventional explanation that the generated force is due to the ion transfer between the plates of the capacitor [6]. M.B. King suggested in his book [7] that electromagnetic fluctuations of the vacuum was the source of the B-B effect, which generates the unidirectional thrust for the dielectric material under high potential electric field. He considered that a slight coherence of vacuum fluctuations due to the high potential electric field caused an alternation of inertial properties of the body with the ionic lattice of a rapidly spinning atom, but its mechanism was not fully explained.

This paper was presented at the Fifth IAA Symposium on “Realistic Near-Term Advanced Scientific Space Missions” in Aosta, Italy on 2-4 July 2007.

The views expressed in this paper are those of the author and do not necessarily reflect the official policy of his current position.

H.E. Puthoff proposed in his article [8] that gravity is a form of long-range van der Waals force associated with the rapid motion of elementary particles (Zitterbewegung) in response to zero-point fluctuations (ZPF) of the vacuum. He suggested that if one could somehow modify the vacuum medium then the mass of a particle or object in it would change according to the zero-point field theory [9]. By using the theory of ZPF field, in this paper the author tries to show that the impulsive electric field applied to the dielectric material may produce a sufficient artificial gravity to propel spacecraft.

2. HONDA EXPERIMENT APPLYING ELECTRIC FIELD TO THE CAPACITOR

From the 1st of February until the 1st of March in 1996, the research group of the HONDA R&D Institute conducted experiments to verify the B-B effect with an improved experimental device which rejected the influence of corona discharges and electric wind around the capacitor by setting the capacitor in the insulator oil contained within a metallic vessel as shown in Fig. 1. The capacitor used at the experiment was a circular plate made of a high permittivity dielectric glass with the thickness, $t = 1 \text{ mm}$, the diameter, $d = 170 \text{ mm}$ and the weight, $W = 62 \text{ g}$. The electric balance used for the experiment had the resolution of 1mg. They conducted experiments for two cases, DC-18kV and AC-8kV pulses supplied to the capacitor by the experimental set-up as shown in Fig. 2. The circuit diagram for generating AC pulses is shown in Fig. 3. The high AC voltage was supplied to the capacitor through the ignition coil to produce rectangular pulses with the repetition of 50 Hz. After amplifying AC pulses by the ignition coil, the impulsive electric field was applied to the capacitor through the diode by changing the polarity to produce minus-biased or plus-biased voltage to the capacitor, as shown in this figure.

The experimental results measured by the Honda research group are shown in Fig. 4. In this figure, DC (1) and DC (2) are

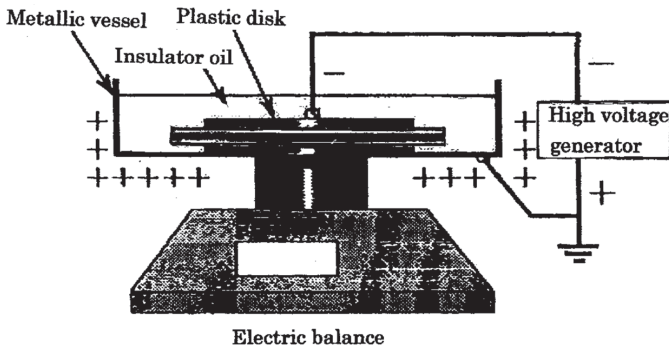

Fig. 1 Schematic diagram of the experiment.

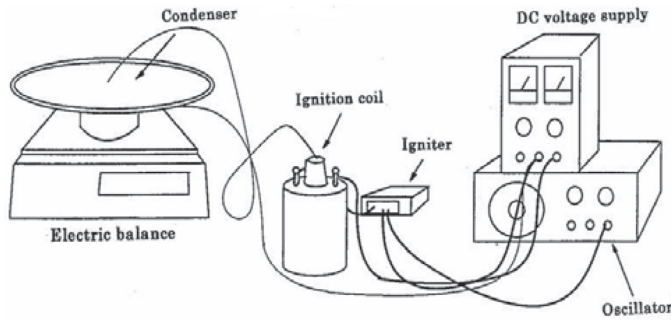

Fig. 2 Experimental set-up for the experiment.

for cases of DC-18kV, and PULSE (1) and PULSE (2) are for cases of AC-8kV pulses, where the horizontal line is for the date of the experiment and the vertical line is for the change of the capacitor's weight.

From experimental results, it was found that the case of AC pulses exhibited higher reduction of weight than the case of DC exposures, the ratio of them becomes $\Delta W'/\Delta W = 2.77 \pm 0.87$, where $\Delta W'$ is a weight reduction for AC pulses and ΔW is for the DC exposures. Maximum weight reduction measured at the experiment by applying AC pulses was 1.92 g, which was about 3% of the own weight of the capacitor used at the experiment [2].

Supposing that the weight reduction of the capacitor is responsible for forces generated by the ionic transfer of the momentum, it can be estimated from the equations given by [10]

$$\Delta M = \sqrt{\frac{2m_0V_0}{q}} \frac{i}{g_0} \quad (1)$$

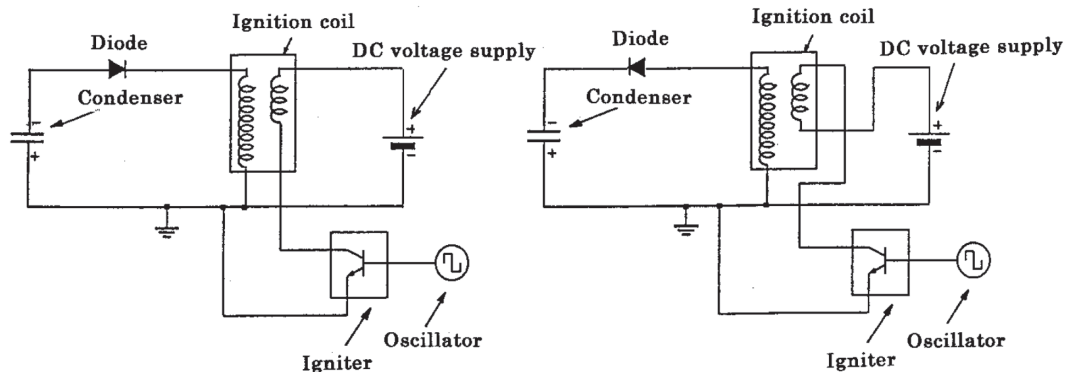

Fig. 3 Circuit diagram for generating AC pulses.

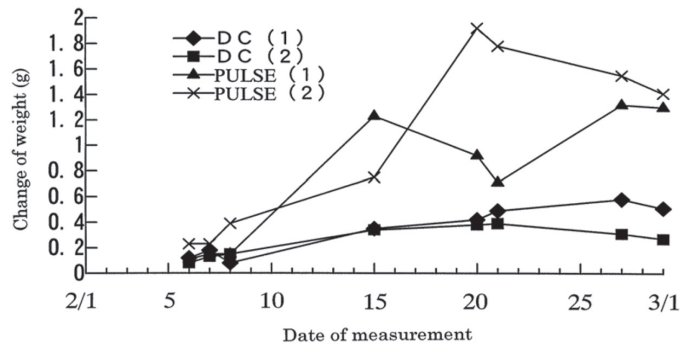

Fig. 4 Measured results at the experiment.

where m_0 is the mass of the carrier of the charge in the medium, q is the charge of the carrier, g_0 is gravity acceleration on the Earth, V_0 is the applied voltage, and i is the current density given by $i = 2\pi fCV_0$ (C : capacity, f : frequency of applied voltage).

By introducing experimental values for AC cases into Eq.(1), where $C = 1682$ pF, $V_0 = 8$ kV and $f = 50$ Hz, the mass reduction due to ionic winds becomes $\Delta M = 1.3 \times 10^{-3}$ g, which is negligible small compared with the experimental result.

The following formula is obtained for the electrogravitic effect induced on a dielectric material from a weak field approximation of Einstein's general relativity theory [11];

$$E_g \approx -Z\sqrt{4\pi\epsilon} G \cdot E = -8.62 \times 10^{-11} Z\sqrt{\epsilon_r} \cdot E \quad (2)$$

where E is a magnitude of electric field impressed to the capacitor, Z is a number of electrons circulating around the atomic nucleus, ϵ is a permittivity of the dielectric material, ϵ_r is a specific inductive capacity of the dielectric material, and G is the gravitational constant. B. Ivanov of the Institute for nuclear Research and Nuclear Energy in Bulgaria also found a similar equation deduced from Weyl Majumdar-Papapetrou solutions of the general relativity theory, which is equivalent (modulo Z) to the author's equation, as shown in the Appendix.

From which, the weight reduction of the capacitor under impressed electric field given by ΔW can be estimated by

$$\Delta W = -M \cdot E_g = 8.62 \times 10^{-11} Z\sqrt{\epsilon_r} EM \quad (3)$$

where M is a mass of the capacitor.

By introducing values of the experiment, $Z = 10$, $\epsilon_r = 10$, $M = 62$ g, into Eq.(3), we obtain $\Delta W = 0.31$ g for DC-18kV

exposures, which is close to $\Delta W = 0.29 \pm 0.17$ g obtained from the experiment, but we have $\Delta W = 0.14$ g for AC-8kV pulses, which is much lower than the experimental result, $\Delta W' = 0.88 \pm 0.63$ g.

Thus it is thought that the B-B effect for AC-8kV pulses might be due to another mechanism other than the ion transfer of momentum or a weight reduction generated by the electrogravitic effect.

3. MASS SHIFT BY THE EXTERNAL ELECTROMAGNETIC FIELD

According to the quantum electrodynamics, the quantum vacuum is filled with the electromagnetic fluctuations of the zero-point field (ZPF). Haish, Rueda and Puthoff pointed out in their paper [12] that the formula on the ZPF-determined inertial mass is remarkably similar to the mass shift derived from the quantum theory. Under the intense electromagnetic field, it has been predicted that the electron experiences an increase in its rest mass under an intense electromagnetic field [13].

The analogical formula with respect to the mass shift of the electron under intense electromagnetic field was discovered by P.Milonni shown as follows [12]:

Let H_A be the electrodynamic Hamiltonian of the particle under high electromagnetic field, it has the form shown as

$$H_A = \frac{e^2}{2m_0c^2} \langle A^2 \rangle \quad (4)$$

where m_0 represents the rest mass of the elementary particle, c is a light speed, e is a charge of the particle and A is a vector potential of the electromagnetic field.

The similar equation by using terms of the ZPF field was also proposed by Haish, Rueda and Puthoff shown as [12]

$$H'_A = \frac{e^2 \hbar}{2\pi m_0 c^3} \omega_c^2 \quad (5)$$

where \hbar is a Plank constant divided by 2π and ω_c is a cutoff frequency of ZPF spectrum in the vacuum.

Assuming that electrodynamic Hamiltonians shown in Eqs. (4) and (5) are identical with each other, then we have $\Delta H_A = \Delta H'_A$ for the dielectric material under impressed electric field as shown in Fig. 5. We suppose that the cutoff frequency of the vacuum is shifted as $\omega_c = \omega_0 + \Delta\omega$ when the electromagnetic field is impressed to the dielectric material, $\Delta H'_A$ becomes

$$\Delta H'_A = \frac{e^2 \hbar}{2\pi m_0 c^3} \{(\omega_0 + \Delta\omega)^2 - \omega_0^2\} \approx \frac{e^2 \hbar}{\pi m_0 c^3} \omega_0 \Delta\omega \quad (6)$$

where ω_0 is the Plank frequency given by

$$\omega_0 = \sqrt{c^5 / \hbar G} \approx 3 \times 10^{43} \text{ Hz}$$

As shown in Fig. 5, $H_A = 0$ at the initial state, then we obtain the formula given by

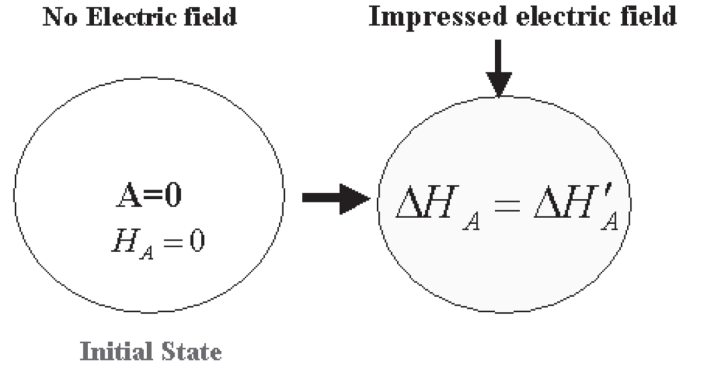

Fig. 5 Electrodynamic Hamiltonian under impressed electric field.

$$\Delta\omega \approx \frac{\pi c}{2\hbar\omega_0} \langle A^2 \rangle \quad (7)$$

According to the gravitational theory proposed by Haish, Rueda and Puthoff [14], we can suppose that the inertial mass of elementary particles induced by ZPF field can be given by

$$m = \frac{\Gamma \hbar \omega_c^2}{2\pi c^2} \quad (8)$$

where Γ is the radiation reaction damping constant defining the interaction of charged elementary particles with electromagnetic radiation field.

From which, we have

$$\Delta m / m = \frac{2\Delta\omega_c}{\omega_c} = \frac{\pi c}{\hbar\omega_0^2} \langle A^2 \rangle \quad (9)$$

For the dipole field generated by the variance of electric charge as shown in Fig. 6, the vector potential of the electromagnetic field becomes [15]

$$A = \frac{1}{4\pi\epsilon_0 c^2} \frac{\dot{p}(t-r/c)}{r} \approx \frac{1}{4\pi\epsilon_0 c^2} \frac{\dot{p}(t)}{r} \quad (10)$$

where p is a dipole momentum given by $p = qd$ (q : charge of particles, d : displacement of the charge).

If we let $p(t) = p_0 \sin \omega t$ ($p_0 = Ned$), then we have

$$A = \frac{1}{4\pi\epsilon_0 c^2} \frac{\omega p_0 \cos \omega t}{r} = \frac{1}{4\pi\epsilon_0 c^2} \frac{\omega Ned \cos \omega t}{r} \quad (11)$$

In this equation, N is a number of charges per unit volume and d is given by

$$d = \frac{e}{m} \frac{E}{\omega_e^2 - \omega^2} \quad (12)$$

where E is an alternating electric field and ω_e is a resonant angular frequency given by

$$\omega_e = \sqrt{Ze^2 / \alpha_e m}$$

(α_e : electron polarizability), which is about $10^{15} \sim 10^{16}$ Hz.

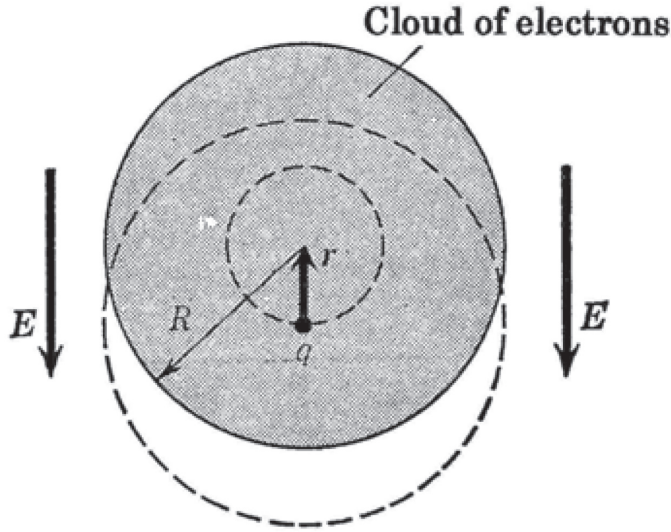

Fig. 6 Dipole field generated by the alternating electric field.

From above equations, we obtain the following equation for the charged sphere with a radius of R ;

$$\begin{aligned} \Delta M(\omega) / M &= \frac{\pi G}{c^4} \int \langle A^2 \rangle dv \\ &= \frac{1}{16\pi} \frac{N^2 e^4 G}{\epsilon_0^2 c^4 m^2} \frac{\omega^2}{(\omega_e^2 - \omega^2)^2} E^2 \int_0^\pi \sin \theta d\theta \int_0^R dr \int_0^{2\pi} d\phi \quad (13) \\ &= \frac{N^2 e^4 G}{4\epsilon_0^2 m^2 c^8} \frac{\omega^2}{(\omega_e^2 - \omega^2)^2} E^2 R \end{aligned}$$

As the energy dissipation can be incorporated into the analysis by replacing real quantities with complex ones as shown $\omega \rightarrow \omega(1 + i\eta/2)$, where η is a damping factor, Eq. (13) becomes

$$\Delta M(\omega) / M = \frac{N^2 e^4 G}{4\epsilon_0^2 m^2 c^8} \frac{\omega^2}{(\omega_e^2 - \omega^2)^2 + \eta^2 \omega^4} E^2 R \quad (14)$$

For the impulsive electric field, which has a wide frequency range of spectrum, $(\omega_2 - \omega_1)$ is large compared to the width of the resonance, the following integration over frequencies across the resonance yields

$$\int_{\omega_1}^{\omega_2} \frac{\omega^2 d\omega}{(\omega_e^2 - \omega^2)^2 + \eta^2 \omega^4} = \frac{\pi}{2\eta\omega_e} \quad (15)$$

From which, we obtain the ratio of the mass shift of the dielectric material vs. its rest mass under the impulsive electromagnetic field given by

$$\Delta M / M = \int_{\omega_1}^{\omega_2} \Delta M(\omega) / M \cdot d\omega = \frac{\pi}{8} \frac{e^4 G}{\epsilon_0^2 m^2 c^8} \frac{N^2 R}{\eta \omega_e} E^2 \quad (16)$$

Assuming that $\eta = 2e^2/3mc^2$, that equals the Abraham-Lorentz damping constant [16], we have

$$\Delta M / M = \frac{3\pi}{16} \frac{e^2 G}{\epsilon_0^2 mc^6} \frac{N^2 R}{\omega_e} E^2 \quad (17)$$

where N is a number of electrons per unit volume in a space

including the dielectric material and R is a radius of the electron cloud and E is a magnitude of the impulsive electric field.

4. POSSIBILITY TO PRODUCE ARTIFICIAL GRAVITY BY ELECTROMAGNETIC FIELD

Combining Eqs. (2) and (17), the force produced by the electrogravitic field E_g becomes

$$F = -(M + \Delta M)E_g \approx Z\sqrt{4\pi\epsilon} G \left(1 + \frac{3\pi}{16} \frac{e^2 G}{\epsilon_0^2 mc^6} \frac{N^2 R}{\omega_e} E^2 \right) EM \quad (18)$$

where M is a mass of the dielectric material.

From this equation, it is seen that the electrogravitic effect generated for the dielectric material can be amplified by the impulsive electric field as observed by the Honda experiment, which also supports the Brown experiment, where he observed a large thrust associated with a spark between electrodes for the disc structure as shown in Fig. 7 [7].

From Eq. (18), the new factors which increase the force for the dielectric material are:

- Increase the magnitude of an electric field impressed to the dielectric material.
- Increase the number of electrons per unit volume in a space including the dielectric material.
- Increase the radius of the electron cloud in a space including the dielectric material.

As the mass shift of the dielectric material under electrogravitic field satisfies $\Delta W = -M \cdot E_g$, then we have

$$\frac{\Delta W'}{\Delta W} \approx \frac{E'_g}{E_g} = \left(1 + \frac{3\pi}{16} \frac{e^2 G}{\epsilon_0^2 mc^6} \frac{N^2 R}{\omega_e} E'^2 \right) \frac{E'}{E} \quad (19)$$

where $\Delta W'$ and ΔW are weight shifts observed at the Honda experiment for AC pulses and DC exposures, and E' and E are amplitudes of the AC and the DC electric fields impressed to the capacitor, respectively.

By introducing values, $E = 18 \times 10^6$ V/m, $E' = 8 \times 10^6$ V/m, $R = 0.5$ mm, $\omega_e = 10^{15}$ rad/s and $m = 9.11 \times 10^{-31}$ kg (for the electron's mass), into Eq.(19), we obtain $\Delta W'/\Delta W = 3.2$, when we suppose $N = 10^{26}$, which is lower than the critical plasma density that equals $N = 10^{28}$ [17].

This is close to the experimental result obtained by the Honda research group and hence it can be considered that the electric discharge between plates, which has a wide range spectrum, produces a large force under the impulsive high potential electric field. As the mass shift predicted by Eq. (17) is dependent on the external electric field, the variance of weight reduction observed at the experiment might be due to the secondary electrostatic effect related global electric field as reported by G.V. Stephenson [18], the influence of which cannot be totally rejected by the electromagnetic shielding.

From the equation for the momentum given by $F = dP/dt$, the momentum produced by the electrogravitic field becomes

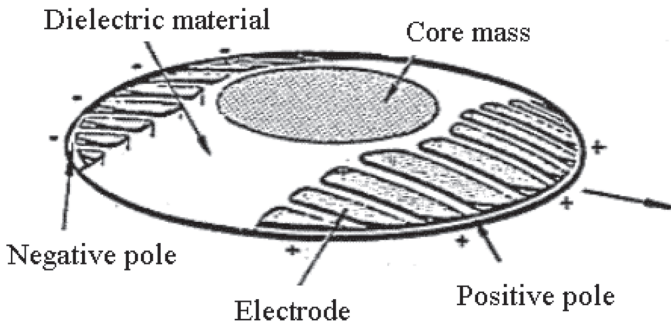

Fig. 7 Structure of the electrogravitic craft by T.T. Brown.

$$P_{field} = \int F dt = \int m \cdot E_g dt \approx m \cdot E_g \Delta t \quad (20)$$

When we let $\Delta t = l/v_d$, where l is a separation between electrodes and v_d is a drift velocity of electrons, the momentum produced by the impulsive electric field becomes

$$P_{field} = \int (M + \Delta M) \cdot E_g dt \quad (21)$$

$$\approx Z \sqrt{4\pi\epsilon_0\epsilon_r} G \left(1 + \frac{3\pi}{16} \frac{e^2 G}{\epsilon_0^2 m c^6} \frac{N^2 R}{\omega_e} E^2 \right) \frac{El}{v_d} M$$

From Eq. (21), the velocity for the disc structure in Fig. 7 can be estimated by $v = P_{field}/M'$ (M' : total mass of the spacecraft) as shown in Fig. 8, when we suppose $Z = 10$, $\epsilon_r = 10$, $l = 1$ m, $R = 1$ m, $\omega_e = 10^{15}$ rad/s, $m = 9.11 \times 10^{-31}$ kg, $N = 10^{26}$, $v_d = 10^8$ m/s (value for the vacuum arc [19]), and $M/M' \approx 1$. In this figure, the horizontal line is for the voltage applied to electrodes and the vertical line is for the velocity, both in a logarithmic scale.

From which, it can be seen that the electrogravitic craft

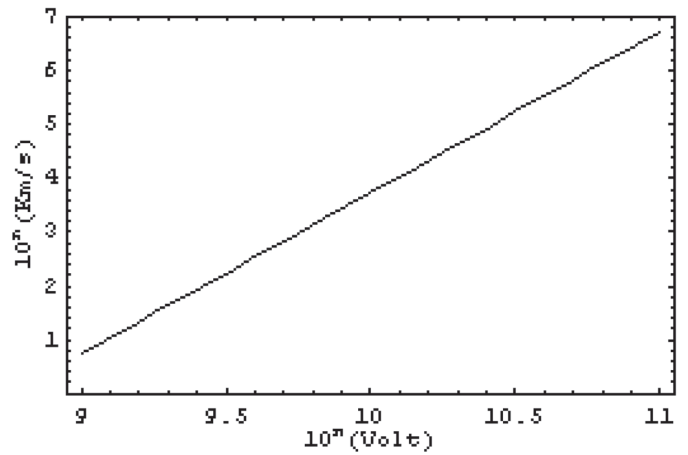

Fig. 8 Velocity produced by the impulsive electric field.

using the Biefeld-Brown effect might attain the velocity to reach 5.3 km/s when impressed 1 Giga Volt to the electrodes. Hence it is considered that this electrogravitic system can be used for space travel instead of the chemical rockets when either of following factors is increased; (1) voltage impressed to the dielectric material, (2) separation between electrodes, (3) number of electrons per unit volume in a space including the dielectric material, (4) radius of the electron cloud.

5. CONCLUSIONS

From the theoretical analysis by the zero-point field theory, it is thought that the origin of the dynamical Biefeld-Brown effect might be attributed to the interaction between zero-point vacuum fluctuations and high potential electric field applied to the capacitor. The theoretical analysis result suggests that the impulsive electric field applied to the dielectric material may produce a sufficient artificial gravity to attain velocities comparable to chemical rockets.

APPENDIX

Dr. Boyko Ivanov has shown that Weyl-Majumdar-Papapetrou solutions of the general relativity theory include the equation for the gravitational field induced by static electric field given by [20]

$$g = c^2 f^{-1} \left(\frac{B'}{2} \sqrt{\frac{\kappa\epsilon}{8\pi} \bar{\phi}_i} + \frac{\kappa\epsilon}{8\pi} \bar{\phi}\bar{\phi}_i \right) \quad (A1)$$

where $f = g_{00}$, B' is a constant and $\kappa = 8\pi G/c^4$.

From which, he derived the formula of gravitational force F_g shown as [20]

$$F_g = \sqrt{G\epsilon} \frac{M}{d} \bar{\psi}_2 = \sqrt{G\epsilon} \mu S \bar{\psi}_2 \quad (A2)$$

where M is the mass of the dielectric, μ is its mass density, ϵ is dielectric constant, d is the distance between the plates, $\bar{\psi}_2$ is the potential of the second plate when $\bar{\psi}_1 = 0$ and S is an area of the plate. This is equivalent (modulo Z) to the formula of the force generated by high potential electric field given by the author shown as

$$F \approx 8.62 \times 10^{-11} Z \mu_0 S \sqrt{\epsilon_r} V / t \quad (A3)$$

where μ_0 is a total mass of the dielectric per unit area, ϵ_r is the specific inductive capacity of the dielectric, V is the impressed voltage to the capacitor and t is its thickness. Those equations are the same except for the modulo Z , which was found by Dr. Ivanov when he passed the numeric coefficient by CGS system to SI system [21], where Dr. Ivanov works in the CGS (Gauss) system of units, while Musha works in the international system SI.

REFERENCES

- INTEL, "Toward Flight without Stress or Strain ...or Weight", *Interavia*, **XI**, pp.373-374, 1956.
- T. Musha, "Theoretical Explanation of the Biefeld-Brown Effect", *Electric Spacecraft Journal*, Issue 31, p.29, 2000, also in N. Iwanaga, "Review of Some Field Propulsion Methods from the General Relativistic Standpoint", *Space Technology and Applications International Forum-1999*, pp.1051-1059, 1999.
- D.R. Buehler, "Exploratory Research on the Phenomenon of the Movement of High Voltage Capacitors", *Journal of Space Mixing*, **2**, pp.1-22, 2004.

4. T.L. Mahood, "Propellantless Propulsion: Recent Experimental Results Exploiting Transient Mass Modification", *Space Technology and Applications International Forum-1999*, pp.1014-1020, 1999.
5. http://peswiki.com/index.php/PowerPedia:Biefeld_Brown_effect. (Date Accessed 24 July 2008)
6. M. Tajmar, "Biefeld-Brown effect: misinterpretation of Corona Wind Phenomena", *ALAA Journal*, **42**, pp.315-318, 2004.
7. M.B. King, "Is Artificial Gravity Possible?", in *Tapping The Zero-Point Energy*, Adventures Unlimited Press, Kempton, Illinois, 2002.
8. H.E. Puthoff, "Gravity as a zero-point-fluctuation force", *Physical Review A*, **39**, pp.2333-2342, 1989.
9. H.E. Puthoff, "Can the vacuum be engineered for space flight applications? Overview of theory and experiments", *Journal of Scientific Exploration*, **12**, pp.295-302, 1998.
10. T.B. Bahder and C. Fazi, "Force on an Asymmetric Capacitor", in *Electrogravitics II*, Integrity Research Institute, Washington, pp.28-59, 2005.
11. T. Musha, "The Possibility of Strong Coupling between Electricity and Gravitation", *Infinite Energy*, Issue 53, pp.61-64, 2004, also in T. Valone, "*Electro Gravitics II*", Integrity Research Institute, Washington, pp.60-69, 2004.
12. B. Haisch, A. Rueda and H.E. Puthoff, "Inertia as zero-point-field Lorentz force", *Physical Review A*, **49**, pp.678-694, 1994.
13. V. Putz and K. Svozil, "Quantum electrodynamics in the squeezed vacuum state: electron mass shift", *Nuovo Cimento*, **119**, pp.175-179, 2004.
14. B. Haish, A. Rueda and H.E. Puthoff, "Physics of the zero-point field: implications for inertia, gravitation and mass", *Speculation in Science and Technology*, **20**, pp.99-114, 1997.
15. R.P. Feynmann, R.B. Leighton and M. Sands, "*The Feynman Lectures on Physics - Vol. II*", Addison-Wesley, New York, 1964.
16. J.D. Jackson, "*Classical Electrodynamics*", Chapter.17, John Wiley & Sons, Inc., New York, 1975.
17. H.L. Anderson, "*A Physicist's Desk Reference*", The second edition of Physics Vade Mecum, American Institute of Physics, New York, 1989.
18. G.V. Stephenson, "The Biefeld brown Effect and the Global Electric Circuit", *Space Technology and Applications International Forum-2005*, pp.1249-1255, 2005.
19. R.L. Boxman, P.J. Martin and D.M. Sanders, "*Handbook of Vacuum Arc Science and Technology: Fundamentals and Applications*", Noyes Publications, 1996.
20. B.V. Ivanov, "Strong gravitational force induced by static electromagnetic fields", <http://lanl.arxiv.org/abs/gr-qc/0407048>. (Date Accessed 24 July 2008)
21. B.V. Ivanov, private communication, 2005.

(Received 3 December 2007; 28 June 2008)

* * *