

**Faucet Repair by Manufacturer - Acorn®\***  
**AMERICAN MANUFACTURED NON-OEM REPLACEMENTS FOR ACORN®\***  
**NOT MANUFACTURED BY OR WITH THE APPROVAL OF ACORN ENGINEERING CO.**

**Check Stop & Strainer Assembly**

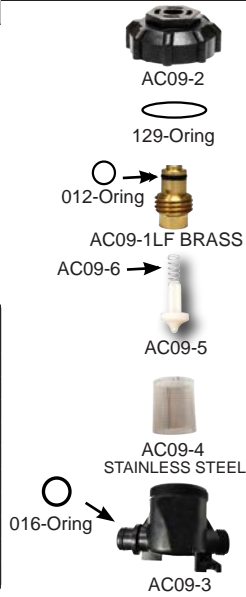

**AC09LF**



**Air Diaphragm For Pneumatic Pumps**



Also Fits Willoughby\* + Others

LMC* Item #	Ref #* TO OEM KITS	Description of NON OEM Kits
AC09LF	2570-000-001*	Complete Check Stop w/Strainer, 1/BX
AC09-1LF	2570-015-199*	Operating Stop Stem (LF Brass), Bulk
AC09-2	2570-012-000*	Large Plastic Bonnet Nut, Bulk
AC09-3	2570-011-001*	Main Body Assembly, Bulk
AC09-4	2570-018-000*	SS Strainer, Bulk
AC09-5	2570-014-000*	Check Stop Stem (TPR), Bulk
AC09-6	2415-002-000*	Check Stop SS Spring re Stem, Bulk
129	0401-129-000*	Check Stop Oring, RE Bonnet, Bulk
016	0401-016-000*	Check Stop Oring, out flow end, Bulk
012	0401-012-000*	Check Stop Oring, RE LF Brass Stem, Bulk

LMC* Item #	Ref #* TO OEM KITS	Description of NON OEM Kits
AC06LFB	2566-050-001*	Acorn* Willoughby* & Others, Air Control ASS, Side Outlet, 1/BG
AC06LFS	2566-025-001*	Acorn* Willoughby* & Others, Air Control ASS, Side Outlet, 1/BG
AC06-1	2566-001-000*, 600201*	Acorn* Willoughby* & Others, Air Control Diaphragm Only, 1/BG

**Complete Diaphragm Kit Including Diaphragm Assembly**



Winner of the 2003 RTIMA Award

**Retainer Cup & Seal**



**Diaphragm Assembly**

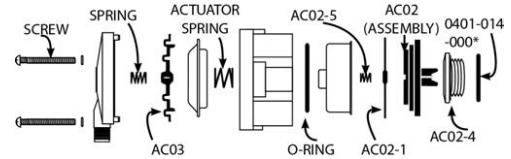

Item #	Ref # to OEM	Description
AC02K	2560-015-001*	PV Rebuild Kit, 1 hole Diaphragm 1/bg
AC02KA	2560-015-001*	PV Rebuild Kit, 2 hole Diaphragm 1/bg

Item #	Description
AC01-1	Retainer Cap (Use w/ AC01-2) 1/BG
AC01-2	Seal Re: Cap (Use w/AC01-1) 1/BG

Item #	Ref # to OEM	Description
AC02	2563-010-001*	Diaphragm Assembly Only
AC02-1	2563-019-001	Magnetic SS Disc w/Seal
AC02-4	2580-000-199*, 2580-000-000	Seat
AC02-5	2563-008-000	Spring

**Diaphragm Assembly Only**



Item #	Ref # to OEM	Description
AC02	2560-015-001*	Diaphragm Assembly Only - Original Style w/One Hole
AC02(A)	2560-015-001*	Diaphragm Assembly Only - New Style w/Two Holes

**Diaphragm Only**



**AC02-2 (1 Hole)**      **AC02-2A (2 Holes)**

Item #	Description
AC02-2	Diaphragm Only - Original Style w/ One Hole
AC02-2A	Diaphragm Only - New Style w/ Two Holes

**Wet-Side Diaphragm**



Item #	Ref # to OEM	Description
AC03	2563-022-000*	Upper Diaphragm 1/bg

**Metering Valve**



Item #	Ref # to OEM	Description
AC040LF	2302-00-001*	Metering Valve, Penal-Matic*, Lead-Free

Winner of the 2003 MGMPMA Award



**Flow Restrictor Assembly**

Item #	Ref # to OEM	Description
AC04A	2367-025-000*	0.5 GPM Urinal
AC04B		0.7 GPM Drinking Fountain
AC04C		1.0 GPM Lavatory
AC04D	1295-100-000*	2.2 GPM Shower
AC04E	0326-011-000*	2.5 GPM Shower
AC04F		1.4 GPM Shower
AC04Z		Universal 5 Way Combo

**Flow Restrictor - Plugs Only (Color Coded)**

Item #	Ref # to OEM	Description
AC04-3A	0469-005*	F.R. Grommet Only, .5 GPM Urinal, Black
AC04-3B	0469-007*	F.R. Grommet Only, .7 GPM Drinking Fountain, Blue
AC04-3C	0469-010*	F.R. Grommet Only, 1.0 GPM Lavatory, Red
AC04-3D	0469-022*	F.R. Grommet Only, 2.2 GPM Shower, Orange
AC04-3E	0469-025*	F.R. Grommet Only, 2.5 GPM Shower, White
AC04-3F		F.R. Grommet Only, 1.4 GPM Shower, Yellow

\*Registered trademark or trade name of the mfg. listed used for reference only. Don't confuse us with the mfg. listed. 2. Products marked "low lead" or "lead free" contain 0.25% lead or less, per California AB 1953 & Vermont S152 Legislative Specs. \*\*PROP 65 WARNING! Exposure to ingredients in these products such as: Acrylamide, Arsenic, Benzene, Cadmium, Lead, Mercury are known to the state of California to cause cancer, birth defects or reproductive harm. (See <http://oehha.ca.gov/prop65.html>). Wash contacted body parts immediately. Assembled and tested in the USA

# Faucet Repair by Manufacturer - Altmans\*

## Pressure Balancing Cartridges



Item #	Ref #	Description
T054H	OM35*	Pressure Balancing Cartridge w/Screws, 1/bg



Item #	Ref #	Description
T055	47-157-000*	Tempress* High-Flow* Gray Cartridge w/Ledges, T*11*EFX*

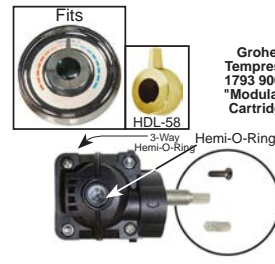

Item #	Ref #	Description
T056	1793 9000*	Tempress* Modular* Cartridge, Black w/3-Way Hemi-O-Ring

## Escutcheon Handle Drive Assembly

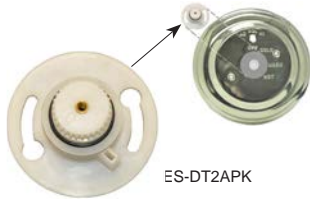

Item #	Ref #	Description
ES-DT2APK	1-207*	Escutcheon HDL Drive Assembly RE 2/pc Escutcheons, 1/bg

## Stop Plus Kit



Item #	Ref #	Description
T054-16K	10494*	Stop Plus Kit, 1/bg

## Stem Adapter



Item #	Description	Bkn/Std Pak
ES-DT1-4K	Stem Adapter w/Screw	12/12

## Stem Adapter and Extender



Item #	Description
ES-DT1-4KE	ES-DT1-4K w/Stem Extension And Screw

TEMPRESS II\*/DANFOSS\*/GROHE\*/PHYLIRICH\*/INDIANA\*/NEWPORT BRASS\*, ETC.....

KIT INCLUDES EVERYTHING:  
CAP, ADAPTERS, SCREWS, NUTS

## VALVE BODY CONVERSION KIT

Works with these cartridges:



Replace various trims used by the sub-manufacturers who marketed this tub shower valve.

ITEM #	REF#	DESCRIPTION	PAK	STD PK
T054VC	47343560*	TEMPRESS*GROHE*ETC REPLACEMENT CAP WITH ESCUTCHEON ADAPTERS	1/BX	6

# Faucet Repair by Manufacturer - American Standard\*

## Pressure Balancing Unit - Style "A"

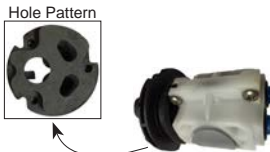

Item #	Ref #	Description
A030A	M952100-0070A*	PB Cartridge, Type P, Face Plate "A", 1/bg

## Pressure Balancing Unit - Style "B"



Item #	Ref #	Description
A030B	077171-0070A*	PB Cartridge, Type P, w/Face Plate "B", 1/bg

## Pressure Balancing Unit - Style "C"

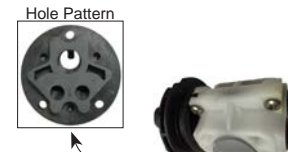

Item #	Ref #	Description
A030C	051091-0071*	PB Cartridge, Type P, w/Face Plate "C", 1/bg

## Pressure Balancing Unit - Combo Model - All Plates Included

**A030Z**  
All in 1 Bag

How to Assemble



Fits The Following Tub & Shower Only:

- Amarillis\* (T345500 Series)
- Archive\* (5414600 Series)
- Ariana\* (6021, 6022 Series)
- Berwick\* (T430500 Series)
- Cadet\* (1674, 1675 Series)
- Caramix\* (2000600, T000500 Series)
- Ceratop\* (2044500 Series)
- Colony\* (1351, 1352, 1355, 1372, 1375, 1371, 1655500, 6444, 6112, T675500 Series)
- Copeland\* (T005500 Series)
- Dazzle\* (T028500 Series)
- Domaine\* (5737600 Series)
- Enfield\* (T373500 Series)
- Green Tea\* (T1010500 Series)
- Hampton\* (7215700, 7212500, 7211700, 7251700, 7252700, 7254700, T215700 Series)
- Jasmine\* (9316500 Series)
- Jocelyn\* (9316500 Series)

Fits The Following Tub & Shower Only:

- Livingston\* (9041500 Series)
- Marquette\* (7262 Series)
- Moments\* (T506600, T506508, T506500 Series)
- Neo\* (6001 Series)
- Palace\* (5636600 Series)
- Pelham\* (9385500 Series)
- Portsmouth\* (T415500, T420500 Series)
- Princeton\* (7051 / T508502 Series)
- Reliant\* (1495500 / 7380 Series)
- Rough Valves\* (R110, R115, R115SS, R116SS, R126, R117, R460, R465, R467, R470, R475, R477, R120, R120SS, R125, R125SS, R127, R127SS, Series)
- Serin\* (T064500 Series)
- Seva\* (1480500 / T480500 Series)
- Standard Collection\* (6181 Series)
- Stemma\* (5339600 Series)
- Stratton\* (931550 Series)
- Studio\* (T590500 Series)
- Swan\* (6012 Series)
- Symphony\* (4501 Series)
- Town Square\* (2555500, 2555500 Series)
- Transitional\* (9027500 / 9026500 Series)
- Triumph\* (7031 Series)
- Tropic\* (T038500 Series)
- Williamsburg\* (1040, 1041 Series)
- Winthrop\* (9046500 Series)

Item #	Ref #	Description
A030Z	NA	PB Cartridge, Multi-Fit, One Cartridge, 3/Adapta-Plates, 1/bg
A030A-1	51091-0070A*	Adapta-Plate, Reliant*, PB Cartridge, 1/bg
A030B-1	077171-0070A*	Adapta-Plate, Ultramix*, PB Cartridge, 1/bg
A030C-1	M952100-0070A*	Adapta-Plate, Colony*, PB Cartridge, 1/bg

# Faucet Repair by Manufacturer - American Standard\*

Ceramic Colony II\* Cartridge  
Dual Control

**Lead Free**



Item #	Ref #	Description
A021	954120-0070A*	Cartridge, AS* Colony II*, Dual Control, Lead-Free 1/bg

Ceramic Colony II\* Cartridge  
Dual Control with Handle Adapter



**Lead Free**



Item #	Ref #	Description
A021A	954120-0070A*	Cartridge w/HDL Adapter Bushing, AS* Colony II*, Dual Control, Lead-Free 1/bg

Colony II\* Cartridge Handle Adapter Bushing

**Fits**

Item #	Ref #	Description
A021-5	M918021-007A*	HDL Adapter Bushing, AS* Colony II*, Fits Cartridge A021A*

Aquaseal\*



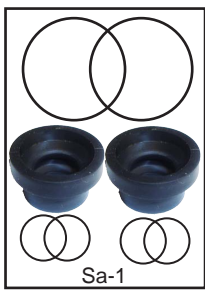

**A001**

**Sa-1**

Item #	Ref #	Description
A001	72940.07*	Aquaseal*, 25/bg
SA-1	72940.07*	Kit for Aquaseals* Models

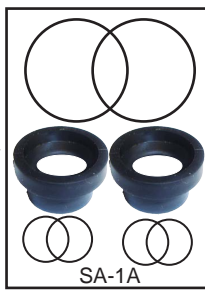
Aquaseal\*

**A001a**

**SA-1A**

Item #	Description
A001A	Aquaseal*, w/ID Disc
SA-1A	Kit for Aquaseals* Models w/ID Disc

Aquaseal\*



**A001**

**A014**

**Sa-3**

**Tub/Shower Only**

**Fits**



Item #	Ref #	Description
A014	72959.07*	AS* Brass Ring RE Aqua Seal*
SA-3		AS* Aquaseal* w/Brass Ring Kit

Cadet Seals\*



**A002**

**SA-2**

Item #	Ref #	Description
A002	44249.87*	Cadet*, NU Seal* Washer, bulk
SA-2	44293.0070*	Cadet* Kit / NU Seal* Models

Cadet Seals\*



**A002A**

**SA-2A**

**Winner Of The 2002 Jipmma Award**

Item #	Description
A002A	Cadet* Aquaseal* w/ID Disc bulk
SA-2A	Cadet* Kit / Nu-Seal* Models w/ID Disc

Push-Pull, Tilt-Turn  
**Tub/Shower Only**



**A003**

**A004**

**A006**

**WFG-1**

**114**

**017**

**118**

**025**

**021**

**015**

**Fits**



Item #	Ref #	Description
SA-4		Combo Kit, Push-Pull, Tilt Turn
A004	72510.07*	Spring, Conical, O/S S/H
A003	12179.07*	Spring, Straight, O/S S/H
A006	12002.07*	Seat, Rubber Top, O/S S/H

Aquamix\*

**Fits**

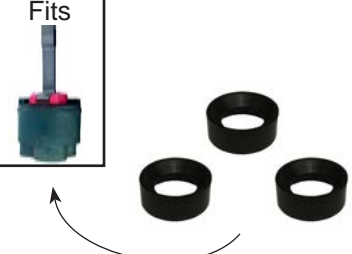

**A005(3BG)**

Item #	Ref #	Description
A005(3BG)	63827.07*	Lower Seal for Aquamix* 3/Set

Aquarian\*

**FITS**

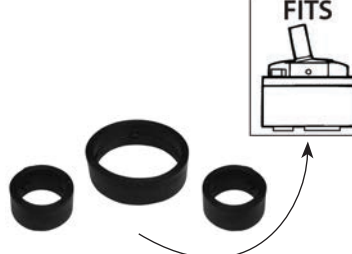

**A011**

Item #	Ref #	Description
A011	57583.07*	Aquarian* 4 Gal Seal Set, 1 set/bg

Aquarian\* Spout Seals

**FITS**

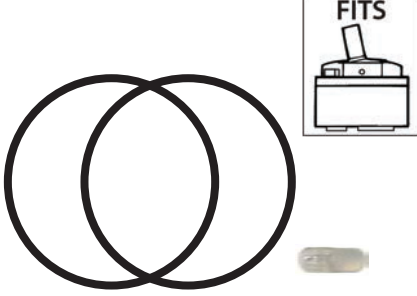



**A015**

Item #	Ref #	Description
A015	69332.07*	Aquarian* 4 Gal Seal Set, 1 set/bg

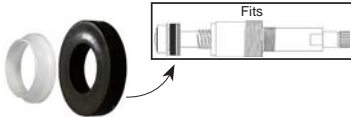

**C1 - FAUCET REPAIR**  
By Manufacturer

\*Registered trademark or trade name of the mfg. listed used for reference only. Don't confuse us with the mfg. listed. 2. Products marked "low lead" or "lead free" contain 0.25% lead or less, per California AB 1953 & Vermont S152 Legislative Specs.  
\*\*PROP 65 WARNING! Exposure to ingredients in these products such as: Acrylamide, Arsenic, Benzene, Cadmium, Lead, Mercury are known to the state of California to cause cancer, birth defects or reproductive harm. (See <http://oehha.ca.gov/prop65.html>). Wash contacted body parts immediately. Assembled and tested in the USA

## Faucet Repair by Manufacturer - American Standard\*

<p style="text-align: center;"><b>Colony*</b></p>  <p>Winner of the 2001 BWSRD Award</p> <table border="1" style="width: 100%; border-collapse: collapse;"> <tr><th>Item #</th><th>Description</th></tr> <tr><td>AS-12</td><td>Repair Kit, Fits Colony* T/S Valve</td></tr> </table>	Item #	Description	AS-12	Repair Kit, Fits Colony* T/S Valve	<p style="text-align: center;"><b>Pop-Up Plug Seal</b></p>  <p style="text-align: center;"><b>A016</b></p> <table border="1" style="width: 100%; border-collapse: collapse;"> <tr><th>Item #</th><th>Description</th></tr> <tr><td>A016</td><td>AS* Pop-Up Plug Washer</td></tr> </table>	Item #	Description	A016	AS* Pop-Up Plug Washer	<p style="text-align: center;"><b>Fit-All Nipple</b></p> <p style="text-align: center;">New &amp; Improved "Will Not Break or Split"</p>  <p>Winner of the 2004 IHMA Award</p> <table border="1" style="width: 100%; border-collapse: collapse;"> <tr><th>Item #</th><th>Description</th></tr> <tr><td>FN-999R</td><td>Multi-Fit Nipple, Hard TP Rubber</td></tr> </table>	Item #	Description	FN-999R	Multi-Fit Nipple, Hard TP Rubber
Item #	Description													
AS-12	Repair Kit, Fits Colony* T/S Valve													
Item #	Description													
A016	AS* Pop-Up Plug Washer													
Item #	Description													
FN-999R	Multi-Fit Nipple, Hard TP Rubber													

### Commercial Vacuum Breakers

 <table border="1" style="width: 100%; border-collapse: collapse;"> <tr><th>Item #</th><th>Description</th></tr> <tr><td>VBAS-1</td><td>AS* Vacuum Breaker Kit</td></tr> </table>	Item #	Description	VBAS-1	AS* Vacuum Breaker Kit	 <table border="1" style="width: 100%; border-collapse: collapse;"> <tr><th>Item #</th><th>Description</th></tr> <tr><td>VBAS-2</td><td>AS* Vacuum Breaker Kit</td></tr> </table>	Item #	Description	VBAS-2	AS* Vacuum Breaker Kit	 <table border="1" style="width: 100%; border-collapse: collapse;"> <tr><th>Item #</th><th>Description</th></tr> <tr><td>VBAS-3</td><td>AS* Monterrey* 8350* Series, Vacuum Breaker Kit, 1/Bg</td></tr> </table>	Item #	Description	VBAS-3	AS* Monterrey* 8350* Series, Vacuum Breaker Kit, 1/Bg
Item #	Description													
VBAS-1	AS* Vacuum Breaker Kit													
Item #	Description													
VBAS-2	AS* Vacuum Breaker Kit													
Item #	Description													
VBAS-3	AS* Monterrey* 8350* Series, Vacuum Breaker Kit, 1/Bg													

### Pedal Valve

- Return Spring For Foot (Pedal) Valve
- Heavy Duty Stainless Steel Construction
- The Same Tension As The OEM.

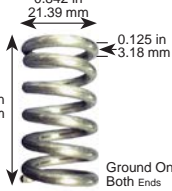



0.842 in  
21.39 mm  
0.125 in  
3.18 mm  
1.573 in  
39.95 mm

Ground On Both Ends

Item #	Ref #	Description
A017(BG)	25-2700*	AS* Foot (Pedal) Valve Return SS Spring, 2/bg

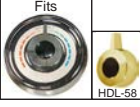
### Pressure Balancing Cartridges

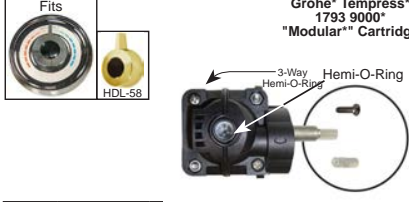
<p style="text-align: center;"><b>HDL-58</b></p>  <table border="1" style="width: 100%; border-collapse: collapse;"> <tr><th>Item #</th><th>Ref #</th><th>Description</th></tr> <tr><td>T054H</td><td>OM35*</td><td>Pressure Balancing Cartridge w/Screws, 1/bg</td></tr> </table>	Item #	Ref #	Description	T054H	OM35*	Pressure Balancing Cartridge w/Screws, 1/bg	<p style="text-align: center;"><b>Grohe* Tempress* 47-157-000* "High Flow*" Cartridge</b></p>  <table border="1" style="width: 100%; border-collapse: collapse;"> <tr><th>Item #</th><th>Ref #</th><th>Description</th></tr> <tr><td>T055</td><td>47-157-000*</td><td>Tempress* High-Flow* Gray Cartridge w/Ledges, T"11"EFX"</td></tr> </table>	Item #	Ref #	Description	T055	47-157-000*	Tempress* High-Flow* Gray Cartridge w/Ledges, T"11"EFX"	<p style="text-align: center;"><b>Grohe* Tempress* 1793 9000* "Modular*" Cartridge</b></p>  <table border="1" style="width: 100%; border-collapse: collapse;"> <tr><th>Item #</th><th>Ref #</th><th>Description</th></tr> <tr><td>T056</td><td>1793 9000*</td><td>Tempress* Modular* Cartridge, Black w/3-Way Hemi-O-Ring</td></tr> </table>	Item #	Ref #	Description	T056	1793 9000*	Tempress* Modular* Cartridge, Black w/3-Way Hemi-O-Ring
Item #	Ref #	Description																		
T054H	OM35*	Pressure Balancing Cartridge w/Screws, 1/bg																		
Item #	Ref #	Description																		
T055	47-157-000*	Tempress* High-Flow* Gray Cartridge w/Ledges, T"11"EFX"																		
Item #	Ref #	Description																		
T056	1793 9000*	Tempress* Modular* Cartridge, Black w/3-Way Hemi-O-Ring																		

### Escutcheon Handle Drive Assembly

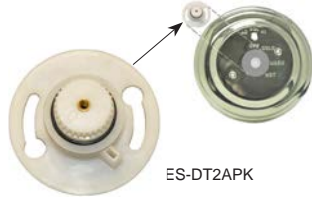

**ES-DT2APK**

Item #	Ref #	Description
ES-DT2APK	1-207*	Escutcheon HDL Drive Assembly RE 2/pc Escutcheons, 1/bg

### Stop Plus Kit



Item #	Ref #	Description
T054-16K	10494*	Stop Plus Kit, 1/bg

### Stem Adapter

**Es-Dt1-4K**



Item #	Description	Bkn/Std Pak
ES-DT1-4K	Stem Adapter w/Screw	12/12

### Stem Adapter and Extender

**Es-Dt1-4Ke**



Item #	Description
ES-DT1-4KE	ES-DT1-4K w/Stem Extension And Screw

TEMPRESS II\*/DANFOSS\*/GROHE\*/PHYLIRICH\*/INDIANA\*/NEWPORT BRASS\*, ETC.....

## VALVE BODY CONVERSION KIT

KIT INCLUDES EVERYTHING:  
CAP, ADAPTERS, SCREWS, NUTS



**Works with these cartridges:**

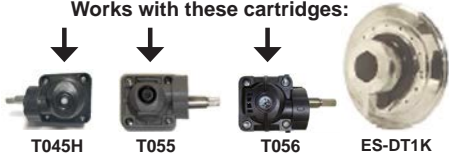

**Replace various trims used by the sub-manufacturers who marketed this tub shower valve.**

ITEM #	REF#	DESCRIPTION	PAK	STD PK
<b>T054VC</b>	47343560*	TEMPRESS*GROHE*ETC REPLACEMENT CAP WITH ESCUTCHEON ADAPTERS	1/BX	6

## Faucet Repair by Manufacturer - Artistic\*

### Lower Cartridge Seals

Winners of the 2003 BWSBWMA Award



Item #	Description
ART-1	A.B.* Lower Cartridge Seal
ART-2	A.B.* Lower Cartridge Seal

## Faucet Repair by Manufacturer - Bradley\*

### Valve Rebuild Kit



**BR02K  
BR02KLS (Less Seat)**

Item #	Ref #	Description
BR02K		Bradley* Prison Valve Rebuild Kit, 1/bg
BR02KLS	S65-110*	Bradley* Prison Valve Rebuild Kit, Less Seat

### Wet Side Diaphragm



← Side View

Winner of the 2003 BWSBWMA Award

Item #	Ref #	Description
AC03	2563-022-000*	Wet Side Diaphragm, 1-34"

# Faucet Repair by Manufacturer - Bradley\*

Flow Restrictor - .5 GPM → 2.5 GPM

Flow Restrictor - Plugs Only (Color Coded)



AC04-3A  
AC04-3B  
AC04-3C  
AC04-3D  
AC04-3E  
AC04-3F

For Brass Body



1/2 Gallon

Item #	Ref #	Description
AC04A	2367-025-000*	Flow Rest Assembly .5 GPM Urinal
AC04B		Flow Rest Assembly .7 GPM Fountain
AC04C		Flow Rest Assembly 1.0 GPM Lavatory
AC04D	1295-100-000*	Flow Rest Assembly 2.2 GPM Shower
AC04E	0326-011-000*	Flow Rest Assembly 2.5 GPM Shower
AC04F		Flow Rest Assembly 1.4 GPM Shower
AC04Z		Flow Rest Assembly Univ 5 way Combo

Item #	Ref #	Description
AC04-3A	0469-005*	FR Grommet Only, .5 GPM Urinal, Black
AC04-3B	0469-007*	FR Grommet, .7 GPM, Blue
AC04-3C	0469-010*	FR Grommet Only, 1.0 GPM Lavatory, Red
AC04-3D	0469-022*	FR Grommet Only, 2.2 GPM Shower, Orange
AC04-3E	0469-025*	FR Grommet Only, 2.5 GPM Shower, White
AC04-3F		FR Grommet Only, 1.4 GPM Shower, Yellow

## Metering Cartridges - 4 Versions

### For Mechanical Metering Faucets

S53-053\* 90-75\* With 4" Centerset  
S53-082\* 90-75\* With 4" Centerset & 8" Trim Plate  
S53-058\* 90-75\* With 4" Centershank  
S53-295\* 90-75\* With 4" Centershank & 8" Trim Plate

\*\*Cartridges (1/BG), Include:  
Cartridge, 2/ea Service Wrenches, Silicone Lubricant Packs, Inlet Filter Disc, Felt Soap Guard Washer, and Instructions

90-75\* Cartridges\*\*  
B400A (S65-074\*)  
B400B (S65-115\*)  
B400C (S65-116\*)  
B400D (S65-084\*)



Cartridge Also Comes With

Soap Guard Washer	Service Wrenches
B400-3-4 (124-047*)	TW-6 5/64" TW-7 3/32"
Inlet Filter Disc	Lube
B400-3-5 (156-010*)	WFG-1 2/E

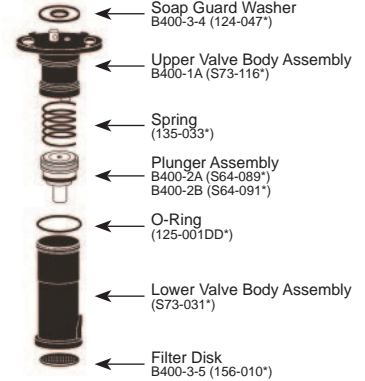

Item #	Ref #	Description
B400ALF	S65-074*	Bradley* 90-75* Cartridge Kit Preset 10-12 seconds
B400BLF	S65-115*	Bradley* 90-75* Cartridge Kit Preset 5-7 seconds
B400CLF	S65-116*	Bradley* Poor Water Cartridge Kit Preset 10-12 seconds
B400DLF	S65-084*	Bradley* Preset 10-12 seconds
B400-1A	S73-116*	Bradley* Top Assembly Kit Preset 10-12 Seconds
B400-2A	S64-089*	Bradley* Plunger Assembly Preset 10-12 Seconds
B400-2B	S64-091*	Bradley* Plunger Assembly Preset 5-7 Seconds
B400-3-4	124-045*	Bradley* Soap Guard Washer
B400-3-5	156-010*	Bradley* Inlet Filter Disc
TW-6		5/64" Service Wrench
TW-7		3/32" Service Wrench
WFG-1		Lube

### Bradley\* Foot Valve

- Uses same repair kit as factory
- All parts interchange with the OEM
- All valves are 100% individually tested
- Made from same materials as the OEM
- Brass body, arm, and seat
- Assembled and Tested in USA

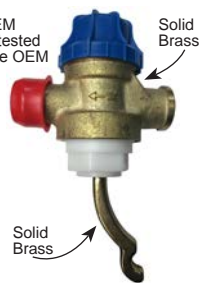
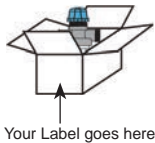

### Bradley\* Old-Style Foot Valve Rebuild Kit



Item #	Ref #	Description
B300K	S65-001A*	Bradley* OS Foot Valve Rebuild Kit (1973-2003)

### Bradley\* New-Style Foot Valve Rebuild Kit



Item #	Ref #	Description
B300AK	S65-230*	Bradley* OS Foot Valve Rebuild Kit (2003-Present)

# Faucet Repair by Manufacturer - Bradley\*, JPI\*, Sears\*

## Brad-Trol\* Single Handle Cartridge

## Posi-Pak II\*

## Posi-Pak II\* Long

Fits

Lead Free Tub/Shower

(Lead Free)

(Lead Free)



Item #	Ref #	Description
B100	300-0050*	Bradley* Kohler* Cole* S/H Cart Brad-Trol* S/H Models

Item #	Ref #	Description
B001	400-02057P*	Posi-Pak II* Hot (Red)
B002	400-02058P*	Posi-Pak II* Cold (Blue)

Item #	Description
B003	Posi-Pak II* Hot, Long (Red)
B004	Posi-Pak II* Cold, Long (Blue)

\*Registered trademark or trade name of the mfg. listed used for reference only. Don't confuse us with the mfg. listed. 2. Products marked "low lead" or "lead free" contain 0.25% lead or less, per California AB 1953 & Vermont S152 Legislative Specs. \*\*PROP 65 WARNING! Exposure to ingredients in these products such as: Acrylamide, Arsenic, Benzene, Cadmium, Lead, Mercury are known to the state of California to cause cancer, birth defects or reproductive harm. (See <http://oehha.ca.gov/prop65.html>). Wash contacted body parts immediately. Assembled and tested in the USA

## Faucet Repair by Manufacturer - Bradley\*, JPI\*, Sears\*

Brad-Trol\* 2 Handle Cartridge - Hot



Brad-Trol\* 2 Handle Cartridge - Cold

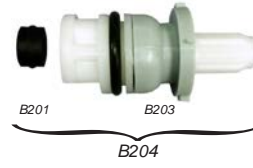

Item #	Ref #	Description
B200	400-08190*	Brad-Trol* 2 HDL Cart, Hot, 12pt Broach
B202	400-08190*	Brad-Trol* 2 HDL Cart, w/Seat, Hot 12pt Broach
B201	300-945*	Brad-Trol* Seat

Item #	Ref #	Description
B203	400-08290*	Bradley*, JPI*, Bradtrol* 2 HDL Cart, Cold, 12pt Broach
B204	300-945*	Bradley*, JPI*, Bradtrol* 2 HDL Cart, w/Seat, Cold, 12pt Broach
B201	300-945*	Brad-Trol* Seat

## Faucet Repair by Manufacturer - Brasstech\*, Broadway Collection by Schlage\*, California Faucets\*, Central Brass\*

Pressure Balancing Cartridges

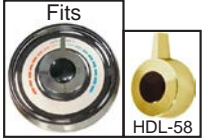

Brasstech\* = 1-028\*  
 Broadway Collection\* = 41031285\*  
 California Faucets\* = Cart-Pbs-Ef\*  
 Central Brass\* = 103-Rc\*

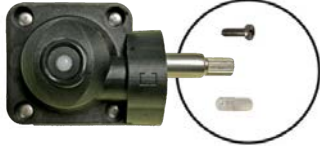

Item #	Ref #	Description
T054H	1-207*	Pressure Balancing Cartridge w/Screws, 1/bg

Grohe\* Tempress\*  
 47-157-000\*  
 "High Flow\*\*" Cartridge



Item #	Ref #	Description
T055	47-157-000*	Tempress* High-Flow* Gray Cartridge With Ledges, T*11 EFX*

Grohe\* Tempress\*  
 1793 9000\*  
 "Modular\*\*" Cartridge



Item #	Ref #	Description
T056	1793 9000*	Tempress* Modular* Cartridge, Black With 3-Way Hemi-O-Ring

Escutcheon Handle Drive Assembly



ES-DT2APK

Item #	Ref #	Description
ES-DT2APK	1-207*	Escutcheon HDL Drive Assembly RE 2/pc Escutcheons, 1/bg

Stop Plus Kit



Item #	Ref #	Description
T054-16K	10494*	Stop Plus Kit, 1/bg

Stem Adapter



Item #	Description	Bkn/Std Pak
ES-DT1-4K	Stem Adapter w/Screw, Tempress* Kohler* Powers* Danfoss*	1/6

Stem Adapter and Extender



Item #	Description
ES-DT1-4KE	ES-DT1-4K w/Stem Extension And Screw

TEMPRESS II\*/DANFOSS\*/GROHE\*/PHYLIRICH\*/INDIANA\*/NEWPORT BRASS\*, ETC.....

### VALVE BODY CONVERSION KIT

KIT INCLUDES EVERYTHING:  
 CAP, ADAPTERS, SCREWS, NUTS



Works with these cartridges:

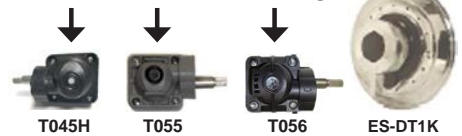

Replace various trims used by the sub-manufacturers who marketed this tub shower valve.

ITEM #	REF#	DESCRIPTION	PAK	STD PK
T054VC	47343560*	TEMPRESS*GROHE*ETC REPLACEMENT CAP WITH ESCUTCHEON ADAPTERS	1/BX	6

## Faucet Repair by Manufacturer - Briggs\*

Valve Rebuild Kit

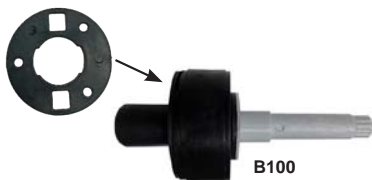

Lead Free  
 Tub/Shower  
 Only



Item #	Ref #	Description
B100	300-0050	Bradley* Kohler* Cole* S/H Cart Brad-Trol* S/H Models, Lead Free

## Faucet Repair by Manufacturer - Cambridge Brass\*

Single Handle Faucet or Urinal Self-Closing Metering Cartridge

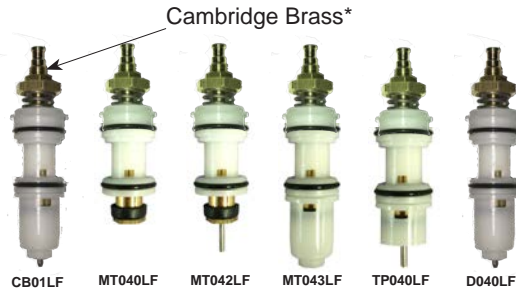

Item #	Ref #	Description
CB01LF	060160A*	Single Handle Self-Closing Faucet Metering Cartridge
MT040LF	MT039*	Metering Cartridge Replacement for Metcraft* Penal Metering Cartridge
MT042LF	190126A*	Metcraft* Tempus* Self Closing Cartridge, Pre 1992
MT043LF	060160A*	Metcraft* Teck* Metering Cartridge, 1992-98
TP040LF	190126A*	Tempus* Short Metering Cartridge
D040LF	RP6399*	DP* Single Side Slow Close Cartridge

## Faucet Repair by Manufacturer - Central Brass\*

### Shower Diverter Washer

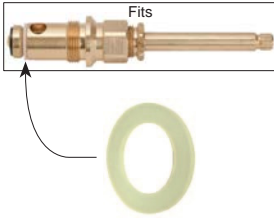

Item #	Ref #	Description
C301	4-MA*	Shower Diverter Washer

### Washerless Repair Kit



Item #	Ref #	Description
C300	3535*, 343DA*	Washerless Repair Kit

### Fit-All Nipple



New & Improved  
"Will Not Break Or Split"



Item #	Description
FN-999R	Multi-Fit Nipple, Hard TP Rubber

Winner  
Of The  
2004  
Ihma  
Award

## Faucet Repair by Manufacturer - Cifial\*

### Pressure Balancing Cartridges

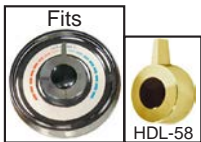

Item #	Ref #	Description
T054H	1-207*	Pressure Balancing Cartridge w/Screws, 1/bg

### Grohe\* Tempress\* 47-157-000\* "High Flow\*" Cartridge

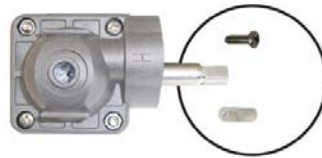

Item #	Ref #	Description
T055	47-157-000*	Tempress* High-Flow* Gray Cartridge With Ledges, T*11*EFX*

### Grohe\* Tempress\* 1793 9000\* "Modular\*" Cartridge



Item #	Ref #	Description
T056	1793 9000*	Tempress* Modular* Cartridge, Black With 3-Way Hemi-O-Ring

### Escutcheon Handle Drive Assembly

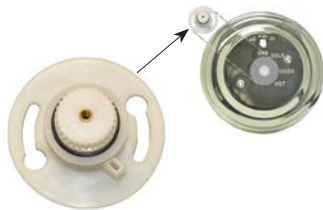

ES-DT2APK

Item #	Ref #	Description
ES-DT2APK	1-207*	Escutcheon HDL Drive Assembly RE 2/pc Escutcheons, 1/bg

### Stop Plus Kit

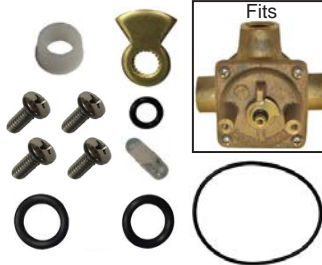

Item #	Ref #	Description
T054-16K	10494*	Stop Plus Kit, 1/bg

### Stem Adapter



Item #	Description	Bkn/Std Pak
ES-DT1-4K	Stem Adapter w/Screw, Tempress* Kohler* Powers* Danfoss*	1/6

### Stem Adapter and Extender



Item #	Description
ES-DT1-4KE	ES-DT1-4K w/Stem Extension And Screw

TEMPRESS II\*/DANFOSS\*/GROHE\*/PHYLIRICH\*/INDIANA\*/NEWPORT BRASS\*, ETC.....

KIT INCLUDES EVERYTHING:  
CAP, ADAPTERS, SCREWS, NUTS



Works with these cartridges:

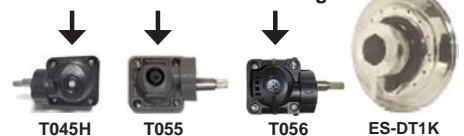

Replace various trims used by the sub-manufacturers who marketed this tub shower valve.

ITEM #	REF#	DESCRIPTION	PAK	STD PK
T054VC	47343560*	TEMPRESS*GROHE*ETC REPLACEMENT CAP WITH ESCUTCHEON ADAPTERS	1/BX	6

\*Registered trademark or trade name of the mfg. listed used for reference only. Don't confuse us with the mfg. listed. 2. Products marked "low lead" or "lead free" contain 0.25% lead or less, per California AB 1953 & Vermont S152 Legislative Specs.  
\*\*PROP 65 WARNING! Exposure to ingredients in these products such as: Acrylamide, Arsenic, Benzene, Cadmium, Lead, Mercury are known to the state of California to cause cancer, birth defects or reproductive harm. (See <http://oehha.ca.gov/prop65.html>). Wash contacted body parts immediately. Assembled and tested in the USA

# Faucet Repair by Manufacturer - Chicago Faucet\*

Vacuum Breaker Kit - Original Style



Vacuum Breaker Kit - New Style



Item #	Ref #	Description
VBCF-1	892-202*	Commercial Vacuum Breaker Kit

Item #	Ref #	Description
VBCF-2A	892-302*	Commercial Vacuum Breaker Kit

Quaturn\* Parts Old Style

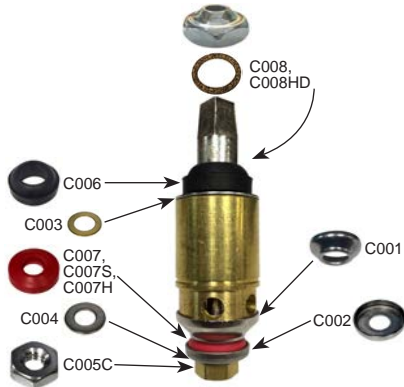

Quaturn\* Parts Later Style

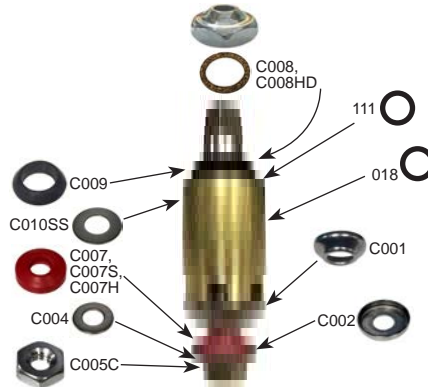

Quaturn\* Parts Later Style (w/Rubber Coated Seat)

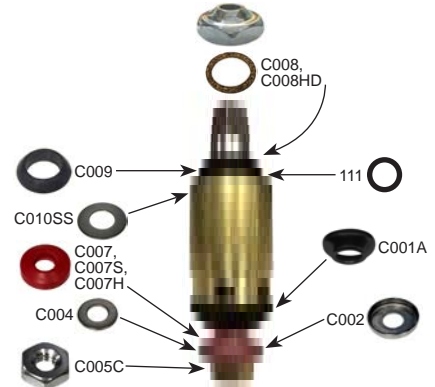

Quaturn\* Parts Newer Style



Niad\* Parts - Metering

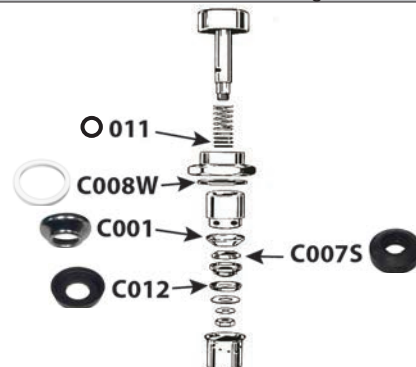

Item #	Ref #	Description
008		O-Ring
011		O-Ring
015		O-Ring
017		O-Ring
018		O-Ring
111		Packing O-Ring
204		O-Ring
C001	1-22*	Seat, Original Stainless Steel Style
C001A		Chicago Faucet* TP Rubber Coated Seat, Original Stainless Steel Style
C002	1-27*	Retainer
C003	1-20*	Old Style Metal Pack Washer (Also See C010)
C004	1-31*	Metal Lower Washer
C005C	1-18*	Nut (333-097JK), Stainless Steel Lead-Free
C006	1-19*	New Style Pack-Rubber Style
C007	1-21*	Bib Washer (Standard Durometer)
C007S	244-006*	Bib Washer (Special Soft) - Self Closing Models
C007H		Bib Washer (Special Hard) - Hospital Models
C008	1-43*	Cork Cap Gasket
C008HD	1-43*	Cork Cap Gasket (Heavy Duty)
C008W		White Cap Seal Replacing Ceramic Cartridge
C009	1-119*	Packing-New Style (Also See C-4)
C010SS		Metal Pack Washer-New Style (See C003)
C011	1-321*	Chicago Faucet* White Bib Washer
C012	333-40*	Diaphragm for Slow Close Models (Cup-Niad)*
C013		New Style Brass Pack Washer
C020	1-99*	Chicago Faucet* Cartridge, Complete Unit, Hot, Tub and Shower Only
C021	1-100*	Chicago Faucet* Cartridge, Complete Unit, Cold, Tub and Shower Only
WFG-1		Silicone Lubricant Capsule

C1 - FAUCET REPAIR By Manufacturer

\*Registered trademark or trade name of the mfg. listed used for reference only. Don't confuse us with the mfg. listed. 2. Products marked "low lead" or "lead free" contain 0.25% lead or less, per California AB 1953 & Vermont S152 Legislative Specs. \*\*PROP 65 WARNING! Exposure to ingredients in these products such as: Acrylamide, Arsenic, Benzene, Cadmium, Lead, Mercury are known to the state of California to cause cancer, birth defects or reproductive harm. (See <http://oehha.ca.gov/prop65.html>). Wash contacted body parts immediately. Assembled and tested in the USA



## Faucet Repair by Manufacturer - Chicago Faucet\* - Kit Breakdown Chart

Item	C-1	C-2	C-3	C-3A	C-4	C-5	C-6	C-7	C-8
	1 Side Old Pak	1 Side New Pak	1 Side Both Paks	1 Side Rubber Coating Both Paks	New Style Pak Kit Only	2 Sides New Pak CF# Jiffy 277*	Swing Spout Pak Kit	Niad* Slow-Close Kit	Newest Style Quatum* Kit Both Paks
<b>To Fit Stems</b>									
008			●	●					●●
011								●●●	
015			○	○					○○
017	○	○	○	○		○○			○○
018						○○			
111		○	○	○	○	○○			
204								●●	●●
C001	●	●	●			●●			
C001A				● Rubber Coated					
C002	●	●	●	●		●●			●●
C003	●								
C004	●	●	●	●		●●			●●
C005C	●	●	●	●		●●			●●
C006	●		●	●					
C007	●	●	●	●		●●			●●
C007S								●●	
C008HD	●	●	●	●		●●			
C008W								○○	○○
C009		●	●	●	●	●●			
C010SS		●	●	●	●	●●			
C012								●●	
C0013									●●
C018						●	●		●
WFG-1						●	●	●	

**C1 - FAUCET REPAIR**  
By Manufacturer

Item #	Ref #	Description
C-1		Chicago Faucet* Kit, Old Style 1 Side
C-2		Chicago Faucet* Kit, New Style 1 Side
C-3		Chicago Faucet* Non-Ceramic Combo Kit, 1 Side w/Both Paks
C-3A		Chicago Faucet* Combo Kit, 1 Side, 2 Paks
C-4		Chicago Faucet* New Style Pack Kit
C-5	1-22*, 277*	Chicago Faucet* Jiffy* Style Kit, 2 Side
C-6		Chicago Faucet* Swing Spout Packing Repair Kit
C-7	1-27*	Chicago Faucet* Niad* Slow-Close Rebuild Kit
C-8	1-20*	Chicago Faucet*, Quatum* Newer Style 2 Side Kit (Replacing Cartridges X & XT)
C018	C-6(1-6)*	Packing-Swing Spout - New Style Rubber

\*Registered trademark or trade name of the mfg. listed used for reference only. Don't confuse us with the mfg. listed. 2. Products marked "low lead" or "lead free" contain 0.25% lead or less, per California AB 1953 & Vermont S152 Legislative Specs.  
 \*\*PROP 65 WARNING! Exposure to ingredients in these products such as: Acrylamide, Arsenic, Benzene, Cadmium, Lead, Mercury are known to the state of California to cause cancer, birth defects or reproductive harm. (See <http://oehha.ca.gov/prop65.html>). Wash contacted body parts immediately. Assembled and tested in the USA

## Faucet Repair by Manufacturer - Crane\*

**Multi-fit Nipple**

**Fits**  
New & Improved  
"Will Not Break or Split"

Winner of the 2004 IHMA Award



Item #	Description
FN-999R	Multi-Fit Nipple, Hard TP Rubber

**Lead Free**

**C108** **C109**

Item #	Ref #	Description
C108	FB11-285*	Classic* 2 HDL Washerless Cartridge
C109		Inlet Seal For Crane*

**Dial-Eze\* Parts**

**Fits**

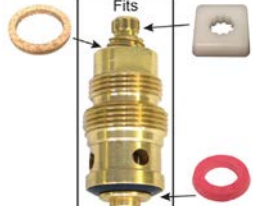

Item #	Ref #	Description
C100	F10592*	Lower Washer - Standard (Red)
C100(25BG)	F11035	Dial Eze* Lower Washer (25/bg) - Std
C100S	F11035*	Lower Washer - Soft (Black)
C100H	F12010*	Lower Washer - Special Hard (White) Old C103
C101	F12560*	Handle Adapter Disk
C102	F10590*	Cork Gap Gasket
C102HD	F10590*	Cork Gap Gasket, Heavy Duty

**Dial-Eze\* Repair Kit**

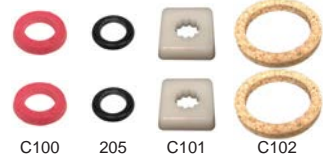

Item #	Description
CR-1	Crane* Dial-eze* Repair Kit w/2 ea: C100, C101, C102, 205

### Crane\* Cartridges (Also See MOEN\* & Powers\*)

**CRANE\*, MOEN\***

**Fits**

**Capri\* Dialette\***

**Lead Free**



Item #	Ref #	Description
M008LF	9704*	S/H Brass Cartridge w/Tool and Instructions - Lead Free

**CRANE\*, POWERS\***

**Fits**



Item #	Ref #	Description
P601	410-378*	Brass Stem Kit 400*/ 410* Models 1 thru 3

## Faucet Repair by Manufacturer - Danfoss\* (Also See Tempress II\*)

### Pressure Balancing Cartridges

**Fits**

**HDL-58**

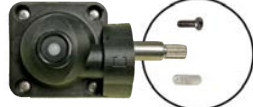

Item #	Ref #	Description
T054H	47078*, 062N1206*, 062N1285*, 17869000	Pressure Balancing Cartridge w/Screws, 1/bg

**Fits**

**HDL-58**

**Grohe\* Tempress\* 47-157-000\* "High Flow\*" Cartridge**



Item #	Ref #	Description
T055	47-157-000*	Tempress* High-Flow* Gray Cartridge With Ledges, T*11*EFX*

**Fits**

**HDL-58**

**Grohe\* Tempress\* 1793 9000\* "Modular\*" Cartridge**

3-Way Hemi-O-Ring



Item #	Ref #	Description
T056	1793 9000*	Tempress* Modular* Cartridge, Black With 3-Way Hemi-O-Ring

### Escutcheon Handle Drive Assembly

**ES-DT2APK**



Item #	Ref #	Description
ES-DT2APK	1-207*	Escutcheon HDL Drive Assembly RE 2/pc Escutcheons, 1/bg

### Stop Plus Kit

**Fits**



Item #	Ref #	Description
T054-16K	10494*	Stop Plus Kit, 1/bg

### Stem Adapter



Item #	Description	Bkn/Std Pak
ES-DT1-4K	Stem Adapter w/Screw, Tempress* Kohler* Powers* Danfoss*	1/6

### Stem Adapter and Extender



Item #	Description
ES-DT1-4KE	ES-DT1-4K w/Stem Extension And Screw

TEMPRESS II\*/DANFOSS\*/GROHE\*/PHYLIRICH\*/INDIANA\*/NEWPORT BRASS\*, ETC.....

## VALVE BODY CONVERSION KIT

**KIT INCLUDES EVERYTHING: CAP, ADAPTERS, SCREWS, NUTS**





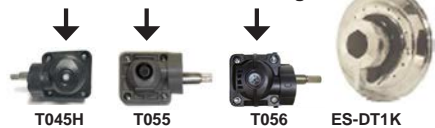





**Works with these cartridges:**



Replace various trims used by the sub-manufacturers who marketed this tub shower valve.

ITEM #	REF#	DESCRIPTION	PAK	STD PK
T054VC	47343560*	TEMPRESS*GROHE*ETC REPLACEMENT CAP WITH ESCUTCHEON ADAPTERS	1/BX	6

# Faucet Repair by Manufacturer - Delta\*, Delex\*, Peerless\* Seats and Springs

Seat - New Style			Seat - Old Style			Seat and Spring Kit					
											
Item #	Ref #	Description	Item #	Ref #	Description	Item #	Description				
D001	RP1806*	Seat - NS (Short)	D002	RP1505*	Seat - O.S. (Long)	D-6	Seat and Spring Kit				
D001R	RP1806*	Formulated N/S Seats - Red - Hot									
D001B	RP1806*	Formulated N/S Seats - Blue - Cold									
Spring - Old Style Straight			Spring - New Style Conical			Seat and Spring Kit					
											
Item #	Ref #	Description	Item #	Ref #	Description	Item #	Description				
D004U	RP1181*	Spring - O.S., Straight	D003U	RP3427*	Spring - N.S., Conical	SD-6	Seat and Spring Kit				
Delta*, Delex*, Peerless* - Cams and Packings											
Cam - White, Heart Center			Cam - White, Slotted Center			Cam - Grey, Heart Center			Cam - Grey, Slotted Center		
 <p>Fits: D008, D009, D008SS</p>			 <p>Fits: D010, D010SS, D011</p>			 <p>4pc</p>			 <p>4pc</p>		
Item #	Ref #	Description	Item #	Ref #	Description	Item #	Ref #	Description	Item #	Ref #	Description
D005	RPB60*	Cam-White-Heart Center	D006	RP1165*	Cam-White-Slotted Center	D005NS	RP1165*	Cam-White-Slotted Center	D006NS	RP1165*	Cam-White-Slotted Center
Ribbed Packing "Siliconized"			TEF Pack			Old Style Peerless*					
						  <p>Control Cap 75-#4-819</p>					
Item #	Ref #	Description	Item #	Ref #	Description	Item #	Description				
D007	RPB251*	Packing Siliconized	D019	RPB25*	Packing w/Teflon Ring	D020	Packing - O/S Peerless* Unarco*, Federal*, Emco*				
Cup Washer			Allen Hex Wrench - 1/8" Short Arm			Wrench With Out Formed Allen Wrench					
 <p>Fits D040LF D040LFK</p>			 <p>1/8"</p>								
Item #	Description		Item #	Description	Bkn/Std Pak	Item #	Description	Bkn/Std Pak			
D040-1	Cup Washer, Slow-Close		D021	Allen Hex Wrench, 1/8 inch Short Arm	100/1000	D023	Wrench Combo w/Out Formed Allen Key	100/1000			
Wrench / Hex Combo - Basic Standard						Combo Wrench - Flat Style					
											
Item #	Description					Item #	Description				
D024	Wrench/Hex Combo, Heavy Duty, 2 pc w/Real (Removable) Allen (Hex) Wrench					D026	Combo Wrench in Flat Style				

C1 - FAUCET REPAIR  
By Manufacturer

\*Registered trademark or trade name of the mfg. listed used for reference only. Don't confuse us with the mfg. listed. 2. Products marked "low lead" or "lead free" contain 0.25% lead or less, per California AB 1953 & Vermont S152 Legislative Specs.  
**\*\*PROP 65 WARNING!** Exposure to ingredients in these products such as: Acrylamide, Arsenic, Benzene, Cadmium, Lead, Mercury are known to the state of California to cause cancer, birth defects or reproductive harm. (See <http://oehha.ca.gov/prop65.html>). Wash contacted body parts immediately. Assembled and tested in the USA

# Faucet Repair by Manufacturer - Delta\*, Delex\*, Peerless\* - Balls

Stainless Steel

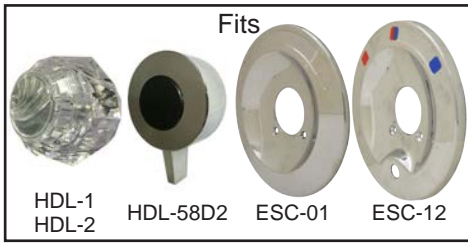

Lead Free

Item #	Ref #	Description
D010SS	RP212*	Ball - 212 Style - Stainless Steel

Brass

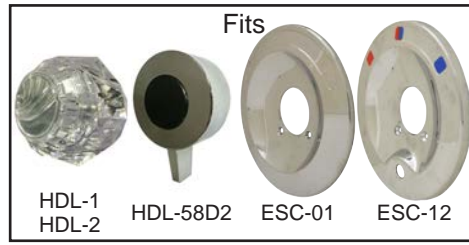

Tub/Shower Only

Item #	Ref #	Description
D011	RP212*	Ball - 212 Style - Brass

Brass



Tub/Shower Only

Item #	Ref #	Description
D009	RP70*	Ball - 70 Style - Brass

Stainless Steel

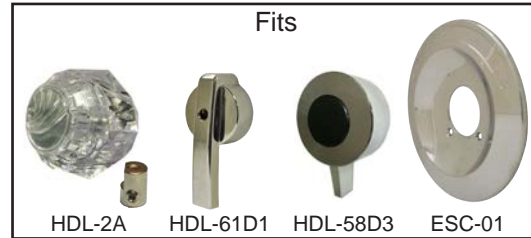

Lead Free

Item #	Ref #	Description
D008SS	RP70*	Ball - 70 Style - Stainless Steel

Plastic



Lead Free

Item #	Ref #	Description
D008	RP70*	Ball - 70 Style - Plastic

Plastic



Lead Free

Item #	Ref #	Description
D010	RPB212*	Ball - 212 Style - Plastic

Cap Assembly



Item #	Ref #	Description
D027	RP50*	Cap Assembly - Complete (CP)

Plastic Adjusting Ring



Item #	Ref #	Description
D022	RP250*	Adjusting Ring, OEM Style Plastic

Brass Adjusting Ring



Item #	Ref #	Description
D016	RP250*	Adjusting Ring - Brass

C1 - FAUCET REPAIR By Manufacturer

\*Registered trademark or trade name of the mfg. listed used for reference only. Don't confuse us with the mfg. listed. 2. Products marked "low lead" or "lead free" contain 0.25% lead or less, per California AB 1953 & Vermont S152 Legislative Specs. \*\*PROP 65 WARNING! Exposure to ingredients in these products such as: Acrylamide, Arsenic, Benzene, Cadmium, Lead, Mercury are known to the state of California to cause cancer, birth defects or reproductive harm. (See <http://oehha.ca.gov/prop65.html>). Wash contacted body parts immediately. Assembled and tested in the USA

# Faucet Repair by Manufacturer - Delta\*

Lead Free

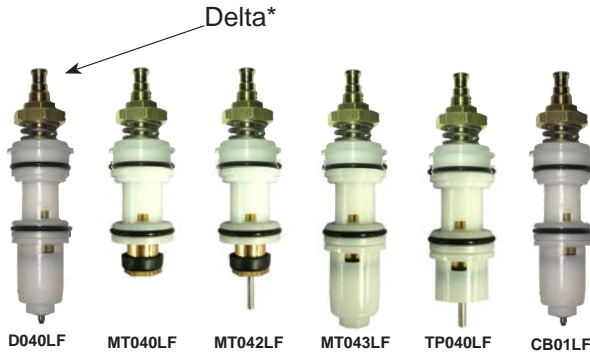

Item #	Ref #	Description
D040LF	RP6399*	DP* Single Side Slow Close Cartridge
MT040LF	MT039*	Metering Cartridge Replacement for Metcraft* Penal Metering Cartridge
MT042LF	190126A*	Metcraft* Tempus* Self Closing Cartridge, Pre 1992
MT043LF	060160A*	Metcraft* Teck* Metering Cartridge, 1992-98
TP040LF	190126A*	Tempus* Short Metering Cartridge
CB01LF	060160A*	Single Handle Self-Closing Faucet Metering Cartridge

## Rebuild Kit for D040F



D040K

Item #	Description
D040K	Kit, Rebuild DP*, Single Side Slow Close

## Sink Spray Diverter



D014LF

Item #	Ref #	Description
D014LF	RP63136*	Diverter - Stainless Steel, Poly- Brass Stem, Plastic Bonnet

## Faucet Repair by Manufacturer - Delta\*, Delex\*, Peerless\*

### Push Button Diverter



ESC-12

ESC-14

ESC-68

Item #	Ref #	Description
D038	RP5649*	Cartridge - Push Button Diverter

Winner of the 1997 DKBBMA Award

Tub/Shower Only

### Cartridge Push Button Diverter Eliminator

Convert Delta\* & Peerless\* Tub Shower Valve Bodies with Push Button Diverter To Standard Valve Bodies Which Use Standard Diverter Spout



D038-PLUG

Other Related Items



Item #	Ref #	Description
D038-PLUG	RP2865*	Delta* Plug Diverter Converter, Brass

### Old Style 2 - Handle



HDL-14(PR)



D012

D012NS

Item #	Ref #	Description
D012	RP1974*	Cartridge - Delex*, Peerless*, Old Style 2 HDL
D012NS	RP1974*	Cartridge - N/S Delex* w/ SS Bottom

Lead Free

### 3 Handle Diverter

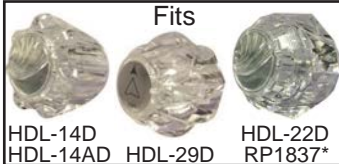

HDL-14D  
HDL-14AD

HDL-29D

RP1837\*

Winner of the 1997 DKBBMA Award



Item #	Ref #	Description
D042	RP17730*	Cartridge - Delex* 3 HDL T/S Diverter

### Delex\* Cartridge Extender



D012 D012NS

Item #	Ref #	Description
D035	RP18627*	Delex* HDL Extender w/ Screw 1/BG
D035(PR)	RP12631*	Delex* HDL EXTENDERS w/Screws 1 PR/BG

Lead Free

### Cartridge - Peerless\*

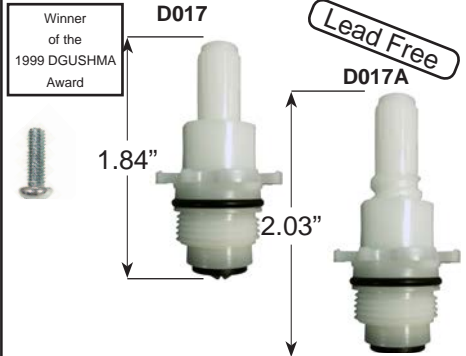

1.84"

2.03"

Winner of the 1999 DGUSHMA Award

Item #	Description
D017	Cartridge - Peerless* Valvuflow* Larden*
D017A	Cartridge - Larden* Peerless* Valueflow* Long

Lead Free

\*Registered trademark or trade name of the mfg. listed used for reference only. Don't confuse us with the mfg. listed. 2. Products marked "low lead" or "lead free" contain 0.25% lead or less, per California AB 1953 & Vermont S152 Legislative Specs.  
 \*\*PROP 65 WARNING! Exposure to ingredients in these products such as: Acrylamide, Arsenic, Benzene, Cadmium, Lead, Mercury are known to the state of California to cause cancer, birth defects or reproductive harm. (See <http://oehha.ca.gov/prop65.html>). Wash contacted body parts immediately. Assembled and tested in the USA

# Faucet Repair by Manufacturer - Delta\*, Delex\*, Peerless\*

## Scald Guard\* Cartridge - Shower Valve



HDL-12 HDL-52CP  
RP2392\* H78\*

Item #	Ref #	Description
D030	RP1991*	Cartridge, Shower Valve, Scald Guard*, Type Replacement, 1/bg

## Scald Guard\* Cartridge Shower Valve, Brass Stem With Hot Stop



HDL-12 HDL-52CP  
RP2392\* H78

Item #	Ref #	Description
D030A	RP1991*	Cart w/Brass Stem, Shower Valve, Scald Guard* Type Replacement, 1/bg

## Monitor\* (N/S)



HDL-12 HDL-53CP  
R2392\* H78\*

HDL-58D1 Monitor\* 1300\*, 1400\* Series



Item #	Ref #	Description
D054FS	RP19804*	Delta* Monitor* N/S Cart Complete Assembly

## What Our Monitor\* Cartridge (D054N) Replaces

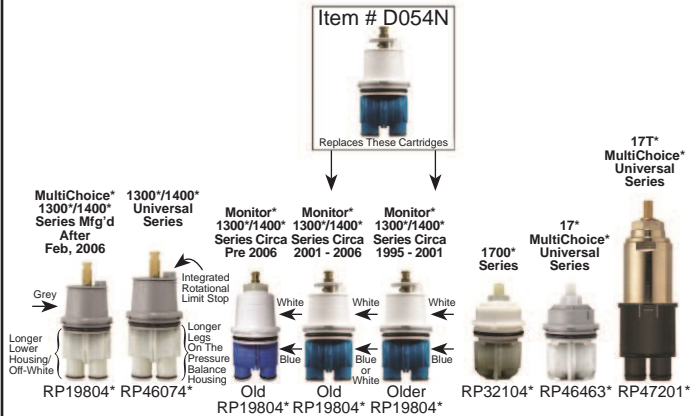

## Female - .5 GPM Large Brass

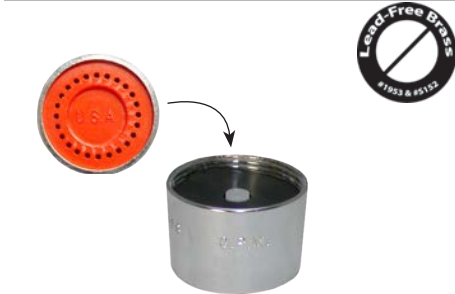

Item #	Description
AER-3F	Standard Large Female Faucet End Piece

## Female - 1.2 GPM Large Brass

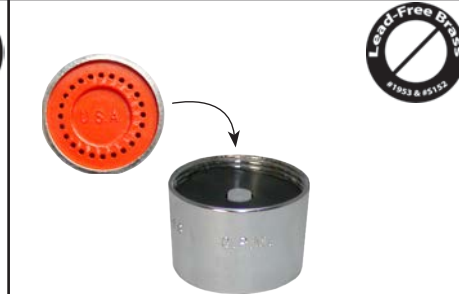

Item #	Ref #	Description
AER-6F		Std Female Aerator w/ Turbo Bottom, CP

## Turbo Design - Female - 2 GPM Brass

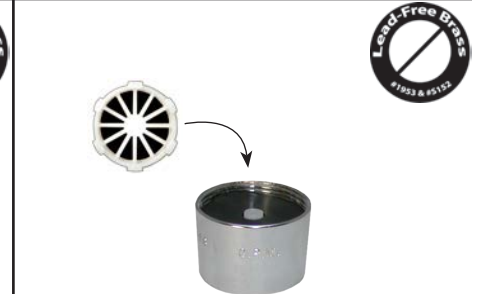

Item #	Ref #	Description
AER-1F	RP11718*	Standard Female Aerator w/Turbo Bottom, CP

## Turbo Design - Male - 2 GPM Black Plastic























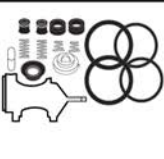
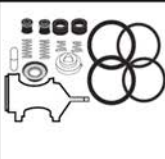



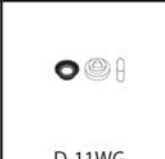







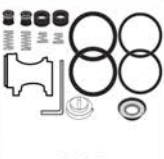

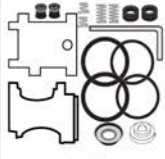





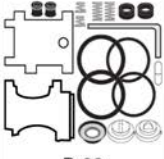
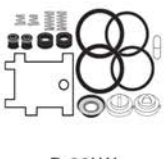





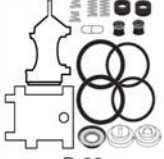



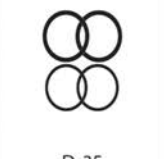

Item #	Ref #	Description
AER-1MPL	RP330*	Standard Male Aerator w/ Turbo Bottom, Black Plastic

C1 - FAUCET REPAIR By Manufacturer

# Faucet Repair by Manufacturer - Delta\*, Delex\*, Peerless\* - Partial Kit Summary

See Next Page for  
Parts Breakdown

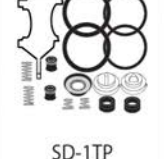
- Note:** 1. All Kits Are Bagged Unless Otherwise Requested  
2. We Can and Will Copy Any Style Kit

 D-1	 D-1A	 D-1TP (RP3614*)	 D-1ATP	 D-2	 D-2TP (RP3616*)	 D-2ATP	 D-3
 D-6 (RP4993*)	 D-7	 D-8	 D-8TP	 D-9	 D-10	 D-11	 D-11WG (RP61*)
 D-12TP D-12	 D-12WG	 D-13	 D-14	 D-16	 D-16ATP	 D-18	 24/EA D-19
 D-20	 10/EA D-21	 D-23	 D-24	 D-25	 D-26	 D-27	 D-29 (RP2055*)
 D-31	 D-32	 D-32LW	 PPD-2ATP	 PPD-4	 SD-1	 SD-1A	 SD-1ATP
 SD-1WG	 D-33	 SD-2	 SD-5	 SD-6	 D-30	 D-33LW	 D-34
 D-35	 D-40	 D-41	 D-42	 D-43	 D-44	 D-45	 PPD-5
 SD-1TP	 SD-2WW	 SD-5NS					

C1 - FAUCET REPAIR  
By Manufacturer

\*Registered trademark or trade name of the mfg. listed used for reference only. Don't confuse us with the mfg. listed. 2. Products marked "low lead" or "lead free" contain 0.25% lead or less, per California AB 1953 & Vermont S152 Legislative Specs.  
\*\*PROP 65 WARNING! Exposure to ingredients in these products such as: Acrylamide, Arsenic, Benzene, Cadmium, Lead, Mercury are known to the state of California to cause cancer, birth defects or reproductive harm. (See <http://oehha.ca.gov/prop65.html>). Wash contacted body parts immediately. Assembled and tested in the USA

Faucet Repair by Manufacturer - Delta\* - Kits Parts Breakdown

Delta\* - Kits Parts Breakdown

L/E KIT # -BOM	D001	D002	D003	D004	D005	D006	D007	D009	D012	D012NS	D013	D019	D021	D022	D023	D026	WFG-1	OR017	OR119	OR123	OR125	OR203	OR204	OR212	OR218
SD-5NS	2	2	2	2	1	1	1	1	1	1	1	1	1	1	1	1	1	1	1	1	2	2	2	2	2
SD-2WW	2	2	2	2	2	2	2	2	2	2	2	2	2	2	2	2	2	2	2	2	2	2	2	2	2
SD-1TP	2	2	2	2	2	2	2	2	2	2	2	2	2	2	2	2	2	2	2	2	2	2	2	2	2
PPD-5	2	2	2	2	2	2	2	2	2	2	2	2	2	2	2	2	2	2	2	2	2	2	2	2	2
D-45	2	2	2	2	2	2	2	2	2	2	2	2	2	2	2	2	2	2	2	2	2	2	2	2	2
D-44	2	2	2	2	2	2	2	2	2	2	2	2	2	2	2	2	2	2	2	2	2	2	2	2	2
D-43	2	2	2	2	2	2	2	2	2	2	2	2	2	2	2	2	2	2	2	2	2	2	2	2	2
D-42	2	2	2	2	2	2	2	2	2	2	2	2	2	2	2	2	2	2	2	2	2	2	2	2	2
D-41	2	2	2	2	2	2	2	2	2	2	2	2	2	2	2	2	2	2	2	2	2	2	2	2	2
D-40	2	2	2	2	2	2	2	2	2	2	2	2	2	2	2	2	2	2	2	2	2	2	2	2	2
D-35	2	2	2	2	2	2	2	2	2	2	2	2	2	2	2	2	2	2	2	2	2	2	2	2	2
D-34	2	2	2	2	2	2	2	2	2	2	2	2	2	2	2	2	2	2	2	2	2	2	2	2	2
D-33LW	2	2	2	2	2	2	2	2	2	2	2	2	2	2	2	2	2	2	2	2	2	2	2	2	2
D-30	2	2	2	2	2	2	2	2	2	2	2	2	2	2	2	2	2	2	2	2	2	2	2	2	2
SD-6	2	2	2	2	2	2	2	2	2	2	2	2	2	2	2	2	2	2	2	2	2	2	2	2	2
SD-5	2	2	2	2	2	2	2	2	2	2	2	2	2	2	2	2	2	2	2	2	2	2	2	2	2
SD-2	2	2	2	2	2	2	2	2	2	2	2	2	2	2	2	2	2	2	2	2	2	2	2	2	2
D-33	2	2	2	2	2	2	2	2	2	2	2	2	2	2	2	2	2	2	2	2	2	2	2	2	2
SD-1WG	2	2	2	2	2	2	2	2	2	2	2	2	2	2	2	2	2	2	2	2	2	2	2	2	2
SD-1ATP	2	2	2	2	2	2	2	2	2	2	2	2	2	2	2	2	2	2	2	2	2	2	2	2	2
SD-1A	2	2	2	2	2	2	2	2	2	2	2	2	2	2	2	2	2	2	2	2	2	2	2	2	2
SD-1	2	2	2	2	2	2	2	2	2	2	2	2	2	2	2	2	2	2	2	2	2	2	2	2	2
PPD-4	2	2	2	2	2	2	2	2	2	2	2	2	2	2	2	2	2	2	2	2	2	2	2	2	2
PPD-2ATP	2	2	2	2	2	2	2	2	2	2	2	2	2	2	2	2	2	2	2	2	2	2	2	2	2
D-32LW	2	2	2	2	2	2	2	2	2	2	2	2	2	2	2	2	2	2	2	2	2	2	2	2	2
D-32	2	2	2	2	2	2	2	2	2	2	2	2	2	2	2	2	2	2	2	2	2	2	2	2	2
D-31	2	2	2	2	2	2	2	2	2	2	2	2	2	2	2	2	2	2	2	2	2	2	2	2	2
D-29	2	2	2	2	2	2	2	2	2	2	2	2	2	2	2	2	2	2	2	2	2	2	2	2	2
D-27	2	2	2	2	2	2	2	2	2	2	2	2	2	2	2	2	2	2	2	2	2	2	2	2	2
D-26	2	2	2	2	2	2	2	2	2	2	2	2	2	2	2	2	2	2	2	2	2	2	2	2	2
D-25	2	2	2	2	2	2	2	2	2	2	2	2	2	2	2	2	2	2	2	2	2	2	2	2	2
D-24	2	2	2	2	2	2	2	2	2	2	2	2	2	2	2	2	2	2	2	2	2	2	2	2	2
D-23	2	2	2	2	2	2	2	2	2	2	2	2	2	2	2	2	2	2	2	2	2	2	2	2	2
D-21	2	2	2	2	2	2	2	2	2	2	2	2	2	2	2	2	2	2	2	2	2	2	2	2	2
D-20	2	2	2	2	2	2	2	2	2	2	2	2	2	2	2	2	2	2	2	2	2	2	2	2	2
D-19	2	2	2	2	2	2	2	2	2	2	2	2	2	2	2	2	2	2	2	2	2	2	2	2	2
D-18	2	2	2	2	2	2	2	2	2	2	2	2	2	2	2	2	2	2	2	2	2	2	2	2	2
D-16ATP	2	2	2	2	2	2	2	2	2	2	2	2	2	2	2	2	2	2	2	2	2	2	2	2	2
D-16	2	2	2	2	2	2	2	2	2	2	2	2	2	2	2	2	2	2	2	2	2	2	2	2	2
D-14	2	2	2	2	2	2	2	2	2	2	2	2	2	2	2	2	2	2	2	2	2	2	2	2	2
D-13	2	2	2	2	2	2	2	2	2	2	2	2	2	2	2	2	2	2	2	2	2	2	2	2	2
D-12WG	2	2	2	2	2	2	2	2	2	2	2	2	2	2	2	2	2	2	2	2	2	2	2	2	2
D-12	2	2	2	2	2	2	2	2	2	2	2	2	2	2	2	2	2	2	2	2	2	2	2	2	2
D-11WG	2	2	2	2	2	2	2	2	2	2	2	2	2	2	2	2	2	2	2	2	2	2	2	2	2
D-11	2	2	2	2	2	2	2	2	2	2	2	2	2	2	2	2	2	2	2	2	2	2	2	2	2
D-10	2	2	2	2	2	2	2	2	2	2	2	2	2	2	2	2	2	2	2	2	2	2	2	2	2
D-9	2	2	2	2	2	2	2	2	2	2	2	2	2	2	2	2	2	2	2	2	2	2	2	2	2
D-8TP	2	2	2	2	2	2	2	2	2	2	2	2	2	2	2	2	2	2	2	2	2	2	2	2	2
D-8	2	2	2	2	2	2	2	2	2	2	2	2	2	2	2	2	2	2	2	2	2	2	2	2	2
D-7	2	2	2	2	2	2	2	2	2	2	2	2	2	2	2	2	2	2	2	2	2	2	2	2	2
D-6	2	2	2	2	2	2	2	2	2	2	2	2	2	2	2	2	2	2	2	2	2	2	2	2	2
D-3	2	2	2	2	2	2	2	2	2	2	2	2	2	2	2	2	2	2	2	2	2	2	2	2	2
D-2TP	2	2	2	2	2	2	2	2	2	2	2	2	2	2	2	2	2	2	2	2	2	2	2	2	2
D-2ATP	2	2	2	2	2	2	2	2	2	2	2	2	2	2	2	2	2	2	2	2	2	2	2	2	2
D-2	2	2	2	2	2	2	2	2	2	2	2	2	2	2	2	2	2	2	2	2	2	2	2	2	2
D-1TP	2	2	2	2	2	2	2	2	2	2	2	2	2	2	2	2	2	2	2	2	2	2	2	2	2
D-1ATP	2	2	2	2	2	2	2	2	2	2	2	2	2	2	2	2	2	2	2	2	2	2	2	2	2
D-1A	2	2	2	2	2	2	2	2	2	2	2	2	2	2	2	2	2	2	2	2	2	2	2	2	2
D-1	2	2	2	2	2	2	2	2	2	2	2	2	2	2	2	2	2	2	2	2	2	2	2	2	2



## Faucet Repair by Manufacturer - Delta\* - Kits Parts Reference

RP250* = D022	NEW STYLE PLASTIC ADJ RING
D016	OLD SIZE/STYLE BRASS ADJ RING
RP50* = D027	CAP ASSEMBLY W/ADJ RING
RP61* = D-26	HEART CAM & PAK
D-11WG	HEART CAM & SIL PAK W/GREASE CAPSULE
PR320* = D014	SS DIVERTERER1 HDL MODELS
PR70* = D008SS	SS DIVERTER 1 HDL MODELS
D008	SS 70 BALL
D009	BRASS BALL
RP61* = D005NS	CAM WHITE HEART CENTER
RP188* = D006NS	CAM WHITE SLOTTED CENTER
RP330* = AER-1M	MALE AERATOR CP
RP-4993* = D-6	N/S SEATS AND SPRINGS
SD-2	N/S & O/S SEATS AND SPRINGS
D-7	O/S SEATS AND SPRINGS
RP25* = D-35A	N/S SPOUT SEALS ONLY (2/E 218)
D-35	N/S & O/S SPOUT SEALS (2/E 218 & 2/E 125 W/ GREASE CAPSULE)
RP1974* = D024	HEAVY DUTY WRENCH
D013	LIGHT DUTY WRENCH
D023	WRENCH LESS HEX WRENCH
D026	WRENCH LESS HEX WRENCH - FLAT STYLE
D021	HEX WRENCH ONLY
RP3614* = D-50	NS FACTORY 3614 REPAIR KIT
D-ATP	OS FACTORY 3614 KITCHEN REPAIR KIT
D-1	PROMO STYLE KITCHEN REPAIR KIT
SD-1	COMBO KIT - O/S N/S SEATS/SPRINGS
D-33	BIGGEST COMBO KIT (BOTH CAMS)
RP21908* = D041	PUMP - SOAP DISPENSER
RP1740* = D012SS	CARTRIDGE - 2HDL W/SS BOTTOM
D012	CARTRIDGE - 2HDL OS W/O SS BOTTOM
H41* = HDL-11PR	MED HDL ASSEMBLIES W/ CAPS
RP183773* = HDL-11PR	HDL CAPS ONLY H/C
H21* = HDL-14APR	SMALL HDL ASSEMBLIES W/ CAPS H/C
H26* = HDL-13PR	CANOPY HDL ASSEMBLIES W/ CAPS H/C
RP2412* = FHC-13PR	HDL CAPS ONLY H/C
RP5885* =	HDL SCREWS - BULK
RP2055* = D-29	SPOUT SEALS, 2 HDL (3/EA W/SIL CAP)
RP27527* = D035	STEM EXTENDER
RP6399* = D040	SLOW CLOSE CARTRIDGE
RP17451* = HDL-1	OFF SET HDL W/ CAP & SCREW
RP17446 = FHC-1	CAP & SCREW ONLY
RP-212 = D010SS	BALL 212 STAINLESS STEEL
D010	BALL 212 PLASTIC
D011	BALL212 BRASS
RP5649* = D038	PUSH BUTTON DIVERTER
RP29827* = ESC-101	RENOVATION PLATE
RP188* = D-26	SLOT CAM & TEF PAK
RP196* = ESC-12CP	ESC DIVERTER HOLE
RP12630* = SCREW-37	ESC SCREWS (10-24 x3") CP
RP5883* = ESC-01CP	ESC STD CP
RP17498* =	TEMP INDICATOR STICKER DELTA ROUND
H71* = HDL-12	HDL RE SCALD GUARD W/ CAP & SCREW
RP20542* = FHC-12	HDL CAP ONLY
RP1991* = D030A	SCALD GUARD CART W/ BRAS STEM/ADJ SCREW

**C1 - FAUCET REPAIR**  
By Manufacturer

\*Registered trademark or trade name of the mfg. listed used for reference only. Don't confuse us with the mfg. listed. 2. Products marked "low lead" or "lead free" contain 0.25% lead or less, per California AB 1953 & Vermont S152 Legislative Specs.  
 \*\*PROP 65 WARNING! Exposure to ingredients in these products such as: Acrylamide, Arsenic, Benzene, Cadmium, Lead, Mercury are known to the state of California to cause cancer, birth defects or reproductive harm. (See <http://oehha.ca.gov/prop65.html>). Wash contacted body parts immediately. Assembled and tested in the USA

# Faucet Repair by Manufacturer - Dornbracht\* & Eljer\*

## Pressure Balancing Cartridges



Item #	Ref #	Description
T054H	47078*	Pressure Balancing Cartridge w/Screws, 1/bg

DORNBRACHT\* =  
0415050-500090\*  
ELJER\* =  
V4750\*



Grohe\*  
Tempress\*  
47-157-000\*  
"High Flow\*\*"  
Cartridge

Item #	Ref #	Description
T055	47-157-000*	Tempress* High-Flow* Gray Cartridge With Ledges, T*11*EFX*



Grohe\*  
Tempress\*  
1793 9000\*  
"Modular\*\*"  
Cartridge

Item #	Ref #	Description
T056	1793 9000*	Tempress* Modular* Cartridge, Black With 3-Way Hemi-O-Ring

## Escutcheon Handle Drive Assembly

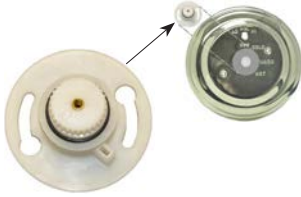

ES-DT2APK

Item #	Ref #	Description
ES-DT2APK	1-207*	Escutcheon HDL Drive Assembly RE 2/pc Escutcheons, 1/bg

## Stop Plus Kit



Item #	Ref #	Description
T054-16K	10494*	Stop Plus Kit, 1/bg

## Stem Adapter



ES-DT1-4K

Item #	Description
ES-DT1-4K	Stem Adapter w/Screw, Tempress* Kohler* Powers* Danfoss*

## Stem Adapter and Extender



ES-DT1-4KE

Item #	Description
ES-DT1-4KE	ES-DT1-4K w/Stem Extension And Screw

TEMPRESS II\*/DANFOSS\*/GROHE\*/PHYLIRICH\*/INDIANA\*/NEWPORT BRASS\*, ETC.....

## VALVE BODY CONVERSION KIT

KIT INCLUDES EVERYTHING:  
CAP, ADAPTERS, SCREWS, NUTS



Works with these cartridges:

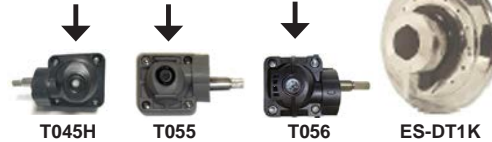

Replace various trims used by the sub-manufacturers who marketed this tub shower valve.

ITEM #	REF#	DESCRIPTION	PAK	STD PK
T054VC	47343560*	TEMPRESS*GROHE*ETC REPLACEMENT CAP WITH ESCUTCHEON ADAPTERS	1/BX	6

## Faucet Repair by Manufacturer - Eljer\* (Also See Powers\* & Valley\*)

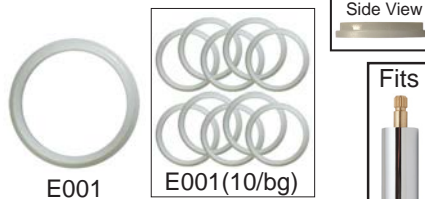

E001

E001(10/bg)

Item #	Description
E001	Shower Diverter Washer
E001(10BG)	Shower Diverter Washer (10/bg)



Item #	Ref #	Description
P601	410-378*	Brass Stem Kit 400/410 Models 1 thru 3

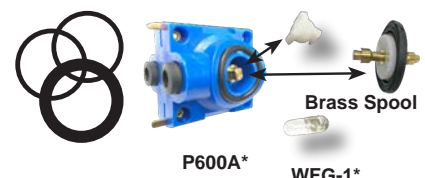

P600A\*

WFG-1\*

Item #	Ref #	Description
P600A	401-183*	PB Pool Assembly, Series 400/410, Models 1 thru 3

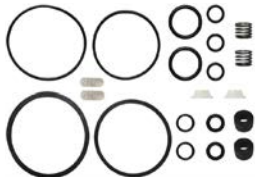

Item #	Ref #	Description
PWR-1	410-182*	Rebuild Kit 400/410 Series w/Handle Cap



Item #	Ref #	Description
V001	410-378*	O/S S/H Cartridge (Current Sterling* & All Phoenix* S/H)



Lead Free

V001



Fits

HDL-5 HDL-58VE1

V010K (Plastic Stem)  
V010AK (Brass Stem)

Lead Free

Item #	Ref #	Description
V010K	VP1964*	S/H Cart, Plastic Stem w/Spout Seals and Wrench
V010AK	VP1965*	S/H Cart, Brass Stem w/Spout Seals and Wrench



Fits

HDL-5

SS Diverter

V011K (Plastic Stem)  
V011AK (Brass Stem)

Lead Free

Item #	Ref #	Description
V011K	VP1964*	S/H Cartridge w/SS Diverter, Plastic Stem w/Spout Seals HDL Screw & Wrench
V011AK	VP1965*	S/H Cartridge w/SS Diverter, Brass Stem w/Spout Seals HDL Screw & Wrench

## Faucet Repair by Manufacturer - Eljer\* (Also See Powers\* & Valley\*)

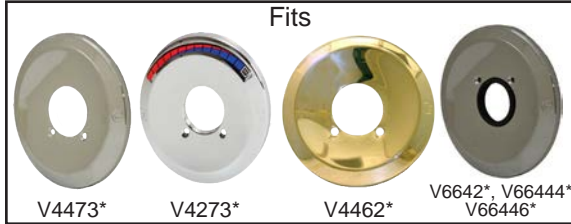

V017 #V6005\*

Item #	Ref #	Description
V017	V6005*	Valley* Cartridge V6005*, Back-To-Back, 1/bg

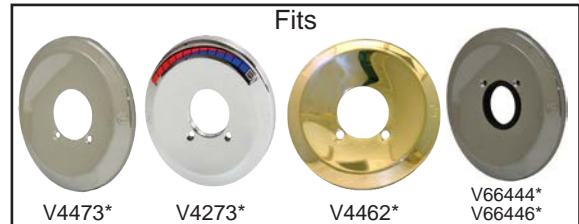

V018 #V4268\*

Item #	Ref #	Description
V018	V4268*	Valley* Pressure Balance Cartridge, T/S, 1/bg

### Elkay\* Haws\* Halsey Taylor\* Drinking Fountain Parts

Elkay\* Haws\* Halsey-Taylor\* Drinking Fountain Parts

With Brass Nut

Without Brass Nut

Holder Assembly Only

EK01-1\*  
50986C\*



EK01NR\* 98732C\*  
(Red Spring)  
EK01NG\* 98536C\*  
(Green Spring)  
EK01



EK01G\* 98732C\*  
(Red Spring)  
EK01R\* 98536C\*  
(Green Spring)



Cartridge



EK02G\* 61314C\*  
(Green Spring)  
EK02R\* 61313C  
(Red Spring)

Cartridge Only



EK02NS\*  
66654C\*  
(No Spring)

Adjusting Ring  
w/ holes



EK01-2\*  
15005C\*



EK01-7\*



EK02-E-3(BG)



OEM Ref #	W/Brass Nut	W/O Brass Nut	Description For Elkay*, Haws*, Halsey-Taylor*	Pack
98732C*	EK01NG	EK01G	Complete body & cartridge assembly, Green Spring	1/BG
98536C*	EK01NR	EK01R	Complete body & cartridge assembly, Red Spring	1/BG
	EK01NNS		Complete body & cartridge assembly, no - spring	1/BG
61314C*	EK02G	N/A	Cartridge Only, Green Spring	1/BG
61313C*	EK02R	N/A	Cartridge Only, Red Spring	1/BG
66654C*	EK02NS	N/A	Cartridge Only, No Spring (SOLINOID Models)	1/BG
15005C*	EK01-2	N/A	Lock Down Ring with holes, OD threads	1/BG
50986C*	EK01-1	N/A	Body Only W/Tube Clinchers only, W/O Brass Nut	1/BG
40045C*	EK01-7(BG)	N/A	Brass Nut, large, RE Body Mounting 1/BG	1/BG
EK02-E-3(BG)		N/A	Bottom main inlet seal, OEM Style Cartridges, 1/BG	1/BG
EK06-1(BG)		N/A	Main Seal Washer for Metal Cartridge, 1/BG	1/BG
36158000* 6983506* 5874*	TW-EK01-2	N/A	Wrench, Spanner, ADJ Ring w/holes RE Lock Rings	1/BG

\*Registered trademark or trade name of the mfg. listed used for reference only. Don't confuse us with the mfg. listed. 2. Products marked "low lead" or "lead free" contain 0.25% lead or less, per California AB 1953 & Vermont S152 Legislative Specs.  
\*\*PROP 65 WARNING! Exposure to ingredients in these products such as: Acrylamide, Arsenic, Benzene, Cadmium, Lead, Mercury are known to the state of California to cause cancer, birth defects or reproductive harm. (See <http://oehha.ca.gov/prop65.html>). Wash contacted body parts immediately. Assembled and tested in the USA

# Faucet Repair by Manufacturer - Emco\*

## Pressure Balancing Cartridges

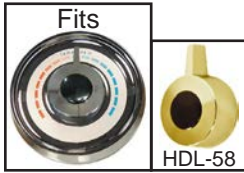

HDL-58

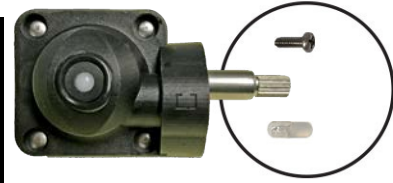

Item #	Ref #	Description
T054H	3103*	Pressure Balancing Cartridge w/Screws, 1/bg

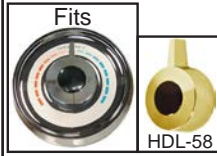

HDL-58

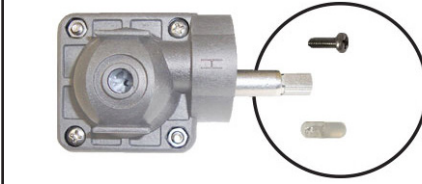

Item #	Ref #	Description
T055	47-157-000*	Tempress* High-Flow* Gray Cartridge With Ledges, T*11*EFX*

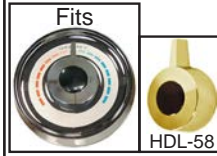

HDL-58

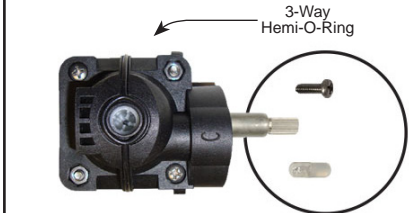

Item #	Ref #	Description
T056	1793 9000*	Tempress* Modular* Cartridge, Black With 3-Way Hemi-O-Ring

**C1 - FAUCET REPAIR By Manufacturer**

## Escutcheon Handle Drive Assembly



ES-DT2APK

Item #	Ref #	Description
ES-DT2APK	1-207*	Escutcheon HDL Drive Assembly RE 2/pc Escutcheons, 1/bg

## Stop Plus Kit

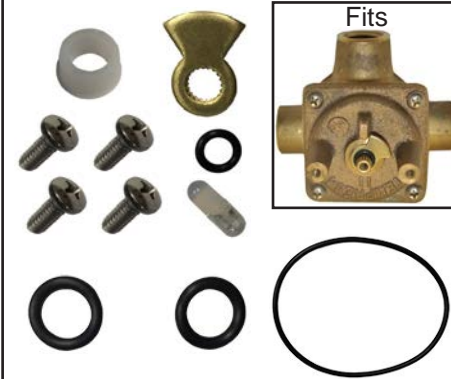

Item #	Ref #	Description
T054-16K	10494*	Stop Plus Kit, 1/bg

## Stem Adapter



ES-DT1-4K

Item #	Ref #	Description	Bkn/Std Pak
ES-DT1-4K	47068000*	Stem Adapter w/Screw, Tempress* Kohler* Powers* Danfoss*	1/6

## Stem Adapter and Extender



Item #	Description
ES-DT1-4KE	ES-DT1-4K w/Stem Extension And Screw

TEMPRESS II\*/DANFOSS\*/GROHE\*/PHYLRIKH\*/INDIANA\*/NEWPORT BRASS\*, ETC.....

## VALVE BODY CONVERSION KIT

KIT INCLUDES EVERYTHING:  
CAP, ADAPTERS, SCREWS, NUTS



Works with these cartridges:



Replace various trims used by the sub-manufacturers who marketed this tub shower valve.

ITEM #	REF#	DESCRIPTION	PAK	STD PK
T054VC	47343560*	TEMPRESS*GROHE*ETC REPLACEMENT CAP WITH ESCUTCHEON ADAPTERS	1/BX	6

## Notes

## Faucet Repair by Manufacturer - Ferguson\*

Pro Flo\* Service Sink Faucet



Item #	Ref #	Description
VBFR-1	PF141553-PK*	Vacuum Breaker, Ferguson* Pro Flo* Service Sink Repair

## Faucet Repair by Manufacturer - Gerber\*



Lead Free

Item #	Ref #	Description
G001	98-710*	Cartridge, 2 HDL Washerless - Hot Side



Lead Free

Item #	Ref #	Description
G003	98-711*	Cartridge, 2 HDL Washerless - Cold Side



Item #	Ref #	Description
G002	93-086*	2 HDL Replacement Seat



Item #	Ref #	Description
G001-5	90-497*	Step Washer, Power, TP Rubber



Item #	Ref #	Description
M013	90-116*	Cartridge Seal Rebuild Kit (Also See Moen* Listing)

Winner of the 2004 IHMA Award



New & Improved "Will Not Break or Split"

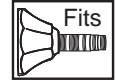

Item #	Description
FN-999R	Multi-Fit Nipple, Hard TP Rubber

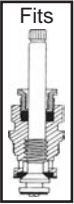

Item #	Ref #	Description
PK002	90-460*	Packing - Rubber, Gerber*, Sterling* T/S Diverter Step

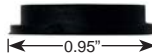

Item #	Ref #	Description
S003	90-380*	Diverter Washer - Gerber* Sterling*

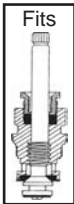
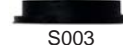

Item #	Description
S-7	Kit - S003 & PK002 w/Lube Kit - Bagged

### Pressure Balancing Cartridges

#### Faucet Repair by Manufacturer - Gerber\*, Grohe\*, Harrington\*, Indiana Brass\*

Gerber\* = 97-510\*  
Grohe\* = 471080.000\*  
Harrington = 62N128500T\*  
Indiana Brass\* = 25709\*

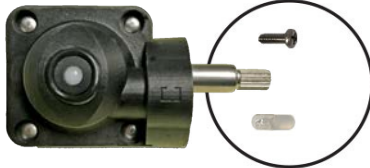
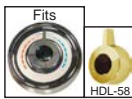

Item #	Description
T054H	Pressure Balancing Cartridge w/ Screws, 1/bg

#### Grohe\* Tempress\* 47-157-000\* "High Flow" Cartridge

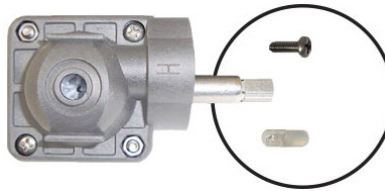

Item #	Ref #	Description
T055	47-157-000*	Tempress* High-Flow* Gray Cartridge With Ledges, T*11*EFX*

#### Grohe\* Tempress\* 1793 9000\* "Modular" Cartridge

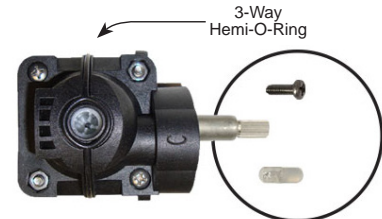

Item #	Ref #	Description
T056	1793 9000*	Tempress* Modular* Cartridge, Black With 3-Way Hemi-O-Ring

TEMPRESS II\*/DANFOSS\*/GROHE\*/PHYLIRICH\*/INDIANA\*/NEWPORT BRASS\*, ETC.....

## VALVE BODY CONVERSION KIT

KIT INCLUDES EVERYTHING:  
CAP, ADAPTERS, SCREWS, NUTS

Works with these cartridges:



Replace various trims used by the sub-manufacturers who marketed this tub shower valve.

ITEM #	REF#	DESCRIPTION	PAK	STD PK
T054VC	47343560*	TEMPRESS*GROHE*ETC REPLACEMENT CAP WITH ESCUTCHEON ADAPTERS	1/BX	6

\*Registered trademark or trade name of the mfg. listed used for reference only. Don't confuse us with the mfg. listed. 2. Products marked "low lead" or "lead free" contain 0.25% lead or less, per California AB 1953 & Vermont S152 Legislative Specs.  
\*\*PROP 65 WARNING! Exposure to ingredients in these products such as: Acrylamide, Arsenic, Benzene, Cadmium, Lead, Mercury are known to the state of California to cause cancer, birth defects or reproductive harm. (See <http://oehha.ca.gov/prop65.html>). Wash contacted body parts immediately. Assembled and tested in the USA

C1 - FAUCET REPAIR  
By Manufacturer

## Faucet Repair by Manufacturer - Gerber\* (Continued)

Escutcheon Handle Drive Assembly

Stop Plus Kit

Stem Adapter



ES-DT2APK

Item #	Ref #	Description
ES-DT2APK	1-207*	Escutcheon HDL Drive Assembly RE 2/pc Escutcheons, 1/bg



Fits

Item #	Ref #	Description
T054-16K	10494*	Stop Plus Kit, 1/bg



ES-DT1-4K

Item #	Description	Bkn/Std Pak
ES-DT1-4K	Stem Adapter w/Screw, Tempress* Kohler* Powers* Danfoss*	1/6

Stem Adapter and Extender



ES-DT1-4KE

Item #	Description
ES-DT1-4KE	ES-DT1-4K w/Stem Extension And Screw

TEMPRESS II\*/DANFOSS\*/GROHE\*/PHYLIRICH\*/INDIANA\*/NEWPORT BRASS\*, ETC.....

KIT INCLUDES EVERYTHING:  
CAP, ADAPTERS, SCREWS, NUTS

### VALVE BODY CONVERSION KIT

Works with these cartridges:

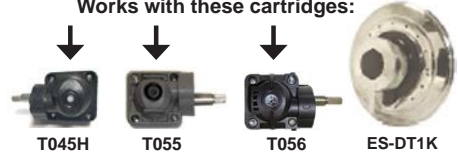

Replace various trims used by the sub-manufacturers who marketed this tub shower valve.

ITEM #	REF#	DESCRIPTION	PAK	STD PK
T054VC	47343560*	TEMPRESS*GROHE*ETC REPLACEMENT CAP WITH ESCUTCHEON ADAPTERS	1/BX	6

## Faucet Repair by Manufacturer - Indiana Brass\*

N003 Tub/Shower  
N003LF Lead Free



Fits



N004  
N005



Fits



N004 #85501-H\*  
N005 #85501-C\*

Item #	Ref #	Description
N003LF	163458*	Cart. O/S Nibco*, Midcor*, Moen*, Aquastream*, Streamway* Proplus* (H/C)

Item #	Ref #	Description
N004	85501-H*	Cartridge, 2 HDL Rep Cart, Hot (White)
N005	85501-C*	Cartridge, 2 HDL Rep Cart, Cold (Black)

Item #	Description
N006	Seat Seal for N004 & N005 Cartridge, bulk
N007	Spring RE N004 & N005, bulk

Winner of the 2004 IHMA Award



New & Improved  
"Will Not Break or Split"

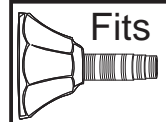

Item #	Description
FN-999R	Multi-Fit Nipple, Hard TP Rubber

## Faucet Repair by Manufacturer - Intersan\*

Complete Diaphragm Kit Including Diaphragm Assembly

Diaphragm Assembly Only



Item #	Ref #	Description
AC02K	2560-015-001*	Acorn* PV Rebuild Kit, 1 Hole Diaphragm 1/bg
AC02KA	2560-015-001*	Acorn* PV Rebuild Kit, 2 Hole Diaphragm 1/bg

Item #	Description
AC02	Diaphragm Assembly Only - Original Style w/One Hole
AC02(A)	Diaphragm Assembly Only - "A" - New Style w/Two Holes

Flow Restrictor Assembly

Flow Restrictor - Plugs Only (Color Coded)

Item #	Ref #	Description
AC04A	2367-025-000*	0.5 GPM Urinal
AC04B		0.7 GPM Drinking Fountain
AC04C		1.0 GPM Lavatory
AC04D	1295-100-000*	2.2 GPM Shower
AC04E	0326-011-000*	2.5 GPM Shower
AC04F		1.4 GPM Shower



Winner of the 2003 MGMPMA Award

Item #	Description
AC04-3A	F.R. Grommet Only, .5 GPM Urinal, Black
AC04-3B	F.R. Grommet Only, .7 GPM Drinking Fountain, Blue
AC04-3C	F.R. Grommet Only, 1.0 GPM Lavatory, Red
AC04-3D	F.R. Grommet Only, 2.2 GPM Shower, Orange
AC04-3E	F.R. Grommet Only, 2.5 GPM Shower, White
AC04-3F	F.R. Grommet Only, 1.4 GPM Shower, Yellow



## Faucet Repair by Manufacturer - Intersan\* (Continued)

Acorn\* Diaphragm Assembly

Wet-Side Diaphragm

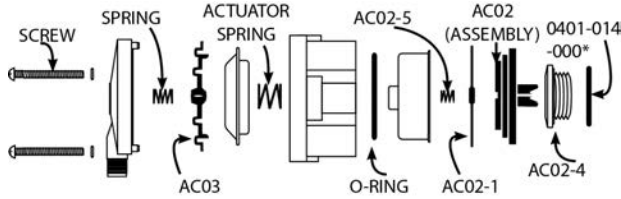

Item #	Ref #	Description
AC02		Diaphragm Assembly Only
AC02-1		Magnetic SS Disc w/Seal
AC02-4	2580-000-199*	Seat
AC02-5		Spring
AC03	2563-022-000*	Acorn* Upper Diaphragm 1/bg



Winner of the 2003 MGMPMA Award

Item #	Ref #	Description
AC03	2563-022-000*	Upper Diaphragm 1/bg

## Faucet Repair by Manufacturer - J.L. Baril\*, Intersan\*, Jado\*, K.W.C.\*

Pressure Balancing Cartridges

J.L. Baril\* = 47078\*  
Jado\* = 599185.191\*  
K.W.C.\* = Z-532-544\*



Item #	Description
T054H	Pressure Balancing Cartridge w/Screws, 1/bg



**Grohe\*  
Tempress\*  
47-157-000\*  
"High Flow"  
Cartridge**

Item #	Ref #	Description
T055	47-157-000*	Tempress* High-Flow* Gray Cartridge With Ledges, T*11*EFX*



**Grohe\*  
Tempress\*  
1793 9000\*  
"Modular"  
Cartridge**

Item #	Ref #	Description
T056	1793 9000*	Tempress* Modular* Cartridge, Black With 3-Way Hemi-O-Ring

Escutcheon Handle Drive Assembly



Item #	Ref #	Description
ES-DT2APK	1-207*	Escutcheon HDL Drive Assembly RE 2/pc Escutcheons, 1/bg

Stop Plus Kit



Item #	Ref #	Description
T054-16K	10494*	Stop Plus Kit, 1/bg

Stem Adapter

Item #	Description	Bkn/Std Pak
ES-DT1-4K	Stem Adapter w/Screw, Tempress* Kohler* Powers* Danfoss*	1/6

Stem Adapter and Extender

Item #	Description
ES-DT1-4KE	ES-DT1-4K w/Stem Extension And Screw

TEMPRESS II\*/DANFOSS\*/GROHE\*/PHYLRIKH\*/INDIANA\*/NEWPORT BRASS\*, ETC.....

## VALVE BODY CONVERSION KIT

KIT INCLUDES EVERYTHING:  
**CAP, ADAPTERS, SCREWS, NUTS**



Works with these cartridge



Replace various trims used by the sub-manufacturers who marketed this tub shower valve.

ITEM #	REF#	DESCRIPTION	PAK	STD PK
T054VC	47343560*	TEMPRESS*GROHE*ETC REPLACEMENT CAP WITH ESCUTCHEON ADAPTERS	1/BX	6

## Faucet Repair by Manufacturer - Kallista\*



Item #	Ref #	Description
K010K	500520*	Kohler* Pressure Balancing Spool (Brass Spool)

Item #	Ref #	Description
K009A	77759*	Kohler* Sterling* Tub/Shower Cartridge 1/bg

Item #	Description
K008B	Kohler* Tub/Shower Cartridge 1/bg

\*Registered trademark or trade name of the mfg. listed used for reference only. Don't confuse us with the mfg. listed. 2. Products marked "low lead" or "lead free" contain 0.25% lead or less, per California AB 1953 & Vermont S152 Legislative Specs.  
\*\*PROP 65 WARNING! Exposure to ingredients in these products such as: Acrylamide, Arsenic, Benzene, Cadmium, Lead, Mercury are known to the state of California to cause cancer, birth defects or reproductive harm. (See <http://oehha.ca.gov/prop65.html>). Wash contacted body parts immediately. Assembled and tested in the USA

## Faucet Repair by Manufacturer - Kohler\* (Also See Sterling\*)

**C1 - FAUCET REPAIR By Manufacturer**



Winner of the 2004 PPTMA Award



Item #	Ref #	Description
K010K	500520*	Kohler* Pressure Balancing Spool (Brass Spool)
K008B	77886*	Kohler* Tub Shower Cartridge Assembly

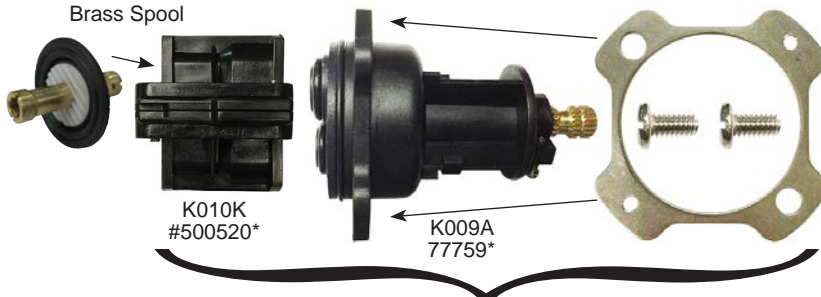

**K019PB #76851\***

Item #	Ref #	Description
K010K	500520*	Kohler* Pressure Balancing Spool (Brass Spool)
K009A	77759*	Kohler* Tub Shower Valve
K019PB	76851*	Kohler* Tub Shower Valve w/Pressure Balancing Spool



Item #	Ref #	Description
K010K	500520*	Kohler* Pressure Balancing Spool (Brass Spool)
S017	71969*	T/S Cartridge, Black, 100*

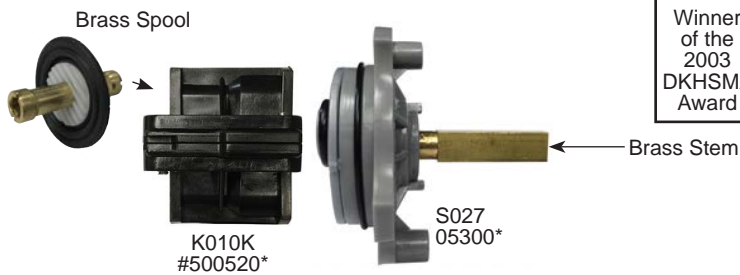

Winner of the 2003 DKHMSA Award



Item #	Ref #	Description
K010K	500520*	Kohler* Pressure Balancing Spool (Brass Spool)
S027A	05300*	Sterling* Fits T/S Cartridge



Item #	Ref #	Description
K010K	500520*	Kohler* Pressure Balancing Spool (Brass Spool)
K003	GP30413*	Kohler* Coralis* SGL HDL Cartridge

\*Registered trademark or trade name of the mfg. listed used for reference only. Don't confuse us with the mfg. listed. 2. Products marked "low lead" or "lead free" contain 0.25% lead or less, per California AB 1953 & Vermont S152 Legislative Specs. \*\*PROP 65 WARNING! Exposure to ingredients in these products such as: Acrylamide, Arsenic, Benzene, Cadmium, Lead, Mercury are known to the state of California to cause cancer, birth defects or reproductive harm. (See <http://oehha.ca.gov/prop65.html>). Wash contacted body parts immediately. Assembled and tested in the USA



# Faucet Repair by Manufacturer - Kohler\* (Also See Sterling\*)



Coralis\* Single HDL Lavatory Models

Lead Free



K003LF

Item #	Ref #	Description
K003LF	GP30413*	Kohler* Coralis* SGL HDL Cartridge



Old-Style Single Handle Cartridge

Gasket

B100

Item #	Ref #	Description
B100	300-1036* P302* P303*	Old Style S/H Cartridge

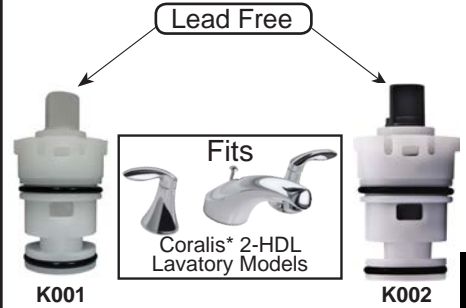

Lead Free

Fits

Coralis\* 2-HDL Lavatory Models

K001

K002

Item #	Ref #	Description
K001	76672*	2 HDL Coralis* Hot
K002	76671*	2 HDL Coralis* Cold

C1 - FAUCET REPAIR  
By Manufacturer



Fits

Tub / Shower Only

Valvet\* GP30004\*

Item #	Description
KL-2	Kohler* Valvet* Cartridge Rebuild Kit



Fits

Tub / Shower Only

GP30002-RP\*  
GP30004-RP\*

Item #	Description
KL-4	Repair Kit To Fit Kohler* Valvet*



Fits

Lead Free

Fits

GP30004-RP\*

K004C

K004H

GP30002-RP\*

Item #	Description
K004C	Kohler* Valvet* Valve Sleeve w/Washer, Cold
K004H	Kohler* Valvet* Valve Sleeve w/Washer, Hot



Item #	Ref #	Description
VBKL-1	30253*	Vacuum Breaker Kit



Item #	Description
M013	Old Style Standyne* Rebuild Kit

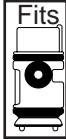

Item #	Description	Bkn/Std Pak
FN-995	Escutcheon Nipple, 5/bg	6/72



Item #	Description	Bkn/Std Pak
FN-999R	Multi-Fit Nipple, Hard TP Rubber	6/72

Winner of the 2003 BWSBWMA Award



New & Improved "Will Not Break or Split"

Winner of the 2004 IHMA Award

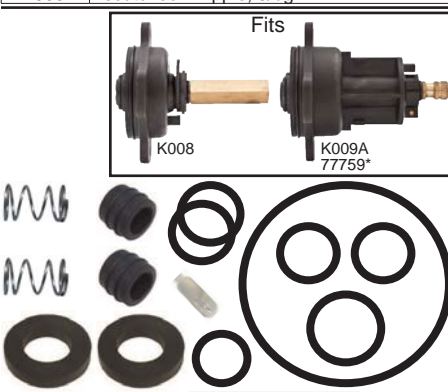

Item #	Ref #	Description
K-9	77886*, 500520*, 77759*	Kohler* Seats & Seals Kit 1/bg

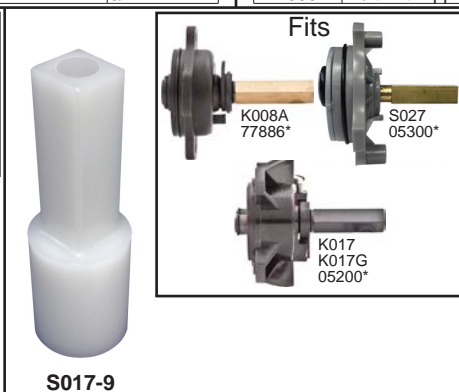

Item #	Ref #	Description
S017-9	71906*	Stem Extender, Kohler* Sterling* Tub Shower

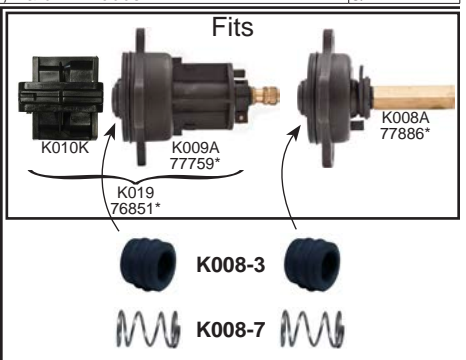

Item #	Description
K008A-3	Inlet Seal (set), Fits K008A, K009A, K019
K008A-7	Stainless Steel Compression Spring Fits K008A, K009A, K019

\*Registered trademark or trade name of the mfg. listed used for reference only. Don't confuse us with the mfg. listed. 2. Products marked "low lead" or "lead free" contain 0.25% lead or less, per California AB 1953 & Vermont S152 Legislative Specs.  
 \*\*PROP 65 WARNING! Exposure to ingredients in these products such as: Acrylamide, Arsenic, Benzene, Cadmium, Lead, Mercury are known to the state of California to cause cancer, birth defects or reproductive harm. (See <http://oehha.ca.gov/prop65.html>). Wash contacted body parts immediately. Assembled and tested in the USA

## Faucet Repair by Manufacturer - Larden\* (Also See Delta\*)

Winner of the 1999 DGUSHMA Award



Lead Free

Winner of the 1999 DGUSHMA Award



Lead Free

Item #	Description
D017	Standard 2 HDL Cartridge

Item #	Description
D017A	Larden* Peerless* Valueflow* - Long

## Faucet Repair by Manufacturer - Leonard\* - Shower Valve

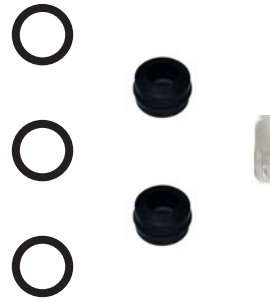
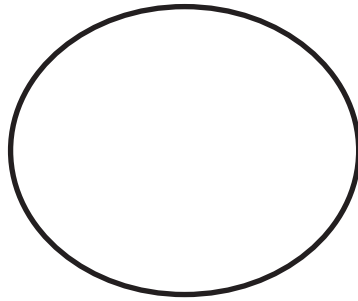

Item #	Ref #	Description
LEO-01	R55*	Rebuild Kit To Leonard* Aquatrol* Shower Valve

## Faucet Repair by Manufacturer - Lifetime\* & Streamway\*



N003 Tub/Shower Only  
N003LF Lead Free

Item #	Description
N003	Moen* Aquastream*, Streamway*, Brass Stem, H/C Cartridge, Tub/Shower Only, 1/bg
N003LF	Moen* Aquastream*, Streamway*, PolyBrass Stem, H/C Cartridge, All Models 1/bg



Lead Free

N004, N005

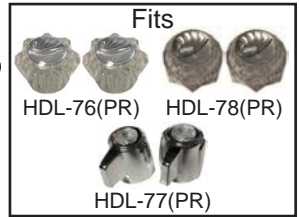

Item #	Ref #	Description
N004	25709*	Cartridge, 2 HDL Rep Cart, Hot (White)
N005		Cartridge, 2 HDL Rep Cart, Cold (Black)



N006  
N007 (2X Original Size)



N004 #25709\*  
N005



New & Improved  
"Will Not Break or Split"



Winner of the 2004 IHMA Award

Item #	Description
N006	Seat Seal for N004 and N005 Cartridge, bulk
N007	Spring RE N004 & N005, bulk

Item #	Description
FN-999R	Multi-Fit Nipple, Hard TP Rubber

# Faucet Repair by Manufacturer - Metcraft\*

Metcraft\* Tempus II\* Cartridge O/S Restrictor - Lead Free

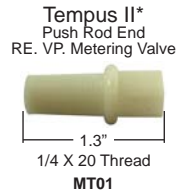
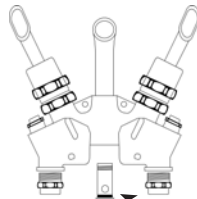
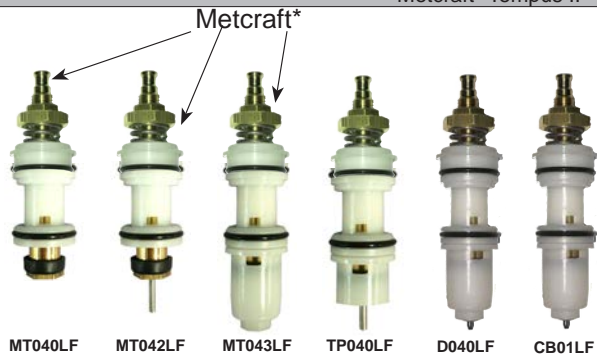

Item #	Ref #	Description
MT040LF	MT039*	Metering Cartridge Replacement for Metcraft* Penal Metering Cartridge
MT042LF	190126A*	Metcraft* Tempus* Self Closing Cartridge, Pre 1992
MT043LF	060160A*	Metcraft* Teck* Metering Cartridge, 1992-98
TP040LF	190126A*	Tempus* Short Metering Cartridge
D040LF	RP6399*	DP* Single Side Slow Close Cartridge
CB01LF	060160A*	Single Handle Self-Closing Faucet Metering Cartridge

Item #	Ref #	GPM	Description
MT041ALF	11113*	.05 GPM	Metcraft* Tempus II* #32 Flow Restrictor, No Lead Brass, .05 GPM
MT041BLF		.07 GPM	Metcraft* Tempus II* #32 Flow Restrictor, No Lead Brass, .07 GPM
MT041CLF		1.0 GPM	Metcraft* Tempus II* #32 Flow Restrictor, No Lead Brass, 1.0 GPM
MT041DLF		2.2 GPM	Metcraft* Tempus II* #32 Flow Restrictor, No Lead Brass, 2.2 GPM
MT041ELF		2.5 GPM	Metcraft* Tempus II* #32 Flow Restrictor, No Lead Brass, 2.5 GPM
MT041FLF		1.4 GPM	Metcraft* Tempus II* #32 Flow Restrictor, No Lead Brass, 1.4 GPM
MT01	0469-025* SF4-166*		Metcraft* Threaded Push Rod End Adjuster

Complete Diaphragm Kit Including Diaphragm Assembly

Diaphragm Assembly Only

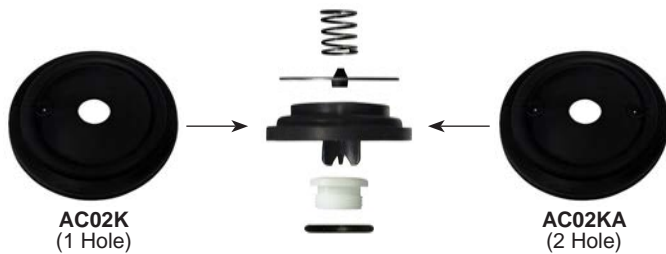

Item #	Ref #	Description
AC02K	2560-015-001*	Metcraft* PV Rebuild Kit, 1 Hole Diaphragm 1/bg
AC02KA	2560-015-001*	Metcraft* PV Rebuild Kit, 2 Hole Diaphragm 1/bg

Item #	Description
AC02	Diaphragm Assembly Only - Original Style w/One Hole
AC02(A)	Diaphragm Assembly Only - "A" - New Style w/Two Holes

Flow Restrictor Assembly - New Style Plastic

Wet-Side Diaphragm

Lead Free



Winner of the 2003 MGMPPMA Award



Winner of the 2003 MGMPPMA Award

Item #	Ref #	Description
AC04A	2367-025-000*	0.5 GPM Urinal
AC04B		0.7 GPM Drinking Fountain
AC04C		1.0 GPM Lavatory
AC04D	1295-100-000*	2.2 GPM Shower
AC04E	0326-011-000*	2.5 GPM Shower
AC04F		1.4 GPM Shower
AC04Z		Universal 5 Way Combo

Item #	Ref #	Description
AC03	2563-022-000*	Metcraft* Upper Diaphragm 1/bg

Flow Restrictor - Plugs Only (Color Coded)

Diaphragm Assembly

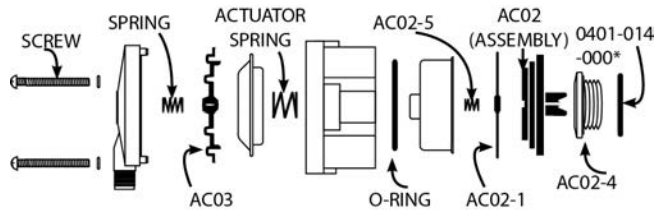

Item #	Description
AC04-3A	F.R. Grommet Only, .5 GPM Urinal, Black
AC04-3B	F.R. Grommet Only, .7 GPM Drinking Fountain, Blue
AC04-3C	F.R. Grommet Only, 1.0 GPM Lavatory, Red
AC04-3D	F.R. Grommet Only, 2.2 GPM Shower, Orange
AC04-3E	F.R. Grommet Only, 2.5 GPM Shower, White
AC04-3F	F.R. Grommet Only, 1.4 GPM Shower, Yellow

Item #	Ref #	Description
AC02		Diaphragm Assembly Only
AC02-1		Magnetic SS Disc w/Seal
AC02-4	2580-000-199*	Seat
AC02-5		Spring
AC03	2563-022-000*	Upper Diaphragm 1/bg

\*Registered trademark or trade name of the mfg. listed used for reference only. Don't confuse us with the mfg. listed. 2. Products marked "low lead" or "lead free" contain 0.25% lead or less, per California AB 1953 & Vermont S152 Legislative Specs.  
 \*\*PROP 65 WARNING! Exposure to ingredients in these products such as: Acrylamide, Arsenic, Benzene, Cadmium, Lead, Mercury are known to the state of California to cause cancer, birth defects or reproductive harm. (See <http://oehha.ca.gov/prop65.html>). Wash contacted body parts immediately. Assembled and tested in the USA

### Faucet Repair by Manufacturer - Midcor\*

Moen\* Streamway\*



N003 **Tub/Shower Only**  
N003LF **Lead Free**

Item #	Description
N003	Moen* Aquastream*, Streamway*, Brass Stem, H/C Cartridge, Tub/Shower Only, 1/bg
N003LF	Moen* Aquastream*, Streamway*, PolyBrass Stem, H/C Cartridge, All Models 1/bg



**Lead Free**

Item #	Description
M100	Shorty



**Lead Free**

Item #	Description
M101	Long Version

### Faucet Repair by Manufacturer - Mixet\*

Fits



Item #	Ref #	Description
S/B M200	MS-5AT-C*	Mixet* Cartridge w/Teflon-Brass End



Item #	Ref #	Description
SB M200B	MS-5AT-C*	Mixet* Standard Cartridge w/Solid Brass End



Item #	Ref #	Description
M205	MS3T*	Mixet* 6 Cartridge, Pre 1968



Item #	Ref #	Description
M206	MINS-EXT*	Mixet* 6.25 Cartridge, Post 1968



Brass Stem Shut-Offs



Item #	Ref #	Description
M209(PR)	MCVS*	Mixet* Integral Stops, Pair



M207

Item #	Ref #	Description
M207	72*	Mixet* Slip On Tub Spout w/O Diverter, CP (Case Pak = 10)

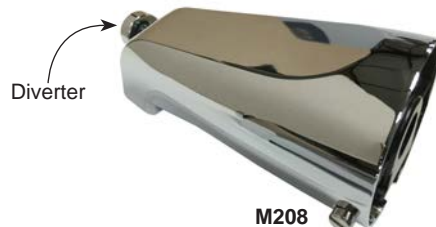

M208

Item #	Ref #	Description
M208	71*	Mixet* Slip On Spout w/Diverter, CP (Case Pak = 10)

# Faucet Repair by manufacturer - Moen

Avoid Costly Replacement . . . It's Simple . . . Rebuild!

## CARTRIDGE REBUILDING KIT

RE: 1255\* 160657\* Moen\* DURALAST\* - Cartridge Rebuild Kit - KITCHEN LAVATORY MODELS  
4600\*SERIES KITCHEN LAVATORY CHATEAU\* SINGLE HANDLE MODELS SINCE 2010

### REBUILDING KIT COVERS IT ALL! KIT INCLUDES



Bonnet Nut    Black Outside Body    Roll Pin    Stem (SS)



Wrench    Handle Screw    Stem Cam    Engagement Disc RE Ceramic



Ceramic Disc Upper (No Holes)    Ceramic Disc Lower (No Holes)



Bottom Seal Retainer



Bottom Seal    Lower Seal Assembly    Silicon Lube Capsule



**HDL-4C\***  
**(150627\*)**  
AVAILABLE NOW

**FITS:**  
HDL-4C  
FHC-4N



MOEN\* 1255  
(CARTRIDGE NOT AVAILABLE)  
REBUILDING KIT AVAILABLE ONLY

PATENTED

### PACKAGED 3 WAYS!



M074LFK (CP)  
Clam Shell  
(2" x 9" x 1")



M074LFK (SLB)  
Slide Blister  
(2" x 9" x 1")



M074LFK (SLB)  
Bagged  
(7" x 7")

C1 - FAUCET REPAIR  
By Manufacturer

### ONE KIT - PACKAGED 3 WAYS

LMC #	Ref #	BRKN/STD PAK	DESCRIPTION	PAK
M074LFK	1255*	1/12	Moen* 1255* 160657* Rebuild Kit W/ Bonnet Nut	1/BG
M074LFK(CP)	1255*	1/12	Moen* 1255* 160657* Rebuild Kit W/ Bonnet Nut	1/CP
M074LF(SLB)	1255*	1/12	Moen* 1255* 160657* Rebuild Kit W/ Bonnet Nut	1/SLB

\*Registered trademark or trade name of the mfg. listed used for reference only. Don't confuse us with the mfg. listed. 2. Products marked "low lead" or "lead free" contain 0.25% lead or less, per California AB 1953 & Vermont S152 Legislative Specs.  
\*\*PROP 65 WARNING! Exposure to ingredients in these products such as: Acrylamide, Arsenic, Benzene, Cadmium, Lead, Mercury are known to the state of California to cause cancer, birth defects or reproductive harm. (See <http://oehha.ca.gov/prop65.html>). Wash contacted body parts immediately. Assembled and tested in the USA

# Faucet Repair by Manufacturer - Moen\* - Master Parts Kits

**C1 - FAUCET REPAIR By Manufacturer**



## M999K(LF)

Includes The Following:

- 2/Ea M008LF Brass Cartridges
- 2/Ea M004LF Magnum\* Style Cartridges
- 2/Ea M054 Posi-Temp\* Style Cartridges
- 2/Ea M064LF Posi-Close™ Style Cartridges
- 1/Ea TW-5 Combo Cartridge Puller
- 6/Ea Of All 4 Style Clips
- 12/Ea of Silicone Capsules
- 3/Ea 219 Large O-Ring Spout Seals
- 3/Ea 211 Small O-Rings Spout Seals
- 1/Ea PRM-3 Plastic Carrying Case
- 1/Ea PRM-1 Clear Box w/Sliding Cover
- 3/Ea FHC-4 O.S Tear-Drop Handle Caps
- 3/Ea FHC-4N N.S. Tear-Drop Handle Caps
- 3/Ea FHC-30 O.S. Round Handle Caps
- 3/Ea FHC-30N O.S. Round Handle Caps
- 3/Ea AER-1F Female Aerators
- 3/Ea AEA-1 M/F Adapter



Item #	Description
M999K(LF)	Master Parts Kit for Moen*

Orange Box



## M004LF(5Bx)

Includes The Following:

- 5/Ea M004LF Magnum\* Style Cartridges
- 5/Ea M004LF-5 Tool

Item #	Description
M004LF(5Bx)	M004LF 5 Piece Moen* Journeymen Kit



## M998K(LF)

Includes The Following:

- 4/Ea M008LF Brass Cartridges
- 2/Ea M004LF Magnum\* Style Cartridges
- 2/Ea M054FS Posi-Temp\* Style Cartridges
- 1/Ea TW-5 Combo Cartridge Puller
- 6/Ea Of All 4 Style Clips
- 12/Ea of Silicone Capsules
- 3/Ea 219 Large O-Ring Spout Seals
- 3/Ea 211 Small O-Rings Spout Seals
- 1/Ea PRM-3 Plastic Carrying Case
- 1/Ea PRM-1 Clear Box w/Sliding Cover
- 3/Ea FHC-4 O.S Tear-Drop Handle Caps
- 3/Ea FHC-4N N.S. Tear-Drop Handle Caps
- 3/Ea FHC-30N O.S. Round Handle Caps
- 3/Ea FHC-15 O.S. Round Handle Caps
- 3/Ea AER-1F Female Aerators
- 3/Ea AEA-1 M/F Adapter



Item #	Description
M998K(LF)	Master Parts Kit for Moen*

Orange Box



## M008LF(5Bx)

Includes The Following:

- 5/Ea M008LF Magnum\* Style Cartridges
- 5/Ea M004LF-5 Tool

Item #	Description
M008LF(5Bx)	M008LF 5 Piece Moen* Journeymen Kit

# Faucet Repair by Manufacturer - The New Moen\* Single Handle Replacement Cartridges

New High Performance Heavy-Duty Replacement Cartridge to Fit Moen\* / Stanadyne\*

**THE NEW GENUINE "COP'R CORE 427"**

"The Heart of Copper - The Proven Durability of Poly-Brass"

Lead Free



Brass Stem  
Clear Cartridge

**M004LF** (OEM # 1225B\*)  
COPPER CORE 427\*  
MAGNUM\* REPLACEMENT

Clear Outer Casting Shows Off The Alloy Stem

Look For the U.S.A. Label

- Also Available:
- Low-Cost Rebuilding Kit with All Seals
  - Packed with All 3 Clips and Spout Selas

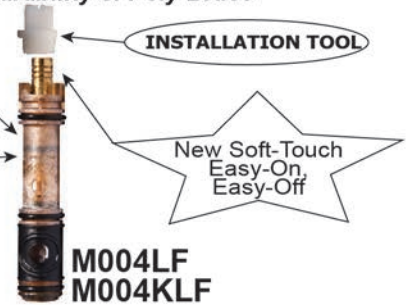

INSTALLATION TOOL

New Soft-Touch Easy-On Easy-Off

**M004LF**  
**M004KLF**

Item #	Ref #	Description
M004LF	1225B	Magnum* Cartridge w/Tool 1/bg and Instructions, Lead Free, 1/bg
M004LFK	1225 (SM-1)*	Magnum* Cartridge Kit w/Tool, Clips, O-rings 1/bg, and Instructions Lead Free, 1/bg

## THE ORIGINAL STYLE MOEN\* BRASS CARTRIDGE

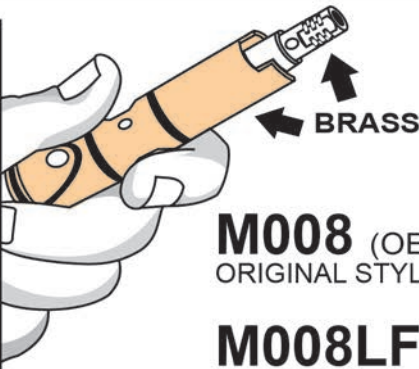

**M008** (OEM# 1200B\*) **Lead Free**  
ORIGINAL STYLE **Tub / Shower Only**

**M008LF** (OEM #1200B\*) **Lead Free**



INSTALLATION TOOL

Solid Brass

**M008**  
**M008LF**

Item #	Ref #	Description
M008	1200B*	S/H Brass Cartridge w/Tool and Instructions - Original Style, 1/bg
M008LF	1200B*	S/H Brass Cartridge w/Tool and Instructions - Lead Free, 1/bg

**PATENTED\***

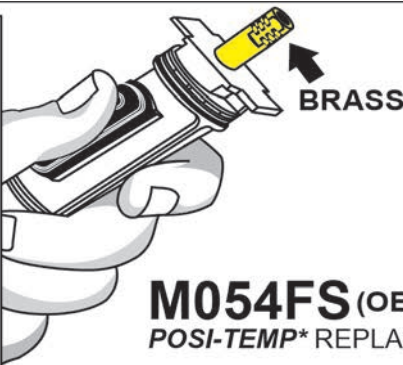

**M054FS** (OEM# 1222\*)  
POSI-TEMP\* REPLACEMENT

- Features:**
- Brass Stem Assembly
  - Teflon\* Balancing Spool
  - Permanently Lubricated Bearing Surface
  - Chemical Resistant Seals
  - Self Cleaning Design
  - Very High Temp. Design
  - SS Seal Surface

New Style Look

**MOEN\* POSI-TEMP\***  
Replacement Cartridge  
**TEFLACORE\***  
Pressure Balancing

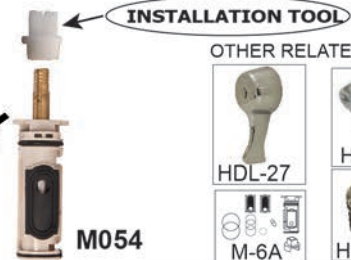

INSTALLATION TOOL

OTHER RELATED ITEMS:



Item #	Ref #	Description
M054FS	1222B*	Moen* Posi-Temp* Cartridge, New Style, 1/bg

**PATENTED\***

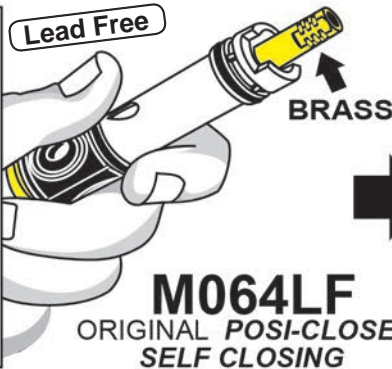

**M064LF**  
ORIGINAL POSI-CLOSE™\*  
SELF CLOSING

**Save Water!**

Apartment Buildings, Public Washrooms,  
Gas Stations, Schools, Government Offices,  
Nursing Homes, Public Housing, Institutional Applications

High Temp Permanently Lubricated Casing  
For Long, Trouble-Free Life Even In  
Commercial Hot Water Applications

-Institutional Grade Brass Assembly  
-Chemical Resistant Side Seals

**POSI-CLOSE™\***  
Retro Fit Self Closing Moen\* Cartridge  
Direct Replacement For 1200\* & 1225\* Series Cartridges



Fits

HDL-4PC

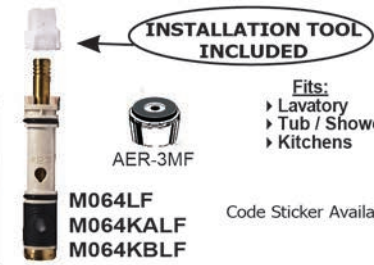

INSTALLATION TOOL INCLUDED

Fits:  
► Lavatory  
► Tub / Shower  
► Kitchens

**M064LF**  
**M064KALF**  
**M064KBLF**

Code Sticker Available

Item #	Description
M064LF	Posi-Close* Cartridge w/Tool, Lead Free, 1/bg
M064KALF	Posi-Close* Cartridge w/HDL-4PC, AER-3MF, ADA-1, Lead Free, 1/bg
M064KBLF	Posi-Close* Cartridge w/HDL-4PC, Lead Free, 1/bg

\*Registered trademark or trade name of the mfg. listed used for reference only. Don't confuse us with the mfg. listed. 2. Products marked "low lead" or "lead free" contain 0.25% lead or less, per California AB 1953 & Vermont S152 Legislative Specs.  
\*\*PROP 65 WARNING! Exposure to ingredients in these products such as: Acrylamide, Arsenic, Benzene, Cadmium, Lead, Mercury are known to the state of California to cause cancer, birth defects or reproductive harm. (See <http://oehha.ca.gov/prop65.html>). Wash contacted body parts immediately. Assembled and tested in the USA

## Faucet Repair by Manufacturer - Moen\* Replacement Cartridges



Lead Free

M004LF

Item #	Ref #	Description
M004LF	1225B*	Magnum* Cartridge w/Tool 1/bg w/ Instructions



M008 Tub/Shower Only  
M008LF Lead Free

Item #	Ref #	Description	Bkn/Std Pak
M008	1200B*	S/H Brass Cartridge w/ Tool w/Instructions - Tub/ Shower	1/6
M008LF	1200B*	S/H Brass Cartridge w/Tool w/Instructions - Lead Free	1/6



M054FS (Patented)

Item #	Ref #	Description
M054GS	1222B*	Moen* Posi-Temp*, Cartridge, New Style

Winner of the 2004 IHMA Award



Moen\*- Patented\* Self-Closing Cartridge (Replaces 1200\* & 1225\*)

Lead Free

M064LF

Winner of the 2004 IHMA Award



Lead Free

M064KALF

M005 M006 M007A

HDL-4PC Series HDL-36A-1A Series

Lead Free



M064KBLF

HDL-4PC Series

Item #	Description
M064LF	Posi-Close* Cartridge w/Tool - Lead Free 1/bg
M064KALF	Posi-Close* Cartridge w/HDL-4PC, HDL-36A-1A, M005, M006, M007A & AER-3MF - Lead Free
M064KBLF	Posi-Close* Cartridge w/HDL-4PC - Lead Free

\*Registered trademark or trade name of the mfg. listed used for reference only. Don't confuse us with the mfg. listed. 2. Products marked "low lead" or "lead free" contain 0.25% lead or less, per California AB 1953 & Vermont S152 Legislative Specs. \*\*PROP 65 WARNING! Exposure to ingredients in these products such as: Acrylamide, Arsenic, Benzene, Cadmium, Lead, Mercury are known to the state of California to cause cancer, birth defects or reproductive harm. (See <http://oehha.ca.gov/prop65.html>). Wash contacted body parts immediately. Assembled and tested in the USA

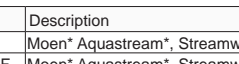

Std. Moen* 2 HDL Washerless Cartridge			Roman Tub Moen* 2 HDL Washerless Cartridge			Import Moen* 2 HDL Washerless Cartridge		
								
Item #	Ref #	Description	Item #	Ref #	Description	Item #	Ref #	Description
M002A	1224	Std. Moen 2 HDL Cartridge	M211	1248*	HiFlow 2HDL Cartridge ("the Fat One")	M017		Moen* Israel

Moen* Streamway* 2 HDL Washerless Cartridge	
	
N003	Tub/Shower Only
	
N003LF	Lead Free
Item #	Description
N003	Moen* Aquastream*, Streamway*, Brass STem, T/S Only
N003LF	Moen* Aquastream*, Streamway*, 2 HDL Cartridge, Lead Free, All Models

Moen* Metering Cartridge		
		
Item #	Ref #	Description
M040LF	16352*	Moen* Metering Cartridge

## CARTRIDGE REBUILDING KIT

RE: 1255\* 160657\* Moen\* DURALAST\* - Cartridge Rebuild Kit - KITCHEN LAVATORY MODELS  
4600\*SERIES KITCHEN LAVATORY CHATEAU\* SINGLE HANDLE MODELS SINCE 2010

Avoid Costly Replacement . . . It's Simple . . . Rebuild!

### REBUILDING KIT COVERS IT ALL! KIT INCLUDES



ONE KIT - PACKAGED 3 WAYS				
LMC #	Ref #	BRKN/STD PAK	DESCRIPTION	PAK
M074LFK	1255*	1/12	Moen* 1255* 160657* Rebuild Kit W/ Bonnet Nut	1/BG
M074LFK(CP)	1255*	1/12	Moen* 1255* 160657* Rebuild Kit W/ Bonnet Nut	1/CP
M074LF(SLB)	1255*	1/12	Moen* 1255* 160657* Rebuild Kit W/ Bonnet Nut	1/SLB

## 150627\*MOEN\*TEAR DROP HDL\*ASSEMBLY

FIT CHATEAU\* SINGLE HANDLE MODELS INC©2010  
KITCHEN AND LAVATORY  
MADE IN USA



**FITS: 1255\* MOEN\* DURALAST\* CARTRIDGE**

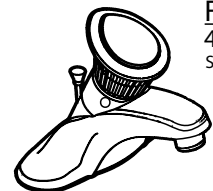

**FITS 4600 SERIES**

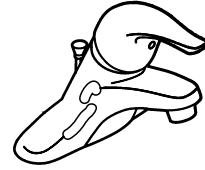

**FITS L4600 SERIES**



AVAILABLE	LMC #	REF#	DESCRIPTION
NOW	HDL-4C	150627*	150627* TEAR CRYSTAL HDL + CAP/SCREW, RE 1255* 1/BG
NOW	FHC-4N	91751*	91751* HDL CAP FITS ALL MOEN* TEAR DROP HDLS, 1/BG

\*Registered trademark or trade name of the mfg. listed used for reference only. Don't confuse us with the mfg. listed. 2. Products marked "low lead" or "lead free" contain 0.25% lead or less, per California AB 1953 & Vermont S152 Legislative Specs.  
\*\*PROP 65 WARNING: Exposure to ingredients in these products such as: Acrylamide, Arsenic, Benzene, Cadmium, Lead, Mercury are known to the state of California to cause cancer, birth defects or reproductive harm. (See <http://oehha.ca.gov/prop65.html>). Wash contacted body parts immediately. Assembled and tested in the USA

## Faucet Repair by Manufacturer - Moen\* Cartridges Pullers

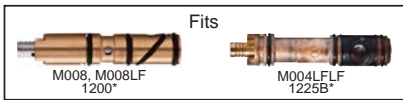

Item #	Description
M018	Puller Tool, All Standard Models

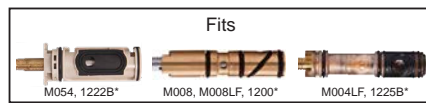

Item #	Description
TW-5	Posi-Puller* to Fit Moen* Posi-Temp* & Standard TS Valves



## Faucet Repair by Manufacturer - Newport Brass\*

### Pressure Balancing Cartridges



Item #	Ref #	Description
T054H	1-207*	Pressure Balancing Cartridge w/Screws, 1/bg

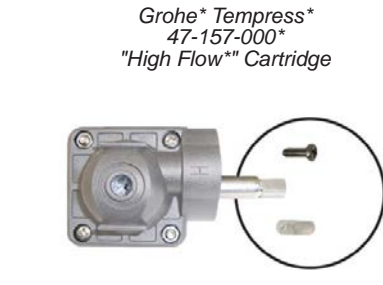

Item #	Ref #	Description
T055	47-157-000*	Tempress* High-Flow* Gray Cartridge With Ledges, T*11*EFX*

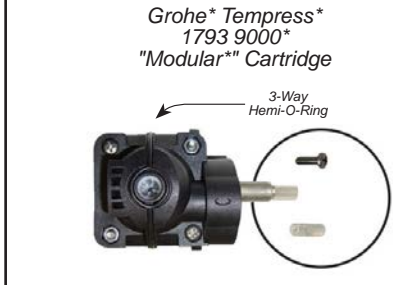

Item #	Ref #	Description
T056	1793 9000*	Tempress* Modular* Cartridge, Black With 3-Way Hemi-O-Ring

### Escutcheon Handle Drive Assembly

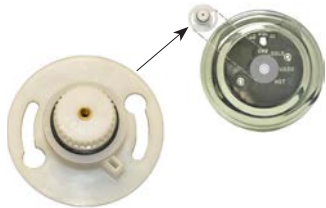

Item #	Ref #	Description
ES-DT2APK	1-207*	Escutcheon HDL Drive Assembly RE 2/pc Escutcheons, 1/bg

### Stop Plus Kit

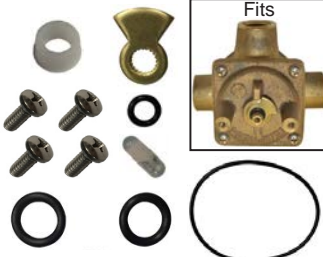

Item #	Ref #	Description
T054-16K	10494*	Stop Plus Kit, 1/bg

### Stem Adapter



Item #	Description	Bkn/Std Pak
ES-DT1-4K	Stem Adapter w/Screw, Tempress* Kohler* Powers* Danfoss*	1/6

### Stem Adapter and Extender



Item #	Description
ES-DT1-4KE	ES-DT1-4K w/Stem Extension And Screw

TEMPRESS II\*/DANFOSS\*/GROHE\*/PHYLIRICH\*/INDIANA\*/NEWPORT BRASS\*, ETC.....

KIT INCLUDES EVERYTHING:  
CAP, ADAPTERS, SCREWS, NUTS

## VALVE BODY CONVERSION KIT

Works with these cartridges:

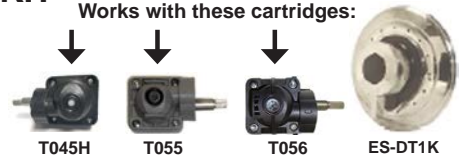

Replace various trims used by the sub-manufacturers who marketed this tub shower valve.

ITEM #	REF#	DESCRIPTION	PAK	STD PK
T054VC	47343560*	TEMPRESS*GROHE*ETC REPLACEMENT CAP WITH ESCUTCHEON ADAPTERS	1/BX	6

## Faucet Repair by Manufacturer - Nibco\* & Lifetime\*, Moen\*, Streamway\*

### Moen\* Streamway\*

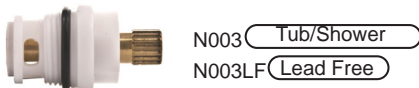

Item #	Ref #	Description
N003	163458*	Moen* Aquastream*, Streamway*, Proplus* Brass Stem, H/C Cartridge, Tub/Shower Only, 1/bg
N003LF	163458*	Moen* Aquastream* Streamway*, PolyBrass Stem, H/C Cartridge, All Models 1/bg

### Lead Free



Item #	Ref #	Description
N004	PH0P22LH*	Cartridge, 2 HDL Replacement Cart, Hot (White)
N005		Cartridge, 2 HDL Replacement Cart, Cold (Black)



Item #	Description
N006	Seat Seal for N004 and N005 Cartridge, bulk
N007	Spring RE N004 & N005, bulk



New & Improved "Will Not Break or Split"



Item #	Description
FN-999R	Multi-Fit Nipple, Hard TP Rubber

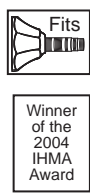

C1 - FAUCET REPAIR By Manufacturer

## Faucet Repair by Manufacturer - Oasis\*

Oasis\* Drinking Fountain

**OASIS\* Drinking Fountain**  
030029-005\*  
**NOZZEL\* ASSEMBLY**

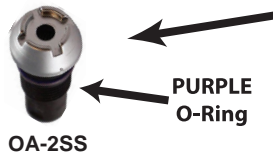
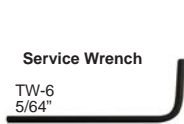

GOES HERE →



CLAMPAK →

STANDARD BLISTER →

BAG →



Item #	Ref #	Description
OA-2SS	030029-005*	Nozzel Assembly, W/ Purple O-Ring & Wrench, 1/bg

## Faucet Repair by Manufacturer - Phoenix\*

Washerless

Plastic Compression

Cartridge



Lead Free



Lead Free



Lead Free



Item #	Ref #	Description
PH01		Cartridge, Washerless

Item #	Ref #	Description
PH02	9-P42*	Cartridge, Plastic Compression

Item #	Ref #	Description
V001	V6680*	O/S S/H Cartridge All Phoenix* S/H
V001K	V6680*	V001 w/Seats

Plastic Diverter Cartridge

NEW!



PH03

Fits: Phoenix\* 3 handle Tub/Shower faucets w/ brass bodies #639, 601 and others

N003 Tub/Shower

N003LF Lead Free



Lead Free



N004, N005



Item #	Ref #	Description
PH03	639-5-0*	Phoenix* Faucet Plastic Diverter Cartridge

Item #	Description
N003	Moen* Aquastream*, Streamway*, Brass Stem, H/C Cartridge, Tub/Shower Only, 1/bg
N003LF	Moen* Aquastream*, Streamway*, PolyBrass Stem, H/C Cartridge, All Models 1/bg

Item #	Ref #	Description
N004	P22*	Cartridge, 2 HDL Rep Cart, Hot (White)
N005	P22LH*	Cartridge, 2 HDL Rep Cart, Cold (Black)

Pressure Balancing Cartridges

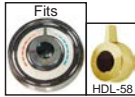

Grohe\* Tempress\* 47-157-000\* "High Flow\*\*" Cartridge



Grohe\* Tempress\* 1793 9000\* "Modular\*\*" Cartridge

Item #	Description
T054H	Pressure Balancing Cartridge w/Screws, 1/bg

Item #	Ref #	Description
T055	47-157-000*	Tempress* High-Flow* Gray Cartridge With Ledges, T*11"EFX*

Item #	Ref #	Description
T056	1793 9000*	Tempress* Modular* Cartridge, Black With 3-Way Hemi-O-Ring

Escutcheon Handle Drive Assembly



ES-DT2APK

Item #	Ref #	Description
ES-DT2APK	1-207*	Escutcheon HDL Drive Assembly RE 2/pc Escutcheons, 1/bg

Stop Plus Kit



Item #	Ref #	Description
T054-16K	10494*	Stop Plus Kit, 1/bg

Stem Adapter



ES-DT1-4K

Item #	Description	Bkn/Std Pak
ES-DT1-4K	Stem Adapter w/Screw, Tempress* Kohler* Powers* Danfoss*	1/6

Stem Adapter and Extender



ES-DT1-4KE

Item #	Description
ES-DT1-4KE	ES-DT1-4K w/Stem Extension And Screw

TEMPRESS II\*/DANFOSS\*/GROHE\*/PHYLIRICH\*/INDIANA\*/NEWPORT BRASS\*, ETC.....

KIT INCLUDES EVERYTHING:  
**CAP, ADAPTERS, SCREWS, NUTS**

## VALVE BODY CONVERSION KIT

Works with these cartridges:



Replace various trims used by the sub-manufacturers who marketed this tub shower valve.

ITEM #	REF#	DESCRIPTION	PAK	STD PK
T054VC	47343560*	TEMPRESS*GROHE*ETC REPLACEMENT CAP WITH ESCUTCHEON ADAPTERS	1/BX	6

\*Registered trademark or trade name of the mfg. listed used for reference only. Don't confuse us with the mfg. listed. 2. Products marked "low lead" or "lead free" contain 0.25% lead or less, per California AB 1953 & Vermont S152 Legislative Specs.  
\*\*PROP 65 WARNING! Exposure to ingredients in these products such as: Acrylamide, Arsenic, Benzene, Cadmium, Lead, Mercury are known to the state of California to cause cancer, birth defects or reproductive harm. (See <http://oehha.ca.gov/prop65.html>). Wash contacted body parts immediately. Assembled and tested in the USA

## Faucet Repair by Manufacturer - Phoenix\* (Institutional)

Complete Diaphragm Kit Including Diaphragm Assembly

Wet-Side Diaphragm

Winner  
of the  
2003  
MGMPMA  
Award



Item #	Ref #	Description
AC02K	2560-015-001*	Phoenix* PV Rebuild Kit, 1 Hole Diaphragm 1/bg
AC02KA	2560-015-001*	Phoenix* PV Rebuild Kit, 2 Hole Diaphragm 1/bg

Item #	Ref #	Description
AC03	2563-022-000*	Phoenix* Upper Diaphragm 1/bg

C1 - FAUCET REPAIR By Manufacturer

Flow Restrictor Assembly

Diaphragm Assembly



Winner  
of the  
2003  
MGMPMA  
Award

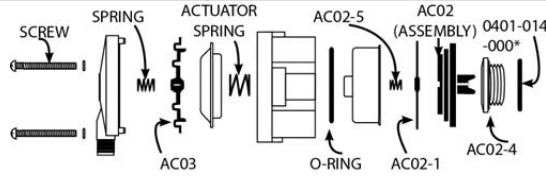

Item #	Ref #	Description
AC04A	2367-025-000*	0.5 GPM Urinal
AC04B		0.7 GPM Drinking Fountain
AC04C		1.0 GPM Lavatory
AC04D	1295-100-000*	2.2 GPM Shower
AC04E	0326-011-000*	2.5 GPM Shower
AC04F		1.4 GPM Shower
AC04Z		Universal 5 way Combo

Item #	Ref #	Description
AC02		Diaphragm Assembly Only
AC02-1		Magnetic SS Disc w/Seal
AC02-4	2580-000-199*	Seat
AC02-5		Spring
AC03	2563-022-000*	Acorn* Upper Diaphragm 1/bg

## Faucet Repair by Manufacturer - Powers\* Cartridges & Miscellaneous Kits

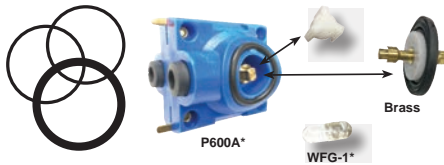

Item #	Ref #	Description
P600A	410-183*	PB Spool Only, Series 400*/410*, Models 1-3

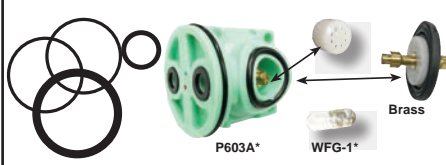

Item #	Ref #	Description
P603A	401-175*	PB Spool Only, Series 400*/410* Models 4-6

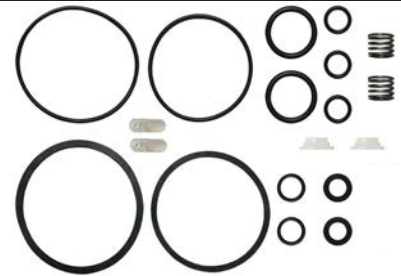

Item #	Ref #	Description
PWR-1	410-182*	Rebuild Kit 400/410 Series w/ Handle Cap



Item #	Ref #	Description
P601	410-378*	Brass Stem Kit 400*/410* Models 1 thru 3

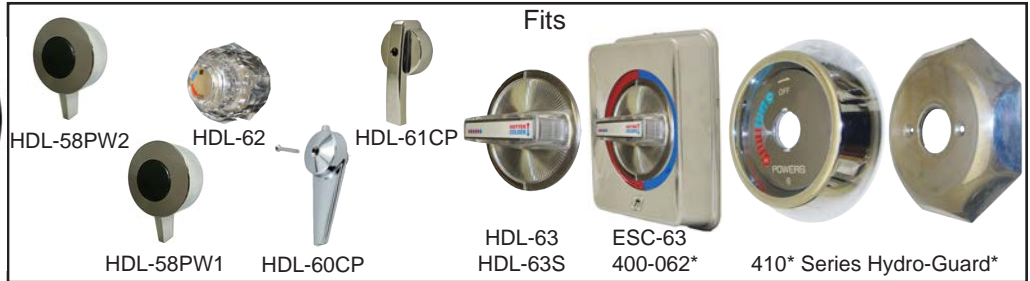

HydroGuard\* 400/410\* Series, Models 1-3 Bonnet Cap For 410-346\*



Item #	Ref #	Description
P611	410-346*	Bonnet* Powers*410* Series, Models 1-3*, 1/bg

\*Registered trademark or trade name of the mfg. listed used for reference only. Don't confuse us with the mfg. listed. 2. Products marked "low lead" or "lead free" contain 0.25% lead or less, per California AB 1953 & Vermont S152 Legislative Specs. \*\*PROP 65 WARNING! Exposure to ingredients in these products such as: Acrylamide, Arsenic, Benzene, Cadmium, Lead, Mercury are known to the state of California to cause cancer, birth defects or reproductive harm. (See <http://oehha.ca.gov/prop65.html>). Wash contacted body parts immediately. Assembled and tested in the USA

# Faucet Repair by Manufacturer - Powers\* Cartridges & Miscellaneous Kits



Item #	Ref #	Description
P602	401-176*	Black Plastic Stem Kit 400*

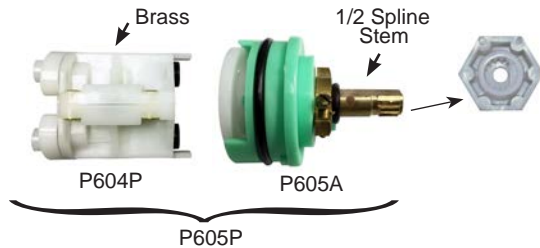

Item #	Ref #	Description
P605P	800-163*	Cartridge + PB Spool 800* Series
P604P	900-240*	Pressure Balancing, Spool Only 800*/900* Series
P605A	800-032A*	Top Valve Assembly Only 800* Series

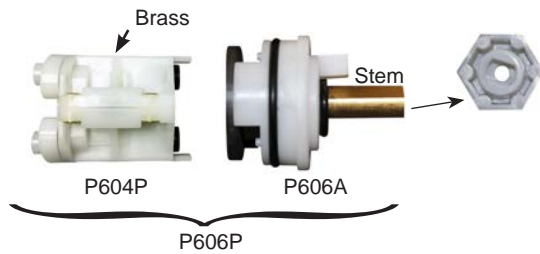

Item #	Ref #	Description
P606P	900-031*	Cartridge w/PB Spool 900* Series
P604P	900-240*	Pressure Balancing, Spool Only 800*/900* Series
P606A	900-032*	Top Valve Assembly Only 900* Series A

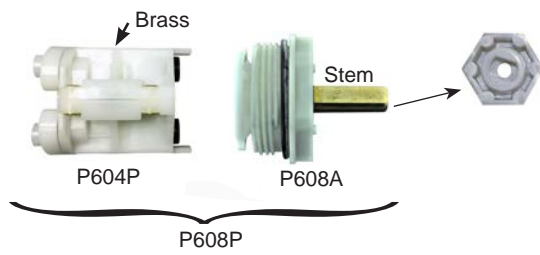
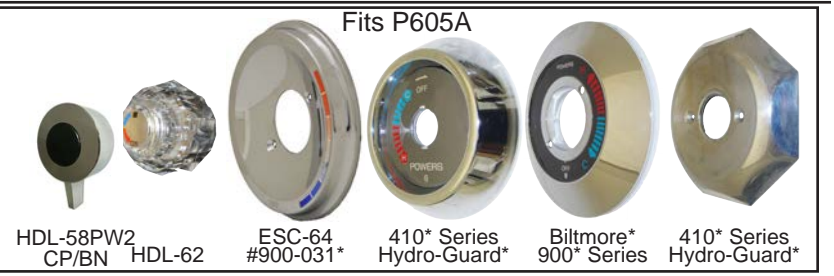

Item #	Ref #	Description
P608P	900-232*	S/H 900 Series N/S Cartridge w/PB Spool Biltmore* #3
P604P	900-240*	Pressure Balancing, Spool Only 800*/900* Series
P608A	900-240*	Top Valve Assembly Only 900* Series B

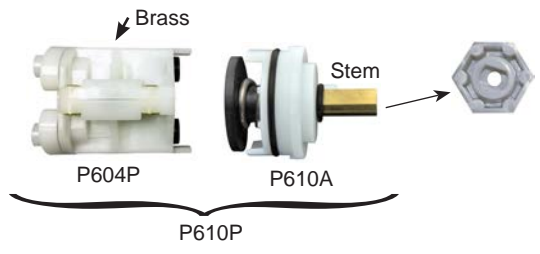
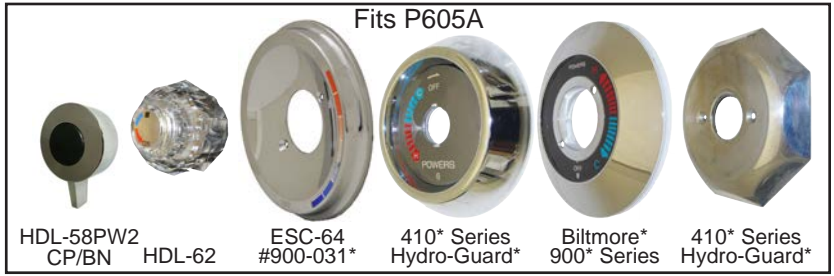

Item #	Ref #	Description
P610P		Powers* 900* P610A Cartridge w/604A Spool, 1/bg
P604P	900-240*	Pressure Balancing, Spool Only 800*/900* Series
P610A	800-044	Powers* Top valve Assembly only Double Flat 800 Series



C1 - FAUCET REPAIR  
By Manufacturer

\*Registered trademark or trade name of the mfg. listed used for reference only. Don't confuse us with the mfg. listed. 2. Products marked "low lead" or "lead free" contain 0.25% lead or less, per California AB 1953 & Vermont S152 Legislative Specs.  
 \*\*PROP 65 WARNING! Exposure to ingredients in these products such as: Acrylamide, Arsenic, Benzene, Cadmium, Lead, Mercury are known to the state of California to cause cancer, birth defects or reproductive harm. (See <http://oehha.ca.gov/prop65.html>). Wash contacted body parts immediately. Assembled and tested in the USA

# Faucet Repair by Manufacturer - Powers\* Cartridges & Miscellaneous Kits

C1 - FAUCET REPAIR By Manufacturer

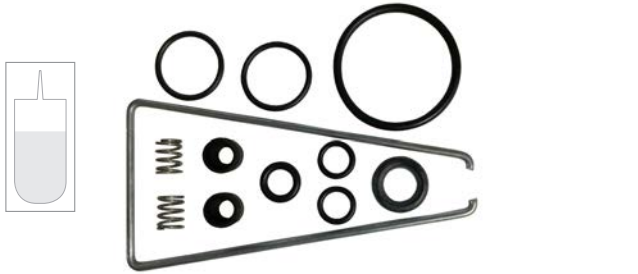

Item #	Ref #	Description
PWR-2	900-030*	Rebuild Kit 900* Series



Item #	Ref #	Description
PWR-3	800-030*	Rebuild Kit 800* Series



Item #	Ref #	Description
P607PR	900-049*	Powers* Integral Stop Assembly 900* Series



Item #	Description
P609PR	Powers* Integral Stop 800* Series PR

# Faucet Repair by Manufacturer - Price Pfister\* Avante\* Faucet Handle Parts

Avante\* Cartridge - New Style



P010AK(Kit)

Lead Free



P010C (Cartridge Only)

Item #	Ref #	Description
P010C	974-292*	Cartridge, N/S S/H Avante* Bedford*
P010CK	974-292*	P010A Cartridge w/Spout Seals, Lube, bagged

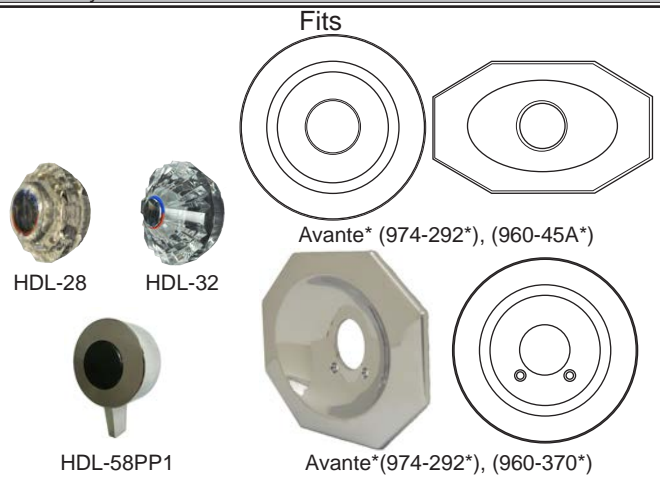

Fits

Avante\* (974-292\*), (960-45A\*)

HDL-28

HDL-32

HDL-58PP1

Avante\*(974-292\*), (960-370\*)

Avante\* New-Style (Sm) Side Seals



P011A



Item #	Description
P011	Avante* S/B Side Seals, Bulk, N/S

Avante\* New-Style Side Rebuild Kit



Item #	Description
PP-9	Avante* N/S Side Seal Rebuild Kit

Avante\* O/S (Lg) Side Seals Kit



Item #	Description
PP-1	Avante* O/S Side Seal Rebuild Kit

Avante\* Kitchen Lever Handle Kit



Item #	Ref	Description
PP-8	962-260*	Kit, P008 & P009 w/Screw, 1/ea per bag

Avante\* Kitchen Lever Handle Retainer Ring



Item #	Ref	Description
P009	962-260*	Avante* Kitchen Lever Handle Retainer Ring

Avante\* Kitchen Lever Handle Yoke



Item #	Ref	Description
P008	974-690*	Avante* Kitchen Lever Handle Yoke

Winner of the 2003 MGMPMA Award

\*Registered trademark or trade name of the mfg. listed used for reference only. Don't confuse us with the mfg. listed. 2. Products marked "low lead" or "lead free" contain 0.25% lead or less, per California AB 1953 & Vermont S152 Legislative Specs. \*\*PROP 65 WARNING! Exposure to ingredients in these products such as: Acrylamide, Arsenic, Benzene, Cadmium, Lead, Mercury are known to the state of California to cause cancer, birth defects or reproductive harm. (See <http://oehha.ca.gov/prop65.html>). Wash contacted body parts immediately. Assembled and tested in the USA

# Faucet Repair by Manufacturer - PRICE PFISTER\* - Two and Three Handle

2 Handle Ceramic Cartridge - Hot

2 Handle Ceramic Cartridge - Cold

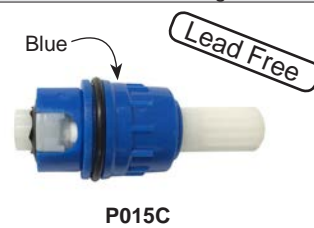
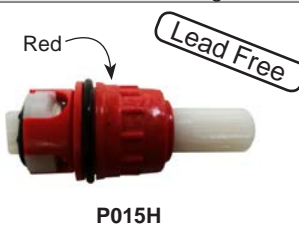

Item #	Ref #	Description
P015H	910-024* 910-031*	Price Pfister* 2 HDL, 1/4 Turn, Ceramic Cartridge, Red, Hot, 1/bg

Item #	Ref #	Description
P015C	910-025* 910-032*	Price Pfister* 2 HDL, 1/4 Turn, Ceramic Cartridge, Blue, Cold, 1/bg

2 Handle Washerless Cartridge

Lower Seal for 2-HDL Washerless Cartridge

Lower Seal for 2-HDL Washerless Cartridge

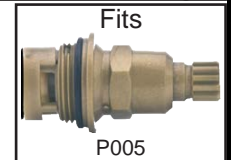
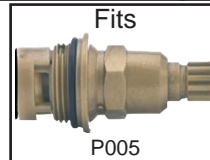
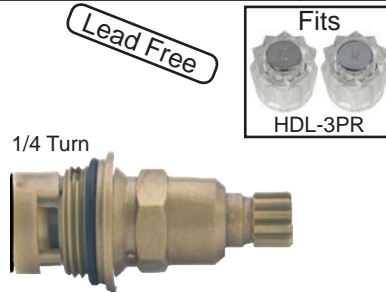

Item #	Ref #	Description
P005LF	910-900*	2 HDL Washerless Cartridge Replacement, 1/4 Turn Design

Item #	Ref #	Description
P006	949-360*	Lower Seal for 2 HDL Washerless Cartridge
PP-20		Kit, 6/ea, Lower Washerless Sels

Item #	Description
PP-6	Lower Seals Kit, 2 Sides With Lube, Bagged

3-Handle Shower Rebuild Kit

Shower Diverter Washer & Packing

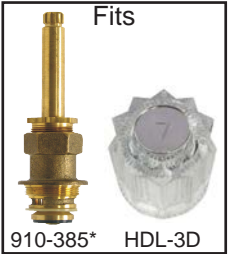
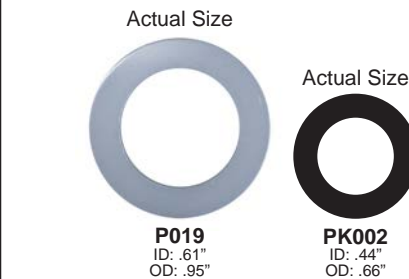
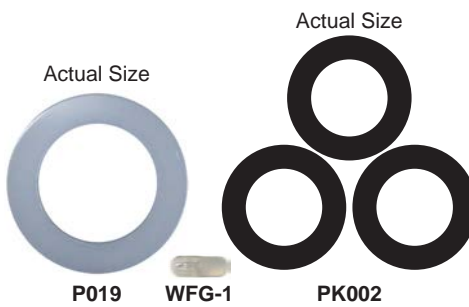

Item #	Description
PP-19	3 HDL Shower Rebuild Kit (P019 1 ea), PK002 (3 ea), WFG-1 (1 ea)

Item #	Ref #	Description
P019	950-040*	Shower Diverter Washer
PK002	90-460*	Packing - Rubber, Gerber*, Sterling* T/S Diverter Step

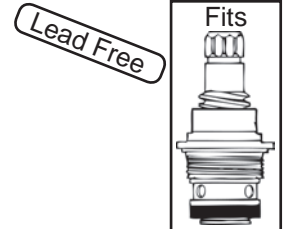
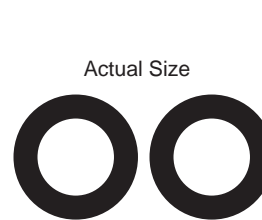
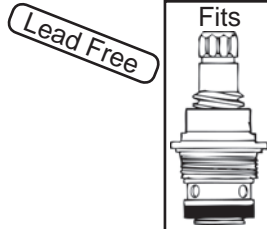

Item #	Description
PP-2	Kit-Cage w/Seals

Item #	Ref #	Description
P003	949-300*	2 HDL Lower Washer

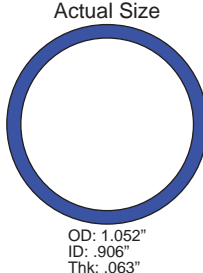
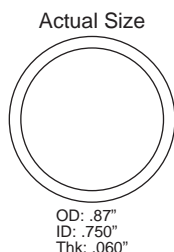

New & Improved  
"Will Not Break or Split"

Winner of the 2004 IHMA Award



Item #	Ref #	Description
CG001	950-170*	Plastic Cap Gasket - 0.875 x 0.750 x 0.063 inches

Item #	Description
CG005	PP* S/V* ETC - (Plastic)

Item #	Description
FN-999R	Multi-Fit Nipple, Hard TP Rubber

\*Registered trademark or trade name of the mfg. listed used for reference only. Don't confuse us with the mfg. listed. 2. Products marked "low lead" or "lead free" contain 0.25% lead or less, per California AB 1953 & Vermont S152 Legislative Specs.  
 \*\*PROP 65 WARNING! Exposure to ingredients in these products such as: Acrylamide, Arsenic, Benzene, Cadmium, Lead, Mercury are known to the state of California to cause cancer, birth defects or reproductive harm. (See <http://oehha.ca.gov/prop65.html>). Wash contacted body parts immediately. Assembled and tested in the USA

C1 - FAUCET REPAIR  
By Manufacturer

## Faucet Repair by Manufacturer - Prism\*

### Complete Diaphragm Kit Including Diaphragm Assembly

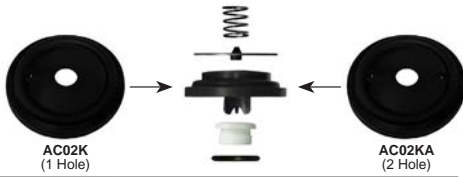

Item #	Ref #	Description
AC02K	2560-015-001*	Prism* PV Rebuild Kit, 1 Hole Diaphragm 1/bg
AC02KA	2560-015-001*	Prism* PV Rebuild Kit, 2 Hole Diaphragm 1/bg

### Diaphragm Assembly

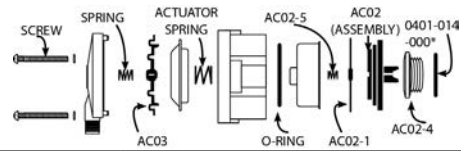

Item #	Ref #	Description
AC02		Diaphragm Assembly Only
AC02-1		Magnetic SS Disc w/Seal
AC02-4	2580-000-199*	Seat
AC02-5		Spring
AC03	2563-022-000*	Prism* Upper Diaphragm 1/bg

### Flow Restrictor Assembly

Item #	Ref #	Description
AC04A	2367-025-000*	0.5 GPM Urinal
AC04B		0.7 GPM Drinking Fountain
AC04C		1.0 GPM Lavatory
AC04D	1295-100-000*	2.2 GPM Shower
AC04E	0326-011-000*	2.5 GPM Shower
AC04F		1.4 GPM Shower
AC04Z		Universal 5 Way Combo



Winner of the 2003 MGMPMA Award

### Wet-Side Diaphragm



Winner of the 2003 MGMPMA Award

Item #	Ref #	Description
AC03	2563-022-000*	Prism* Upper Diaphragm 1/bg

## Faucet Repair by Manufacturer - Rohl\*

### Pressure Balancing Cartridges

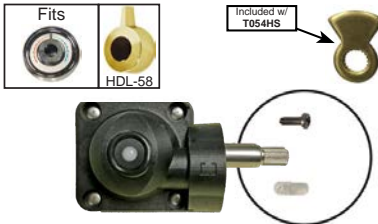

Item #	Ref #	Description
T054H		Tested Good, Tempress* II* Cartridge
T054HS		Tested Good, Tempress* II* Cartridge+ External Stop 1/bg

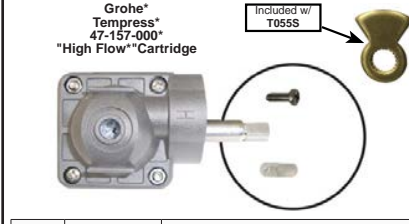

Item #	Ref #	Description
T055	4113-0001*	Tempress* High-Flow* Gray Cartridge With Ledges, T*11*EFX*
T055S	4113-0001*	Tempress* High-Flow* Gray Cartridge w/ Ledges + External Stop, T*11*EFX*

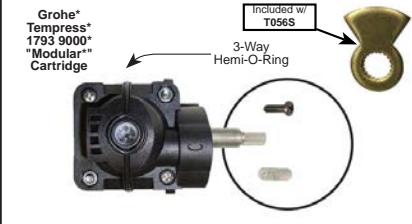

Item #	Ref #	Description
T056	1793 9000*	Tempress* Modular* Cartridge, Black With 3-Way Hemi-O-Ring
T056S	1793 9000*	Tempress* Modular* Cartridge, Black w/ 3-Way Hemi-O-Ring + External Stop

### Escutcheon Handle Drive Assembly



Item #	Ref #	Description
ES-DT2APK	1-207*	Escutcheon HDL Drive Assembly RE 2/pc Escutcheons, 1/bg

### Stop Plus Kit



Item #	Ref #	Description
T054-16K	10494*	Stop Plus Kit, 1/bg

### Stem Adapter



Item #	Description	Bkn/Std Pak
ES-DT1-4K	Stem Adapter w/Screw, Tempress* Kohler* Powers* Danfoss*	1/6

### Stem Adapter and Extender



Item #	Description
ES-DT1-4KE	ES-DT1-4K w/Stem Extension And Screw

TEMPRESS II\*/DANFOSS\*/GROHE\*/PHYLIRICH\*/INDIANA\*/NEWPORT BRASS\*, ETC.....

## VALVE BODY CONVERSION KIT

KIT INCLUDES EVERYTHING:  
CAP, ADAPTERS, SCREWS, NUTS



Works with these cartridges:

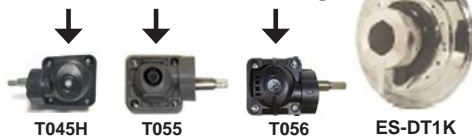

Replace various trims used by the sub-manufacturers who marketed this tub shower valve.

ITEM #	REF#	DESCRIPTION	PAK	STD PK
T054VC	47343560*	TEMPRESS*GROHE*ETC REPLACEMENT CAP WITH ESCUTCHEON ADAPTERS	1/BX	6

## Faucet Repair by Manufacturer - Sayco\*

### Old-Style Single Handle Cartridge



Item #	Ref #	Description
B100	300-0050	Bradley* Kohler* Cole* S/H Cart BradTrol* S/H Models



### 2-Handle Compression Stem Rebuild Kit



Item #	Description
SAY-1	Sayco* T/S Stem Rebuild Kit 1/bg



## Faucet Repair by Manufacturer - Speakman\*

Vacuum Breaker Repair Kit



VBSP-1



VBSP-2

Item #	Ref #	Description
VBSP-1	RPG05-0520*	Speakman* Vacuum Breaker Repair Kit, N/S 1/bg
VBSP-2	RPG05-0520*	Speakman* Vacuum Breaker Repair Kit, N/S 1/bg

Vacuum Breaker Repair Kit



SPK-01

Item #	Description
SPK-01	Speakman* Handle/Broach Adapter Inner/Outer Splined Sleeve, Bulk

## Faucet Repair by Manufacturer - Sterling\* - Single Handle (Also See Kohler\*)

Tub / Shower Cartridge # 05200\*

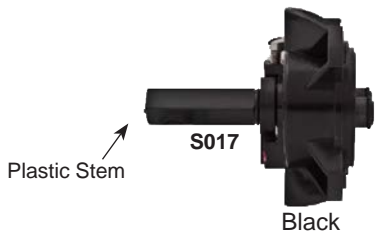

S017

Black

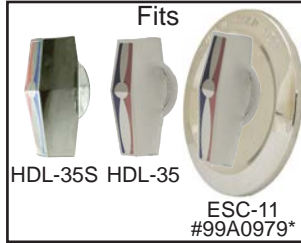

ESC-11 #99A0979\*

Winner of the 2003 DKHSMA Award

Tub / Shower Cartridge # 05300\*



S027A



ESC-51 #00A2974\*

Item #	Ref #	Description
S017	05200*	T/S Cartridge Black, 100*

Item #	Ref #	Description
S027A	05300*	Sterling* Fits T/S Cartridge

Stem Extender



S017-9

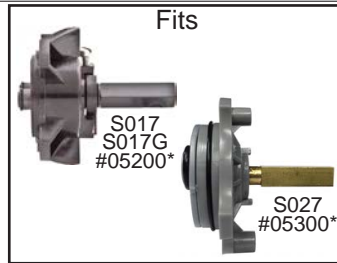

S017, S017G #05200\*

S027 #05300\*

Item #	Ref #	Description
S017-9	71906*	Stem Extender, Kohler* Sterling* Tub Shower



K010K #500520\*

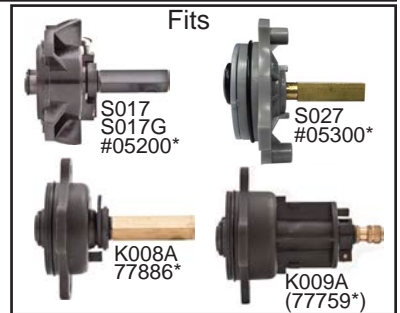

S017, S017G #05200\*

S027 #05300\*

K008A 77886\*

K009A (77759\*)

Item #	Ref #	Description
K010K	500520*	Kohler* Pressure Balancing Spool

Rebuild Kit for Cartridge S017/S017G # 05200\*



S017, S017G #05200\*

Item #	Description
S-14	Sterling* Kit, Fits S017

Cartridge # 00A5013\* & #00A5023\*



S015 & S016



HDL-5M

HDL-48

ESC-21 #99B3326\*

Item #	Ref #	Description
S015	00A5013*	Cartridge w/o SS Diverter
S016	00A5023*	Cartridge, w/SS Diverter

\*Registered trademark or trade name of the mfg. listed used for reference only. Don't confuse us with the mfg. listed. 2. Products marked "low lead" or "lead free" contain 0.25% lead or less, per California AB 1953 & Vermont S152 Legislative Specs. \*\*PROP 65 WARNING! Exposure to ingredients in these products such as: Acrylamide, Arsenic, Benzene, Cadmium, Lead, Mercury are known to the state of California to cause cancer, birth defects or reproductive harm. (See <http://oehha.ca.gov/prop65.html>). Wash contacted body parts immediately. Assembled and tested in the USA

# Faucet Repair by Manufacturer - Sterling\* - Single Handle (Also See Kohler\*)

**C1 - FAUCET REPAIR By Manufacturer**

## Single Handle Kitchen Cartridge Kit



Lead Free

Item #	Ref #	Description
S-8	05020*	Kit-S/H Kitchen (S010) - Bagged

## Single Handle Rebuild Cartridge Kit

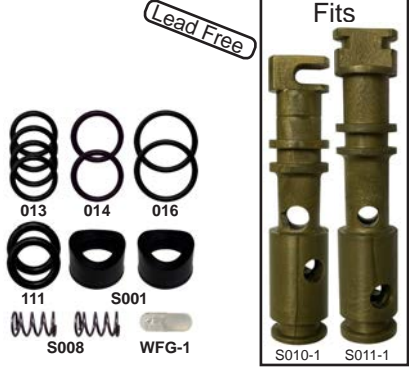

Lead Free



Item #	Description
S-1	Kit-Single HDL-Washerless

## Single Handle Washerless Cartridge Kit



Lead Free

Item #	Ref #	Description
S-9	05010*	Kit-S/H Lavatory and T/S (S011) Bagged

## 2 Handle Washerless Kit



Lead Free

Item #	Ref #	Description
S-3	05050*	Complete 2 HDL Washerless Kit, w/O Bonnet w/Stem, Seat, Seal, and Spring

## 2 Handle Washerless Kit w/Stem & Bonnet



Lead Free

Item #	Ref #	Description
S-3A	05050*	Complete 2 HDL Washerless Kit, w/Bonnet

## 2 Handle Washerless Seal Kit

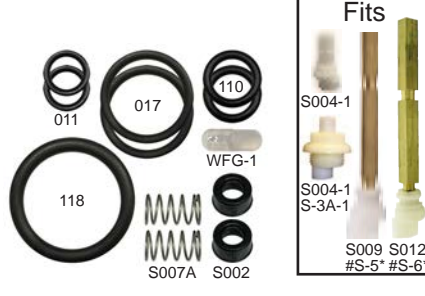

Item #	Description
S-2	Kit-2 HDL Washerless

## 2 Handle Tub/Shower Stem Kit w/1 Stem



Item #	Ref #	Description
S-5	05030*	Kit, 2 HDL T/S Stem Seats, Seals, w/S009, bagged

## 2 Handle Tub/Shower Stem Kit w/1 Long Stem



Item #	Description
S-10	Kit-S/H, T/S (S012), bagged

## 2 Handle Tub/Shower Stem Kit w/2 Stems



Item #	Ref #	Description
S-6	0503A*	Kit, 2 HDL T/S, 2 Stems (S-5 w/ S012), bagged

## Packing & Diverter Washer Kit

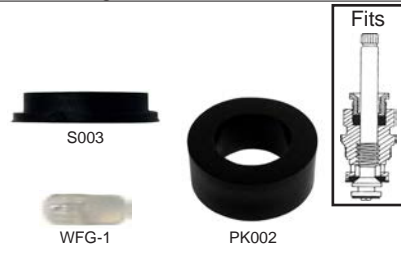

Item #	Description
S-7	Kit - S003 & PK002 w/Lube Kit, bagged

## Packing & Diverter Washer - Bulk

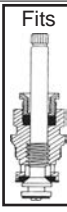

Item #	Ref #	Description
PK002	90-460*	Packing - Rubber, Gerb*, Steri* T/S Diverter Step
S003		Packing, Rubber

## Fit-All Nipple



Winner of the 2004 IHMA Award

Item #	Description
FN-999R	Multi-Fit Nipple, Hard TP Rubber

\*Registered trademark or trade name of the mfg. listed used for reference only. Don't confuse us with the mfg. listed. 2. Products marked "low lead" or "lead free" contain 0.25% lead or less, per California AB 1953 & Vermont S152 Legislative Specs. \*\*PROP 65 WARNING! Exposure to ingredients in these products such as: Acrylamide, Arsenic, Benzene, Cadmium, Lead, Mercury are known to the state of California to cause cancer, birth defects or reproductive harm. (See <http://oehha.ca.gov/prop65.html>). Wash contacted body parts immediately. Assembled and tested in the USA

# Faucet Repair by Manufacturer - Symmons\*

Temptrol\* Cartridge # TA-10\*

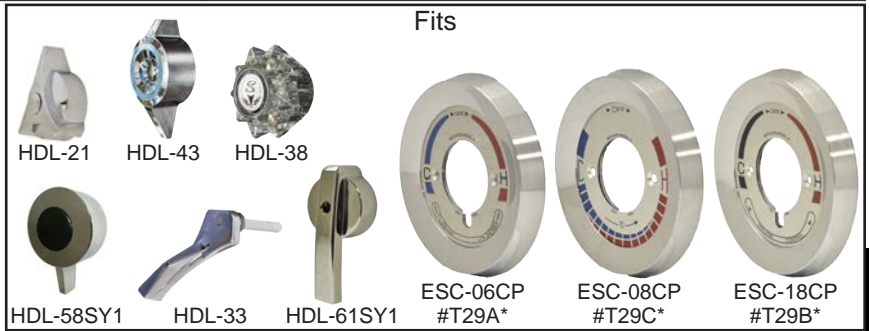

Item #	Ref #	Description
S200	TA-10*	Complete Temptrol* Spindle Assembly

## Temptrol\* Brass Seat Kit

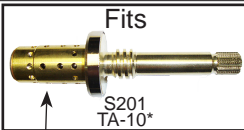

Item #	Ref #	Description
S201	TA-4* (S-1/3)*	2 pc Seat Kit

## Temptrol\* Diverter Spindle

(Tub/Shower Only)

Winner of the 2001 MGBBCMA Award



Item #	Ref #	Description
S205	T-25A*	Symmons* Temptrol* Diverter, Plastic Broach
S205N	T-25A*	Symmons* Temptrol* Diverter, Brass Broach
S205B	TA-25B*	Symmons* Temptrol* Volume Control, Black, Plastic Broach
S205BN	TA-25B*	Symmons* Temptrol* Volume Control, Black, Brass Broach

## Temptrol\* Washer Kit

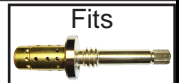

Item #	Ref #	Description
S202	TA-9*	Temptrol* Washer Kit

## Safetymix\* Cartridge #C-5\*

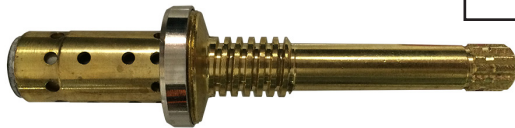

Item #	Ref #	Description
S210	C-5*	Safetymix* Cartridge

## Safetymix\* Seat

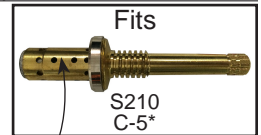

Item #	Ref #	Description
S211	SC-3*	Safetymix* Seat

## Safetymix\* Washer Kit

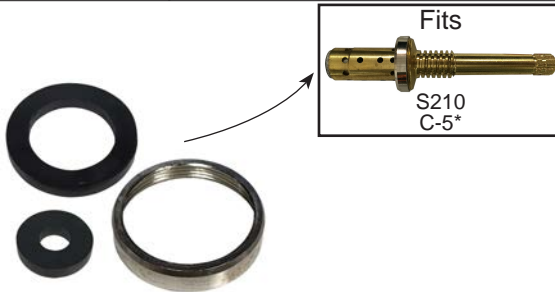

Item #	Ref #	Description
S203	KIT-BT-9*	Safetymix* Washer Kit

## Safetymix\* Washer & Gasket Kit

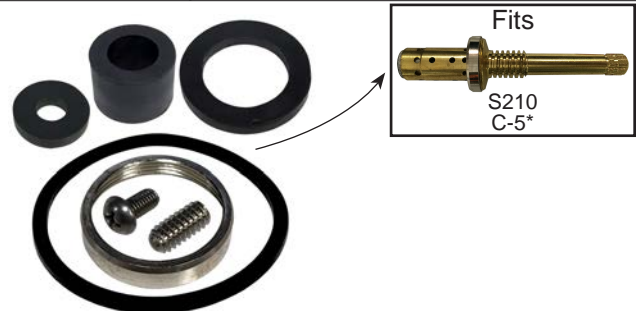

Item #	Ref #	Description
PK007	SC-17*	Safetymix* PAK

\*Registered trademark or trade name of the mfg. listed used for reference only. Don't confuse us with the mfg. listed. 2. Products marked "low lead" or "lead free" contain 0.25% lead or less, per California AB 1953 & Vermont S152 Legislative Specs. \*\*PROP 65 WARNING! Exposure to ingredients in these products such as: Acrylamide, Arsenic, Cadmium, Lead, Mercury are known to the state of California to cause cancer, birth defects or reproductive harm. (See <http://oehha.ca.gov/prop65.html>). Wash contacted body parts immediately. Assembled and tested in the USA

## Faucet Repair by Manufacturer - Teck\* Tempus\* (Tempress II\*)

**NOTE: Industry Confusion Alert! If You Do Not Have A Cartridge To Match...**

Then Look At Brass Cast Body For Brand.

1. If Marked Tempus\* (i.e. Pre 1992) Use TP040\* (190126A\*)
2. If Marked Teck\* (i.e. 1992-98) Use MT040\* (06160A\* / RP14120\*)

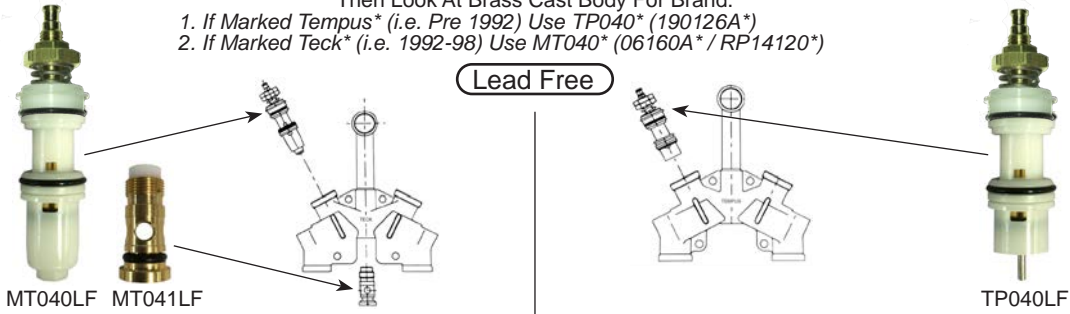

Item #	Ref #	Description	Pkg
MT040LF	060160A*	Teck* Standard Metering Cartridge, Lead Free	1/bg
TP040LF	190126A*	Tempus* Short Metering Cartridge, Lead Free	1/bg
MT041ALF	77344*	Teck* 0.5 GPM #32 Flow Control, Lead Free	1/bg
MT041BLF	77262*	Teck* 0.7 GPM #32 Flow Control, Lead Free	1/bg
MT041CLF		Teck* 1.0 GPM #32 Flow Control, Lead Free	1/bg
MT041DLF		Teck* 2.2 GPM #32 Flow Control, Lead Free	1/bg
MT041ELF	77288*	Teck* 2.5 GPM #32 Flow Control, Lead Free	1/bg
MT041FLF		Teck* 1.4 GPM #32 Flow Control, Lead Free	1/bg

## Faucet Repair by Manufacturer - Tempress II\* (Also See Danfoss\*)

### Pressure Balancing Cartridges



Item #	Ref #	Description
T054H	47078*, 4103-1285*	Pressure Balancing Cartridge w/Screws, 1/bg



Item #	Ref #	Description
T055	47-157-000*	Tempress* High-Flow* Gray Cartridge With Ledges, T*11*EFX*



Item #	Ref #	Description
T056	1793 9000*	Tempress* Modular* Cartridge, Black With 3-Way Hemi-O-Ring

**Grohe\* Tempress\* 1793 9000\* "Modular" Cartridge**

### Escutcheon Handle Drive Assembly



ES-DT2APK

Item #	Ref #	Description
ES-DT2APK	1-207*	Escutcheon HDL Drive Assembly RE 2/pc Escutcheons, 1/bg

### Stop Plus Kit

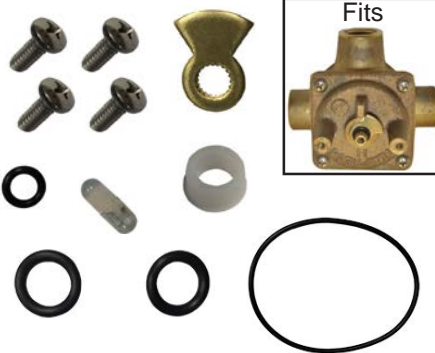

Item #	Ref #	Description
T054-16K	10494*	Stop Plus Kit, 1/bg

### Stem Adapter

Item #	Description	Bkn/Std Pak
ES-DT1-4K	Stem Adapter w/Screw, Tempress* Kohler* Powers* Danfoss*	1/6

### Stem Adapter and Extender

Item #	Description
ES-DT1-4KE	ES-DT1-4K w/Stem Extension And Screw

## TEMPRESS II\*/DANFOSS\*/GROHE\*/PHYLIRICH\*/INDIANA\*/NEWPORT BRASS\*, ETC..... VALVE BODY CONVERSION KIT

**KIT INCLUDES EVERYTHING:  
CAP, ADAPTERS, SCREWS, NUTS**



**Works with these cartridge**

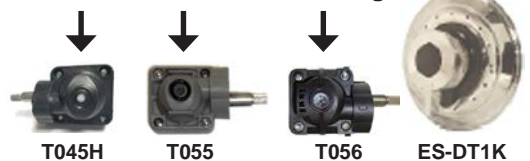

**Replace various trims used by the sub-manufacturers who marketed this tub shower valve.**

ITEM #	REF#	DESCRIPTION	PAK	STD PK
<b>T054VC</b>	47343560*	TEMPRESS*GROHE*ETC REPLACEMENT CAP WITH ESCUTCHEON ADAPTERS	1/BX	6

**C1 - FAUCET REPAIR  
By Manufacturer**

\*Registered trademark or trade name of the mfg. listed used for reference only. Don't confuse us with the mfg. listed. 2. Products marked "low lead" or "lead free" contain 0.25% lead or less, per California AB 1953 & Vermont S152 Legislative Specs. \*\*PROP 65 WARNING! Exposure to ingredients in these products such as: Acrylamide, Arsenic, Benzene, Cadmium, Lead, Mercury are known to the state of California to cause cancer, birth defects or reproductive harm. (See <http://oehha.ca.gov/prop65.html>). Wash contacted body parts immediately. Assembled and tested in the USA

# Faucet Repair by Manufacturer - T&S Brass\*

Fits T&S & Service Spray # B-107\*

New-Style Metering Cartridge

Replacement Cartridge / Bonnet / Handle Conversion Kit

Complies With the 1.4 G.P.M. @ 60 p.s.i. Water Saving Code (EPA Act of 2005)

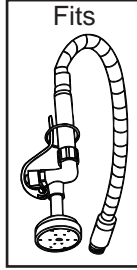

It's Easy!  
A Direct Conversion.  
Nothing To Do Except Install!

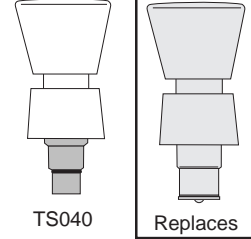

Lead Free

Item #	Ref #	Description
TS-01A		New Style Face Plate 1.42 GPM @ 60 psi
TS-01	TS1121-45*	Face Plate, Gray Plastic
TS-02	7861-45*	Protector Ring, TP Rubber
P003	949-300*	2 HDL Lower Washer

Item #	Description
TS040	T/S* N/S Metering Cartridge w/Handle & Bonnet Timing Wrench
HDL-66(CP)	Handle HDL-66(CP)

T&S\* Eterna\* Rebuild Kit

**Also Upgrades Import Spindle Assemblies To OEM Standards!**

Rebuilds This Assembly



RE: T&S\* #002711-40 & #002712-40



Rebuilds This Assembly



RE: T&S\* #002713-40 & #002714-40



Item #	Ref #	Description
TS038K	002711-40*, 002712-40*	T&S* Eterna* Spindle Rebuild Kit, w/Spring Check Assembly (1/bg)
TS039K	002713-40*, 002714-40*	T&S* Spindle Rebuild Kit, Eterna* 2713/14-40* (1/bg)

Hot / Cold Spindle Rebuild Kits  
T&S\* Workboard\* 027\* 028\*

Kits Include:			
Item #	Item Description	TS037K QTY	TS036K QTY
TS-PK-1-1	Packing Carrier	2	2
010	Packing O-Rings	2	2
W002	Hi Temp Bib Washer	2	—
SCREW-5	8/32 Bib Screw	2	—
WFG-1	Silicone Lube Capsule	1	2
INST	Instructions	1	1



**TS037K REPLACES**  
New 2 Piece Packing Design Replaces All Old Packing Parts

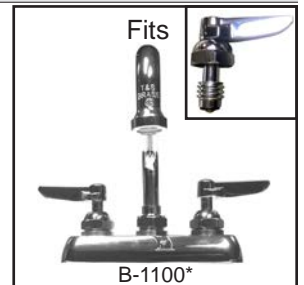

Item #	Ref #	Description
TS037K	B-1100*, 002709-40*, 002710-40*	T&S* Workboard* 2709/10-40* Spindle Rebuild Kit
TS036K	027A*, 028A*, 002709-40*, 002710-40*	T&S* Workboard* 2709/10-40* Spindle Packing Kit

Vacuum Breaker Kits to Fit T&S Brass\*

Commercial Vacuum Breakers

Commercial Vacuum Breakers



Item #	Ref #	Description
VBTS-1	B-0968*	T&S* Vacuum Breaker Kit (3/8 NPT)

Item #	Ref #	Description
VBTS-2	B-0969*	T&S* Vacuum Breaker Kit (1/2 IPS)

\*Registered trademark or trade name of the mfg. listed used for reference only. Don't confuse us with the mfg. listed. 2. Products marked "low lead" or "lead free" contain 0.25% lead or less, per California AB 1953 & Vermont S152 Legislative Specs.  
\*\*PROP 65 WARNING! Exposure to ingredients in these products such as: Acrylamide, Arsenic, Benzene, Cadmium, Lead, Mercury are known to the state of California to cause cancer, birth defects or reproductive harm. (See <http://oehha.ca.gov/prop65.html>). Wash contacted body parts immediately. Assembled and tested in the USA

Updated 02/20/23

Page # C1-45

C1 - FAUCET REPAIR  
By Manufacturer

# Faucet Repair by Manufacturer - Universal Rundle\*, Milwaukee\*, Sears\*

## Repair Parts for Single Handle Faucets

### Single Handle Cartridge - New Style #W1005\*

Lead Free



Item #	Ref #	Description
U010(LF)	R1005*	Cartridge, New Style S/H Replacement

### Inlet Seal and Spring for U010(LF) #W1005\*

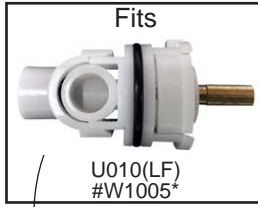

Lead Free



Item #	Description
U011	S/H Inlet Seal (Seat) - Fits U010(LF)
U012	S/H Inlet Spring - Fits U010(LF)

### Single Handle Rebuild Kit



Item #	Description
U-4	Lube, Bagged to Rebuild U/R* S/H Cartridge, R1005*

C1 - FAUCET REPAIR By Manufacturer

## Repair Parts for 2 Handle Faucets

### Short Stem Kit w/Seats & Springs #P9354\*

Lead Free



Item #	Ref #	Description
U-2	P9354*	Kit - U001, Seats & Springs

### Long Stem Kit w/U002 Stem, Seats & Springs

Lead Free

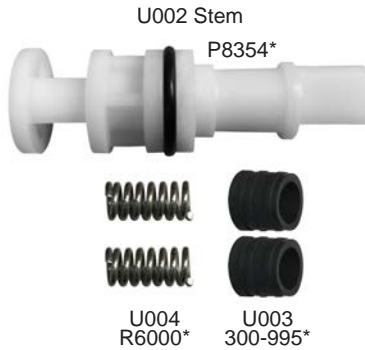

Item #	Description
U-3	Kit - U002, Seats & Springs

### Stem Kit w/Seat & Spring # W1019\*

Lead Free



Item #	Ref #	Description
U007-8	W1019*	Kit - U007, Seats & Springs

### 2-Handle Cartridge #W1004\*

Lead Free



Item #	Ref #	Description
U005	R1004*	Cartridge - Hot - Red
U006	R1004*	Cartridge - Cold - Blue



Item #	Ref #	Description
U-1	P8184*	Kit, 4/ea Seats (U003*) & Springs (U004*), bagged
U-5		Kit, 2/ea Seats (U003) & Springs (U004), bagged
U003	300-995*	Seat (RE U001, U002, U005, U006, U007, U008)
U004	R6000*	Spring (RE U001, U002, U005, U006, U007, U008)

## Faucet Repair by Manufacturer - Union Brass\*

2 Handle Washerless Cartridge #1839A\*

Single Handle Safeguard\* Pressure Balancing Cartridge



Lead Free



Item #	Ref #	Description
U100	1839A*	2 HDL Washerless, Shorty

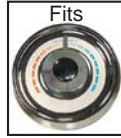

Item #	Ref #	Description
T054H	Safeguard* = 316*, Tempress II* = 47078*	Union Brass* Safeguard* Pressure Balancing Cartridge w/Screws, 1/bg



**Grohe\* Tempress\* 47-157-000\* "High Flow\*\*" Cartridge**

Item #	Ref #	Description
T055	47-157-000*	Tempress* High-Flow* Gray Cartridge w/ Ledges, T*11*EFX*



**Grohe\* Tempress\* 1793 9000\* "Modular\*\*" Cartridge**

Item #	Ref #	Description
T056	1793 9000*	Tempress* Modular* Cartridge, Black w/3-Way Hemi-O-Ring

TEMPRESS II\*/DANFOSS\*/GROHE\*/PHYLIRICH\*/INDIANA\*/NEWPORT BRASS\*, ETC.....

### VALVE BODY CONVERSION KIT

KIT INCLUDES EVERYTHING:  
**CAP, ADAPTERS, SCREWS, NUTS**



Works with these cartridges:



Replace various trims used by the sub-manufacturers who marketed this tub shower valve.

ITEM #	REF#	DESCRIPTION	PAK	STD PK
T054VC	47343560*	TEMPRESS*GROHE*ETC REPLACEMENT CAP WITH ESCUTCHEON ADAPTERS	1/BX	6

## Faucet Repair by Manufacturer - Valley\*, Ace\*, Aqualine\*, Eljer\*, Phoenix\*, Sears\*, Speakman\*

Single Handle Cartridge - Old Style



Lead Free

Item #	Ref #	Description
V001	V6680*	O/S S/H Cartridge All Phoenix* S/H
V001K	V6680*	V001 w/Seats



Single Handle Cartridge - New Style



Lead Free

Item #	Ref #	Description
V010K	VP1964*	N/S S/H Cart, Plastic Stem w/Spout Seals HDL Screw & Wrench
V010AK	VP1964*	V010K w/Brass Stem
V011K	VP1965*	Valley* S/H w/Spray Diverter
V011AK	VP1965*	V010K w/Brass Stem

Faucet Parts to Fit Valley\*, Ace\*, Aqualine\*, Eljer\*, Phoenix\*, Sears\*, Speakman\*

Single Handle Back-To-Back Tub/Shower Cartridge #V6005\*

Single Handle Tub / Shower Cartridge #V4268\*

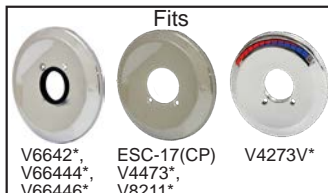

Item #	Ref #	Description
V017	V6005*	S/H Back-To-Back T/S Cartridge, 1/bg

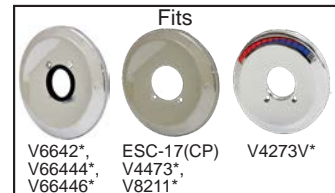

Item #	Ref #	Description
V018	V4268*	S/H T/S Cartridge, 1/bg

\*Registered trademark or trade name of the mfg. listed used for reference only. Don't confuse us with the mfg. listed. 2. Products marked "low lead" or "lead free" contain 0.25% lead or less, per California AB 1953 & Vermont S152 Legislative Specs.  
\*\*PROP 65 WARNING! Exposure to ingredients in these products such as: Acrylamide, Arsenic, Benzene, Cadmium, Lead, Mercury are known to the state of California to cause cancer, birth defects or reproductive harm. (See <http://oehha.ca.gov/prop65.html>). Wash contacted body parts immediately. Assembled and tested in the USA

## Faucet Repair by Manufacturer -

**Valley\*, Ace\*, Aqualine\*, Eljer\*, Phoenix\*, Sears\*, Speakman\***



Item #	Ref #	Description
SV-2	V6804*	V003 w/Seat, Spring, Insert - 2 Handle
V003	V6804*	Cartridge - 2 HDL, 1/bg



Item #	Description
V035C	VALLEY* Cartridge Extender, 2 HDL, Cold, White
V035H	VALLEY* Cartridge Extender, 2 HDL, Hot, Black



Item #	Ref #	Description
V006	V6860*	Replacement Cart - Hi-Flo* Roman Tub & All Canada, 1/bg

## Faucet Repair by Manufacturer - Valley\*



Item #	Ref #	Description
SV-1	V1001CD*	Complete Rebuild Kit - V001 Single Handle Series, 1/bg

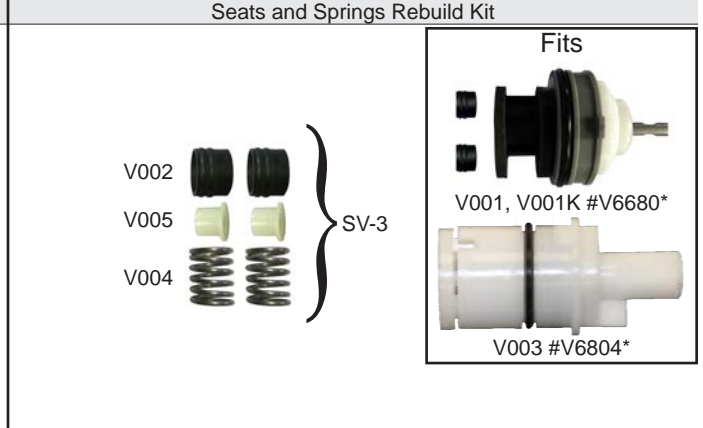

Item #	Ref #	Description
SV-3	V1001CD*	Seats, Springs, Inserts - V001 & V003 2/bg

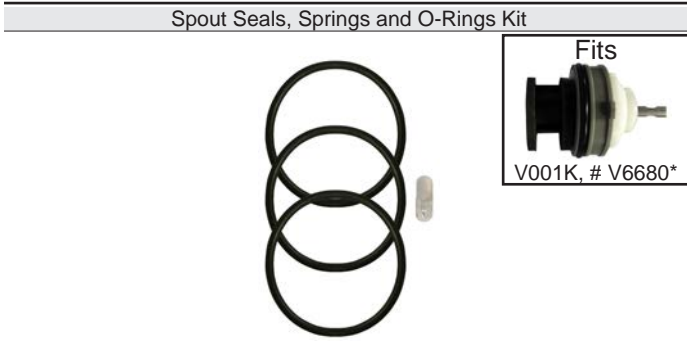

Item #	Ref #	Description
SV-4	V1112*	Spout Seals - V001 S/H Series, 1/bg

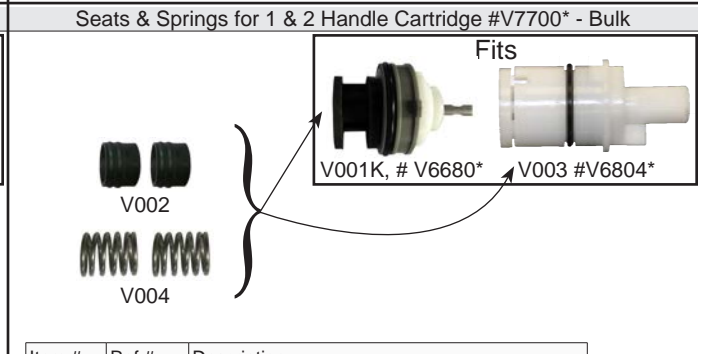

Item #	Ref #	Description
V002	V7700*	Seat S/H & 2 HDL, bulk
V004		Spring, bulk

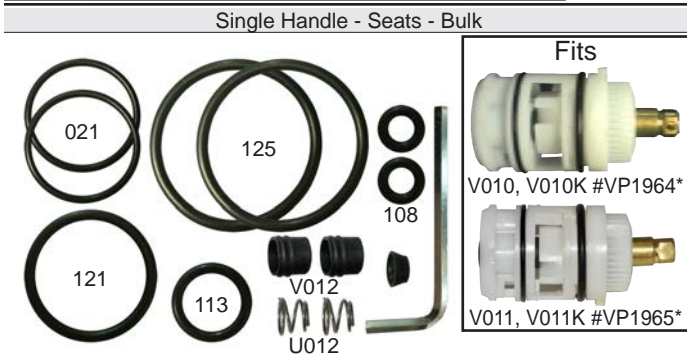

Item #	Description
SV-7	Valley* New Style Single Handle Cartridge Rebuild Kit For VP1964* & VP1965*

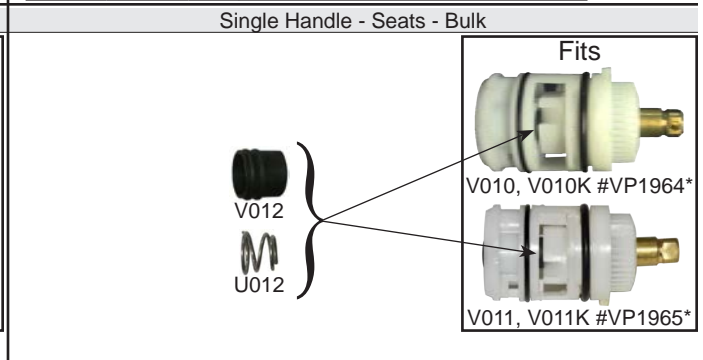

Item #	Description
V012	S/H Seat
U012	Spring







\*Registered trademark or trade name of the mfg. listed used for reference only. Don't confuse us with the mfg. listed. 2. Products marked "low lead" or "lead free" contain 0.25% lead or less, per California AB 1953 & Vermont S152 Legislative Specs. \*\*PROP 65 WARNING! Exposure to ingredients in these products such as: Acrylamide, Arsenic, Benzene, Cadmium, Lead, Mercury are known to the state of California to cause cancer, birth defects or reproductive harm. (See <http://oehha.ca.gov/prop65.html>). Wash contacted body parts immediately. Assembled and tested in the USA



## Faucet Repair by Manufacturer - Valley\*

Wrench / Hex Combo - Basic Standard with Integral Hex Wrench	Wrench / Hex Combo - Basic Standard with Removable Hex Wrench	Combo Wrench - Flat Style														
 <p>Formed Steel Hex Wrench</p>																
<table border="1" style="width: 100%; border-collapse: collapse;"> <tr><th>Item #</th><th>Ref #</th><th>Description</th></tr> <tr><td>D013</td><td>RPB1974*</td><td>Wrench Combo w/Integral Hex Wrench</td></tr> </table>	Item #	Ref #	Description	D013	RPB1974*	Wrench Combo w/Integral Hex Wrench	<table border="1" style="width: 100%; border-collapse: collapse;"> <tr><th>Item #</th><th>Description</th></tr> <tr><td>D024</td><td>Wrench / Hex Combo, Heavy Duty, 2pc w/Real (Removable) Allen (Hex) Wrench</td></tr> </table>	Item #	Description	D024	Wrench / Hex Combo, Heavy Duty, 2pc w/Real (Removable) Allen (Hex) Wrench	<table border="1" style="width: 100%; border-collapse: collapse;"> <tr><th>Item #</th><th>Description</th></tr> <tr><td>D026</td><td>Combo Wrench In Flat Style</td></tr> </table>	Item #	Description	D026	Combo Wrench In Flat Style
Item #	Ref #	Description														
D013	RPB1974*	Wrench Combo w/Integral Hex Wrench														
Item #	Description															
D024	Wrench / Hex Combo, Heavy Duty, 2pc w/Real (Removable) Allen (Hex) Wrench															
Item #	Description															
D026	Combo Wrench In Flat Style															

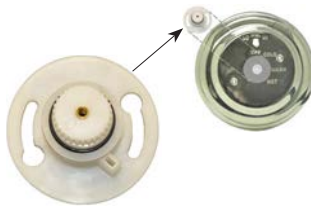
## Faucet Repair by Manufacturer - Valley\* (Also See Danfoss\*)

Pressure Balancing Cartridges																				
 <p>HDL-58</p>	<p style="text-align: center;"><b>Grohe* Tempress* 47-157-000* "High Flow*" Cartridge</b></p> 	<p style="text-align: center;"><b>Grohe* Tempress* 1793 9000* "Modular*" Cartridge</b></p>  <p>3-Way Hemi-O-Ring</p>																		
<table border="1" style="width: 100%; border-collapse: collapse;"> <tr><th>Item #</th><th>Ref #</th><th>Description</th></tr> <tr><td>T054H</td><td>V4750*</td><td>Pressure Balancing Cartridge w/Screws, 1/bg</td></tr> </table>	Item #	Ref #	Description	T054H	V4750*	Pressure Balancing Cartridge w/Screws, 1/bg	<table border="1" style="width: 100%; border-collapse: collapse;"> <tr><th>Item #</th><th>Ref #</th><th>Description</th></tr> <tr><td>T055</td><td>47-157-000*</td><td>Tempress* High-Flow* Gray Cartridge With Ledges, T*11"EFX*</td></tr> </table>	Item #	Ref #	Description	T055	47-157-000*	Tempress* High-Flow* Gray Cartridge With Ledges, T*11"EFX*	<table border="1" style="width: 100%; border-collapse: collapse;"> <tr><th>Item #</th><th>Ref #</th><th>Description</th></tr> <tr><td>T056</td><td>1793 9000*</td><td>Tempress* Modular* Cartridge, Black With 3-Way Hemi-O-Ring</td></tr> </table>	Item #	Ref #	Description	T056	1793 9000*	Tempress* Modular* Cartridge, Black With 3-Way Hemi-O-Ring
Item #	Ref #	Description																		
T054H	V4750*	Pressure Balancing Cartridge w/Screws, 1/bg																		
Item #	Ref #	Description																		
T055	47-157-000*	Tempress* High-Flow* Gray Cartridge With Ledges, T*11"EFX*																		
Item #	Ref #	Description																		
T056	1793 9000*	Tempress* Modular* Cartridge, Black With 3-Way Hemi-O-Ring																		
Stem Adapter	Escutcheon Handle Drive Assembly	Stop Plus Kit																		
	 <p>ES-DT2APK</p>	 <p>Fits</p>																		
<table border="1" style="width: 100%; border-collapse: collapse;"> <tr><th>Item #</th><th>Description</th></tr> <tr><td>ES-DT1-4K</td><td>Stem Adapter w/Screw, Tempress* Kohler* Powers* Danfoss*</td></tr> </table>	Item #	Description	ES-DT1-4K	Stem Adapter w/Screw, Tempress* Kohler* Powers* Danfoss*	<table border="1" style="width: 100%; border-collapse: collapse;"> <tr><th>Item #</th><th>Ref #</th><th>Description</th></tr> <tr><td>ES-DT2APK</td><td>1-207*</td><td>Escutcheon HDL Drive Assembly RE 2/pc Escutcheons, 1/bg</td></tr> </table>	Item #	Ref #	Description	ES-DT2APK	1-207*	Escutcheon HDL Drive Assembly RE 2/pc Escutcheons, 1/bg	<table border="1" style="width: 100%; border-collapse: collapse;"> <tr><th>Item #</th><th>Ref #</th><th>Description</th></tr> <tr><td>T054-16K</td><td>10494*</td><td>Stop Plus Kit, 1/bg</td></tr> </table>	Item #	Ref #	Description	T054-16K	10494*	Stop Plus Kit, 1/bg		
Item #	Description																			
ES-DT1-4K	Stem Adapter w/Screw, Tempress* Kohler* Powers* Danfoss*																			
Item #	Ref #	Description																		
ES-DT2APK	1-207*	Escutcheon HDL Drive Assembly RE 2/pc Escutcheons, 1/bg																		
Item #	Ref #	Description																		
T054-16K	10494*	Stop Plus Kit, 1/bg																		
Stem Adapter and Extender																				
																				
<table border="1" style="width: 100%; border-collapse: collapse;"> <tr><th>Item #</th><th>Description</th></tr> <tr><td>ES-DT1-4KE</td><td>ES-DT1-4K w/Stem Extension And Screw</td></tr> </table>	Item #	Description	ES-DT1-4KE	ES-DT1-4K w/Stem Extension And Screw																
Item #	Description																			
ES-DT1-4KE	ES-DT1-4K w/Stem Extension And Screw																			

TEMPRESS II\*/DANFOSS\*/GROHE\*/PHYLIRICH\*/INDIANA\*/NEWPORT BRASS\*, ETC.....

### VALVE BODY CONVERSION KIT

KIT INCLUDES EVERYTHING:  
CAP, ADAPTERS, SCREWS, NUTS

Works with these cartridges:

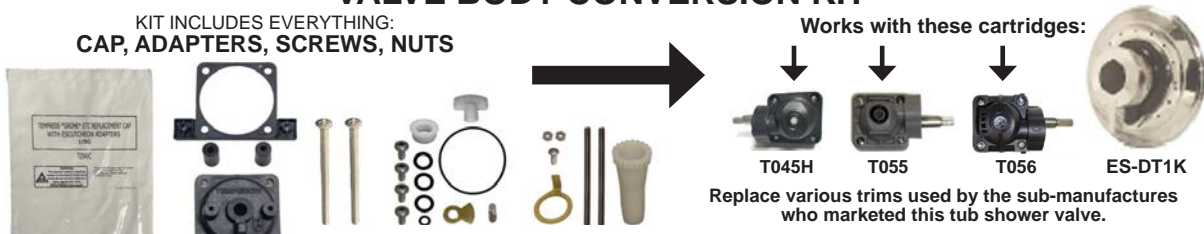

ITEM #	REF#	DESCRIPTION	PAK	STD PK
T054VC	47343560*	TEMPRESS*GROHE*ETC REPLACEMENT CAP WITH ESCUTCHEON ADAPTERS	1/BX	6

### Faucet Repair by Manufacturer - Watts\* Commercial Vacuum Breakers

### WATSAVER\* LABORATORY INDEX BUTTONS THREADED - COLOR CODED - IMPRINTED

 <p>(3/8") <b>Lead Free</b></p>	 <p>(3/4") <b>Lead Free</b></p>																																																																													
<table border="1" style="width: 100%; border-collapse: collapse;"> <tr><th>Item #</th><th>Ref #</th><th>Description</th></tr> <tr><td>VBWT-1</td><td>887170*</td><td>Vacuum Breaker Kit for T&amp;S* and Watts*</td></tr> <tr><td colspan="3">T&amp;S*: 1/4" &amp; 3/8"</td></tr> </table>	Item #	Ref #	Description	VBWT-1	887170*	Vacuum Breaker Kit for T&S* and Watts*	T&S*: 1/4" & 3/8"			<table border="1" style="width: 100%; border-collapse: collapse;"> <tr><th>Item #</th><th>Ref #</th><th>Description</th></tr> <tr><td>VBWT-2</td><td>887171*</td><td>Vacuum Breaker Kit for T&amp;S* and Watts*</td></tr> <tr><td colspan="3">T&amp;S*: 1/2"</td></tr> </table>	Item #	Ref #	Description	VBWT-2	887171*	Vacuum Breaker Kit for T&S* and Watts*	T&S*: 1/2"			<table border="1" style="width: 100%; border-collapse: collapse;"> <tr><th>Item #</th><th>Ref #</th><th>Description</th></tr> <tr><td>VBWT-3</td><td>887172*</td><td>Vacuum Breaker Kit for T&amp;S* and Watts*</td></tr> <tr><td colspan="3">T&amp;S*: 3/4" &amp; 1"</td></tr> </table>	Item #	Ref #	Description	VBWT-3	887172*	Vacuum Breaker Kit for T&S* and Watts*	T&S*: 3/4" & 1"			<table border="1" style="width: 100%; border-collapse: collapse;"> <tr> <th>AVAIL</th> <th>LMC# BULK</th> <th>LMC# BAGGED</th> <th>COLOR</th> <th>APPLICATION</th> <th>DESCRIPTION</th> </tr> <tr> <td>NOW</td> <td>FHC-88(AIR)</td> <td>FHC-88(AIR)BG</td> <td>ORANGE</td> <td>AIR</td> <td>THREADED LABORATORY HDL CAP, ORANGE, AIR</td> </tr> <tr> <td>NOW</td> <td>FHC-88(CW)</td> <td>FHC-88(CW) BG</td> <td>GREEN</td> <td>COLD WATER</td> <td>THREADED LABORATORY HDL CAP, GREEN, CW</td> </tr> <tr> <td>NOW</td> <td>FHC-88(DI)</td> <td>FHC-88(DI) BG</td> <td>CREAM</td> <td>DI-IONIZED WATER</td> <td>THREADED LABORATORY HDL CAP, CREAM, DI</td> </tr> <tr> <td>NOW</td> <td>FHC-88(DW)</td> <td>FHC-88(DW) BG</td> <td>WHITE</td> <td>DISTILLED WATER</td> <td>THREADED LABORATORY HDL CAP, WHITE, DW</td> </tr> <tr> <td>NOW</td> <td>FHC-88(GAS)</td> <td>FHC-88(GAS) BG</td> <td>BLUE</td> <td>GAS</td> <td>THREADED LABORATORY HDL CAP, BLUE, GAS</td> </tr> <tr> <td>NOW</td> <td>FHC-88(HW)</td> <td>FHC-88(HW) BG</td> <td>RED</td> <td>HOT WATER</td> <td>THREADED LABORATORY HDL CAP, RED, HW</td> </tr> <tr> <td>NOW</td> <td>FHC-88(VAC)</td> <td>FHC-88(VAC) BG</td> <td>YELLOW</td> <td>VACUUM</td> <td>THREADED LABORATORY HDL CAP, YELLOW, VAC</td> </tr> </table>	AVAIL	LMC# BULK	LMC# BAGGED	COLOR	APPLICATION	DESCRIPTION	NOW	FHC-88(AIR)	FHC-88(AIR)BG	ORANGE	AIR	THREADED LABORATORY HDL CAP, ORANGE, AIR	NOW	FHC-88(CW)	FHC-88(CW) BG	GREEN	COLD WATER	THREADED LABORATORY HDL CAP, GREEN, CW	NOW	FHC-88(DI)	FHC-88(DI) BG	CREAM	DI-IONIZED WATER	THREADED LABORATORY HDL CAP, CREAM, DI	NOW	FHC-88(DW)	FHC-88(DW) BG	WHITE	DISTILLED WATER	THREADED LABORATORY HDL CAP, WHITE, DW	NOW	FHC-88(GAS)	FHC-88(GAS) BG	BLUE	GAS	THREADED LABORATORY HDL CAP, BLUE, GAS	NOW	FHC-88(HW)	FHC-88(HW) BG	RED	HOT WATER	THREADED LABORATORY HDL CAP, RED, HW	NOW	FHC-88(VAC)	FHC-88(VAC) BG	YELLOW	VACUUM	THREADED LABORATORY HDL CAP, YELLOW, VAC
Item #	Ref #	Description																																																																												
VBWT-1	887170*	Vacuum Breaker Kit for T&S* and Watts*																																																																												
T&S*: 1/4" & 3/8"																																																																														
Item #	Ref #	Description																																																																												
VBWT-2	887171*	Vacuum Breaker Kit for T&S* and Watts*																																																																												
T&S*: 1/2"																																																																														
Item #	Ref #	Description																																																																												
VBWT-3	887172*	Vacuum Breaker Kit for T&S* and Watts*																																																																												
T&S*: 3/4" & 1"																																																																														
AVAIL	LMC# BULK	LMC# BAGGED	COLOR	APPLICATION	DESCRIPTION																																																																									
NOW	FHC-88(AIR)	FHC-88(AIR)BG	ORANGE	AIR	THREADED LABORATORY HDL CAP, ORANGE, AIR																																																																									
NOW	FHC-88(CW)	FHC-88(CW) BG	GREEN	COLD WATER	THREADED LABORATORY HDL CAP, GREEN, CW																																																																									
NOW	FHC-88(DI)	FHC-88(DI) BG	CREAM	DI-IONIZED WATER	THREADED LABORATORY HDL CAP, CREAM, DI																																																																									
NOW	FHC-88(DW)	FHC-88(DW) BG	WHITE	DISTILLED WATER	THREADED LABORATORY HDL CAP, WHITE, DW																																																																									
NOW	FHC-88(GAS)	FHC-88(GAS) BG	BLUE	GAS	THREADED LABORATORY HDL CAP, BLUE, GAS																																																																									
NOW	FHC-88(HW)	FHC-88(HW) BG	RED	HOT WATER	THREADED LABORATORY HDL CAP, RED, HW																																																																									
NOW	FHC-88(VAC)	FHC-88(VAC) BG	YELLOW	VACUUM	THREADED LABORATORY HDL CAP, YELLOW, VAC																																																																									

\*Registered trademark or trade name of the mfg. listed used for reference only. Don't confuse us with the mfg. listed. 2. Products marked "low lead" or "lead free" contain 0.25% lead or less, per California AB 1953 & Vermont S152 Legislative Specs. \*\*PROP 65 WARNING! Exposure to ingredients in these products such as: Acrylamide, Arsenic, Benzene, Cadmium, Lead, Mercury are known to the state of California to cause cancer, birth defects or reproductive harm. (See <http://oehha.ca.gov/prop65.html>). Wash contacted body parts immediately. Assembled and tested in the USA



# Faucet Repair by Manufacturer - Zurn\* (Also See Chicago Faucet\*)

Service Sink Vacuum Breaker Repair Kit



Item #	Ref #	Description
VBZU-1	JP1996-SFVB-RK*	Vacuum Breaker, Zurn* Service Sink Repair

Swing Spout Repair Kit with Silicone Lube

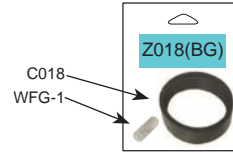

Item #	Ref #	Description
Z18(BG)	G60523*	Zurn* Swing Spout Repair Kit w/ Silicone Lube, 1/bg

## Pressure Balancing Cartridges

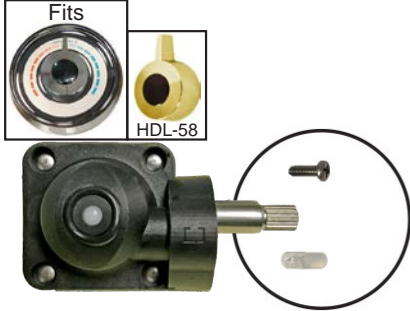

Item #	Ref #	Description
T054H	Z7600*	Pressure Balancing Cartridge w/Screws, 1/bg

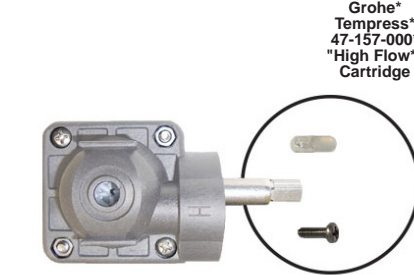

Item #	Ref #	Description
T055	47-157-000*	Tempress* High-Flow* Gray Cartridge With Ledges, T*11*EFX*

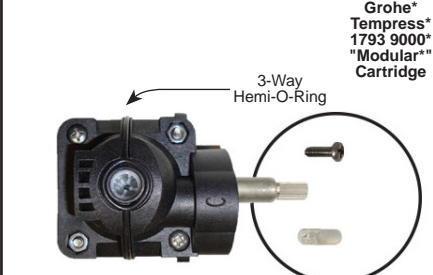

Item #	Ref #	Description
T056	1793 9000*	Tempress* Modular* Cartridge, Black With 3-Way Hemi-O-Ring

## Escutcheon Handle Drive Assembly

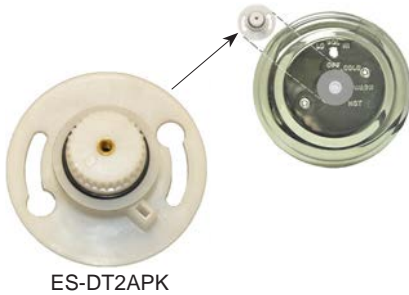

Item #	Ref #	Description
ES-DT2APK	1-207*	Escutcheon HDL Drive Assembly RE 2/pc Escutcheons, 1/bg

## Stop Plus Kit

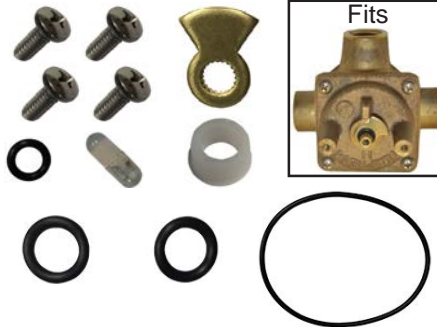

Item #	Ref #	Description
T054-16K	10494*	Stop Plus Kit, 1/bg

## Stem Adapter



Item #	Description
ES-DT1-4K	Stem Adapter w/Screw, Tempress* Kohler* Powers* Danfoss*

## Stem Adapter and Extender



Item #	Description
ES-DT1-4KE	ES-DT1-4K w/Stem Extension And Screw

TEMPRESS II\*/DANFOSS\*/GROHE\*/PHYLIRICH\*/INDIANA\*/NEWPORT BRASS\*, ETC.....

## VALVE BODY CONVERSION KIT

KIT INCLUDES EVERYTHING:  
CAP, ADAPTERS, SCREWS, NUTS

Works with these cartridge

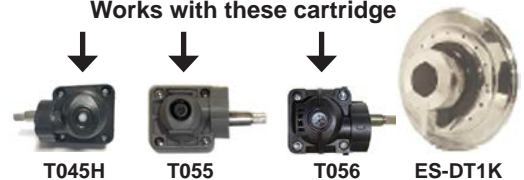

Replace various trims used by the sub-manufacturers who marketed this tub shower valve.

ITEM #	REF#	DESCRIPTION	PAK	STD PK
T054VC	47343560*	TEMPRESS*GROHE*ETC REPLACEMENT CAP WITH ESCUTCHEON ADAPTERS	1/BX	6

## Notes

\*Registered trademark or trade name of the mfg. listed used for reference only. Don't confuse us with the mfg. listed. 2. Products marked "low lead" or "lead free" contain 0.25% lead or less, per California AB 1953 & Vermont S152 Legislative Specs.  
\*\*PROP 65 WARNING! Exposure to ingredients in these products such as: Acrylamide, Arsenic, Benzene, Cadmium, Lead, Mercury are known to the state of California to cause cancer, birth defects or reproductive harm. (See <http://oehha.ca.gov/prop65.html>). Wash contacted body parts immediately. Assembled and tested in the USA

