

Heat Transfer Physics

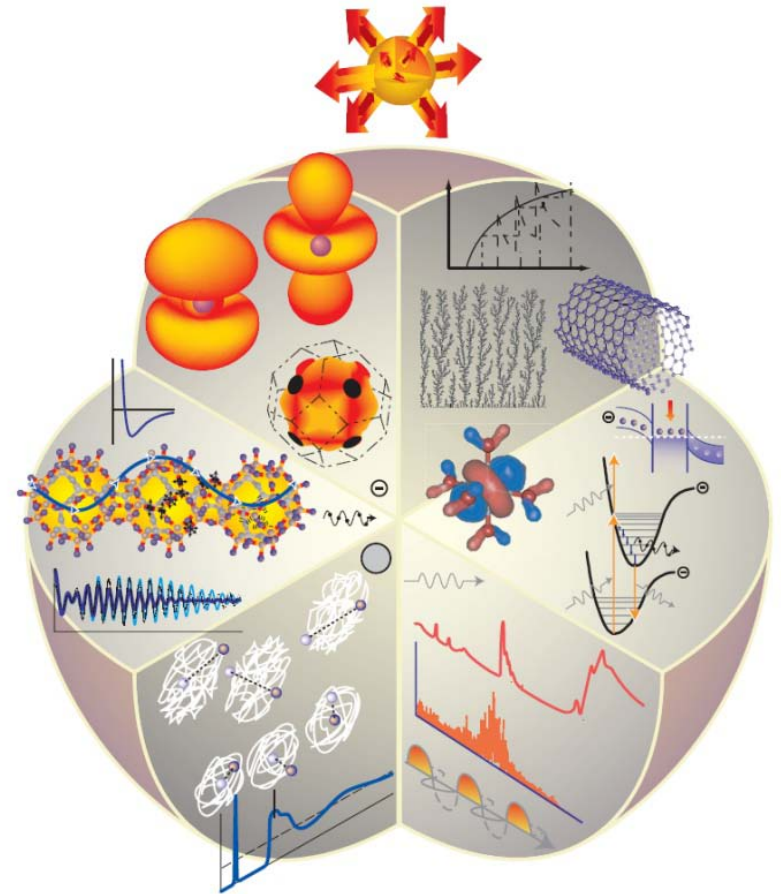

Massoud Kaviany
University of Michigan
kaviany@umich.edu



Macroscopic Energy Equation

Divergence of \mathbf{q} is integral of its surface normal component on the differential surface area A of a vanishing differential volume V .

The rate of energy conversion to and from thermal energy \dot{s}_{i-j} is determined by the nature and frequency of the interactions between the principal energy carriers i and j . This rate describes various **bonds** (chemical and physical), **electromagnetic**, and **mechanical energy conversions**.

It is this interplay among storage, transport, and transformation rates that allows for the behaviors exhibited by energy conversion phenomena and devices.

Energy equation

\mathbf{q} : Heat Transport

$-\frac{\partial}{\partial t} \rho c_p T + \dot{s}_{i-j}$: Heat Storage and Conversion

$$\nabla \cdot \mathbf{q} = -\frac{\partial}{\partial t} \rho c_p T + \sum_{i,j} \dot{s}_{i-j}, \quad \nabla \cdot \mathbf{q} = \frac{\int_{\Delta A} (\mathbf{q} \cdot \mathbf{s}_n) dA}{\Delta V \rightarrow 0}$$

Heat flux vector

$$\mathbf{q} = \mathbf{q}_k + \mathbf{q}_u + \mathbf{q}_r = -k \nabla T + \rho c_p \mathbf{u} T + 2\pi \int_0^\infty \int_{-1}^1 s I_{ph,\omega} d\mu d\omega$$

A	area, m^2
$I_{ph,\omega}$	spectral, directional radiation intensity, $\text{W}/(\text{m}^2\text{-sr-rad/s})$
c_p	specific heat capacity, J/kg-K
k	thermal conductivity, W/m-K
\mathbf{q}	heat flux vector, W/m^2
\mathbf{s}_n	surface normal, unit vector
\mathbf{s}	unit vector
\dot{s}_{i-j}	energy conversion rate between principal carrier i and carrier j , W/m^3
T	temperature, K
\mathbf{u}	velocity, m/s
V	volume, m^3
ρ	density, kg/m^3
μ	$\cos \theta$, θ is polar angle
ω	angular frequency, rad/s

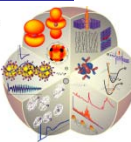

From Macro- to Atomic-Level Heat Transfer

- Macroscopic heat transfer is around the heat flux vector \mathbf{q} , with conduction, convection, surface-convection, and radiation mechanisms. It assumes sensible heat is in microscopic (atomic) equilibrium.
- Atomic-level heat transfer is around four principal energy carriers, phonon, electron, fluid particle, and photon. Transport of heat is due to nonequilibrium energy occupancy of these carriers. Conversion of heat is also about inelastic interactions of the nonequilibrium carriers.
- Here we give examples of both treatments, and how they are used in innovative applications.
- In macroscopic treatment we use heat regeneration in internal combustion engine.
- In heat transfer physics we use phonon recycling in ion-doped laser.
- Let's start with the macroscopic energy equation and its examples, and then review heat transfer physics and its example.

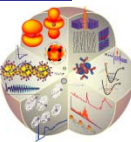

Three Things to Take Away from Heat Transfer Physics Short Course

The four thermal energy carriers:

phonon, electron, fluid particle, and photon

The four levels of treatment of heat transfer and their connections:

ab initio (Schrödinger equation), molecular dynamics, Boltzmann transport, and macroscopic

Applications of heat transfer physics:

examples of using atomic-level insights to design new energy conversion materials/processes.

Please ask questions, since no prior knowledge of the above is expected.

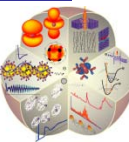

Thermal Motion as Waste Heat in Energy Conversion: Heat Recycling?

“After countless metamorphoses all energy, unless it is stored, eventually turns into heat and adds its share to the thermal budget”. H.C. von Baeyer (Author: Taming The Atom, Dover, 2000).



Estimated U.S. Energy Use in 2007: ~101.5 Quads

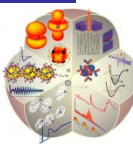
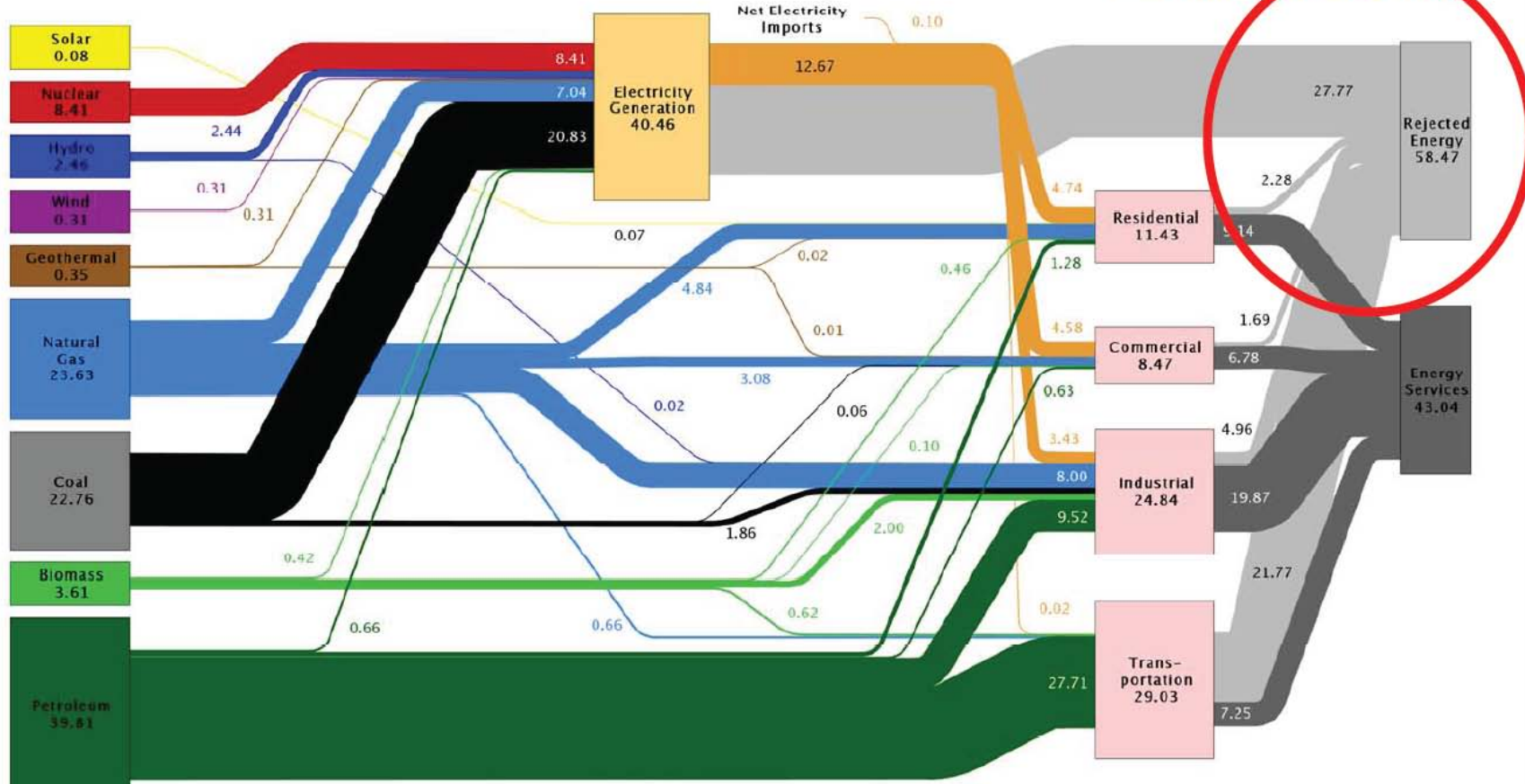

Energy Conversion

Downconversion in Chemical Solar, and Nuclear Energy Conversion: Chemical-bond, nuclear and solar energy conversions begin with high energy carriers, but in Carnot energy conversion they downconvert to heat ($k_B T$). Direct conversions, such as Solar photovoltaic and fuel cells have been able to reduce this energy downconversion.

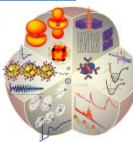
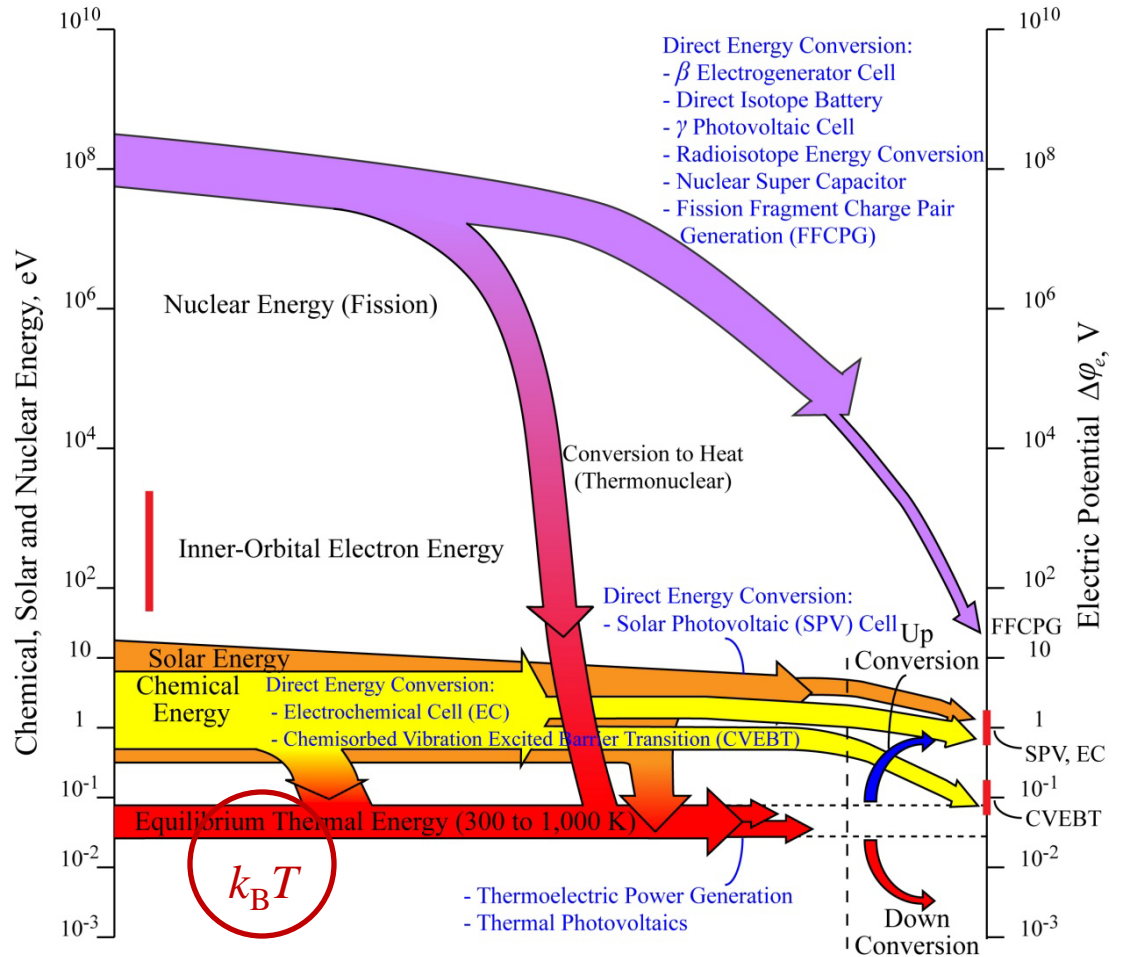

Practical realization of thermoelectricity (TE) ($\text{Bi}_2\text{Te}_3/\text{Sb}_2\text{Te}_3$; PbTe; Si-Ge)

Peltier Cooler
COLD

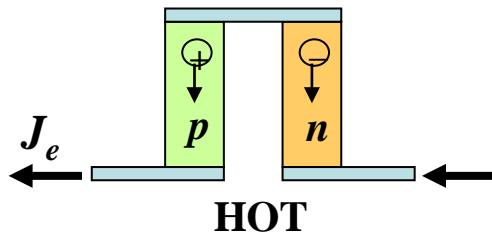

$$\text{COP} = \frac{T_c}{(T_h - T_c)} \frac{(1 + Z_e \frac{T_c + T_h}{2})^{1/2} - \frac{T_h}{T_c}}{(1 + Z_e \frac{T_c + T_h}{2})^{1/2} + 1}$$

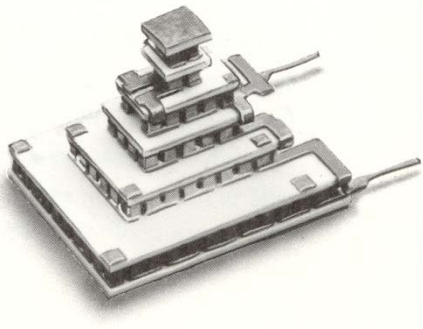

Power Generator

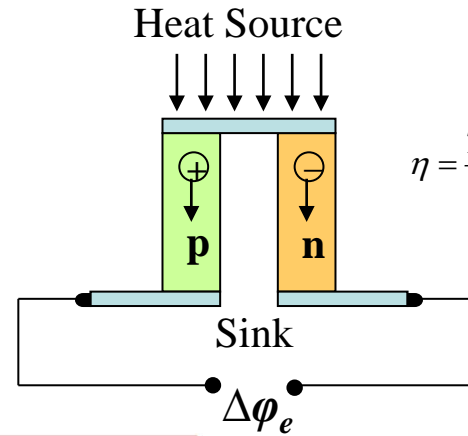

$$\eta = \frac{T_h - T_c}{T_h} \frac{(1 + Z_e \frac{T_c + T_h}{2})^{1/2} - 1}{(1 + Z_e \frac{T_h + T_c}{2})^{1/2} + \frac{T_c}{T_h}}$$

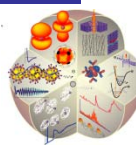
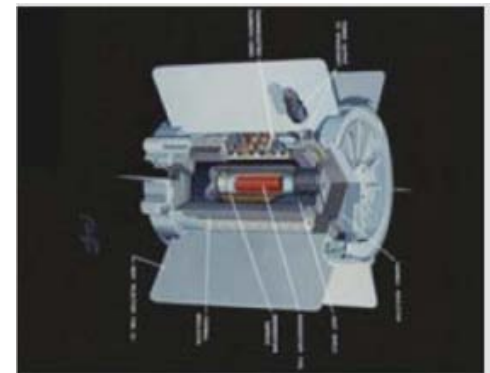
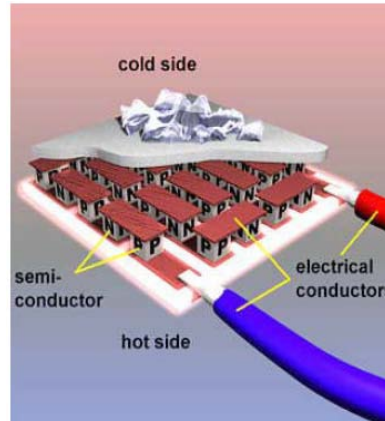

Exhaust Gas TE Power Generation

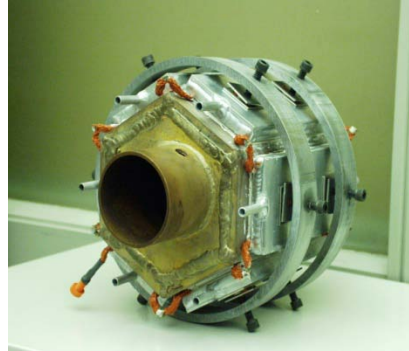

An early model of a 110 W air-cooled thermoelectric generator to be used on the exhaust tail pipe of a car.

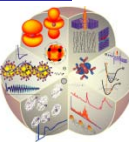

Nuclear Energy-Time Diagram

Fission Energy Conversion

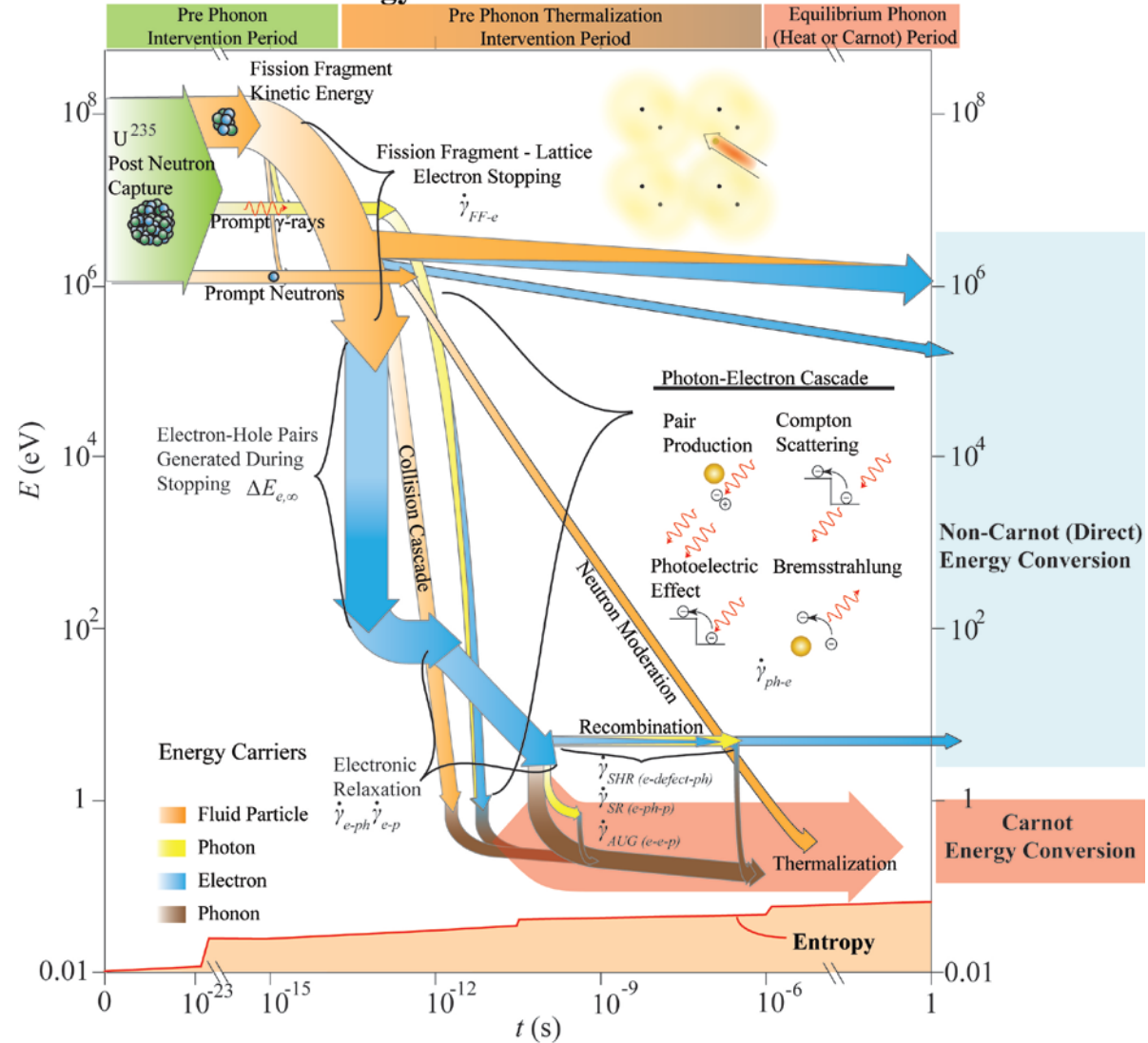

When a fissionable nucleus captures a neutron, its energy increases dramatically due to, neutron pairing, mass decrease, and neutron energy (for fast neutrons)

Nucleus begins to deform until the coulomb force overcomes the strong force.

Nucleus scissions, creating ~ 200 MeV in the form of: two energetic fission fragments (~ 170 MeV total), γ -rays (~ 7 MeV), and fast neutrons (~ 5 MeV)

The figure to right shows the path of the fission energy over time, the causes for its quality loss, and some direct energy conversion pathways .

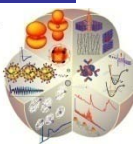

Photovoltaic Energy-Time Diagram

Solar Energy Conversion

Figure to right shows the energy-time evolution of solar energy in photovoltaic conversion. Phonons are emitted by decay of hot electrons, by electron-hole recombination, and by decay of intraband excited electrons. These phonons may be recycled through a heterogeneous barrier transition, where they gain electric potential.

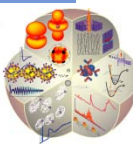
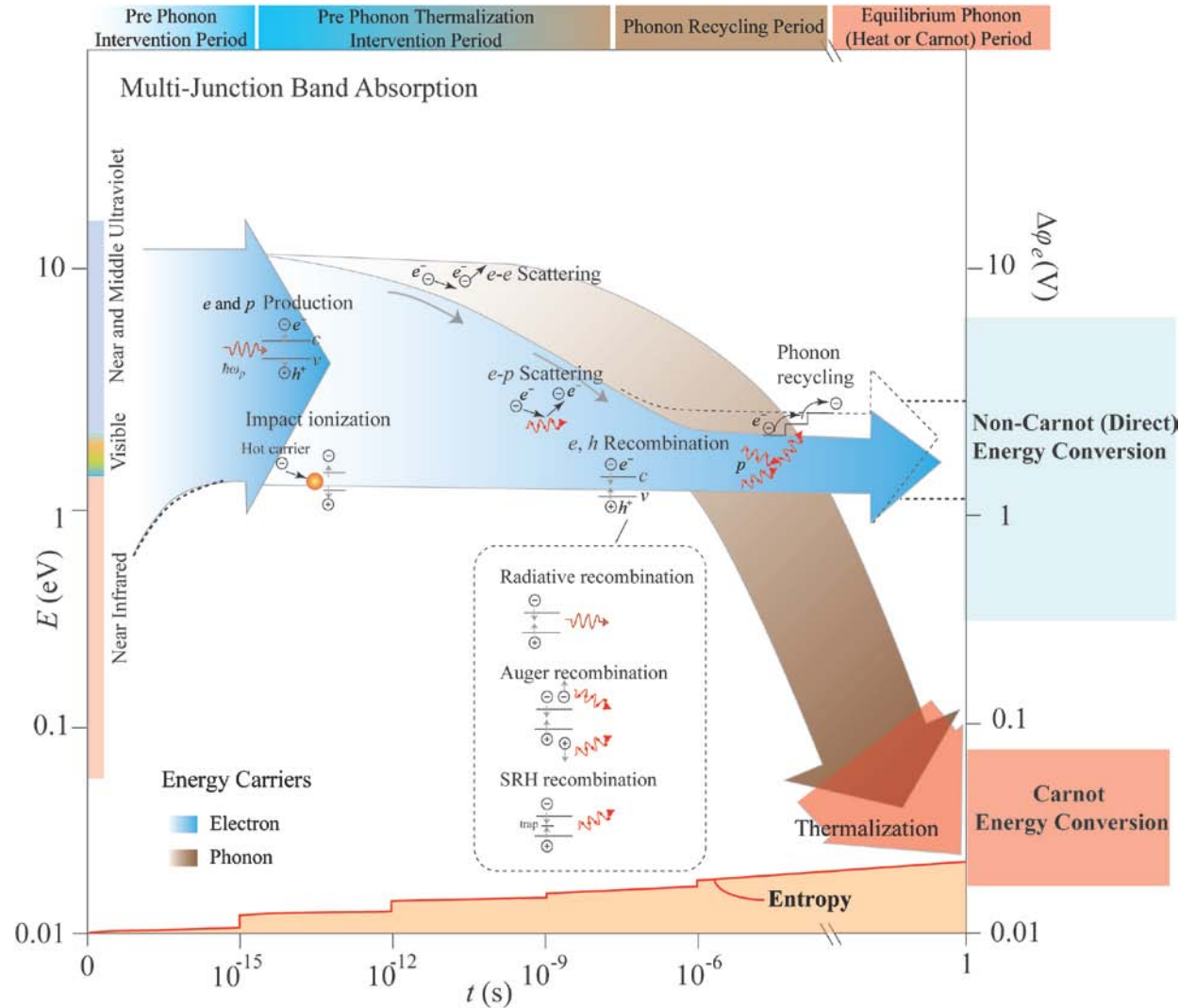

Energy-Time Diagram for Chemical Energy

Chemisorbed Energy Conversion

Can we directly convert chemical energy to electrical energy?

Main processes:

1. chemical-bond energy
-> kinetic energy of fluid particles
2. kinetic energy (chemisorption)
-> phonons in solid
3. phonons
-> potential energy of circuit electrons

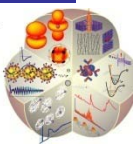
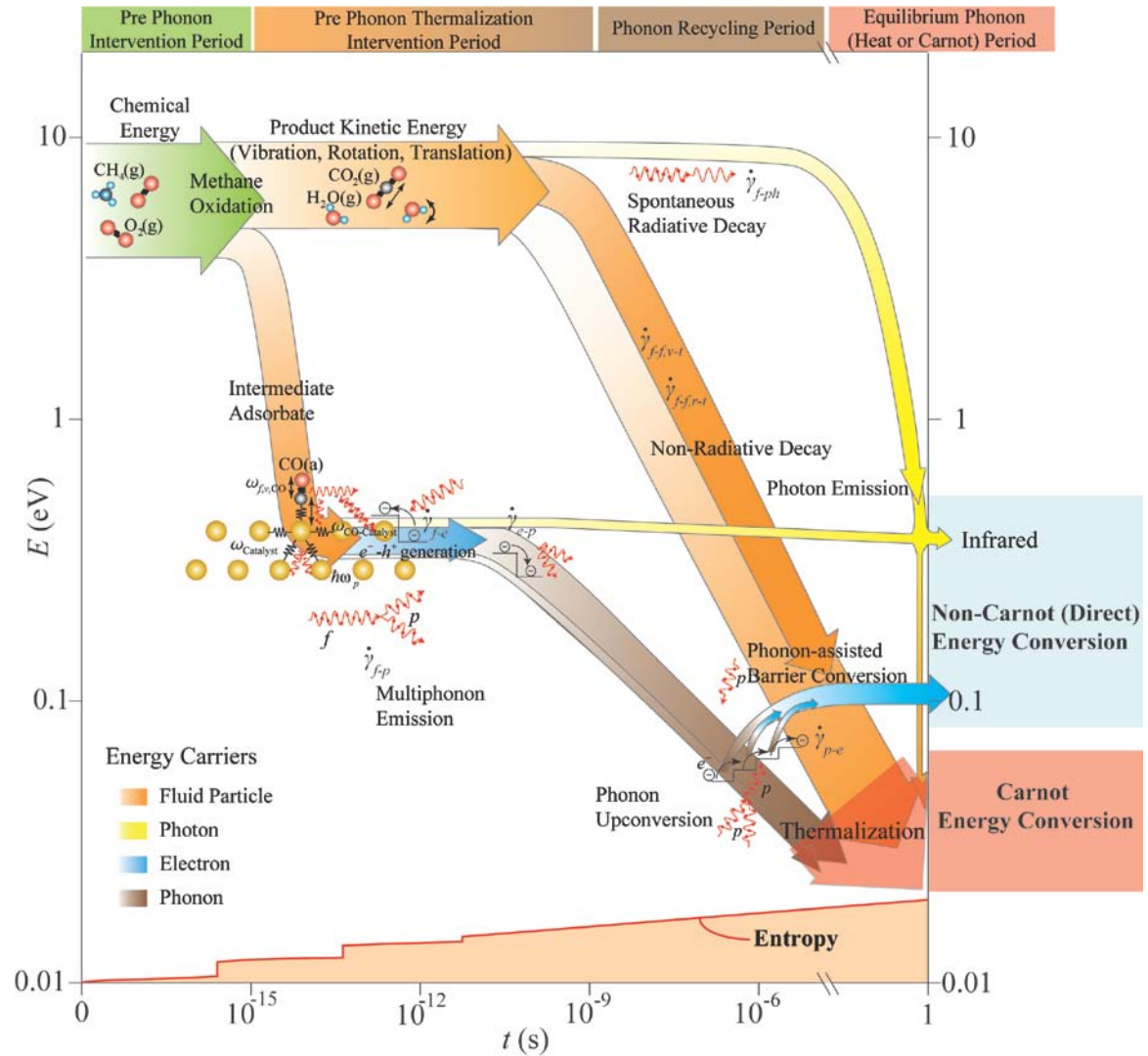

Heat Transfer Physics: Principal Energy Carriers

- The macroscopic conduction, convection, and radiation heat transfer can be understood and analyzed using the four underlying atomic-level (principal) energy carriers.
- **Phonon** (lattice vibration, cause of thermal conduction in electric insulators, and participant in energy conversion involving kinetic energy of solids).
- **Electron** (when free to move under applied field, its number density is constant in metals but temperature dependent in semiconductors, contributes to thermal conduction, and participant in energy conversion with its potential or kinetic energy).
- **Fluid Particle** (mono- or polyatomic, moves under applied force, conducts heat by colliding with neighbors and participant in energy conversion through bond and kinetic energies).
- **Photon** (has the largest range of energy, carries its energy even through vacuum, and interacts with electric and magnetic entities in energy conversion).

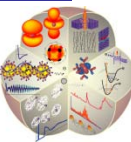

Phonons

- Multibody dynamics using Newtonian mechanics (classical molecular dynamics) allows for intuitive understanding of lattice vibration in real space.
- Phonon represent combined potential and kinetic energy of the lattice and its kinetic portion defines the lattice temperature.
- Phonons are presented by their frequency which is related to its wave number through the dispersion relation.
- The dispersion relation depends on atomic structure.
- The phonon are classified by the direction of atomic displacement into transverse and longitudinal, and by relative displacement of adjacent atoms (in phase displacement gives acoustic and out of phase gives optical phonons).
- Phonons generally have energy $\hbar\omega_p$ less than 0.1 eV.
- Phonons cause lattice thermal conductivity k_p of solids (dominant in nonmetals).
- Phonons interact (scatter) with each other, with electrons, and with impurities.
- Phonons can be absorbed to heat or emitted to cool the solid.

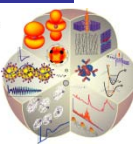
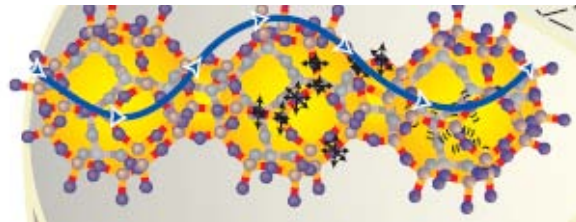

Electrons

- Energy of bound electrons are quantized (Schrödinger equation).
- The conduction electron density and Fermi energy are constant for metals.
- For semiconductors these are temperature dependent. For intrinsic semiconductors, the number of number density of conduction electrons and holes are the same. Due to defects and also by adding dopants, extrinsic semiconductors have excess conduction electron or hole densities.
- Conduction electrons have potential energy ΔE_e less than tens of eV, in addition they have electron kinetic energy (under applied field).
- The kinetic energy of conduction electrons defines its temperature which may not be the same as the lattice temperature.
- Electrons cause electric thermal conductivity k_e .
- Electron interact with each other and other charged particles and electric and magnetic entities, and with phonons, impurities, and photons.
- Flow of electrons (electric current) also gives rise to heat current, through thermoelectricity.

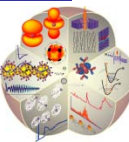

Fluid Particle

- Polyatomic fluid particles with translational, rotational and vibrational energy have high quantized energies with some occupied only at high temperature.
- While the translational and rotational $B_f j(j+1)$ energies of fluid particle are generally less than 0.1 eV, its vibrational energy transition $\hbar\omega_f \Delta l$ is much larger (but equilibrium occupation is low at low temperatures).
- Fluid particles collide with each other (average distance between collisions is the mean free path) and this gives rise to thermal conductivity k_f (and viscosity).
- When the fluid particles mean free path is nearly the larger than the clearance distance between surfaces confining them, the flow is called molecular.
- Depending on interatomic interaction field, fluid particle colliding with solid surface can come to thermal equilibrium with it (complete accommodation) or keep their initial energy.
- At high temperatures fluid particles ionize and dissociate forming thermal plasmas.
- Liquids have a very small mean free path (about a few interatomic spacing).

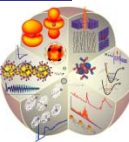

Photon

- Both EM wave (coherence) and quasi-particle (non-coherent) treatment of phonon are needed.
- Photon have the largest range of energy $\hbar\omega_{ph}$, from a fraction of meV to thousands of eV.
- Photon interact with electric or magnetic entities which represent their atomic-level structure and signature (e.g., free electron, electronic band gap, vibrating polar fluid particle).
- Blackbody radiation is thermal with a large frequency band and random in direction.
- Laser radiation is nonthermal (it is resonant and amplified), with small bandwidth and is directional.
- Photon absorption can excite electrons (or other electric entities for example polar, vibrational modes) which in turn can decay to give stimulated (phase coherent with absorbed photon) or spontaneous emission, or decay to emit photon or other motion (kinetic) energy.
- In laser cooling, phonon or fluid particle vibrational energy is used in photon absorption thus the emitted photon has a larger energy than the absorbed photon (anti-Stokes fluorescence).

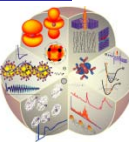
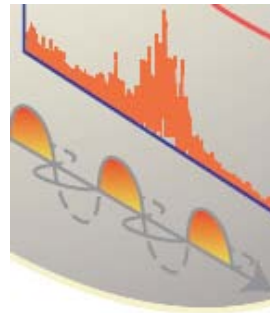

Beyond Visible and Blackbody Radiation



Reflection

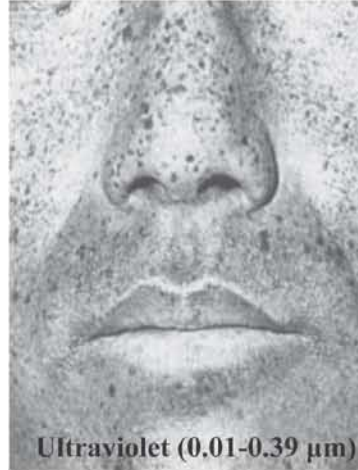

Reflection

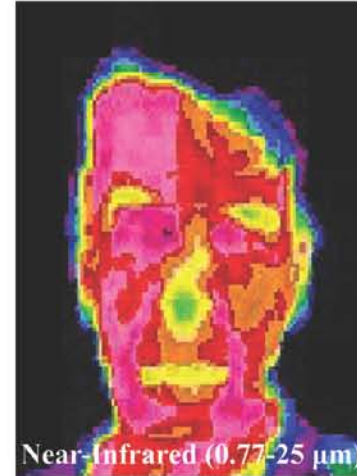

Emission



Transmission

Also, let's look for nonequilibrium (energy occupancy or population) radiation, such as lasers (lasers are a special case where the population is **inverted** and **maintained**).

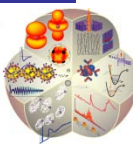

How Laser Pointer Upconverts Photons

Cross-section drawing and dissection of a laser pointer producing green light. There are both down- and upconversion of photon energy by lasing and frequency-doubling media.

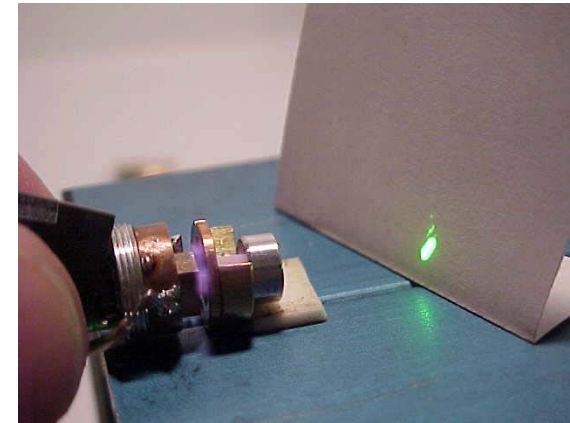
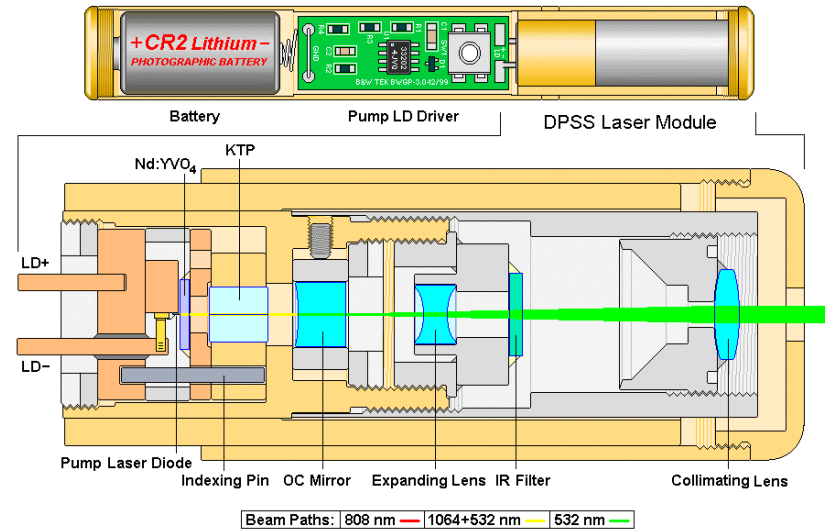

Order of components by function from left to right. Semiconductor diode laser (infrared pump, 808 nm), Nd: YVO₄ (doped vanadate, **downconvert** to 1064 nm), KTP [KTiOPO₄ (potassium titanyl phosphate) nonlinear optic (crystal lacking inversion symmetry), second harmonic generator (SHG) or **upconverter** to green 532 nm], OC (output coupler), filter (there is an expanding lens hidden under the IR filter inside the aluminum cylinder), and collimator. The pin locates the three items on the left and the three set screws adjust and hold the OC.

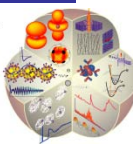

Other Upconversions of Photons

Scheme 1. Processes Involved in Photon Upconversion Based on Sensitized Triplet–Triplet Annihilation (UC-STTA)^{a,b}

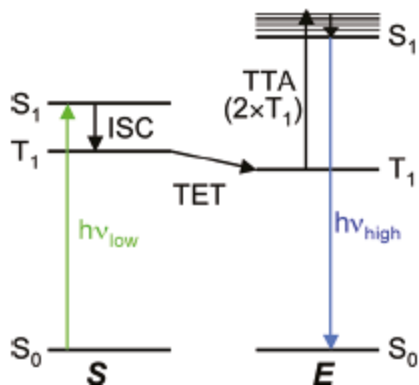

^a S, sensitizer; E, emitter; S₀, ground state; S₁, first excited singlet state; T₁, first excited triplet state; ISC, intersystem crossing; TET, triplet energy transfer; TTA, triplet–triplet annihilation. ^b See text for more details.

Scheme 2. Proposed Mechanism for UC-STTA on DPA–PtOEP-Sensitized Nanocrystalline ZrO₂

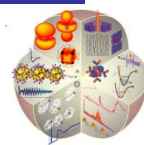
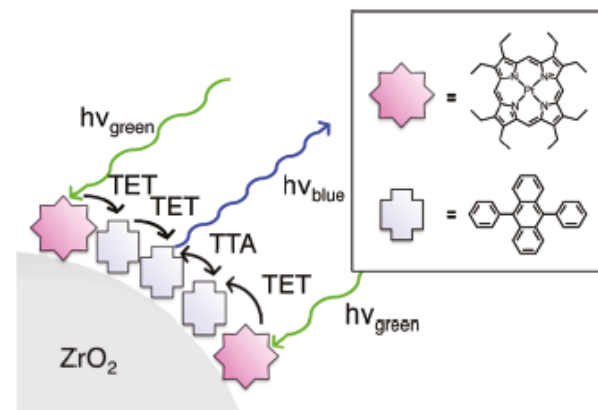

Light Emitting Diode (LED)

Like a normal diode, the LED consists of a chip of semiconducting material impregnated, or doped, with impurities to create a *p-n* junction.

As in other diodes, current flows easily from the *p*-side, or anode, to the *n*-side, or cathode, but not in the reverse direction.

Charge carriers (electrons and holes) flow into the junction from electrodes with different voltages. When an electron meets a hole, it falls into a lower energy level, and releases energy in the form of a photon.

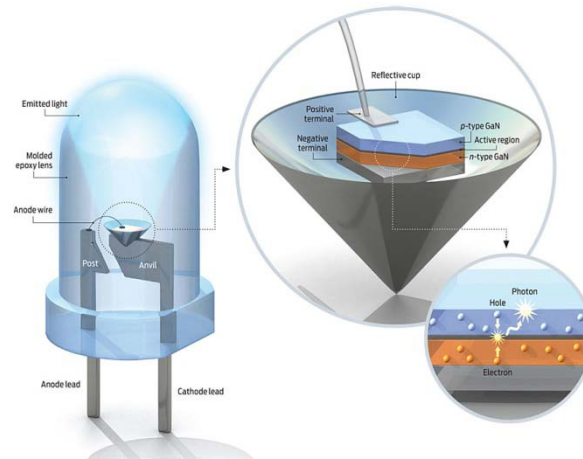
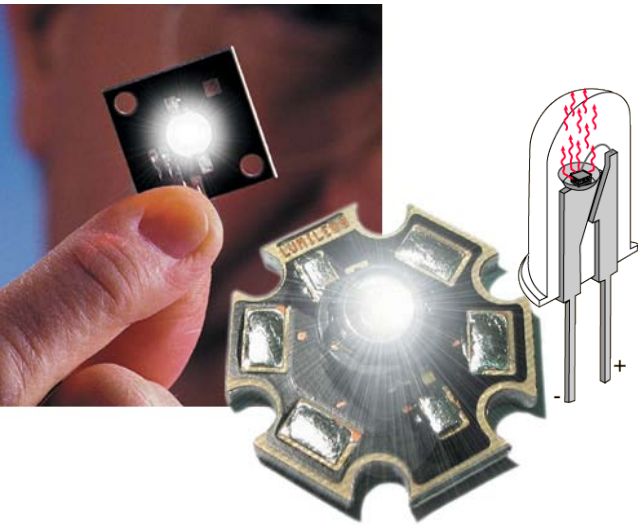
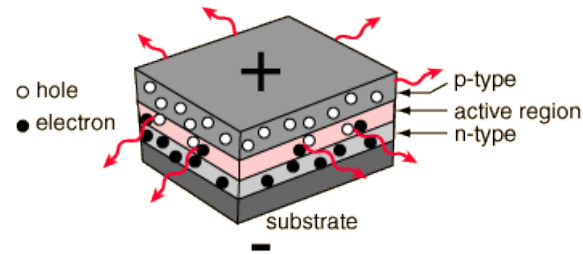
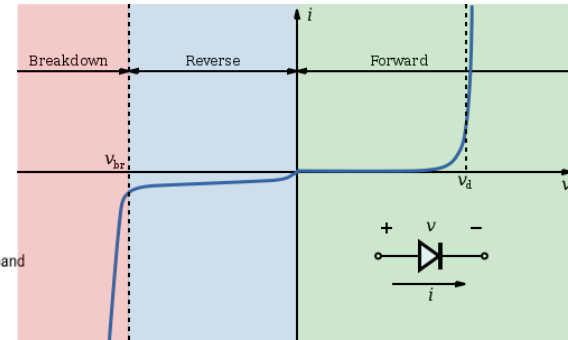
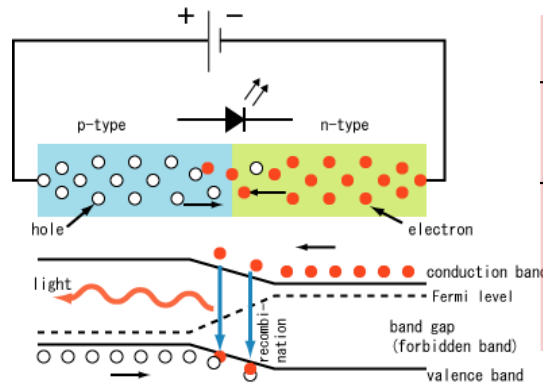

LED with Paraffin Liquid for Spherical (diffuse) Radiance

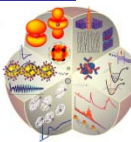

Length-Time Scales and Treatments

Macroscopic Energy Equation
 (Length $L \gg \lambda_i$ and Time $t \gg \tau_{i-j}$ Scales)
 (Combines All Carriers)

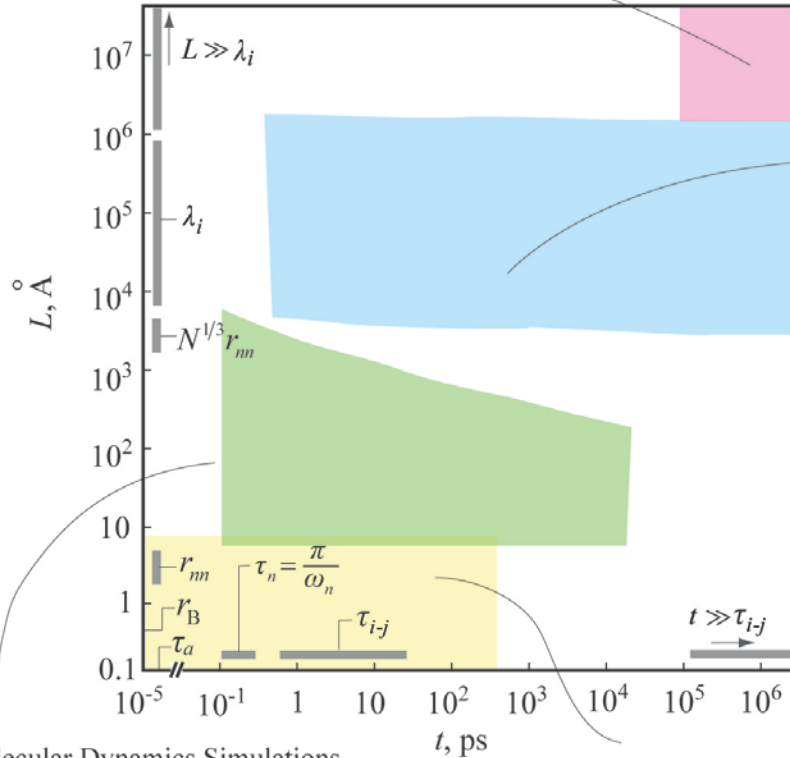

Boltzmann Transport Equation
 (Length $> N^{1/3} r_{nm}$, and Time $> \tau_{i-j}$ Scales)
 (Phonon, Electron, Fluid Particle, and Photon)

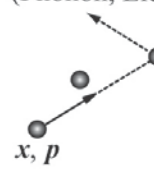

Maxwell Equations (Table 3.5)
 (Electric and Magnetic Entities
 and Photon as EM Wave)

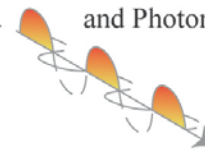

Molecular Dynamics Simulations
 (Classical)
 (Interatomic Length r_{nm} Time π/ω_n Scales)
 (Phonon, Electron, Fluid Particle, and Photon)

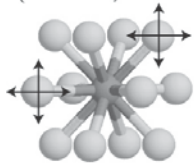

Ab Initio (Fine Structure)
 Schrödinger Equation
 (Atomic Length r_B and Time τ_a Scales)
 (Phonon, Electron, Fluid Particle, and Photon)

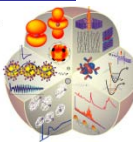
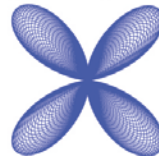

Example of Macroscopic Heat Transfer: In-Situ Heat Recycling in IC Engine

Heat flux vector tracking for the regenerative, internal combustion engine. The porous regenerator is attached to a rod and moves up and down inside the cylinder, synchronized to the movement of the piston.

During the regenerative heating stroke, the regenerator moves down, from the cylinder top to the piston head, and during the regenerative cooling stroke the regenerator moves up, from the piston top to the cylinder head.

Following combustion and expansion, the products of combustion (exhaust gases) still have an appreciable amount of energy in the form of sensible heat.

Typical macroscopic time constants (kinetics) are products of heat capacitance and thermal resistance R_t . Examples are: conduction, surface-radiation, conduction-convection, surface convection, and average convection resistances.

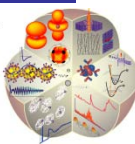
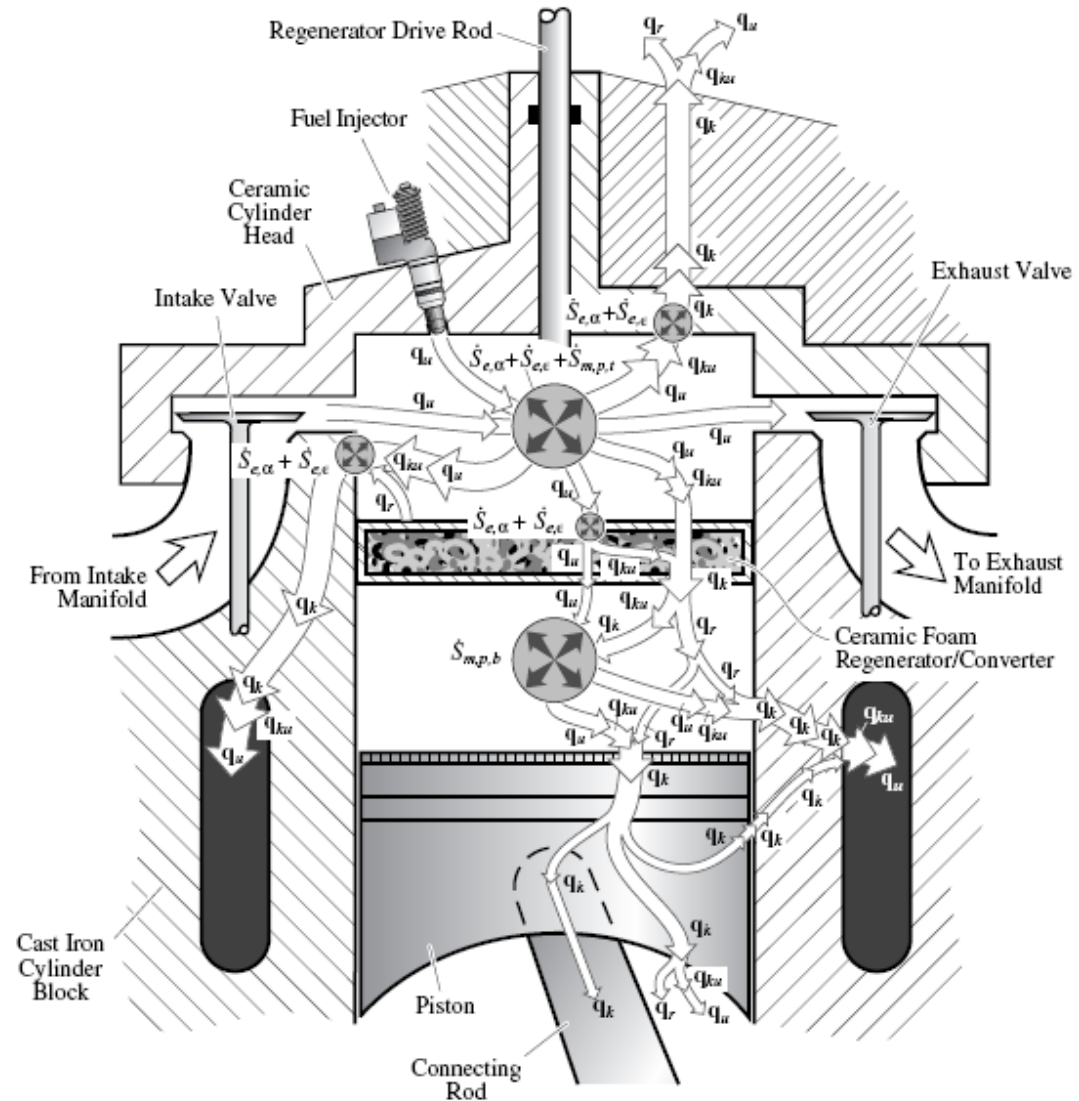

Increase in Engine Efficiency

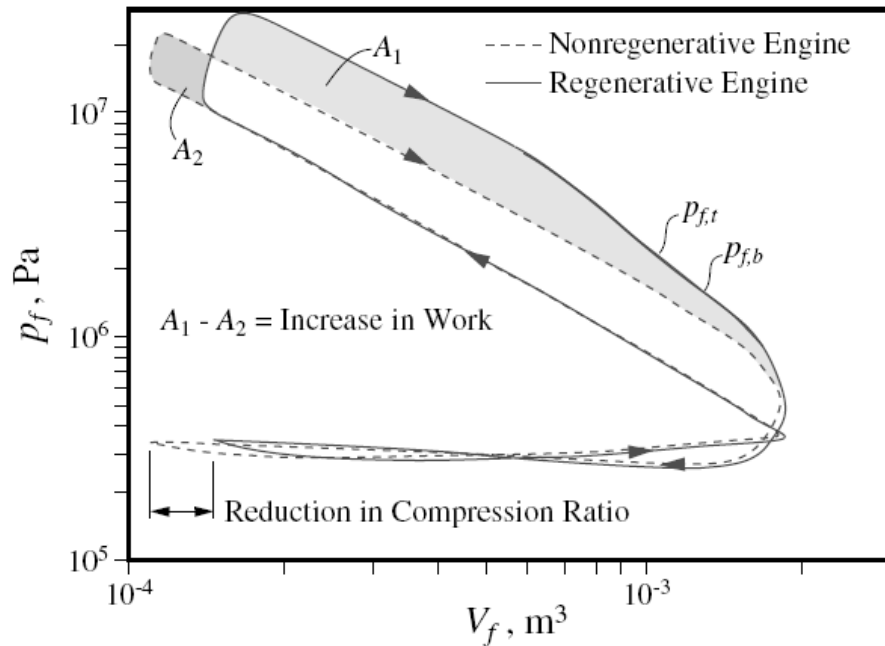

Parameter or Variable		Nonregenerative	Regenerative
V_d	cm^3	1,718	1,718
V_c	cm^3	110.8	245.4
r_c		16.5	10
$M_{a,o}$	g	6.494	6.494
$M_{F,o}$	g	0.2165	0.2165
$(A/F)_a$		30	30
$p_{f,max}$	MPa	23.9	top: 30.3 bottom: 30.3
$T_{f,max}$	K	1,619	top: 2,305 bottom: 964
$\overline{T_{exh}}$	K	882	780
$W_{c,i,n}(720^\circ)$	kJ	3.97	4.86
$P_{c,i}(720^\circ)$	kW	53.0	64.8
$p_{mep,i,n}$	MPa	2.31	2.82
η_F		0.43	0.53
η_V		0.94	0.92
Δh_{isfc}^{-1}	g/kW-hr	196	160

Comparison of results for nonregenerative and regenerative engines in table shows the thermal efficiency increases from 43% to 53%. The volumetric efficiency decrease slightly, from 94% to 92%. For the same power generation, the regenerative engine consumes a less fuel than the nonregenerative.

In making this analysis, we did not consider times smaller than micorsecond and lengths smaller than 0.1 mm (100 micron).

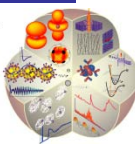

Atomic Kinetic and Potential Energies

T	E_i	q	\dot{s}_{i-j}
Temperature	Energy	Heat Flow Kinetics	Energy Conversion Kinetics
Atomic/Molecular Kinetic Energy (Thermal Energy), c.g., Molecular Vibration	Phonon, Electron, Fluid Particle, and Photon	Nonequilibrium Carrier Population Gradient and Net Fluid Particles and Photon Fluxes	Role of Thermal Energy in Energy Conversion Kinetics (in Particular before Equilibration of Carrier Kinetic Energy Population)
$T = \frac{\langle \sum_{i=1}^N m_i u_i^2 \rangle}{N_f k_B}$	$E_i = E_{k,i} + E_{p,i}$ or $E_i = \hbar\omega_i$	$q = \sum_i \sum_\alpha \frac{1}{C\pi^3} \int [E_i(\kappa) - \mu] u_i(\kappa) f_i'(\kappa) d\kappa$ $+ \rho c_p \mathbf{u} T + 2\pi \int_0^\infty \int_{-1}^1 s I_{ph,\omega} d\mu d\omega$	$\dot{s}_{i-j} = n_d \frac{\tau_{ph,tr}}{\tau_{ph-e-p}} \left(1 - \frac{\bar{\omega}_{ph,e}}{\omega_{ph,i}} \frac{\tau_{ph-e}^{-1}}{\tau_{ph-e}^{-1} + \tau_{e-p}^{-1}} \right) Q_{ph,i}$

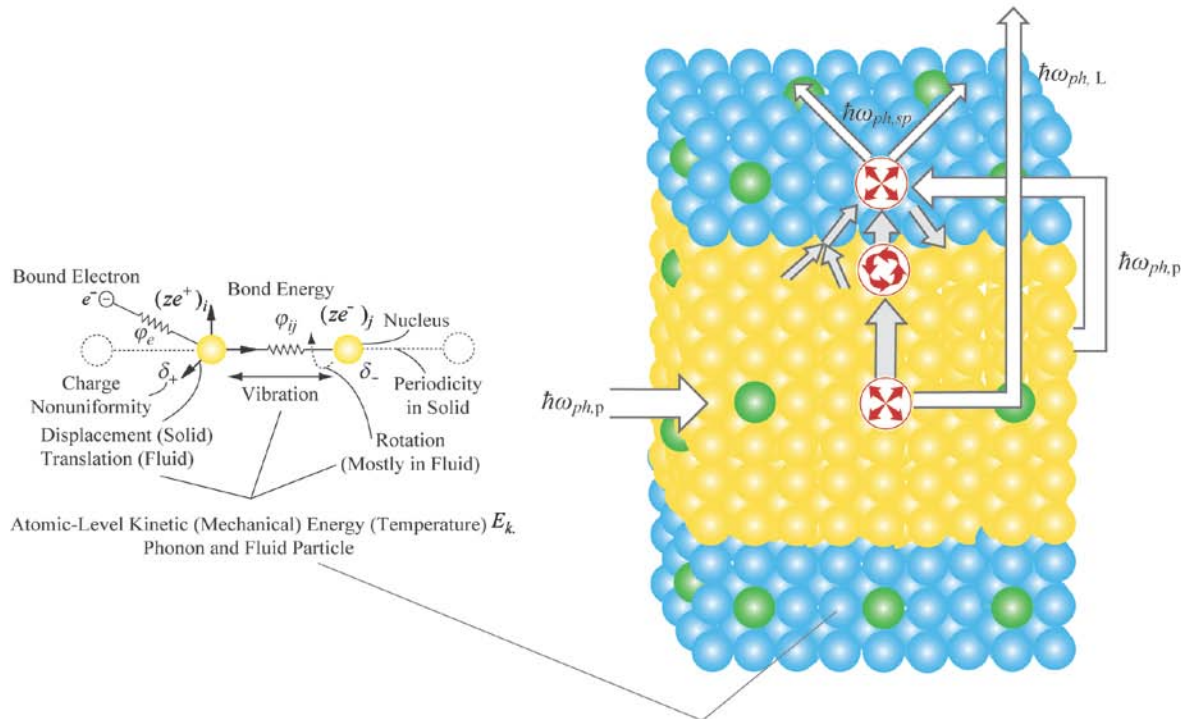

Atomic-Level Design of Energy Carriers

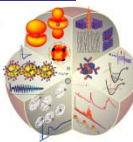

Heat Flux Vector: QM, MD, BTE and Macroscopic Treatments

- Using master-equation **quantum mechanics**, the conduction heat flux vector in a subsystem of cross section A connecting (along unit vector s_{l-r}) two phonon-statistics reservoirs and experiencing transition (anharmonic vibration) from state n (population f_n) to m at rate $1/\tau_{n \rightarrow m, l}$ in interaction with left reservoir (l) and a similar transition in interaction with right reservoir (r), with subsystem operator $S_{m,n}$, is

$$\mathbf{q}_k = \frac{1}{2A} \sum_{n,m} (E_m - E_n) |S_{n,m}|^2 f_n \left(\frac{1}{\tau_{n \rightarrow m, l}} - \frac{1}{\tau_{n \rightarrow m, r}} \right) \mathbf{s}_{l-r}$$

- Using **MD**, the conduction heat flux vector (conduction and molecular- and net-convection) is calculated from the position, velocity, potential, and force as (the interatomic potential is based on *ab initio* calculations)

$$\mathbf{q}_k = \frac{1}{V} \left[\sum_i \frac{1}{2} m_i (\mathbf{u}_i \cdot \mathbf{u}_i) \mathbf{u}_i + \sum_i \varphi_i \mathbf{u}_i + \frac{1}{2} \sum_i \sum_j (\mathbf{u}_i \cdot \mathbf{F}_{ij}) \mathbf{x}_{ij} \right]$$

- Using **BTE**, the conduction heat flux vector (conduction involving phonon and electron, or fluid particle) is calculated from deviation from equilibrium population f' (depends on relaxation time which is MD or *ab initio* based) as

$$\mathbf{q}_k = \sum_i \sum_{\alpha} \frac{1}{C \pi^3} \int [k E_i(\mathbf{c}) - \mu] f'_i(\mathbf{c}) d\mathbf{c}$$

- Using **macroscopic** treatment, the heat flux vector (Fourier conduction, net-convection and radiation) is (the photon intensity I_{ph} depends on absorption coefficient which is *ab initio* based)

$$\mathbf{q} = \mathbf{q}_k + \mathbf{q}_u + \mathbf{q}_r = -k \nabla T + \rho c_p \mathbf{u} T + 2\pi \int_0^{\infty} \int_{-1}^1 \mathbf{s} I_{ph, \omega} d\mu d\omega$$

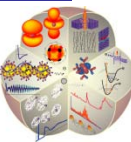

A Rendering of Atomic-Level Heat Transfer

Pieter Bruegel tells multiple folklore stories (Netherlandish Proverbs, 1559) in a painting, such as “*big fish eat little fish*”, “*banging one's head against a brick wall*”, “*having one's roof tiled with tarts*”, and “*shear them but don't skin them*”. These are about notable human tendencies.



Can we do the same for Heat Transfer Physics (HTP)?

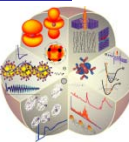

Here Is The HTP Story, with Its Fundamental Equations

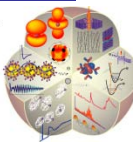
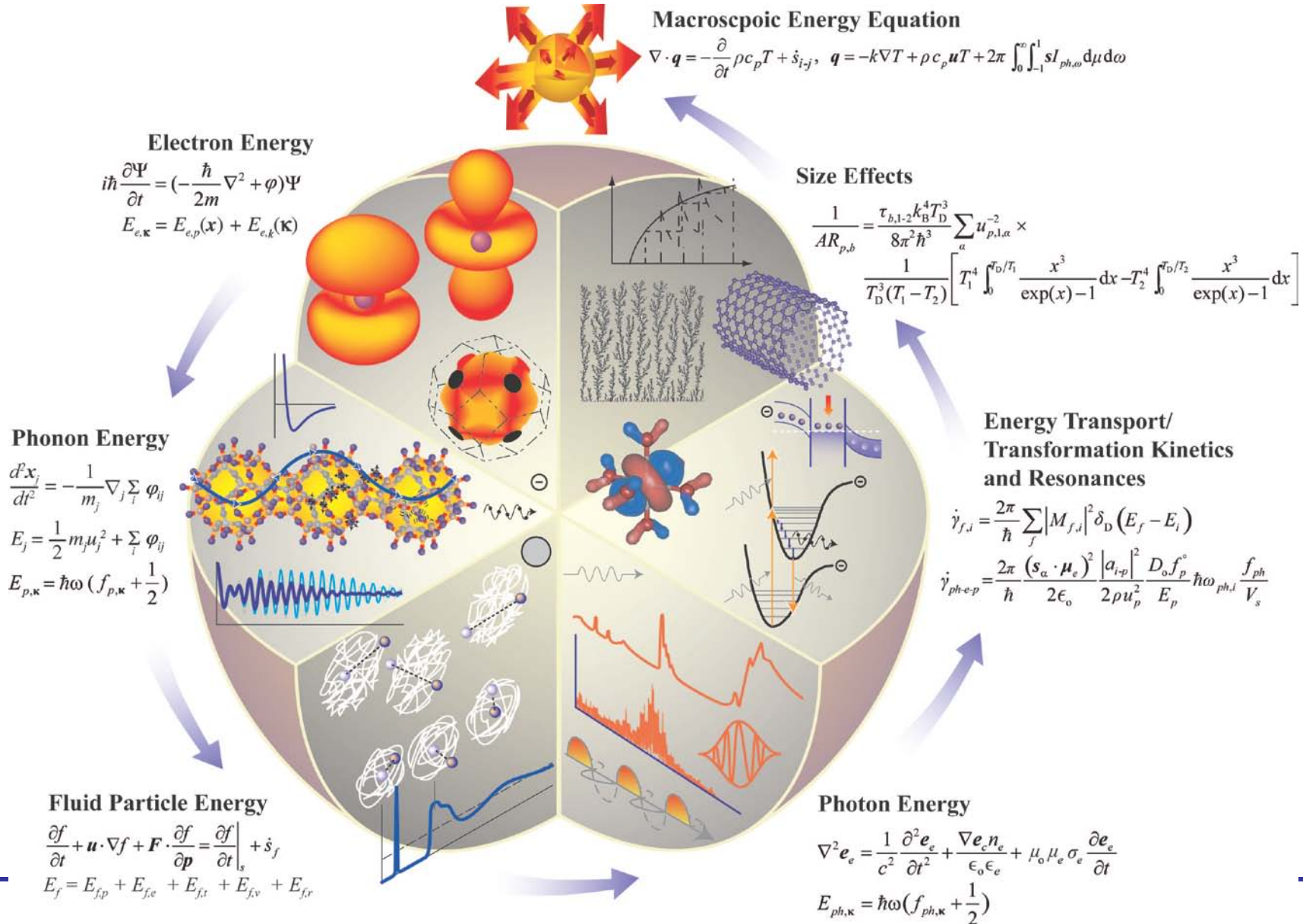

Heat Transfer Physics: Schrödinger, Boltzmann, EM, MD, FGR,

- Heat transfer physics describes how the spatial and temporal variations, as well as creation/removal, of **carrier energy occupancy** f_i , and the carrier allowed energy states (**density of states**) D_i , are governed by **carrier interaction kinetics** and the atomic structure. These in turn determine the thermal function of the material or device.
- For example, the Boltzmann transport equation gives (nonequilibrium energy occupancy depends on applied force and source/sink)

$$\frac{\partial f_i}{\partial t} + \mathbf{u}_i \cdot \nabla_{\mathbf{x}} f_i + \mathbf{F}_i \cdot \nabla_{\mathbf{p}} f_i = \frac{\partial f_i}{\partial t} \Big|_s + \dot{s}_{f,i}, \quad i = p, e, f, ph$$

\mathbf{F}_i applied force, N
 f_i i particle probability distribution function
 $\dot{s}_{f,i}$ i carrier source rate, 1/s
 $\nabla_{\mathbf{x}}$ spatial gradient, 1/m
 $\nabla_{\mathbf{p}}$ momentum gradient, 1/N-s

- Scattering term uses relaxation time [obtained from Fermi golden rule (FGR)].
- The electron density of states of intrinsic Si (found from Schrödinger i.e., *ab initio* calculations). The density of states is a signature of the atomic structure.
- Photon interaction is in part treated using Maxwell equation [Electromagnetism (EM)].

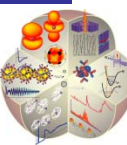
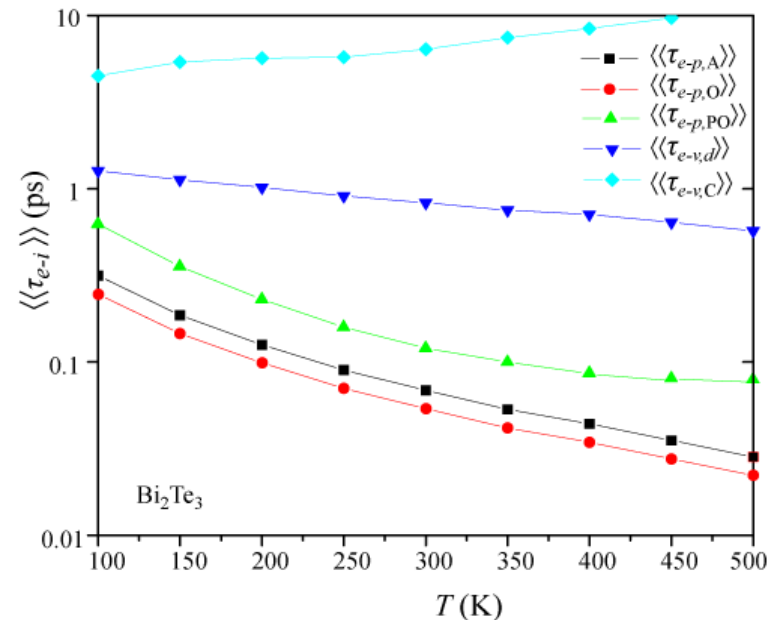

Equilibrium Carrier Energy Population Distribution

As the quantum energy population depends on temperature; most systems at high temperatures obey the classical (Maxwell–Boltzmann) limit.

Both Fermi–Dirac (fermion) and Bose–Einstein (boson) become Maxwell–Boltzmann statistics at low population.

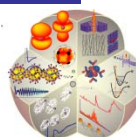
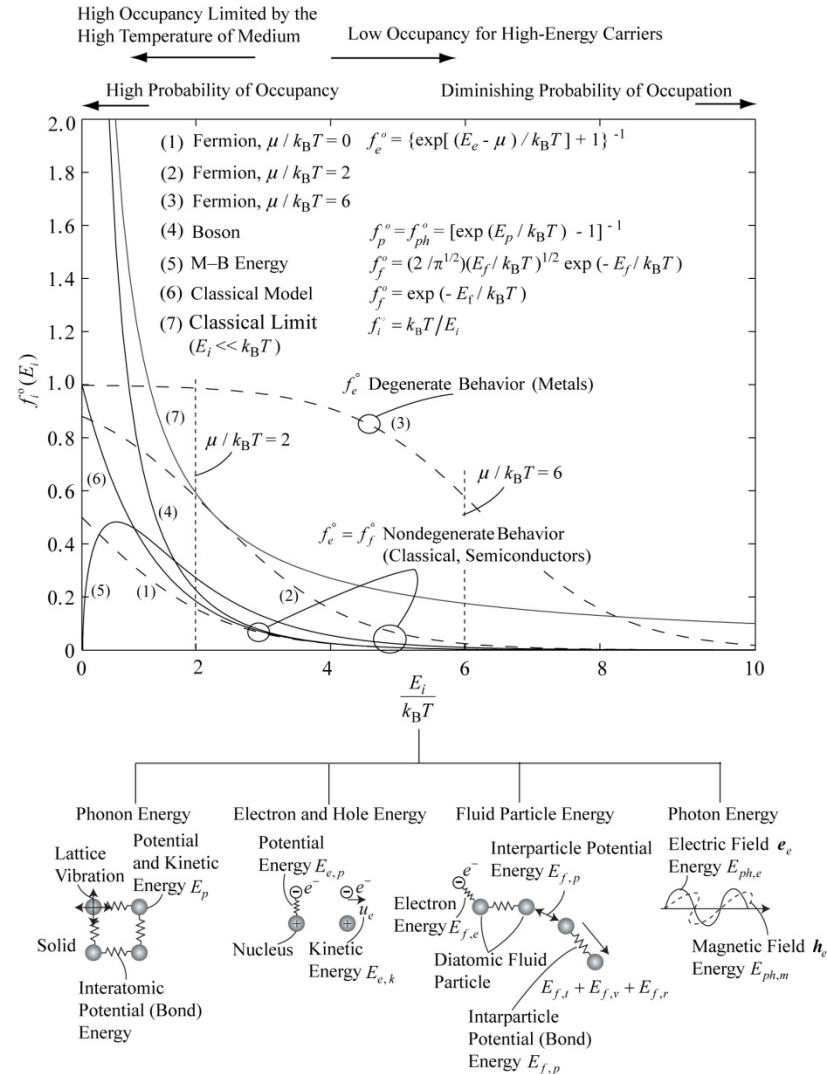

Density of States for other Carriers

In statistical and condensed matter physics, the density of states (DOS) of a system describes the number of states at each energy level that are available to be occupied. A high DOS at a specific energy level means that there are many states available for occupation. A DOS of zero means that no states can be occupied at that energy level.

Waves, or wave-like particles, can only exist within quantum mechanical (QM) systems if the properties of the system allow the wave to exist. In some systems, the interatomic spacing and the atomic charge of the material allows only electrons of certain wavelengths to exist. In other systems, the crystalline structure of the material allows waves to propagate in one direction, while suppressing wave propagation in another direction. Waves in a QM system have specific wavelengths and can propagate in specific directions, and each wave occupies a different mode, or state. Because many of these states have the same wavelength, and therefore share the same energy, there may be many states available at certain energy levels, while no states are available at other energy levels.

The figures to right show DOS of Si crystal, for phonon (a), electron (b), and photon (emission) (c).

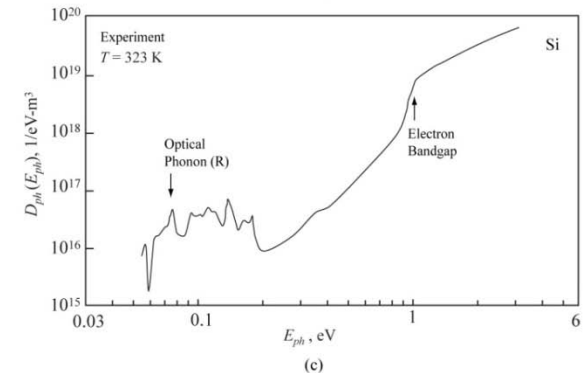
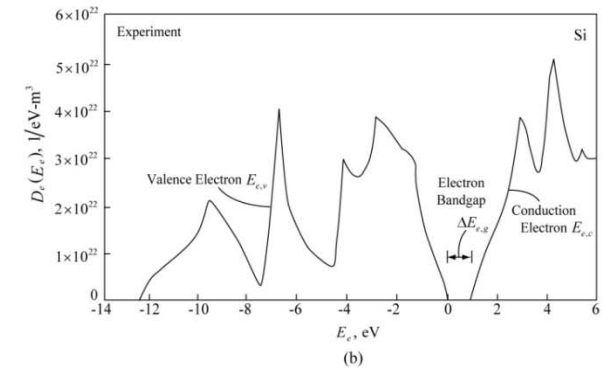
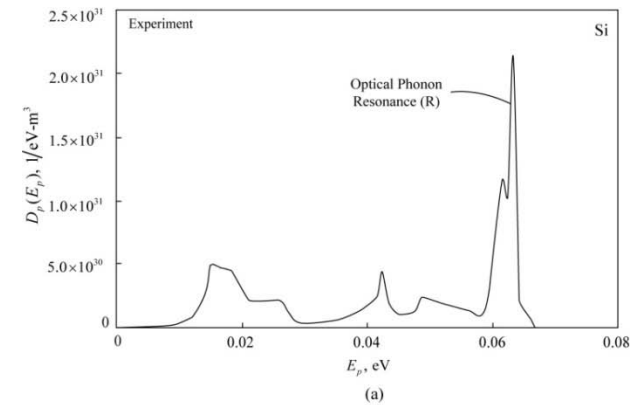

Density of States

Waves, or wave-like particles, can only exist within quantum mechanical (QM) systems if the properties of the system allow the wave to exist. In some systems, the interatomic spacing and the atomic charge of the material allows only electrons of certain wavelengths to exist. In other systems, the crystalline structure of the material allows waves to propagate in one direction, while suppressing wave propagation in another direction. Waves in a QM system have specific wavelengths and can propagate in specific directions, and each wave occupies a different mode, or state. Because many of these states have the same wavelength, and therefore share the same energy, there may be many states available at certain energy levels, while no states are available at other energy levels.

The figures to right show DOS of Si crystal, for phonon (a), electron (b), and photon (emission) (c). Below are the vibrational states of CO₂ gas.

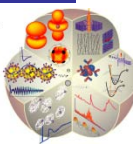
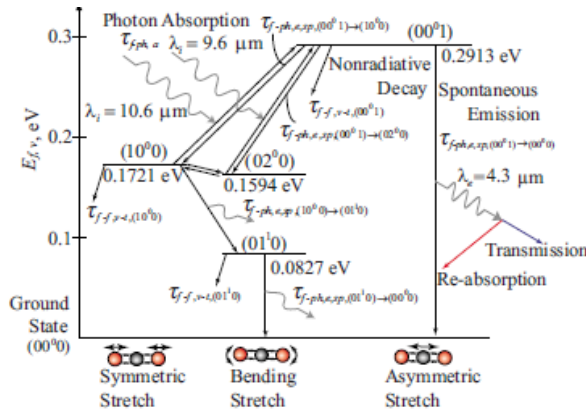
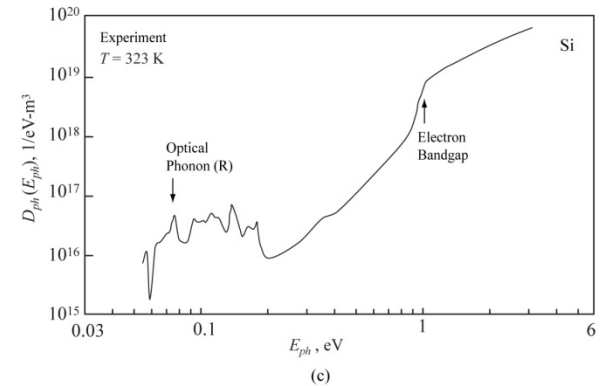
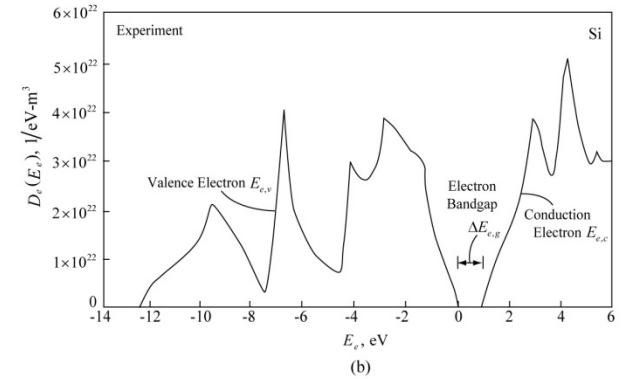
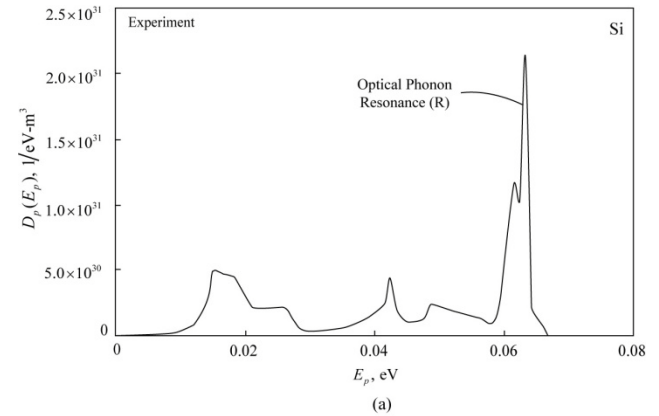

Creating and Harvesting Resonant Carrier Population Nonequilibrium f_i'

- In laser the photon population is far from equilibrium.
- During energy transitions nonequilibrium carrier populations are created.
- Resonant nonequilibrium phonons are created in nonradiative decay of electronic transition.
- Resonant vibrational states are created in absorption of photons (laser) by fluid particles.
- The resonant motion (kinetic energy) such as phonon and vibrational if not immediately harvested, turn into heat by thermalization (creation of equilibrium energy occupancy).
- So before creating waste heat, this energy has a resonant signature and can be harvested.

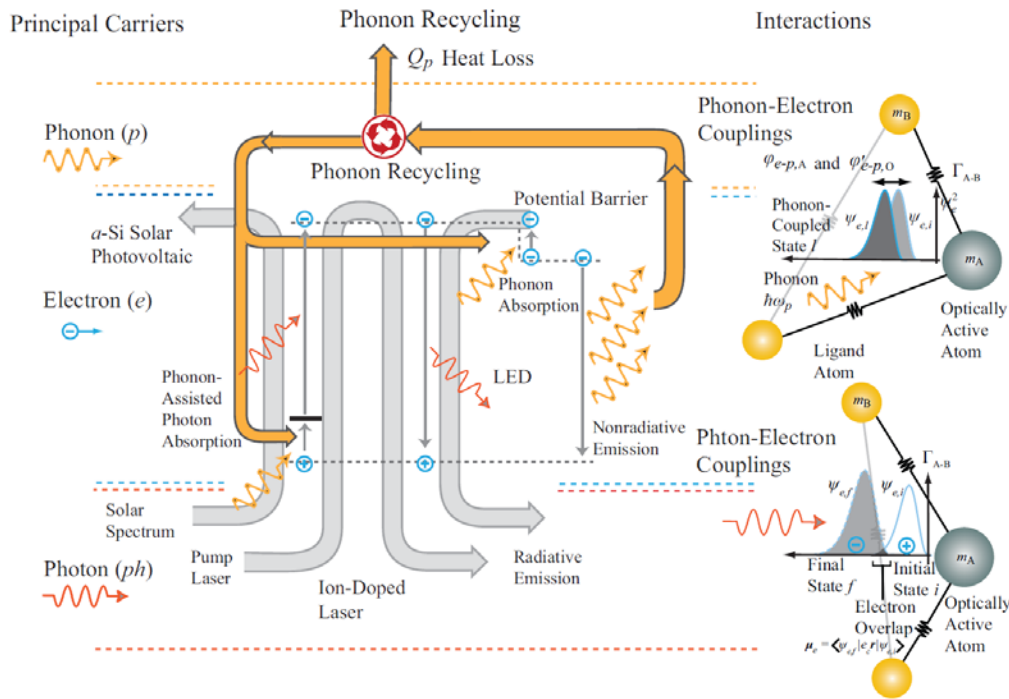

Example of phonon recycling introduced in photonic energy conversion systems. The input and output energy paths are shown with the light grey arrows, while the phonon energy path is shown in different shade. The photon, electron, and phonon energy conversion regimes are labeled and the carrier couplings are also shown.

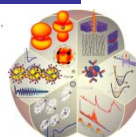

Example of Population Inversion

Example of vibrational energy population Nonequilibrium created by photon absorption. To maintain this the kinetics (represented by time constants) of the transition should favor keeping this population inversion.

- (a) Five-level vibrational energy transitions and their time constants in laser cooling of CO₂ gas.
- (b) Equilibrium and nonequilibrium population distributions of CO₂ vibrational modes in laser cooling. The photon wavelength is selected to transition with the most effective cooling.

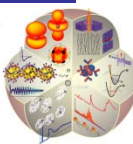
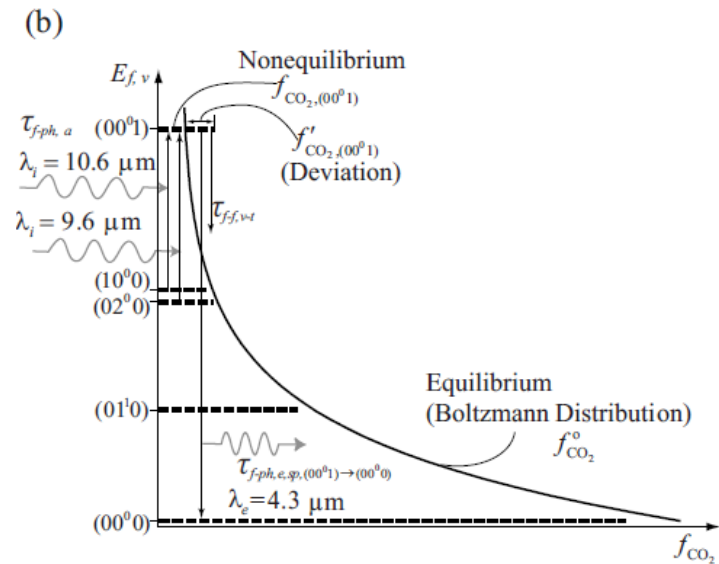
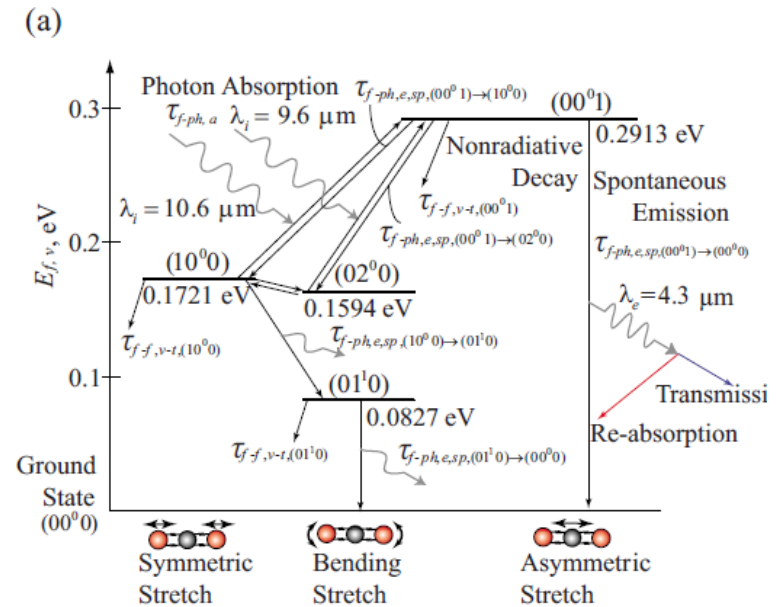

Energies of Principal Carriers

Examples of typical energies for the four principal energy carriers. The highest phonon energies are in the optical phonons, the highest fluid particle energies are the electronic energy, the highest electron energies are in electron emissions and in accelerated electrons, and the highest photon energies are in γ -rays and cosmic radiations. Symbol R stands for a resonance phenomenon.

Heat transfer physics mostly encounters energies from fractions of $k_B T$ (0.025 eV at 300 K, in infrared regime) to several eV (as in large bandgap semiconductors, in ultraviolet regime).

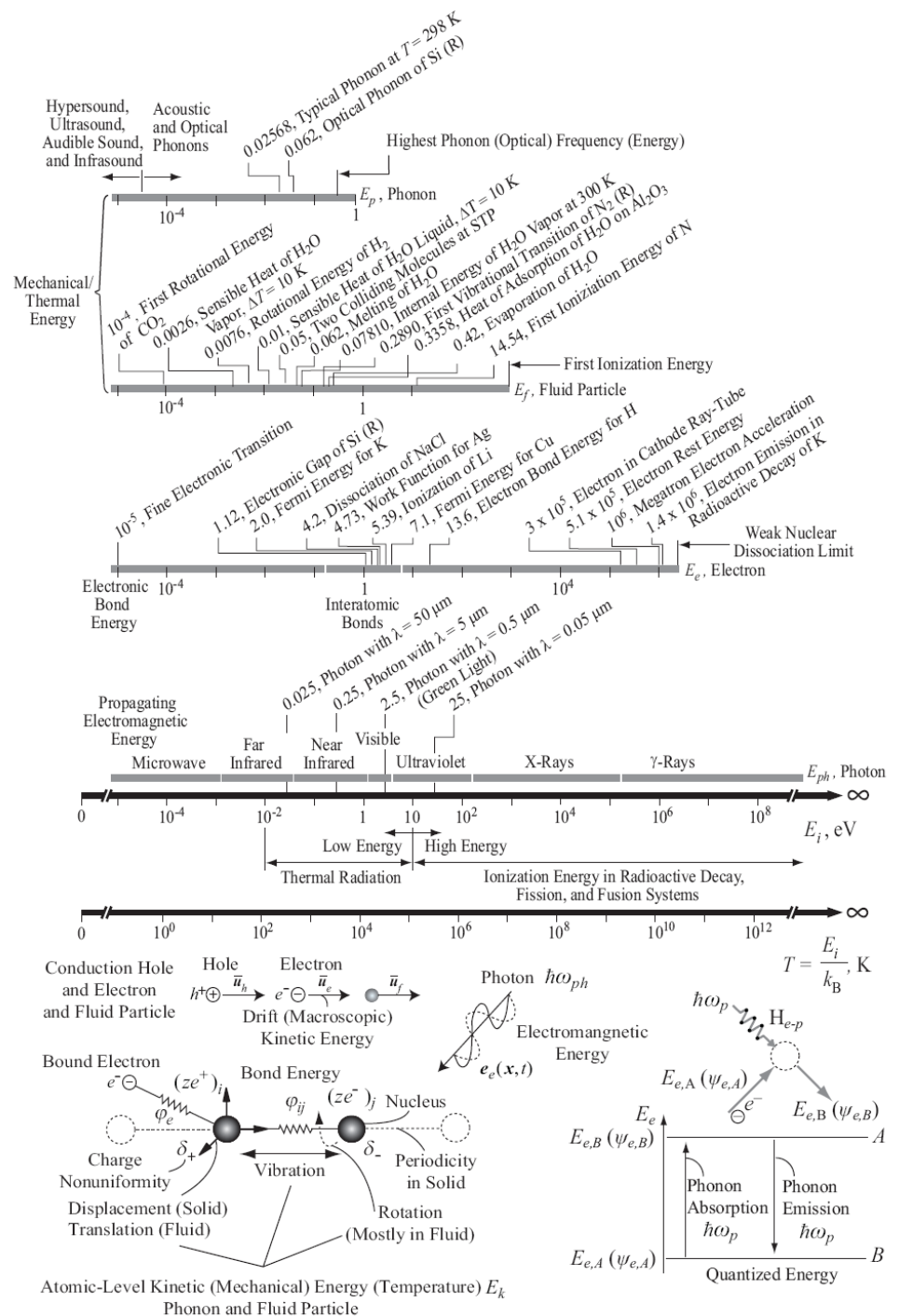

Interaction Times (Kinetics)

Kinetics of atomic-level energy transport and transition interaction. Examples of typical energy interaction (transition) times for various principal energy carrier pairs. The frequency ($1/\tau$) is also shown. Unless specified, $T = 300$ K. Symbol R indicates resonance.

Thermalization is the process of return to equilibrium energy occupancy by intra-carrier collisions. It is fastest for electrons (less than ps) and slowest for fluid particles (hundreds of ps).

Energy conversion are generally bottlenecked with the slowest transition rate (inverse of time constant), while transport is bottlenecked with the fast scattering (smallest time constant).

The kinetics (or rates) are represented by time constants which are inverse of rates. For transition among quantum state, the rate is based on **Fermi golden rule**.

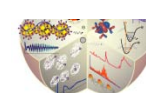
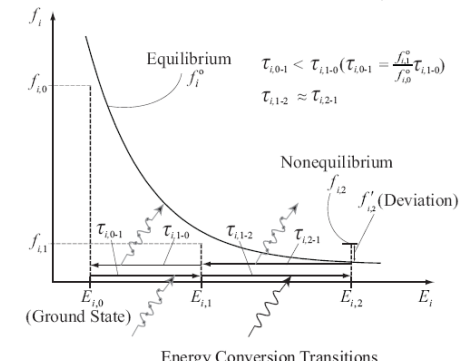
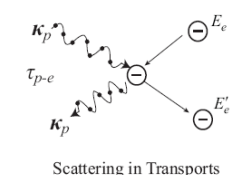
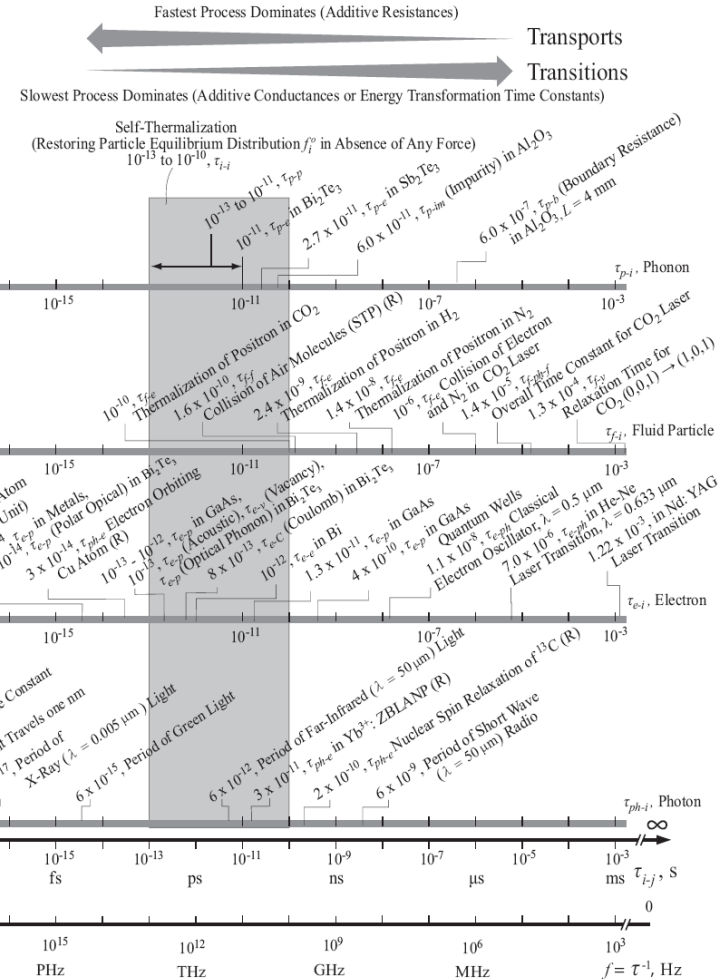

Fermi Golden Rule for Rates

What is a golden rule (GR)?

Example: the Norman Rockwell GR

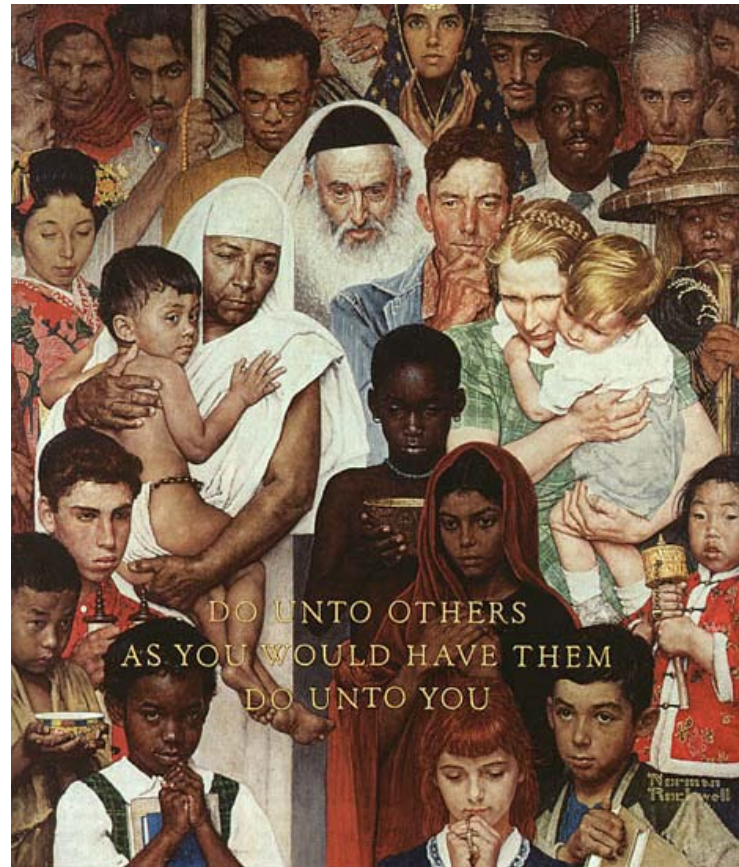

Seriously, golden rule means a useful, universal relation, and the Fermi GR (FGR) is developed for transition rate between quantum states, as for electronic transitions caused by Hamiltonian H' is

$$\dot{\gamma}_{e-i}(\kappa', \kappa) = \frac{1}{\tau_{e-i}(\kappa', \kappa)} = \frac{2\pi}{\hbar} |M_{\kappa', \kappa}|^2 \delta_D(E_{\kappa'} - E_{\kappa} \mp \hbar\omega_i)$$

FGR for transition probability rate,

$$M_{\kappa', \kappa} = \int \psi_{\kappa'}^\dagger H' \psi_{\kappa} dV \quad \text{interaction matrix element.}$$

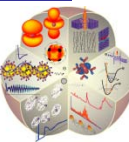

Example: Phonon Thermal Conductivity

- For example, the Debye model density of states of phonon uses a cutoff frequency T_D and using this and the total phonon relaxation time τ_p , the phonon thermal conductivity tensor is

$$q = \sum \frac{1}{C\pi^3} \int [E_p(\kappa) - \mu] \mathbf{u}_p(\kappa) f'_p(\kappa) d\kappa \quad k_p = (48\pi^2)^{1/3} \frac{1}{a} \frac{k_B^3 T^3}{h_P^2 T_D} \int_0^{T_D/T} \tau_p(x) \frac{x^4 e^x}{(e^x - 1)^2} dx$$

$$K_p = \frac{1}{8\pi^3} \sum_{\alpha} \int c_{v,p} \tau_p \mathbf{u}_p \mathbf{u}_p d\kappa \quad \frac{1}{\tau_p} = \sum_j \frac{1}{\tau_{p,j}}$$

Since τ_p has temperature-dependent contributions from phonon scattering by phonons, impurities, electrons, and by grain boundary, k_p has a peak value near $0.1 T_D$. Figure shows behavior of phonon conductivity with respect to temperature, with marked regimes of important (or dominant) phonon-scattering mechanisms. The behavior of an amorphous solid is also shown (the crystalline solid has a higher thermal conductivity).

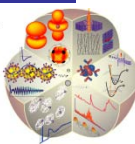
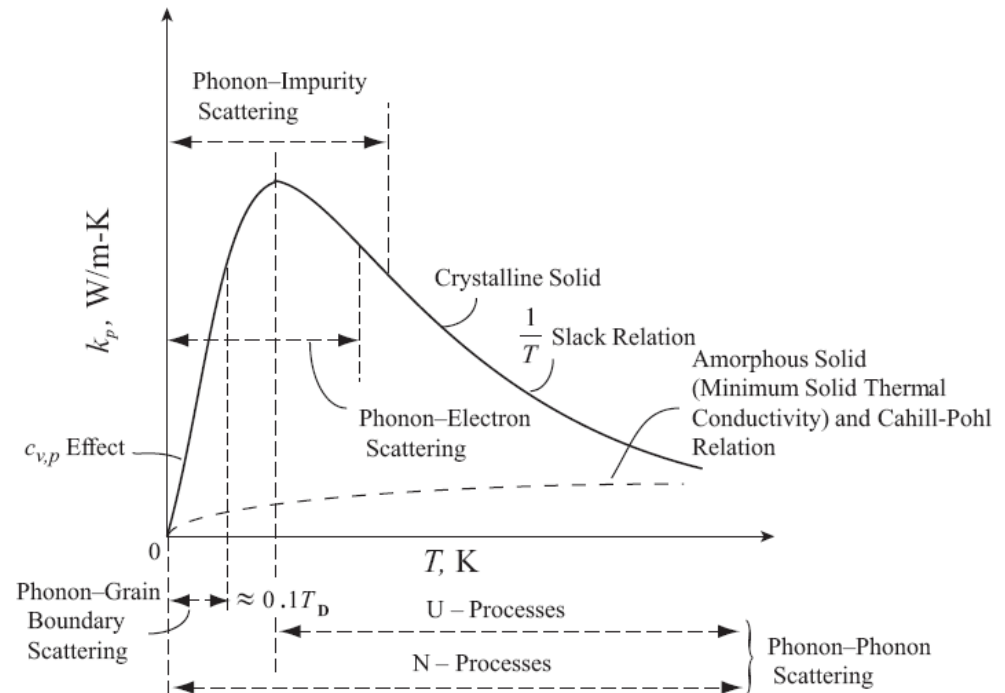

Example of f'_p

Nonequilibrium in Phonon Transport (GaAs Phonon Distribution)

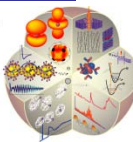
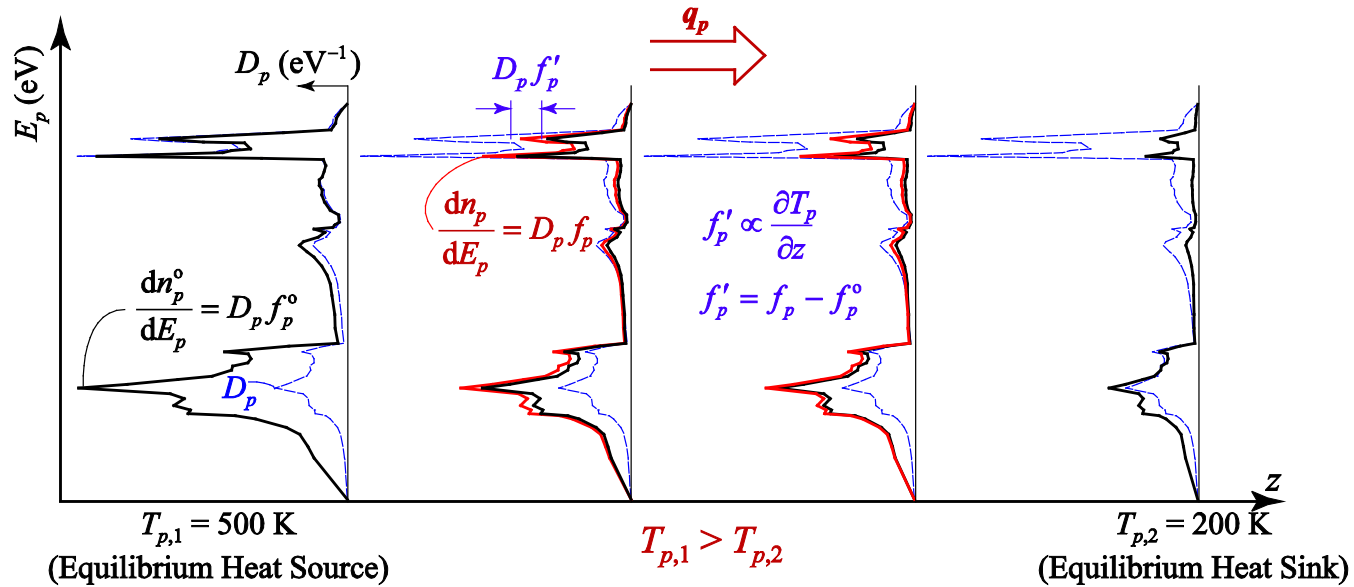

Aim of Heat Transfer Physics

- Insight into **atomic** and **quantum (resonance)** aspects of heat transfer and energy conversion.
- Engineering of **nonequilibrium energy occupancy f_i** of principal energy carriers, their **density of states**, their interaction kinetics.
- Atomic structure analyses to allow for indentifying/using **resonance** features (band gaps and other energy transitions) for storage, transport, and conversion of energy.
- Engineering of **kinetics (rates or time constants)** of energy transport and conversion.
- **Synthesis** of low and high thermal conductivity solids, thermoelectric materials, thermal plasmas, photon localization for heating, lasers, laser cooling of gases of solids, energy conversion among principal carriers (e.g., photovoltaics, phonon recycling in lasers), etc.
- Addressing the **size effects** and their usage in heat transfer and energy conversion.

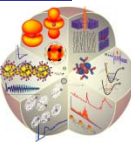

Summary

Key Concepts: Principles of Atomic-Level Description of Thermal Energy Storage–Transport–Transformation

- Four principal thermal energy carriers: phonon, electron (hole), fluid particle, and photon
- Particle, waves, wave packets, and quasi-particle behaviors and statistics of bosons, fermions, and classical particles
- Atomic (fine structure) scales and units
- Molecular orbitals, interatomic potential (Schrödinger equation *ab initio* calculations) and potential models
- Molecular dynamics (MD) simulations and MD scales
- Schrödinger equation and its solutions: harmonic oscillator, electron gas, and electron in hydrogen-like atoms
- Boltzmann transport equation (BTE), particle scattering (interaction), and BTE scales
- Scattering (interaction) rate kinetics and Fermi golden rule (FGR)
- Maxwell equations: electromagnetic (EM) wave equation and relation to photon
- Onsager coupled transport coefficients and theorems
- Stochastic particle dynamics and transport (Langevin equation)
- Green–Kubo (G–K) transport coefficients (fluctuation-dissipation correlations)
- Macroscopic conservation equations (energy, fluid dynamics, and elastic-solid mechanics) and scales

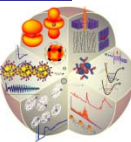

Key Concepts: *Phonon Energy Storage, Transport and Transformation Kinetics*

- Lattice and its vibration (phonon dispersion, bandgap, and density of states)
- Phonon heat capacity (Debye model)
- Phonon BTE, mean free path, and thermal conductivity (Callaway model)
- Phonon scattering mechanisms and relaxation-time models
- Cahill–Pohl minimum thermal conductivity model
- Slack relation and structural metrics of high-temperature phonon conductivity
- Phonon conductivity from MD and G–K autocorrelation decay and conductivity decomposition
- Phonon boundary resistance (diffuse and specular) using photon treatment and Debye model
- Size effects: Superlattice effective phonon conductivity

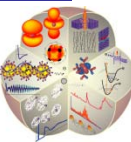

Key Concepts: *Electron Energy Storage, Transport and Transformation Kinetics*

- Electrons in solids, **band structure**, allowed states and **bandgaps** and band-structure models, effective mass
- Electron **density of states** and heat capacity of metals and semiconductors
- Electron BTE and **thermoelectric transport properties** for semiconductors and metals
- **Electron–phonon (acoustic and optical) scattering rates** (scattering) from FGR
- Electron scattering by impurities and their **relaxation-time models**
- **Electric thermal conductivity** of solids (**Wiedemann–Franz relation**)
- Thermoelectricity (**Seebeck, Thomson, Peltier coefficients**) and figure of merit $Z_e T$ for metals and semiconductors
- **Electron–phonon thermal nonequilibrium** and cooling length
- **Size effects**: quantum well for improved $Z_e T$; reduced electron–phonon scattering rate in quantum wells



Key Concepts: *Fluid Particle Energy Storage, Transport and Transformation Kinetics*

- Gas and liquid heat capacity (energy partition function and quantum fluid-particle energies)
- BTE and Maxwell-Boltzmann statistics, collision rate, thermal speeds, relaxation time and mean free path
- Gas thermal conductivity from BTE
- Liquid thermal conductivity (random, localized fluid particle motion)
- Conductivity of suspended particles in liquid (Brownian motion and nanofluid conductivity)
- Gas particle interaction with surface (fluid flow regimes and accommodations and slips)
- Solid particle thermophoresis in gases
- Physical surface adsorption and desorption of gas molecules
- Fluid-flow regimes: molecular-flow, Knudsen-flow, and turbulent-flow structure and transport
- Thermal plasmas and electron-heavy species thermal nonequilibrium
- Size effects: gas thermal conductivity in narrow gaps; thermal creep (slip) flow in narrow gaps

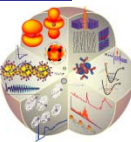

Key Concepts: *Photon Energy Storage, Transport and Transformation Kinetics*

- **Quantum-Particle Treatment:** photon gas (**blackbody**) emission and radiation intensity
- **Laser and near-field emission** (bandwidth and direction)
- Photon absorption and **spontaneous and stimulated emission** in two-level electronic systems
- Photon BTE and photon (and phonon) Equation of Radiative Transfer (**ERT**)
- **EM Wave Treatment:** including **photon localization**
- Mechanisms of **spectral absorption** in **solids** based on FGR (including semiconductors and metals)
- Mechanisms of spectral absorption in **gases** based on FGR (vibrational bands)
- Near- and far-field emission and reciprocity with absorption
- Radiative and **nonradiative** (e.g., phonon emission) **decays** and **quantum efficiency**
- Photon–electron–phonon couplings and **laser cooling of solids** (FGR)
- Role of fluid-particle quantum energy in gas laser and **laser cooling of gases**
- Role of phonon in **photovoltaics** and extraction of hot electrons
- **Size effects:** near-field radiation heat transfer; photon energy confinement by near-field optical microscopy

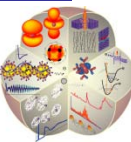

Thanks

- Thanks to you for joining me in the **Heat Transfer Physics** experience!
- And let's start going over these key concepts in some details.
- Remember that **only good questions** can lead to quality answers!
- **Stop** me for any question, do not hesitate!

This course has been given in US, France, Hong Kong, Iran, South Korea, and Brazil:

- **Heat Transfer Physics**
- **Transfert de chaleur physique**
- **传热物理**
- **فیزیک انتقال حرارت**
- **열전달 물리학**
- **Transferência de Calor Física**

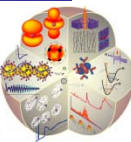

Lighting as an Example: LED Efficiency

- A LED might produce 25-60% visible light and 75-40% heat (phonon emission). Also, performance deteriorates with increase in temperature.

- **lumen** is defined as $lm = cd \Omega$

Ω is solid angle and candela (cd) is power emitted by a light source in a particular direction, weighted by the luminosity function (a standardized model of sensitivity of human eye to different wavelengths, also known as luminous efficiency function).

- Keeping the LED temperature low is critical.

Characteristics of Common Light Sources			
Light Source	Efficiency (Lumens/Watt)	Luminaire Efficiency	Overall Efficiency
Standard Incandescent	5-20	50%	2.5-10
Tungsten Halogen	15-25	50%	7-12
Compact Fluorescent	20-55	50%	10-27
Fluorescent (T5 Covered)	60-100	65%	39-65
Mercury Vapour	25-50	80%	20-40
Metal Halide	45-100	80%	36-80
High Pressure Sodium	45-110	80%	36-88
LED	25-60	100%	25-60

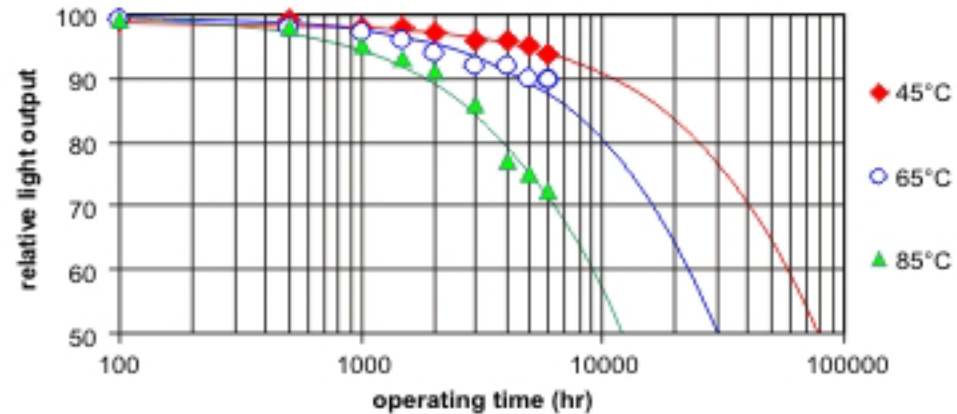
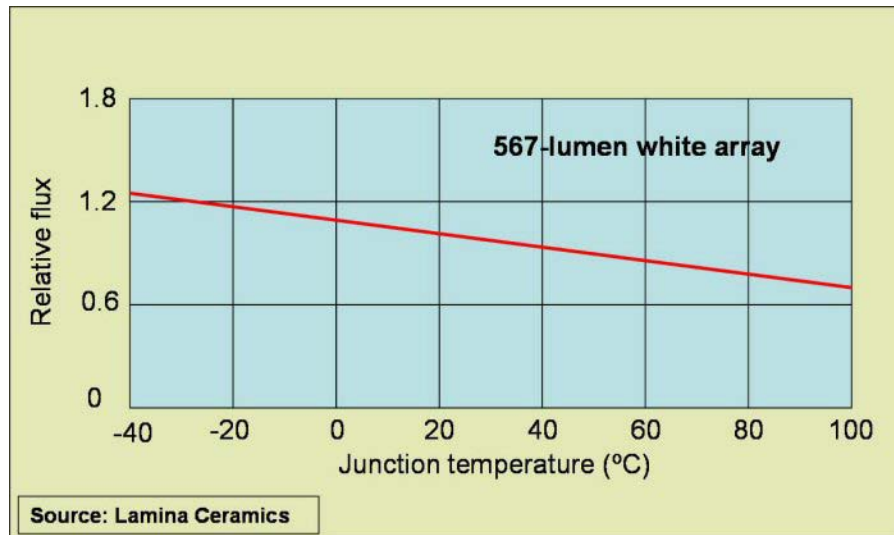

Improving Efficiency of Incandescent Bulb

Incandescent Bulb: Old and New



Infrared (Photon) Recycling (a) and (b) using Internal Selective Band-Pass Filter with $a = 350$ nm, $d = 250$ nm, $h = 500$ nm, $w = 50$ nm.

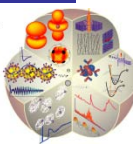
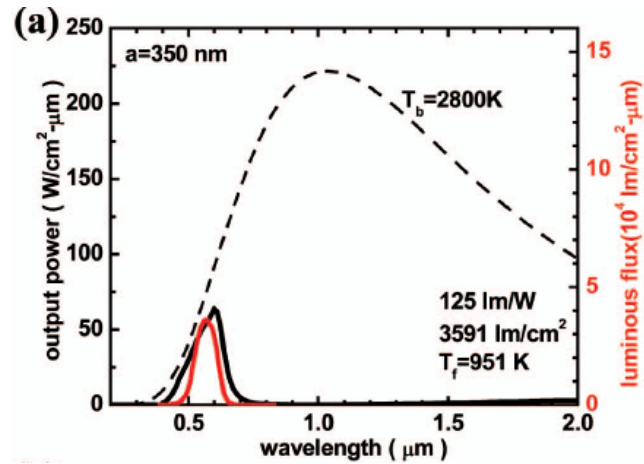
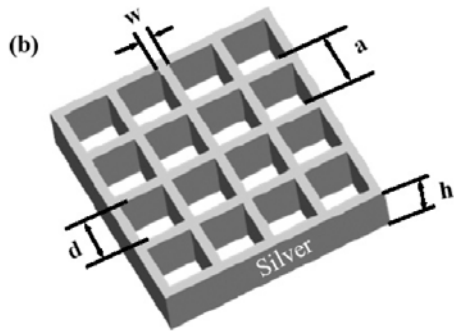
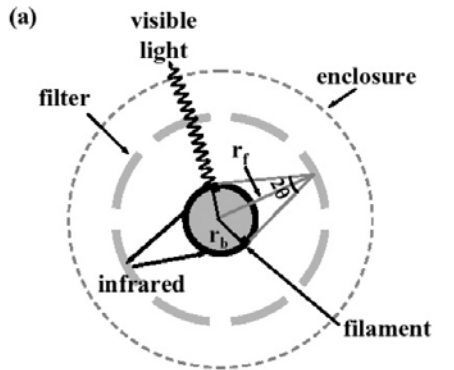

Fluorescent Lamp

Fluorescent lamp a gas-discharge lamp using electric current (accelerated free electrons) to collide and cause electronic excitation of mercury atoms (as vapor). The excited mercury electron undergoes radiative decay and produces short-wave ultraviolet light. This in turn is absorbed by phosphor coating causes the phosphor to fluoresce, producing visible light.

- Atomic-level insight and synthesis are needed to improve the light bulb efficiency.
- Note that **quantum mechanics** plays progressive roles: from Edison blackbody filament radiation to more tailored, band radiations.
- **Recycling** of photon, gas vibration, and phonon, also play roles in these devices.

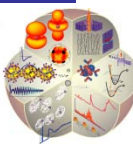
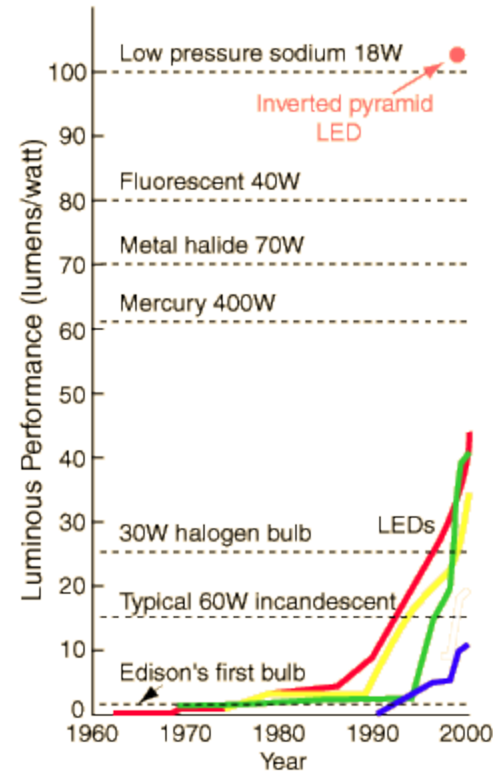
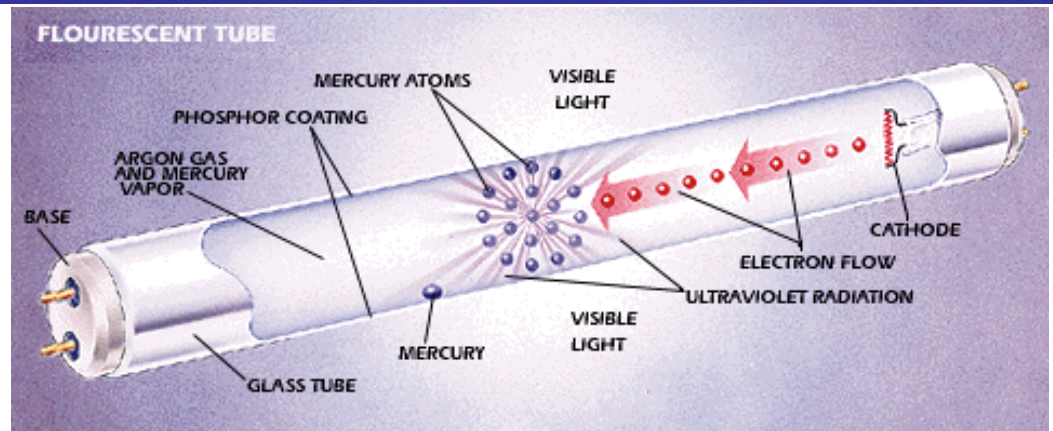

Another Example, Heat Recycling in Combustion-Thermoelectric Tube

Exothermic, gaseous reaction in tubes (and porous media in general) allows for preheating of the reactants by conduction through the tube wall. If in addition the gas flow is allowed to reciprocate in direction, heat can be stored within the tube. The combination of the preheating and storage allows for creation of high temperatures using a very small amount of heat of reaction per kilogram of the reactants. These high temperatures can in turn be used for direct thermoelectric energy conversion.

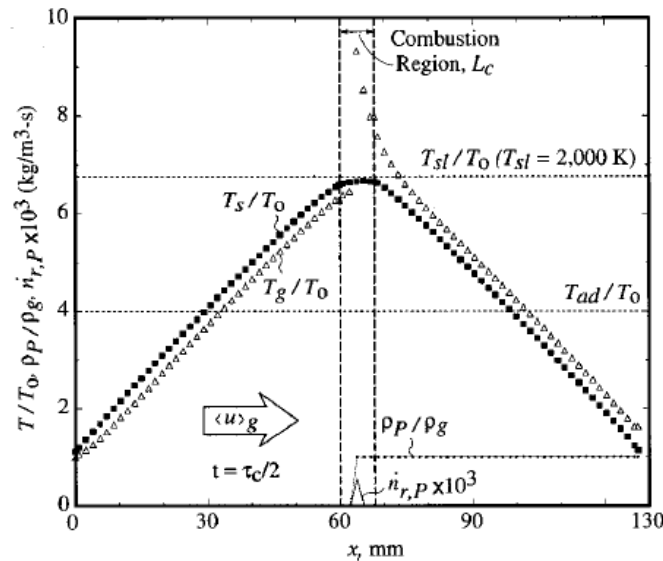
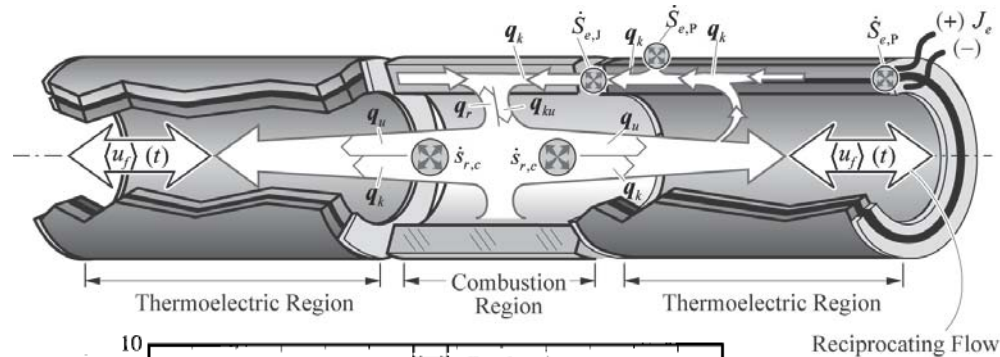

An Example: Multiphonon Absorption Thermionic Cooling in LED

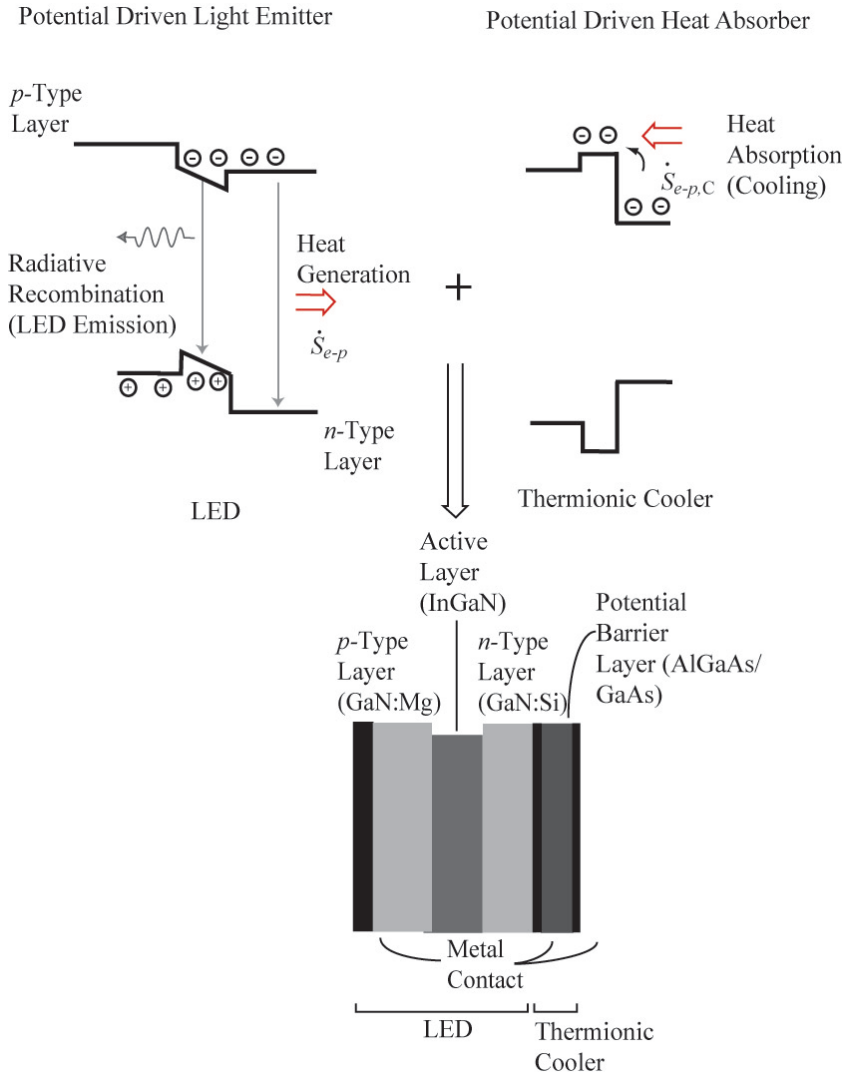

- Figure 1 shows the energy diagram of LED. In LEDs 50 to 90% of electrical energy converts to heat.
- This heat is initially in optical phonons (high-energy atomic vibrations), i.e., nonequilibrium optical phonon population.
- Thermionic coolers operating principle is by ballistic movement of nonequilibrium electron over a potential barrier by absorption of phonon (heat content). This is also shown in Figure 1.
- Theoretical models predict COP for thermionics much higher than that of thermoelectrics [1-3].
- Predicted cooling rate is as high as 100 W/cm² (at high current density) [4].
- We predict effective thermionic cooling of high power LEDs.

Figure 1. Electronic energy levels of LED and thermionic cooler is shown. Heat generation occurs at the chip-level where nonradiative decay due to defect states is a significant problem in LED heterojunctions. Metal-semiconductor-metal heterojunction thermionic cooler operates by voltage driven ballistic movement of the electrons over a potential barrier with the energy provided by absorbing phonons. These to system can be integrated in self-cooled LED system as shown.

- [1] G.D. Mahan, J. Appl. Phys. 76, 4362 (1994).
 [2] A.G. Mal'shukov and K.A. Chao, Phys. Rev. Lett. 86, 5570 (2001).
 [3] A. Shakouri and J.E. Bowers, Appl. Phys. Lett. 71, 1234 (1997).
 [4] S. Yen, K. Lee, J. Appl. Phys. 107, 054513 (2010).

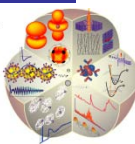

Physics of Thermionic Cooling (Phonon Absorption) in LED

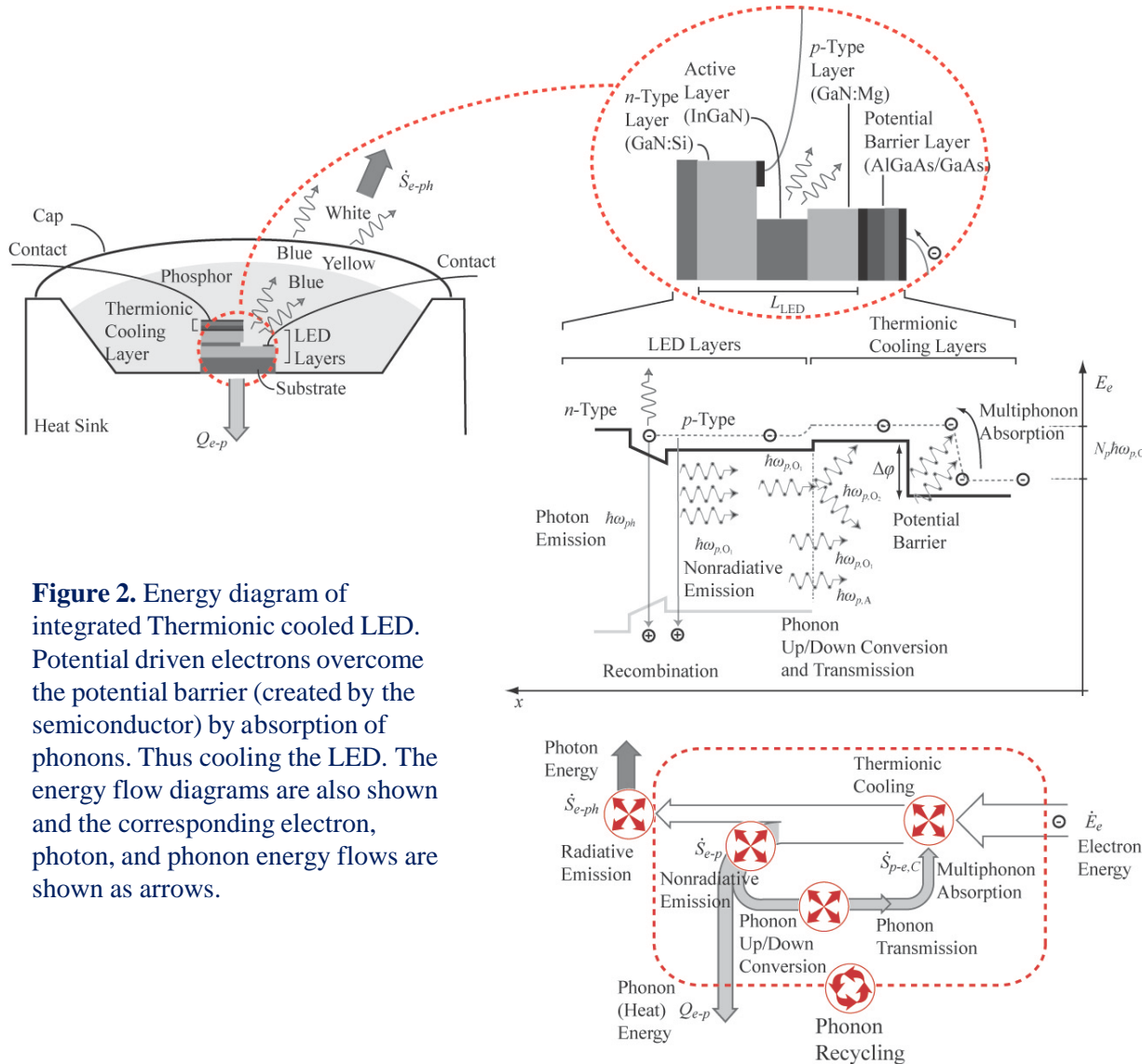

- Integrated structure emits phonons at the defect sites (among other sources) during the LED operation.
- Due to spatial nonuniform (and nonequilibrium) phonon distribution, the phonons are transmitted either to the heat sink (Q_{e-p}) or to the thermionic cooling site (a semiconductor barrier) to be used as part of multiphonon absorption process ($S_{p-e,C}$).
- Composition of the semiconductor barrier is optimized for phonon energies resulting in the highest cooling rate with minimal obstruction to the LED performance.

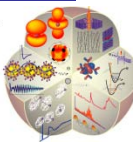

Transition Rates

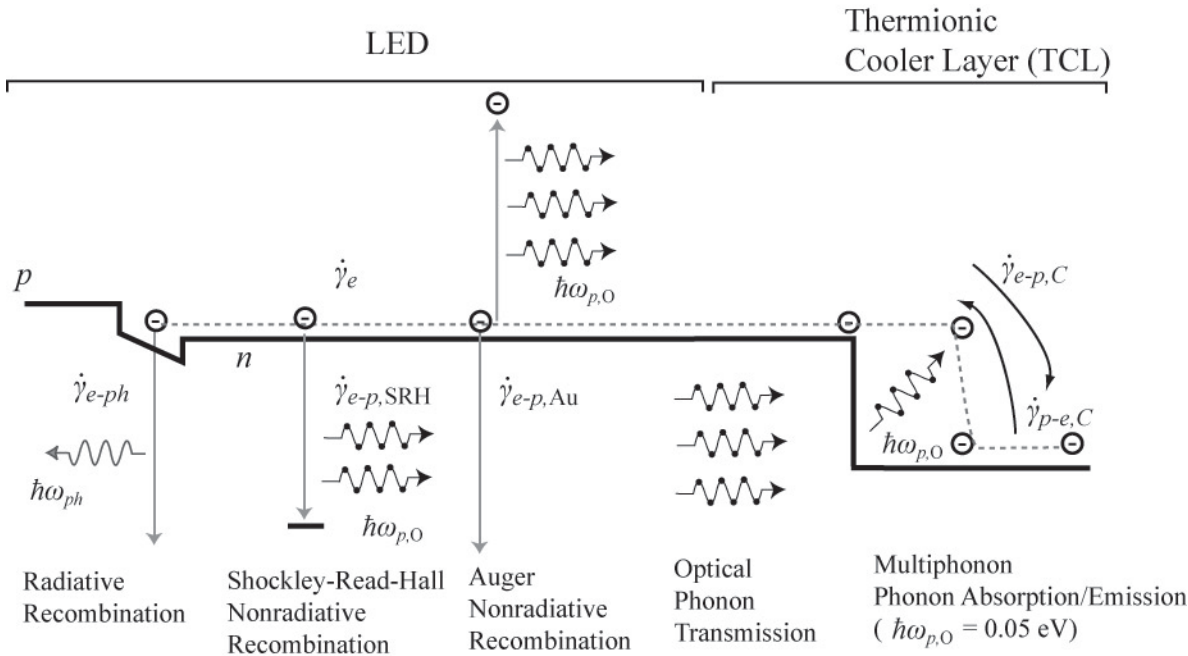
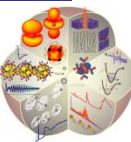
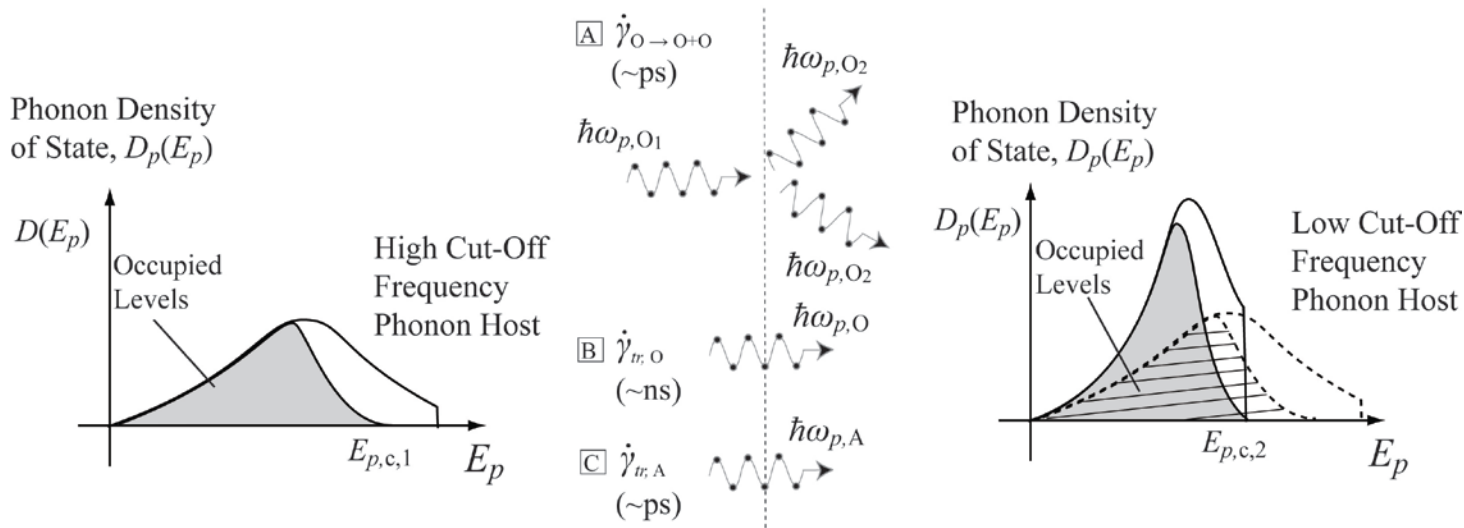

Figure 3. The kinetics involved in LED and the thermionic cooler. The total system performance relies on the slowest transition process. The transition rates can be compared for performance characterization and optimization.

- The transition rates for individual processes involved in LED and the thermionic cooler will determine the total allowable current for given voltage.
- Shockley-Read-Hall and Auger nonradiative recombination processes are the dominant phonon emission processes.
- Optical phonon transmission between the LED layer and TC layer need to be fast enough to allow sufficient phonon transmission.
- Optimization of the bottle-neck process will maximize the cooling rate with maxim quantum efficiency.



Phonon Transmission



- A Optical-Optical Phonon Downconversion (3 Phonon Process)
 - B Optical Phonon Transmission C Acoustic Phonon Transmission
- Equilibrium Phonon Distribution

Figure 4. The kinetics involved in phonon transmission between a high cut-off frequency phonon host and low cut-off frequency phonon host. Down conversion is expected during the transmission of optical phonon from LED to TC layer.

- High phonon cut-off frequency in Nitride structures will require optical phonon down conversion when transmitted to a low phonon cut-off frequency material such as GaAs.
- The down conversion is expected to be a ps process which is orders of magnitudes faster than the electronic transition process.

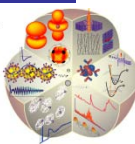

Transition Rates 1

- Shockley-Read-Hall recombination is given by [5]

$$\dot{\gamma}_{e-p,SRH} = A_{SRH} n_e,$$

where A_{SRH} is the Shockley-Read-Hall recombination constant and n_e is the carrier density.

- Auger recombination is given by [5]

$$\dot{\gamma}_{e-p,SRH} = A_{Au} n_e^2$$

where A_{Au} is the Auger recombination constant.

- Using the optical phonon scattering model, the phonon absorption rate for electron having energy E_e becomes [6]

$$\dot{\gamma}_{p-e} = \frac{\varphi'_{e-p}{}^2 m_{e,e}^{3/2} E_e^{1/2} f_p(E_p)}{\rho \omega_p 2^{1/2} \pi \hbar^3}$$

where φ'_{e-p} is the optical phonon deformation potential, $m_{e,e}$ is the reduced electron mass, E_e is the electron energy, $f_p(E_p)$ is the Boson distribution function, and ρ is the density.

$\dot{\gamma}_{e-ph}^a$	$\dot{\gamma}_{e-p,SRH}^b$	$\dot{\gamma}_{e-p,Auger}^c$	$\dot{\gamma}_{p-p}^d$	$\dot{\gamma}_{p-e}^e$
5.5×10^7	2.4×10^7	3.5×10^7	1.5×10^8	6.0×10^{11}

a. $A_{e-ph} = 1.1 \times 10^{-11} \text{ cm}^3\text{-s}^{-1}$	$\gamma_G = 0.8$
b. $A_{SRH} = 2.4 \times 10^7 \text{ s}^{-1}$	$R = 0.128$
c. $A_{Auger} = 1.4 \times 10^{-30} \text{ cm}^6\text{-s}^{-1}$	e. $\varphi'_{e-p} = 9.0 \text{ eV/\AA}$
d. $\rho = 5317 \text{ kg/m}^3$	$m_{e,e} = 0.0819 m_e$
$u_{p,A} = 2800 \text{ m/s}$	$E_e = 0.05 \text{ eV}$
$\omega_{p,O} = 8.6 \text{ THz/s}$	$\hbar\omega_{p,O} = 0.035 \text{ eV}$
$\omega_{p,A} = 4.3 \text{ THz/s}$	

Table 1. Radiative, Shockley-Read-Hall, and Auger recombination rates for InGaAs LED [7]. The single optical phonon absorption rate is calculated at $T = 323 \text{ K}$ using the parabolic electron density of states model.

[5] E. Fred Schubert, *Lighth-Emitting Diodes*, Cambridge University Press, 2nd Ed, 2006.

[6] J. Singh, *Electronic and Optoelectronic Properties of Semiconductor Structures*, Cambridge University press, 2007.

[7] Y.C. Shen, G.O. Mueller, S. Watanabe, N.F. Gardner, A. Munkholm, and M.R. Krames, *Appl. Phys. Lett.* **91**, 141101 (2007).

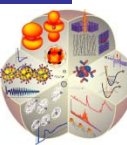

Transition Rates 2

- Using the multiphonon absorption model, the transition rate is proportional to the powers of distribution function [8]

$$\dot{\gamma}_{p-e,C} = \frac{\varphi_{e-p}^2 m_{e,e}^{3/2} E_e^{1/2} f_p^{N_p}(E_p)}{\rho \omega_p 2^{1/2} \pi \hbar^3}$$

where N_p is the number of phonons involved in the transition over the potential barrier.

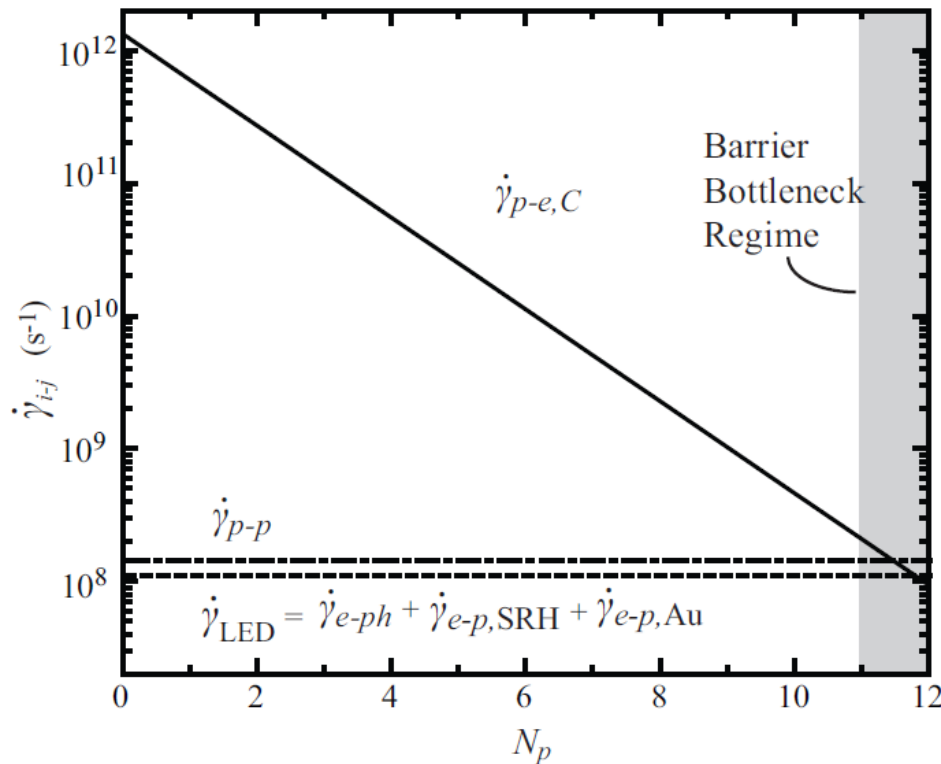
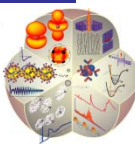

Figure 5. (a) Variations of multiphonon absorption cooling rates and constant incoming electronic energy given in [7], with respect to number of phonons (N_p). The phonon absorption rate becomes a bottle neck when 8 or more phonons are absorbed crossing the potential barrier in thermionic cooling layer.

[8] C.B. Layne, W.H. Lowdermilk, and M.J. Weber, Phys. Rev. B. **16**, 10 (1997).



Transition Rates 3

- The energy conversion rates are found by

$$\dot{S}_{i-j} = \hbar\omega_i n_e V \dot{\gamma}_{i-j}$$

where n_e is the carrier density and V is the volume.

- The quantum efficiency of the LED can be expressed as

$$\eta_{e-ph} = \frac{\dot{S}_{e-ph}}{\dot{E}_e} = \frac{\dot{S}_{e-ph}}{\dot{S}_{e-ph} + \dot{S}_{e-p}} = \frac{\dot{S}_{e-ph}}{\dot{S}_{e-ph} + \dot{S}_{e-p,SRH} + \dot{S}_{e-p,Au}},$$

where E_e is the total electron energy coming in (voltage x current).

- The phonon emission due to back current created by the thermionic cooling layer is given by [9]

$$\dot{S}_{e-p,C} = E_e \exp[-(\Delta\phi_i - N_p \hbar\omega_p) / k_B T],$$

where $\Delta\phi$ is the applied potential over the conduction band.

- The quantum efficiency of the LED with Thermionic cooling layer can be expressed as

$$\eta_{e-ph} = \frac{\dot{S}_{e-ph} - \dot{S}_{e-p,C}}{\dot{S}_{e-ph} - \dot{S}_{e-p,C} + Q_{e-p}} = \frac{\dot{S}_{e-ph} - \dot{S}_{e-p,C}}{\dot{S}_{e-ph} + \dot{S}_{e-p,C} + \dot{S}_{e-p} + \dot{S}_{p-e,C}},$$

where the subscripts for energy conversion rates S are radiative ($e-ph$), phonon emission at Thermionic cooling layer ($e-p,C$), phonon absorption at Thermionic cooling layer ($p-e,C$), and nonradiative emission at LED ($e-p$). Q_{e-p} is the phonon (heat) energy rejected to heat sink.

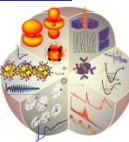

Transition Rates 4

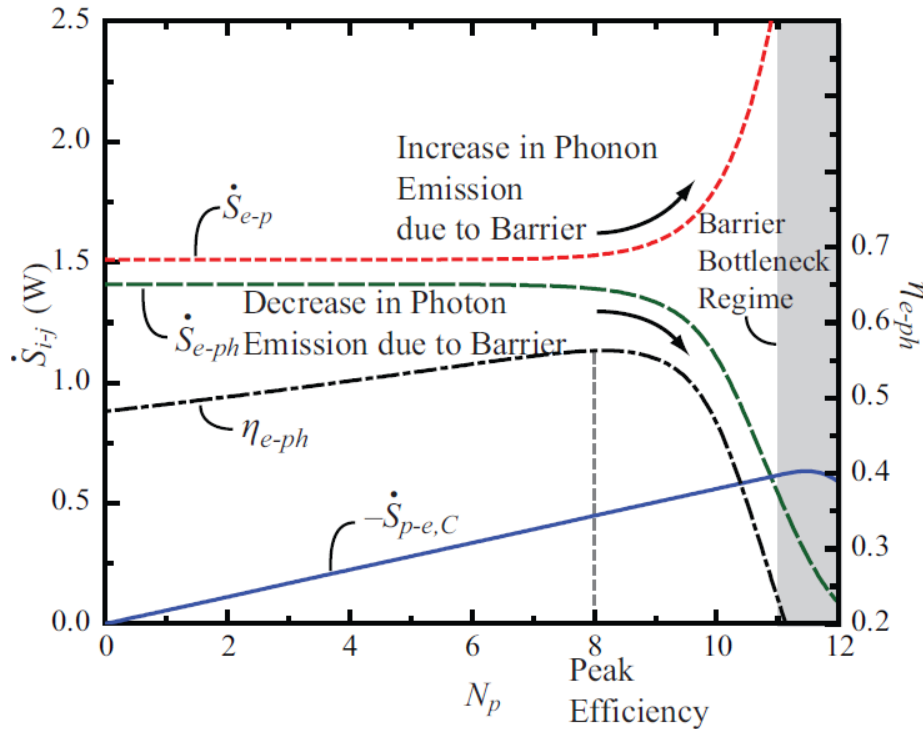
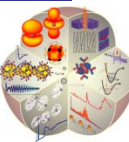

Figure 5. Variation of the thermionic cooling rate $S_{p-e,C}$, photon emission rate S_{e-ph} , non-radiative emission S_{e-p} , with respect to N_p , for InGaN LED [7] and AlGaAs/GaAs Thermionic cooling layer. Barrier bottleneck regime is when $N_p > 8$. The variation of quantum efficiency η_{e-ph} is also shown and the peak efficiency is found to be at $N_p = 6$ which 12% improvement over no thermionic cooling layer.



Transfer Atomic-Motion before Heat (Thermal Energy)

- **Sensible Heat** refers to the equilibrium occupation distribution of the atomic kinetic energy, however this kinetic energy has a nonequilibrium (coherent) beginning which may be harvested (transferred or transformed) before equilibration (internal conversion and thermalization).
- Examples include nonradiative decays (e.g., coherent vibrational energy production) of electronic and vibrational excitations and resonant vibration produced in chemo- and photoreactions.
- If these coherent kinetic energies are now immediately used, anharmonic coupling of vibrational modes to other intramolecular modes makes for dephasing of these coherent excitations (relaxation and deactivation).
- So how about some **Transfer “before” Heat** (as compared to Heat Transfer)?!
- There is high quality (low entropy) energy **before** it is heat! For example in combustion, where coherent fluid vibrational energies are created by chemical bond changes. Let's think of more examples!
- In order to harvest these energies, **atomic resonances** should be targeted. And this needs to be done fast, sometime faster than 10^{-12} (picosecond) and sometime even faster 10^{-15} (femtosecond). (Phonons speed is of order of 10^3 m/s and they travel one nanometer in one picosecond.)

