

System Specification

Specification

Operating System

- MS-DOS (Minimal)
- Windows® XP SP2 Home / Professional
- Windows® XP Professional x 64 Edition
- Windows® XP Professional Media Center Edition
- Windows® XP embedded
- Windows® Vista™(Ultimate/Premium/Basic/Business)
- Microsoft Vista upgrade support
- Linux Suse v9.1 and Limpus v9.2 (Driver support)

Platform

- Intel® Centrino® Duo mobile processor technology featuring:
 - Intel® Core2 Duo mobile processor T7300/T7500/T7700 (4 MB L2 cache, 2/2.2 /2.4 GHz, 800 MHz FSB), or T7100 (2 MB L2 cache, 1.8 GHz, 800 MHz), supporting Intel 64 architecture
 - Mobile Intel® PM965 Express Chipset
 - Intel® Wireless WiFi Link 4965AGN (dual-band quad-mode 802.11a/b/g/Draft-N) network connection, supporting Acer SignalUp with InviLink Nplify wireless technology, or
 - Intel® PRO/Wireless 3945ABG (dual-band tri-mode 802.11a/b/g) network connection Wi-Fi CERTIFIED® solution, supporting Acer SignalUp wireless technology

System Memory

- DDR II 533/677 SDRAM memory interface design. 2 memory slots, 2GB maximum memory for one Slot. Total 4GB using two soDIMM modules

Display and Graphics^T

- 20.1"(1680X1050) WSXGA+ 300-nit Acer CrystalBrite™ high-brightness TFT LCD, 16 ms(Typical on/off)/ 5 ms(Average grey-to-grey) response time
- Supporting simultaneous multi-window viewing via Acer GridVista™
- NVIDIA® GeForce8600M GT/GS with up to 1024 MB of TurboCache technology (256/512 MB of dedicated GDDR2 VRAM, up to 768 MB of shared system memory).
- Supporting NVIDIA® PureVideo™ technology (WMV HD, High-Definition MPEG-2 Hardware Acceleration, Microsoft® DirectX® 9.0 and DirectX® 10. OpenEXR High Dynamic Range (HDR) technology and PCI Express
- Dual independent display
- 16.7 million colors
- MPEG-2/DVD hardware-assisted capability (acceleration)
- WMV9 (VC-1) and H.264 (AVC) support (acceleration)
- S-video/TV-out (NTSC/PAL) support

-
- DVI-D (true digital video interface) with HDCP (High-bandwidth Digital Content Protection) support
 - Acer Arcade™ featuring Acer CinemaVision™ and Acer ClearVision technologies

Audio

- Dolby®-certified surround sound system with two built-in stereo speakers and one subwoofer supporting low-frequency effects
- Dolby® Home Theater audio enhancement featuring Dolby® Digital, Dolby® Digital Live, Dolby® PRO LOGIC® II, Dolby® Digital Stereo Creator, Dolby® Headphone and Dolby® Virtual Speaker technologies
- Intel® High Definition Audio support
- S/PDIF (Sony/Philips Digital Interface) support for digital speakers
- MS-Sound compatible
- Acer PureZone technology with two built-in stereo microphones featuring beam forming, echo cancellation, and noise suppression technologies

Storage Subsystem

- One or two 80/120/160/240/250 GB or larger hard disk drives
- Intel® Turbo Memory supported (for selected models)
- Optical drive options: HD-DVD, DVD-Super Multi double-layer drive, DVD/CD-RW combo drive.
- 5-in-1 card reader, supporting Secure Digital (SD), MultiMediaCard (MMC), Memory Stick (MS), Memory Stick PRO (MS PRO), xD-Picture Card (xD)

Communication

- Acer Video Conference, featuring:
 - Integrated Acer Crystal Eye webcam, supporting Acer PrimaLite technology
 - Acer PureZone technology
 - Optional Acer Xpress VoIP phone
- WLAN: Intel® Wireless WiFi Link 4965AGN (dual-band quad-mode 802.11a/b/g/Draft-N) network connection, supporting Acer SignalUp with InviLink Nplify wireless technology or Intel PRO/Wireless 3945ABG (dual-band tri-mode 802.11a/b/g) Wi-Fi CERTIFIED network connection, supporting Acer SignalUp wireless technology
- WPAN: Bluetooth® 2.0+EDR (Enhanced Data Rate)
- LAN: Gigabit Ethernet; Wake-on-LAN ready
- Modem: 56K ITU V.92 with PTT approval; Wake-on-Ring ready

Input Devices

- Darfon 17 KB - FV2-New Aspire gcommon K/B
- 12 function keys, four cursor keys, two Windows® keys, hotkey controls, embedded numeric keypad, international language support
- Touch pad with 4-way scroll button
- Five easy-launch buttons: Empowering Key, email, Internet, Hibernation and user-programmable button
- Two communication LED switches: WLAN and Bluetooth®

I/O Interface

- VGA port, 15 pins

-
- Microphone-in jack
 - Line-in jack
 - Headphones/Speaker/line-out port with S/PDIF support
 - S-Video port/TV-out (NTSC/PAL) port
 - AV-in port
 - TV-tuner antenna-in port
 - External USB 2.0 connectors x 4
 - DC in jack
 - RJ-11 jack for Modem
 - RJ-45 jack for LAN
 - IEEE 1394a x1(4-pin)
 - PCMCIA slot
 - PCI-Express Card
 - Consumer infrared (CIR) port
 - Parallel port
 - Serial port
 - DVI-D
 - CMOS Camera
 - 5-in-1 card reader (SD/MMC/MS/MS PRO/xD)

Power Subsystem

- ACPI 2.0 CPU power management standards: Stand-by and Hibernation power-saving modes support
- 71W 4800mAh 8-cell Li-Ion battery pack
- Acer 2QuickCharge™ technology:
 - 80% charge in 1 hour
 - 2-hour rapid charge system-off
 - 2.5-hour charge-in-use
- 3-pin 135 W AC adapter

Security

- Kensington lock slot
- BIOS user and supervisor passwords

Dimensions and Weight

- 490 (W) X 380 (D) X 60 (H) mm (19.3 x 14.9 x 2.4 inches)
- 7.8kg with TV-tuner/2nd HDD/20.1" LCM

Environment

- Temperature:
 - Operating: 5 °C to 35 °C
 - Non-operating: -20 °C to 65 °C
- Humidity (non-condensing):
 - Operating: 20% to 80%
 - Non-operating: 20% to 80%

Warning!For safety reasons, do not use non-compliant parts when you add or change components.

Norton Internet Security

Norton Internet Security is an anti-virus utility that can protect against viruses, keeping your data safe and secure

How do I check for viruses?

1. Double-click the Norton Internet Security icon on the Windows desktop.
2. Select Tasks & Scans.

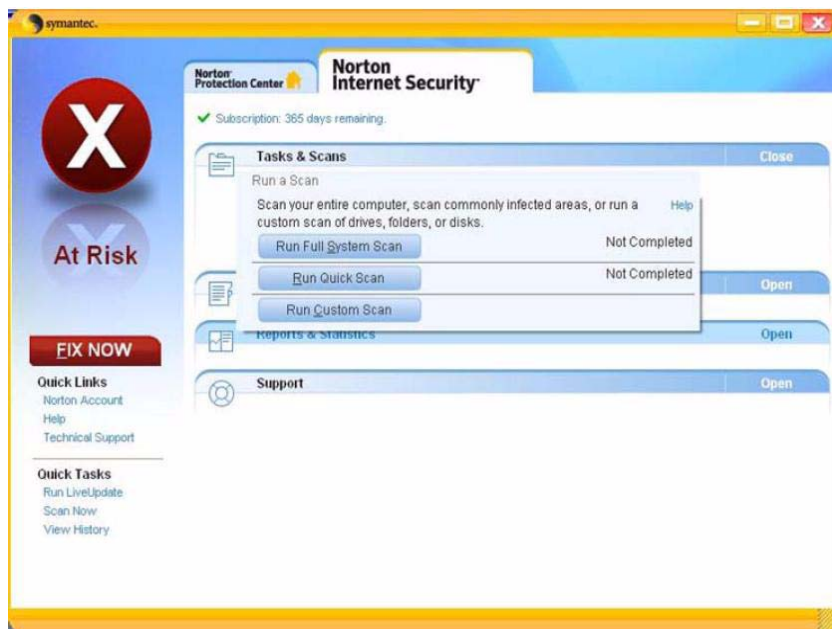

3. Select Run Scan to scan your system.
4. When the scan is complete, review the results of the scan.

You can schedule customized virus scans that run unattended on specific dates and times or at periodic intervals. If you are using the computer when the scheduled scan begins, it runs in the background so that you do not have to stop working.

For more information, please refer to the Norton Internet Security help files.

Block Diagram

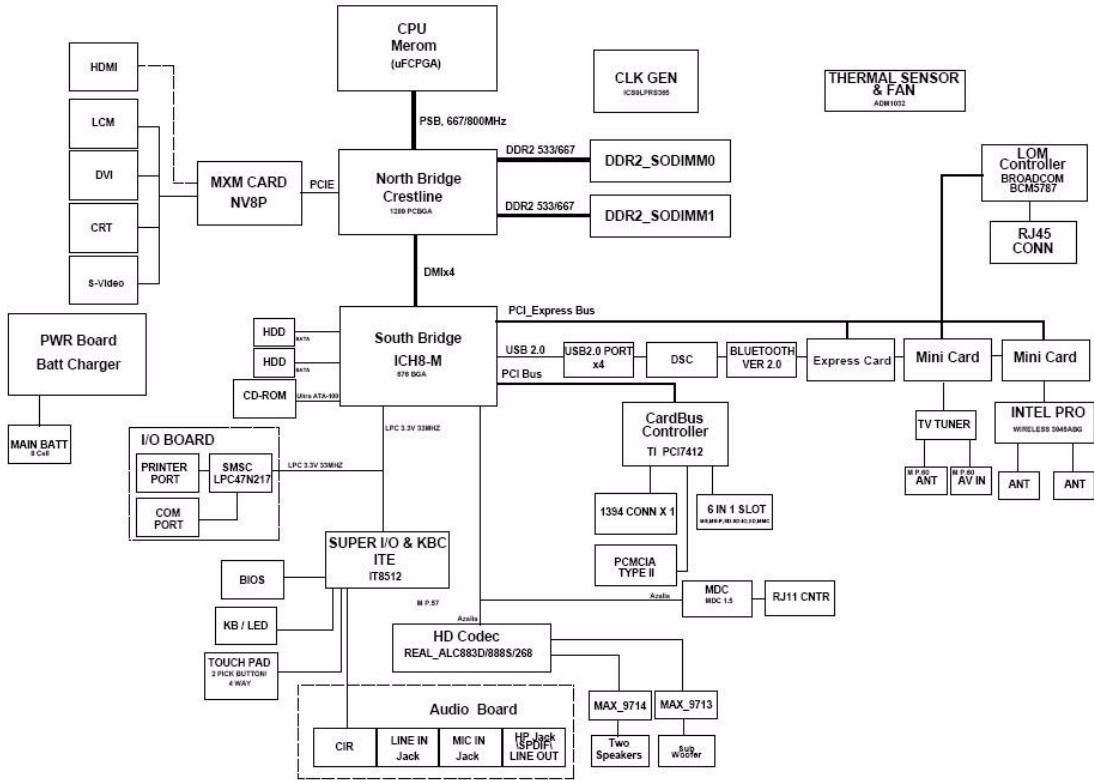

Outlook Tour

Front View









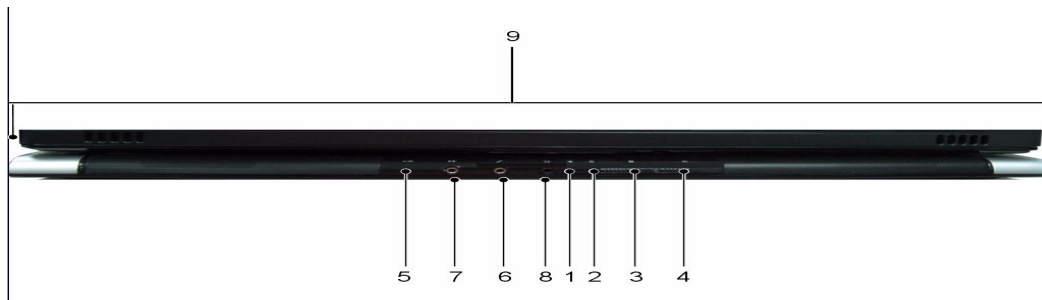

9

#	Item	Description
1	Acer Orbicam	1.3 megapixel web camera for video communication. (for selected models)
2	Display screen	Also called Liquid-Crystal Display (LCD), displays computer output.
3	Keyboard	Serves to enter data into the computer.
4	Microphone	Internal microphone for sound recording.
5	Touch pad	Touch-sensitive pointing device which functions like a computer mouse.
6	Status indicators	Light-Emitting Diodes (LEDs) that light up to show the status of the computer's functions and components.
7	3D sonic speakers	Left and right speakers deliver stereo audio output.
8	Click buttons (left, center and right)	The left and right buttons work like the left and right mouse buttons; the center button serves as a four-way scroll button.
9	Palmrest	Comfortable support area for your hands when you use the computer.
10	Power button	Turns the computer on and off.
11	Easy-launch buttons	Buttons for launching frequently used programs
12	Media/volume buttons	For use with Acer Arcade and other media playing programs.

Closed Front View



#	Icon	Item	Description
1		Power indicator	Indicates the computer's power status.
2		Battery indicator	Indicates the computer's battery status.
3		Bluetooth communication button/indicator	Enables/disables the Bluetooth communication. Indicates the status of Bluetooth communication.
4		Wireless communication button/indicator	Enables/disables the wireless function. Indicates the status of wireless LAN communication.
5		Infrared port	Interfaces with infrared devices (e.g., infrared printer and IR-aware computer).
6		Microphone-in jack	Accepts input from external microphones.
7		Line-in jack	Accepts audio line-in devices (e.g., audio CD player, stereo walkman).
8		Headphones/speaker/line-out jack	Connects to audio line-out devices (e.g., speakers, headphones).
9	N/A	Latch	Locks and releases the lid.

Left View



#	Icon	Item	Description
1		4-pin IEEE 1394 port	Connects to IEEE 1394 devices. (for selected models)
2		Two USB 2.0 ports	Connect to USB 2.0 devices (e.g., USB mouse, USB camera). (3 total)
3	ExpressCard/34	ExpressCard/34 slot	Accepts one ExpressCard module. (for selected models)
4		5-in-1 card reader	Accepts Memory Stick (MS), Memory Stick Pro (MS PRO), Multi Media Card (MMC), Secure Digital (SD) and xD-Picture Card (xD). (for selected models)
5		PC Card slot	Accepts one Type II PC Card.
6	N/A	PC Card slot eject button	Ejects the PC Card from the slot.
7	N/A	Latch	Locks and releases the lid.

Right View









9

#	Item	Description
1	Acer Media Bay optical drive	Internal optical drive; accepts CDs or DVDs.
2	Optical disk access indicator	Lights up when the optical drive is active.
3	Optical drive eject button	Ejects the optical disk from the drive.
4	Emergency eject hole	Ejects the optical drive tray when the computer is turned off.
5	USB 2.0 port	Connects to USB 2.0 devices (e.g., USB mouse, USB camera). (3 total)
6	Modem (RJ-11) port	Connects to a phone line.

Rear View



#	Icon	Item	Description
1		S-video port/TV out port (NTSC/PAL) port	Connects to a television or display device with S-video input. (for selected models)
2		Ethernet (RJ-45) port	Connects to an Ethernet 10/100/1000-based networks.
3		Serial port	Connects to serial devices.
4		Digital Video Interface - Digital port	Supports digital video connections. (for selected models)
5		External display (VGA) port	Connects to an external display device (e.g., external monitor, LCD projector).
6		DC-in jack	Connects to an AC adapter.
7		Kensington lock slot	Connects to a Kensington-compatible computers security lock.
8	N/A	Ventilation slots	Enable the computer to stay cool, even after prolonged use.
9	N/A	Parallel port	Connects to parallel devices.
10	N/A	TV-in port	Accepts input signals from analog/digital TVtuner devices (for selected models)
11	N/A	AV-in port	Accepts input signals from audio/video (AV) devices (manufacturing option)

Base View









#	Item	Description
1	Ventilation slots and cooling fan	Enable the computer to stay cool, even after prolonged use. Note: Do not cover or obstruct the opening of the fan
2	Memory compartment	Houses the computer's main memory
3	Battery lock	Locks the battery in position.
4	Battery latch	Releases the battery for removal.
5	Battery bay	Houses the computer's battery pack.
6	Hard disk bay	Houses the computer's hard disk (secured with screws).
7	Sub woofer	Emits low frequency sound output.

Indicators

The computer has eight several easy-to-read status indicators, including five on the front panel. The power, battery and wireless communication status indicators are visible even when the LCD display is closed.



Icon	Item	Description
	Num Lock	Lights up when Num Lock is activated.
	Caps Lock	Lights up when Caps Lock is activated.
	HDD	Indicates when the hard disk drive is active.
	Bluetooth	Indicates the status of Bluetooth communication
	Wireless LAN	Indicates the status of wireless LAN communication
	Power	Lights when the computer is on.
	Battery	Lights when the battery is being charged.

Note: The light shows amber when the battery is charging. The light shows green when the system is under AC mode.

Easy-launch Buttons

There are several conveniently located easy-launch buttons. They are one user-programmable button, web browser button, mail button, and Acer Empowering Key *e*. Press *e* to run the Acer Empowering Technology. Although the mail and web browser buttons are pre-set to E-mail and Internet programs, they can be redefined by users. To set the web browser, mail and programmable buttons, run the Acer Launch Manager.



Easy-launch button	Default application
<i>e</i>	Acer Empowering Technology (user-programmable)
Mail	E-mail application (user-programmable)
Web browser	Internet browser (user-programmable)
P	User-programmable

Touchpad

The built-in touchpad is a pointing device that senses movement on its surface. This means the cursor responds as you move your finger across the surface of the touchpad. The central location on the palmrest provides optimum comfort and support.

Touchpad Basics

The following items will show you how to use the touchpad.



- Move your finger across the touchpad **(2)** to move the cursor.
- Press the left **(1)** and right **(4)** buttons to perform selection and execution functions. These two buttons are similar to the left and right buttons on a mouse. Tapping on the touchpad is the same as clicking the left button.
- Use the 4-way scroll **(3)** button to scroll up or down and move left or right a page. This button mimics the cursor pressing on the right scroll bar of Windows applications.

Function	Left button (1)	Right button (4)	Main touchpad (2)	Center button (3)
Execute	Quickly click twice.		Tap twice (at the same speed as double-clicking a mouse button).	
Select	Click once		Tap once.	
Drag	Click and hold, then use finger on the touchpad to drag the cursor.		Tap twice (at the same speed as double-clicking a mouse button); rest your finger on the touchpad on the second tap and drag the cursor.	
Access context menu		Click once.		
Scroll				Click and hold to move up/down/left/right.

Note: Keep your fingers, as well as the surface of the touchpad dry and clean. The touchpad is sensitive to your finger movement; hence, the lighter the touch, the better the response. Tapping hard will not increase the touchpad's responsiveness.

Note: By default, vertical and horizontal scrolling is enabled on your touch pad. It can be disabled under

Mouse settings in Windows Control Panel.

Using the Keyboard

The full-sized keyboard includes an embedded numeric keypad, separate cursor, lock, Windows, function and special keys.

Lock Keys and Embedded Numeric Keypad



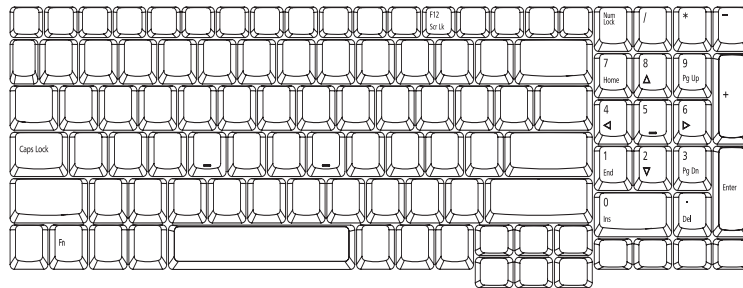













The keyboard has three lock keys which you can toggle on and off.



Lock Key	Description
Caps Lock	When Caps Lock is on, all alphabetic characters are typed in uppercase.
Num Lock <Fn> + <F11>	When Num Lock is on, the separate keypad is in numeric mode. The keys function as a calculator (complete with the arithmetic operators +, -, *, and /). Use this mode when you need to do a lot of numeric data entry.
Scroll Lock <Fn> + <F12>	When Scroll Lock is on, the screen moves one line up or down when you press the up or down arrow keys respectively. scroll Lock does not work with some applications.

Windows keys

The keyboard has two keys that perform Windows-specific functions.

Key	Icon	Description
Windows key		<p>Press alone. This key has the same effect as clicking on the Windows Start button. It launches the Start menu. It can also be used with other keys to provide a variety of functions:</p> <ul style="list-style-type: none">  + <D>: Display the desktop.  + <E>: Opens Windows Explorer.  + <F>: Opens the Find (All Files dialog box).  + <G>: Cycle through Sidebar gadgets.  + <L>: Lock your computer (if you are connected to a network domain), or switch users (if you're not connected to a network domain) .  + <M>: Minimizes all windows. + <R>: Open the Run dialog box.  + <T>: Cycle through program on the taskbar.  + <U>: Open Ease of Access Center.  + <X>: Open Windows Mobility Center  + <BREAK>: Display the System Properties dialog box.  + <SHIFT+M>: Restore minimized windows to the desktop.  + <TAB>: Cycle through programs on the taskbar by using Windows Flip 3-D.  + <SPACEBAR>: Bring all gadgets to the front and select Windows Sidebar. <CTRL>+  + <F>: Search for computers (if you are on a network). <CTRL>+  + <TAB>: Use the arrow keys to cycle through program on the taskbar by using Windows Flip 3-D .
Application key		This key has the same effect as clicking the right mouse button. It opens the application's context menu.

Hotkeys

The computer employs hotkeys or key combinations to access most of the computer's controls like screen brightness, volume output and the BIOS utility. To activate hotkeys, press and hold the **<Fn>** key before pressing the other key in the hotkey combination.

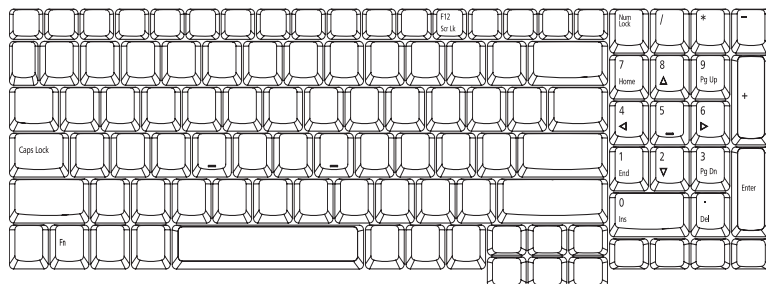

Hot Key	Icon	Function	Description
<Fn> + <F1>	?	Hot key help	Displays help on hotkeys.
<Fn> + <F2>		Acer eSettings	Launches the Acer eSettings in Acer Empowering Technology.
<Fn> + <F3>		Acer ePower Management	Launches the Acer ePower Management in Acer Empowering Technology.
<Fn> + <F4>	Z ^z	Sleep	Leads the computer to Sleep mode.
<Fn> + <F5>		Display toggle	Switches the display output between the display screen, external monitor (if connected) and both.
<Fn> + <F6>		Screen blank	Turns off the display screen backlight to save power. Press any key to return.
<Fn> + <F7>		Touchpad toggle	Turns the internal touchpad on and off.
<Fn> + <F8>		Speaker toggle	Turns the speakers on and off.
<Fn> + <↑>		Volume up	Increases the sound volume.
<Fn> + <↓>		Volume down	Decreases the sound volume.
<Fn> + <→>		Brightness up	Increases the screen brightness.
<Fn> + <←>		Brightness down	Decreases the screen brightness.

Special keys

You can locate the Euro symbol and US dollar sign at the upper-center and/or bottom-right of your keyboard.

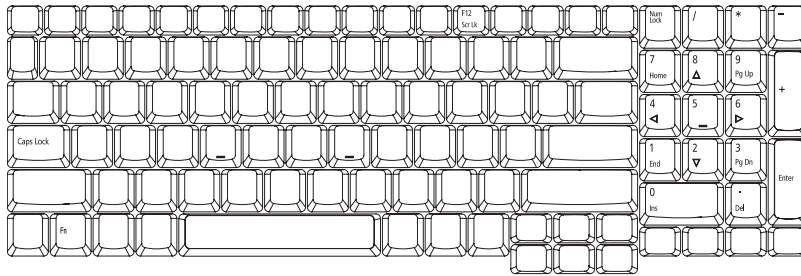

The Euro symbol

1. Open a text editor or word processor.
2. Either directly press the <€> symbol at the bottom-right of the keyboard, or hold <Alt Gr> and then press the<5> symbol at the upper-center of the keyboard.

NOTE: Some fonts and software do not support the Euro symbol. Please refer to www.microsoft.com/typography/faq/faq12.htm for more information.

The US dollar sign

1. Open a text editor or word processor.
2. Either directly press the <\$> key at the bottom-right of the keyboard, or hold <Shift> and then press the <4> key at the upper-center of the keyboard.

Note: This function varies by the operating system version.

Acer OrbiCam

The Acer OrbiCam is a 1.3 megapixel CMOS camera appropriately mounted on top of the LCD panel. The camera's 225-degree ergonomic rotation allows you to capture high-resolution photos or videos up front or at the back of the LCD panel. The Acer OrbiCam fully supports the Acer Video Conference technology so you transmit the best video conference quality over an instant messenger service.

#	Item
1	Lens
2	Power indicator

Rotating the Acer OrbiCam

The Acer OrbiCam rotates 225 degrees counterclockwise to achieve the desired angle. Refer to the illustrations below:

Note: Do NOT rotate the camera clockwise to prevent damage to the device.

For your convenience, the camera snaps 45 degrees to match the position of your face in front or at the back of the LCD panel.

Launching the Acer OrbiCam

To launch the Acer OrbiCam, double-click on the Acer OrbiCam icon on the desktop, or click Start > All Programs > Acer > Acer OrbiCam. The Acer OrbiCam capture window will appear as below.



Changing the Acer OrbiCam Settings

Resolution

To change the capture resolution, click the displayed resolution at the bottom right corner of the capture window, then select the desired resolution.

Note: Setting the camera resolution to 640 x 480 or larger does not change the capture window size.

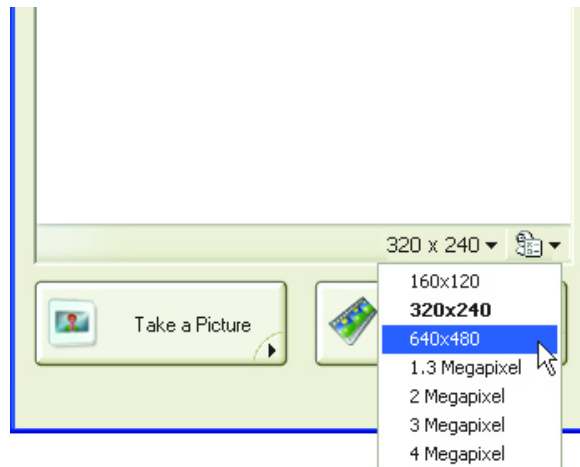

Options

Click **Options** to display the **Window**, **Preview**, and **Folder** tabs. Use the options to change the capture window size, preview settings, and the folder for captured photos or videos.

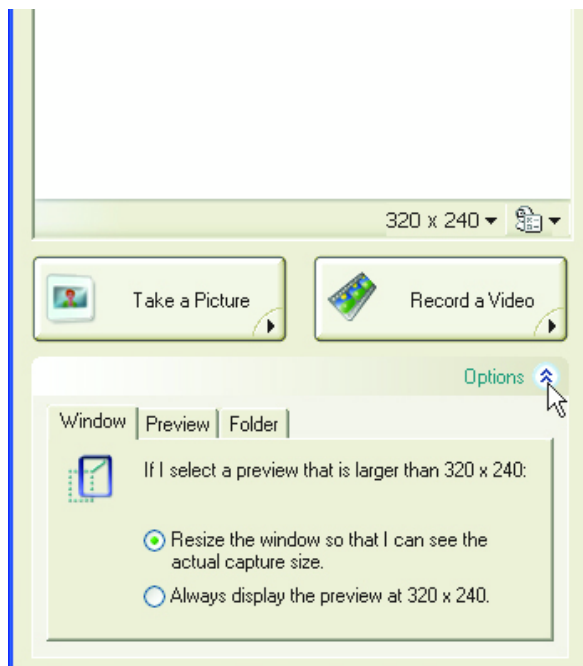

Camera Settings

Basic Settings

Click the Camera Settings icon on the bottom right corner of the capture display, then select **Camera Settings** from the pop-up menu. You can adjust the **Video**, **Audio**, and **Zoom/Face tracking** options from this window.

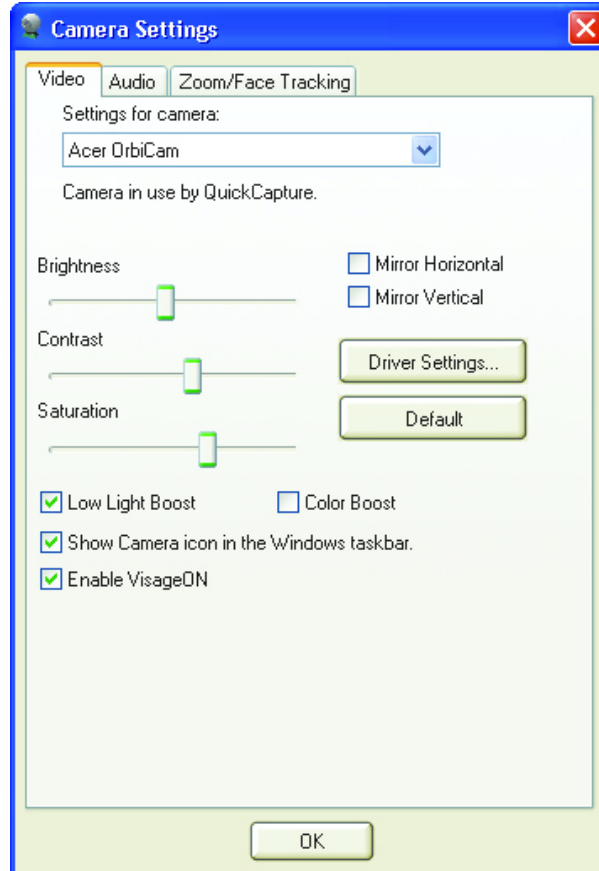

Capture Settings

From the Camera Settings window, click the **Driver Settings** button. The **Properties** window will appear.

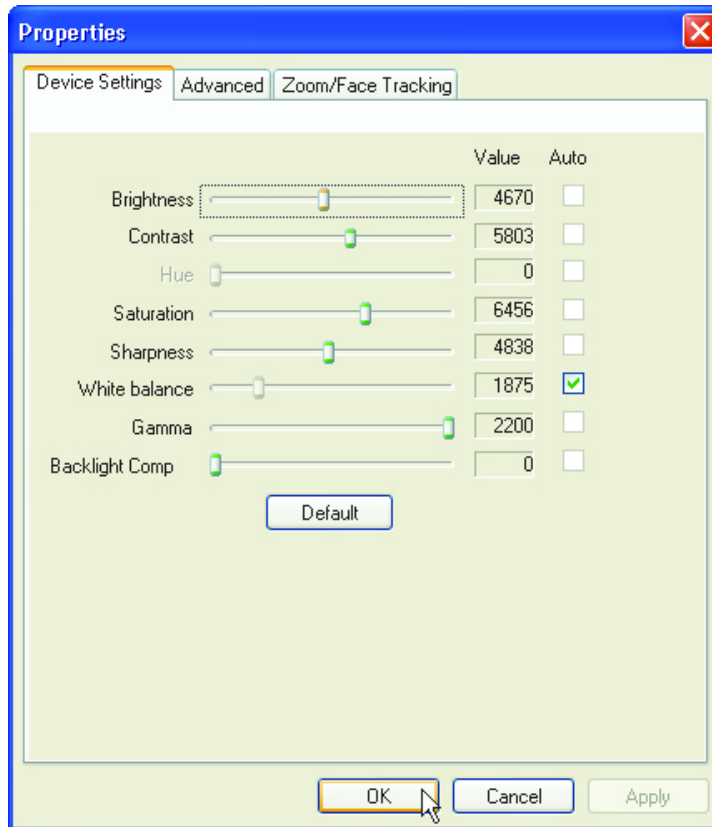

Device Settings allows you to change the camera brightness, contrast, hue, saturation, sharpness, etc.

Advanced Settings allows you to achieve gain control, implement image mirror, select image enhancements and anti-flicker settings, and turn on/off the camera indicator.

Zoom/Face Track Settings allows you to adjust the zoom level and turn the face tracking feature on or off.

Capturing Photos/Videos

To capture a photo or a video clip, rotate the Acer OrbiCam to get the desired angle, then click the **Take a Picture** or **Record a Video** button. The **Windows Picture and Fax Viewer** or the **Windows Media Player** automatically launches to display or play a preview of the photo/video clip.

Note: By default, all photos and videos are saved in the **My Pictures** and **My Videos** folder.

Using the Acer OrbiCam as Webcam

The Acer OrbiCam is automatically selected as the capture device of any instant messenger (IM) application. To use the Acer OrbiCam as a webcam, open the IM service, then select the video/webcam feature. You can now broadcast from your location to an IM partner anywhere in the world.

Enabling the Acer VisageON (for 1.3 megapixel camera models only)

The **Acer VisageON** technology comes with two features: **Face tracking**. The face tracking feature tracks your head movement and automatically centers your face in the capture window.

Note: The face tracking feature is not capable of centering your face beyond the capture window frame. Minimal head movements are tracked more efficiently.

Please follow the steps below to enable the Acer VisageON.

1. Right click on this icon, then select **VisageON** from the pop-up menu.

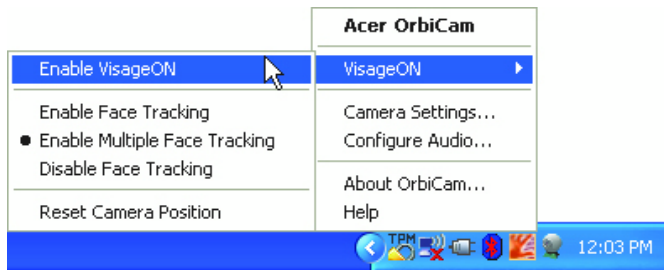

The VisageON window will appear as below:



2. Select and apply a video effect in the left section of the VisageON window. Change the face tracking settings and options in the right section.

Using the Face Tracking Feature

To use the face tracking feature:

1. Click the left icon down arrow button, then select Single User or Multiple Users from the pop-up menu. For multiple users, the face tracking feature automatically centers all the users' face in the capture window, otherwise the utility centers the face of the user closest to the camera.

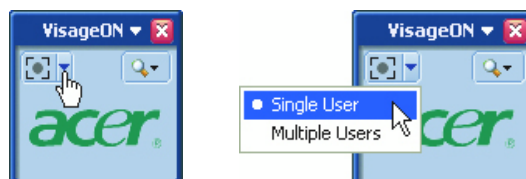

2. Click the right icon to zoom in/out or reset the current view.

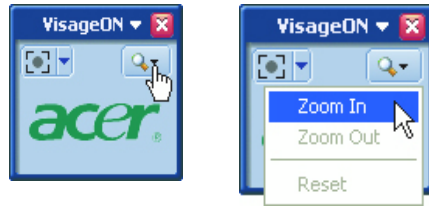

3. Click VisageON to display a menu that allows to change the configuration of the camera, face tracking and video effects settings.

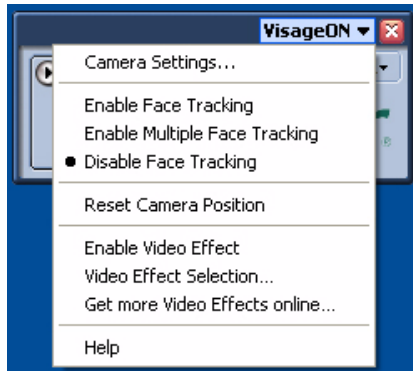

Acer Empowering Technology

Acer's innovative Empowering Technology toolbar makes it easy to have access to the frequently used functions and manage the notebook. Displayed by default in the upper-right corner of the screen, it features the following handy utilities:

- Acer eNet Management hooks up to location-based networks intelligently.
- **Acer ePower Management** extends battery power via versatile usage profiles.
- **Acer ePresentation Management** connects to a projector and adjusts display settings conveniently.
- **Acer TPM-based eDataSecurity Management** protects data with passwords and advanced encryption algorithms in TPM.
- Acer eLock Management limits access to external storage media and removable data devices.
- **Acer eRecovery Management** backs up and recovers data flexibly, reliably and completely.
- **Acer eSettings Management** accesses system information and adjusts settings easily.
- **Acer ePerformance Management** improves system performance by optimizing disk space, memory and registry setting.



For more information, right click on the Empowering Technology toolbar, then select the Help or Tutorial function.

Empowering Technology Password

Before using Acer eLock Management and Acer eRecovery Management, You must initialize the Empowering Technology password. Right click on the Empowering Technology toolbar and select **Password Setup** to do so. If you do not initialize the Empowering Technology password, you will be prompted to do so when running Acer eLock Management or Acer eRecovery Management for the first time.

Note: If you lose your password, there is no method to reset it except by reformatting your notebook or taking your notebook to an Acer Customer Service Center. Be sure to remember or write down your password.

Acer eNet Management

Acer eNet Management helps you to quickly and easily connect to both wired and wireless networks in a variety of locations. To access this utility, either click on the **Acer eNet Management** icon on your notebook, or start the program from the Start menu. You also have the option to set Acer eNet Management to start automatically when you boot up your PC.

Acer eNet Management automatically detects the best settings for a new location, while offering you the freedom to manually adjust the settings to meet your needs.

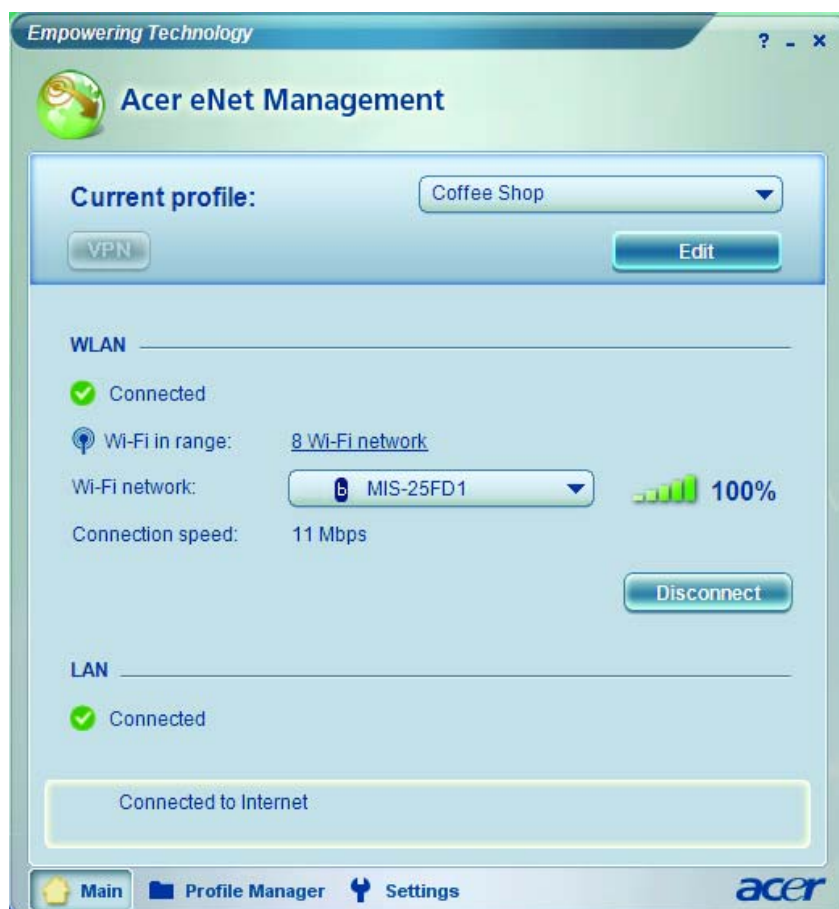

Acer eNet Management can save network settings for a location to a profile, and automatically switch to the appropriate profile when you move from one location to another. Settings stored include network connection settings (IP and DNS settings, wireless AP details, etc.), as well as default printer settings.

Security and safety concerns mean that Acer eNet Management does not store username and password information.

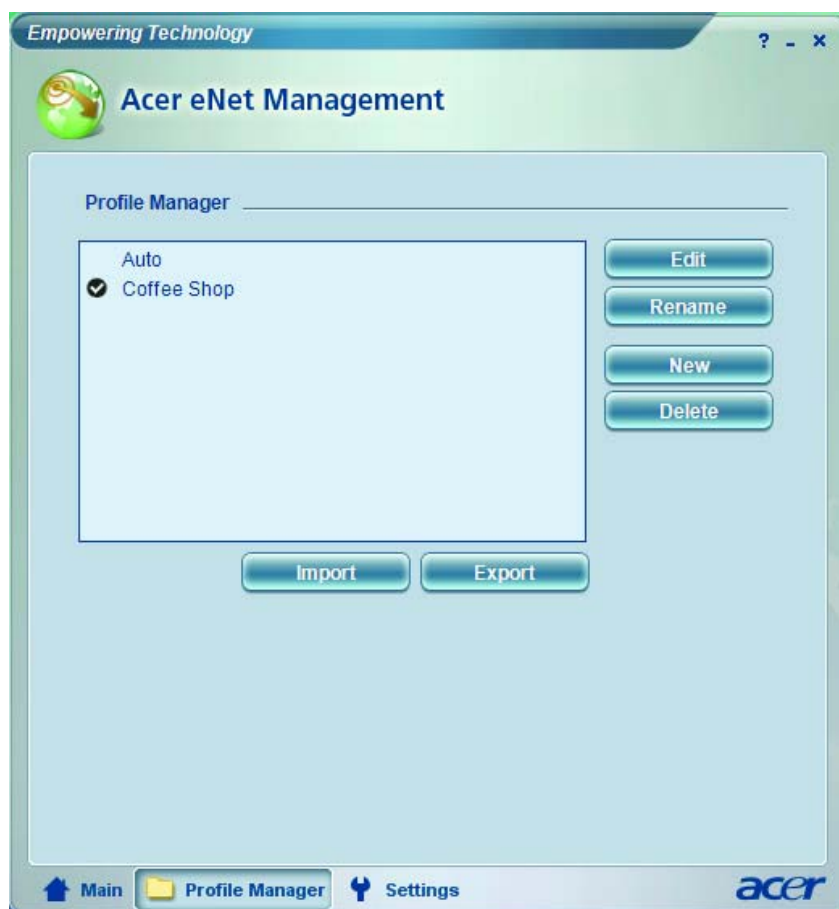

Acer ePower Management

Acer ePower Management features a straightforward user interface. To launch it, select Acer ePower Management from the Empowering Technology interface.

AC Mode (Adapter Mode)

The default setting is Maximum Performance. You can adjust CPU speed, LCD brightness and other settings, or click on buttons to turn the following functions on/off: wireless LAN, Bluetooth, CardBus, firewire (1394), wired LAN and optical device if supported.

DC Mode (Battery Mode)

There are four pre-defined profiles: Entertainment, Presentation, Word Processing, and Battery Life. You can also define up to three of your own.

To Create a New Power Profile

1. Change power settings as desired.
2. Click **Save as...** to save to a new power profile.
3. Name the newly created profile.
4. Select whether this profile is for Adapter or Battery mode, then click **OK**.
5. The new profile will appear in the profile list.

Battery Status

For real-time battery life estimates based on current usage, refer to the panel on the upper half side of the window.



For additional options, click **Settings** to:

- Set alarms.
- Reload factory defaults.
- Select what actions to be taken when the cover is closed or the power button is pressed.
- Set passwords for accessing the system after Hibernation or Stand-by.
- View information about Acer ePower Management.



Acer ePresentation Management

Acer ePresentation Management lets you project your computer's display to an external device or projector using the hotkey: <Fn> + <F5>. If auto-detection hardware is implemented in the system and the external display supports it, your system display will be automatically switched out when an external display is connected to the system. For projectors and external devices that are not auto-detected, launch Acer ePresentation Management to choose an appropriate display setting.



Note: If the restored resolution is not correct after disconnecting a projector, or you need to use an external resolution that is not supported by Acer ePresentation Management, adjust your display settings using Display Properties or the utility provided by the graphics vendor.

Acer TPM-Based eDataSecurity Management

Acer TPM-based eDataSecurity Management is a handy file encryption utility that protects the files from being accessed by unauthorized persons. It is conveniently integrated with Windows Explorer as a shell extension for quick and easy data encryption/decryption and also supports on-the-fly file encryption for MSN Messenger and Microsoft Outlook.

The Acer eDataSecurity Management setup wizard will prompt you for a supervisor password and default encryption. This encryption will be used to encrypt files by default, or you can choose to enter your own file-specific password when encrypting a file.

Acer eDataSecurity Management can be integrated with TPM on computers equipped with the TPM hardware. On computers equipped with the TPM hardware, there will be additional Acer eDataSecurity Management system setup and administration procedures which allow the user to utilize TPM for the PSD and the File/Folder encryption functions. If the **Use TPM** option is selected during Acer eDataSecurity Management's initial system setup or system administration, the PSD and the File/Folder encryption functions will be protected by TPM.



Note: The password used to encrypt a file is the unique key that the system needs to decrypt it. If you lose the password, the supervisor password is the only other key capable of decrypting the file. **If you lose both passwords, there will be no way to decrypt your encrypted file! Be sure to safeguard all related passwords!**

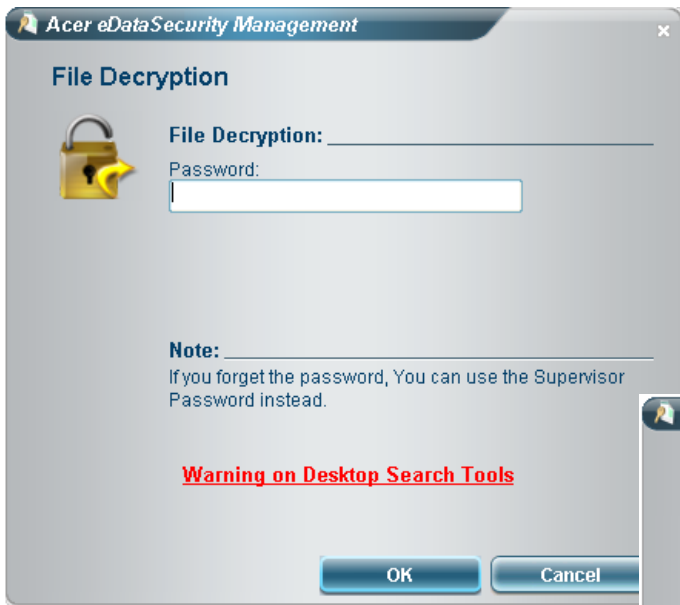
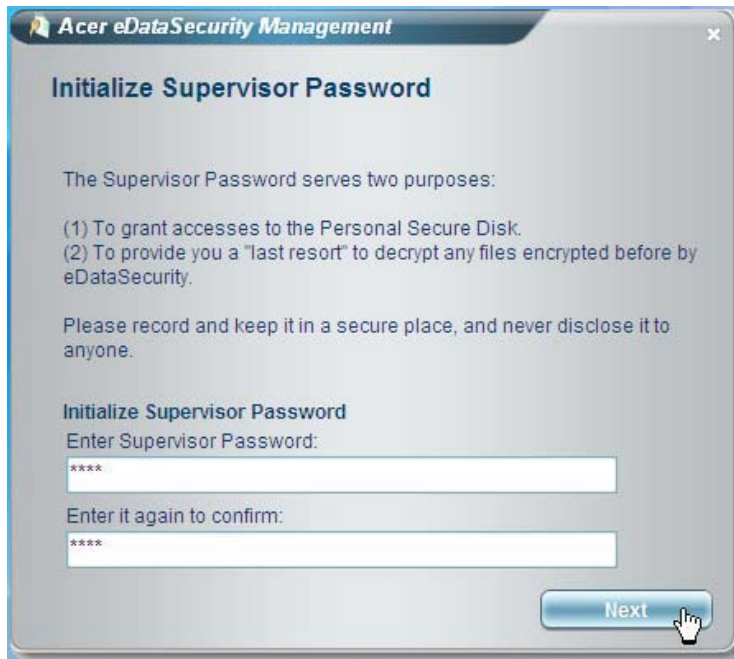

Acer eRecovery Management

Acer eRecovery Management is a powerful utility with the need for recovery disks provided by the manufacturer. The Acer eRecovery Management utility occupies space in a hidden partition on the system's HDD. By default, user-created backups are stored on D:\ drive. Acer eRecovery Management provides:

- Password protection
- Recovery of applications and drives
- Image or data backup:
 - Backup to HDD (set recovery point)
 - Backup to CD or DVD
- Image/data recovery tools:
 - Recovery from a hidden partition (factory defaults)
 - Recovery from the HDD (most recent user-defined recovery point)
 - Recovery from CD or DVD

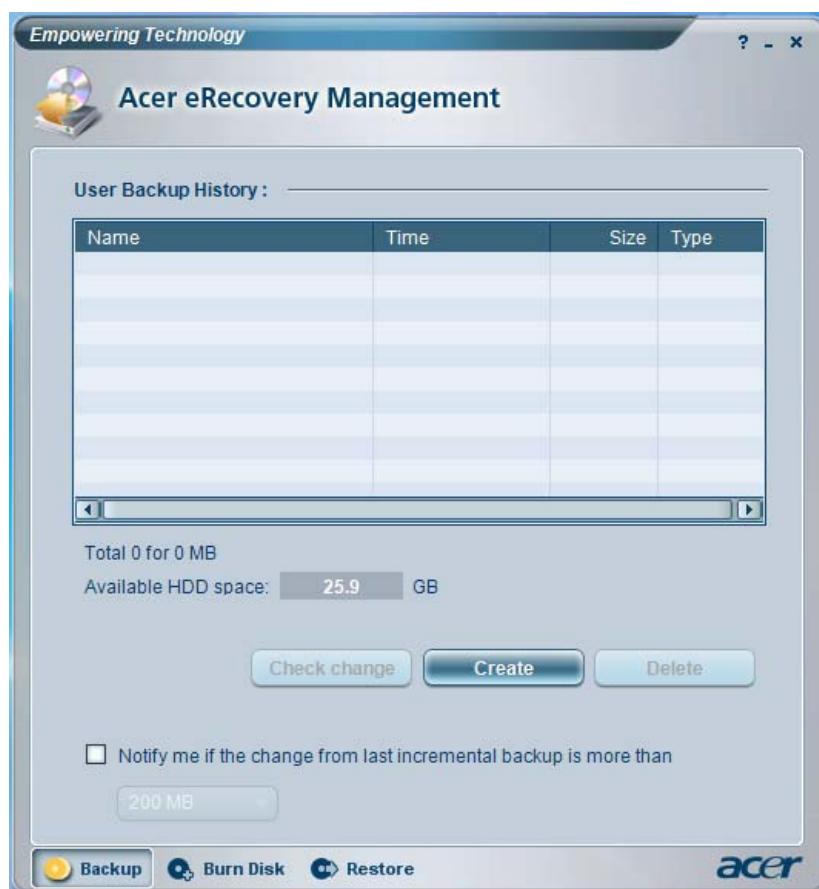

Note: If the computer did not come with a Recovery CD or System CD, please use Acer eRecovery Management's **System backup to optical disk** feature to burn a backup image to CD or DVD. To ensure the best results when recovering the system using a CD or Acer eRecovery Management, detach all peripherals (except external Acer ODD, if equipped), including the Acer ezDock.

Acer eSettings Management

Acer eSettings Management allows you to inspect hardware specification, change BIOS passwords or other Windows settings, and to monitor the system health status.

Acer eSettings Management also:

- Provides a simple graphical user interface for navigation.
- Displays general system status and advanced monitoring for power users on Acer computer.



Acer ePerformance Management

Acer ePerformance Management is a system optimization tool that boosts the performance of the Acer notebook. It provides an express optimization method to release unused memory and disk space quickly. The user can also enable advanced options for full control over the following options:

- Disk optimization: removes unneeded items and files.
- Speed optimization: improves the usability and performance of the Windows XP system.
- Memory optimization: releases unused memory and check usage.



Using the System Utilities

Note: The system utilities work under Microsoft Windows XP only.

Acer GridVista (dual-display compatible)

Note: This feature is only available on certain models.

To enable the dual monitor feature of the notebook, first ensure that the second monitor is connected, then select **Start, Control Panel, Display** and click on **Settings**. Select the secondary monitor (**2**) icon in the display box and then click the check box **Extend my windows desktop onto this monitor**. Finally, click **Apply** to confirm the new settings and click **OK** to complete the process.

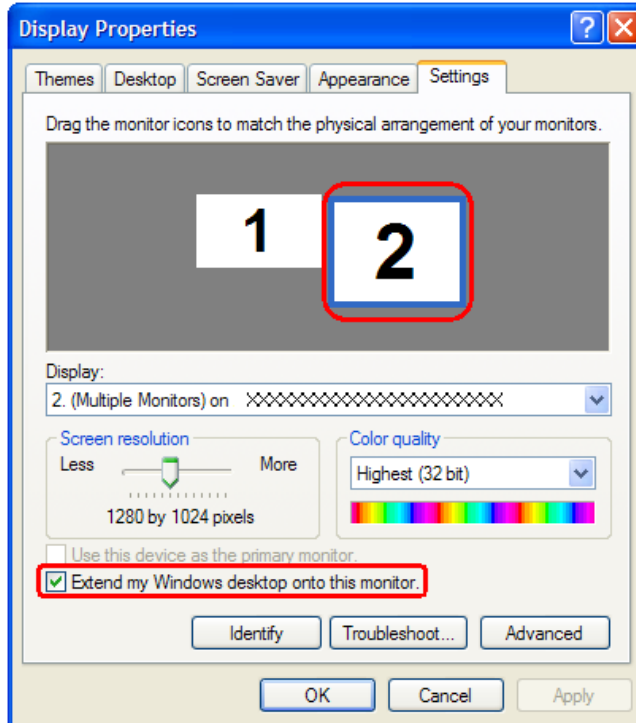

Acer GridVista is a handy utility that offers four pre-defined display settings so you can view multiple windows on the same screen. To access this function, please go to **Start > All Programs** and click on **Acer GridVista**. You may choose any one of the four display settings indicated below:



Double (vertical), Triple (primary at left), Triple (primary at right), or Quad

Acer GridVista is dual-display compatible, allowing two displays to be partitioned independently. Acer GridVista is simple to set up:

1. Run Acer GridVista and select your preferred screen configuration for each display from the task bar.
2. Drag and drop each window into the appropriate grid.
3. Enjoy the convenience of a well-organized desktop.

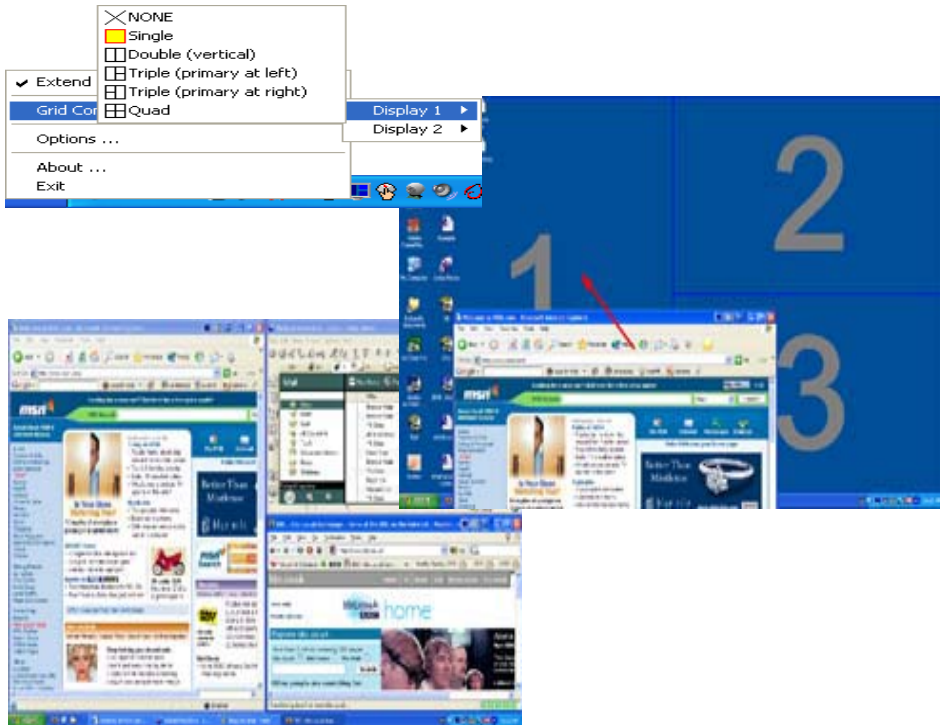

Note: Please ensure that the resolution setting of the second monitor is set to the manufacturer's recommended value.

Launch Manager

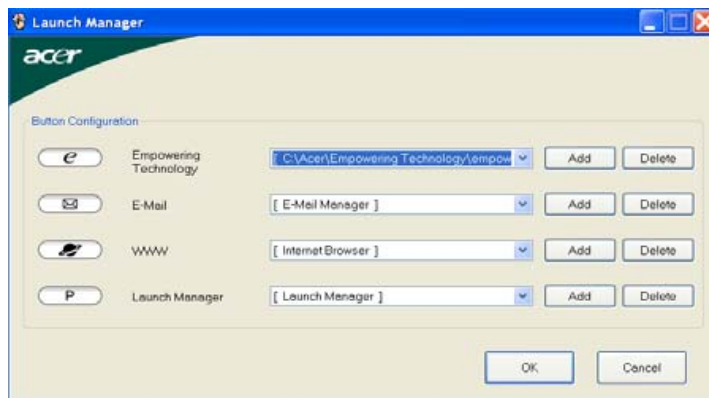

Launch Manager allows you to set the four easy-launch buttons located above the keyboard. You can access the Launch Manager by clicking on Start > All Programs > Launch Manager to start the application.

Hardware Specifications and Configurations

Processor

Item	Specification
CPU type	Intel CPU Core2Dual
Core logic	Intel®965PM+ICH8M-E
CPU package	uFCPGA, Socket P
CPU core voltage	0.944~1.3V

CPU Fan True Value Table

TEST Condition: 35W@Ambient 35 degree C			
CPU Temperature		Fan Speed	Acoustic Level
Core 0	Core 1	(rpm)	(dBA)
86	86	3700	39
88	88	3450	36.5
91	91	3150	34.5
95	95	2800	31

BIOS

Item	Specification
BIOS vendor	PhneoiX
BIOS Version	
BIOS ROM type	Flash ROM
BIOS ROM size	1MB
BIOS package	8-PIN SOIC
Supported protocols	ACPI 1.0b/2.0/3.0, PCI 2.2, System/HDD Password Security Control, INT 13h Extensions, PnP BIOS 1.0a, SMBIOS 2.4, BIOS Boot Specification (Compal, Phoenix, Intel), Simple Boot Flag 1.0, Boot Block, PCI Bus Power Management Interface Specification, USB1.1/2.0, IEEE 1394 1.0, USB/1394 CD-ROM Boot Up support, PC Card standard 1995 (PCMCIA 3.0 Compliant Device), IrDA 1.0, Support HD audio, WfM 2.0, PXE 2.1 (Preboot Execution Environment), BIS 1.0 (Boot Integrity Service Application Program Interface), PC2002 and PC2005 Compliant, Intel Enganced SpeedStep Technology, AHCI support
BIOS password control	Set by setup manual

NOTE: If you need to check PXE version, press F2 to enter BIOS then enable boot from LAN function. After that, power off the system and remove the HDD. Last, reboot the laptop. Then you will see PXE version displaying on the screen.

Second Level Cache

Item	Specification
Cache controller	Built-in CPU
Cache size	4MB
1st level cache control	Always enabled
2st level cache control	Always enabled
Cache scheme control	Fixed in write-back

System Memory

Item	Specification
Memory controller	Intel® PM965
Memory size	0MB (no on-board memory)
DIMM socket number	2 sockets
Supports memory size per socket	2GB
Supports maximum memory size	4GB
Supports DIMM type	DDR 2 Synchronous DRAM
Supports DIMM Speed	533/667 MHz
Supports DIMM voltage	1.8V and 0.9V
Supports DIMM package	200-pin soDIMM
Memory module combinations	You can install memory modules in any combinations as long as they match the above specifications.

Memory Combinations

Slot 1	Slot 2	Total Memory
0MB	128MB	128MB
0MB	256MB	256MB
0MB	512MB	512MB
0MB	1024MB	1024MB
0MB	2048MB	2048MB
128MB	128MB	256MB
128MB	256MB	384MB
128MB	512MB	640MB
128MB	1024MB	1152MB
128MB	2048MB	2176MB
256MB	128MB	384MB
256MB	256MB	512MB
256MB	512MB	768MB
256MB	1024MB	1280MB
256MB	2048MB	2304MB
512MB	128MB	640MB
512MB	256MB	768MB
512MB	512MB	1024MB
512MB	1024MB	1536MB
512MB	2048MB	2560MB
1024MB	0MB	1024MB
1024MB	128MB	1152MB
1024MB	256MB	1280MB
1024MB	512MB	1536MB
1024MB	1024MB	2048MB
1024MB	2048MB	3072MB

NOTE: Above table lists some system memory configurations. You may combine DIMMs with various capacities to form other combinations. On above table, the configuration of slot 1 and slot 2 could be

reversed.

LAN Interface

Item	Specification
Chipset	Broadcom 5787
Supports LAN protocol	10/100/1000 Ethernet PCI-E Giga
LAN connector type	RJ45
LAN connector location	Rear side
Features	Integrated 10/100/1000 BASE-T transceiver Wake on LAN support compliant with ACPI 2.0 PCI v2.2

Modem Interface

Item	Specification
Data modem data baud rate (bps)	56K
Supports modem protocol	V.92
Modem connector type	RJ11
Modem connector location	Left side

Bluetooth Interface

Item	Specification
Chipset	Built-in ICH8M-E
Data throughput	723 bps (full speed data rate)
Protocol	Bluetooth 1.1 (Upgradeable to Bluetooth 1.2 when SIG specification is ratified).
Interface	USB 2.0
Connector type	USB

Hard Disk Drive Interface

Item			
Vendor & Model Name	HGST HTS541680J9SA00 WD WD800BEVS-22RST0	Seagate ST9120822AS Toshiba MK1237GSX HGST HTS541612J9SA00 WD WD1200BEVS-22RST0	TOSHIBA MK1637GSX SEAGATE ST9160821AS HGST HTS541616J9SA00 WD WD1600BEVS-22RST0
Capacity (MB)	80000	120000	160000
Bytes per sector	512	512	512
Data heads	2	3 for Seagate and WD 4 for Toshiba and HGST	4
Drive Format			
Disks	1	2	2
Spindle speed (RPM)	5400 RPM	5400 RPM	5400 RPM
Performance Specifications			
Buffer size	8M	8M	8M
Interface	SATA	SATA	SATA
Max. media transfer rate (disk-buffer, Mbytes/s)	100,150	150,300,100,150	300,150,100,150

Hard Disk Drive Interface

Item			
Data transfer rate (host-buffer, Mbytes/s)	100 MB/Sec. Ultra DMA mode-5	100 MB/Sec. Ultra DMA mode-5	100 MB/Sec. Ultra DMA mode-5
DC Power Requirements			
Voltage tolerance	5V(DC) +/- 5%	5V(DC) +/- 5%	5V(DC) +/- 5%

DVD-SuperMulti Interface

Item	Specification	
Vendor & model name	TOSHIBA 8X TS-L632D PHILIPS 8X DS-8A1P HLDS 8X GSA-T20N	
Performance Specification	With CD Diskette	With DVD Diskette
Transfer rate (KB/sec)	Sustained: Max 3.6Mbytes/sec	Sustained: Max 10.8Mbytes/sec
Buffer Memory	2MB	
Interface	Enhanced IDE(ATAPI) compatible	
Applicable disc format	Support disc formats 1. Reads data in each CD-ROM, CD-ROM XA, CD-1, Video CD, CD-Extra and CD-Plus 2. Reads data in super Audio CD (SACD) Hybrid type 3. Reads standard CD-DA 4. Reads and writes CD-R discs 5. Reads and writes CD-RW and HSRW discs 6. Reads and writes US & US+RW 7. Reads data in each DVD-ROM and DVD-Dual 8. Reads and writes in each DVD-R (Ver. 2.0 for general), DVD-RW and DVD+R/RW (Ver1.1) 9. Reads and writes DVD+-R Dual 10. Reads and writes DVD-RAM	
Loading mechanism	Load: Manual Release: (a) Electrical Release (Release Button) (b) Release by ATAPI command (c) Emergency Release	
Power Requirement		
Input Voltage	5 V +/- 5 % (Operating)	

Audio Interface

Item	Specification
Audio Controller	Realtek ALC268(Dolby version) (co-layout w/ 888S)
Audio onboard or optional	Built-in
Mono or Stereo	Stereo
Resolution	18 bit stereo full duplex
Compatibility	HD audio Interface; S/PDIF output for PCM or AC-3 content
Sampling rate	1Hz resolution VSR (Variable Sampling Rate)
Internal microphone	Yes
Internal speaker / Quantity	Yes/2(1.5W speakers)
Supports PnP DMA channel	DMA channel 0 DMA channel 1
Supports PnP IRQ	IRQ10, IRQ11

Video Interface

Item	Specification
Chipset	nVidia NV8P-GS
Package	MXM 820-ball BGA 33mm x33mm
Interface	Internal PCIE
Supports ZV (Zoomed Video) port	

Video Memory

Item	Specification
Chipset	
Memory size	Dedicated Video memory size: 128-bit DDR2/GDDR3/GDDR4
Interface	DDR2/GDDR3/GDDR4

USB Port

Item	Specification
Chipset	Built-in ICH8M-E
USB Compliancy Level	2.0
OHCI	USB 1.1 and USB 2.0 Host controller
Number of USB port	4
Location	One on the left side; three on the right side
Serial port function control	Enable/Disable by BIOS Setup

PCMCIA Port

Item	Specification
PCMCIA controller	TI PCI 7412
Supports card type	Type-II
Number of slots	One type-II
Access location	Left panel
Supports ZV (Zoomed Video) port	No ZV support
Supports 32 bit CardBus	Yes

Express Card Interface

Item	Specification
Express card controller	Built-in ICH8M-E
Supports card type	75mmx54mm(W)x5mm
Number of slots	One
Access location	Right panel
Interface	PCI Express

System Board Major Chips

Item	Controller
Core logic	Intel®Crestline PM965 + ICH8M-E

System Board Major Chips

Item	Controller
VGA	nVidia NV8P-GS MXM
LAN	Broadcom 5787
USB 2.0	Built in ICH8M-E
Super I/O controller	ITE 8305E
MODEM	Foxconn T60M955
Bluetooth	Foxconn T60H928.01
Wireless 802.11 a+b+g	Built-in ICH8-M
PCMCIA	TI PCI 7412
Audio	Realtek ALC268(Dolby version)

Keyboard

Item	Specification
Keyboard controller	ITE 8512E
Total number of keypads	88-/89-key
Windows logo key	Yes
Internal & external keyboard work simultaneously	Plug USB keyboard to the USB port directly: Yes

Battery

Item	Specification
Vendor & model name	BATTERY PACK SANYO LI-ION 8 CELL2.4, 4800MAH BATTERY PACK SONY LI-ION 8CELL2.4, 4800MAH
Battery Type	Li-ion
Pack capacity	4800 mAh
Number of battery cell	8
Package configuration	4 cells in series, 2 series in parallel
Normal voltage	14.8V
Charge voltage	16.8+-0.2V

LCD 20.1" inch

Item	Specification			
Vendor & model name	AUO M201EW02 V9 GLARE			
Screen Diagonal (mm)	20.1 inches			
Active Area (mm)	304.1x228.1			
Display resolution (pixels)	1680x1050 WSXGA			
Pixel Pitch	0.099x0.297			
Pixel Arrangement	R.G.B. Vertical Stripe			
Display Mode	Normally White			

LCD 20.1" inch

Item	Specification			
Typical White Luminance (cd/m ²) also called Brightness	300			
Luminance Uniformity	N/A			
Contrast Ratio	300			
Response Time (Optical Rise Time/Fall Time)msec	8			
Nominal Input Voltage VDD	+3.3V			
Typical Power Consumption (watt)	3.96			
Weight	570			
Physical Size(mm)	317.3x242.0x5.9			
Electrical Interface	1 channel LVDS			
Support Color	262,144			
Viewing Angle (degree) Horizontal: Right/Left Vertical: Upper/Lower	45/45 15/35			
Temperature Range(° C) Operating Storage (shipping)	0 to +50 -25 to +60			

LCD Inverter

Item	Specification
Vendor & model name	TDK
Brightness conditions	N/A
Input voltage (V)	9~21
Input current (mA)	2.56 (max)
Output voltage (V, rms)	780V (2000V for kick off)
Output current (mA, rms)	6.5 (max)
Output voltage frequency (k Hz)	65K Hz (max)

AC Adaptor

Item	Specification
Input rating	90V AC to 264V AC, 47Hz to 63Hz
Maximum input AC current	1.7A
Inrush current	220A@115VAC 220A@230VAC
Efficiency	82% min. @115VAC input full load

System Power Management

ACPI mode	Power Management
Mech. Off (G3)	All devices in the system are turned off completely.
Soft Off (G2/S5)	OS initiated shutdown. All devices in the system are turned off completely.
Working (G0/S0)	Individual devices such as the CPU and hard disc may be power managed in this state.

System Power Management

ACPI mode	Power Management
Suspend to RAM (S3)	CPU set power down VGA Suspend PCMCIA Suspend Audio Power Down Hard Disk Power Down CD-ROM Power Down Super I/O Low Power mode
Save to Disk (S4)	Also called Hibernation Mode. System saves all system states and data onto the disc prior to power off the whole system.

System Fan True Value Table

Cheela 2.0 CPU 真值表			
TEST CONDITION: 35W @Ambient 25degC			
CPU Temperature		FAN SPEED	Acoustic Level
CORE0	CORE1	(rpm)	(dBA)
82	80	3600	36.1
86	86	3300	34.3
92	94	2900	31.2
Throttling	Throttling	2500	29.2

System Utilities

BIOS Setup Utility

The BIOS Setup Utility is a hardware configuration program built into your computer's BIOS (Basic Input/Output System).

Your computer is already properly configured and optimized, and you do not need to run this utility. However, if you encounter configuration problems, you may need to run Setup. Please also refer to Chapter 4 Troubleshooting when problem arises.

To activate the BIOS Utility, press F2 during POST (when "Press <F2> to enter Setup" message is prompted on the bottom of screen).

Press <F12> during POST to enter multi-boot menu. In this menu, user can change boot device without entering BIOS SETUP Utility. However, The default parameter of F12 Boot Menu is set to "disabled". If you want to change boot device without entering BIOS Setup Utility, please set the parameter to "enabled".

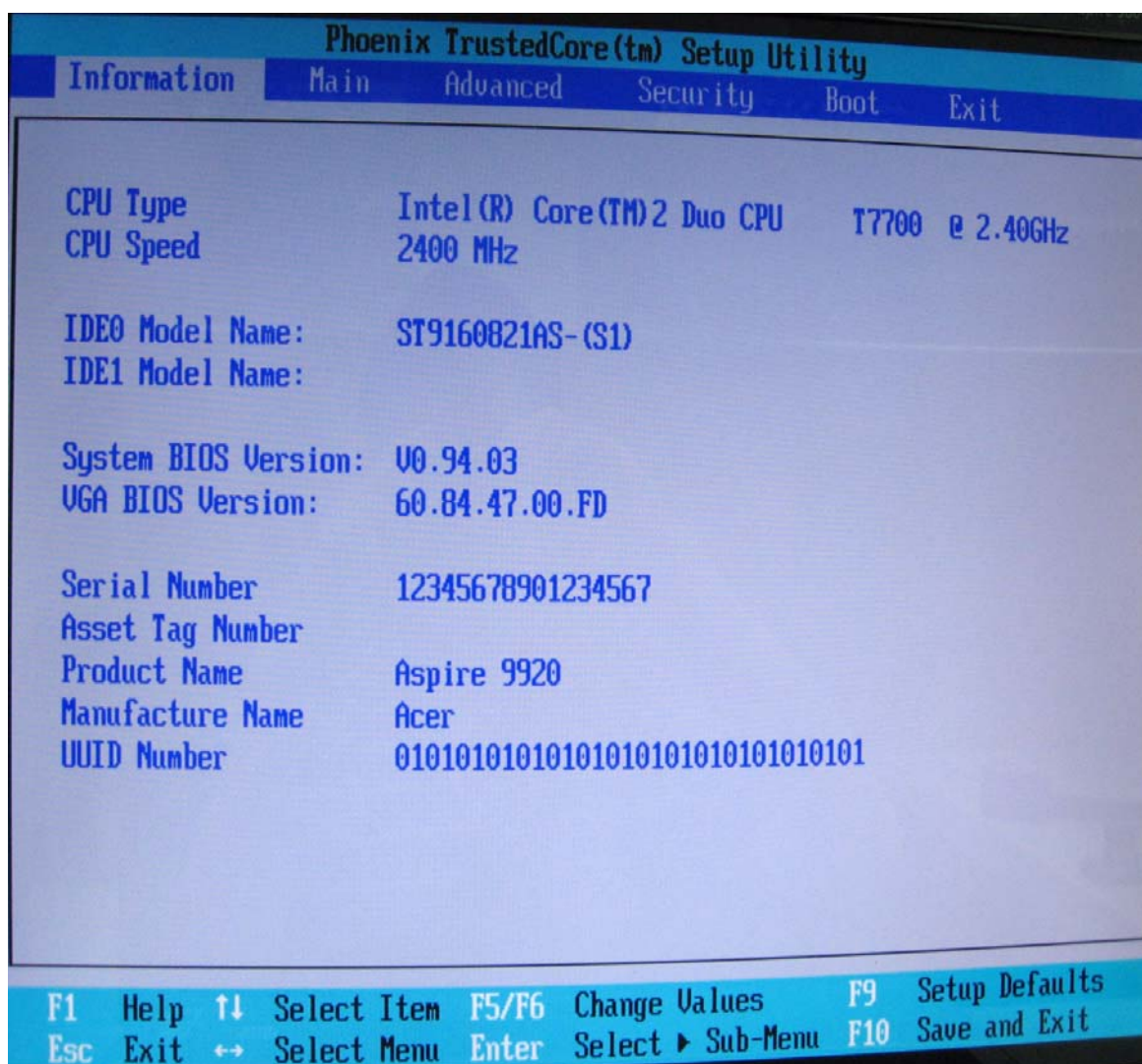

Navigating the BIOS Utility

There are six menu options: Information, Main, Advanced, Security, Boot, and Exit.

Follow these instructions:

- q To choose a menu, use the cursor left/right keys .
- q To choose a parameter, use the cursor up/down keys .
- q To change the value of a parameter, press F5 or F6.
- q A plus sign (+) indicates the item has sub-items. Press `Enter` to expand this item.
- q Press `Esc` while you are in any of the menu options to go to the Exit menu.
- q In any menu, you can load default settings by pressing F9. You can also press F10 to save any changes made and exit the BIOS Setup Utility.

NOTE: You can change the value of a parameter if it is enclosed in square brackets. Navigation keys for a particular menu are shown on the bottom of the screen. Help for parameters are found in the Item Specific Help part of the screen. Read this carefully when making changes to parameter values. **Please note that system information is subject to different models.**

Information

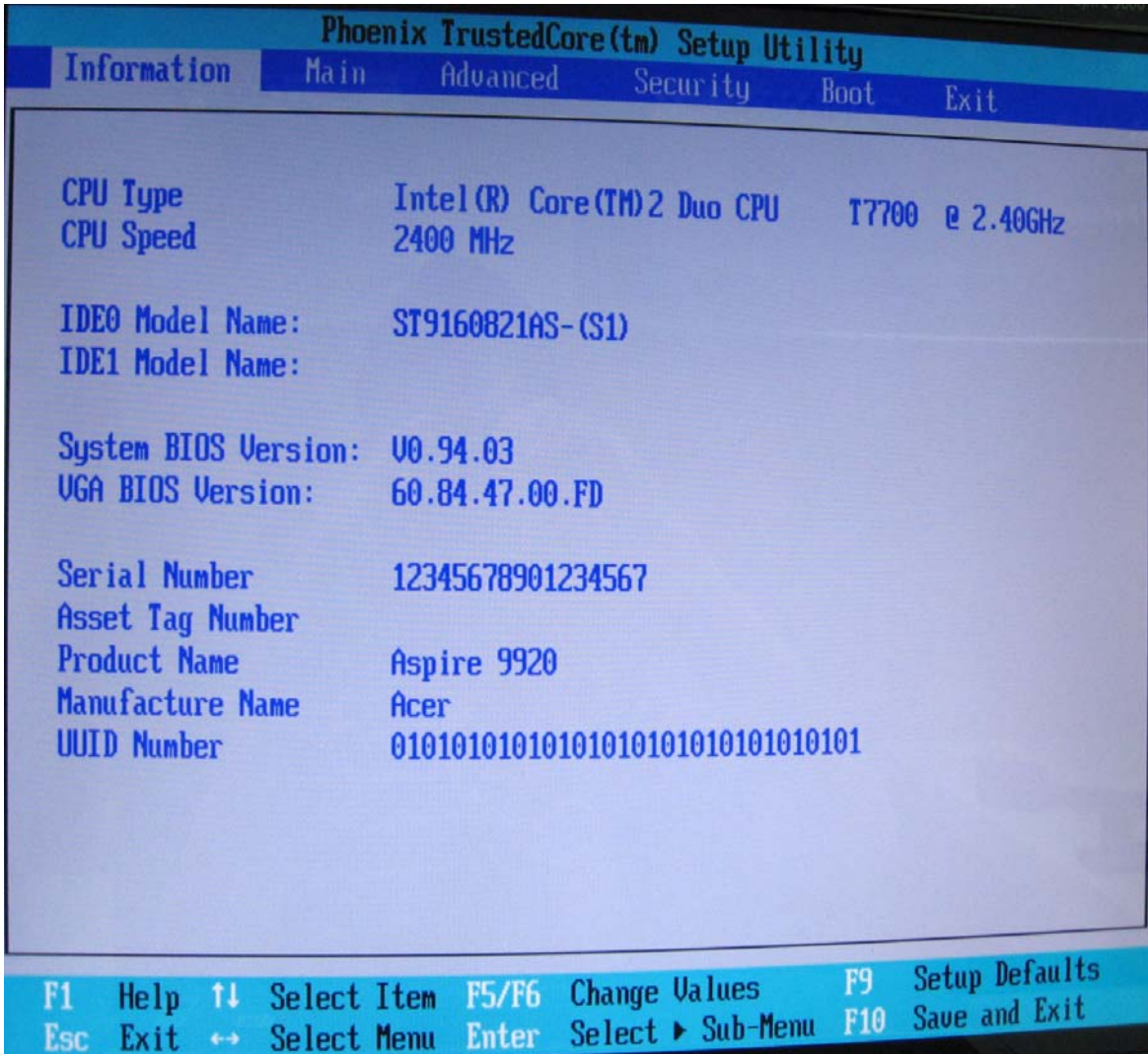

NOTE: The system information is subject to different models.

Parameter	Description
CPU Type	This field shows the CPU type of the system.
CPU Speed	This field shows the CPU speed of the system.
IDE0 Model Name	This field shows the model name of HDD installed on system.
IDE1 Model Name	This field shows the model name of HDD installed on system
System BIOS version	Displays system BIOS version.
VGA BIOS Version	This field displays the VGA firmware version of the system.
Serial Number	This field displays the serial number of this unit.
Asset Tag Number	This field displays the asset tag number of the system.
Product Name	This field shows product name of the system.
Manufacturer Name	This field displays the manufacturer of this system.
UUID Number	This will be visible only when an internal LAN device is presenting. UUID=32bytes

Main

The Main screen displays a summary of your computer hardware information, and also includes basic setup parameters. It allows the user to specify standard IBM PC AT system parameters.

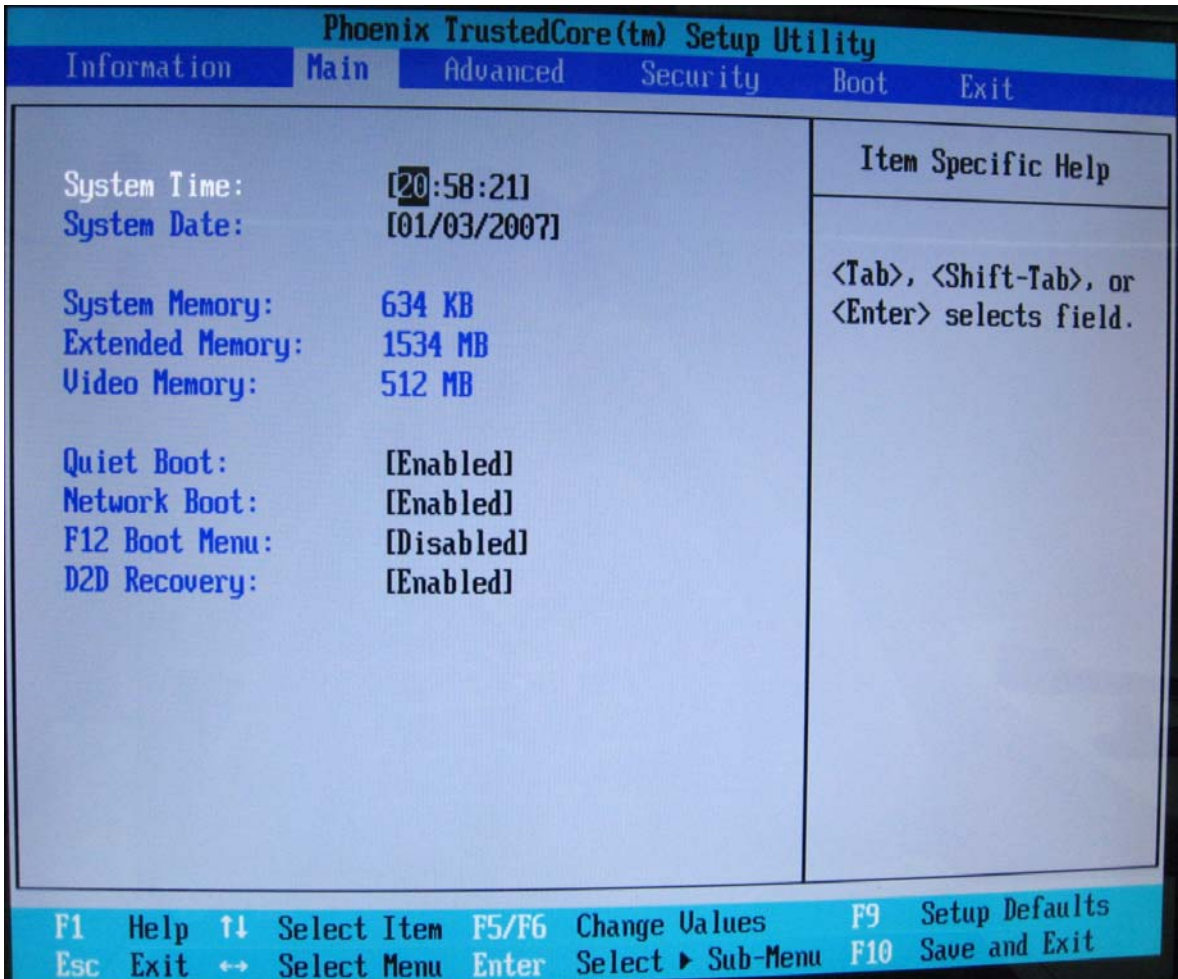

NOTE: The screen above is for your reference only. Actual values may differ.

The table below describes the parameters in this screen. Settings in **boldface** are the default and suggested parameter settings.

Parameter	Description	Format/Option
System Time	Sets the system time. The hours are displayed with 24-hour format.	Format: HH:MM:SS (hour:minute:second) System Time
System Date	Sets the system date.	Format MM/DD/YYYY (month/day/year) System Date
System Memory	This field reports the memory size of the system. Memory size is fixed to 640MB	
Extended Memory	This field reports the memory size of the extended memory in the system. Extended Memory size=Total memory size-1MB	
VGA Memory	Shows the VGA memory size. VGA Memory size=64/128MB	
Quiet Boot	Determines if Customer Logo will be displayed or not; shows Summary Screen is disabled or enabled. Enabled: Customer Logo is displayed, and Summary Screen is disabled. Disabled: Customer Logo is not displayed, and Summary Screen is enabled.	Option: Enabled or Disabled
Network Boot	Enables, disables the system boot from LAN (remote server).	Option: Enabled or Disabled
F12 Boot Menu	Enables, disables Boot Menu during POST.	Option: Disabled or Enabled
D2D Recovery	Enables, disables D2D Recovery function. The function allows the user to create a hidden partition on hard disc drive to store operation system and restore the system to factory defaults.	Option: Enabled or Disabled

NOTE: The sub-items under each device will not be shown if the device control is set to disable or auto. This is because the user is not allowed to control the settings in these cases.

Advanced

The Advanced screen displays advanced settings in BIOS.

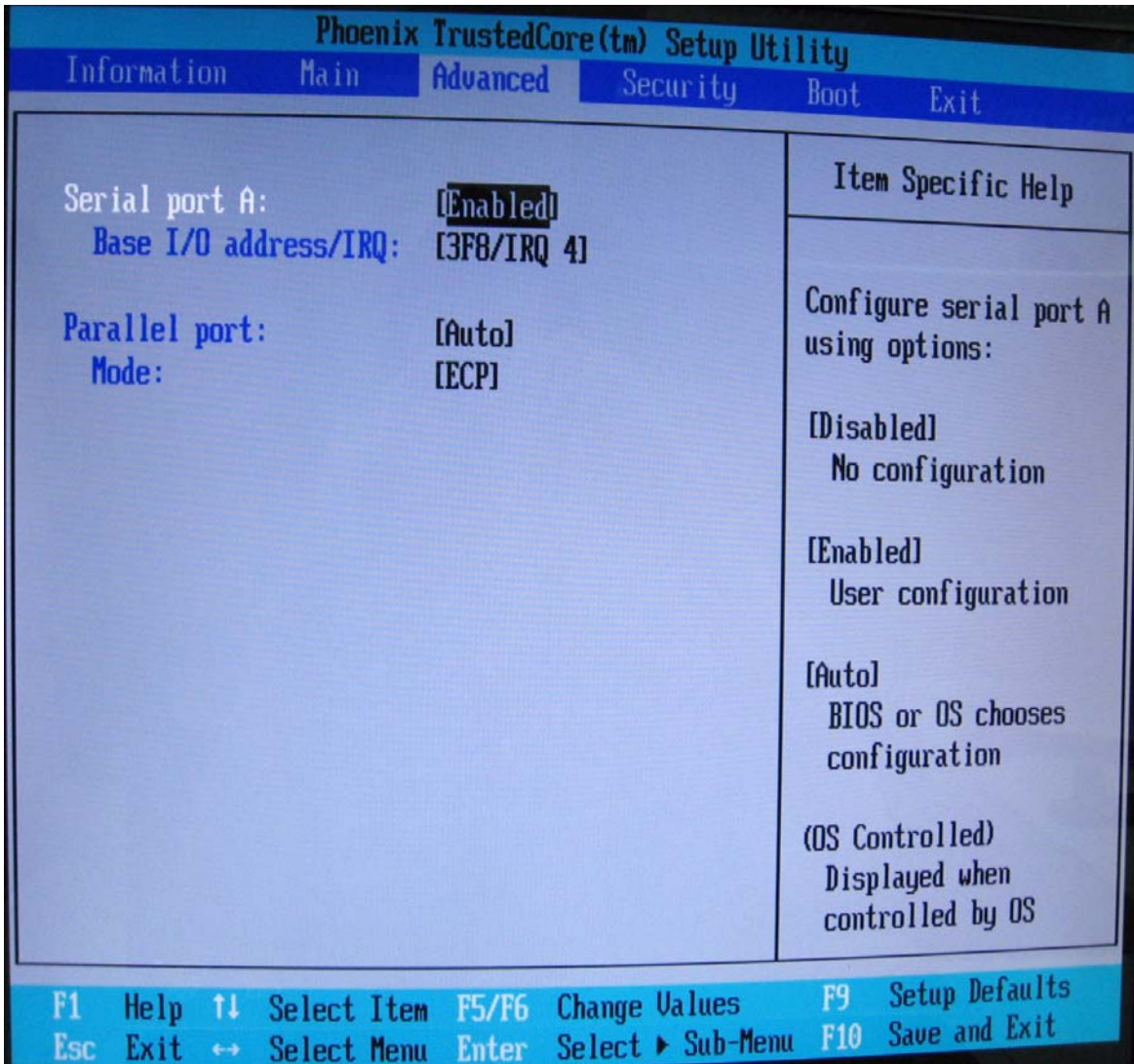

The table below describes the parameters in this screen. Settings in **boldface** are the default and suggested parameter settings.

Parameter	Description	Option
Serial port A	Displays the settings of the serial port	Enabled, Disabled, AUTO
Parallel port	Shows the settings of the parallel port	Enabled, Disabled, AUTO

Security

The Security screen contains parameters that help safeguard and protect your computer from unauthorized use.

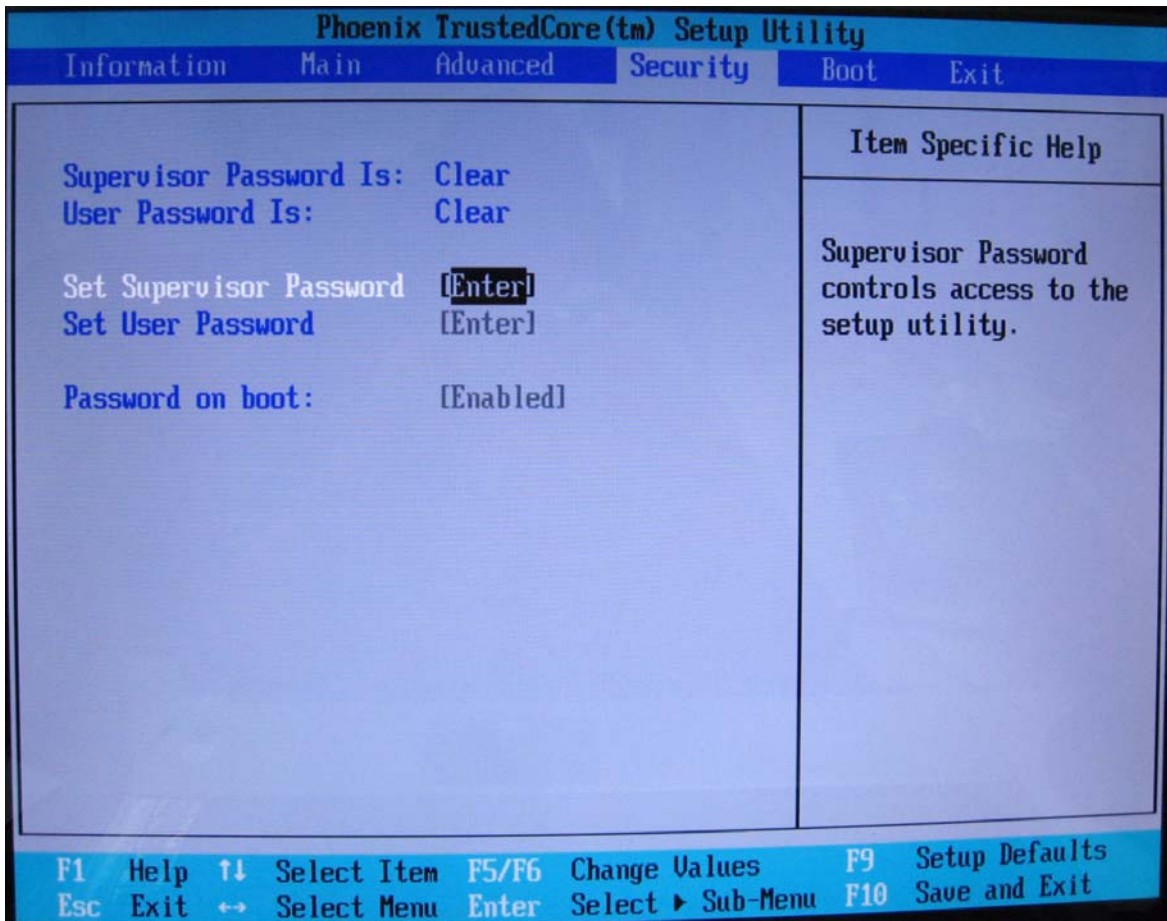

The table below describes the parameters in this screen. Settings in **boldface** are the default and suggested parameter settings.

Parameter	Description	Option
User Password is	Shows the setting of the user password.	Clear or Set
Supervisor Password is	Shows the setting of the Supervisor password	Clear or Set
Set User Password	Press Enter to set the user password. When user password is set, this password protects the BIOS Setup Utility from unauthorized access. The user can enter Setup menu only and does not have right to change the value of parameters.	
Set Supervisor Password	Press Enter to set the supervisor password. When set, this password protects the BIOS Setup Utility from unauthorized access. The user can not either enter the Setup menu nor change the value of parameters.	
Password on Boot	Defines whether a password is required or not while the events defined in this group happened. The following sub-options are all requires the Supervisor password for changes and should be grayed out if the user password was used to enter setup.	Disabled or Enabled

NOTE: When you are prompted to enter a password, you have three tries before the system halts. Don't forget your password. If you forget your password, you may have to return your notebook computer to your dealer to reset it.

Setting a Password

Follow these steps as you set the user or the supervisor password:

1. Use the cursor up/down key to highlight the Set Supervisor Password parameter and press the Enter key. The Set Supervisor Password box appears:

Set Supervisor Password

Enter New Password []

Confirm New Password []

2. Type a password in the "Enter New Password" field. The password length can not exceeds 8 alphanumeric characters (A-Z, a-z, 0-9, not case sensitive). Retype the password in the "Confirm New Password" field.

IMPORTANT: Be very careful when typing your password because the characters do not appear on the screen.

3. Press Enter.
After setting the password, the computer sets the User Password parameter to "Set".
4. If desired, you can enable the Password on boot parameter.
5. When you are done, press F10 to save the changes and exit the BIOS Setup Utility.

Removing a Password

Follow these steps:

1. Use the cursor up/down key to highlight the Set Supervisor Password parameter and press the Enter key. The Set Password box appears:

Set Supervisor Password		
Enter current password	[]
Enter New Password	[]
Confirm New Password	[]

2. Type the current password in the Enter Current Password field and press Enter.
3. Press Enter twice **without** typing anything in the Enter New Password and Confirm New Password fields. The computer then sets the Supervisor Password parameter to "Clear".
4. When you have changed the settings, press F10 to save the changes and exit the BIOS Setup Utility.

Changing a Password

1. Use the cursor up/down key to highlight to highlight the Set Supervisor Password parameter and press the Enter key. The Set Password box appears:

Set Supervisor Password		
Enter current password	[]
Enter New Password	[]
Confirm New Password	[]

2. Type the current password in the Enter Current Password field and press Enter.
3. Type a password in the Enter New Password field. Retype the password in the Confirm New Password field.
4. Press Enter. After setting the password, the computer sets the User Password parameter to "Set".
5. If desired, you can enable the Password on boot parameter.
6. When you are done, press F10 to save the changes and exit the BIOS Setup Utility.

If the verification is OK, the screen will display as following.

Setup Notice
Changes have been saved.
[continue]

The password setting is complete after the user presses Enter.

If the current password entered does not match the actual current password, the screen will show you the Setup Warning.

Setup Warning
Invalid password
[continue]

If the new password and confirm new password strings do not match, the screen will display the following message.

Setup Warning
Password do not match
Re-enter Password

Boot

This menu allows the user to decide the order of boot devices to load the operating system. Bootable devices includes the distette drive in module bay, the onboard hard disk drive, wake up on LAN, USB KEY and the CD-ROM in module bay.

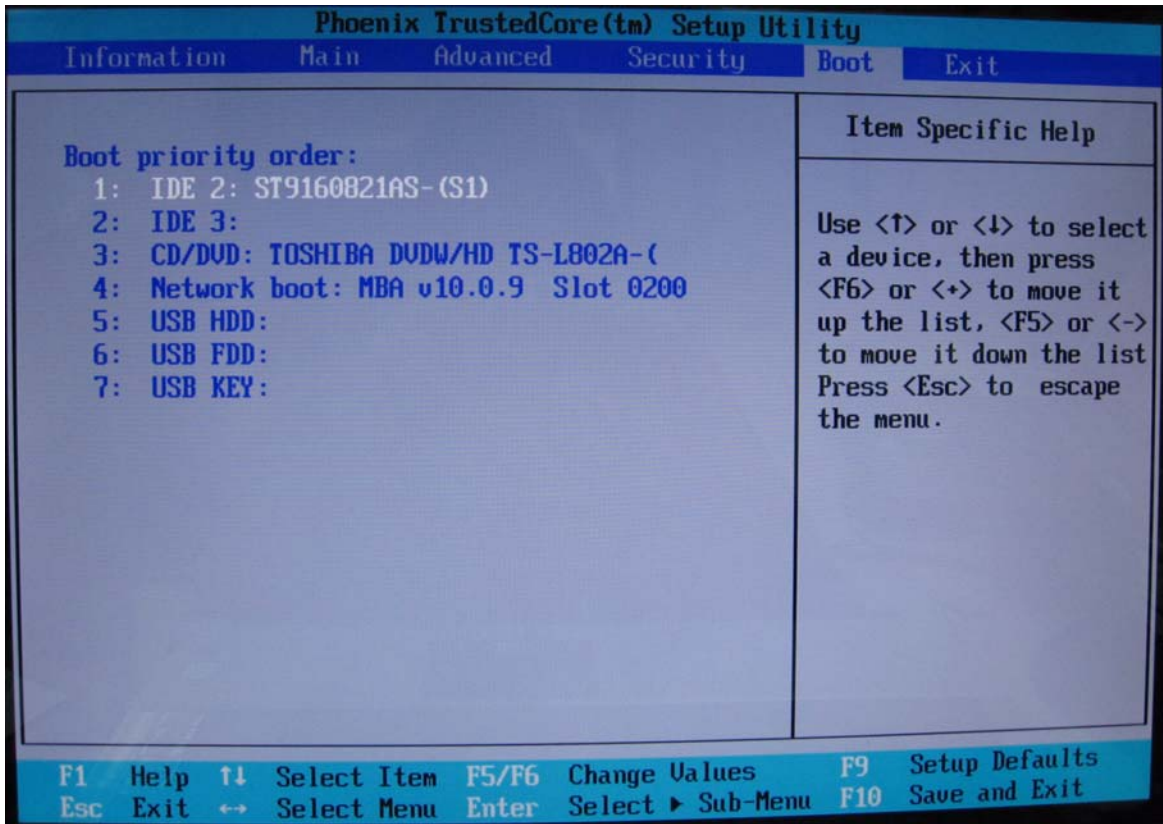

Exit

The Exit screen contains parameters that help safeguard and protect your computer from unauthorized use.

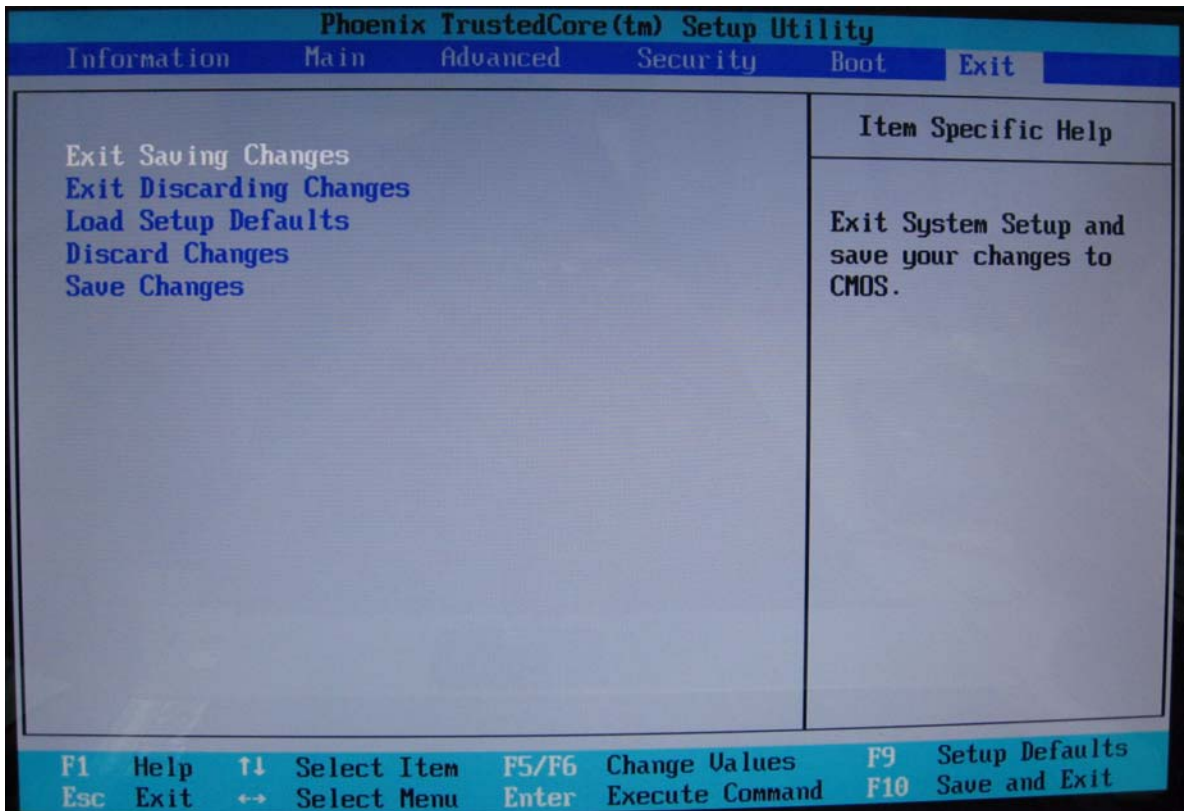

The table below describes the parameters in this screen.

Parameter	Description
Exit Saving Changes	Exit System Setup and save your changes to CMOS.
Exit Discarding Changes	Exit utility without saving setup data to CMOS.
Load Setup Default	Load default values for all SETUP item.
Discard Changes	Load previous values from CMOS for all SETUP items.
Save Changes	Save Setup Data to CMOS.

BIOS Flash Utility

The BIOS flash memory update is required for the following conditions:

- q New versions of system programs
- q New features or options
- q Restore a BIOS when it becomes corrupted.

Use the Phlash utility to update the system BIOS flash ROM.

NOTE: If you do not have a crisis recovery diskette at hand, then you should create a **Crisis Recovery Diskette** before you use the Phlash utility.

NOTE: Do not install memory-related drivers (XMS, EMS, DPMS) when you use the Phlash.

NOTE: Please use the AC adaptor power supply when you run the Phlash utility. If the battery pack does not contain enough power to finish BIOS flash, you may not boot the system because the BIOS is not completely loaded.

Follow the steps below to run the Phlash.

1. Prepare a bootable diskette.
2. Copy the flash utilities and BIOS code to the bootable diskette.
3. Then boot the system from the bootable diskette. Type "Phlash16 ****.rom" (if XMS is present, then add parameter "/x" in the end).
4. BIOS flash will be auto-execution, then power off system.
5. Remove diskette and power on system.

Machine Disassembly and Replacement

This chapter contains step-by-step procedures on how to disassemble the notebook computer Aspire 9920 for maintenance and troubleshooting.

To disassemble the computer, you need the following tools:

- q Wrist grounding strap and conductive mat for preventing electrostatic discharge
- q Small Philips screw driver
- q Philips screwdriver
- q Plastic flat head screw driver
- q Tweezers

NOTE: The screws for the different components vary in size. During the disassembly process, group the screws with the corresponding components to avoid mismatch when putting back the components. When you remove the stripe cover, please be careful not to scrape the cover.

General Information

Before You Begin

Before proceeding with the disassembly procedure, make sure that you do the following:

1. Turn off the power to the system and all peripherals.
2. Unplug the AC adapter and all power and signal cables from the system.
3. Remove the battery pack.

Disassembly Procedure Flowchart

The flowchart on the succeeding page gives you a graphic representation on the entire disassembly sequence and instructs you on the components that need to be removed during servicing. For example, if you want to remove the system board, you must first remove the keyboard, then disassemble the inside assembly frame in that order.

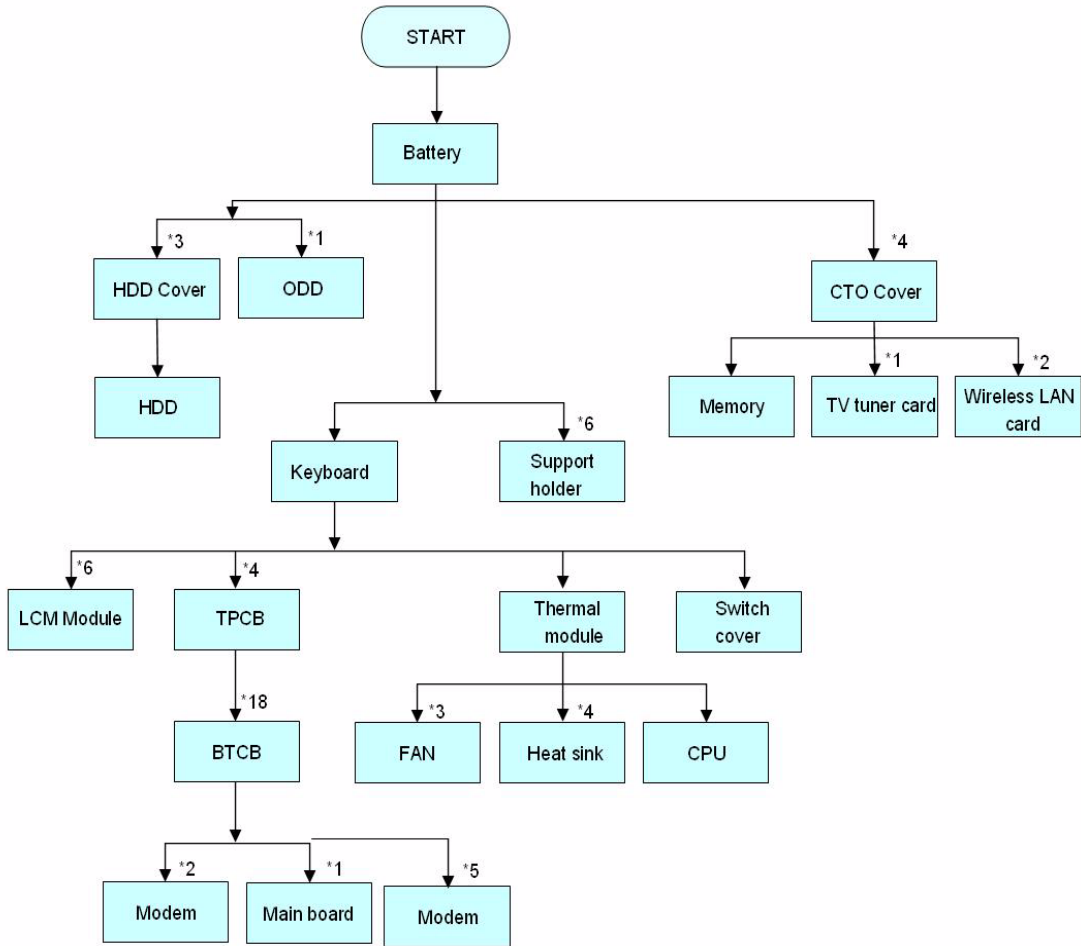

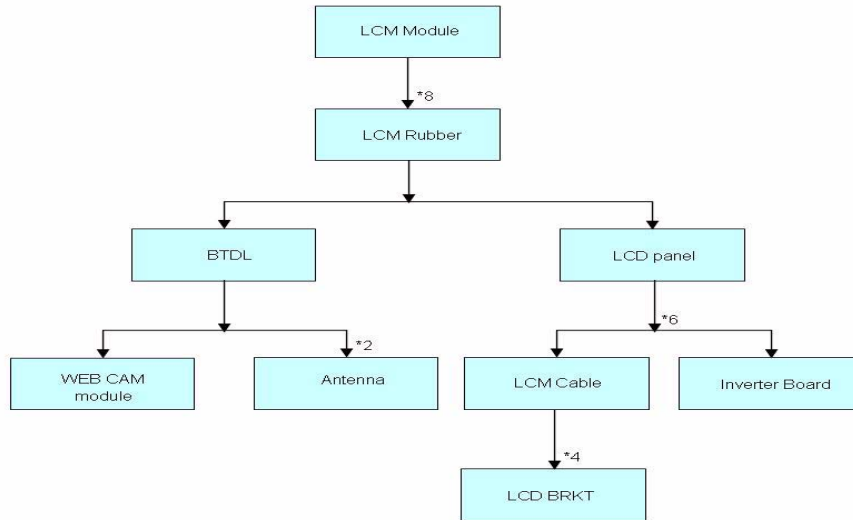

Screw List

Item	Description	Part Number
A	SCREW M2.5*3(NL)	86.TAVV5.001
B	SCREW M2.5*6(NL)	86.TAVV5.002
C	SCREW M2.5*10(NL)	86.TAVV5.003
D	SCREW M2.5*15(NL)	86.TAVV5.004
E	SCREW M2*2.2	86.TAVV5.005
F	SCREW M2*3(NL)	86.TAVV5.006
G	SCREW M2*4	86.TAVV5.007
H	SCREW M3*4(NL)	86.TAVV5.008
I	SCREW D-SUB 4#X40* 1/5-NI (NL)	86.TAVV5.009

Removing the Battery Pack

1. Release the battery.
2. Slide the battery latch then remove the battery.



Removing the HDD/Memory Module/Wireless LAN Card/TV Tuner Card/ System Fan/Thermal Modules/CPU and the LCD Module

Removing the HDD

1. Remove the three screws fastening the HDD door.
2. Detach the HDD door from the notebook.
3. Then disconnect the two HDD as shown (Some notebooks may have only one HDD).

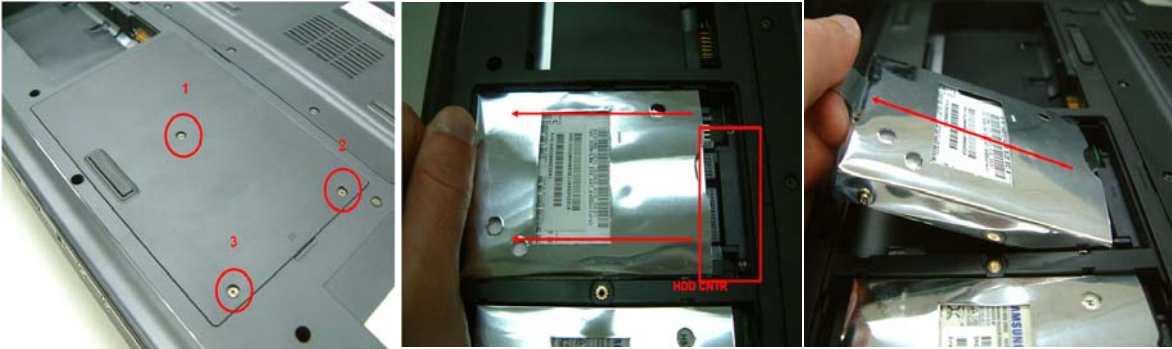

Removing the Memory Module

4. Remove the four screws holding the CTO cover.
5. Detach the CTO cover from the main unit.
6. Pop out the memory module from the DIMM socket then remove it (If the notebook has two memory modules, then repeat this step).

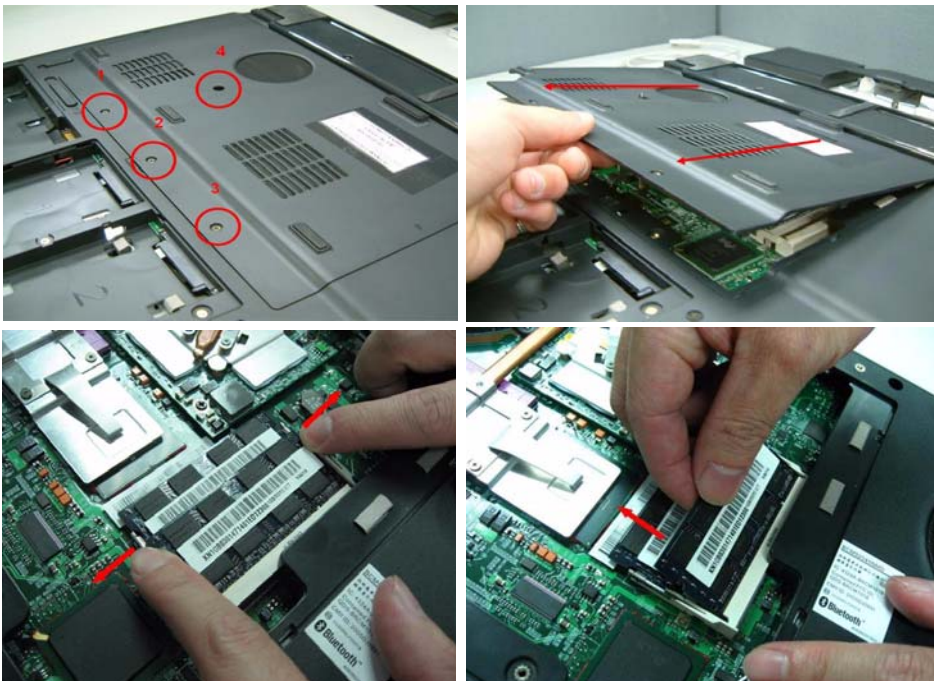

Removing the Wireless LAN Card/TV Tunder Card and System Fan

7. Remove the two screws fastening the wireless LAN card.

8. Disconnect the main and auxiliary antennae from the wireless LAN card.
9. Then take out the wireless LAN card from the main unit.



10. Remove the two screws fastening the TV tuner card.
11. Disconnect the TV-in cable then remove the TV tuner card.

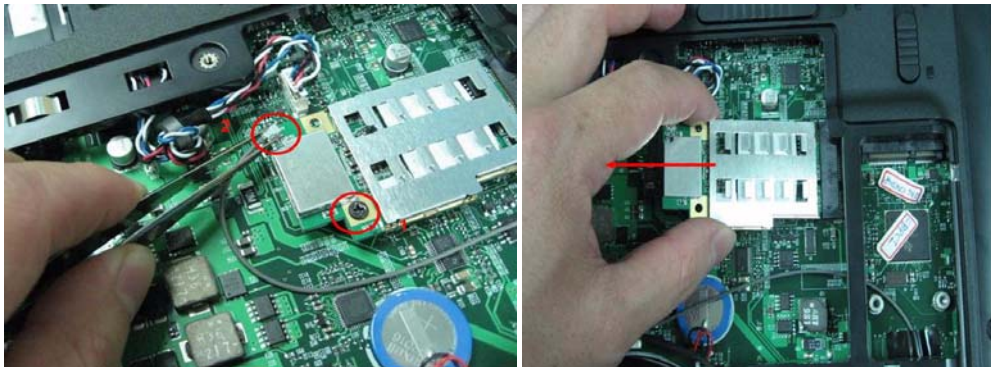

12. Remove two screws holding the support holder as shown.
13. Remove four screws fastening the support holder on the rear side as shown.
14. Detach the support holder from the main unit.



15. Remove the three screws holding the system fan.
16. Disconnect the fan cable from the main board.
17. Take out the system fan from the main unit as shown.

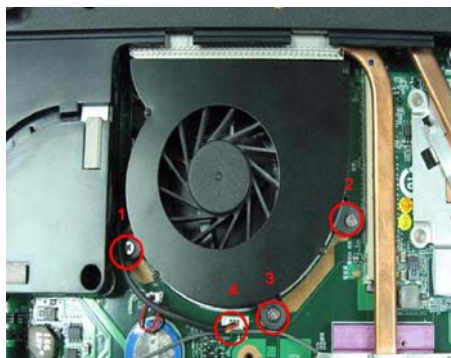

Removing the Thermal Modules and the CPU

18. Remove the two screws holding the finger heatsink.
19. Detach the finger heatsink from the main board.
20. Then take out the CPU heatsink from the main board.
21. Use a flat screwdriver to release the CPU lock (Turn counter clock-wise) then remove the CPU carefully.

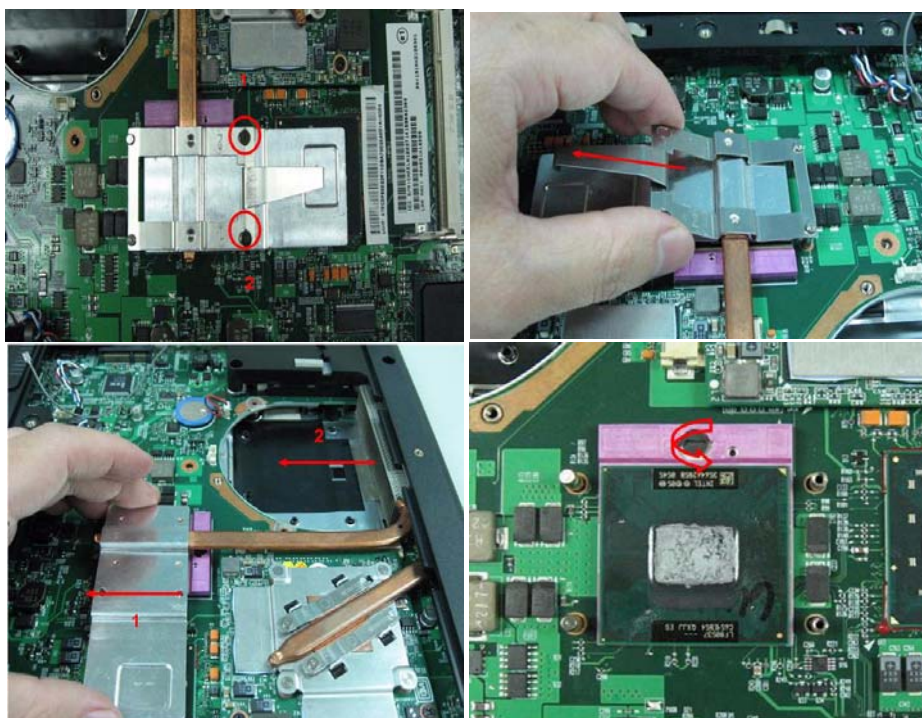

22. Remove the two screws fastening the MXM heatsink.
23. Detach the MXM heatsink from the main board.
24. Remove the two screws fastening the MXM card
25. Remove the MXM card carefully.

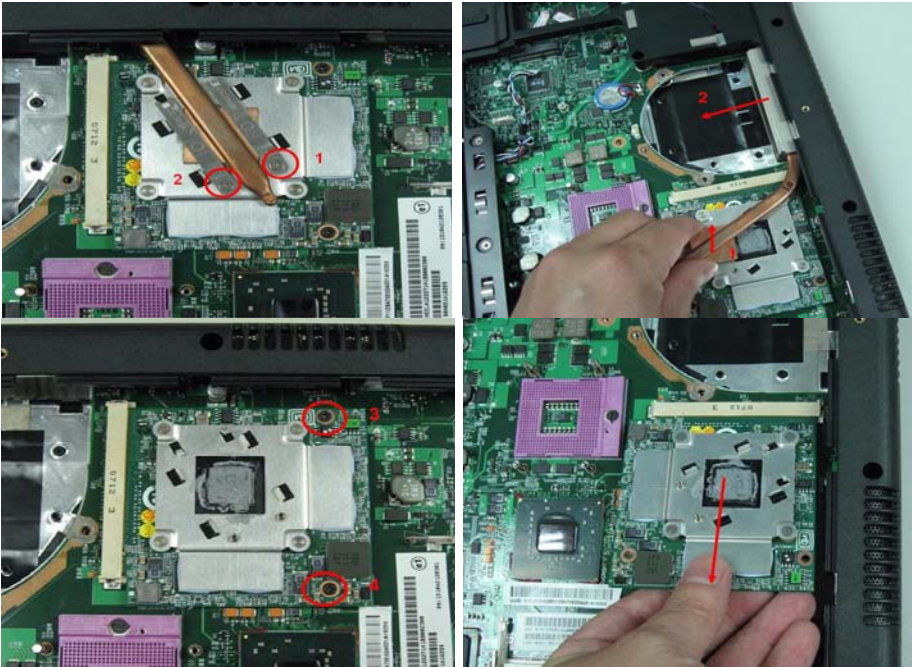

Removing the ODD and Dummy cards

26. Remove the screw fastening the optical disk drive module on the bottom.
27. Use a tool to push the optical disk drive module outwards and remove the ODD module.
28. Then remove the PC dummy card.
29. Remove the express dummy card.



Removing the LCD Module

30. Detach the middle cover from the rear side as shown.



31. Then detach the middle cover from the front side and remove it.
32. Take out the LCD cable from the groove.
33. Disconnect the LCD cable from the main board.
34. Remove the six screws holding the LCM module.
35. Detach the LCD module from the main unit.

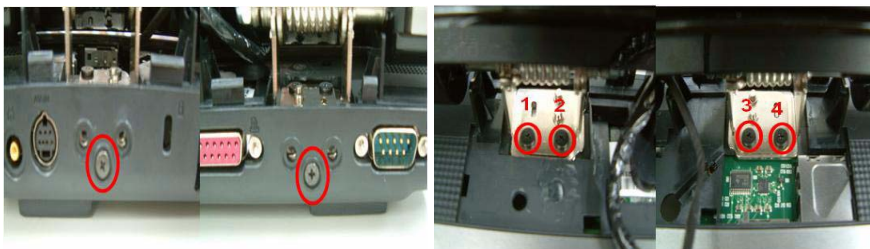

Disassembling the Main Unit

Separate the Main Unit Into the Upper and the Lower Case Assembly

1. Release the four keyboard lock as shown (Use a flat screwdriver and push the keyboard lock upwards).
2. Turn over the keyboard as the image shows.
3. Disconnect the Keyboard FFC from the main board
4. Then remove the keyboard from the main unit.



5. Remove the 18 screws fastening the upper case and the lower case assembly as shown.
6. Disconnect the Speaker cable from the main board.



7. Disconnect the Audio board FFC from the main board.
8. Disconnect the Hotkey board FFC from the main board.
9. Disconnect the Touch pad FFC from the main board.
10. Carefully detach the upper case assembly from the lower case assembly.

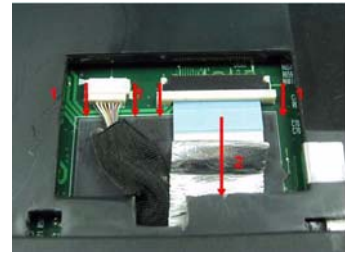
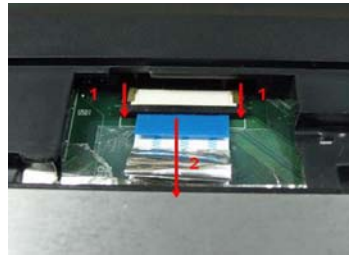
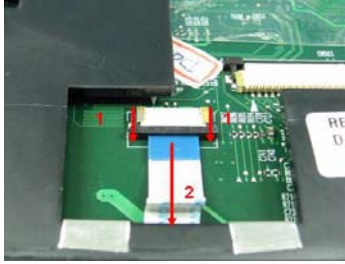
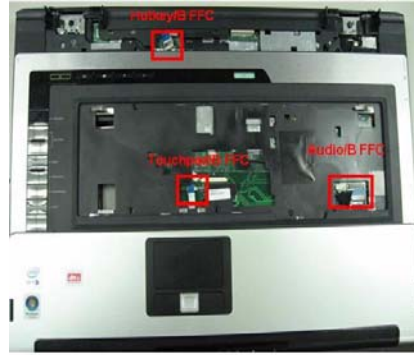
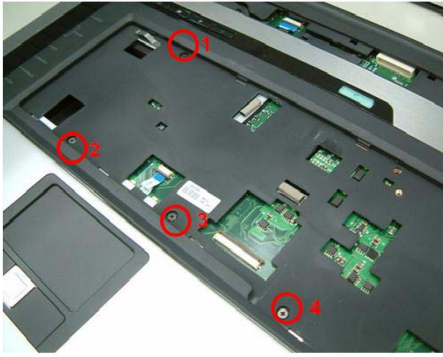

Disassembling the Lower Case Assembly

11. Disconnect the bluetooth cable from the main board and detach the bluetooth module from the lower case.
12. Remove the two screws fastening the modem board and disconnect the modem board from the main board.
13. Disconnect the modem cable and remove the modem board.

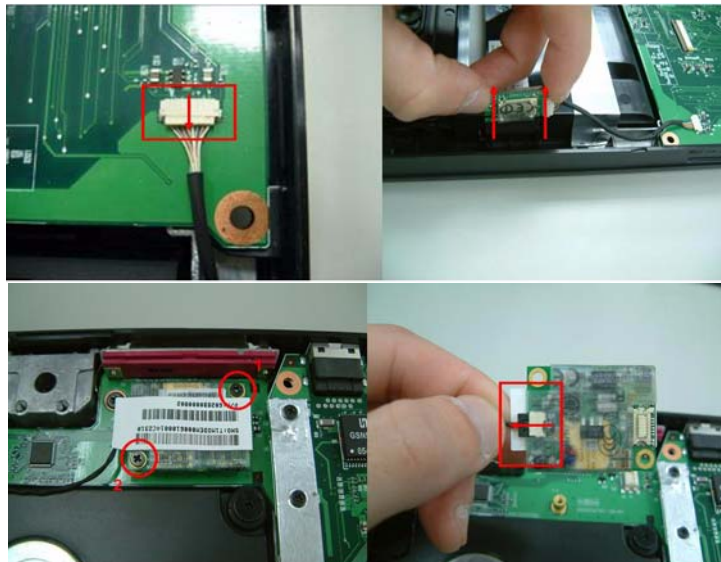

14. Remove the three screws fastening the main board to the lower case.
15. Detach the main board from the lower case assembly.

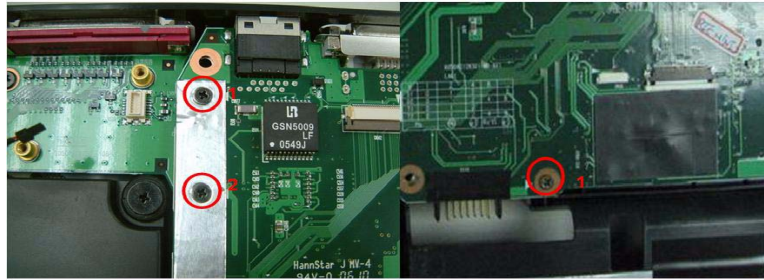

16. Remove the three screws holding the IO board to the lower case.
17. Detach the IO board from the lower case.
18. Then detach the modem cable (with RJ11 connector) from the lower case.
19. Remove MB fom lower case.

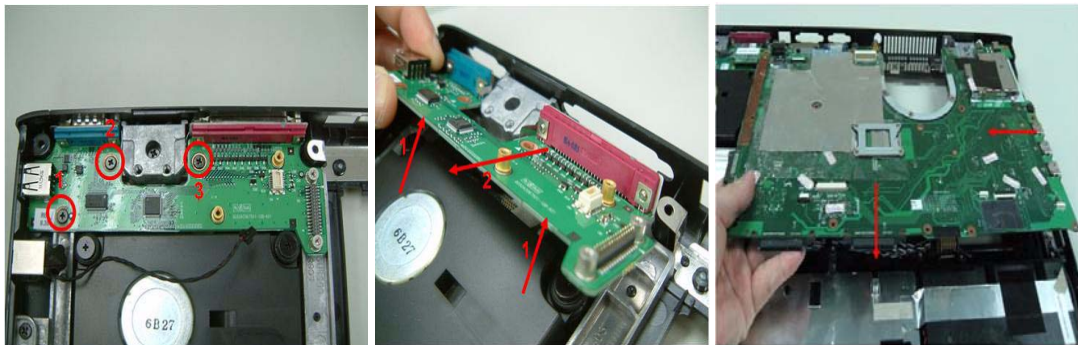

20. Tear off the mylar holding the speaker set cable carefully.
21. Remove the eight screws fastening the speaker and sub-woofer set.
22. Then remove the speaker and sub-woofer set from the lower case.



Disassembling the Upper Case Assembly

1. Disconnect the touchpad board to main board FFC and remove it.
2. Remove the seven screws and disconnect the touchpad to touchpad board FFC.

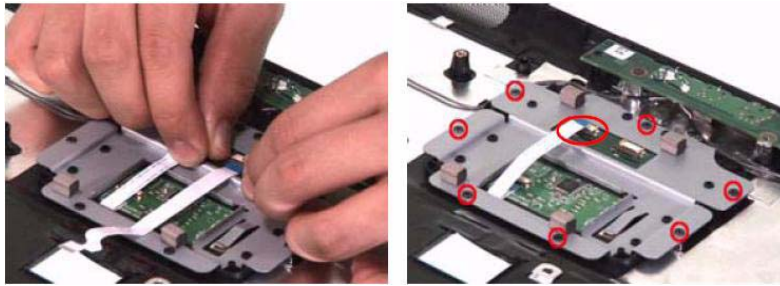

3. Detach the touchpad bracket from the upper case.
4. Remove the touchpad board from the upper case.
5. Disconnect the touchpad to touchpad board FFC then remove the FFC and the touchpad.



6. Disconnect the launch board FFC from the launch board and the media board and remove the FFC.
7. Remove the three screws fastening the media board to the upper case.
8. Remove the media board from the upper case.

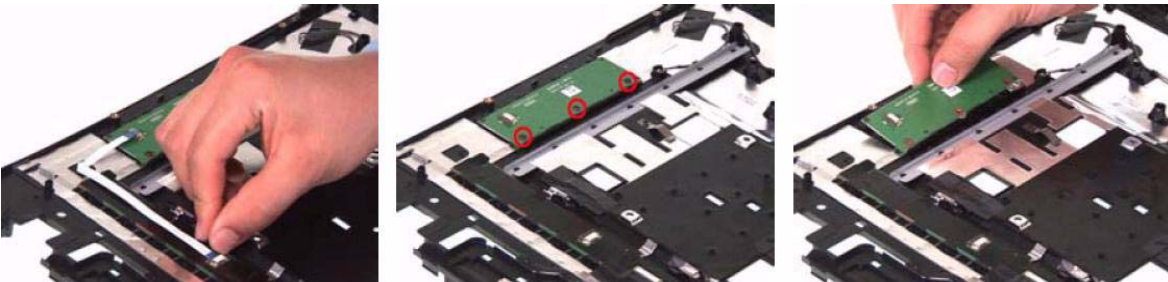

9. Remove the two screws holding the audio board to the upper case.
10. Tear off the audio cable from the lower case.
11. Turn over the audio board as shown.

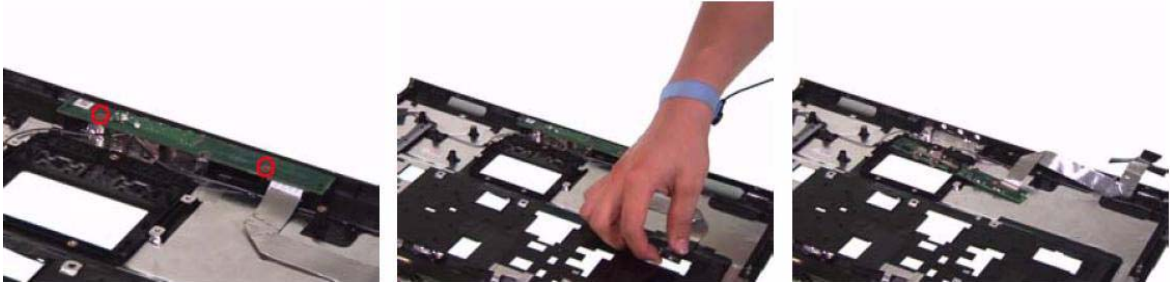

12. Disconnect the audio board cable from the audio board and remove the cable.
13. Disconnect the microphone cable and remove the audio board.
14. Carefully take out the microphone cable and the microphones from the lower case.



15. Detach and disconnect the launch board cable and remove it.
16. Detach the launch board insulator as shown.

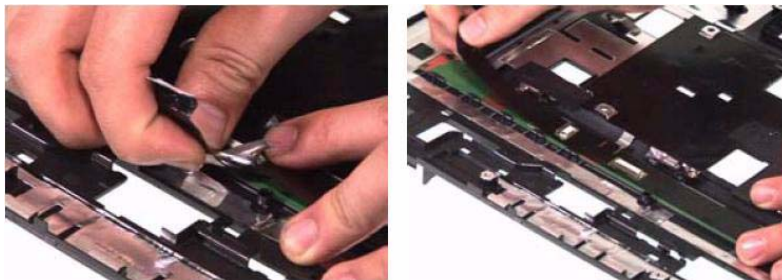

17. Remove the four screws fastening the launch board.
18. Take out the launch board from the upper case.
19. Then take out the touchpad frame from the upper case.

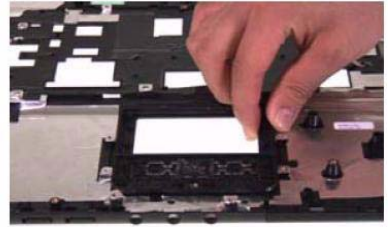
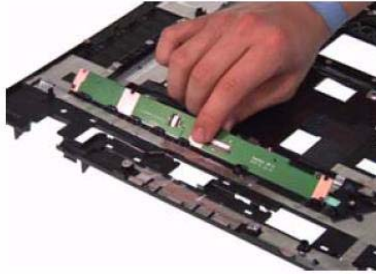
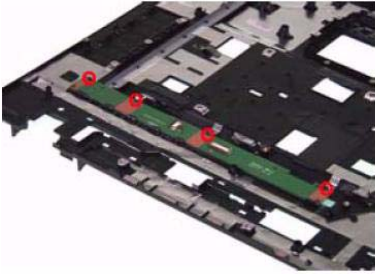

Disassembling the LCD Module

1. Remove the eight screw rubber as shown.
2. Then remove the eight screws fastening the LCD bezel.
3. Detach the LCD bezel from the LCD module carefully.

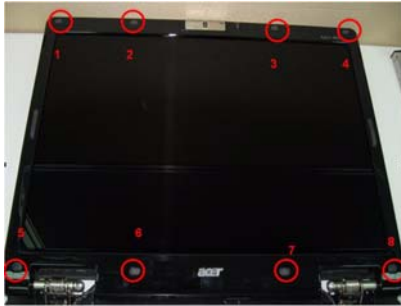

4. Disconnect the CCD cable from the CCD board.
5. Then remove CCD module.

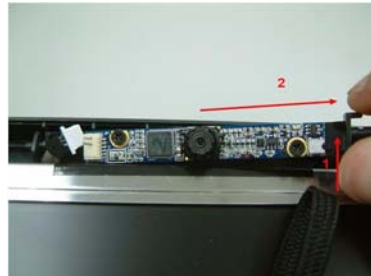

6. Take out the LCD from the LCD panel.
7. Remove the four screws fastening the right/left LCD brackets.
8. Detach the right/left LCD brackets.



9. Disconnect the LCM cable from the LCD and inverter.
10. Disconnect Inverter cable from LCD panel and detach the inverter.

11. Remove the two screws fastening the wireless antenna set and take out the antenna set from the LCD panel.

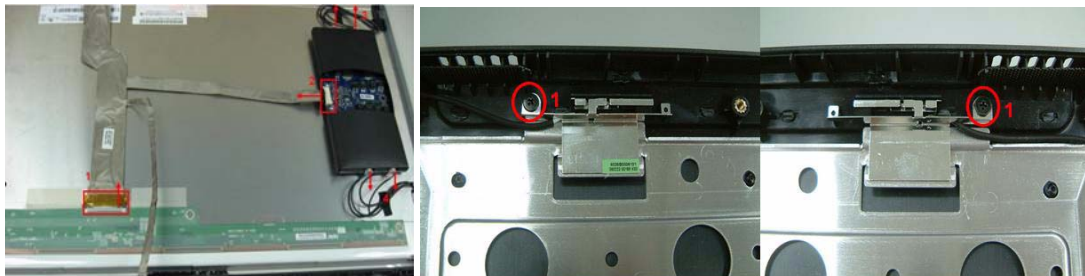

Disassembling the External Modules

Disassembling the HDD Module

1. Remove the four screws holding the HDD (hard disk drive) foil; two on each side.
2. Carefully take out the hard disk drive from the HDD foil.



Disassembling the ODD Module

1. Remove the two screws holding the optical bracket.
2. Then remove the optical bracket from the optical disk drive.



Troubleshooting

Use the following procedure as a guide for computer problems.

NOTE: The diagnostic tests are intended to test only Acer products. Non-Acer products, prototype cards, or modified options can give false errors and invalid system responses.

1. Obtain the failing symptoms in as much detail as possible.
2. Verify the symptoms by attempting to re-create the failure by running the diagnostic test or by repeating the same operation.
3. Use the following table with the verified symptom to determine which page to go to.

Symptoms (Verified)	Go To
Power failure. (The power indicator does not go on or stay on.)	"Power System Check" on page 80.
POST does not complete. No beep or error codes are indicated.	"Power-On Self-Test (POST) Error Message" on page 84 "Undetermined Problems" on page 96
POST detects an error and displayed messages on screen.	"Error Message List" on page 85
Other symptoms (i.e. LCD display problems or others).	"Power-On Self-Test (POST) Error Message" on page 84
Symptoms cannot be re-created (intermittent problems).	Use the customer-reported symptoms and go to "Power-On Self-Test (POST) Error Message" on page 84 "Intermittent Problems" on page 95 "Undetermined Problems" on page 96

System Check Procedures

External CD-ROM Drive Check

Do the following to isolate the problem to a controller, drive, or CD-ROM. Make sure that the CD-ROM does not have any label attached to it. The label can cause damage to the drive or can cause the drive to fail.

Do the following to select the test device:

1. Boot from the diagnostics diskette and start the diagnostics program.
2. See if CD-ROM Test is passed when the program runs to CD-ROM Test.
3. Follow the instructions in the message window.

If an error occurs, reconnect the connector on the System board. If the error still remains:

1. Reconnect the external diskette drive/CD-ROM module.
2. Replace the external diskette drive/CD-ROM module.
3. Replace the main board.

Keyboard or Auxiliary Input Device Check

Remove the external keyboard if the internal keyboard is to be tested.

If the internal keyboard does not work or an unexpected character appears, make sure that the flexible cable extending from the keyboard is correctly seated in the connector on the system board.

If the keyboard cable connection is correct, run the Keyboard Test.

If the tests detect a keyboard problem, do the following one at a time to correct the problem. Do not replace a non-defective FRU:

1. Reconnect the keyboard cables.
2. Replace the keyboard.
3. Replace the main board.

The following auxiliary input devices are supported by this computer:

- q Numeric keypad
- q External keyboard

If any of these devices do not work, reconnect the cable connector and repeat the failing operation.

Memory check

Memory errors might stop system operations, show error messages on the screen, or hang the system.

1. Boot from the diagnostics diskette and start the doagmpstotics program (please refer to main board).
2. Go to the diagnostic memory in the test items.
3. Press F2 in the test items.
4. Follow the instructions in the message window.

NOTE: Make sure that the DIMM is fully installed into the connector. A loose connection can cause an error.

Power System Check

To verify the symptom of the problem, power on the computer using each of the following power sources:

1. Remove the battery pack.
2. Connect the power adapter and check that power is supplied.

-
- 3.** Disconnect the power adapter and install the charged battery pack; then check that power is supplied by the battery pack.

If you suspect a power problem, see the appropriate power supply check in the following list:

- q "Check the Power Adapter" on page 82
- q "Check the Battery Pack" on page 83

Check the Power Adapter

Unplug the power adapter cable from the computer and measure the output voltage at the plug of the power adapter cable. See the following figure

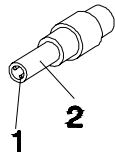

Pin 1: +19 to +20.5V
Pin 2: 0V, Ground

1. If the voltage is not correct, replace the power adapter.
2. If the voltage is within the range, do the following:
 - q Replace the System board.
 - q If the problem is not corrected, see “Undetermined Problems” on page 96.
 - q If the voltage is not correct, go to the next step.

NOTE: An audible noise from the power adapter does not always indicate a defect.

3. If the power-on indicator does not light up, check the power cord of the power adapter for correct continuity and installation.
4. If the operational charge does not work, see “Check the Battery Pack” on page 83.

Check the Battery Pack

To check the battery pack, do the following:

From Software:

1. Check out the Power Management in control Panel
2. In Power Meter, confirm that if the parameters shown in the screen for Current Power Source and Total Battery Power Remaining are correct.
3. Repeat the steps 1 and 2, for both battery and adapter.
4. This helps you identify first the problem is on recharging or discharging.

From Hardware:

1. Power off the computer.
2. Remove the battery pack and measure the voltage between battery terminals 1(+) and 6(ground). See the following figure

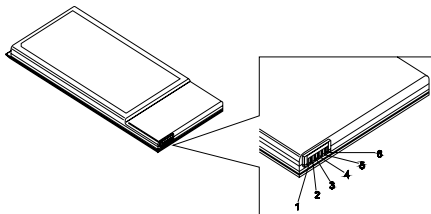

3. If the voltage is still less than 7.5 Vdc after recharging, replace the battery.

To check the battery charge operation, use a discharged battery pack or a battery pack that has less than 50% of the total power remaining when installed in the computer.

If the battery status indicator does not light up, remove the battery pack and let it return to room temperature. Re-install the battery pack.

If the charge indicator still does not light up, replace the battery pack. If the charge indicator still does not light up, replace the DC/DC charger board.

Touchpad Check

If the touchpad doesn't work, do the following actions one at a time to correct the problem. Do not replace a non-defective FRU:

1. Reconnect the touchpad cables.
2. Replace the touchpad.
3. Replace the system board.

After you use the touchpad, the pointer drifts on the screen for a short time. This self-acting pointer movement can occur when a slight, steady pressure is applied to the touchpad pointer. This symptom is not a hardware problem. No service actions are necessary if the pointer movement stops in a short period of time.

Power-On Self-Test (POST) Error Message

The POST error message index lists the error message and their possible causes. The most likely cause is listed first.

NOTE: Perform the FRU replacement or actions in the sequence shown in FRU/Action column, if the FRU replacement does not solve the problem, put the original part back in the computer. Do not replace a non-defective FRU.

This index can also help you determine the next possible FRU to be replaced when servicing a computer.

If the symptom is not listed, see “Undetermined Problems” on page 96.

The following lists the error messages that the BIOS displays on the screen and the error symptoms classified by function.

NOTE: Most of the error messages occur during POST. Some of them display information about a hardware device, e.g., the amount of memory installed. Others may indicate a problem with a device, such as the way it has been configured.

NOTE: If the system fails after you make changes in the BIOS Setup Utility menus, reset the computer, enter Setup and install Setup defaults or correct the error.

Index of Error Messages

Error Code List

Error Codes	Error Messages
006	Equipment Configuration Error Causes: 1. CPU BIOS Update Code Mismatch 2. IDE Primary Channel Master Drive Error (The causes will be shown before "Equipment Configuration Error")
010	Memory Error at xxx:xxx:xxxh (R:xxxh, W:xxxh)
070	Real Time Clock Error
071	CMOS Battery Bad
072	CMOS Checksum Error
110	System disabled. Incorrect password is specified.
<No error code>	Battery critical LOW In this situation BIOS will issue 4 short beeps then shut down system, no message will show.
<No error code>	Thermal critical High In this situation BIOS will shut down system, not show message.

Error Message List

Error Messages	FRU/Action in Sequence
Failure Fixed Disk	Reconnect hard disk drive connector. "Load Default Settings" in BIOS Setup Utility. Hard disk drive System board
Stuck Key	see "Keyboard or Auxiliary Input Device Check" on page 80.
Keyboard error	see "Keyboard or Auxiliary Input Device Check" on page 80.
Keyboard Controller Failed	see "Keyboard or Auxiliary Input Device Check" on page 80.
Keyboard locked - Unlock key switch	Unlock external keyboard
Monitor type does not match CMOS - Run Setup	Run "Load Default Settings" in BIOS Setup Utility.
Shadow RAM Failed at offset: nnnn	BIOS ROM System board
System RAM Failed at offset: nnnn	DIMM System board
Extended RAM Failed at offset: nnnn	DIMM System board
System battery is dead - Replace and run Setup	Replace RTC battery and Run BIOS Setup Utility to reconfigure system time, then reboot system.
System CMOS checksum bad - Default configuration used	RTC battery Run BIOS Setup Utility to reconfigure system time, then reboot system.
System timer error	RTC battery Run BIOS Setup Utility to reconfigure system time, then reboot system. System board

Error Message List

Error Messages	FRU/Action in Sequence
Real time clock error	RTC battery Run BIOS Setup Utility to reconfigure system time, then reboot system. System board
Previous boot incomplete - Default configuration used	Run "Load Default Settings" in BIOS Setup Utility. RTC battery System board
Memory size found by POST differed from CMOS	Run "Load Default Settings" in BIOS Setup Utility. DIMM System board
Diskette drive A error	Check the drive is defined with the proper diskette type in BIOS Setup Utility See "External Diskette Drive Check" on page 80.
Incorrect Drive A type - run SETUP	Check the drive is defined with the proper diskette type in BIOS Setup Utility
System cache error - Cache disabled	System board
CPU ID:	System board
DMA Test Failed	DIMM System board
Software NMI Failed	DIMM System board
Fail-Safe Timer NMI Failed	DIMM System board
Device Address Conflict	Run "Load Default Settings" in BIOS Setup Utility. RTC battery System board
Allocation Error for device	Run "Load Default Settings" in BIOS Setup Utility. RTC battery System board
Failing Bits: nnnn	DIMM BIOS ROM System board
Fixed Disk n	None
Invalid System Configuration Data	BIOS ROM System board
I/O device IRQ conflict	Run "Load Default Settings" in BIOS Setup Utility. RTC battery System board
Operating system not found	Enter Setup and see if fixed disk and drive A: are properly identified. Diskette drive Hard disk drive System board

Error Message List

No beep Error Messages	FRU/Action in Sequence
No beep, power-on indicator turns off and LCD is blank.	Power source (battery pack and power adapter). See "Power System Check" on page 80.. Ensure every connector is connected tightly and correctly. Reconnect the DIMM. LED board. System board.
No beep, power-on indicator turns on and LCD is blank.	Power source (battery pack and power adapter). See "Power System Check" on page 80.. Reconnect the LCD connector Hard disk drive LCD inverter ID LCD cable LCD Inverter LCD System board
No beep, power-on indicator turns on and LCD is blank. But you can see POST on an external CRT.	Reconnect the LCD connectors. LCD inverter ID LCD cable LCD inverter LCD System board
No beep, power-on indicator turns on and a blinking cursor shown on LCD during POST.	Ensure every connector is connected tightly and correctly. System board
No beep during POST but system runs correctly.	Speaker System board

Phoenix BIOS Beep Codes

Code	Beeps	POST Routine Description
02h		Verify Real Mode
03h		Disable Non-Maskable Interrupt (NMI)
04h		Get CPU type
06h		Initialize system hardware
08h		Initialize chipset with initial POST values
09h		Set IN POST flag
0Ah		Initialize CPU registers
0Bh		Enable CPU cache
0Ch		Initialize caches to initial POST values
0Eh		Initialize I/O component
0Fh		Initialize the local bus IDE
10h		Initialize Power Management
11h		Load alternate registers with initial POST values
12h		Restore CPU control word during warm boot
13h		Initialize PCI Bus Mastering devices
14h		Initialize keyboard controller
16h	1-2-2-3	BIOS ROM checksum
17h		Initialize cache before memory autosize
18h		8254 timer initialization
1Ah		8237 DMA controller initialization
1Ch		Reset Programmable Interrupt Controller
20h	1-3-1-1	Test DRAM refresh
22h	1-3-1-3	Test 8742 Keyboard Controller
24h		Set ES segment register to 4 GB
26h		Enable A20 line
28h		Autosize DRAM
29h		Initialize POST Memory Manager
2Ah		Clear 215 KB base RAM
2Ch	1-3-4-1	RAM failure on address line xxxx
2Eh	1-3-4-3	RAM failure on data bits xxxx of low byte of memory bus
2Fh		Enable cache before system BIOS shadow
30h	1-4-1-1	RAM failure on data bits xxxx of high byte of memory bus
32h		Test CPU bus-clock frequency
33h		Initialize Phoenix Dispatch Manager
36h		Warm start shut down
38h		Shadow system BIOS ROM
3Ah		Autosize cache
3Ch		Advanced configuration of chipset registers
3Dh		Load alternate registers with CMOS values
42h		Initialize interrupt vectors
45h		POST device initialization

Code	Beeps	POST Routine Description
46h	2-1-2-3	Check ROM copyright notice
48h		Check video configuration against CMOS
49h		Initialize PCI bus and devices
4Ah		Initialize all video adapters in system
4Bh		QuietBoot start (optional)
4Ch		Shadow video BIOS ROM
4Eh		Display BIOS copyright notice
50h		Display CPU type and speed
51h		Initialize EISA board
52h		Test keyboard
54h		Set key click if enabled
58h	2-2-3-1	Test for unexpected interrupts
59h		Initialize POST display service
5Ah		Display prompt "Press F2 to enter SETUP"
5Bh		Disable CPU cache
5Ch		Test RAM between 512 and 640 KB
60h		Test extended memory
62h		Test extended memory address lines
64h		Jump to User Patch1
66h		Configure advanced cache registers
67h		Initialize Multi Processor APIC
68h		Enable external and CPU caches
69h		Setup System Management Mode (SMM) area
6Ah		Display external L2 cache size
6Bh		Load custom defaults (optional)
6Ch		Display shadow-area message
6Eh		Display possible high address for UMB recovery
70h		Display error messages
72h		Check for configuration errors
76h		Check for keyboard errors
7Ch		Set up hardware interrupt vectors
7Eh		Initialize coprocessor if present
80h		Disable onboard Super I/O ports and IRQs
81h		Late POST device initialization
82h		Detect and install external RS232 ports
83h		Configure non-MCD IDE controllers
84h		Detect and install external parallel ports
85h		Initialize PC-compatible PnP ISA devices
86h		Re-initialize onboard I/O ports
87h		Configure Motherboard Configurable Devices (optional)
88h		Initialize BIOS Area
89h		Enable Non-Maskable Interrupts (NMIs)
8Ah		Initialize Extended BIOS Data Area
8Bh		Test and initialize PS/2 mouse

Code	Beeps	POST Routine Description
8Ch		Initialize floppy controller
8Fh		Determine number of ATA drives (optional)
90h		Initialize hard-disk controllers
91h		Initialize local-bus hard-disk controllers
92h		Jump to UserPatch2
93h		Build MPTABLE for multi-processor boards
95h		Install CD ROM for boot
96h		Clear huge ES segment register
97h		Fixup Multi Processor table
98h	1-2	Search for option ROMs. One long, two short beeps on checksum failure.
99h		Check for SMART drive (optional)
9Ah		Shadow option ROMs
9Ch		Set up Power Management
9Dh		Initialize security engine (optional)
9Eh		Enable hardware interrupts
9Fh		Determine number of ATA and SCSI drives
A0h		Set time of day
A2h		Check key lock
A4h		Initialize Typematic rate
A8h		Erase F2 prompt
AAh		Scan for F2 key stroke
ACh		Enter SETUP
A Eh		Clear Boot flag
B0h		Check for errors
B2h		POST done- prepare to boot operating system
B4h	1	One short beep before boot
B5h		Terminate QuietBoot (optional)
B6h		Check password (optional)
B9h		Prepare Boot
BAh		Initialize DMI parameters
BBh		Initialize PnP Option ROMs
BCh		Clear parity checkers
BDh		Display MultiBoot menu
BEh		Clear screen (optional)
BFh		Check virus and backup reminders
C0h		Try to boot with INT 19
C1h		Initialize POST Error Manager (PEM)
C2h		Initialize error logging
C3h		Initialize error display function
C4h		Initialize system error handler
C5h		PnPnd dual CMOS (optional)
C6h		Initialize notebook docking (optional)
C7h		Initialize notebook docking late
C8h		Force check (optional)
C9h		Extended checksum (optional)

Code	Beeps	POST Routine Description
D2h		Unknown interrupt

Code	Beeps	POST Routine Description
E0h		Initialize the chipset
E1h		Initialize the bridge
E2h		Initialize the CPU
E3h		Initialize the system timer
E4h		Initialize system I/O
E5h		Check force recovery boot
E6h		Checksum BIOS ROM
E7h		Go to BIOS
E8h		Set Huge Segment
E9h		Initialize Multi Processor
EAh		Initialize OEM special code
EBh		Initialize PIC and DMA
ECh		Initialize Memory type
EDh		Initialize Memory size
EEh		Shadow Boot Block
EFh		System memory test
F0h		Initialize interrupt vectors
F1h		Initialize Run Time Clock
F2h		Initialize video
F3h		Initialize System Management Mode
F4h	1	Output one beep before boot
F5h		Boot to Mini DOS
F6h		Clear Huge Segment
F7h		Boot to Full DOS

Index of Symptom-to-FRU Error Message

LCD-Related Symptoms

Symptom / Error	Action in Sequence
LCD backlight doesn't work LCD is too dark LCD brightness cannot be adjusted LCD contrast cannot be adjusted	Enter BIOS Utility to execute "Load Setup Default Settings", then reboot system. Reconnect the LCD connectors. Keyboard (if contrast and brightness function key doesn't work). LCD inverter ID LCD cable LCD inverter LCD System board
Unreadable LCD screen Missing pels in characters Abnormal screen Wrong color displayed	Reconnect the LCD connector LCD inverter ID LCD cable LCD inverter LCD System board
LCD has extra horizontal or vertical lines displayed.	LCD inverter ID LCD inverter LCD cable LCD System board

Indicator-Related Symptoms

Symptom / Error	Action in Sequence
Indicator incorrectly remains off or on, but system runs correctly	Reconnect the inverter board Inverter board System board

Power-Related Symptoms

Symptom / Error	Action in Sequence
Power shuts down during operation	Power source (battery pack and power adapter). See "Power System Check" on page 80. Battery pack Power adapter Hard drive & battery connection board System board
The system doesn't power-on.	Power source (battery pack and power adapter). See "Power System Check" on page 80. Battery pack Power adapter Hard drive & battery connection board System board
The system doesn't power-off.	Power source (battery pack and power adapter). See "Power System Check" on page 80. Hold and press the power switch for more than 4 seconds. System board

Power-Related Symptoms

Symptom / Error	Action in Sequence
Battery can't be charged	See "Check the Battery Pack" on page 83. Battery pack System board

PCMCIA-Related Symptoms

Symptom / Error	Action in Sequence
System cannot detect the PC Card (PCMCIA)	PCMCIA slot assembly System board
PCMCIA slot pin is damaged.	PCMCIA slot assembly

Memory-Related Symptoms

Symptom / Error	Action in Sequence
Memory count (size) appears different from actual size.	Enter BIOS Setup Utility to execute "Load Default Settings, then reboot system. DIMM System board

Speaker-Related Symptoms

Symptom / Error	Action in Sequence
In Windows, multimedia programs, no sound comes from the computer.	Audio driver Speaker System board
Internal speakers make noise or emit no sound.	Speaker System board

Power Management-Related Symptoms

Symptom / Error	Action in Sequence
The system will not enter hibernation	See "Save to Disk (S4)" on page 45. Keyboard (if control is from the keyboard) Hard disk drive System board
The system doesn't enter hibernation mode and four short beeps every minute.	Press Fn+ O and see if the computer enters hibernation mode. Touchpad Keyboard Hard disk connection board Hard disk drive System board
The system doesn't enter standby mode after closing the LCD	See "Save to Disk (S4)" on page 45. LCD cover switch System board
The system doesn't resume from hibernation mode.	See "Save to Disk (S4)" on page 45. Hard disk connection board Hard disk drive System board
The system doesn't resume from standby mode after opening the LCD.	See "Save to Disk (S4)" on page 45. LCD cover switch System board

Power Management-Related Symptoms

Symptom / Error	Action in Sequence
Battery fuel gauge in Windows doesn't go higher than 90%.	Remove battery pack and let it cool for 2 hours. Refresh battery (continue use battery until power off, then charge battery). Battery pack System board
System hangs intermittently.	Reconnect hard disk/CD-ROM drives. Hard disk connection board System board

Peripheral-Related Symptoms

Symptom / Error	Action in Sequence
System configuration does not match the installed devices.	Enter BIOS Setup Utility to execute "Load Default Settings", then reboot system. Reconnect hard disk/CD-ROM/diskette drives.
External display does not work correctly.	Press Fn+F5, LCD/CRT/Both display switching System board
USB does not work correctly	System board
Print problems.	Ensure the "Parallel Port" in the "Onboard Devices Configuration" of BIOS Setup Utility is set to Enabled. Onboard Devices Configuration Run printer self-test. Printer driver Printer cable Printer System Board
Serial or parallel port device problems.	Ensure the "Serial Port" in the Devices Configuration" of BIOS Setup Utility is set to Enabled. Device driver Device cable Device System board

Keyboard/Touchpad-Related Symptoms

Symptom / Error	Action in Sequence
Keyboard (one or more keys) does not work.	Reconnect the keyboard cable. Keyboard System board
Touchpad does not work.	Reconnect touchpad cable. Touchpad board System board

Modem-Related Symptoms

Symptom / Error	Action in Sequence
Internal modem does not work correctly.	Modem phone port modem combo board System board

NOTE: If you cannot find a symptom or an error in this list and the problem remains, see "Undetermined Problems" on page 96.

Intermittent Problems

Intermittent system hang problems can be caused by a variety of reasons that have nothing to do with a hardware defect, such as: cosmic radiation, electrostatic discharge, or software errors. FRU replacement should be considered only when a recurring problem exists.

When analyzing an intermittent problem, do the following:

1. Run the advanced diagnostic test for the system board in loop mode at least 10 times.
2. If no error is detected, do not replace any FRU.
3. If any error is detected, replace the FRU. Rerun the test to verify that there are no more errors.

Undetermined Problems

The diagnostic problems does not identify which adapter or device failed, which installed devices are incorrect, whether a short circuit is suspected, or whether the system is inoperative.

Follow these procedures to isolate the failing FRU (do not isolate non-defective FRU).

NOTE: Verify that all attached devices are supported by the computer.

NOTE: Verify that the power supply being used at the time of the failure is operating correctly. (See "Power System Check" on page 80.):

1. Power-off the computer.
2. Visually check them for damage. If any problems are found, replace the FRU.
3. Remove or disconnect all of the following devices:
 - q Non-Acer devices
 - q Printer, mouse, and other external devices
 - q Battery pack
 - q Hard disk drive
 - q DIMM
 - q CD-ROM/Diskette drive Module
 - q PC Cards
4. Power-on the computer.
5. Determine if the problem has changed.
6. If the problem does not recur, reconnect the removed devices one at a time until you find the failing FRU.
7. If the problem remains, replace the following FRU one at a time. Do not replace a non-defective FRU:
 - q System board
 - q LCD assembly

Jumper and Connector Locations

Top View

TOP view

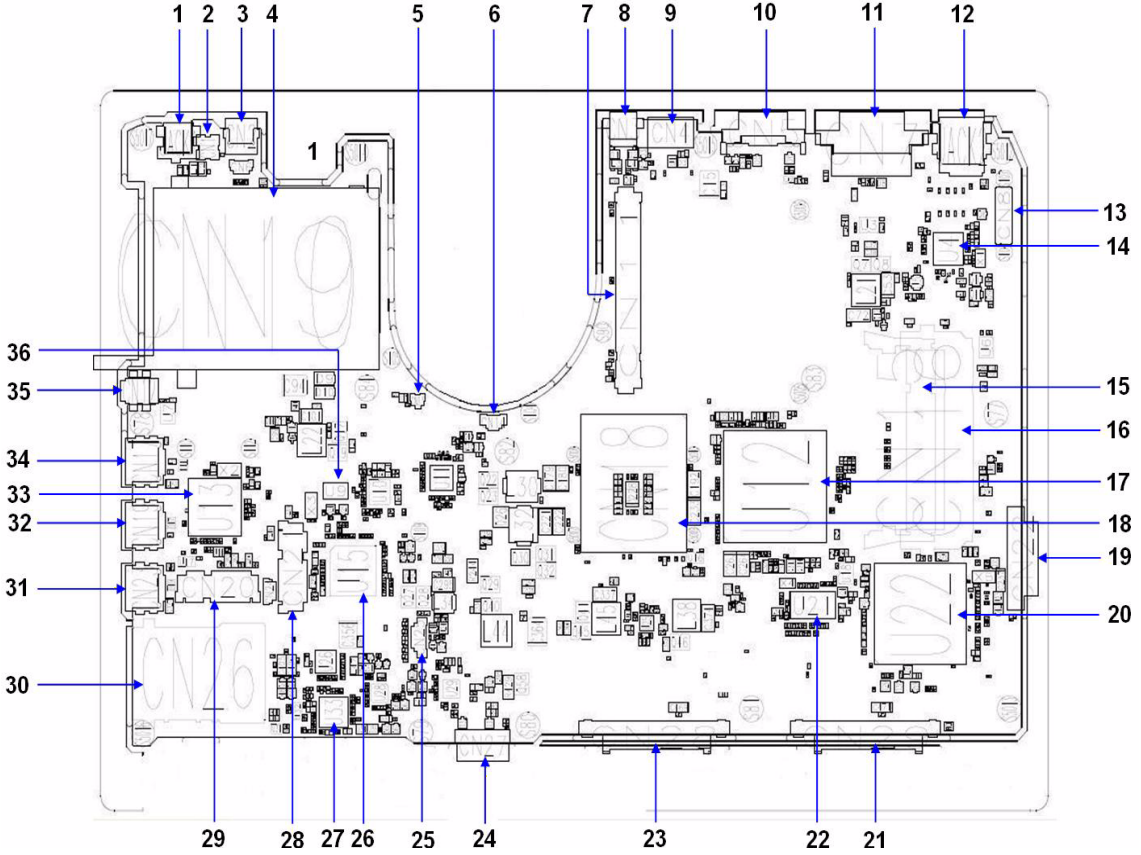

Cheela 2.0 M/B layout and connector location TOP view					
No.	Name	Description	No.	Name	Description
1	JACK1	Power JSCK	19	CN22	ODD Connector
2	CN1	TV Antenna Connector	20	U22	South Bridge
3	CN2	S-Video Connector	21	CN29	SATA HDD Connector
4	CN10	PCMCIA Connector	22	U21	Clock Generator
5	CN13	RTC Battery Connector	23	CN28	SATA HDD Connector
6	CN14	Fan Connector	24	CN27	Battery Connector
7	CN11	MXM Socket	25	CN25	Speaker Connector
8	CN3	AV-In connector	26	U15	KBC
9	CN4	HDMI Connector	27	U33	Audio Codec
10	CN5	VGA Port	28	CN21	MINI card Connect
11	CN7	DVI Connector	29	CN20	MINI card Connect
12	JACK2	RJ45 LAN Connector	30	CN26	5 in 1 Card reader
13	CN8	I/O board Connector	31	CN23	USB Connector
14	U4	LAN Controller	32	CN19	USB Connector
15	CN15	RAM Socket	33	U13	Carbus/Card Reader/1394 Controller
16	CN16	RAM Socket	34	CN17	USB Connector
17	U12	North Bridge	35	CN12	1394 Connector
18	CN18	CPU Socket	36	U9	BIOS EEPROM

Bottom View

Bottom view

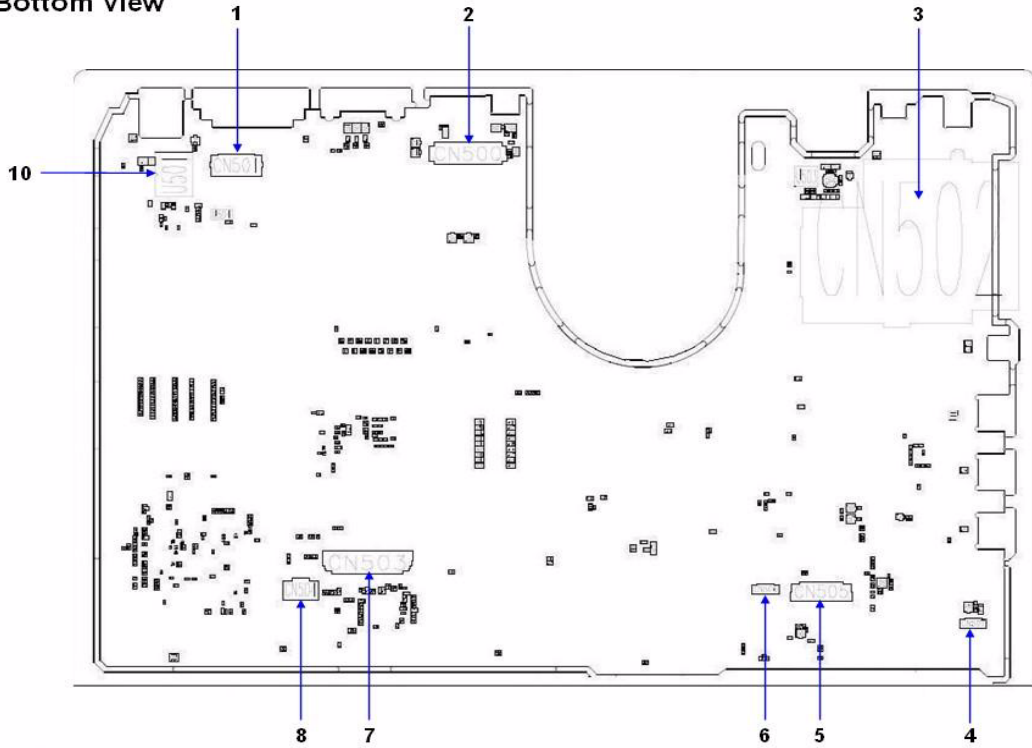

Bottom view connector description

Cheela 2.0 M/B layout and connector location		
Bottom view		
No.	Name	Description
1	CN501	Hot Key Board Connector
2	CN500	LCM Connector
3	CN502	Express Card
4	CN507	Bluetooth Connector
5	CN505	Audio Board Connector
6	CN506	CIR Connector
7	CN503	KB Connector
8	CN504	Touch Pad Connector
9	U501	LAN Transformer

FRU (Field Replaceable Unit) List

This chapter gives you the FRU (Field Replaceable Unit) listing in global configurations of Aspire 9920. Refer to this chapter whenever ordering for parts to repair or for RMA (Return Merchandise Authorization).







Please note that WHEN ORDERING FRU PARTS, you should check the most up-to-date information available on your regional web or channel. For whatever reasons a part number change is made, it will not be noted on the printed Service Guide. For ACER AUTHORIZED SERVICE PROVIDERS, your Acer office may have a DIFFERENT part number code from those given in the FRU list of this printed Service Guide. You MUST use the local FRU list provided by your regional Acer office to order FRU parts for repair and service of customer machines.

NOTE: To scrap or to return the defective parts, you should follow the local government ordinance or regulations on how to dispose it properly, or follow the rules set by your regional Acer office on how to return it.





Aspire 9800 Exploded Diagram

Category	No.	Part Name and Description	Acer Part No.
ADAPTER			
		ADAPTER 135W 3PIN DELTA SADP-135EB BAF BLUE1.7X5.5X11 LF	AP.13501.006
		ADAPTER 135W 19V 3PIN LITE-ON PA-131-08 RI LF	AP.13503.006
BATTERY			
		BATTERY PACK SANYO LI-ION 8 CELL2.4, 4800MAH	BT.00803.019
		BATTERY PACK SONY LI-ION 8CELL2.4, 4800MAH	BT.00804.016
BOARD			
		BLUETOOTH BOARD FOXCONN T60H928.01	54.AAMVN.004
		MODEM BOARD FOXCONN T60M955.00	54.TCXVN.001
		MINI WIRELESS BOARD 802.11 A/B/G MOW2 INTEL MM872659	KI.GLN01.002
		MINI WIRELESS BOARD 802.11 A/B/G ROW INTEL MM874511	KI.GLN01.003
		MINI WIRELESS BOARD 802.11 A/B/G JP INTEL MM874740	KI.GLN01.004
		MINI WIRELESS LAN BOARD 802.11BG INTEL WM3945AGBG	KI.GLN01.005
		WIRELESS LAN BOARD 802.11AGN INTEL 4965AGN MOW1 MINI PCI	KI.KDN01.001
		WIRELESS LAN BOARD 802.11AGN INTEL 4965AGN MOW2 MINI PCI	KI.KDN01.002
		MINI WIRELESS BOARD 802.11 A/B/G MOW1 INTEL MM872612	KI.GLN01.001
		WIRELESS LAN BOARD 802.11AGN INTEL 4965AGN ROW MINI PCI	KI.KDN01.003
		WIRELESS LAN BOARD 802.11AG INTEL 4965AG MOW1 MINI PCI	KI.KDN01.006



Category	No.	Part Name and Description	Acer Part No.
		WIRELESS LAN BOARD 802.11ABG INTEL 4965AG MOW2 MINI PCI	KI.KDN01.007
		WIRELESS LAN BOARD 802.11AG INTEL 4965AG ROW MINI PCI	KI.KDN01.008
		VGA CARD nVidia NB8P-GS DDRII 512MB 400MHz 32*16 MXM II W/ HDCP (IEC VBIOS)	55.AKE0N.004
		I/O BOARD	55.AKE0N.002
		LAUNCH BOARD (Above image is top view; below image is bottom view)	55.AKE0N.003
		MEDIA BOARD (Above image is top view; below image is bottom view)	55.AAMVN.013
		AUDIO BOARD	55.AKE0N.001
		TOUCHPAD BOTTON BOARD	55.AAMVN.005
CABLE			
		POWER CORD 3PIN USA	27.AAMVN.001
		POWER CORD 3PIN EUR	27.AAMVN.002
		POWER CORD AUSTRALIA W/LABEL	27.AAMVN.003
		POWER CORD 3PIN UK	27.AAMVN.004
		POWER CORD 3PIN CHINA	27.AAMVN.005
		POWER CORD 3PIN SWISS	27.AAMVN.006

Category	No.	Part Name and Description	Acer Part No.
		POWER CORD SOUTH AFRICA (AIL)	27.AAMVN.007
		POWER CORD 3PIN SOUTH AFRICA	27.AAMVN.008
		POER CORD 3PIN ITALIAN	27.AAMVN.009
		POWER CORD 3PIN DENMARK	27.AAMVN.010
		POWER CORD ISRAEL	27.AAMVN.011
		SMART CARD READER WITH CABLE	60.TLK0N.003
		HOT KEYBOARD CABLE	50.AAMVN.003
		MEDIA BOARD CABLE	50.AAMVN.004
		IR CABLE 8PIN (VERSION A05)	50.AAMVN.031
		AUDIO BOARD CABLE	50.AKE0N.001
		BUTTON BOARD CABLE 6 PINS	50.AAMVN.006
		BUTTON BOARD CABLE 12 PINS	50.AAMVN.007
		MODEM CABLE WITH RJ11 CONNECTOR	50.AAMVN.010
CASE/COVER/BRACKET ASSEMBLY			





Category	No.	Part Name and Description	Acer Part No.
		LOWER CASE	60.AAMVN.001
		UPPER CASE	60.AKE0N.001
		MIDDLE COVER	60.AAMVN.003
		ASSY THERMAL COVER	60.AAMVN.004
		SUPPORT COVER	60.AAMVN.005
		HDD COVER	42.AAMVN.001

Category	No.	Part Name and Description	Acer Part No.
		TOUCHPAD FRAME	42.AAMVN.002
		MINI DUMMY CARD	42.AAMVN.003
		PCMCIA DUMMY CARD	42.AAMVN.004
		TOUCHPAD BRACKET (Note: The ACTUAL spare part: touchpad bracket does NOT contain touchpad bracket gesket. However the touchpad bracket image here has the touchpad bracket gesket. If you need to replace the touchpad bracket, please take off the gesket from old touchpad bracket and then stick them to new touchpad bracket..	33.AAMVN.001
CPU/PROCESSOR			
		CPU INTEL CORE2DUAL T7100 PGA 1.8G 2M 800	KC.71001.DTP
		CPU INTEL CORE2DUAL T7300 PGA 2.0G 4M FSB800	KC.73001.DTP
		CPU INTEL CORE2DUAL T7500 PGA 2.2G 4M FSB800	KC.75001.DTP
		CPU INTEL CORE2DUAL T7700 PGA 2.4G 4M FSB800	KC.77001.DTP
COMBO MODULE			

Category	No.	Part Name and Description	Acer Part No.
		ASSEMBLY HD DVD ROM 1X MODULE	6M.AKE0N.002
		OPTICAL BRACKET	33.AAMVN.002
		HD DVD BEZEL	42.AAMVN.016
		HD 1X DVD ROM TOSHIBA TS-L802A LF W/O BEZEL FW:AC06 FOR VISTA	KV.00101.003
		ASSEMBLY SUPLER MULTI MODULE 8X	6M.AKE0N.001
		OPTICAL BRACKET	33.AAMVN.002
		SUPER MULTI BEZEL GBASE	42.AAMVN.013
DVD-RW DRIVE			
		DVD-RW DRIVE 8X SUPER MULTI TOSHIBA TS-L632D W/O BEZEL	KU.00809.019
		DVD-RW DRIVE 8X SUPER MULTI GBASE PHILIPS DS-8A1P LF W/O BEZEL	KU.00809.010

Category	No.	Part Name and Description	Acer Part No.
		DVD-RW DRIVE 8X SUPER MULTI GBASE HLDS GSA-T20N LF W/O BEZEL	KU.0080D.027
FAN			
	FAN	BLOWER.SET,AXIAL,5V,0.15A,3500RP M,78.4X7	23.AAMVN.003
HDD/HARD DISK DRIVER			
		HDD 80GB 5400RPM SATA HGST HTS541680J9SA00 SURUGA-B LF F/ W: C70P	KH.08007.021
		HDD 80GB 5400RPM SATA WD WD800BEVS-22RST0 ML80 LF F/ W:04.01G04	KH.08008.033
		HDD 120GB SATA 5400RPM SEAGATE ST9120822AS VENUS LF F/W:3.ALD	KH.12001.031
		HDD 120GB 5400RPM SATA TOSHIBA MK1237GSX GEMINI BS LF F/ W:DL130J	KH.12004.006
		HDD 120GB 5400RPM SATA HGST HTS541612J9SA00 SURUGA-B LF F/ W:C70P	KH.12007.010
		HDD 120GB 5400RPM SATA WD WD1200BEVS-22RST0 ML80 LF	KH.12008.018
		HDD 160GB 5400RPM SATA SEAGATE ST9160821AS VENUS LF FW: 3.ALD	KH.16001.026
		HDD 160GB 5400RPM SATA TOSHIBA MK1637GSX GEMINI BS LF F/W: DL030J	KH.16004.001
		HDD 160GB 5400RPM SATA HITACHI HTS541616J9SA00 SURUGA-B LF F/ W:C70P	KH.16007.011
		HDD 160GB 5400RPM SATA WD WD1600BEVS-22RST0 ML80 LF	KH.16008.019
		HDD 250GB 5400RPM SATA WD WD2500BEVS-22UST0 ML125 LF F/ W:01.01A01	KH.25008.018

Category	No.	Part Name and Description	Acer Part No.
		HDD INSULATOR	42.AAMVN.005
HEATSINK			
		VGA HEATSINK	60.AKE0N.003
		CPU HEATSINK	60.AKE0N.002
		VGA HEATSINK FINGER	33.AKE0N.003
		CPU HEATSINK FINGER	33.AKE0N.002
KEYBOARD			
		KEYBOARD 17KB-FV2 105KS BLACK US INTERNATIONAL NO SPONGE	KB.INT00.105
		KEYBOARD 17KB-FV2 106KS BLACK UK NO SPONGE	KB.INT00.107
		KEYBOARD 17KB-FV2 106KS BLACK SWISS/G NO SPONGE	KB.INT00.110
		KEYBOARD 17KB-FV2 105KS BLACK THAILAND NO SPONGE	KB.INT00.109
		KEYBOARD 17KB-FV2 106KS BLACK PORTUGUESE NO SPONGE	KB.INT00.117
		KEYBOARD 17KB-FV2 105KS BLACK ARABIC/ENGLISH NO SPONGE	KB.INT00.137
		KEYBOARD 17KB-FV2 106KS BLACK CZECH NO SPONGE	KB.INT00.132
		KEYBOARD 17KB-FV2 106KS BLACK DANISH NO SPONGE	KB.INT00.131
		KEYBOARD 17KB-FV2 106KS BLACK ITALIAN NO SPONGE	KB.INT00.122
		KEYBOARD 17KB-FV2 106KS BLACK FRENCH NO SPONGE	KB.INT00.128
		KEYBOARD 17KB-FV2 106KS BLACK GERMAN NO SPONGE	KB.INT00.127
		KEYBOARD 17KB-FV2 105KS BLACK US ISRAEL NO SPONGE	KB.INT00.123
		KEYBOARD 17KB-FV2 105KS BLACK GREEK NO SPONGE	KB.INT00.126
		KEYBOARD 17KB-FV2 106KS BLACK CANADIAN FRENCH NO SPONGE	KB.INT00.134
		KEYBOARD 17KB-FV2 106KS BLACK NORWEGIAN NO SPONGE	KB.INT00.119
		KEYBOARD 17KB-FV2 106KS BLACK HUNGARIAN NO SPONGE	KB.INT00.125

Category	No.	Part Name and Description	Acer Part No.
		KEYBOARD 17KB-FV2 105KS BLACK RUSSIAN NO SPONGE	KB.INT00.116
		KEYBOARD 17KB-FV2 106KS BLACK TURKISH NO SPONGE	KB.INT00.108
		KEYBOARD 17KB-FV2 106KS BLACK SWEDISH NO SPONGE	KB.INT00.111
		KEYBOARD 17KB-FV2 106KS BLACK BELGIUM NO SPONGE	KB.INT00.136
		KEYBOARD 17KB-FV2 106KS BLACK BRAZILIAN PORTUGUESE NO SPONGE	KB.INT00.135
		KEYBOARD 17KB-FV2 106KS BLACK SLOVENIAN NO SPONGE	KB.INT00.113
LCD			
		LCD MODULE 20.1" WSXGA+ AU GLARE W/ANTENNA & CCD 0.3M	6M.AKE0N.003
		LCD CABLE 20.1IN. AUO W/CCD CABLE	50.AF60N.001
		WIRELESS ANTENNA FOR 20.1IN.	25.AAMVN.002
		CCD MODULE 0.3M BISON BN30V6O714320	57.TLT0N.001
		CCD BRACKET	33.AAZ0N.001
		LCD BEZEL 20" W/LOGO	60.AKE0N.004
		LCD COVER 20" W/LOGO	60.AKE0N.005
		LCD BARCKET L W/HINGE 20.1IN.	33.AAMVN.007
		LCD BARCKET R W/HINGE 20.1IN.	33.AAMVN.008

Category	No.	Part Name and Description	Acer Part No.
		LCD 20.1IN. WSXGA+ AUO M20EW02 V9 5MS GLARE	LK.20105.016
MAINBOARD			
		MAINBOARD AS9920G INTEL PM965 ICH8M LF SATA/GIGALAN	MB.AJH0B.001
MEMORY			
		SO-DIMM DDRII667 512MB ECC INFINEON HYS72T64000HU-3S-A LF	KN.51203.032
		SO-DIMM DDRII667 512MB SAMSUNG M470T6554EZ3-CE6 LF	KN.5120B.023
		SO-DIMM DDRII667 512MB HYNIX HYMP564S64CP6-Y5 LF (.08UM)	KN.5120G.019
		SO-DIMM DDRII667 1GB NANYA NT1GT64U8HB0BN-3C LF (0.09UM)	KN.1GB03.014
		SO-DIMM DDRII667 1GB SAMSUNG M470T2953EZ3-CE6 LF	KN.1GB0B.011
		SO-DIMM DDRII667 1GB HYNIX HYMP512S64CP8-Y5 LF	KN.1GB0G.006
MISCELLANEOUS			
		LCD RUBBER CUSHION	47.AAMVN.001
		SPEAKER BUMPER	47.AAMVN.002
		VGA BRACKET TOP	33.AKE0N.004
		EXTERNAL ANTENNA SET	25.AAMVN.004
		VGA BRACKET BOTTOM	33.AKE0N.005
		NTSC ADAPTER	25.AKE0N.002
		RF ADAPTER	25.AKE0N.001
ACCESSORY			
		EXTERNAL ANTENNA SET	25.AAMVN.004
		REMOTE CONTROLLER RC803V TC WITH DANULE SNOWFLAKE	LZ.20400.009
		REMOTE CONTROLLER RC803V EN WITH DANULE SNOWFLAKE	LZ.20400.011
		REMOTE CONTROLLER RC803V EU WITH DANULE SNOWFLAKE	LZ.20400.008
		REMOTE CONTROLLER RC803V SC WITH DANULE SNOWFLAKE	LZ.20400.010

Category	No.	Part Name and Description	Acer Part No.
ACCESSORY			
		MICROPHONE	23.AAMVN.001
		SPEAKER SET	23.AAMVN.002
SCERW			
		SCREW	86.AAMVN.001
		SCREW	86.AAMVN.002
		SCREW	86.AAMVN.003
		SCREW	86.AAMVN.004
		SCREW	86.AAMVN.005
		SCREW	86.AAMVN.006
		SCREW	86.AAMVN.007
		SCREW	86.AAMVN.008
		SCREW	86.AAMVN.009
		SCREW	86.AAMVN.010
		SCREW	86.AAMVN.011
		SCREW	86.AAMVN.012
		SCREW 4.5Dx0.8T NI-PATCH	86.AKE0N.001