

# Four-State Dairy Nutrition and Management Conference

June 9 & 10, 2021

**Virtual Conference**

**Cooperative Extension for:**

Iowa State University

University of Illinois

University of Minnesota

University of Wisconsin



# 2021

Volume 31



*Thank You 2021 Sponsors*

**Gold**

Ag Processing, Inc.  
Alltech  
Arm & Hammer Animal and Food Production  
Central Life Sciences  
D&D Ingredient Distributors  
Dairyland Laboratories, Inc.  
Diamond V  
Elanco Animal Health  
Flint Hills Resources/NexPro  
GLC Minerals  
Kemin Animal Nutrition & Health  
Milk Specialties Global  
Papillon Agricultural Co.  
Phibro Animal Health Corp.  
Phileo by Lesaffre  
Pioneer  
Quality Roasting, Inc.  
Virtus Nutrition  
Westway Feed Products

**Silver**

Amelikor  
Balchem Animal Nutrition & Health  
Huvepharma  
Lallemand Animal Nutrition  
Novita Nutrition  
NutriQuest  
Zinpro Corporation

**Bronze**

Alforex Seeds  
Canolamazing  
Kent Nutrition Group  
Multimin USA  
Natural Biologics, Inc.  
Origination, LLC

# Wednesday - June 9, 2021

## General Session

“Nutrient Requirements of Dairy Cattle”

9:30 - 10:30 - Questions and Discussion

Page

Update on Estimating Energy Supply and Energy Requirements for Dairy Cows .....1  
Dr. Bill Weiss, Ohio State University

A New System for Determining Nutrient Requirements of Young Dairy Calves .....9  
Dr. Jim Drackley University of Illinois

Essential Amino Acid Supply and Use for Lactating Dairy Cattle .....15  
Dr. Mark Hanigan, Virginia Tech

10:30 - 12:00 - Questions and Discussion

Panel: Guidelines for Feeding Cows in the Future

Dr. Mike Hutjens, University of Illinois

Dr. Mark Hanigan, Virginia Tech

Dr. Bill Weiss, Ohio State University

Dr. Jim Drackley, University of Illinois

Nutritionists:

Lee Klockner, Ag Partners .....20

Dr. Brian Gerloff, Renaissance Nutrition .....22

## Pre-Recorded Breakout Sessions I

Interpretation and Use of New Passive Immunity Guidelines for Newborn Dairy Calves .....27  
Dr. Jim Drackley, University of Illinois

Mineral Availability to Dairy Cows .....30  
Dr. Bill Weiss, the Ohio State University

Balancing Lactating Cow Diets or Amino Acids: Using Efficiencies .....37  
Dr. Mark Hanigan, Virginia Tech

Optimizing Use of Sexed Semen in Dairy Herds Strategies to Optimize Fertility with Sexed .....40  
Semen in Primiparous Holstein Cows and Nulliparous Holstein Heifers  
Dr. Paul Fricke, University of Wisconsin

Nutritional Strategies for Alleviating Heat Stress in Dairy Cows .....67  
Dr. Phil Cardoso, University of Illinois

Mindset Tactics for Brain Health and Behavioral Well-Being .....75  
Dr. Larry Tranel, Iowa State University

# Thursday, June 10, 2021

## General Session

“Feed Efficiency”

9:30 - 10:30 - Questions and Discussion

Hypocalcemia can be Reduced. Steps That We Know will Work .....88  
Dr. Jesse Goff, Iowa State University

Perturbations in Calcium Around Calving .....96  
Dr. Laura Hernandez, University of Wisconsin

10:30 - 12:00 - Questions and Discussion

Using Reduced-Lignin Alfalfa in Lactating Dairy Cow Diets .....115  
Dr. Ken Kalscheur, USDA Forage Research Center

Corn Silage Fiber Digestibility - Why Do Cows Care?.....121  
Dr. Luiz Ferraretto, University of Wisconsin

**Pre-Recorded Breakout Sessions II**

Dairy Heifer Coccidiosis Research With Novel Egg Antibodies and Essential Oils .....127  
Dr. Matt Akins, University of Wisconsin

Opportunities to Combine Genetics with New Technologies to Improve Feed Efficiency in Dairy Cattle .....133  
Dr. James Koltes, Iowa State University

Using Summer to Winter Ratios to Evaluate Summer Slump .....138  
Dr. Derek Nolan, University of Illinois

Lackluster Calves – Using Lung Ultrasound to Identify a “Calories-out” Problem.....146  
Dr. Terri Ollivett, University of Wisconsin

What is Happening in the Gut in the Scouring Calf and Effective Fluid Therapy .....168  
Dr. Jesse Goff, Iowa State University

The Use of Canola Meal in the Diets of Early Lactation Dairy Cows .....177  
Dr. Ken Kalscheur, USDA Forage Research Center

Speaker’s Bios.....181



# Update on Estimating Energy Supply and Energy Requirements for Dairy Cows

**Dr. Bill Weiss**  
**Ohio State University**



# Update on Estimating Energy Supply and Energy Requirements for Dairy Cows

Bill Weiss  
Department of Animal Sciences (retired)  
Ohio Agricultural Research and Development Center  
The Ohio State University, Wooster 44691

## Summary

Estimated energy balance is an essential output of ration formulation/evaluation software. However, energy balance is calculated from estimated energy intake and estimated energy requirements, both of which are exceedingly difficult to estimate accurately. The most common energy system used in the U.S. is the net energy-lactation (NEL) system. Theoretically this accounts for energy losses via feces, urine, gas (mostly ruminal methane) and heat increment. Fecal energy (averages about 33% of gross energy) and heat increment (averages about 20% of gross energy) are the two largest losses and are the most difficult to estimate accurately. About 25 years ago, we developed an equation to estimate TDN of feeds using commonly measured feed components. The equation was substantially modified in 1992 (Weiss, et al., 1992), and in 2001 it was incorporated into the NRC but was altered to estimate digestible energy (DE) rather than TDN. After years of use, weaknesses have been identified and we modified the equation again in 2018 (Weiss and Tebbe, 2018). The major modifications include replacing nonfiber carbohydrate (NFC) with starch and residual organic matter (ROM). This allows using feed specific starch digestibility coefficients and because ROM is a uniform fraction, ROM from all feeds have the same digestibility coefficient (96%). The digestibility coefficient for fatty acids was changed to 74% based on a large database and lastly the metabolic fecal energy term was modified. New equations have been derived to account for the effects of intake (de Souza, et al., 2018) and dietary starch (Ferraretto, et al., 2013) on DE and those could replace the discount factor used by NRC (2001) which over discounted many diets. Overall, these changes should increase the accuracy of estimating dietary DE. Additional factors that are known to affect digestibility such as dietary concentrations of certain minerals and crude protein need to be incorporated into DE equations. Previously, metabolizable energy (ME) was calculated directly from DE using a regression equation. However, this approach overestimated the ME concentration of diets with excess CP and likely overestimated the ME in high fiber diets. A better approach is to estimate methane production using an equation (e.g., (Nielsen, et al., 2013) and estimate urine energy from estimated urinary nitrogen output (Morris, et al.). These changes should make estimated ME more accurate. The area that has had essentially no improvements is the conversion of ME to NEL. Moraes et al. (2015) re-evaluated older data and derived a slightly different average efficiency (0.66) that can be used to convert ME to NEL. However, this is still a constant which brings into question the value of using NEL rather than ME.

On the requirement side of the equation, other than changing the efficiency of converting ME to NEL from 0.64 to 0.66, current data suggest that the NEL requirements for lactation and gestation are largely adequate. However, several studies have indicated that the equation for the maintenance requirement in NRC (2001) which has been in use since about 1982 likely underestimates the requirement for today's cows. Averaging across several studies, the current equation may underestimate maintenance requirement by an average of about 25%. This will significantly affect total energy requirements for low producing cows and dry cows but will have a relatively small effect on total energy requirements for high producing cows. Improvements in estimating energy supply and energy requirements will increase the accuracy of estimating energy balance of cows which should result in better diets.

See following slide set for details.

## References

- de Souza, R. A., R. J. Tempelman, M. S. Allen, W. P. Weiss, J. K. Bernard, and M. J. VandeHaar. 2018. Predicting nutrient digestibility in high-producing dairy cows. *J Dairy Sci.* 101:1123-1135. Online. Available: <https://doi.org/10.3168/jds.2017-13344>.
- Ferraretto, L. F., P. M. Crump, and R. D. Shaver. 2013. Effect of cereal grain type and corn grain harvesting and processing methods on intake, digestion, and milk production by dairy cows through a meta-analysis. *J Dairy Sci.* 96:533-550. Online. Available: <https://doi.org/10.3168/jds.2012-5932>.
- Moraes, L. E., E. Kebreab, A. B. Strathe, J. Dijkstra, J. France, D. P. Casper, and J. G. Fadel. 2015. Multivariate and univariate analysis of energy balance data from lactating dairy cows. *J Dairy Sci.* 98:4012-4029. Online. Available: <https://doi.org/10.3168/jds.2014-8995>.

- Morris, D. L., J. L. Firkins, C. Lee, W. P. Weiss, and P. J. Kononoff. Relationship between urinary energy and urinary nitrogen or carbon excretion in lactating Jersey cows. *J Dairy Sci.* Online. Available: <https://doi.org/10.3168/jds.2020-19684> (in press)
- Nielsen, N. I., H. Volden, M. Åkerlind, M. Brask, A. L. F. Hellwing, T. Storlien, and J. Bertilsson. 2013. A prediction equation for enteric methane emission from dairy cows for use in NorFor. *Acta Agriculturae Scand Section A — Anim Sci.* 63:126-130. Online. Available: <https://doi.org/10.1080/09064702.2013.851275>.
- Weiss, W. P., H. R. Conrad, and N. R. S. Pierre. 1992. A theoretically-based model for predicting total digestible nutrient values of forages and concentrates. *Anim. Feed Sci. Technol.* 39:95-110.
- Weiss, W. P. and A. W. Tebbe. 2018. Estimating digestible energy values of feeds and diets and integrating those values into net energy systems. *Trans Anim Sci.* 3(3):953-961. Online. Available: <https://doi.org/10.1093/tas/txy119>.

## Update on Estimating Supply and Requirements of Energy

Bill Weiss, Animal Sciences



Ohio Agricultural Research and Development Center

1

## Energy nutrition must be looked at as a system

Estimated energy supply is calibrated against requirements (or vice versa)

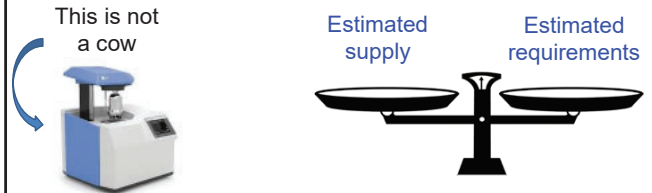

2

## Approach based on classical energy system

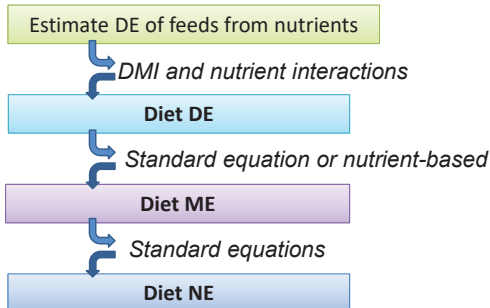

3

## Range in Diet Energy Losses

(Weiss lab, Wilkerson et al., 1995; 1997)

Mean Losses (% of GE)	
Urinary: 3.5%	Fecal: 33%
Methane: 4.8%	HI: 21.5%

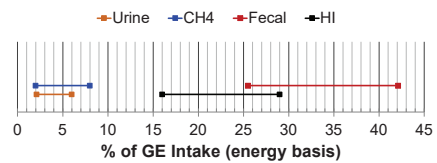

4

## Estimating Feed/Diet DE Values

### Old Summative Equation

$$DE = dCP (CP * e^{-0.012 * ADIN}) + dNDF (NDF * (0.75 * NDF - Lig) * (1 - (L/NDF)^{0.67}) \text{ or } NDF * IVNDFD - 48h) + dNFC (PAF * NFC) \text{ PAF constant within feed} + dFA (FA * 0.92 \text{ or } (EE - 1) * 0.92) - MFE (0.31 \text{ Mcal/kg})$$

$\Delta H$ , Mcal/kg

CP = 5.6; NFC = 4.2; NDF = 4.2; FA = 9.4; MFE = 4.4

5

## Summative Equation (2019 version)

$$DE = [(RDP + RUP * dRUP) \text{ or } CP * e^{-0.012 * ADIN}] * 0.056 + (NDF * \{0.75 * NDF - Lignin * [1 - (L/NDF)^{0.67}]\}) * 0.042 \text{ or } [a * IVNDFD(48 h) - b] + (\text{Starch} * \text{Feed Constant}) * 0.042 + (0.74 * FA) * 0.094 \text{ (adjustments for supplements)} + (0.96 * ROM) * 0.04 \text{ (ROM = 100 - NDF - CP - Starch - ash - FA)} - 0.31 \text{ Mcal/kg (metabolic fecal energy)}$$

Then adjust for **associative effects and DMI**, subtract est. methane and urinary energy, multiply by k and get NEL

6



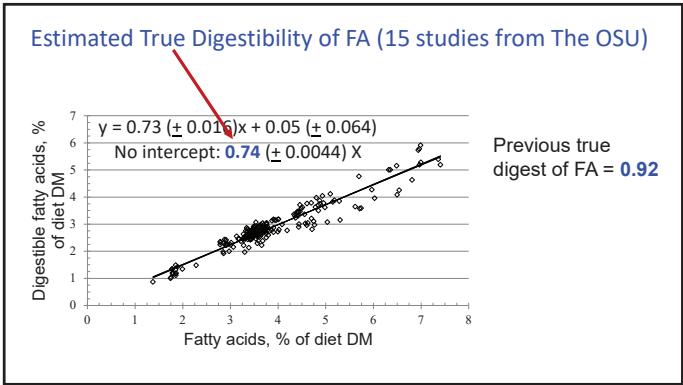

7

### Energy from NFC: Improved

**NFC = Starch + Everything else (ROM)**

Sugars, organic acids, sol fiber, glycerol, waxes . . .

#### Benefits

1. ROM smaller diet fraction than NFC (8-24%) (35-45%)
2. Starch is a routine assay
3. Large database on starch digestibility

8

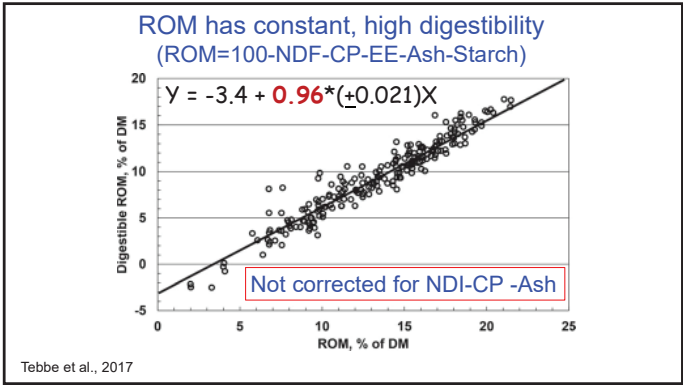

9

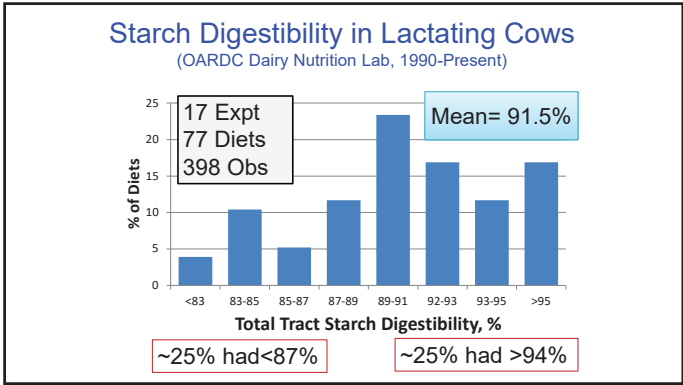

10

### Variation in starch digestibility

- In 50% of diets, using mean = >2% DE error (~1.5 kg of milk)
- Need a **validated** lab assay to estimate total tract starch digest
- Many sources of variation are known and semi-quantified
  - Grain type
  - Particle size
  - Flake density
  - Moisture content
  - Maturity of corn silage

11

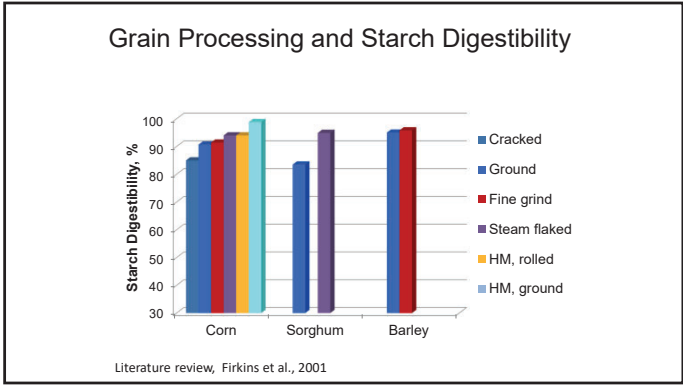

12

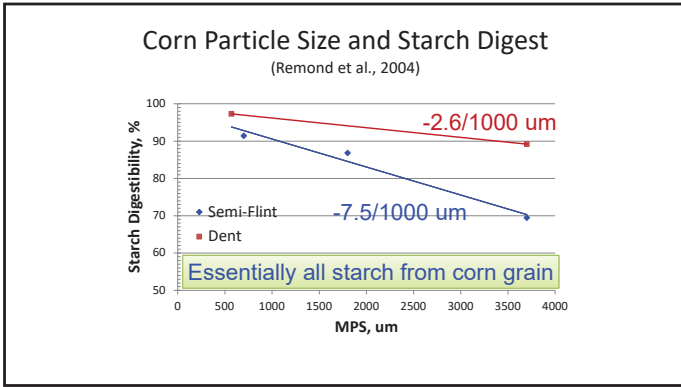

13

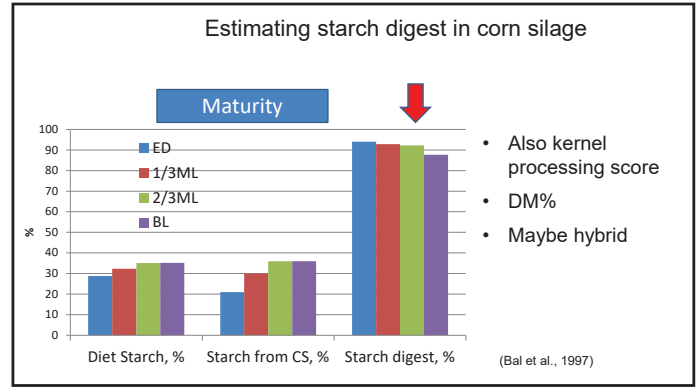

14

### Estimating NDF Digestibility

1. Lignin-based: lack of sensitivity
2. Kinetic-based: assay precision, variability within feeds
3. IVNDFD: assay precision, variability within feeds, equation accuracy (IVNDFD ≠ in vivo)

- All methods lack vigorous evaluation
- Feed vs. TMR
- Interactions with diet and DMI

15

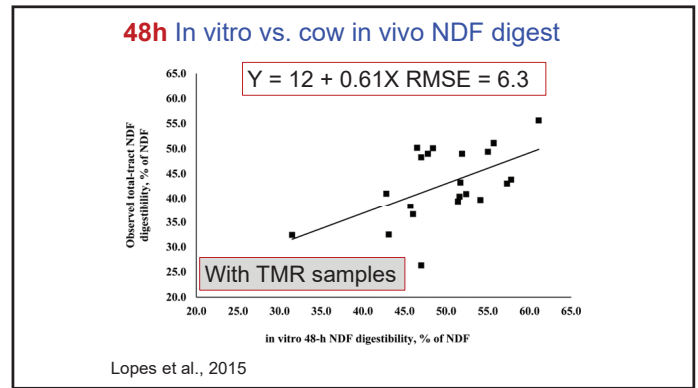

16

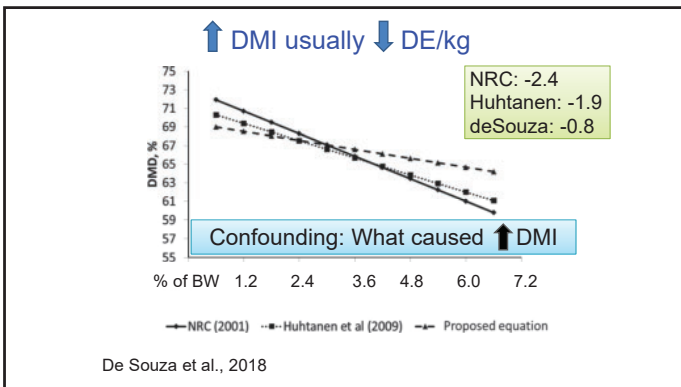

17

### Associative and Other Effects

- NDF digestibility
  - ↑ Starch% = ↓ Digestibility
  - ↑ CP/RDP% = ↑ Digestibility
  - ↑ DCAD = ↑ Digestibility

Interactions and confounding ???

18

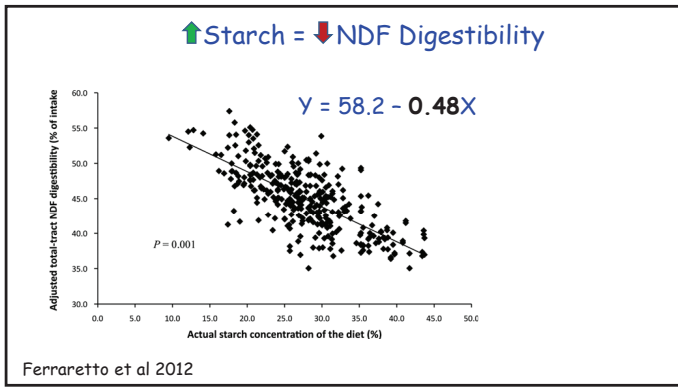

19

### Need to Make Additional Adjustments of Digestibility

1. Additional diet factors to incorporate
  - CP, RDP, DCAD, S, sugars ...
2. More interactions
  - DMI x diet factors
  - Nutrient x nutrient interactions
3. Management factors
  - Feeding frequency, crowdedness, ...

Lee et al., 2011

20

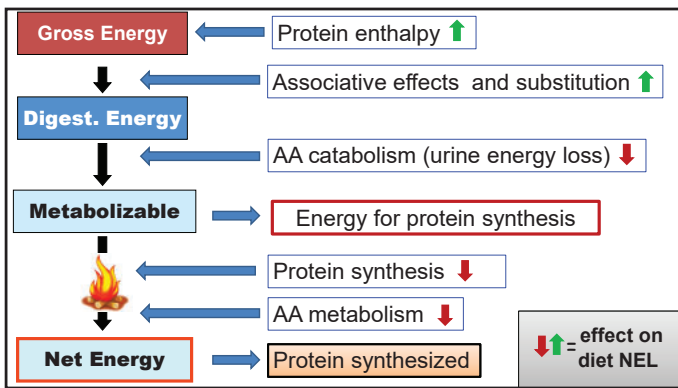

21

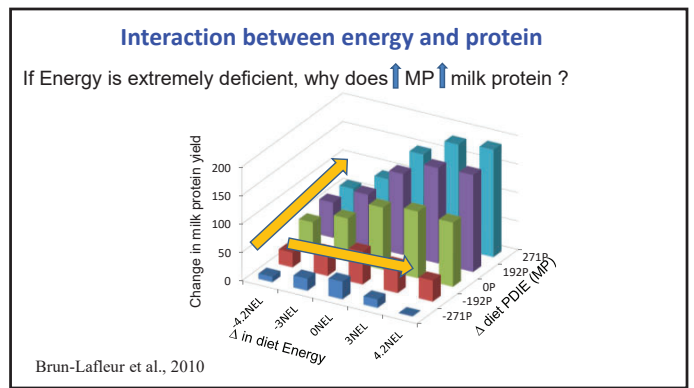

22

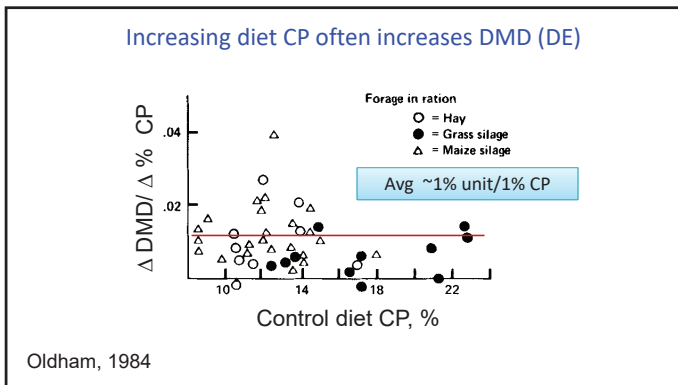

23

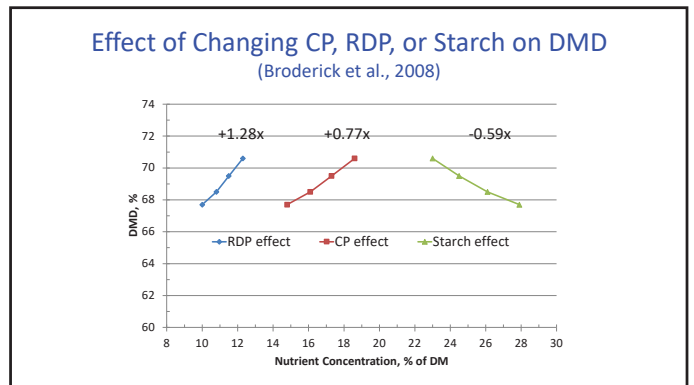

24

### Lower CP can reduce digestibility

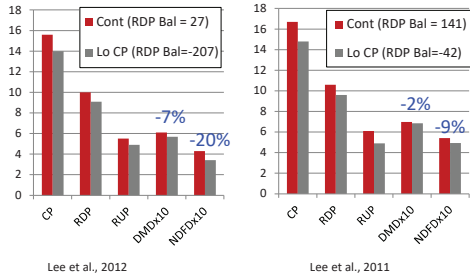

25

### Estimating Diet ME Values

$$\left. \begin{aligned} ME &= 0.96DE - 0.3 \text{ (Galvayan et al., 2016)} \\ ME &= 1.01DE - 0.45 \text{ (NRC, 2001)} \end{aligned} \right\} 0.85-0.88$$

**ME = DE**

- CH4 ← dNDF, Fat
- Urine energy ← AA balance, dCP intake, milk protein yield

$$CH4 = 1.23DMI - 0.145FA + 0.171dNDF$$

MJ/d                      kg/d                      g/kg                      g/kg (Nielsen et al., 2013)

Urine Energy = 14.3 kcal/g N

26

### Either need to account for variation in heat increment or just use ME

**NE = ME - Heat Increment**

- ↑ Dietary fiber and FA
- Starch
- Excess RDP
- Protein synthesis
- AA catabolism

Lack of Adequate Data  
 $NE = 0.66 * ME$  (0.66 from Moraes et al., 2015)

27

### Theoretical effect of replacing 2% units of CHO with CP (CHO = 50/50 NDF/Starch)

1. Increase diet GE (5.6 vs 4.2 Mcal/kg) + Increase digestibility : 3.12 vs 3.03 Mcal/kg **DE = +2.3 Mcal/d**
2. Increase urinary energy loss: 56 g N/d x 0.0143 Mcal/g = 0.8 Mcal/d **ME = +1.5 Mcal/d**
3. Increase heat increment (not very accurate) +0.88 Mcal/d **NEL = + 0.62 Mcal/d**

Energy equal to about 0.9 kg milk (2 lbs)

28

### Theoretical effect of replacing 2% units of CHO with CP

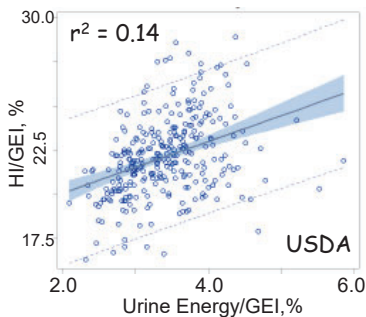

#### 15 to 17% CP (DMI = 25 kg)

- Change in DE: **+2.4 Mcal/d**
- +~56 g urine N (+0.8 Mcal/d)
- ME **+1.6 Mcal/d**
- HI (+0.8 Mcal/d)
- NEL **+0.8 Mcal/d**
- Milk ~+1.1 kg/d

29

### Energy Requirements



- Maintenance** (fasting heat production + some extra)
- Milk** (heat when milk is combusted; ~0.72/kg for avg Holstein)
- Gestation** (energy in fetus and conceptus)
- Growth** (energy in frame gain)
- Extra activity** (grazing but maybe large pens with 3X milking)
- Body reserves** (energy in change in BCS)

30

## Effect of changing NEL maintenance requirement

Maintenance would increase 25% (i.e., 0.08 to 0.10)

### Change in total NEL requirements

- 1550 lb dry cow, 260 d pregnant: +2.7 Mcal/d (~20% increase)
- 1440 lb cow, 110 lbs of milk: +2.5 Mcal/d (~6% increase)
- 1440 lb cow, 55 lbs of milk: +2.5 Mcal/d (~9% increase)
- 1000 lb cow, 50 lbs of Jersey milk +2 Mcal/d (~7% increase)

31

## Maintenance of modern dairy cow >0.08\* MBW

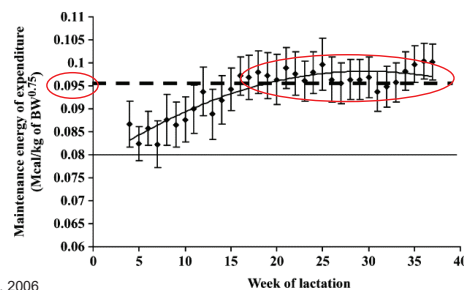

32

## NEL Maintenance Requirement

Historic:  $0.08 \times BW^{0.75}$  (650 kg cow = 10.3 Mcal)

- Underestimates for modern dairy cow
  - Less body fat
  - Greater proportion of body as organs

Maint =  $\sim 0.10 \times BW^{0.75}$  (650 kg cow = 12.9 Mcal)

### Examples:

- Ellis et al., (2006): **0.085 to 0.095**  
Moraes et al., (2015): **0.088 to 0.124**  
Agnew and Yan (2000): **0.118 to 0.160**

33

## Milk and Pregnancy NEL

- **Milk energy** is function of fat, protein and lactose conc. and established heats of combustion (9.3, 5.6, and 4 Mcal/kg)
  - ✓ NEL/ME: 0.64 (NRC, 2001)
  - ✓ NEL/ME: **0.60** (60-70's); **0.63** (70 to 80's) and **0.70** (80 to 90's (Moraes et al 2015)

Greater efficiency means diet has more NEL  
(i.e., less energy needed to make milk)

- **Pregnancy**: essentially no new data since Bell et al. (1995)

34

## Activity Requirements

- With pedometers, GPS, heart rate monitors, etc. we have better estimates of energy expenditures of walking cows
- NRC (2001) likely overestimated energy required for walking
- Still have poor estimates on effects of topography
- For Holstein on fairly flat ground:  $\sim 0.9$  to 1.4 Mcal/day

35



## Summary

- Summative equation has been improved (starch, FA)
- Equations to account for DMI and starch have been improved but need to incorporate other factors (eg RDP)
- Should predict ME from estimated methane and urinary N
- Maintenance requirement has increased in modern dairy cows
- Other requirements likely haven't changed much

36



# **A New System for Determining Nutrient Requirements of Young Dairy Calves**

**Dr. Jim Drackley  
University of Illinois**



## A New System for Determining Nutrient Requirements of Young Dairy Calves

Jim Drackley

Professor of Animal Sciences  
University of Illinois at Urbana-Champaign



1

Feed is the major cost of heifer raising:  
Predicting nutrient requirements and performance is critical!



2

### Outline

- Problems with existing (NRC, 2001) model
- Development of new model – energy
- Development of new model – protein
- Comparison of new model with NRC, 2001

3

### *Nutrient Requirements of Dairy Cattle*

7th Revised Edition, 2001



National Research Council (NRC)  
Subcommittee on Dairy Cattle Nutrition

National Academy Press, Washington, DC

- Separate chapter (chapter 10) for the young calf (<100 kg)

4

### **NRC 2001: A major advance...**

- Importance of the calf
- First step toward recognition of the calf as a dairy animal with variable requirements based on body size and performance (i.e., growth rate)
- Provision of a computer model
- Helped spur years of much-needed research

5

### **General features of existing calf model**

- Based on **energy-allowable growth**.
- Protein requirements calculated as maintenance plus body N deposition at energy-allowable growth rate.
- Minerals and vitamins are calculated as percentages of dry matter intake.
- *Prediction of retained energy (i.e., net energy) is central to model performance.*

6

### Comparison of Observed and Predicted Retained Energy Values for Pre-ruminant Calves

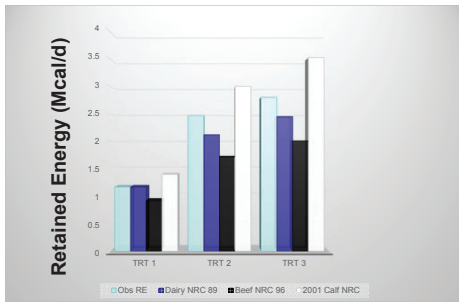

Diaz et al. 2001

### Comparison of Observed and Predicted ADG for Pre-weaned Calves

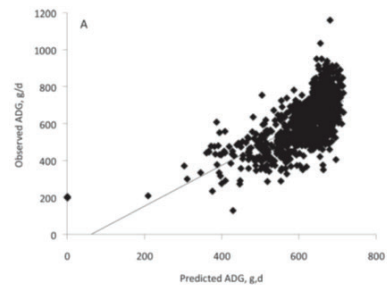

997 individual calves from 20 studies; R<sup>2</sup> = 0.42

Hill et al. 2013

7

8

### Comparison of Observed and Predicted ADG for Calves

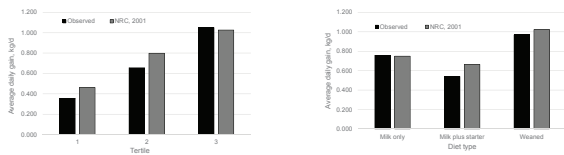

111 treatment means from the literature

Drackley, unpublished 2021

9

### Problem!



10

### Problems with NRC 2001 energy equations

- Data from which Toullec ME equation was derived came from studies with heavier veal calves fed milk only.
- Efficiency of converting ME to RE is too high for lighter weight growing calves depositing primarily protein.

11

### To determine RE we must know composition of BW gain

Comparative slaughter studies  
 Measured RE = ME intake – Heat production

12



**Definitions:**

	Milk only	Milk + Starter	Weaned
EBW:FBW	0.94	0.93	0.85
EBWG:ADG	0.91	0.91	0.85

- Source of error and confusion with NRC 2001
- All calculations for energy and body composition based on EBW, converted to BW basis

13

**Example of problem – changing from preruminant to ruminant**

Stage	BW, kg	EBW: BW	EBW, kg	ADG, kg/d	EBWG, kg/d	EBWG: ADG
Prewean	80.0	0.94	74.4	---	---	---
Postwean (+20 d)	100.0	0.85	85.0	1.0	0.53	0.53
Postwean (+40 d)	120.0	0.85	102	1.0	0.85	0.85

NRC 2001 actually was more accurate if you used EBW rather than “LBW”, but according to original data source (Toullec, 1989), LBW was used

14

**Since publication of NRC 2001, several body composition studies have been reported**

- Database of 255 calves (7 studies, Cornell, Illinois, Virginia Tech) with full body composition and changes from baseline (RE)
  - 6 published, 1 Ph.D. thesis
  - 6 Holstein, 1 Jersey
  - 2 with starter, 5 without
- Used to derive:
  - maintenance energy
  - relationships between retained energy and empty body weight gain and metabolic body size
  - efficiencies of ME use
  - nitrogen deposition

15

Heat production (HP), Mcal/d = MEI Mcal/d – RE, Mcal/d

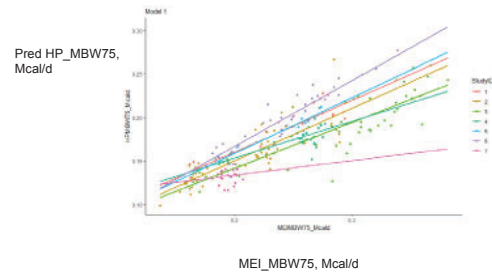

16

$$HP = \beta_0 \times e^{\beta_1 \times MEI} \quad HP, \text{Mcal/kg EBW}^{0.75} = 0.077 \times e^{(3.3426 \times MEI, \text{Mcal/kg EBW}^{0.75})}$$

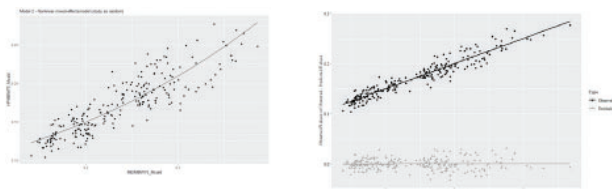

NE<sub>m</sub>, Mcal/kg EBW<sup>0.75</sup> = 0.077  
 ME<sub>m</sub>, Mcal/kg EBW<sup>0.75</sup> = 0.107 Mcal/kg EBW<sup>0.75</sup>

**Next need to derive an equation linking retained energy (NEg) to body weight gain**

- Ultimately allows linking dietary energy (ME) supply to predicted BW gain
- Equation selected was:

$$RE, \text{Mcal/d} = (\text{EBG}^{1.100}, \text{kg/d}) \times (\text{EBW}, \text{kg})^{0.205}$$

17

18

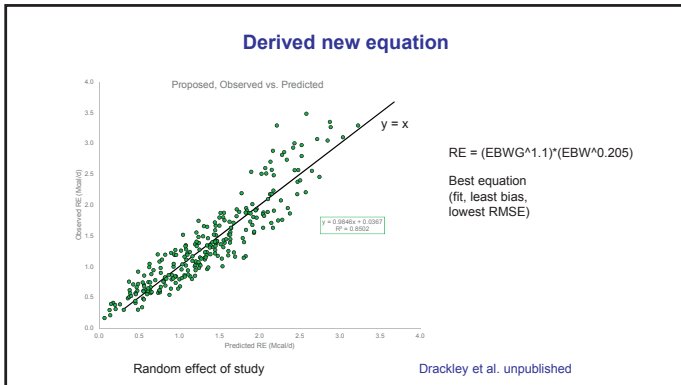

19

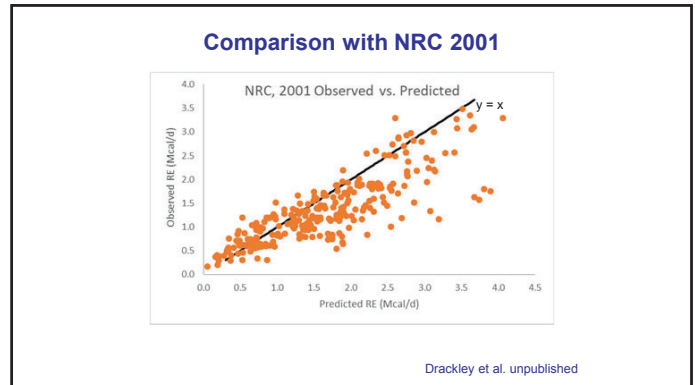

20

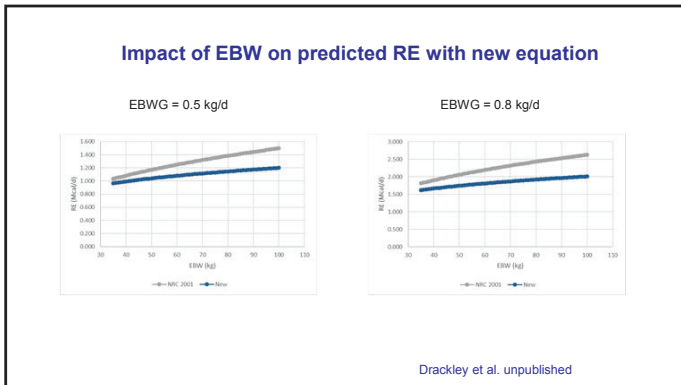

21

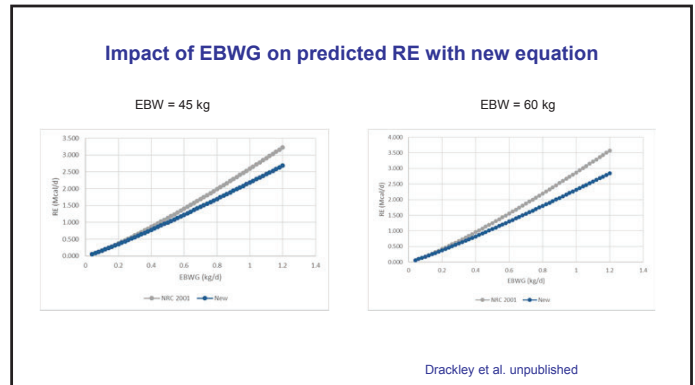

22

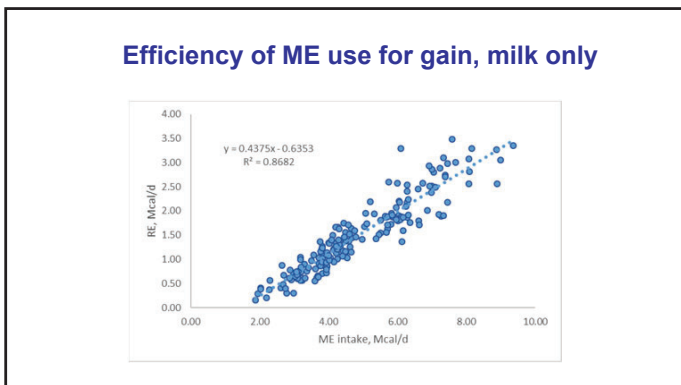

23

- ### Efficiency of ME use for gain, milk only
- On a metabolic body weight basis = 46%
  - Summary of older studies, basis of NRC 2001 = 69%
  - INRA, 2019 = 55%
  - Use 55% as compromise to represent all calves
  - Efficiency for calves fed milk plus starter is lower

24

## Efficiency of ME use from starter

$$\text{NEg, Mcal/kg DM} = (1.1376 \times \text{ME}) - (0.1198 \times \text{ME}^2) + (0.0076 \times \text{ME}^3) - 1.2979$$

Galyean et al. (2016)

Over typical starter ME range (i.e., 2.5 to 3.5 Mcal/kg), RE:ME varies from 0.38 to 0.44

Efficiency of mixed diet (milk plus starter) is additive

25

## Summary and significance

Using data published since NRC 2001, we are able to more accurately predict RE, and therefore also more accurately predict ADG.

26

## Energy and protein supply

- Must be in correct proportion to each other
- Energy intake is primarily determined by the **amount** of milk or replacer fed and amount of starter consumed
- Protein intake is affected both by amount fed and the protein content in the milk replacer and starter



27

## Comparison of Observed and Predicted Retained Protein Values for Pre-ruminant Calves

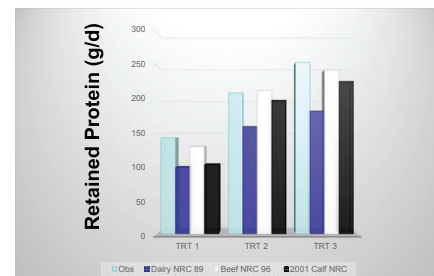

Diaz et al. 2001

28

## Metabolizable protein for maintenance

- Relatively small
- Calculated similarly to NRC, 2001 except with addition of scurf protein and reduced efficiency of use (0.68 vs 0.80)

29

## Nitrogen Composition of the Gain

NRC 2001 used a mean value of 30 g N/kg liveweight gain (Blaxter and Wood, 1951; Roy, 1970; Donnelly and Hutton, 1976)

- Equivalent to 188 g CP/kg LWG

Re-evaluated using the new database:

$$\text{NPg} = (166.2 \times \text{EBW gain, kg/d}) + (6.1276 \times (\text{RE, Mcal/d} / \text{EBW gain, kg/d}))$$

30

### Comparison of new system with NRC, 2001

- For a 50-kg calf fed 1.0 kg of milk replacer (28/20) and consuming 0.2 kg of starter daily
- Calculated requirement:
  - New system = 0.88 kg/d
  - NRC, 2001 = 0.96 kg/d

31

### Comparison of new system with NRC, 2001

- For a 50-kg calf fed 0.68 kg of milk replacer (26/17) and consuming 0.4 kg of starter daily
- Calculated requirement:
  - New system = 0.63 kg/d
  - NRC, 2001 = 0.72 kg/d

32

### Other features of new calf model

- Prediction equations for starter intake
- Refined mineral requirements in quantity per day
- Revised fat-soluble vitamin recommendations

33

### Looking ahead

- These recent advances should allow improvement of NRC predictions of calf requirements and predicted performance.
- Modified equations will result in more accurate prediction of growth, both with and without starter.

34



35



# **Essential Amino Acid Supply and Use for Lactating Dairy Cattle**

**Mark D. Hanigan  
Department of Dairy Science  
Virginia Tech**



# Essential Amino Acid Supply and Use for Lactating Dairy Cattle

Mark D. Hanigan  
Department of Dairy Science  
Virginia Tech

Department of Dairy Science at Virginia Tech - dsc.vt.edu

1

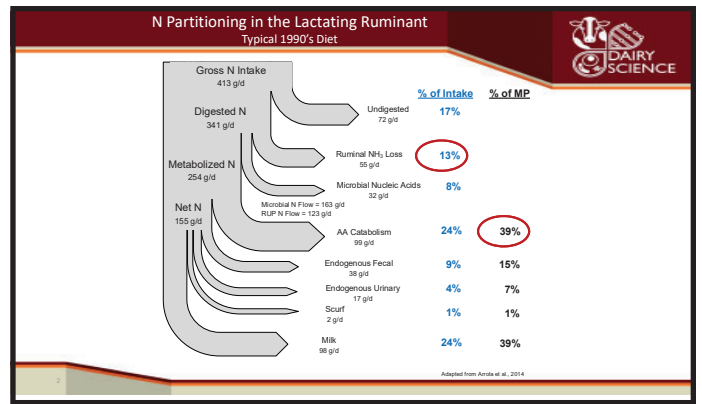

2

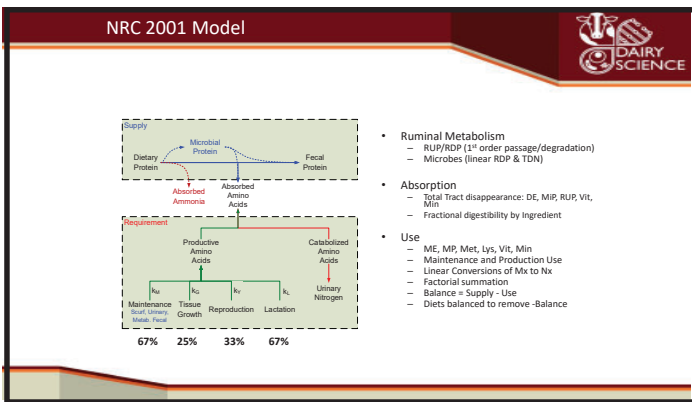

3

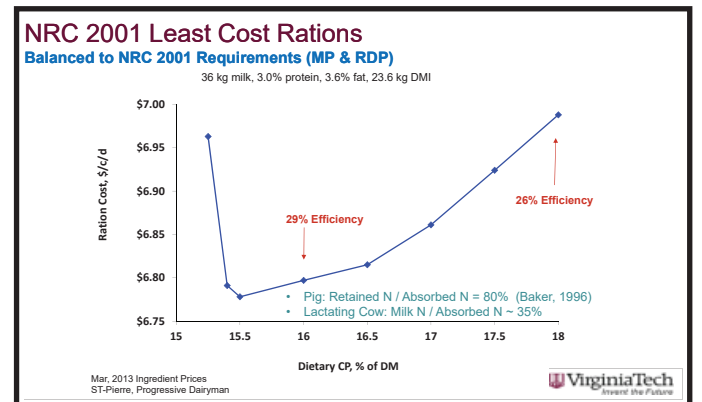

4

### Ohio Dairy Nutrient Values – 5-year Average

Nutrient values derived using Sesame  
Buckeye Dairy News: Vol 22, Issue 2 (March, 2020)

Nutrient	Cost/Unit	Daily Supply*	Cost/cow/d
NEL (3X, NRC 2001) MCal	\$0.08	35.4 MCal	\$2.83
Metabolizable Protein (NRC) Lbs	\$0.43	5.44 lbs	\$2.34
Effective NDF (forage NDF) Lbs	\$0.14	10.4 lbs	\$1.46
Non-effective NDF (Total NDF – Forage NDF) Lbs	-\$0.02	7.3 lbs	-\$0.15
Total Cost for Energy, Protein and Fiber			\$6.48

\* 1600 lb cow, 80 lbs milk/d, 3.0% protein, 3.5% fat

<https://dairy.vt.edu/newsletter/buckeye-dairy-news/volume-22-issue-2/milk-prices-costs-margins-and-comparison>  
Sesame can be licensed and used for local markets

5

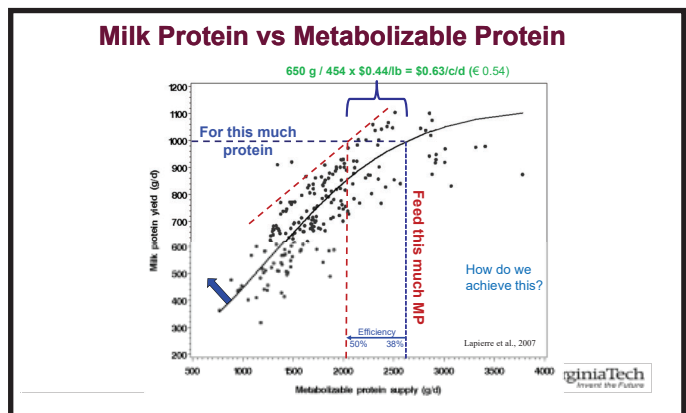

6

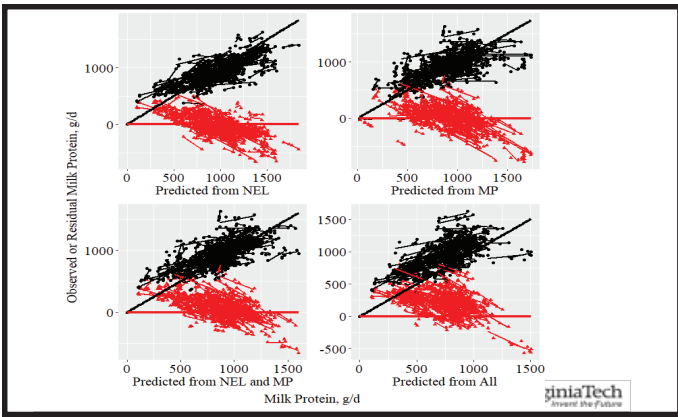

7

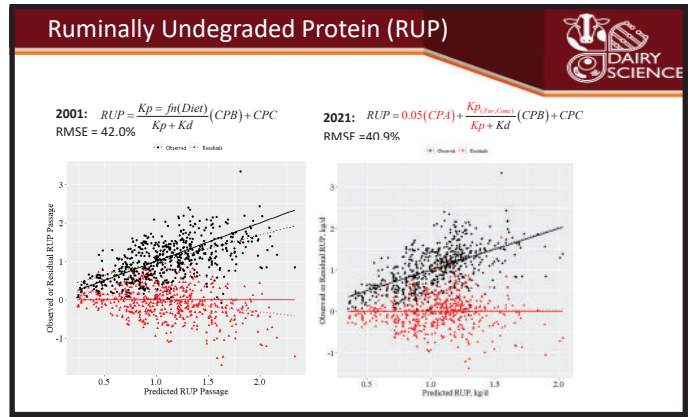

8

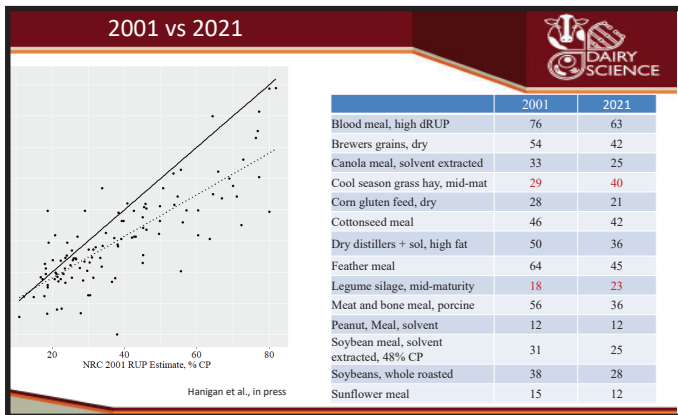

9

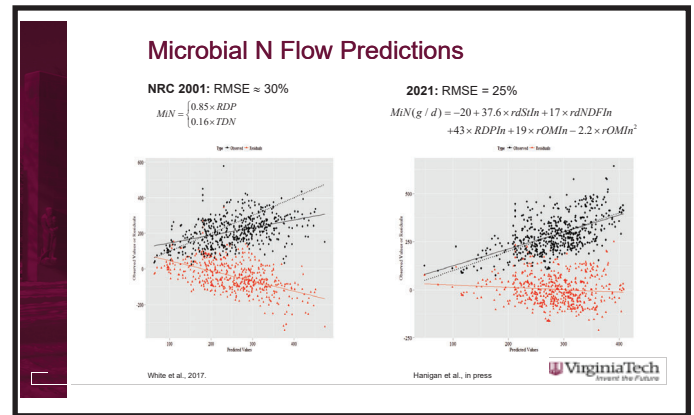

10

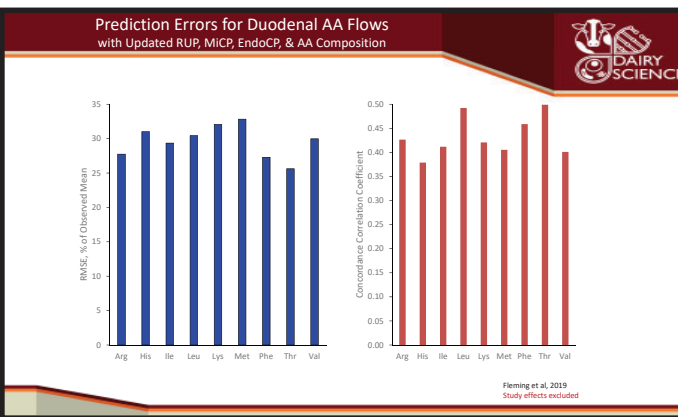

11

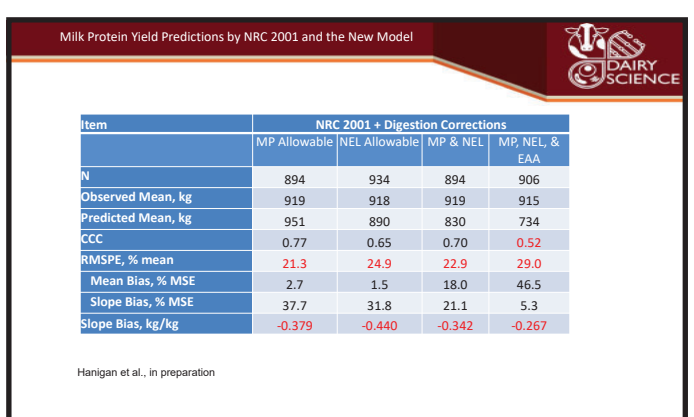

12

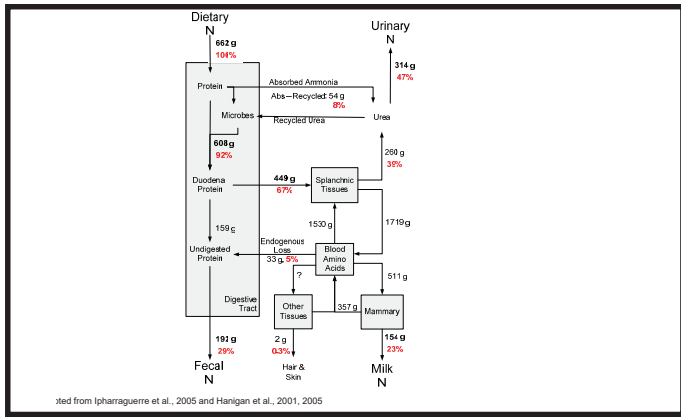

13

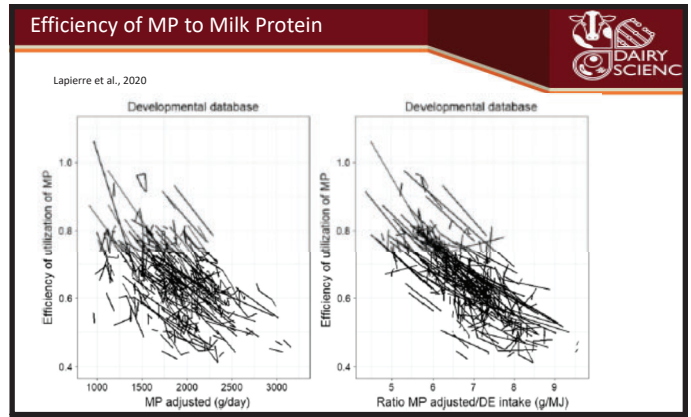

14

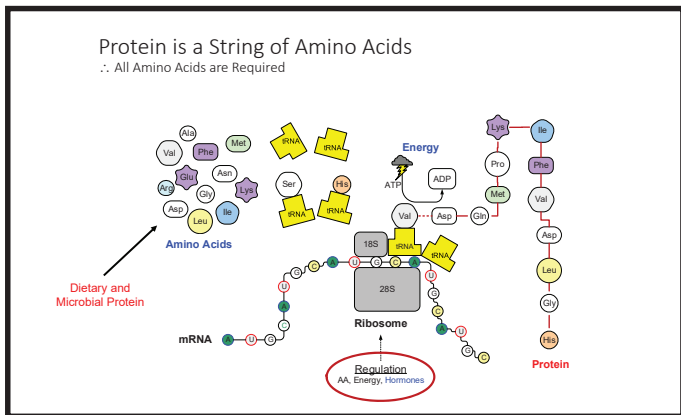

15

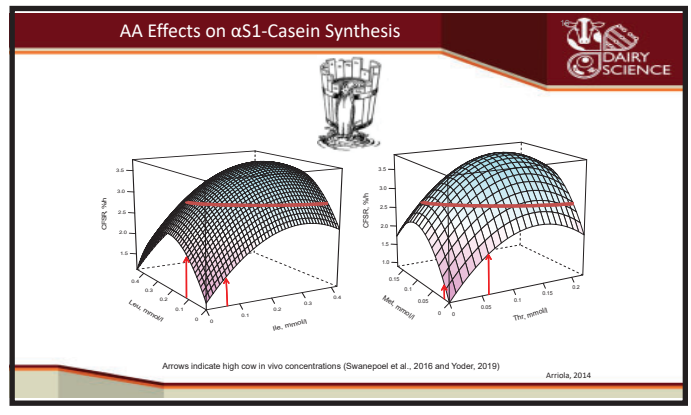

16

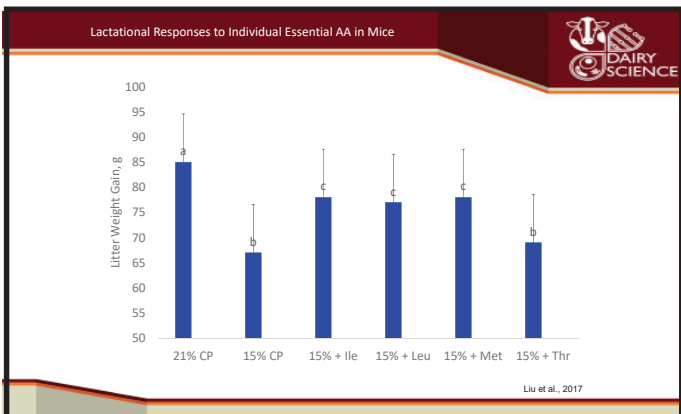

17

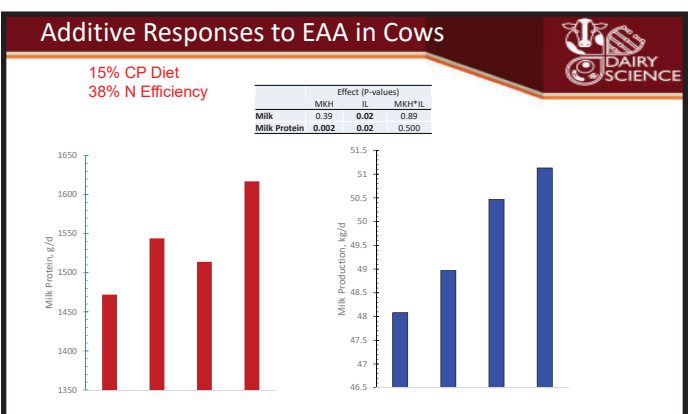

18



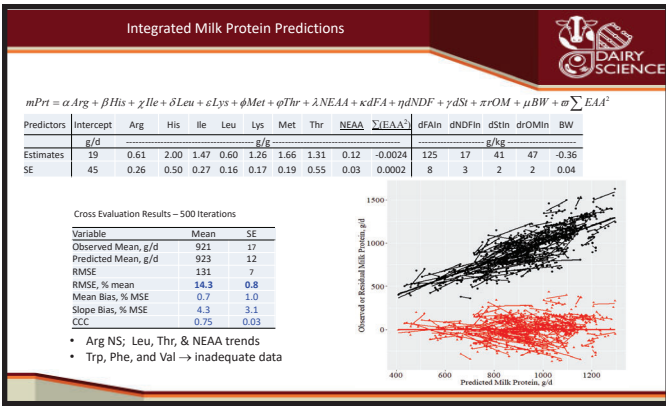

19

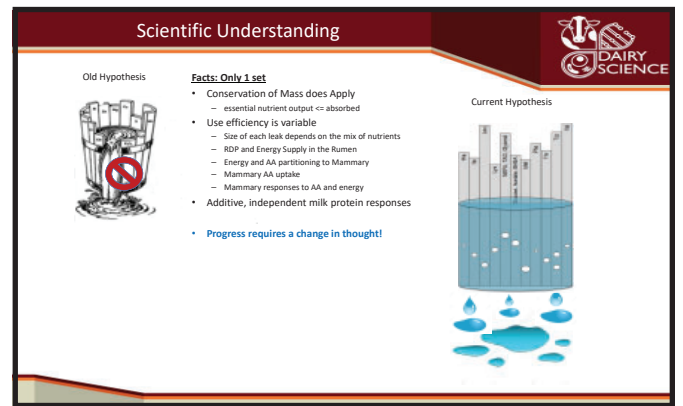

20

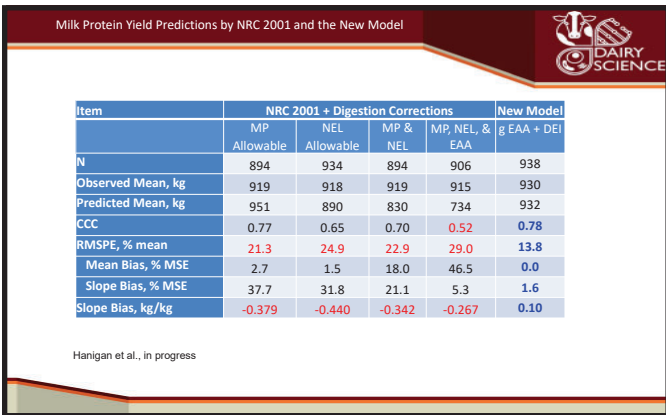

21

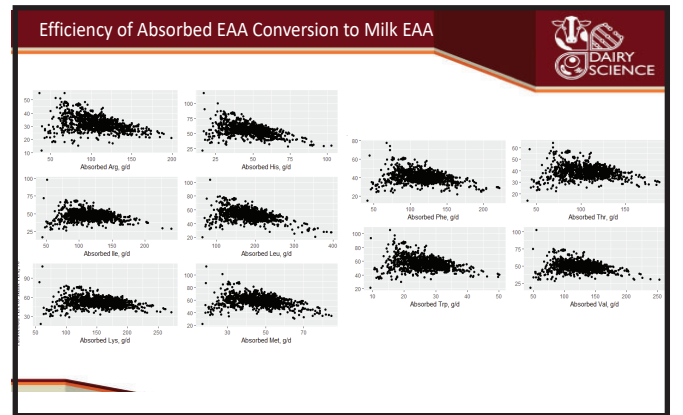

22

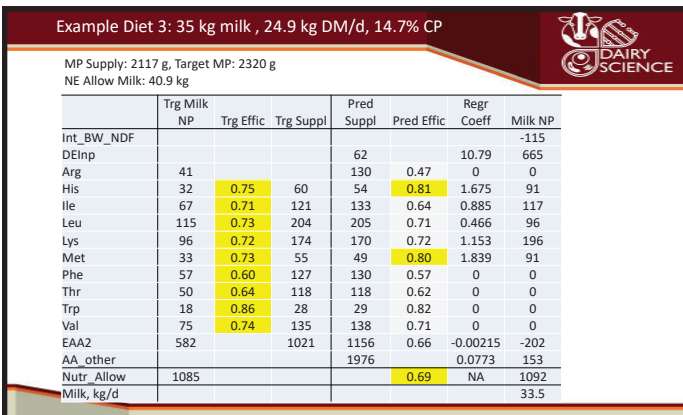

23

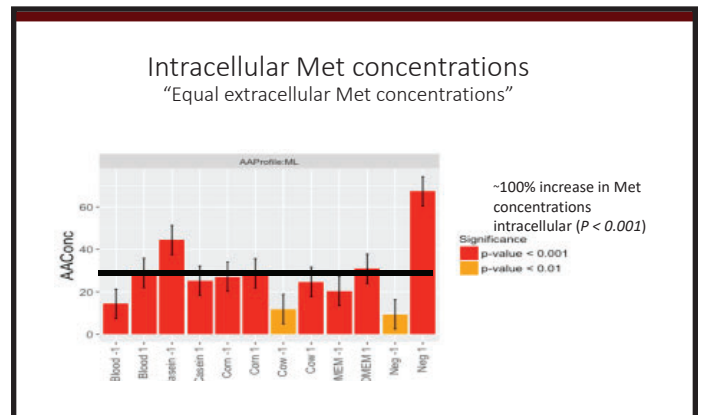

24



L = 70% and H=200% of In Vivo  
NEAA: Ala, Gln, and Gly

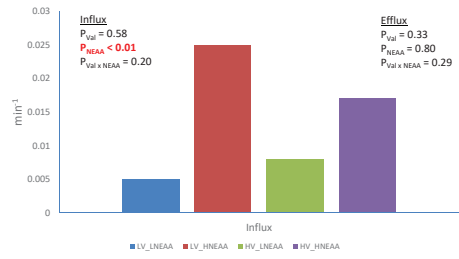

25



- ✓ Revised RUP and Microbial CP predictions
- ✓ New concepts for milk protein predictions
  - 5 to 7 EAA, dFA, dNDF, dSt, drOM (DEI)
  - Energy supply very important
  - No such thing as a single-limiting AA
  - Marginal responses to individual AA not high
  - AA responses > MP and RPAA input cost
- ✓ NRC out in 2021
- ✓  **Optimize** or  **Plug and Chug?**
  - dNDF, dStarch, RDP, dFat, 8 dEAA, 2 dFA, 38 MV, Ingr\$, Milk\$
  - How much money are you leaving on the table????



26



# **Guidelines for Feeding Cows in the Future**

**Lee Kloeckner, MS, PAS  
Dairy Nutrition and Production Specialist,  
Ag Partners**



# Guidelines for feeding cows in the future

Lee Kloeckner, MS, PAS  
Dairy Nutrition and Production Specialist, Ag Partners



1

## Ration Philosophy

1. Focus on the rumen
  - aNDFom
  - Rumen available carbohydrates
  - Rumen degradable protein
2. Amino acid balance
  - Lysine & Methionine
  - Blood or blood products
3. Fatty acid balance

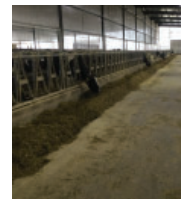

2

## Common Additives

- Yeast
- Monensin
- Lysine/Methionine
- Blood/Blood products
- Bypass fat
- Chelated trace minerals
- Biotin
- Organic selenium



3

## Transition Cows

- Primarily one-group TMR
  - Minimize potassium
  - Amino acids
  - Yeast
  - Monensin
  - Sulfate minerals
- Other additives: anions, B vitamins, choline, chromium, X-zelit



4

## Feed Test Key Considerations

- Moisture
- aNDFom
- uNDFom240
- NDFD30
- pdNDF
- Crude protein
- Starch
- Ash
- NDF kd
- Starch kd



5

## Tools

- What do the cows tell me?
  - DMI, milk yield, components, cud chewing, manure
- On farm data
  - DC305, feed management software, activity, rumination, daily milk weights
- Feed & TMR analysis
- Shaker box
- Mycotoxin testing
- Fermentation tests
- Supplier support



6

## Future Considerations

- Feed and nutrient efficiency
- Merging feed and agronomy
- Improving ration models
- Better characterize feeds
- Interactions & Antagonists
- Environmental concerns





# **Guidelines for Feeding Cows in the Future**

**Brian J Gerloff, DVM, PhD  
Renaissance Nutrition**





1

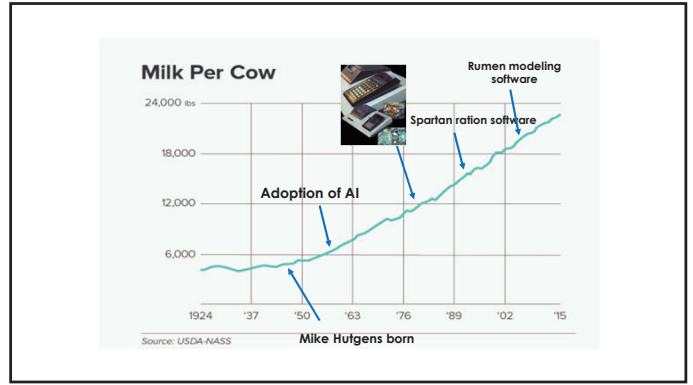

2

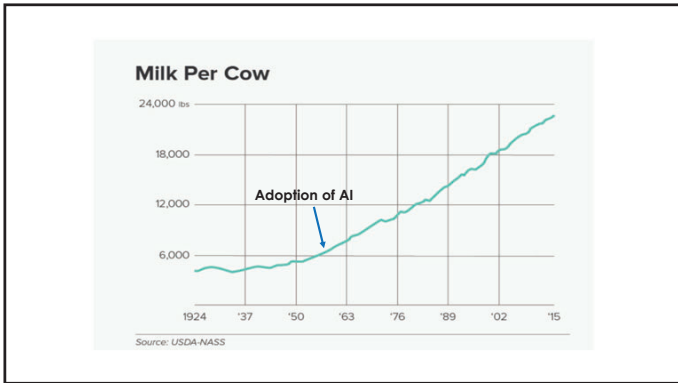

3

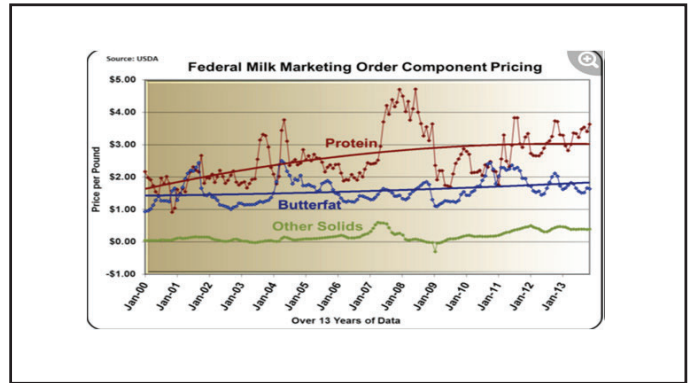

4

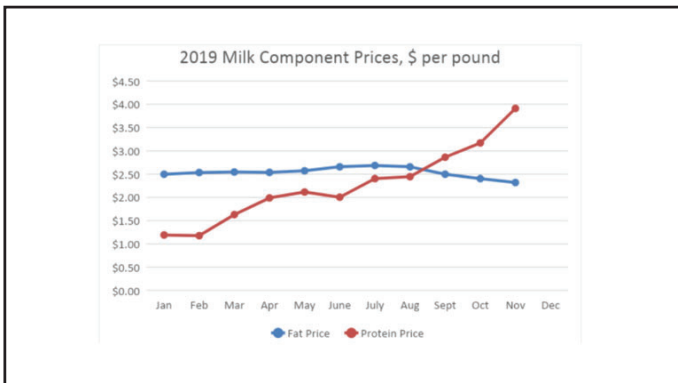

5

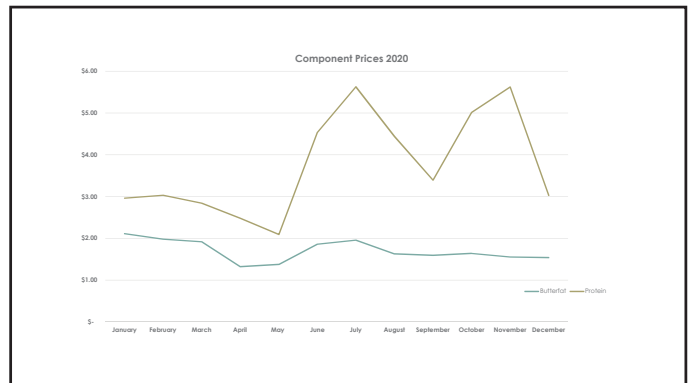

6

On top of all that, we have the reality of processor and cooperative restrictions and quotas

So...

Increasingly, will need to try and affect milk volume and milk components more independently of each other

7

#### Influencing Milk Protein

Historically, as we have worked to increase milk protein production, we have typically focused on pounds of protein, and often driven improvements through more pounds of milk...

But in the future, that may be less profitable than driving % protein higher, independently of milk production.

8

#### Influencing Milk Fat

Typically, not as valuable as milk protein, but watched very closely by our clients...

But again, driving percent fat higher without increasing milk may be more profitable in the future.

9

#### Milk Protein

- Amino acid supplementation, especially methionine
- Fermentable carbohydrates, especially NDF

10

#### Milk Fat

- Amino acid supplementation, especially rumen available methionine
- Fermentable carbohydrates, - complex interaction between NDF and starch
- Fat profile and levels – also complex interaction between starch, NDF and NDFD, and fatty acid profile

11

#### Example 1:

Good milk with very high components

12



Feed	As Fed lb	DH lb	DH %	\$/lb
BMR CS 12.15.20	64,000.00	20,988.00	32.87	
Whey Permeate	11,200.00	2,352.00	21.00	
Slupe 12.1.20	6,800.00	3,300.00	48.53	
0 DM4 Hy(12.1.20)	16,000.00	7,273.50	45.46	
Canola Meal Solvent 37% (CCC)	4,700.00	4,230.00	90.00	360.000
Corn Dist Ethanol Nx	2,250.00	1,990.00	88.00	250.000
Corn gluten feed	1,000.00	884.50	88.45	289.000
Corn grain 69% Starch medium	10,500.00	9,200.10	87.52	150.000
Supplement mix	11,300.00	10,277.00	90.95	418.112

As Fed tot lb	127,750.00	DM tot lb	60,424.00	F 62.10%
Wgt TMR lb	127,750.00	DMI TMR lb	60,424.00	C 47.90%
DMI pred lb	64.76 (x3.9 lb)	-4.33 (93.3%)	3.75 %BW	DMI 47.3%
DMI pred lb	231.4 (x4.4 lb)	uNDF1 %BW 0.26	NDF1 %BW 0.96	FIDF1 %BW 0.72

13

Days in milk	169.0				
Milk production lb	86.00	ECM lb	102.57	BCS c	3.00
Milk Fat % w/w	4.90	BW lb	1,610.0	BCS t	3.00
Milk Protein % w/w	3.58		2.77	days	100

**7+ pounds of components at 86# milk - Holsteins**

14

### Supplement

Supplement mix	AF lb 11.30	DH lb 10.28
Corn grain 69% Starch medium	5.85	4.43
Amnio Plus	2.43	2.14
Sodium Disophtate Hydrd	0.91	0.80
9208 Palm 80 Palm Fat C18	0.55	0.54
9558 Blood Meal	0.52	0.46
Calcium Carbonate	0.27	0.27
Urea	0.16	0.16
1952 Mx Mix 2 no K	0.14	0.13
9200 Megalac	0.41	0.40
Salt	0.13	0.13
MHA adjusted	0.13	0.11
Smartamine H (ADDFEC)	0.05	0.05
Smartamine VL	0.03	0.03
9191 Magnesium Oxide	0.04	0.04
Zincpro Availa Zn 120 (ZnPRO)	0.01	0.01
Zincpro Availa Mn 60 (ZnPRO)	0.01	0.01
Diamond V XPC	0.01	0.01
9168 IntegralA+	0.02	0.02
Selenium DS	0.01	0.01
Ruminant 90	0.01	0.01
Mix AD	0.52	0.51

15

D.M.	%	47.30
CP	%	16.90
Soluble Protein	%	7.15
Ammonia (Prot.A1)	%	1.32
Forage	%	52.10
Forage aNDFom	%	19.21
peNDF	%	17.19
aNDFom	%	25.50
CHO C uNDF	%	6.85
ADF	%	17.57
Sugar (WSC)	%	6.51
Starch	%	27.31
Soluble Fiber	%	6.86
NFC	%	43.47
EE	%	5.42
TFA	%	4.14

16

### Are amino acid targets reasonable and practical?

	Supply	Balance	% Req.	%	Milk lb
ME Mcal/day	72.32	1.53	102.2		88.57
MP g/day	3,064.4	184.6	105.4		94.02
NH3-N g		111.7	151.4		
Urea (CPE) g	417.7	9.0 %CP	91 g RDUeP/lb fCHO		
uNDF30 lb	4.66	30.2 %NDF			7.71 %DMI
MP % DMI	11.18	42.4 g/Mcal ME			
Total RUFAL g/d	674.2 (2.5%)	High-risk RUFAL g	303.4 (2.1%)		
Met g/Mcal ME	1.16	-0.01			1.17 opt.
Lys g/Mcal ME	2.85	-0.31			3.16 opt.

17

### 30 hr uNDF as a percent of NDF

	Initial recipe	Current recipe	DHI lb/day					
	lb/day	%DM	%BW	lb/day	%DM	%BW	Δ	Expected
DHI	60,454		60,454					
NDF Intake	15,429	25.52	0.96	15,407	25.50	0.96	+0.01	60.44
uNDF Intake	4,134	6.84	0.26	4,138	6.85	0.26	-0.01	60.41
uNDF Rumen	7,339		0.45	7,349		0.45	+0.00	60.42
uNDF Ratio Rumen/Intake	1.78			1.78				
peuNDF Intake	2,788	4.51		2,789	4.52		-0.01	60.41
uNDF30 Intake	4,659	7.71	0.29	4,659	7.71	0.29	+0.00	60.43

(25.5-7.71) / 25.5 = 69.8%  
Is ≥70% a good target?

18

Example 2: Improving 30 hour NDF digestibility

19

1st cut alfalfa haylage	26.0000	7.8858	30.33	50.000
home corn silage	24.0000	8.6088	35.87	35.000
HM Corn silo	20.0000	14.7540	73.77	100.000
protein 10.20.20	13.5000	12.2320	90.01	502.378
2nd cutting hay	12.0000	10.3368	85.14	120.000
Palmit 98	0.2500	0.2488	99.50	1,235.000

As Fed tot lb	95.7500	DMI tot lb	54.0662	F 49.63%
Wgt TMR lb	95.7500	DMI TMR lb	54.0662	C 50.37%
DMI pred lb	54.79 (±1 lb)	-0.72 (88.7%)	3.06 %BW	DM 56.5%
DMI pred lb	242.0 (±40 lb)	uNDF1 %BW 0.36	NDF1 %BW 0.96	hNDF1 %BW 0.72

20

Days in milk	150.0				
Milk production lb	78.00	ECM lb	85.92	BCS c.	3.00
Milk Fat % w/w	4.30	BW lb	1,519.7	BCS l.	3.00
Milk Protein % w/w	3.36		2.63	days	100

Ingredients	DM %	Supply lb
DM	56.47	54.07
CP	16.06	8.68
Soluble Protein	5.30	2.87
Ammonia (Prot A1)	0.34	0.19
Forage	49.52	
Forage aNDFom	20.25	10.95
peNDF	20.18	10.91
aNDFom	26.99	14.59
CHO C uNDF	10.10	5.46
ADF	19.37	10.47
Sugar (WSC)	5.23	2.83
Starch	27.63	14.94
Soluble Fiber	8.11	4.38
NFC	43.69	23.62
EE	4.99	2.70
TFA	3.98	2.15

21

30 hr uNDF as Percent of NDF

	Initial recipe			Current recipe		
	lb/day	%DM	%BW	lb/day	%DM	%BW
DMI	54.066			54.066		
NDF Intake	14.593	26.99	0.96	14.593	26.99	0.96
uNDF Intake	5.461	10.10	0.36	5.461	10.10	0.36
uNDF Rumen	9.688		0.64	9.688		0.64
uNDF Ratio Rumen/Intake	1.77			1.77		
peuNDF Intake	4.084	7.55		4.084	7.55	
uNDF30 Intake	5.598	10.35	0.37	5.598	10.35	0.37

$$(26.99 - 10.35) / 26.99 = 61.6\%$$

Too low!

22

	As Fed lb	DM lb	DM %	g/Tons
home corn silage	28.5000	10.2229	35.87	35.000
1st cut alfalfa haylage	22.5000	6.8242	30.33	50.000
HM Corn silo	20.0000	14.7540	73.77	100.000
protein 10.20.20	14.5000	13.1381	90.01	502.378
2nd cutting hay	7.0000	6.0208	85.14	150.000
Possible grass	4.0000	3.4800	87.00	150.000

Replace alfalfa with grass

23

With grass

With alfalfa

Ingredients	DM %	Supply lb
DM	56.42	54.07
CP	15.86	8.68
Soluble Protein	5.13	2.87
Ammonia (Prot A1)	0.36	0.19
Forage	48.77	
Forage aNDFom	19.99	10.95
peNDF	19.74	10.91
aNDFom	27.03	14.59
CHO C uNDF	8.67	5.46
ADF	18.68	10.47
Sugar (WSC)	5.16	2.83
Starch	28.45	14.94
Soluble Fiber	7.71	4.38
NFC	44.04	23.62
EE	4.75	2.70
TFA	3.69	2.15

Ingredients	DM %	Supply lb
DM	56.47	54.07
CP	16.06	8.68
Soluble Protein	5.30	2.87
Ammonia (Prot A1)	0.34	0.19
Forage	49.63	
Forage aNDFom	20.25	10.95
peNDF	20.18	10.91
aNDFom	26.99	14.59
CHO C uNDF	10.10	5.46
ADF	19.37	10.47
Sugar (WSC)	5.23	2.83
Starch	27.63	14.94
Soluble Fiber	8.11	4.38
NFC	43.69	23.62
EE	4.99	2.70
TFA	3.98	2.15

24

**With grass**

	Supply	Balance	% Req.	%	Milk lb
HE Hcal/day	66.49	0.96	101.5		87.75
HP g/day	2,675.1	10.4	100.4		86.48
NH3-N g		81.0	139.6		
Urea (CPE) g			97 g R2burep/lb RCHO		
uNDF30 lb	5.04	34.3 uNDF			9.26 %DMI
HP % DMI	10.83	40.2 g/Hcal HE			
Total RUFAL g/d	697.0 (2.8%)	High-risk RUFAL g	553.2 (2.2%)		
Met g/Hcal HE	1.04	-0.13			1.17 opt.
Lys g/Hcal HE	2.75	-0.41			3.16 opt.

**With alfalfa**

	Supply	Balance	% Req.	%	Milk lb
HE Hcal/day	65.09	3.59	105.8		84.58
HP g/day	2,626.8	115.3	104.6		83.32
NH3-N g		96.4	149.6		
Urea (CPE) g			102 g R2burep/lb RCHO		
uNDF30 lb	5.60	38.4 uNDF			10.33 %DMI
HP % DMI	10.71	40.4 g/Hcal HE			
Total RUFAL g/d	661.3 (2.7%)	High-risk RUFAL g	527.5 (2.2%)		
Met g/Hcal HE	1.03	-0.14			1.17 opt.
Lys g/Hcal HE	2.73	-0.43			3.16 opt.

25

**30 hr uNDF as Percent of NDF**

	lb/day	%DM	%BW	lb/day	%DM	%BW
DMI	54.449			54.449		
NDF Intake	14.719	27.03	0.97	14.719	27.03	0.97
uNDF Intake	4.719	8.67	0.31	4.719	8.67	0.31
uNDF Rumen	8.350		0.55	8.350		0.55
uNDF Ratio Rumen/Intake	1.77			1.77		
peuNDF Intake	3.447	6.33		3.447	6.33	
uNDF30 Intake	5.044	9.26	0.33	5.044	9.26	0.33

$(27.03 - 9.26) / 27.03 = 65.7\%$

26

**Result-  
Increase of 8# milk, no loss of components**

Days in milk	150.0				
Milk production lb	86.00	ECM lb	94.73	BCS c.	3.00
Milk Fat % w/w	4.30	BW lb	1,519.7	BCS t.	3.00
Milk Protein % w/w	3.36		2.63	days	100

6.4# CFP

27

- The Future of Feeding Cows?**
- Better characterize rumen fiber digestion and its effect on milk and component production
  - Utilize amino acid nutrition to optimize milk protein production
  - Utilize diet characteristics to move milk, fat, and protein production semi-independently of each other

28



# **Interpretation and Use of New Passive Immunity Guidelines for Newborn Dairy Calves**

**Dr. Jim Drackley  
University of Illinois**



## Interpretation and use of new passive immunity guidelines for newborn dairy calves

Jim Drackley

Professor of Animal Sciences  
University of Illinois at Urbana-Champaign



1

## Colostrum: Nature's first food



• Single most important management factor for calf health and survival

• 31% of calves deaths preventable by improved colostrum management (Wells et al., 1996)

- Rich first source of nutrients
- Rich in bioactive factors



2

## Introduction

- We need to switch acronyms for accuracy:
  - “Passive transfer of immunity” should be “transfer of passive immunity” (TPI)
  - “Failure of passive transfer” should be “failure of passive immunity” (FPI)
- Serum IgG serves as a proxy for other valuable aspects of colostrum intake (nutrition, bioactive factors, fluid, warmth, etc)

3

## Introduction

- FPI has long been defined as serum IgG concentrations <10 g/L.
- Studies have shown decreased morbidity (sickness) with serum IgG concentrations higher than traditionally recommended.
- TPI in beef calves is defined at much higher levels than in dairy calves (>24-27 g/L).
- In recent NAHMS survey, 90% of Holstein heifers met industry standards for TPI, yet morbidity remains high.

4

Is it time to revise our standards for what constitutes satisfactory TPI?

What about herd-level goals for TPI management?

5



J. Dairy Sci. 103:7611–7624  
<https://doi.org/10.3168/jds.2019-17955>

© 2020 American Dairy Science Association®. Published by Elsevier Inc. and Foss Inc. All rights reserved.

### Consensus recommendations on calf- and herd-level passive immunity in dairy calves in the United States

J. Lombard,<sup>1†</sup> N. Urie,<sup>1</sup> F. Garry,<sup>2</sup> S. Godden,<sup>2</sup> J. Quigley,<sup>4</sup> T. Earleywine,<sup>2</sup> S. McGuirk,<sup>4</sup> D. Moore,<sup>7</sup> M. Branan,<sup>1</sup> M. Chamorro,<sup>8</sup> G. Smith,<sup>9</sup> C. Shively,<sup>1</sup> D. Catherman,<sup>10</sup> D. Haines,<sup>11</sup> A. J. Heinrichs,<sup>12</sup> R. James,<sup>13</sup> J. Maas,<sup>14</sup> and K. Sterner<sup>15</sup>

<sup>1</sup>USDA-Animal and Plant Health Inspection Service-Veterinary Services, Center for Epidemiology and Animal Health, National Animal Health Monitoring System, Fort Collins, CO 80526-8117

<sup>2</sup>Department of Clinical Sciences, College of Veterinary Medicine and Biomedical Sciences, Colorado State University, Fort Collins 80523-1678

<sup>3</sup>Department of Veterinary Population Medicine, College of Veterinary Medicine, University of Minnesota, St. Paul 55108

<sup>4</sup>Cargill Animal Nutrition, Brookville, OH 45309

<sup>5</sup>Land O'Lakes Animal Milk Solutions, Cottage Grove, WI 53527

<sup>6</sup>School of Veterinary Medicine, University of Wisconsin, Madison 53706

<sup>7</sup>Department of Veterinary Clinical Sciences, College of Veterinary Medicine, Washington State University, Pullman 99164

<sup>8</sup>Department of Clinical Sciences, College of Veterinary Medicine, Auburn University, Auburn, AL 36849

<sup>9</sup>Department of Population Health and Pathobiology, North Carolina State University, Raleigh 27707

<sup>10</sup>Scausa Foods, Waterloo, WI 53098

<sup>11</sup>ISCC, Saskatoon, Saskatchewan, Canada, S7N 6A2

<sup>12</sup>Department of Animal Science, The Pennsylvania State University, University Park 16802

<sup>13</sup>Dorset Home Heifer Solutions, Blacksburg, VA 24060

<sup>14</sup>School of Veterinary Medicine, University of California, Davis 95616

<sup>15</sup>Siemer Veterinary Clinic P.C., Irma, MI 48846

6

## Methodology

- Data from NAHMS Dairy 2014 Calf Component (Urie et al., 2018a,b) used to determine relationships between serum IgG and calf morbidity and mortality
- Four different models with different number of categories were proposed.
- Option adopted was: <10.0 g/L, 10.0 to 17.9 g/L, 18.0 to 24.9 g/L, and  $\geq$  25.0 g/L

7

## Methodology

- Calves were excluded from analysis when:
  - Blood collected <24 h after birth or >7 d of age
  - Serum IgG <1 g/L, total protein >11 g/L, or Brix score >15%
  - Fed colostrum replacer or supplement

8

## Results

Table 4. Consensus serum IgG concentrations and equivalent total protein (TP) and Brix measurements, and percentage of calves recommended in each transfer of passive immunity (TPI) category<sup>a</sup>

TPI category	Serum IgG category (g/L)	Equivalent TP (g/dL)	Equivalent %Brix	Consensus <sup>b</sup> (% calves)	NAHMS study <sup>b</sup> (% calves)
Excellent	$\geq$ 25.0	$\geq$ 6.2	$\geq$ 9.4	$>$ 40	35.5
Good	18.0-24.9	5.8-6.1	8.9-9.3	$\sim$ 30	25.7
Fair	10.0-17.9	5.1-5.7	8.1-8.8	$\sim$ 20	26.8
Poor	$<$ 10.0	$<$ 5.1	$<$ 8.1	$<$ 10	12.0

<sup>a</sup>Modified from Gaskin et al. (2019).

<sup>b</sup>Consensus recommendation for percent of a farm's calves in each category.

<sup>c</sup>Percent of calves in National Animal Health Monitoring System (NAHMS) 2014 Dairy study (Shivley et al., 2018) in each consensus category.

9

Table 5. Model predicted morbidity and mortality at specified serum IgG concentrations representing categories for option 3 for calves in the National Animal Health Monitoring System Dairy 2014 study

IgG level (g/L)	Model predicted, percent (95% CI)	
	Morbidity	Mortality
8.0	41.3 (34.6-48.8)	8.2 (6.2-10.7)
14.0	37.8 (31.8-44.3)	6.6 (5.3-8.2)
21.5	33.6 (28.2-39.5)	5.0 (4.1-6.2)
27.0	30.6 (25.2-36.6)	4.1 (3.1-5.4)

10

## Results

Table 6. Number and percentage of heifer calves and calf morbidity and mortality by consensus category of serum IgG and total protein concentration, and Brix percentage for calves in the National Animal Health Monitoring System Dairy 2014 study

Measure	Category	Heifer calves (n = 2,360)		Calf morbidity (n = 899)		Calf mortality (n = 75)	
		Number	Percent	Number	Percent	Number	Percent
Serum IgG (g/L)	$<$ 10.0	284	12.0	131	46.1	21	7.4
	10.0-17.9	631	26.7	228	36.1	24	3.8
	18.0-24.9	607	25.7	211	34.8	9	1.5
Serum total protein (g/dL)	$\geq$ 25.0	838	35.5	299	28.5	21	2.5
	$<$ 5.1	349	14.8	165	47.3	22	6.3
	5.1-5.7	638	27.0	225	35.3	17	2.7
Serum Brix (%)	5.8-6.1	459	19.4	151	32.9	13	2.8
	$\geq$ 6.2	914	38.7	268	29.3	23	2.5
	$<$ 8.1	340	14.4	162	47.6	22	6.5
	8.1-8.8	570	24.2	202	35.4	15	2.6
	8.9-9.3	486	20.6	162	33.3	15	3.1
	$\geq$ 9.4	964	40.8	283	29.4	23	2.4

11

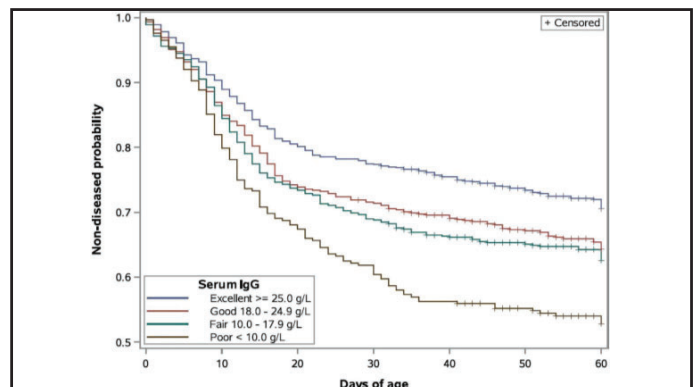

12

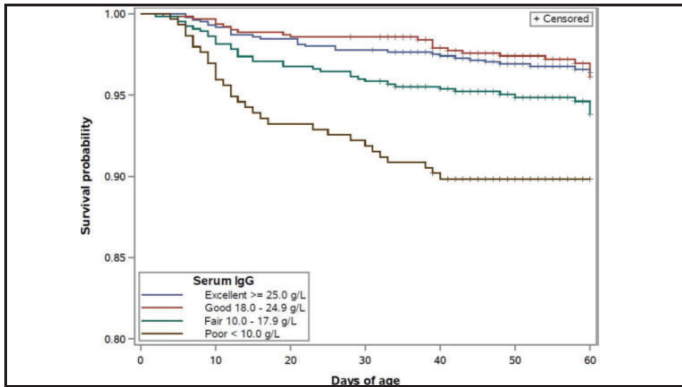

13

### Results

**Table 7.** Descriptive statistics for colostrum management practices for calves in the National Animal Health Monitoring System transfer of passive immunity data set having excellent passive immunity ( $\geq 25$  g/L serum IgG) and fed single or multiple colostrum feedings

Measurement	Single colostrum feeding (n = 251)		Multiple colostrum feedings (n = 453)	
	Mean	SD	Mean	SD
Calf birth weight (kg)	42.0	5.5	42.1	5.8
Volume of first colostrum feeding (L)	3.3	0.8	2.7	0.9
First feeding colostrum IgG fed (g)	286.7	123.0	226.6	112.3
Age at first colostrum feeding (h)	2.0	1.9	2.8	2.2
Total volume of colostrum fed in 24 h (L)	3.3	0.8	5.3	1.4
Total colostrum IgG fed (g)	286.7	123.0	421.2	137.5
Serum IgG (g/L)	32.0	5.5	33.9	8.2

14

- ### Summary
- We are transitioning to a TPI system with 4 serum IgG categories: excellent, good, fair, and poor.
  - Corresponding serum IgG concentrations of  $\geq 25.0$ , 18.0–24.9, 10.0–17.9, and  $< 10$  g/L.
  - At the herd level, it is proposed that  $>40$ , 30, 20, and  $<10\%$  of calves are in the excellent, good, fair, and poor TPI categories, respectively.
  - Corresponding serum total protein and %Brix values are available.

15



16



# Mineral Availability to Dairy Cows

**Dr. Bill Weiss**

**Department of Animal Sciences (retired)**

**Ohio Agricultural Research and Development Center**

**The Ohio State University, Wooster 44691**





# Mineral Availability to Dairy Cows

Bill Weiss  
Department of Animal Sciences (retired)  
Ohio Agricultural Research and Development Center  
The Ohio State University, Wooster 44691

## Summary

Minerals need to be absorbed to perform most, but not all, their functions. Because absorption can depend on the source of the mineral, many diet formulation systems are now based on absorbed minerals rather than total dietary minerals. Formulating diets based on available minerals should be superior to formulating for total minerals; however, we have very limited data on mineral availability. For most minerals, only source of minerals (e.g., organic feedstuffs vs. dicalcium phosphate vs. monosodium phosphate) affects the estimated absorption coefficient (AC) used by the software even though for some minerals other factors such as antagonism and mineral status of the cow have substantial impact on the AC.

Measuring the AC for most minerals is extremely difficult and virtually impossible to do for individual ingredients. For example, dietary calcium can come from corn, corn silage, alfalfa, soybean meal, limestone etc. and we can (with some difficulty) determine the AC for calcium for that diet but we cannot determine the AC for each ingredient. For the electrolytes (sodium, potassium, chloride) and for magnesium (with certain caveats) we can estimate the dietary AC using a statistical approach called the Lucas Test. In this test we regress intake of apparently absorbed mineral (intake – fecal excretion of minerals) on intake of total minerals. The slope of the equation is the true absorption of the mineral and the intercept which must be 0 or a negative number equals the endogenous fecal secretion of the mineral. This approach only works if absorption of the mineral is not regulated by the cow, is not affected greatly by source and is high. Magnesium absorption is affected by source which is why this approach has to be used selectively to estimate AC for magnesium. For all the other minerals we need to use other approaches to estimate AC such as experiments using isotopically labeled minerals or semi-purified diets both of which are expensive and difficult to conduct. This is why we have so few data on mineral availability. Because of a greatly expanded database, we can use the Lucas test to derive improved estimates of magnesium AC. Based on new data, the AC of Mg from feedstuffs is substantially greater than the AC used in NRC (2001) but the AC for average MgO is substantially less.

The NRC (2001) reviewed the literature and published AC for most minerals. Within a mineral, most feedstuffs were given the same AC but the AC of mineral supplements may have varied. We have made little progress in estimating the AC for specific feeds with the exception of phosphorus. Organic feedstuffs contain both inorganic and organic P and the AC of those two fractions differ (0.84 vs 0.68) (Feng, et al., 2015). If labs can partition total P within a feed into organic and inorganic P we can calculate an AC for the specific feedstuff. We have made some progress on accounting for effects of antagonists on mineral absorption. We have adequate data to estimate the effect of dietary potassium on Mg absorption and to estimate the effect of dietary sulfur on copper absorption. Although numerous other antagonists exist we do not have adequate data to develop equations.

Estimating the AC for trace minerals is extraordinarily difficult. Errors are large because we are dealing with such small amounts, generally absorption is tightly regulated and antagonism is common. Therefore, for many trace mineral sources we only have relative absorption values which are then extrapolated to estimate AC. For example, based on change in liver copper concentrations we might know that under a specific situation, copper from supplement 'X' is twice as available as copper sulfate. If we assume the AC for copper sulfate is 0.05 then product X has an AC of 0.10. However, we cannot know with certainty whether copper sulfate in that situation had an AC of 0.05. To calculate relative AC we need to be able to measure something that respond to change in supply of available mineral. For copper, liver concentrations work well, but for minerals such as zinc or manganese, liver is not very sensitive. In addition, relative AC are dependent on the diet and status of the cows used in the experiment. If the diet has antagonists (e.g., high sulfur) the relative AC may be very different than if we conducted the experiment with diets that did not have high sulfur (Spears, et al., 2004).

Another issue of formulating diets based on absorbed mineral is that some minerals do not need to be absorbed to have effects. For example, feeding sulfate trace minerals (copper, zinc, and manganese) tend to reduce ruminal fiber digestion compared to other sources of trace minerals. Source of trace mineral can affect the ruminal and intestinal microbiome (Faulkner, et al., 2017) which could affect immunity. These 'non-absorptive' effects have been poorly quantified and if we balance diets totally on absorbed minerals we may not maximize potential benefits from the minerals. Details of these topics can be found in the following slide set.

## References

- Faulkner, M. J., B. A. Wenner, L. M. Solden, and W. P. Weiss. 2017. Source of supplemental dietary copper, zinc, and manganese affects fecal microbial relative abundance in lactating dairy cows. *J Dairy Sci.* 100:1037-1044.
- Feng, X., K. F. Knowlton, and M. D. Hanigan. 2015. Parameterization of a ruminant model of phosphorus digestion and metabolism. *J Dairy Sci.* 98:7194-7208.
- National Research Council. 2001. *Nutrient Requirements of Dairy Cattle*. 7th rev. ed. ed. Natl. Acad. Press, Washington DC.
- Spears, J. W., E. B. Kegley, and L. A. Mullis. 2004. Bioavailability of copper from tribasic copper chloride and copper sulfate in growing cattle. *Anim Feed Sci Tech.* 116:1-13.

### Assessing Mineral Availability and Real-World Implications



**The Periodic Table**

THE OHIO STATE UNIVERSITY  
COLLEGE OF FOOD, AGRICULTURAL, AND ENVIRONMENTAL SCIENCES

Bill Weiss  
Animal Sciences

Ohio Agricultural Research and Development Center    Ohio State University Extension

1

### Most formulation systems in US are based on factorial approach and absorbed minerals

Feed enough **absorbable** minerals to maintain **adequate** labile body stores and fluid concentrations

- Replace inevitable losses via feces and urine (i.e., maint.)
- Replace minerals secreted in milk
- Replace minerals accreted in new tissue (growth)
- Replace minerals accreted in fetus

2

### Most formulation systems in US are based on factorial approach and absorbed minerals

Feed enough **absorbable** minerals to maintain **adequate** labile body stores and fluid concentrations

- Replace **Must know what's adequate**
- Replace **Is adequacy constant?**
- Replace minerals accreted in new tissue (growth)
- Replace minerals accreted in fetus

Must know what is absorbed (nt.)

Must know concentrations

3

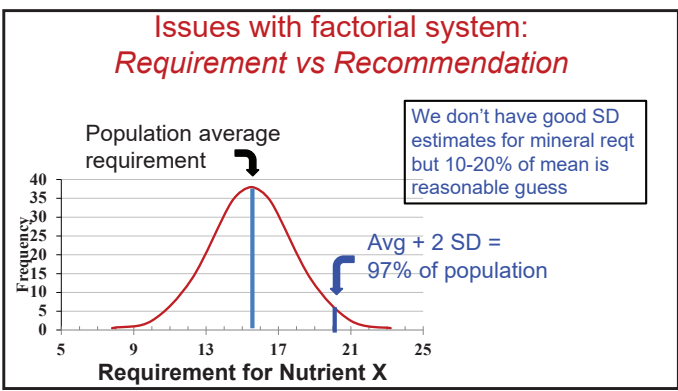

4

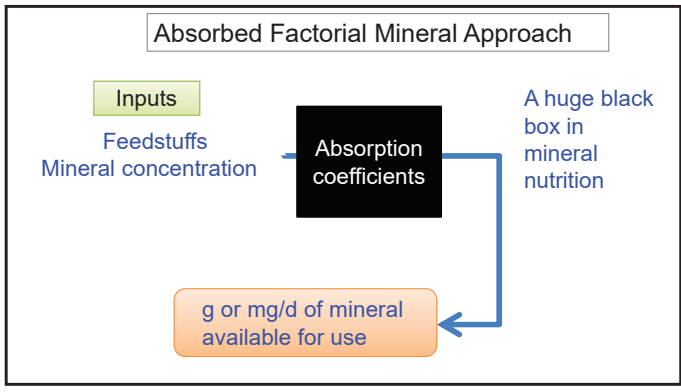

5

### Apparent absorption ≠ Absorption coefficient

- Fecal mineral losses :
  - Unabsorbed dietary
  - Endogenous (Metabolic) Fecal ← Part of maint. reqt
  - Homeostatic excretion

“True” Availability =  $\frac{\text{Intake} - (\text{Feces} - \text{Met} - \text{Homeo Fecal})}{\text{Intake}}$

AC = True availability measured when cows fed approximately at requirement

6

## Estimating True Availability via Lucas Test

$$\text{Absorbed K, g/kg DM} = 1.02(+0.06) \times \text{Diet K} - 2.48(+0.74)$$

True Absorption

Metabolic Fecal K (implied maintenance)  
Error is large (CV = 30%)

- Approach works well if:
  - Absorption rate is not regulated (and high)
  - Surplus mineral is excreted in the urine
  - Sources/diets have similar availability
- Used for the strong ions: K, Na, and Cl
- Can be used with Mg (source adjustment)

## Obtaining AC and endo. fecal (Lucas plot)

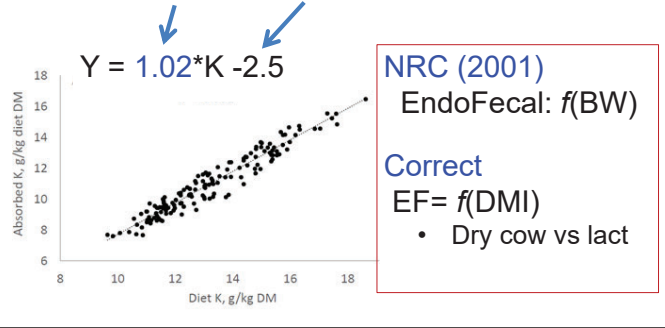

7

8

## Absorption of Calcium



- AC for  $\text{CaCl}_2 = 0.95$  (NRC 2001) (calf data)
- AC actually  $\sim 0.6$  in older cattle
- Other sources were relative to  $\text{CaCl}_2$
- Based on newer data, EF loss too high

Estimated AC and EF loss are often correlated  
(lower AC often = lower EF loss)

## Absorption of Phosphorus



- Form of P matters (Feng et al: 2015)
  - Inorganic P = 0.84
  - Organic P (including phytate) = 0.68
  - Labs could offer assay

Grass hay: 67% Inorganic; 33% organic:  
AC =  $0.67 \cdot .84 + .33 \cdot 0.68 = 0.79$

SBM: 7% Inorganic; 93% organic: AC = 0.69

9

10

## Magnesium



1. Absorbed from rumen
2. Absorption does not appear to be regulated
3. Real world antagonists
  - K (linear)
  - LCFA (-10 to 20%)
  - Soluble CP (must be very high)

## K and Mg Absorption in Dairy Cows

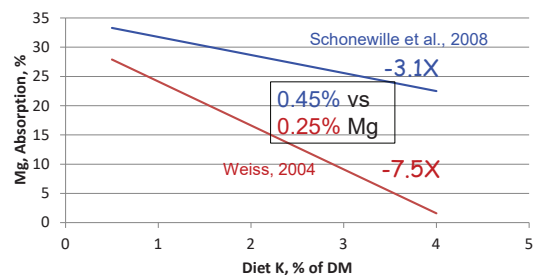

11

12

## Monensin ↑ and ↓ Mg absorption

- All diets 2.1% K (0.8 from K carb)
- 0.35% Mg (0.2 basal)
- Treatments
  - MgO or MgSO<sub>4</sub>
  - 0.2 vs 0.4% S
  - 0 or 14 mg/kg monensin

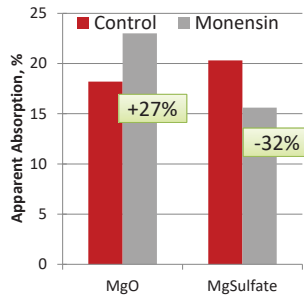

Tebbe et al., 2018

13

## Mg AC in NRC (2001) needs revised

	NRC, 2001	Revised
Basal feeds	0.16	0.30* (± 0.16)
Good MgO	0.70	0.20* to 0.25
MgSO <sub>4</sub>	0.90	0.35* to 0.40

\* Standardized to 1.2% K

Feeds are better, supplements are worse than we thought

14

## Mg Availability from 4 sources of MgO

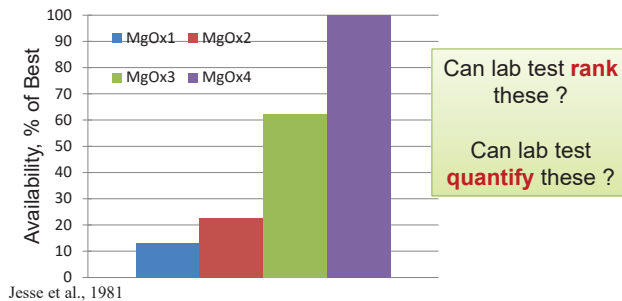

Jesse et al., 1981

Can lab test **rank** these ?  
Can lab test **quantify** these ?

15

## Measuring AC of TM is extremely difficult

- Very low AC (large measurement errors)
- Numerous antagonists
- Likely source x antagonist interactions
- Homeostatic fecal excretion
- Regulated absorption

Diet may have greater effect on AC than mineral source

16

## Corn Silage

AC for ingredients are still mostly constants

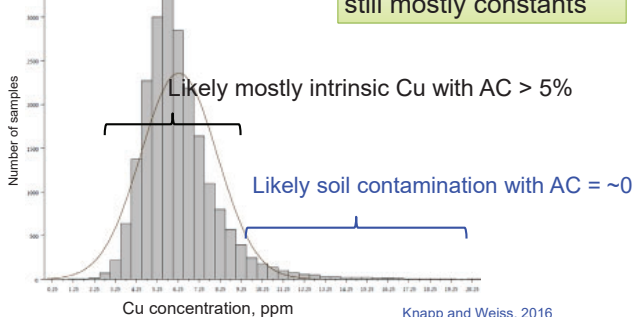

Knapp and Weiss, 2016

17

## Known and potential antagonists for TM

Cu (0 to 0.1)	Mn (0 to 0.01)	Zn (0.05 to 0.2)
• S	• P	• S
• Soil (clay)	• S	• Cu (?)
• Mo+S	• Ca (?)	• Phytate (?)
• Fe	• K (?)	• Fiber
• Zn (?)	• Fe	
• Fiber		
		<b>Se</b>
		• S
		• Ca
		• Met (yeast)

Can't quantify yet, but qualitative adjustment may be needed

18

## Relative Availability (often used for commercial TM)

1. Feed a standard mineral (e.g.,  $\text{CuSO}_4$ )
2. Feed test mineral X (same amount)
3. Measure **appropriate response** and report ratio

Liver Cu when fed source X  
 Liver Cu when fed Cu sulfate

1. Diet specific
2. Animal specific
3. Everything is relative

19

## Relative Availability Coefficients

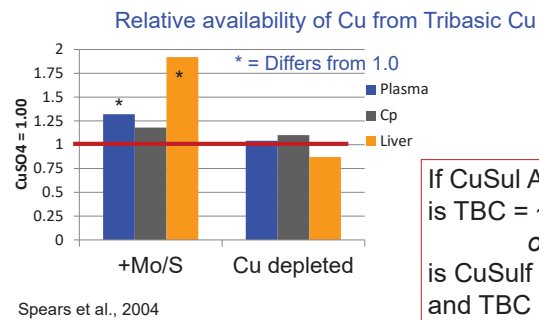

If CuSul AC = 0.05  
 is TBC = ~0.10 ?  
 or  
 is CuSulf = 0.025  
 and TBC = 0.05 ?

20

## Does the response measure have value ?

Se-Y: 1.2 to 2X better

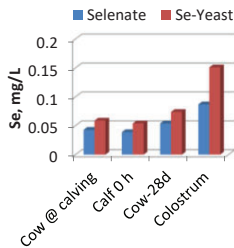

Weiss and Hogan, 2006

Se-Y = selenite

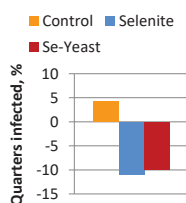

Malbe et al., 1995

21

## How do you use relative availability data?

If data show product X is twice as good as sulfate, *should I feed half as much ?*

1. **Cu**: Yes, adjust for availability
2. **Se**: Don't adjust
3. **Mn**: Probably doesn't matter
4. **Zn**: Don't adjust (microbiome effects?)

22

## Revised Ingredient AC

### Macrominerals

**Ca: 0.4 to 0.6**  
 P: 0.7 to 0.9\*  
**Mg: 0.2 to 0.35**  
 K, Na, Cl: ~1.0  
 \* Adjust based on lab tests?

### Trace Minerals

Cu: ~0 to 0.1  
 Fe: 0.05 to 0.15  
**Mn: ~0 to 0.01**  
 Se: 0.5 to 0.85  
 Zn: 0.05 to 0.20

23

## Are OTM more available ? Yes

- 30 to 30 DIM
- Sulfate or AA-complex Cu, Mn, Zn (Co only in AA)
- TMR (mg/kg PF/ Fresh):
  - Zn 83 or 70
  - Mn 76 or 70
  - Cu 14 or 12

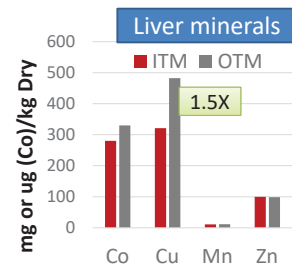

Osorio et al., 2016

24

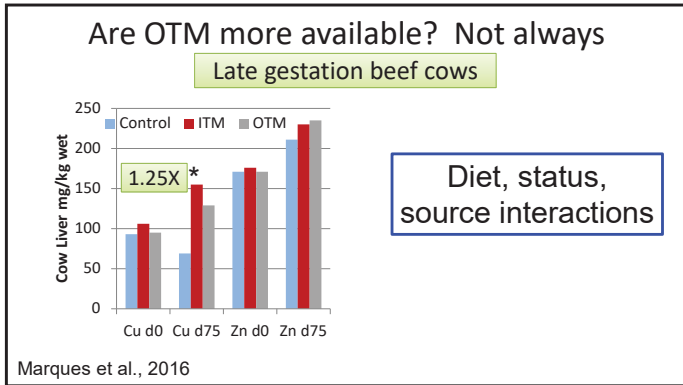

25

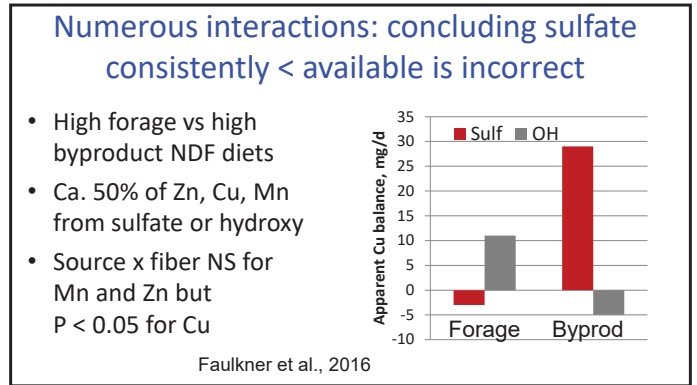

26

### Do minerals have to be absorbed to affect cow ?

**Mineral requirements:**

- Maintains body stores ✓
- Supports productive functions ✓
  - growth
  - lactation
  - reproduction
- Maintains good health ?
- GI function/ nutrient digestion ?

**Absorbed ?**

27

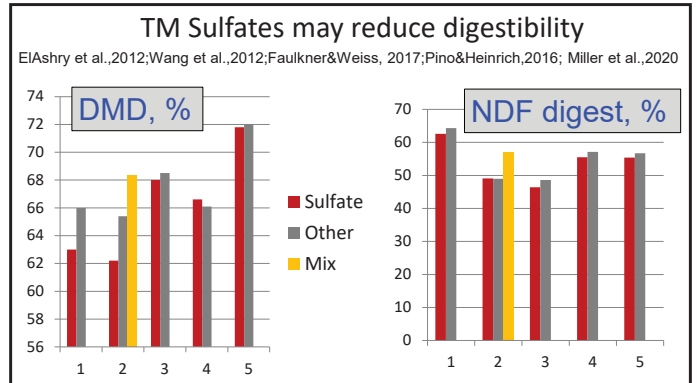

28

### Are differences between organic and inorganic TM only bioavailability?

Organic Zn reduced the pathogen associated with digital dermatitis in feces (inorganic did not)

Faulkner et al., 2017

Intestine is a very important immune organ

↕

Microbiome affects immunity

29

### Conclusions

- ✓ We need to incorporate more sources of variation into AC
- ✓ AC for TM are still poorly defined but better than using only concentrations
- ✓ Minerals don't have to be absorbed to affect cows

30



# **Balancing Lactating Cow Diets for Amino Acids: Using Efficiencies**

**Mark D. Hanigan**

**Collaborators: Helene Lapierre\*, Roger Martineau\***

**Department of Dairy Science**

**VirginiaTech**







# Balancing Lactating Cow Diets for Amino Acids: Using Efficiencies

Mark D. Hanigan  
 Collaborators: Helene Lapiere\*, Roger Martineau\*

Department of Dairy Science  
 Virginia Tech

\*Agriculture and Agri-Food Canada

Department of Dairy Science at Virginia Tech - dasc.vt.edu

1

# Milk Protein vs Metabolizable Protein

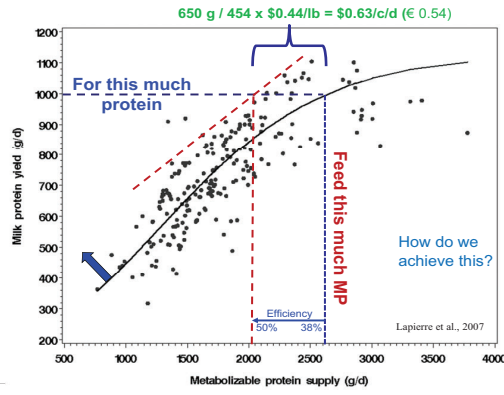

2

# N Partitioning in the Lactating Ruminant Typical 1990's Diet

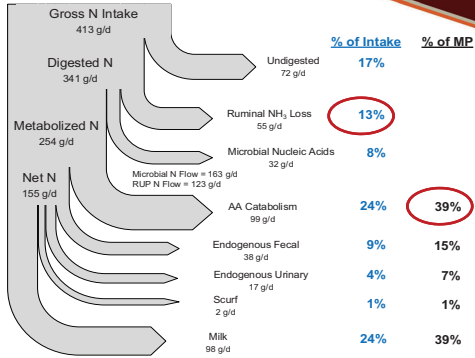

Adapted from Amola et al., 2014

3

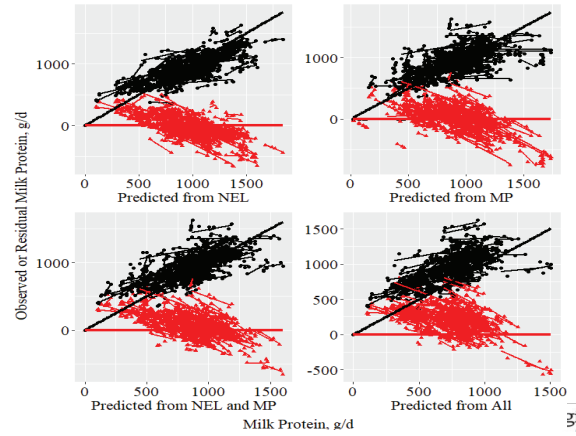

4

# Protein is a String of Amino Acids ∴ All Amino Acids are Required

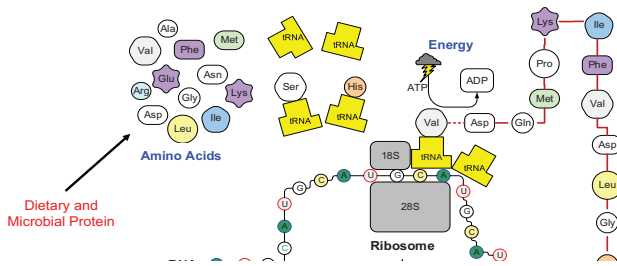

5

# Additive Responses to EAA in Cows



15% CP Diet  
 38% N Efficiency

	Effect (P-values)		
	MKH	IL	MKH*IL
Milk	0.39	0.02	0.89
Milk Protein	0.002	0.02	0.500

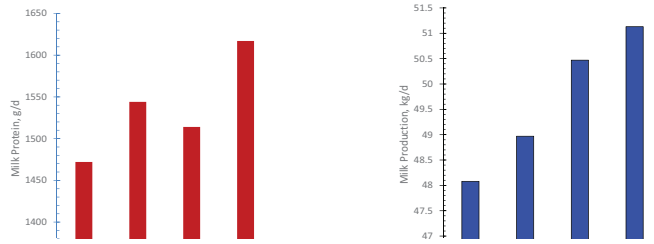

6

### Water Barrel Analogy

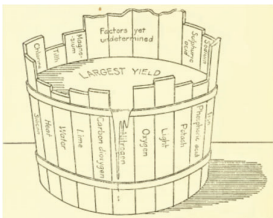

FIG. 2.—Illustrating the principle of limiting factors in soil fertility.

### Lowest stave limits performance

- **Sprengel, 1828**
  - A soil nutrient can limit plant growth
  - When limiting, growth will be proportion to supply
- **von Liebig, 1862**
  - If a nutrient is limiting, then growth can't respond to another nutrient
  - "Law of the Minimum"
- **Whitson and Harlow, 1909**
  - Barrel and Stave Analogy
- **Mitchell and Block, 1946**
  - Application of AA in rats
  - Order of limitation
  - Assumes Constant Efficiencies

Intercept	His	Ile	Leu	Lys	Met	Thr	NEAA	$\Sigma(EAA^2)$	dFA	dNDF	dst	drOM	BW
g/d													
	1.72	1.34	0.36	1.31	1.73	1.58	0.14	-0.0020	122	20	45	47	-0.38

### Cross Evaluation Results – 500 Iterations

Variable	Mean	SE
Observed Mean, g/d	924	17
Predicted Mean, g/d	924	13
RMSE	126	7
RMSE, % mean	13.7	0.8
Mean Bias, % MSE	0.7	0.9
Slope Bias, % MSE	2.8	2.4
CCC	0.78	0.03

- Arg significant but variable
- Trp, Phe, and Val → inadequate data

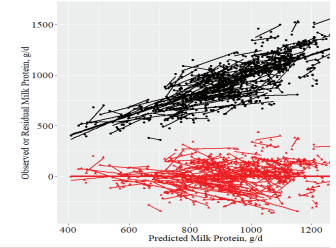

7

8

### Efficiency of Absorbed EAA Conversion to Milk EAA

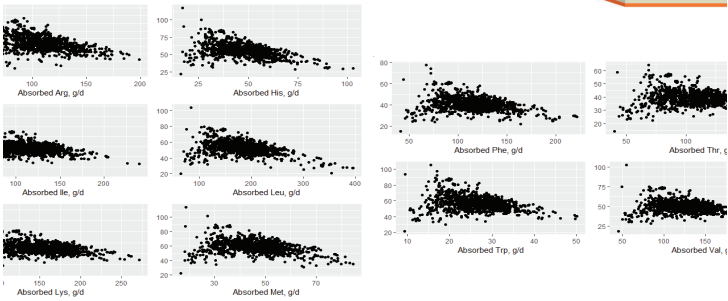

9

### Example Diet 1

MP Supply: 2383 g, Target MP: 2301 g  
NE Allow Milk: 40.4 kg

	Trg Milk NP	Trg Effic	Trg Suppl	Pred Suppl	Pred Effic	Regr Coeff	Milk NP
W_NDF on prot)				59		10.79	-125
41				137	0.45	0	638
32	0.75	60	57	0.77	1.675	95	0
67	0.71	121	142	0.59	0.885	125	0
115	0.73	205	214	0.68	0.466	100	0
96	0.72	174	182	0.66	1.153	210	0
33	0.73	55	52	0.75	1.839	95	0
57	0.60	127	138	0.54	0	0	0
50	0.64	118	126	0.58	0	0	0
18	0.86	28	31	0.75	0	0	0
75	0.74	135	147	0.66	0	0	0
582		1025	1224	0.62	-0.00215	-225	
her			2095		0.0773	162	
Allow kg/d	1085			0.65	NA	1075	34.7

- 35 kg milk
- 24.9 kg DM/d
- 17.5% CP
- Corn Silage
- Legume Silage
- Mixed Hay
- Corn
- SBM
- Expeller SBM

10

### Example Diet 2

MP Supply: 2249 g, Target MP: 2293 g  
NE Allow Milk: 41.8 kg

	Trg Milk NP	Trg Effic	Trg Suppl	Pred Suppl	Pred Effic	Regr Coeff	Milk NP
W_NDF				62		10.79	-115
41				130	0.47	0	665
32	0.75	60	54	0.81	1.675	91	0
67	0.71	121	133	0.64	0.885	117	0
115	0.73	204	205	0.71	0.466	96	0
96	0.72	174	170	0.72	1.153	196	0
33	0.73	55	49	0.80	1.839	91	0
57	0.60	127	130	0.57	0	0	0
50	0.64	118	118	0.62	0	0	0
18	0.86	28	29	0.82	0	0	0
75	0.74	135	138	0.71	0	0	0
582		1021	1156	0.66	-0.00215	-202	

- 35 kg milk
- 24.9 kg DM/d
- 15.9% CP
- Corn Silage
- Mixed Hay
- Corn
- SBM
- Expeller SBM

11

### Example Diet 3

MP Supply: 2117 g, Target MP: 2320 g  
NE Allow Milk: 40.9 kg

	Trg Milk NP	Trg Effic	Trg Suppl	Pred Suppl	Pred Effic	Regr Coeff	Milk NP
V_NDF				62		10.79	-115
41				130	0.47	0	665
32	0.75	60	54	0.81	1.675	91	0
67	0.71	121	133	0.64	0.885	117	0
115	0.73	204	205	0.71	0.466	96	0
96	0.72	174	170	0.72	1.153	196	0
33	0.73	55	49	0.80	1.839	91	0
57	0.60	127	130	0.57	0	0	0
50	0.64	118	118	0.62	0	0	0
18	0.86	28	29	0.82	0	0	0
75	0.74	135	138	0.71	0	0	0
582		1021	1156	0.66	-0.00215	-202	

- 35 kg milk
- 24.9 kg DM/d
- 14.7% CP
- Corn Silage
- Mixed Hay
- Corn
- Corn Distillers
- Soyhulls

12



- ✓ New concepts for milk protein predictions
  - 5 EAA, DEInp, dNDF
  - Marginal responses to individual AA not high
  - Energy supply very important
  - No such thing as a single-limiting AA

✓ Efficiency of Use of EAA is a good tool



✓  **Optimize** or  **Plug and Chug?**

- dNDF, dStarch, RDP, dFat, 5 dEAA, 2 dFA, 38 MV, Ingr\$, Milk\$
- How much money are you leaving on the table???





# **Strategies to Optimize Fertility with Sexed Semen in Primiparous Holstein Cows and Nulliparous Holstein Heifers**

**Dr. Paul Fricke, Ph.D.  
and  
Megan R. Lauber M.S.  
University of Wisconsin**



# Strategies to optimize fertility with sexed semen in primiparous Holstein cows and nulliparous Holstein heifers



ANIMAL &  
DAIRY SCIENCES  
University of Wisconsin-Madison

Paul M. Fricke, Ph.D.  
and  
Megan R. Lauber M.S.

1

## Outline

- Background on sexed semen
- **Cow Study:** Effect of timing of induction of ovulation relative to TAI using sexed semen on pregnancy outcomes in primiparous Holstein cows
- **Heifer Study:** Comparison of reproductive management programs for submission of Holstein heifers for first AI with conventional or sexed semen based on expression of estrus, pregnancy outcomes, and cost per pregnancy
- Acknowledgments
- Questions

2

# Methods for Sexing Semen

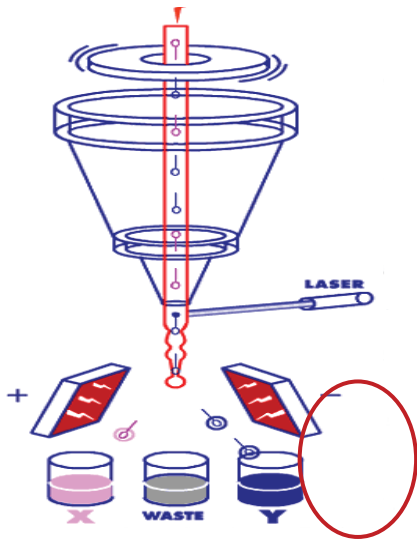

- X-chromosome has 4% more DNA
- Sperm stained with dye & sorted or killed by laser
- 85% to 90% accuracy
- 75% of total sperm discarded in process

Garner et al., 2006, Garner et al., 2012

3

# Selective Killing

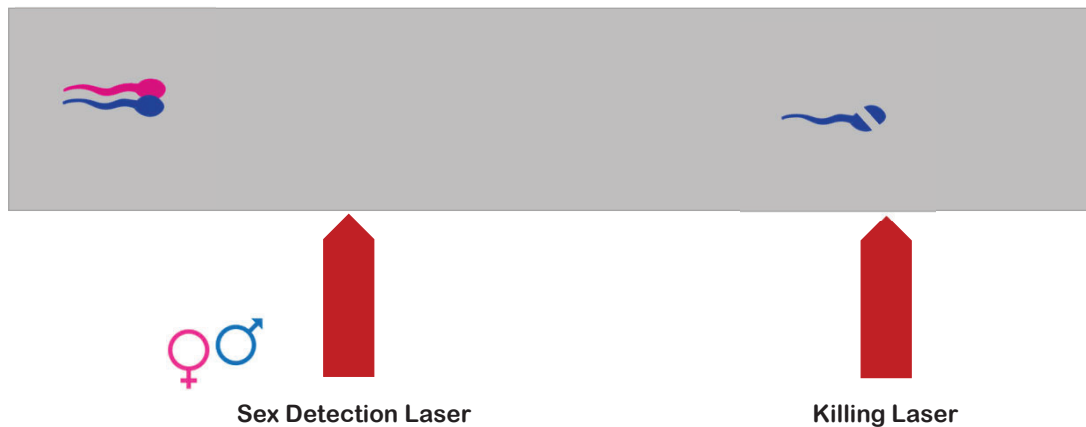

4

# A Brief History of Sexed Semen

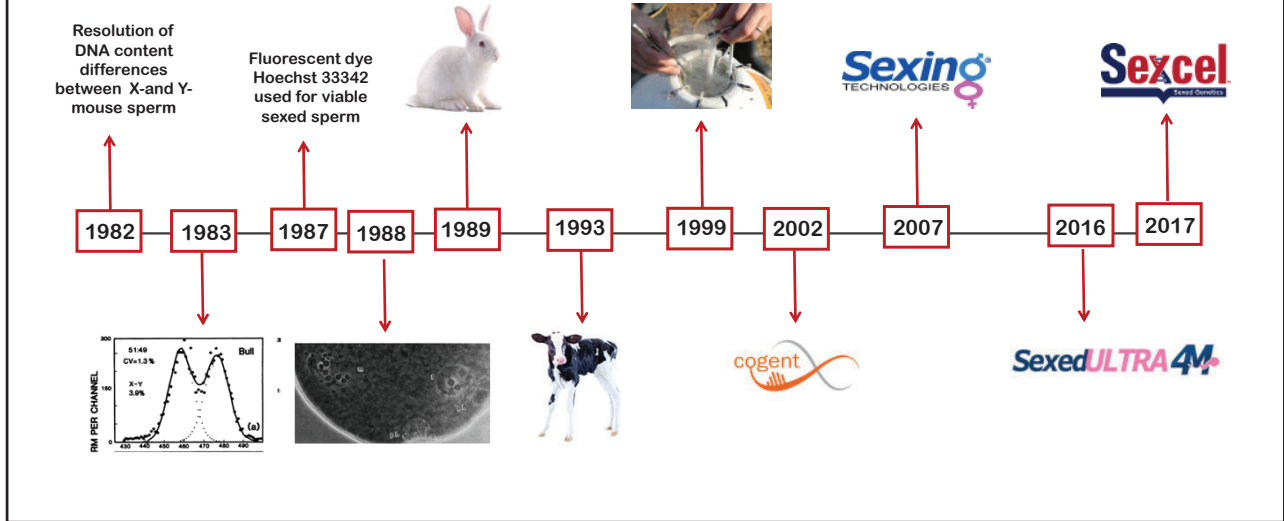

5

# Use of Genomics, Sexed Semen, and Beef Semen

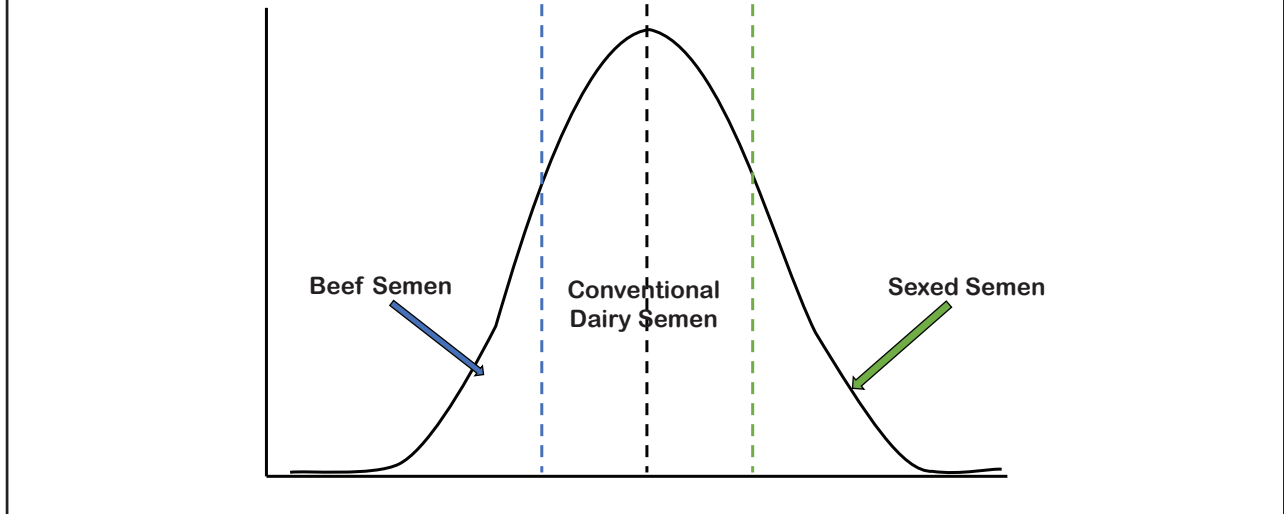

6

## Inseminations in Holstein Females

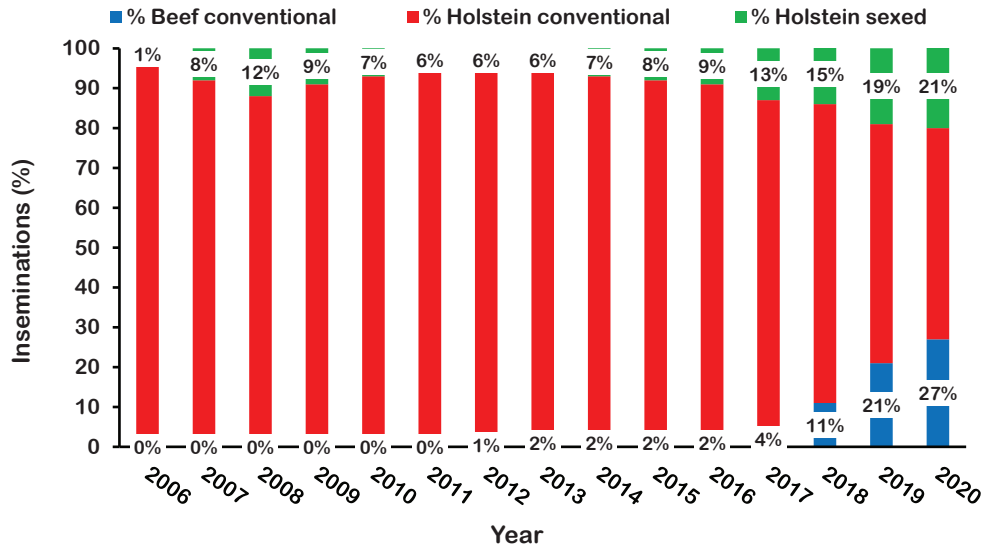

AgSource 2021

7

## Inseminations in Jersey Females

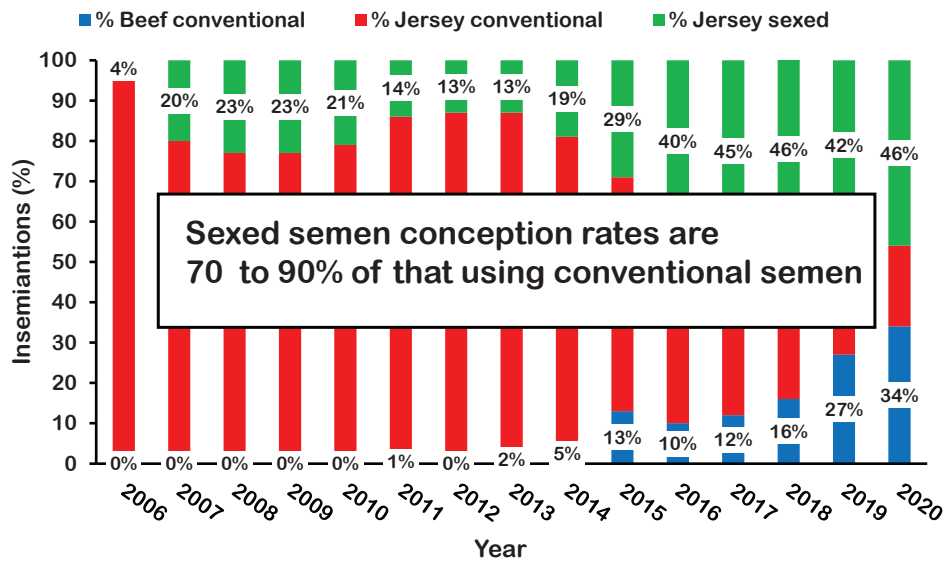

Karakaya-Bilen et al., 2019, Chebel and Cunha 2020, Drake et al., 2020 AgSource 2021

8





### Short communication: Effect of timing of induction of ovulation relative to timed artificial insemination using sexed semen on pregnancy outcomes in primiparous Holstein cows

M. R. Lauber,<sup>1</sup> B. McMullen,<sup>2</sup> J. J. Parrish,<sup>3</sup> and P. M. Fricke<sup>1\*</sup>

<sup>1</sup>Department of Dairy Science, University of Wisconsin-Madison, Madison 53706

<sup>2</sup>Bridgewater Dairy Group, Montpelier, OH 43543

<sup>3</sup>Department of Animal Sciences, University of Wisconsin-Madison, Madison 53706

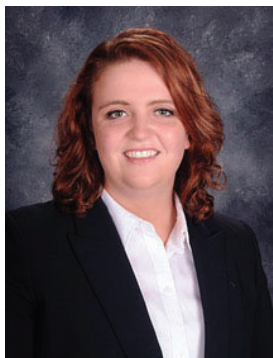

## Objective

To determine the effect of altering timing of induction of ovulation relative to TAI with sexed semen after a Double-Ovsynch protocol in primiparous Holstein cows

## Hypothesis

Induction of ovulation (G2) earlier relative to TAI in a Double-Ovsynch protocol will result in more P/AI

9



Time of insemination relative to reaching activity threshold is associated with pregnancy risk when using sex-sorted semen for lactating Jersey cows



Gabriel D. Bombardelli<sup>a,b</sup>, Henrique F. Soares<sup>a,b</sup>, Ricardo C. Chebel<sup>a,b,\*</sup>

<sup>a</sup>Department of Large Animal Clinical Sciences, University of Florida, Gainesville, Florida, USA

<sup>b</sup>Department of Animal Sciences, University of Florida, Gainesville, Florida, USA



Journal of Dairy & Veterinary Sciences  
ISSN: 2573-2196



Research Article

Volume 3 Issue 4, January 2018

ISSN: 2573-2196

Dairy and Vet Sci J

Copyright © All rights are reserved by Ray Nebel

Time of Insemination Relative to onset of Activity Threshold of Cow Manager ® is Associated with Pregnancy Risk When Using Gender Selected™ Semen for Jersey Cattle



Ray Nebel\*

Department of animal reproduction, Select Sires Inc, USA

Submission: October 27, 2017; Published: January 25, 2018

Inseminating later relative to the onset of activity yielded increased fertility with sexed semen

10



## Assessment of an accelerometer system for detection of estrus and treatment with gonadotropin-releasing hormone at the time of insemination in lactating dairy cows

A. Valenza,\*†‡ J. O. Giordano,\*<sup>1</sup> G. Lopes Jr.,\*<sup>1</sup> L. Vincenti,‡ M. C. Amundson,\* and P. M. Fricke\*<sup>2</sup>

\*Department of Dairy Science, University of Wisconsin, Madison 53706

†Department of Animal Science, School of Agriculture, University of Turin, Turin, Italy 10095

‡Department of Animal Pathology, School of Veterinary Medicine, University of Turin, Turin, Italy 10095

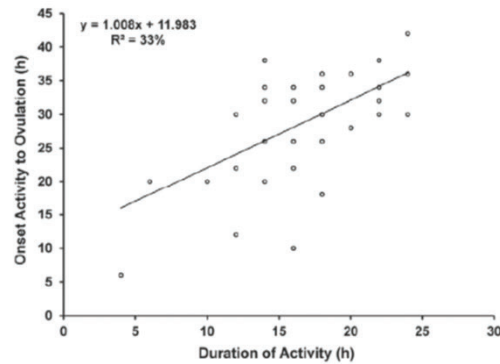
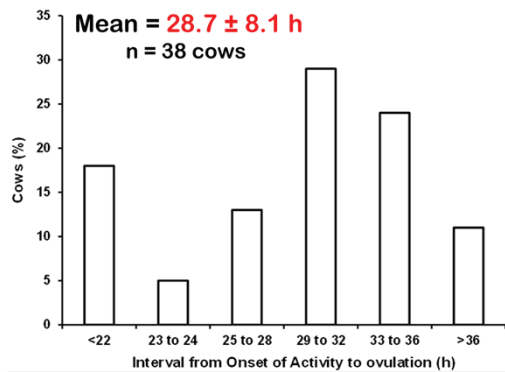

11

## Current Idea

Inseminating later relative to the onset of activity or estrus will lead to increased fertility with sexed semen

- May be the case when inseminating cows based on estrus or increased activity
- This idea has not been tested in a synchronized breeding protocol in which timing of ovulation is precisely controlled

Bombardelli et al., 2016, Nebel 2018

12

## Collaborating Farms

- Three locations:
  - Nebraska, Ohio, Wisconsin
- Primiparous cows only (n = 730)
- All farms submitted cows for first Timed AI using a Double-Ovsynch protocol
  - Farm A: 6,650 cows; ME305 = 11,318 kg.
  - Farm B: 1,800 cows; ME305 = 12,954 kg.
  - Farm C: 2,260 cows; ME305 = 14,091 kg.



13

## Standard Double-Ovsynch Protocol

G2 to TAI = 16 h

Sun	Mon	Tue	Wed	Thu	Fri	Sat
					GnRH a.m.	
					PGF <sub>2α</sub> a.m.	
	GnRH a.m.					
	GnRH a.m.		G2-16			
	PGF <sub>2α</sub> a.m.	PGF <sub>2α</sub> a.m.	G2 p.m.	TAI a.m.		

14

# Modified Double-Ovsynch Protocol

G2 to TAI = 24 h

Sun	Mon	Tue	Wed	Thu	Fri	Sat
					GnRH a.m.	
					PGF <sub>2α</sub> a.m.	
	GnRH a.m.					
	GnRH a.m.		<b>G2-24</b>			
	PGF <sub>2α</sub> a.m.	PGF <sub>2α</sub> a.m.	G2 a.m.	TAI a.m.		

15

## Effect of Treatment on P/AI

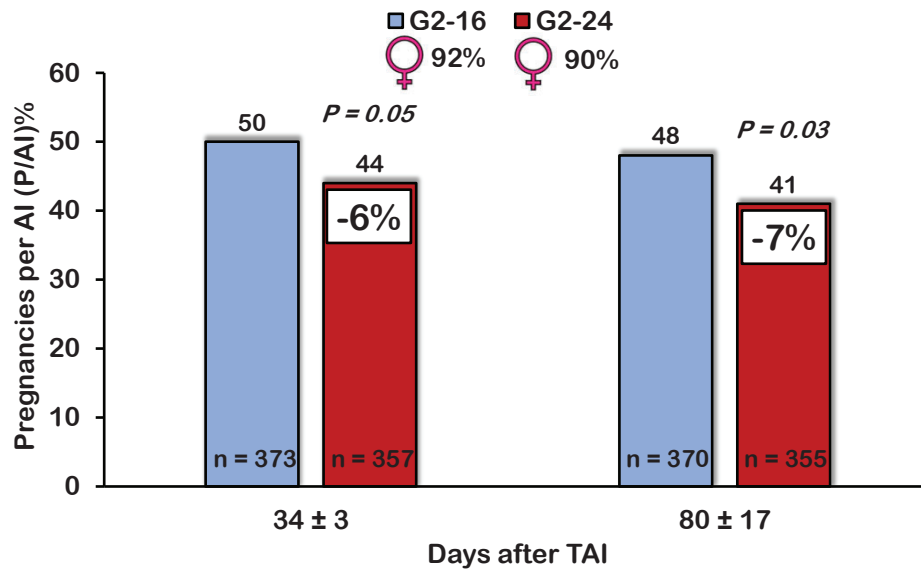

16

# Factors Affecting Fertility

- Time for sperm transport and capacitation
  - **G2-16** cows: 8 to 16 h ; **G2-24** cows: 0 to 8 h
  - Sustained transport requires 8 to 12 h
- Time for luteolysis
  - **G2-24** cows had 8 fewer hours than **G2-16** cows
    - Altered estradiol and progesterone concentrations
- Ovulatory follicle size
  - **G2-24** cows likely ovulated smaller follicles because they had 8 fewer hours to develop during the synchronized follicular wave than **G2-16** cows

Hunter and Wilmut 1983, Peters and Pursley 2003, Carvalho et al., 2018

17

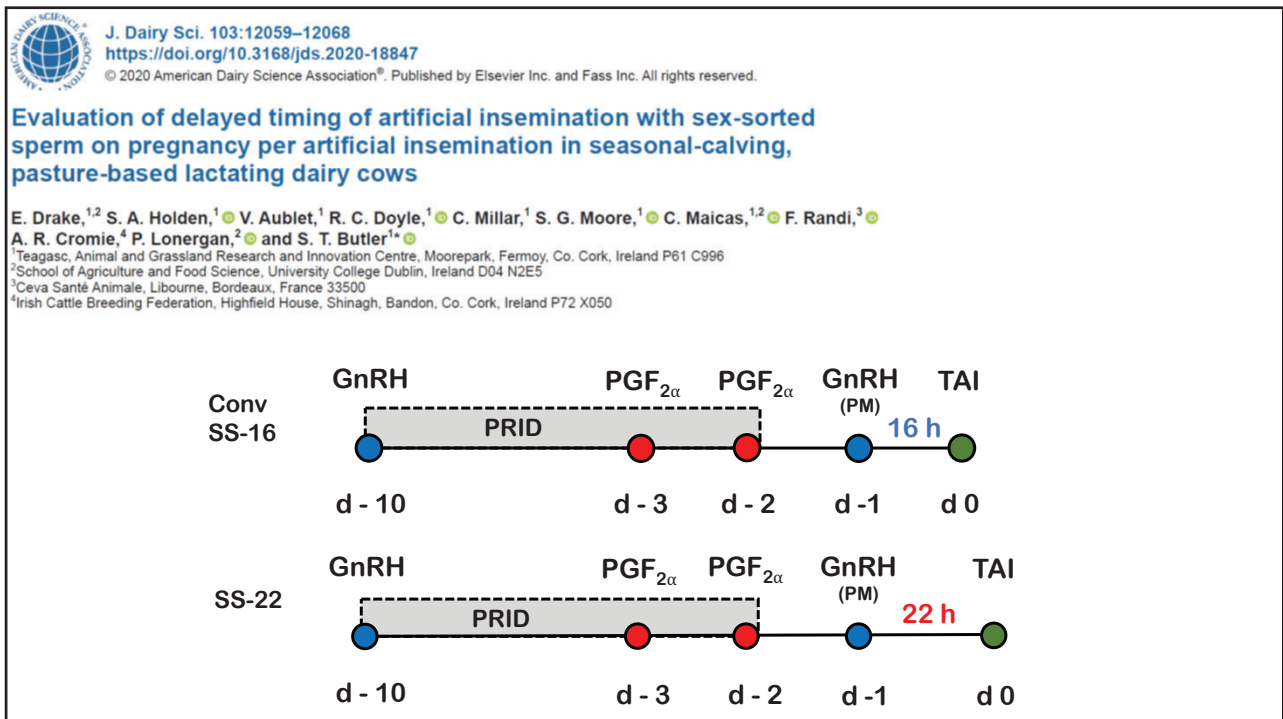

18



## Evaluation of delayed timing of artificial insemination with sex-sorted sperm on pregnancy per artificial insemination in seasonal-calving, pasture-based lactating dairy cows

E. Drake,<sup>1,2</sup> S. A. Holden,<sup>1</sup> V. Aublet,<sup>1</sup> R. C. Doyle,<sup>1</sup> C. Millar,<sup>1</sup> S. G. Moore,<sup>1</sup> C. Maicas,<sup>1,2</sup> F. Randi,<sup>3</sup> A. R. Cromie,<sup>4</sup> P. Lonergan,<sup>2</sup> and S. T. Butler<sup>1\*</sup>

<sup>1</sup>Teagasc, Animal and Grassland Research and Innovation Centre, Moorepark, Fermoy, Co. Cork, Ireland P61 C996

<sup>2</sup>School of Agriculture and Food Science, University College Dublin, Ireland D04 N2E5

<sup>3</sup>Ceva Santé Animale, Libourne, Bordeaux, France 33500

<sup>4</sup>Irish Cattle Breeding Federation, Highfield House, Shinagh, Bandon, Co. Cork, Ireland P72 X050

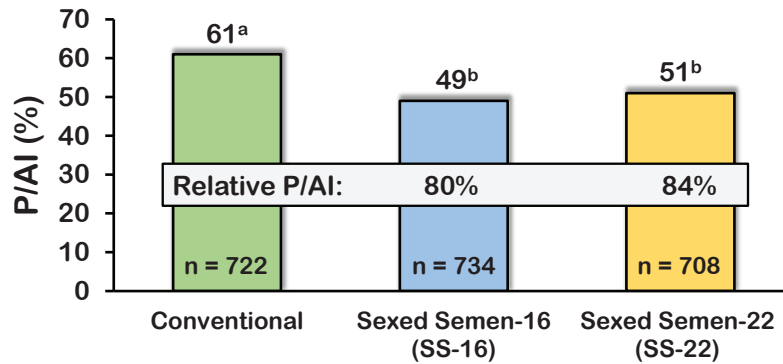

19

## Hypothesis

Induction of ovulation (G2) earlier relative to TAI in a Double-Ovsynch protocol will result in more P/AI

Reject

20



**Heifers!**

21

**Comparison of reproductive management programs for submission of Holstein heifers for first insemination with conventional or sexed semen based on expression of estrus, pregnancy outcomes, and cost per pregnancy**

**M. R. Lauber, E. M. Cabrera, V. G. Santos, P. D. Carvalho, C. Maia, B. Carneiro, V. E. Cabrera, J. J. Parrish and P. M. Fricke**

22

### Characterization of Holstein Heifer Fertility in the United States

M. T. Kuhn, J. L. Hutchison, and G. R. Wiggins

Animal Improvement Programs Laboratory, Agricultural Research Service, USDA, Beltsville, MD 20705-2350

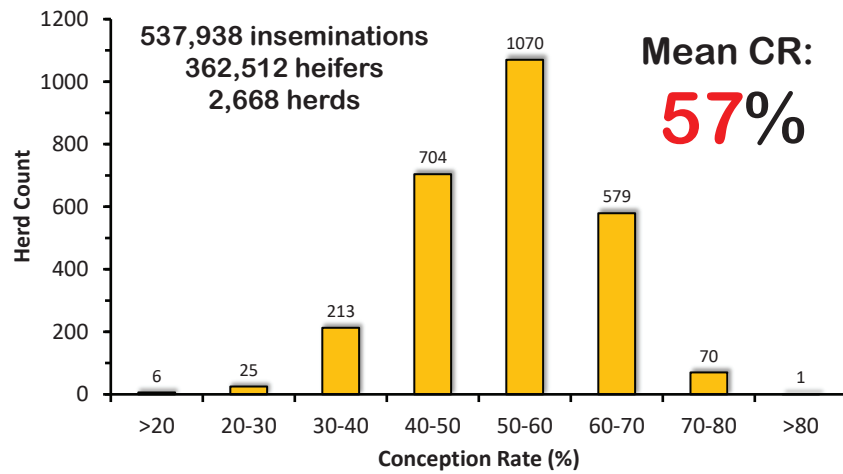

23



### Effect of treatment with human chorionic gonadotropin 7 days after artificial insemination or at the time of embryo transfer on reproductive outcomes in nulliparous Holstein heifers

A. M. Niles, H. P. Fricke, P. D. Carvalho, M. C. Wiltbank, L. L. Hernandez, and P. M. Fricke\*

Department of Dairy Science, University of Wisconsin-Madison, Madison 53706

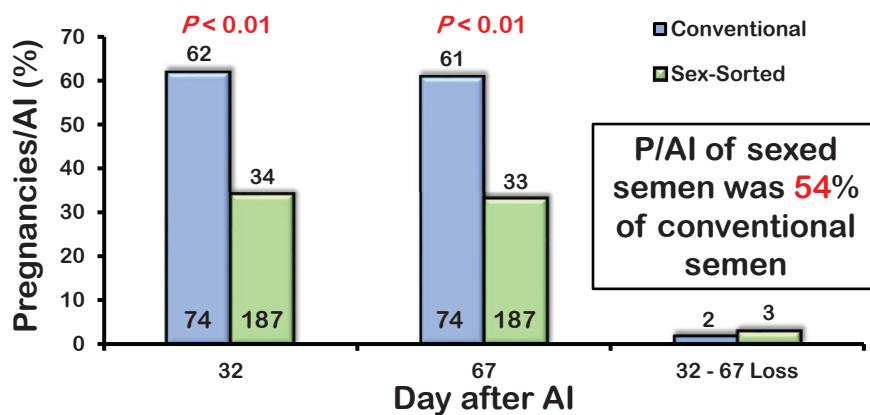

24



### Hormonal manipulations in the 5-day timed artificial insemination protocol to optimize estrous cycle synchrony and fertility in dairy heifers

F. S. Lima,\* E. S. Ribeiro,\* R. S. Bisinotto,\* L. F. Greco,\* N. Martinez,\* M. Amstalden,† W. W. Thatcher,\* and J. E. P. Santos\*<sup>1</sup>

\*Department of Animal Sciences, University of Florida, Gainesville 32611  
 †Department of Animal Sciences, Texas A&M University, College Station 77843

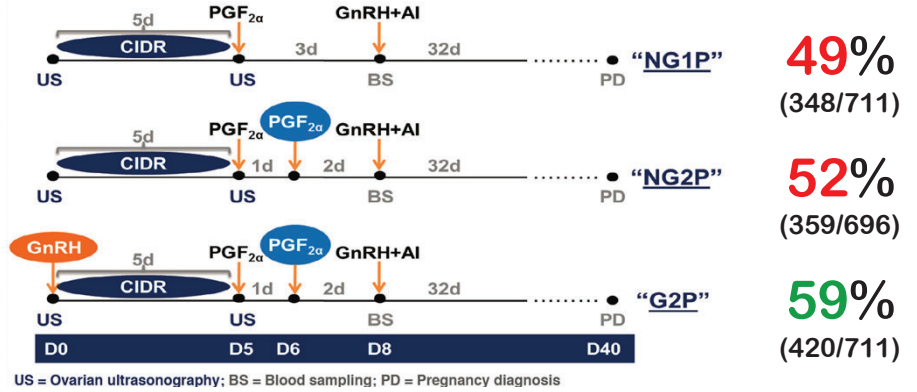

25

### Synchronized ovulation for first insemination improves reproductive performance and reduces cost per pregnancy in dairy heifers

T. V. Silva,\*† F. S. Lima,‡ W. W. Thatcher,\*† and J. E. P. Santos\*†<sup>1</sup>

\*Department of Animal Sciences, and  
 †D. H. Barron Reproductive and Perinatal Biology Research Program, University of Florida, Gainesville 32611  
 ‡Department of Veterinary Clinical Medicine, University of Illinois, Urbana 61802

Semen type	Treatment		P-value
	Estrus	TAI	
Conventional	66 (155/240)	65 (151/231)	0.86
Sexed	48% of Conventional 32 (18/57)	55 (40/73)	85% of Conventional

26

## Objective of Experiment 1

To determine the effect of delaying PRID removal by 24 h until d 6 during a 5-d PRID-Synch protocol on early expression of estrus before TAI and P/AI in nulliparous Holstein heifers inseminated with **conventional semen**

27

## Hypothesis for Experiment 1

Delaying PRID removal by 24 h until d 6 will decrease early expression of estrus before scheduled TAI without affecting P/AI in nulliparous Holstein heifers inseminated with **conventional semen**

28

# Estrus $\geq$ 24 h before TAI

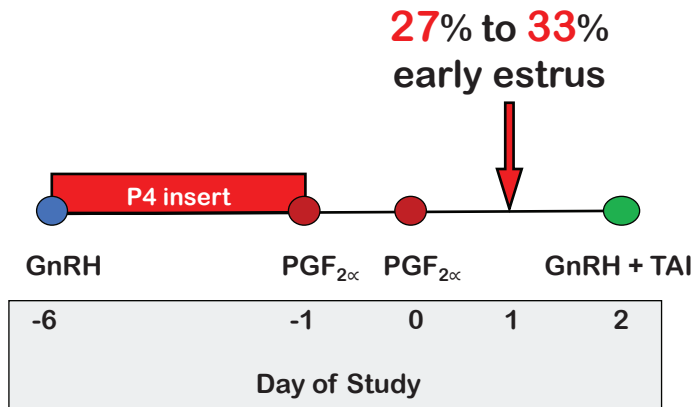

Silva et al., 2015, Masello et al., 2019

29

## 5-d PRID

n = 230

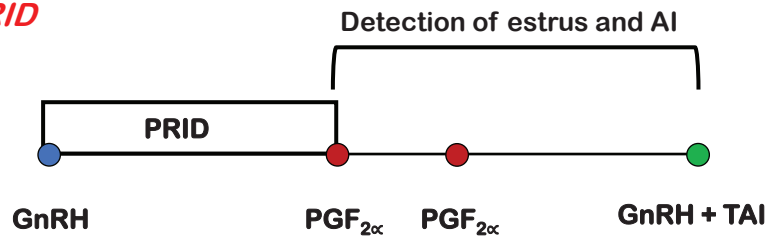

## 6-d PRID

n = 232

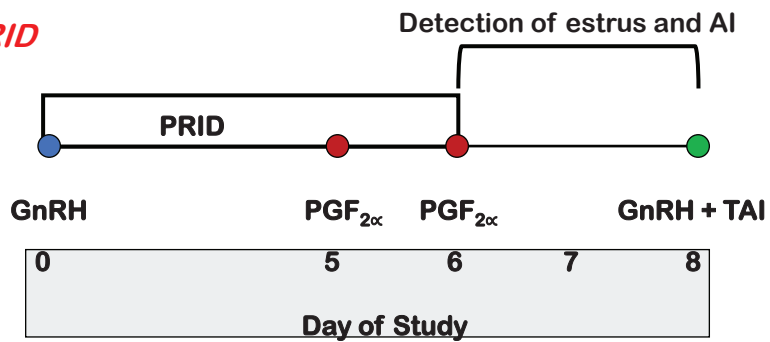

30

## Effect of treatment on estrus before TAI

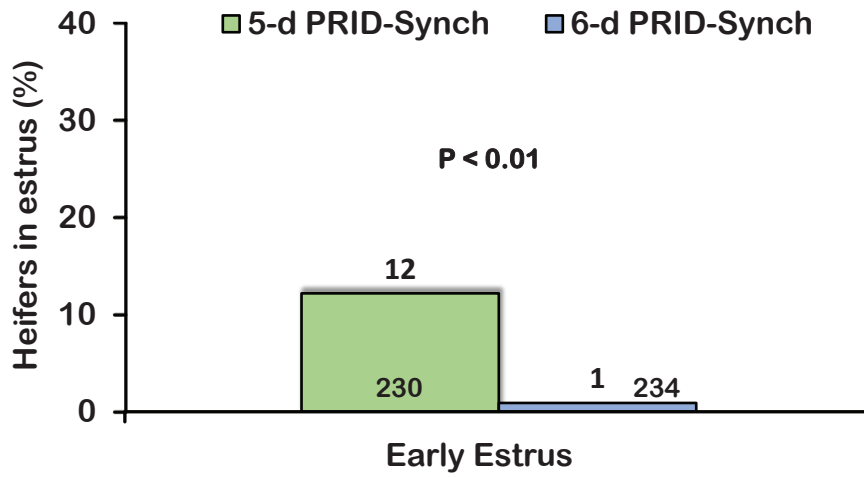

31

## Effect of treatment on Pregnancies per AI

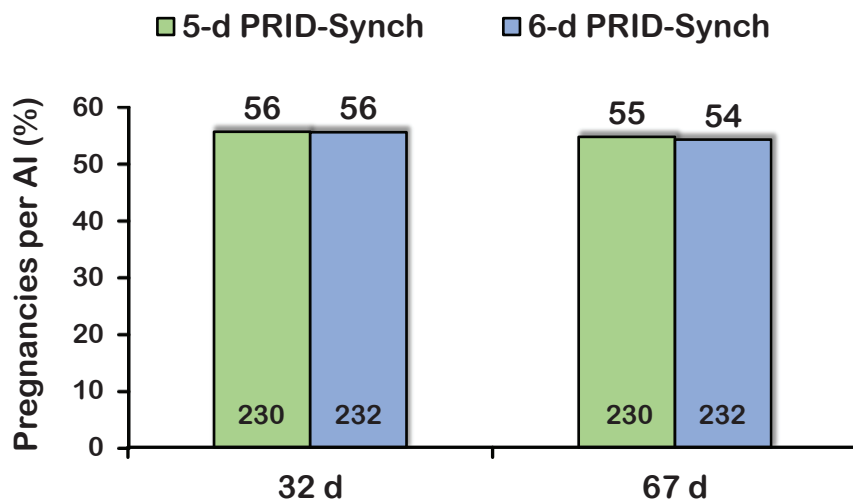

32

## Objectives of Experiment 2

1. To determine the effect of delayed CIDR removal by 24 h during a 5-d CIDR-Synch protocol on expression of estrus and P/AI of heifers inseminated with **sexed semen**
2. To compare TAI versus once-daily detection of estrus (EDAI) for first AI on P/AI and days to first AI and pregnancy
3. To compare costs per pregnancy during an 84-d breeding period when TAI or EDAI was used for first AI

33

## Hypotheses for Experiment 2

1. Delayed CIDR removal will decrease expression of estrus before TAI with no effect on P/AI for nulliparous Holstein heifers inseminated with **sexed semen**
2. TAI will increase P/AI and decrease days to AI and pregnancy for heifers inseminated with sexed semen compared with EDAI
3. The cost per pregnancy will be less for TAI than EDAI because of fewer days on feed

34

# Collaborating Farms

- Three farms in south-central WI
- Nulliparous Holstein heifers (n = 828)
- Once-daily detection of estrus with tail chalk



	Farm		
	A	B	C
Heifers	1,434	815	805
Cows	643	1,061	879
ME305	14,266	12,452	14,600



35

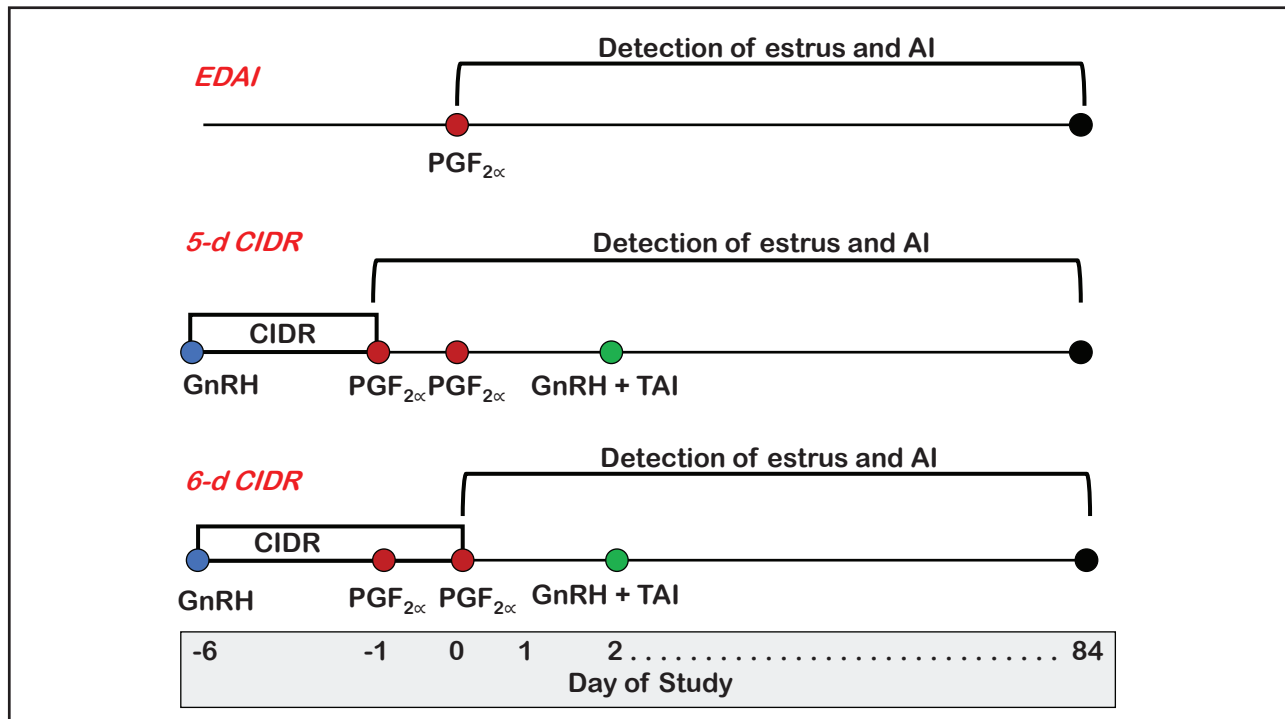

36

## Enrollment

	Treatment			Total
	5-d CIDR	6-d CIDR	EDAI	
Initial	277	269	282	828
Excluded	22	15	55	92
Final	255	254	227	736

37

## Heifer Weight and Age

Item	Treatment			P - value
	5-d CIDR	6-d CIDR	EDAI	
n	255	254	227	
Weight <sup>1</sup> (kg)	426.08 ± 2.17	423.37 ± 2.19	419.47 ± 2.27	0.15
Age (d) <sup>2</sup>	400.59 ± 0.93	400.17 ± 0.92	399.52 ± 0.79	0.47

<sup>1</sup> Weight in kg of nulliparous Holstein heifers on d 0

<sup>2</sup> Age in days at enrollment (d -6)

38

## Early estrus $\geq 24$ h before TAI day 1

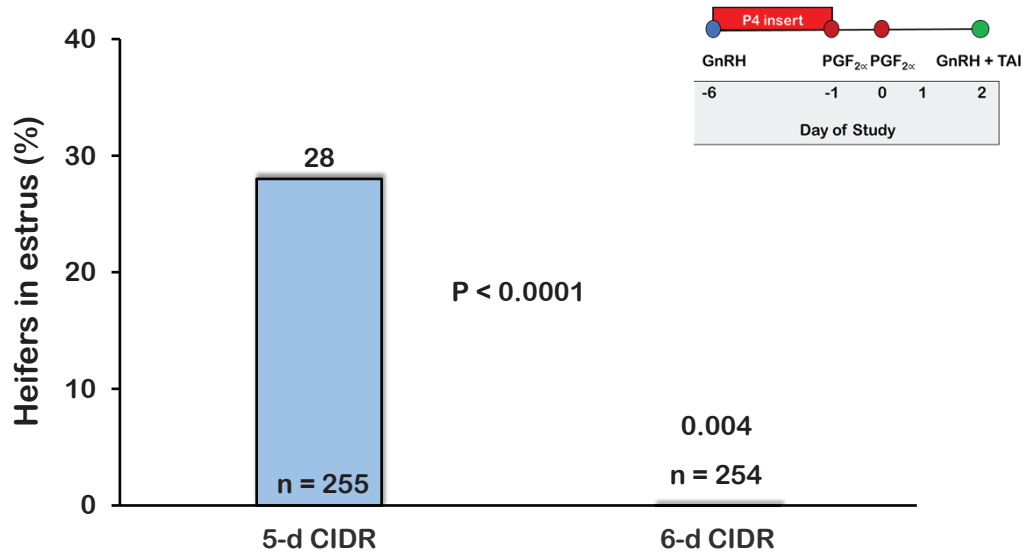

39

## Expression of Estrus at TAI day 2

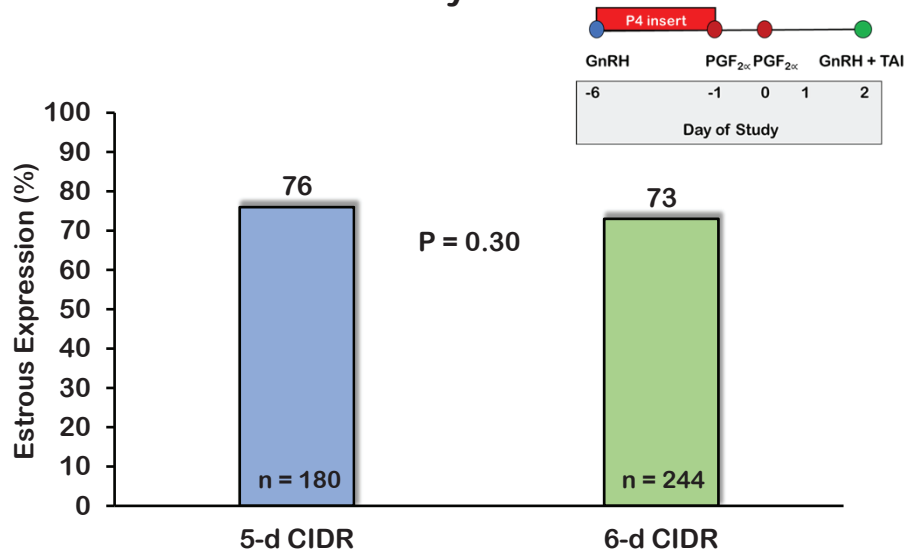

40



## Overall Expression of Estrus days 1 & 2

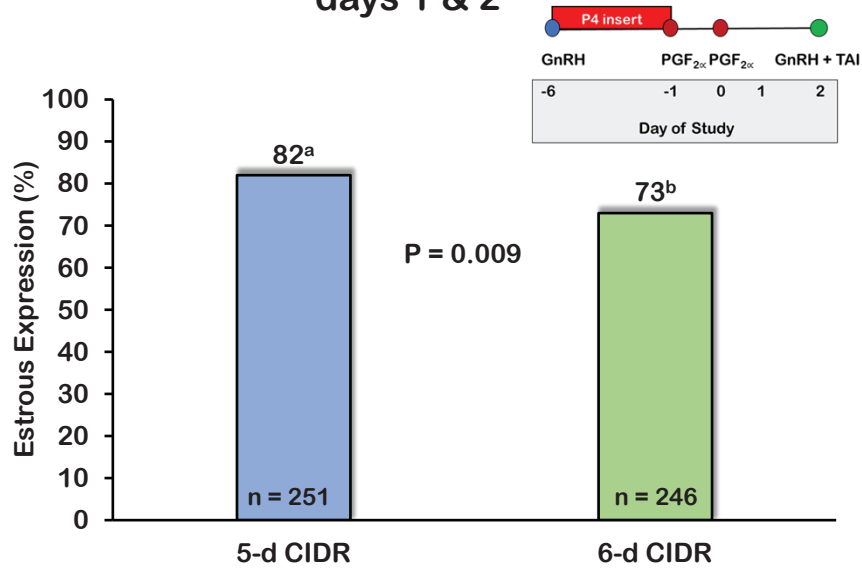

41

## P/AI 64 ± 5 d after AI Overall

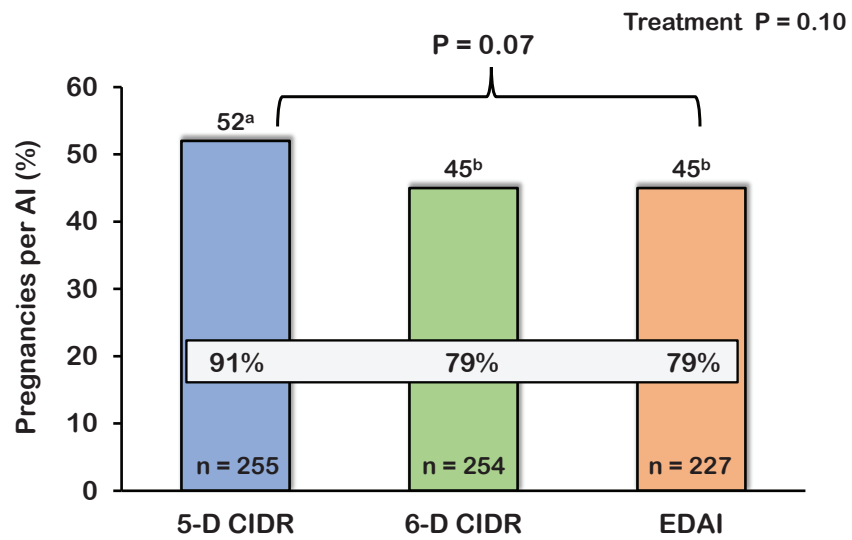

42

## P/AI $64 \pm 5$ d after AI

TAI vs. Early Estrus

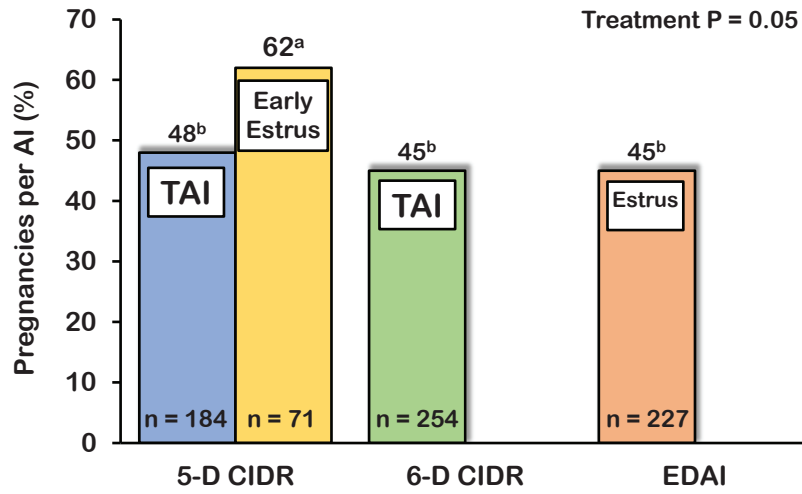

43

## P/AI d $64 \pm 5$ after TAI

CIDR-Synch heifers inseminated at TAI

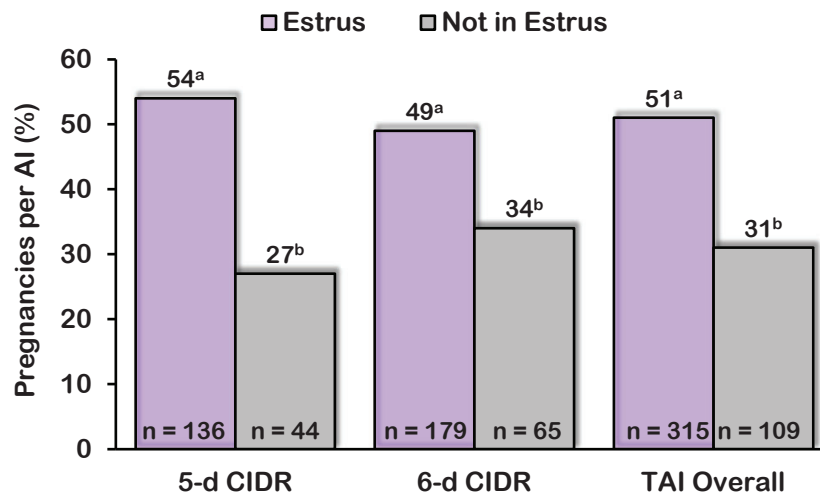

44

## Serum Progesterone Concentrations

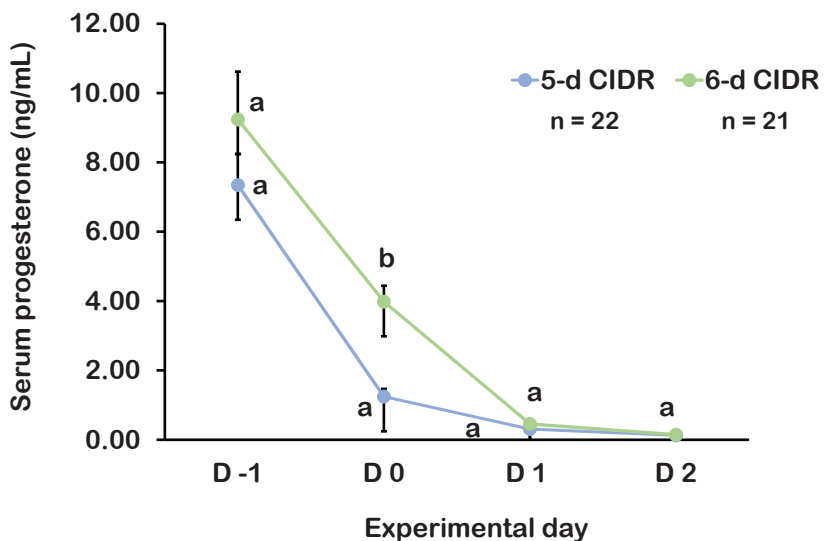

45

## Physiology of Delayed CIDR Removal

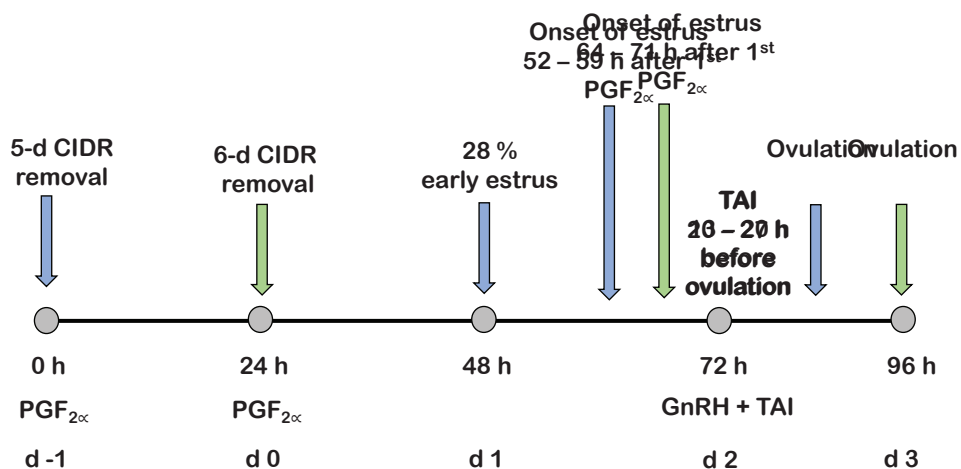

46

## Survival Analysis of Days to First AI

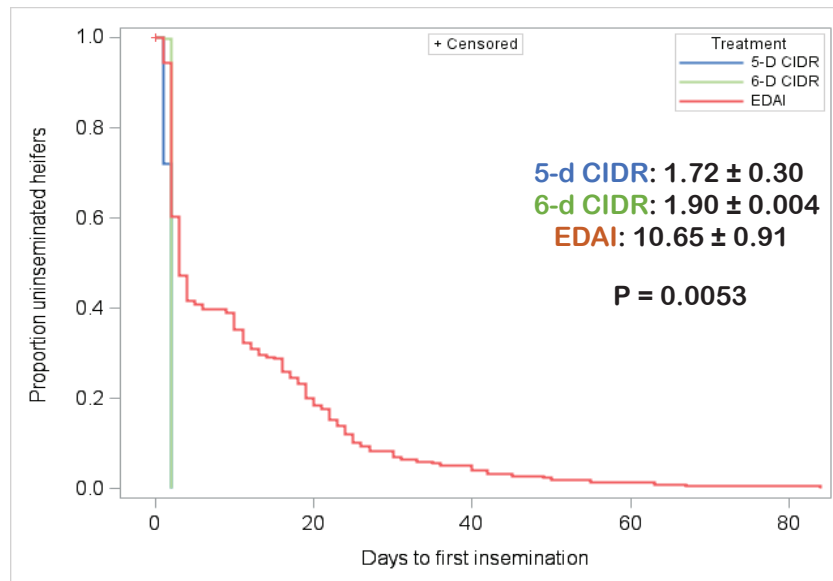

47

## Survival Analysis of Days to Conception

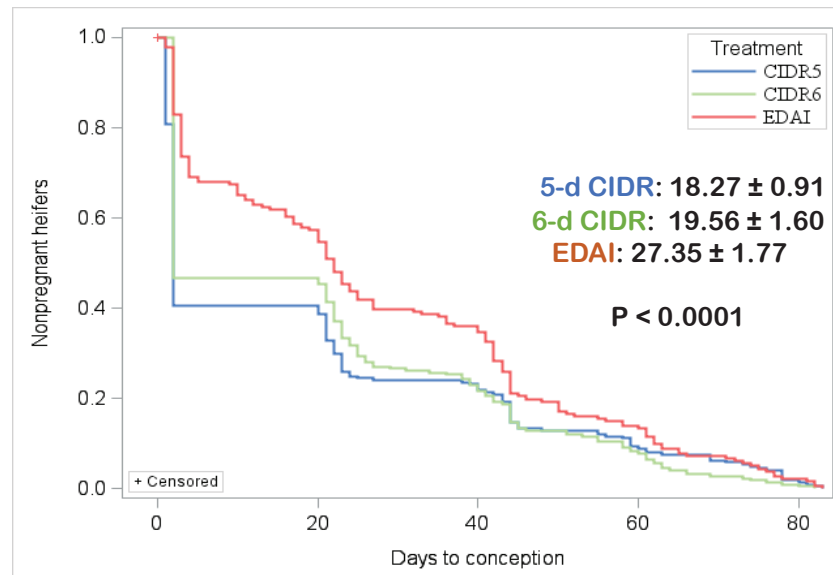

48

## Partial Budget Analysis

Cost per pregnancy, US\$	Treatment			P- value
	EDAI n = 181	5-d CIDR n = 225	6-d CIDR n = 218	
Hormonal treatment	4.05 ± 0.38 <sup>a</sup>	22.29 ± 0.36 <sup>b</sup>	21.85 ± 0.36 <sup>b</sup>	< 0.0001
Detection of estrus	3.04 ± 0.19 <sup>a</sup>	2.03 ± 0.18 <sup>b</sup>	2.18 ± 0.17 <sup>b</sup>	< 0.0001
Semen and AI	70.50 ± 2.47	69.78 ± 2.37	72.02 ± 2.28	0.39
Pregnancy diagnosis	9.55 ± 0.24	9.50 ± 0.14	9.42 ± 0.13	0.42
Feed	82.79 ± 3.01 <sup>a</sup>	50.10 ± 2.73 <sup>b</sup>	56.84 ± 2.56 <sup>b</sup>	< 0.0001
<b>Total per pregnancy</b>	<b>169.92 ± 5.55<sup>a</sup></b>	<b>153.26 ± 5.36<sup>b</sup></b>	<b>162.75 ± 5.03<sup>ab</sup></b>	<b>0.04</b>

**\$153.26 - \$169.92 = -\$16.66**

49

## Feed Cost Sensitivity Analysis

Difference in Cost per Pregnancy by 84 d

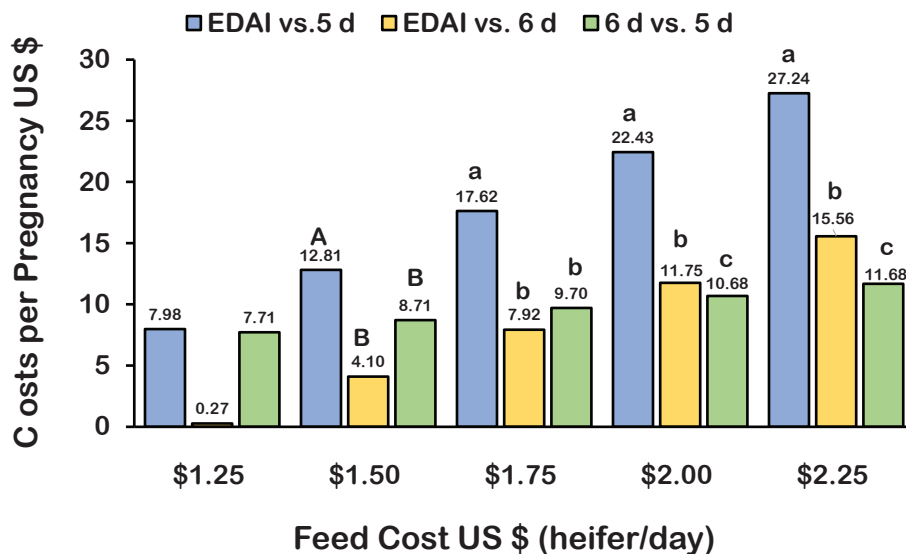

50

## Hypotheses

1. Delayed CIDR removal will decrease expression of estrus before TAI with no effect on P/AI for nulliparous Holstein heifers
  - Experiment 1 with conventional semen: **Accept**
  - Experiment 2 with sexed semen: **Reject**
2. TAI will increase P/AI and decrease days to AI and pregnancy for heifers inseminated with sexed semen compared with EDAI
  - **Accept**
3. The cost per pregnancy will be less for TAI than EDAI because of fewer days on feed
  - **Accept**

51

## Acknowledgments

### Funding & Product Donation

Hatch project 1019532  
CARE project 2021-68008-34105



### Farms & Veterinary Clinics

Bridgewater Dairy  
Rams Horn Dairy  
Double-P Dairy  
Helt Dairy LLC  
Mulcahy Farms LLC  
G&N Endres Farms LLC  
Lodi Veterinary Clinic  
Waunakee Veterinary  
Services

52

# Questions?

SOCIAL DISTANCING

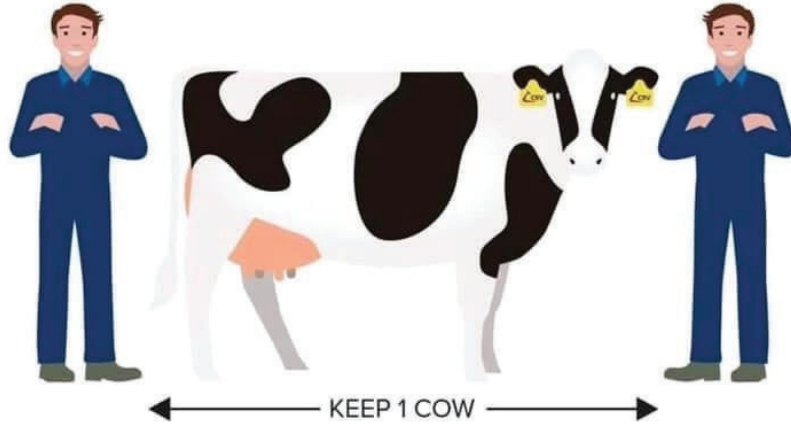

53



# **Nutritional Strategies for Alleviating Heat Stress in Dairy Cows**

**Dr. Phil Cardoso**  
**University of Illinois**





# Nutritional Strategies for Alleviating Heat Stress in Dairy Cows

**Phil Cardoso, DVM, MS, PhD**

UNIVERSITY OF ILLINOIS AT URBANA-CHAMPAIGN

150 100

Dairy Food Safety

1

# Average Land Surface Temperature 2001-2011

**July**

**December**

University of Illinois at Urbana-Champaign

2

Thousands of livestock are also dying from the intense heat. Dairy farmers are using sprinkler systems and shaded barns to try to keep the cows cool.

*The New York Times, July 27th 2006*

**Death of > 25,000 cows in CA**

University of Illinois at Urbana-Champaign

3

# What is Heat Stress ?

http://www.youtube.com/watch?v=600H6Twwc58

4

# Temperature Humidity Index (THI)

$THI = Tdb - [(0.55 - (0.55 \times RH/100)) \times Tdb - 58]$

Practical examples of heat stress	[Temperature; Relative Humidity]	Duration (hours/day)	Milk loss under heat stress [kg/h; kg/cow/day]
Stress Threshold THI [68-71]	[22°C (72°F); 50%]	4	[-0.283kg/h ; -1.1kg/cow/day]
Mid-Moderate Stress THI [72-79]	[25°C (77°F); 50%]	9	[-0.303kg/h ; -2.7kg/cow/day]
Moderate-Severe Stress THI [80-89]	[30°C (86°F); 75%]	12	[-0.322kg/h ; -3.9kg/cow/day]
Severe Stress THI [90-99]	[34°C (93°F); 85%]	Not measured	

**Milk Yield**

University of Illinois at Urbana-Champaign

Burgos Zimbelman and Collier, 2011

5

# Nutrients & Heat Abatement

- Water

Cool Season (13.4°C)		Warm Season (27.4°C)	
Milk Yield (kg/d)	Water Intake (L/d)	Milk Yield (kg/d)	Water Intake (L/d)
0	47.7	0	59.8
18	77.9	18	90.8
27	90.4	27	102.2
36	102.9	36	112.0
45	115.0	45	121.9
54	127.2	54	131.7

University of Illinois at Urbana-Champaign

Adapted from Beede, 1994

6

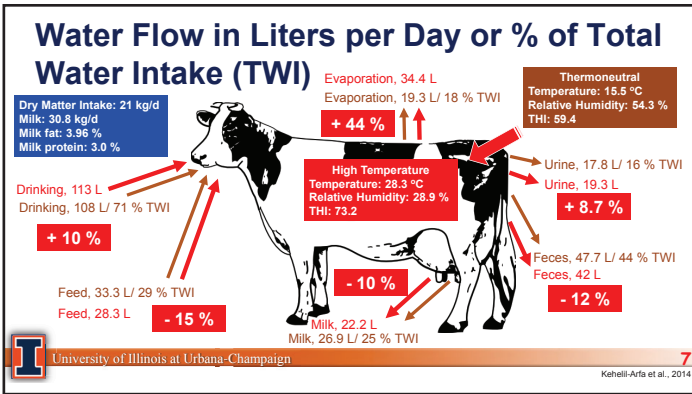

7



8

### Nutrients & Heat Abatement

- Water**
- Minerals**
  - Macro (DCAD)
    - K, Na, Mg
  - Trace
    - Se, Zn
- Vitamins**
  - Niacin (B<sub>3</sub>)
- Protein**
  - Amino acids (Methionine)
- Energy** (not a nutrient)
  - Fat
  - Starch
  - Fiber
- Feed additives**
  - Yeast, buffer

University of Illinois at Urbana-Champaign

9

### Heat Stress and Minerals

**Water Flow in Liters per Day or % of Total Water Intake (TWI)** (repeated from slide 7)

**Graph:** Milk Yield (kg) vs Average Daily Intake (kg). Shows a decrease in milk yield as intake increases, with Na and K levels indicated.

**Text:** CO<sub>2</sub> expelling (reduced saliva buffering power); Reduced Rumen pH and rumination; Potential for acidosis related problems.

University of Illinois at Urbana-Champaign | Mischner-Siemens et al., 2020

10

### Recommendations for Lactation – (% DM)

Mineral	NRC 1989	NRC 2001	U of I Summer
Calcium	0.66	0.60	
Phosphorus	0.41	0.38	
Magnesium	0.25	0.21	0.40
Sodium	0.25	0.22	0.40
Potassium	1.00	1.07	1.20
Chloride	0.25	0.29	
Sulfur	0.20	0.20	

University of Illinois at Urbana-Champaign

11

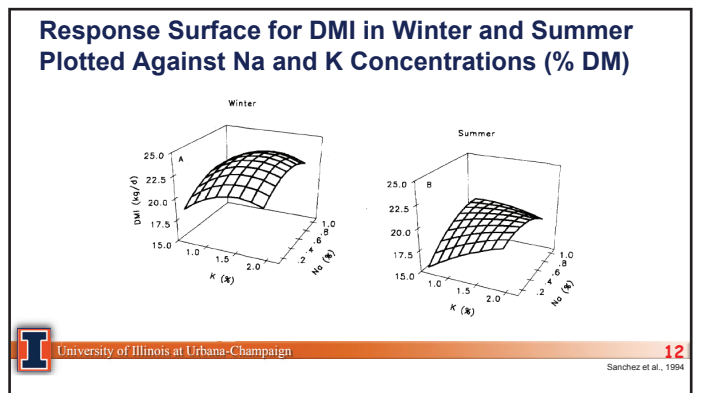

12

## DCAD (Dietary cation-anion difference)

### DCAD mEq (milliequivalents)/100g (grams) dietary DM

$$[(\%Na \times 43.5 + \%K \times 25.6) - (\%Cl \times 28.2 + \%S \times 62.5)], \text{ NRC 2001}$$

Mineral % are on a dry matter (DM) basis

$$Na + K - Cl - 0.6S, \text{ Goff et al. (2004)}$$

**Negative DCAD:** prevent metabolic disorders (dry cows)

**Positive DCAD:** increase milk yield and composition (lactating cows)

## DCAD Lactating Cows

- Positive DCAD of 250 to 400 mEq/kg DM is effective and adequate to maximize feed intake and milk production.
- Improve milk yield and DM intake of lactating dairy cows in hot or cool environmental conditions.
- Useful in **heat stress** conditions. Cows under heat stress experience losses of bicarbonate and potassium.

13

14

## Meta-Analysis on Responses to Increasing DCAD

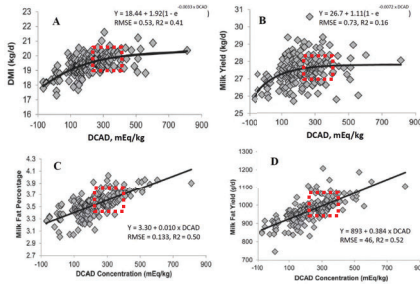

15



16

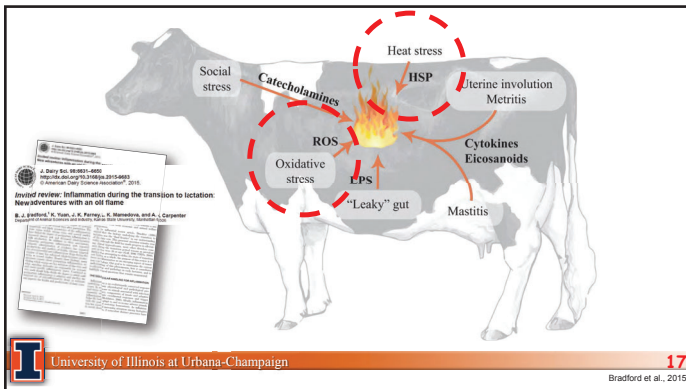

17

## Heat Stress

- Enhances reactive oxygen species (ROS) production and induces oxidative stress, which can lead to cytotoxicity
- Similar to oxidative stress, because of correspondences in the genes expressed after heat exposure (heat-shock proteins and antioxidant enzymes), in comparison with those expressed following oxidant agents' exposure

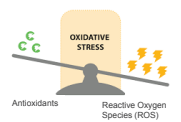
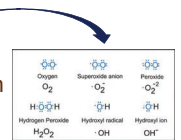

18

# Heat Stress

- Enhanced production can be achieved
- Similar correlations after antioxidant exposure

Antioxidants: Glutathione, Catalase, Peroxisome, Superoxide, Hydroxyl, Nitric Oxide, Hydrogen Peroxide

Reactive Oxygen Species (ROS)

University of Illinois at Urbana-Champaign

Rhoads et al., 2013; Simen et al., 2016

19

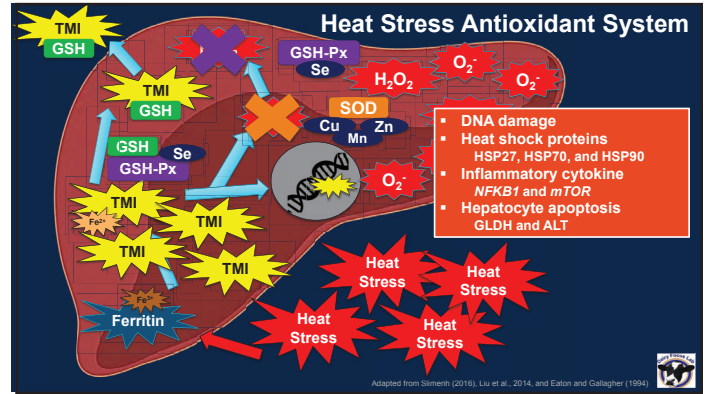

20

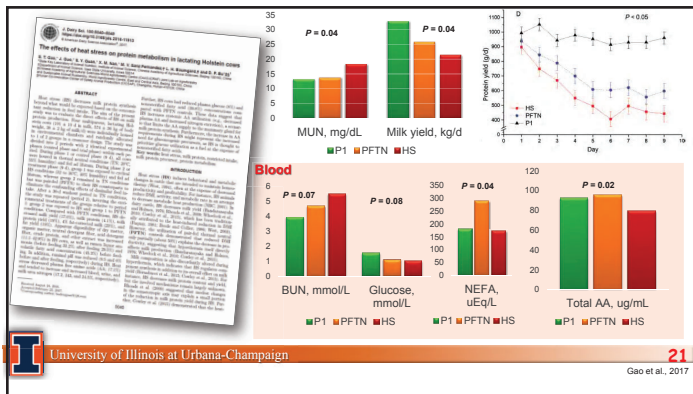

21

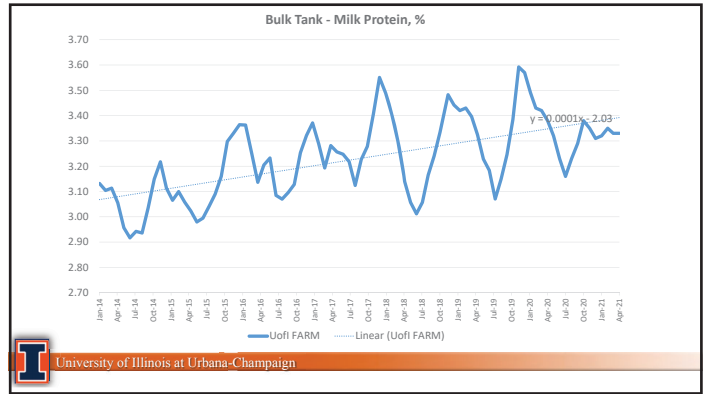

22

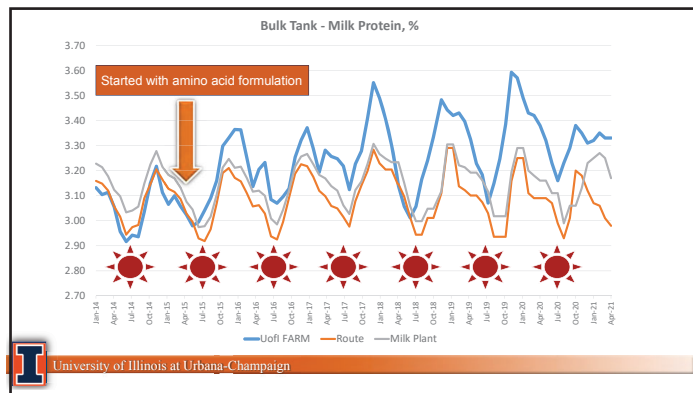

23

**Effects of rumen-protected methionine on lactation performance and physiological variables during a heat stress challenge in lactating Holstein cows**

R. T. Pate,<sup>1</sup> D. Luchini,<sup>2</sup> M. R. Murphy,<sup>1</sup> and F. C. Cardoso<sup>1\*</sup>

<sup>1</sup>Department of Animal Sciences, University of Illinois, Urbana 61801

<sup>2</sup>Adisano, Alpharetta, GA 30022

J. Dairy Sci. 103:2800–2815  
<https://doi.org/10.3168/jds.2019-17305>  
 © American Dairy Science Association, 2020.

ILLINOIS  
 State University

24

## Materials and Methods



**Crossover design**  
September to December 2018

**32 multiparous Holstein cows**  
184 ± 59 d in milk  
2.8 ± 1.1 lactation number

**2 dietary treatments**  
RPM – 0.105% of DMI [-30g] as RPM\*  
CON – No RPM\*



**2 environmental treatments**  
HS –using electric heat blanket (EHB), ad libitum intake  
PFTN – thermoneutral conditions, pair-fed to HS counterparts

\* Mixed with 300 g molasses

ILLINOIS Animal Sciences  
Pate et al., 2020

25

## Environmental Treatment: Electric Heat Blankets

ILLINOIS Animal Sciences  
Pate et al., 2020

26

## Environmental Treatment: Pair-Fed Thermoneutral



ILLINOIS Animal Sciences  
Pate et al., 2020

27

## Heat Stress Challenge

## Pair-Fed Thermoneutral

ILLINOIS Animal Sciences  
Pate et al., 2020

28

## Split-Plot Crossover Design

Environmental Treatment (E)	Period 1 (18 d)				Period 2 (18 d)			
	Adaption (7 d)	Phase 1 – Baseline (9 d)	Phase 2 – Trial (9 d)	Wash-out period (14 d)	Adaption (7 d)	Phase 1 – Baseline (9 d)	Phase 2 – Trial (9 d)	
Heat stress challenge	---	---	Group 1 (RPM and CON)	---	---	Group 2 (RPM and CON)	Group 2 (RPM and CON)	
Thermal neutral and pair-fed	---	---	Group 2 (RPM and CON)	---	---	Group 1 (RPM and CON)	Group 1 (RPM and CON)	
Thermal neutral and ad libitum	Group 1 (RPM and CON) Group 2 (RPM and CON)	Group 1 (RPM and CON) Group 2 (RPM and CON)	---	Group 1 Group 2	Group 1 (RPM and CON) Group 2 (RPM and CON)	Group 1 (RPM and CON) Group 2 (RPM and CON)	---	

Sequence (S) →

ILLINOIS Animal Sciences  
Pate et al., 2020

29

## Period Timeline



Phase 1 – Baseline Phase (No HS or PFTN)

Phase 2 – Trial Phase (HS or PFTN)

**Physiological Measurements**  
Vaginal Temperature (10 min)  
Rectal Temperature (3x/day)  
Respiration Rate (Daily)  
Heart Rate (Daily)

**Performance Measurements**  
Milk Yield (Daily)  
Dry Matter Intake (Daily)  
Milk Composition (3 d/phase)

★ = Milk Sample (3x/d)

ILLINOIS Animal Sciences  
Pate et al., 2020

30

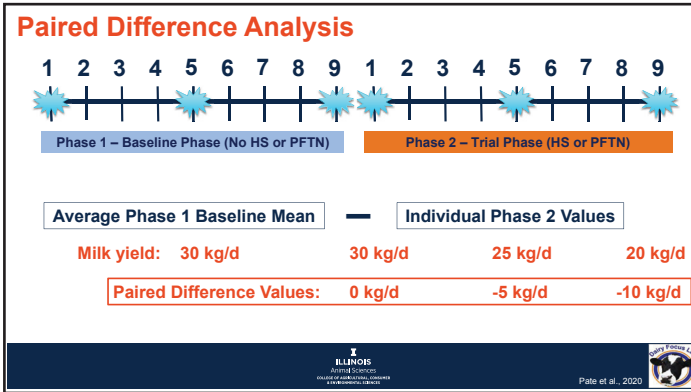

31

Diet Formulation		Chemical Analysis*		
Ingredient	% of DM	Item	Mean	SD
Corn silage	40.9	DM, %	47.0	1.0
Dry ground corn grain	17.7	CP, % of DM	15.6	0.2
Alfalfa silage	12.3	ADF, % of DM	18.5	0.7
Corn gluten feed pellets	8.4	NDF, % of DM	29.0	0.6
Alfalfa hay	6.3	Starch, % of DM	31.8	2.2
Grain and mineral mix	6.7	Crude fat, % of DM	5.1	0.2
Soybean meal RUP source	3.4	Ash, % of DM	7.5	0.9
Molasses	3.3			
Canola meal	1.7			
Rumen protected lysine	0.4			

\*Phase 1 and 2 from periods 1 and 2 (n = 4)

TMR Analysis  
ILLINOIS Animal Sciences  
NRC (2001)  
Pate et al., 2020

32

Item	RPM	CON
CP, % of DM	16.08	16.02
Met as % of MP	2.57	2.03
Met g/Mcal ME	1.09	0.85
Lys as % of MP	7.01	7.05
Lys g/Mcal ME	2.96	2.97
Lys to Met Ratio	2.73	3.47

ILLINOIS Animal Sciences  
AMTS, Cattle Pro version 4.7  
Pate et al., 2020

33

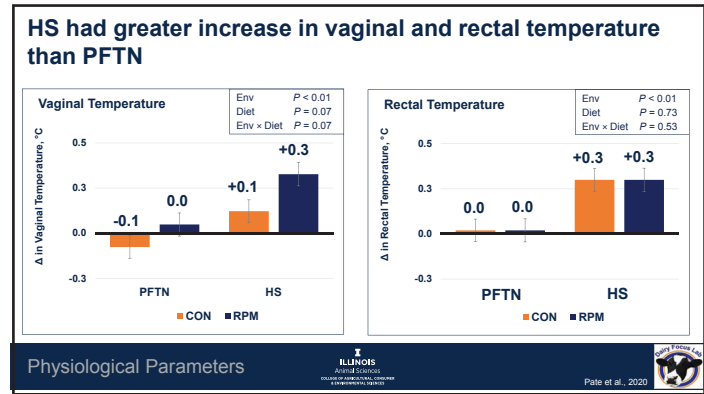

34

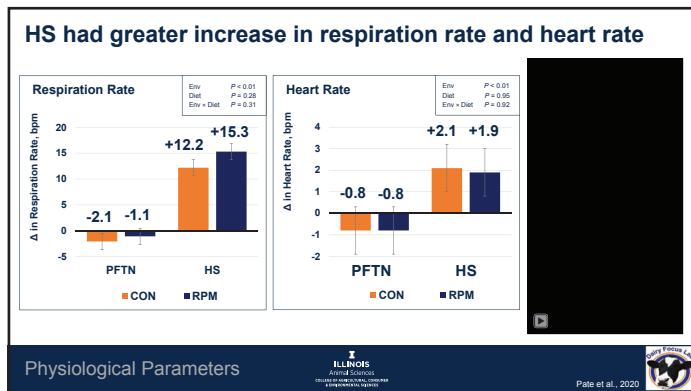

35

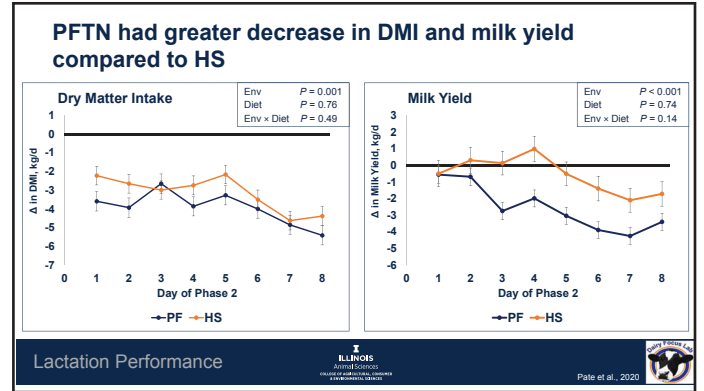

36

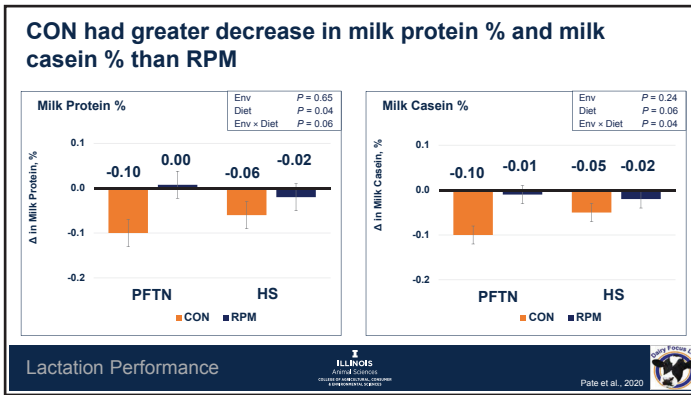

37

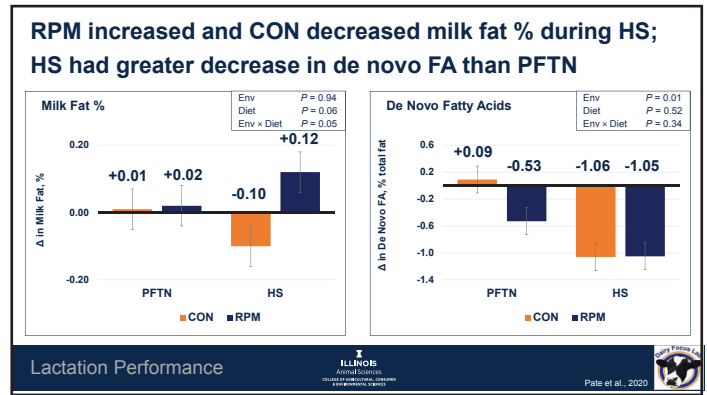

38

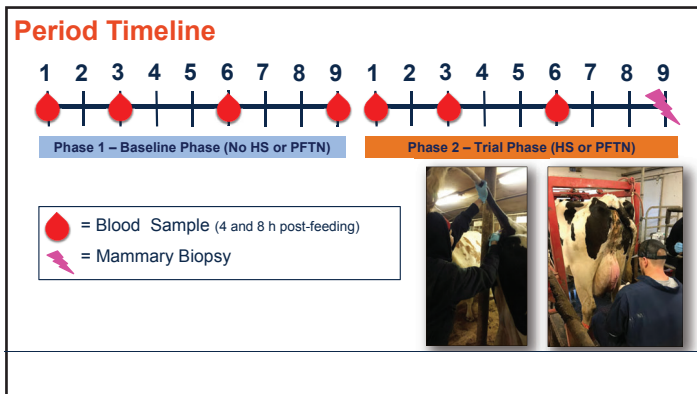

39

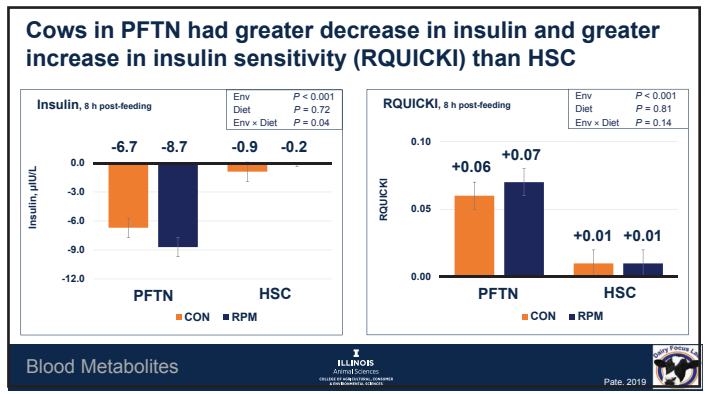

40

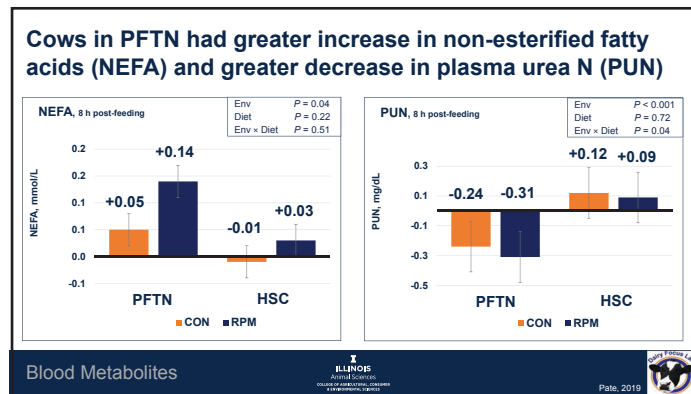

41

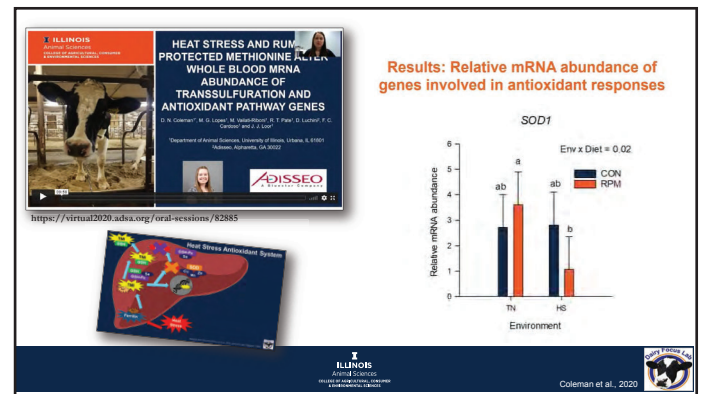

42

## From these studies:

Feeding RPM did not alter physiological parameters, but had a positive impact on lactation performance during a HS challenge

HS challenge caused marked changes in metabolism and immune system of dairy cows; while RPM improved mammary cellular protection capacity

Feeding RPM during heat stress may also help cows maintain their hepatic homeostasis and may enhance the antioxidant response

ILLINOIS  
Animal Sciences  
COLLEGE OF AGRICULTURAL, CONSUMER  
& ENVIRONMENTAL SCIENCES



43



44

## Summary

- There is no dietary magic pill
  - Minerals
    - K, Na, Mg (DCAD)
    - Se (GP<sub>x</sub>)
  - Amino acids
    - Methionine
- Heat stress abatement (shade, soakers, fans, etc.) should be the primary strategy!



Improve cow's ability to maintain or recover homeostasis



University of Illinois at Urbana-Champaign

45

45

ILLINOIS  
Animal Sciences  
COLLEGE OF AGRICULTURAL, CONSUMER  
& ENVIRONMENTAL SCIENCES

# THANK YOU!

DairyFocusAtIllinois  
@DairyIllinois  
DairyFocusAtIllinois

cardoso2@Illinois.edu

www.dairyfocus.Illinois.edu

46





# **Mindset Tactics for Brain Health and Behavioral Well-Being**

**Larry Tranel, Psy.D.  
Dairy Specialist  
Iowa State University**



Mindset Tactics for Brain Health and Behavioral Well-Being



This presentation is Part IV of ISU Extension's Rural Resiliency Series

Larry Tranel, Psy.D. Dairy Specialist NE/SE Iowa 4-State Dairy Nutrition and Management Conference, 2021

1



Stressed

2

Life is Difficult – Full of CHAOS—Relationships \$ 🕒

- Not: Stress Free
- Fat Free
- Illness Free
- Money Free
- Grief Free

Goal is to Put Life in ORDER, Pro-actively Overcome the Crosses Grow to Higher Meaning

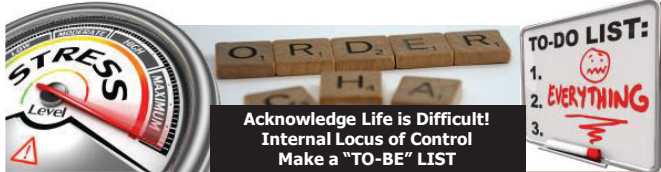

Acknowledge Life is Difficult! Internal Locus of Control Make a "TO-BE" LIST

3

Co-VID 19 Changes Social Interactions



Happy 😊 Forward Looking

Defensive Protective Mode



Layers of Stress adds to Stress and Compounds Issue

What is the Emotion Behind the Mask?

Even without COVID, What's behind the mask!

4

How we think of stress and how we handle stress is often more important than the stress itself!

30,000 person study

43% increase in dying from stress

BUT only for those reported being under stress and thinking stress was bad!

For those who didn't think stress was bad, there wasn't a difference Keller, et.al., 2012



Believing that stress is bad for us has Correlation NOT Causation! Adaptive Cognition? I-L-O-C?

5

My Concern:

Farmers think ALL stress is bad maybe because that's what we tell them

Attention to negativity of stress might increase emotionality to stress!

Causing MORE STRESS!



6

## Those who think stress is...



### **BAD**

Have increased heart rate and blood vessel constriction.

### **GOOD**

Still have increased heart rate, **but** the blood vessels stay relaxed just as if **experiencing joy and courage**

Kelly McGonigal, Stanford University Psychologist

IOWA STATE UNIVERSITY  
Extension and Outreach

Healthy People. Environments. Economies.

7



Acknowledging arousal and performance "stress" as good **is GOOD!!!**

Distress **NOT** so **GOOD!!!**  
So keep from going there!

IOWA STATE UNIVERSITY  
Extension and Outreach

Healthy People. Environments. Economies.

8

## Tale of Two Minds Protective vs Higher Reasoning



**Fight or Flight**  
Volatility - Withdrawal



**PFC**



### Whatcha gonna do when stress comes for you?

IOWA STATE UNIVERSITY  
Extension and Outreach

Healthy People. Environments. Economies.

9

## The Mind that Wins is the Mind One Feeds!

**Primitive mind magnifies risk protective mode**

hesitation, guilt, shame, fear, impulses

protector emotions often negatively exhibited

**Pre-frontal cortex higher reasoning mind**

Cut off from operating all unnecessary function

Focus on threat when mind is in **protective mode**.



The solution to **DISTRESS** is often **Minds Apart** — literally!

IOWA STATE UNIVERSITY  
Extension and Outreach

Healthy People. Environments. Economies.

10

## Tale of Two Minds Protective vs Higher Reasoning

### Mental or Physical Risk

- **instinctively** go into protection mode
- focus **overwhelmingly** on the risks
- **refrain** from higher purpose reasoning
- often **self-defeating** our good behaviors

We avoid possible pain much more than seeking better gain!

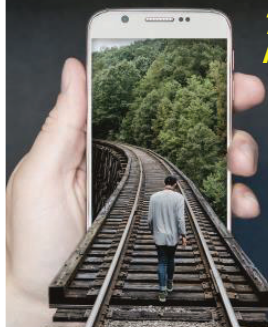

IOWA STATE UNIVERSITY  
Extension and Outreach

Healthy People. Environments. Economies.

11

## How can we use the best of both minds?



A Holstein "Hack" or Jersey "Hijack"



54321 zyxxw

**INTERNAL CONFLICT**

We can **TRICK** our protective mind to better deal with **STRESS**

IOWA STATE UNIVERSITY  
Extension and Outreach

Healthy People. Environments. Economies.

12

# Human Function Curve

Dr. Peter Nixon, 1979

## Tip

Some Stress is GOOD

TOO Much is NOT!

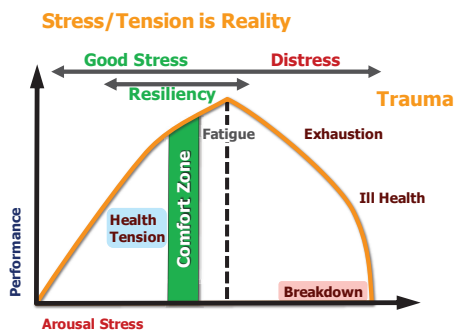

# Human Function Curve



Goal: optimal human function in comfort zone

- NOT at one's highest performance level.
- YES, Can push beyond for higher performance

Cost is often living beyond the margins:

- time, energy, focus
- **brain health**
- relationships, self-care
- **behavioral health**

We need to operate INSIDE the Box – WITHIN Margins!

## Neuron Code

Change Thought → Code → Emotion +

Families who **reinterpret** initial **negative situations** to more **positive meanings** are more likely to:

- be in control of stressors
- find possible solutions to crisis situations
- adapt well eventually to the crisis

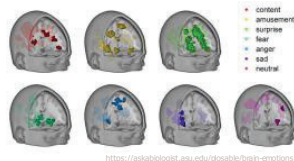

Xu, 2007

## Damage of Negative Facials on Brain Health

**Disgust** **Cortisol Concern Long Term**

- hormone release (cortisol);
- attitude towards source;
- and typically - behavior.

**Distrust**

- not trust the markets, system, themselves, spouse, kids, or others to do the right thing.

**Frown (scowl)**

- difficult planning, - communication,
- relationships; - decision-making.



## Damage of Negative Facials on Brain Health

The Way we **Face** Stress, Can Help us **Better Face** Stress 😊

Larry Tranel

Be like a proton **be positive and smile!**



## Damage of Negative Facials on Brain Health

Facial movements had small-to-medium effects on self-reports of happiness, anger, and disgust. APA, Coles et al. 2019

**Be your own scientist:**

In your real world, how does a smile impact you compared to a frown?

What do you want to see come in door or in mirror?



## Dr. Larry's "B-S" Minute Breathe and Smile 😊

1. Lay, recline, sit or stand in a **relaxing position**
2. Eyes open or closed, picture/think **something positive**
3. Breathe in slowly, **fake smiling** as you do so
4. Breathe out slowly, **fake smiling** to the bottom
5. Chuckle (**fake laugh**) at bottom of the breath

**Repeat 2 through 6**, breathing deeper, smiling wider and chuckling more each time for total of one minute.

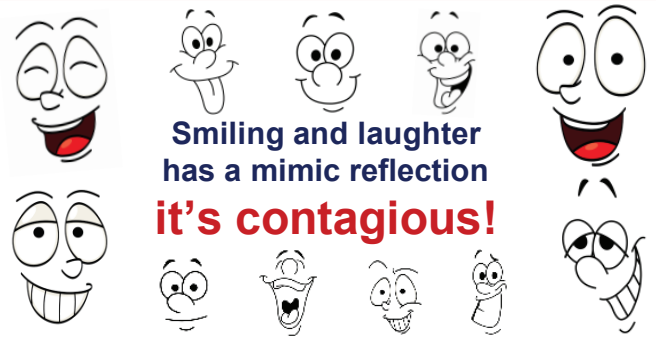

**Smiling and laughter  
has a mimic reflection  
it's contagious!**

## Dr. Larry's "B-S" Minute Breathe and Smile 😊

**After doing so, people tend to report:**

- Feeling better and **more relaxed/less stressed**
- **Smiling continued** shortly afterwards
- Having **more energy/enthusiasm** afterwards
- Frowning was more difficult shortly afterwards  
*if not, try doing the exercise again and try to frown*
- Facial Disgust was more difficult shortly afterwards  
*if not, try doing the exercise again and show disgust*
- Overall **well-being increased** afterwards



## Dr. Larry's "B-S" Minute Breathe and Smile 😊

**The "B-S Minute"  
is anything but BS  
it increases serotonin!**



## Standing Tall is "Posturing for Success"

Neurochemistry of victory and defeat  
(**success** or **failure**) can be  
**self-promoting** or **self-defeating**,  
often dependent on one's postural flexion  
**our posture reaction!**



## Standing Tall is "Posturing for Success"

Just like smiling  
increases serotonin,  
a "**look up and  
stand tall posture**",  
with shoulders back  
**increases serotonin.**

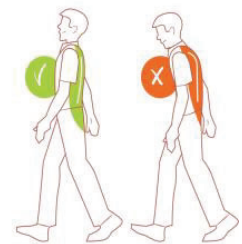

## Standing Tall is “Posturing for Success”

### Serotonin drops

when feeling defeated, as one’s posture droops, look down, feel threatened, hurt, anxious or weak.

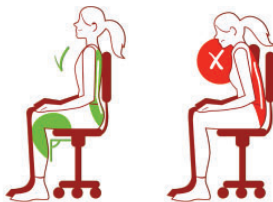

## Standing Tall is “Posturing for Success”



Want to lower your attitude and social status?

**Lower your posture!**

The 2 Minute Power Pose -- Hulk  
↑ serotonin/testosterone ↓ cortisol



## Take Care of **Self** and Your “Perspective” Situation in Life

### Some people...

take better care of their pets, their crops, their livestock **than care for themselves** (own worse employee/boss).



## Take Care of **Self** and Your “Perspective” Situation in Life

### Some people...

wallow in self-pity even when things **are good**.



## Take Care of **Self** and Your “Perspective” Situation in Life

### Some people...

treat others with **more respect** than selves.

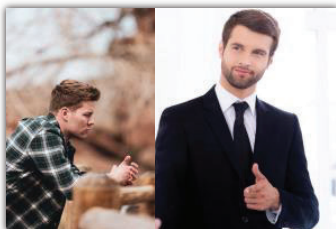

## Take Care of **Self** and Your “Perspective” Situation in Life

### Some people...

amplify their **suffering** and **stress** for attention or by branding it as injustice (unfair markets, no societal respect)



## Take Care of **Self** and Your “Perspective” Situation in Life

Some people...

refuse to strive to improve (neutral not good).

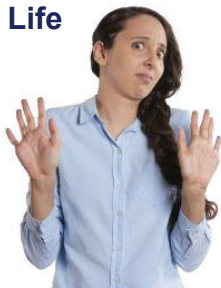

## Take Care of **Self** and Your “Perspective” Situation in Life



Don't Be These

# Some People

as Not Happy 😞

## No Matter What!

## Desire to Improve Needed for Progress

In order to improve one must:

- Have **desire** to improve or **admit** there is a problem
- **Take responsibility** for one's life or the problem
- **Act** accordingly (difficult in distress)
- Get **help** if needed (pro-active, not passive)



## Desire to Improve Needed for Progress

Neutral is **not** associated with **personal growth** or **happiness**.

Might work harder just to maintain the same level of success.

**Just keeping one's life or finances above water +**



## Brain Health Tied to the Heart

**Oxytocin**, a bonding hormone, or a “milk letdown” hormone to some, is a neuro-hormone that fine tunes close relationships, empathy, help and support for people one cares about.



Belgium Bond

## Brain Health Tied to the Heart

**Oxytocin** – also a stress hormone that pumps out as much as adrenaline when **under stress**, motivating people to **seek support** and tell someone how you feel. Under difficulty, a stress response is being surrounded by people who care.

*Psychologist Kelly McGoginal*



## Brain Health Tied to the Heart

Loneliness equates to **smoking 15 cigs a day!**  
Stay Close!

IOWA STATE UNIVERSITY  
Extension and Outreach

Healthy People. Environments. Economies.

37

## Oxytocin—an Underappreciated Stress Relief

**Oxytocin** - **protects the body**—the heart has receptors for oxytocin and can help **strengthen** and **repair** it.

When reaching out or **feeling closer** to others through connecting conversation and/or physical touch, **more oxytocin is released.**

Oxytocin release - a stress response with **resiliency** component.

IOWA STATE UNIVERSITY  
Extension and Outreach

Healthy People. Environments. Economies.

38

## Oxytocin

can help put in better  
“MOOOOOODD”

IOWA STATE UNIVERSITY  
Extension and Outreach

Healthy People. Environments. Economies.

39

## A Happy Tip 😊

**Do Something:**

**For Others = ++**

**For Planet = +**

**For Self = no benefit**

IOWA STATE UNIVERSITY  
Extension and Outreach

Healthy People. Environments. Economies.

40

## Brain Health is Tied to Routine

### Routine

- is necessary, especially for distressed people.
- helps people make better decisions.

Anxiety and depression **cannot** be easily treated if the sufferer has unpredictable daily routines.

**THE SYSTEMS TIED TO** mediate **negative emotions** are tied to the proper cyclical (daily) biological rhythms. Reference available upon request

IOWA STATE UNIVERSITY  
Extension and Outreach

Healthy People. Environments. Economies.

41

## Brain Health is Tied to Routine

Observational research indicates that individuals in good health engage in highly routine health behaviors. For example, those successful at maintaining weight loss often eat the same foods, engage in consistent exercise, and do not skip meals. Behavioral Medicine Review, Katherine R. Arlinghaus, et.al.

IOWA STATE UNIVERSITY  
Extension and Outreach

Healthy People. Environments. Economies.

42



## Brain Health is Tied to Gut Health

Behavioral health is a function of gut biochemistry, **heavily impacted by diet.**

**Serotonin "Happy Hormone" is 90-95% secreted by the gut**, only 5-10% by the brain.

**Turn off NEWS while Eating!** Mild stress can tip gut microbial balance making one more vulnerable to infectious disease and **negative nervous system feedback.**



IOWA STATE UNIVERSITY  
Extension and Outreach

Healthy People. Environments. Economies.

43

## Brain Health is Tied to Gut Health

Know Your **"Gut Feeling"** is **Cooperating with Your Brain!**

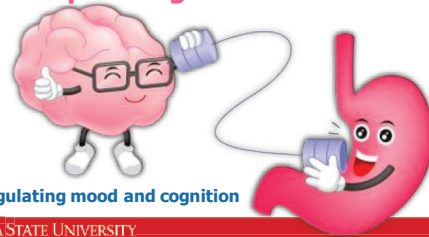

regulating mood and cognition



IOWA STATE UNIVERSITY  
Extension and Outreach

Healthy People. Environments. Economies.

44

## Brain Health Tied to Added Sugars & Processed Carbs



The **sugar** we eat **in 7 hours** is what a person in 1822 ate **in 5 days!** **3x2Much!**

IOWA STATE UNIVERSITY  
Extension and Outreach

Healthy People. Environments. Economies.

45

## Brain Health Tied to Added Sugars & Processed Carbs

Much like cocaine, **sugar is addictive**, as the brain then releases dopamine, creating more receptors for dopamine, thus craving it even more.



IOWA STATE UNIVERSITY  
Extension and Outreach

Healthy People. Environments. Economies.

46

## Brain Health Tied to Added Sugars & Processed Carbs

**Common Fact:** Extra sugar **spikes insulin levels.** *Insulin and weight gain often go hand in hand, Mayo Clinic Staff*

### Your Brain on Sugar

It's pretty clear excessive glucose in the form of refined sugar can be very detrimental to your brain, ultimately affecting your **attention** span, your **short-term memory**, and your **mood stability.**

*Teresa Aubele, Ph.D., is a coauthor of Train Your Brain to Get Happy. Neuroscientific researcher at Florida State University.*



IOWA STATE UNIVERSITY  
Extension and Outreach

Healthy People. Environments. Economies.

47

## Brain Health Tied to Added Sugars & Processed Carbs

High glucose levels resulting from quick, easy sugar intake slowly but surely damage cells everywhere in the body, **especially those in the brain.**

*Salk Institute in California Research*

Having too little glucose and having too much glucose are both problematic. Either extreme can leave you feeling **woozy, nervous, fatigued, and shaky.**

*Teresa Aubele, Ph.D., is a coauthor of Train Your Brain to Get Happy. Neuroscientific researcher at Florida State University.*



IOWA STATE UNIVERSITY  
Extension and Outreach

Healthy People. Environments. Economies.

48

## Brain Health Tied to Added Sugars & Processed Carbs

Relative hypoglycemia is one of the most common causes of neuropsychiatric illness, treated by a diet high in protein and fat and low in carbohydrate. Salzer, 1966 (emphasize healthy fat and refined carbohydrate).

Preliminary results of Italian study indicate that perceived work stress can be statistically associated with increased blood glucose. Pub Med.gov A Sancini, et.al, 2017 Alexandria Rowles, RD, 2017 Healthline



IOWA STATE UNIVERSITY  
Extension and Outreach

Healthy People. Environments. Economies.

49

## Brain Health Tied to Added Sugars & Processed Carbs

**Distress** causes high cortisol release causing **craving** of pleasurable food intake, especially added sugars and unprocessed carbohydrates (turns into simple sugar).

**Less sleep** can also initiate the **craving**, spiking insulin.

One is often blind to the robber until one is robbed blind - **a sugary truth!**



IOWA STATE UNIVERSITY  
Extension and Outreach

Healthy People. Environments. Economies.

50

## Brain Health Tied to Smart Phone Use?



Dopamine **rewards users** with each like, each post, each search—addictive!



IOWA STATE UNIVERSITY  
Extension and Outreach

Healthy People. Environments. Economies.

51

## Brain Health Tied to Smart Phone Use?

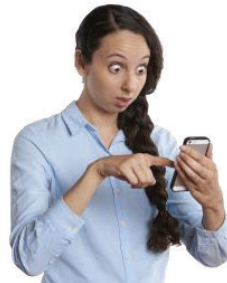

Can be as **addictive** as a slot machine and provide excessive stimulation, increased emotionality, and decreased real social interaction.

Can **move users into distress**, with constant interruptions, notifications, dopamine releases, social stimulations, unending searches and the conjuring of both real and false spectacles of life.

IOWA STATE UNIVERSITY  
Extension and Outreach

Healthy People. Environments. Economies.

52

## Brain Health Tied to Smart Phone Use?

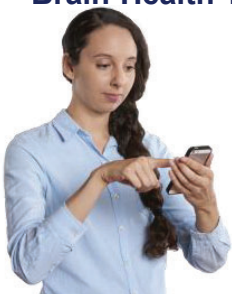

The natural rhythms of the brain are interrupted, **every 6-12 minutes** for most people with many struggling to go even 10 minutes without phone.

One often blind to the robber until one is robbed blind - **a smartphone truth!**

IOWA STATE UNIVERSITY  
Extension and Outreach

Healthy People. Environments. Economies.

53

## Brain Health Tied to Smart Phone Use?

Those constantly **"connected"** are:

- more stressed
- feel lonelier
- are more likely to experience depression or a sleep disorder.



Pew Research - U of Missouri 2015

IOWA STATE UNIVERSITY  
Extension and Outreach

Healthy People. Environments. Economies.

54

## Brain Health Tied to Smart Phone Use?

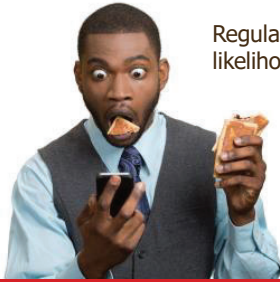

Regular use of social media increased the likelihood of **envy and depression**.

Smartphone overuse **can reduce performance, social interaction, sleep, and mental health** by increasing stress, anxiety, depression, envy, other - mindsets.

IOWA STATE UNIVERSITY  
Extension and Outreach

Healthy People. Environments. Economies.

55

## Brain Health Tied to Smart Phone Use?

Using phone to get a **"feel-good" dopamine response**, needing more of it each time to get the same level of response, then finding it just isn't there, **can end in negative emotion**, anxiety, depression, and false reality

**Don't Let Family Relationships Hide Behind Screens!**



IOWA STATE UNIVERSITY  
Extension and Outreach

Healthy People. Environments. Economies.

56

## Smart Phones Need Scheduled Time Off

**Disable notifications** stealing attention from real moments at hand.

**Detox phrase: Family B4 Phone!**

## Smart Phones Need Their Places

The blue light inhibits melatonin, reducing both quality and quantity of sleep.

**Detox Phrase: Out of sight, out of mind!**



IOWA STATE UNIVERSITY  
Extension and Outreach

Healthy People. Environments. Economies.

57

## Smart Phones are Secondary to Relationships

Raw dopamine and spontaneous conversation is changing in households, classrooms and on the farm.

**Detox Phrase:**  
**Get Dopamine Raw - Face to Face!**

**Being Bored is more important than checking this every 5 minutes?**



IOWA STATE UNIVERSITY  
Extension and Outreach

Healthy People. Environments. Economies.

58

## Maintain Sense of Aim, Direction and Control

**Farm distress is experienced when one senses loss**

loss of direction, control, finances, way of life, farm and family dreams, hope for future, security of family, one's position/lot in life, or when tragedy strikes.



IOWA STATE UNIVERSITY  
Extension and Outreach

Healthy People. Environments. Economies.

59

## Maintain Sense of Aim, Direction and Control

People that have a larger **WHY** in life (virtues in something larger than self), seem to deal with problems in a **healthy, proactive way**.



IOWA STATE UNIVERSITY  
Extension and Outreach

Healthy People. Environments. Economies.

60

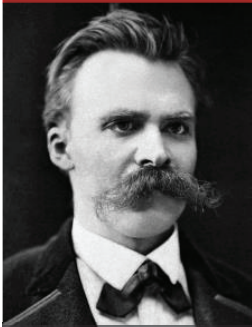

"He whose life has a **WHY** can bear almost any **HOW**."

Know your **WHY**,  
Don't lose your **WHY**,  
your **Hope in Life**

German Philosopher, Friedrich Nietzsche  
IOWA STATE UNIVERSITY  
Extension and Outreach

Healthy People. Environments. Economies.

61

## Behavioral Health Simply Hold Your Breath!"

Research shows holding one's breath for 15 seconds significantly helps to "purge the urge" to let the feeling pass and not act on it..

This 15 second breather allows the **brain's logic connection** to engage, giving logic in time to "purge the urge."

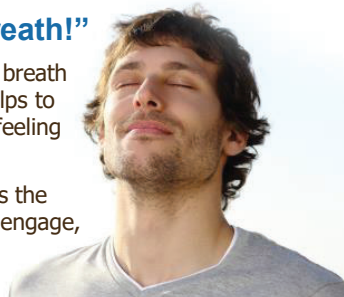

IOWA STATE UNIVERSITY  
Extension and Outreach

Healthy People. Environments. Economies.

62

When experiencing failure, research shows don't be too hard by guilt or shame as it increases anxiety, keeping one's mind stuck in impulse mode, and **actually encourages the behavior to continue**

**Hold breath**  
Stare at that sweet snack!  
**Let the urge pass!**

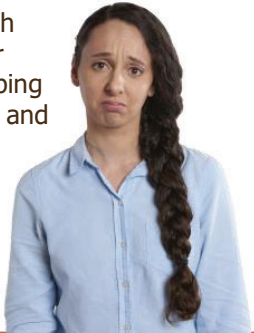

IOWA STATE UNIVERSITY  
Extension and Outreach

Healthy People. Environments. Economies.

63

## Behavioral Health Tied to Communication Skill

1. Others do not always **think** and **feel** the same way
2. Others may have **different values**, right or wrong
3. If glued to a **point of view**, it is difficult to see other's view
4. **Anger** can skew a person's point of view
5. **Positive Feelings** change a person's reality

Primitive Mind Focus on Ego-Protective Self  
What is Best for Good of All?



IOWA STATE UNIVERSITY  
Extension and Outreach

Healthy People. Environments. Economies.

64

## Behavioral Health Tied to Communication Skill

6. **Negative feelings** change another person's reality
7. When **distressed**, expressions of care and empathy are often not as effective and genuine
8. Active listening does not guarantee the message was received correctly
9. Emotions transfer quickly to others
10. Judging other's emotions/intentions is often a faulty judgement

**Skill:**  
**Think good, well-wishing thoughts to those you meet = ↑ joy**

IOWA STATE UNIVERSITY  
Extension and Outreach

Healthy People. Environments. Economies.

65

## Mindset Tactics to Increase Resiliency

- Loss can build a Cross resurrect us to newer life**
- Pain can turn to Gain moving onward/upward**
- Stress can turn to Best helps motivate us**
- Grieve to Believe in love of what was lost**



IOWA STATE UNIVERSITY  
Extension and Outreach

Healthy People. Environments. Economies.

66

## Phrase of the Week

Smile 😊 Be Happy

## Words of the Year

Breathe/Relax/Stand Tall

### Tip:

Mindset Tactics aim to give inspiration and higher level reasoning.

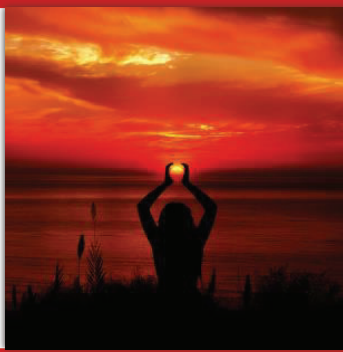

IOWA STATE UNIVERSITY  
Extension and Outreach

Healthy People, Environments, Economies.

67

## Know the Value of "Being" versus Doing "Things"

### Moons ago

Life was more about **being** and much less about **things**.

### Mindfulness vs Thingsfulness

Make life more about **being** and less about **things**.

Value of  
"BEING"

Cost of  
"THINGS"



IOWA STATE UNIVERSITY  
Extension and Outreach

Healthy People, Environments, Economies.

68

## Know the Value of "Being" versus doing "Things"

Time **"to be"** versus time **"to do"** or to **"take care of things"**

Tight margins of **time/energy/attention** focus more on short term **threats and pleasures**, **not long-term vision/happiness**.



IOWA STATE UNIVERSITY  
Extension and Outreach

Healthy People, Environments, Economies.

69

## Know the Value of "Being" versus Cost of "Things"

Anxiety or problems with health or relationships can arise as one meanders through chaos in life with less time for **"being"** and more time spent on **"doing things"** or just take care of **"things"**.

Human **"Beings"** versus Human **"Doers"** or **"Tied to Things"**



IOWA STATE UNIVERSITY  
Extension and Outreach

Healthy People, Environments, Economies.

70

## Be Mindful of Present

Breathe – Smile - Stand Tall

Take Care and Have Respect for Self

Be Proactive and Responsible for Self/Life



IOWA STATE UNIVERSITY  
Extension and Outreach

Healthy People, Environments, Economies.

71

## Realize Life's Value Goes Well Beyond the Farm

Leave **Pity Parties** to Attend to Higher Virtues/Values

Swap Processed Carbs and Added Sugars **OUT!**

Don't let **SCREEN** Time deplete **DREAM** Time

Generosity/Gratitude increased **Happy Hormones**



IOWA STATE UNIVERSITY  
Extension and Outreach

Healthy People, Environments, Economies.

72

## Meditative Prayer: Caring for You and Yours

Help me, \_\_\_\_\_, to use higher reasoning thoughts, to better face and manage my emotions, breathing deeply and smiling widely, caring in my words and actions, cautious in what I eat and drink, exercising to my heart's content, portraying positive posture, attitude and intent, keeping my ears to the ground for others, with my eyes fixed on the bigger horizon, looking forward and upward for myself, and for my greater WHY in life. Amen.

### ISU Extension and Outreach Dairy Team



Fred Hall  
Dairy Specialist  
NW Iowa



Jenn Bentley  
Dairy Specialist  
NE Iowa



Larry Tranel  
Psy.D.  
Dairy Specialist  
NE/SE Iowa

IOWA STATE UNIVERSITY  
Extension and Outreach

Healthy People. Environments. Economies.

73

## Rural Resiliency: Caring for You and Yours

4 Part Series archived on our Dairy Team Website:

**Part I: Farm Stress Resiliency and Grief**

**Part II: Personality Keys When "Married" to Farm Stress**

**Part III: Stress of Men, Women, and Kids**

**Part IV: Brain and Behavioral Health "Hacks" to Mitigate Distress**

<https://www.extension.iastate.edu/dairyteam/stressresiliency>

Contact: [tranel@iastate.edu](mailto:tranel@iastate.edu) or 563-583-6496

### ISU Extension and Outreach Dairy Team



Fred Hall  
Dairy Specialist  
NW Iowa



Jenn Bentley  
Dairy Specialist  
NE Iowa



Larry Tranel  
Psy.D.  
Dairy Specialist  
NE/SE Iowa

IOWA STATE UNIVERSITY  
Extension and Outreach

Healthy People. Environments. Economies.

74



# **Hypocalcemia can be Reduced. Steps That We Know will Work**

**Jesse Goff, DVM, PhD  
Iowa State University  
College of Veterinary Medicine**



**"Hypocalcemia can be Reduced. Steps That We Know will Work"**

Jesse Goff, DVM, PhD  
Iowa State University  
College of Veterinary Medicine

1

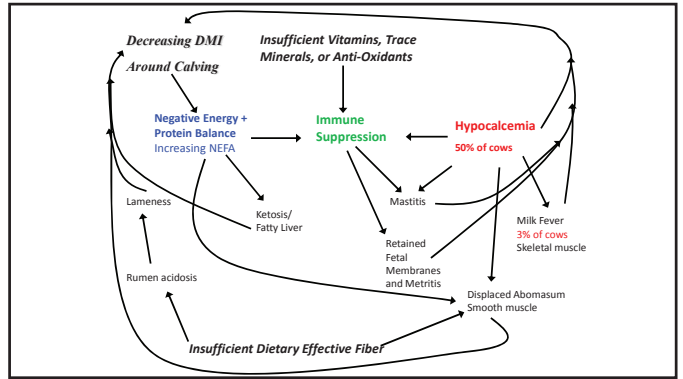

2

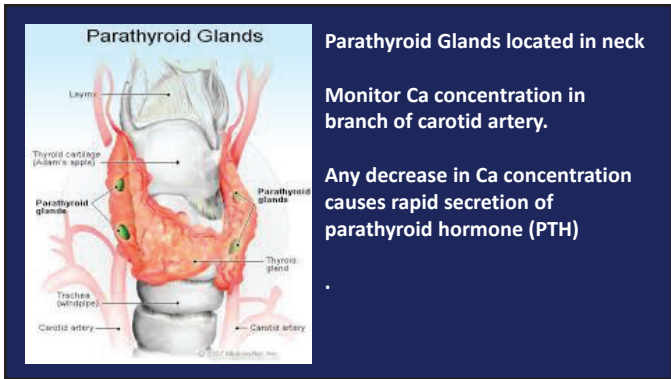

3

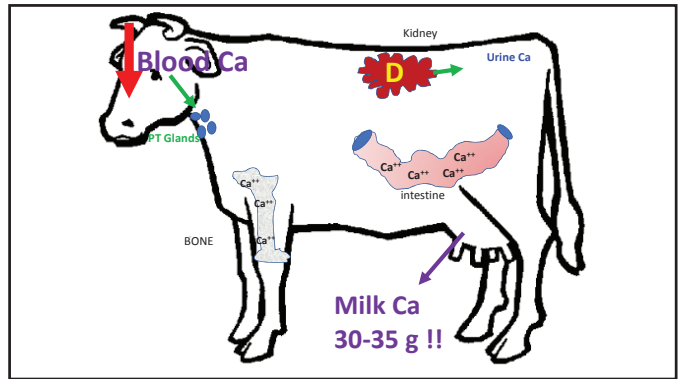

4

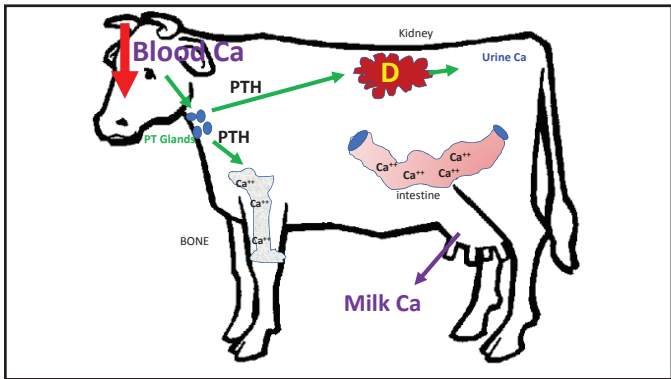

5

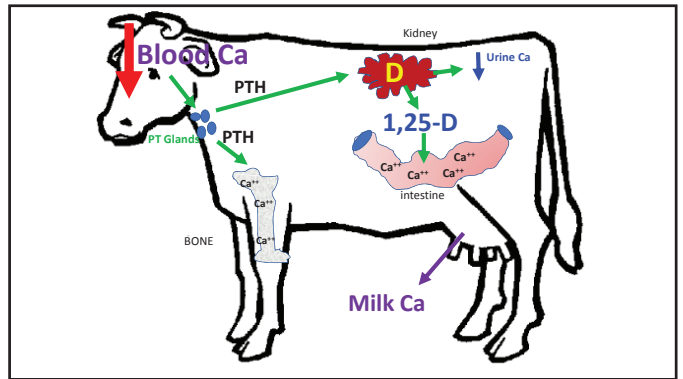

6



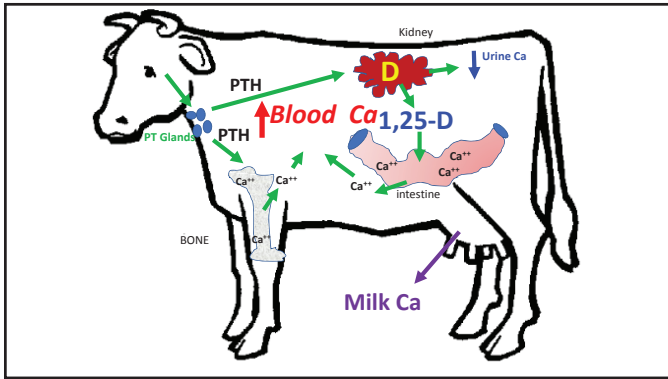

7

Why doesn't Ca Homeostasis work for all cows???

Aged cows lose vitamin D receptors in intestine

Aged cows have fewer sites of active bone resorption (fewer osteoclasts) capable of responding to PTH rapidly

**BLOOD pH AFFECTS TISSUE RESPONSIVENESS TO PTH!**

8

**Blood pH is dependent on Diet Cation –Anion Difference**

**DCAD = (mEq Na<sup>+</sup> + mEq K<sup>+</sup>) - (mEq Cl<sup>-</sup> + mEq SO<sub>4</sub><sup>-2</sup>)**

High DCAD diets, where K and Na are in much greater concentration than Cl or SO<sub>4</sub> cause Alkalosis & milk fever

Cations (+) **absorbed** from forages and diet cause the blood and urine of the cow to become alkaline

Anions (-) **absorbed** from forages and diet cause the blood and urine of the cow to become acidic

9

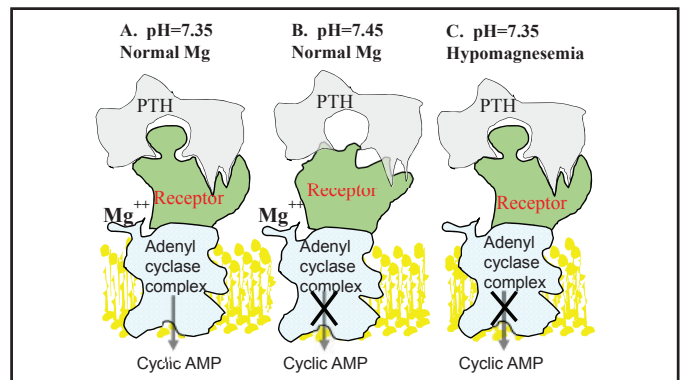

10

**Milk Fever & Hypocalcemia Prevention**

1. **Avoid very high potassium forages for close-up cows so they are not highly alkalinized;**

Practiced by many dairies in US.

11

**Low K Forages**

Use forage from fields with no manure application

Warm season grasses (corn!) accumulate less K than cool season grasses

As plants mature they contain lower K concentration (wheat straw! Maybe NOT oat straw)

12

### Milk Fever & Hypocalcemia Prevention

1. Avoid very high potassium forages for close-up cows; practiced by most dairies in US.
2. **Add anions (Cl or Sulfate) to diet to reduce blood and urine pH and improve tissue ability to respond to PTH!**

Choosing the right anion sources

13

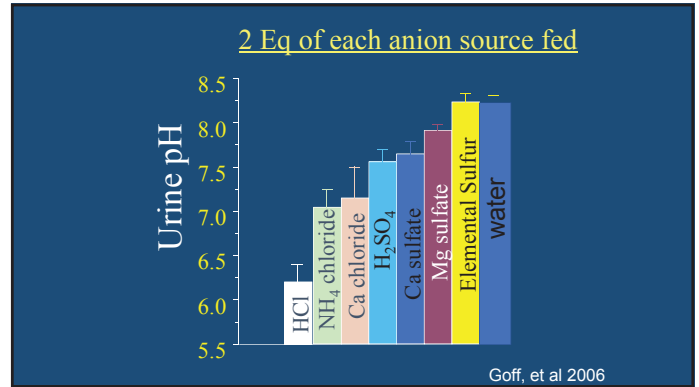

14

### Milk Fever & Hypocalcemia Prevention

1. Avoid very high potassium forages for close-up cows; practiced by most dairies in US.
2. **Add anions (Cl or Sulfate) to diet to reduce blood and urine pH and improve tissue ability to respond to PTH!**

Choosing the right anion sources

Palatability Issues

Over and under acidification

15

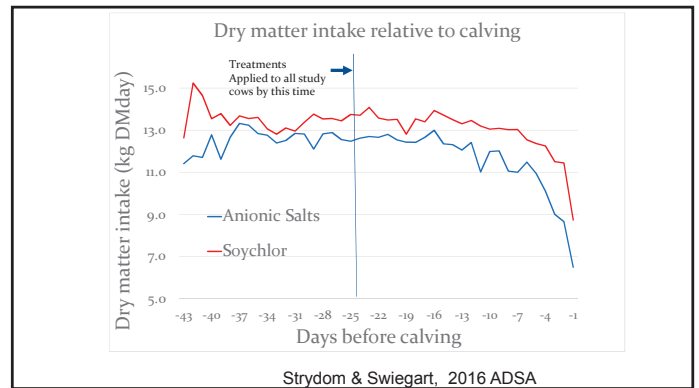

16

### Milk Fever & Hypocalcemia Prevention

1. Avoid very high potassium forages for close-up cows; practiced by most dairies in US.
2. **Add anions (Cl or Sulfate) to diet to reduce blood and urine pH and improve tissue ability to respond to PTH!**

Choosing the right anion sources

Palatability Issues

Over and under acidification

17

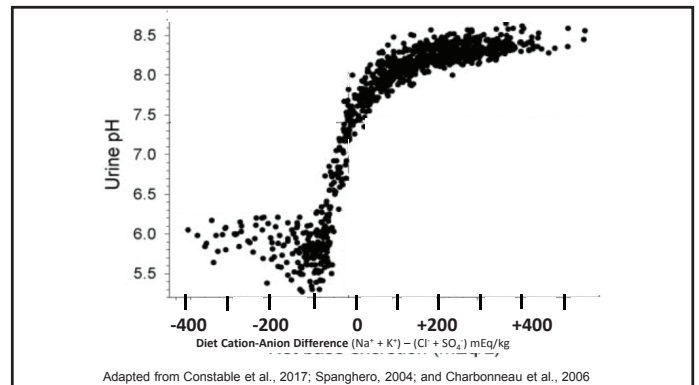

18

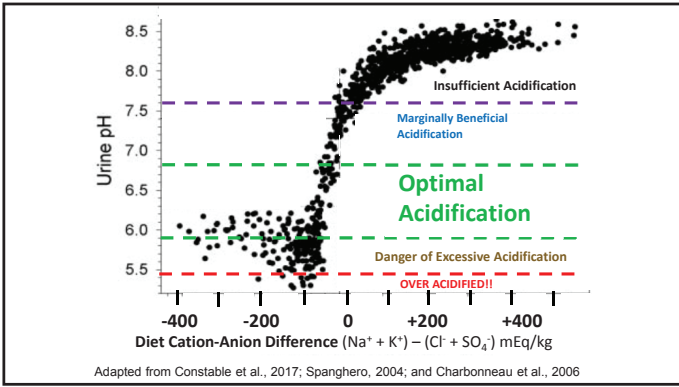

19

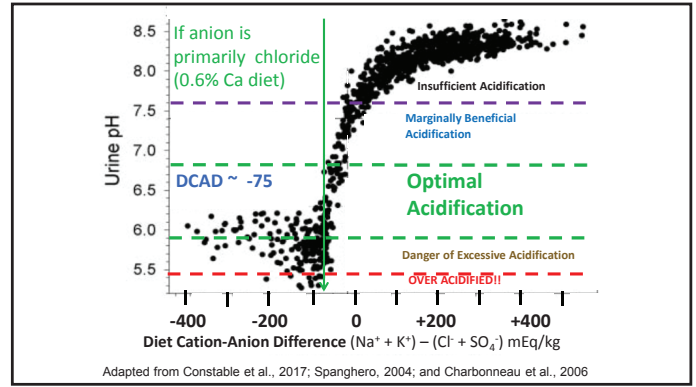

20

DCAD Equations

1. Traditional equation  $(Na + K) - (Cl + S)$   
Does not account for fact S is not as acidifying as Cl
2.  $(Na + K) - (Cl + 0.6 S)$  may be more biologically correct!!!  
- which means mathematically you need to feed a more negative diet on paper when using the sulfate salts to acidify

21

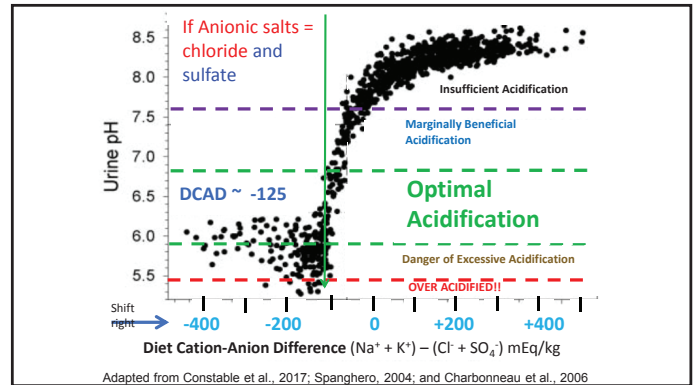

22

How much Ca should I feed with a low DCAD diet???

23

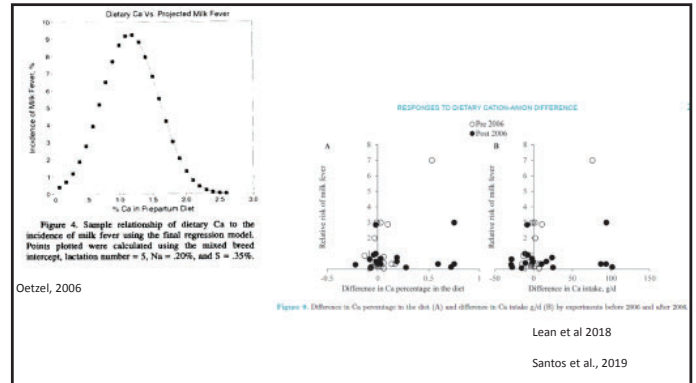

24

DCAD Equations

1. Traditional equation  $(Na + K) - (Cl + S)$

Does not account for fact S is not as acidifying as Cl

2. Better !!  $(Na + K) - (Cl + 0.6 S)$

- but does not account for alkalinizing effect of diet  $Ca^{++}$  coming from Calcium carbonate/ Limestone

25

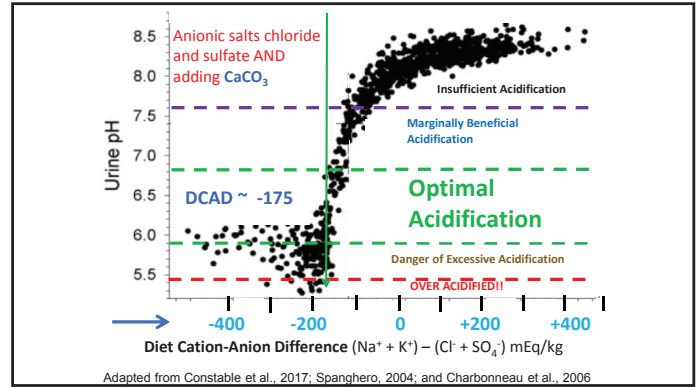

26

Impact of Reducing DCAD on health and milk production

Lean et al., 2019. Meta-analysis indicates significant beneficial effects ( $P < 0.02$ ) on:  
Milk Fever, Blood Ca (the day of calving and "postpartum"), Retained Placenta, Metritis, and risk of Multiple Health Events

But not on Mastitis ( $P=0.63$ ) and LDA ( $P=0.73$ )

Milk Production – Multiparous  $\rightarrow +1.1$  kg/day  
Nulliparous  $\rightarrow -1.28$  kg/day

Santos et al., 2019 reducing DCAD from +200 to -100  
Multiparous  $\rightarrow 1.7$  kg more milk / day (+1 kg DMI/d)  
Nulliparous  $\rightarrow 1.4$  kg less milk / day

27

Mecitoglu et al., 2016

Fed 115 cows anionic salts and had 13 cows (11%) develop LDA. Found cows with LDA had lower prepartum urine pH than non-LDA cows. Concluded that urine pH below 6.0 increased likelihood of a cow developing a LDA.

Table-1. Mean ( $\pm$  SE) urine pH, serum ionized Calcium (mmol/L) and blood pH for LDA and healthy groups

	LDA Group	Healthy Group	P value
Urine pH	6.11 $\pm$ 0.2	6.65 $\pm$ 0.1	$P < 0.05$
Serum iCa <sup>++</sup>	1.39 $\pm$ 0.01	1.36 $\pm$ 0.01	Not significant
Blood pH	7.27 $\pm$ 0.01	7.32 $\pm$ 0.01	$P < 0.05$

28

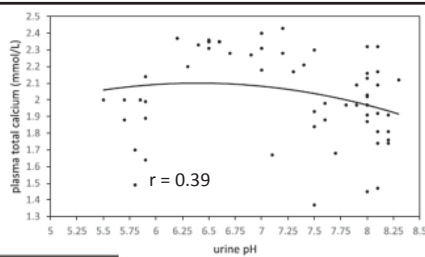

Urine pH	Stillborn %
<6.0 (n = 22)	13.6 <sup>a</sup> (3/22)
6.0-7.0 (n = 46)	8.7 <sup>ab</sup> (4/46)
>7.0 (n = 135)	4.4 <sup>b</sup> (6/135)

Melendez et al., Animal:2021

29

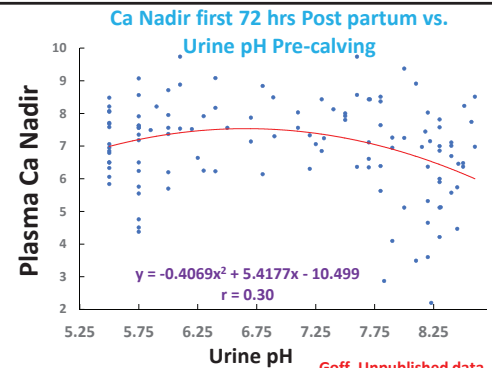

Goff, Unpublished data

30

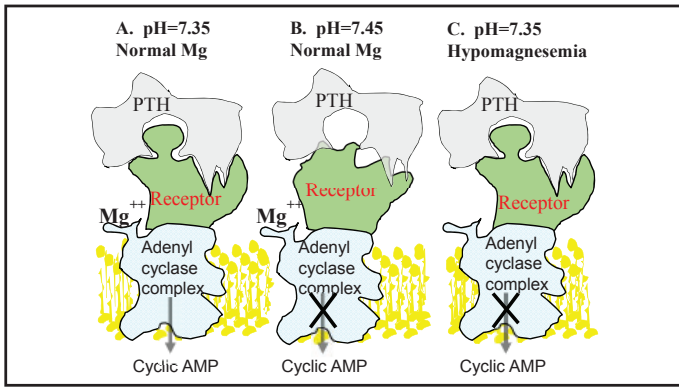

31

### Milk Fever & Hypocalcemia Prevention

1. Avoid very high potassium forages for close-up cows; practiced by most dairies in US.
2. Add anions (Cl or Sulfate) to diet to reduce blood and urine pH; various forms practiced.
3. **Diet Mg ~ 0.4% and Diet P < 0.35%, better below 0.25%**

32

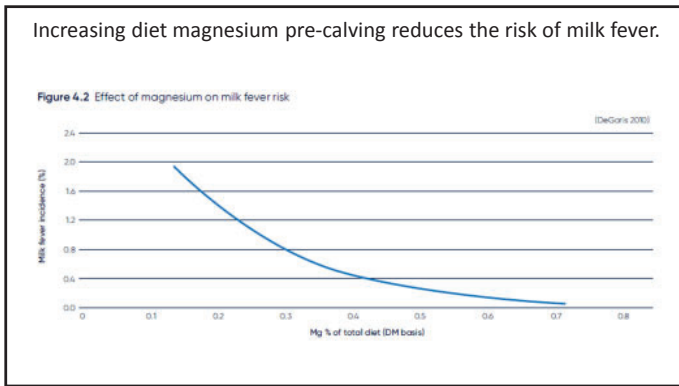

33

### Magnesium sources

Pre-calving

- using  $MgSO_4$  or  $MgCl_2$  as "anions" also supplies readily available, **soluble Mg**.
- The better anion supplements on the market include Mg in this form to remove Mg worries pre-calving.

**Post-calving is the bigger issue!!!!!!**  
**Magnesium Oxide – supplies Mg and acts as rumen alkalizer.**

**MgO must be available for absorption by rumen wall!!!!**

34

### Milk Fever/ Hypocalcemia Prevention Strategies

1. Avoid high potassium forages for close-up cows so cows are less alkaline
2. Add anions (Cl or Sulfate) to diet to reduce blood (and urine) pH.
3. Diet Mg ~ 0.4% , Diet P < 0.35%!
4. **Reduce diet Ca to stimulate parathyroid hormone release well before calving.**

35

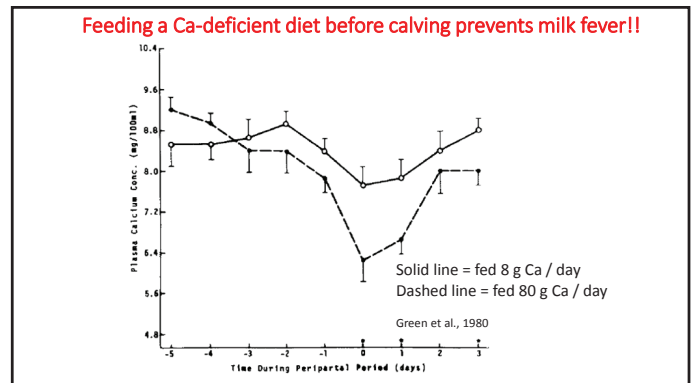

36

### Milk Fever Prevention Strategies

1. Avoid high potassium forages for close-up cows so cows are less alkaline
2. Add anions (Cl or Sulfate) to diet to reduce blood (and urine) pH.
3. Diet Mg = 0.4% must be available to cow
4. **Reduce diet Ca to stimulate parathyroid hormone release well before calving.**  
*Zeolite may make it realistic to achieve*
5. Oral calcium therapies (IV Ca?)

37

### Zeolite A (Thilsing-Hansen, et al. 2001)

In a test tube the sodium aluminosilicate can bind 1 g of Ca for every 10 g zeolite.

Seems to bind phosphate and magnesium as well. Trace minerals?? Transient reduction blood Mg and Phos.

38

Kerwin et al., 2019

Added 0.5 kg zeolite to a diet that was :

0.65 % Ca ,  
0.39% Phos,  
0.42% Mg  
DCAD of + 268 mEq/kg

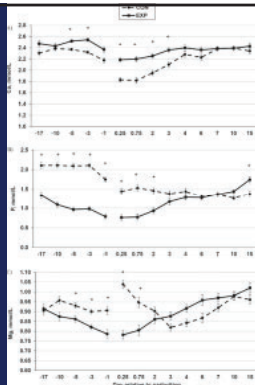

39

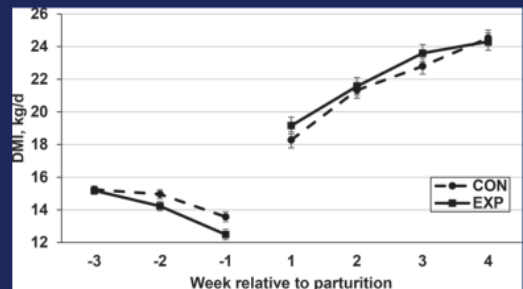

DMI Treatment X week P= 0.04  
Rumination rate significantly decreased with zeolite prepartum.P=0.03

40

### Milk Fever & Hypocalcemia Prevention

1. Avoid very high potassium forages for close-up cows; practiced by most dairies in US.
2. Add anions (Cl or Sulfate) to diet to reduce blood and urine pH; various forms practiced.
3. Diet Mg ~ 0.4% , Diet P < 0.35%
4. Reduce diet Ca to stimulate parathyroid hormone release well before calving. Zeolite?

**5. Vitamin D administration – too dangerous at effective doses**

41

### Milk Fever & Hypocalcemia Prevention

1. Avoid very high potassium forages for close-up cows; practiced by most dairies in US.
2. Add anions (Cl or Sulfate) to diet to reduce blood and urine pH; various forms practiced.
3. Diet Mg ~ 0.4% , Diet P < 0.35%
4. Reduce diet Ca to stimulate parathyroid hormone release well before calving. Zeolite?
5. Vitamin D administration – too dangerous at effective doses

**6. Oral Calcium drench, bolus, gels.**  
**7. IV calcium to each cow??**

42

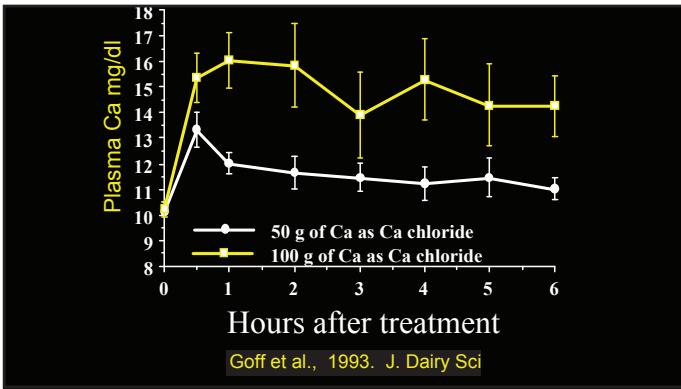

43

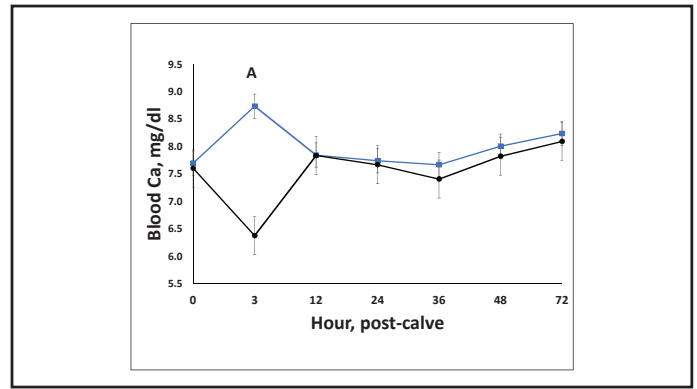

44

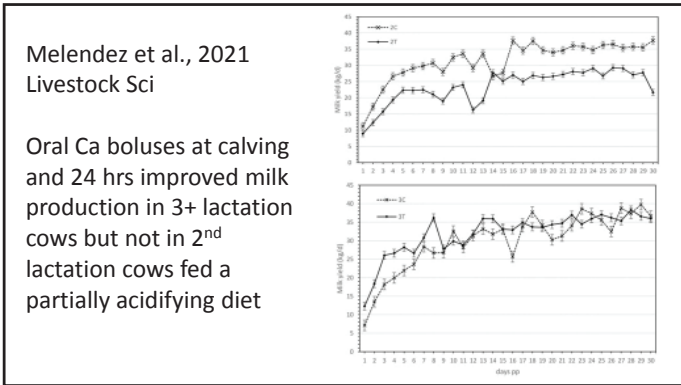

45

Roberts, et. al. N Zeal Vet J 2018

First Ca bolus (41 g Ca) at 1<sup>st</sup> milking  
Urine collected 12 hours after calving

5/13 (41%) treated cows had urine pH <7

0/12 (0%) control cows (p<0.001)

Second bolus given ~12 hrs after calving  
24 hr Urine

13/13 (100%) treated cows had urine pH <7

0/12 (0%) control cows (p<0.001).

46

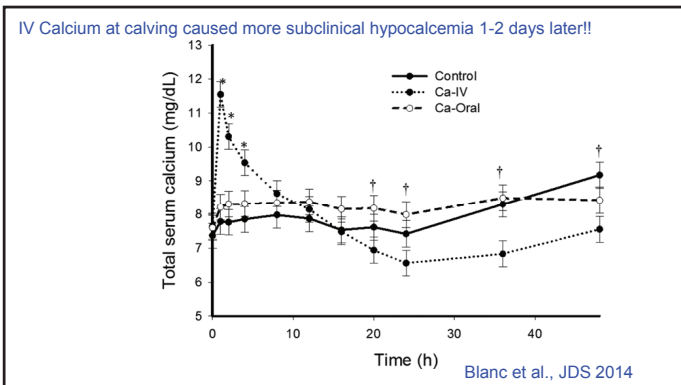

47

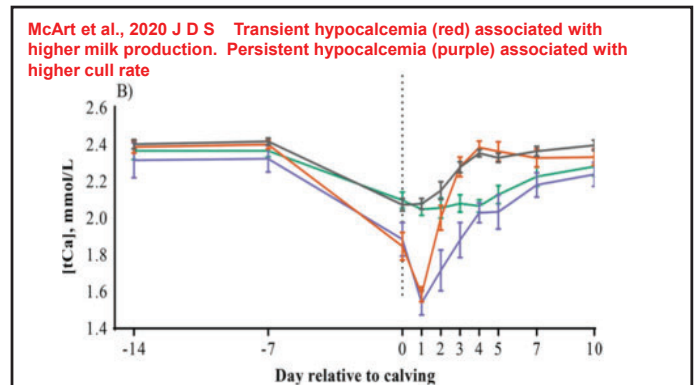

48



# **Perturbations in Calcium Around Calving**

**Dr. Laura Hernandez  
University of Wisconsin**







# Perturbations in Calcium Around Calving

Laura L. Hernandez, Ph.D., Department of Animal and Dairy Sciences



1

## Calcium loss associated with pregnancy and lactation



- Growing Fetus → 3-6 g/d
- Colostrum → ~ 23 g/d
- Early Milk → 30-50 g/d
- Peak Milk → ~ 80 g/d



5 g



80 g

2



Skeletal Ca is required



7.8 – 8.5 kg

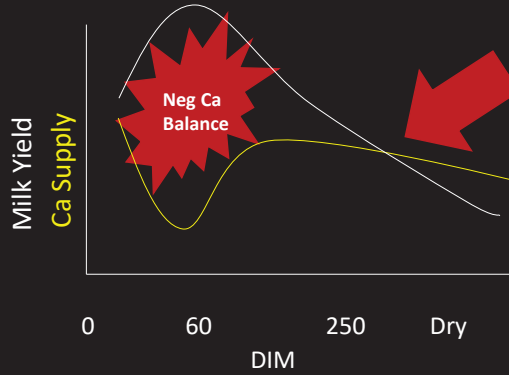

Dietary Ca solely meets fetal and maintenance requirements

3

### Calcium Status of Periparturient Dairy Cows based on Serum Calcium Concentrations

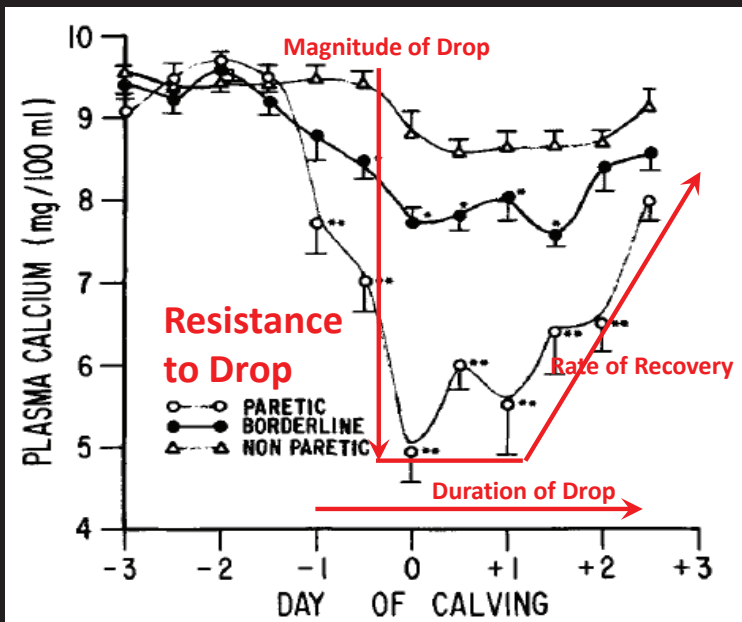

- Several factors contribute to regulating calcium homeostasis:
  - *Resistance to Drop*
  - *Magnitude of Drop*
  - *Duration of Drop*
  - *Rate of Recovery*

Horst and Jorgensen, 1982

4

# Lactation

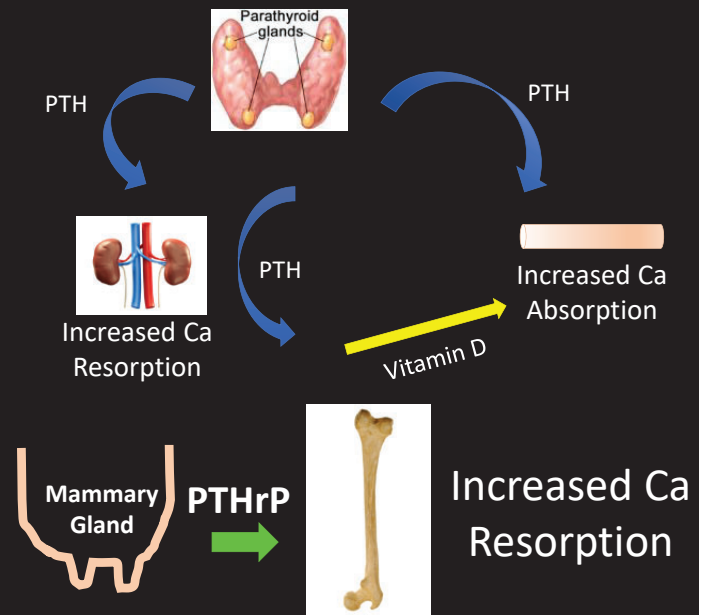

5

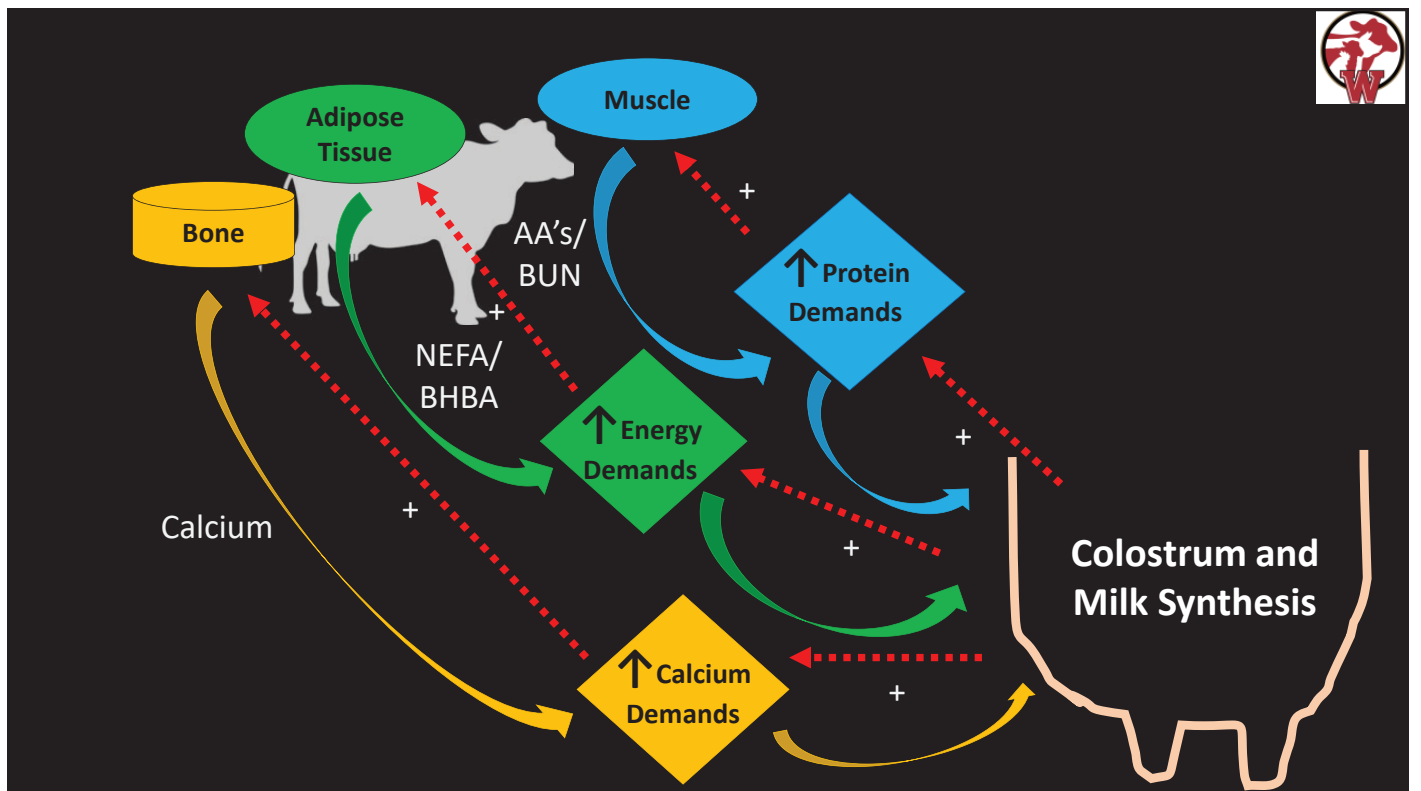

6



# Milk synthesis controls calcium decline at parturition

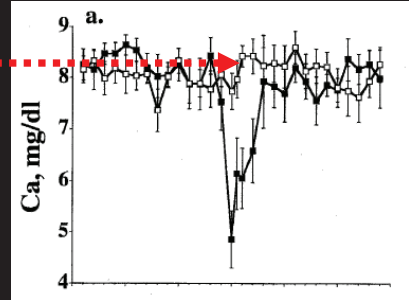
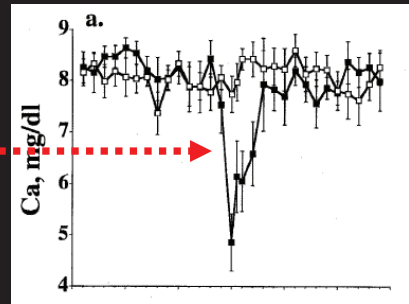
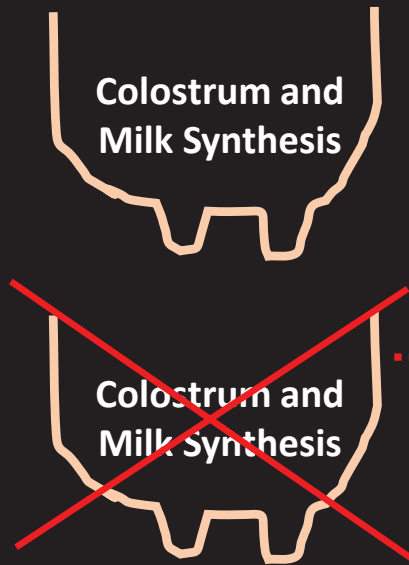

Goff et al., 2002

7



# Mammary Epithelial Cell $Ca^{2+}$ Dynamics During Lactation

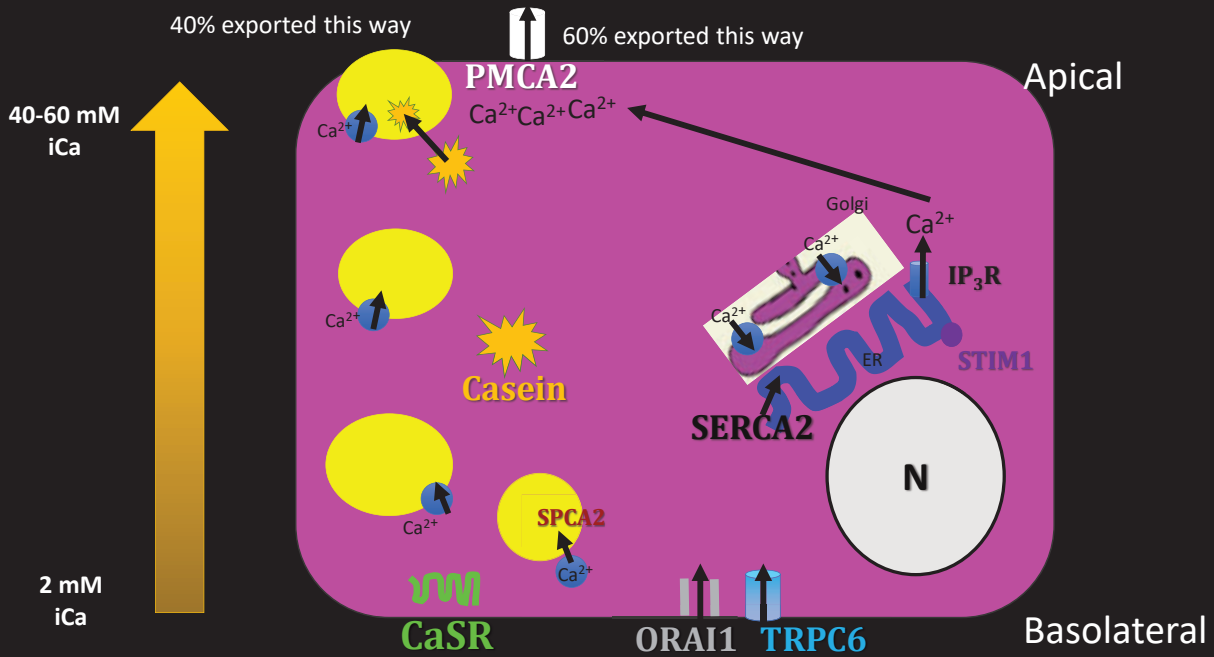

Neville, 2005; Shennan, 2008; Cross et al., 2014

8



# How do early lactation cows respond to calcium challenges?

9

## Experimental Treatments



### Infusions:

*i.*) a continuous 24hr intravenous solution of 0.9% saline (n=6 lactating, n=6 non-lactating) to maintain normocalcemia or

*ii.*) 5% ethylene glycol tetraacetic acid (EGTA) in 0.9% saline (n=6 lactating, n=6 non-lactating) to induce and maintain subclinical hypocalcemia ( $<1.0 \text{ mM } i\text{Ca}^{2+}$ ).

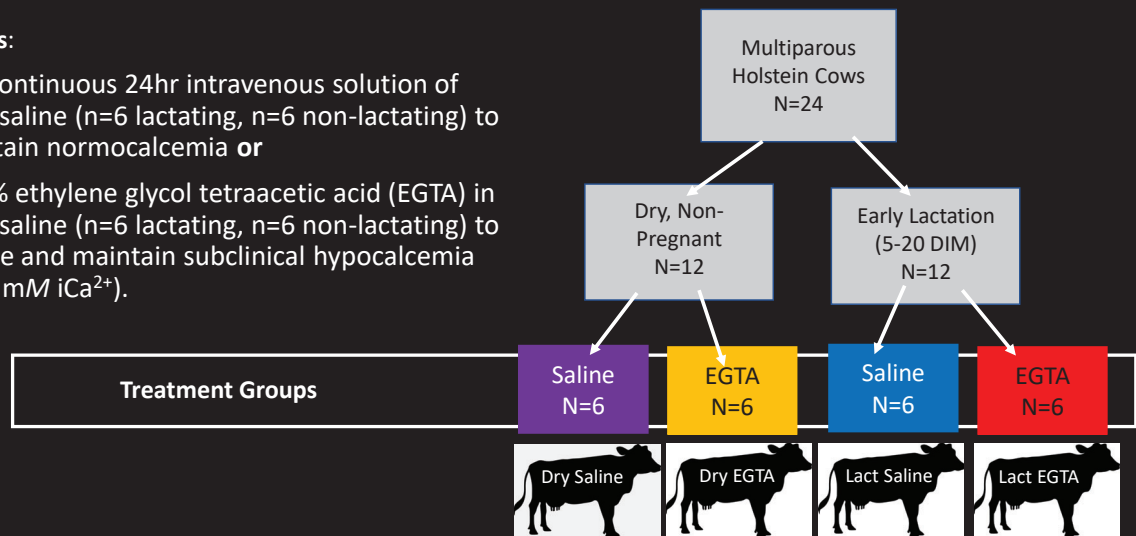

*Ethylene glycol tetraacetic acid (EGTA) is a selective calcium chelator*

10



## Experimental Timeline

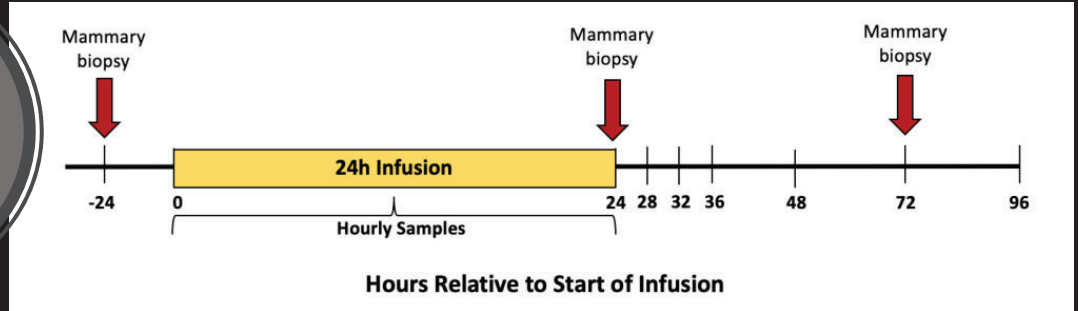

11

## Results: $iCa^{2+}$ mM

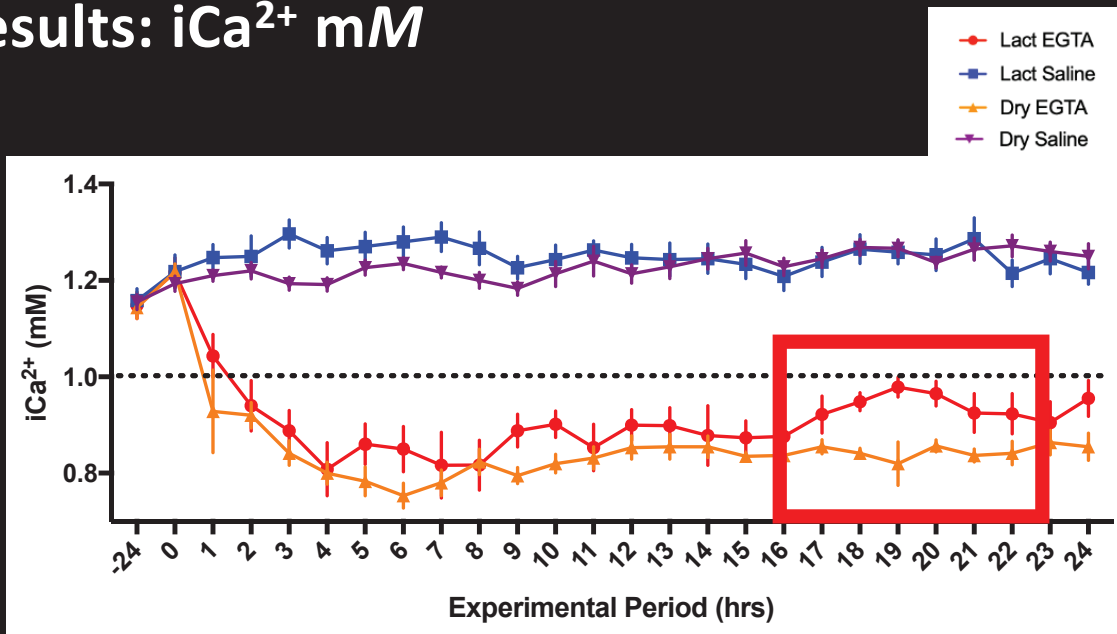

Connelly, unpublished results

12



# Results: $iCa^{2+}$ mM

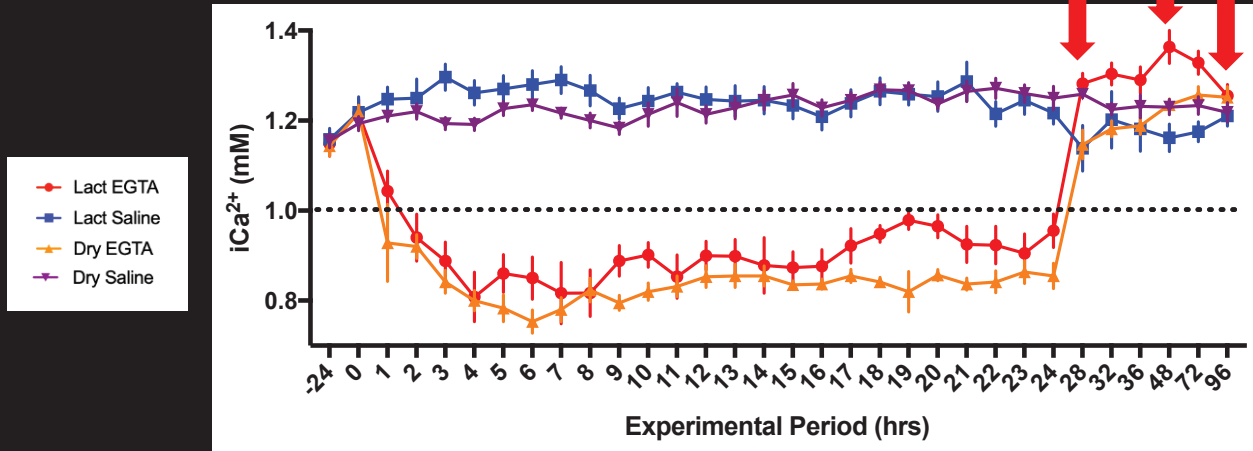

Connelly, unpublished results

13



# Results: $iCa^{2+}$ mM

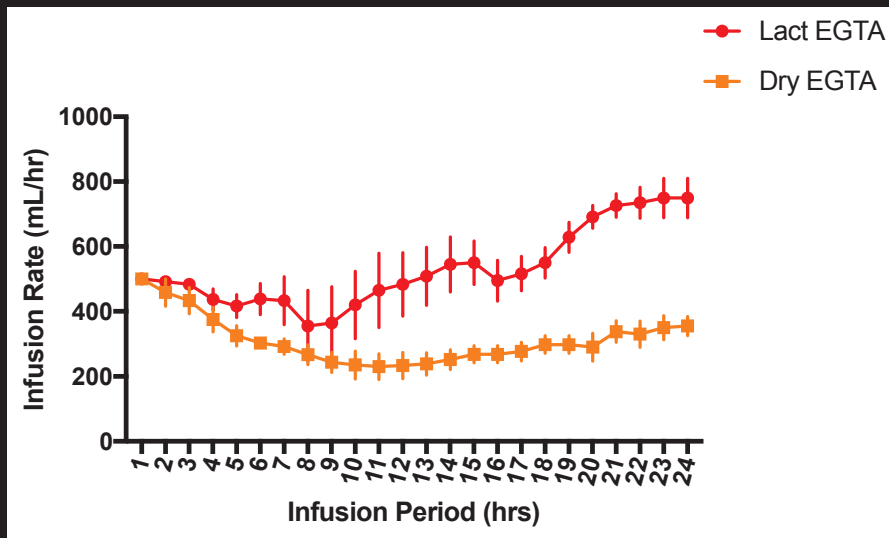

14



# Results: tCa mM

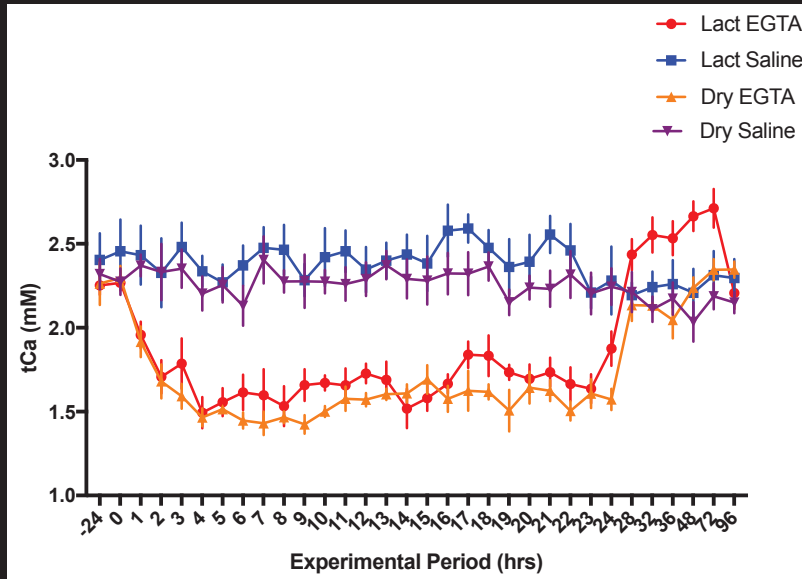

15

# Results: iCa<sup>2+</sup> mM v. tCa mM

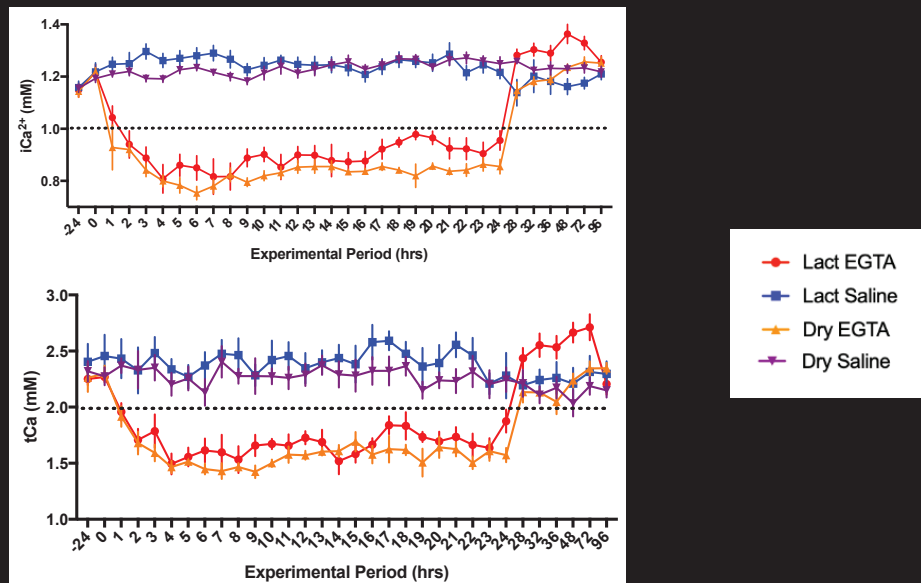

16





## Results: Serotonin

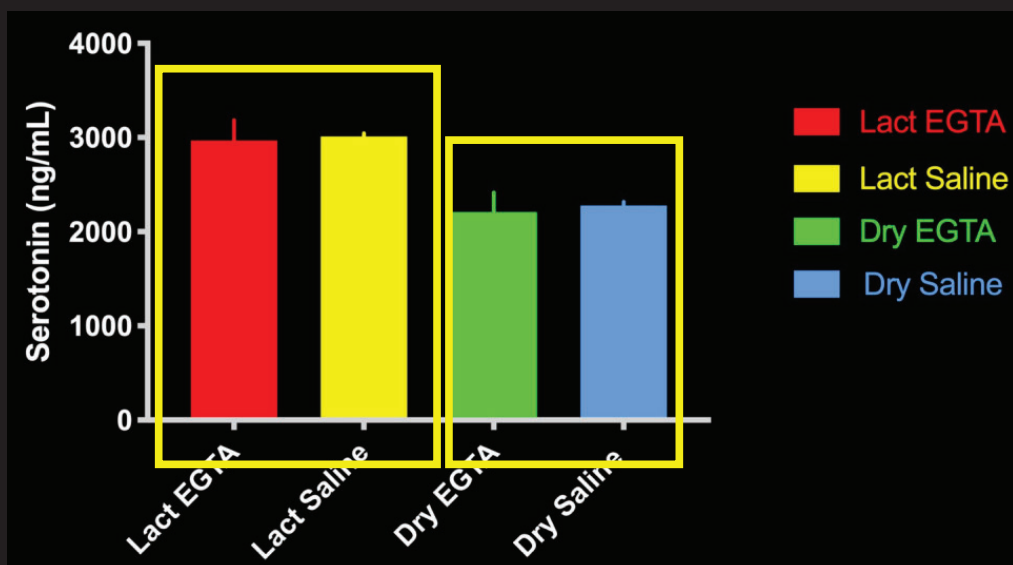

Connelly, unpublished results

17



What is a “normal” hypocalcemia needed to activate calcium homeostasis at parturition?

18



# Timeline

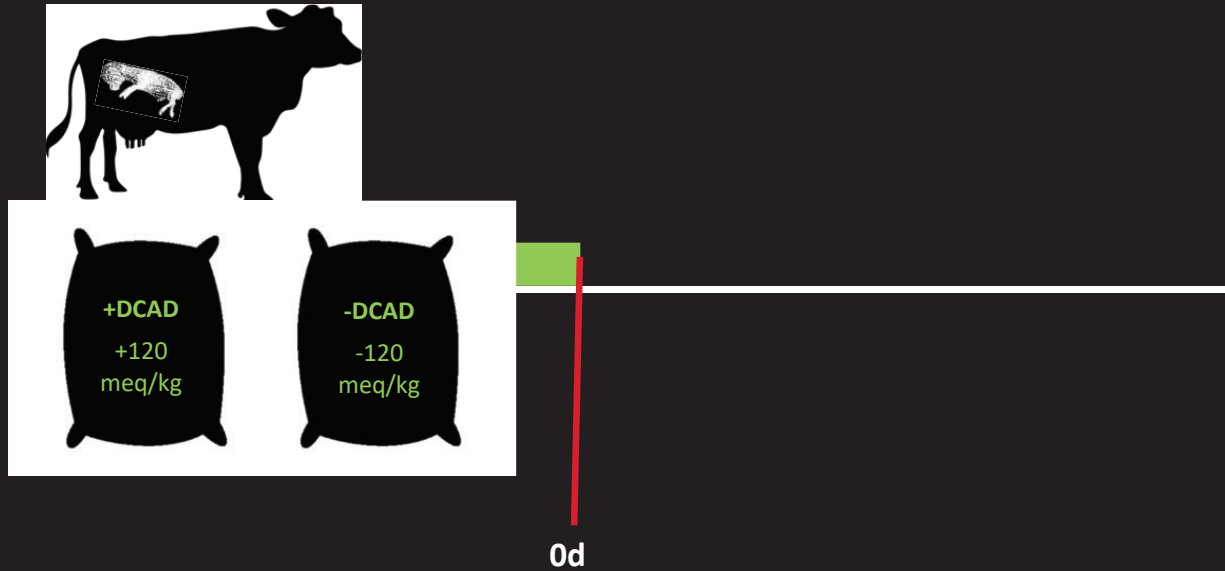

19



# Timeline

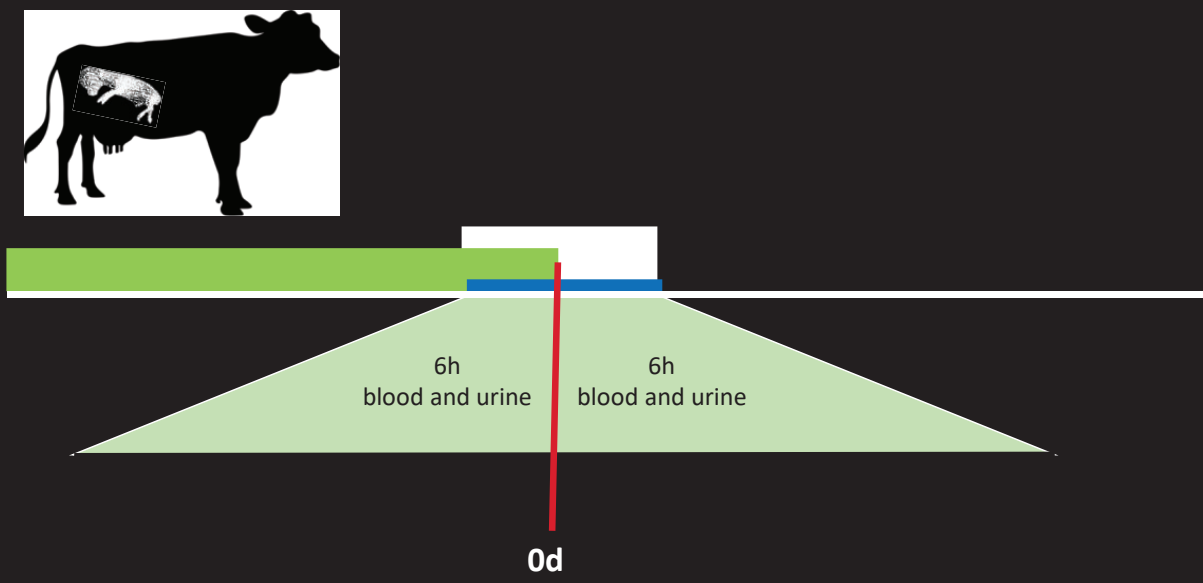

20

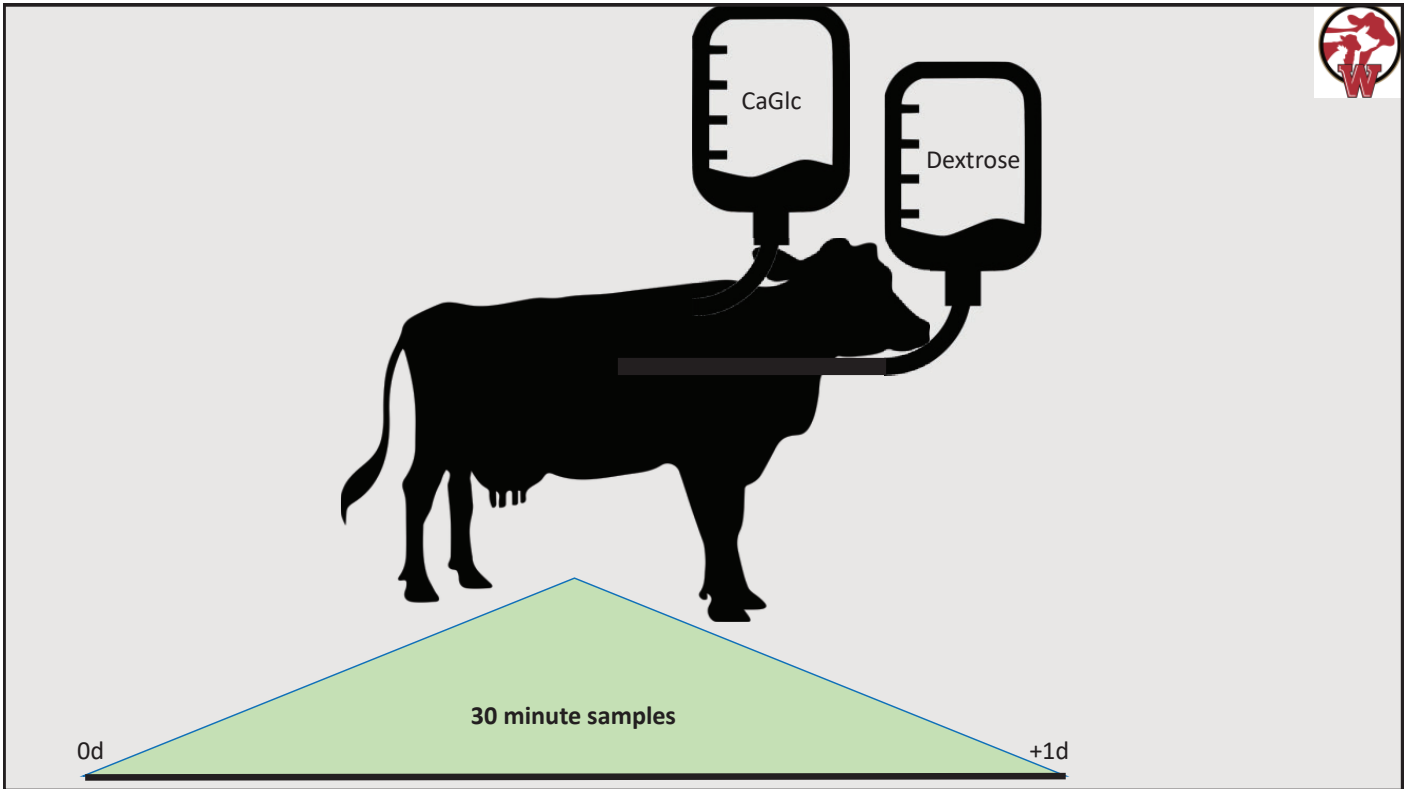

21

## Results: Infusion Rates

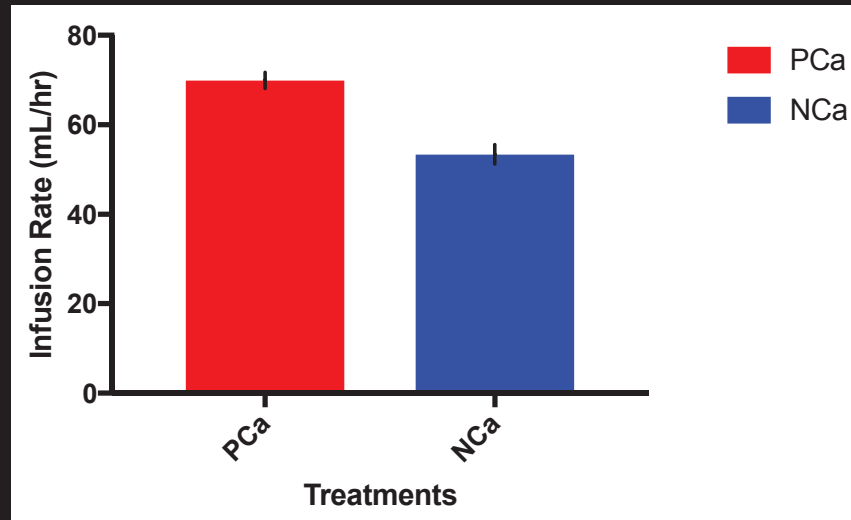

22

# Results: Infusion Rates

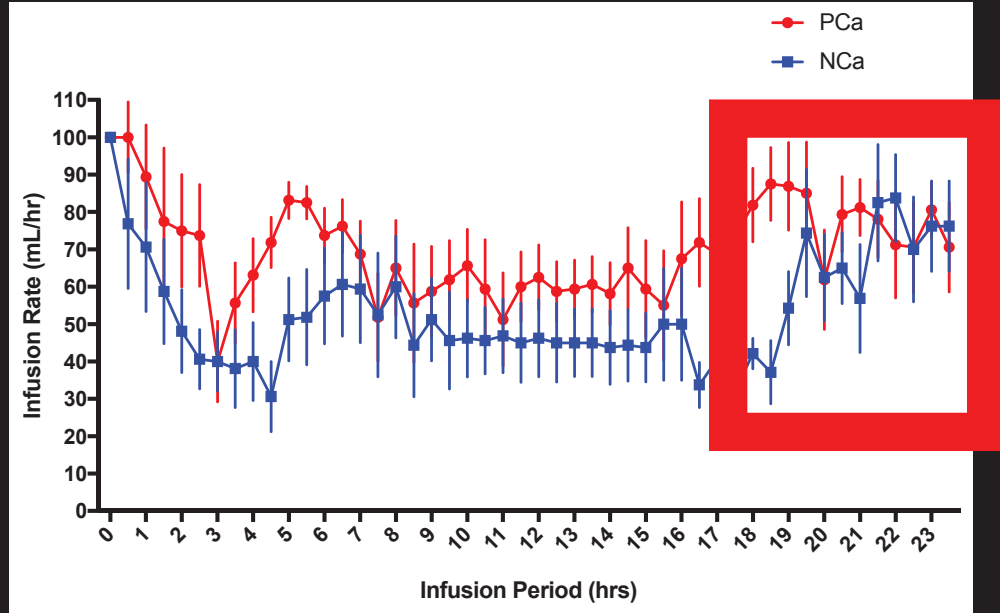

Connolly, unpublished results

23

# Timeline

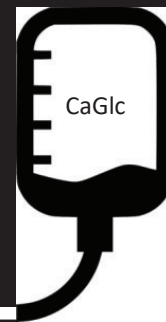
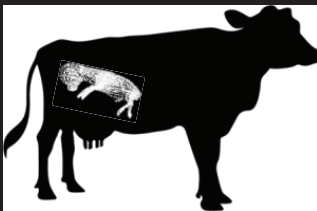

Ud +1d

24



# Timeline

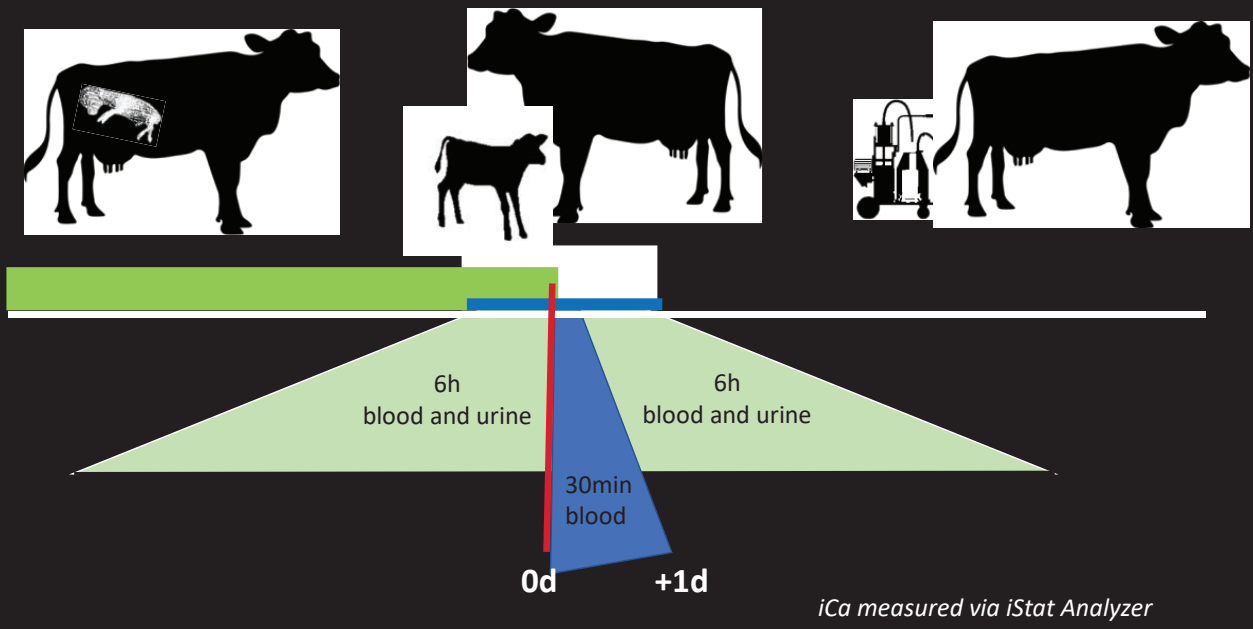

25



# Results: $iCa^{2+}$ mM

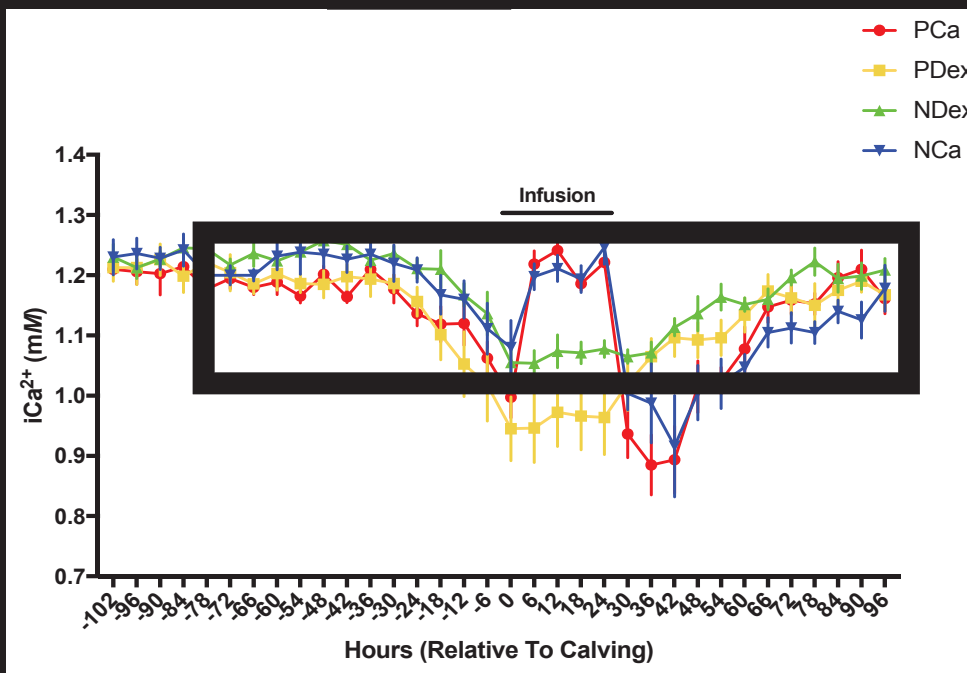

Negative Feedback is Necessary?  
Negative Feedback is Important?

26

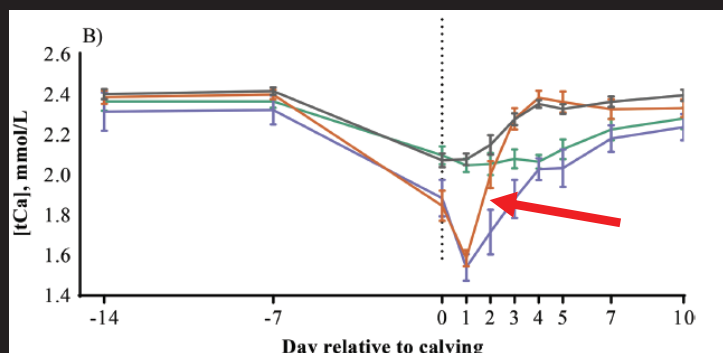

**Red**=transient hypocalcemia  
**Black**=normocalcemia  
**Green**=persistent hypocalcemia  
**Blue**=delayed hypocalcemia

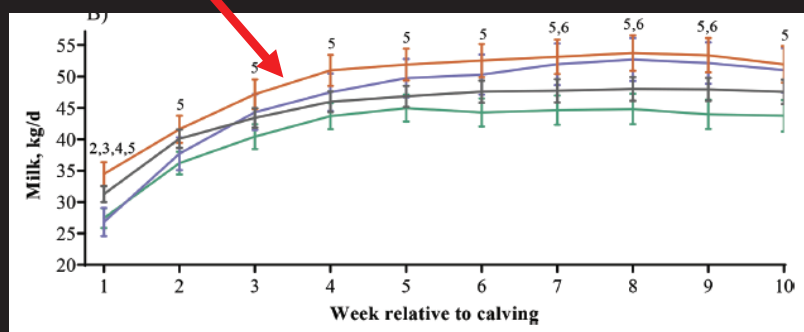

McCart and Neves, 2019

27



## Homeostatic (6hr) and homeorhetic (day-day) relationship between two metabolites

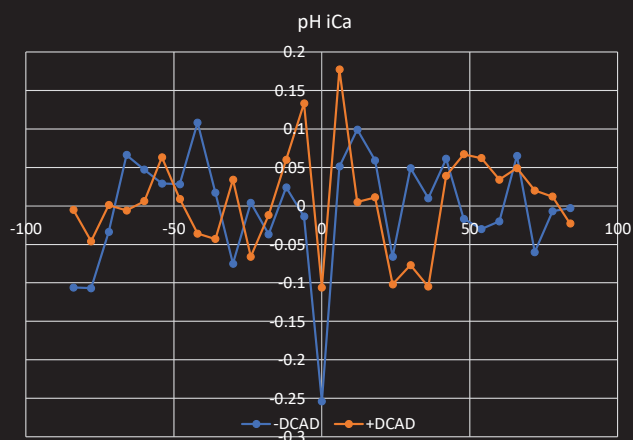
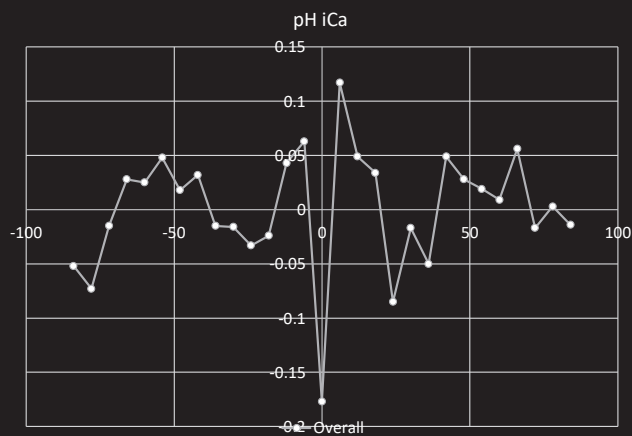

28

# Determination of effects of feeding DCAD and X-Zelit on transition cows



BCS: D0, D7, D14, D21, D35 and D49

Metricheck: D3, D7 and D10 post partum

Body Weights: recorded weekly

Milk Samples: collected weekly until D21 lactation

Feed Samples: collected weekly

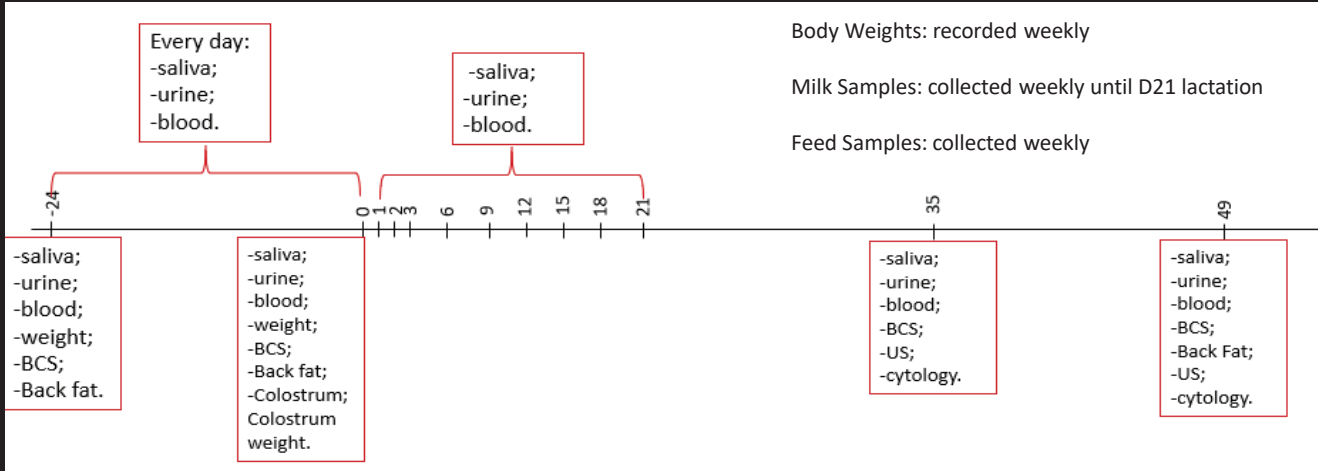

29

## Ionized Calcium

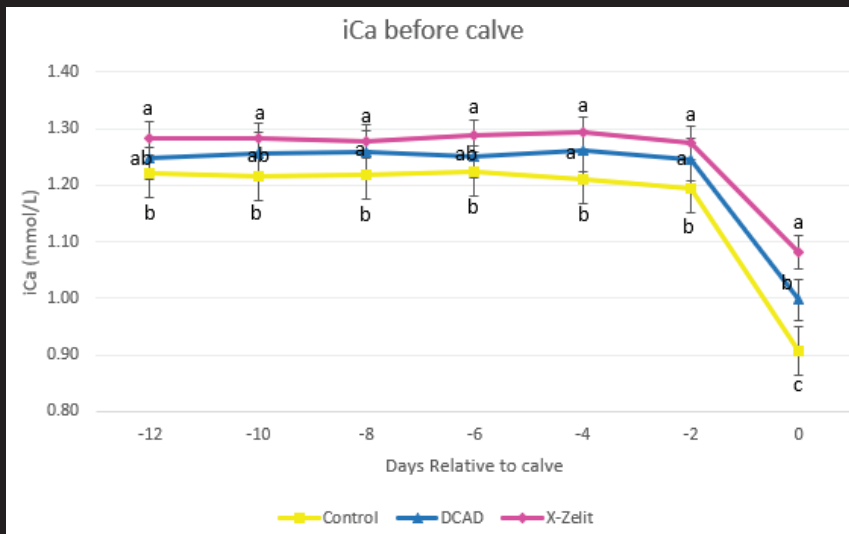

Treatment:  $p < 0.01$ ;  
Time:  $p < 0.01$ ;  
Treatment\*Time:  $p < 0.01$ .

30



# Ionized Calcium

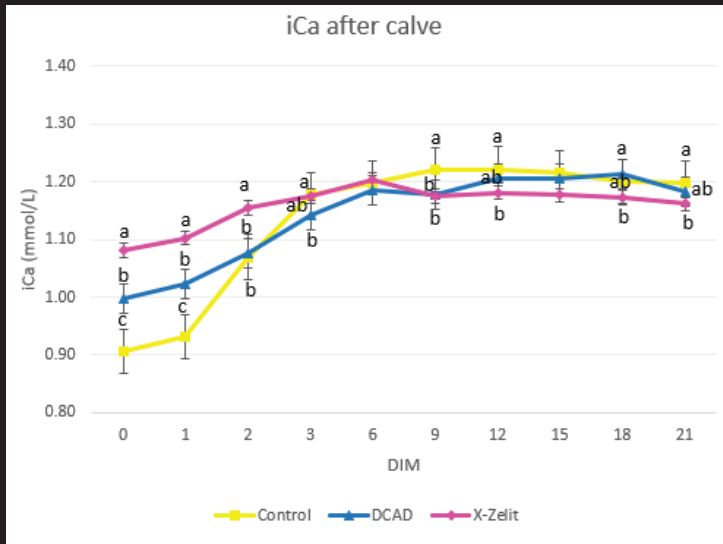

Treatment:  $p < 0.01$ ; Time:  $p < 0.01$ ;

Treatment\*Time:  $p < 0.01$ .

Between D-2 and D0:

- Control: ↓ 24.1%;

- DCAD: ↓ 19.89%;

- X-Zelit: ↓ 15.17%.

31



# Milk Yield

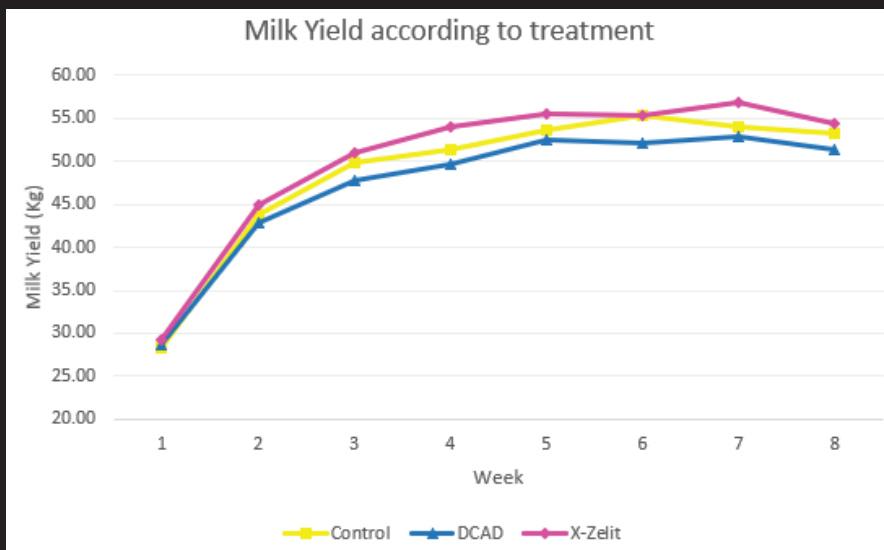

• Treatment:  $p = 0.09$ ;

• Time:  $p < 0.01$ ;

• Treatment\*Time:  $p = 0.61$ .

32





# Body Weight

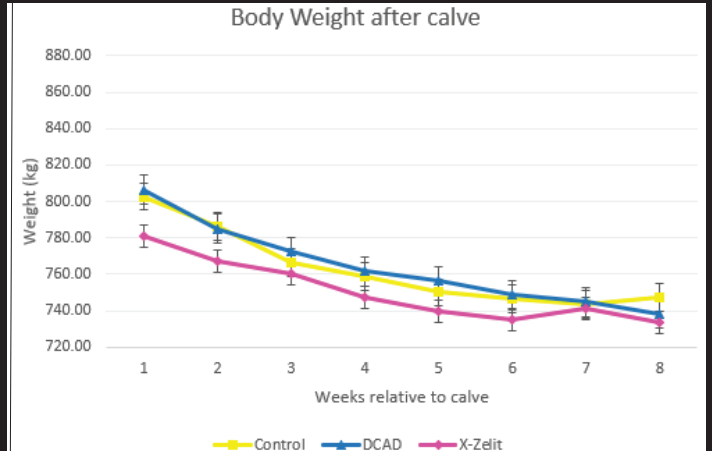
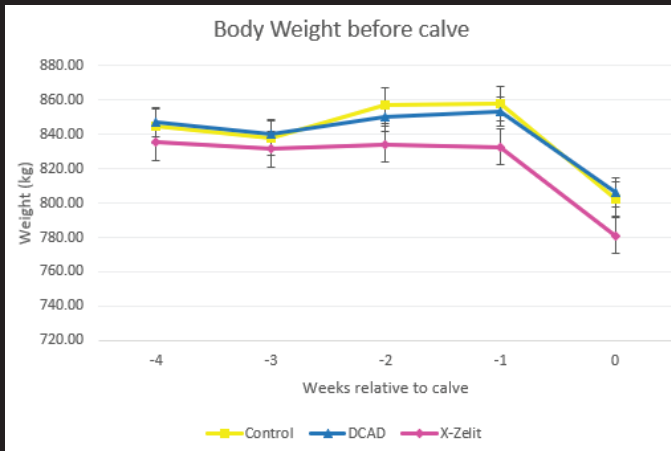

Treatment:  $p = 0.0760$ ; Treatment\*Time:  $p = 9979$ .  
Time:  $p < 0.01$ ;

Treatment:  $p = 0.0660$ ; Treatment\*Time:  $p = 1.00$ .  
Time:  $p < 0.01$ ;

33



# Anovulation Rate

Treatment	Number of cows	Number Anovulation cows	% Anovulation
Control	43	6	13.95
DCAD	41	9	21.95
X-Zelit	42	10	23.81
Total	126	24	19.05

34



# Pregnancy/AI according to treatments

Treatment	Number of cows	Number Pregnant Cows	Pregnancy/AI
Control	20	5	25.00%
DCAD	19	8	42.11%
X-Zelit	19	10	52.63%
<b>Total</b>	<b>58</b>	<b>23</b>	<b>39.66%</b>

35



## Nonpregnant cows according to DIM

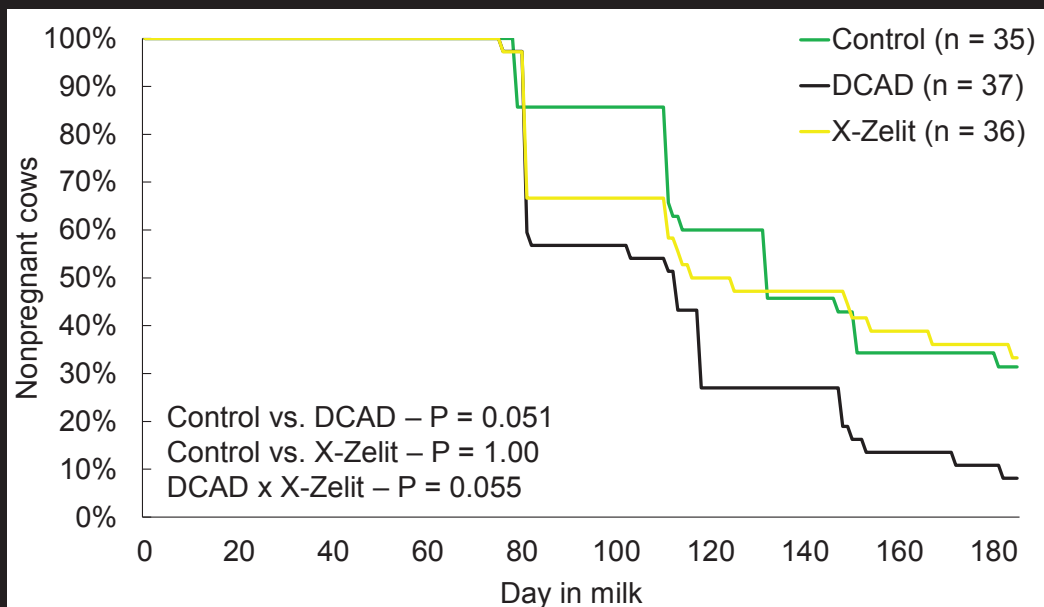

36

# Can EGTA treatment improve calcium homeostasis postpartum and how does that effect energy and immune status?

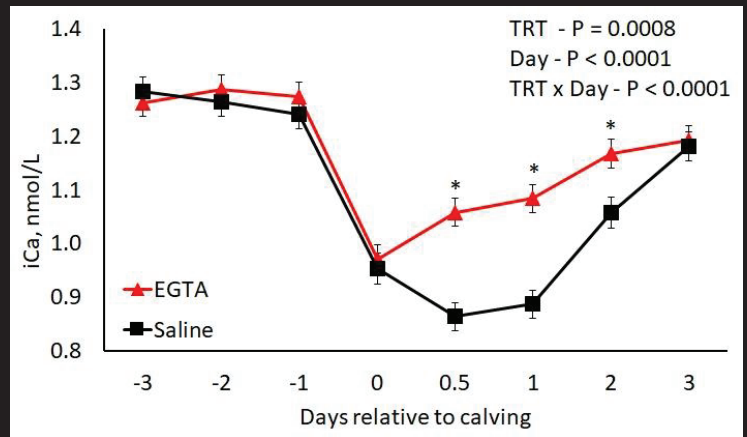
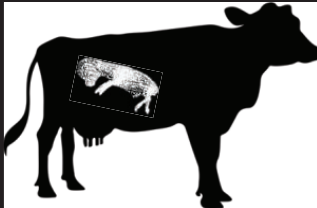
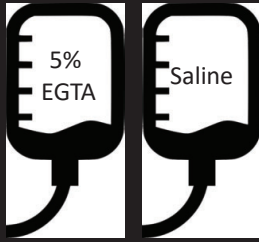

Treatments for 7 days prepartum

37

## Conclusions



- Early lactation cows are equipped to maintain their calcemic status when challenged with hypocalcemia
- A certain level of decreased calcium around parturition is necessary to activate homeostatic mechanisms related to maintenance of adequate calcium concentrations
- It is critical to manage the prepartum cow to ensure proper calcium homeostasis post-partum
- We aim to determine the homeostatic relationships surrounding calving that are indicative of a healthy transition into lactation and the interactions with immune and energy status

38



# Department of Animal & Dairy Sciences

UNIVERSITY OF WISCONSIN-MADISON



United States Department of Agriculture National Institute of Food and Agriculture

USDA/NIFA:2016-67015-24584

USDA/NIFA:2020-67015-31260

WIS01732: USDA-Hatch



Australian National University





# Using Reduced-Lignin Alfalfa in Lactating Dairy Cow Diets

**Dr. Ken Kalscheur**  
**USDA Forage Research Center**



# Using Reduced-Lignin Alfalfa in Lactating Dairy Cow Diets

Hannah C. Wilson and Kenneth F. Kalscheur  
USDA-ARS Dairy Forage Research Center, Madison, WI  
kenneth.kalscheur@usda.gov

## SUMMARY

- Increasing fiber digestion leads to improved milk production
- Reduced-lignin alfalfa offers flexibility for harvest dates while maintaining forage quality
- Reduced-lignin alfalfa can be harvested at greater intervals than conventional alfalfa and maintain lactating cow performance

## INTRODUCTION

Maintaining forage crop sustainability for perennial legumes is largely dependent on increasing fiber digestibility (Martin et al., 2017). Alfalfa (*Medicago sativa* L.) is a regularly grown forage fed to ruminants in the U.S. with approximately 11.5 million acres (42 million dry tons) harvested in 2020 (NASS, 2021). Alfalfa is commonly credited for its high nutritional value. However, alfalfa is often limited on its nutritive value because of the indigestible lignin components in the cell wall, which continue to accumulate as the plant matures (Albrecht et al. 1987). Utilizing technology to improve fiber digestibility in alfalfa provides opportunities for increased flexibility and improved animal production.

## INCREASING FIBER DIGESTIBILITY

Incomplete fiber digestion reduces the profitability and performance of a dairy operation mainly by limiting intake and increasing manure production leading to overall reduced animal productivity. Compared with substrates from starch, ruminal fermentation of fiber generates more hydrogen ions that reduce carbon dioxide to methane (Adesogan et al, 2019). By improving fiber digestion, additional energy may go towards the cow's energy supply and reduce the enteric methane production which is an environmental concern. Thus, it is critically important to maximize fiber digestibility to take full advantage of the nutrients in forage sources. Increases in forage NDF digestibility (NDFD) are associated with a 0.17 kg/d increase in DMI and a 0.25 kg/d increase in milk production (Oba and Allen, 1999). Additionally, each percentage unit increase in lignin concentration in forage cell walls severely constrains DMI and milk production.

## LIGNIN

Lignin, a complex structural polymer, provides strength and rigidity for the plant, leading to decreased digestibility as the concentration of lignin increases with maturity. During the thickening of secondary cell walls in plants during maturity, lignin is responsible for providing structural integrity to hold the plant upright and protect against environmental and pest stresses (Jung and Engels, 2002). Lignin content can also be directly related to cell wall digestibility by forming cross-linkages with other cell wall constituents, notably cellulose and hemicellulose, that would otherwise be more digestible without these cross-linkages (Moore and Jung, 2001).

## REDUCED LIGNIN ALFALFA

A multitude of alfalfa varieties with reduced-lignin content have achieved significantly greater fiber digestibility due to less lignification of the plant cell wall (Baucher et al., 1999; Reddy et al., 2005; Chen et al., 2006; Zhou et al., 2010; Cherney et al., 2020). One such specific variety, marketed as HarvXtra, has demonstrated to be successful in improving forage digestibility by downregulation of caffeic acid 3-O-methyltransferase and caffeoyl CoA 3-O-methyltransferase (Guo et al., 2001).

Other alfalfa varieties attempt to manipulate the leaf:stem ratio utilizing conventional breeding, one marketed under the name Hi-Gest. Fiber digestibility of alfalfa declines as the stem lignifies with advancing maturity and the leaves fall off. This can also occur with leaf loss during harvest (Albrecht, 1987). Alfalfa leaves maintain high NDF digestibility throughout the growth cycle, while the stem material becomes increasingly lignified as the plant approaches full bloom (Buxton and Hornstein, 1986). Conventionally bred, reduced-lignin alfalfa, offers a slight improvement in the digestibility of alfalfa stems compared to conventional alfalfa and an increase in the rate of digestion of NDF.

## HARVEST FLEXIBILITY

Alfalfa has environmental and sustainability advantages when compared to corn silage, another popular forage source. However, because corn silage is harvested one time in the fall it has a perceived economical advantage over alfalfa which must be cut 4 to 5 times in a season, requiring more labor and machinery costs. Alfalfa is often cut more frequently, sacrificing yield, to maximize quality and fiber digestibility. Harvest timing is critical for obtaining optimal forage nutritive value, yet harvest decisions are often made without knowledge of forage nutritive value due to the time constraint of obtaining laboratory test results (Arnold et al. 2019).

In addition to improved nutritive value, reduced-lignin alfalfa can also offer an advantage to harvest management flexibility. The reduced-lignin concentration and increased digestibility may lengthen the time window when alfalfa has suitable nutritive value, allowing for wider optimal harvest windows. This would allow for alfalfa growers to accumulate larger amounts of forage by delaying harvest but still maintaining acceptable nutritive value (Grev et al., 2017; Undersander et al., 2009). A field experiment conducted at 6 locations (KS, MI, OH, PA, CA, and WI) over 2 years reported that reduced-lignin alfalfa (HarvXtra) contained consistently lower neutral detergent fiber (NDF; -3.5 to -7.5%), reduced acid detergent lignin (-8.4%) and an increase in neutral detergent fiber digestibility (5.3 to 7.7%) compared to two other varieties of alfalfa which represented at 7-to-10-day advantage in nutritive value using a 38-day cutting schedule (Arnold et al., 2019). Another study reported no differences in yield or nutrient quality when harvested at 28-day intervals (Getachew et al., 2018). However, in the same study extending harvest to a 35-day cutting interval led to increased yield but also maintained nutritional quality compared to a control alfalfa which sacrificed quality for greater yields. Figure 1, adapted from Barros et al. (2019), illustrates the relationship of increased yield as cutting interval increases in exchange for a dramatic decrease in NDF digestibility (NDFD). However, the HarvXtra variety had a similar rise in yield but a 12-15% advantage in digestibility.

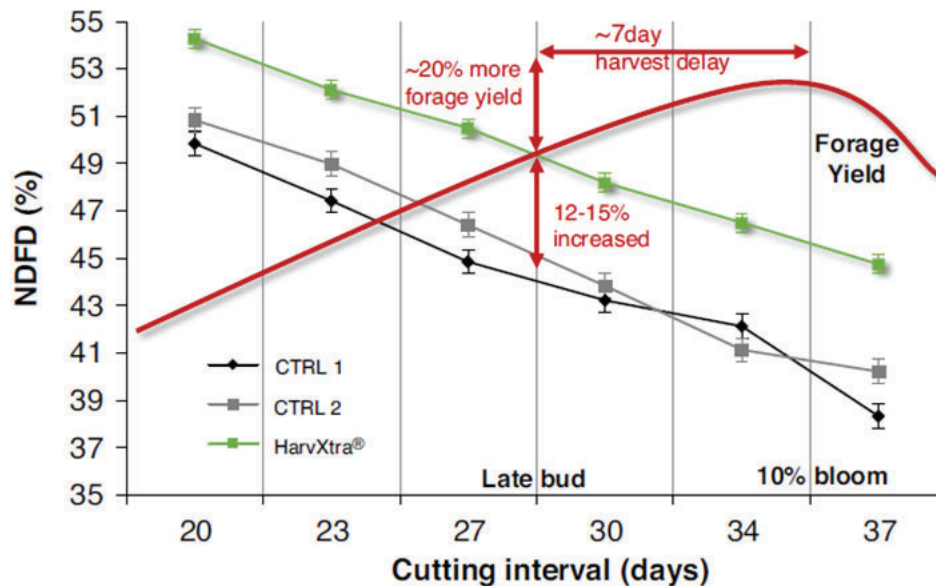

**Figure 1.** Relationship of cutting interval and neutral detergent fiber digestibility (NDFD) in addition to forage yield for 2 control varieties of alfalfa (CTRL 1, CTRL 2) compared to a reduced-lignin alfalfa (HarvXtra). Adapted from Barros et al. (2019).

## REDUCED-LIGNIN ALFALFA AND ANIMAL PERFORMANCE

Feeding increasingly digestible alfalfa, despite the reduced-lignin variety, is primarily a response of increased intake. Improving the nutritive value of alfalfa, subsequently by increasing fiber digestibility, could lead to increased milk production (Oba and Allen, 1999). It is important to consider harvest intervals simultaneously. Improved fiber digestibility or increased milk production may not be expected if reduced-lignin alfalfa is being utilized from delayed harvest, or increased harvest intervals to increase tonnage. If a normal cutting schedule is maintained a higher quality reduced-lignin alfalfa may lead to an increase in milk production. However, research utilizing reduced-lignin alfalfa in lactating dairy cow diets is limited.

The first study conducted at the U.S. Dairy Forage Research Center evaluated the inclusion of reduced-lignin alfalfa silage as a replacement for soyhulls and supplemental protein in dairy cow diets. Forty-eight lactating Holstein cows (24 multiparous, 24 primiparous) averaging 141 DIM at the beginning of the experiment. The experiment had a 2-wk covariate period where cows were fed a common diet, followed by an 8-wk treatment period where cows were assigned randomly to 4 treatments in a randomized complete block design. Diets consisted of 40% BMR corn silage, 10% conventional alfalfa silage (AS) and either 0, 6, 12, or 18% high quality (reduced lignin) alfalfa silage (OAS, 6AS, 12AS, 18AS, respectively) on a DM basis.

Increasing AS in the diets linearly decreased DMI from 26.3 kg/d (0% AS) down to 24.9 kg/d (18% AS;  $P \leq 0.05$ ). Milk production was unaffected ( $P > 0.10$ ) by AS inclusion but feed conversion efficiency (ECM/DMI) increased linearly from 1.63 to 1.83 when AS was incrementally increased in the diets. Milk fat % and yield increased linearly as AS replaced concentrate feedstuffs (3.35 to 3.90% fat, 1.48 to 1.65 kg/d fat). Percentage and yield of both milk protein and lactose did not differ among the treatments. Substitution of protein and non-forage fiber feedstuffs up to 18% of the diet (DM basis) with reduced-lignin AS did not reduce milk production and increased milk fat yield, milk fat % and feed conversion efficiency.

A second study conducted at the U.S. Dairy Forage Research Center evaluated two different harvest intervals to determine retention of nutritive value during later harvests in both conventional and reduced-lignin alfalfa. It was hypothesized that reduced-lignin alfalfa may either increase milk production or feed conversion efficiency because of greater fiber digestibility (and increasing DM intake) if harvested at similar intervals as the conventional alfalfa. Conversely, if harvest is delayed (late), utilizing reduced-lignin alfalfa may maintain milk production compared to possible losses in efficiency when feeding late harvested conventional alfalfa.

A lactation study was conducted utilizing 55 lactating Holstein cows (16 primiparous and 39 multiparous cows) averaging 89 DIM at the start of the experiment. After all cows were fed a common covariate diet for 2 weeks, cows were assigned randomly to 1 of 4 alfalfa silage treatments and fed for 8 weeks. The four alfalfa silage treatments were an early harvest (EH) conventional alfalfa (CA; 28-day interval from previous cutting), late harvest (LH) conventional alfalfa (35-day interval from previous cutting), early harvest reduced-lignin alfalfa (RLA), and late harvest reduced-lignin alfalfa (both harvested on the same day as the respective conventional alfalfa). Alfalfa used in the experiment was 3rd cutting alfalfa harvested in August 2019. The basal diet consisted of 30% BMR corn silage, 19% high-moisture corn, 6% canola meal, 8% soybean hulls, 4.5% Soyplus, 2.5% mineral and vitamins, and 30% of 1 of 4 treatment alfalfa silages.

Cows fed EH-RLA and LH-CA had the greatest DMI (27.9 and 27.2 kg/d, respectively) compared to EH-CA and LH-RLA (26.7 and 26.4 kg/d respectively; Table 1). There was a tendency for milk production to be greater for EH regardless of alfalfa hybrid. There were no differences in milk protein (%) or lactose (%). However, milk fat (%) tended to be least for cows fed LH-CA, intermediate for EH-RLA and LH-RLA, and greatest for EH-CA. There was a tendency for TS (%) to be least (12.8) for LH-CA and EH-RLA, but greater (12.9) for EH-CA and LH-RLA. There was no effect of alfalfa hybrid on FCM, however, EH led to greater ECM and FCM compared to cows fed LH alfalfa. When compared on a DMI basis, FCM/DMI was least for LH-CA, intermediate for EH-RLA and LH-RLA, and greatest for EH-CA.

As expected, cows fed the LH-CA resulted in the poorest feed conversion efficiency because it took greater intake to produce similar yields of milk. Because this alfalfa was likely of poorer quality (further analysis pending), cows consumed more feed to meet energy requirements to produce milk. The additional digestibility in the EH-RLA allowed cows to eat more and produce numerically more milk, but the cows were not as efficient as EH-CA on a fat-corrected basis.

## CONCLUSIONS

Reduced-lignin alfalfa can be a useful tool to improve harvest flexibility compared to conventional alfalfa. Delayed harvest using reduced-lignin alfalfa may reduce total milk production compared to harvesting at shorter intervals. However, delaying harvest using reduced-lignin varieties allows for greater tonnage to be procured with minimal sacrifices in forage quality while maintaining feed conversion efficiency.



**Table 1.** Milk production and components for 55 lactating Holstein cows fed conventional or reduced-lignin alfalfa at two harvest intervals.1

Item	CA		RLA		SEM	P-value		
	EH	LH	EH	LH		H × A	H	A
DMI, kg/d	26.7 <sup>a</sup>	27.2 <sup>ab</sup>	27.9 <sup>b</sup>	26.4 <sup>a</sup>	0.35	<0.01	0.12	0.52
Milk, kg/d	47.0	46.6	48.1	46.7	0.54	0.29	0.08	0.23
Fat, %	4.08 <sup>a</sup>	3.92 <sup>b</sup>	3.97 <sup>ab</sup>	4.00 <sup>ab</sup>	0.05	0.06	0.20	0.73
Protein, %	3.06	3.07	3.07	3.04	0.02	0.27	0.67	0.58
Lactose, %	4.79	4.78	4.79	4.78	0.01	0.85	0.32	0.90
TS, %	12.9	12.8	12.8	12.9	0.06	0.08	0.19	0.97
MUN, mg/dL	13.0 <sup>a</sup>	12.9 <sup>ab</sup>	12.2 <sup>b</sup>	13.0 <sup>a</sup>	0.20	<0.01	0.08	0.08
FCM	46.9	45.4	47.5	46.5	0.68	0.68	0.05	0.17
ECM <sup>2</sup>	49.8	48.5	50.7	49.5	0.67	0.96	0.05	0.13
FCM/DMI	1.77 <sup>a</sup>	1.65 <sup>c</sup>	1.71 <sup>bc</sup>	1.75 <sup>ab</sup>	0.03	<0.01	0.13	0.47
ECM/DMI	1.88 <sup>a</sup>	1.77 <sup>b</sup>	1.83 <sup>ab</sup>	1.86 <sup>ab</sup>	0.03	<0.01	0.14	0.38

<sup>abc</sup> indicated significant differences between treatment means

<sup>1</sup>CA = Conventional alfalfa, RLA = Reduced-lignin alfalfa, EH = Early harvest, LH = late harvest, H = effect harvest interval, A = effect of alfalfa hybrid

<sup>2</sup>ECM = [0.327 × milk yield (kg)] + [12.95 × fat yield (kg)] + [7.2 × protein yield (kg)]

## REFERENCES

- Albrecht, K.A., W.F. Wedin, and D.R. Buxton. 1987. Cell-wall composition and digestibility of alfalfa stems and leaves. *Crop Sci.* 27:735–741. doi:10.2135/cropsci1987.0011183X002700040027x
- Andesogan, A.T., K.G. Arriola, Y. Jiang, J.J. Romero, L.F. Ferraretto, and D. Vyas. 2019. Symposium review: Technologies for improving fiber utilization. *J. Dairy Sci.* 102:5726–5755. Doi:10.3168/jds.2018-15334
- Arnold, A.M., K.A. Cassida, K.A. Albrecht, M.H. Hall, D. Min, X. Xu, S. Orloff, D.J. Undersander, E. van Santen, and R.M. Sulc. 2019. Multistate evaluation of reduced-lignin alfalfa harvested at different intervals. *J. Crop Sci.* 59:1799–1807. doi:10.2135/cropsci2019.01.0023
- Barros J., S. Temple, and R. Dixon. 2019. Development and commercialization of reduced lignin alfalfa. *Curr. Opin. Biotechnol.* 56:48–54. doi:10.1016/j.copbio.2018.09.003
- Baucher, M., M.A. Bernard-vailhé, B. Chabbert, J.-M. Besle, C. Opsomer, M. Van Montagu, and J. Botterman. 1999. Down-regulation of cinnamyl alcohol dehydrogenase in transgenic alfalfa (*Medicago sativa* L.) and the effect on lignin composition and digestibility. *Plant Mol. Biol.* 39:437–447. doi:10.1023/A:1006182925584
- Chen, F., M.S.S. Reddy, S. Temple, L. Jackson, G.L. Shadle, and R.A. Dixon. 2006. Multi-site genetic modulation of monolignol biosynthesis suggests new routes for the formation of syringyl lignin and wall-bound ferulic acid in alfalfa (*Medicago sativa* L.). *Plant J.* 48:113–124. doi:10.1111/j.1365-313X.2006.02857.x
- Cherney, J.H., S.R. Smith, C.C. Sheaffer, and D.J. Cherney. 2020. Nutritive value and yield of reduced-lignin alfalfa cultivars in monoculture and in binary mixtures with perennial grass. *Agron. J.* 112:352–367. doi:10.1002/agj2.20045
- Getachew, G., E.A. Laca, D.H. Putnam, D. Witte, M. McCaslin, K.P. Ortega, and E.J. DePeters, 2018. The impact of lignin downregulation on alfalfa yield, chemical composition, and in vitro gas production. *J. Sci. Food Agric.* 98:4205–4215. doi:10.1002/jsfa.8942
- Grev, A.M., M.S. Wells, D.A. Samac, K.L. Martinson, and C.C. Sheaffer. 2017. Forage accumulation and nutritive value of reduced lignin and reference alfalfa cultivars. *Agron. J.* 109:2749–2761. doi:10.2134/agronj2017.04.0237
- Guo, D., F. Chen, J. Wheeler, J. Winder, S. Selman, M. Peterson, and R.A. Dixon. 2001. Improvement of in-rumen digestibility of alfalfa forage by genetic manipulation of lignin O-methyltransferases. *Transgenic Res.* 10:457–464. doi:10.1023/A:1012278106147
- Jung, H.G., and R.M. Engels. 2002. Alfalfa stem tissues: Cell wall deposition, composition, and degradability. *Crop Sci.* 42:524–534. doi:10.2135/cropsci2002.5240
- Martin, N.P., M.P. Russelle, J.M. Powell, C.J. Sniffen, S.I. Smith, J.M. Tricarico, and R.J. Grant. 2017. Sustainable forage and grain crop production for the US dairy industry. *J. Dairy Sci.* 100:9479–9494. doi:10.3168/jds.2017-13080

- Moore, K. and H.J. Jung. 2001. Lignin and fiber digestion. *J. Range Manag.* 54:420-430. doi:10.2307/4003113.
- NASS. National Agricultural Statistics Service, USDA. National Statistics for Hay & Haylage: Hay & Haylage, Alfalfa ([https://www.nass.usda.gov/Statistics\\_by\\_Subject/result](https://www.nass.usda.gov/Statistics_by_Subject/result)) Accessed 4/29/2021.
- Oba, M., and M.S. Allen. 1999. Evaluation of the importance of the digestibility of neutral detergent fiber from forage: Effects on dry matter intake and milk yield of dairy cows. *J. Dairy Sci.* 82:589–596. doi:10.3168/jds.S0022-0302(99)75271-9
- Reddy, M.S.S., F. Chen, G. Shadle, L. Jackson, H. Aljoe, and R.A. Dixon. 2005. Targeted down-regulation of cytochrome P450 enzymes for forage quality improvement in alfalfa (*Medicago sativa* L.). *Proc. Natl. Acad. Sci. USA.* 102:16573–16578. doi:10.1073/pnas.0505749102
- Undersander, D., M. McCaslin, C. Sheaffer, D. Whalen, D. Miller, D. Putnam, and S. Orloff. 2009. Low lignin alfalfa: Redefining the yield/quality tradeoff. UC Coop. Ext., Reno, NV. p. 1–4. [https://alfalfa.ucdavis.edu/+symposium/2009/files/talks/09WAS23\\_Undersander\\_LowLignin.pdf](https://alfalfa.ucdavis.edu/+symposium/2009/files/talks/09WAS23_Undersander_LowLignin.pdf). Accessed 5/11/2021.
- Zhou, R., L. Jackson, G. Shadle, J. Nakashima, S. Temple, F. Chen, and R.A. Dixon. 2010. Distinct cinnamoyl CoA reductases involved in parallel routes to lignin in *Medicago truncatula*. *Proc. Natl. Acad. Sci. USA.* 107:17803–17808. doi:10.1073/pnas.1012900107



# **Corn Silage Fiber Digestibility - Why Do Cows Care?**

**Luiz F. Ferraretto, Ph.D., PAS  
Assistant Professor and Ruminant  
Nutrition Extension Specialist  
University of Wisconsin**



## Corn silage fiber digestibility - why do cows care?

Luiz F. Ferraretto, Ph.D., PAS  
Assistant Professor and Ruminant Nutrition Extension Specialist



1

## Speaking "Fiber"

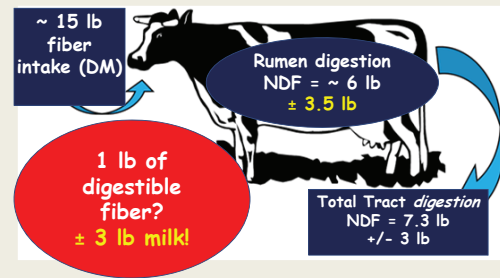

Adapted from slide courtesy of Dr. John Goesser, RRL

2

## Objectives

- Review the importance of fiber digestibility
- Introduce indicators of forage/diet nutritive value
- Highlight the use and application of these indices

3

## US Fiber Quality Summary

Parameter	Indicates Better Quality	n	Normal Range
NDF (% DM)	↓	384,715	36 - 46
Lignin (% DM)	↓	344,134	3 - 4
uNDF <sub>240</sub> (% DM)	↓	81,418	8 - 13
NDFD <sub>30</sub> (% NDF)	↑	170,634	48 - 60
TTNDFD (% NDF)	↑	27,954	36 - 46

Summary of combined multi-year, multi-lab (CVAS, DairyOne, RRL, DL) data, except TTNDFD only from RRL

Adapted from slide courtesy of Dr. Randy Shaver, UW-Madison

4

## What holds cows back?

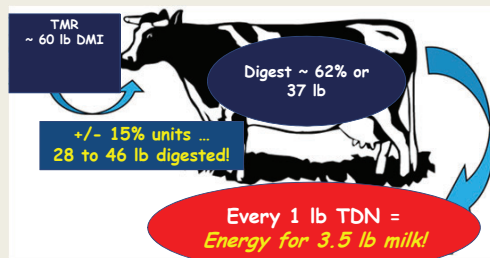

Adapted from slide courtesy of Dr. John Goesser, RRL

5

## Why do we care about these assays?

- Prediction models
- Forage ranking
- To standardize laboratory assays

6

## Fiber Quality Indicators

Indicator	Practical Implication
NDF (% DM)	▪ Intake limitation through rumen fill
Lignin (% DM)	
uNDF <sub>240</sub> (% DM)	▪ Impact milk yield and the establishment of high-forage diets
NDFD <sub>30</sub> (% NDF)	
TTNDFD (% NDF)	

Methods vary across laboratories and may include calculation of pools and rates of digestion.

7

## Effect of eating time on lactation performance

Data expressed as expected response for each min of increased eating time

Item	n	effect	P-value
Milk, lb/d	415	-0.053	0.001
3.5% FCM, lb/d	415	-0.024	0.03
ECM, lb/d	405	-0.035	0.001
Milk protein, %	405	-0.0005	0.04
Milk protein, lb/d	405	-0.0020	0.001

Adapted from Krentz et al., 2018: ADSA Abstract

8

## Forage NDF digestibility and cow performance

For every 1 percentage-unit increase in NDF digestibility

- +0.40 lb/d DMI
- +0.55 lb/d 4%FCM (Oba and Allen, 1999)

>40% corn silage in diet

- +0.26 lb/d DMI
- +0.31 lb/d 3.5%FCM (Jung et al., 2010)

Slide courtesy of Dr. Rick Grant, Miner Institute

9

## uNDF and intake

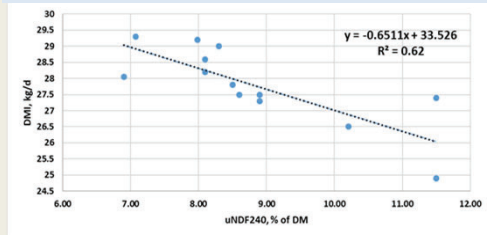

uNDF Intake - 0.25 to 0.45% of BW

Adapted from slide by Dr. Rick Grant, Miner Institute

10

## Fiber digestibility and chewing behavior

Study	Intake	Eating time
Grant et al., 1994	88.3	120.7
Aydin et al., 1999 Exp. 1	85.0	117.9
Aydin et al., 1999 Exp. 2	95.6	105.6
Oliver et al., 2004	95.5	114.9

Data presented as percentage of control treatment

Grant and Ferraretto, 2018: JDS

11

## uNDF and ECM Yield

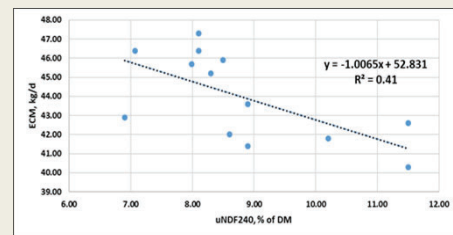

Adapted from slide by Dr. Rick Grant, Miner Institute

12

## Brown mid-rib mutant hybrids

- BMR mutation reduces forage lignin
- Characteristic brown mid-rib color
- Markedly improved digestibility outweighs lower yields



13

## Pools and uNDF of forages

Parameter	BMR	Conventional	Alfalfa hay	Alfalfa silage	Alfalfa silage
aNDFom, % DM	43.8	41.3	38.8	38.1	40.9
uNDFom, % aNDFom	23.7	30.3	51.3	36.2	42.8
Fast pool, % aNDFom	67.8	8.8	35.7	55.2	33.4
Slow pool, % aNDFom	8.5	60.9	13.0	8.7	23.9

Adapted from Zontini and Van Amburgh

14

## Nutrient composition of corn hybrids

Item	BMR	CONS	P-value
DM, % as fed	33.7	33.9	0.27
CP, %DM	8.1	7.8	0.07
NDF, %DM	43.0	42.8	0.34
Lignin, %DM	2.0 <sup>b</sup>	2.9 <sup>a</sup>	0.001
ivNDFD, % NDF <sup>1</sup>	58.1	46.7	0.001
Starch, %DM	28.7 <sup>ab</sup>	29.7 <sup>a</sup>	0.05

<sup>1</sup>Ruminal in vitro NDF digestibility after 30 or 48 h of incubation

Ferraretto and Shaver, 2015

15

## Does uNDF explain intake changes?

Parameter	BMR	LFY
Diet NDF, % DM	29.4	30.1
Diet uNDF, % DM	8.4	8.9
30 h ivNDFD, % of NDF	50.9	44.1
Intake of DM, lb/d	61.9	58.1
Intake of uNDF, lb/d	5.15	5.11
Intake of uNDF, % BW	0.32	0.31
Milk, lb/d	107.9	103.1

Adapted from Lopes et al., 2015 - using diets from Ferraretto et al., 2015

16

## Effect of BMR corn silage on lactation performance

Item	Control	Difference
DMI, lb/d	53	+2
Milk, lb/d	82.2	+3.3
Fat, %	3.63	-0.11
MUN, mg/dL	15	-1
NDFD, % NDF	42.3	+2.5
TTSD, % Starch	92.7	-1.4

Adapted from Ferraretto and Shaver, 2015

17

## Diet ingredient and nutrient composition

Ingredient, % DM	Week 1 to 7		Week 8 to 14	
	BMR	LFY	BMR	LFY
Corn Silage	41.8	41.8	41.8	44.2
Alfalfa Silage	20.6	20.6	20.6	20.6
Wheat Straw	2.4	2.4	2.4	0.0
Concentrate	35.2	35.2	35.2	35.2
Nutrient, % DM				
CP	17.3	16.6	17.6	17.0
NDF	29.4	32.0	29.4	29.1
Lignin	3.5	3.9	3.5	3.5
Starch	23.1	21.4	22.6	22.8

Ferraretto et al., 2015

18

## Lactation performance

Item	BMR	LFY	P-value
DMI, lb/d	61.9	58.1	0.01
Milk, lb/d	107.9	103.1	0.05
ECM, lb/d	111.2	107.9	0.07
Fat, %	3.83	4.05	0.01
Protein, %	3.27	3.27	0.98
MUN, mg/dL	15.6	16.8	0.001

No interactions between treatment and week or period were detected.

Ferraretto et al., 2015

## Interaction with forage concentration?

Item	Control Silage		BMR Silage		P-value		
	Low	High	Low	High	H	F	Int
Eating time, min/d	273	301	250	273	0.01	0.01	0.73
Rumination time, min/d	514	543	463	536	0.08	0.01	0.17
Meal length, min/meal	29.2	31.3	27.5	28.4	0.11	0.28	0.64
Meal bout, bouts/d	11.8	12.1	11.5	11.9	0.45	0.33	0.95

Miller et al., 2021

19

20

## Interaction with forage concentration?

Nutrient, % DM	Control Silage		BMR Silage	
	Low	High	Low	High
CP	17.0	17.0	16.7	16.7
aNDFom	30.8	33.7	30.7	33.5
ADL	3.1	3.6	2.7	2.9
Starch	28.0	21.2	27.8	23.8
24 h ivNDFD, % NDF	56.3	54.0	62.0	60.0
uNDFom	8.2	9.6	6.9	7.6

Miller et al., 2021

21

## Predicting the benefits of CH

- Several studies have evaluated the influence of cutting height corn silage yield and quality
- However, an evaluation across multiple studies has yet to be conducted
- Our objective was to assess the influence of cutting height on nutrient composition and yield of whole-plant corn silage through a meta-analysis

22

## Interaction with forage concentration?

Item	Control Silage		BMR Silage		P-value		
	Low	High	Low	High	H	F	Int
DMI, lb/d	63.9	58.4	64.5	64.3	0.01	0.01	0.02
uNDFom, lb/d	19.4	19.8	19.2	20.9	0.07	0.01	0.02
uNDFom, %BW	0.35	0.38	0.29	0.32	0.01	0.01	0.97
Milk, lb/d	103.5	94.9	107.0	104.0	0.01	0.01	0.15
ECM, lb/d	109.0	101.1	111.9	110.4	0.02	0.05	0.16
Milk fat, %	3.82	4.02	3.76	3.94	0.27	0.01	0.84
Milk protein, %	3.06	2.92	3.10	3.02	0.01	0.01	0.05

Miller et al., 2021

23

## Cutting Height Equations

Data expressed as expected response for each 10-inches of increased chop height

Item	n	Effect	P-value
DM, % of as fed	62	2.18	0.02
Starch, % of DM	55	2.08	0.01
NDF, % of DM	64	-2.48	0.001
Lignin, % of DM	25	-0.29	0.08
NDFD <sup>1</sup> , % of NDF	49	2.02	0.01
DM yield, ton/acre	52	-0.52	0.001

<sup>1</sup>NDFD = ruminal in vitro or in situ NDF digestibility at 30 or 48 h

Adapted from Paula et al., 2019; ADSA Abstract

24

## Simulation

	CS	High-cut CS	High-cut simulation
Cutting height, inches	10	25	25
NDF, % of DM	38.9	34.6	35.1
Starch, % of DM	39.0	44.1	42.1
NDFD, % of NDF	65.2	69.0	68.2

Data adapted from Diepersloot et al., unpublished  
Simulation performed with equations by Paula et al., 2019

25

## peuNDF and intake

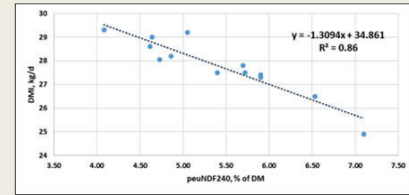

Adapted from slide by Dr. Rick Grant, Miner Institute

26

## Particle Size

The PSPS procedure is conducted manually using 3 sieves (19-mm, 8-mm, and 1.18-mm) and a pan (Kononoff et al. (2003))



27

## peuNDF and ECM Yield

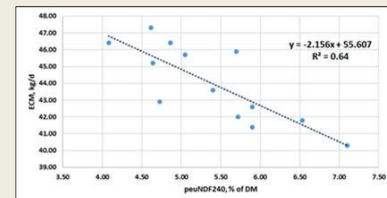

Adapted from slide by Dr. Rick Grant, Miner Institute

28

## Particle Size

Sieve	Why does it matter?
19 mm	Sortable particles, may affect silage density and eating time
8 mm	Physically effective fiber
1.18 or 4 mm	May provide physical effective fiber / intact kernels
Pan	Broken kernels / small fiber fraction

If using specific theoretical length of cut - why do we need to measure particle size?

29

## Conclusions

- Many factors alter fiber digestibility of whole-plant corn silage
- Initial data evaluating uNDF is promising, but interactions with other factors (i.e. forage NDF, starch, particle size) may play a major role
- Fiber digestibility modulate feeding behavior patterns

30



## Questions



[ferraretto@wisc.edu](mailto:ferraretto@wisc.edu)



[Linkedin.com/in/luiz-ferraretto-7a726731](https://www.linkedin.com/in/luiz-ferraretto-7a726731)



[ferraretto\\_ruminant\\_nutrition](https://www.instagram.com/ferraretto_ruminant_nutrition)





# **Dairy Heifer Coccidiosis Research With Novel Egg**

**Dr. Matt Akins  
University of Wisconsin**



 ANIMAL & DAIRY SCIENCES  
University of Wisconsin-Madison

## Dairy Heifer Coccidiosis Research With Novel Egg Antibodies

Matt Akins, Abbey Niebuhr, Cherrie Nolden,  
Dan Schaefer, Mark Cook  
UW-Madison Animal and Dairy Science

This project was supported by the USDA National Institute  
of Food and Agriculture, Hatch project 1013011.

 Extension  
UNIVERSITY OF WISCONSIN-MADISON

1

 ANIMAL & DAIRY SCIENCES  
University of Wisconsin-Madison

## Overview

- Coccidiosis lifecycle
- Development of egg-based antibodies at UW
- Recent UW research with dairy heifers

2

 ANIMAL & DAIRY SCIENCES  
University of Wisconsin-Madison

## What is Coccidiosis?

Disease caused by the protozoa of the genus *Eimeria* (coccidia) that invade the animal's intestinal lining

- Certain species pathogenic to cattle
  - *E. bovis* and *E. zurnii*
- Common from 1 month to 1 year old
  - Especially during stress events
  - Develop immunity with exposure
- Recent US NAHMS study in weaned beef calves reported over a 60% prevalence from 99 operations (Stromberg et al., 2015)

3

 ANIMAL & DAIRY SCIENCES  
University of Wisconsin-Madison

## Bovine Eimeria species

Common species and incubation times:  
*Eimeria zurnii*: 15-20 days  
*Eimeria bovis*: 15-20 days  
*Eimeria auburnensis*: 18-20 days

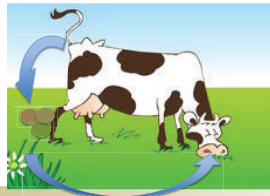
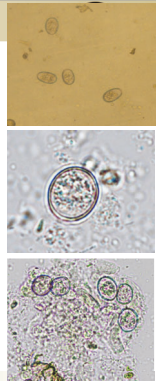
4

 ANIMAL & DAIRY SCIENCES  
University of Wisconsin-Madison

## Coccidia life cycle

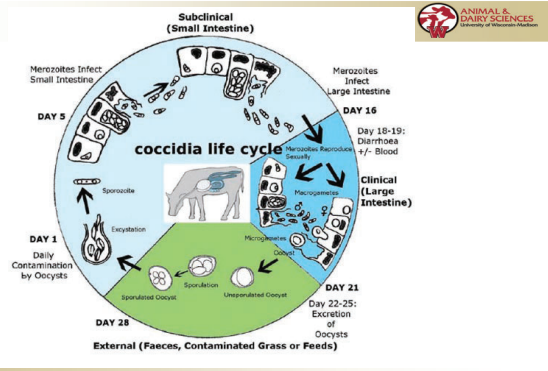

<https://www.corid.com/Coccidia.html>

5

 ANIMAL & DAIRY SCIENCES  
University of Wisconsin-Madison

## Coccidiosis Symptoms

- Variable signs depending on ingested oocyst load
- Small % typically clinical; high portion sub-clinical
  - Decreased feed intake and growth

Clinical signs

- Condition loss; anorexia
- Severe, watery diarrhea
- Straining to defecate
- Damage to intestinal cells can cause bloody feces
- Death (due to electrolyte loss/dehydration)



<https://www.vetent.co.nz/dairy-disease-management/coccidiosis.html>

6

 ANIMAL & DAIRY SCIENCES  
University of Wisconsin-Madison

## Coccidiostats

- Monensin/Lasalocid - ionophores
  - act by increasing transfer of ions into cell
  - cell use energy to transport ions out of cell
  - Also acts on rumen bacteria to improve efficiency
- Decoquinate
  - Disrupts energetic functions in the cell

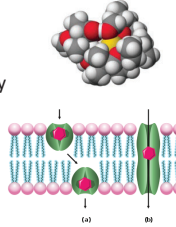

en.wikipedia.org/wiki/ionophore

7

 ANIMAL & DAIRY SCIENCES  
University of Wisconsin-Madison

## UW Research – Egg-based antibodies

-Mark Cook's lab found that *Eimeria* infected chickens had elevated levels of interleukin-10 in the intestines

### Day 4 Post Coccidia Infection

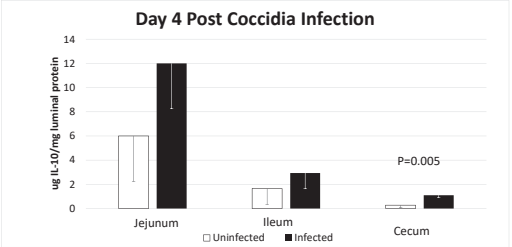

Location	Uninfected (ug IL-10/mg luminal protein)	Infected (ug IL-10/mg luminal protein)
Jejunum	~6	~12
Ileum	~1.5	~3
Cecum	~0.5	~1

Cook et al., 2016

8

 ANIMAL & DAIRY SCIENCES  
University of Wisconsin-Madison

## Interleukin 10

- Anti-inflammatory cytokine
  - Immune system communication molecule
- Inhibits activity of immune cells that attack pathogens
- IL-10 is secreted from regulatory T cells after infection cleared
- IL-10 suppresses other inflammatory cytokines

Couper et al., 2008

9

 ANIMAL & DAIRY SCIENCES  
University of Wisconsin-Madison

## Mucosal Microenvironment

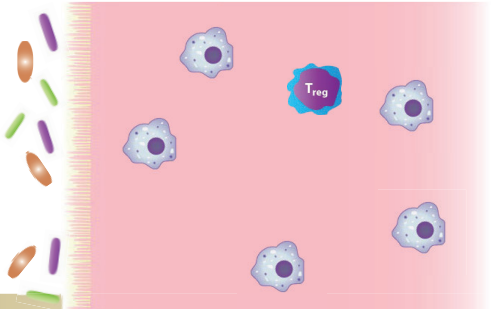

10

 ANIMAL & DAIRY SCIENCES  
University of Wisconsin-Madison

## Conventional

### Pathogen Invasion - Conventional Defense

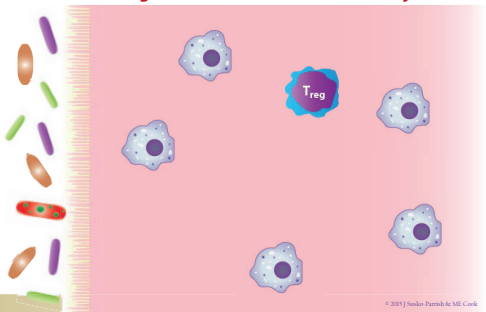

© 2013 Sanku Parash & ME Cook

11

 ANIMAL & DAIRY SCIENCES  
University of Wisconsin-Madison

## Deception

### Pathogen turns Down Signaling

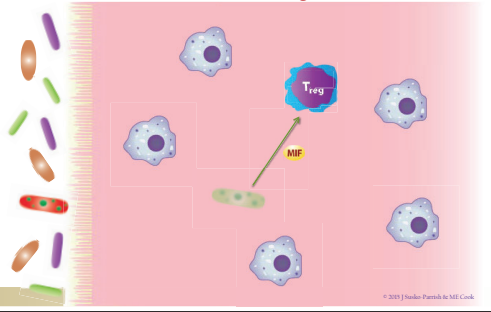

© 2013 Sanku Parash & ME Cook

12

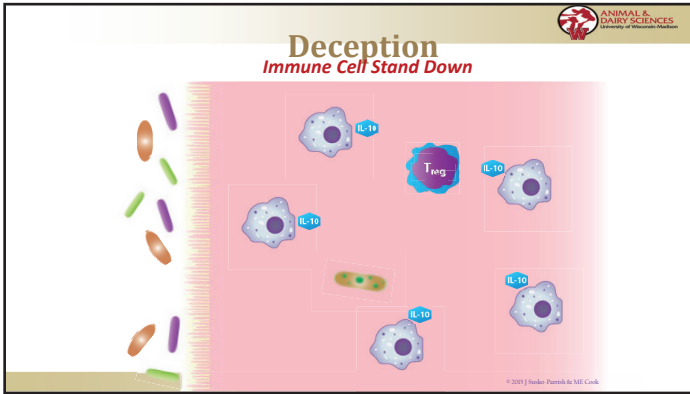

13

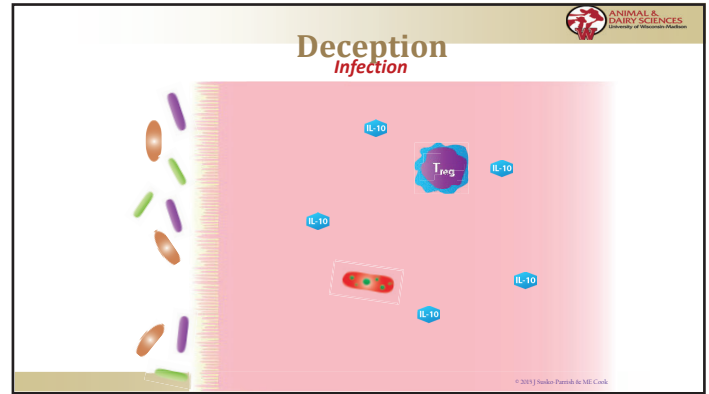

14

**Anti IL-10 Current thinking**

- **By binding IL-10:**
  - Pathogens are no longer able to suppress an adaptive immune response
  - Adaptive immunity is initiated at onset of infection and pathogen is cleared by normal immune processes
  - Animal is able to generate long term immunity to a certain pathogen

Cook et al., 2016

15

**Where/How is Anti IL-10 made?**

- Made by immunized laying hens
- aIL-10 is found in the egg yolks
  - Not found in egg albumen
  - Can be pasteurized
- Developed by Dr. Mark Cook

16

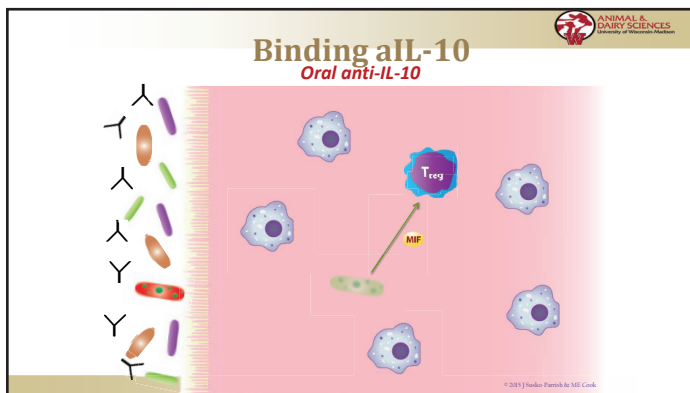

17

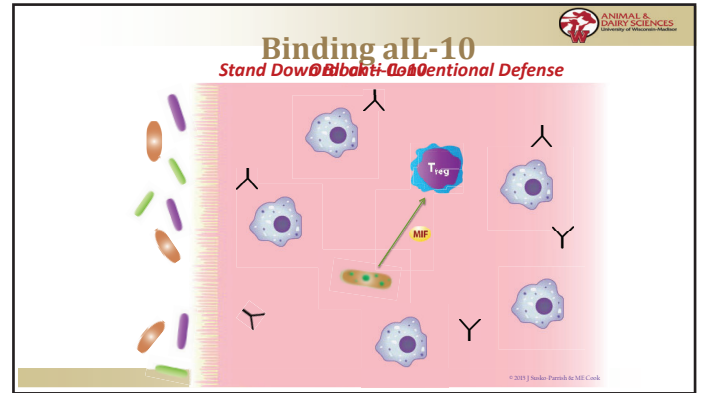

18

**IL-10 antibody in *Eimeria*-infected broilers**

**Table 1.** Experiment 1. Effects of anti-IL-10 on performance of chicks challenged with *Eimeria* spp.

Diet	Weight (Grams)		Feed Conversion <sup>a</sup>		Oocyst/Gram Excreta	
	Control	<i>Eimeria</i>	Control	<i>Eimeria</i>	Control	<i>Eimeria</i>
Control	670 <sup>a</sup>	611 <sup>b</sup>	1.82	1.75	4,890	119,700
Anti-IL-10	633 <sup>a,b</sup>	659 <sup>a,b</sup>	1.65	1.6	6,030	31,860
SEM	27.6		0.157		12,210	

**P Values**

Antibody	0.78	0.19	0.06
<i>Eimeria</i>	0.42	0.61	0.008
Antibody × <i>Eimeria</i>	0.0341	0.94	0.0745

<sup>a</sup>Feed conversion was calculated by divided the feed consumption by the total cage weight n = 10.  
<sup>a,b</sup>Means with different superscript in the same column were significantly different ( $P < 0.05$ ).

Sand et al., 2016

19

**Previous Research – Beef Cattle**

**Feeding aIL-10 to newly arrived feedlot steers and effects on growth performance and antibiotic usage**

	Control	aIL-10	SEM	P-value
No. of pens (steers)	9 (56)	9 (57)	-	-
Initial wt, lb	653	653	16.6	0.77
Final wt, lb	860	873	19.1	0.14
ADG, lb	3.26	3.48	0.11	0.13
DMI, lb	17.8	18.0	0.44	0.84
G:F	0.182 <sup>b</sup>	0.193 <sup>a</sup>	0.003	0.04
BRD treatment, %				
1X	16	16	5.4	0.97
2X	7	0	2.6	0.09

Schaefer et al., 2016

20

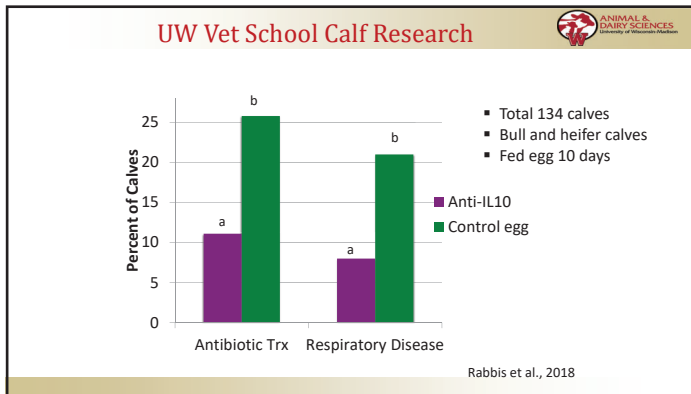

21

- UW Dairy Heifer Research**
- Evaluate the use of aIL-10 in newly relocated dairy heifers and its effect on:
    - disease incidence
    - growth
    - feed conversion
- Hypothesis:**  
 Feeding aIL-10 will allow heifers to more quickly develop immunity to *Eimeria*

22

- 2018 Dairy Heifer Research**
- 20 pens of heifers with 8 animals per pen
- 4 Treatments:**
- Ionophore (sodium monensin; 150 mg/hd/d)
  - Anti IL-10 (egg yolk with IL-10 antibodies)
    - Fed for 14 days after arrival
  - Egg Control (egg yolk without IL10 antibodies)
  - Negative control
- Heifers transported from Arlington to Marshfield at 3 Months of age
  - Tracked intakes, growth, and sampled blood and feces
    - Fecal floats to measure coccidia
    - Blood immunoglobulins

23



24

 ANIMAL & DAIRY SCIENCES  
University of Wisconsin-Madison

## Dairy Heifer Coccidiosis Research With Novel Egg Antibodies

Matt Akins, Abbey Niebuhr, Cherrie Nolden,  
Dan Schaefer, Mark Cook  
UW-Madison Animal and Dairy Science

This project was supported by the USDA National Institute  
of Food and Agriculture, Hatch project 1013011.

 Extension  
UNIVERSITY OF WISCONSIN-MADISON

25

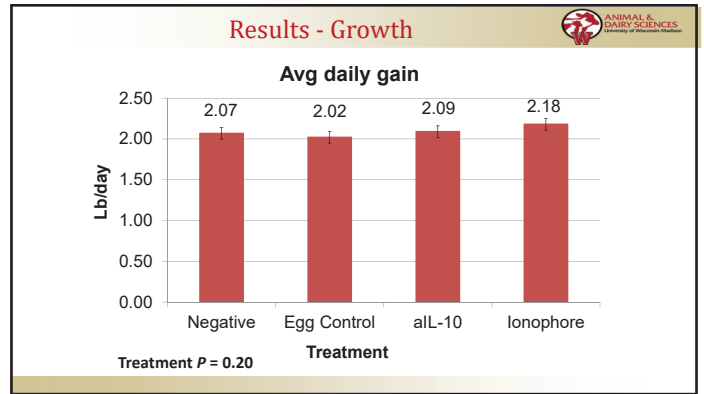

26

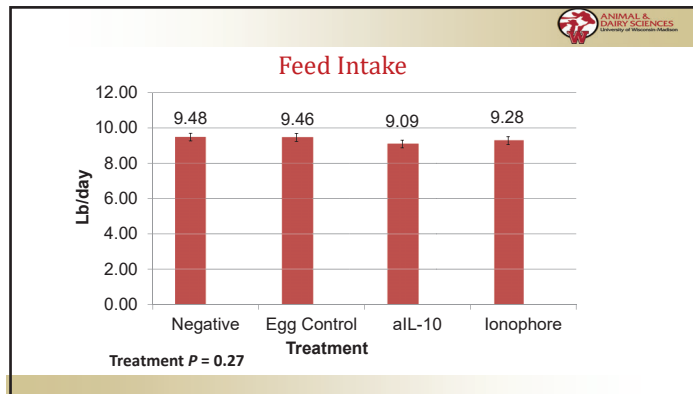

27

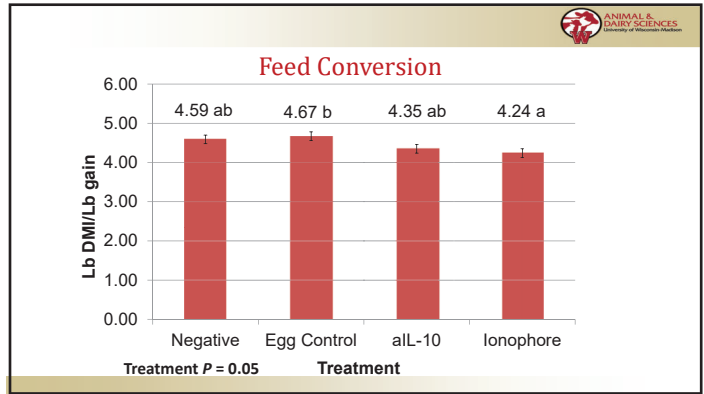

28

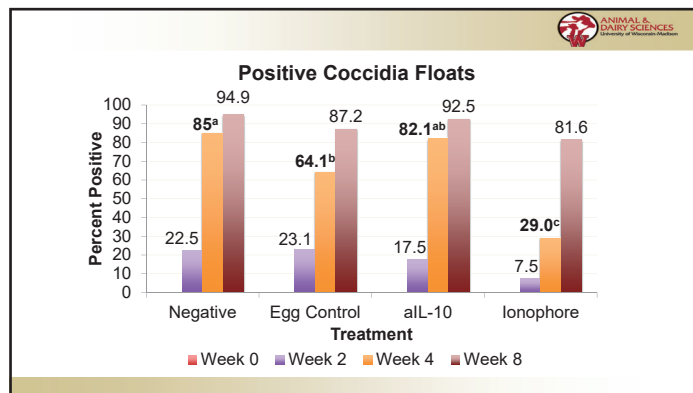

29

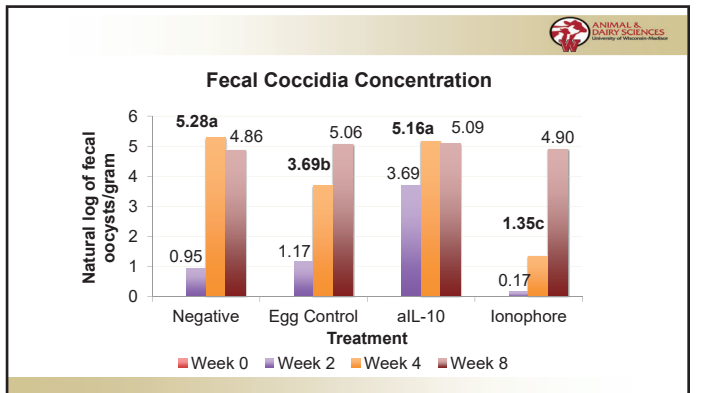

30

 ANIMAL & DAIRY SCIENCES  
University of Wisconsin-Madison

## Dairy Heifer Coccidiosis Research With Novel Egg Antibodies

Matt Akins, Abbey Niebuhr, Cherrie Nolden,  
Dan Schaefer, Mark Cook  
UW-Madison Animal and Dairy Science

This project was supported by the USDA National Institute  
of Food and Agriculture, Hatch project 1013011.

 Extension  
UNIVERSITY OF WISCONSIN-MADISON

31

 ANIMAL & DAIRY SCIENCES  
University of Wisconsin-Madison

## 2019 Dairy Heifer Research

20 pens of heifers with 8 animals per pen

4 Treatments:

- Ionophore (sodium monensin; 150 mg/hd/d)
- Anti IL-10 (egg yolk with IL-10 antibodies)
  - **Fed for 14 days from week 2 to week 4 after arrival**
- Egg Control (egg yolk without IL10 antibodies)
- Negative control

- Heifers transported from Arlington to Marshfield at 3 months of age
- Tracked intakes, growth, and sampled blood and feces
  - Fecal floats to measure coccidia
  - Blood immunoglobulins

32

 ANIMAL & DAIRY SCIENCES  
University of Wisconsin-Madison

## 2019 Results

- No difference in daily gain across treatments but ionophore numerically higher growth
- Feed efficiency tended to be improved for ionophore
- Similar trends in fecal oocysts prevalence/concentrations as previous study
- Lower clinical digestive treatments for ionophore
- Higher respiratory treatments for Egg Control

33

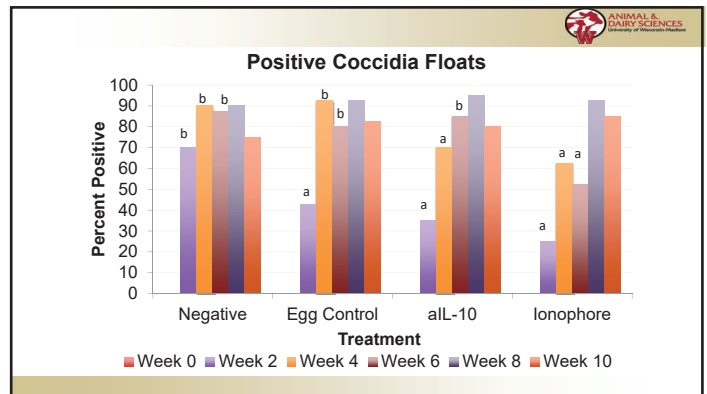

34

 ANIMAL & DAIRY SCIENCES  
University of Wisconsin-Madison

## Summary

- Cleanliness and management critical to control
- Coccidiostats delayed oocyst shedding and reduced treatments
  - Similar oocyst shedding by end of trial
- Anti IL-10 has not shown improved growth or efficiency compared to Control or Ionophore
  - Impact of feeding rate or rumen degradation?

35

 ANIMAL & DAIRY SCIENCES  
University of Wisconsin-Madison

## Thank You! Questions?

www.fyi.uwex.edu/heifermgmt  
msakins@wisc.edu  
715-384-9459



36





# **Opportunities to Combine Genetics with New Technologies to Improve Feed Efficiency in Dairy Cattle**

**Dr. James Koltes  
Iowa State University**



Animal Breeding & Genetics IOWA STATE UNIVERSITY Animal Breeding & Genetics

## Opportunities to combine genetics with new technologies to improve feed efficiency in dairy cattle



**Dr. James E Koltes**  
Assistant Professor  
Dairy Genetics  
jekoltes@iastate.edu



IOWA STATE UNIVERSITY Department of Animal Science Enriching lives through animals Animal Breeding & Genetics

1

## The dairy industry continues to improve sustainability



LIVESTOCK NEWS  
U.S. dairy industry pushes toward carbon neutrality by 2050  
By AGDaily Reporter - Published: October 12, 2020

Share Tweet Pin

Image by USDA, Shutterstock

IOWA STATE UNIVERSITY Department of Animal Science Enriching lives through animals Animal Breeding & Genetics

2



## Feed Intake is a major part of sustainability

- Feed accounts for upwards of 40% - 50% of production costs (USDA - ERS, 2017).
- Improving feed efficiency is an opportunity to continue to reduce the environmental footprint of dairy cattle.
- Equipment to measure individual feed intake is expensive and requires additional labor.
  - Precision livestock technologies may provide lower cost opportunities as feed intake proxies
- A 1% genetic gain in feed efficiency = ~\$4.5 million/year to the U.S. dairy industry (VanRaden, 2017.)

IOWA STATE UNIVERSITY Department of Animal Science Enriching lives through animals Animal Breeding & Genetics

3

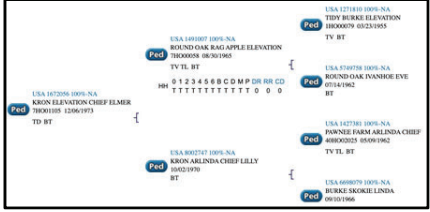
## Genetic tools to enhance feed efficiency

IOWA STATE UNIVERSITY Department of Animal Science Enriching lives through animals Animal Breeding & Genetics

4

## A national effort to boost feed efficiency in Holstein Dairy cattle (2019-2024)

*Improving dairy feed efficiency, sustainability and profitability by impacting farmer's breeding & culling decisions.*

**Feed Efficiency Team:** Mike Vandehaar, Rob Tempelman, Kent Weigel, Heather White, Jose Santos, Francisco Penigaricano, James Koltes, Randy Baldwin, Paul Van Raden, Kristen Gaddis



IOWA STATE UNIVERSITY Department of Animal Science Enriching lives through animals Animal Breeding & Genetics

5

## Objectives of the FFAR Dairy Feed Efficiency Project

**Project Aims:**

- 1) Increase reliability of genomic predictions for feed efficiency → Collect feed intake on 3600 cows
- 2) Implement a plan to update the feed intake reference population → with CDCB
- 3) Develop sensor-based analytics to predict dry matter intake → ID indicators of feed intake
- 4) Study associations between feed efficiency and methane emissions



IOWA STATE UNIVERSITY Department of Animal Science Enriching lives through animals Animal Breeding & Genetics

6

## Development of feed efficiency genetic selection tool: PTA Feed Saved

- **Feed Saved** predicted transmitting ability (PTA) represents the expected pounds of feed saved per lactation by accounting for differences in individual body weight and dry mater intake.
- Larger, positive values are more favorable.
- Feed Saved  $h^2 = 0.14$
- Feed Saved is calculated to be unrelated (correlation  $\sim 0$ ) with other traits.
  - Adjusted for : milk energy traits and body weight (factors impacting maintenance)
  - Combines information about residual feed intake and maintenance energy estimates

IOWA STATE UNIVERSITY

Department of Animal Science  
Enriching lives through animals



7

## What Does Feed Saved (FSAV) look like in practice?

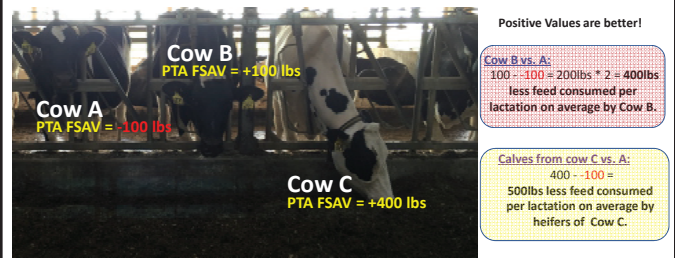

IOWA STATE UNIVERSITY

Department of Animal Science  
Enriching lives through animals



8

## What are the typical differences we will expect in PTA Feed Saved (FSAV) for bulls?

68% bulls: +109 and -109 lbs PTA FSAV:  
up to 218lbs feed/ lactation daughter differences expected for these bulls

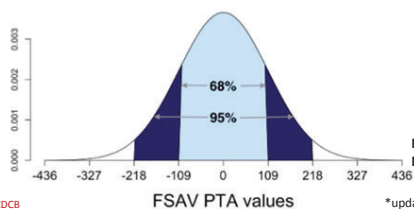

218 lbs. feed/ lactation X  
3 lactations=  
654 lbs. feed less/ lifetime

Maximum PTA FSAV: 633 lbs.\*  
Minimum PTA FSAV: -822 lbs.

Data courtesy CDCB

\*update: 2021: 1700 lbs PTA difference!

IOWA STATE UNIVERSITY

Department of Animal Science  
Enriching lives through animals



9

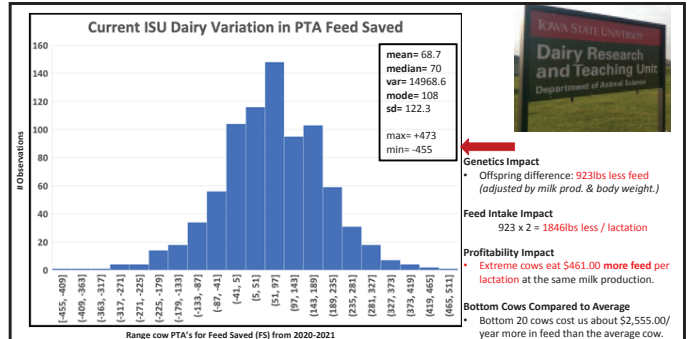

IOWA STATE UNIVERSITY

Department of Animal Science  
Enriching lives through animals



10

## How is Feed Saved related to other important traits?

Trait	Genetic Correlation
Milk yield	0.002
Protein yield	0.02
Fat yield	-0.02
SCS	-0.02
Productive Life	0.04
Livability	0.15
Daughter Pregnancy Rate	0.10
Health Traits	0.10

Uncorrelated (Independent)  
from production traits

Data courtesy CDCB- bulls born since 2000 with NMS > 90%

IOWA STATE UNIVERSITY

Department of Animal Science  
Enriching lives through animals



11

## Data Collection for the Feed Saved PTA

- Collecting Feed Intake is expensive!
- Each cow: 28-42days of feed intake data
- >5200 cows have contributed data (May 2021)



**Funder 1**  
**USDA**  
 2010-2015  
 \$5,000,000  
 4753 cows

**Funder 2**  
**FFAR**  
 2019-2024  
 \$2,000,000  
**CDCB**  
 3600 cows

IOWA STATE UNIVERSITY

Department of Animal Science  
Enriching lives through animals



12

## Expected Economic Impact of Feed Saved (FSAV)

- \$8 million / year estimated savings based on FSAV variation, reliability, feed costs.
- FSAV could be 3<sup>rd</sup> most important trait in \$NM index in August 2021
- Because REL is lower for PTA FSAV, \$NM REL will be lower when FSAV is included.
  - FSAV will increase profitability over current \$NM index version.

IOWA STATE UNIVERSITY

Department of Animal Science  
Enriching lives through animals



13

## Precision technologies as proxies for feed intake



IOWA STATE UNIVERSITY

Department of Animal Science  
Enriching lives through animals



14

## Goals for Precision Technologies in Predicting Feed Efficiency

Collect genotypes

**Goal: Increase the accuracy of predicting feed intake\* by adding sensor data to feed intake, body weight, production traits and genomic data**

\*PTA Feed Saved = new feed efficiency trait used for breeding



IOWA STATE UNIVERSITY

Department of Animal Science  
Enriching lives through animals



15

## Possible Sensor & Milk Proxies for Feed Intake

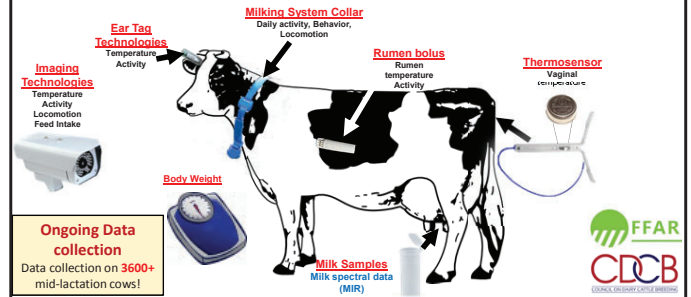

IOWA STATE UNIVERSITY

Department of Animal Science  
Enriching lives through animals



16

## How do we know if a sensor was a good indicator of feed intake?

### Consistent association with Feed Intake

Assuming Milk Production traits are held constant\*

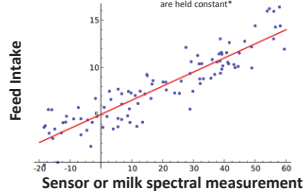

### Favorable relationship with other traits of interest under selection



Reduced incidence of Health problems  
Increased sensor measure (increased feed efficiency)

\*Assumes specific milk components do not require a lot more feed

IOWA STATE UNIVERSITY

Department of Animal Science  
Enriching lives through animals



17

## Experiment 1: Are sensor measures associated with feed intake in lactating Holstein cows?



IOWA STATE UNIVERSITY

Department of Animal Science  
Enriching lives through animals



18

## Are sensor measures associated with adjusted dry matter intake?

### Sensor Measures associated with feed intake ( $p < 0.05$ )

- Ear tag activity<sup>1</sup>
- Rumen Bolus activity<sup>2</sup>
- Rumen temperature<sup>3</sup>

### Sensors that may be associated with feed intake ( $0.05 < p < 0.10$ )

Rumen pH



<sup>1</sup> = 107 cows  
<sup>2</sup> = 57 cows  
<sup>3</sup> = 41 cows

IOWA STATE UNIVERSITY

Department of Animal Science  
Enriching lives through animals



19

## Does temperature (THI) impact sensor relationships with feed intake?

### Sensor Measures impacted by THI ( $p < 0.05$ )

- Ear tag activity
- Ear tag temperature
- Rumen Bolus activity
- Rumen temperature
- Rumen pH

### Sensors who's relationship with feed intake may change with heat stress ( $p < 0.05$ )

- Ear tag activity
- Ear tag temperature

THI calculated as described: Johnson, 1965

IOWA STATE UNIVERSITY

Department of Animal Science  
Enriching lives through animals



20

## Does health status affect sensor associations?

### Questions considered:

- How do health events\* impact the ability of a sensor to detect differences in feed intake?
- What's the impact of health events on feed intake/ efficiency?

### Possible Health event categories:

Lameness  
Mastitis  
Multiple  
Other (injury)

\*35 cows with health events

IOWA STATE UNIVERSITY

Department of Animal Science  
Enriching lives through animals



21

## How do health events impact sensor associations with feed intake?

### Sensor Measures impacted by health ( $p < 0.05$ )

- All activity and temperature measures
- Rumen pH
- Rumination

### Sensors who's relationship with feed intake change with different health events ( $p < 0.05$ )

- All sensor measurements

**Health events evaluated:** Lameness, Mastitis, Other (injury), Multiple events

- Health event evaluated during the clinical illness event only

Lameness (N = 11 animals; 154 days)  
Mastitis (N = 17 animals; 291 days)

IOWA STATE UNIVERSITY

Department of Animal Science  
Enriching lives through animals



22

## Estimated impact of health events on daily feed efficiency

1kg = 2.2 lbs

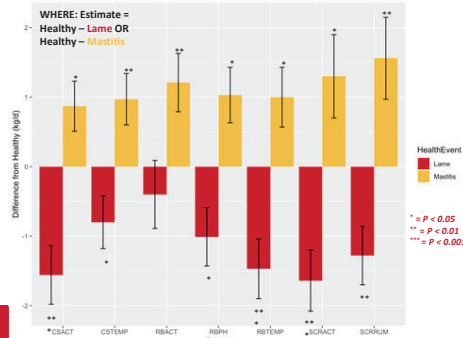

IOWA STATE UNIVERSITY

Department of Animal Science  
Enriching lives through animals



23

## Health events appear to decrease Gross Feed Efficiency

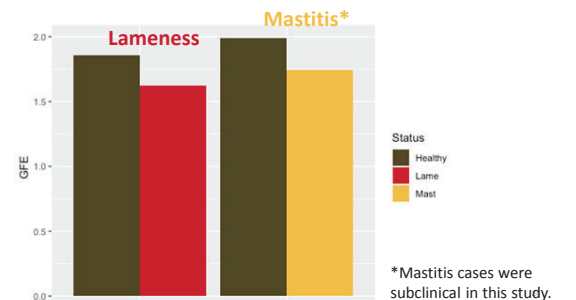

IOWA STATE UNIVERSITY

Department of Animal Science  
Enriching lives through animals



24

## Is Milk Collar Activity Associated With Dry Mater Intake ?

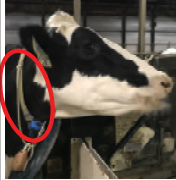

$$Y_{ijk} = \mu + \text{Activity}_k + \text{CG}_i + \text{Parity}_j + \text{Cow}_k + \epsilon_{ijk}$$

Variable	Estimate (kg DMI)	P-value
Log Activity	0.362	<0.05

- Increase in daily activity → increase in intake

N = 676 cows

Boumatic/ Nedap activity monitors

25

## Next Question: If you can relate sensors to feed intake, can we predict feed intake?



Sensor	Base Model $r^2$ (MSE)	Sensors Added $r^2$ (MSE)
Ear tag	0.4477 (12.50)	0.4576 (12.32)
Rumen bolus	0.4298 (13.25)	0.4635 (12.53)

**Change in Prediction Accuracy**  
**+1% boost from ear tags\***  
**+4% boost from rumen bolus**

\*Currently being replicated with larger datasets

26

## Milk Spectral Data also appears promising

J. Dairy Sci. 101:5878–5889  
<https://doi.org/10.3168/jds.2017-13997>  
 © American Dairy Science Association<sup>®</sup>, 2018.

Mining data from milk infrared spectroscopy to improve feed intake predictions in lactating dairy cows

J. R. R. Dórea,\* G. J. M. Rosa,† K. A. Weld,\* and L. E. Armentano<sup>1</sup>  
 \*Department of Dairy Science, and  
 †Department of Animal Sciences, University of Wisconsin, Madison 53706

J. Dairy Sci. 101:6232–6243  
<https://doi.org/10.3168/jds.2017-13874>  
 © American Dairy Science Association<sup>®</sup>, 2018.

Milk mid-infrared spectral data as a tool to predict feed intake in lactating Norwegian Red dairy cows

S. E. Wallén,\* E. Prestøkken,\* T. H. E. Meuwissen,\* S. McParland,† and D. P. Berry†  
 \*Norwegian University of Life Sciences, Department of Animal and Aquacultural Sciences, Ås, 1432, Norway  
 †Animal and Grassland Research and Innovation Centre, Teagasc, Moorepark, Co. Cork, P61C996, Ireland

IOWA STATE UNIVERSITY

Department of Animal Science  
 Enriching lives through animals



27

## Take home points

- *PTA feed saved* is a new genetic tool to select more feed efficient cattle
- Multiple sensors are being investigated as potential predictors of feed intake in Holstein dairy cows
- Sensor measurements have been associated with feed intake and health
- Heat stress and illness (mastitis and lameness) impact how sensor measures relate to feed intake
- Mild mastitis and lameness are costing 2 to 6 lbs. lost feed efficiency/cow/day.
- FFAR/CDCB Project Plan: test if sensor measurements & milk spectral data are useful to improve the accuracy of feed intake prediction tools
- **Sensor data appears promising for predicting feed intake**

IOWA STATE UNIVERSITY

Department of Animal Science  
 Enriching lives through animals



28



## Acknowledgements

Improving dairy feed efficiency, sustainability and profitability by impacting farmer's breeding & culling decisions.



The Dairy Feed Efficiency Team

Questions

IOWA STATE UNIVERSITY

Department of Animal Science  
 Enriching lives through animals



29



# Using Summer to Winter Ratios to Evaluate Summer Slump

**Dr. Derek Nolan**  
**University of Illinois**



## Using Summer : Winter Ratios to Evaluate Summer Slump



### Dairy Extension

**I** ILLINOIS ACES

Derek T. Nolan, Ph.D  
4-State Dairy Nutrition and Management Conference  
June 9 and 10, 2021

## Battling Heat Stress

- Temperature humidity index above 68
- Risks of increased disease incidence and lower milk production
- Somatic cell count, body condition scoring, lameness scoring
- Summer to winter ratio to measure effectiveness of heat abatement strategies

1

2

### What is a summer to winter ratio?

- Extension Service of the Ministry of Agriculture and Israel Cattle Breeders Association
- Metric used to quantify seasonal effects on cow performance



### What is a summer to winter ratio?

- Summer production value divided by winter production value
- A ratio under 1 = reduced performance in summer
- SCC or SCS – higher ratios = higher SCC in summer
- $\frac{\text{summer performance variable}}{\text{winter performance variable}} = \frac{25}{25} = 1.00$

3

4

### Ratio Examples

- $\frac{\text{summer milk production}}{\text{winter milk production}} = \frac{23 \text{ kg (51 lb)}}{28 \text{ kg (62 lb)}} = 0.82$
- $\frac{\text{summer SCS}}{\text{winter SCS}} = \frac{3.5}{3.0} = 1.17$



J. Dairy Sci. 102:11777–11785  
<https://doi.org/10.3168/jds.2018-16170>  
© American Dairy Science Association<sup>®</sup>, 2019.

#### Comparing dairy farm milk yield and components, somatic cell score, and reproductive performance among United States regions using summer to winter ratios

Jenna M. Guinn,<sup>1</sup> D. T. Nolan,<sup>1</sup> P. D. Krawczel,<sup>2</sup> C. S. Petersson-Wolfe,<sup>3</sup> G. M. Pighetti,<sup>2</sup> A. E. Stone,<sup>1,4</sup> S. H. Ward,<sup>4,5</sup> J. M. Bewley,<sup>6</sup> and Joao H. C. Costa<sup>1\*</sup>

<sup>1</sup>Department of Animal and Food Sciences, University of Kentucky, Lexington 40506  
<sup>2</sup>Department of Animal Science, University of Tennessee, Knoxville 37996  
<sup>3</sup>Department of Dairy Science, Virginia Polytechnic Institute and State University, Blacksburg 24061  
<sup>4</sup>Department of Animal and Dairy Science, Mississippi State University, Starkville 39769  
<sup>5</sup>Department of Animal Science, North Carolina State University, Raleigh 27607  
<sup>6</sup>Altech, Nicholasville, KY 40356

5

6



- Collected from 2007 to 2016
- Summer = June 21 to September 21
- Winter = December 21 to March 19

- Energy corrected milk (ECM)
- Fat percent
- Protein percent
- Somatic cell score
- Conception rate
- Pregnancy rate
- Heat detection rate

7

ILLINOIS

8

ILLINOIS

## US Regions



## Summer and winter THI by region

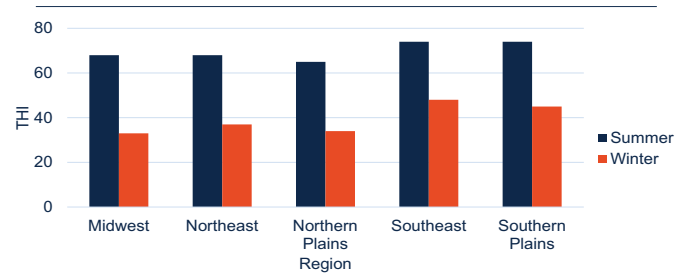

9

ILLINOIS

10

ILLINOIS

## Milk Production Variables

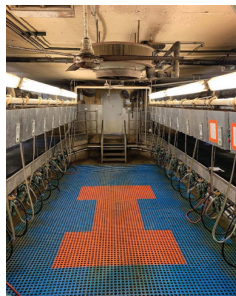

## Regional Benchmarks – ECM

Percentile	Midwest	Northeast	Northern Plains	Southeast	Southern Plains	Total
75 <sup>th</sup>	0.99	0.99	0.97	0.94	0.93	0.99
50 <sup>th</sup>	0.94	0.94	0.93	0.89	0.88	0.94
25 <sup>th</sup>	0.89	0.89	0.88	0.84	0.82	0.89

11

ILLINOIS

12

ILLINOIS

### 4-State Energy Corrected Milk Ratios

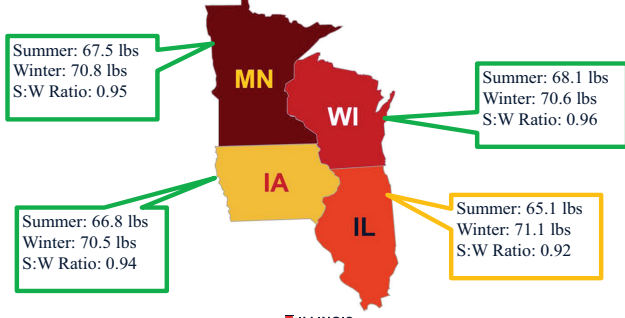

### Regional Benchmarks – SCS

Percentile	Midwest	Northeast	Northern Plains	Southeast	Southern Plains	Total
75 <sup>th</sup>	1.14	1.17	1.09	1.15	1.18	1.15
50 <sup>th</sup>	1.04	1.06	1.00	1.05	1.07	1.05
25 <sup>th</sup>	0.95	0.96	0.91	0.97	0.97	0.95

13

14

### 4-State Somatic Cell Score Ratios

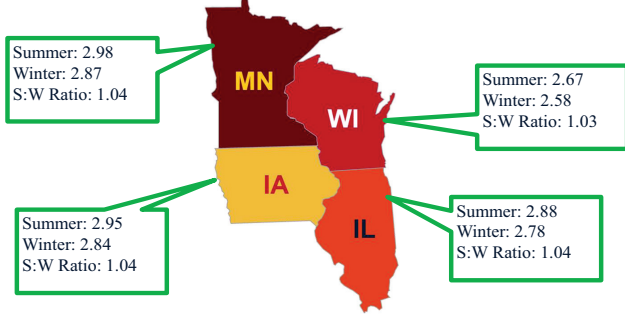

### Regional Benchmarks – Fat %

Percentile	Midwest	Northeast	Northern Plains	Southeast	Southern Plains	Total
75 <sup>th</sup>	0.98	0.97	0.97	0.99	0.99	0.98
50 <sup>th</sup>	0.95	0.95	0.93	0.95	0.95	0.94
25 <sup>th</sup>	0.91	0.91	0.90	0.91	0.91	0.90

15

16

### 4-State Fat Percent Ratios

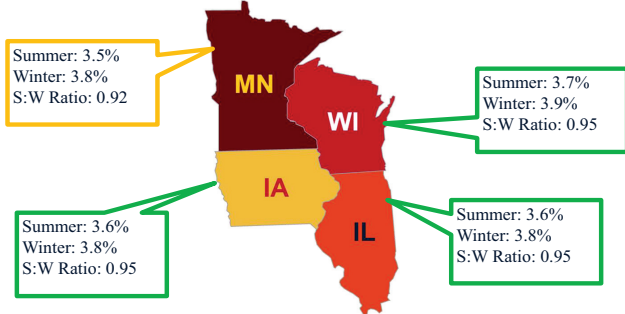

### Regional Benchmarks – Protein %

Percentile	Midwest	Northeast	Northern Plains	Southeast	Southern Plains	Total
75 <sup>th</sup>	0.98	0.99	0.97	0.99	0.99	0.98
50 <sup>th</sup>	0.96	0.97	0.95	0.97	0.96	0.97
25 <sup>th</sup>	0.94	0.95	0.93	0.95	0.94	0.94

17

18

### 4-State Protein Percent Ratios

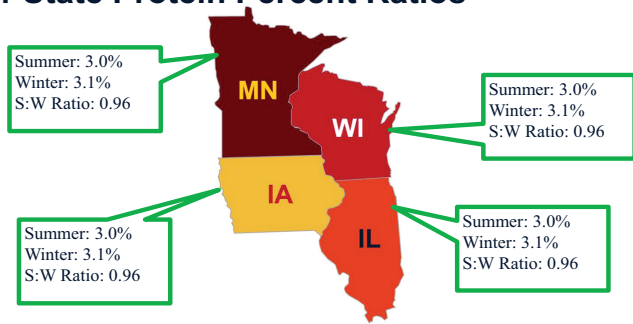

### Reproduction Variables



19

ILLINOIS

20

ILLINOIS

### Regional Benchmarks – CR

Percentile	Midwest	Northeast	Northern Plains	Southeast	Southern Plains	Total
75 <sup>th</sup>	1.06	1.09	1.05	1.00	1.02	1.07
50 <sup>th</sup>	0.89	0.89	0.87	0.81	0.80	0.88
25 <sup>th</sup>	0.73	0.72	0.71	0.64	0.64	0.71

### 4-State Conception Rate Ratios

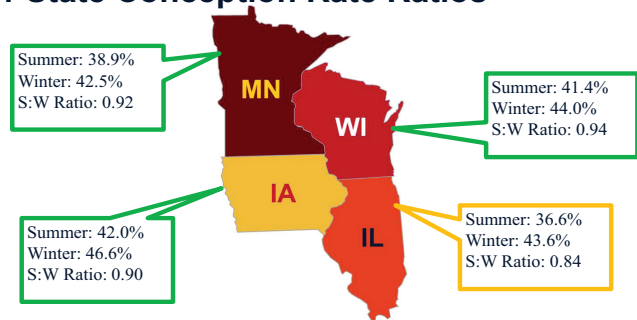

21

ILLINOIS

22

ILLINOIS

### Regional Benchmarks – HDR

Percentile	Midwest	Northeast	Northern Plains	Southeast	Southern Plains	Total
75 <sup>th</sup>	1.09	1.12	1.10	1.06	1.02	1.10
50 <sup>th</sup>	0.95	0.96	0.95	0.91	0.86	0.95
25 <sup>th</sup>	0.80	0.82	0.78	0.76	0.70	0.81

### 4-State Heat Detection Rate Ratios

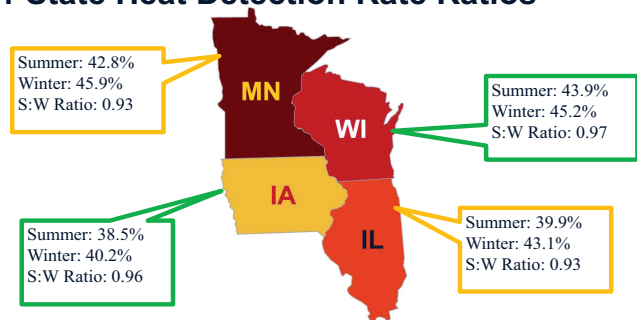

23

ILLINOIS

24

ILLINOIS

## Regional Benchmarks – PR

Percentile	Midwest	Northeast	Northern Plains	Southeast	Southern Plains	Total
75 <sup>th</sup>	1.04	1.09	1.03	0.86	0.79	1.06
50 <sup>th</sup>	0.81	0.84	0.79	0.64	0.59	0.81
25 <sup>th</sup>	0.62	0.63	0.58	0.47	0.45	0.61

## 4-State Pregnancy Rate Ratios

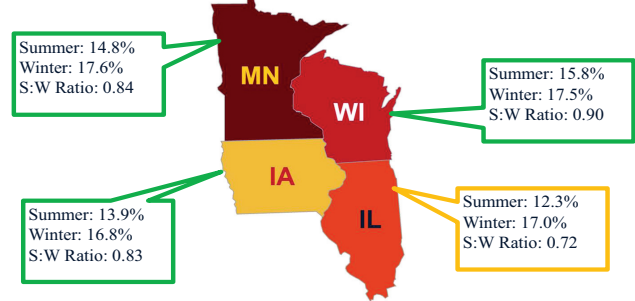

25

26

## What strategies are effective for increasing (or decreasing) S:W Ratio?



J. Dairy Sci. 102:11777–11785  
<https://doi.org/10.3168/jds.2018-16170>  
 © American Dairy Science Association®, 2019.



Comparing dairy farm milk yield and components, somatic cell score, and reproductive performance among United States regions using summer to winter ratios

Jenna M. Guinn,<sup>1</sup> D. T. Nolan,<sup>1</sup> P. D. Krawczel,<sup>2</sup> C. S. Petersson-Wolfe,<sup>3</sup> G. M. Pighetti,<sup>2</sup> A. E. Stone,<sup>1,4</sup> S. H. Ward,<sup>4,5</sup> J. M. Bewley,<sup>3</sup> and Joao H. C. Costa<sup>1\*</sup>

<sup>1</sup>Department of Animal and Food Sciences, University of Kentucky, Lexington 40506  
<sup>2</sup>Department of Animal Science, University of Tennessee, Knoxville 37996  
<sup>3</sup>Department of Dairy Science, Virginia Polytechnic Institute and State University, Blacksburg 24061  
<sup>4</sup>Department of Animal and Dairy Science, Mississippi State University, Starkville 39759  
<sup>5</sup>Department of Animal Science, North Carolina State University, Raleigh 27607  
<sup>\*</sup>Alltech, Nicholasville, KY 40356

27

28

## Southeast Quality Milk Initiative

- Completed over 122 farm assessments on farms in Southeast region
- A single on-farm assessment was conducted over 2014 to 2015
  - Survey
  - Housing assessment



## Milk Production Variables

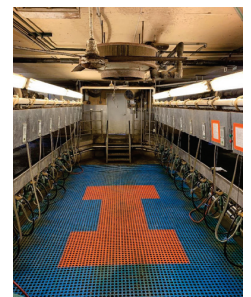

29

30

Herds that turned on fans at lower temperatures had higher ECM S:W Ratios

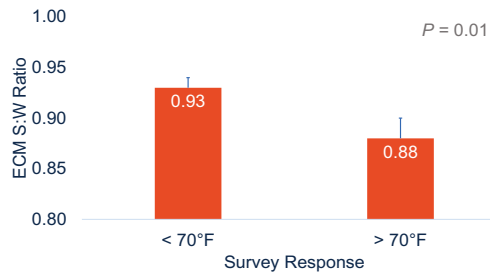

Herds that had fans in the holding pen had higher ECM S:W Ratios

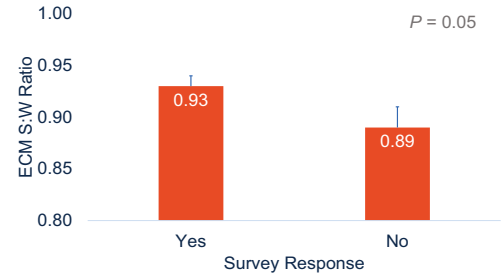

31

32

Herds that had fans in the holding pen had lower SCS S:W Ratios

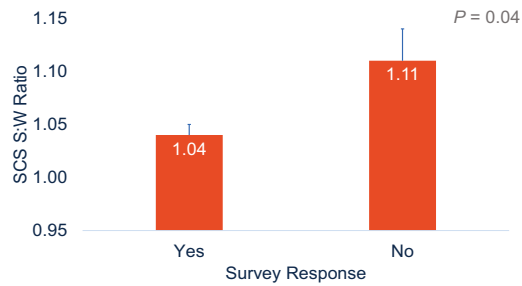

Herds that had sprinklers in the holding pen had higher SCS S:W Ratios

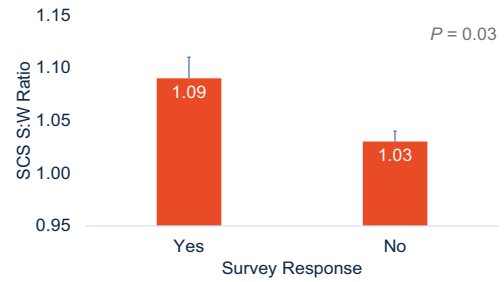

33

34

Herds that had fans + sprinklers had higher Fat % S:W Ratios than herds with none

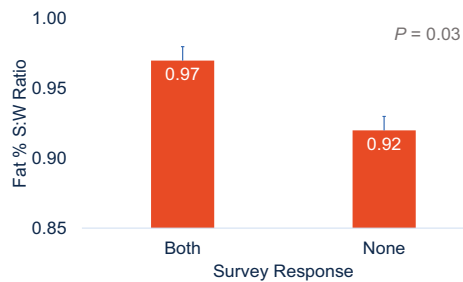

## Reproduction Variables



35

36

Herds that had fans + sprinklers in the holding pen had higher conception rate S:W Ratios than herds with none

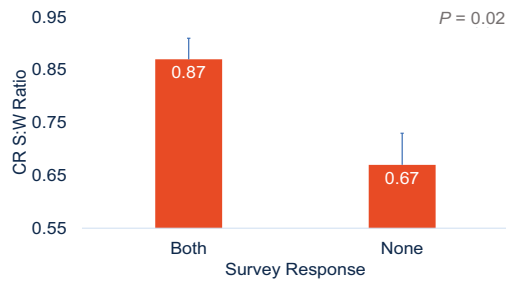

Herds that had fans + sprinklers in the holding pen had higher HDR S:W Ratios than herds with none

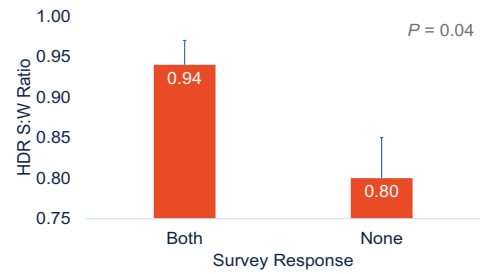

37

38

Herds that had fans + sprinklers had higher HDR S:W Ratios than herds with none

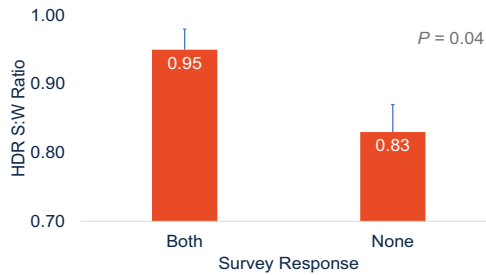

Herds that had ridge vents in lactating cow facilities had higher conception rate S:W Ratios than herds with none

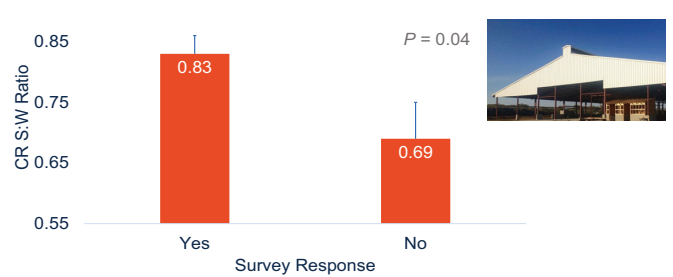

39

40

### Take Home Messages

- Summer : Winter Ratios can be used to determine effectiveness of heat abatement
- Goals depend on farms and regions – optimal would be a ratio of 1
- See more of an impact of reproductive performance

### Take Home Messages

- Turning fans on at lower temperatures associated with higher S:W Ratios
- Heat abatement in holding pin associated with higher S:W Ratios
- Using fans and sprinklers associated with higher reproductive S:W Ratios

41

42

## Coming Soon!

- University of Illinois Dairy Decisions Suite

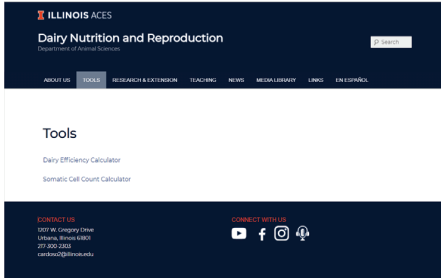

43

ILLINOIS

## Thank You

- Four State committee
- Four State Sponsors
- Jenna Guinn



44

ILLINOIS

## Thank you

Derek T. Nolan  
Teaching Assistant Professor  
Dairy Extension Specialist  
University of Illinois  
217-244-7637  
[dtnolan@illinois.edu](mailto:dtnolan@illinois.edu)



45

ILLINOIS



# **Lackluster Calves – Using Lung Ultrasound to Identify a “Calories-out” Problem**

**Dr. Terri Ollivett  
University of Wisconsin**





# Lackluster calves

using lung ultrasound to identify a “calories-out” problem



TL Ollivett, DVM, PhD, DACVIM  
Assistant Professor  
UW School of Veterinary Medicine

1

Respiratory disease is a symptom – rarely occurs in isolation

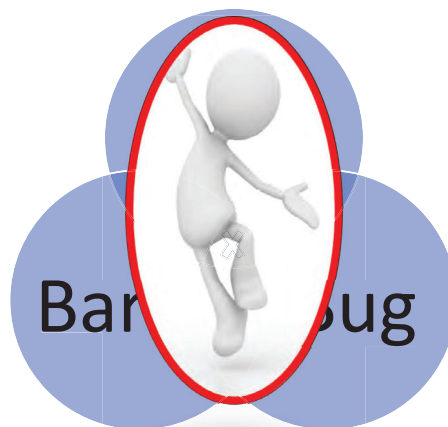
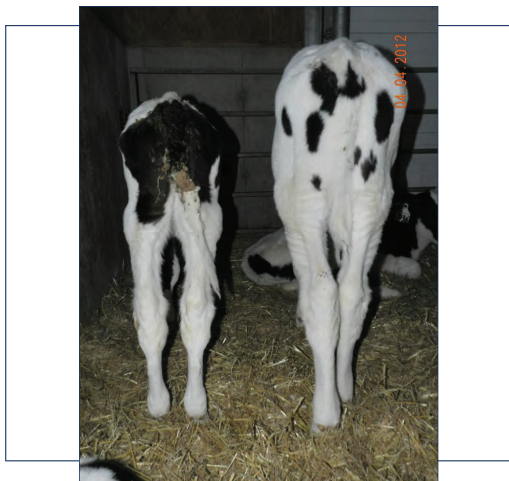

2

# Respiratory Disease in Dairy Calves

- variable occurrence, 13 – 92%
- depends on method of detection
- catastrophic for some operations

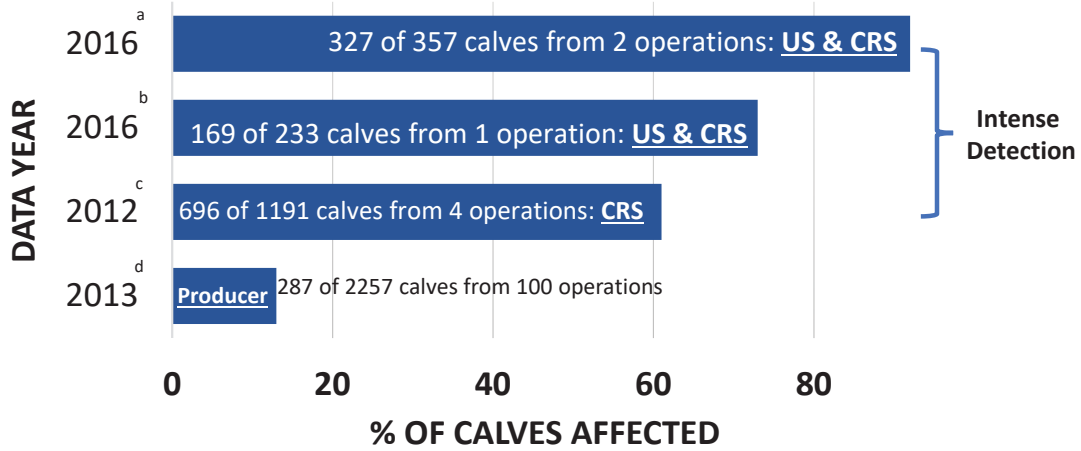

<sup>a</sup> Binversie et al., 2020 <sup>b</sup> Cramer et al., 2019 <sup>c</sup> Heins et al., 2014 <sup>d</sup> Urie et al., 2018  
 US: lung ultrasound CRS: UW clinical respiratory score Producer: producer defined disease

3

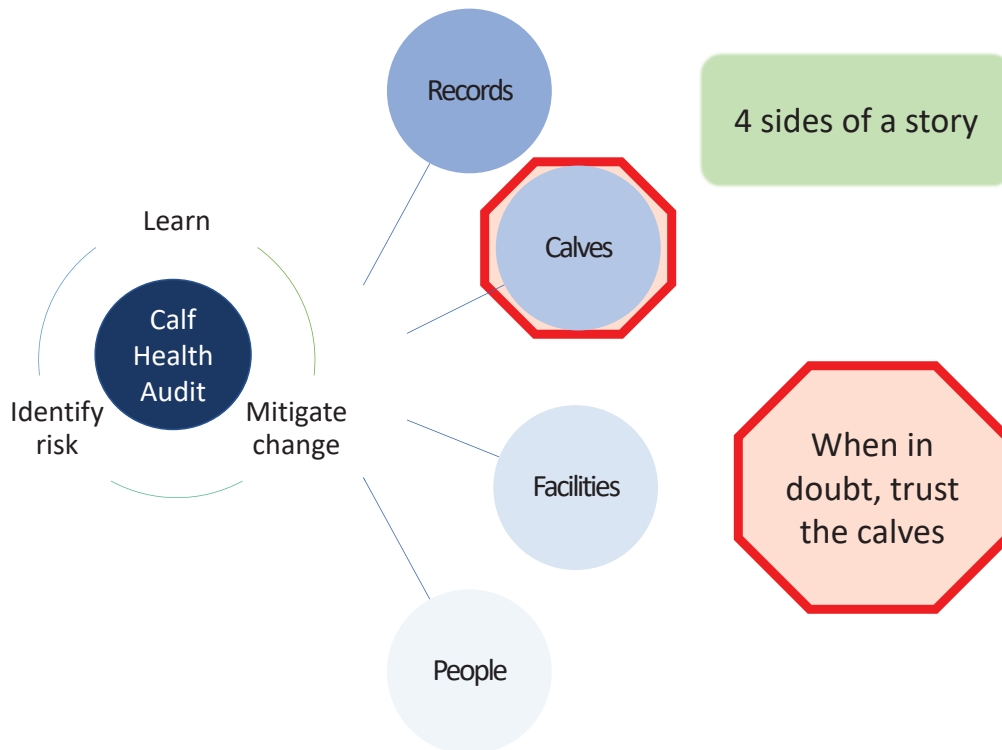

4

# Spectrum of clinical signs...

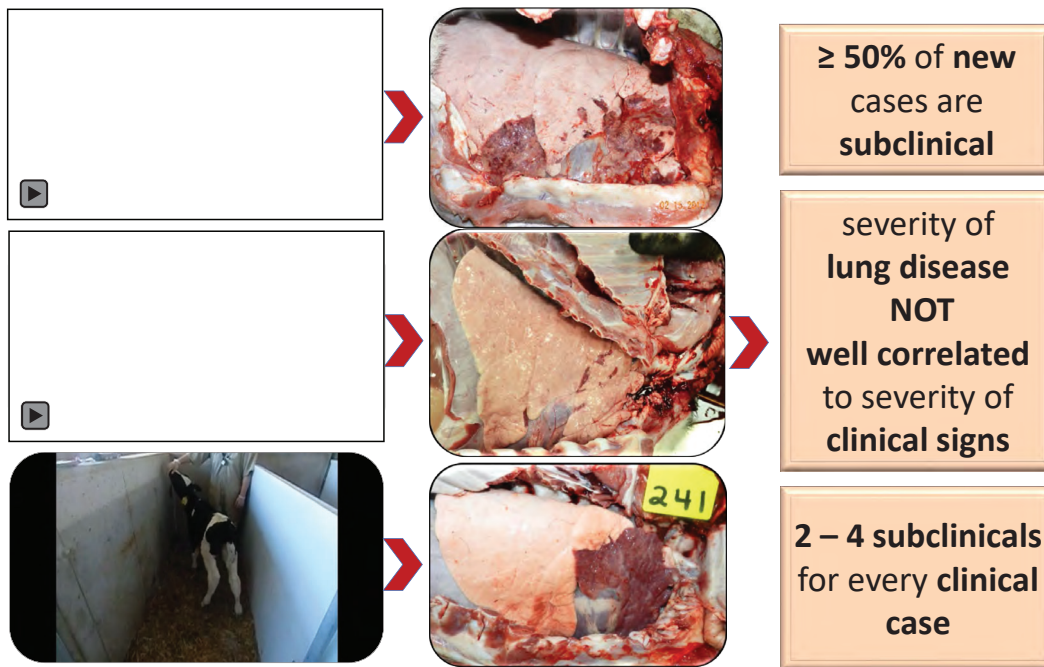

5

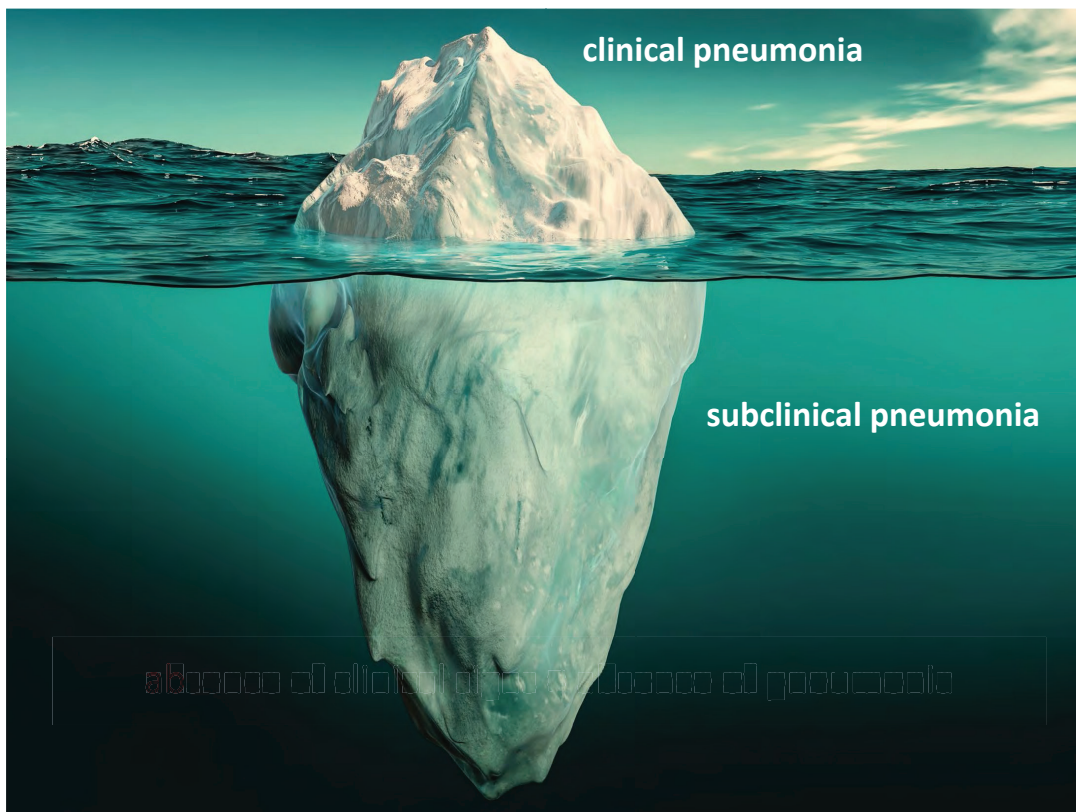

6

# absence of clinical signs $\neq$ absence of pneumonia

Respiratory health after **bacterial challenge** in saline (dark gray, n = 11) and ampicillin (light gray, n = 17) treated dairy calves

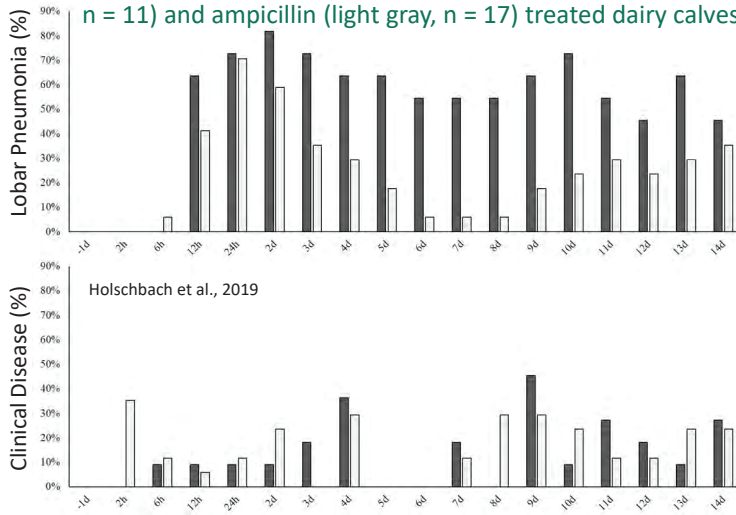

Holschbach et al., 2019

7

*P. multocida* PCR positive on lung tissue at d14 after challenge

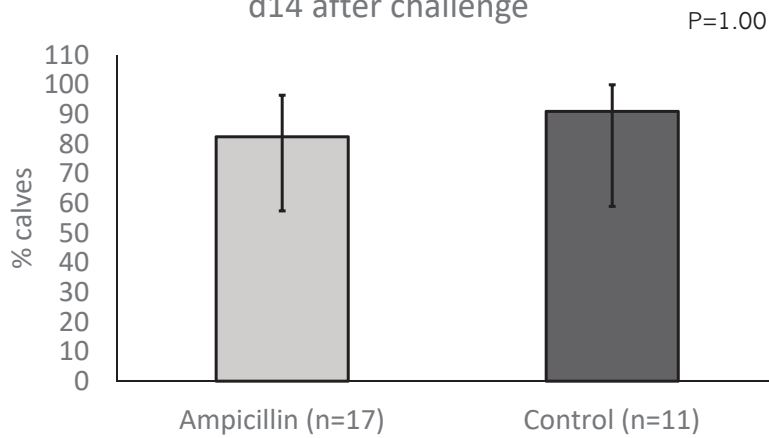

8

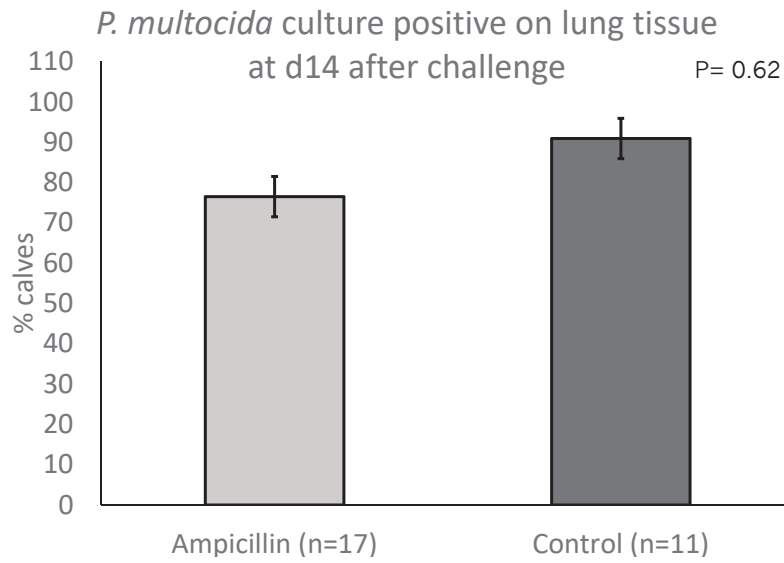

absence of clinical signs  $\neq$  absence of pneumonia

Respiratory health at weaning following antibiotic therapy for **naturally occurring** respiratory disease in 239 dairy calves

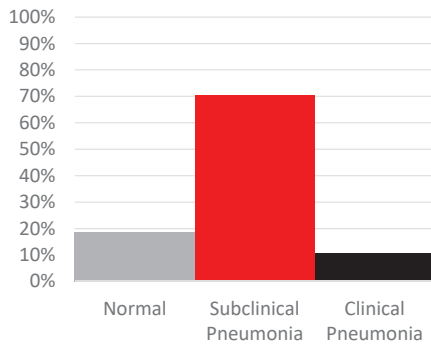

## Calf lung ultrasound...

**Fast** (less than 1 minute)

**Sensitive** (>88%)

- Better than clinical exam (~60%) or auscultation (<10%)

Associated with short term outcomes

- **Growth**
- **Vaccine, antibiotic response**

Associated with long term outcomes

- **Death**
- **Removal**
- **Decreased pregnancy risk**
- **Decreased milk production (1200# L1)**

**Attitude scores and Feeding behavior**

- clinical pneumonia not subclinical pneumonia



**Heritability estimates** at 3 wk (0.21) were higher than estimates at 6 wk (0.08), suggesting greater influence of management and environmental conditions over time.

**Resolution of disease following treatment** – not guaranteed

11

## Lung disease and average daily gain

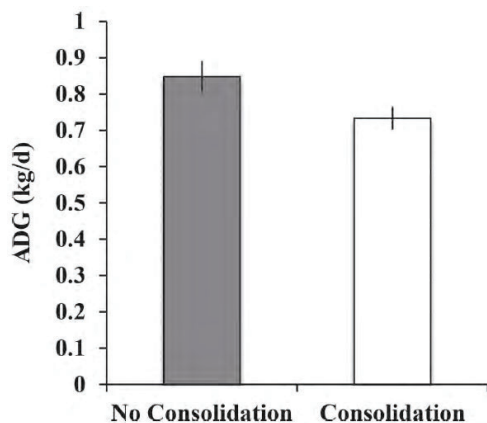

**Figure 1.** Least squares means ( $\pm$ SE) estimates for ADG (kg/d) for 233 preweaned, group-housed calves with no lung consolidation ( $<1 \text{ cm}^2$  of consolidation at all ultrasound exams) or with lung consolidation ( $\geq 1 \text{ cm}^2$  of consolidation for at least one ultrasound exam;  $P = 0.01$ ). This simplified ultrasound score was adapted from Ollivett and Buczinski (2016). Estimates were obtained from a multivariable linear model that controlled for clinical respiratory disease status of the calf, cohort, and breed.

What drives the impact on gain?

- Reduced intakes?
- Metabolic cost of disease?

Cramer et al., 2019

12

# Lung disease and feeding behavior

**Table 2.** Raw values for feeding behaviors, by Bovine Respiratory Disease (BRD) status, over the 3 d before, the d of, and the 3 d after BRD detection. Calves were enrolled in the study at  $21 \pm 6$  (mean  $\pm$  SD) d of age and underwent twice weekly health exams.

Feeding Behavior	BRD Status		
	Clinical BRD (CBRD) (n = 18)	Subclinical BRD (SBRD) (n = 73)	Without BRD (NOBRD) (n = 12)
Average daily drinking speed (mL/min; mean $\pm$ SD)	716 $\pm$ 230	827 $\pm$ 221	879 $\pm$ 250
Average daily milk intake (L/d; mean $\pm$ SD)	10 $\pm$ 2.9	10.6 $\pm$ 4.0	10.3 $\pm$ 3.4
Average meal size (L/meal; mean $\pm$ SD)	1.8 $\pm$ 0.9	1.7 $\pm$ 0.8	1.6 $\pm$ 0.8
Number of rewarded visits (no./d; median; 1st quartile, 3rd quartile)	6 (5, 9)	6 (4, 9)	7 (4, 9)
Number of unrewarded visits (no./d; median; 1st quartile, 3rd quartile)	0 (0, 1)	0 (0, 1)	0 (0, 2)

Calves with CBRD drank slower than both calves with SBRD ( $687 \pm 42$  vs.  $782 \pm 25$  mL/min;  $p = 0.02$ ) and calves with NOBRD ( $687 \pm 42$  vs.  $844 \pm 51$  mL/min;  $p = 0.01$ ; Table 3). There was no difference in drinking speed between calves with SBRD and calves with NOBRD ( $782 \pm 25$  vs.  $844 \pm 51$  mL/min;  $p = 0.26$ ). There was **no effect of BRD status on milk intake** ( $p = 0.64$ ), average meal size ( $p = 0.79$ ), rewarded visits ( $p = 0.26$ ), or unrewarded visits ( $p = 0.19$ ; model results not shown).

Cramer et al., 2020

13

## Lung lesion pathophysiology

- Bacterial infection
  - Bronchopneumonia
  - Neutrophils in the airways

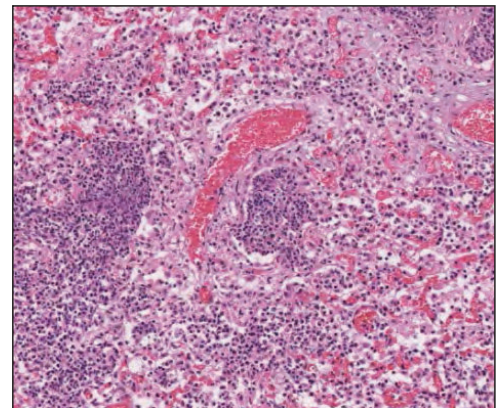
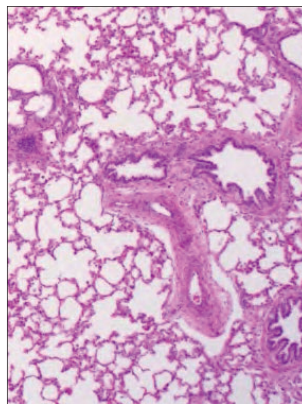

**Constant recruitment of neutrophils into the airways - WEEKS not days**

14

# Early life plane of nutrition & growth

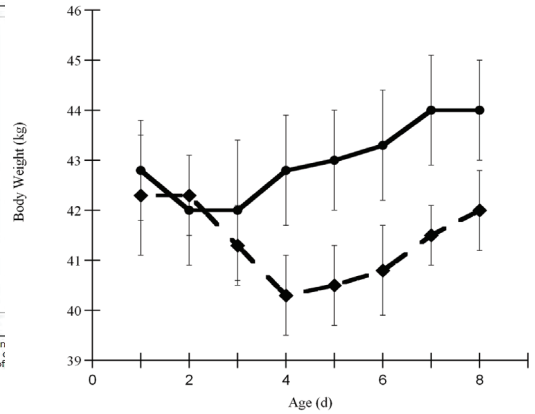
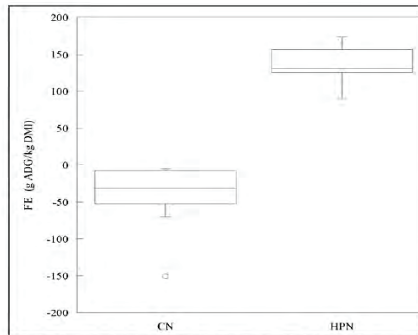
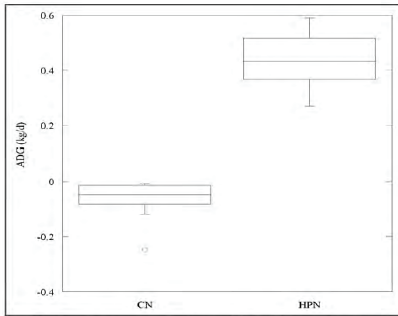

HPN: 28/22% MR: 1.8 lb/d DM x 7d; then 2.4 lb/d  
 CN: 20/20% MR: 1 lb/d DM

Ollivett et al., 2010; 2012

15

## When will cold stress happen?

Consider the lower critical temperature for newborn and young calves: **< 60°F**

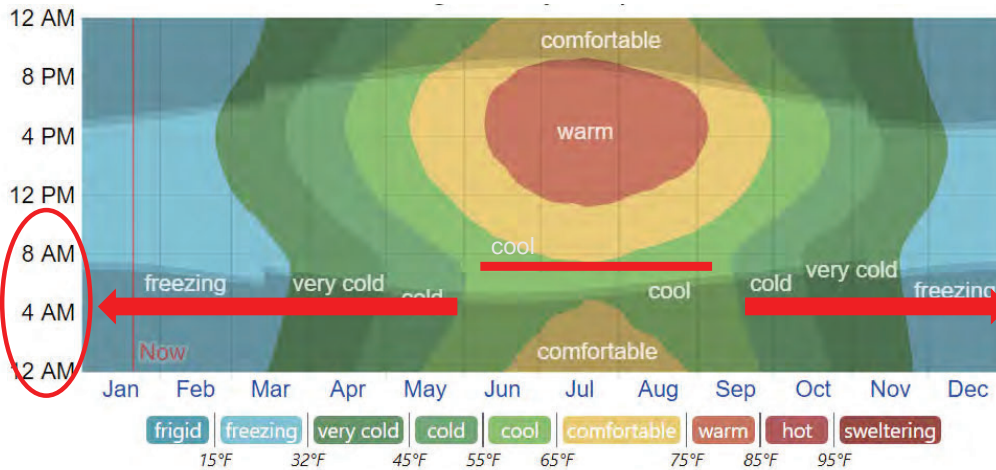

<https://weatherspark.com/y/12796/Average-Weather-in-Madison-Wisconsin-United-States-Year-Round#Sections-Temperature>

Wisconsin, USA: weather throughout the year

16



# Chicken or Egg – Growth and BRD



- Subclinical pneumonia = calorie sink
- Confirm onset, severity with ultrasound
- Feed calves to grow in week 1
- Keep gut healthy in week 2

**No growth = No lungs = No growth**

17

 School of Veterinary Medicine  
UNIVERSITY OF WISCONSIN - MADISON

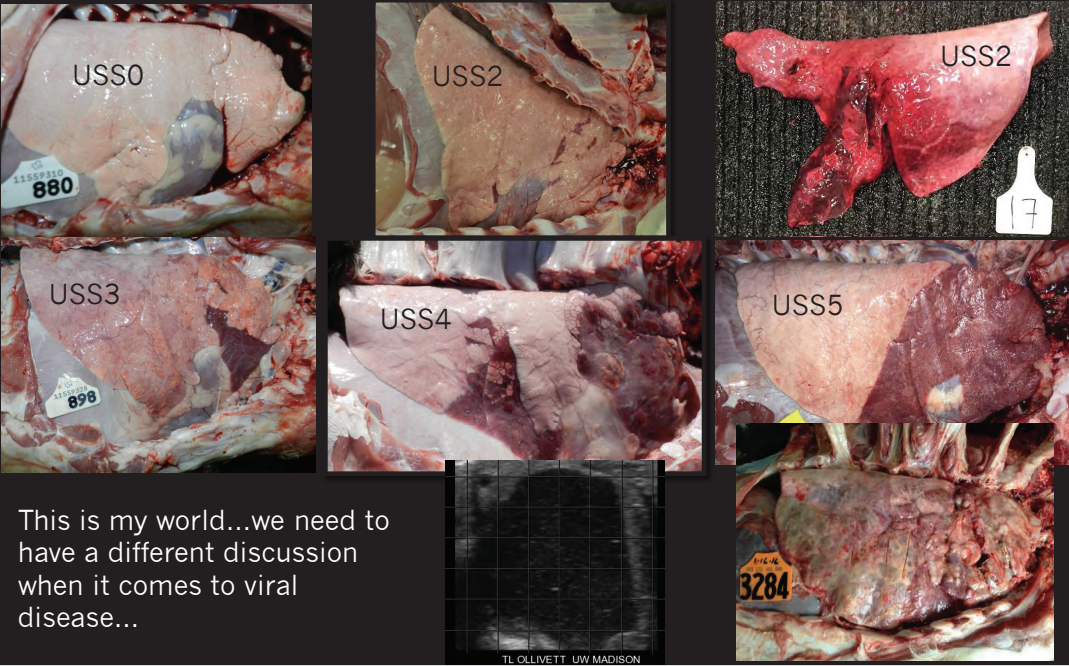

This is my world...we need to have a different discussion when it comes to viral disease...

TL OLLIVETT UW MADISON

18

## Why is pneumonia subclinical?

- 1) Prey species: 60-80%\* subclinical for ~ 7d before we see them
- 2) Failure to cure and relapse of subclinical/clinical disease

\*Salmonella changes this relationship...

19

### Respiratory disease and antibiotic therapy

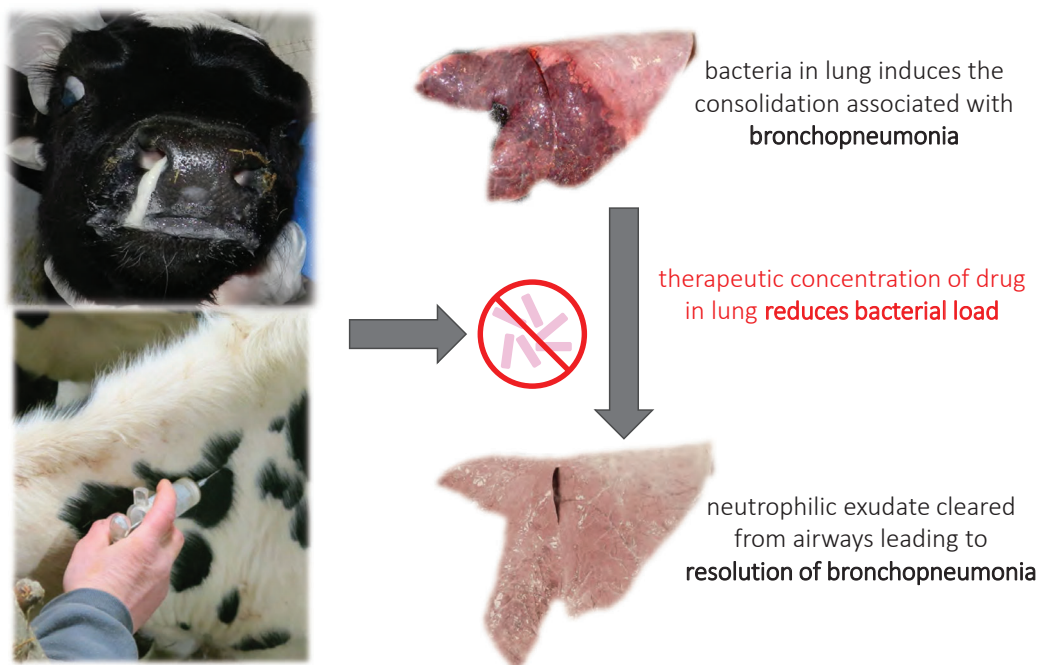

20

## Respiratory disease and antibiotic therapy

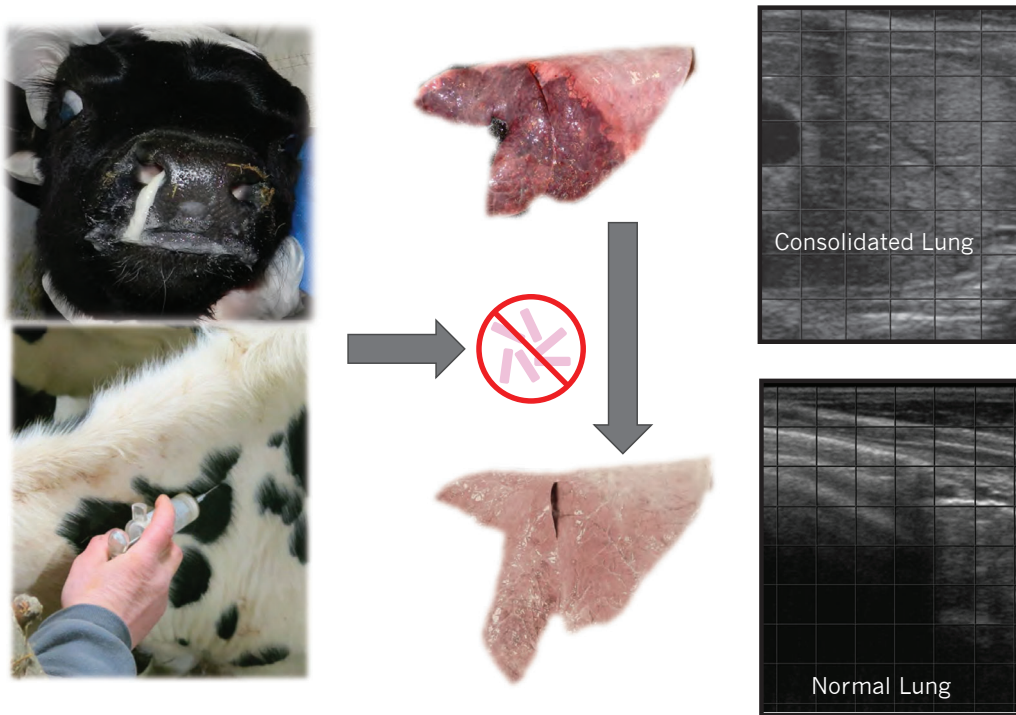

21

**Approved dosing strategies are based on PK data.**

**Efficacy is characterized by:**

- survival
- rectal temperature < 104°F
- lack of depression
- lack of heavy breathing or increased rate

**Two common misconceptions based on this information:**

- 1) Approved dosing strategies are best, or optimal
- 2) Resolution of severe clinical signs = resolution of pneumonia

DeDonder and Apley, 2015

22

# absence of clinical signs $\neq$ absence of pneumonia

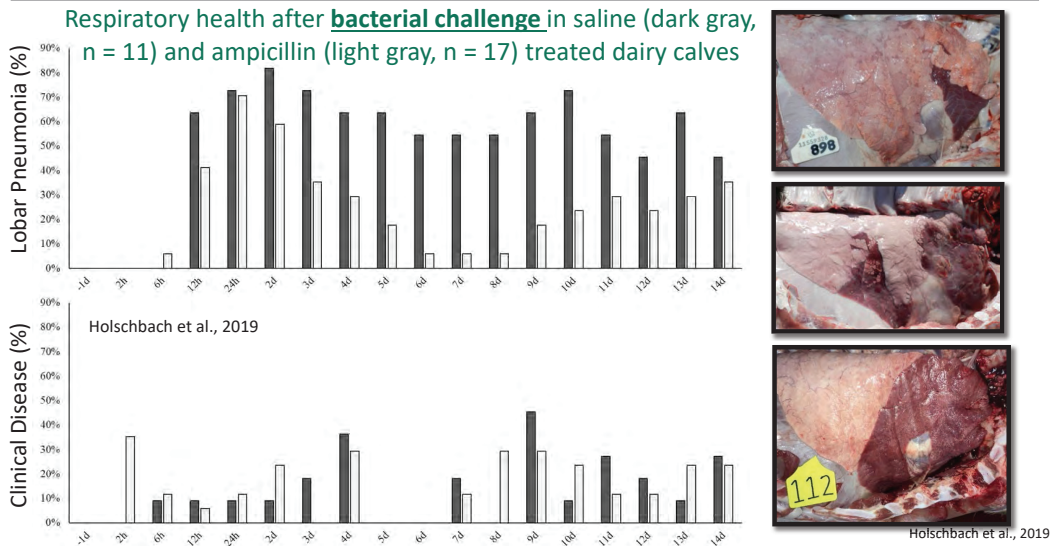

23

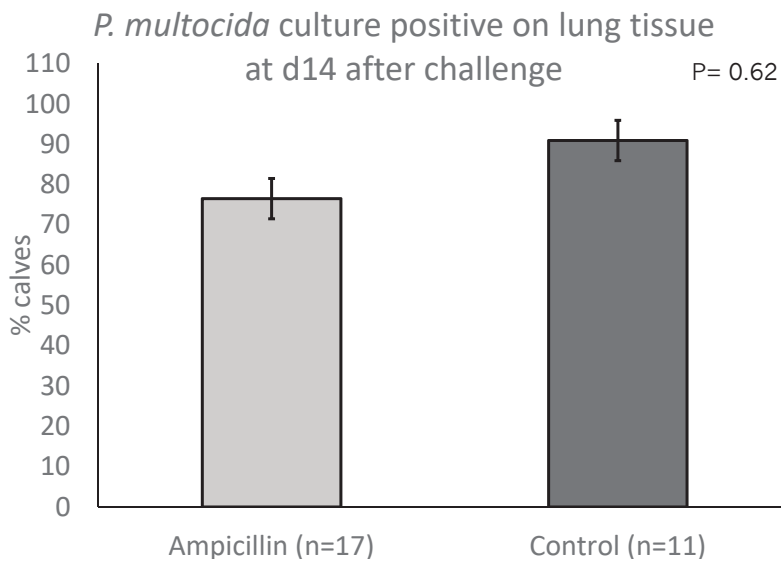

24

Why does treatment efficacy matter? Exposure time

	Week 3	Week 4	Week 5	Week 6	Week 7	Week 8
# new cases	5	5	5	5	5	
# cures – good (80%)	4	4	4	4	4	5
# cures-bad (40%)	2	2	2	2	2	15

25

ID	28-Nov	6-Dec	13-Dec	30-Dec	7-Jan
22179			0	3	
22178			0	0	
22177			0	0	
22176			0	0	
22175			2	0	
22174			0	0	
22173			0	2	
22172		0	2	3	
22171		2	2	4	
22170		0	0	0	
22169		0	0	0	
22168		2	0	2/3	
22167		0	2	3	
22165		0	3	3	
22164		0	0		
22159	1	2	3		
22158	0	2	0		
22157	0	2	2/4		
22156	0	2	5		
22155	2	2	2/3		4
22154	0	3	2/3		3
22153	2	2	3		4
22152	3	4	5		5
22151	0	3	5		3
22150	0	4	3		3
22149		0	0		0
22148		0	3		4
22147		2	3		4

Age (d)  
<9  
10-19  
20-27  
28-34  
49-54

Routine 12x7 weekly scans at 2200 cow Holstein dairy in WI

These calves did NOT #WeanClean™

26

## Calf Health Module – #WeanClean

This module is an educational resource and will serve as a spring board for troubleshooting disease as well as learning the ultrasound and respiratory scoring techniques, and provide general management information (e.g. nutrition, sanitation, etc).

### #WeanClean™ Philosophy

**Mission:** Use lung ultrasound to promote calf health management that maximizes every calf's potential to begin and transition through the weaning process with clean, healthy lungs.

### Guiding Principles:

The guiding principle of #WeanClean™ is that calves with healthy, ultrasonographically clean lungs will maintain growth during weaning and will be less likely to require antibiotics for clinical respiratory disease following weaning.

To promote #WeanClean™, use this **4-point ultrasound strategy** to measure lung disease at weaning, determine detection and treatment efficiencies, and identify high risk age-groups for follow-up management.

1. **Start of weaning** – how many have pneumonia at the start of weaning? **Goal: < 15%**
2. **Start of treatment** – how many score > 3 or < 2 at their first treatment? **Goal: < 15%**
3. **7-10 d after treatment** – how many score > 2 after their first treatment? **Goal: < 15%**
4. **12x7 scans** – starting at 7d of age, scan 12 at 7d intervals to find high-risk age group

There are only a few general reasons for missing these goals. Understanding these reasons provides a **framework for troubleshooting** respiratory disease as well as many of the other significant causes of poor health and welfare in young dairy cattle.



Calf Health Module

Calf Health Module

[Training Videos](#)

[Google](#)

27

## #WeanClean™ Philosophy

When calves **don't wean clean**, we **failed them not once but twice**

- We let her get pneumonia (many reasons why this happens)
- We didn't treat her effectively (fewer reasons why this happens)

Scan lungs at **4 strategic points** to promote #WeanClean philosophy

1. **Start of weaning** – how many have pneumonia at the start of weaning? **Goal: < 15%**
2. **Start of treatment** – how many score > 3 or < 2 at their first treatment? **Goal: < 15%**
3. **7-10 d after treatment** – how many have lesions after first treatment? **Goal: < 15%**
4. **12x7 scans** – starting at 7d old, scan 12 calves at 7d intervals to find high-risk ages

(Olivett, 2019)

28



- Too many calves **weaning with lung lesions?** **3 reasons** - weren't treated, weren't treated right, or they have poor **immune function**
- Too many calves with **high lung scores at first treatment?** **2 reasons** – don't spend enough time looking at the right group of calves, and/or don't recognize early signs
- Too many calves with **normal lung at first treatment?** **2 reasons** – misdiagnosing toxemia or septicemia, and/or don't recognize early signs of pneumonia
- Too many calves with **high lung scores after first treatment?** **3 reasons** – used right drug in wrong way (late, wrong dose, duration, frequency), used wrong drug (wrong class, resistant bug), or they have poor **immune function**
- Does **age at first treatment reflect reality?** Use **12x7 scans** to confirm onset of disease, train treaters to focus on the right calves, treat subclinicals

(Ollivett, 2019)

29

## Calf Lung Ultrasound

TL Ollivett, 2012

30

# Pneumonia

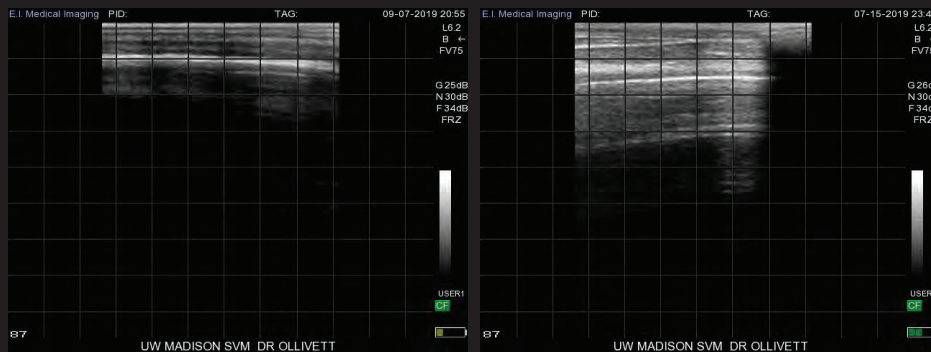

Severe pneumonia

Normal lung

31

## Abscesses...

- Abscesses have fluid inside a capsule, occasionally gas
- **Pics left to right:** 6 week old Holstein bull **caudal lobe abscess**, 3 month old Jersey heifer **caudal lobe abscess**, 4 week old Holstein bull **caudal lobe abscess**.

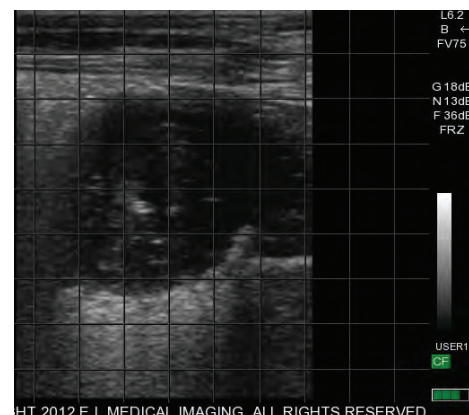
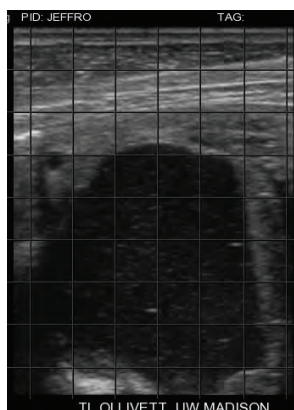
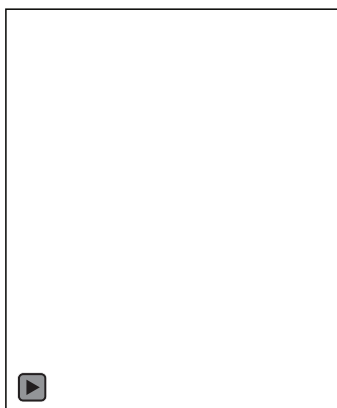

32



## Scoring lungs

- Staff competency – yes
- Treatment response – yes
- Culling – yes
- Purchasing – yes
- Metaphylaxis – yes
- Diagnostic sampling – yes
- Onset of disease – yes
- Overall Prevalence – NO, use 1 cm cut off

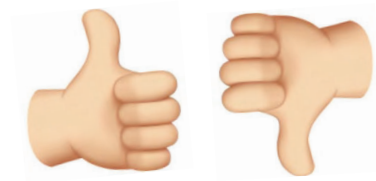

33

## 0 – 5 TUS scoring system 0 and 1 = normal

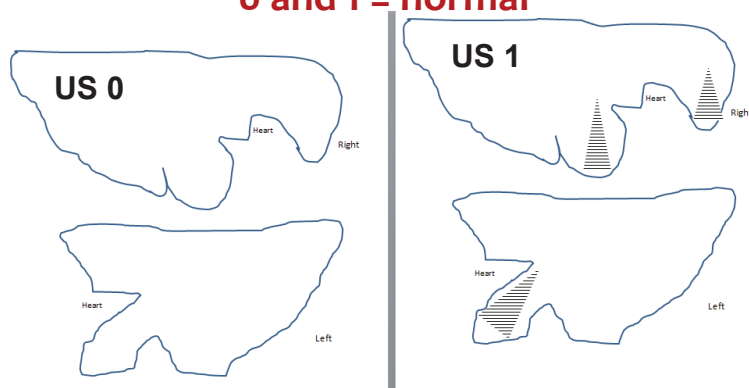

34

**2 = lobular pneumonia**  
**3 = lobar pneumonia 1 lobe**

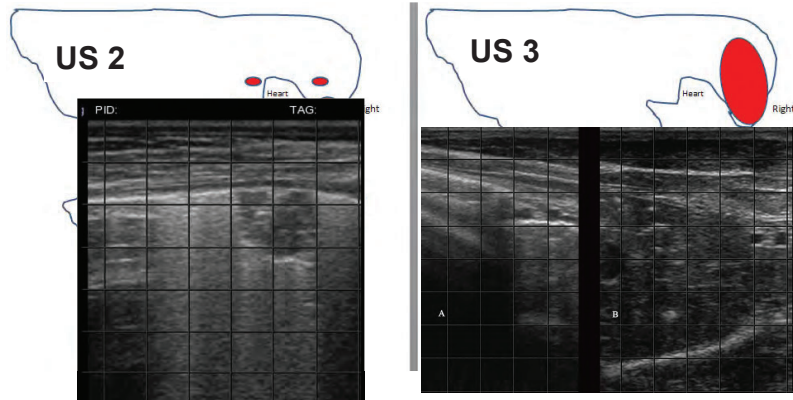

35

**4 = lobar pneumonia 2 lobes**  
**5 = lobar pneumonia 3 + lobes**

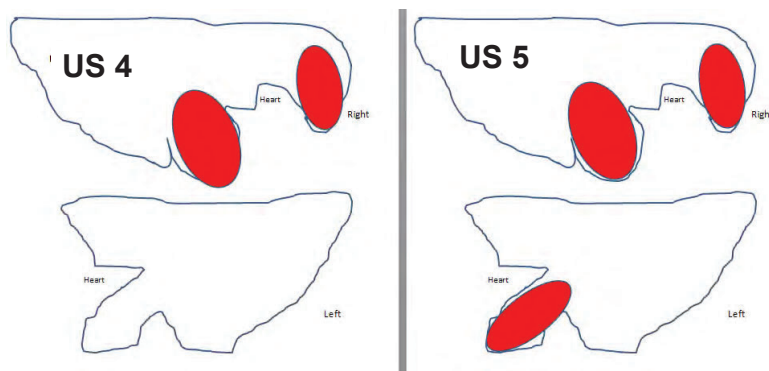

36

## Ultrasound scores at first treatment

**GOOD**

**BAD**

REVIEW DETECTION PROTOCOLS  
Look for obviously sick calves 2x/d  
Look for mild cases 2x/w with respiratory score  
Mark high risk calves (FPT, scours) for easier detection

37

## Ultrasound scores 7 – 10 days after treatment

**GOOD**

**BAD**

**BAD**

Expect normal ultrasound exams after treatment

38

## Ultrasound scores 7 – 10 days after treatment

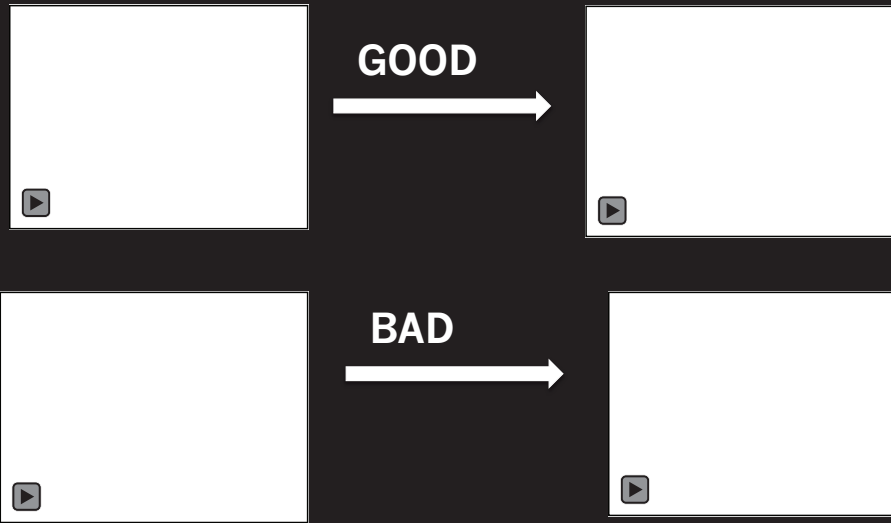

39

### After implementing lung ultrasound to treat subclinical pneumonia:

- detection and treatment happens earlier now
- rare to treat a calf for the first time after weaning
- **Better growth, fewer deaths from untreated/late treated pneumonia**

Year	% of calves treated for the first time after weaning
2019	42%
2020	10%
2021 (Jan - Apr)	0%

age at first treatment before scanning	35 d	350 calves
age at first treatment after starting scanning	21 d	1140 calves

40

**% All Pneumonia (USS > 1) by Scan Date Nov 2019 - April 2021**

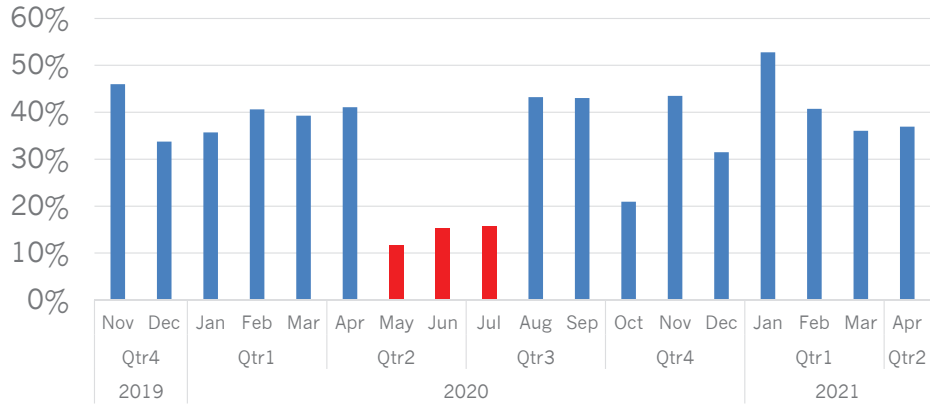

**Warm weather big reduction in disease**

1272 calves scanned since Nov. 2019

41

**% Severe Pneumonia (USS 3+) by Scan Date Nov 2019 – April 2021**

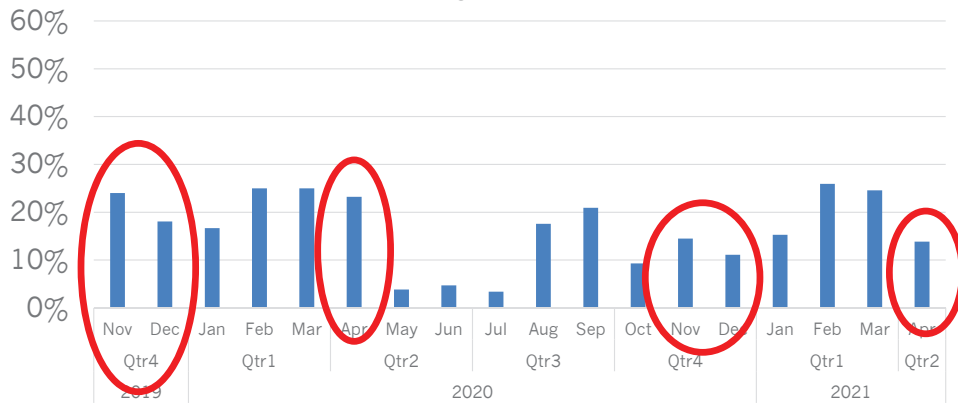

**Seeing drops in severe pneumonia during second year of scanning**

1272 calves scanned since Nov. 2019

42

# Chicken or Egg – Growth and BRD



- Subclinical pneumonia = calorie sink
- Confirm onset, severity with ultrasound
- Feed calves to grow in week 1
- Implement routine scanning to address SCP

**No growth = No lungs = No growth**

43



Questions?

[ollivett@wisc.edu](mailto:ollivett@wisc.edu)

608.358.1640

**#WeanClean™**

<https://thedairylandinitiative.vetmed.wisc.edu/home/calf-health-module/>

44



# **What is Happening in the Gut in the Scouring Calf and Effective Fluid Therapy**

**Jesse Goff, DVM, PhD  
Iowa State University  
College of Veterinary Medicine**



# What is Happening in the Gut in the Scouring Calf and Effective Fluid Therapy

Jesse Goff DVM, PhD  
Iowa State University



1

## How the intestines are supposed to work!

Need to absorb water, electrolytes and the simple sugars, short chain fatty acids, and amino acids left after digestion of milk proteins, fats, and lactose.

Microscopic Anatomy

Physiology of absorption

3 Forms of Diarrhea

How electrolytes work to rehydrate calves

2

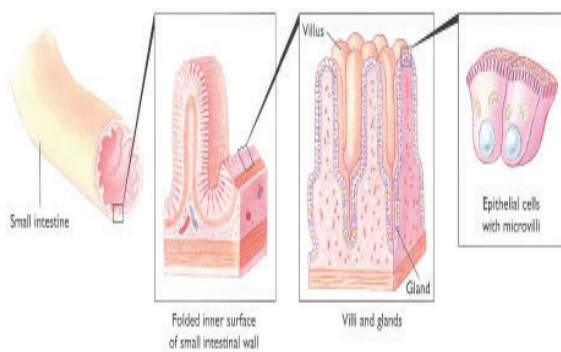

Folds & villi & microvilli greatly increase surface area

Sjaastad Hove, Sand: Physiology of Domestic Animals

3

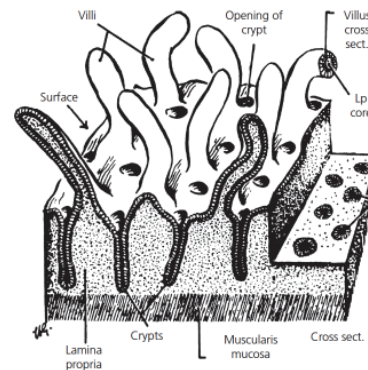

**Figure 43.11** Three-dimensional representation of the small intestine lining. The villi are finger-like processes with cores of lamina propria that extend into the lumen. The crypts of Lieberkühn are depressions in the lamina propria (Lp). From Ham, A.W. (1974) *Histology*, 7th edn. J.B. Lippincott, Philadelphia. Reproduced with permission from Lippincott Williams & Wilkins.

4

Single layer of cells attached to each other by tight junction proteins forms a barrier to keep bacteria and most toxins out of body!!  
Nutrients need to get across this barrier to reach bloodstream

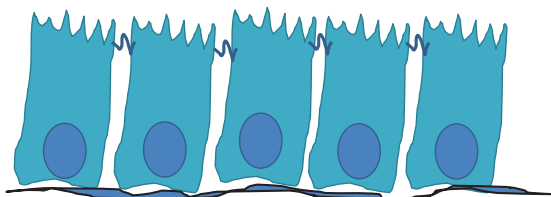

5

Nutrients (example Salt) require various **Transporter proteins** to cross cell membrane 2 times to reach bloodstream

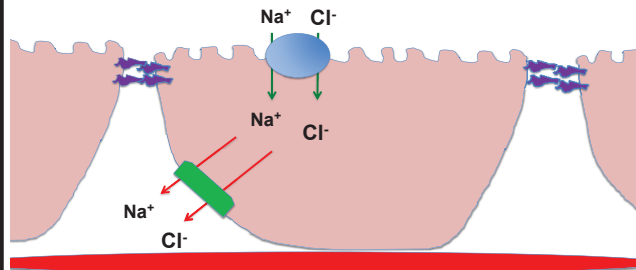

6



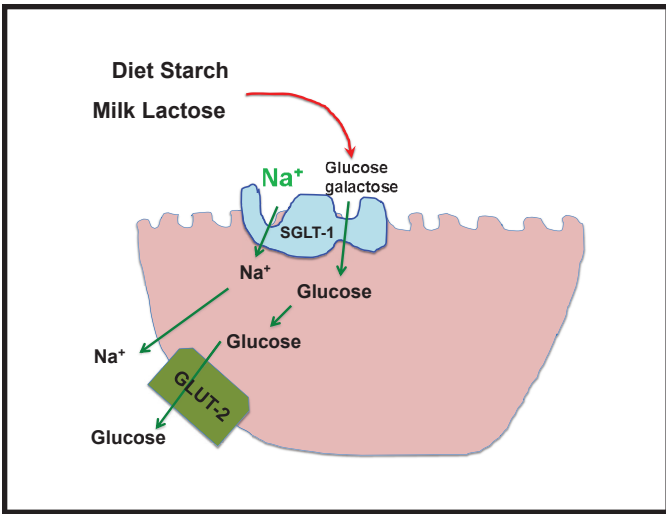

7

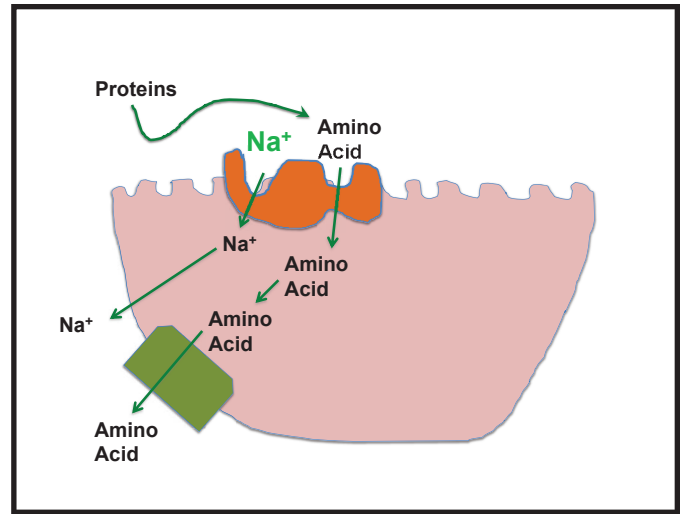

8

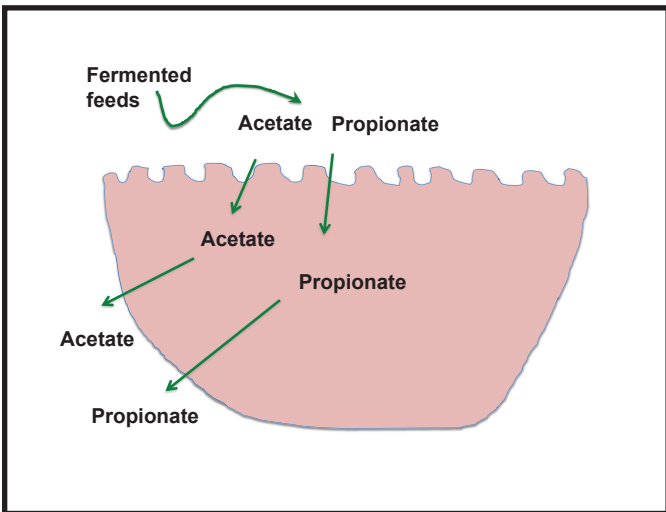

9

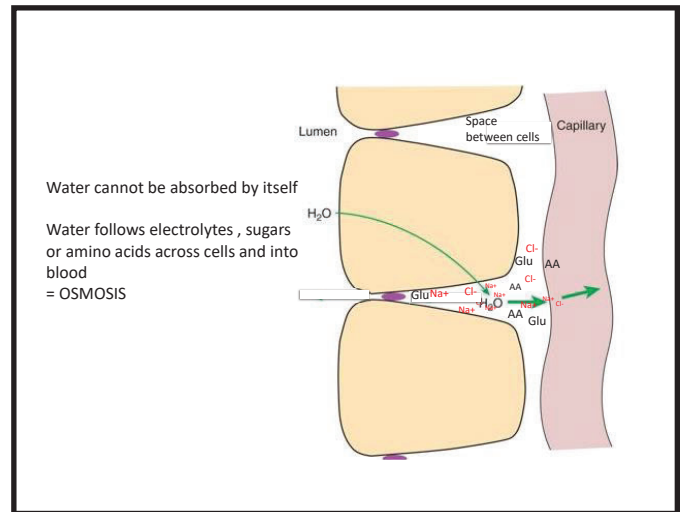

10

**No Na<sup>+</sup> = No absorption of sugar, AA, or Cl<sup>-</sup> !!!!!**

**No Absorption of sugar, AA, or salts = NO ABSORPTION OF H<sub>2</sub>O**

**Where does the needed Na<sup>+</sup> come from??**

**It is NOT the diet!!!**

**Intestinal cells in crypts secrete Cl, Na and water**

11

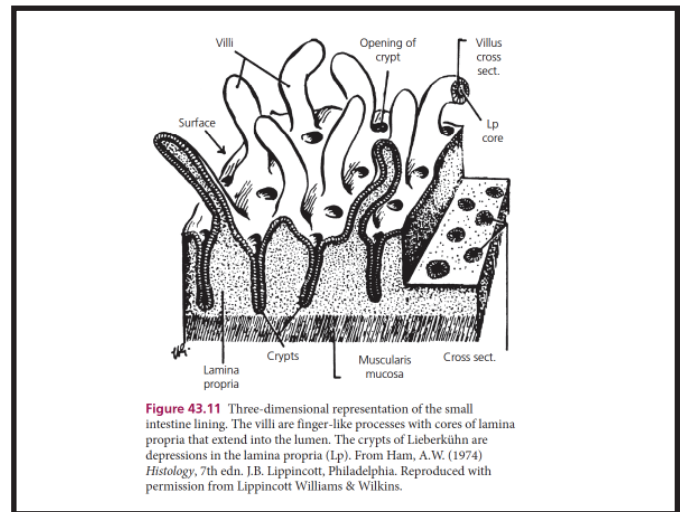

12

## NORMALLY

Crypt cells secrete Na, Cl and water needed for sugar and amino acid absorption by villus cells **only when it is needed!!!!**

**Locally controlled** by stretch of gut to stimulate secretion in that section of intestine only

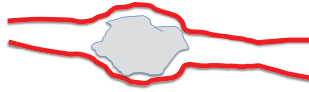

13

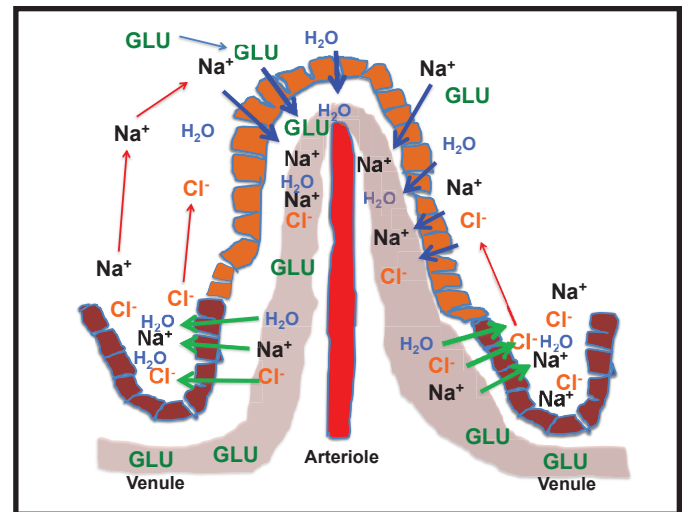

14

## Diarrhea

Classically broken into 3 "Causes"

1. **Secretory Excessive** secretion of Na, Cl and water
2. **Malabsorption** of solutes and water
3. **Osmotic** diarrhea

15

## General Diarrhea Timetable

### First 5 days of life

*E. coli* predominate.

Enterotoxigenic produce toxins → extreme secretory diarrhea, Rarely starts beyond day 7 of life

Effacing *E. coli* - latch onto surface and destroy microvilli and cells → malabsorptive bloody diarrhea. Can occur up to 2 months of life

### Days 5-14

Viral diarrheas common - Rotavirus, coronavirus, Breda (torovirus)- malabsorptive tinged with blood

Cryptosporidium parasite- takes at least 7 days to reproduce so diarrhea first seen after 8 days of age - watery diarrhea tinged with blood

### Onset After week 2

Salmonella - fever, bloody diarrhea, septicemia (Dublin)

Clostridia perfringens - abomasum and gut hemorrhage. Can die before diarrhea is observed!!!

Campylobacter - inflammation → watery diarrhea, some blood

### Onset after weaning

Coccidiosis parasite- moderate watery diarrhea in most. Heavily loaded calves show bloody diarrhea as well.

16

## Inflammation Causes Prostaglandin Release

Intestinal Cells damaged by bacteria, viruses or parasites release prostaglandins

Prostaglandins stimulate hypersecretion of salt and water by crypt cells in a local area of cell damage.

A protective mechanism ???

Flushes toxins, bacteria, viruses, parasites further out with feces

17

## Local inflammation causes localized areas of hypersecretion

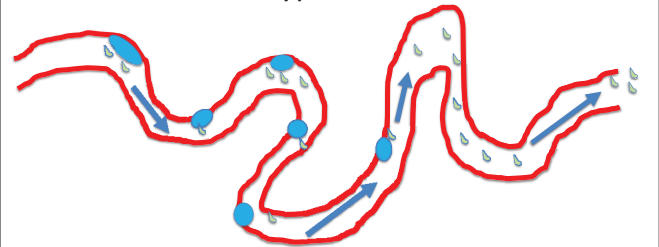

18

## Enterotoxigenic E Coli Diarrhea

Some Strains of E. Coli secrete Toxin into gut

Toxin binds directly to small intestine cells and **activates extreme hypersecretion of Na and Cl**

→ SEVERE WATERY DIARRHEA

This toxin spreads throughout small intestine

19

E.Coli toxin causes widespread areas of hypersecretion.

Watery green/yellow diarrhea NO BLOOD

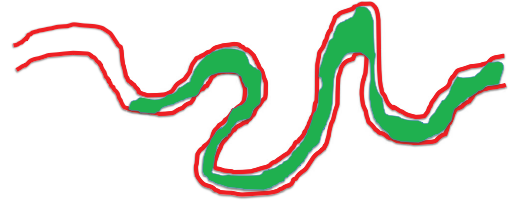

20

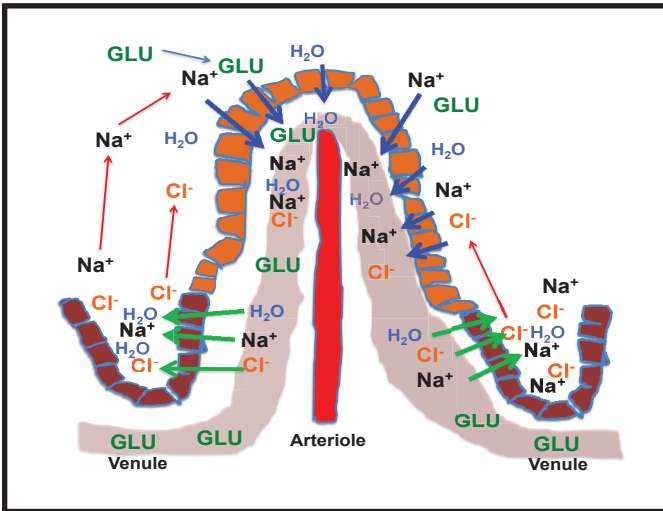

21

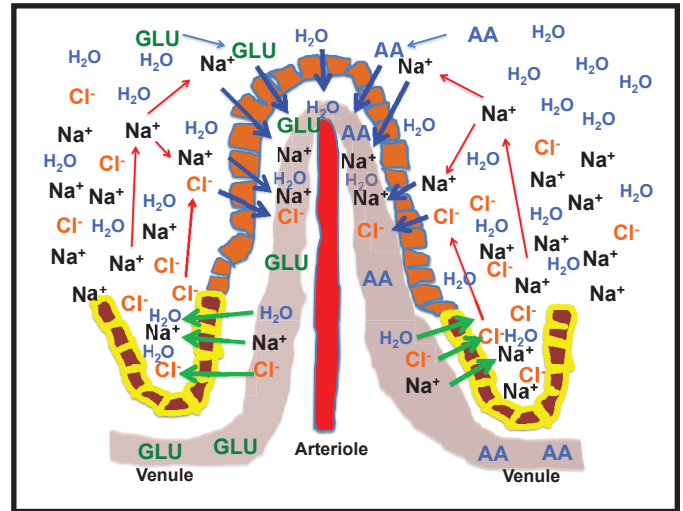

22

## Malabsorptive Diarrhea

Pathogens or toxins can destroy gut lining cells breaking barrier

- Salmonella
- E. Coli
- Rotavirus
- Coronavirus
- Campylobacter
- Clostridia
- Cryptosporidium

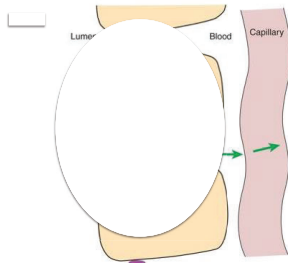

23

Gut pathogens may also invade blood vessels under the surface cells

= BLOODY DIARRHEA!!

Hallmark of a Severe Malabsorptive diarrhea!!!!

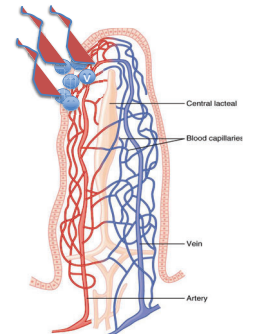
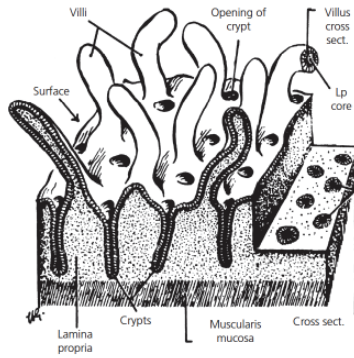

Figure 62-8; Guyton & Hall

24



**Figure 43.11** Three-dimensional representation of the small intestine lining. The villi are finger-like processes with cores of lamina propria that extend into the lumen. The crypts of Lieberkühn are depressions in the lamina propria (Lp). From Ham, A.W. (1974) *Histology*, 7th edn. I.B. Lippincott, Philadelphia. Reproduced with permission from Lippincott Williams & Wilkins.

25

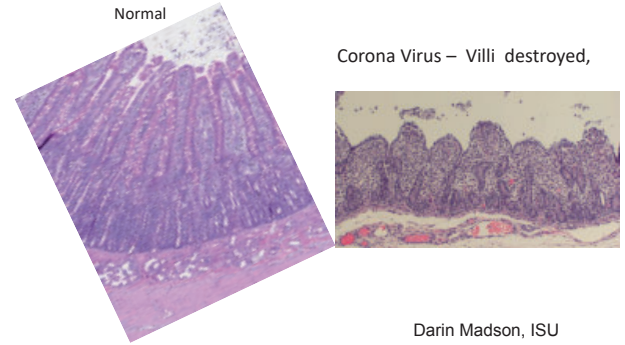

Darin Madson, ISU

26

### Parasitic Malabsorptive Diarrhea

#### Cryptosporidiosis

Takes 7 days for life cycle of parasite to be completed so diarrhea day 8-15.  
Lifelong immunity generally develops after an attack.

#### Coccidiosis—single cell eukaryote parasite

Attacks colon and cecum !!  
Takes 21 days for the life cycle of the parasite to be completed so diarrhea generally after day 25



27

### Cryptosporidiosis

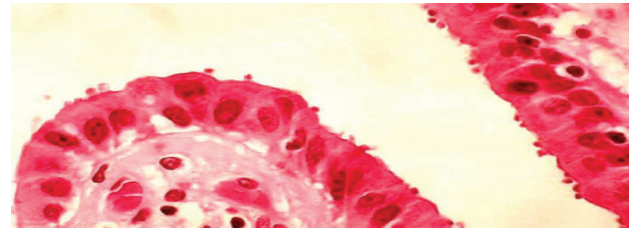

28

### Malabsorptive Diarrhea – general truths

#### Small Intestine

Pathogens affecting small intestine cause more severe dehydration than diseases of colon.

Small intestine pathogens will often leave the colon intact.

#### Large intestine

Colon pathogens often result in blood and lots of mucus in feces.

But since colon does not have same secretory capability as small intestine, dehydration tends to be less severe.

29

### Osmotic Diarrhea

Diet ingredients are not absorbed to an adequate extent or are non-absorbable

- their presence draws water into gut

#### Examples

- Milk of magnesia ( $Mg(OH)_2$ ) , epsom salts ( $MgSO_4$ )
- Prune juice – has sorbitol which is not absorbed well

CALVES- Inadequate absorption of nutrients due to

**Overfeeding**

30

## Neonates and Osmotic diarrhea

Natural suckling = small meals many times/day

Dairy calves – fed milk or MILK REPLACERS 2X/day.

Milk – casein protein forms curd to slow passage from abomasum.

Milk replacer – whey proteins do not form curd. Speeds rate at which they leave abomasum and reach intestine

Worsened if you try to compensate for cold weather and feed more milk replacer – but still feed 2x day!!

Or when you add more powder than called for → hypertonic and draws water into gut from blood

Overwhelm ability to digest lactose

→ osmotic diarrhea

31

Calves with diarrhea die from:

Dehydration

Acidosis and High blood potassium

- loss of suckle reflex, recumbency

Starvation (hypoglycemia)

Low Body Temperature (Hypothermia)



32

What can the calf with diarrhea absorb orally??

I will focus on calves less than 2 weeks of age

33

### 100 lb calf with diarrhea

Calf Health	% Dehydrated	Daily Milk	Oral Fluids	qts
Healthy calf	0%	4.4 kg	0 kg per day	
Mild diarrhea	2%	4.4 kg	1.1 kg per day	<b>1</b>
Mild diarrhea	4%	4.4 kg	2.2 kg per day	<b>2</b>
Depressed	6%	4.4 kg	3.3 kg per day	<b>3</b>
Very ill	8%	4.4 kg	4.4 kg per day	<b>4.5</b>
Recumbent	>10%	4.4 kg	Need intravenous fluids	

Geof Smith, UNC vet college

34

Diet Starch  
Diet Lactose

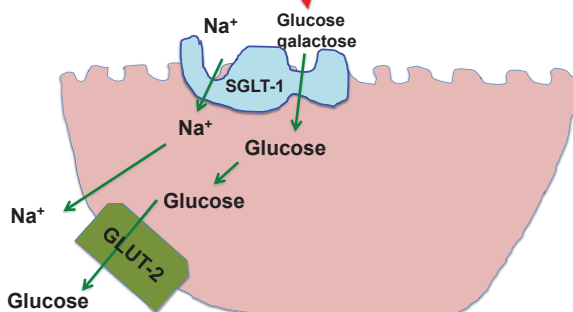

35

Proteins

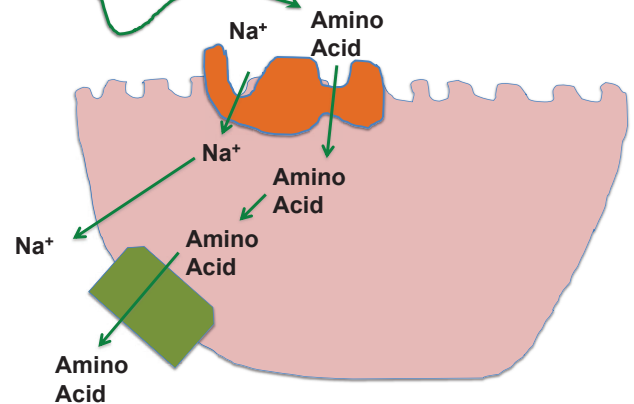

36

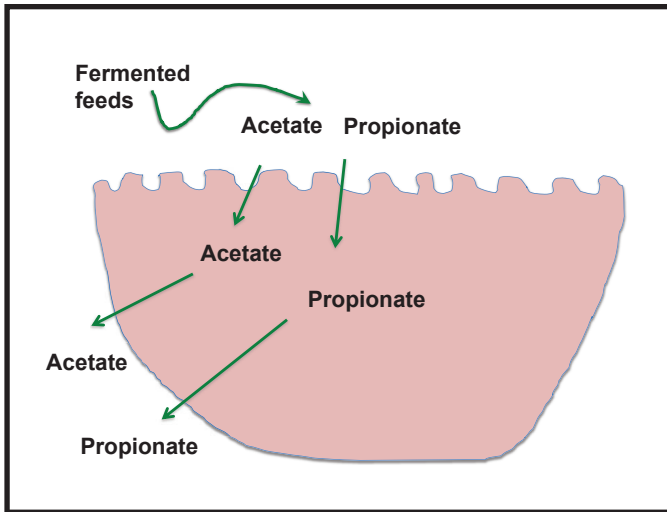

37

**COLON COMPENSATION**

Colon is usually intact - most viruses fairly specific for small intestine cells.

Colon can absorb some Na, Cl, K,  $\text{HCO}_3^-$  and water will follow.  
Colon absorbs acetate and propionate very well!!

Absorb electrolytes, acetate and propionate and water follows

BUT Colon has No ability to absorb sugars or amino acids .

38

**Oral Rehydration Therapy**

Na, K, Cl - Electrolytes to restore circulation if absorbed. Colon absorption still working!!

- Water
- Sodium (4-5%) (100 meq/L) - as NaCl, sodium bicarb, sodium citrate, sodium acetate
- Potassium (2-3%) (20-25 meq/L) - KCl
- Chloride (4-5%) (70-75 meq/L)

**Glucose (60-70 g / L) & Amino Acid (glycine) (30-60 g / L)**

Take advantage of Na-sugar and Na-amino acid transport mechanisms which are intact to get Na and chloride (and water) back into circulation

Also provides energy .

**Needs to have an alkalinizer to combat acidosis of blood**

Sodium Bicarbonate- fast acting but raises pH of gut  
Sodium acetate or sodium propionate → raise pH of blood only also provide energy  
acetate and propionate may slow Salmonella growth

Should be mildly Hypertonic – 400-450 mOsm

39

**Gel type Oral ReHydration products**

Usually have **psyllium** in them to increase thickening of manure  
- Manure looks good, but is it effective?

Blocks glucose absorption (Cebra et al., 1998)  
So calf isn't getting energy it needs

40

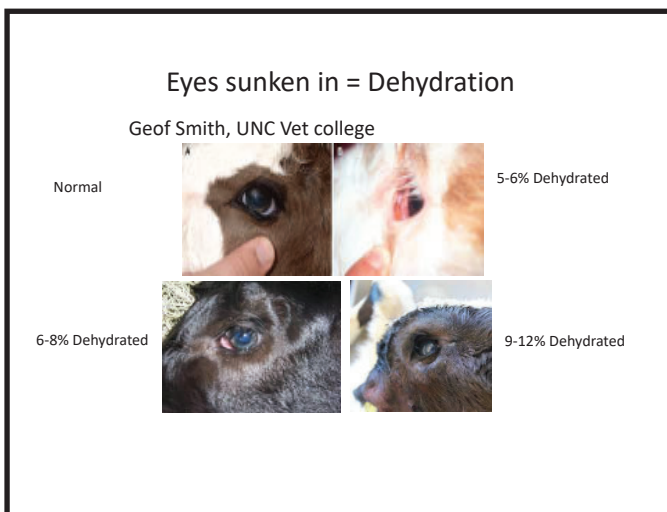

41



42

**Table 1:** Assessing Dehydration

Clinical Sign	Percent Dehydrated
Few clinical signs	<5%
Sunken eyes, skin tenting for 3-5 seconds	6-7%
Depression, skin tenting for 8-10 seconds, dry mucous membranes	8-10%
Recumbent, cool extremities, poor pulse	11-12%
Death	>12%

Source: Sheila M. McGuirk, DVM, PhD, and Pamela Ruegg, DVM, MPVM. University of Wisconsin-Madison

**100 lb calf with diarrhea**

Calf Health	% Dehydrated	Daily Milk	Oral Fluids	qts
Healthy calf	0%	4.4 kg	0 kg per day	
Mild diarrhea	2%	4.4 kg	1.1 kg per day	<b>1</b>
Mild diarrhea	4%	4.4 kg	2.2 kg per day	<b>2</b>
Depressed	6%	4.4 kg	3.3 kg per day	<b>3</b>
Very ill	8%	4.4 kg	4.4 kg per day	<b>4.5</b>
Recumbent	>10%	4.4 kg	Need intravenous fluids	

Geof Smith, UNC vet college

43

44

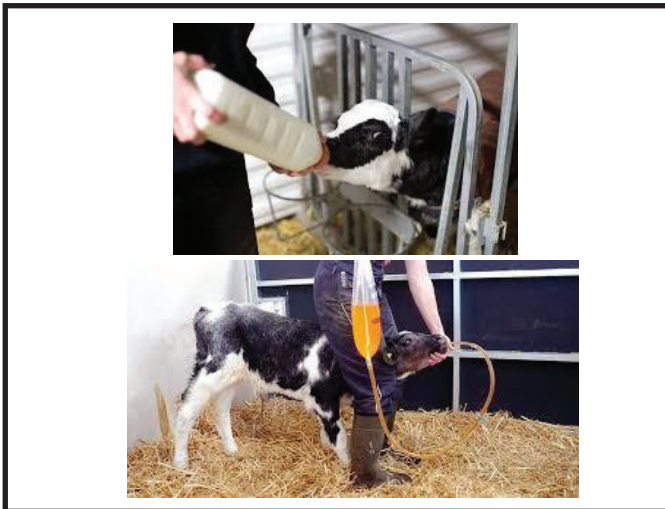

45

**Feed milk???**

Maybe we should give the intestine a break from milk digestion??

- seems like milk makes diarrhea worse
- giving bacteria food to grow
- milk slows intestinal healing

**NO EVIDENCE SUPPORTING ANY OF THESE REASONS**

46

**Feed Milk along with oral electrolytes**

Ideal

Feed milk and oral electrolytes several hrs apart

Most effective when fed in smaller and more frequent amounts!!!!

Withhold milk → calf starves!!!!

47

**electrolytes into milk?**

It raises osmolarity (saltiness) of the milk to the point that it makes scouring worse → osmotic diarrhea.

Hyperosmolarity can slow abomasal emptying → abomasal bloat (Nisbet & Constable, 2006)

sodium bicarbonate is main alkalinizer – it can interfere with milk protein digestion.

48

Probiotics ?  
Mannan oligosaccharides?  
Other support?  
-antibiotics, NSAIDs



49





# **The Use of Canola Meal in the Diets of Early Lactation Dairy Cows**

**Dr. Ken Kalscheur**  
**USDA Forage Research Center**



# The Use of Canola Meal in the Diets of Early Lactation Dairy Cows

Jordan M. Kuehn, University of Wisconsin, Madison, WI  
Kenneth F. Kalscheur, USDA-ARS Dairy Forage Research Center, Madison, WI  
kenneth.kalscheur@usda.gov

## TAKE-HOME MESSAGES

### SUMMARY

- Early lactation presents a unique set of challenges when formulating diets fed to dairy cows as they recover from calving, fend off numerous metabolic disorders, and increase milk production towards peak lactation
- Canola meal contains an amino acid profile with more methionine than other protein sources, such as soybean meal, making it an ideal protein source for early lactation diets
- 3.9 to 9.8 lb/d increase in milk yield for cows consuming diets supplemented with canola meal compared to soybean meal, based on 4 early-lactation studies
- Canola meal supplementation increases production efficiency, as evidenced by increased feed efficiency and decreased MUN

### EARLY LACTATION

Early lactation is unquestionably the most challenging time period of the lactation cycle for dairy cows from a metabolic standpoint. Generally regarded as the first 100 days of milk production, critical events such as the recovery from calving, weeks of negative energy balance, and peak milk production all occur during early lactation. Following parturition, the postpartum dairy cow is challenged with the task of supporting a rapid increase in milk production while concurrently burdened by heightened metabolic stressors, putting her at increased risk for metabolic disorders such as displaced abomasum, ketosis, mastitis, metritis, and milk fever. While these burdens are occurring, cows are also in a period of negative energy balance. This typically occurs during the first few weeks postpartum when the energetic and nutrient demands of milk production outpace nutrients provided via dry matter intake (Bauman and Currie, 1980). To remedy this nutritional deficiency, dairy cows mobilize adipose and skeletal muscle tissue to supply nutrients required for milk production. Approximately 18 to 46 pounds of skeletal muscle during the first 5 to 6 weeks of lactation (Komaragiri and Erdman, 1997; Komaragiri et al., 1998; Overton and Burhans, 2013) and 110 to 154 pounds of adipose tissue during the first 5 to 12 weeks of lactation (Komaragiri and Erdman, 1997) have been estimated to be mobilized. Moreover, the demand for glucose increases by more than 2 pounds per day during the first few days postpartum (Bertics et al., 1992; Reynolds et al., 2003). Considering the dramatic increase in nutrient demands to support milk production during early lactation, at the same time when dry matter intake is depressed, improved dietary formulations may alleviate these demands by affording the dairy cow a more favorable nutrient profile to utilize. Rapidly gaining popularity in dairy cow diets, canola meal (CM) is a protein supplement that holds potential towards achieving this goal. This paper will explore the utilization of CM in diets fed to early lactation dairy cows.

### AMINO ACIDS AND METHIONINE AS A METHYL DONOR

Historically, soybean meal (SBM), and to a lesser extent dried distillers grains and cottonseed meal, have been the predominant protein sources used to formulate diets fed to dairy cows. In recent years, however, CM has rapidly gained popularity as an alternative protein source. Between the crop years 2014/2015 and 2017/2018, the total meal export from Canada, the world's leading canola producer, to the United States and China increased by more than 25% (Canola Council of Canada, 2019). These protein sources differ in their overall nutrient profile, with special consideration given to their respective amino acid profiles when formulating diets. An optimal balance of amino acids supplied via the diet is critical to optimize milk protein production. Of the 20 amino acids used to synthesize milk protein, lysine and methionine are generally recognized as the two most limiting. Therefore, incorporation of protein sources that contain ideal amounts of lysine and methionine for milk protein production is advantageous. The crude protein in cow's milk contains 7.7% lysine and 2.7% methionine, which equates to a ratio of approximately 2.85:1 lysine to methionine (NRC, 2001). On a crude protein basis, CM contains 5.62% lysine and 1.87% methionine (3.01:1 ratio), whereas SBM (48% CP, solvent extracted) contains 6.29% lysine and 1.44% methionine (4.37:1 ratio; NRC, 2001). From these calculated values, it is clear that CM contains a ratio of lysine to methionine that is more ideal for milk protein synthesis compared to SBM. Furthermore, it is the increased methionine content of CM that is contributing to this more ideal ratio.

While methionine is one of the two amino acids generally recognized as most limiting for milk protein synthesis, the benefits of increased methionine concentration in the diet reach far beyond this. These far-reaching effects stem from methionine's role as a methyl donor and its ability to alter DNA and proteins in the cow. As a methyl donor, methionine is known to improve liver and immune function (Osorio et al., 2013; Zhou et al., 2017), decrease the risk of ketosis (Osorio et al., 2013), decrease inflammation (Batistel et al., 2018), decrease oxidative stress (Batistel et al., 2018), and positively alter pregnancy and offspring metabolism and growth (Acosta et al., 2016; Toledo et al., 2017). Given these benefits, the overall well-being of the periparturient and early lactation dairy cow, under the concurrent stressors of recovering from calving while increasing milk production, should improve from increased methionine concentration in the diet. This can be achieved by substitution of protein sources in the diet, i.e. CM in the place of SBM.

## EARLY LACTATION STUDIES

Due to the various challenges of early lactation dairy cow studies, only a handful of CM feeding studies have been conducted thus far. Utilizing 79 multiparous Holstein cows from calving through 16 weeks of lactation, Moore and Kalscheur (2016) tested the effects of low (16.2%) and high (18.1%) crude protein diets formulated with either SBM or CM as the main protein source. The diets contained a 55:45 forage to concentrate ratio, with 39.6% corn silage and 15.4% alfalfa silage. Canola meal was included at 11.9% and 19.4% DM, whereas SBM was included at 8.9% and 14.5% DM for the low and high CP diets, respectively. Cows consuming diets formulated with CM increased milk yield compared to cows consuming diets formulated with SBM (mean  $\pm$  SEM; 122.5 vs. 112.7  $\pm$  2.13 lb/d). Furthermore, ECM and FCM were both increased in cows consuming the CM diets compared to the SBM diets (126.7 vs. 117.9  $\pm$  3.04 lb/d and 120.9 vs. 112.2  $\pm$  3.00 lb/d, respectively). While the cows consuming the CM diets tended to have increased DMI compared to the cows consuming the SBM diets (56.8 vs. 55.0  $\pm$  0.75 lb/d), this increase is not enough to support the level of increased milk production. Furthermore, there was no difference in body weight or body condition score throughout the experiment to compensate for this discrepancy. These data suggest that cows consuming CM-based diets utilized dietary nutrients more efficiently for milk production compared to the cows consuming SBM-based diets. This is reflected in the increased feed efficiency (ECM/DMI) for cows consuming the CM diets compared to the SBM diets (2.27 vs. 2.16  $\pm$  0.06). Furthermore, cows consuming CM-based diets decreased MUN compared to cows consuming SBM-based diets (10.9 vs. 11.4  $\pm$  0.2 mg/dL). This indicates a more efficient use of nitrogen in the diets. There was no difference in milk fat, protein, or lactose percentage between cows consuming the CM-based or SBM-based diets. However, cows consuming the CM diets had increased milk fat, protein, and lactose yields over cows fed the SBM-based diet because of the increase in milk yield.

After observing a production increase of 9.8 lb/d for cows consuming diets formulated with CM compared to diets formulated with SBM in Moore and Kalscheur (2016), a subsequent study by Kuehnl and Kalscheur (2021) further explored CM supplementation during early lactation. However, Kuehnl and Kalscheur (2021) additionally sought to determine the effect of CM supplementation during the close-up dry period on milk production and related measurements. Eighty multiparous Holstein cows were fed isonitrogenous diets containing either SBM or CM as the primary protein source from 3 weeks prepartum through 16 weeks of lactation. From 3 weeks prepartum through calving, 40 cows consumed the diet containing SBM, whereas the other 40 cows consumed the diet containing CM. At calving, half of the cows consuming each of the prepartum diets switched to the postpartum diet containing the other protein source, whereas the other half remained on the diet with the same protein source. There were 4 treatment groups of 20 cows each, 1) SBM pre- and postpartum, 2) SBM pre- and CM postpartum, 3) CM pre- and SBM postpartum, and 4) CM pre- and postpartum. A transition diet was fed for the first three weeks postpartum, with the objective of this diet being to include more crude protein to support milk production and less starch to minimize the possibility of metabolic disorders. Canola meal was included at 19.4%, 16.5%, and 13.5% of the diet (DM basis), whereas SBM was included at 14.2%, 12.1%, and 9.9% in the close-up, transition, and lactating diets, respectively. The close-up, transition, and lactating diets contained 14.5%, 17.7%, and 17.2% crude protein on a DM basis, respectively. Cows consuming the CM diet postpartum tended to have increased milk yield compared to cows consuming the SBM diet postpartum (116.2 vs. 112.2  $\pm$  1.58 lb/d). Cows consuming the CM diets had increased dry matter intake both prepartum (33.7 vs. 31.9  $\pm$  0.57 lb/d) and postpartum (57.6 vs. 55.0  $\pm$  0.79 lb/d). There was no difference in ECM, FCM, or feed efficiency between diets. Prepartum supplementation of CM had no effect on milk yield despite the prepartum increase in dry matter intake. Unlike Moore and Kalscheur (2016), Kuehnl and Kalscheur (2021) observed no difference in milk fat, protein, or lactose yields. Moreover, there was no difference in milk fat, protein, or lactose percentages. However, cows consuming CM postpartum had decreased MUN compared to cows consuming SBM postpartum (12.9 vs. 13.7  $\pm$  0.22 mg/dL), which is in agreement with Moore and Kalscheur (2016) and other CM feeding studies (Maxin et al., 2013; Acharya et al., 2015).

A study by Gauthier et al. (2019) examined the role of CM supplementation on a 5,000 Holstein cow dairy farm in California. In Gauthier et al. (2019), three pens of early lactation, multiparous Holstein cows were used to test the effects of three isonitrogenous diets containing increasing concentrations of CM. Cows were eligible to move into one of the

three pens at 12 DIM and to move out of the pen at 160 DIM. The three diets contained 3.5% and 7% (diet 1), 8.2% and 3.5% (diet 2), and 13.0% and 0% (diet 3) CM and SBM, respectively, on a dry matter basis. Corn dried distillers grain with solubles was included at a constant rate of 7.5% of diet DM. Interestingly, while dry matter intake was not different between diets, cows consuming diets 2 and 3 had increased milk yield compared to diet 1 (98.6 vs. 97.9 vs. 93.1 lb/d). Milk fat, true protein, and lactose yields were all increased in cows consuming diets 2 and 3 compared to diet 1 as well. Similar to the data set from Moore and Kalscheur (2016), these results suggest more efficient nutrient utilization in the cows consuming diets 2 and 3, i.e. the diets containing 8.2% and 13.0% CM, compared to diet 1, i.e. the 3.5% CM diet. Furthermore, body condition score and change in body condition score (units/30 days) were both highest in diet 3 compared to diets 1 and 2. Considering the milk production and body condition score data together, it may be inferred that the cows consuming diet 3 (the 13.0% CM diet) were in a less negative energy balance compared to cows consuming diets 1 and 2 (the 3.5% and 8.2% CM diets).

Following up the study of Gauthier et al. (2019), Swanepoel et al. (2020) sought to further determine the effects of CM supplementation during early lactation in a commercial setting. Similar to the previous study, Swanepoel et al. (2020) utilized three pens of early lactation, multiparous Holstein dairy cows. Cows were assigned to one of the pens beginning at 13 DIM and remained on study until 160 DIM. There were three isonitrogenous diets tested, which included a diet with 14.5% CM (CM), a diet with 6.5% each of CM and SBM (SBM), and a diet with 6.5% each of CM and SBM supplemented with rumen protected methionine at a rate of 7.9 g/cow/day (SBM+M). There was no difference in dry matter intake between the three diets. Despite no difference in dry matter intake, milk yield was increased in the cows consuming the CM diet compared to cows consuming the SBM diet (112.9 vs. 109.0 ± 1.04 lb/d). Interestingly, there was no difference in milk production between the cows consuming the SBM and SBM+M diets. This suggests that either the amount of rumen protected methionine supplemented was not enough to elicit a production difference or that another intrinsic factor of CM was responsible for the increase in milk yield in this experiment. Furthermore, milk fat, true protein, and lactose yields were all increased in the cows consuming the CM diet compared to the SBM diet. There was no difference in body condition score or body condition score change in this experiment, potentially indicating no difference in energy balance between diets.

## CONCLUSION

Early lactation is the most challenging period of the lactation curve for dairy cows. Factors such as recovery from calving, a prolonged period of negative energy balance, and the rapid increase of milk yield all occur during this time. Improved ration formulation, by utilizing protein sources such as CM that better match the amino acid profile for milk production, is one time-tested approach to successfully overcoming this challenge. The limited number of CM feeding studies conducted during early lactation arrive at the consensus that milk yields are improved when CM is incorporated into the ration. Other benefits of CM supplementation include increased production efficiency, which is achieved through increased feed efficiency and decreased MUN. Further research is necessary to determine how to best incorporate CM into early lactation dairy cow rations.

## REFERENCES

- Acharya, I. P., D. J. Schingoethe, K. F. Kalscheur, and D. P. Casper. 2015. Response of lactating dairy cows to dietary protein from canola meal or distillers' grains on dry matter intake, milk production, milk composition, and amino acid status. *Can. J. Anim. Sci.* 95:267-279.
- Acosta, D. A. V., M. I. Rivelli, C. Skenandore, Z. Zhou, D. H. Keisler, D. Luchini, M. N. Corrêa, and F. C. Cardoso. 2017. Effects of rumen protected methionine and choline supplementation on steroidogenic potential of the first postpartum dominant follicle and expression of immune mediators in Holstein cows. *Theriogenology*. 96:1-9.
- Batistel, F., J. M. Arroyo, C. I. M. Garces, E. Trevisi, C. Parys, M. A. Ballou, F. C. Cardoso, and J. J. Loor. 2018. Ethyl-cellulose rumen-protected methionine alleviates inflammation and oxidative stress and improves neutrophil function during the periparturient period and early lactation in Holstein dairy cows. *J. Dairy Sci.* 101(1):480-490.
- Bauman, D. E., and W. B. Currie. 1980. Partitioning of nutrients during pregnancy and lactation: A review of mechanisms involving homeostasis and homeorhesis. *J. Dairy Sci.* 63(9):1514-1529.
- Bertics, S. J., R. R. Grummer, C. Cardoniga-Valino, and E. E. Stoddard. 1992. Effect of prepartum dry matter intake on liver triglyceride concentration and early lactation. *J. Dairy Sci.* 75(7):1914-1922.
- Canola Council of Canada. 2019. CM dairy feed guide. 6th ed. Manitoba, Canada.
- Gauthier, H., N. Swanepoel, and P. H. Robinson, 2019. Impacts of incremental substitution of SBM for CM in lactating dairy cow diets containing a constant base level of corn derived dried distillers' grains with solubles. *Anim. Feed Sci. Tech.* 252:51-63
- Komaragiri, M. V., and R. A. Erdman. 1997. Factors affecting body tissue mobilization in early lactation dairy cows. 1. Effect of dietary protein on mobilization of body fat and protein. *J. Dairy Sci.* 80(5):929-937.

- Komaragiri, M. V., D. P. Casper, and R. A. Erdman. 1998. Factors affecting body tissue mobilization in early lactation dairy cows. 2. Effect of dietary fat on mobilization of body fat and protein. *J. Dairy Sci.* 81(1):169-175.
- Kuehn, J. M., and K. F. Kalscheur. 2021. Production and temporal plasma metabolite effects of SBM versus CM fed to dairy cows during the transition period and early lactation. Presented at the ADSA 2021 Virtual Annual Meeting, July 11-14, 2021.
- Maxin, G., D. R. Ouellet, and H. Lapierre. 2013. Effect of substitution of soybean meal by canola meal or distillers grains in dairy rations on amino acid and glucose availability. *J. Dairy Sci.* 96(12):7806-7817.
- Moore, S. A. E. and K. F. Kalscheur. 2016. CM in dairy cow diets during early lactation increases production compared to SBM. *J. Dairy Sci.* 99 (E-Suppl. 1):719. (Abstr.) Presented at the 2016 Joint Annual Meeting of ADSA/ASAS in Salt Lake City, July 19-23, 2016.
- National Research Council. 2001. *Nutrient Requirements of Dairy Cattle*. 7th rev. ed. Natl. Acad. Sci., Washington, DC.
- Osorio, J. S., P. Ji, J. K. Drackley, D. Luchini, and J. J. Loo. 2013. Supplemental Smartamine M or MetaSmart during the transition period benefits postpartal cow performance and blood neutrophil function. *J. Dairy Sci.* 96(10):6248-6263.
- Overton, T. R., and W. S. Burhans. 2013. Protein and amino acid nutrition of the transition cow. *Proc. Cornell Nutr. Manage. Conf.*
- Reynolds, C. K., P. A. Aikman, B. Lupoli, D. J. Humphries, and D. E. Beever. 2003. Splanchnic metabolism of dairy cows during the transition from late gestation through early lactation. *J. Dairy Sci.* 86(4):1201-1217.
- Swanepoel, N., P. H. Robinson, and A. Conley. 2020. Impacts of substitution of CM with SBM, with and without ruminally protected methionine, on production, reproduction and health of early lactation multiparous Holstein cows through 160 days in milk. *Anim. Feed Sci. Tech.* 264: 114494.
- Toledo, M. Z., G. M. Baez, A. Garcia-Guerra, N. E. Lobos, J. N. Guenther, E. Trevisol, D. Luchini, R. D. Shaver, and M. C. Wiltbank. 2017. Effect of feeding rumen-protected methionine on productive and reproductive performance of dairy cows. *PLoS One.* 12(12): e0189117.
- Zhou, Z., E. Trevisi, D. N. Luchini, and J. J. Loo. 2017. Differences in liver functionality indexes in periparturient dairy cows fed rumen-protected methionine or choline are associated with performance, oxidative stress status, and plasma amino acid profiles. *J. Dairy Sci.* 100(8):6720-6732.

# 2021 Speakers



## **Matt Akins**

Matt Akins is an extension dairy specialist and assistant scientist at the University of Wisconsin Madison. Matt's work focuses on dairy heifer nutrition and health including the use of sorghum forages, roughage sources, grazing and coccidiosis control. He is originally from Sussex, WI and obtained a BS in Animal Science from UW-Platteville, MS in Animal Science from University of Arkansas, a PhD in Dairy Science from UW-Madison.

## **Dr. Phil Cardoso**

Dr. Phil Cardoso is an associate professor at the University of Illinois at Urbana-Champaign. He received his D.V.M., and M.S. degrees from the Universidade Federal Do Rio Grande do Sul in Brazil, and his Ph.D. from the University of Illinois. Since 2012, Cardoso has established a unique program that seamlessly blends his teaching, extension, and research efforts. Phil's Dairy Science program impact by placing students in applied positions and academia. Phil and his students have published over 75 peer-reviewed manuscripts (original research and invited reviews) and 3 invited book chapters to date. The program builds from dairy producers' questions and focuses on having the dairy cow's diet as a medical prescription for performance, health, and reproduction. That is achieved by understanding the impact of nutrition on metabolism, reproduction, and health in dairy cows and mechanisms of metabolic adaptation to stressors and forage quality.



## **Dr. Devan Paulus Compart**

March 1st, 2021, Dr. Devan Paulus Compart joined the North American Animal Nutrition team as Ruminant Business Development Manager. In this capacity she will support Evonik's Animal Nutrition business by working with farmers, nutritionists, feed producer and distributors on the concepts and use of feed additives in dairy and beef cattle diets. This includes the coordination of sales, marketing, technical services and communication activities with respect to Evonik's ruminant business.

Dr. Paulus Compart obtained her Bachelor's degree from the University of California Davis in the area of animal science with a focus on ruminant nutrition. Her Master's and PhD were both obtained from the University of Minnesota in ruminant nutrition. While attending the University of Minnesota, she was also an active member of the state-wide beef extension team.

## **James K. Drackley, Ph.D.**

Dr. Drackley is Professor of Animal Sciences at the University of Illinois at Urbana-Champaign, USA. His research program has focused on nutrition and metabolism of dairy cows during the transition from pregnancy to lactation, fat utilization and metabolism, and aspects of calf nutrition and management. Dr. Drackley has published extensively, has supervised more than 45 post-graduate students to MS or PhD degrees, and has received numerous professional awards. Drackley is widely sought by the global dairy industry for speaking and consulting services. He is currently serving on the National Academies of Science, Engineering, and Medicine committee to prepare the 8th edition of Nutrient Requirements of Dairy Cattle.





### **Dr. Luiz Ferraretto**

Dr. Luiz Ferraretto is originally from Brazil where he earned his B.S. in Animal Science from São Paulo State University in 2008. Immediately after the completion of his B.S. Degree, Luiz joined University of Wisconsin-Madison for an internship (2009) followed by a M.S. (2011) and Ph.D. (2015) in dairy science with focus on applied dairy nutrition and forage quality. After the completion of his Ph.D., Luiz joined The William H. Miner Agricultural Research Institute as a Post-doctoral Research Associate. From 2016 to 2020, he worked as Assistant Professor of Livestock Nutrition at University of Florida. Currently, Luiz is an Assistant Professor and Ruminant Nutrition Extension Specialist in the Department of Animal and Dairy Sciences at University of Wisconsin-Madison and his research interests are applied dairy cattle nutrition and management with emphasis on starch and fiber utilization by dairy cows, corn silage and high-moisture corn quality and digestibility, the use of alternative by-products as feed ingredients, and supplementation of feed additives to lactating cows.

### **Dr. Paul Fricke**

Dr. Paul Fricke was raised on his family’s row crop and dairy farm located near Papillion, Nebraska where his father and uncle continue to farm today. After receiving a B.S. degree in Animal Science in 1988 from the University of Nebraska, Paul went on to complete a M.S. degree in 1992 and a Ph.D. degree in 1996 in Reproductive Physiology from the department of Animal Sciences at North Dakota State University. Paul joined the faculty at the University of Wisconsin-Madison in 1998. His current position includes 70% Extension and 30% research appointments in dairy cattle reproduction. Dr. Fricke’s research program focuses on understanding the biology underlying the many reproductive problems of dairy cattle. The goal of Dr. Fricke’s extension program is to improve reproductive efficiency of dairy cattle by applying scientific research to develop practical management strategies and assess new reproductive technologies.



### **Dr. Brian Gerloff**

Brian Gerloff was born and grew up on a small dairy farm in Woodstock, Illinois, where he currently lives. He attended Michigan State University and earned degrees in dairy science and veterinary medicine. After working in Ohio for several years, he returned to Michigan State and received a PhD in dairy nutrition, while concurrently working as a resident in the Large Animal Department.

He then established a veterinary practice in his home area of Illinois providing both veterinary and nutritional services to much of his clientele. After 25 years, in 2012 he transitioned to a full time position as a nutritional consultant, working with Renaissance Nutrition in southern Wisconsin, northern Illinois and eastern Iowa.

He has been active and held leadership positions locally in his church and community and nationally in the American Association of Bovine Practitioners. He has been honored with awards from the American Association of Bovine Practitioners, Michigan State University, the University of Illinois, and the Illinois Association of School Boards and has maintained a passion for working with dairies for his entire career that continues today. He is married to Carole, a kindergarden teacher, with twin sons Robert and Joseph who are still in high school and thinking they are likely not going to be dairy veterinarians.

### **Dr. Jesse Goff**

Goff received his BS from Cornell University, and MS, DVM, and PhD degrees from Iowa State University. He worked for the USDA at the National Animal Disease Center in IA for 23 years, studying causes, treatments and prevention of milk fever and other metabolic and mineral disorders of cattle hogs and poultry. In addition Goff studied the immune responses of cattle, especially how the immune system was affected by metabolic diseases. Goff worked for the West Central Farmer’s co-operative to help them refine Soychlor and Soyplus products and work with their clients as a nutritional consultant. In 2008, Goff started teaching and doing research at the Iowa State University College of Veterinary Medicine, where he taught Physiology courses and a Veterinary Nutrition course and took part in clinical rotations with the 4th year veterinary students. Goff is now professor emeritus at Iowa State and runs his veterinary consulting practice out of his barn in Gilbert IA, where he and wife Sandy have one child at home and 3 more grown-up children.





### **Dr. Mark Hanigan**

Dr. Hanigan began his career as a dairy farmer in Western Iowa followed by a B.S. in Dairy Science from Iowa State University, an M.S. in Animal Science from UC-Davis, a Ph.D. in Nutrition from UC-Davis, and post-doctoral work in Biochemistry and Biophysics at UC-Davis. He joined the Dairy Research group at Purina Mills in 1993 and moved to the Dept. of Dairy Science at Virginia Tech in 2005.

He works in the area of nutrient metabolism using experimental and mathematical modeling approaches focusing on protein and energy metabolism. The long-term objective of his work is to improve animal efficiency and reduce the impact of animal-based production systems on the environment while maintaining a viable industry.

He is a member of the current NRC Nutrient Requirements of Dairy Cattle rewrite committee, and the chair of the National Animal Nutrition Program Modeling Subcommittee. He is an author or co-author of more than 120 peer-reviewed research publications.

### **Dr. Laura L. Hernandez**

Dr. Laura L. Hernandez is an Associate Professor in the Department of Animal and Dairy Sciences at the University of Wisconsin-Madison. She received her Ph.D. in 2008 from the University of Arizona and completed her Post-Doctoral Fellowship at the University of Cincinnati in 2011. Laura's area of research has focused on how serotonin controls the mammary gland's ability to make milk and various aspects of lactation. Dr. Hernandez combines basic research from the cell to whole-animal level in a variety of mammalian species to broaden the focus on the importance of the mammary gland and its contributions to and regulation of a successful lactation in dairy cattle. The outcomes of her novel research are aimed at understanding how serotonin control the cow's physiology while lactating, particularly during the transition period when cows are the most metabolically and physiologically challenged. She specifically focuses on the interaction of serotonin and calcium metabolism during the transition period and how we can better manage calcium around the time of calving to optimize cow health and production. Her research has determined that serotonin is an important regulator of mammary gland and maternal calcium homeostasis during lactation.



### **Jay Joy**

Jay Joy has spent his entire career focused on the business of agriculture. He is currently the General Manager of Pagel Family Businesses, LLC., which own/operate 2 large dairies, a calf ranch, and a large crop farming enterprise in Northeast Wisconsin. Jay is also the founder of Milk Money, LLC., a financial and management coaching practice focused exclusively on helping farmers make more profit by developing their people. Prior to starting Milk Money, Jay spent nearly 10 years in banking with several leading financial institutions where he financed and advised a number of large commercial dairies, cattle feeders, and grain companies. In addition to his banking and coaching experience, Jay has been fortunate to spend time in his career as the General Manager of 2 large dairies and a heifer ranch in Southwest Kansas, and as the CFO of a large corn and alfalfa farm in North Central Kansas. A native Kansan, Jay completed his undergraduate degree at Fort Hays State University, his MBA at the University of Nebraska-Lincoln, and executive development programs at Cornell University and the University of Wisconsin-Madison.

### **Dr. Kenneth Kalscheur**

Kenneth Kalscheur received his B.S. in Dairy Science from the University of Wisconsin-Madison, and his M.S. and Ph.D. degrees in Animal Science from the University of Maryland. From 2001 to 2014, Kenneth F. Kalscheur was a Professor of Dairy Science at South Dakota State University. His appointment at South Dakota State University consists of teaching dairy science courses and conducting research on dairy cattle nutrition and management. Since 2014, Dr. Kalscheur is a Research Animal Scientist at USDA-Agricultural Research Service, U.S. Dairy Forage Research Center in Madison, Wisconsin. Research conducted by Dr. Kalscheur includes utilization of forages and agro-industry coproducts in dairy cattle diets to improve milk production and nutrient utilization by dairy cattle and the environmental impact of animal management and feeding practices in dairy production systems.





## Lee Kloeckner

Lee's dairy experience began when he was in middle school by working on a neighbor's dairy farm and continued there through his first year of college. While attending the University of Minnesota for a degree in animal science, he had internships as an AI technician and a herdsman on a 350-cow dairy. After graduating with his bachelor's degree in 2014, Lee stayed at the U of M for his master's degree working with Dr. Marcia Endres. His Master's project was a dairy management survey of 84 Minnesota dairy farms ranging from 150 to 2100 cows. Following the completion of his master's degree, Lee began working at Ag Partners Coop in the fall of 2016 where he works as a Dairy Nutrition and Production Specialist in Southeast Minnesota and Western Wisconsin. Lee and his wife Aly reside outside of Red Wing, MN.



## Dr. James Koltes

Dr. James Koltes is an Assistant Professor in the Department of Animal Science within the Animal Breeding and Genetics group at Iowa State University. Dr. Koltes received his BS in Dairy Science and Genetics from the University of Wisconsin-Madison and PhD from Iowa State University in Genetics. His research at focuses on the use of new tools such as sensors and biomarkers in the genetic improvement of feed efficiency and health in dairy cattle. He also works on development of computational tools and resources to advance the application of genomics in livestock breeding.

## Dr. Derek Nolan

Derek Nolan grew up on a dairy farm in Northeast Iowa. Derek received his BS in Dairy Science at Iowa State University and completed both his MS and Ph.D. at Kentucky with a research focus in milk quality and decision economics. He is now a Teaching Assistant Professor and Dairy Extension Specialist in the Animal Sciences Department at the University of Illinois. Derek strives to help dairy producers reach their goals by providing tools to assist them in making informed management decisions and improving milk quality. He focuses on providing hands-on experiences that help youth better understand the dairy cow and dairy production system.



## Theresa Ollivett, DVM, PhD, DACVIM (Large Animal)

Assistant Professor in Food Animal Production Medicine section at UW-Madison School of Veterinary Medicine

Dr. Ollivett is a veterinary epidemiologist and board-certified large animal internist. After graduating from the College of Veterinary Medicine at Cornell University in 2004, Dr. Ollivett practiced in a predominantly mixed large animal clinic in northern NY. She returned to Cornell University in 2007 and completed a residency in Large Animal Medicine between 2008-2011. In 2014, she completed her doctoral studies at the University of Guelph by validating portable lung ultrasound as a means of diagnosing respiratory disease in dairy calves. As an assistant professor in the Food Animal Production Medicine section at the School of Veterinary Medicine at UW-Madison, Dr. Ollivett works to advance the academic, veterinary and professional dairy industry's awareness and understanding of lung ultrasound as a means to monitor preweaned calf lung health and promote a #WeanClean™ philosophy on dairy farms.

## **Dr. Larry Tranel**

Dr. Larry Tranel grew up on a Wisconsin dairy farm and has continued his dairy farm involvement with his extended family. Larry graduated from UW-Platteville with B.S. degrees in Agricultural Economics and International Studies, an M.S. in Ag Industries. Dr. Tranel also holds a doctorate in Pastoral Psychology. He spent 10 years with University of Wisconsin-Extension as a Dairy Farm Management Agent and the past 21 years as Dairy Field Specialist with Iowa State University Extension and Outreach specializing in low cost parlors, robotic milking, financial management and comparison of conventional, grazing, organic and grass milk systems. He is the main lead on Iowa's Farm Couple Getaways and spends approximately half of his time working with farm behavioral and brain health.



## **Dr. Bill Weiss**

Dr. Bill Weiss was a Professor and Extension Specialist of dairy cattle nutrition at The Ohio State University but after more than 33 years on faculty, he retired in early 2021. His main research areas were factors affecting digestibility by dairy cows, relationships between minerals and vitamins and health of dairy cows, and developing methods to incorporate cow and diet variability into ration formulation. Dr. Weiss has published more than 140 journal articles and 450 proceedings and extension articles. He has won several ADSA awards and was named a Fellow of the American Dairy Science Association in 2015. He is also a member of ARPAS and a Diplomat of the American College of Animal Nutrition. He was a member of the 2001 NRC Dairy Committee and is serving as co-chair on the 2020 NRC Dairy Committee.