

DENON

AV SURROUND RECEIVER

AVR-989

Owner's Manual

SAFETY PRECAUTIONS

CAUTION
RISK OF ELECTRIC SHOCK
DO NOT OPEN

CAUTION:
TO REDUCE THE RISK OF ELECTRIC SHOCK, DO NOT REMOVE COVER (OR BACK). NO USER-SERVICEABLE PARTS INSIDE. REFER SERVICING TO QUALIFIED SERVICE PERSONNEL.

The lightning flash with arrowhead symbol, within an equilateral triangle, is intended to alert the user to the presence of uninsulated "dangerous voltage" within the product's enclosure that may be of sufficient magnitude to constitute a risk of electric shock to persons.

The exclamation point within an equilateral triangle is intended to alert the user to the presence of important operating and maintenance (servicing) instructions in the literature accompanying the appliance.

WARNING:
TO REDUCE THE RISK OF FIRE OR ELECTRIC SHOCK, DO NOT EXPOSE THIS APPLIANCE TO RAIN OR MOISTURE.

SAFETY INSTRUCTIONS

1. Read Instructions – All the safety and operating instructions should be read before the product is operated.
2. Retain Instructions – The safety and operating instructions should be retained for future reference.
3. Heed Warnings – All warnings on the product and in the operating instructions should be adhered to.
4. Follow Instructions – All operating and use instructions should be followed.
5. Cleaning – Unplug this product from the wall outlet before cleaning. Do not use liquid cleaners or aerosol cleaners.
6. Attachments – Do not use attachments not recommended by the product manufacturer as they may cause hazards.
7. Water and Moisture – Do not use this product near water – for example, near a bath tub, wash bowl, kitchen sink, or laundry tub; in a wet basement; or near a swimming pool; and the like.
8. Accessories – Do not place this product on an unstable cart, stand, tripod, bracket, or table. The product may fall, causing serious injury to a child or adult, and serious damage to the product. Use only with a cart, stand, tripod, bracket, or table recommended by the manufacturer, or sold with the product. Any mounting of the product should follow the manufacturer's instructions, and should use a mounting accessory recommended by the manufacturer.
9. A product and cart combination should be moved with care. Quick stops, excessive force, and uneven surfaces may cause the product and cart combination to overturn.
10. Ventilation – Slots and openings in the cabinet are provided for ventilation and to ensure reliable operation of the product and to protect it from overheating, and these openings must not be blocked or covered. The openings should never be blocked by placing the product on a bed, sofa, rug, or other similar surface. This product should not be placed in a built-in installation such as a bookcase or rack unless proper ventilation is provided or the manufacturer's instructions have been adhered to.
11. Power Sources – This product should be operated only from the type of power source indicated on the marking label. If you are not sure of the type of power supply to your home, consult your product dealer or local power company. For products intended to operate from battery power, or other sources, refer to the operating instructions.
12. Grounding or Polarization – This product may be equipped with a polarized alternating-current line plug (a plug having one blade wider than the other). This plug will fit into the power outlet only one way. This is a safety feature. If you are unable to insert the plug fully into the outlet, try reversing the plug. If the plug should still fail to fit, contact your electrician to replace your obsolete outlet. Do not defeat the safety purpose of the polarized plug.
13. Power-Cord Protection – Power-supply cords should be routed so that they are not likely to be walked on or pinched by items placed upon or against them, paying particular attention to cords at plugs, convenience receptacles, and the point where they exit from the product.
15. Outdoor Antenna Grounding – If an outside antenna or cable system is connected to the product, be sure the antenna or cable system is grounded so as to provide some protection against voltage surges and built-up static charges. Article 810 of the National Electrical Code, ANSI/NFPA 70, provides information with regard to proper grounding of the mast and supporting structure, grounding of the lead-in wire to an antenna discharge unit, size of grounding conductors, location of antenna-discharge unit, connection to grounding electrodes, and requirements for the grounding electrode. See Figure A.
16. Lightning – For added protection for this product during a lightning storm, or when it is left unattended and unused for long periods of time, unplug it from the wall outlet and disconnect the antenna or cable system. This will prevent damage to the product due to lightning and power-line surges.
17. Power Lines – An outside antenna system should not be located in the vicinity of overhead power lines or other electric light or power circuits, or where it can fall into such power lines or circuits. When installing an outside antenna system, extreme care should be taken to keep from touching such power lines or circuits as contact with them might be fatal.
18. Overloading – Do not overload wall outlets, extension cords, or integral convenience receptacles as this can result in a risk of fire or electric shock.
19. Object and Liquid Entry – Never push objects of any kind into this product through openings as they may touch dangerous voltage points or short-out parts that could result in a fire or electric shock. Never spill liquid of any kind on the product.
20. Servicing – Do not attempt to service this product yourself as opening or removing covers may expose you to dangerous voltage or other hazards. Refer all servicing to qualified service personnel.
21. Damage Requiring Service – Unplug this product from the wall outlet and refer servicing to qualified service personnel under the following conditions:
 - a) When the power-supply cord or plug is damaged,
 - b) If liquid has been spilled, or objects have fallen into the product,
 - c) If the product has been exposed to rain or water,
 - d) If the product does not operate normally by following the operating instructions. Adjust only those controls that are covered by the operating instructions as an improper adjustment of other controls may result in damage and will often require extensive work by a qualified technician to restore the product to its normal operation,
 - e) If the product has been dropped or damaged in any way, and
 - f) When the product exhibits a distinct change in performance – this indicates a need for service.
22. Replacement Parts – When replacement parts are required, be sure the service technician has used replacement parts specified by the manufacturer or have the same characteristics as the original part. Unauthorized substitutions may result in fire, electric shock, or other hazards.
23. Safety Check – Upon completion of any service or repairs to this product, ask the service technician to perform safety checks to determine that the product is in proper operating condition.
24. Wall or Ceiling Mounting – The product should be mounted to a wall or ceiling only as recommended by the manufacturer.
25. Heat – The product should be situated away from heat sources such as radiators, heat registers, stoves, or other products (including amplifiers) that produce heat.

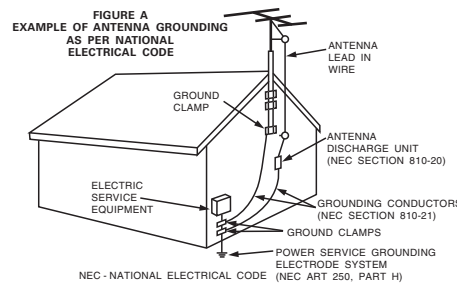

FCC INFORMATION (For US customers)

1. PRODUCT

This product complies with Part 15 of the FCC Rules. Operation is subject to the following two conditions: (1) this product may not cause harmful interference, and (2) this product must accept any interference received, including interference that may cause undesired operation.

2. IMPORTANT NOTICE: DO NOT MODIFY THIS PRODUCT

This product, when installed as indicated in the instructions contained in this manual, meets FCC requirements. Modification not expressly approved by DENON may void your authority, granted by the FCC, to use the product.

3. NOTE

This product has been tested and found to comply with the limits for a Class B digital device, pursuant to Part 15 of the FCC Rules. These limits are designed to provide reasonable protection against harmful interference in a residential installation.

This product generates, uses and can radiate radio frequency energy and, if not installed and used in accordance with the instructions, may cause harmful interference to radio communications. However, there is no guarantee that interference will not occur in a particular installation. If this product does cause harmful interference to radio or television reception, which can be determined by turning the product OFF and ON, the user is encouraged to try to correct the interference by one or more of the following measures:

- Reorient or relocate the receiving antenna.
- Increase the separation between the equipment and receiver.
- Connect the product into an outlet on a circuit different from that to which the receiver is connected.
- Consult the local retailer authorized to distribute this type of product or an experienced radio/TV technician for help.

This Class B digital apparatus complies with Canadian ICES-003.

Cet appareil numérique de la classe B est conforme à la norme NMB-003 du Canada.

NOTE ON USE / OBSERVATIONS RELATIVES A L'UTILISATION

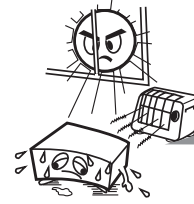

- Avoid high temperatures. Allow for sufficient heat dispersion when installed in a rack.
- Éviter des températures élevées. Tenir compte d'une dispersion de chaleur suffisante lors de l'installation sur une étagère.



- Keep the unit free from moisture, water, and dust.
- Protéger l'appareil contre l'humidité, l'eau et la poussière.



- Do not let foreign objects into the unit.
- Ne pas laisser des objets étrangers dans l'appareil.

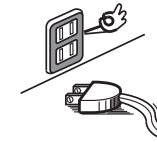

- Unplug the power cord when not using the unit for long periods of time.
- Débrancher le cordon d'alimentation lorsque l'appareil n'est pas utilisé pendant de longues périodes.

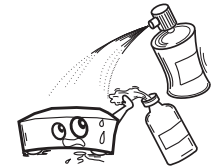

- Do not let insecticides, benzene, and thinner come in contact with the unit.
- Ne pas mettre en contact des insecticides, du benzène et un diluant avec l'appareil.

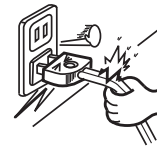

- Handle the power cord carefully. Hold the plug when unplugging the cord.
- Manipuler le cordon d'alimentation avec précaution. Tenir la prise lors du débranchement du cordon.



* (For apparatuses with ventilation holes)

- Do not obstruct the ventilation holes.
- Ne pas obstruer les trous d'aération.



- Never disassemble or modify the unit in any way.
- Ne jamais démonter ou modifier l'appareil d'une manière ou d'une autre.

□ Contents

Getting Started

Accessories	2
Cautions on Handling	3
Cautions on Installation	3
About the Remote Control Unit	3
Inserting the Batteries	3
Operating Range of the Remote Control Unit	3
Part Names and Functions	4
Front Panel	4
Display	5
Rear Panel	6
Remote Control Unit	7

Connections

Preparations	8
Cables Used for Connections	8
Video Conversion Function	9
On-Screen Display for Component Video Outputs and HDMI Output	9
Speaker Connections	9
Speaker Installation	9
Speaker Connections	10
Connecting Equipment with HDMI Connectors	11
Connecting the Monitor	12
Connecting the Playback Components	12
Blu-ray Disc Player / DVD Player	12
Record Player	13
CD Player	13
iPod®	13
TV/CABLE Tuner	14
Satellite Receiver	14
Connecting the Recording Components	15
Digital Video Recorder	15
Video Cassette Recorder	15
CD Recorder / MD Recorder / Tape Deck	16
Connections to Other Devices	16
Video Camera / Game Console	16
Component with Multi-channel Output Connectors	16
External Power Amplifier	17
Antenna Terminals	17
XM Connector	18
SIRIUS Connector	18
Multi-zone	19
External Controller	19
Connecting the Power Cord	20
Once Connections are Completed	20

Menu Operations

Operations	20
Example of Display of Default Values	21
Examples of On-screen Display and Front Display	21
Menu Map	22

Auto Setup

Preparations	23
Auto Setup	24
1 Start Menu	24
2 Parameter Check	26
Error Messages	26

Manual Setup

Speaker Setup	27
1 Speaker Configuration	27
2 Subwoofer Setup	28
3 Distance	28
4 Channel Level	28
5 Crossover Frequency	29
6 Front Speaker Setup	29
HDMI Setup	29
1 Color Space	29
2 RGB Range	29
3 Auto Lipsync	29
4 HDMI Audio Out	30
5 HDMI Control	30
6 Power Off Control	30
Audio Setup	30
1 EXT. IN Subwoofer Level	30
2 2ch Direct/Stereo	30
3 Dolby Digital Setup	31
4 Auto Surround Mode	31
5 EQ Preset	31
ZONE2 Setup	31
1 Level Lch	31
2 Level Rch	32
3 Volume Level	32
4 Volume Limit	32
5 Power On Level	32
6 Mute Level	32

Option Setup	32
1 Amp Assign	32
2 Volume Control	33
3 Source Delete	33
4 On-Screen Display	33
5 Quick Select Name	34
6 Trigger Out	34
7 Remote ID Setup	34
8 232C Port	34
9 Display	34
10 Setup Lock	34

Input Setup

Settings Related to Playing Input Sources	36
1 Auto Preset	36
2 Preset Skip	36
3 Preset Name	36
4 Video	36
5 Input Mode	37
6 Rename	38
7 Source Level	38
8 Assign	38
9 iPod	39
10 Antenna Aiming	39
11 Parental Lock	39

Surround Modes

① Standard Playback	40
Surround Playback of 2-channel Sources	40
Playing Multi-channel Sources (Dolby Digital, DTS, etc.)	41
② DSP Simulation Playback	41
③ Direct Playback	41
④ Stereo Playback	42
Playback in the PURE DIRECT Mode	42

Parameter

Adjusting the parameters	42
Surround Parameter	43
Surround Parameter	43
Tone	45
Audyssey Settings	45
RESTORER	47
Night Mode	47
Audio Delay	47

Information

Status	48
1 MAIN ZONE	48
2 ZONE2	48
Audio Input Signal	48
HDMI Information	49
1 HDMI Signal Information	49
2 HDMI Monitor Information	49
Auto Surround Mode	49
Quick Select	49
Preset Station	49

Playback

Preparations	50
Turning the Power On	50
Selecting the Input Source	50
Operations During Playback	50
Playing Video and Audio Equipment	51
Basic Operation	51
Listening to FM/AM Broadcasts	51
Basic Operation	51
Presetting Radio Stations (Preset Memory)	51
Listening to Preset Stations	52
Listening to XM Satellite Radio Programs	52
Basic Operation	52
Checking the XM Signal Strength and Radio ID	53
Presetting Radio Channels (Preset Memory)	53
Listening to Preset Channels	53
Searching Categories	54
Listening to SIRIUS Satellite Radio Programs	54
Basic Operation	54
Checking the SIRIUS Signal Strength and Radio ID	54
Presetting Radio Channels (Preset Memory)	54
Listening to Preset Channels	54
Searching Categories	55
Parental Lock	55
iPod® Playback	55
Basic Operation	55
Listening to Music	56
Viewing Still Pictures or Videos on the iPod	56

Other Operations and Functions

Other Operations	57
Playing Super Audio CD	57
Recording on an External Equipment (REC OUT mode)	57
Convenient Functions	58
HDMI Control Function	58
Channel Level	59
Fader Function	59
Quick Select Function	60
Personal Memory Plus Function	60
Last Function Memory	60
Backup Memory	60
Resetting the Microprocessor	60

Remote Control Unit Operations

Operating DENON Audio Components	61
Presetting	61
Operating Preset Components	61
Punch Through Function	64

Amp Assign / Multi-zone Connections and Operations

Multi-zone Settings with the Amp Assign Function	65
Multi-zone Settings and Operations with Zone Output	66
Multi-zone Operations	67
Turning the Power On and Off	67
Selecting the Input Source	67
Adjusting the Volume	67
Turning off the Sound Temporarily	67

Other Information

Troubleshooting

Specifications

List of preset codes

End of this manual

Getting Started

Thank you for purchasing this DENON product. To ensure proper operation, please read this owner's manual carefully before using the product.

After reading them, be sure to keep them for future reference.

Accessories

Check that the following parts are supplied with the product.

1 Owner's manual	1
2 Warranty (for North America model only)	1
3 Getting started	1
4 Service station list	1
5 Power cord (Cord length: Approx. 6.2 ft / 1.9 m)	1
6 Remote control unit (RC-1105)	1
7 R6/AA batteries (for RC-1105)	2
8 FM indoor antenna	1
9 AM loop antenna	1
10 Setup microphone (DM-A409, Cord length: Approx. 25 ft / 7.6 m)	1

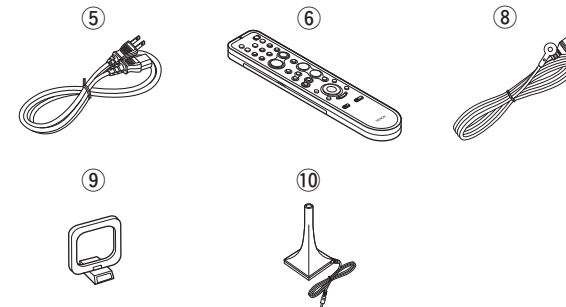

Cautions on Handling

• Before turning the power switch on

Check once again that all connections are correct and that there are no problems with the connection cables.

- Power is supplied to some of the circuitry even when the unit is set to the standby mode. When traveling or leaving home for long periods of time, be sure to unplug the power cord from the power outlet.

• About condensation

If there is a major difference in temperature between the inside of the unit and the surroundings, condensation (dew) may form on the operating parts inside the unit, causing the unit not to operate properly.

If this happens, let the unit sit for an hour or two with the power turned off and wait until there is little difference in temperature before using the unit.

• Cautions on using mobile phones

Using a mobile phone near this unit may result in noise. If so, move the mobile phone away from this unit when it is in use.

• Moving the unit

Turn off the power and unplug the power cord from the power outlet.

Next, disconnect the connection cables to other system units before moving the unit.

- Note that the illustrations in these instructions may differ from the actual unit for explanation purposes.

Cautions on Installation

Note:

For proper heat dispersal, do not install this unit in a confined space, such as a bookcase or similar enclosure.

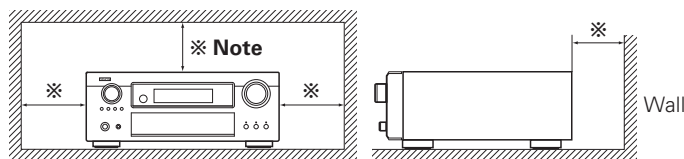

About the Remote Control Unit

In addition to the AVR-989, the included remote control unit (RC-1105) can also be used to operate the equipment listed below.

- ① DENON system components
- ② Non-DENON system components
 - By setting the preset memory (page 61 ~ 63)

Inserting the Batteries

- ① Lift the clasp and remove the rear cover.

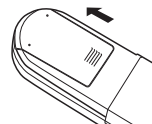

- ② Load the two batteries properly as indicated by the marks in the battery compartment.

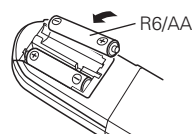

- ③ Put the rear cover back on.

NOTE

- Replace the batteries with new ones if the set does not operate even when the remote control unit is operated close to the unit.
- The supplied batteries are only for verifying operation.
- When inserting the batteries, be sure to do so in the proper direction, following the “⊕” and “⊖” marks in the battery compartment.
- To prevent damage or leakage of battery fluid:
 - Do not use a new battery together with an old one.
 - Do not use two different types of batteries.
 - Do not attempt to charge dry batteries.
 - Do not short-circuit, disassemble, heat or dispose of batteries in flames.
- If the battery fluid should leak, carefully wipe the fluid off the inside of the battery compartment and insert new batteries.
- Remove the batteries from the remote control unit if it will not be in use for long periods.
- When replacing the batteries, have the new batteries ready and insert them as quickly as possible.

Operating Range of the Remote Control Unit

Point the remote control unit at the remote sensor when operating it.

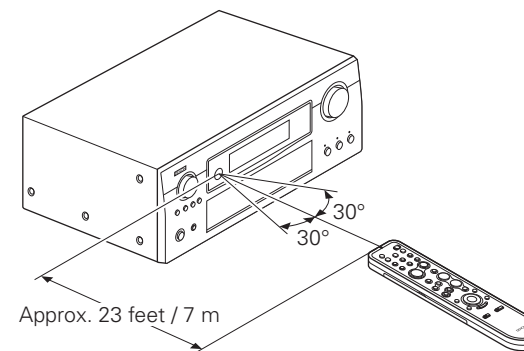

NOTE

The set may function improperly or the remote control unit may not operate if the remote control sensor is exposed to direct sunlight, strong artificial light from an inverter type fluorescent lamp or infrared light.

Part Names and Functions

For buttons not explained here, see the page indicated in parentheses ().

Front Panel

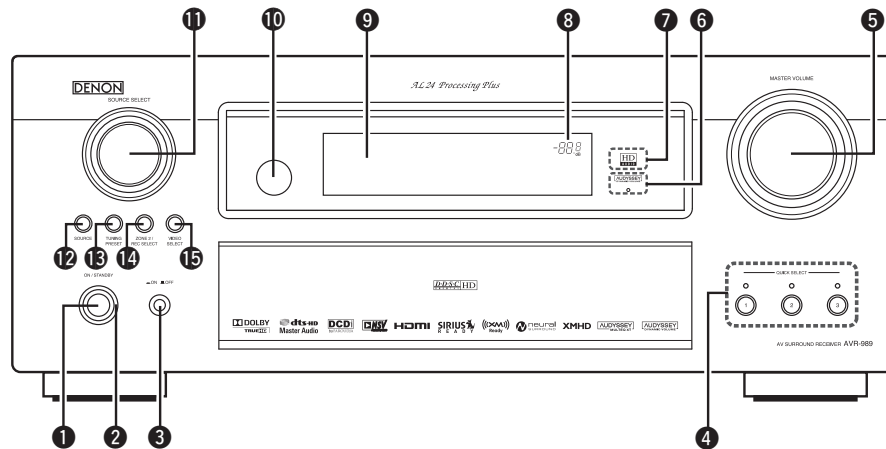

[With the door open]

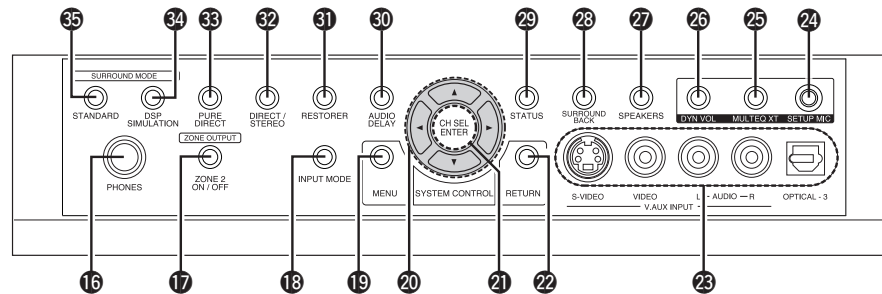

① Power operation button (ON/STANDBY)	(50)	⑪ SOURCE SELECT knob	(50)
② Power indicator	(50)	⑫ SOURCE button	(50)
③ Power switch (ON/OFF)	(50)	⑬ TUNING PRESET button	(52)
④ QUICK SELECT buttons / indicators	(60)	⑭ ZONE2 / REC SELECT button	(67)
⑤ MASTER VOLUME control knob	(50)	⑮ VIDEO SELECT button	(36)
⑥ AUDYSSEY DYNAMIC VOLUME indicator	(46)	⑯ Headphones jack (PHONES)	(50)
⑦ HD AUDIO indicator	(41)	⑰ ZONE2 ON/OFF button	(67)
⑧ Master volume indicator	(46)	⑱ INPUT MODE button	(16, 37)
⑨ Display	(41)	⑲ MENU button	(20)
⑩ Remote control sensor	(3)	⑳ CURSOR buttons (Δ ▽ ◀ ▶)	(20)

⑳ CH SEL / ENTER button	(20, 59)
㉑ RETURN button	(20)
㉒ V.AUX INPUT connectors	(16)
㉓ SETUP MIC jack	(23)
㉔ MULTEQ XT button	(45)
㉕ DYNAMIC VOLUME button	(46)
※ About Dynamic Volume	
Audyssey Dynamic Volume™ solves the problem of large variations in volume level between television programs, commercials, and between the soft and loud passages of movies. Audyssey Dynamic EQ™ is integrated into Dynamic Volume so that as the playback volume is adjusted automatically, the perceived bass response, tonal balance, surround impression, and dialog clarity remain the same.	
※ About Dynamic EQ	
Audyssey Dynamic EQ solves the problem of deteriorating sound quality as volume is decreased by taking into account human perception and room acoustics. Audyssey Dynamic EQ works in tandem with Audyssey MultEQ® XT to provide well-balanced sound for every listener at any volume level.	
㉖ SPEAKERS button	(50)
㉗ SURROUND BACK button	(44)
㉘ STATUS button	(48)
㉙ AUDIO DELAY button	(47)
㉚ RESTORER button	(47)
㉛ DIRECT/STEREO button	(41)
㉜ PURE DIRECT button	(42)
㉝ DSP SIMULATION button	(41)
㉞ STANDARD button	(40)

Display

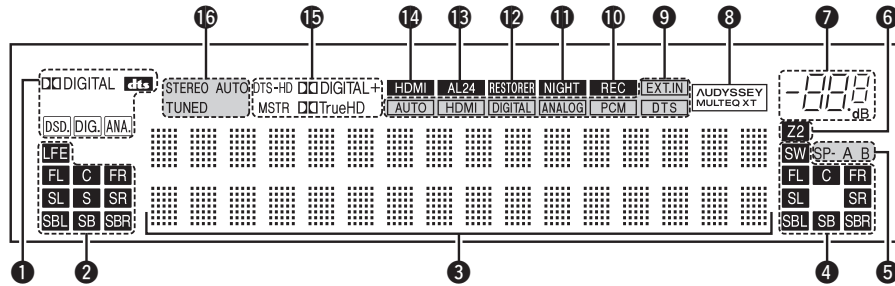

1 Input signal indicators

2 Input signal channel indicators

These light when digital signals are input.

3 Information display

The input source name, surround mode, setting values and other information are displayed here.

4 Output signal channel indicators

5 Front speaker indicator

These light according to the settings of the front A and B speakers.

6 ZONE2 output indicator

This lights when the power for the ZONE2 is turned on.

7 Master volume indicator

8 AUDYSSEY MULTEQ XT indicator

This lights when MultEQ XT is selected.

9 Input mode indicators

10 Recording output source indicator

This lights when the REC OUT mode is selected.

11 NIGHT indicator

This lights when the night mode is selected.

12 RESTORER indicator

This lights when the RESTORER mode is selected.

13 AL24 indicator

This lights when AL24 Processing Plus is activated (see page 70).

14 HDMI indicator

This lights when playing using HDMI connections.

15 Decoder indicators

These light when the respective decoders are operating.

16 Tuner reception mode indicators

This lights according to the reception conditions when the input source is set to "TUNER".

- **AUTO**

This lights when in the auto tuning mode.

- **STEREO**

In the FM mode, this lights when receiving analog stereo broadcasts.

- **TUNED**

This lights when the broadcast is properly tuned in.

Rear Panel

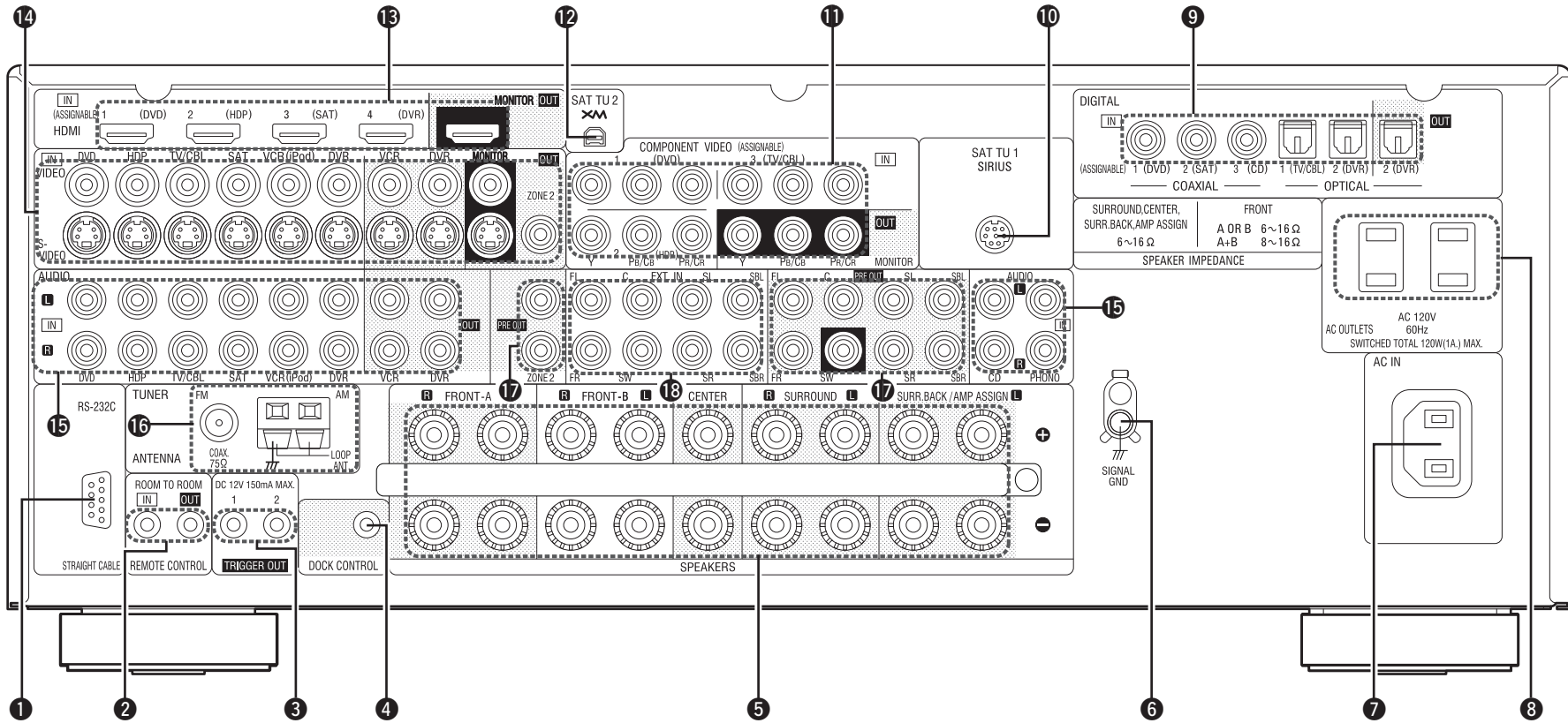

- | | | |
|---|--|--|
| ① RS-232C connector.....(19) | ⑦ AC inlet (AC IN).....(20) | ⑬ HDMI connectors.....(11, 12, 14, 15) |
| ② REMOTE CONTROL jacks.....(19) | ⑧ AC OUTLET.....(20) | ⑭ VIDEO / S-VIDEO connectors.....(12 ~ 16, 19) |
| ③ TRIGGER OUT jacks.....(19) | ⑨ Digital audio connectors (OPTICAL / COAXIAL).....(12 ~ 16) | ⑮ Analog audio connectors (AUDIO).....(12 ~ 16) |
| ④ DOCK CONTROL jack.....(13) | ⑩ SIRIUS connector (SAT TU1).....(18) | ⑯ FM/AM antenna terminals (TUNER ANTENNA).....(17) |
| ⑤ Speaker terminals (SPEAKERS).....(10) | ⑪ COMPONENT VIDEO connectors.....(12, 14) | ⑰ PRE OUT connectors.....(10, 17, 19) |
| ⑥ SIGNAL GND terminal.....(13) | ⑫ XM connector (SAT TU2).....(18) | ⑱ EXT. IN connectors.....(16) |

Remote Control Unit

[Front]

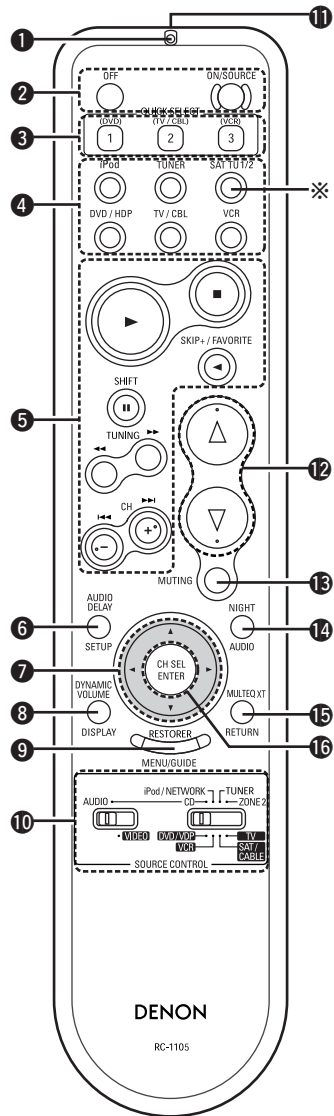

- 1 Indicator (61)
- 2 Power buttons (50)
- 3 QUICK SELECT buttons (60)
- 4 Source select buttons (50)
※ : To select "SIRIUS", "XM" as the input source, use the **SAT TU1/2** button.
- 5 System buttons (56)
- 6 AUDIO DELAY button (47)
- 7 Cursor buttons (Δ▽◀▶) (20)
- 8 DYNAMIC VOLUME button (46)
- 9 RESTORER button (47)
- 10 SOURCE CONTROL switches (20, 61)
- 11 Remote control signal transmitter (3)
- 12 Master volume control buttons (50)
- 13 MUTING button (50)
- 14 NIGHT button (47)
- 15 MULTEQ XT button (45)
- 16 Channel select (CH SEL) / ENTER button (20, 59)

[Rear]

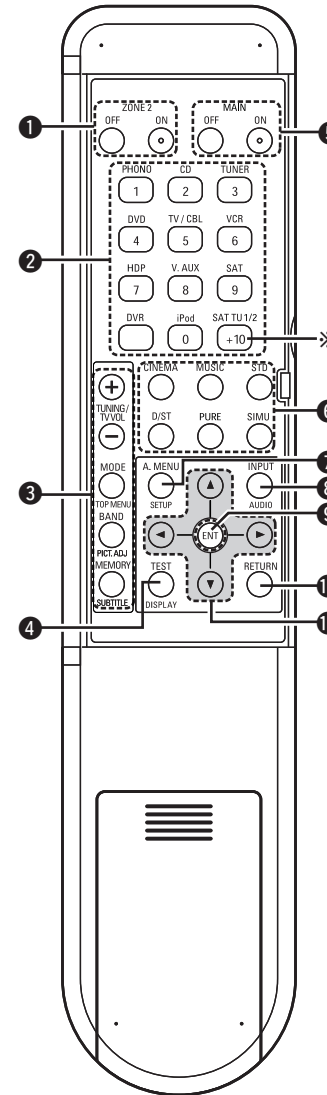

- 1 ZONE2 power buttons (67)
- 2 Source select buttons (50)
※ : To select "SIRIUS", "XM" as the input source, use the **SAT TU1/2** button.
- 3 Tuner system buttons (51)
- 4 Test tone button (TEST) (28)
- 5 MAIN ZONE power buttons (MAIN) (67)
- 6 Surround mode buttons (40, 41)
- 7 Amp menu button (A. MENU) (20)
- 8 Input mode button (INPUT) (16, 37)
- 9 Enter button (ENT) (20, 59)
- 10 RETURN button (20)
- 11 Cursor buttons (Δ▽◀▶) (20)

NOTE

If buttons on the front or rear are pressed strongly, the button on the opposite side will be activated too.

Connections

Connections for all compatible audio and video signal formats are described in this owner's manual. Please select the types of connections suited for the equipment you are connecting.

With some types of connections, certain settings must be made on the AVR-989. For details, refer to the instructions for the respective connection items below.











































NOTE

- Do not plug in the power cord until all connections have been completed.
- When making connections, also refer to the operating instructions of the other components.
- Be sure to connect the left and right channels properly (left with left, right with right).
- Do not bundle power cords together with connection cables. Doing so can result in humming or noise.

Preparations

Cables Used for Connections

Select the cables according to the equipment being connected.

Audio cables	Video cables
<p>Coaxial digital connections</p> <p>(Orange)   </p> <p>Coaxial digital (75 Ω/ohms pin-plug) cable</p> <p>Optical digital connections</p> <p>  </p> <p>Optical cable</p> <p>Analog connections (stereo)</p> <p>(White)   </p> <p>(Red)   </p> <p>Stereo pin-plug cable</p> <p>Analog connections (monaural, for subwoofer)</p> <p>(Black)   </p> <p>Pin-plug cable</p> <p>Speaker connections</p> <p>+  +</p> <p>- -</p> <p>Speaker cables</p>	<p>Component video connections</p> <p>(Green)    (Y)</p> <p>(Blue)    (PB/CB)</p> <p>(Red)    (PR/CR)</p> <p>Component video cable</p> <p>S-Video connections</p> <p>  </p> <p>S-Video cable</p> <p>Video connections</p> <p>(Yellow)   </p> <p>75 Ω/ohms pin-plug video cable</p> <p>Audio and video cables</p> <p>HDMI connections</p> <p>  </p> <p>19-pin HDMI cable</p> <p>Signal direction</p> <p>Audio signal:</p> <p>Output  Input </p> <p>Input  Output </p> <p>Video signal:</p> <p>Output  Input </p> <p>Input  Output </p>

Video Conversion Function

- This function automatically converts various formats of video signals input to the AVR-989 into the format used to output the video signals from the AVR-989 to a monitor.
- The AVR-989's video input/output circuitry is compatible with the following four types of video signals:
 Digital video signals: HDMI
 Analog video signals: Component video, S-Video and Video

[Flow of video signals inside the AVR-989]

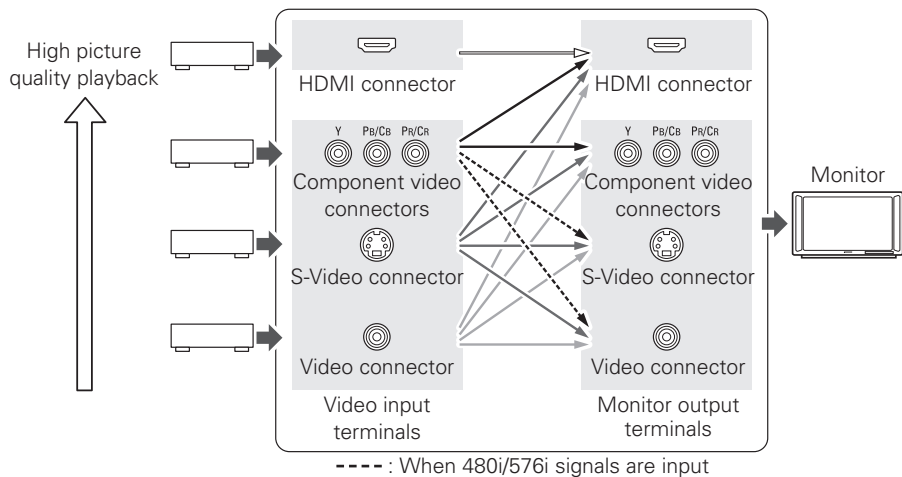

- When not using this function, connect a monitor output with the same type of connector as the video input connector.
- The resolution of the HDMI input-compatible monitor connected to the AVR-989 can be checked at menu "Information" – "HDMI Information" (page 49).

NOTE

- HDMI signals cannot be converted into analog signals.
- 1080p component input video signals cannot be output to anything other than component video connectors.
- 480p/576p, 1080i and 720p component input video signals cannot be converted into S-Video or Video format.
- When a non-standard video signal from a game machine or some other source is input, the video conversion function might not operate.

On-Screen Display for Component Video Outputs and HDMI Output

- When viewing HDMI or component video signals via the AVR-989, the on-screen display appears when the **MENU** button on the main unit or the **A.MENU** button on the main remote control unit is operated.
- When only HDMI or component video signals are input to the AVR-989, the characters of the on-screen display are not displayed over the picture.

Speaker Connections

Speaker Installation

The illustration below shows a basic example of installation of the amplifier combined with 8 speakers and a monitor.

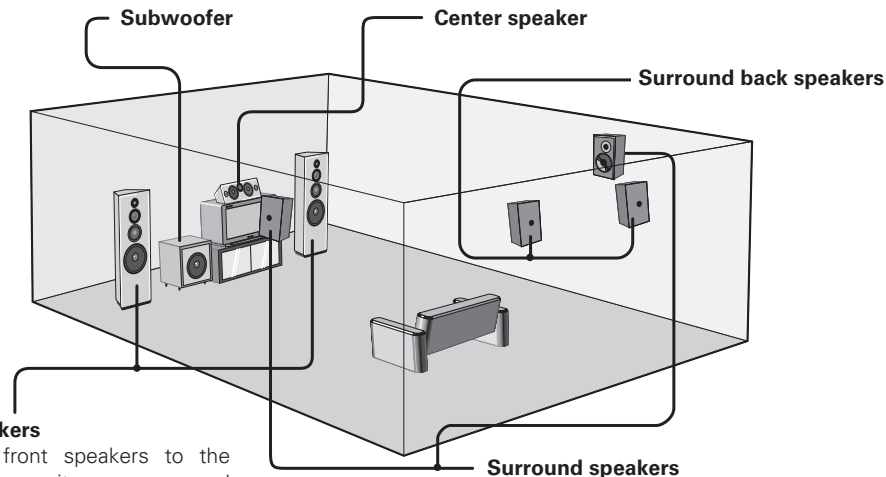

Front speakers
Place the front speakers to the sides of the monitor or screen and as flush with the screen surface as possible.



The table below shows a typical speaker configuration for the AVR-989.

	FRONT		CENTER	SURROUND		SURROUND BACK			SUBWOOFER
	L	R		L	R	L	R	1 speaker	
7.1-channels (FRONT A+B)	○	○	○	○	○	○	○	-	○
7.1-channels	○	○	○	○	○	○	○	-	○
6.1-channels	○	○	○	○	○	-	-	○	○
5.1-channels	○	○	○	○	○	-	-	-	○
3.1-channels	○	○	○	-	-	-	-	-	○
2.1-channels	○	○	-	-	-	-	-	-	○
2-channels	○	○	-	-	-	-	-	-	-

Speaker Connections

Example: 5.1 / 7.1-channels

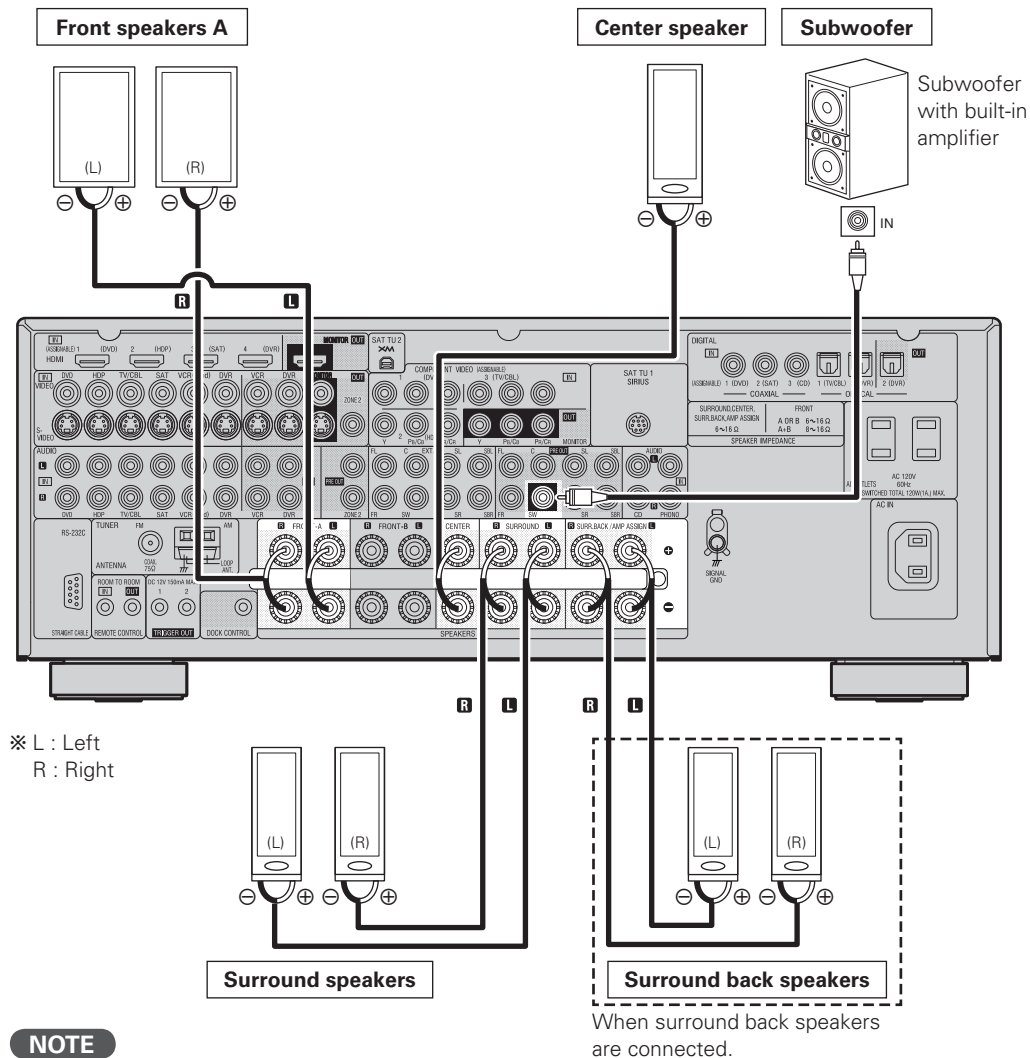

NOTE

For surround back speakers :

- Since "Amp Assign" of AVR-989 is set to "ZONE2" by default, audio is not output from the surround back speakers. When using the surround back speakers with MAIN ZONE, change the "Amp Assign" setting to "7.1ch" (☞ page 32).
- When using just one surround back speaker, connect it to the left channel (SBL).

For ZONE2 speakers :

- When outputting audio from the surround back speakers with ZONE2, set to "ZONE2" with "Manual Setup" - "Option Setup" - "Amp Assign" from the menu. For multi-zone connection and operation, see "Amp Assign / Multi-zone Connections and Operations" (☞ page 65, 66).

Connecting the Speaker Cables

Carefully check the left (L) and right (R) channels and + (red) and - (black) polarities on the speakers being connected to the AVR-989, and be sure to interconnect the channels and polarities correctly.

1 Peel off about 0.03 ft/10 mm of sheathing from the tip of the speaker cable, then either twist the core wire tightly or terminate it.



2 Turn the speaker terminal counterclockwise to loosen it.



3 Insert the speaker cable's core wire to the hilt into the speaker terminal.



4 Turn the speaker terminal clockwise to tighten it.



When using a banana plug

Tighten the speaker terminal firmly before inserting the banana plug.



NOTE

- Use speakers with an impedance of 6 to 16 Ω /ohms. When using front A and B speakers simultaneously, use speakers with an impedance of 8 to 16 Ω /ohms.
- Connect the speaker cables in such a way that they do not stick out of the speaker terminals. The protection circuit may be activated if the core wires touch the rear panel or if the + and - sides touch each other (☞ "Protection circuit").
- Never touch the speaker terminals while the power supply is connected. Doing so could result in electric shock.

Protection circuit

If the core wires touch the rear panel and the screws etc., or the \pm sides touch each other, the protection circuit will be activated and the power indicator will flash red at intervals of 0.5 secs.

If the protection circuit is activated, the speaker output is isolated, and the power supply goes to the standby state. If the power supply is turned off, after the power supply cord is withdrawn, please confirm that speaker cable and input cable are connected.

Also, if replaying large sound levels by using a speaker having an impedance less than that specified (eg, 4 Ω /ohms), the temperature will rise, and the protection circuit might be activated. The power supply will go into the standby state, and the power indicator will flash red at 2 second intervals.

In this case, please switch off the power supply, and wait until the AVR-989 has cooled down, and the surrounding ventilation is good.

Even if there are no problems with the surrounding ventilation and connections, in the event of the protection circuit becoming activated, due to thinking that the AVR-989 has failed, please contact DENON Service center after switching off.

Connecting Equipment with HDMI Connectors

With HDMI connections, the video and audio signals can be transferred with a single cable.

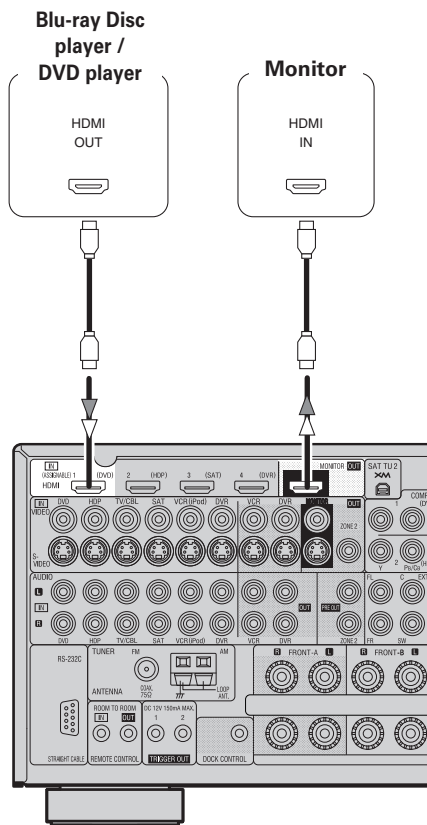

- ※ The AVR-989 is equipped for HDMI version 1.3a. This version is compatible with other versions, allowing connection to all components equipped with an HDMI connector.
- ※ The AVR-989 is compatible with 30- and 36-bit Deep Color.

Compatible audio format	Details	Discs (examples)
2-channel linear PCM	2ch 32-192 kHz 16/20/24 bits	CD, DVD-Video, DVD-Audio
Multi-channel linear PCM	8ch 32-192 kHz 16/20/24 bits	DVD-Audio, Blu-ray
Dolby Digital, DTS	Bitstream	DVD-Video
DSD	2/5.1ch 2.8224 MHz 1 bit	SACD
Dolby Digital Plus, Dolby TrueHD, DTS-HD	Bitstream	Blu-ray



- By default, the HDMI audio signals are output from the speakers connected to the AVR-989.
- To output the sound from the TV, make the settings at menu “Manual Setup” – “HDMI Setup” – “HDMI Audio Out” – “TV” (page 30).

NOTE

- The audio signals output from the HDMI connector (sampling frequency, bit rate, etc.) may be restricted by the connected device.
- Video signals are not output properly when using devices that are not HDCP-compatible.
- Video signals are not output if the input video signals do not match the monitor’s resolution. In this case, switch the Blu-ray Disc player / DVD player’s resolution to a resolution with which the monitor is compatible.
- If the menu “Manual Setup” – “HDMI Setup” – “HDMI Audio Out” setting (page 30) is set to “AMP”, the sound may be interrupted when the monitor’s power is turned off.
- Use a cable on which the HDMI logo is indicated (a certified HDMI product) for connection to the HDMI connector. Normal playback may not be possible when using a cable other than one on which the HDMI logo is indicated (a non-HDMI-certified product).
- If the monitor or Blu-ray Disc player / DVD player does not support Deep Color, deep color signal transfer is not possible.
- If the monitor or Blu-ray Disc player / DVD player does not support xvYCC, xvYCC signal transfer is not possible.
- If the monitor does not support “Auto Lipsync Correction” function, this function will not work.
- The AVR-989 is compatible with the HDMI’s CEC (Consumer Electronics Control) function. Please note the following.
 - It may not work depending on the device it is connected to and its setup.
 - It does not operate with televisions or players that are not compatible with HDMI’s CEC.



- When the AVR-989 and Blu-ray Disc player / DVD player are connected using an HDMI cable, also connect the AVR-989 and monitor using an HDMI cable.
- If the connected monitor or Blu-ray Disc player / DVD player only has a DVI-D connector, use an HDMI/DVI converter cable. **When using a DVI cable, no audio signals are transmitted.**
- Use a Deep Color compatible cable for connection to Deep Color compatible devices.

When connecting with an HDMI/DVI converter cable (adapter)

- HDMI video signals are theoretically compatible with the DVI format. When connecting to a monitor, etc., equipped with a DVI-D connector, connection is possible using an HDMI/DVI converter cable, but depending on the combination of components in some cases the video signals will not be output.
- When connecting using an HDMI/DVI converter adapter, the video signals may not be output properly due to poor connections with the connected cable, etc.

Copyright protection system (HDCP)

In order to play the digital video and audio signals of a Blu-ray, DVD-Video or DVD-Audio disc using HDMI/DVI connections, both the connected Blu-ray Disc player / DVD player and monitor must be equipped for a copyright protection system called “HDCP” (High-bandwidth Digital Content Protection). HDCP is a copy protection technology consisting of data encoding and mutual identification of the devices. The AVR-989 is HDCP-compatible. For details on the Blu-ray Disc player / DVD player or monitor you are using, refer to its operating instructions.

Connecting the Monitor

- Select the terminal to use and connect the device (☞ page 9 “Video Conversion Function”).
- With HDMI connections, the video and audio signals can be transferred with a single cable.
- To output the audio signals to the monitor with HDMI connections, set menu “Manual Setup” – “HDMI Setup” – “HDMI Audio Out” to “TV” (☞ page 30).

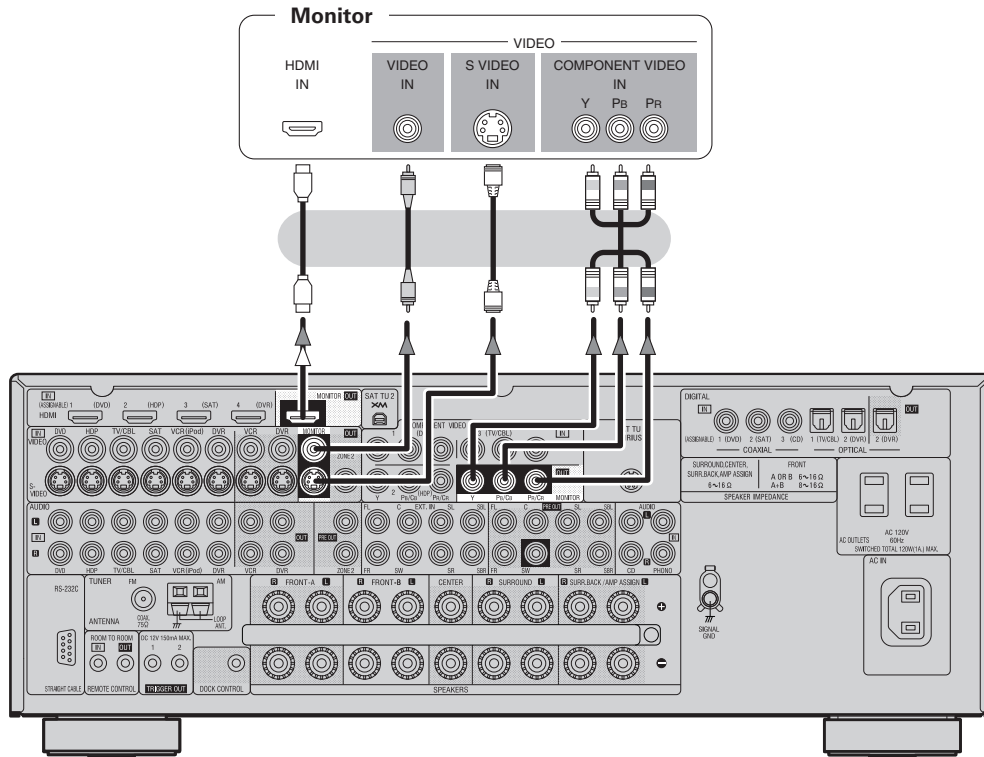

NOTE

- The component video connectors may be indicated differently on your monitor. For details, see the monitor's operating instructions.
- The audio signals output from the HDMI connectors are only the HDMI input signals.

Connecting the Playback Components

Carefully check the left (L) and right (R) channels and the inputs and outputs, and be sure to interconnect correctly.

Blu-ray Disc Player / DVD Player

Select the terminal to use and connect the device.

- ※ When connected to a Blu-ray Disc player, and playing Dolby TrueHD, DTS-HD, Dolby Digital Plus, connect the HDMI.

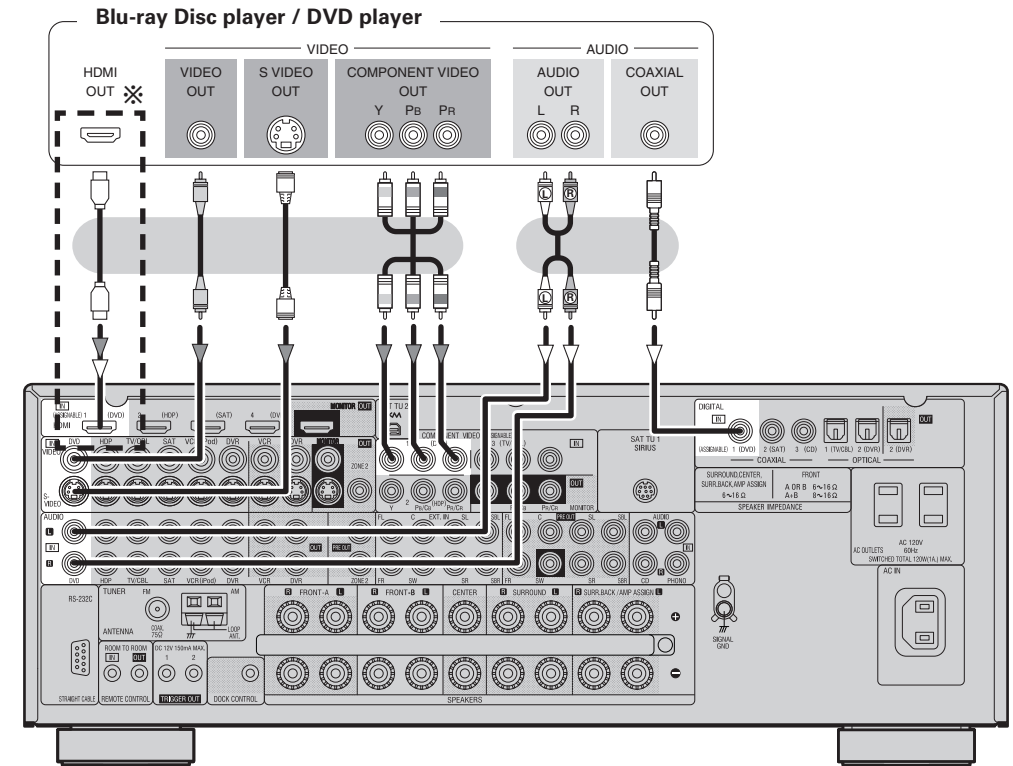

When using an optical cable for the digital audio connection, make the settings at menu “Input Setup” – “Assign” – “Digital In” (☞ page 38).

Record Player

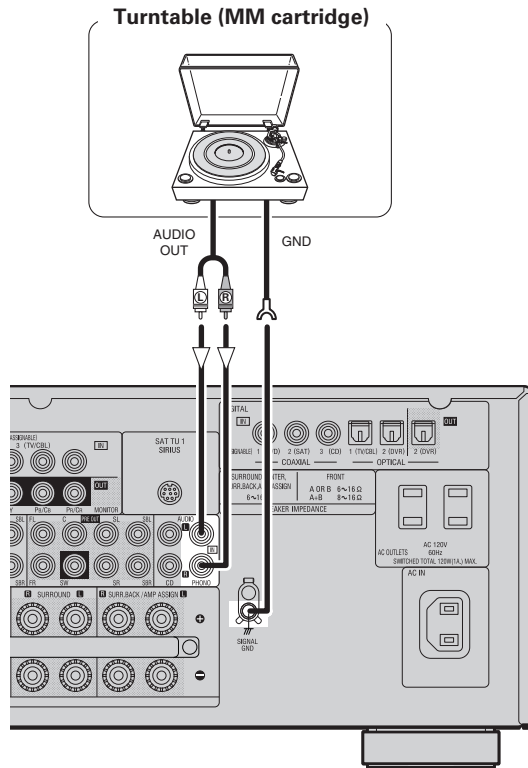

- When connecting a record player with an MC cartridge, use a commercially available MC head amplifier or a step-up transformer.
- Induction humming (a booming sound) may be produced from the speakers if the volume is raised with no record player connected.
- With some record players, noise may be generated when the ground wire is connected. If so, disconnect the ground wire.

NOTE

The AVR-989's SIGNAL GND terminal is meant to reduce noise when a record player is connected. This is not a safety ground terminal.

CD Player

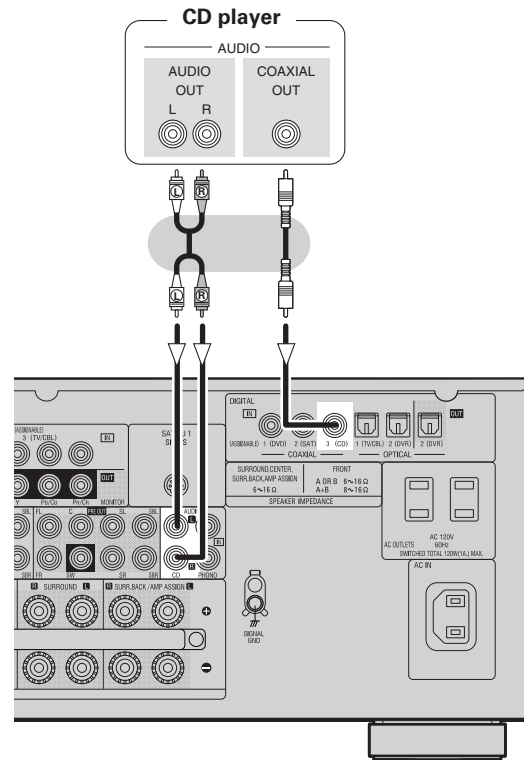

When using an optical cable for the digital audio connection, make the settings at menu "Input Setup" – "Assign" – "Digital In" (page 38).

iPod®

Use a DENON control dock for iPod (ASD-1R, ASD-3N or ASD-3W sold separately) to connect the iPod to the AVR-989. For instructions on the control dock for iPod settings, refer to the control dock for iPod's operating instructions.

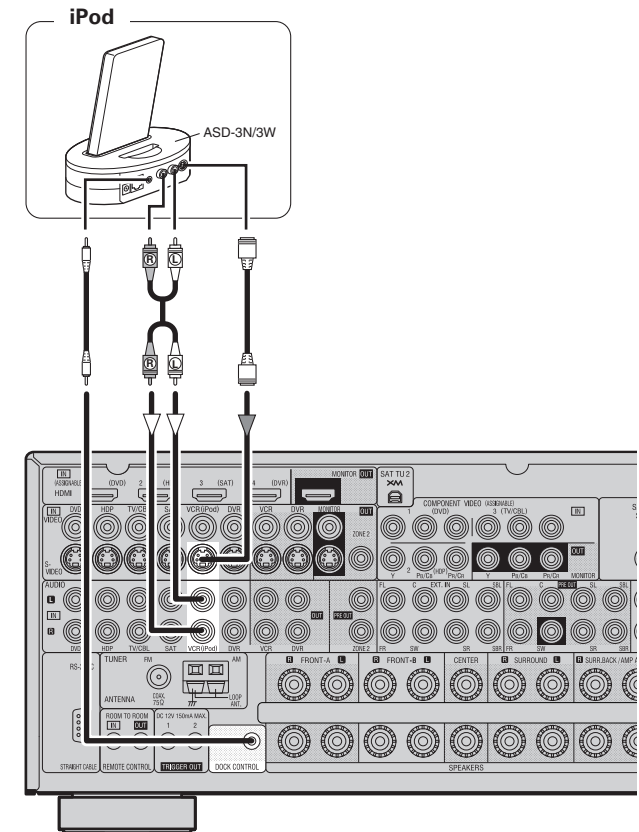

- With the default settings, the iPod can be used connected to the VCR (iPod) connector.
- To assign the iPod to a connector other than VCR (iPod), make the settings at menu "Input Setup" – "(input source to which iPod dock assigned)" – "Assign" – "iPod Dock" (page 39).

TV/CABLE Tuner

Select the terminal to use and connect the device.

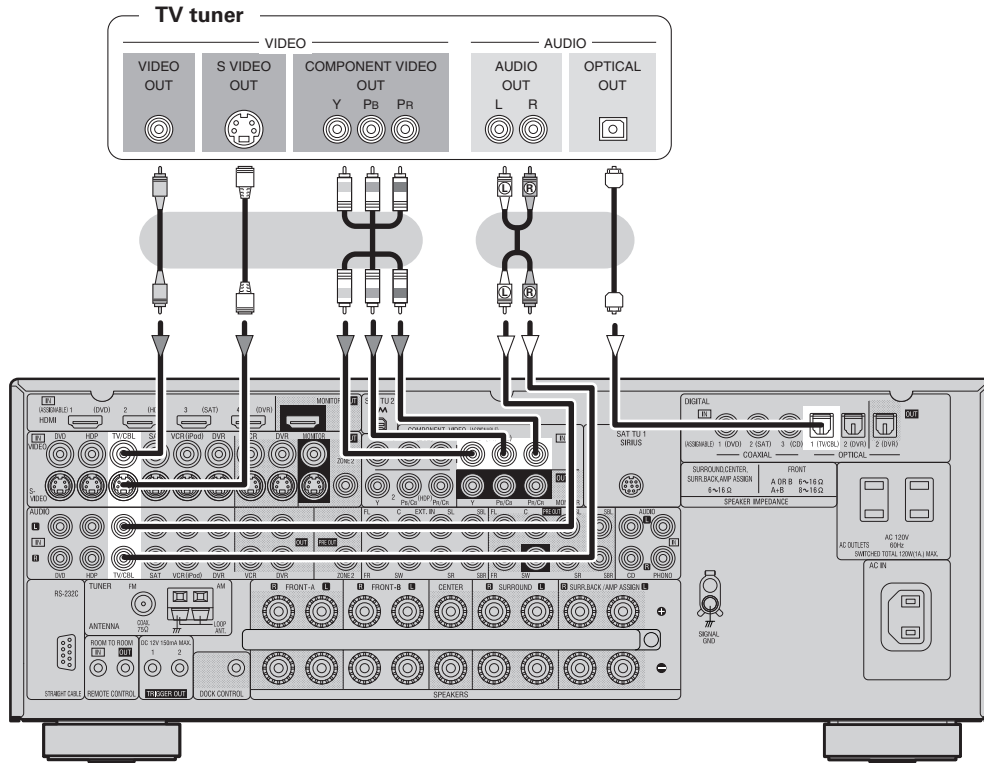

When using a coaxial cable for the digital audio connection, make the settings at menu "Input Setup" – "Assign" – "Digital In" (page 38).

Satellite Receiver

Select the terminal to use and connect the device.

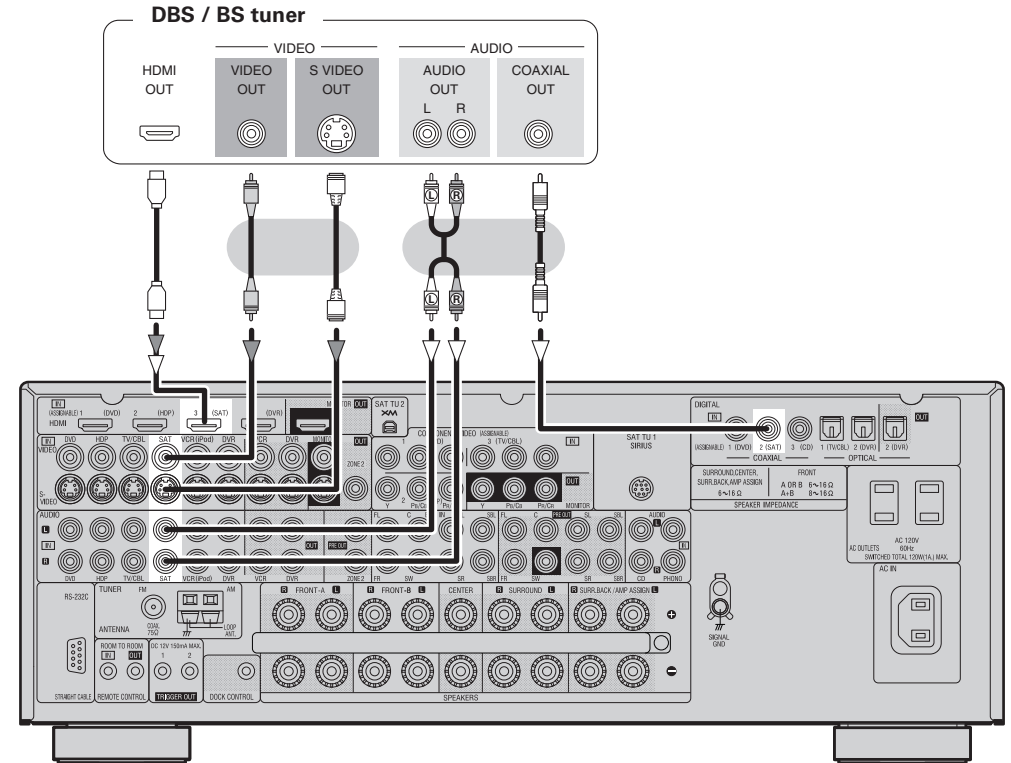

- When using an optical digital cable for the digital audio connection, make the settings at menu "Input Setup" – "Assign" – "Digital In" (page 38).
- When using a component video cable for the video connection, make the settings at menu "Input Setup" – "Assign" – "Component In" (page 38).

Connecting the Recording Components

Carefully check the left (L) and right (R) channels and the inputs and outputs, and be sure to interconnect correctly.

Digital Video Recorder

Select the terminal to use and connect the device.

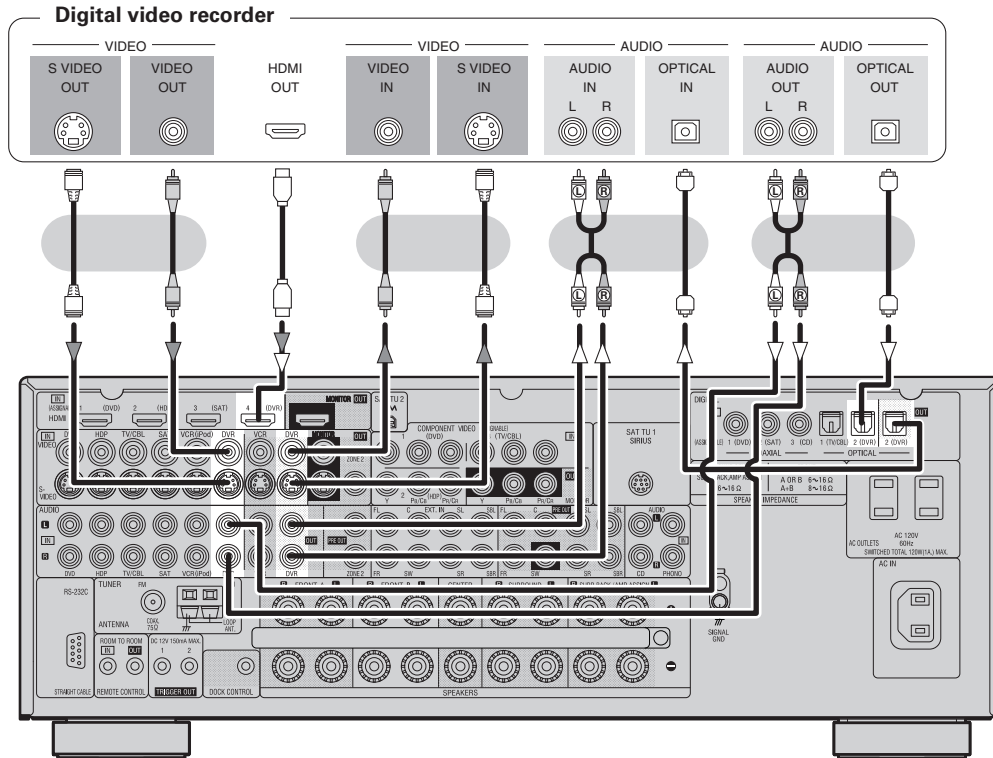

- Make analog connections if you wish to record analog audio signals.
- When recording via the AVR-989, the playback device's cable must be of the same type as the cable used to connect the AVR-989's DVR OUT connector.
Example: TV IN → S-Video cable : DVR OUT → S-Video cable
TV IN → Video cable : DVR OUT → Video cable
- When using a component video cable for the video connection, make the settings at menu "Input Setup" – "Assign" – "Component In" (page 38).

NOTE

Do not connect the output of the component connected to the AVR-989's OPTICAL2 output connector to any input connector other than OPTICAL2.

Video Cassette Recorder

Select the terminal to use and connect the device.

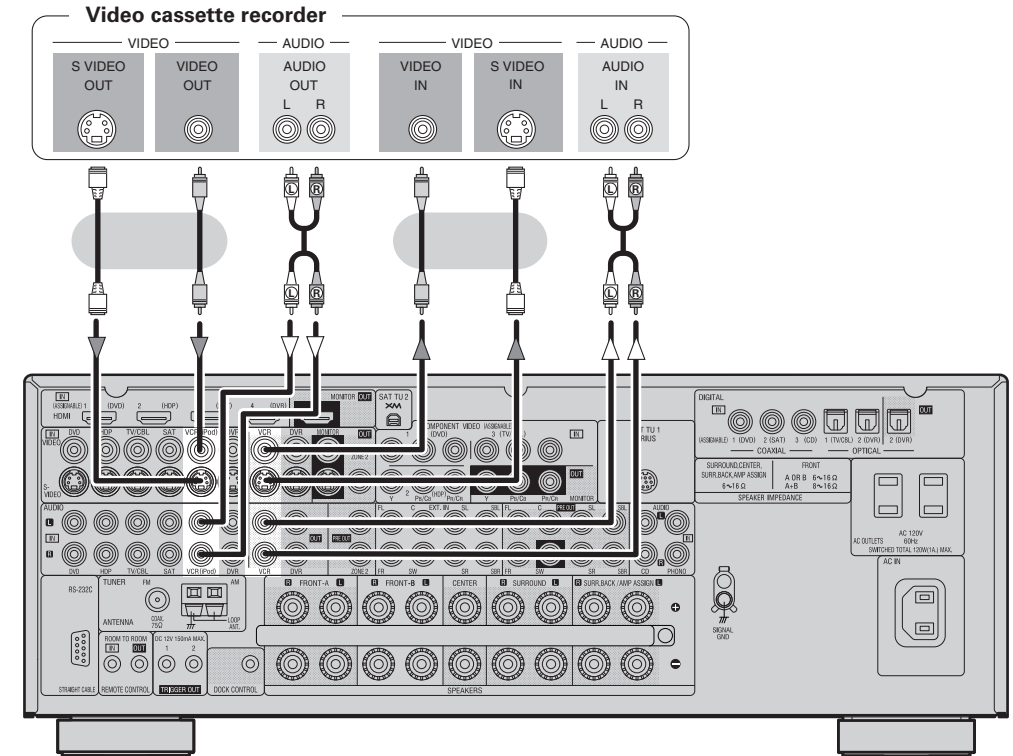

- When recording via the AVR-989, the playback device's cable must be of the same type as the cable used to connect the AVR-989's VCR OUT connector.
Example: TV IN → S-Video cable : VCR OUT → S-Video cable
TV IN → Video cable : VCR OUT → Video cable
- When using a component video cable for the video connection, make the settings at menu "Input Setup" – "Assign" – "Component In" (page 38).

CD Recorder / MD Recorder / Tape Deck

Select the terminal to use and connect the device.

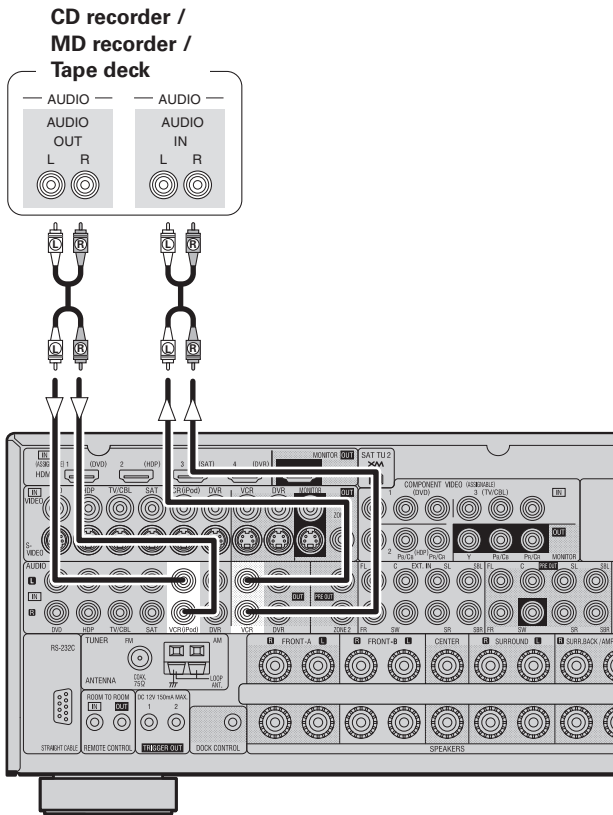

- Make analog connections if you wish to record analog audio signals, or digital connections if you wish to record digital audio signals, depending on the types of connectors on the components being used.
- When recording via the AVR-989, the playback device's cable must be of the same type as the cable used to connect the AVR-989's VCR OUT connector.

Example: CD IN → Analog cable : VCR OUT → Analog cable

Connections to Other Devices

Carefully check the left (L) and right (R) channels and the inputs and outputs, and be sure to interconnect correctly.

Video Camera / Game Console

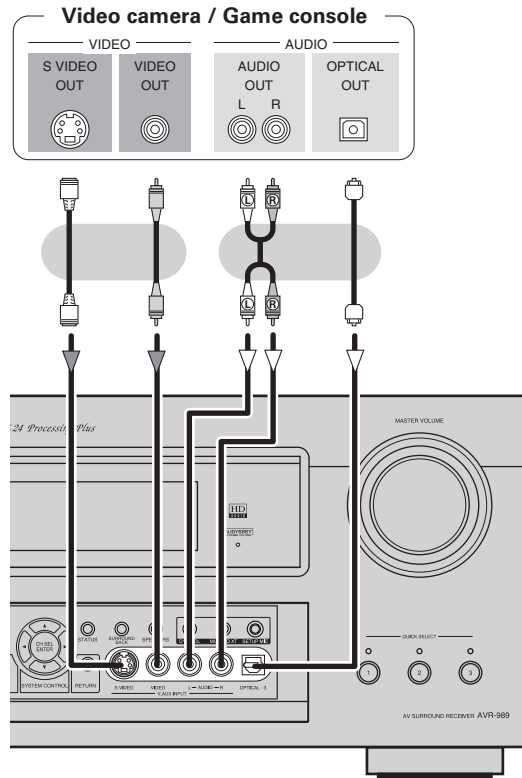

Component with Multi-channel Output Connectors

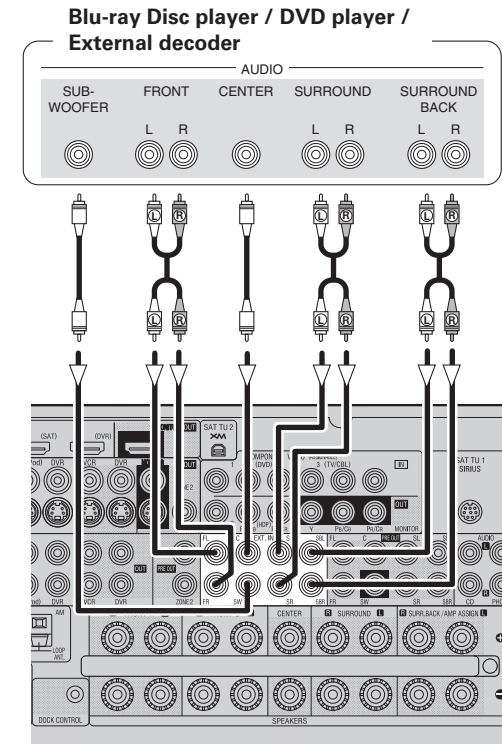

- To play the analog input signals input to the EXT. IN connectors, press the **INPUT MODE** button on the main unit or **INPUT** button on the remote control unit and select "EXT. IN" or make the settings at menu "Input Setup" – "Input Mode" – "Input Mode" – "EXT. IN" (page 37).
- The video signal can be connected in the same way as a Blu-ray Disc player / DVD player (page 12).

External Power Amplifier

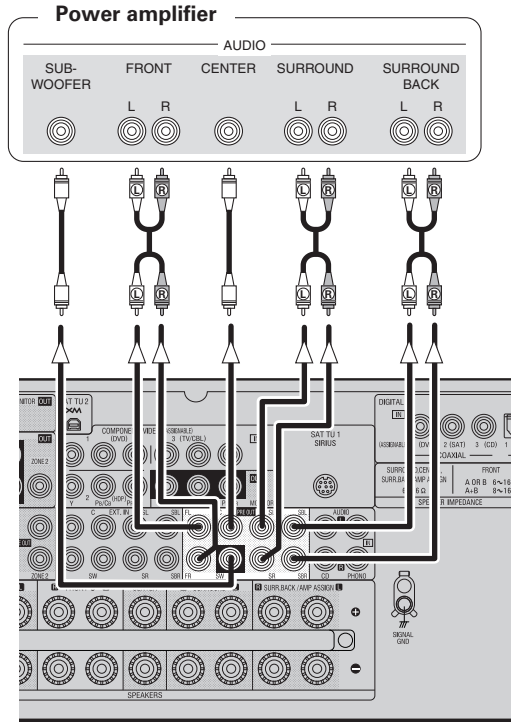

When using just one surround back speaker, connect it to the left channel (SBL).

Antenna Terminals

An F-type FM antenna cable plug can be connected directly.

Direction of broadcasting station

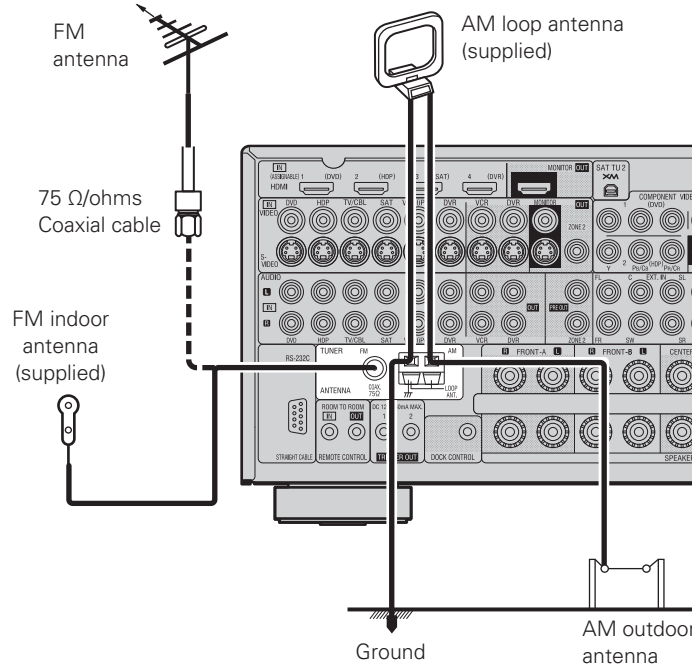

AM loop antenna assembly

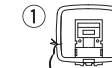

Remove the vinyl tie and take out the connection line.



Bend in the reverse direction.



a. With the antenna on top of any stable surface.

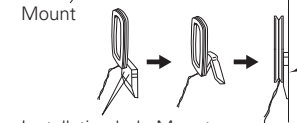

b. With the antenna attached to a wall.

Mount

Installation hole Mount on wall, etc.

Connection of AM antennas

1. Push the lever.
2. Insert the conductor.
3. Return the lever.



NOTE

- Do not connect two FM antennas simultaneously.
- Even if an external AM antenna is used, do not disconnect the AM loop antenna.
- Make sure the AM loop antenna lead terminals do not touch metal parts of the panel.

Note to CATV system installer:

This reminder is provided to call the CATV system installer's attention to Article 820-40 of the NEC which provides guidelines for proper grounding and, in particular, specifies that the cable ground shall be connected to the grounding system of the building, as close to the point of cable entry as practical.

XM Connector

- The AVR-989 is an XM Ready® receiver. You can receive XM® Satellite Radio by connecting to the XM Mini-Tuner and Home Dock (includes home antenna, each sold separately) and subscribing to the XM service.
 - Plug the XM Mini-Tuner and Home Dock into the XM connector on the rear panel.
 - Position the Home Dock antenna near a south-facing window to receive the best signal.
- For details, see "Listening to XM Satellite Radio Programs" (page 52 ~ 54).

When making connections, also refer to the operating instructions of the XM Mini-Tuner and Home Dock.

XM Mini-Tuner and Home Dock

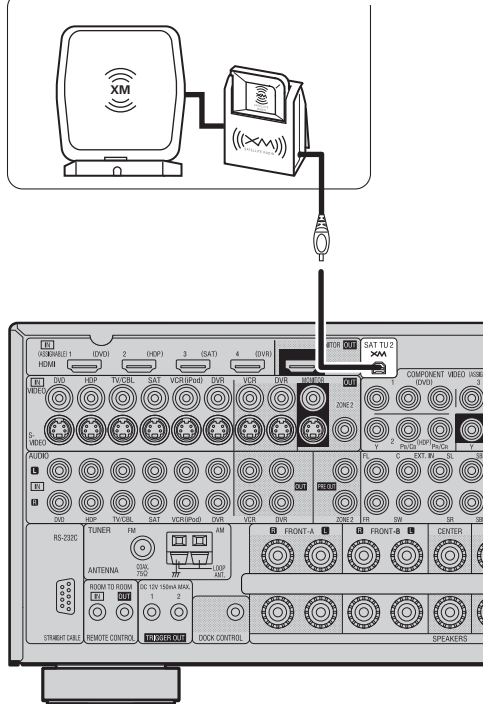

NOTE

Keep the power cord unplugged until the XM Mini-Tuner and Home Dock connection have been completed.

- The XM name and related logo are registered trademarks of XM Satellite Radio Inc. All rights reserved.
- XM Ready® is a registered trademark of XM Satellite Radio Inc. All rights reserved.

SIRIUS Connector

- The AVR-989 is a SIRIUS Satellite Radio Ready® receiver. You can receive SIRIUS® Satellite Radio by connecting to the SiriusConnect Home Tuner and subscribing to the SIRIUS service.
 - Plug the SIRIUS connector on the rear panel.
 - Position the Home Tuner antenna near a south-facing window to receive the best signal.
- For details, see "Listening to SIRIUS Satellite Radio Programs" (page 54, 55).
- When making connections, also refer to the operating instructions of the SiriusConnect Home Tuner.

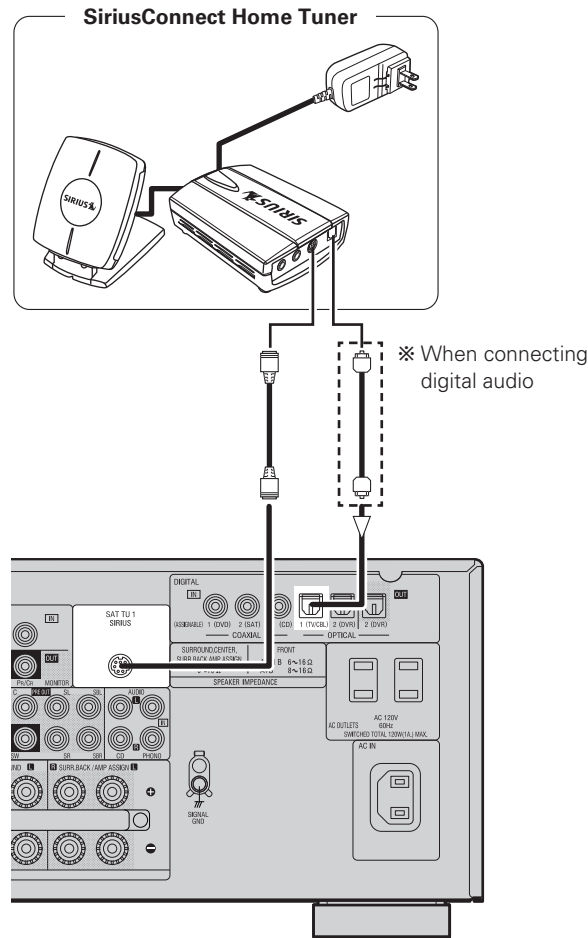

When connecting digital of the SiriusConnect Home Tuner, perform the setting "Input Setup" – "Assign" – "Digital In" from the menu. (page 38).

NOTE

Keep the power cord unplugged until the SiriusConnect Home Tuner connection have been completed.

©2006 SIRIUS Satellite Radio Inc. "SIRIUS", the SIRIUS dog logo, and channel names and logos are trademarks of SIRIUS Satellite Radio Inc.

Positioning the Antenna

For a consistent satellite signal, the antenna must be positioned correctly. Use the following map to determine which area you are in and position the antenna accordingly.

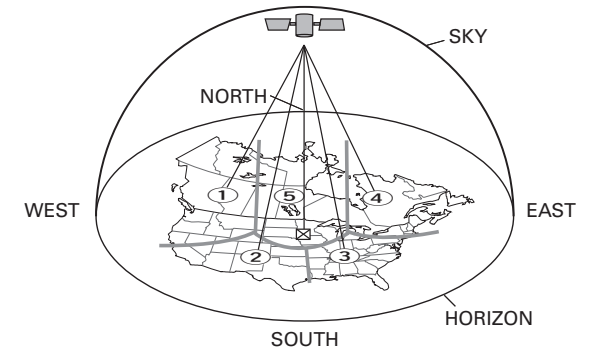

- Area 1 :** Point the antenna toward the sky in the **east, northeast, or southeast**, either through a window or outside.
- Area 2 :** Point the antenna toward the sky in the **north or northeast**, either through a window or outside.
- Area 3 :** Point the antenna toward the sky in the **north or northwest**, either through a window or outside.
- Area 4 :** Point the antenna toward the sky in the **west, northwest, or southwest**, either through a window or outside.
- Area 5 :** Put the antenna outside and point it **straight up**. The antenna cannot be used indoors.

Multi-zone

ZONE2 Pre-out Connections

- If another power amplifier or pre-main (integrated) amplifier is connected, the ZONE2 pre-out (variable or fixed level) connectors can be used to play a different program source in ZONE2 the same time (page 67 ~ 69).
- When using an S-Video cable or a video cable for connection between the AVR-989 and an input device, connect to the video connectors.

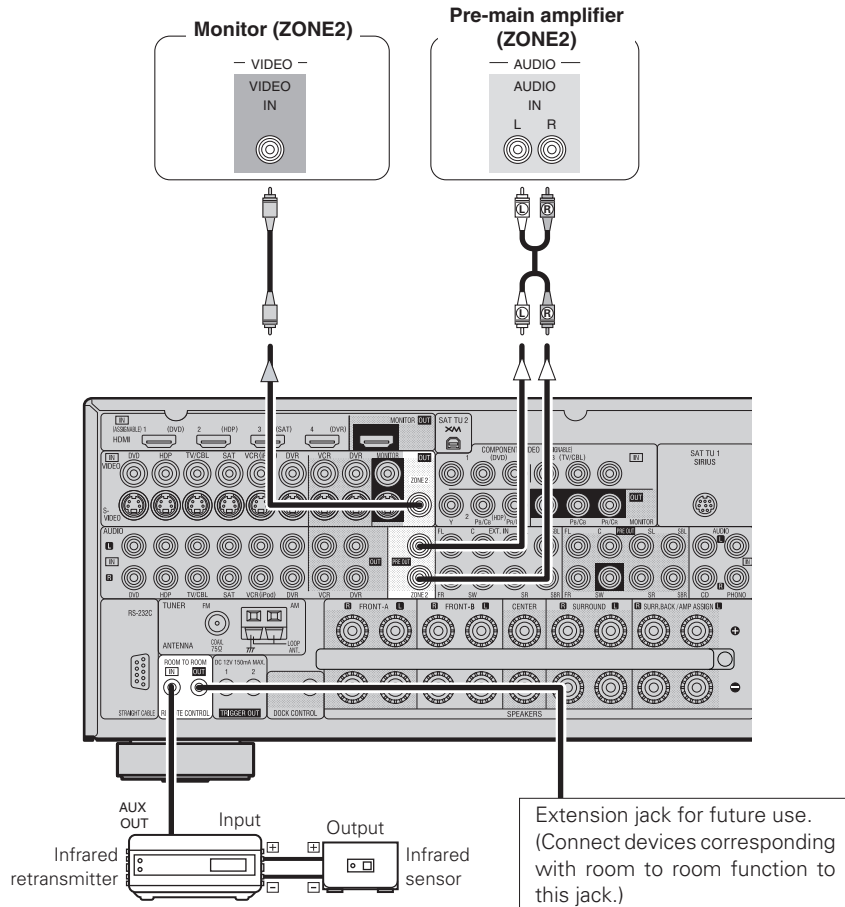

NOTE

- For the audio output, use high quality pin-plug cords so that no induction humming or noise is produced.
- For instructions on installing and operating separately sold devices, refer to the respective devices' operating instructions.
- To conduct multi-zone playback, see "Amp Assign / Multi-zone Connections and Operations" (page 65, 66).

External Controller

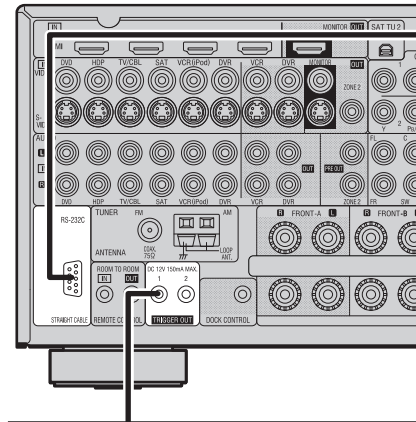

Trigger output jack

The power of an external device equipped with a trigger input jack can be turned on and off in association with operations on the AVR-989. For details, see menu "Manual Setup" – "Option Setup" – "Trigger Out" (page 34).

- Output: DC 12 V 150 mA MAX.
Check the trigger input conditions of the connected device.

RS-232C connector

This connector is used for an external controller.

- ※ If you wish to control the AVR-989 from an external controller using the RS-232C connector, perform the operation below beforehand.

- ① Turn on the AVR-989's power.
- ② Turn off the AVR-989's power from the external controller.
- ③ Check that the AVR-989 is in the standby mode.



- When using in combination with an RF Remote Controller (RC-7000CI, sold separately) or RF Remote Receiver (RC-7001RCI, sold separately) two-way communication with an RF Remote Controller is possible.

The AVR-989's status information as well as iPod can be browsed watching the RF Remote Controller's display. For details, refer to the operating instructions of the respective devices.

- When used in combination with an RF Remote Controller or RF Remote Receiver, make the settings at menu "Manual Setup" – "Option Setup" – "232C Port" – "2Way Remote" (page 34).
- On the menu, when setting "Manual Setup" – "Option Setup" – "232C Port" to "2Way Remote", you cannot use the RS-232C connector as an external controller (page 34).

Connecting the Power Cord

Wait until all connections have been completed before connecting the power cord.

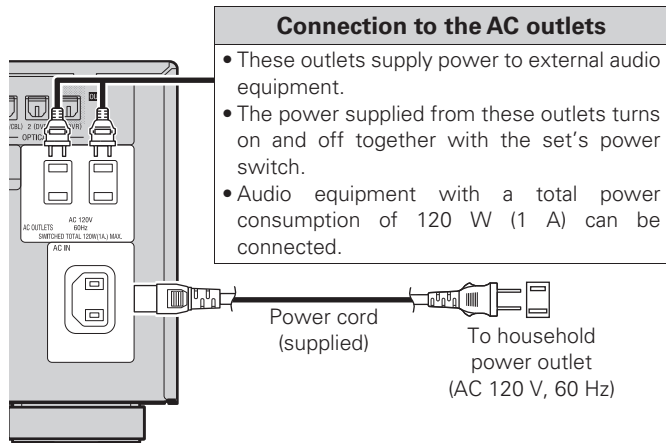

NOTE

- Insert the AC plugs securely. Incomplete connections could cause noise.
- Only use the AC outlets to plug in audio equipment. Do not use them as power supplies for hairdryers or anything other than audio equipment.

Once Connections are Completed

Turning the Power On (👉 page 50)

Menu Operations



Symbols used to indicate buttons in this manual

- Button located on both the main unit and the remote control unit → **BUTTON**
- Button only on the main unit → **<BUTTON>**
- Button only on the remote control unit → **[BUTTON]**

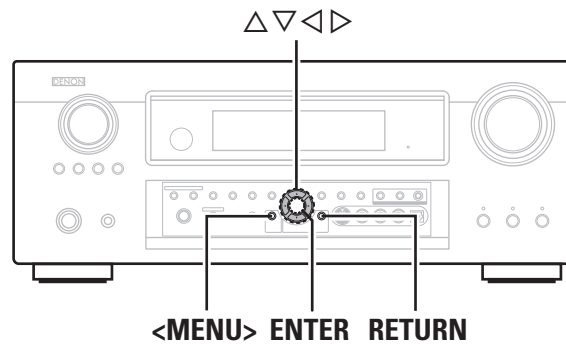

[Front]

[Rear]

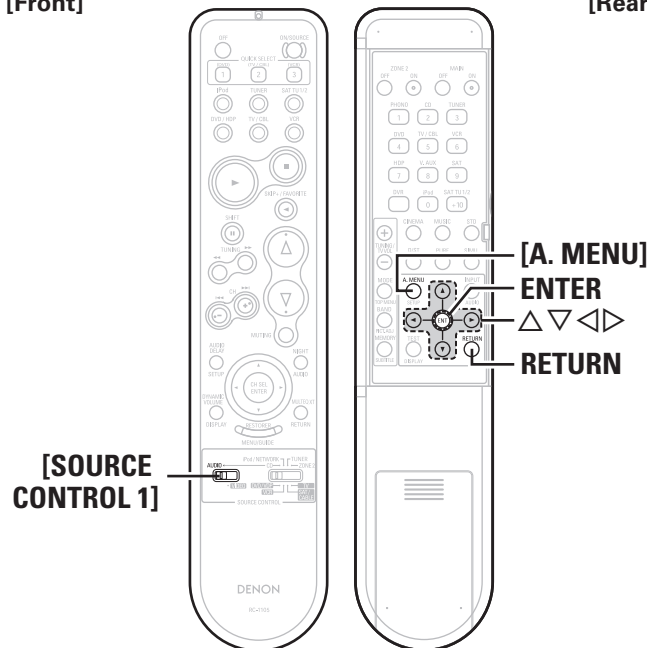

With the AVR-989, settings and operations for most functions can be performed by operating while looking at the menu displayed on the monitor screen.

Operations

The same operation is possible on the main unit or remote control unit.

1 Press **<MENU>** or **[A.MENU]**.

The menu is displayed.

※ To operate from the remote control unit, be sure to set the **[SOURCE CONTROL 1]** to "AUDIO".

2 Press **△ ▽** to select the item you want to set, then press **ENTER**.

3 Press **△ ▽** again to select the item you want to set, then press **ENTER**.

4 To change the setting:

4 Press **△ ▽** to select the item you want to change, then press **◀ ▶** to change the setting.

※ To return to the previous item, press **RETURN**.

※ Select "Default Yes", then press **◀** to reset to the default setting.

5 Press **ENTER** to enter the setting.

6 Press **<MENU>** or **[A.MENU]** to finish.



When **<MENU>** or **[A.MENU]** is pressed, the settings made up to that point are entered and the settings menu screen turns off.

Example of Display of Default Values

In lists of selectable items or adjustable ranges, the item surrounded by a border is the default value.

[Selectable items] **A** B A + B

Examples of On-screen Display and Front Display

Some typical examples are described below.

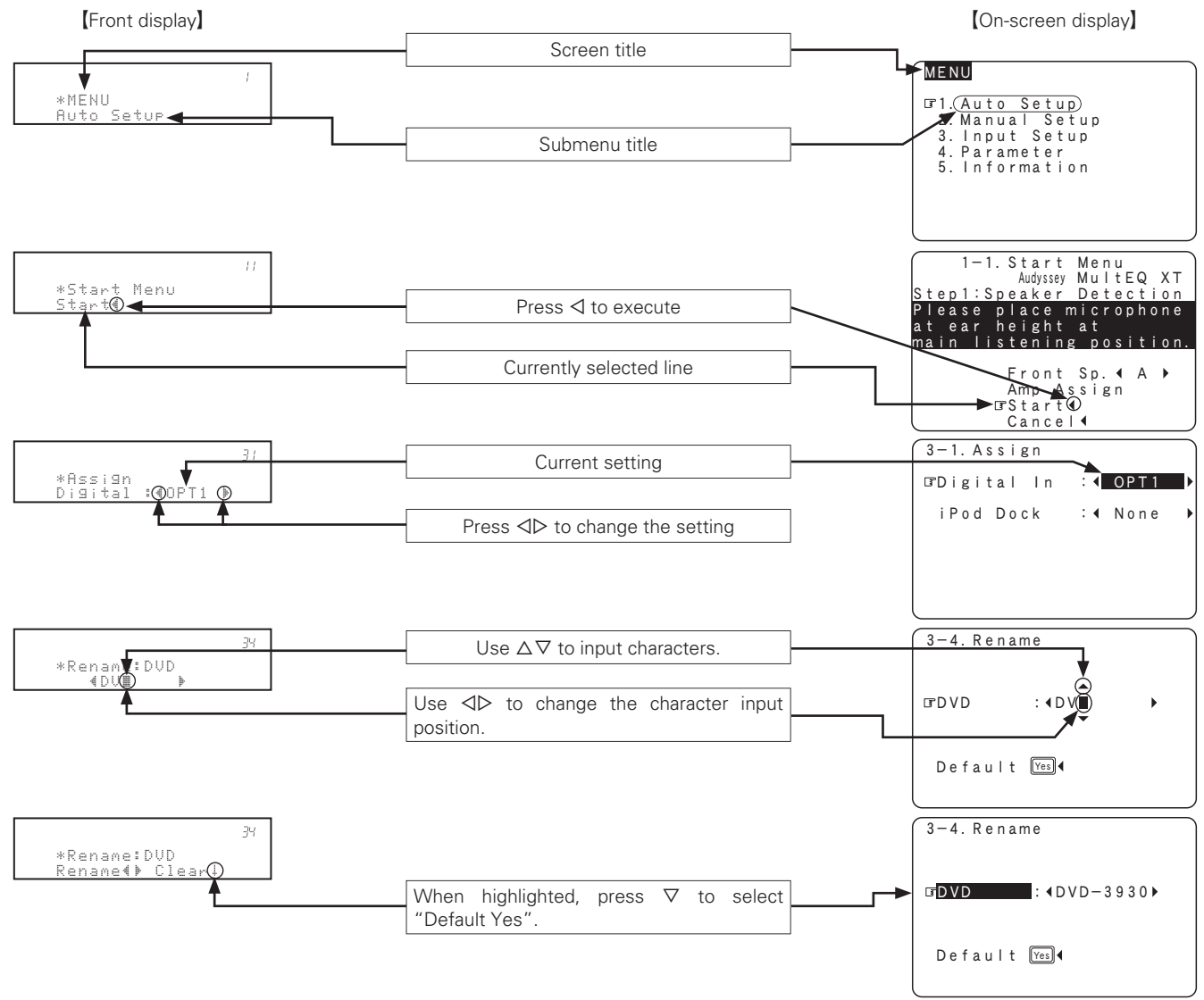

The selected setup menu number is shown in the master volume indicator section of the display.

Menu Map

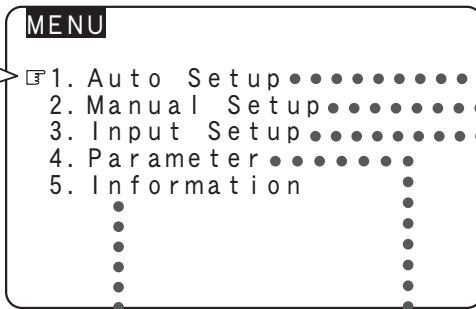
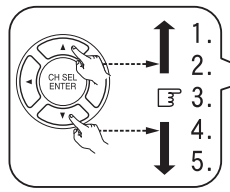

Information
(page 48, 49)

- ❑ Status
 - MAIN ZONE
 - ZONE2
- ❑ Audio Input Signal
- ❑ HDMI Information
- ❑ Auto Surround Mode
- ❑ Quick Select
- ❑ Preset Station

Parameter
(page 42 ~ 47)

- ❑ Surround Parameter
 - Mode
 - Cinema EQ
 - DRC
 - Dynamic Range Compression
 - LFE
 - Center Image
 - Panorama
 - Dimension
 - Center Width
 - Delay Time
 - Effect
 - Effect Level
 - Room Size
 - AFDM
 - SB CH Out
 - SW ATT
 - Subwoofer
- ❑ Tone
 - Tone Control
 - Bass
 - Treble
- ❑ Audyssey Settings
 - MultEQ XT
 - Dynamic EQ
 - Dynamic Volume
 - Setting
- ❑ RESTORER
- ❑ Night Mode
- ❑ Audio Delay

Auto Setup (page 23 ~ 26)

- ❑ Start Menu
 - Step 1: Speaker Detection
 - Step 2: Measurement
 - Step 3: Calculation
 - Step 4: Check
 - Step 5: Store
- ❑ Parameter Check
 - Speaker Configuration Check
 - Distance Check
 - Channel Level Check
 - Crossover Frequency Check
 - EQ Check
 - Restore

Manual Setup (page 27 ~ 34)

- ❑ Speaker Setup (page 27 ~ 29)
 - Speaker Configuration
 - Subwoofer Setup
 - Distance
 - Channel Level
 - Crossover Frequency
 - Front Speaker Setup
- ❑ HDMI Setup (page 29, 30)
 - Color Space
 - RGB Range
 - Auto Lipsync
 - HDMI Audio Out
 - HDMI Control
 - Power Off Control
- ❑ Audio Setup (page 30, 31)
 - EXT. IN Subwoofer Level
 - 2ch Direct/Stereo
 - Dolby Digital Setup
 - Auto Surround Mode
 - EQ Preset
- ❑ ZONE2 Setup (page 31, 32)
 - Level Lch
 - Level Rch
 - Volume Level
 - Volume Limit
 - Power On Level
 - Mute Level
- ❑ Option Setup (page 32 ~ 34)
 - Amp Assign
 - Volume Control
 - Source Delete
 - On-Screen Display
 - Quick Select Name
 - Trigger Out
 - Remote ID Setup
 - 232C Port
 - Display
 - Setup Lock

Input Setup (page 35 ~ 39)

- ❑ TUNER (FM/AM)
 - Auto Preset
 - Preset Skip
 - Preset Name
 - Video
 - Input Mode
 - Rename
 - Source Level
- ❑ PHONO
 - Video
 - Input Mode
 - Rename
 - Source Level
- ❑ CD, DVD, HDP, TV/CBL, SAT, VCR, DVR, V.AUX
 - Assign
 - Video
 - Input Mode
 - Rename
 - Source Level
 - iPod
- ❑ XM
 - Preset Skip
 - Antenna Aiming
 - Video
 - Input Mode
 - Rename
 - Source Level
- ❑ SIRIUS
 - Preset Skip
 - Parental Lock
 - Antenna Aiming
 - Assign
 - Video
 - Input Mode
 - Rename
 - Source Level

Auto Setup

Symbols used to indicate buttons in this manual

- Button located on both the main unit and the remote control unit → **BUTTON**
- Button only on the main unit → **<BUTTON>**
- Button only on the remote control unit → **[BUTTON]**

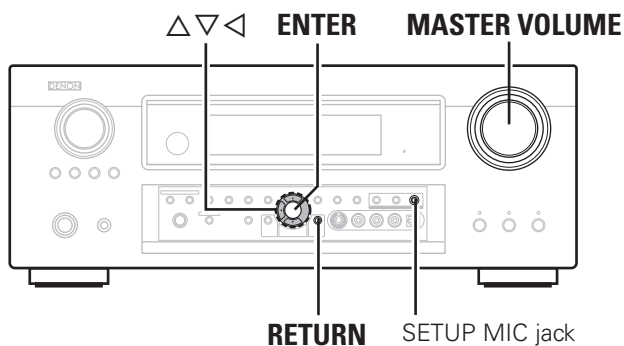

[Front]

[Rear]

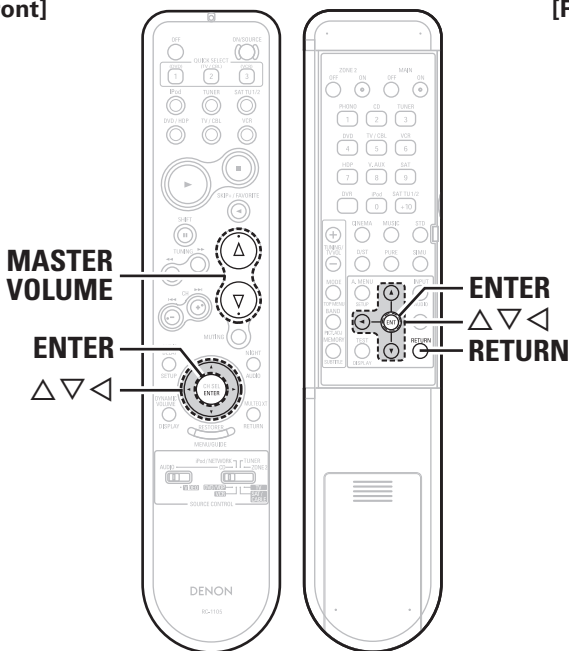

- Audyssey MultEQ® XT automatically measures the acoustical problems in the listening environment to create the best audio experience for your home theater.
- Audyssey MultEQ XT optimizes a large listening area where one or more listeners are seated. Measurements are performed by placing the calibrated microphone (DM-A409) successively at multiple positions throughout the listening area as shown in **Example ①**. For best results, it is strongly recommended to measure 6 positions so that the measurements have the proper spatial weighting. Even if the listening environment is small as shown in **Example ②**, measuring at multiple points throughout the listening environment results in more effective correction.

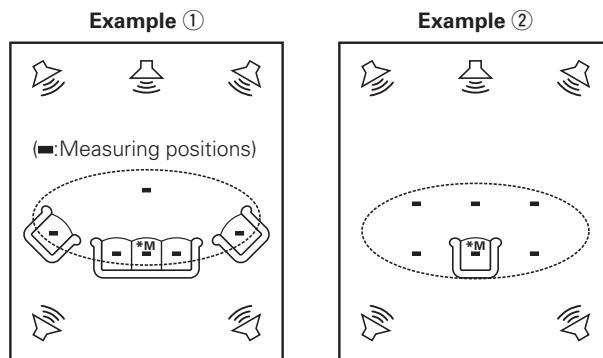

About the main listening position (*M)

The main listening position refers to the most central position where one would normally sit within the listening environment. MultEQ XT uses the measurements from this position to calculate speaker distance, level, polarity, and the optimum crossover value for the subwoofer.

To make manual adjustments to the settings, see pages 27 ~ 29.

Preparations

- 1 Connect the included calibrated setup microphone to the SETUP MIC jack on the main unit.**
The auto setup screen appears automatically.

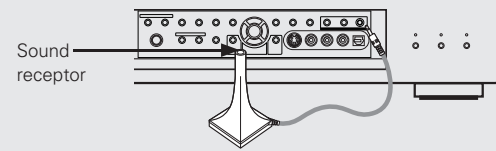

- 2 Place the microphone at ear height on a tripod or stand with the microphone pointing directly up towards the ceiling.**

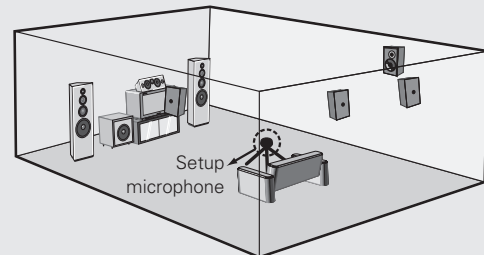

※ Do not hold the microphone in your hand during measurements. Be sure that the path from microphone to the speakers is not blocked by objects. Avoid placing the microphone close to a seat back or wall as sound reflections may give inaccurate results.

When using a subwoofer, make the following settings before starting the auto setup procedure:

- Defeat the volume and crossover controls if possible
- If this is not possible then set
 - Volume: "12 o'clock" position
 - Crossover frequency: "Maximum/Highest Frequency"
 - Low pass filter: "Off"
 - Standby mode: "Off"

NOTE

- Do not disconnect the setup microphone until the auto setup procedure is completed.
- When using headphones, unplug the headphones before starting the auto setup procedure.

Auto Setup

Optimize settings for speakers in use.

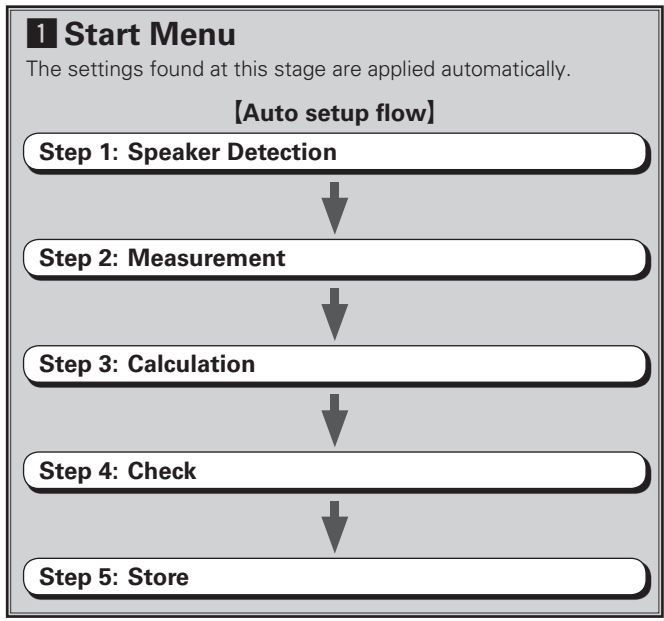

NOTE

- Loud test sounds may be played during Audyssey MultEQ XT automatic speaker setup. This is part of normal operation. If there is background noise in room, these test signals will increase in volume.
- Do not stand between the speakers and setup microphone or allow obstacles in the path while the measurements are being made. This will cause inaccurate readings.
- Make the room as quiet as possible. Background noise can disrupt the room measurements. Close windows, silence cell phones, televisions, radios, air conditioners, fluorescent lights, home appliances, light dimmers, or other devices as measurements may be affected by these sounds. Cell phones should be placed away from all audio electronics during the measurement process as Radio Frequency Interference (RFI) may cause measurement disruptions (even if the cell phone is not in use).
- Operating **MASTER VOLUME** during the measurements will cancel the measurements.

About the Auto Setup

The Audyssey MultEQ XT auto setup function detects the presence of each speaker and automatically calculates the speaker size, channel level, distance, and optimal crossover frequency setting. Audyssey MultEQ XT corrects acoustical distortions within the listening area. Before starting, connect and position all of your speakers. Once started, MultEQ XT will play a series of test tones through each speaker.

※ Before starting Auto Setup (👉 ①)

If adjustment to the environment is necessary, set the following items before proceeding.

- Front Speaker**
The front speaker to be measured can be selected ahead of time here.

[Selectable items]

- A** : Output test tone from front speakers A.
- B** : Output test tone from front speakers B.
- A+B** : Output test tone from front speakers A and B.

- Amp Assign**
Advanced setting : changes power amplifier assignment. You can use the surround back speaker for multi-zone, and for front channel bi-amp use. (Default : ZONE2)
For details, refer to "Amp Assign" (📖 page 32).

NOTE

Since "Amp Assign" of AVR-989 is set to "ZONE2" by default, audio is not output from the surround back speakers. When using the surround back speakers with MAIN ZONE, change the "Amp Assign" setting to "7.1ch".

Step 1 : Speaker Detection

● **Menu screen** ●

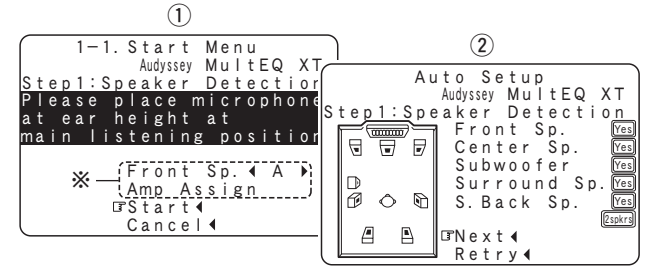

The speaker connection and polarity are detected at the first measurement position (main listening position). The following attributes are also determined at this time: "Speaker Size", "Speaker Distance", "Channel Level", "Crossover Frequency".

- ① Select "Start ◀", then press ◀.
 - ② Select "Next ◀", then press ◀.
- To cancel Auto Setup**
Press Δ ▽ to select "Cancel ◀", then press ◀.

- 🔧 If an error message appears during the measurements, check "Error Messages", take the advised action, then start the measurements again (📖 page 26).
- If the result differs from the actual connection status or an error message appears, use ▽ to on-screen display "Retry ◀" and then press ◀ to repeat the measurement.
- If the result still differs from the actual connection status after re-measurement or the error message still appears, it is possible that the speakers are not connected properly. Turn the AVR-989 off, check the speaker connections and repeat the measurement process from the beginning.

NOTE

Do not change the speaker connections or subwoofer volume after "Step 1".

Step 2 : Measurement

● Menu screen ●

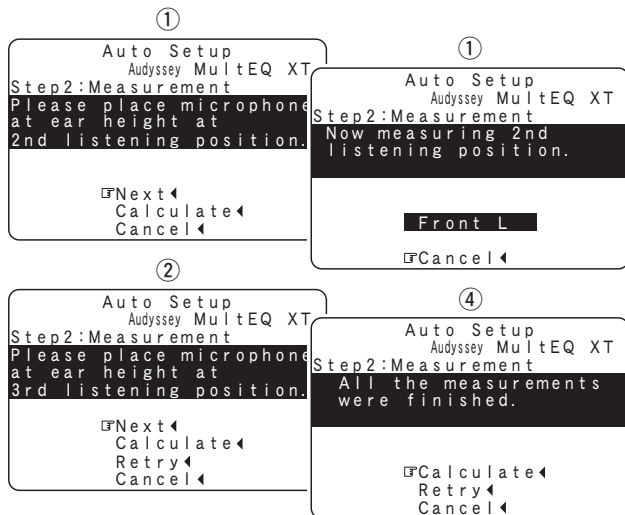

- ① Select "Next ◀", then press ◀.
 - The measurement of the 2nd position starts.
 - Select "Calculate ◀" with ▾, and press ◀ to proceed to Step 3.
- ② Move the microphone to the 3rd position and press ◀.
 - The measurement of the 3rd position starts.
 - Select "Calculate ◀" with ▾, and press ◀ to proceed to Step 3.
- ③ Perform repeatedly through the 6th position or more. A maximum of 8 position can be measured .
- ④ "All the measurements were finished." is displayed on the on-screen display, when you have completed measurements in 8th positions.
 - Select "Calculate ◀", and press ◀ to proceed to Step 3.

❑ To cancel Auto Setup

Press △▽ to select "Cancel ◀", then press ◀.



After completing a measurement position, move the microphone to the next position.

Measure at least 6 positions: the main listening position and 5 other surrounding positions. Although it is allowable to measure less than 6 positions, it is recommended to measure 6 or more positions (with a maximum of 8 positions) for best results.

Step 3 : Calculation

● Menu screen ●

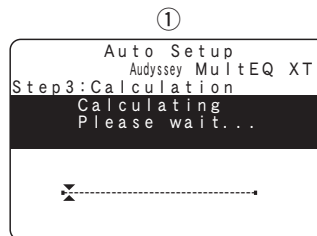

The values obtained from the measurements are automatically analyzed and the attributes for each of the speakers in the listening area are determined.

- ① Select "Calculate ◀" at Step 2, then press ◀.
 - Analysis begins.



- Analysis takes several minutes to complete.
- The time required for this analysis depends on the number of speakers connected. The greater the number of speakers connected, the longer analysis will take.

NOTE

- Do not change the speaker connections or subwoofer volume, or speaker locations after making measurements. If changes are necessary, make the changes and use Audyssey MultEQ XT auto setup once again for an updated EQ solution.
- For instance, if the location or direction of a speaker is altered, the Auto Setup should be performed again to ensure the correct EQ solution for the new room configuration.

Step 4 : Check

● Menu screen ●

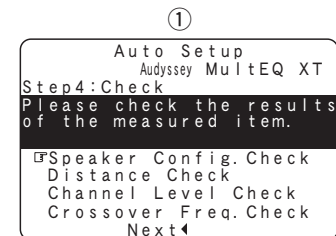

When analysis is complete, check the analysis results for the following four items.

- ① Make your selection using △▽ and press **ENTER**.
 - Presence and size of speaker "Speaker Config. Check"
 - Distance of speaker from listening position "Distance Check"
 - Speaker channel level "Channel Level Check"
 - Crossover Frequency "Crossover Freq. Check"
- ② Use △▽ to change which speaker is displayed.
- ③ Press **RETURN**.
 - This returns you to analysis results items, so repeat step ①.
- ④ Press ▾ to select "Next ◀", and then press ◀ to proceed to Step 5.



Distance values that are greater than the actual distance of a speaker may be accurate for speakers with built-in filters (subwoofers, etc). This is because these filters add electrical delay (distance) to the signal that is compensated for by the Auto Setup process.

Step 5 : Store

● Menu screen ●

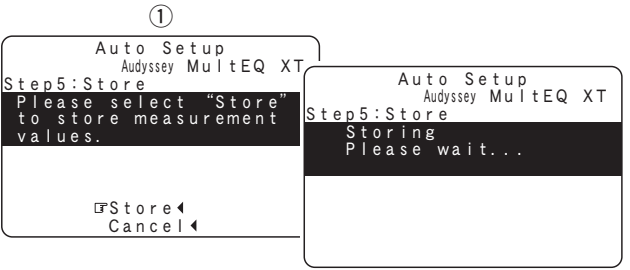

- The auto setup measurement results are stored in the AVR-989.
- ① Select "Store ◀", then press ◀.
 - "Storing Please wait..." is displayed on the on-screen display while the results are being stored.
 - When storing is complete, "Storing complete. Auto Setup is now finished." is displayed on the on-screen display.
 - ② Select "Exit", then press **ENTER**.
 - ③ Disconnect the setup microphone from the AVR-989.

❑ To cancel storing

- Press △▽ to select "Cancel ◀", then press ◀.
- All the measured auto setup data will be erased.

NOTE

Do not turn the power off while the settings are being stored.

2 Parameter Check

Check auto setup measurement results.
This is displayed after the auto setup procedure is completed.

[Selectable items]

- | | |
|-----------------------|-----------------------|
| Speaker Config. Check | Distance Check |
| Channel Level Check | Crossover Freq. Check |
| EQ Check | |



The auto setup results can be set again when "Restore" is selected.

Error Messages

If the auto setup procedure could not be completed due to speaker installation, the measuring environment, etc., an error message is displayed. If this happens, check the relevant items, be sure to take the necessary measures, then perform the auto setup procedure over again.

Error messages (examples)	Cause	Measures
	<ul style="list-style-type: none"> • Included setup microphone is not connected. • Not all speakers could be detected. • The front L speaker was not properly detected. 	<ul style="list-style-type: none"> • Connect the included setup microphone to the SETUP MIC jack on the main unit. • Check the speaker connections.
	<ul style="list-style-type: none"> • Too much noise in the room for accurate measurements to be made. • Speaker or subwoofer sound is too low for accurate measurements to be made. 	<ul style="list-style-type: none"> • Either turn off any device generating noise or move it away. • Try again when the surroundings are quieter. • Check the speaker installation and the direction in which the speakers are facing. • Adjust the subwoofer's volume.
	<ul style="list-style-type: none"> • Displayed speaker could not be detected. <ul style="list-style-type: none"> · The front R speaker were not properly detected. · Only one channel of the surround speakers was detected. · Sound was output from the R channel when only one surround back speaker was connected. · The surround back, but the surround speaker was not detected. 	<ul style="list-style-type: none"> • Check the connections of the displayed speaker.
	<ul style="list-style-type: none"> • Displayed speaker connected with the polarities reversed. 	<ul style="list-style-type: none"> • Check the polarities of the displayed speaker. • For some speakers, this error message may be displayed even if the speaker is properly connected. If you are sure that the wiring is correct, select "Skip".



Select "Retry" to measure again.

NOTE Be sure to turn the power off before checking the speaker connections.

Manual Setup

Symbols used to indicate buttons in this manual

- Button located on both the main unit and the remote control unit → **BUTTON**
- Button only on the main unit → **<BUTTON>**
- Button only on the remote control unit → **[BUTTON]**

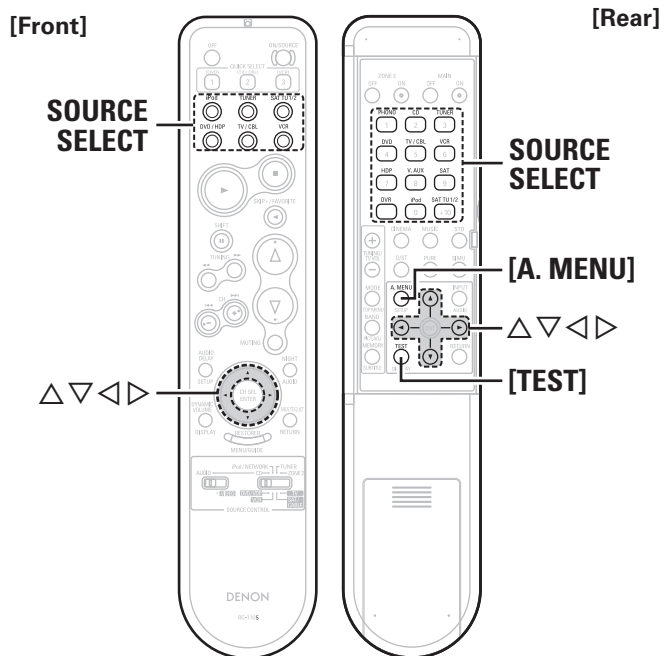
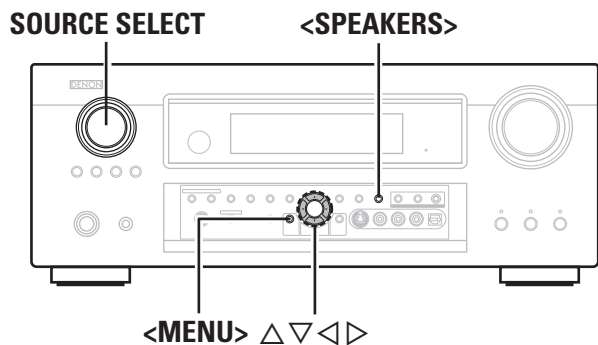

Make detail settings for various parameters.

Speaker Setup

Use this procedure to set the speakers manually or if you wish to change the settings made with the auto setup procedure.

● Menu screen ●

MENU

1. Auto Setup
2. Manual Setup
3. Input Setup
4. Parameter
5. Information

2. Manual Setup

1. Speaker Setup
2. HDMI Setup
3. Audio Setup
4. ZONE2 Setup
5. Option Setup

2-1. Speaker Setup

1. Speaker Config.
2. Subwoofer Setup
3. Distance
4. Channel Level
5. Crossover Freq.
6. Front Speaker Setup

1 Speaker Configuration

Select speaker configuration and size.
(bass reproduction capability)

Front Speaker

Select front speaker size.

[Selectable items] **Large** **Small**

Center Speaker

Select center speaker use and size.

[Selectable items] **Large** **Small** **None**

Subwoofer

Select subwoofer use.

[Selectable items] **Yes** **No**

Surround Speaker

Select surround speaker use and size.

[Selectable items] **Large** **Small** **None**

Surround Back Speaker

Select surround back speaker use and size.

[Selectable items] (**Large** **Small** **None**)
(**2spkr** **1spkr**)

NOTE

Since "Amp Assign" of AVR-989 is set to "ZONE2" by default, audio is not output from the surround back speakers. When using the surround back speakers with MAIN ZONE, change the "Amp Assign" setting to "7.1ch" (page 32).

Large :Select this when using large speakers with ample low frequency reproduction capabilities.

Small :Select this when using small speakers without ample low frequency reproduction capabilities.

None :Select this when no speaker is connected.

Yes :Select this when a subwoofer is connected.

No :Select this when no subwoofer is connected.

2spkr **1spkr** :

Select the number of surround back speakers.

Even when the surround back speaker setting is other than "None", sound may not be emitted from the surround back speaker, depending on the playback source. In this case, make a menu "Parameter" - "Surround Parameter" - "SB CH Out" setting other than "OFF" (page 44).



- Select “Large” or “Small” not according to the physical size of the speaker but according to the low frequency reproduction capabilities based on the frequency set at “Crossover Frequency” (page 29).
- When “Front Speaker” is set to “Small”, “Subwoofer” can automatically set to “Yes”.
- If “Subwoofer” is set to “No”, “Front Speaker” is automatically set to “Large”.
- If “Surround Speaker” is set to “None”, “Surround Back Speaker” is automatically set to “None”.
- When “Front Speaker” is set to “Small”, “Center Speaker” can not be set to “Large”.
- When using just one surround back speaker, connect it to the left channel (SBL).
- When set to other than “7.1ch” with “Amp Assign”, “Surround Back Speaker” is not displayed.

2 Subwoofer Setup

Select low range signal to be reproduced by subwoofer.

[Selectable items]

LFE : Play low range and LFE signal of channels set to “Small”.

LFE+Main : Play low range and LFE signal of all channels.



- This can be set when menu “Speaker Configuration” – “Subwoofer” is set to “Yes”.
- Play music or a movie source and select the mode offering the strongest bass.
- Select “LFE+Main” if you want the bass signals to always be produced from the subwoofer.

3 Distance

Set distance from listening position to speakers. Before making the settings, measure the distance from the listening position to the different speakers.

Unit

Select unit for distance.

[Selectable items] **Feet** **Meters**

Step

Select step. (smallest distance)

[Selectable items]

1ft **0.1ft** : Can be selected when “Feet” is set.

0.1m **0.01m** : Can be selected when “Meters” is set.

Default

Resets the settings to the default values.

Distance measurement

Select the speaker you want to set, then set the distance. Set the value closest to the measured distance.

[Variable range]

0.0ft ~ 60.0ft : Display when “Feet” is set.

0.00m ~ 18.00m : Display when “Meters” is set.

NOTE

Set the distance between the listening position and the various speakers to no more than 20.0 ft (6.00 meters).

4 Channel Level

Adjust channel levels to obtain equal volume from all speakers.

Test Tone

Select test tone playback method.

[Selectable items]

Auto : Automatically switch speaker from which test tone is output.

Manual : Manually switch speaker from which test tone is output.

Test Tone Start

Output test tone.

[Variable range] **OFF** * **-12dB** ~ **0dB** ~ **+12dB**

* In the case of a subwoofer, reducing the volume when it is at “-12dB” will change the setting to “OFF” (none).

Default

Reset the settings to the default values.



Operating from the remote control unit

Adjusting with the remote control unit using the test tones is only possible in the “Auto” mode and only effective in the STANDARD mode. The adjusted levels for the different modes are automatically stored in the memory.

[Adjusting using test tones]

- ① Press **[TEST]**.
Test tones are output from the various speakers.
- ② Use **<** **>** to adjust so that the volume is equal for all speakers.
- ③ When the adjustments are completed, press **[TEST]** again.



- When the menu “Speaker Configuration” – “Surround Back Speaker” setting (page 27) is set to “1spkr”, the surround back speaker display is set to “SB”.
- Speakers set to “None” in the “Speaker Configuration” settings are not displayed.
- When “Channel Level” is adjusted, the adjusted values are set for all the surround modes. To adjust the channel level separately for the different surround modes, use the operation see page 59.

5 Crossover Frequency

Select crossover frequency from which subwoofer handles low range signal.

[Selectable items]

40Hz 60Hz 80Hz 90Hz 100Hz 110Hz 120Hz 150Hz
200Hz 250Hz :

Only the portion of the bass sound of the various speakers output from the subwoofer that has a frequency below the frequency set here is output.

Set this according to the low frequency reproduction capabilities of the speakers you are using.

Advanced :

Set the crossover frequency separately for the different speakers.



- If in the “Advanced” settings, “Subwoofer Setup” (page 28) in the menu is set to “LFE”, it is possible to make this setting for speakers set to “Small” at “Speaker Configuration”. If set to “LFE+Main”, this setting can be made regardless of the speaker size.
- For speakers set to “Small”, sound below the crossover frequency is cut from the sound output. The cut bass sound is output from the subwoofer or front speakers.
- Always set the crossover frequency to “80 Hz”. When using small speakers, however, we recommend setting the crossover frequency to a higher frequency.

6 Front Speaker Setup

Select front speakers to use for each surround mode.

[Selectable items]

Normal : To change the settings, select “Custom”.

Custom : When set to “Custom”, you can select beforehand the front speaker to use for each surround mode.

[Selectable items]

DIRECT/STEREO : **A** **B** **A+B**
MULTI CH : **A** **B** **A+B**

NOTE

When set to “Custom”, <SPEAKERS> does not operate.

HDMI Setup

Make settings for HDMI video/audio output.

● Menu screen ●

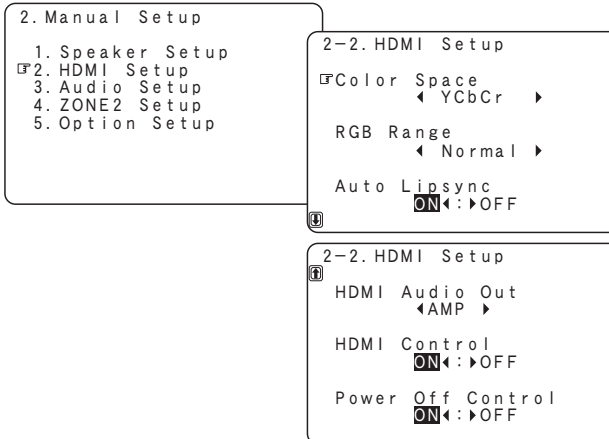

1 Color Space

Make settings for output color space.

[Selectable items]

YCbCr : Output using YCbCr format.

RGB : Output using RGB format.



When connected to a monitor with a DVI-D connector (HDCP compatible) using an HDMI/DVI converter cable, the signals are output in RGB format, regardless of this setting.

2 RGB Range

Make settings for RGB output range.

[Selectable items]

Normal : Use video range from 16 (black) to 235 (white).

Enhanced : Video range from 0 (black) to 255 (white). Use this setting to avoid black washout.



When “YCbCr” is selected under “Color Space”, “RGB Range” will have no effect.

3 Auto Lipsync

Automatic compensation for timing shift in audio and video output.

[Selectable items] **ON** **OFF**

4 HDMI Audio Out

Select HDMI audio output device.

[Selectable items]

AMP : Use speakers connected to receiver for audio playback.

TV : Use speakers of TV for audio playback.

NOTE

When the HDMI control function is operating, the setting of audio playback in the connected TV takes priority (☞ page 58 “HDMI Control Function”).

5 HDMI Control

Make settings for HDMI control function.

[Selectable items] **ON** **OFF**



Please consult the operating instructions for each connected device to check the settings.

NOTE

For details, see “HDMI Control Function” (☞ page 58).

6 Power Off Control

Interlock power OFF with HDMI control.

[Selectable items] **ON** **OFF**



- This can be set when “HDMI Control” is set to “ON”.
- Please consult the operating instructions for each connected device to check the settings.

NOTE

- When the “HDMI Control” setting has been changed, always turn off the power to the connecting devices afterwards and then turn back on.
- The “HDMI Control” and “Power Off Control” does not work when the power to the equipment is off.
- For details, see “HDMI Control Function” (☞ page 58).

Audio Setup

Make settings for audio playback.

● Menu screen ●

2. Manual Setup

1. Speaker Setup
2. HDMI Setup
3. Audio Setup
4. ZONE2 Setup
5. Option Setup

2-3. Audio Setup

1. EXT. IN SW Level
2. 2ch Direct/Stereo
3. Dolby Digital Setup
4. Auto Surround Mode
5. EQ Preset

1 EXT. IN Subwoofer Level

Set the subwoofer level for playback.

[Selectable items] **0dB** **+5dB** **+10dB** **+15dB**



We recommend setting to “+15dB”.

2 2ch Direct/Stereo

Make speaker settings for 2-channel mode playback.

Setting

To change the settings, select “Custom”.

[Selectable items]

Basic : Use the same settings as in “Speaker Setup”.

Custom : Make separate settings for 2-channel mode.

Front

Select front speaker size.

[Selectable items]

Large **Small** : Select front speaker size.

Subwoofer

Select subwoofer use.

[Selectable items]

Yes **No** : Select subwoofer use.

Subwoofer Mode

Select low range signal to be reproduced by subwoofer.

[Selectable items]

LFE **LFE+Main** : Select subwoofer signal.

Crossover

Select crossover frequency from which subwoofer handles low range signal.

[Selectable items]

40Hz **60Hz** **80Hz** **90Hz** **100Hz** **110Hz** **120Hz** **150Hz**
200Hz **250Hz** : Select crossover frequency.

Distance FL

Set distance from listening position to front left speaker.

[Variable range] **0.0ft ~ 60.0ft**

Distance FR

Set distance from listening position to front right speaker.

[Variable range] **0.0ft ~ 60.0ft**

NOTE

Set the distance between the listening position and the various speakers to no more than 20.0 ft (6.00 meters).

3 Dolby Digital Setup

Set dynamic range for downmix playback of Dolby Digital sources.

[Selectable items]

ON : Compression is used. Select this if sound from front speakers is distorted.

OFF : Do not use compression. This is the recommended setting.



- Set this to "ON" if the sound from the front speakers seems distorted.
- When not using the center speaker or surround speakers, the playback sound is down-mixed and output from the front speakers.

4 Auto Surround Mode

Make setting for memorizing surround mode setting for each input signal type.

[Selectable items]

ON : Memorize settings. Most recently stored surround mode is automatically selected.

OFF : Do not memorize settings. Surround mode does not change according to input signal.



- The auto surround mode function lets you store in the memory the surround mode last used for playing the four types of input signals listed below.
 - ① Analog and PCM 2-channel signals
 - ② Dolby Digital and DTS 2-channel signals
 - ③ Dolby Digital and DTS multi-channel signals
 - ④ Multi-channel signals other than Dolby Digital and DTS (PCM, DSD, etc.)
- When playing in the PURE DIRECT mode, the surround mode does not change even if the input signal is changed.

5 EQ Preset

Set MultEQ XT related settings and Manual EQ beforehand.

EQ Customize

When MultEQ® XT and Manual EQ you are not using are preset, MultEQ XT can be skipped when selected on the main unit or remote control unit.

Before running Auto Setup

[Selectable items]

Manual : **Used** **Not Used**

After running Auto Setup

[Selectable items]

Audyssey Byp. L/R : **Used** **Not Used**

Audyssey Flat : **Used** **Not Used**

Manual : **Used** **Not Used**

Direct Mode

Select "MultEQ XT" use for DIRECT or PURE DIRECT mode.

[Selectable items]

ON : Use "MultEQ XT".

OFF : Do not use "MultEQ XT".

Manual EQ

Adjust tonal quality for each speaker using graphic equalizer.

Default

Resets the settings to the default values.

Base Curve Copy

Copy the MultEQ XT "Audyssey Flat" correction curve.



"Base Curve Copy" is displayed after the auto setup procedure has been performed.

Adjust CH

① Select speaker adjustment method.

[Selectable items]

Each CH : Adjust tonal quality for each speaker separately.

L/R CH : Adjust tonal quality for each L/R speaker pair.

All CH : Adjust tonal quality for all speakers together.

② Select the speaker and frequency band and adjust the level.

[Selectable items] **63Hz** **125Hz** **250Hz** **500Hz** **1kHz**
2kHz **4kHz** **8kHz** **16kHz**

[Variable range] **-20dB** ~ **0dB** ~ **+6dB**

ZONE2 Setup

Make settings for audio playback in a ZONE2 system.

● Menu screen ●

2. Manual Setup

1. Speaker Setup
 2. HDMI Setup
 3. Audio Setup
 4. ZONE2 Setup
 5. Option Setup

2-4. ZONE2 Setup

Level Lch : ◀ 0dB ▶
 Rch : ◀ 0dB ▶
 Vol. Level : ◀ VAR ▶
 Vol. Limit : ◀ OFF ▶
 Power On Lev. : Last ▶
 Mute Lev. : ◀ Full ▶

1 Level Lch

Adjust the left channel output level.

[Variable range] **-12dB** ~ **0dB** ~ **+12dB**



The "Level Lch" and "Level Rch" can be set when "Channel" is set to "Stereo".

2 Level Rch

Adjust the right channel output level.

[Variable range] **-12dB** ~ **0dB** ~ **+12dB**

3 Volume Level

Adjust the main volume level.

[Selectable items]

VAR : Allow volume adjustment by remote control.

-40dB : Fix the volume to -40 dB.

0dB : Fix the volume to 0 dB.



"VAR" is fixed when a power amplifier is assigned to the ZONE2 output channel at menu "Manual Setup" – "Option Setup" – "Amp Assign" (☞ page 32).

4 Volume Limit

Make a setting for maximum volume.

[Selectable items]

OFF : Do not set a maximum volume.

-20dB : Set the maximum volume to -20 dB.

-10dB : Set the maximum volume to -10 dB.

0dB : Set the maximum volume to 0 dB.



This can be set when "Volume Level" is set to "VAR".

5 Power On Level

Define the volume setting that is active when the power is turned on.

[Selectable items]

Last : Use the memorized setting from the last session.

--- : Always use the muting on condition when power is turned on.

[Variable range]

-70dB ~ +18dB : Set the volume level when the power is turned on in units of 1 dB.



This can be set when "Volume Level" is set to "VAR".

6 Mute Level

Set the amount of attenuation when muting is on.

[Selectable items]

Full : The sound is cut off entirely.

-40dB : The sound is attenuated by 40 dB.

-20dB : The sound is attenuated by 20 dB.

Option Setup

Make various other settings.

● Menu screen ●

2. Manual Setup

1. Speaker Setup
2. HDMI Setup
3. Audio Setup
4. ZONE2 Setup
- ☞ 5. Option Setup

- 2-5. Option Setup
 - ☞ 1. Amp Assign
 2. Vol. Control
 3. Source Delete
 4. On-Screen Display
 5. Quick Select Name
 6. Trigger Out
 7. Remote ID Setup
 8. 2.32C Port
 9. Display
 10. Setup Lock

1 Amp Assign

Define how the amplifier for the surround back speaker channels is used.

The places where the surround back amplifier are used can be set freely according to the usage environment. This makes it possible to output sound to rooms other than the room (the MAIN ZONE) where surround playback is performed (multi-zone playback) or play the sound with high quality using the front speakers (bi-amp connections).

[Selectable items]

7.1ch : The surround back channel is output from the speakers connected to the SURR.BACK/AMP ASSIGN terminals.

ZONE2 : When ZONE2 power is on, ZONE2 sound is emitted from the speaker connected to the SURR.BACK/AMP ASSIGN terminal.

FrontA Bi-Amp : The Front A channel for Bi-Amp use is output from the speakers connected to the SURR.BACK/AMP ASSIGN terminals.

FrontB Bi-Amp : The Front B channel for Bi-Amp use is output from the speakers connected to the SURR.BACK/AMP ASSIGN terminals.



For details, see “Amp Assign / Multi-zone Connections and Operations” (page 65, 66).

2 Volume Control

Set the MAIN ZONE volume setting.

Volume Limit

Make a setting for maximum volume.

[Selectable items]

OFF : Do not set a maximum volume.

-20dB : Set the maximum volume to -20 dB.

-10dB : Set the maximum volume to -10 dB.

0dB : Set the maximum volume to 0 dB.

Power On Level

This sets the volume set when the MAIN ZONE's power is turned on.

[Selectable items]

Last : Use the memorized setting from the last session.

--- : Always use the muting on condition when power is turned on.

[Variable range]

-80dB ~ +18dB : Set the volume level when the power is turned on in units of 1 dB.

Mute Level

This sets the amount of attenuation of the volume when the mute mode is set in the MAIN ZONE.

[Selectable items]

Full : The sound is cut off entirely.

-40dB : The sound is attenuated by 40 dB.

-20dB : The sound is attenuated by 20 dB.

3 Source Delete

Remove input sources that are not used from the display.

[Selectable items]

ON : Use this source.

Delete : Do not use this source.

Default

Reset the settings to the default values.

NOTE

- Input sources being used in the various zones cannot be deleted.
- Input sources set to “Delete” cannot be selected using **SOURCE SELECT**.

4 On-Screen Display

Make on-screen display related settings.

Screensaver

Make screensaver settings.

Use the screensaver to prevent burn-in on the monitor screen.

When set to “ON”, the screensaver is activated if there is no activity for about 3 minutes.

[Selectable items]

ON : Activate the screensaver if there is no activity for about 3 minutes.

OFF : Turn the screensaver function off.



When “Screensaver” is set to “ON”, the screensaver is activated if no operation is performed for about 3 minutes.

When you press $\Delta \nabla \triangleleft \triangleright$, the screensaver is cancelled and the screen before that screensaver started is displayed.

Text

Input source and mode display.

[Selectable items]

ON : Turn display on.

OFF : Turn display off.

Master Volume

Master volume display during adjustment.

[Selectable items]

ON : Turn display on.

OFF : Turn display off.

Tuner Information

This sets the time the on-screen display is displayed when a tuner operation is performed.

[Selectable items]

Always : Show display continuously.

30sec : Show display for 30 seconds after operation.

10sec : Show display for 10 seconds after operation.

OFF : Turn display off.

iPod Information

This sets the time the on-screen display is displayed when an iPod operation is performed.

[Selectable items]

Always : Show display continuously.

30sec : Show display for 30 seconds after operation.

10sec : Show display for 10 seconds after operation.

OFF : Turn display off.

Display Mode

Select the on-screen display's display mode.

[Selectable items]

Mode1 : If there is no video signal, flickering of the on-screen display is not prevented.

Mode2 : Prevents flickering of the on-screen display when there is no video signal.

Use this mode if the on-screen display does not appear in the Mode 1, as may happen according to the TV being used.

5 Quick Select Name

Change the Quick Select name.
Up to 16 characters can be input.

[Input characters]

A~Z **a~z** **0~9** **!#%&'()*+,-./:;="?@[\]** (space)

Default

Reset the settings to the default values.

6 Trigger Out

Select the conditions to turn on the trigger out with respect to the zone, input source, surround mode, etc. For details about the trigger out function, see page 19.

Selecting the Zone

Select the zone for which the trigger out is set.

[Selectable items] **ALL** **MAIN** **ZONE2**

Setting with Respect to the Input Source

When the input source set to on is selected, the trigger out turns on.

[Selectable items]

ON : Activate trigger on this mode.

--- : Do not activate trigger on this mode.

Setting with Respect to the Surround Mode

- When the surround mode set to on is selected, the trigger out turns on.
- Associated with respect to surround modes that are set to "ON".
- This can be set if the "MAIN ZONE" is selected at "Selecting the Zone".
- Associated when an input source for which "Setting with Respect to the Input Source" is set to "ON" is selected.

[Selectable items]

ON : Activate trigger on this mode.

--- : Do not activate trigger on this mode.

Default

Reset the settings to the default values.

7 Remote ID Setup

Set remote control ID.

[Selectable items] **1** **2** **3** **4**



When using the AVR-989 with only the included remote control unit (RC-1105), use Remote ID "1" (default).

When using a separately sold remote control unit (RC-7000CI, etc.), this function can be used. Match the ID setting of the remote control unit and the receiver.

8 232C Port

Set when external controller or 2-way remote control unit is connected.

[Selectable items]

Serial Control : Set when using an external controller.

2Way Remote : Set when using a 2-way remote control unit.

NOTE

When using a 2-way remote control unit (RC-7000CI and RC-7001RCI, sold separately), set this to "2Way Remote".
In this case, you can not use the RS-232C connector as an external controller.

9 Display

Adjust display brightness of the receiver.

[Selectable items]

Bright : Normal display brightness.

Dim : Reduced display brightness.

Dark : Very low display brightness.

OFF : Display is off unless controls are operated.



When setting to "OFF", the display brightness of the menu setting in operation changes to "Dark".

10 Setup Lock

Protect settings from inadvertent change.

[Selectable items]

ON : Turn protection on.

OFF : Turn protection off.



- When "Setup Lock" is set to "ON", the settings listed below can no longer be changed. Also, "SETUP LOCKED!" is displayed if you attempt to operate related settings.

- RESTORER
- Night Mode
- MultEQ XT
- Dynamic EQ
- Dynamic Volume
- Channel Level
- Audio Delay

- To cancel the setting, press <MENU> or [A.MENU] to re-display the "Setup Lock" screen, then change the setting to "OFF".

Input Setup

Symbols used to indicate buttons in this manual

- Button located on both the main unit and the remote control unit → **BUTTON**
- Button only on the main unit → **<BUTTON>**
- Button only on the remote control unit → **[BUTTON]**

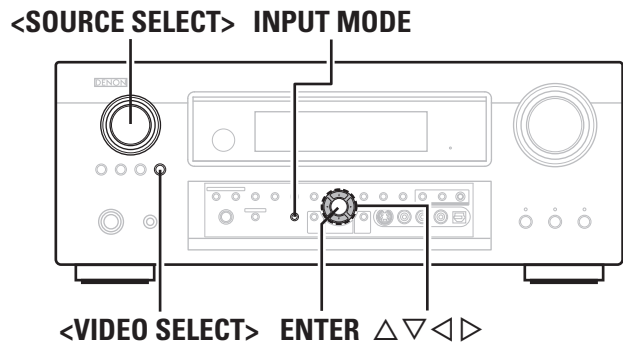

[Rear]

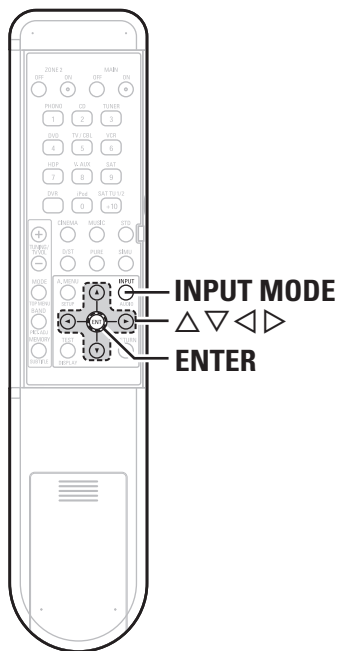

Use this procedure to select the input source and make the settings related to playing input sources.

☐ TUNER (AM/FM)

This menu is for "TUNER".

● Menu screen ●

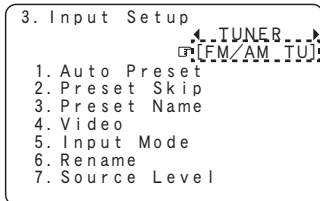

Displayed when source name is changed with "Rename".

☐ XM

This menu is for "XM".

● Menu screen ●

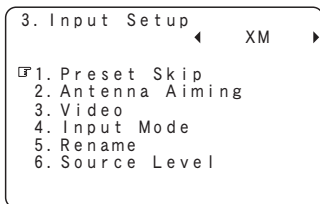

☐ SIRIUS

This menu is for "SIRIUS".

● Menu screen ●

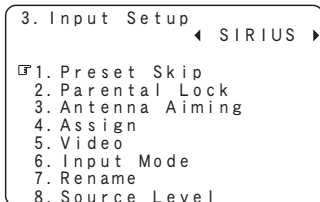

☐ PHONO

This menu is for "PHONO".

● Menu screen ●

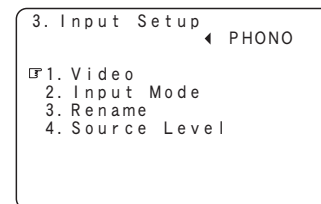

☐ CD, DVD, HDP, TV/CBL, SAT, VCR, DVR, V.AUX

This menu is for "CD", "DVD", "HDP", "TV/CBL", "SAT", "VCR", "DVR", "V.AUX".

● Menu screen ●

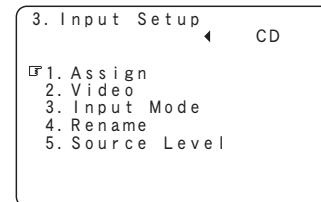

※ The menu settings below can be made for these input sources when "iPod Dock" is set to "Assign".

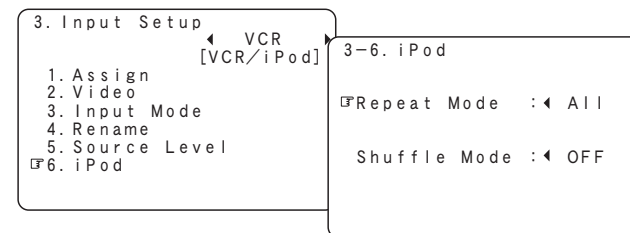

Changing the input source within Input Setup

3. Input Setup

- 1. Assign
- 2. Video
- 3. Input Mode
- 4. Rename
- 5. Source Level

CD

Press Δ to align the cursor with the top right of the menu screen, and press $\triangleleft \triangleright$ to change the input source.



The input source currently selected in the MAIN ZONE is not changed even when the input source within Input Setup is changed.

Settings Related to Playing Input Sources

1 Auto Preset

Use the auto preset function to program radio stations.

[Input source] **TUNER**

[Selectable items]

Start : Start the auto preset process.



If an FM station cannot be preset automatically, select the desired station by tuning it in manually, then preset it manually.

2 Preset Skip

Set the preset memories that you do not want to display when tuning.

A ~ G

Select the preset channel(s) you do not want to display.

[Input source] **TUNER** **XM** **SIRIUS**

[Selectable items]

ON : Display this number.

Skip : Skip this number.



If you set "Block Presets" to "Skip", you can skip the preset memory blocks (A to G).

3 Preset Name

Assign name to a preset memory.
Names containing up to 8 characters can be input.

A1 ~ G8

Select the preset memory number.

[Input source] **TUNER**

[Characters that can be input]

A ~ Z **a ~ z** **0 ~ 9** **! # % & ' () * + , - . / : ; = " ? @ [\] (space)**

Default

Reset the settings to the default values.

4 Video

Setting the video source.

Video Select

Switch video input source while listening to audio signal.

[Input source] **TUNER** **PHONO** **CD** **DVD** **HDP** **TV/CBL**
SAT **VCR** **DVR** **V.AUX** **XM** **SIRIUS**

[Selectable items]

DVD **HDP** **TV/CBL** **SAT** **VCR** **DVR** **V.AUX** :

Select video input source to view.

Source :

The video and audio for the same input source are played.



Operating from the main unit

Press **<VIDEO SELECT>**, then turn **<SOURCE SELECT>** until the desired picture appears.

※ To cancel, press **<VIDEO SELECT>**, then turn **<SOURCE SELECT>** and select "Source".

NOTE

- It is not possible to select HDMI input signals.
- When playing HDMI video input signals, the analog video signal of another input source cannot be selected for the HDMI video output.
- Input sources for which "Delete" is selected at "Source Delete" cannot be selected.

Convert

Automatically convert video input signal to monitor output format.

[Input source] **DVD** **HDP** **TV/CBL** **SAT** **VCR** **DVR**

V.AUX

[Selectable items]

ON : Enable conversion.

OFF : Disable conversion.

NOTE

When a non-standard video signal from a game machine or some other source is input, the video conversion function might not operate. If this happens, please set the conversion mode to "OFF".

i/p Scaler

Make settings for i/p scaler function.

[Input source] **DVD** **HDP** **TV/CBL** **SAT** **VCR** **DVR**

V.AUX

[Selectable items]

A to H : Use i/p scaler function for analog video signal.

OFF : Do not use i/p scaler function.

NOTE

When the "Convert" setting is "OFF", you cannot set "i/p Scaler".

Resolution

Make settings for resolution of HDMI video output signal.

[Input source] **DVD** **HDP** **TV/CBL** **SAT** **VCR** **DVR**
V.AUX

[Selectable items]

- Auto** : Detect monitor panel resolution and automatically set output resolution.
- 480p/576p** : Output at 480p/576p resolution.
- 1080i** : Output at 1080i resolution.
- 720p** : Output at 720p resolution.
- 1080p** : Output at 1080p resolution.

This can be set when "i/p Scaler" is set to "A to H".

- NOTE**
- It is not possible to convert "1080i" signals into "720p" format.
 - It is not possible to convert "720p" signals into "1080i" format.

Progressive Mode

Select optimum progressive mode for video material.

[Input source] **DVD** **HDP** **TV/CBL** **SAT** **VCR** **DVR**
V.AUX

[Selectable items]

- Auto** : Automatically detect video material type.
- Video1** : Select mode suitable for video playback.
- Video2** : Select mode suitable for video and 30-frame film material playback.

This can be set when "i/p Scaler" is set to "A to H".

Aspect

This sets the aspect ratio when outputting 480i/576i or 480p/576p input signals from the HDMI output connector.

[Input source] **DVD** **HDP** **TV/CBL** **SAT** **VCR** **DVR**
V.AUX

[Selectable items]

- Full** : Output at 16:9 aspect ratio.
- Normal** : Output at 4:3 aspect ratio.

This can be set when "i/p Scaler" is set to "A to H".

5 Input Mode
Make input mode and decode mode settings for this source. The selectable input modes depend on the input source and "Assign" setting (page 38).

Input Mode

Set the input mode for this source.

[Input source] **TUNER** **PHONO**

[Selectable items]

- Analog** : Play only signals from analog input.
- EXT. IN** : Play only signals from EXT. IN input.

[Input source] **XM**

[Selectable items]

- Auto** : Automatically detect input signal and perform playback.
- EXT. IN** : Play only signals from EXT. IN input.

[Input source] **CD** **DVD** **HDP** **TV/CBL** **SAT** **VCR** **DVR**
V.AUX **SIRIUS**

[Selectable items]

- Auto** : Automatically detect input signal and perform playback.
- HDMI** *1 : Play only signals from HDMI input. (Excluding CD and SIRIUS)
- Digital** *2 : Play only signals from digital input.
- Analog** : Play only signals from analog input.
- EXT. IN** : Play only signals from EXT. IN input.

*1: This can be selected for input sources for which the menu "Assign" setting is set to "HDMI In".

*2: This can be selected for input sources for which the menu "Assign" setting is set to "Digital In" (page 38).

- When a digital signal is properly input, the "DIG." indicator lights on the display. If the "DIG." indicator does not light, check the digital input connector assignment and the connections.
- The surround mode cannot be set if the input mode is set to "EXT. IN".

Operating from the main unit or remote control unit

Press **INPUT MODE**. Each time you press the button, the input mode display will change.



*1: This can be selected for input sources for which the menu "Assign" setting is set to "HDMI In".

*2: This can be selected for input sources for which the menu "Assign" setting is set to "Digital In" (page 38).

Decode Mode

Set the decode mode for this source.

[Input source] **CD** **DVD** **HDP** **TV/CBL** **SAT** **VCR** **DVR**
V.AUX

[Selectable items]

- Auto** : Detect type of digital input signal and decode and play automatically.
- PCM** : Decode and play only PCM input signals.
- DTS** : Decode and play only DTS input signals.



- This can be selected for input sources for which the menu "Assign" setting is set to "HDMI In" or "Digital In" (page 38).
- Only set "PCM" and "DTS" when playing the respective signals.

6 Rename

Change the display name for this source.
 Names containing up to 8 characters can be input.

[Characters that can be input]

A ~ Z **a ~ z** **0 ~ 9** **! # % & ' () * + , - . / : ; = " ? @ [\]** (space)

Default

Reset the settings to the default values.

7 Source Level

Corrects the playback level of the selected input source's audio input.

[Variable range] **-12dB** ~ **0dB** ~ **+12dB**



For input sources for which "HDMI In" and "Digital In" are set at the menu "Assign" setting, the analog input level and digital input level can be set separately.

8 Assign

Assign input sources to input connectors.

HDMI In

Select HDMI connector to assign to this source.

[Input source] **DVD** **HDP** **TV/CBL** **SAT** **VCR** **DVR**
V.AUX

[Selectable items]

- HDMI1** : Assign HDMI1 input connector.
- HDMI2** : Assign HDMI2 input connector.
- HDMI3** : Assign HDMI3 input connector.
- HDMI4** : Assign HDMI4 input connector.
- None** : No HDMI input connector assigned.

Input source	DVD	HDP	TV/CBL	SAT
Default setting	HDMI1	HDMI2	None	HDMI3

Input source	VCR	DVR	V.AUX
Default setting	None	HDMI4	None



- With HDMI, the video and audio signals are transferred simultaneously. When HDMI is assigned to an input source, the audio signal switches to HDMI along with the video signal. To use with the digital audio input connectors assigned, set menu "Input Mode" to "Digital".
- When the AVR-989 and monitor are connected with an HDMI cable, if the monitor is not compatible with HDMI audio signal playback, only the video signals are output to the monitor.
- The audio signals input from the analog, digital and EXT. IN connectors are not output to the monitor.

Digital In

Select digital input connector to assign to this source.

[Input source] **CD** **DVD** **HDP** **TV/CBL** **SAT** **VCR** **DVR**
V.AUX **SIRIUS**

[Selectable items]

- COAX1** : Assign COAXIAL 1 input connector.
- COAX2** : Assign COAXIAL 2 input connector.
- COAX3** : Assign COAXIAL 3 input connector.
- OPT1** : Assign OPTICAL 1 input connector.
- OPT2** : Assign OPTICAL 2 input connector.
- OPT3** : Assign OPTICAL 3 input connector.
- None** : No digital input connector assigned.

Input source	CD	DVD	HDP	TV/CBL	SAT
Default setting	COAX3	COAX1	None	OPT1	COAX2

Input source	VCR	DVR	V.AUX	SIRIUS
Default setting	None	OPT2	OPT3	None

Component In

Select component video input to assign to this source.

[Input source] **DVD** **HDP** **TV/CBL** **SAT** **VCR** **DVR**
V.AUX

[Selectable items]

- 1-RCA** : Assign component video 1 input connector.
- 2-RCA** : Assign component video 2 input connector.
- 3-RCA** : Assign component video 3 input connector.
- None** : No component video input connector assigned.

Input source	DVD	HDP	TV/CBL	SAT
Default setting	1-RCA	2-RCA	3-RCA	None

Input source	VCR	DVR	V.AUX
Default setting	None	None	None

iPod Dock

Assign control dock for iPod to this source.

[Input source] **CD** **DVD** **HDP** **TV/CBL** **SAT** **VCR** **DVR**
V.AUX

[Selectable items]

Assign : Assign iPod input.

None : Do not assign iPod input.



- With the default settings, the control dock for iPod can be used connected to the VCR (iPod) connector.
- Even if “iPod Dock” is set to “Assign”, if AVR-989 and control dock for iPod are not connected, the input is used as the normal input source.

9 iPod

Make settings for “iPod” playback.

[Input source] **CD** **DVD** **HDP** **TV/CBL** **SAT** **VCR** **DVR**
V.AUX

Repeat Mode

Make settings for repeat mode.

[Selectable items]

All : Repeat all songs.

One : Repeat the current song.

OFF : Cancel repeat mode.

Shuffle Mode

Make settings for shuffle mode.

When DENON control dock for iPod ASD-1R is connected

[Selectable items]

Songs : Shuffle all songs.

Albums : Shuffle songs from current album only.

OFF : Cancel shuffle mode.

When DENON control dock for iPod ASD-3N/3W is connected

[Selectable items]

ON : Shuffle mode on.

OFF : Cancel shuffle mode.



This can be selected for input sources for which “Assign” is assigned at the “iPod Dock” setting.

10 Antenna Aiming

Check the XM and SIRIUS radio reception sensitivity.

[Input source] **XM** **SIRIUS**

Satellite

Indicate satellite signal strength.

Terrestrial

Indicate terrestrial signal strength.

XM Antenna Aiming

Display	Condition
■■■■■	Signal strength is strong
■■■■	Signal strength is good
■■■	Signal strength is marginal
■■	Signal strength is weak
■	No signal

SIRIUS Antenna Aiming

Display	Condition
■■■■■	Signal strength is excellent
■■■■	Signal strength is good
■■■	Signal strength is weak
■	No signal

11 Parental Lock

For any channel, set the radio reception limits.

[Input source] **SIRIUS**

Lock Setting

Set the channel radio reception limits.

- ① Press **ENTER**.
- ② Using $\Delta \nabla \triangleleft \triangleright$, input the password (4 digits number) and press **ENTER**.
- ③ Select channel by pressing $\Delta \nabla$, and set the lock by pressing $\triangleleft \triangleright$.

[Selectable items]

Unlock : Do not lock selected channel(s).

Lock : Lock selected channel(s).

※ When a Parental Locked channel is tuned, “Code : []” is displayed, then input the password.



- The default password is “0000”.
- If the password is wrong, “Incorrect Code” is displayed. Input the correct password.
- While listening to the channel being played, you can also set parental lock (👉 page 55).

Edit Lock Code

Change the password.

- ① Press **ENTER**.
- ② Input old password (4 digits) using $\Delta \nabla \triangleleft \triangleright$, and press **ENTER**.
- ③ Input new password (4 digits) using $\Delta \nabla \triangleleft \triangleright$, and press **ENTER**.
- ④ Input new password (4 digits) again using $\Delta \nabla \triangleleft \triangleright$, and press **ENTER**. If the correct password is input, “Completed” is displayed, and the new password is modified.



- If the old password is incorrectly input, “Current Lock Code Incorrect” is displayed, and proceed again from step ①.
- If the password input is 3 digits or less, “Input 4-digit” is displayed, and input again with a 4 digit password.
- If the new password is not correctly input, “New Lock Code Disagreement” is displayed and the password does not change.

Surround Modes

Symbols used to indicate buttons in this manual

- Button located on both the main unit and the remote control unit → **BUTTON**
- Button only on the main unit → **<BUTTON>**
- Button only on the remote control unit → **[BUTTON]**

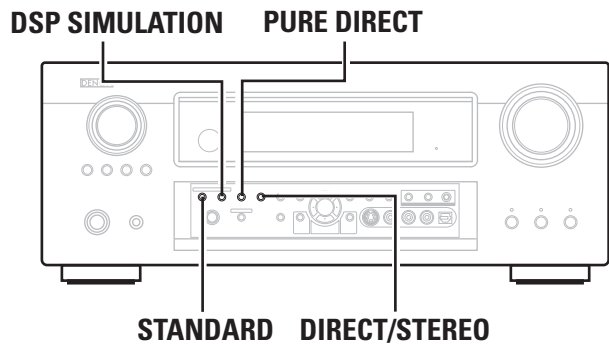

[Rear]

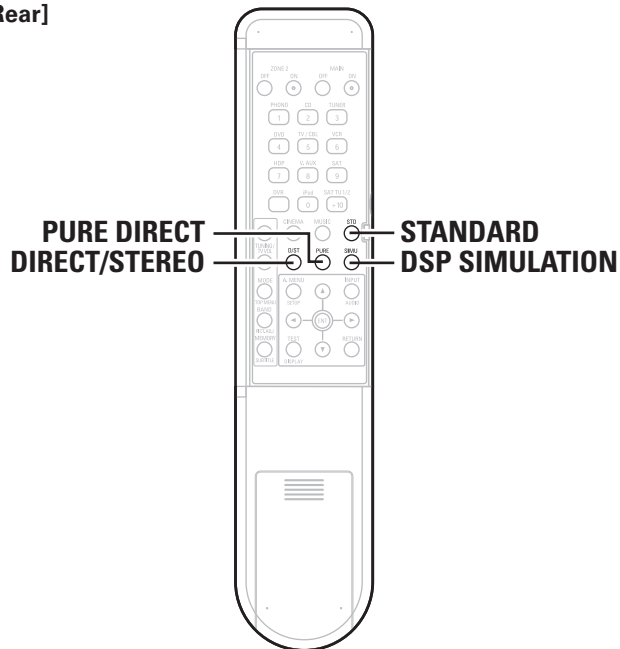

① Standard Playback

This is the mode for enjoying surround sound according to the program source.

Surround Playback of 2-channel Sources

Selecting the surround mode

Select by press **STANDARD**.
The mode switches each time the button is pressed.

[Selectable items]

DOLBY PLIIx *
or
DOLBY PLII : The signals are decoded in DOLBY PLIIx or DOLBY PLII for playback.

DTS NEO:6 : The signals are decoded in DTS NEO:6 for playback.

neural : It is possible to play analog input signals and PCM (2-channel, 48 kHz or less) in the surround mode. This is the optimum mode for playing sources recorded in XM HD Surround (page 70).

*: DOLBY PLIIx can be selected when surround back speakers are being used.
DOLBY PLII can be selected when surround back speakers are not being used.

Select the mode to suit the source

Select the "Cinema", "Music", "Game" and "Pro Logic" modes at menu "Parameter" - "Surround Parameter" - "Mode" (page 43).

□ DOLBY PLIIx or DOLBY PLII

Cinema : This mode is suited for movie sources.

Music : This mode is suited for music sources.

Game : This mode is suited for games.

Pro Logic : This is the Pro Logic playback mode. This can be selected when playing with a DOLBY PLII decoder. When this mode is selected, "DOLBY PL" is displayed.

□ DTS NEO:6

Cinema : This mode is suited for movie sources.

Music : This mode is suited for music sources.

Playing Multi-channel Sources (Dolby Digital, DTS, etc.)

In the case of standard playback of multi channel sources, the AVR-989 recognizes the format of the multi-channel audio input signal and automatically operates the appropriate decoder for surround sound.

[Selectable items]

STANDARD :

Any of the surround modes in the “Display” column in the following table.

The mode changes depending upon factors such as the

- Input signal
- Whether or not surround back speakers are being used.

Input signal	Display
DOLBY DIGITAL (other than 2ch) / DOLBY DIGITAL EX	DOLBY DIGITAL
	DOLBY DIGITAL EX
	DOLBY DIGITAL+PLIIx CINEMA
	DOLBY DIGITAL+PLIIx MUSIC
DOLBY DIGITAL Plus (*4)	DOLBY DIGITAL +
DOLBY TrueHD (*4)	DOLBY TrueHD
	DOLBY HD+EX
	DOLBY HD+PLIIx CINEMA
	DOLBY HD+PLIIx MUSIC
DTS (5.1ch) / DTS-ES Discrete 6.1 / DTS-ES Matrix 6.1 / DTS 96/24	DTS SURROUND
	DTS+PLIIx CINEMA
	DTS+PLIIx MUSIC
	DTS+NEO:6
	DTS ES MTRX6.1 (*1)
	DTS ES DSCRT6.1 (*2)
	DTS 96/24 (*3)
DTS-HD (*4)	DTS-HD HI RES
	DTS-HD MSTR
	DTS-HD+NEO:6
	DTS-HD+PLIIx CINEMA
	DTS-HD+PLIIx MUSIC
PCM (multi ch) / DSD (multi ch)	MULTI CH IN
	MULTI IN+PLIIx CINEMA
	MULTI IN+PLIIx MUSIC
	MULTI CH IN 7.1

*1 : This is displayed when the input signal is “DTS-ES Matrix 6.1” and the AVR-989’s “AFDM” setting is set to “ON”.

*2 : This is displayed when the input signal is “DTS-ES Discrete 6.1”.

*3 : This is displayed when the input signal is “DTS 96/24”.

*4 : When a signal is input, the HD AUDIO indicator lights.



For details, see pages 73, 74.

② DSP Simulation Playback

The desired mode according to the program source and viewing situation can be selected from among 10 **DENON original surround modes**.

The surround parameters can be adjusted (page 71, 72) to achieve an even more realistic, powerful sound field.

Selecting the surround mode

Select by press **DSP SIMULATION**.

The mode switches each time the button is pressed.

[Selectable items]

5CH / 7CH STEREO *1 : This mode is for enjoying stereo sound from all speakers.

WIDE SCREEN : This mode is for enjoying the atmosphere of viewing a movie on a large screen.

SUPER STADIUM : This mode is suited for viewing sports programs.

ROCK ARENA : This mode is for enjoying the atmosphere of a live concert in an arena.

JAZZ CLUB : This mode is for enjoying the atmosphere of a live concert in a jazz club.

CLASSIC CONCERT : This mode is for appreciating classical concert programs.

MONO MOVIE *2 : This mode is for playing monaural movie sources with surround sound.

VIDEO GAME : This mode is suited for achieving surround sound with video games.

MATRIX : This mode lets you add a sense of expansion to stereo music sources.

VIRTUAL : This mode is for enjoying surround effects using only the front speakers or headphones.

*1: “5CH STEREO” is displayed when “Surround Parameter” – “SB CH Out” is “OFF”, and “Amp Assign” is set to “ZONE2” (page 32, 44).

*2: When playing sources recorded in monaural in the MONO MOVIE mode, the sound will be off balance with a single channel (left or right), so input to both channels.



Depending on the program source being played, it may not be possible to achieve a satisfactory surround effect. In this case, try other modes to achieve a sound field suited to your tastes.

③ Direct Playback

Selecting the mode

Select by press **DIRECT/STEREO**.

[Selectable items]

DIRECT :

In this mode the signals bypass the tone adjustment circuitry for high quality sound.

The sound is output to the same channels as the input signal.

Input signal	Display
Analog signal / PCM (2ch) / Dolby Digital source / DTS source / Other 2-channel digital signals	DIRECT
DSD (2ch)	DSD DIRECT (*)
PCM (multi ch)	MULTI CH DIRECT
	M DIRECT + PLIIx CINEMA
	M DIRECT + PLIIx MUSIC
	M DIRECT 7.1
DSD (multi ch)	DSD MULTI DIRECT (*)

* : When DSD signals are converted to PCM signals as set by the audio parameters and speaker settings, “DIRECT” or “MULTI CH DIRECT” is displayed.



For details, see page 74.

④ Stereo Playback

Selecting the mode

Select by press **DIRECT/STEREO**.

[Selectable items]

STEREO :

This is the mode for playing in stereo. The tone can be adjusted. Sound is output from the front left and right speakers and subwoofer.



When **DIRECT/STEREO** is pressed, DIRECT mode can be switched to STEREO mode.

Playback in the PURE DIRECT Mode

This is the mode that recreates the original sound most faithfully, providing extremely high quality sound.

Press PURE DIRECT.



- To cancel, press **PURE DIRECT** again.
- When in the PURE DIRECT mode, the on-screen display is not displayed and the display on the main unit is turned off.
- If the HDMI input connector is selected, video outputs are output in the PURE DIRECT mode.
- The channel level and surround parameters in the PURE DIRECT mode are the same as in the DIRECT mode.

Parameter



Symbols used to indicate buttons in this manual

- Button located on both the main unit and the remote control unit → **BUTTON**
- Button only on the main unit → **<BUTTON>**
- Button only on the remote control unit → **[BUTTON]**

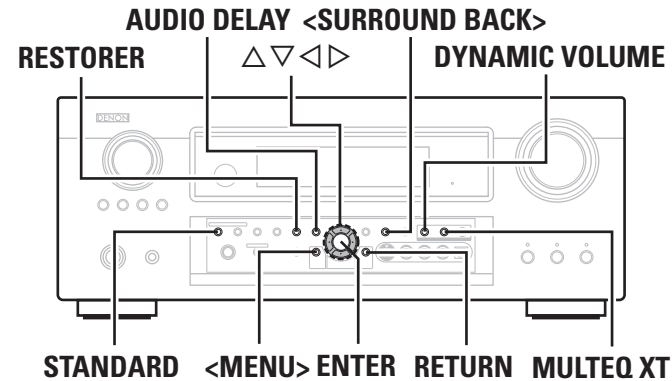

[Front]

[Rear]

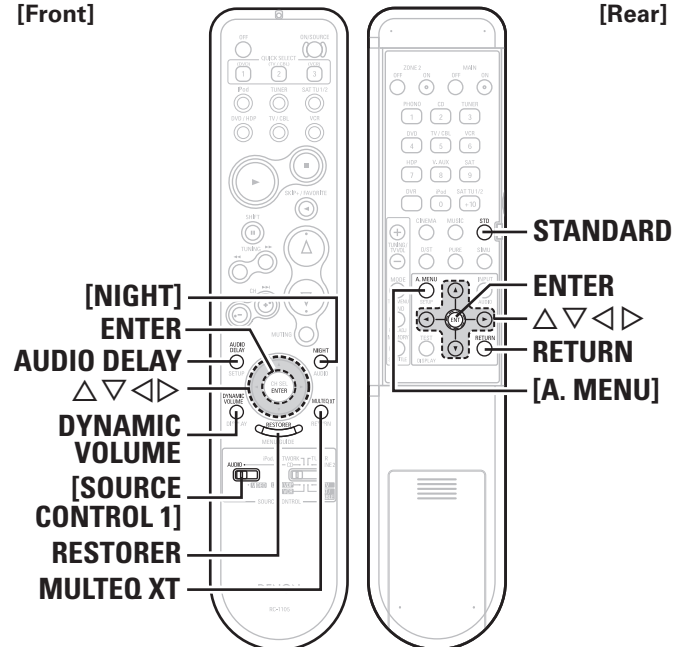

Adjusting the parameters

1 Press <MENU> or [A.MENU].

The menu is displayed.

※ To operate from the remote control unit, be sure to set the [SOURCE CONTROL 1] to "AUDIO".

2 Press Δ ∇ to select "Parameter", then press ENTER.

3 To change the setting:

Press Δ ∇ to select the item you want to change, then press \triangleleft \triangleright to change the setting.

※ To return to the previous item, press **RETURN**.

※ Select "Default Yes", then press \triangleleft to reset to the default setting.

4 Press ENTER to enter the setting.

□ To exit adjustment

Press <MENU> or [A.MENU] during adjustment.

Surround Parameter

Adjust surround sound parameters.

The parameters (items) which can be adjusted differ depending upon the following conditions.

- Whether an input signal is present (when playing) or not (when stopped, etc.).
- The type of input signal
- The type of surround mode

For details of which parameters can be adjusted in each surround mode, see "Surround Modes and Parameters" (page 71, 72).

Surround Parameter

- 1 Mode**
- 2 Cinema EQ**
- 3 DRC**
- 4 Dynamic Range Compression**
- 5 LFE**
- 6 Center Image**
- 7 Panorama**
- 8 Dimension**
- 9 Center Width**
- 10 Delay Time**
- 11 Effect**
- 12 Effect Level**
- 13 Room Size**
- 14 AFDM (Auto Flag Detect Mode)**
- 15 SB CH Out**
- 16 SUBWOOFER ATT**
- 17 Subwoofer**
- Tone**
 - 18 Tone Control**
 - 19 Bass**
 - 20 Treble**
- Audyssey Settings**
 - 21 MultEQ XT**
 - 22 Dynamic EQ**
 - 23 Dynamic Volume**
 - 24 Setting**
- RESTORER**
- Night Mode**
- Audio Delay**

Menu screen

- ```

4. Parameter
└─ 1. Surround Parameter
 2. Tone
 3. Audyssey Settings
 4. RESTORER
 5. Night Mode
 6. Audio Delay

```

## Surround Parameter

Adjust surround sound parameters.

The adjustable parameters differ for the different surround modes (page 71, 72).

### 1 Mode

Select the mode to match the source (cinema source, music source, etc.).

#### In the PLIIx or PLII mode

[Selectable items]

**Cinema** : This is the mode for cinema source.

**Music** : This is the mode for music source.

**Game** : This is the mode for game source.

**PL** : Dolby Pro Logic playback mode (PLII mode only).  
(This is the mode for 4-channel playback (front L, front R, center, surround (MONO)).)

#### In the DTS NEO:6 mode

[Selectable items]

**Cinema** : This is the mode for cinema source.

**Music** : This is the mode for music source.



The "Music" mode is also effective for movie sources including a lot of stereo music.

### 2 Cinema EQ

Soften the treble range of movie soundtracks for better understanding.

[Selectable items]

**ON** : "Cinema EQ" is used.

**OFF** : "Cinema EQ" is not used.

### 3 DRC

Compress dynamic range (difference between loud and soft sounds).

[Selectable items] **Auto** **Low** **Mid** **High** **OFF**



This can be set in the Dolby TrueHD mode.

### 4 Dynamic Range Compression

Compress dynamic range (difference between loud and soft sounds).

[Selectable items]

**OFF** : Turn dynamic range compression off.

**Low** : Low setting.

**Mid** : Middle setting.

**High** : High setting.



When playing DTS sources, this is only displayed for compatible software.

### 5 LFE

Adjust the low-frequency effects level (LFE).

[Variable range] **-10dB** ~ **0dB**



For proper playback of the different program sources, we recommend setting to the values below.

- Dolby Digital sources: "0 dB"
- DTS movie sources: "0 dB"
- DTS music sources: "-10 dB"

### 6 Center Image

Assign center channel signal to front left and right channels for wider sound.

[Variable range] **0.0** ~ **0.3** ~ **1.0**

### 7 Panorama

Assign front L/R signal also to surround channels, for wider sound. If the surround effect seems weak, set "Panorama" to "ON".

[Selectable items] **ON** **OFF**

## 8 Dimension

Shift sound image center to front or rear, to adjust playback balance.

[Variable range] 0 ~ 3 ~ 6

## 9 Center Width

Assign center channel signal to front left and right channels for wider sound.

[Variable range] 0 ~ 3 ~ 7

## 10 Delay Time

Adjust delay time to control sound stage size.

[Variable range] 0 ms ~ 30 ms ~ 300 ms

## 11 Effect

Switch effect signal for multi-surround speakers on and off. When "Effect" is set to "ON", a surround effect with a strong sense of expansion is achieved.

[Selectable items] ON OFF



Set to a lower level if the positioning and sense of phase of the surround signals seems unnatural.

## 12 Effect Level

Adjust effect signal level.

[Variable range] 1 ~ 10 ~ 15



Set to a lower level if the positioning and sense of phase of the surround signals seems unnatural.

## 13 Room Size

Determine size of acoustic environment.

### [Selectable items]

- Small** : Simulate acoustics of a small room.  
**Med.S** : Simulate acoustics of a medium-small room.  
**Medium** : Simulate acoustics of a medium room.  
**Med.L** : Simulate acoustics of a medium-large room.  
**Large** : Simulate acoustics of a large room.

### NOTE

"Room Size" does not indicate the size of the room in which sources are played.

## 14 AFDM (Auto Flag Detect Mode)

Auto-select surround mode by source.

This function only works for software containing a special identification signal.

If the software being played is recorded in Dolby Digital EX or DTS-ES, it is played in 6.1-channels. If not, it is played in 5.1-channels.

[Selectable items] ON OFF

### Example : Playing Dolby Digital software (with EX flag)

- When "AFDM" is set to "ON", the surround mode is automatically set to the DOLBY + PLIIx CINEMA mode.
- To play in the Dolby Digital EX mode, set "AFDM" to "OFF" and "SB CH Out" to "MTRX ON".



- Some Dolby Digital EX sources do not include EX flags. If the playback mode does not switch automatically even when "AFDM" is set to "ON", set "SB CH Out" to "MTRX ON" or "PLIIx CINEMA".
- When the "Amp Assign" setting is "7.1ch", and using the surround back speakers, you can set "AFDM".

## 15 SB CH Out (for Multi-channel sources)

Select playback mode for surround back channels.

### [Selectable items]

- OFF** : No signal is played from the surround back channels.  
**MTRX ON** : The surround channel signals undergo digital matrix processing and are output from the surround back channels.  
**PLIIx CINEMA** \*1 : Decoded in Dolby Pro Logic IIx Cinema mode, surround back signal played.  
**PLIIx MUSIC** \*2 : Decoded in Dolby Pro Logic IIx Music mode, surround back signal played.  
**ES MTRX** \*3 : DTS signal played with digital matrix processing.  
**ES DSCRT** \*4 : Signal included in DTS-ES Discrete 6.1-channel sources played.  
**DSCRT ON** : Mode for discrete playback of surround back signals included in 7.1-channel digital discrete audio signals (DVD, etc.).

\*1: This can be selected when "Surround Back Speaker" is set to "2spkr" at the menu "Manual Setup" – "Speaker Setup" – "Speaker Configuration" setting (page 27).

\*2: This can be selected when "Surround Back Speaker" is set to "2spkr" or "1spkr" at the menu "Manual Setup" – "Speaker Setup" – "Speaker Configuration" setting.

\*3: This can be selected when playing DTS sources.

\*4: This can be selected when playing DTS sources including a discrete 6.1-channel signal identification signal.



Settings can also be made when **STANDARD** or **<SURROUND BACK>** is pressed.

When using surround back speakers, adopt the following settings.

- ① Adopt "7.1ch" for the "Amp Assign" setting.
  - The default setting for the Amp Assign mode of AVR-989 is "ZONE2".
- ② Adopt a setting other than "OFF" for the "SB CH Out" setting of "Surround Parameter".

### 15 SB CH Out (for 2-channel sources)

Determine whether to use surround back speakers.

#### [Selectable items]

**ON** : The surround back channel signal is played.

**OFF** : The surround back channel signal is not played.



This operation can be performed directly pressing **<SURROUND BACK>**.

### 16 SUBWOOFER ATT

Attenuate subwoofer level when using EXT. IN mode.

#### [Selectable items]

**ON** : The input from the subwoofer channel is attenuated.

**OFF** : The input from the subwoofer channel is not attenuated. Usually use in this mode.



Set this to "ON" if the subwoofer channel level seems too high when playing audio signal.

### 17 Subwoofer

Turn subwoofer output on and off.

#### [Selectable items]

**ON** : The subwoofer is used.

**OFF** : The subwoofer is not used.

### Tone

Adjust the tonal quality of the sound.

### 18 Tone Control

Turn tone adjustments off.

#### [Selectable items]

**ON** : Allow tone adjustment (treble, bass).

**OFF** : Playback without tone adjustment.



The tone cannot be adjusted when in the DIRECT mode.

#### NOTE

When the "Dynamic EQ" setting is "ON", setting is not possible.

### 19 Bass

Adjust low frequency range (bass).

[Variable range] **-6dB ~ +6dB**

### 20 Treble

Adjust high frequency range (treble).

[Variable range] **-6dB ~ +6dB**



"Bass" and "Treble" can be set when "Tone Control" is set to "ON".

### Audyssey Settings

Select MultEQ XT, Dynamic EQ and Dynamic Volume.

### 21 MultEQ XT

Select the type of room correction desired from the following list:

#### [Selectable items]

**Audyssey** : Optimize frequency response of all speakers.

**Audyssey Byp. L/R** : Optimize frequency response of speakers except front L and R speakers.

**Audyssey Flat** : Optimize frequency response of all speakers to flat response.

**Manual** : Apply frequency response set with "Manual EQ" (page 31).

**OFF** : Turn equalizer off.



#### Operating from the main unit or remote control unit

Press **MULTEQ XT**.

- When "Audyssey", "Audyssey Byp. L/R" or "Audyssey Flat" is selected, "AUDYSSEY MULTEQ XT" lights.
- After running Auto Setup, if the Speaker Configuration, Distance, Channel Level, and Crossover Frequency have changed without increasing the number of speakers measured, only "AUDYSSEY MULTEQ XT" lights.



- "Audyssey", "Audyssey Byp. L/R" and "Audyssey Flat" can be selected after the auto setup procedure has been performed.
- After performing "Auto Setup", the "MultEQ XT" setting automatically becomes "Audyssey".
- If the settings of speakers for which "None" has been determined at "Auto Setup" are changed, "Audyssey", "Audyssey Byp. L/R" and "Audyssey Flat" cannot be selected. Either perform Auto Setup again, or return to the setting after running Auto Setup with "Auto Setup" - "Parameter Check" - "Restore".
- MultEQ XT and Manual EQ set to "Not Used" with "Manual Setup" - "Audio Setup" - "EQ Preset" - "EQ Customize" (page 31) on the menu, cannot be selected.
- When using headphones, "MultEQ XT" is set to "OFF".



## 22 Dynamic EQ

Audyssey Dynamic EQ solves the problem of deteriorating sound quality as volume is decreased by taking into account human perception and room acoustics. Audyssey Dynamic EQ works in tandem with Audyssey MultEQ XT to provide well-balanced sound for every listener at any volume level.

### [Selectable items]

**ON** : Use Dynamic EQ function.

**OFF** : Do not use Dynamic EQ function.

### Operating from the main unit or remote control unit

Press **DYNAMIC VOLUME**.

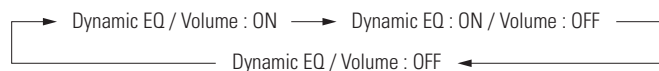

- “Dynamic EQ” can only be set when auto setup has been performed.
- After performing “Auto Setup”, the “Dynamic EQ” setting automatically becomes “ON”.
- “Dynamic EQ” cannot be set in the following situations.
  - If “Auto Setup” fails to be completed.
  - After running Auto Setup, when the number of used speakers has increased from the number of measured speakers.
- When “MultEQ XT” is set to “OFF” or “Manual”, “Dynamic EQ” is automatically set to “OFF”.
- Before running Auto Setup and after running Auto Setup, if the number of speakers has increased or you pressed **DYNAMIC VOLUME**, “Run Audyssey” is displayed. In this case, either perform Auto Setup, or return to the setting after running Auto Setup with “Auto Setup” – “Parameter Check” – “Restore”.

### NOTE

When you set “Dynamic EQ” to “ON”, “Tone Control” and “Night Mode” are switched “OFF”.

#### Operating conditions for each function

- **Dynamic EQ** : When “MultEQ XT” is set to “ON”
- **Dynamic Volume** : When “Dynamic EQ” is set to “ON”
- **Setting** : When “Dynamic Volume” is set to “ON”

#### 21 MultEQ XT

#### 22 Dynamic EQ

#### 23 Dynamic Volume

#### 24 Setting

## 23 Dynamic Volume

Audyssey Dynamic Volume solves the problem of large variations in volume level between television programs, commercials, and between the soft and loud passages of movies.

Audyssey Dynamic EQ is integrated into Dynamic Volume so that as the playback volume is adjusted automatically, the perceived bass response, tonal balance, surround impression, and dialog clarity remain the same.

### [Selectable items]

**ON** : Use Dynamic Volume.  
The Dynamic Volume effect will be at the level of the “Setting”.

**OFF** : Do not use Dynamic Volume.



### Operating from the main unit or remote control unit

Press **DYNAMIC VOLUME**.

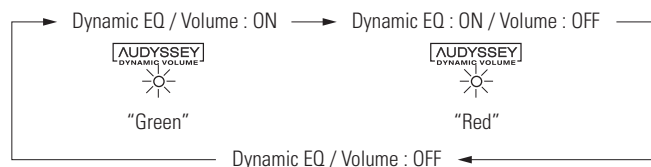

- “Dynamic Volume” can only be set when auto setup has been performed.
- “Dynamic Volume” cannot be set in the following situations.
  - If “Auto Setup” fails to be completed.
  - After running Auto Setup, when the number of used speakers has increased from the number of measured speakers.
- When “MultEQ XT” is set to “OFF” or “Manual”, “Dynamic Volume” is automatically set to “OFF”.
- Before running Auto Setup and after running Auto Setup, if the number of speakers has increased or you pressed **DYNAMIC VOLUME**, “Run Audyssey” is displayed. In this case, either perform Auto Setup, or return to the setting after running Auto Setup with “Auto Setup” – “Parameter Check” – “Restore”.

### NOTE

“Dynamic Volume” and “Night Mode” cannot be used jointly.

## 24 Setting

Can be set when “Dynamic Volume” is set to “ON”.  
Set Dynamic Volume effect.

### [Selectable items]

**Midnight** : High setting affects volume the most, causing all sounds to be of equal loudness.

**Evening** : Middle setting prevents loud and soft sounds from being much louder and softer respectively than average sounds.

**Day** : Low setting provides the least adjustments to the loudest and softest of sounds.

### NOTE

- “Setting” can only be set when auto setup has been performed.
- “Setting” cannot be set in the following situations.
  - If “Auto Setup” fails to be completed.
  - After running Auto Setup, when the number of used speakers has increased from the number of measured speakers.
  - If “Dynamic Volume” setting is “OFF”.

### About Dynamic EQ

Audyssey Dynamic EQ™ solves the problem of deteriorating sound quality as volume is decreased by taking into account human perception and room acoustics. Dynamic EQ selects the correct frequency response and surround levels moment-by-moment at any user-selected volume setting. The result is bass response, tonal balance, and surround impression that remain constant despite changes in volume. Dynamic EQ combines information from incoming source levels with actual output sound levels in the room, a prerequisite for delivering a loudness correction solution. Audyssey Dynamic EQ works in tandem with Audyssey MultEQ XT to provide well-balanced sound for every listener at any volume level.

### About Dynamic Volume

Audyssey Dynamic Volume™ solves the problem of large variations in volume level between television programs, commercials, and between the soft and loud passages of movies. Dynamic Volume looks at the preferred volume setting by the user and then monitors how the volume of program material is being perceived by listeners in real time to decide whether an adjustment is needed. Whenever necessary, Dynamic Volume makes the necessary rapid or gradual adjustments to maintain the desired playback volume level while optimizing the dynamic range. Audyssey Dynamic EQ is integrated into Dynamic Volume so that as the playback volume is adjusted automatically, the perceived bass response, tonal balance, surround impression, and dialog clarity remain the same whether watching movies, flipping between television channels, or changing from stereo to surround sound content.

## RESTORER

This function restores compressed audio signals to how they were before compression and corrects the sense of volume of the bass and treble to obtain richer playback sound.

### [Selectable items]

**OFF** :

Do not use RESTORER.

**Mode1** (RESTORER 64):

Optimized mode for compressed sources with very weak highs.

**Mode2** (RESTORER 96):

Apply suitable bass and treble boost for all compressed sources.

**Mode3** (RESTORER HQ):

Optimized mode for compressed sources with normal highs.

The default setting for "iPod" is "Mode3". All others are set to "OFF".

When set to something other than "OFF", "**RESTORER**" is displayed.

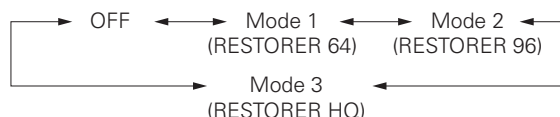

### Operating from the main unit or remote control unit

Press **RESTORER**.

#### About the RESTORER function

- Such compressed audio formats as MP3, WMA (Windows Media Audio) and MPEG-4 AAC reduce the amount of data by eliminating signal components that are hard for the human ear to hear. The RESTORER function generates the signals eliminated upon compression, restoring the sound to conditions near those of the original sound before compression. It also corrects the sense of volume of the bass to obtain richer sound with compressed audio signals.
- This is displayed on the menu and can be set when the input source is selected to "XM", or analog signals (including AM/FM and SIRIUS signals) or PCM signals (fs = 44.1/48 kHz) are input.

## Night Mode

Optimized setting for late-night listening.

Set the dynamic range compression of the output audio.

### [Selectable items]

**OFF** : Turn night mode off.

**Low** : Low setting.

**Mid** : Middle setting.

**High** : High setting.



### Operating from the remote control unit

Press **[NIGHT]**.

The "**NIGHT**" indicator lights when "Low", "Mid" or "High" is selected.

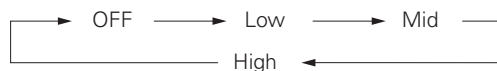

### NOTE

- When the "Dynamic EQ" setting is "ON", setting is not possible.
- When a HD-Audio (DOLBY DIGITAL Plus, DOLBY TrueHD, DTS-HD) signal is input, the "Night Mode" can not be selected.

## Audio Delay

Compensate for mismatched timing between video and audio.

Delay audio.

This sets the delay time for audio signals.

[Variable range] **0 ms** ~ **200 ms**

If you wish to adjust the "Audio Delay" while playing HDMI or component video signals, press  $\Delta$  to set "OSD" to "OFF". This way the audio delay can be adjusted while watching the picture. (Press  $\Delta$  again to switch to the on-screen display.)



### Operating from the main unit or remote control unit

Press **AUDIO DELAY**, then press  $\triangleleft \triangleright$  to adjust audio delay.

### NOTE

When operating by remote control, the on-screen display is not shown.



- This cannot be adjusted when playing in the EXT. IN, DIRECT or STEREO mode (with "Front Speaker" set to "Large", "Tone Control" to "OFF" and "MultEQ XT", "RESTORER" and "Night Mode" to "OFF".)
- When the Auto Lipsync Correction function is operating, you can set within the range 0 ~ 100 ms.
- Store "Audio Delay" for each input source.

# Information

**Symbols used to indicate buttons in this manual**

- Button located on both the main unit and the remote control unit → **BUTTON**
- Button only on the main unit → **<BUTTON>**
- Button only on the remote control unit → **[BUTTON]**

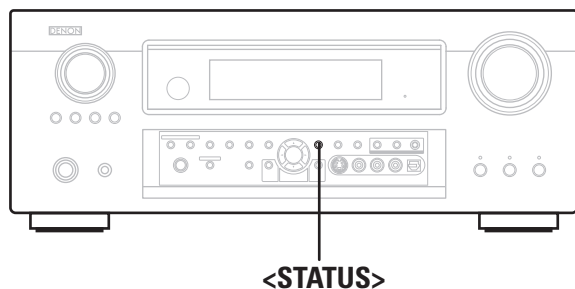

When **<STATUS>** is pressed, the set's status can be checked on the display.

## Status

Shows information about current settings.

### ● Menu screen ●

```

5. Information
┌──┐
1. Status
2. Audio Input Signal
3. HDMI Information
4. Auto Surround Mode
5. Quick Select
6. Preset Station

5-1. Status
Select Source:TUNER
Name :FM/AM TU

Surround Mode:
STEREO

Input Mode :Analog

```

### 1 MAIN ZONE

Shows information about settings for MAIN ZONE.  
The items displayed differ according to the input source.

#### [Items to be checked]

|               |                |               |               |
|---------------|----------------|---------------|---------------|
| Select Source | Name           | Surround Mode | Input Mode    |
| Rec Select    | Video Select   | Source Level  | MultEQ XT     |
| Dynamic EQ    | Dynamic Volume | Night Mode    | RESTORER etc. |

### 2 ZONE2

Shows information about settings for multi-zone.

#### [Items to be checked]

|       |               |              |
|-------|---------------|--------------|
| Power | Select Source | Volume Level |
|-------|---------------|--------------|

## Audio Input Signal

Shows information about audio input signals.

### ● Menu screen ●

```

5. Information
┌──┐
1. Status
2. Audio Input Signal
3. HDMI Information
4. Auto Surround Mode
5. Quick Select

5-2. Audio Input Signal
Surround Mode:
DOLBY DIGITAL EX

SIGNAL:Dolby Digital
fs :48kHz
Format:3/2/.1
Offset:-4dB

```

#### [Items to be checked]

**Surround Mode** : The currently set surround mode is displayed.

**SIGNAL** : The input signal type is displayed.

**fs** : The input signal's sampling frequency is displayed.

**Format** : The number of channels in the input signal (front, surround, LFE) is displayed.

**Offset** : The dialogue normalization correction value is displayed.

**Flag** : "MATRIX" is displayed if the input signal has undergone matrix processing, "DISCRETE" if the input signal has undergone discrete processing.

### Dialogue normalization function

This is automatically activated when playing Dolby Digital sources. This function automatically corrects the standard signal level for individual program sources. The correction value can be checked using **<STATUS>**.

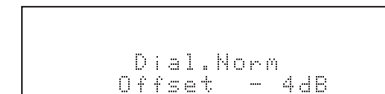

The figure is the correction value when the standard level is corrected.

## HDMI Information

Shows information about HDMI input signals and monitor.

### ● Menu screen ●

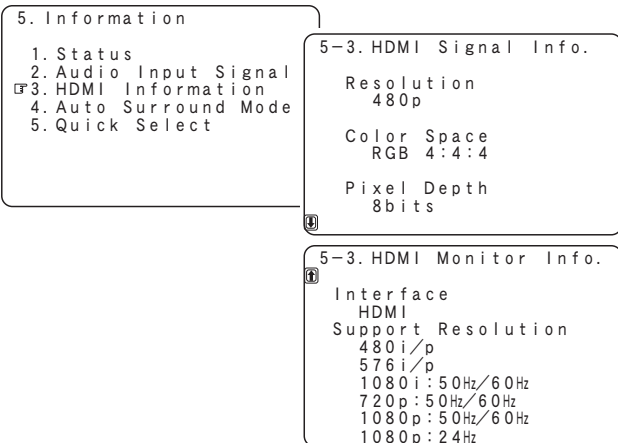

### 1 HDMI Signal Information

The HDMI input signal information is displayed.

#### [Items to be checked]

**Resolution** **Color Space** **Pixel Depth**

### 2 HDMI Monitor Information

The HDMI monitor information is displayed.

#### [Items to be checked]

**Interface** **Support Resolution**

## Auto Surround Mode

Shows information about auto surround mode settings.  
The surround mode for which the last memory function was used for the different input signal types is displayed.

### ● Menu screen ●

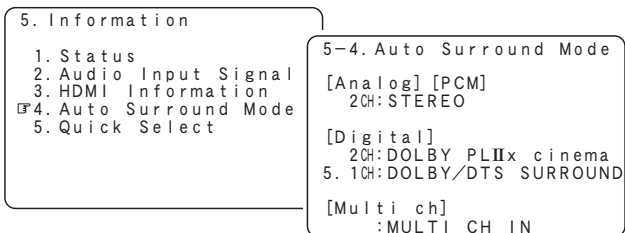

#### [Items to be checked]

**Analog/PCM 2CH** **Digital 2CH** **Digital 5.1CH** **Multi ch**

## Quick Select

Shows information about quick select settings.

### ● Menu screen ●

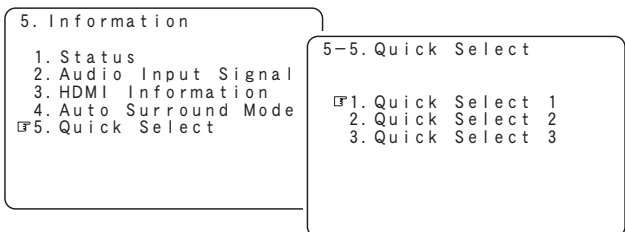

#### [Items to be checked]

**Name** **Input Source** **Input Mode** **Volume Level** **MultEQ XT**

**Dynamic EQ** **Dynamic Volume** **Front Sp** **Analog/PCM 2CH**

**Digital 2CH** **Digital 5.1CH** **Multi ch**



For instructions on storing settings at Quick Select 1 to 3, see page 60.

## Preset Station

Shows information about preset stations.

### ● Menu screen ●

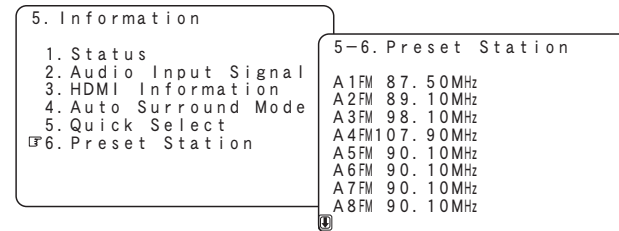

#### [Input source]

**TUNER** **XM** **SIRIUS**

#### [Items to be checked]

**A1 ~ G8**

# Playback

**Symbols used to indicate buttons in this manual**

- Button located on both the main unit and the remote control unit → **BUTTON**
- Button only on the main unit → **<BUTTON>**
- Button only on the remote control unit → **[BUTTON]**

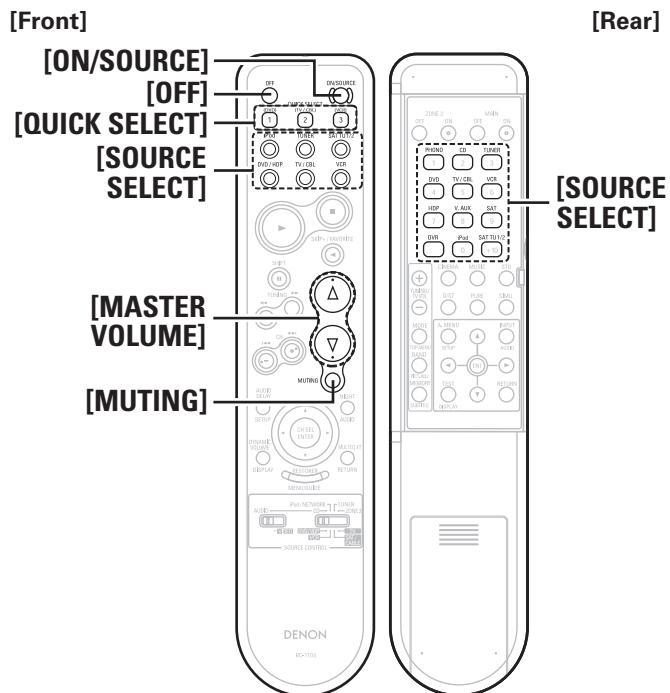
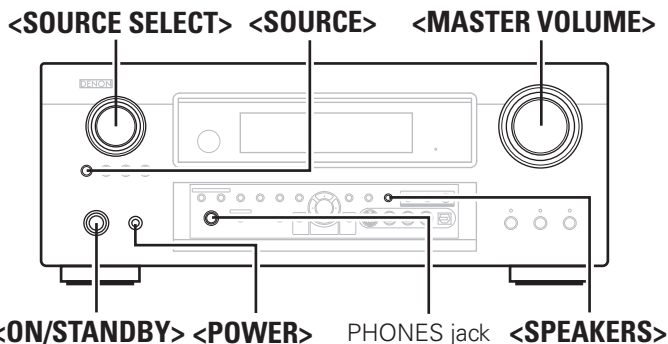

## Preparations

### Turning the Power On

- 1 Press **<POWER>**.  
The power indicator lights red and the power is set to the standby mode.
- 2 Press **<ON/STANDBY>** or **[ON/SOURCE]**.  
The power indicator flashes green and the power turns on.  
  - ※ Also press **[SOURCE SELECT]** when in standby mode, the power turns on. In this case the input source is selected by remote control unit.
  - ※ Also press **[QUICK SELECT]** when in standby mode, the power turns on. In this case Quick Select is selected.

### Turning the Power Off

- ① Press **<ON/STANDBY>** or **[OFF]**.  
The power is set to the standby mode.
- ② Press **<POWER>**.  
The power indicator turns off, and so does the power.

#### NOTE

Power continues to be supplied to some of the circuitry even when the power is in the standby mode. When leaving home for long periods of time or when traveling, either press **<POWER>** to turn off the power, or unplug the power cord from the power outlet.

### Selecting the Input Source

Select the source using **SOURCE SELECT**. Turn **<SOURCE SELECT>** or press **[SOURCE SELECT]** to switch between input sources.



If "ZONE2 / Rec Select", "Tuning Preset" or "Video Select" is selected, press **<SOURCE>** before turning **<SOURCE SELECT>**.

## Operations During Playback

### Adjusting the Master Volume

Either turn **<MASTER VOLUME>** or press **[MASTER VOLUME]**.

[Variable range] --- -80.0dB ~ 18.0dB

#### NOTE

The adjustable range will differ depending upon factors such as the type of input signal and the channel level setting.

### Turning Off the Sound Temporarily (Muting)

Press **[MUTING]**.



The sound is reduced to the level set at menu "Manual Setup" – "Option Setup" – "Volume control" – "Mute Level". To cancel, press **[MUTING]** again. Muting can also be canceled by adjusting the master volume.

### Listening with Headphones

Plug the headphones into the **PHONES** jack on the main unit.

The sound from the speakers and pre-out connectors is automatically cut.

#### NOTE

Be careful not to set the volume too high when using headphones.

### Switching the front speakers

Press **<SPEAKERS>**.

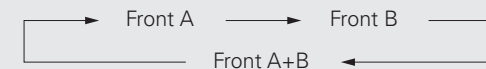

#### NOTE

When set to "Custom", **<SPEAKERS>** does not operate.



## Listening to Preset Stations

### Operation on the Main Unit

Press **<TUNING PRESET>**, then turn **<SOURCE SELECT>** to select the preset radio station.

### Operation on the Remote control Unit

**1** Press **[SHIFT]** to select the memory block (A to G).

**2** Press **[CHANNEL + -]** or **[NUMBER (1 ~ 8)]** to select the desired preset channel.

### □ Default settings

| Auto tuner presets |                                                            |
|--------------------|------------------------------------------------------------|
| A1 ~ A8            | 87.5 / 89.1 / 98.1 / 107.9 / 90.1 / 90.1 / 90.1 / 90.1 MHz |
| B1 ~ B8            | 520 / 600 / 1000 / 1400 / 1500 / 1710 kHz, 90.1 / 90.1 MHz |
| C1 ~ C8            | 90.1 MHz                                                   |
| D1 ~ D8            | 90.1 MHz                                                   |
| E1 ~ E8            | 90.1 MHz                                                   |
| F1 ~ F8            | 90.1 MHz                                                   |
| G1 ~ G8            | 90.1 MHz                                                   |

## Listening to XM Satellite Radio Programs

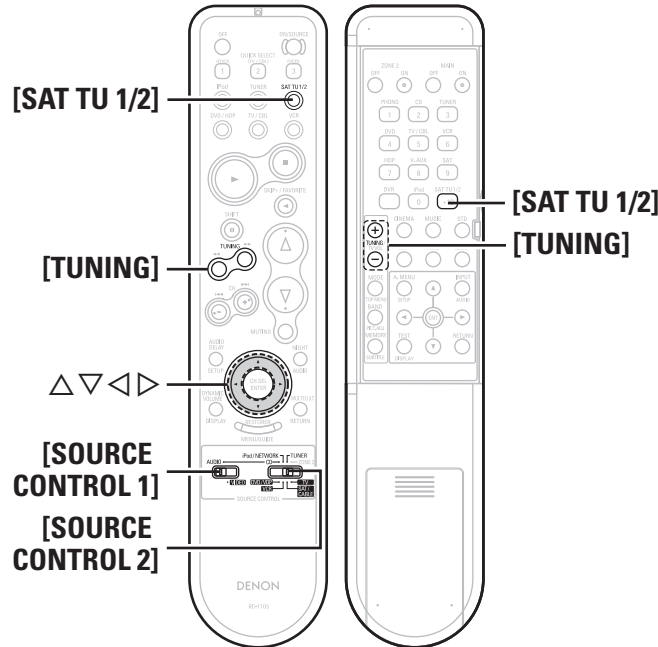

### About XM Radio

XM is North America's number one satellite radio company, offering an extraordinary variety of commercial-free music, plus the best in premier sports, news, talk radio, comedy, children's and entertainment programming, broadcast in superior digital audio quality coast to coast. For more information, or to subscribe, U.S. customers visit [xmradio.com](http://xmradio.com) or call XM Listener Care at 1-800-XMRADIO (1-800-967-2346); Canadian customers visit [xmradio.ca](http://xmradio.ca) or call XM Listener Care at 1-877-GETXMSR (1-877-438-9677).

### XM Ready® Legal

XM monthly service subscription sold separately. XM Mini-Tuner and Home Dock required (each sold separately) to receive XM service. It is prohibited to copy, decompile, disassemble, reverse engineer, hack, manipulate or otherwise make available any technology or software incorporated in receivers compatible with the XM satellite Radio System. Installation costs and other fees and taxes, including a one-time activation fee may apply. All fees and programming subject to change. Channels with frequent explicit language are indicated with an XL. Channel blocking is available for XM radio receivers by calling 1-800-XMRADIO (U.S. residents) and 1-877-GETXMSR (Canadian residents). XM Service only available in the 48 contiguous United States and Canada. ©2008 XM Satellite Radio Inc. All rights reserved.

## XM Ready® Subscription

Once you have installed the XM Mini-Tuner Home Dock, inserted the XM Mini-Tuner, connected the XM Mini-Tuner Home Dock to your XM Ready® audio system, and installed the antenna, you are ready to subscribe and begin receiving XM programming. There are three places to find your eight character XM Radio ID: On the XM Mini-Tuner, on the XM Mini-Tuner package, and on XM Channel 0. Record the Radio ID below for reference.



**Note:** The XM Radio ID does not use the letters "I", "O", "S" or "F". Activate your XM Satellite Radio service in the U.S. online at <http://activate.xmradio.com> or call 1-800-XMRADIO (1-800-967-2346). Activate your XM Satellite Radio service in Canada online at <https://activate.xmradio.ca> or call 1-877-GET-XMSR (1-877-438-9677). You will need a major credit card. XM will send a signal from the satellites to activate the full channel lineup. Activation normally takes 10-15 minutes, but during peak busy periods you may need to keep your XM Ready audio system on for up to an hour. When you can access the full lineup on your XM Ready audio system you are done.

### Basic Operation

- 1** Either turn **<SOURCE SELECT>** or press **[SAT TU 1/2]** to select "XM".
- 2** Set **[SOURCE CONTROL 1]** to "AUDIO" and **[SOURCE CONTROL 2]** to "TUNER".  
(☞ page 61 "Remote Control Unit Operations")
- 3** Use **[TUNING]** to select the channel.  
When the channel is tuned in, the name of the song and artist are displayed.



- The channel switches continuously when **[TUNING]** is pressed and held.
- The artist name, song title, category and reception level can be checked by pressing **<STATUS>**.
- The time (default : 30sec) for which the on-screen display are displayed can be set at menu "Manual Setup" – "Option Setup" – "On-Screen Display" (☞ page 33).  
Press **△▽◀▶** to return to the original screen.

**Hand icon** Symbols used to indicate buttons in this manual

- Button located on both the main unit and the remote control unit → **BUTTON**
- Button only on the main unit → **<BUTTON>**
- Button only on the remote control unit → **[BUTTON]**

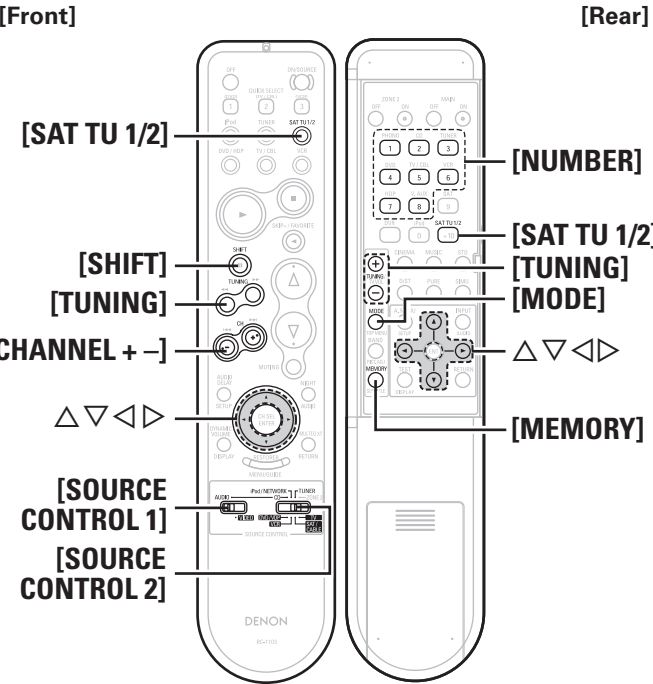
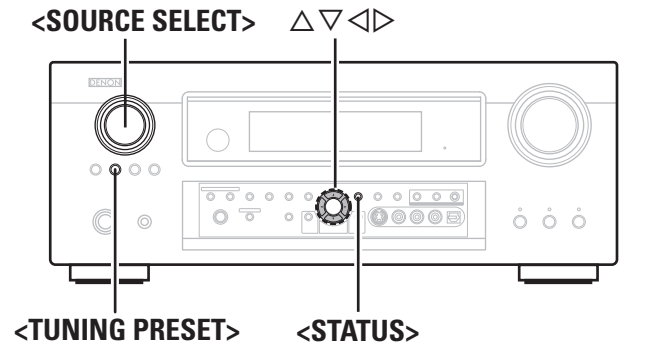

### Checking the XM Signal Strength and Radio ID

- 1 Either turn **<SOURCE SELECT>** or press **[SAT TU 1/2]** to select “XM”.
- 2 Press **<STATUS>** until “SIGNAL” appears on the display.  
The display will switch as shown below, depending on the reception conditions.
- 3 Adjust the position of the antenna until “SIGNAL: GOOD” is shown on the display.
- 4 Press **<STATUS>** until the channel you want to check (example: “XM001”) is displayed.
- 5 Press **[TUNING]** and select channel 0 (XM000).  
The radio ID is shown on the display.

| Display  | Status                      |
|----------|-----------------------------|
| GOOD     | Signal strength is good     |
| MARGINAL | Signal strength is marginal |
| WEAK     | Signal strength is weak     |
| NO       | No signal                   |

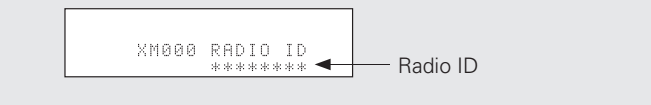

The strength of both the XM satellite and terrestrial signals can be checked at menu “Input Setup” – “Antenna Aiming” (page 39).

### Presetting Radio Channels (Preset Memory)

Your favorite broadcast channels can be preset so that you can tune them in easily. Up to 56 channels can be preset.

- 1 Tune in the broadcast channel you want to preset.
- 2 Press **[MEMORY]**.
- 3 Press **[SHIFT]** to select the block (A to G) in which the station is to be preset.
- 4 Press **[CHANNEL + -]** or **[NUMBER (1 ~ 8)]** to select the preset number.
- 5 Press **[MEMORY]** again to complete the setting.

To preset other channels, repeat steps 1 to 5.

**NOTE**  
Preset channels are erased by overwriting them.

### Listening to Preset Channels

**Operation on the Main Unit**  
Press **<TUNING PRESET>**, then turn **<SOURCE SELECT>** to select the preset channel.

**Operation on the Remote control Unit.**

- 1 Press **[SHIFT]** to select the memory block (A to G).
- 2 Press **[CHANNEL + -]** or **[NUMBER (1 ~ 8)]** to select the desired preset channel.



## Searching Categories

**1** Press ◀ ▶.



**2** Use ◀ ▶ to select the category, then use ▲ ▼ to select the desired channel.



- “LOADING” is displayed while channels or data are being received.
- Refer to “Troubleshooting” – “XM Satellite Radio” regarding other messages (☞ page 79).

## Listening to SIRIUS Satellite Radio Programs

### What is SIRIUS Satellite Radio?

Simply The Best Radio on RadioTM with all your favorite entertainment including 100% commercial-free music, plus superior sports coverage, uncensored talk and comedy, world-class entertainment, news, weather and more for your car, home or office. For more information visit [sirius.com](http://sirius.com) or [siriuscanada.ca](http://siriuscanada.ca)

Sirius is available in the US for subscribers with addresses in the continental US and is available in Canada for subscribers with a Canadian address. Required subscription plus compatible SIRIUS tuner and antenna are required and sold separately. SIRIUS Programming is subject to change. Visit [sirius.com](http://sirius.com) for the most complete and up-to-date channel lineup and product information. “SIRIUS” and the SIRIUS dog logo and related marks are trademarks of Sirius Satellite Radio Inc. All rights reserved.

## Basic Operation

**1** Either turn <SOURCE SELECT> or press [SAT TU 1/2] to select “SIRIUS”.

**2** Set [SOURCE CONTROL 1] to “AUDIO” and [SOURCE CONTROL 2] to “TUNER”.

(☞ page 61 “Remote Control Unit Operations”)

**3** Use [TUNING] to select the channel.  
When the channel is tuned in, the name of the song and artist are displayed.



- The channel switches continuously when [TUNING] is pressed and held.
- The song title, artist name, composer name, category and reception level can be checked by pressing <STATUS>.
- The time (default : 30sec) for which the on-screen display are displayed can be set at menu “Manual Setup” – “Option Setup” – “On-Screen Display” (☞ page 33).  
Press ▲ ▼ ◀ ▶ to return to the original screen.

## Checking the SIRIUS Signal Strength and Radio ID

**1** Either turn <SOURCE SELECT> or press [SAT TU 1/2] to select “SIRIUS”.

**2** Press <STATUS> until “SIGNAL” appears on the display.

The display will switch as shown below, depending on the reception conditions.

| Display   | Status                       |
|-----------|------------------------------|
| EXCELLENT | Signal strength is excellent |
| GOOD      | Signal strength is good      |
| WEAK      | Signal strength is weak      |
| NO SIGNAL | No signal                    |

**3** Adjust the position of the antenna until “SIGNAL: EXCELLENT” is shown on the display.

**4** Press <STATUS> until the channel you want to check (example: “SR001”) is displayed.

**5** Press [TUNING] and select channel 0 (SR000).  
Channel No. and Sirius ID are alternately shown on the display.

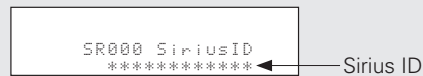

※ Write your own SIRIUS ID for storage use.

Sirius ID : \_\_\_\_\_



The strength of both the SIRIUS satellite and terrestrial signals can be checked at menu “Input Setup” – “Antenna Aiming” (☞ page 39).

## Presetting Radio Channels (Preset Memory)

Your favorite broadcast channels can be preset so that you can tune them in easily. Up to 56 channels can be preset.

**1** Tune in the broadcast channel you want to preset.

**2** Press [MEMORY].

**3** Press [SHIFT] to select the block in which the channel is to be preset.

**4** Press [CHANNEL + -] or [NUMBER (1 ~ 8)] to select the preset number.

**5** Press [MEMORY] again to complete the setting.



To preset other channels, repeat steps 1 to 5.

### NOTE

Preset channels are erased by overwriting them.

## Listening to Preset Channels

### Operation on the Main Unit

Press <TUNING PRESET>, then turn <SOURCE SELECT> to select the preset channel.

### Operation on the Remote control Unit.

**1** Press [SHIFT] to select the memory block (A to G).

**2** Press [CHANNEL + -] or [NUMBER (1 ~ 8)] to select the desired preset channel.

**Symbols used to indicate buttons in this manual**

Button located on both the main unit and the remote control unit → **BUTTON**  
 Button only on the main unit → **<BUTTON>**  
 Button only on the remote control unit → **[BUTTON]**

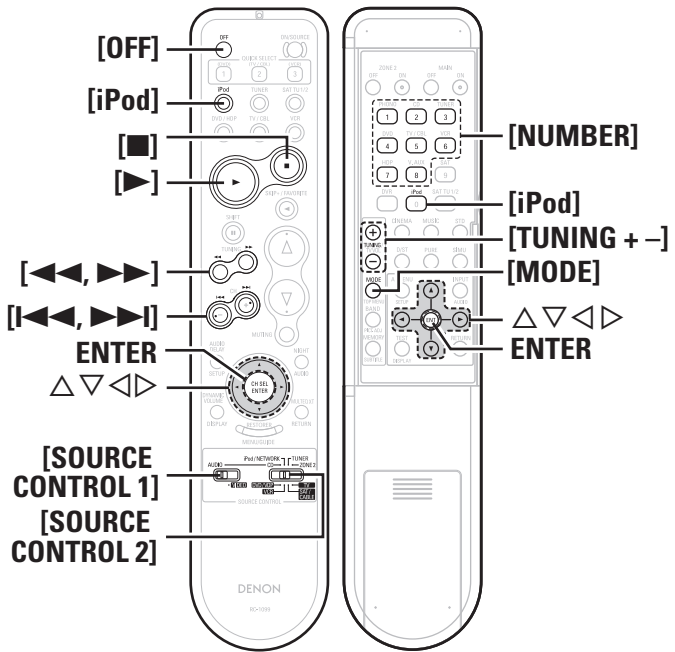
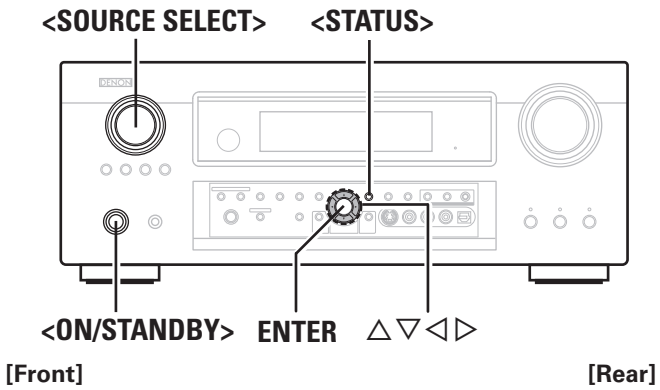

### Searching Categories

**1** Press ◀▶.

SR001 Hits 1  
 CAT : Pops

← Channel category

**2** Use ◀▶ to select the category, to use Δ▽ to select the desired channel.

- “UPDATING” is displayed while the encoding code is being updated.
- “SIRIUS UPDATING” is displayed when updating SIRIUS tuner firmware.
- Refer to “Troubleshooting” – “SIRIUS Satellite Radio” regarding other messages (☞ page 79).

### Parental Lock

**1** Tune to the channel you want to lock.

**2** Press [ENTER] for at least 3 seconds.  
“Code: [ ]” is displayed.

**3** Enter the 4-digit lock code using Δ▽◀▶.  
When you enter the correct code, the corresponding channel is locked.

**4** Press [ENTER].

- Channels under Parental Lock cannot be tuned in by performing Tuning Up/Down or by category search.
- Channels stored in preset memory can be tuned in by the preset channel select operation, even if Parental Lock is applied.
- When a channel to which Parental Lock is applied is being played, Parental Lock for that channel is cancelled by performing Step 2.
- See “Edit Lock Cord” (☞ page 39) for the method of changing Parental Lock Cord.
- You can also set “Parental Lock” from the menu. (☞ page 39).

### iPod® Playback

The music on an iPod can be played by using the control dock for iPod (ASD-1R, ASD-3N or ASD-3W sold separately). The operation can also be performed using the buttons on the main unit or remote control unit while watching the menus.

**Made for iPod** iPod is a trademark of Apple Inc., registered in the U.S. and other countries.

※ The iPod may only be used to copy or play contents that are not copyrighted or contents for which copying or playback is legally permitted for your private use as an individual. Be sure to comply with applicable copyright legislation.

### Basic Operation

**1** Make the necessary preparations.

- ① Set the iPod in the DENON control dock for iPod.  
(☞ See the control dock for iPod’s operating instructions.)
- ② Assign the control dock for iPod’s input.  
The input for the control dock for iPod is assigned to VCR by default.

**MENU : “Input Setup” – “Assign” – “iPod Dock”**  
 (☞ page 39)

**2** Either turn <SOURCE SELECT> or press [iPod] to select the input source assigned in step 1-② above.

iPod 🔋  
 DENON  
 OK to disconnect.  
 (iPod screen)

※ If the screens above are not displayed, the iPod may not be properly connected. Try connecting again.

### 3 Set [SOURCE CONTROL 1] to “AUDIO” and [SOURCE CONTROL 2] to “iPod/NETWORK”.

(☞ page 61 “Remote Control Unit Operations”)

### 4 Press [MODE] and hold it down for a 2 seconds or more to select the display mode.

To switch between modes, press and hold down the button. When remote mode is active, “Remote” is displayed.

| [Selectable mode] |                               | Browse mode              | Remote mode              |
|-------------------|-------------------------------|--------------------------|--------------------------|
| Display location  |                               | Main unit display        | iPod display             |
| Playable files    | Audio file                    | <input type="radio"/>    | <input type="radio"/>    |
|                   | Video file                    | <input type="radio"/> *1 | <input type="radio"/> *2 |
| Active buttons    | Remote control unit (AVR-989) | <input type="radio"/>    | <input type="radio"/>    |
|                   | iPod                          | ×                        | <input type="radio"/>    |

\*1 : When using an ASD-3N or ASD-3W control dock for iPod.

\*2 : Video may not be output, depending on the combination of ASD-1R and iPod.



- With the default settings, the iPod can be used connected to the VCR (iPod) connector.
- Use the RESTORER mode to expand the low and high frequency components of compressed audio files and achieve a richer sound. The default setting is “Mode3” (☞ page 47).
- Press <ON/STANDBY> or [OFF] and set the AVR-989’s power to the standby mode before disconnecting the iPod. Also switch the input source to one to which the menu “iPod Dock” is not assigned before disconnecting the iPod.
- When using an ASD-3N or ASD-3W control dock for iPod, refer to the respective manual to operate.

## Listening to Music

1 Use  $\Delta$   $\nabla$  to select the menu, then press ENTER or  $\triangleright$  to select the music file to be played.

2 Press ENTER or  $\triangleright$ .  
Playback starts.

### Stopping playback temporarily

During playback, press ENTER or  $\triangleright$ .  
Press again to resume playback.

### Fast-forwarding or fast-reversing

During playback, either press and hold [ $\lll$ ] (to fast-reverse) or [ $\ggg$ ] (to fast-forward).

### To cue to the beginning of a track

During playback, either press [ $\lll$ ] (to cue to the previous track) or [ $\ggg$ ] (to cue to the next track).

### To stop

During playback, either press and hold ENTER or press  $\blacksquare$ .

### Playing repeatedly

Press [TUNING -].

[Selectable items] All One OFF

MENU : “Input Setup” – “iPod” – “Repeat Mode” (☞ page 39)

### Shuffling playback

Press [TUNING +].

• When DENON control dock for iPod ASD-1R is connected

[Selectable items] Albums Songs OFF

• When DENON control dock for iPod ASD-3N/3W is connected

[Selectable items] ON OFF

MENU : “Input Setup” – “iPod” – “Shuffle Mode” (☞ page 39)



- To check the name of the title, the artist or the album when playing in browse mode, press <STATUS>.
- The folder name and the file name can be displayed in browse mode. Only alphanumeric characters and certain symbols can be displayed. Any characters that cannot be displayed are replaced with “.” (period).
- The time (default : 30sec) for which the on-screen display are displayed can be set at menu “Manual Setup” – “Option Setup” – “On-Screen Display” – “iPod Information” (☞ page 33).  
Press  $\Delta$   $\nabla$   $\triangleleft$   $\triangleright$  to return to the original screen.

## Viewing Still Pictures or Videos on the iPod

Photo and video data on the iPod can be viewed on the monitor. Only for iPod equipped with slideshow or video functions. (When using an ASD-1R)

1 Press and hold [MODE] to set the Remote mode.

2 Watching the iPod’s screen, use  $\Delta$   $\nabla$  to select “Photos” or “Videos”.

3 Press [ENTER] until the image you want to view is displayed.



- “TV Out” at the iPod’s “Slideshow Settings” or “Video Settings” must be set to “On” in order to display the iPod’s photo data or videos on the monitor. For details, see the iPod’s operating instructions.
- When viewing an iPod video file, select “iPod” - “Video” in browse mode. (When using an ASD-3N or ASD-3W)

### NOTE

- Depending on the type of iPod and the software version, some functions may not operate.
- DENON will accept no responsibility whatsoever for any loss of iPod data.

# Other Operations and Functions

**Symbols used to indicate buttons in this manual**

- Button located on both the main unit and the remote control unit → **BUTTON**
- Button only on the main unit → **<BUTTON>**
- Button only on the remote control unit → **[BUTTON]**

## <SOURCE SELECT> INPUT MODE

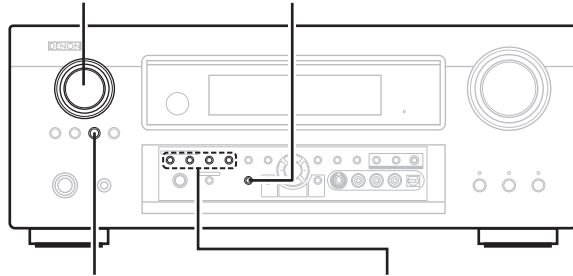

<ZONE 2 / REC SELECT> Surround mode

[Front]

[Rear]

[SOURCE SELECT]

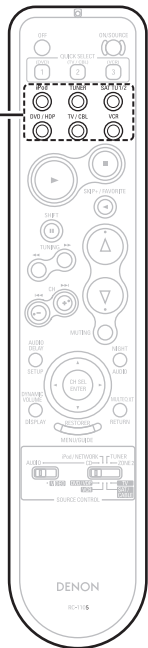

[SOURCE SELECT]

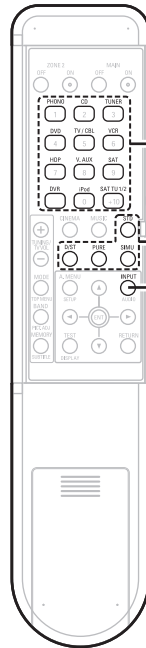

Surround mode

INPUT MODE

## Other Operations

### Playing Super Audio CD

- 1 Assign the HDMI input connector at the “HDMI” setting (☞ page 38).
- 2 Either turn <SOURCE SELECT> or press [SOURCE SELECT] to select the input source assigned in step 1. The “HDMI” indicator lights on the display.
- 3 Press INPUT MODE to select “AUTO” (☞ page 37). Select the input mode according to the program source to be played.
- 4 Select the surround mode (☞ page 40 ~ 42). We recommend playing in the DIRECT mode.
- 5 Start playing the Super Audio CD. The “DSD” indicator lights on the display. For operating instructions, refer to the respective equipment’s operating instructions.



- When playing DSD signals in the DIRECT or PURE DIRECT mode, the DSD signals are converted as such into analog signals. When playing in other surround modes, the DSD signals are first converted into PCM format, then into analog signals.
- “DSD DIRECT” is shown on the display when playing DSD 2-channel signals in the DIRECT mode. “DSD MULTI DIRECT” is shown on the display when playing DSD multi-channel signals in the DIRECT mode.

### Recording on an External Equipment (REC OUT mode)

You can listen to one program source while recording a different program source.

- 1 Press <ZONE2 / REC SELECT> until “ZONE2 Source”. “ZONE2 Source” is shown on the display.
- 2 Turn <SOURCE SELECT> until “RECOUT Source” is displayed. The “REC” indicator lights.
 

ZONE2 Source ↔ ZONE2 TUNER ↔ ... ↔ ZONE2 SIRIUS

↑ ↓

RECOUT SIRIUS ↔ ..... ↔ RECOUT TUNER ↔ RECOUT Source
- 3 Turn <SOURCE SELECT> to choose the input source to be recorded.
- 4 Play the program source. For operating instructions, refer to the respective equipment’s operating instructions. To record FM or AM broadcasts, select the broadcast (☞ page 51).
- 5 Start recording. For operating instructions, refer to the respective equipment’s operating instructions.



- To cancel, press **<ZONE2 / REC SELECT>**, then turn **<SOURCE SELECT>** until "ZONE2 Source" is displayed.
- Make a test recording before starting the actual recording.
- Signals are only output to the analog REC OUT connectors when the digital signals input to the digital input connectors (OPTICAL/COAXIAL) are PCM (2-channel) signals.
- Digital audio signals input to the HDMI connectors are not output to the REC OUT connectors, so connect using the OPTICAL or COAXIAL connectors.
- Sources selected with the REC OUT mode are output from ZONE2 as well.
- In the REC OUT mode, the remote control unit's ZONE2 mode buttons cannot be operated.
- The "XM" digital audio output signal is not output from the OPTICAL2 output connector.

### NOTE

- Recordings you make are for your personal enjoyment and should not be used for other purposes without permission of the copyright holder.
- Input sources for which "Delete" is selected at "Source Delete" cannot be selected.

## Convenient Functions

### HDMI Control Function

When AVR-989 is connected to a TV and player compatible with HDMI control function, you can perform the following operations.

Settings other than AVR-989 settings must be made on the respective devices. (Check the operating instructions of each device for details.)

- AVR-989 power off can be linked to the TV power off step. When you set "Output audio from amp" in the TV audio output setup operation, you can switch the amp power on.
- You can switch audio output devices with a TV operation. (When outputting from the TV speakers, output switches from speakers connected to AVR-989).
- You can adjust AVR-989 volume in the TV volume adjustment operation.
- You can switch AVR-989 functions through linkage to TV input function switching.
- When playing the player, the AVR-989 input function switches to the function of that player.



- When you want to listen to TV audio by AVR-989, connect optical digital or analog. If the TV you are using has both connection jacks, use the optical digital connection.
- When using these functions set as follows: menu "Manual Setup" – "HDMI Setup" – "HDMI Control" set to "ON" (🔧 page 30).

## Connections

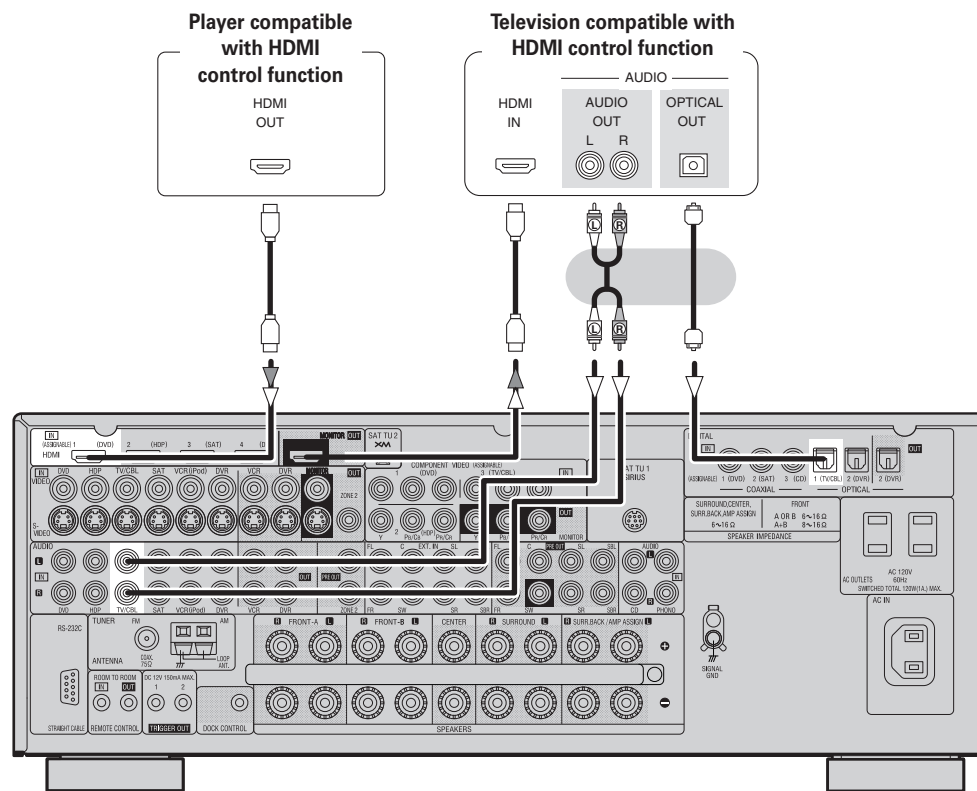

### NOTE

When using the HDMI control function, do not assign HDMI input to "TV/CBL" by setting "Input Setup" – "Assign" – "HDMI In" in the menu.

**Operations**

- 1** Connect the HDMI to the AVR-989 with equipment compatible with the HDMI control function (☞ page 58).
- 2** Put the power on for all the equipment connected to the HDMI.
- 3** Check the settings for all the equipment connected to the HDMI and make HDMI available to them.
  - ※ Please consult the operating instructions for the connected equipment to check the settings.
  - ※ Steps 1~3 do not have to be repeated once started.
  - ※ Carryout steps 2 and 3 should any of the equipment be plugged out.
- 4** Switch the television input to the HDMI connected to the AVR-989.
- 5** Switch the AVR-989 input to the HDMI input source and check if the picture from the player is ok.
- 6** Put the television power on standby and check if the AVR-989 goes into standby.



- If the AVR-989 does not work please check the following.
- Is the menu "Manual Setup" – "HDMI Setup" – "HDMI Control" (☞ page 30) set to "ON"?
  - Is the menu "Manual Setup" – "HDMI Setup" – "Power Off Control" (☞ page 30) set to "ON"?
  - Is the control function used for the television HDMI properly set? (Check the television operating instructions for details.)
  - Should any of the operations below be performed, the interlocking function may be reset, in which case, repeat step's 2 and 3.
    - Menu "Input Setup" – "Assign" – "HDMI In" (☞ page 38) setting has changed.
    - There is a change to the connection between the equipment and the HDMI, or an increase in equipment.

**☞ Symbols used to indicate buttons in this manual**

- Button located on both the main unit and the remote control unit → **BUTTON**
- Button only on the main unit → **<BUTTON>**
- Button only on the remote control unit → **[BUTTON]**

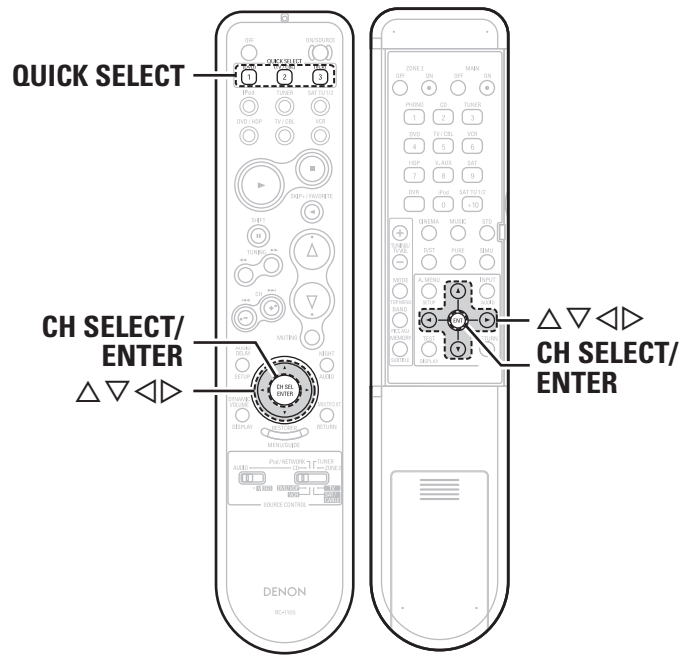
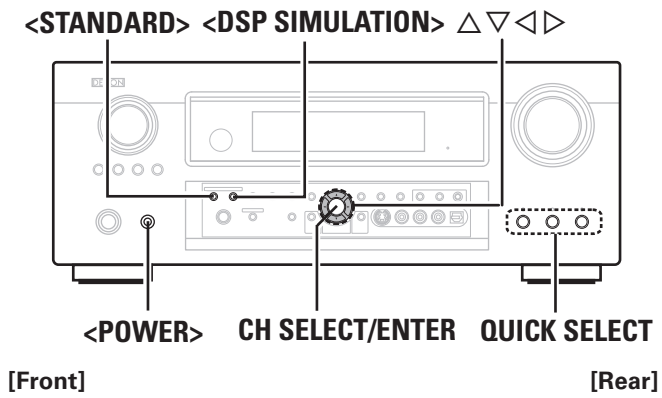

**Channel Level**  
You can adjust the channel level either according to the playback sources or to suit your taste, as described below.

- 1** Press **CH SELECT/ENTER**.
 

| Channel Volume   |           |     |       |
|------------------|-----------|-----|-------|
| FL               | ◀ 0.0dB ▶ | SR  | 0.0dB |
| C                | 0.0dB     | SBR | 0.0dB |
| FR               | 0.0dB     | SBL | 0.0dB |
| SW               | 0.0dB     | SL  | 0.0dB |
| Fader            |           |     |       |
| FRONT ◀ : ▶ REAR |           |     |       |
- 2** Use **△▽** or **CH SELECT/ENTER** to select the speaker. The speaker that can be set switches each time one of the buttons is pressed.
- 3** Use **◀▶** to adjust the volume.
  - ※ In the case of a subwoofer, reducing the volume when it is at "–12 dB" will change the setting to "OFF" (none).

**NOTE**  
When the input source is "iPod", you cannot perform channel level setting.

**Fader Function**  
This function lets you adjust (fade) the sound from all the front or rear speakers at once.

- 1** Press **CH SELECT/ENTER**.
- 2** Press **△▽** or **CH SELECT/ENTER** to select "Fader".
- 3** Use **◀▶** to adjust the volume of the speakers. (◀: front, ▶: rear)

- ☞**
- The fader function does not affect the subwoofer.
  - The fader can be adjusted until the volume of the speaker adjusted to the lowest value is –12 dB.

## Quick Select Function

With this function, the currently playing input source, input mode, surround mode, MultEQ XT settings and volume can be stored in the memory.

**1** Set the input source, surround mode, MultEQ XT, Dynamic EQ, Dynamic Volume, Front Speaker settings and volume to the conditions you want to store.

**2** Press and hold the desired **QUICK SELECT** until “Memory” appears on the display.  
The current settings will be memorized.

### [Quick Select Defaults]

|                | Input Source | Volume |
|----------------|--------------|--------|
| Quick Select 1 | DVD          | -40 dB |
| Quick Select 2 | TV/CBL       | -40 dB |
| Quick Select 3 | VCR          | -40 dB |



- To call out the settings, press **QUICK SELECT** at which the desired settings were stored.
- The Quick Select name can be changed (🔧 page 34).

### NOTE

Input sources stored with the quick select function cannot be selected if they have been deleted at menu “Manual Setup” – “Option Setup” – “Source Delete” (🔧 page 33). In this case, store them again.

## Personal Memory Plus Function

This function sets the settings (input mode, surround mode, HDMI output mode, MultEQ XT, Dynamic EQ, Dynamic Volume, audio delay etc.) last selected for the individual input sources.

When you switch to an input source, the settings are automatically set to the ones that were set the last time that input source was used.



The surround parameters, tone settings and the volumes of the different speakers are stored for the individual surround modes.

## Last Function Memory

This stores the settings as they were directly before the standby mode was set.

When the power is turned back on, the settings are restored to as they were directly before the standby mode was set.

## Backup Memory

The various settings are backed up for about 1 week, even if the power is turned off or the power cord is disconnected.

## Resetting the Microprocessor

Perform this procedure if the display is abnormal or if operations cannot be performed.

When the microprocessor is reset, all the settings are reset to their default values.

**1** Turn off the power using **<POWER>**.

**2** Press **<POWER>** while simultaneously pressing **<STANDARD>** and **<DSP SIMULATION>**.

**3** Once the display starts flashing at intervals of about 1 second, release the two buttons.



If in step 3 the display does not flash at intervals of about 1 second, start over from step 1.

# Remote Control Unit Operations

[Front]

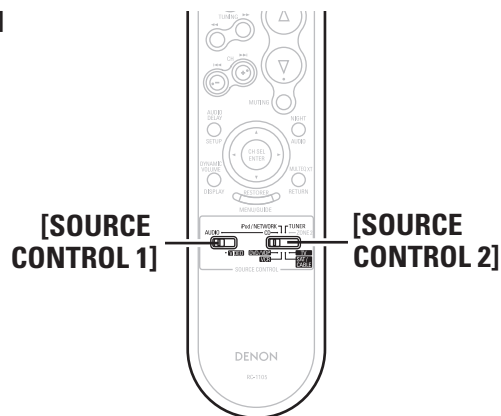

## Operating DENON Audio Components

- 1 Set **[SOURCE CONTROL 1]** to “AUDIO”.
- 2 Set **[SOURCE CONTROL 2]** to the position for the component to be operated (CD, iPod/NETWORK or TUNER).
- 3 Operate the audio component.

※ For details, refer to the component’s operating instructions.  
※ While this remote control is compatible with a wide range of infrared controlled components, it may be the case that some component models cannot be operated with this remote control.



- The signals for the pressed buttons are emitted while setting the preset memory. To avoid accidental operation, cover the remote control unit’s transmitting window while setting the preset memory.
- Depending on the model and year of manufacture, this function cannot be used for some models, even if they are of makes listed in the list of preset codes.
- Some manufacturers use more than one type of remote control code. Refer to the included list of preset codes to change the number and verify correct operation.
- The preset memory can be set for one component only among the following: DVD/HDP and SAT/CABLE.
- VDP (Video Disc Player) can be preset when **[SOURCE CONTROL 2]** is set to “DVD/HDP”.

[Rear]

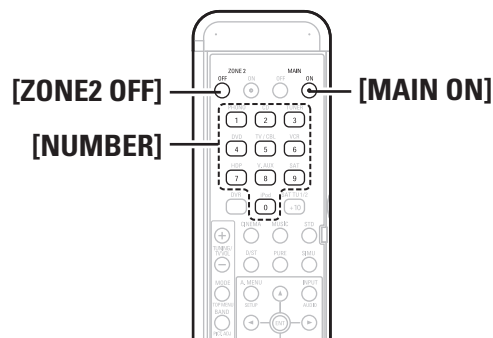

## Presetting

- DENON and other makes of components can be operated by setting the preset memory.
- Operation is not possible for some models.

- 1 Set **[SOURCE CONTROL 1]** to “AUDIO” or “VIDEO”.  
※ Set to the AUDIO side for the CD position, and to the VIDEO side for the DVD/HDP, VCR, SAT/CABLE or TV position.
- 2 Set **[SOURCE CONTROL 2]** to the component to be registered.
- 3 Press **[ZONE2 OFF]** and **[MAIN ON]** at the same time.  
The indicator starts flashing.
- 4 Press **[NUMBER]** and input the 3-digit number of the brand of the component to be preset. The numbers are shown in the Preset Code Table (☞ End of this manual).
- 5 To store the codes of another component in the memory, repeat steps 1 to 4.

## Operating Preset Components

- 1 Set **[SOURCE CONTROL 1]** to “AUDIO” or “VIDEO”.  
※ Set to the AUDIO side for the CD position, and to the VIDEO side for the DVD/HDP, VCR, SAT/CABLE or TV position.
- 2 Set **[SOURCE CONTROL 2]** to the component you want to operate.
- 3 Operate the component.  
※ For details, refer to the component’s operating instructions.  
※ Some models cannot be operated with this remote control unit.



Depending on the model and year of manufacture of your equipment, some buttons may not operate.



## Functions of Buttons by Component

### □ Front

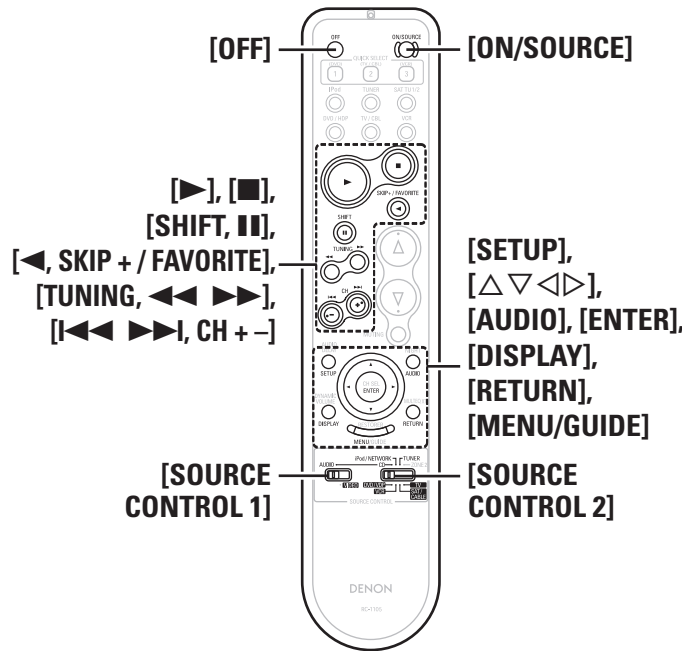

| Device operated                 | CD Player                                   | iPod                                        | Tuner               | DVD Player                                  | Blu-ray Disc Player                         | Video Disc Player (VDP)                     | Video Deck                                  | Satellite Receiver     | Cable TV              | TV (Monitor)          |
|---------------------------------|---------------------------------------------|---------------------------------------------|---------------------|---------------------------------------------|---------------------------------------------|---------------------------------------------|---------------------------------------------|------------------------|-----------------------|-----------------------|
| <b>SOURCE CONTROL 1</b>         | <b>AUDIO</b>                                |                                             |                     | <b>VIDEO</b>                                |                                             |                                             |                                             |                        |                       |                       |
| <b>SOURCE CONTROL 2</b>         | <b>CD</b>                                   | <b>iPod/NETWORK</b>                         | <b>TUNER</b>        | <b>DVD / HDP</b>                            |                                             |                                             | <b>VCR</b>                                  | <b>SAT / CABLE</b>     |                       | <b>TV</b>             |
| <b>OFF</b>                      | –                                           | –                                           | –                   | Power off                                   | Power off                                   | –                                           | –                                           | –                      | –                     | –                     |
| <b>ON/SOURCE</b>                | –                                           | –                                           | –                   | Power on                                    | Power on                                    | Power on / Standby                          | Power on / Standby                          | Power on / Standby     | Power on / Standby    | Power on / Standby    |
| <b>▶</b>                        | Play                                        | Play / Pause                                | –                   | Play                                        | Play                                        | Play                                        | Play                                        | Punch through          | Punch through         | Punch through         |
| <b>■</b>                        | Stop                                        | Stop                                        | –                   | Stop                                        | Stop                                        | Stop                                        | Stop                                        |                        |                       |                       |
| <b>SHIFT, II</b>                | Pause                                       | –                                           | Shift               | Pause                                       | Pause                                       | Pause                                       | Pause                                       |                        |                       |                       |
| <b>◀, SKIP + / FAVORITE</b>     | Disc skip +                                 | ※ Favorites Direct                          | –                   | Disc skip                                   | –                                           | –                                           | –                                           |                        |                       |                       |
| <b>TUNING, &lt;&lt;&gt;&gt;</b> | Manual search (fast-reverse / fast-forward) | Manual search (fast-reverse / fast-forward) | Tuning down / up    | Manual search (fast-reverse / fast-forward) | Manual search (fast-reverse / fast-forward) | Manual search (fast-reverse / fast-forward) | Manual search (fast-reverse / fast-forward) | Switch channels (–, +) |                       |                       |
| <b>&lt;&lt;&gt;&gt;, CH + –</b> | Auto search (cue)                           | Auto search (cue)                           | Tuner Channel – / + | Auto search (cue)                           | Auto search (cue)                           | Auto search (cue)                           | Auto search (cue)                           |                        |                       |                       |
| <b>SETUP</b>                    | –                                           | –                                           | –                   | Setup                                       | Setup                                       | –                                           | –                                           | –                      | –                     | –                     |
| <b>&lt; &gt; &lt;&gt;&gt;</b>   | –                                           | Cursor                                      | –                   | Cursor operation                            | Cursor operation                            | –                                           | –                                           | Cursor operation       | Cursor operation      | Cursor operation      |
| <b>AUDIO</b>                    | –                                           | –                                           | –                   | Switching the audio signal                  | Switching the audio signal                  | –                                           | –                                           | –                      | –                     | –                     |
| <b>ENTER</b>                    | –                                           | Enter                                       | –                   | Enter setting                               | Enter setting                               | –                                           | –                                           | Enter setting          | Enter setting         | Enter setting         |
| <b>DISPLAY</b>                  | –                                           | –                                           | –                   | Switching the display                       | Switching the display                       | –                                           | –                                           | Switching the display  | Switching the display | Switching the display |
| <b>RETURN</b>                   | –                                           | –                                           | –                   | Return                                      | Return                                      | –                                           | –                                           | Return                 | Return                | Return                |
| <b>MENU / GUIDE</b>             | –                                           | –                                           | –                   | Calling out the menus                       | Calling out the menus                       | –                                           | –                                           | Calling out the menus  | Calling out the menus | Calling out the menus |

※ The iPod/NETWORK's **FAVORITE** button can be operated when using a control dock for iPod ASD-3N/3W.

□ Rear

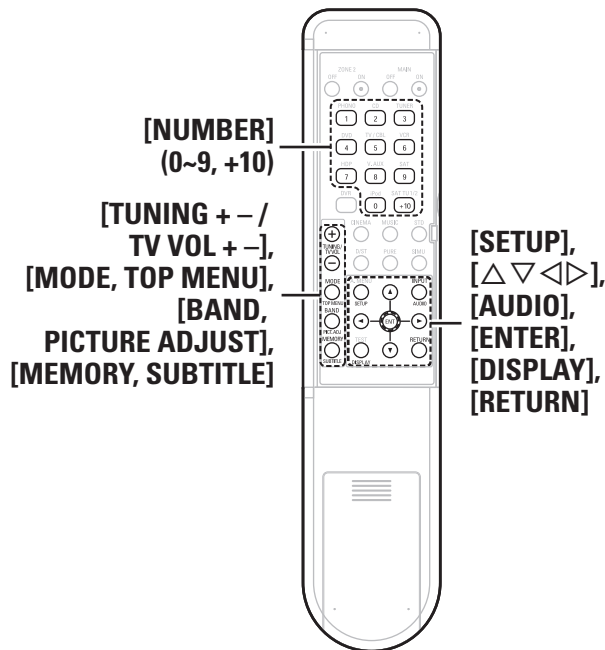

| Device operated                      | CD Player                  | iPod                                                                      | Tuner                        | DVD Player                     | Blu-ray Disc Player                            | Video Disc Player (VDP)        | Video Deck                     | Satellite Receiver               | Cable TV                             | TV (Monitor)                   |
|--------------------------------------|----------------------------|---------------------------------------------------------------------------|------------------------------|--------------------------------|------------------------------------------------|--------------------------------|--------------------------------|----------------------------------|--------------------------------------|--------------------------------|
| <b>SOURCE CONTROL 1</b>              | <b>AUDIO</b>               |                                                                           |                              | <b>VIDEO</b>                   |                                                |                                |                                |                                  |                                      |                                |
| <b>SOURCE CONTROL 2</b>              | <b>CD</b>                  | <b>iPod/NETWORK</b>                                                       | <b>TUNER</b>                 | <b>DVD / HDP</b>               |                                                |                                | <b>VCR</b>                     | <b>SAT / CABLE</b>               |                                      | <b>TV</b>                      |
| <b>NUMBER (0 ~ 9, +10)</b>           | –                          | –                                                                         | –                            | Number input / Track selection | Number input / Track selection                 | Number input / Track selection | –                              | Channels                         | Channels                             | Channels                       |
| <b>TUNING (+, -) / TV VOL (+, -)</b> | ⊕ CD Random<br>⊖ CD Repeat | ⊕ iPod Random<br>⊖ iPod Repeat                                            | ⊕ Tuning up<br>⊖ Tuning down | ⊕ DVD Random<br>⊖ DVD Repeat   | ⊕ Blu-ray Disc Random<br>⊖ Blu-ray Disc Repeat | ⊕ TV Volume ▲<br>⊖ TV Volume ▼ | ⊕ TV Volume ▲<br>⊖ TV Volume ▼ | ⊕ DBS Volume ▲<br>⊖ DBS Volume ▼ | ⊕ Cable Volume ▲<br>⊖ Cable Volume ▼ | ⊕ TV Volume ▲<br>⊖ TV Volume ▼ |
| <b>MODE, TOP MENU</b>                | –                          | Page search mode (once) and Browse/Remote mode switching (Press and hold) | Switch search modes          | Calling out the menus          | Calling out the top menus                      | –                              | –                              | Calling out the menus            | Calling out the menus                | Calling out the menus          |
| <b>SETUP</b>                         | –                          | –                                                                         | –                            | Setup                          | Setup                                          | –                              | –                              | –                                | –                                    | –                              |
| Δ▽◀▶                                 | –                          | –                                                                         | –                            | Cursor operation               | Cursor operation                               | –                              | –                              | Cursor operation                 | Cursor operation                     | Cursor operation               |
| <b>AUDIO</b>                         | –                          | –                                                                         | –                            | Audio                          | Audio                                          | –                              | –                              | –                                | –                                    | –                              |
| <b>BAND, PICTURE ADJUST</b>          | –                          | ※1 Top menu                                                               | AM / FM switching            | Picture adjust                 | Picture adjust                                 | –                              | –                              | –                                | –                                    | –                              |
| <b>ENTER</b>                         | –                          | –                                                                         | –                            | Enter setting                  | Enter setting                                  | –                              | –                              | Enter setting                    | Enter setting                        | Enter setting                  |
| <b>MEMORY, SUBTITLE</b>              | –                          | ※1 Favorite memory                                                        | Preset memory                | Subtitle                       | Subtitle                                       | –                              | –                              | –                                | –                                    | –                              |
| <b>DISPLAY</b>                       | –                          | –                                                                         | –                            | Switching the display          | Switching the display                          | –                              | –                              | Switching the display            | Switching the display                | Switching the display          |
| <b>RETURN</b>                        | –                          | –                                                                         | –                            | Return                         | Return                                         | –                              | –                              | Return                           | Return                               | Return                         |
| <b>Default setting (Preset code)</b> | DENON (111)                | –                                                                         | –                            | DENON (111)                    | ※2 DENON (121)                                 | –                              | HITACHI (108)                  | –                                | ABC (007)                            | HITACHI (134)                  |
| <b>Special Remarks</b>               | ①                          | –                                                                         | –                            | ①, ②                           |                                                |                                | ①                              | ①, ③                             |                                      | ①, ③                           |

**[Special Remarks]**

- ① Only one device can be set in the preset memory for each mode. When a new preset code is registered, the existing code is automatically erased.
- ② For some brands, the DVD remote control buttons may have different function names. Check beforehand.
- ③ One of the following buttons can be assigned to the TV and satellite receiver or cable TV: CD, iPod/NETWORK, TUNER, DVD/HDP, VCR (☞ page 64 “Punch Through Function”).

※1: This button can be operated when using a control dock for iPod ASD-3N/3W.

※2: The initial setting of Preset code is 111 (DVD Player).

With the Blu-ray Disc Player setting, when you have set the remote controller code to “DENON2”, use the Blu-ray Disc Player preset code “121”.

[Front]

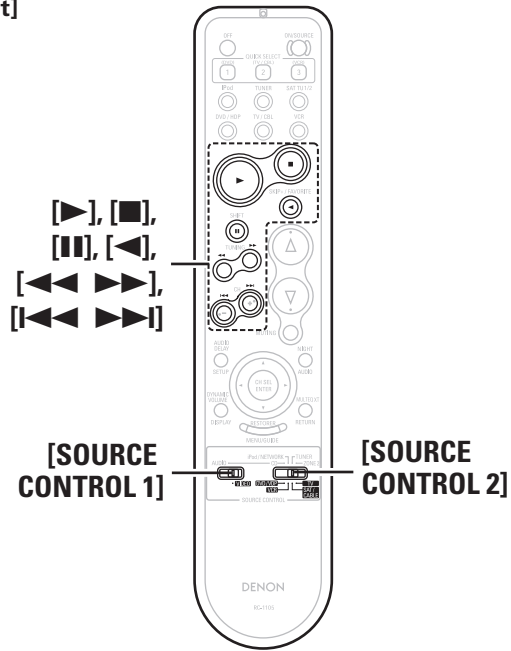

[Rear]

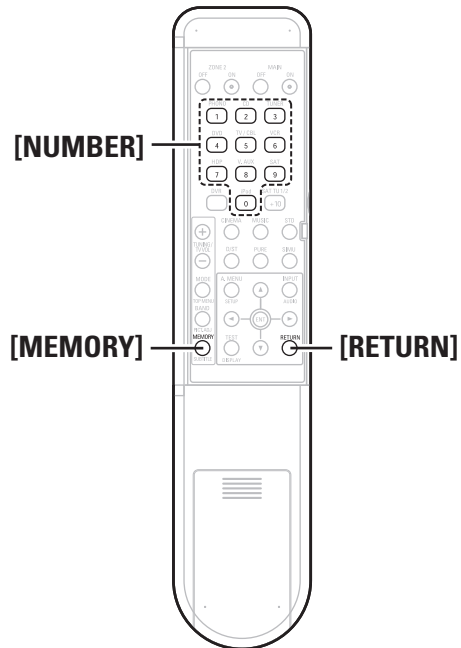

## Punch Through Function

“Punch Through” is a function allowing you to operate ►, ■, ■■, ◀, ◀◀, ▶▶, ◀◀◀ and ▶▶▶ on CD, iPod/NETWORK, TUNER, DVD/HDP or VCR components when in the SAT/CABLE or TV mode. By default, nothing is set.

- 1** Set [SOURCE CONTROL 1] to “VIDEO”.
- 2** Set [SOURCE CONTROL 2] to the component to be registered (TV or SAT/CABLE).
- 3** Press [MEMORY] and [RETURN] at the same time. The indicator starts flashing.
- 4** Input the number of the component you want to set.

|              | No. |
|--------------|-----|
| CD           | 1   |
| iPod/NETWORK | 2   |
| TUNER        | 3   |
| DVD/HDP      | 4   |
| VCR          | 5   |
| No setting   | 0   |

# Amp Assign / Multi-zone Connections and Operations

The AVR-989 is compatible with the following types of playback:

- **Multi-zone playback (ZONE2)**
- **Bi-amp playback (front speakers)**

## NOTE

- For bi-amp playback, use speakers compatible with that type of connection.
- When conducting bi-amp playback, remove the short-circuiting boards (or wires) from the speaker terminals.

## ❑ Amp Assign mode setting and speakers connected to the various speaker terminals

| Speaker terminal / Amp Assign mode | FRONT |    | CENTER | SURROUND |    | SURROUND BACK / AMP ASSIGN |     |
|------------------------------------|-------|----|--------|----------|----|----------------------------|-----|
|                                    | R     | L  |        | R        | L  | R                          | L   |
| ZONE2                              | FR    | FL | C      | SR       | SL | Z2R                        | Z2L |



When ZONE2 power is on, the ZONE2 channel is output from speakers connected to the SURR.BACK/AMP ASSIGN terminals.

## Multi-zone Settings with the Amp Assign Function

The amp assign function lets you assign the amplifiers for the different channels built into the AVR-989 to the speaker outputs for the different zones.

Select the desired playback environment from among "Setting 1" to "Setting 3", then set the corresponding "Amp Assign" mode at menu "Manual Setup" – "Option Setup" – "Amp Assign" (page 32).

Connect the speakers as described at "Amp Assign mode setting and speakers connected to the various speaker terminals".

### Setting 1 :

#### ● Multi-zone playback (Default Setting)

5.1-channel playback + ZONE2 stereo playback

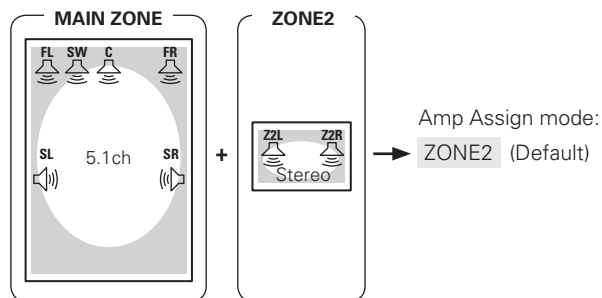

### Setting 2 :

#### ● 7.1-channel playback

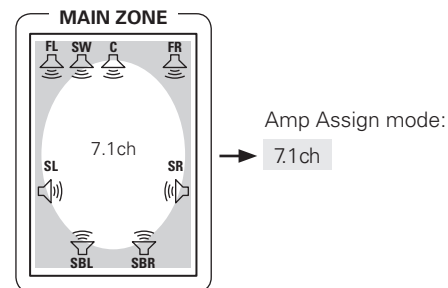

## ❑ Amp Assign mode setting and speakers connected to the various speaker terminals

| Speaker terminal / Amp Assign mode | FRONT |    | CENTER | SURROUND |    | SURROUND BACK / AMP ASSIGN |     |
|------------------------------------|-------|----|--------|----------|----|----------------------------|-----|
|                                    | R     | L  |        | R        | L  | R                          | L   |
| 7.1ch                              | FR    | FL | C      | SR       | SL | SBR                        | SBL |



The surround back channel is output from the speakers connected to the SURR.BACK/AMP ASSIGN terminals.

### Setting 3 :

- Making bi-amp connections for the FL and FR channels in the MAIN ZONE and conducting 5.1-channel playback (switching with other modes not possible)

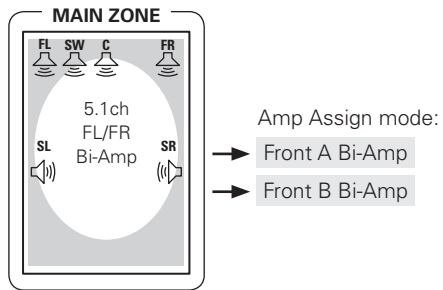

#### □ Amp Assign mode setting and speakers connected to the various speaker terminals

| Speaker terminal | FRONT-A |      | FRONT-B |      | CENTER | SURROUND |    | SURROUND BACK / AMP ASSIGN  |    |
|------------------|---------|------|---------|------|--------|----------|----|-----------------------------|----|
|                  | R       | L    | R       | L    |        | R        | L  | R                           | L  |
| Front A Bi-Amp   |         |      |         |      |        |          |    | FR                          | FL |
|                  |         |      |         |      |        |          |    | FL-A/FR-A Bi-Amp connection |    |
| Front B Bi-Amp   | FR-A    | FL-A | FR-B    | FL-B | C      | SR       | SL | FR                          | FL |
|                  |         |      |         |      |        |          |    | FL-B/FR-B Bi-Amp connection |    |



The Front A or Front B channel for Bi-Amp use is output from the speakers connected to the SURR.BACK/AMP ASSIGN terminals.

## Multi-zone Settings and Operations with Zone Output

Prepare power amplifiers for ZONE2.

|       | Connectors for audio output | Audio signals | Connectors for video output |
|-------|-----------------------------|---------------|-----------------------------|
| ZONE2 | ZONE2 PRE OUT               | Stereo        | ZONE2 VIDEO OUT             |

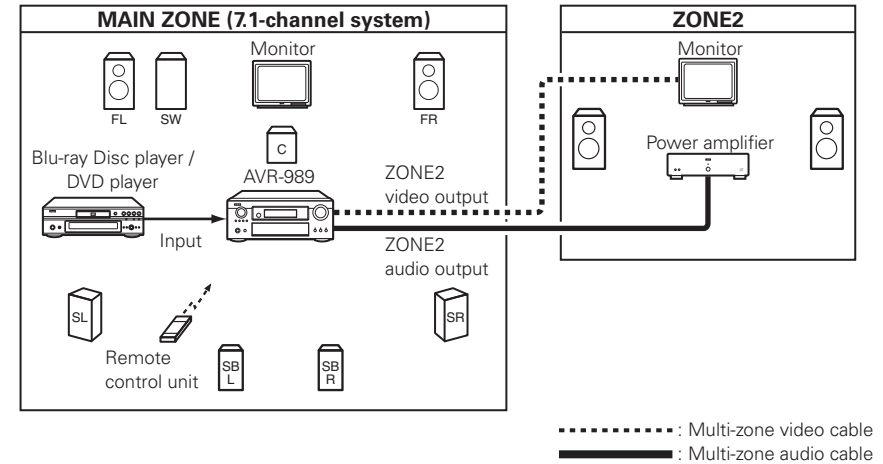

**Symbols used to indicate buttons in this manual**

Button located on both the main unit and the remote control unit → **BUTTON**  
 Button only on the main unit → **<BUTTON>**  
 Button only on the remote control unit → **[BUTTON]**

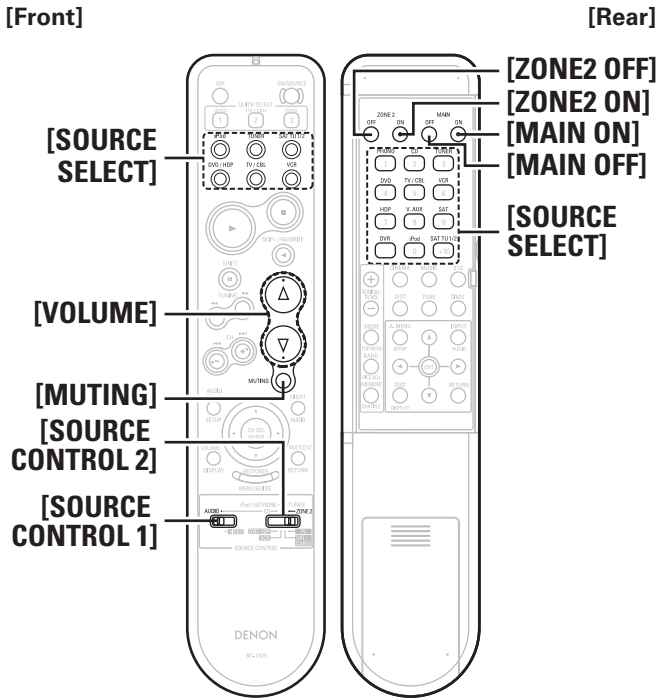
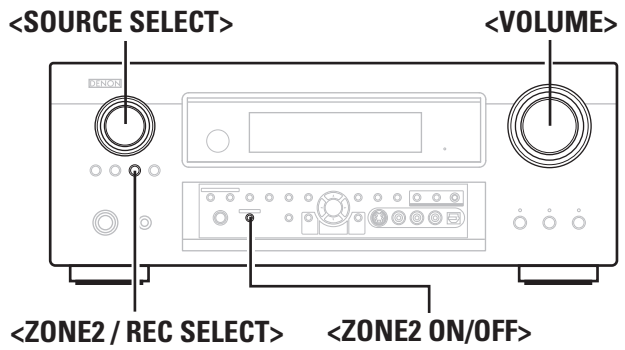

## Multi-zone Operations

### Turning the Power On and Off

**[Operation on the main unit]**  
 Press **<ZONE2 ON/OFF>**.  
 When the power turns on, the multi-zone indicator (**Z2**) lights on the display.

**[Operation on the remote control unit]**  
 In the zone mode you want to operate, press **[ZONE2 ON]** or **[ZONE2 OFF]**.

- Also press **[SOURCE SELECT]** when in standby mode, the power turns on.
- When using ZONE2, it is possible to turn the power for the MAIN ZONE only on or off by pressing **[MAIN ON]** or **[MAIN OFF]**.

### Selecting the Input Source

**[Operation on the main unit]**  
 ① Press **<ZONE2 / REC SELECT>** and select the zone to be adjusted.  
 ② Turn **<SOURCE SELECT>**.

**[Operation on the remote control unit]**  
 ① Set **[SOURCE CONTROL 1]** to "AUDIO" and **[SOURCE CONTROL 2]** to "ZONE2".  
 ② Press **[SOURCE SELECT]**.

### Adjusting the Volume

**[Operation on the main unit]**  
 ① Press **<ZONE2 / REC SELECT>** and select the zone to be adjusted.  
 ② Turn **<VOLUME>** to adjust.

**[Operation on the remote control unit]**  
 ① Set **[SOURCE CONTROL 1]** to "AUDIO" and **[SOURCE CONTROL 2]** to "ZONE2".  
 ② Press **[VOLUME]**.

**[Variable range]** --- **-70dB** ~ **-40dB** ~ **+18dB**

- The volume can be increased up to the value set at menu "Manual Setup" - "ZONE2 Setup" - "Volume Limit" (page 32).
- The ZONE2 volume can be adjusted only when "ZONE2" is selected at menu "Manual Setup" - "Option Setup" - "Amp Assign" (page 32).

### Turning off the Sound Temporarily

① Set **[SOURCE CONTROL 1]** to "AUDIO" and **[SOURCE CONTROL 2]** to "ZONE2".  
 ② Press **[MUTING]**.  
 The sound is reduced to the level set at menu "Manual Setup" - "ZONE2 Setup" - "Mute Level" (page 32).  
 To cancel, either adjust the volume or press **[MUTING]** again.  
 The setting is canceled when the zone's power is turned off.

- The source selected for ZONE2 is also output from the recording output connectors.
- When the input source to which the digital input connectors (OPTICAL/COAXIAL) are assigned is selected in ZONE2, playback is only possible if the digital signal being input is in PCM (2-channel) format.

**NOTE**

- Digital audio signals input from the HDMI connectors cannot be played in multi-zone.
- When certain digital signals are being input, noise may be output from the ZONE2 audio output connectors.

## About Speaker Installation

### Surround back speakers

Sound positioning directly to the rear can be achieved easily by adding a surround back speaker to a 5.1-channel system. In addition, the acoustic image extending between the sides and the rear is narrowed, thus greatly improving the expression of the surround signals for sounds moving from the sides to the back and from the front to the point directly behind the listening position.

#### Change of positioning and acoustic image with 5.1-channel systems

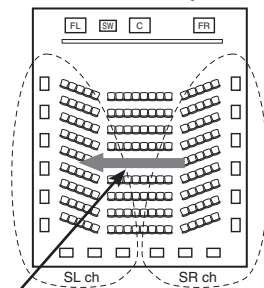

Movement of acoustic image from SR to SL

#### Change of positioning and acoustic image with 6.1-channel systems

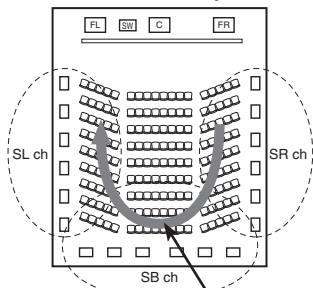

Movement of acoustic image from SR to SB to SL

In addition to sources recorded in 6.1-channels, the surround effect of conventional 2- to 5.1-channel sources can also be enhanced.

### Number of surround back speakers

We recommend using 2 speakers. When using dipolar speakers in particular, be sure to use 2 speakers.

### Placement of the surround left and right channels when using surround back speakers

We recommend installing the speakers for the surround "L" and "R" channels a bit forward.

### Examples of speaker layouts

Below we introduce examples of speaker layouts. Refer to these to arrange your speakers according to their type and how you want to use them.

#### [1] Using surround back speaker(s)

##### ① When mainly playing movies

Recommended when your surround speakers are single or 2-way speakers.

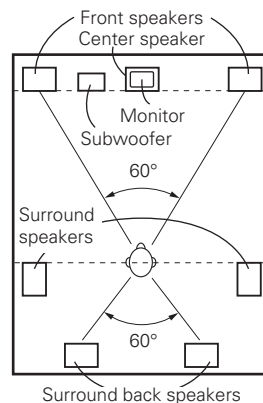

[As seen from above]

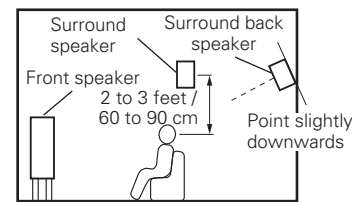

[As seen from the side]

##### ② Setting for primarily watching movies using diffusion type speakers for the surround speakers

For the greatest sense of surround sound envelopment, diffuse radiation speakers such as bipolar types, or dipolar types, provide a wider dispersion than is possible to obtain from a direct radiating speaker (monopolar). Place these speakers at either side of the prime listening position, mounted above ear level.

#### Path of the surround sound from the speakers to the listening position

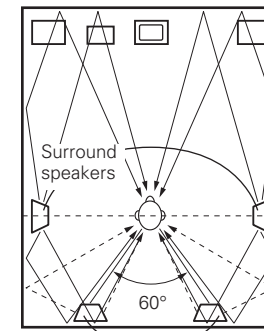

[As seen from above]

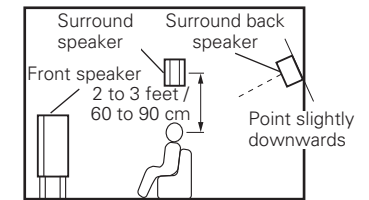

[As seen from the side]

##### ③ When playing movies and music

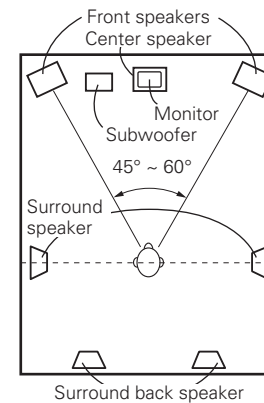

[As seen from above]

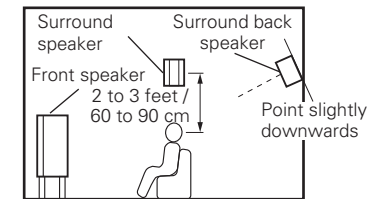

[As seen from the side]

## [2] When not using surround back speakers

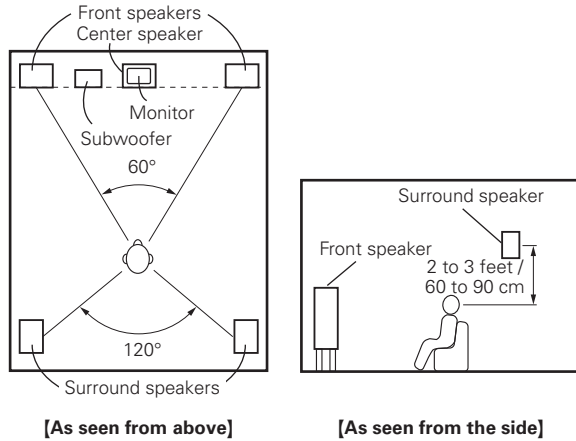

## Surround

The AVR-989 is equipped with a digital signal processing circuit that lets you play program sources in the surround mode to achieve the same sense of presence as in a movie theater.

## Dolby Surround

### Dolby Digital

Dolby Digital is a multichannel digital signal format developed by Dolby Laboratories.

A total of 5.1-channels are played: 3 front channels ("FL", "FR" and "C"), 2 surround channels ("SL" and "SR") and the "LFE" channel for low frequencies.

Because of this, there is no crosstalk between channels and a realistic sound field with a "three-dimensional" feeling (sense of distance, movement and positioning) is achieved.

A real, overpowering sense of presence is achieved when playing movie sources in AV rooms as well.

### Dolby Digital Plus

Dolby Digital Plus is an improved Dolby Digital signal format that is compatible with up to 7.1-channels of discrete digital sound and also improves sound quality thanks to extra data bit rate performance. It is upwardly compatible with conventional Dolby Digital, so it offers greater flexibility in response to the source signal and the conditions of the playback equipment.

### Dolby TrueHD

Dolby TrueHD is a high definition audio technology developed by Dolby Laboratories, using lossless coding technology to faithfully reproduce the sound of the studio master.

This format is compatible with a maximum sampling frequency of 96 kHz and up to 7.1-channels, so it is used for applications particularly prioritizing sound quality.

### Dolby Pro Logic II

Dolby Pro Logic II is a matrix decoding technology developed by Dolby Laboratories.

Regular music such as that on CDs is encoded into 5-channels to achieve an excellent surround effect.

The surround channel signals are converted into stereo and full band signals (with a frequency response of 20 Hz to 20 kHz or greater) to create a "three-dimensional" sound image offering a rich sense of presence for all stereo sources.

### Dolby Pro Logic IIx

Dolby Pro Logic IIx is a further improved version of the Dolby Pro Logic II matrix decoding technology.

Audio signals recorded in 2-channels are decoded to achieve a natural sound with up to 7.1-channels.

There are 3 modes: "Music" suited for playing music, "Cinema" suited for playing movies, and "Game" which is optimized for playing games.

### Dolby Digital EX

Dolby Digital EX is a 6.1-channel surround format proposed by Dolby Laboratories that allows users to enjoy in their homes the "DOLBY DIGITAL SURROUND EX" audio format jointly developed by Dolby Laboratories and Lucas Films.

The 6.1 channels of sound, including surround back channels, provide improved sound positioning and expression of space.

Manufactured under license from Dolby Laboratories.  
"Dolby", "Pro Logic" and the double-D symbol are trademarks of Dolby Laboratories.

## DTS Surround

### DTS Digital Surround

DTS Digital Surround is the standard digital surround format of DTS, Inc., compatible with a sampling frequency of 44.1 or 48 kHz and up to 5.1-channels of digital discrete surround sound.

### DTS-HD High Resolution Audio

DTS-HD High Resolution Audio is an improved version of the conventional DTS, DTS-ES and DTS 96/24 signals formats, compatible with sampling frequencies of 96 or 48 kHz and up to 7.1-channels of discrete digital sound. High data bit rate performance provides high quality sound. This format is fully compatible with conventional products, including conventional DTS digital surround 5.1-channel data.

### DTS-HD Master Audio

DTS-HD Master Audio is DTS, Inc.'s lossless audio format compatible with up to 96 kHz/7.1-channels. The lossless audio coding technology faithfully reproduces the sound of the studio master. It is fully compatible with conventional products, including conventional DTS digital surround 5.1-channel data.

### DTS-ES™ Discrete 6.1

DTS-ES™ Discrete 6.1 is a 6.1-channel discrete digital audio format adding a surround back (SB) channel to the DTS digital surround sound. Decoding of conventional 5.1-channel audio signals is also possible according to the decoder.

### DTS-ES™ Matrix 6.1

DTS-ES™ Matrix 6.1 is a 6.1-channel discrete digital audio format inserting a surround back (SB) channel to the DTS digital surround sound through matrix encoding. Decoding of conventional 5.1-channel audio signals is also possible according to the decoder.

### DTS NEO:6™ Surround

DTS NEO:6™ is a matrix decoding technology for achieving 6.1-channel surround playback with 2-channel sources. It includes "DTS NEO:6 Cinema" suited for playing movies and "DTS NEO:6 Music" suited for playing music.



## DTS 96/24

DTS 96/24 is a digital audio format enabling high sound quality playback in 5.1-channels with a sampling frequency of 96 kHz and 24 bit quantization on DVD-Video.

Manufactured under license under U.S. Patent #'s: 5,451,942; 5,956,674; 5,974,380; 5,978,762; 6,226,616; 6,487,535 & other U.S. and worldwide patents issued & pending. DTS is a registered trademark and the DTS logos, Symbol, DTS-HD and DTS-HD Master Audio are trademarks of DTS, Inc.©1996-2007 DTS, Inc. All Rights Reserved.

## Neural Surround

Neural Surround™, a breakthrough in audio technology, will bring the excitement of surround music to more of America's listening audience. It provides the rich envelopment and discrete image detail of surround sound in a format 100 % compatible with stereo. With superior spectral resolution and channel separation, Neural Surround™ draws the brain's attention to sonic details in musical instruments, vocals, and ambience that are typically masked by other playback systems. This allows the listener to fully experience the richness and subtleties in recorded performance as never before. As the chosen format for XM Satellite Radio's new XM HD surround programming, Neural Surround will help deliver more surround music to more listeners than any other broadcast format. XM Satellite Radio will be the first radio company to broadcast surround sound on the radio 24 hours a day and will offer three channels fully dedicated to Neural Surround™ music. This alone will amount to more than 25,000 hours of Neural Surround™ music each year.



This product is manufactured under license from Neural Audio Corporation.

D&M Holdings Inc. hereby grants the user a non-exclusive, nontransferable, limited license right exercisable to use the NA SURROUND Technology and other US and World Wide Patents Pending technology.

"Neural" and "Neural Audio" and "Neural Surround" are trademarks of Neural Audio Corporation. All Rights Reserved.

## Audyssey

### Audyssey MultEQ® XT

Audyssey MultEQ XT is a room equalization solution that calibrates any audio system so that it can achieve optimum performance for every listener in a large listening area. Based on several room measurements, MultEQ XT calculates an equalization solution that corrects for both time and frequency response problems in the listening area and also performs a fully automated surround system setup.

### Audyssey Dynamic EQ™

Audyssey Dynamic EQ solves the problem of deteriorating sound quality as volume is decreased by taking into account human perception and room acoustics. Audyssey Dynamic EQ works in tandem with Audyssey MultEQ XT to provide well-balanced sound for every listener at any volume level.

### Audyssey Dynamic Volume™

Audyssey Dynamic Volume solves the problem of large variations in volume level between television programs, commercials, and between the soft and loud passages of movies.

Audyssey Dynamic EQ is integrated into Dynamic Volume so that as the playback volume is adjusted automatically, the perceived bass response, tonal balance, surround impression, and dialog clarity remain the same.



Manufactured under license from Audyssey Laboratories. U.S. and foreign patents pending. Audyssey MultEQ® XT is a registered trademark of Audyssey Laboratories. Audyssey Dynamic EQ™ is a trademark of Audyssey Laboratories. Audyssey Dynamic Volume™ is a trademark of Audyssey Laboratories.

## AL24 Processing Plus

### AL24 Processing for All Channels

DENON has further developed its proprietary AL24 Processing, an analog waveform reproduction technology, to support the 192-kHz sampling frequency. AL24 Processing Plus, thoroughly suppresses quantization noise associated with D/A conversion of LPCM signals to reproduce the low-level signals with optimum clarity that will bring out all the delicate nuances of the music.

Equipped for not only front left and right channels but also for the surround left and right, center and subwoofer channels.

## HDMI (High-Definition Multimedia Interface)

HDMI is a digital interface standard for next generation TVs based on DVI (Digital Visual Interface) standards and optimized for use in consumer equipment.

Non-compressed digital video and multi-channel audio signals are transmitted with a single connection.

HDMI is also compatible with HDCP (High-bandwidth Digital Contents Protection), a technology for protecting copyrights that encrypts digital video signals in the same way as with DVI.

### Deep Color

Eliminates on-screen color banding, for smooth tonal transitions and subtle gradations between colors.

Enables increased contrast ratio.

Can represent many times more shades of gray between black and white.

At 30-bit pixel depth, a four times improvement would be the minimum, and the typical improvement would be eight times or more.

### xvYCC

Next-generation "xvYCC" color space supports 1.8 times as many colors as existing HDTV signals.

Lets HDTVs display colors more accurately.

Enables displays with natural, vivid colors.

### LipSync

Because consumer electronics devices are using increasingly complex digital signal processing to enhance the clarity and detail of the content, synchronization of video and audio in user devices has become a greater challenge and could potentially require complex end-user adjustments. HDMI 1.3 incorporates an automatic video/audio syncing capability that allows devices to perform this synchronization automatically with total accuracy.

"HDMI", "HDMI logo" and "High-Definition Multimedia Interface" are trademarks or registered trademarks of HDMI Licensing LLC.

# Surround Modes and Parameters

| Surround mode       | Signals and adjustability in the different modes |        |              |                   |           |                                                     |                    |                     |           |            |            |            |            |            |           |                    |
|---------------------|--------------------------------------------------|--------|--------------|-------------------|-----------|-----------------------------------------------------|--------------------|---------------------|-----------|------------|------------|------------|------------|------------|-----------|--------------------|
|                     | Channel output                                   |        |              |                   |           | Parameter (default values are shown in parentheses) |                    |                     |           |            |            |            |            |            |           |                    |
|                     | Front L/R                                        | Center | Surround L/R | Surround Back L/R | Subwoofer | D. Comp * <sub>1</sub>                              | LFE * <sub>2</sub> | AFDM * <sub>1</sub> | SB CH Out | Cinema EQ. | Mode       | Room Size  | Level      | Delay time | Subwoofer | DRC * <sub>3</sub> |
| PURE DIRECT, DIRECT | ○                                                | ×      | ×            | ×                 | ◎         | ○ (OFF)                                             | ○ (0dB)            | ×                   | ×         | ×          | ×          | ×          | ×          | ×          | ○ (Auto)  |                    |
| DSD DIRECT          | ○                                                | ×      | ×            | ×                 | ×         | ×                                                   | ×                  | ×                   | ×         | ×          | ×          | ×          | ×          | ×          | ×         |                    |
| DSD MULTI DIRECT    | ○                                                | ×      | ×            | ×                 | ×         | ×                                                   | ○ (0dB)            | ×                   | ○         | ×          | ×          | ×          | ×          | ×          | ×         |                    |
| MULTI CH DIRECT     | ○                                                | ◎      | ◎            | ◎                 | ◎         | ×                                                   | ○ (0dB)            | ○ (ON)              | ○         | ×          | ×          | ×          | ×          | ×          | ×         |                    |
| STEREO              | ○                                                | ×      | ×            | ×                 | ◎         | ○ (OFF)                                             | ○ (0dB)            | ×                   | ×         | ×          | ×          | ×          | ×          | ×          | ○ (Auto)  |                    |
| EXT. IN             | ○                                                | ◎      | ◎            | ◎                 | ◎         | ×                                                   | ×                  | ×                   | ×         | ×          | ×          | ×          | ×          | ×          | ×         |                    |
| MULTI CH IN         | ○                                                | ◎      | ◎            | ◎                 | ◎         | ×                                                   | ○ (0dB)            | ○ (ON)              | ○         | ×          | ×          | ×          | ×          | ×          | ×         |                    |
| DOLBY PRO LOGIC IIx | ○                                                | ◎      | ◎            | ◎                 | ◎         | ○ (OFF)                                             | ×                  | ×                   | ○         | ○ (NOTE1)  | ○ (Cinema) | ×          | ×          | ×          | ○ (Auto)  |                    |
| DOLBY PRO LOGIC II  | ○                                                | ◎      | ◎            | ×                 | ◎         | ○ (OFF)                                             | ×                  | ×                   | ○         | ○ (NOTE2)  | ○ (Cinema) | ×          | ×          | ×          | ○ (Auto)  |                    |
| DTS NEO:6           | ○                                                | ◎      | ◎            | ◎                 | ◎         | ○ (OFF)                                             | ×                  | ×                   | ○         | ○ (NOTE1)  | ○ (Cinema) | ×          | ×          | ×          | ×         |                    |
| DOLBY DIGITAL       | ○                                                | ◎      | ◎            | ◎                 | ◎         | ○ (OFF)                                             | ○ (0dB)            | ○ (ON)              | ○         | ○ (OFF)    | ×          | ×          | ×          | ×          | ×         |                    |
| DOLBY DIGITAL Plus  | ○                                                | ◎      | ◎            | ◎                 | ◎         | ○ (OFF)                                             | ○ (0dB)            | ○ (ON)              | ○         | ○ (OFF)    | ×          | ×          | ×          | ×          | ×         |                    |
| DOLBY TrueHD        | ○                                                | ◎      | ◎            | ◎                 | ◎         | ○ (OFF)                                             | ○ (0dB)            | ○ (ON)              | ○         | ○ (OFF)    | ×          | ×          | ×          | ×          | ○ (Auto)  |                    |
| DTS SURROUND        | ○                                                | ◎      | ◎            | ◎                 | ◎         | ○ (OFF)                                             | ○ (0dB)            | ○ (ON)              | ○         | ○ (OFF)    | ×          | ×          | ×          | ×          | ×         |                    |
| DTS 96/24           | ○                                                | ◎      | ◎            | ◎                 | ◎         | ○ (OFF)                                             | ○ (0dB)            | ○ (ON)              | ○         | ○ (OFF)    | ×          | ×          | ×          | ×          | ×         |                    |
| DTS-HD              | ○                                                | ◎      | ◎            | ◎                 | ◎         | ○ (OFF)                                             | ○ (0dB)            | ○ (ON)              | ○         | ○ (OFF)    | ×          | ×          | ×          | ×          | ×         |                    |
| neural              | ○                                                | ◎      | ◎            | ◎                 | ◎         | ×                                                   | ×                  | ×                   | ○         | ×          | ×          | ×          | ×          | ×          | ○ (Auto)  |                    |
| 5CH/7CH STEREO      | ○                                                | ◎      | ◎            | ◎                 | ◎         | ○ (OFF)                                             | ○ (0dB)            | ×                   | ○         | ×          | ×          | ×          | ×          | ×          | ○ (Auto)  |                    |
| WIDE SCREEN         | ○                                                | ◎      | ◎            | ◎                 | ◎         | ○ (OFF)                                             | ○ (0dB)            | ×                   | ○         | ○ (OFF)    | ×          | ×          | ○ (ON, 10) | ×          | ○ (Auto)  |                    |
| SUPER STADIUM       | ○                                                | ◎      | ◎            | ◎                 | ◎         | ○ (OFF)                                             | ○ (0dB)            | ×                   | ○         | ×          | ×          | ○ (Medium) | ○ (10)     | ×          | ○ (Auto)  |                    |
| ROCK ARENA          | ○                                                | ◎      | ◎            | ◎                 | ◎         | ○ (OFF)                                             | ○ (0dB)            | ×                   | ○         | ×          | ×          | ○ (Medium) | ○ (10)     | ×          | ○ (Auto)  |                    |
| JAZZ CLUB           | ○                                                | ◎      | ◎            | ◎                 | ◎         | ○ (OFF)                                             | ○ (0dB)            | ×                   | ○         | ×          | ×          | ○ (Medium) | ○ (10)     | ×          | ○ (Auto)  |                    |
| CLASSIC CONCERT     | ○                                                | ◎      | ◎            | ◎                 | ◎         | ○ (OFF)                                             | ○ (0dB)            | ×                   | ○         | ×          | ×          | ○ (Medium) | ○ (10)     | ×          | ○ (Auto)  |                    |
| MONO MOVIE          | ○                                                | ◎      | ◎            | ◎                 | ◎         | ○ (OFF)                                             | ○ (0dB)            | ×                   | ○         | ×          | ×          | ○ (Medium) | ○ (10)     | ×          | ○ (Auto)  |                    |
| VIDEO GAME          | ○                                                | ◎      | ◎            | ◎                 | ◎         | ○ (OFF)                                             | ○ (0dB)            | ×                   | ○         | ×          | ×          | ○ (Medium) | ○ (10)     | ×          | ○ (Auto)  |                    |
| MATRIX              | ○                                                | ◎      | ◎            | ◎                 | ◎         | ○ (OFF)                                             | ○ (0dB)            | ×                   | ○         | ×          | ×          | ×          | ×          | ○ (30 ms)  | ○ (Auto)  |                    |
| VIRTUAL             | ○                                                | ×      | ×            | ×                 | ◎         | ○ (OFF)                                             | ○ (0dB)            | ×                   | ×         | ×          | ×          | ×          | ×          | ×          | ○ (Auto)  |                    |

- : Signal / Adjustable
- ×
- ◎ : Turned on or off by speaker configuration setting

- : Signal / Adjustable
- ×
- NOTE1 : This parameter is available when the menu "Parameter" - "Surround Parameter" - "Mode" is set to "Cinema" (page 43).
- NOTE2 : This parameter is available when the menu "Parameter" - "Surround Parameter" - "Mode" is set to "Cinema" or "PL" (page 43).
- NOTE:**
- \*1 : When playing Dolby Digital and DTS signals.
- \*2 : When playing Dolby Digital, DTS and Linear PCM (multi ch).
- \*3 : When playing Dolby TrueHD signal.

| Surround mode       | Signals and adjustability in the different modes    |           |          |                       |              |              |                    |           |                    |                        |          |
|---------------------|-----------------------------------------------------|-----------|----------|-----------------------|--------------|--------------|--------------------|-----------|--------------------|------------------------|----------|
|                     | Parameter (default values are shown in parentheses) |           |          |                       |              |              |                    |           |                    |                        |          |
|                     | PRO LOGIC II/IIx MUSIC mode only                    |           |          | NEO:6 MUSIC mode only | EXT. IN only | Tone (NOTE6) | Night Mode (NOTE6) | MultEQ XT | Dynamic EQ (NOTE7) | Dynamic Volume (NOTE8) | RESTORER |
|                     | Panorama                                            | Dimension | C. Width | Center Image          | SW ATT       |              |                    |           |                    |                        |          |
| PURE DIRECT, DIRECT | ×                                                   | ×         | ×        | ×                     | ×            | ×            | ○ (OFF)            | ○ (NOTE5) | ○ (NOTE5)          | ○ (NOTE5)              | ○        |
| DSD DIRECT          | ×                                                   | ×         | ×        | ×                     | ×            | ×            | ×                  | ○ (NOTE5) | ○ (NOTE5)          | ○ (NOTE5)              | ×        |
| DSD MULTI DIRECT    | ×                                                   | ×         | ×        | ×                     | ×            | ×            | ×                  | ○ (NOTE5) | ○ (NOTE5)          | ○ (NOTE5)              | ×        |
| MULTI CH DIRECT     | ×                                                   | ×         | ×        | ×                     | ×            | ×            | ○ (OFF)            | ○ (NOTE5) | ○ (NOTE5)          | ○ (NOTE5)              | ×        |
| STEREO              | ×                                                   | ×         | ×        | ×                     | ×            | ○ (0dB)      | ○ (OFF)            | ○ (OFF)   | ○ (OFF)            | ○ (OFF)                | ○        |
| EXT. IN             | ×                                                   | ×         | ×        | ×                     | ○            | ×            | ×                  | ×         | ×                  | ×                      | ×        |
| MULTI CH IN         | ×                                                   | ×         | ×        | ×                     | ×            | ○ (0dB)      | ○ (OFF)            | ○ (OFF)   | ○ (OFF)            | ○ (OFF)                | ×        |
| DOLBY PRO LOGIC IIx | ○ (OFF)                                             | ○ (3)     | ○ (3)    | ×                     | ×            | ○ (0dB)      | ○ (OFF)            | ○ (OFF)   | ○ (OFF)            | ○ (OFF)                | ○        |
| DOLBY PRO LOGIC II  | ○ (OFF)                                             | ○ (3)     | ○ (3)    | ×                     | ×            | ○ (0dB)      | ○ (OFF)            | ○ (OFF)   | ○ (OFF)            | ○ (OFF)                | ○        |
| DTS NEO:6           | ×                                                   | ×         | ×        | ○ (0.3)               | ×            | ○ (0dB)      | ○ (OFF)            | ○ (OFF)   | ○ (OFF)            | ○ (OFF)                | ○        |
| DOLBY DIGITAL       | ×                                                   | ×         | ×        | ×                     | ×            | ○ (0dB)      | ○ (OFF)            | ○ (OFF)   | ○ (OFF)            | ○ (OFF)                | ×        |
| DOLBY DIGITAL Plus  | ×                                                   | ×         | ×        | ×                     | ×            | ○ (0dB)      | ×                  | ○ (OFF)   | ○ (OFF)            | ○ (OFF)                | ×        |
| DOLBY TrueHD        | ×                                                   | ×         | ×        | ×                     | ×            | ○ (0dB)      | ×                  | ○ (OFF)   | ○ (OFF)            | ○ (OFF)                | ×        |
| DTS SURROUND        | ×                                                   | ×         | ×        | ×                     | ×            | ○ (0dB)      | ○ (OFF)            | ○ (OFF)   | ○ (OFF)            | ○ (OFF)                | ×        |
| DTS-96/24           | ×                                                   | ×         | ×        | ×                     | ×            | ○ (0dB)      | ○ (OFF)            | ○ (OFF)   | ○ (OFF)            | ○ (OFF)                | ×        |
| DTS-HD              | ×                                                   | ×         | ×        | ×                     | ×            | ○ (0dB)      | ×                  | ○ (OFF)   | ○ (OFF)            | ○ (OFF)                | ×        |
| neural              | ×                                                   | ×         | ×        | ×                     | ×            | ○ (0dB)      | ○ (OFF)            | ○ (OFF)   | ○ (OFF)            | ○ (OFF)                | ○        |
| 5CH/7CH STEREO      | ×                                                   | ×         | ×        | ×                     | ×            | ○ (0dB)      | ○ (OFF)            | ○ (OFF)   | ○ (OFF)            | ○ (OFF)                | ○        |
| WIDE SCREEN         | ×                                                   | ×         | ×        | ×                     | ×            | ○ (0dB)      | ○ (OFF)            | ○ (OFF)   | ○ (OFF)            | ○ (OFF)                | ○        |
| SUPER STADIUM       | ×                                                   | ×         | ×        | ×                     | ×            | ○ (NOTE3)    | ○ (OFF)            | ○ (OFF)   | ○ (OFF)            | ○ (OFF)                | ○        |
| ROCK ARENA          | ×                                                   | ×         | ×        | ×                     | ×            | ○ (NOTE4)    | ○ (OFF)            | ○ (OFF)   | ○ (OFF)            | ○ (OFF)                | ○        |
| JAZZ CLUB           | ×                                                   | ×         | ×        | ×                     | ×            | ○ (0dB)      | ○ (OFF)            | ○ (OFF)   | ○ (OFF)            | ○ (OFF)                | ○        |
| CLASSIC CONCERT     | ×                                                   | ×         | ×        | ×                     | ×            | ○ (0dB)      | ○ (OFF)            | ○ (OFF)   | ○ (OFF)            | ○ (OFF)                | ○        |
| MONO MOVIE          | ×                                                   | ×         | ×        | ×                     | ×            | ○ (0dB)      | ○ (OFF)            | ○ (OFF)   | ○ (OFF)            | ○ (OFF)                | ○        |
| VIDEO GAME          | ×                                                   | ×         | ×        | ×                     | ×            | ○ (0dB)      | ○ (OFF)            | ○ (OFF)   | ○ (OFF)            | ○ (OFF)                | ○        |
| MATRIX              | ×                                                   | ×         | ×        | ×                     | ×            | ○ (0dB)      | ○ (OFF)            | ○ (OFF)   | ○ (OFF)            | ○ (OFF)                | ○        |
| VIRTUAL             | ×                                                   | ×         | ×        | ×                     | ×            | ○ (0dB)      | ○ (OFF)            | ○ (OFF)   | ○ (OFF)            | ○ (OFF)                | ○        |

○ : Adjustable

× : Not adjustable

NOTE3 : BASS +6 dB, TREBLE 0 dB

NOTE4 : BASS +6 dB, TREBLE +4 dB

NOTE5 : Can be used according to the "Audio Setup" – "EQ Preset" – "Direct Mode" setting (page 31).

NOTE6 : Cannot be set when the "Dynamic EQ" setting is "ON" (page 46).

NOTE7 : Cannot be set when the "MultEQ XT" setting is "OFF" (page 45).

NOTE8 : Cannot be set when the "Dynamic EQ" setting is "OFF" (page 46).

## Differences in Surround Mode Names Depending on the Input Signals

| Button         | Surround mode                     | Note  | Input signals |                       |                  |                     |                              |                          |                         |             |           |              |                    |                              |                                 |                           |                       |                     |                |           |
|----------------|-----------------------------------|-------|---------------|-----------------------|------------------|---------------------|------------------------------|--------------------------|-------------------------|-------------|-----------|--------------|--------------------|------------------------------|---------------------------------|---------------------------|-----------------------|---------------------|----------------|-----------|
|                |                                   |       | ANALOG        | PCM                   |                  | DTS-HD              |                              | DTS                      |                         |             |           | DOLBY        |                    | DOLBY DIGITAL                |                                 |                           |                       |                     | SACD           |           |
|                |                                   |       |               | Linear PCM (multi ch) | Linear PCM (2ch) | DTS-HD Master Audio | DTS-HD High Resolution Audio | DTS ES DSCRT (With Flag) | DTS ES MTRX (With Flag) | DTS (5.1ch) | DTS 96/24 | DOLBY TrueHD | DOLBY DIGITAL Plus | DOLBY DIGITAL EX (With Flag) | DOLBY DIGITAL EX (With no Flag) | DOLBY DIGITAL (5.1/5/4ch) | DOLBY DIGITAL (4/3ch) | DOLBY DIGITAL (2ch) | DSD (multi ch) | DSD (2ch) |
| STANDARD       |                                   |       |               |                       |                  |                     |                              |                          |                         |             |           |              |                    |                              |                                 |                           |                       |                     |                |           |
| DTS SURROUND   |                                   |       |               |                       |                  |                     |                              |                          |                         |             |           |              |                    |                              |                                 |                           |                       |                     |                |           |
|                | DTS-HD MSTR                       |       | ×             | ×                     | ×                | ●                   | ×                            | ×                        | ×                       | ×           | ×         | ×            | ×                  | ×                            | ×                               | ×                         | ×                     | ×                   | ×              | ×         |
|                | DTS-HD HI RES                     |       | ×             | ×                     | ×                | ×                   | ●                            | ×                        | ×                       | ×           | ×         | ×            | ×                  | ×                            | ×                               | ×                         | ×                     | ×                   | ×              | ×         |
|                | DTS ES DSCRT6.1                   | *1 *3 | ×             | ×                     | ×                | ×                   | ×                            | ●◎                       | ×                       | ×           | ×         | ×            | ×                  | ×                            | ×                               | ×                         | ×                     | ×                   | ×              | ×         |
|                | DTS ES MTRX6.1                    | *1 *3 | ×             | ×                     | ×                | ×                   | ×                            | ●◎                       | ×                       | ×           | ×         | ×            | ×                  | ×                            | ×                               | ×                         | ×                     | ×                   | ×              | ×         |
|                | DTS SURROUND                      |       | ×             | ×                     | ×                | ×                   | ×                            | ○                        | ○                       | ●           | ×         | ×            | ×                  | ×                            | ×                               | ×                         | ×                     | ×                   | ×              | ×         |
|                | DTS 96/24                         |       | ×             | ×                     | ×                | ×                   | ×                            | ×                        | ×                       | ●           | ×         | ×            | ×                  | ×                            | ×                               | ×                         | ×                     | ×                   | ×              | ×         |
|                | DTS (-HD) + PLIIx CINEMA          | *2 *3 | ×             | ×                     | ×                | ○                   | ○                            | ○                        | ○                       | ○           | ×         | ×            | ×                  | ×                            | ×                               | ×                         | ×                     | ×                   | ×              | ×         |
|                | DTS (-HD) + PLIIx MUSIC           | *1 *3 | ×             | ×                     | ×                | ○                   | ○                            | ○                        | ○                       | ○           | ×         | ×            | ×                  | ×                            | ×                               | ×                         | ×                     | ×                   | ×              | ×         |
|                | DTS (-HD) + NEO:6                 | *1 *3 | ×             | ×                     | ×                | ○                   | ○                            | ×                        | ○                       | ○           | ×         | ×            | ×                  | ×                            | ×                               | ×                         | ×                     | ×                   | ×              | ×         |
|                | DTS NEO:6 CINEMA                  |       | ○             | ×                     | ○                | ×                   | ×                            | ×                        | ×                       | ×           | ×         | ×            | ×                  | ×                            | ×                               | ×                         | ×                     | ○                   | ×              | ○         |
|                | DTS NEO:6 MUSIC                   |       | ○             | ×                     | ○                | ×                   | ×                            | ×                        | ×                       | ×           | ×         | ×            | ×                  | ×                            | ×                               | ×                         | ×                     | ○                   | ×              | ○         |
| DOLBY SURROUND |                                   |       |               |                       |                  |                     |                              |                          |                         |             |           |              |                    |                              |                                 |                           |                       |                     |                |           |
|                | DOLBY TrueHD                      |       | ×             | ×                     | ×                | ×                   | ×                            | ×                        | ×                       | ×           | ×         | ●            | ×                  | ×                            | ×                               | ×                         | ×                     | ×                   | ×              | ×         |
|                | DOLBY DIGITAL+                    |       | ×             | ×                     | ×                | ×                   | ×                            | ×                        | ×                       | ×           | ×         | ×            | ●                  | ×                            | ×                               | ×                         | ×                     | ×                   | ×              | ×         |
|                | DOLBY DIGITAL EX                  | *1 *3 | ×             | ×                     | ×                | ×                   | ×                            | ×                        | ×                       | ×           | ×         | ×            | ×                  | ○                            | ○                               | ○                         | ○                     | ×                   | ×              | ×         |
|                | DOLBY (D+) (HD) +EX               | *1 *3 | ×             | ×                     | ×                | ×                   | ×                            | ×                        | ×                       | ×           | ×         | ○            | ○                  | ×                            | ×                               | ×                         | ×                     | ×                   | ×              | ×         |
|                | DOLBY DIGITAL                     |       | ×             | ×                     | ×                | ×                   | ×                            | ×                        | ×                       | ×           | ×         | ×            | ×                  | ○                            | ●                               | ●                         | ●                     | ×                   | ×              | ×         |
|                | DOLBY (D) (D+) (HD) +PLIIx CINEMA | *2 *3 | ×             | ×                     | ×                | ×                   | ×                            | ×                        | ×                       | ×           | ○         | ○            | ●◎                 | ○                            | ○                               | ○                         | ○                     | ×                   | ×              | ×         |
|                | DOLBY (D) (D+) (HD) +PLIIx MUSIC  | *1 *3 | ×             | ×                     | ×                | ×                   | ×                            | ×                        | ×                       | ×           | ○         | ○            | ○                  | ○                            | ○                               | ○                         | ○                     | ×                   | ×              | ×         |
|                | DOLBY PRO LOGIC IIx CINEMA        | *3    | ○             | ×                     | ○                | ×                   | ×                            | ×                        | ×                       | ×           | ×         | ×            | ×                  | ×                            | ×                               | ×                         | ×                     | ●                   | ×              | ○         |
|                | DOLBY PRO LOGIC IIx MUSIC         | *3    | ○             | ×                     | ○                | ×                   | ×                            | ×                        | ×                       | ×           | ×         | ×            | ×                  | ×                            | ×                               | ×                         | ×                     | ○                   | ×              | ○         |
|                | DOLBY PRO LOGIC IIx GAME          | *3    | ○             | ×                     | ○                | ×                   | ×                            | ×                        | ×                       | ×           | ×         | ×            | ×                  | ×                            | ×                               | ×                         | ×                     | ○                   | ×              | ○         |
|                | DOLBY PRO LOGIC II CINEMA         |       | ○             | ×                     | ○                | ×                   | ×                            | ×                        | ×                       | ×           | ×         | ×            | ×                  | ×                            | ×                               | ×                         | ×                     | ○                   | ×              | ○         |
|                | DOLBY PRO LOGIC II MUSIC          |       | ○             | ×                     | ○                | ×                   | ×                            | ×                        | ×                       | ×           | ×         | ×            | ×                  | ×                            | ×                               | ×                         | ×                     | ○                   | ×              | ○         |
|                | DOLBY PRO LOGIC II GAME           |       | ○             | ×                     | ○                | ×                   | ×                            | ×                        | ×                       | ×           | ×         | ×            | ×                  | ×                            | ×                               | ×                         | ×                     | ○                   | ×              | ○         |
|                | DOLBY PRO LOGIC                   |       | ○             | ×                     | ○                | ×                   | ×                            | ×                        | ×                       | ×           | ×         | ×            | ×                  | ×                            | ×                               | ×                         | ×                     | ○                   | ×              | ○         |
|                | neural                            |       | ○             | ×                     | ○                | ×                   | ×                            | ×                        | ×                       | ×           | ×         | ×            | ×                  | ×                            | ×                               | ×                         | ×                     | ×                   | ×              | ×         |

**NOTE:**

- \*1: This mode is not available when the surround back speaker setup is set to "None".
- \*2: This mode is not available when the surround back speaker setup is set to "1spkr" or "None".
- \*3: Cannot be set when "Amp Assign" is set to "ZONE2".

- : Mode selectable in initial status
- ◎ : Mode fixed when "AFDM" is "ON"
- : Selectable mode
- × : Non-selectable mode

| Button                  | Surround mode | Note | Input signals |                       |                  |                     |                              |                          |                         |             |           |              |                    |                              |                                 |                           |                       |                     |                |           |   |   |
|-------------------------|---------------|------|---------------|-----------------------|------------------|---------------------|------------------------------|--------------------------|-------------------------|-------------|-----------|--------------|--------------------|------------------------------|---------------------------------|---------------------------|-----------------------|---------------------|----------------|-----------|---|---|
|                         |               |      | ANALOG        | PCM                   |                  | DTS-HD              |                              | DTS                      |                         |             |           | DOLBY        |                    | DOLBY DIGITAL                |                                 |                           |                       |                     | SACD           |           |   |   |
|                         |               |      |               | Linear PCM (multi ch) | Linear PCM (2ch) | DTS-HD Master Audio | DTS-HD High Resolution Audio | DTS ES DSCRT (With Flag) | DTS ES MTRX (With Flag) | DTS (5.1ch) | DTS 96/24 | DOLBY TrueHD | DOLBY DIGITAL Plus | DOLBY DIGITAL EX (With Flag) | DOLBY DIGITAL EX (With no Flag) | DOLBY DIGITAL (5.1/5/4ch) | DOLBY DIGITAL (4/3ch) | DOLBY DIGITAL (2ch) | DSD (multi ch) | DSD (2ch) |   |   |
| STANDARD                |               |      |               |                       |                  |                     |                              |                          |                         |             |           |              |                    |                              |                                 |                           |                       |                     |                |           |   |   |
| MULTI CH IN             |               |      |               |                       |                  |                     |                              |                          |                         |             |           |              |                    |                              |                                 |                           |                       |                     |                |           |   |   |
| MULTI CH IN             |               |      | ×             | ●                     | ×                | ×                   | ×                            | ×                        | ×                       | ×           | ×         | ×            | ×                  | ×                            | ×                               | ×                         | ×                     | ×                   | ●              | ×         |   |   |
| MULTI IN + PLIIx CINEMA |               |      | *2 *3         | ×                     | ○                | ×                   | ×                            | ×                        | ×                       | ×           | ×         | ×            | ×                  | ×                            | ×                               | ×                         | ×                     | ×                   | ×              | ○         | × |   |
| MULTI IN + PLIIx MUSIC  |               |      | *1 *3         | ×                     | ○                | ×                   | ×                            | ×                        | ×                       | ×           | ×         | ×            | ×                  | ×                            | ×                               | ×                         | ×                     | ×                   | ×              | ○         | × |   |
| MULTI IN + Dolby EX     |               |      | *1 *3         | ×                     | ○                | ×                   | ×                            | ×                        | ×                       | ×           | ×         | ×            | ×                  | ×                            | ×                               | ×                         | ×                     | ×                   | ×              | ○         | × |   |
| MULTI CH IN 7.1         |               |      | *3            | ×                     | ● ◎ (7.1)        | ×                   | ×                            | ×                        | ×                       | ×           | ×         | ×            | ×                  | ×                            | ×                               | ×                         | ×                     | ×                   | ×              | ×         | × |   |
| DIRECT                  |               |      |               |                       |                  |                     |                              |                          |                         |             |           |              |                    |                              |                                 |                           |                       |                     |                |           |   |   |
| DIRECT                  |               |      | ○             | ×                     | ○                | ○                   | ○                            | ○                        | ○                       | ○           | ○         | ○            | ○                  | ○                            | ○                               | ○                         | ○                     | ○                   | ○              | ×         | ○ |   |
| DSD DIRECT              |               |      | ×             | ×                     | ×                | ×                   | ×                            | ×                        | ×                       | ×           | ×         | ×            | ×                  | ×                            | ×                               | ×                         | ×                     | ×                   | ×              | ×         | ○ |   |
| DSD MULTI DIRECT        |               |      | ×             | ×                     | ×                | ×                   | ×                            | ×                        | ×                       | ×           | ×         | ×            | ×                  | ×                            | ×                               | ×                         | ×                     | ×                   | ×              | ○         | × |   |
| MULTI CH DIRECT         |               |      | ×             | ○                     | ×                | ×                   | ×                            | ×                        | ×                       | ×           | ×         | ×            | ×                  | ×                            | ×                               | ×                         | ×                     | ×                   | ×              | ○         | × |   |
| M DIRECT + PLIIx CINEMA |               |      | *2 *3         | ×                     | ○                | ×                   | ×                            | ×                        | ×                       | ×           | ×         | ×            | ×                  | ×                            | ×                               | ×                         | ×                     | ×                   | ×              | ○         | × |   |
| M DIRECT + PLIIx MUSIC  |               |      | *1 *3         | ×                     | ○                | ×                   | ×                            | ×                        | ×                       | ×           | ×         | ×            | ×                  | ×                            | ×                               | ×                         | ×                     | ×                   | ×              | ○         | × |   |
| M DIRECT + Dolby EX     |               |      | *1 *3         | ×                     | ○                | ×                   | ×                            | ×                        | ×                       | ×           | ×         | ×            | ×                  | ×                            | ×                               | ×                         | ×                     | ×                   | ×              | ○         | × |   |
| M DIRECT 7.1            |               |      | *3            | ×                     | ○ (7.1)          | ×                   | ×                            | ×                        | ×                       | ×           | ×         | ×            | ×                  | ×                            | ×                               | ×                         | ×                     | ×                   | ×              | ×         | × |   |
| PURE DIRECT             |               |      |               |                       |                  |                     |                              |                          |                         |             |           |              |                    |                              |                                 |                           |                       |                     |                |           |   |   |
| PURE DIRECT             |               |      | ○             | ×                     | ○                | ○                   | ○                            | ○                        | ○                       | ○           | ○         | ○            | ○                  | ○                            | ○                               | ○                         | ○                     | ○                   | ○              | ×         | ○ |   |
| DSD PURE DIRECT         |               |      | ×             | ×                     | ×                | ×                   | ×                            | ×                        | ×                       | ×           | ×         | ×            | ×                  | ×                            | ×                               | ×                         | ×                     | ×                   | ×              | ×         | ○ |   |
| DSD MULTI PURE          |               |      | ×             | ×                     | ×                | ×                   | ×                            | ×                        | ×                       | ×           | ×         | ×            | ×                  | ×                            | ×                               | ×                         | ×                     | ×                   | ×              | ○         | × |   |
| MULTI CH PURE DIRECT    |               |      | ×             | ○                     | ×                | ×                   | ×                            | ×                        | ×                       | ×           | ×         | ×            | ×                  | ×                            | ×                               | ×                         | ×                     | ×                   | ×              | ○         | × |   |
| M PURE D + PLIIx CINEMA |               |      | *2 *3         | ×                     | ○                | ×                   | ×                            | ×                        | ×                       | ×           | ×         | ×            | ×                  | ×                            | ×                               | ×                         | ×                     | ×                   | ×              | ○         | × |   |
| M PURE D + PLIIx MUSIC  |               |      | *1 *3         | ×                     | ○                | ×                   | ×                            | ×                        | ×                       | ×           | ×         | ×            | ×                  | ×                            | ×                               | ×                         | ×                     | ×                   | ×              | ○         | × |   |
| M PURE D + Dolby EX     |               |      | *1 *3         | ×                     | ○                | ×                   | ×                            | ×                        | ×                       | ×           | ×         | ×            | ×                  | ×                            | ×                               | ×                         | ×                     | ×                   | ×              | ○         | × |   |
| M CH PURE DIRECT 7.1    |               |      | *3            | ×                     | ○ (7.1)          | ×                   | ×                            | ×                        | ×                       | ×           | ×         | ×            | ×                  | ×                            | ×                               | ×                         | ×                     | ×                   | ×              | ×         | × |   |
| DSP SIMULATION          |               |      |               |                       |                  |                     |                              |                          |                         |             |           |              |                    |                              |                                 |                           |                       |                     |                |           |   |   |
| 5CH/7CH STEREO          |               |      | *4            | ○                     | ○                | ○                   | ○                            | ○                        | ○                       | ○           | ○         | ○            | ○                  | ○                            | ○                               | ○                         | ○                     | ○                   | ○              | ○         | ○ |   |
| WIDE SCREEN             |               |      | ○             | ○                     | ○                | ○                   | ○                            | ○                        | ○                       | ○           | ○         | ○            | ○                  | ○                            | ○                               | ○                         | ○                     | ○                   | ○              | ○         | ○ |   |
| SUPER STADIUM           |               |      | ○             | ○                     | ○                | ○                   | ○                            | ○                        | ○                       | ○           | ○         | ○            | ○                  | ○                            | ○                               | ○                         | ○                     | ○                   | ○              | ○         | ○ |   |
| ROCK ARENA              |               |      | ○             | ○                     | ○                | ○                   | ○                            | ○                        | ○                       | ○           | ○         | ○            | ○                  | ○                            | ○                               | ○                         | ○                     | ○                   | ○              | ○         | ○ |   |
| JAZZ CLUB               |               |      | ○             | ○                     | ○                | ○                   | ○                            | ○                        | ○                       | ○           | ○         | ○            | ○                  | ○                            | ○                               | ○                         | ○                     | ○                   | ○              | ○         | ○ |   |
| CLASSIC CONCERT         |               |      | ○             | ○                     | ○                | ○                   | ○                            | ○                        | ○                       | ○           | ○         | ○            | ○                  | ○                            | ○                               | ○                         | ○                     | ○                   | ○              | ○         | ○ |   |
| MONO MOVIE              |               |      | ○             | ○                     | ○                | ○                   | ○                            | ○                        | ○                       | ○           | ○         | ○            | ○                  | ○                            | ○                               | ○                         | ○                     | ○                   | ○              | ○         | ○ |   |
| VIDEO GAME              |               |      | ○             | ○                     | ○                | ○                   | ○                            | ○                        | ○                       | ○           | ○         | ○            | ○                  | ○                            | ○                               | ○                         | ○                     | ○                   | ○              | ○         | ○ |   |
| MATRIX                  |               |      | ○             | ○                     | ○                | ○                   | ○                            | ○                        | ○                       | ○           | ○         | ○            | ○                  | ○                            | ○                               | ○                         | ○                     | ○                   | ○              | ○         | ○ |   |
| VIRTUAL                 |               |      | ○             | ○                     | ○                | ○                   | ○                            | ○                        | ○                       | ○           | ○         | ○            | ○                  | ○                            | ○                               | ○                         | ○                     | ○                   | ○              | ○         | ○ |   |
| STEREO                  |               |      |               |                       |                  |                     |                              |                          |                         |             |           |              |                    |                              |                                 |                           |                       |                     |                |           |   |   |
| STEREO                  |               |      | ●             | ○                     | ●                | ○                   | ○                            | ○                        | ○                       | ○           | ○         | ○            | ○                  | ○                            | ○                               | ○                         | ○                     | ○                   | ○              | ○         | ○ | ● |

**NOTE :**

- \*1: This mode is not available when the surround back speaker setup is set to "None".
- \*2: This mode is not available when the surround back speaker setup is set to "1spkr" or "None".
- \*3: Cannot be set when "Amp Assign" is set to "ZONE2".
- \*4: If the surround back speaker setup is set to "None", then "5CH STEREO" is displayed.

- : Mode selectable in initial status
  - ◎ : Mode fixed when "AFDM" is "ON"
  - : Selectable mode
  - ×
- Non-selectable mode

# Relationship Between Video Signals and Monitor Output

| Video convert | Input signals |                            |         |       | Monitor output |              |           |           |
|---------------|---------------|----------------------------|---------|-------|----------------|--------------|-----------|-----------|
|               | HDMI          | COMPONENT                  | S-VIDEO | VIDEO | HDMI           | COMPONENT    | S-VIDEO   | VIDEO     |
| ON            | ×             | ×                          | ×       | ×     | ×              | ×            | ×         | ×         |
|               | ×             | ×                          | ×       | ○     | VIDEO          | VIDEO        | VIDEO     | VIDEO     |
|               | ×             | ×                          | ○       | ×     | S-VIDEO        | S-VIDEO      | S-VIDEO   | S-VIDEO   |
|               | ×             | ×                          | ○       | ○     | S-VIDEO        | S-VIDEO      | S-VIDEO   | S-VIDEO   |
|               | ×             | ○ (1080p)                  | ×       | ×     | ×              | COMPONENT    | ×         | ×         |
|               | ×             | ○ (480p ~ 720p)            | ×       | ×     | COMPONENT      | COMPONENT    | ×         | ×         |
|               | ×             | ○ (480i / 576i)            | ×       | ×     | COMPONENT      | COMPONENT    | COMPONENT | COMPONENT |
|               | ×             | ○ (1080p)                  | ×       | ○     | VIDEO          | COMPONENT *1 | VIDEO     | VIDEO     |
|               | ×             | ○ (480p ~ 720p)            | ×       | ○     | COMPONENT *1   | COMPONENT *1 | ×         | VIDEO     |
|               | ×             | ○ (480i / 576i)            | ×       | ○     | COMPONENT *1   | COMPONENT *1 | COMPONENT | VIDEO     |
|               | ×             | ○ (1080p)                  | ○       | ×     | S-VIDEO        | COMPONENT *2 | S-VIDEO   | S-VIDEO   |
|               | ×             | ○ (480p ~ 720p)            | ○       | ×     | COMPONENT *2   | COMPONENT *2 | S-VIDEO   | S-VIDEO   |
|               | ×             | ○ (480i / 576i)            | ○       | ×     | COMPONENT *2   | COMPONENT *2 | S-VIDEO   | S-VIDEO   |
|               | ×             | ○ (1080p)                  | ○       | ○     | S-VIDEO        | COMPONENT *2 | S-VIDEO   | S-VIDEO   |
|               | ×             | ○ (480p ~ 720p)            | ○       | ○     | COMPONENT *2   | COMPONENT *2 | S-VIDEO   | S-VIDEO   |
|               | ×             | ○ (480i / 576i)            | ○       | ○     | COMPONENT *2   | COMPONENT *2 | S-VIDEO   | S-VIDEO   |
|               | ○             | ×                          | ×       | ×     | HDMI           | ×            | ×         | ×         |
|               | ○             | ×                          | ×       | ○     | HDMI *1        | VIDEO        | VIDEO     | VIDEO     |
|               | ○             | ×                          | ○       | ×     | HDMI *2        | S-VIDEO      | S-VIDEO   | S-VIDEO   |
|               | ○             | ×                          | ○       | ○     | HDMI *2        | S-VIDEO      | S-VIDEO   | S-VIDEO   |
|               | ○             | ○ (Other than 480i / 576i) | ×       | ×     | HDMI           | COMPONENT    | ×         | ×         |
|               | ○             | ○ (480i / 576i)            | ×       | ×     | HDMI           | COMPONENT    | COMPONENT | COMPONENT |
|               | ○             | ○ (1080p)                  | ×       | ○     | HDMI *1        | COMPONENT *1 | VIDEO     | VIDEO     |
|               | ○             | ○ (480p ~ 720p)            | ×       | ○     | HDMI *1        | COMPONENT *1 | ×         | VIDEO     |
|               | ○             | ○ (480i / 576i)            | ×       | ○     | HDMI *1        | COMPONENT *1 | COMPONENT | VIDEO     |
|               | ○             | ○ (Other than 480i / 576i) | ○       | ×     | HDMI *2        | COMPONENT *2 | S-VIDEO   | S-VIDEO   |
|               | ○             | ○ (480i / 576i)            | ○       | ×     | HDMI *2        | COMPONENT *2 | S-VIDEO   | S-VIDEO   |
|               | ○             | ○ (Other than 480i / 576i) | ○       | ○     | HDMI *2        | COMPONENT *2 | S-VIDEO   | S-VIDEO   |
|               | ○             | ○ (480i / 576i)            | ○       | ○     | HDMI *2        | COMPONENT *2 | S-VIDEO   | S-VIDEO   |

○ : Signal input  
 × : No signal  
 480p ~ 720p: 480p / 576p / 1080i / 720p

× : Not output  
 \*1 : On-screen display superimposed on video signal and output.  
 \*2 : On-screen display superimposed on S-Video signal and output.  
 COMPONENT or HDMI:  
 On-screen display only displayed for the **MENU** button on the main unit or the **A.MENU** button on the main remote control unit.  
 ■ : Video signals are not output when the analog to HDMI convert function is set to "OFF".

| Video convert | S-VIDEO MONITOR OUT | Input signals |           |         |       | Monitor output |              |         |          |
|---------------|---------------------|---------------|-----------|---------|-------|----------------|--------------|---------|----------|
|               |                     | HDMI          | COMPONENT | S-VIDEO | VIDEO | HDMI           | COMPONENT    | S-VIDEO | VIDEO    |
| OFF           | —                   | ×             | ×         | ×       | ×     | ×              | ×            | ×       | ×        |
|               | —                   | ×             | ×         | ×       | ○     | ×              | ×            | ×       | VIDEO    |
|               | —                   | ×             | ×         | ○       | ×     | ×              | ×            | S-VIDEO | ×        |
|               | Used                | ×             | ×         | ○       | ○     | ×              | ×            | S-VIDEO | VIDEO *2 |
|               | Not used            | ×             | ×         | ○       | ○     | ×              | ×            | —       | VIDEO    |
|               | —                   | ×             | ○         | ×       | ×     | ×              | COMPONENT    | ×       | ×        |
|               | —                   | ×             | ○         | ×       | ○     | ×              | COMPONENT *1 | ×       | VIDEO    |
|               | —                   | ×             | ○         | ○       | ×     | ×              | COMPONENT *2 | S-VIDEO | ×        |
|               | Used                | ×             | ○         | ○       | ○     | ×              | COMPONENT *2 | S-VIDEO | VIDEO *2 |
|               | Not used            | ×             | ○         | ○       | ○     | ×              | COMPONENT *1 | —       | VIDEO    |
|               | —                   | ○             | ×         | ×       | ×     | HDMI           | ×            | ×       | ×        |
|               | —                   | ○             | ×         | ×       | ○     | HDMI           | ×            | ×       | VIDEO    |
|               | —                   | ○             | ×         | ○       | ×     | HDMI           | ×            | S-VIDEO | ×        |
|               | Used                | ○             | ×         | ○       | ○     | HDMI           | ×            | S-VIDEO | VIDEO *2 |
|               | Not used            | ○             | ×         | ○       | ○     | HDMI           | ×            | —       | VIDEO    |
|               | —                   | ○             | ○         | ×       | ×     | HDMI           | COMPONENT    | ×       | ×        |
|               | —                   | ○             | ○         | ×       | ○     | HDMI           | COMPONENT *1 | ×       | VIDEO    |
|               | —                   | ○             | ○         | ○       | ×     | HDMI           | COMPONENT *2 | S-VIDEO | ×        |
|               | Used                | ○             | ○         | ○       | ○     | HDMI           | COMPONENT *2 | S-VIDEO | VIDEO *2 |
|               | Not used            | ○             | ○         | ○       | ○     | HDMI           | COMPONENT *1 | —       | VIDEO    |

○ : Signal input  
 × : No signal

× : Not output  
 \*1 : On-screen display superimposed on video signal and output.  
 \*2 : On-screen display superimposed on S-Video signal and output.  
 COMPONENT or HDMI:  
 On-screen display only displayed for the **MENU** button on the main unit or the **A.MENU** button on the main remote control unit.

- The MAIN ZONE video conversion function is compatible with the following format: NTSC, PAL, SECAM, NTSC4.43, PAL-N, PAL-M and PAL-60.
- When SECAM signals of video input are up-converted, the signals are output in PAL format from the S-Video connector.
- When the input signal is a component 1080i or 720p signal, the signal upconverted to HDMI is output with that resolution or 1080p.
- When the input signal is a video, S-Video or component 480i, 480p, 576i or 576p signals, the signal up-converted to HDMI is output according to the setting made at "Resolution" under "Input Setup" – "Video" – "Resolution" (page 37).
- With assigned input sources "TUNER", "XM", "SIRIUS" and "iPod", when you output video with "Video Select", video output in the above table changes depending on the following settings.
  - ① When "Tuner Information" and "iPod Information" are other than "OFF" : Superimposed S-video or Video signal is output.
  - ② When "Tuner Information" and "iPod Information" are "OFF" : Signal output is as in the above table.
 See page 33 for "Tuner Information" and "iPod Information" setting.

# Troubleshooting

If a problem should arise, first check the following:

1. Are the connections correct?
2. Is the set being operated as described in the owner's manual?
3. Are the other components operating properly?

If this unit does not operate properly, check the items listed in the table below. Should the problem persist, there may be a malfunction.

In this case, disconnect the power immediately and contact your store of purchase.

## [General]

| Symptom                                                               | Cause                                                                                                                                                                                                                                                                                                                                                                   | Countermeasure                                                                                                                                              | Page |
|-----------------------------------------------------------------------|-------------------------------------------------------------------------------------------------------------------------------------------------------------------------------------------------------------------------------------------------------------------------------------------------------------------------------------------------------------------------|-------------------------------------------------------------------------------------------------------------------------------------------------------------|------|
| Set does not operate properly.                                        | <ul style="list-style-type: none"> <li>• External noise or interference is causing the set to malfunction.</li> </ul>                                                                                                                                                                                                                                                   | <ul style="list-style-type: none"> <li>• Reset the microprocessor.</li> </ul>                                                                               | 60   |
| Power does not turn on, or turns off directly after it was turned on. | <ul style="list-style-type: none"> <li>• Connection of the power cord is faulty.</li> </ul>                                                                                                                                                                                                                                                                             | <ul style="list-style-type: none"> <li>• Check that the power plugs are securely inserted into the AVR-989's AC inlet and the wall power outlet.</li> </ul> | 20   |
| No sound is produced from speakers.                                   | <ul style="list-style-type: none"> <li>• Connection with the input devices or connection of the speaker cables is faulty.</li> <li>• Device you want to play and set input source do not match.</li> <li>• Master volume is turned too low.</li> <li>• Mute mode is set.</li> <li>• Headphones are connected.</li> <li>• No digital signals are being input.</li> </ul> | <ul style="list-style-type: none"> <li>• Check the connections.</li> </ul>                                                                                  | 10   |
|                                                                       |                                                                                                                                                                                                                                                                                                                                                                         | <ul style="list-style-type: none"> <li>• Select an appropriate input source.</li> </ul>                                                                     | 50   |
|                                                                       |                                                                                                                                                                                                                                                                                                                                                                         | <ul style="list-style-type: none"> <li>• Adjust the master volume to an appropriate level.</li> </ul>                                                       | 50   |
|                                                                       |                                                                                                                                                                                                                                                                                                                                                                         | <ul style="list-style-type: none"> <li>• Cancel the mute mode.</li> </ul>                                                                                   | 50   |
|                                                                       |                                                                                                                                                                                                                                                                                                                                                                         | <ul style="list-style-type: none"> <li>• Disconnect the headphones.</li> </ul>                                                                              | 50   |
| Display is off.                                                       | <ul style="list-style-type: none"> <li>• The "Dimmer" setting is set to "OFF".</li> <li>• The PURE DIRECT mode is set.</li> </ul>                                                                                                                                                                                                                                       | <ul style="list-style-type: none"> <li>• Select an input source for which the digital input setting has been made.</li> </ul>                               | 38   |
|                                                                       |                                                                                                                                                                                                                                                                                                                                                                         | <ul style="list-style-type: none"> <li>• Set the input mode.</li> </ul>                                                                                     | 37   |
| Display is off.                                                       | <ul style="list-style-type: none"> <li>• The "Dimmer" setting is set to "OFF".</li> <li>• The PURE DIRECT mode is set.</li> </ul>                                                                                                                                                                                                                                       | <ul style="list-style-type: none"> <li>• Set to something other than "OFF".</li> </ul>                                                                      | 34   |
|                                                                       |                                                                                                                                                                                                                                                                                                                                                                         | <ul style="list-style-type: none"> <li>• Set a surround mode other than the PURE DIRECT mode.</li> </ul>                                                    | 42   |

| Symptom                                                                                                                                     | Cause                                                                                                                                                                                                                                                                                                                                                | Countermeasure                                                                                                                                                                                                                           | Page |
|---------------------------------------------------------------------------------------------------------------------------------------------|------------------------------------------------------------------------------------------------------------------------------------------------------------------------------------------------------------------------------------------------------------------------------------------------------------------------------------------------------|------------------------------------------------------------------------------------------------------------------------------------------------------------------------------------------------------------------------------------------|------|
| "DOLBY DIGITAL" indicator does not appear on display.                                                                                       | <ul style="list-style-type: none"> <li>• Blu-ray Disc player / DVD player's digital audio output setting is not proper.</li> </ul>                                                                                                                                                                                                                   | <ul style="list-style-type: none"> <li>• Check the Blu-ray Disc player / DVD player's audio output setting. For details, read the Blu-ray Disc player / DVD player's operating instructions.</li> </ul>                                  | –    |
| Power switches off suddenly while you are using the AVR-989, the power indicator will flash in red at intervals of approximately 2 seconds. | <ul style="list-style-type: none"> <li>• The protection circuit will be activated depending upon the temperature rise in the internal parts of the unit.</li> </ul>                                                                                                                                                                                  | <ul style="list-style-type: none"> <li>• Please switch off power at once, and re-apply the power after the body temperature has fallen sufficiently.</li> <li>• Please re-install AVR-989 in a place having good ventilation.</li> </ul> | 10   |
| Power switches off suddenly while you are using the AVR-989, the power indicator will flash red at intervals of approximately 0.5 seconds.  | <ul style="list-style-type: none"> <li>• Use speakers having impedance less than that specified.</li> <li>• If speaker cable core wires touch each other or the core wires become disconnected from their terminals, the protection circuit will be activated in the event of core wires coming into contact with the AVR-989 rear panel.</li> </ul> | <ul style="list-style-type: none"> <li>• Please use speakers which have the specified impedance.</li> </ul>                                                                                                                              | 10   |
|                                                                                                                                             |                                                                                                                                                                                                                                                                                                                                                      | <ul style="list-style-type: none"> <li>• Unplug the power cord, then after twisting the core wires together tightly again, or effecting termination treatments etc, please reconnect once again.</li> </ul>                              | 10   |
| Even applying power, the power display flashes red at intervals of approximately 0.5 seconds.                                               | <ul style="list-style-type: none"> <li>• The AVR-989 amplifier circuit has failed.</li> </ul>                                                                                                                                                                                                                                                        | <ul style="list-style-type: none"> <li>• Switch off the power and please contact the DENON service adviser.</li> </ul>                                                                                                                   | –    |

**[Remote Control Unit]**

| Symptom                                                       | Cause                                                                                                                       | Countermeasure                                                                                           | Page |
|---------------------------------------------------------------|-----------------------------------------------------------------------------------------------------------------------------|----------------------------------------------------------------------------------------------------------|------|
| Set does not work properly when remote control unit operated. | • Batteries are worn.                                                                                                       | • Replace with new batteries.                                                                            | 3    |
|                                                               | • You are operating outside of the specified range.                                                                         | • Operate within the specified range.                                                                    | 3    |
|                                                               | • Obstacle between main unit and remote control unit.                                                                       | • Remove the obstacle.                                                                                   | 3    |
|                                                               | • The batteries are not inserted in the proper direction, as indicated by the polarity marks in the battery compartment.    | • Insert the batteries in the proper direction, following the polarity marks in the battery compartment. | 3    |
|                                                               | • The set's remote control sensor is exposed to strong light (direct sunlight, inverter type fluorescent bulb light, etc.). | • Move the set to a place in which the remote control sensor will not be exposed to strong light.        | 3    |
|                                                               | • The remote ID of the main unit and remote control unit do not match.                                                      | • Set the same remote IDs for the main unit and remote control unit.                                     | 34   |
|                                                               | • Settings do not match the remote control unit's <b>SOURCE CONTROL</b> switch.                                             | • Match the settings to the remote control unit's <b>SOURCE CONTROL</b> switch.                          | 61   |

**[Audio]**

| Symptom                                          | Cause                                                                                                           | Countermeasure                                                                              | Page    |
|--------------------------------------------------|-----------------------------------------------------------------------------------------------------------------|---------------------------------------------------------------------------------------------|---------|
| No sound is produced from center speaker.        | • You are playing a monaural source (TV, AM radio broadcast, etc.) in the "STANDARD" (Dolby/DTS Surround) mode. | • The mode is set to something other than "STANDARD" (Dolby/DTS Surround).                  | 41      |
| No sound is produced from surround speakers.     | • The surround mode is set to "STEREO", "DIRECT" or "PURE DIRECT".                                              | • Set to a surround playback mode.                                                          | 41, 42  |
| No sound is produced from surround back speaker. | • The surround back speaker's power amplifier is assigned to a different channel.                               | • Check the setting and change it as necessary.                                             | 32      |
|                                                  | • Surround back speaker setting is set to "None".                                                               | • Set to something other than "None".                                                       | 27      |
|                                                  | • The "Parameter" – "Surround Parameter" – "SB CH Out" settings are "OFF".                                      | • Please set "Parameter" – "Surround Parameter" – "SB CH Out" to settings other than "OFF". | 44, 45  |
|                                                  | • Surround mode not set to a mode for 6.1- or 7.1-channel playback.                                             | • Select a surround playback mode.                                                          | 40 ~ 42 |

| Symptom                                                                              | Cause                                                                              | Countermeasure                                                                                                                   | Page   |
|--------------------------------------------------------------------------------------|------------------------------------------------------------------------------------|----------------------------------------------------------------------------------------------------------------------------------|--------|
| No sound is produced from subwoofer.                                                 | • Subwoofer's power not turned on.                                                 | • Turn on the subwoofer's power.                                                                                                 | –      |
|                                                                                      | • The "Subwoofer" setting at "Speaker Configuration" is set to "No".               | • Set to "Yes".                                                                                                                  | 27     |
|                                                                                      | • The subwoofer is not properly connected.                                         | • Check the connections.                                                                                                         | 10     |
| No test tones are produced when remote control unit's <b>TEST</b> button is pressed. | • The subwoofer's volume is turned off.                                            | • Adjust the subwoofer's volume to an appropriate level.                                                                         | 59     |
|                                                                                      | • Surround mode not set to "STANDARD" (Dolby/DTS Surround).                        | • Set to the "STANDARD" (Dolby/DTS Surround) mode.                                                                               | 41     |
| DTS sound is not output.                                                             | • Blu-ray Disc player / DVD player's audio output setting is not set to bitstream. | • Set the Blu-ray Disc player / DVD player. For details, refer to the Blu-ray Disc player / DVD player's operating instructions. | –      |
|                                                                                      | • Blu-ray Disc player / DVD player is not compatible with DTS sound playback.      | • Use a DTS-compatible player.                                                                                                   | –      |
|                                                                                      | • The AVR-989's "Decode Mode" setting is set to "PCM".                             | • Set to the "Auto" or "DTS" mode.                                                                                               | 38     |
| HDMI audio signals are not output from speakers.                                     | • The "Manual Setup" – "HDMI Setup" – "HDMI Audio Out" setting is set to "TV".     | • Set to "AMP".                                                                                                                  | 30     |
| No sound is output from the monitor connected with HDMI connections.                 | • The "Manual Setup" – "HDMI Setup" – "HDMI Audio Out" setting is set to "AMP".    | • Set to "TV".                                                                                                                   | 30     |
| Dolby TrueHD, DTS-HD, Dolby Digital Plus audio is not output.                        | • HDMI is not connected.                                                           | • Connect the HDMI.                                                                                                              | 11, 12 |
|                                                                                      | • Blu-ray Disc player's audio output setting is not set to bitstream.              | • Set the Blu-ray Disc player. For details, refer to the Blu-ray Disc player's operating instructions.                           | –      |
|                                                                                      | • Blu-ray Disc player is not compatible with DTS sound playback.                   | • Use a DTS-compatible player.                                                                                                   | –      |



## [Video]

| Symptom                                                                                                                                                                                                                                         | Cause                                                                                                                                                                                                                                                                                                                                                 | Countermeasure                                                                                                                                                                                                                                     | Page        |
|-------------------------------------------------------------------------------------------------------------------------------------------------------------------------------------------------------------------------------------------------|-------------------------------------------------------------------------------------------------------------------------------------------------------------------------------------------------------------------------------------------------------------------------------------------------------------------------------------------------------|----------------------------------------------------------------------------------------------------------------------------------------------------------------------------------------------------------------------------------------------------|-------------|
| No picture appears.                                                                                                                                                                                                                             | <ul style="list-style-type: none"> <li>The connections between the AVR-989 and monitor are faulty.</li> <li>The monitor's input setting is wrong.</li> <li>PURE DIRECT mode is set.</li> <li>The player is connected using the component input connectors, the monitor is connected using the video (yellow) or S-Video output connectors.</li> </ul> | <ul style="list-style-type: none"> <li>Check the connections.</li> </ul>                                                                                                                                                                           | 11 ~ 16, 19 |
|                                                                                                                                                                                                                                                 |                                                                                                                                                                                                                                                                                                                                                       | <ul style="list-style-type: none"> <li>Set properly.</li> </ul>                                                                                                                                                                                    | -           |
|                                                                                                                                                                                                                                                 |                                                                                                                                                                                                                                                                                                                                                       | <ul style="list-style-type: none"> <li>Cancel the PURE DIRECT mode.</li> <li>High definition (1080i/720p) and progressive (480p/576p) video signals are not down-converted. Set the player to interlace (480i/576i) signals.</li> </ul>            | 42<br>-     |
| Picture cannot be recorded.                                                                                                                                                                                                                     | <ul style="list-style-type: none"> <li>Input source does not match recorder's video connection connector (video or S-Video).</li> </ul>                                                                                                                                                                                                               | <ul style="list-style-type: none"> <li>The video conversion function does not work for the REC OUT connectors. Match the input source and recorder connections.</li> </ul>                                                                         | 15          |
| DVDs cannot be copied on a VCR.                                                                                                                                                                                                                 | -                                                                                                                                                                                                                                                                                                                                                     | <ul style="list-style-type: none"> <li>This is not a malfunction. Most movie software includes copy prevention signals and cannot be copied.</li> </ul>                                                                                            | -           |
| On-screen display is not shown.                                                                                                                                                                                                                 |                                                                                                                                                                                                                                                                                                                                                       | <ul style="list-style-type: none"> <li>When viewing HDMI or component video signals via the AVR-889, the on-screen display appears when the <b>MENU</b> button on the main unit or the <b>A.MENU</b> button on the remote control unit.</li> </ul> | 9           |
|                                                                                                                                                                                                                                                 |                                                                                                                                                                                                                                                                                                                                                       | <ul style="list-style-type: none"> <li>When only HDMI or component video signals are input to the AVR-989, the characters of the on-screen display are not displayed over the picture.</li> </ul>                                                  | 9           |
|                                                                                                                                                                                                                                                 |                                                                                                                                                                                                                                                                                                                                                       | <ul style="list-style-type: none"> <li>Set "Manual Setup" - "Option Setup" - "On-Screen Display" - "Text" to "ON".</li> </ul>                                                                                                                      | 33          |
|                                                                                                                                                                                                                                                 |                                                                                                                                                                                                                                                                                                                                                       | <ul style="list-style-type: none"> <li>Set "Manual Setup" - "Option Setup" - "On-Screen Display" - "Master Volume" to "ON".</li> </ul>                                                                                                             | 33          |
|                                                                                                                                                                                                                                                 |                                                                                                                                                                                                                                                                                                                                                       | <ul style="list-style-type: none"> <li>Set when "Manual Setup" - "On-Screen Display" - "Tuner Information" is not "OFF".</li> </ul>                                                                                                                | 33          |
| <ul style="list-style-type: none"> <li>The operation content display is "OFF".</li> <li>The main volume display is "OFF".</li> <li>The display during tuner operation is "OFF".</li> <li>The display during iPod operation is "OFF".</li> </ul> | <ul style="list-style-type: none"> <li>Set when "Manual Setup" - "On-Screen Display" - "iPod Information" is not "OFF".</li> </ul>                                                                                                                                                                                                                    | 33                                                                                                                                                                                                                                                 |             |

## [HDMI]

| Symptom                                                                                                                                                                                                                                                     | Cause                                                                                                                                                                                                                                                                                   | Countermeasure                                                                                                                                                                                                            | Page     |
|-------------------------------------------------------------------------------------------------------------------------------------------------------------------------------------------------------------------------------------------------------------|-----------------------------------------------------------------------------------------------------------------------------------------------------------------------------------------------------------------------------------------------------------------------------------------|---------------------------------------------------------------------------------------------------------------------------------------------------------------------------------------------------------------------------|----------|
| HDMI audio signals are not output from speakers.                                                                                                                                                                                                            | <ul style="list-style-type: none"> <li>The "Manual Setup" - "HDMI Setup" - "HDMI Audio Out" setting is set to "TV".</li> </ul>                                                                                                                                                          | <ul style="list-style-type: none"> <li>Set to "Amp".</li> </ul>                                                                                                                                                           | 30       |
| No picture appears with HDMI connections.                                                                                                                                                                                                                   | <ul style="list-style-type: none"> <li>The connections to the HDMI connectors are faulty.</li> <li>HDMI input setting is improper.</li> <li>The monitor is not compatible with copyright protection (HDCP).</li> <li>The HDMI format of the player and monitor do not match.</li> </ul> | <ul style="list-style-type: none"> <li>Check the connections.</li> </ul>                                                                                                                                                  | 11       |
|                                                                                                                                                                                                                                                             |                                                                                                                                                                                                                                                                                         | <ul style="list-style-type: none"> <li>Check the HDMI input setting.</li> <li>Connect a monitor that is compatible with copyright protection (HDCP).</li> <li>Match the HDMI format of the player and monitor.</li> </ul> | 38<br>11 |
| No sound is output from the monitor connected with HDMI connections.                                                                                                                                                                                        | <ul style="list-style-type: none"> <li>The "Manual Setup" - "HDMI Setup" - "HDMI Audio Out" setting is set to "Amp".</li> </ul>                                                                                                                                                         | <ul style="list-style-type: none"> <li>Set to "TV".</li> </ul>                                                                                                                                                            | 30       |
| When performing the following operations on a connected device, AVR-989 has the same operations. <ul style="list-style-type: none"> <li>Power ON/OFF</li> <li>Switching audio output devices</li> <li>Adjust volume</li> <li>Switch input source</li> </ul> | <ul style="list-style-type: none"> <li>HDMI's CEC function is operating.</li> </ul>                                                                                                                                                                                                     | <ul style="list-style-type: none"> <li>Set "Manual Setup" - "HDMI Setup" - "HDMI Control" to "OFF".</li> </ul> <p>When you only want to operate the power on/off each device, set "Power Off Control" to "OFF".</p>       | 30       |

## [iPod]

| Symptom                | Cause                                                                                                                                                                                                                               | Countermeasure                                                                                                     | Page |
|------------------------|-------------------------------------------------------------------------------------------------------------------------------------------------------------------------------------------------------------------------------------|--------------------------------------------------------------------------------------------------------------------|------|
| iPod cannot be played. | <ul style="list-style-type: none"> <li>The input source assigned to "iPod Dock" is not selected.</li> <li>Cable is not properly connected.</li> <li>Control dock for iPod's AC adapter is not connected to power outlet.</li> </ul> | <ul style="list-style-type: none"> <li>Switch to the input source assigned at "iPod Dock".</li> </ul>              | 39   |
|                        |                                                                                                                                                                                                                                     | <ul style="list-style-type: none"> <li>Reconnect.</li> </ul>                                                       | 13   |
|                        |                                                                                                                                                                                                                                     | <ul style="list-style-type: none"> <li>Plug the control dock for iPod's AC adapter into a power outlet.</li> </ul> | -    |

**[XM Satellite Radio]**

| Symptom                             | Cause                                                                                                                                                                                                                               | Countermeasure                                                                                                                                                                                                                                                                                                                                                                                                 | Page   |
|-------------------------------------|-------------------------------------------------------------------------------------------------------------------------------------------------------------------------------------------------------------------------------------|----------------------------------------------------------------------------------------------------------------------------------------------------------------------------------------------------------------------------------------------------------------------------------------------------------------------------------------------------------------------------------------------------------------|--------|
| "CHECK XM TUNER" is displayed.      | • The XM Mini-Tuner is not installed or not fully seated in the XM Mini-Tuner Dock or the XM Mini-Tuner dock is not connected to the AVR-989.                                                                                       | • Confirm the XM Mini-Tuner is fully seated in the dock and check the XM Mini-Tuner dock cable is connected to the AVR-989.                                                                                                                                                                                                                                                                                    | 18     |
| "CHECK ANTENNA" is displayed.       | • AVR-989's XM connector and the XM Mini-Tuner and Home Dock is not properly connected.                                                                                                                                             | • Check that the connections are correct.                                                                                                                                                                                                                                                                                                                                                                      | 18, 53 |
| "NO SIGNAL" is displayed.           | • The signal cannot be received.                                                                                                                                                                                                    | • Reposition your XM Mini-Tuner and Home Dock antenna.                                                                                                                                                                                                                                                                                                                                                         | -      |
| "OFF AIR" is displayed.             | • The selected channel is not currently broadcasting.                                                                                                                                                                               | • Select another channel.                                                                                                                                                                                                                                                                                                                                                                                      | -      |
| Receiving only XM channels 0 and 1. | • The XM Mini-Tuner is not activated.                                                                                                                                                                                               | • Contact XM Radio.                                                                                                                                                                                                                                                                                                                                                                                            | -      |
| "XM ---" is displayed.              | • The selected channel is not available. The channel may have been reassigned to a different channel number. This message may occur initially with a new radio or a radio that has not received XM's signal for an extended period. | • Consult the latest channel guide at <a href="http://www.xmradio.com">www.xmradio.com</a> or <a href="http://www.xmradio.ca">www.xmradio.ca</a> for the current list of channels. For cases of a new radio or a radio that has not received XM's signal for an extended period, allow the radio to receive the XM satellite signal for at least 5 minutes and then try to select the channel again.           | -      |
| "CH UNAVAILABLE" is displayed.      | • Channel is not present.                                                                                                                                                                                                           | • Select another channel.                                                                                                                                                                                                                                                                                                                                                                                      | -      |
| "CH UNAUTHORIZED" is displayed.     | • You selected an XM channel that is blocked or cannot be received with your XM subscription package.                                                                                                                               | • Consult the latest channel guide at <a href="http://www.xmradio.com">www.xmradio.com</a> or <a href="http://www.xmradio.ca">www.xmradio.ca</a> for the current list of channels. For information on receiving this channel, visit <a href="http://www.xmradio.com">www.xmradio.com</a> or <a href="http://www.xmradio.ca">www.xmradio.ca</a> contact XM Satellite Radio at 1-800-967-2346 or 1-877-438-9677. | -      |

**[SIRIUS Satellite Radio]**

| Symptom                              | Cause                                                                                                 | Countermeasure                                                    | Page |
|--------------------------------------|-------------------------------------------------------------------------------------------------------|-------------------------------------------------------------------|------|
| "CHECK SIRIUS TUNER" is displayed.   | • The Sirius Tuner unit is not connected.                                                             | • Check that the connections are correct.                         | 18   |
| "ANTENNA ERROR" is displayed.        | • If the Sirius Tuner is not connected, it will be broken.                                            | • Check that the connections are correct.                         | 18   |
| "NO SIGNAL" is displayed.            | • The signal cannot be received.                                                                      | • Reposition your SiriusConnect Home Tuner antenna.               | -    |
| "INVALID CHANNEL" is displayed.      | • Channel is not present.                                                                             | • Select another channel.                                         | -    |
| "NO CHANNEL AVAILABLE" is displayed. | • Even searching categories, if none of the channels are present, the "Parental Lock" is on (locked). | • Please search for other categories.                             | -    |
| "ACQUIRING SIGNAL" is displayed.     | • The signal cannot be received.<br>• Displays while SiriusConnect Home Tuner is connected.           | • Reposition your SiriusConnect Home Tuner and Home Dock antenna. | -    |
| "Call SIRIUS" * is displayed.        | • Channels are not subscribed to.                                                                     | • If you subscribe to the channel, you can receive the channel.   | -    |
| "SUBSCRIPTION UPDATED" is displayed. | • While updating contract information.                                                                | -                                                                 | -    |
| "Enter Lock Code [ ]" is displayed.  | • Selected channels are locked.                                                                       | • Please insert pass word (4 digits) into "[ ]".                  | -    |

\* : After scroll displays "Call 888-539-...." twice, displays "Call SIRIUS".

# Specifications

## Audio section

### Power amplifier

**Rated output:** Front (A, B):  
 115 W + 115 W (8 Ω/ohms, 20 Hz ~ 20 kHz with 0.08 % T.H.D.)  
 145 W + 145 W (6 Ω/ohms, 1 kHz with 0.7 % T.H.D.)  
 Center:  
 115 W (8 Ω/ohms, 20 Hz ~ 20 kHz with 0.08 % T.H.D.)  
 145 W (6 Ω/ohms, 1 kHz with 0.7 % T.H.D.)

Surround:  
 115 W + 115 W (8 Ω/ohms, 20 Hz ~ 20 kHz with 0.08 % T.H.D.)  
 145 W + 145 W (6 Ω/ohms, 1 kHz with 0.7 % T.H.D.)

Surround Back:  
 115 W + 115 W (8 Ω/ohms, 20 Hz ~ 20 kHz with 0.08 % T.H.D.)  
 145 W + 145 W (6 Ω/ohms, 1 kHz with 0.7 % T.H.D.)

**Dynamic power:** 130 W x 2ch (8 Ω/ohms)  
 180 W x 2ch (4 Ω/ohms)

**Output connectors:** Front: A or B 6 ~ 16 Ω/ohms  
 A + B 8 ~ 16 Ω/ohms  
 Center, Surround, Surround Back: 6 ~ 16 Ω/ohms

### Analog

**Input sensitivity / Input impedance:** 200 mV / 47 kΩ/kohms  
**Frequency response:** 10 Hz ~ 100 kHz — +1, -3 dB (DIRECT mode)  
**S/N:** 102 dB (IHF-A weighted, DIRECT mode)  
**Distortion:** 0.005 % (20 Hz ~ 20 kHz) (DIRECT mode)  
**Rated output:** 1.2 V

### Digital

**D/A output:** Rated output — 2 V (at 0 dB playback)  
 Total harmonic distortion — 0.008 % (1 kHz, at 0 dB)  
 S/N ratio — 102 dB  
 Dynamic range — 96 dB  
 Format — Digital audio interface

### Digital input:

### Phono equalizer (PHONO input — REC OUT)

**Input sensitivity:** 2.5 mV  
**RIAA deviation:** ±1 dB (20 Hz to 20 kHz)  
**S/N:** 74 dB (A weighting, with 5 mV input)  
**Rated output:** 150 mV  
**Distortion factor:** 0.03 % (1 kHz, 3 V)

## Video section

### Standard video connectors

**Input / output level and impedance:** 1 V<sub>p-p</sub>, 75 Ω/ohms  
**Frequency response:** 5 Hz ~ 10 MHz — +0, -3 dB (when video convert set to "OFF")

### S-Video connectors

**Input / output level and impedance:** Y (brightness) signal — 1 V<sub>p-p</sub>, 75 Ω/ohms  
 C (color) signal — 0.286 V<sub>p-p</sub>, 75 Ω/ohms  
**Frequency response:** 5 Hz ~ 10 MHz — +0, -3 dB (when video convert set to "OFF")

### Color component video connector

**Input / output level and impedance:** Y (brightness) signal — 1 V<sub>p-p</sub>, 75 Ω/ohms  
 P<sub>B</sub> / C<sub>B</sub> signal — 0.7 V<sub>p-p</sub>, 75 Ω/ohms  
 P<sub>R</sub> / C<sub>R</sub> signal — 0.7 V<sub>p-p</sub>, 75 Ω/ohms  
**Frequency response:** 5 Hz ~ 100 MHz — +0, -3 dB (when video convert set to "OFF")

## Tuner section

|                                              | [FM]                                              | [AM]               |
|----------------------------------------------|---------------------------------------------------|--------------------|
| <b>Receiving Range:</b>                      | 87.5 MHz ~ 107.9 MHz                              | 520 kHz ~ 1710 kHz |
| <b>Usable Sensitivity:</b>                   | 1.0 μV (11.2 dBf)                                 | 18 μV              |
| <b>50 dB Quieting Sensitivity:</b>           | MONO 1.6 μV (15.3 dBf)<br>STEREO 23 μV (38.5 dBf) |                    |
| <b>S/N (IHF-A):</b>                          | MONO 77 dB<br>STEREO 72 dB                        |                    |
| <b>Total harmonic Distortion (at 1 kHz):</b> | MONO 0.15 %<br>STEREO 0.3 %                       |                    |

(note: μV at 75 Ω/ohms, 0 dBf = 1 x 10<sup>-15</sup> W)

## General

**Power supply:** AC 120 V, 60 Hz  
**Power consumption:** 6.0 A  
 0.1 W (Standby)  
**Maximum external dimensions:** 434 (W) x 171 (H) x 414 (D) mm (17-3/32" x 6-47/64" x 16-19/64")  
**Weight:** 12.8 kg (28 lbs 3.5 oz)

## Remote control unit (RC-1105)

**Batteries:** R6/AA type (two batteries)  
**Maximum external dimensions:** 52 (W) x 243 (H) x 21 (D) mm (2-3/64" x 9-9/16" x 53/64")  
**Weight:** 184 g (Approx 6.5 oz) (including batteries)

\* For purposes of improvement, specifications and design are subject to change without notice.

## List of preset codes

### DVD Player

|          |            |                    |
|----------|------------|--------------------|
| <b>A</b> | Aiwa       | 009                |
| <b>D</b> | Denon      | 014, [111]*        |
| <b>H</b> | Hitachi    | 010                |
| <b>J</b> | JVC        | 006, 011           |
| <b>K</b> | Konka      | 012, 013           |
| <b>M</b> | Magnavox   | 005                |
|          | Mitsubishi | 004                |
| <b>P</b> | Panasonic  | 014                |
|          | Philips    | 005, 015, 016, 017 |
|          | Pioneer    | 003, 008           |
| <b>S</b> | Sanyo      | 018                |
|          | Sony       | 002, 019, 020      |
| <b>T</b> | Toshiba    | 001, 021, 022      |
| <b>Z</b> | Zenith     | 023                |

### Blu-Ray Disc Player

|          |       |                                   |
|----------|-------|-----------------------------------|
| <b>D</b> | Denon | [111]* (Denon 1)<br>121 (Denon 2) |
|----------|-------|-----------------------------------|

### VDP

|          |            |                    |
|----------|------------|--------------------|
| <b>D</b> | Denon      | 028, 029, 112      |
| <b>M</b> | Magnavox   | 026                |
|          | Mitsubishi | 028                |
| <b>P</b> | Panasonic  | 029, 030           |
|          | Philips    | 026                |
|          | Pioneer    | 028, 031           |
| <b>R</b> | RCA        | 032                |
| <b>S</b> | Sony       | 033, 034, 035, 036 |

### VCR

|          |               |                                   |
|----------|---------------|-----------------------------------|
| <b>A</b> | Admiral       | 081                               |
|          | Aiko          | 095                               |
|          | Aiwa          | 009                               |
|          | Akai          | 026, 027, 070, 072, 082, 083, 084 |
|          | Alba          | 055                               |
|          | Amstrad       | 009                               |
|          | ASA           | 042                               |
|          | Asha          | 087                               |
|          | Audio Dynamic | 005, 085                          |
|          | Audiovox      | 088                               |
|          | Beaumarck     | 087                               |
|          | Broksonic     | 086, 093                          |
| <b>C</b> | Calix         | 088                               |
|          | Candle        | 006, 087, 088, 089, 090           |
|          | Canon         | 049, 057                          |
|          | Capehart      | 025, 055, 056, 071                |

|          |                 |                                                                                |
|----------|-----------------|--------------------------------------------------------------------------------|
|          | Carver          | 015                                                                            |
|          | CCE             | 095                                                                            |
|          | Citizen         | 006, 007, 087, 088, 089, 090, 095                                              |
|          | Craig           | 007, 087, 088, 091, 115                                                        |
|          | Curtis Mathes   | 006, 049, 073, 080, 087, 090, 092                                              |
|          | Cybernex        | 087                                                                            |
| <b>D</b> | Daewoo          | 025, 055, 059, 074, 089, 093, 095, 096                                         |
|          | Daytron         | 025, 055                                                                       |
|          | DBX             | 005, 085                                                                       |
|          | Dumont          | 053                                                                            |
|          | Dynatech        | 009                                                                            |
| <b>E</b> | Electrohome     | 001, 088, 097                                                                  |
|          | Electroponic    | 088                                                                            |
|          | Emerson         | 001, 009, 017, 027, 086, 088, 089, 092, 093, 097, 100, 101, 102, 103, 104, 117 |
|          | Emerson         | 009, 028, 031, 053, 054, 091, 099, 115                                         |
| <b>F</b> | Fisher          | 007, 011, 049, 050, 051, 052, 073, 080, 087                                    |
| <b>G</b> | GE              | 007, 011, 049, 050, 051, 052, 073, 080, 087                                    |
|          | Go Video        | 047, 048                                                                       |
|          | Goldstar        | 000, 006, 012, 062, 088                                                        |
|          | Gradiente       | 094                                                                            |
|          | Grundig         | 042                                                                            |
| <b>H</b> | Harley Davidson | 094                                                                            |
|          | Harman Kardon   | 040, 062                                                                       |
|          | Hi-Q            | 091                                                                            |
|          | Hitachi         | 009, 013, 023, 026, 058, [108]*, 109, 110, 111                                 |
| <b>J</b> | JC Penny        | 004, 005, 007, 023, 028, 049, 062, 085, 087, 088                               |
|          | Jensen          | 013, 026                                                                       |
|          | JVC             | 004, 005, 006, 026, 029, 043, 044, 045, 046, 085                               |
| <b>K</b> | Kenwood         | 004, 005, 006, 026, 029, 033, 045, 085, 090                                    |
|          | Kodak           | 088                                                                            |
| <b>L</b> | Lloyd           | 009, 094                                                                       |
|          | LXI             | 088                                                                            |
| <b>M</b> | Magnavox        | 015, 016, 042, 049, 063, 106                                                   |
|          | Magnin          | 087                                                                            |
|          | Marantz         | 004, 005, 006, 015, 042, 049, 085, 090                                         |
|          | Marta           | 088                                                                            |
|          | MEI             | 049                                                                            |
|          | Memorex         | 009, 033, 049, 053, 060, 081, 087, 088, 091, 094, 115                          |
|          | Metz            | 123, 124, 125, 126, 127, 128                                                   |
|          | MGA             | 001, 017, 027, 041, 097                                                        |
|          | MGN Technology  | 087                                                                            |
|          | Midland         | 011                                                                            |
|          | Minolta         | 013, 023                                                                       |

|          |                 |                                                                                                                             |
|----------|-----------------|-----------------------------------------------------------------------------------------------------------------------------|
|          | Mitsubishi      | 001, 003, 008, 013, 014, 017, 027, 029, 039, 040, 041, 045, 097                                                             |
|          | Motorola        | 081                                                                                                                         |
|          | Montgomery Ward | 001, 002, 007, 009, 049, 063, 081, 115, 117                                                                                 |
|          | MTC             | 009, 087, 094                                                                                                               |
|          | Multitech       | 007, 009, 011, 087, 090, 094                                                                                                |
| <b>N</b> | NAD             | 038                                                                                                                         |
|          | NEC             | 004, 005, 006, 018, 026, 029, 045, 061, 062, 085                                                                            |
|          | Nikko           | 088                                                                                                                         |
|          | Noblex          | 087                                                                                                                         |
| <b>O</b> | Optimus         | 081, 088                                                                                                                    |
|          | Optonica        | 021                                                                                                                         |
| <b>P</b> | Panasonic       | 024, 049, 064, 066, 067, 068, 069, 107                                                                                      |
|          | Perdio          | 009                                                                                                                         |
|          | Pentax          | 009, 013, 023, 058, 090                                                                                                     |
|          | Philco          | 015, 016, 049                                                                                                               |
|          | Philips         | 015, 021, 042, 049, 105                                                                                                     |
|          | Pilot           | 088                                                                                                                         |
|          | Pioneer         | 005, 013, 029, 036, 037, 038, 045, 085                                                                                      |
|          | Portland        | 025, 055, 090                                                                                                               |
|          | Proscan         | 063, 080                                                                                                                    |
|          | Pulsar          | 060                                                                                                                         |
| <b>Q</b> | Quartz          | 033                                                                                                                         |
|          | Quasar          | 034, 035, 049                                                                                                               |
| <b>R</b> | Radio Shack     | 001, 002, 021, 081, 087, 088, 091, 094, 097, 098, 115                                                                       |
|          | Radix           | 088                                                                                                                         |
|          | Randex          | 088                                                                                                                         |
|          | RCA             | 007, 013, 019, 023, 058, 063, 064, 065, 073, 080, 082, 087, 009, 021, 031, 033, 049, 053, 081, 087, 088, 091, 094, 097, 098 |
|          | Realistic       | 088                                                                                                                         |
| <b>S</b> | Ricoh           | 055                                                                                                                         |
|          | Salora          | 033, 041                                                                                                                    |
|          | Samsung         | 007, 011, 051, 059, 070, 083, 087, 089, 113                                                                                 |
|          | Sanky           | 081                                                                                                                         |
|          | Sansui          | 005, 026, 029, 045, 061, 085, 114                                                                                           |
|          | Sanyo           | 032, 033, 053, 087, 091, 115, 116                                                                                           |
|          | SBR             | 042                                                                                                                         |
|          | Scott           | 017, 020, 086, 089, 093, 117                                                                                                |
|          | Sears           | 013, 023, 028, 031, 033, 053, 054, 088, 091, 098, 099, 115                                                                  |
|          | Sentra          | 055                                                                                                                         |
|          | Sharp           | 001, 002, 021, 097                                                                                                          |
|          | Shogun          | 087                                                                                                                         |
|          | Sony            | 075, 076, 077, 078, 079, 121, 122                                                                                           |
|          | STS             | 023                                                                                                                         |

|          |                 |                                                            |
|----------|-----------------|------------------------------------------------------------|
|          | Sylvania        | 009, 015, 016, 017, 041, 049, 094                          |
|          | Symphonic       | 009, 094                                                   |
| <b>T</b> | Tandy           | 009                                                        |
|          | Tashiko         | 009, 088                                                   |
|          | Tatung          | 004, 026, 030                                              |
|          | Teac            | 004, 009, 026, 094                                         |
|          | Technics        | 024, 049                                                   |
|          | TMK             | 087, 092                                                   |
|          | Toshiba         | 013, 017, 020, 041, 059, 089, 098, 099, 117                |
|          | Totevision      | 007, 087, 088                                              |
| <b>U</b> | Unirech         | 087                                                        |
| <b>V</b> | Vector Research | 005, 062, 085, 089, 090                                    |
|          | Victor          | 005, 045, 046, 085                                         |
|          | Video Concepts  | 005, 027, 085, 089, 090                                    |
|          | Videosonic      | 007, 087                                                   |
| <b>W</b> | Wards           | 013, 021, 023, 087, 088, 089, 091, 094, 097, 118, 119, 120 |
| <b>X</b> | XR-1000         | 094                                                        |
| <b>Y</b> | Yamaha          | 004, 005, 006, 026, 062, 085                               |
| <b>Z</b> | Zenith          | 060, 078, 079                                              |

### Television

|          |               |                                                                      |
|----------|---------------|----------------------------------------------------------------------|
| <b>A</b> | Admiral       | 045, 121                                                             |
|          | Adventura     | 122                                                                  |
|          | Aiko          | 054                                                                  |
|          | Akai          | 016, 027, 046                                                        |
|          | Alleron       | 062                                                                  |
|          | A-Mark        | 007                                                                  |
|          | Amtron        | 061                                                                  |
|          | Anam          | 006, 007, 036                                                        |
|          | Anam National | 061, 147                                                             |
|          | AOC           | 003, 007, 033, 038, 039, 047, 048, 049, 133                          |
|          | Archer        | 007                                                                  |
|          | Audiovox      | 007, 061                                                             |
| <b>B</b> | Bauer         | 155                                                                  |
|          | Belcor        | 047                                                                  |
|          | Bell & Howell | 045, 118                                                             |
|          | Bradford      | 061                                                                  |
|          | Brockwood     | 003, 047                                                             |
| <b>C</b> | Candle        | 003, 030, 031, 032, 038, 047, 049, 050, 122                          |
|          | Capehart      | 003                                                                  |
|          | Celebrity     | 046                                                                  |
|          | Circuit City  | 003                                                                  |
|          | Citizen       | 029, 030, 031, 032, 034, 038, 047, 049, 050, 054, 061, 095, 122, 123 |
|          | Concerto      | 031, 047, 049                                                        |
|          | Colorlyme     | 003, 047, 049, 135                                                   |

|          |                |                                                                                                                             |
|----------|----------------|-----------------------------------------------------------------------------------------------------------------------------|
|          | Contec         | 013, 051, 052, 061                                                                                                          |
|          | Cony           | 051, 052, 061                                                                                                               |
|          | Craig          | 004, 061                                                                                                                    |
|          | Crown          | 029                                                                                                                         |
|          | Curtis Mathes  | 029, 034, 038, 044, 047, 049, 053, 095, 118                                                                                 |
| <b>D</b> | Daewoo         | 027, 029, 039, 048, 049, 054, 055, 106, 107, 137                                                                            |
|          | Daytron        | 003, 049                                                                                                                    |
|          | Dimensia       | 044                                                                                                                         |
|          | Dixi           | 007, 015, 027                                                                                                               |
| <b>E</b> | Electroband    | 046                                                                                                                         |
|          | Electrohome    | 029, 056, 057, 058, 147                                                                                                     |
|          | Elta           | 027                                                                                                                         |
|          | Emerson        | 029, 051, 059, 060, 061, 062, 118, 123, 124, 139, 148                                                                       |
|          | Envision       | 038                                                                                                                         |
|          | Etron          | 027                                                                                                                         |
| <b>F</b> | Fisher         | 014, 021, 063, 064, 065, 118                                                                                                |
|          | Formenti       | 155                                                                                                                         |
|          | Fortress       | 012                                                                                                                         |
|          | Fujitsu        | 004, 062                                                                                                                    |
|          | Funai          | 004, 062                                                                                                                    |
|          | Futuretech     | 004                                                                                                                         |
| <b>G</b> | GE             | 020, 036, 037, 040, 044, 058, 066, 088, 119, 120, 125, 147, 000, 015, 029, 031, 039, 048, 051, 056, 057, 067, 068, 069, 116 |
|          | Goldstar       |                                                                                                                             |
|          | Grundy         | 062                                                                                                                         |
| <b>H</b> | Hitachi        | 029, 031, 051, 052, 070, 111, 112, 113, 124, [134]*                                                                         |
|          | Hitachi Pay TV | 151                                                                                                                         |
| <b>I</b> | Infinity       | 017, 071                                                                                                                    |
| <b>J</b> | Janeil         | 122                                                                                                                         |
|          | JBL            | 017, 071                                                                                                                    |
|          | JC Penny       | 020, 034, 039, 040, 041, 044, 048, 050, 058, 066, 069, 076, 088, 090, 095, 125, 136, 159                                    |
|          | JCB            | 046                                                                                                                         |
|          | JVC            | 019, 051, 052, 072, 073, 091, 117, 126                                                                                      |
| <b>K</b> | Kawasho        | 018, 046                                                                                                                    |
|          | Kenwood        | 038, 056, 057                                                                                                               |
|          | Kloss          | 010, 032                                                                                                                    |
|          | Kloss Novabeam | 005, 122, 127, 131                                                                                                          |
|          | KTV            | 074, 123                                                                                                                    |
| <b>L</b> | Loewe          | 071                                                                                                                         |
|          | logik          | 144                                                                                                                         |
|          | Luxman         | 031                                                                                                                         |
|          | LXI            | 008, 014, 017, 024, 040, 044, 063, 071, 075, 076, 077, 118, 125                                                             |
| <b>M</b> | Magnavox       | 005, 010, 017, 030, 033, 038, 050, 056, 071, 078, 079, 085, 089, 108, 109, 110, 127, 131, 132, 145                          |

|                   |                                                                                                         |
|-------------------|---------------------------------------------------------------------------------------------------------|
| Marantz           | 015, 017, 071, 080                                                                                      |
| Matsui            | 027                                                                                                     |
| Memorex           | 014, 027, 045, 083, 118, 144                                                                            |
| Metz              | 160, 161, 162, 163                                                                                      |
| MGA               | 001, 039, 048, 056, 057, 058, 065, 081, 083                                                             |
| Midland           | 125                                                                                                     |
| Minutz            | 066                                                                                                     |
| Mitsubishi        | 001, 016, 039, 048, 056, 057, 058, 065, 081, 082, 083, 105                                              |
| Montgomery Ward   | 011, 020, 144, 145, 146                                                                                 |
| Motorola          | 121, 147                                                                                                |
| MTC               | 031, 034, 039, 048, 095                                                                                 |
| NAD               | 008, 075, 076, 128                                                                                      |
| National          | 002, 036, 061, 147                                                                                      |
| National Quenties | 002                                                                                                     |
| NEC               | 031, 038, 039, 048, 057, 084, 086, 135, 147                                                             |
| Nikko             | 054                                                                                                     |
| NTC               | 054                                                                                                     |
| Optimus           | 128                                                                                                     |
| Optonica          | 011, 012, 093, 121                                                                                      |
| Orion             | 004, 139                                                                                                |
| Panasonic         | 002, 009, 017, 036, 037, 071, 141, 143, 147                                                             |
| Philco            | 005, 010, 030, 050, 051, 056, 079, 085, 127, 131, 132, 145, 147                                         |
| Philips           | 005, 015, 017, 050, 051, 056, 078, 087, 088, 089, 131, 132, 147                                         |
| Pioneer           | 124, 128, 142                                                                                           |
| Portland          | 054                                                                                                     |
| Price Club        | 095                                                                                                     |
| Proscan           | 040, 044, 125                                                                                           |
| Proton            | 035, 051, 092, 129                                                                                      |
| Pulsar            | 042                                                                                                     |
| Quasar            | 036, 037, 074, 141                                                                                      |
| Radio Shack       | 011, 044, 063, 093, 118                                                                                 |
| RCA               | 040, 044, 125, 130, 137, 151, 152                                                                       |
| Realistic         | 014, 063, 093, 118                                                                                      |
| Saisho            | 027                                                                                                     |
| Samsung           | 003, 015, 034, 053, 055, 057, 094, 095, 136, 153                                                        |
| Sansui            | 139                                                                                                     |
| Sanyo             | 013, 014, 021, 022, 063, 064, 081, 096                                                                  |
| SBR               | 015                                                                                                     |
| Schneider         | 015                                                                                                     |
| Scott             | 062                                                                                                     |
| Sears             | 008, 014, 021, 022, 023, 024, 025, 040, 052, 057, 062, 063, 064, 065, 073, 075, 076, 097, 098, 125, 159 |
| Sharp             | 011, 012, 013, 026, 093, 099, 100, 104, 121                                                             |
| Siemens           | 013                                                                                                     |
| Signature         | 045, 144                                                                                                |

|                |                                                                      |
|----------------|----------------------------------------------------------------------|
| Simpson        | 050                                                                  |
| Sony           | 043, 046, 138, 146, 150                                              |
| Soundesign     | 030, 050, 062                                                        |
| Spectricon     | 007, 033                                                             |
| Squareview     | 004                                                                  |
| Supre-Macy     | 032, 122                                                             |
| Supreme        | 046                                                                  |
| Sylvania       | 005, 010, 017, 030, 078, 079, 085, 089, 101, 127, 131, 132, 145, 155 |
| Symphonic      | 004, 148                                                             |
| Tandy          | 012, 121                                                             |
| Tatung         | 036, 124                                                             |
| Technics       | 037                                                                  |
| Teknika        | 001, 030, 032, 034, 052, 054, 078, 083, 095, 144, 156, 157           |
| Tera           | 035, 129                                                             |
| THOMSON        | 165, 166                                                             |
| Toshiba        | 008, 014, 034, 063, 075, 076, 095, 097, 136, 158, 159                |
| Universal      | 020, 066, 088                                                        |
| Victor         | 019, 073, 126                                                        |
| Video Concepts | 016                                                                  |
| Viking         | 032, 122                                                             |
| Wards          | 005, 045, 066, 078, 085, 088, 089, 093, 102, 103, 131, 132, 148      |
| Zenith         | 042, 114, 115, 140, 144, 149                                         |
| Zonda          | 007                                                                  |

## Cable

|                    |                         |
|--------------------|-------------------------|
| ABC                | 006, [007]*, 008, 009   |
| Archer             | 010, 011                |
| Century            | 011                     |
| Citizen            | 011                     |
| Colour Voice       | 012, 013                |
| Comtronic          | 014                     |
| Eastern            | 015                     |
| Garrard            | 011                     |
| Gemini             | 030, 033, 034           |
| General Instrument | 030, 031, 032           |
| Hytex              | 006                     |
| Jasco              | 011                     |
| Jerrold            | 009, 016, 017, 026, 032 |
| Magnavox           | 018                     |
| Movie Time         | 019                     |
| NSC                | 019                     |
| Oak                | 000, 006, 020           |
| Panasonic          | 001, 005                |
| Philips            | 011, 012, 013, 018, 021 |
| Pioneer            | 002, 003, 022           |
| RCA                | 029                     |
| Regency            | 015                     |
| Samsung            | 014, 023                |

|                    |               |
|--------------------|---------------|
| Scientific Atlanta | 004, 024, 025 |
| Signal             | 014           |
| SL Marx            | 014           |
| Starcom            | 009           |
| Stargate           | 014           |
| Televue            | 014           |
| Tocom              | 007, 016      |
| TV86               | 019           |
| Unika              | 011           |
| United Artists     | 006           |
| Universal          | 010, 011      |
| Viewstar           | 018, 019      |
| Zenith             | 027, 028      |

## Satellite Receiver

|                     |                         |
|---------------------|-------------------------|
| Alphastar           | 054                     |
| Chaparrali          | 035, 036                |
| Dishnet             | 053                     |
| Drake               | 037, 038                |
| Echostar Dish       | 062, 066                |
| GE                  | 048, 055, 056           |
| General Instruments | 039, 040, 041           |
| Grundig             | 070, 071, 072, 073      |
| Hitachi             | 058, 059                |
| Hughes Networkr     | 063, 064, 065, 069      |
| JVC                 | 057                     |
| Kathrein            | 074, 075, 076, 083      |
| Magnavoxl           | 060                     |
| Nokia               | 070, 080, 084, 085, 086 |
| Philips             | 060                     |
| Primestar           | 051                     |
| Proscan             | 048, 055, 056           |
| RCA                 | 048, 055, 056, 068      |
| Realistic           | 042                     |
| Sierra I            | 036                     |
| Sierra II           | 036                     |
| Sierra III          | 036                     |
| Sony                | 049, 067                |
| STS1                | 043                     |
| STS2                | 044                     |
| STS3                | 045                     |
| SRS4                | 046                     |
| Technisat           | 077, 078, 079, 081, 082 |
| Toshiba             | 047, 050                |
| Uniden              | 061                     |

## CD Player

|          |               |
|----------|---------------|
| Aiwa     | 001, 035, 043 |
| Burmster | 002           |
| Carvery  | 003, 035      |

|          |                         |
|----------|-------------------------|
| Denon    | [111]*, 044             |
| Emerson  | 004, 005, 006, 007      |
| Fisher   | 003, 008, 009, 010      |
| JVC      | 018, 019                |
| Kenwood  | 011, 012, 013, 014, 017 |
| Magnavox | 006, 015, 035           |
| Marantz  | 016, 028, 035           |
| MCS      | 016, 024                |
| Onkyo    | 025, 027                |
| Optimus  | 017, 020, 021, 022, 023 |
| Philips  | 014, 032, 033, 035      |
| Pioneer  | 006, 022, 030           |
| Sears    | 006                     |
| Sony     | 023, 031                |
| Teac     | 002, 009, 028           |
| Technics | 016, 029, 036           |
| Wards    | 035, 037                |
| Yamaha   | 038, 039, 040, 041      |
| Zenith   | 042                     |

| DVD preset codes |               |            |          |
|------------------|---------------|------------|----------|
|                  | 111 (default) | 014        |          |
| DENON Model No.  | DVD-555       | DVD-2900   | DVD-800  |
|                  | DVD-556       | DVD-2910   | DVD-1600 |
|                  | DVD-557       | DVD-2930CI | DVD-2000 |
|                  | DVD-558       | DVD-3800   | DVD-2500 |
|                  | DVD-755       | DVD-3910   | DVD-3000 |
|                  | DVD-756       | DVD-3930CI | DVD-3300 |
|                  | DVD-757       | DVD-5900   |          |
|                  | DVD-758       | DVD-5910   |          |
|                  | DVD-900       | DVD-5910CI |          |
|                  | DVD-910       | DVD-9000   |          |
|                  | DVD-955       | DVD-2500BT |          |
|                  | DVD-1000      | DVD-3800BD |          |
|                  | DVD-1200      | DVM-715    |          |
|                  | DVD-1500      | DVM-735    |          |
|                  | DVD-1710      | DVM-745    |          |
|                  | DVD-1720      | DVM-1800   |          |
|                  | DVD-1730      | DVM-1805   |          |
|                  | DVD-1740      | DVM-1815   |          |
|                  | DVD-1910      | DVM-1835   |          |
|                  | DVD-1920      | DVM-1845   |          |
| DVD-1930CI       | DVM-2815      |            |          |
| DVD-1940CI       | DVM-2845CI    |            |          |
| DVD-2200         | DVM-4800      |            |          |
| DVD-2800         |               |            |          |
| DVD-2800II       |               |            |          |

[\*]: Preset codes set upon shipment from the factory.

**DENON**

[www.denon.com](http://www.denon.com)

Denon Brand Company, D&M Holdings Inc.  
Printed in Japan 5411 10114 000DA